

# Birta Central Library

PILANI (Jaipur State)

Class No :- 660

Book No :- K941I

Accession No :- 33701

Acc. No. 33701

**ISSUE LABEL**

**Not later than the latest date stamped below.**

~~8 Mar 22~~

14 Apr 25  
~~FXT 21~~

~~12 Feb 76 259~~



# Inorganic Process Industries



THE MACMILLAN COMPANY  
NEW YORK · BOSTON · CHICAGO · DALLAS  
ATLANTA · SAN FRANCISCO

MACMILLAN AND CO., LIMITED  
LONDON · BOMBAY · CALCUTTA · MADRAS  
MELBOURNE

THE MACMILLAN COMPANY  
OF CANADA, LIMITED  
TORONTO

# Inorganic Process Industries

---

*Kenneth A. Kobe*

PROFESSOR OF CHEMICAL ENGINEERING, UNIVERSITY OF TEXAS

---

The Macmillan Company    *New York 1948*

COPYRIGHT, 1948, BY THE MACMILLAN COMPANY

All rights reserved—no part of this book may be reproduced in any form without permission in writing from the publisher, except by a reviewer who wishes to quote brief passages in connection with a review written for inclusion in magazine or newspaper.

PRINTED IN THE UNITED STATES OF AMERICA

## Preface

---

The student who learns about the chemical process industries without appreciating their rate of growth, the rapidly changing technology, and the economic forces affecting the industry has not been properly trained. No textbook can adequately treat all phases of an industry, nor can it keep up with the rapid advances being made. The student who does not maintain contact with the important advances made during and after the war, and which are being described in the technical journals, is playing Rip van Winkle. Only an instructor, not a textbook, can stimulate students to advance along with industrial progress.

This book attempts to supply the basic information needed by the student who must prepare himself to learn from current periodicals what is occurring in the inorganic chemical industry.

With this objective, the first chapter, which is devoted to "The Chemical Literature," gives the student a method of attack in surveying a particular subject relating to a chemical process industry. The "Student Exercises" at the ends of the other chapters are merely suggestive of topics which might be used for such surveys\* to augment the material given in the text. At the end of each chapter there is also given a list of "Recommended Reading," divided into a first part consisting of books and a second of journal articles. The purpose of this list is to make available immediately some monographs and leading articles in the field which the student can use as a basis for his survey to bring his topic report up to date.

Some criticism may be directed towards the historical method of presenting the industry. If present practice were the only objective of this text, the criticism would be merited. But if the economic forces in the industry are to be observed, we must note what has happened in the past. The Leblanc soda industry, for example, must be studied historically to note what economic and technical forces caused its rise and

\*Kobcr, *J. Chem. Education*, **10**, 679-81, 738-40 (1933), **11**, 40-2, 108-9 (1934)



its decline, and to realize that, contrary to student belief, it is not dead but continues to operate in the sulfate pulp industry. Other industries are stressed more than their products merit because the author believes that they illustrate technological or economic factors which should be studied. The arc process of nitrogen fixation is an example of such a process.

Problems have not been included in this book. It is the author's belief that the working of problems concerning a particular industry is not the way in which the broad aspects of the industry and factors affecting the industry are impressed on the student. The solution of "typical" problems is better conducted in a separate course in which the emphasis is on the general principle employed in the solution of the problem; courses in stoichiometry, unit operations, thermodynamics, and design should use such problems.

Process flowsheets shown in this text have been generalized so that they represent operation conditions in most applications. References are made to other flowsheets which show more detail. These usually are the pictured flowsheets which appear each month in *Chemical Engineering*, or in their collected book of *Chemical Engineering Flowsheets*.

The author will appreciate being informed of errors and receiving constructive criticism.

*Kenneth A. Kobe*  
Austin, Texas

# Contents

---

1. The Chemical Literature	1
2. The Natural Sodium Salts Industries	13
3. The Natural Potassium Salts Industries	55
✓4. The Sodium Carbonate Industry	81
✓5. The Electrolytic Caustic-Chlorine Industries	121
6. The Chamber Sulfuric Acid Industry	161
✓7. The Contact Sulfuric Acid Industry	200
8. The Nitrogen Fixation Industries	230
9. The Nitrogen Products Industries	275
✓10. The Phosphorus Products Industries	305
<i>Appendix</i>	350
<i>Index</i>	363



# CHAPTER 1

## The Chemical Literature

---

### I. *Introduction*

- A. WHY STUDY THE LITERATURE?
- B. THE LITERATURE SEARCH

### II. *Organized Information*

- A. ENCYCLOPEDIAS
- B. MONOGRAPHS
- C. NUMERICAL DATA
- D. RECIPES

### III. *Periodicals*

- A. ABSTRACT JOURNALS
- B. INDUSTRIAL JOURNALS
- C. PURE CHEMISTRY
- D. REVIEWS
- E. ENGINEERING JOURNALS

### IV. *Public Documents*

- A. UNITED STATES GOVERNMENT
- B. STATE GOVERNMENTS
- C. BRITISH DOCUMENTS

### V. *Patents*

- A. UNITED STATES
- B. FOREIGN

### VI. *Trade Literature*

- A. TRADE ASSOCIATIONS
- B. MANUFACTURERS

### VII. *The Engineering Report*

### VIII. *Recommended Reading*

---

EVERY issue of each technical journal announces some new product, process, piece of equipment, material of construction, or marketing change in the chemical industries. No book can keep pace with or cover all of the important developments. It is part of the training of the chemical engineer and chemist to become familiar with at least that portion of the scientific, technical and economic literature which pertains to their fields of work.

Dean F. C. Whitmore of the School of Chemistry and Physics at Pennsylvania State College stated: "Most employers of chemists (and

chemical engineers) say that most of their men do not know how to use the library. Obviously, the chemist seeking information should get it from the library if it is there rather than by using up valuable materials and more valuable time in the laboratory to find it out.”\* This statement makes as serious a charge against the man as that of inefficiency in the laboratory, engineering office, or plant. The literature is a vast storehouse of data which the technical man should consult instead of performing the work in the laboratory. He must be just as efficient in performing this work as in performing that of the laboratory, engineering office, or plant. For this reason, the sources of information and methods of securing it are here discussed.

## THE LITERATURE SEARCH

The process of searching the technical literature is shown in Figure 1-1. The searcher, knowing little about the subject, but with an adequate technical background to understand what he reads, first consults an encyclopedia to gain a general knowledge of the subject; this allows him to decide what should be stressed in the rest of his survey. He then goes to the card catalog in the library to secure a list of books, bulletins, reprints, and periodicals containing references to his subject. The more general textbooks are consulted first to amplify the background obtained from an encyclopedia. An effort is made to secure a monograph devoted to the particular subject. Thus one interested in formaldehyde would find an American Chemical Society monograph devoted to this compound, which might supply all the information necessary. Articles dealing with later developments are found by a search of abstract journals. In the chemical and engineering fields *Chemical Abstracts* and the *Engineering Index* are consulted first. In the former, references are found both to journal articles and to patents, in the latter to journal articles only. The appropriate journal is located in the library and the original article read. During the reading the previous literature cited by the author is noted to obtain other important references to journal articles. Patent references are consulted in the Patent Gazette or copies of patent specifications are ordered from the Commissioner of Patents.

### *Organized Information*

Before detailed search is made for information in a particular field, a general idea must be obtained of that field. This is secured from encyclo-

\* *Ind. Eng. Chem., News Ed.*, 5, No. 3, 4 (1927)

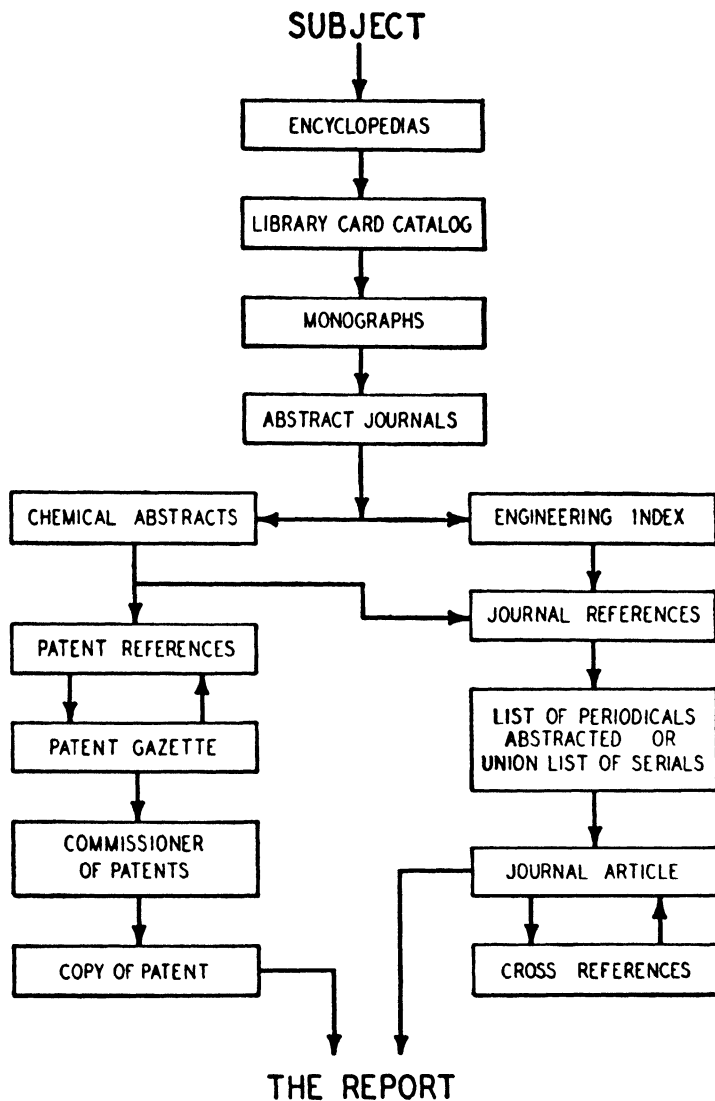

FIGURE 1-1. The Literature Search

pedias or general reference books. It is surprising how much technical information can be found in the *Encyclopaedia Britannica*.

## ENCYCLOPEDIAS

Each field of chemistry has a general reference work devoted to it. Thorpe, *Dictionary of Applied Chemistry* probably is the best known of the

encyclopedias dealing with industrial processes and products. The forthcoming *Encyclopedia of Chemical Technology* will be a more extensive and modern reference in this field. Ullman, *Enzyklopadie der technischen Chemie* is descriptive of processes and products up to 1932, with emphasis on German technology. Euchen and Jacob, *Der Chemie-Ingenieur* discusses certain unit operations, materials, and design methods for various industries.

In inorganic chemistry, Mellor, *Comprehensive Treatise on Inorganic and Theoretical Chemistry*, and Friend, *Textbook of Inorganic Chemistry*, review in detail the chemistry of each element and its compounds. The *Encyclopedia of Chemical Reactions* lists the reactions, and reaction conditions, for all elements. In organic chemistry, Heilbron and Bunbury, *Dictionary of Organic Compounds* gives the constitution, and the physical and chemical properties of many compounds, as well as references to the original literature. In German are Beilstein, *Handbuch der Organischen Chemie*, and Meyer and Jacobson *Lehrbuch der Organischen Chemie*.

#### MONOGRAPHS

Fortified with the background obtained from encyclopedias the searcher goes to the library card catalog to obtain the list of textbooks, monographs, bulletins, reprints, and periodicals pertinent to his subject. When these are secured, the textbooks may give a better description of his subject than that obtained from an encyclopedia, or tie it in with the broader picture of the industry. What the searcher most desires is an authoritative monograph discussing his subject in detail. The American Chemical Society sponsors a series in both pure and applied chemistry. Various publishing firms sponsor similar series.

#### NUMERICAL DATA

These are most frequently found in handbooks and tables. The chemical engineer usually looks first in Perry, *Chemical Engineers' Handbook*, not only for numerical data but also for concise discussion of important topics. Lange, *Handbook of Chemistry* and Hodgman, *Handbook of Chemistry and Physics* are devoted almost entirely to tables of data. For data not found in the handbooks, the *International Critical Tables* are consulted. These seven volumes published from 1926 to 1930 give collated physical data in many fields. Seidell, *Solubilities* (1940-1) gives data on both inorganic and organic compounds. Some monographs are devoted entirely to

physical data, as Bichowsky and Rossini, *Thermochemistry of Chemical Substances*.

## RECIPES

Directions for compounding many commercial preparations are given in Bennett, *Chemical Formulary* (seven volumes and cumulative index).

A glance at the title page of the book shows the date of publication. Although a book is published in the present year its preparation and printing have consumed at least two years, so that important articles have appeared in the technical literature after the publication of the monograph. Accordingly, articles appearing on this subject must be consulted in the various periodicals.

## Periodicals

A tremendous number of technical journals is published, all of which might have something of importance on the subject. Some 4000 journals in 31 languages are abstracted by *Chemical Abstracts*. In order to use this literature the searcher must first consult the abstract journals.

## ABSTRACT JOURNALS

The best known of these is *Chemical Abstracts*, started in 1907. The abstracts are indexed annually and decennially. The annual index includes authors, subjects, patent numbers, and formulas. *Chemical Abstracts* makes every effort to cover the field of journals related to pure chemistry, technology, and related phases of chemical engineering. It also abstracts patents in the chemical field issued in all countries. The abstracts are comparatively brief and the reader must consult the original article for the complete information.

Other abstract journals in the chemical field can be consulted to secure more complete abstracts or those issued before 1907. *British Chemical and Physiological Abstracts*, published since 1926, devotes Part A to pure chemistry and physiology, and Part B to applied chemistry. The abstracts are quite complete, particularly British and United States patents. Previous to 1926, abstracts in pure chemistry were carried by the *Journal of the Chemical Society* (1841- ) and in applied chemistry by the *Journal of the Society of Chemical Industry* (1882- ). The *Chemisches Zentral-*



*blatt* was started in 1830; hence its abstracts cover practically the entire period of chemical endeavor. Abstracts of German patents are quite full.

The *Engineering Index* (1906– ) covers most engineering journals published in English and a few in foreign languages. Its advantage lies in both the coverage of engineering journals and the listing of the abstracts under the index title. Hence no turning from index to abstracts is necessary, as with *Chemical Abstracts*. Most technical chemical periodicals in the United States are abstracted, but patents are not. Thus the use of the *Engineering Index* gives a rapid coverage of the important engineering and technological articles printed in English.

Abstract journals in related fields are: *Industrial Arts Index* (1913– ) which lists titles from many trade publications; *Agricultural Index* (1916– ); *Science Abstracts* (1903– ), Part A devoted to physics and Part B to electrical engineering.

To ascertain whether or not the local library, or what library, has available the particular journal desired, two reference sources are used. A revised *List of Periodicals Abstracted by Chemical Abstracts* was published in the issue of *Chemical Abstracts* for December 20, 1946. It is also available as a separate pamphlet. The *Union List of Serials* lists all journals published at its date of issue, 1943.

## INDUSTRIAL JOURNALS

Several journals are devoted to chemical engineering technology in each country which has an extensive chemical industry. In the United States the leading journal is *Industrial and Engineering Chemistry* (1909– ), published by the American Chemical Society. This is devoted to articles reporting applied research, chemical processes, economics, unit operations and processes, and engineering design. *Analytical Chemistry*, which was published from 1929 to 1946 as the Analytical Edition of *Industrial and Engineering Chemistry*, is devoted to analytical methods in both pure and industrial chemistry and to laboratory equipment. *Chemical and Engineering News*, a weekly publication of the American Chemical Society, is devoted to timely survey articles, and news of the industry and Society. *Chemical Engineering* (1902– ), named *Chemical and Metallurgical Engineering* until August, 1946,\* is devoted to descriptions of chemical plants, processes and equipment. Its editorial reports, such as materials of construction, commodity surveys, managerial problems, and pictured flow-

\* Reference will be made to *Chemical and Metallurgical Engineering* in the sections on Recommended Reading at the end of each chapter for articles that appeared before this date.

sheets of chemical processes, are monthly features. *Chemical Industries* (1933– ) rates itself as “the chemical business magazine.” The American Institute of Chemical Engineers publish monthly two journals combined in one cover; their *Transactions* (1909– ) is devoted mainly to research in chemical engineering operations and processes, whereas the new *Chemical Engineering Progress* (1947– ) contains descriptive articles of more general interest and news of the Institute.

There are numerous publications, each devoted to one particular industry, in which are stressed trade and economic as well as technical features. Among such periodicals are: *Paper Trade Journal*, *Food Industries*, *Petroleum Refiner*, *Soap*, *Rubber Age*, and many others.

Some of the foreign journals in the industrial field are: *Canadian Chemistry and Process Industries* (1917– ), *Journal of the Society of Chemical Industry* (1882– ) in two sections as *Transactions* and *Chemistry and Industry*, *Transactions of the Institution of Chemical Engineers* (1923– ), all published in English. Journals from other countries are in a chaotic condition at present, but some well known ones are *Chemie et Industrie* (1918– ) in France, *Die Chemische Industrie* (1878– ) in Germany, *Journal of Applied Chemistry* (U.S.S.R.) (1925– ) in Russia, and many others.

## PURE CHEMISTRY

Every country has one or more journals devoted to the publication of the results of research without regard to its immediate bearing on industry. The foundations of many important industries are in these journals devoted to “pure” chemistry, for the saying, “Theory now is practice 20 years hence,” is a truism. Some of the better known journals published in English are the *Journal of the American Chemical Society* (1876– ), *Journal of Physical and Colloid Chemistry* (1896– ), *Journal of Organic Chemistry* (1936– ), *Journal of Chemical Physics* (1933– ), and the *Journal of the Chemical Society* (1841– ).

## REVIEWS

Journals devoted to reviews in pure and applied chemistry rank with monographs in making surveys. *Chemical Reviews* (1924– ) is devoted mainly to pure chemistry. Ahren's *Sammlung Chemischer und Chemisch-technischer Vorträge* (1896– ) has published much on both pure and applied chemistry. The industrial journals frequently publish reviews. The *National Research Council Bulletins* 50, 71, and 86, *Bibliography of Bibliog-*

*raphies on Chemistry and Chemical Technology*, should be consulted early in the search.

## ENGINEERING JOURNALS

Many periodicals in various fields of engineering are of importance. The *Proceedings of the American Society for Testing Materials* (1898– ) contains original papers on properties and uses of engineering materials. The *A.S.T.M. Standards* (1910– ) gives specifications and testing procedures for materials. It is revised frequently and kept up to date. The *Transactions of the American Society of Mechanical Engineers* (1879– ) contains many articles of interest on plant operation, materials, and unit operations. *Materials and Methods, Mining and Metallurgy, Engineering and Mining Journal, Power, American Gas Journal, Water Works and Sewage* are just a few of these important journals.

### *Public Documents*

A multitude of federal and state agencies are publishing at irregular intervals a wealth of material of importance to chemical industry.

## UNITED STATES GOVERNMENT DOCUMENTS

These are published by various agencies in the executive, legislative and judicial branches. Some of the agencies are:

### Department of the Interior

- Bureau of Mines
- Geological Survey
- Division of Power
- Bonneville Power Administration

### Department of Commerce

- Bureau of Standards
- Bureau of the Census
- Patent Office
- Bureau of Foreign and Domestic Commerce

### Department of Agriculture

- Bureau of Agriculture and Industrial Chemistry
- Forest Service, including Forest Products Laboratory

Treasury Department

Bureau of Internal Revenue  
Federal Specifications Division

Miscellaneous

Interstate Commerce Commission  
U. S. Tariff Commission  
Tennessee Valley Authority

Government documents are sold by the Superintendent of Documents, Washington, D. C., for cash or money order only. Coupons can be purchased for twenty for \$1.00 and used like cash. Many publications can be obtained without cost from the agency concerned.

STATE GOVERNMENT DOCUMENTS

These publications are usually from research groups at some state laboratory. Publications are issued by universities and state colleges, engineering experimental stations, public health and industrial pollution agencies, and others. Unfortunately, due to the irregular nature of publication, reference to many of these is not found in the abstract journals.

BRITISH DOCUMENTS

Information concerning these can be secured from the British Information Services, 30 Rockefeller Plaza, New York 20, N. Y.

*Patents*

Patents are an extremely important part of the literature of chemical industry. Much work appears first in patents before articles are written for technical journals and many times the patents contain all the information. A patent is a legal grant made by a government in exchange for a complete and adequate disclosure that would enable one skilled in the art to reproduce the results. References to patents are found in the search in *Chemical Abstracts*.

UNITED STATES PATENTS

For United States patents, if the abstract is not sufficient the searcher must turn to the *Official Gazette of the United States Patent Office* (1872- ).

This contains one or two typical claims and one drawing, if any, from each patent. If this is not sufficient, the searcher should order a copy of the patent from the Commissioner of Patents, Washington, D. C. The price is 25 cents for each copy, payable in cash, money order, or coupons. Coupons can be purchased from the Commissioner in books of twenty for \$5.00 or one hundred for \$25.00.

Each issue of the *Official Gazette* contains an alphabetical list of patentees and assignees, titles of patents, and a classification list of patents. The annual index contains only the alphabetical list of patentees and assignees and titles of patents. Making a search of United States patent using the official classification system and the *Gazette* is complicated for one unskilled in such work.

#### FOREIGN PATENTS

Foreign patents can be checked in the *British Official Journal*, *Canadian Patent Office Record*, or *German Patentblatt* or *Auszüge*. Directions for obtaining copies of foreign patents are given in the first issue of *Chemical Abstracts* each year. Usually the quickest procedure is to order a photostatic copy from the United States Patent Office.

#### *Trade Literature*

The first announcement of the availability of a chemical product or material is usually in the trade literature. This may be an advertisement in a publication, a bulletin of technical data distributed to some group, or a letter of announcement. Trade literature may be sponsored by an individual or a group.

#### TRADE ASSOCIATIONS

These represent individuals producing in one field who have grouped together to maintain research, advertise, export, lobby, maintain standards, or to carry on other mutually important activities. Most of them publish technical information, trade statistics, or pamphlets extolling their commodity.

#### MANUFACTURER

This individual has something to sell. He can do so by supplying technical data on his product and telling how it can be used best for a

particular purpose. Every manufacturer has a series of leaflets, pamphlets, or bulletins which supply such information on his product. They usually are supplied for the asking.

It should be emphasized that the advertisements each month in the technical journals represent the effort of the manufacturer to attract attention to his product by supplying information concerning it. Current industrial practice is first seen in advertisements.

### *The Engineering Report*

The results of the survey of the technical and patent literature must be put in form intelligible to the person who is to use them. This calls for the preparation of an engineering report. Such a report may have many forms, in all of which clarity and coherence are essential. The formal arrangement of such a report has been discussed in a number of textbooks on English. It is to be emphasized that the skillful preparation of such a report is as important as is a skillful search of the literature and intelligent interpretation of results presented.

### *Recommended Reading*

#### I.

Agg and Foster, *The Preparation of Engineering Reports*, New York, McGraw-Hill Book Co., 1935

Boyd, *U. S. Government Publications*, New York, H. W. Wilson Co., 1941

Cameron, *A Manual of the Literature of Chemistry*, Baton Rouge, Louisiana State University, 1940

Crane and Patterson, *A Guide to the Literature of Chemistry*, New York, Wiley & Sons., 1927

Hohenhoff, *Bibliography of Journals, Books and Compilations which List and Abstract Patents*, Baltimore, Special Libraries Association, 1936

Huntress, *A Brief Introduction to the Use of Beilstein's Handbuch der organischen Chemie*, New York, Wiley & Sons, 1938

Mason, *Introduction to the Literature of Chemistry*, London, Oxford U. Press, 1925

Mellon, *Chemical Publications*, New York, McGraw-Hill Book Co., 1940

Nelson, *Writing the Technical Report*, New York, McGraw-Hill Book Co., 1940

Rossman, *The Law of Patents for Chemists*, Baltimore, Williams & Wilkins Co., 1934

Schmeckebier, *Government Publications and Their Use*, Washington, The Brookings Institution, 1939

Soule, *Library Guide for the Chemist*, New York, McGraw-Hill Book Co., 1938

## II.

- Smith, "Patent Literature as a Source of Information,"  
*Chem. Met. Eng.*, **34**, 160-2 (1927)
- Hamor and Bass, "Bibliochresis: The Pilot of Research,"  
*Science*, **71**, 375-8 (1930)
- Hoshall, "Chemical Drawing,"  
*J. Chem. Education*, **11**, 21-7, 154-8, 235-41, 546-50 (1934)
- Molstad, "The Literature of Chemistry and Chemical Engineering,"  
*Ind. Eng. Chem., News Edition*, **16**, 206-14 (1938)
- Culhane, "The Importance of Scientific Literature in Patent Applications,"  
*J. Chem. Education*, **20**, 601-2 (1943)
- Egloff, et al., "Problems of Scientific Literature Research,"  
*J. Chem. Education*, **20**, 587-92 (1943)
- Wall, "The Importance of Technical Writing in Chemical Education,"  
*J. Chem. Education*, **20**, 580-6 (1943)
- Harden, "The Use of Government Publications in Chemical Research,"  
*J. Chem. Education*, **21**, 326-32 (1944)
- Hollabaugh, "Protection of the Results of Chemical Research,"  
*J. Chem. Education*, **21**, 321-5 (1944)
- Tolpin, "The Place of Russian Scientific Literature in Bibliographical Work,"  
*J. Chem. Education*, **21**, 336-42 (1944)
- Wall, "The Essentials of a Good Report," *J. Chem. Education*, **24**, 129-40 (1947)
- Hoffman, "Techniques Employed in Making Literature Searches for a Patent Department," *J. Chem. Education*, **24**, 546-9, 555 (1947)

# CHAPTER 2

## Natural Sodium Salts

---

- I. *Introduction*
  - II. *Occurrence of Salt*
    - A. SEA WATER
      - 1. *Deposition of salt*
    - B. SALT DEPOSITS IN THE UNITED STATES
      - 1. *Theory of formation*
      - 2. *Principal deposits*
    - C. NATURAL BRINES
  - III. *Production of Salt*
    - A. STATISTICS
    - B. METHODS
  - IV. *Mining and Milling of Rock Salt*
  - V. *Brine Wells*
  - VI. *Materials of Construction*
  - VII. *Evaporation of Brines*
    - A. PRINCIPLES OF SALT DEPOSITION
      - 1. *Solubility*
      - 2. *System NaCl—H<sub>2</sub>O*
    - B. PRINCIPLES OF CRYSTALLIZATION
      - 1. *Ostwald-Miers theory*
      - 2. *Ross theory*
      - 3. *Factors effecting crystal growth*
  - VIII. *Solar Evaporation*
  - IX. *Grainer Evaporation*
  - X. *Vacuum Evaporation*
  - XI. *Flash Evaporation*
  - XII. *Marketing of Salt*
    - A. ECONOMIC FACTORS
    - B. TABLE SALT
    - C. BY-PRODUCTS
  - XIII. *Sodium Sulfate*
    - A. SYSTEM Na<sub>2</sub>SO<sub>4</sub>—H<sub>2</sub>O
    - B. PROCESSING
  - XIV. *Sodium Carbonate*
    - A. SYSTEM Na<sub>2</sub>CO<sub>3</sub>—H<sub>2</sub>O
    - B. CARBONATE-BICARBONATE EQUILIBRIUM
    - C. PROCESSING
  - XV. *Student Exercises*
  - XVI. *Recommended Reading*
-



**SALT** (sodium chloride) is the raw material around which the early chemical industry of this country grew. It remains a determining factor in the location of many of the heavy chemical plants, for on it depends the country's supply of soda ash, caustic soda, chlorine, and other heavy chemicals. In Figure 2-1 is shown the industrial position of salt. The extremely diverse applications of salt as a commodity and as a raw material for chemical industry are apparent.

The principles and processes used for the production of sodium chloride are typical of many industrial salts and will be discussed in some detail. Thus, the recovery of sodium nitrate from Chilean "caliche," sodium sulfate from mirabilite, and magnesium sulfate from natural brines, all follow the principles discussed in the sodium chloride industry.

### *Occurrence of Salt*

#### SEA WATER

An inexhaustible supply of salt is available from sea water in the form of a 3.5 per cent solution. The composition of sea water varies slightly with its position on the earth's surface and with its depth; it is quite constant however, except when diluted by an influx of fresh river water. The mean of 77 analyses is given in Table 2-1 with both ionic and combined values.

TABLE 2-1 Composition of Sea Water

	<i>Per cent of salts</i>	<i>Per cent in sea water</i>		<i>Per cent</i>
Cl <sup>-</sup>	55.29	1.968	NaCl	77.76
Br <sup>-</sup>	0.19	0.007	MgCl <sub>2</sub>	10.88
SO <sub>4</sub> <sup>--</sup>	7.69	0.274	MgSO <sub>4</sub>	4.74
CO <sub>3</sub> <sup>--</sup>	0.21	0.008	CaSO <sub>4</sub>	3.60
Na <sup>+</sup>	30.59	1.089	K <sub>2</sub> SO <sub>4</sub>	2.46
K <sup>+</sup>	1.11	0.040	MgBr <sub>2</sub>	0.22
Ca <sup>++</sup>	1.20	0.043	CaCO <sub>3</sub>	0.34
Mg <sup>++</sup>	3.72	0.133		
	100.00	3.562		100.00

The amount of oceanic salts is calculated to be over  $533 \times 10^{14}$  tons, or approximately 5,000,000 cubic miles of salts, enough to cover the

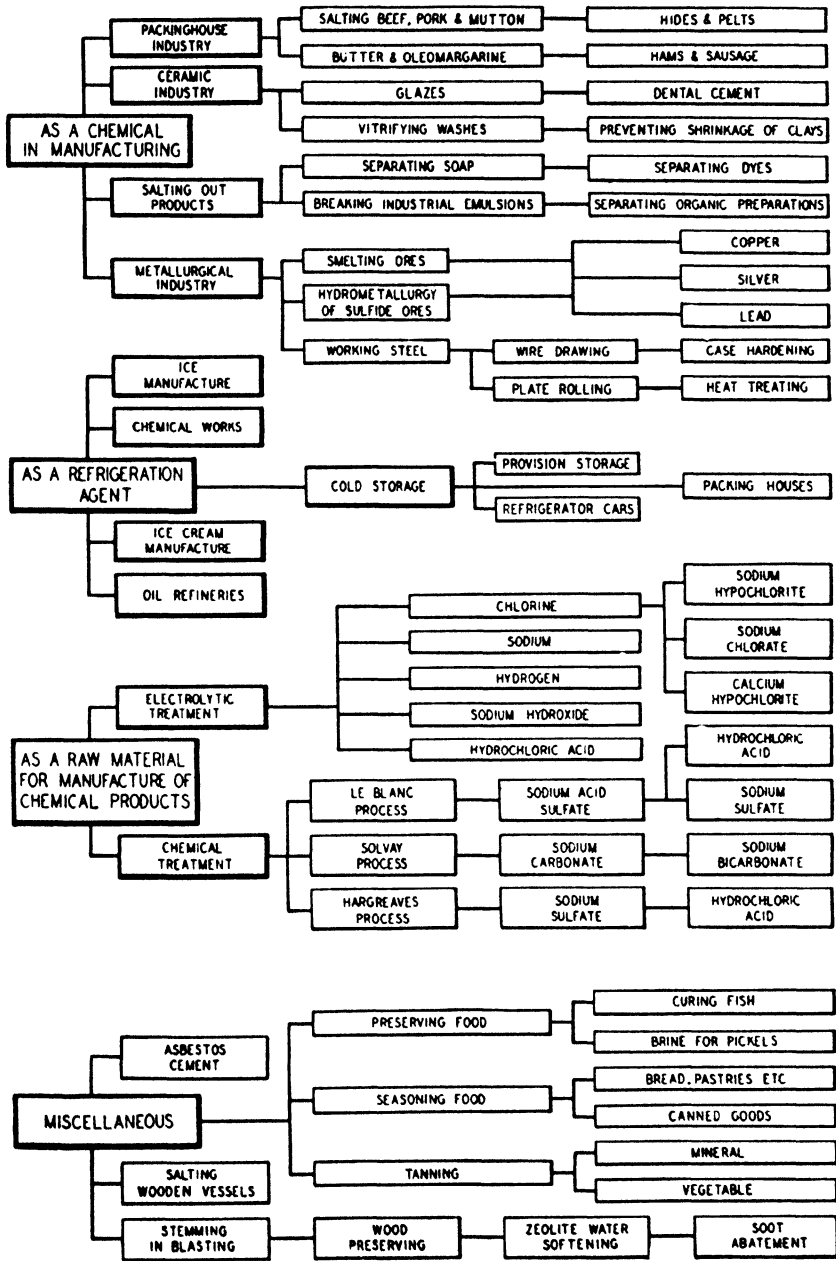

*Courtesy of the International Salt Company*

FIGURE 2-1. The Industria' Position of Salt

entire surface of the United States with a layer of salt 1.6 miles in thickness.

DEPOSITION OF SALT

Of the useful minerals found in the United States none occurs in greater abundance or is more widely distributed than common salt. Various types of deposits occur, ranging from the rock salt deposits of New York and the salt domes of the Gulf Coast to the surface saline deposits in arid western regions.

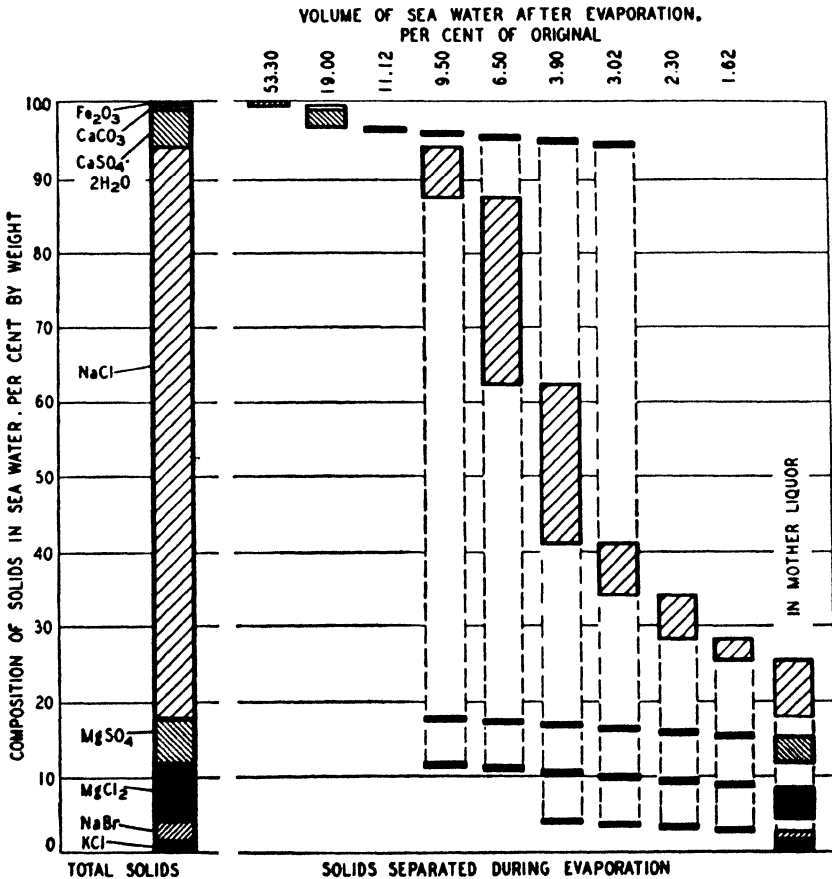
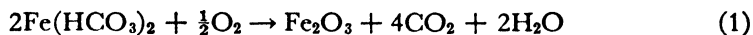

FIGURE 2-2. Order of Separation of Salts When Sea Water Is Evaporated

The large salt deposits have been produced mainly by evaporation of sea water in long-past geological ages. Whenever a saline water is concentrated by evaporation it deposits salts in the reverse order of their

solubility. This has been studied by Usiglio for sea water. Figure 2-2 shows the order of separation of salts as evaporation of sea water occurs. During evaporation down to 53.3 per cent of the original volume all ferric oxide, from ferrous ions in solution (equation 1), and part of the



calcium carbonate were deposited. On continued evaporation calcium carbonate was deposited due to the decomposition of the bicarbonate (equation 2). When the volume was reduced to 19.0 per cent of the



original,  $\text{CaSO}_4 \cdot 2\text{H}_2\text{O}$  began to be deposited and continued until the volume was 3.0 per cent. This continued deposition of gypsum caused it to be incorporated in the rock salt beds. Not until the volume was reduced to 9.5 per cent, where the concentration of salts was approximately 356 grams per liter, did sodium chloride precipitate, and then it was accompanied by small amounts of magnesium sulfate and chloride. These three salts, plus sodium bromide, continued to crystallize until a mother liquor amounting to 1.62 per cent of the original volume remained. At this point 91.3 per cent of the sodium chloride had crystallized. The mother liquor contained 523 grams per liter of salts, which comprised all the potassium salts along with the remaining sodium and magnesium sulfates and chlorides. This small volume could have been lost in a large deposit, or washed away before it could crystallize. Crystallization from such a mother liquor will be discussed in the next chapter.

Various theories have been advanced for the formation of the rock salt deposits from New York to Michigan. Alling in his bulletin on the New York salines outlines nine theories, and favors the following: An arm of the sea was cut off from the open ocean by warping of the land or by some other barrier. The water was subjected to evaporation under desert conditions, but into this saline lake flowed streams carrying lime-muds and salts derived from the decomposition of marine limestones situated in the drainage basin. Interruptions by fresh influx of river water produced alternate beds of salt and gypsum. Upon drying, the saline substances were redistributed as a result of the gypsum sands being blown over the desert area, and of subsequent leaching of the more soluble substances by rain or river water. The deposits as they exist now may be the product of many incomplete cycles of evaporation and fresh influx of sea water from the ocean.

## SALT DEPOSITS IN THE UNITED STATES

This country can be divided roughly into two areas, eastern and western. In the eastern area the salt occurs in the earth, being protected from solution by impervious strata of shale and limestone. In the western section, owing to the arid conditions, salt exists on the surface of the earth as well as in deposits. It is possible to see the processes of leaching, accumulation, and deposition being carried out at various places. Thus the division into two areas is not only geographic but also climatic. The distribution of salt deposits and salt-producing plants is shown in Figure 2-3.

The New York state deposits are the oldest worked deposits in this country. They were formed by the evaporation of the Silurian Sea which covered most of central North America during geological ages. The saline remains occupy two basins, one forming the New York-Pennsylvania-Ohio deposit and the other the Michigan-Ontario deposit. Evaporation was never completed, so no potash deposits have been found. Several evaporation cycles are indicated by the succession of layers of limestone, gypsum, and salt in the deposit. An area in excess of 1100 square miles is underlaid with salt, ranging from surface level to 1500 feet below the surface and in beds up to 500 feet in thickness. Thus an inexhaustible supply of salt attracted early chemical industries, and the Solvay soda process was first located here.

The Michigan deposit ranks first as a producer of salt, producing both rock salt and brine (Table 2-3). The presence of other chemicals in the brines was responsible for the location of the Dow Chemical Company at Midland, Michigan, which began the production of bromine from brine. The magnesium industry of the United States was developed there because of the occurrence of magnesium chloride in the brine.

The Permian Salt Basin deposit extending over parts of Kansas, Colorado, Oklahoma, Texas, and New Mexico covers an area of about 100,000 square miles. Evaporation was completed in one of the deposits, giving rise to the potash minerals at Carlsbad in southeastern New Mexico. Rock salt is mined at various locations in this area, but production is relatively low because of the smallness of the related chemical industry.

Texas and Louisiana along the Gulf coast possess interesting salt "domes" (Figure 2-4), associated with petroleum and sulfur deposits. These domes rise through as much as 25,000 feet of sedimentary deposits and often form mounds or domes contrasting with the surrounding flat

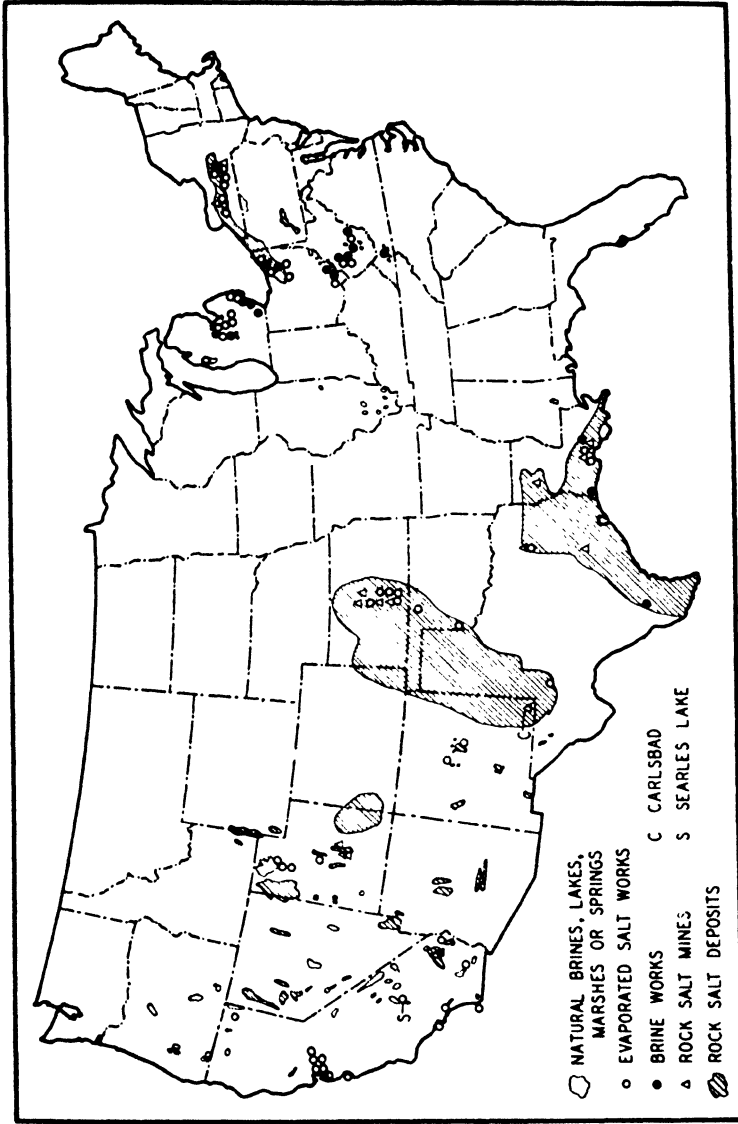

FIGURE 2-3. Geographical Distribution of Salt Deposits and Operating Plants

country. The diameter of the salt "plug" varies, and in the largest dome (Hockley, Texas) it is 3 miles wide by 4 miles long and at least 5 miles in depth. The top of the plug may be covered with a cap rock of gypsum

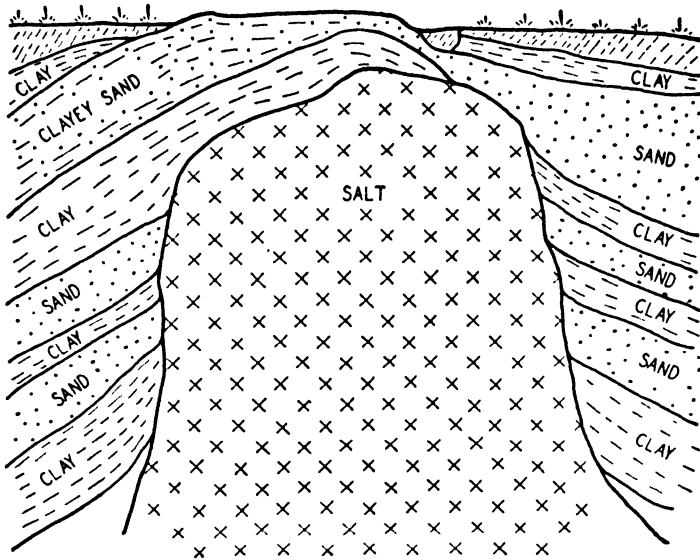

FIGURE 2-4. Section of a Cap-less Coastal Dome Structure (Redrawn from *Trans. Am. Inst. Chem. Engrs.* 25, 241 (1930) with permission)

and limestone. The prevailing theory is that the salt has been forced upward at numerous points of least resistance from a basic salt stratum by plastic flow caused by the pressure of the overburden.

California possesses salt in practically all forms: rock salt, salt lakes and springs, and the ocean. Solar evaporation of sea water is practiced extensively.

#### NATURAL BRINES

The high salinity of the waters of closed basins is due to a cyclic process which comprises the leaching of the connate salts by fresh water, the flowing of the salt solution into the lake, and evaporation of the water. Some lakes are saturated solutions, while others are dry deposits during the summer and covered with water in wet seasons. The remains of such lakes, now evaporated and covered with drift, form natural deposits in many western states. The composition of the brine depends on the connate salts occurring in the surrounding country but it is chiefly saline or

alkaline. The best known is the Great Salt Lake of Utah, the chief remnant of Lake Bonneville which covered a vast area in geological time. In composition the water is quite similar to sea water, but the content of calcium and magnesium ions is lower. During winter months the solution precipitates  $\text{Na}_2\text{SO}_4 \cdot 10\text{H}_2\text{O}$ . An analysis is given in Table 2-2.

Nevada possesses a number of alkaline lakes; geological Lake Lahontan once covered 8400 square miles in the northwestern part of the state, and the small alkaline lakes and many alkaline and saline deposits are the remains of that once great lake. California also has a number of lakes resembling those of the Lahontan basin.

The composition of the ions present in some of the natural brines is given in Table 2-2.

TABLE 2-2 Composition of Natural Brines

	A	B PER CENT	C	
$\text{Cl}^-$	55.48	25.40	13.28	
$\text{SO}_4^{--}$	6.68	9.89	16.44	A = Great Salt Lake, Utah
$\text{CO}_3^{--}$	0.09	22.70	30.22	
$\text{B}_4\text{O}_7^{--}$		1.89		B = Owens Lake, California, 1914
$\text{Na}^+$	33.17	37.83	39.60	
$\text{K}^+$	1.66	2.09		C = Soap Lake, Washington
$\text{Ca}^{++}$	0.16			
$\text{Mg}^{++}$	2.76		0.04	
$\text{SiO}_2$		0.20	0.42	
	100.00	100.80	99.58	

*Production of Salt*

In 1945 in the United States 74 plants of 49 companies located in 13 states and Puerto Rico produced 15,344,141 tons of salt valued at \$46,069,064. The distribution of production is given in Table 2-3.



TABLE 2-3 Salt Sold or Used by U. S. Producers in 1945

<i>State</i>	<i>Tons</i>	<i>Per cent</i>
Michigan	4,285,493	27.8
New York	2,862,224	18.6
Ohio	2,764,926	17.9
Louisiana	1,867,689	12.1
Texas	1,100,791	7.2
Kansas	855,806	5.6
California	694,609	4.5
West Virginia	370,260	2.4
Utah	122,997	0.8
Puerto Rico	12,513	0.1
New Mexico	9,980	0.1
Nevada, Virginia and Oklahoma	446,853	2.9
	15,394,141	100.0

The production methods for securing salt may be enumerated as:

1. Mining of rock salt
2. Evaporation of solutions
  - a. By solar evaporation
  - b. In direct-fired evaporators
  - c. In grainers
  - d. In vacuum evaporators
  - e. In flash evaporators

In 1945, salt production and salt sold or used by producers, including brine used as such in other processes, was distributed as shown in Table 2-4.

TABLE 2-4 Salt Production in the United States, 1944

<i>Sold or used by producers:</i>	<i>Tons</i>	<i>Per cent</i>
Manufactured (evaporated)	3,630,729	23.6
In brine	8,257,672	53.6
Rock Salt	3,505,740	22.8
	15,394,141	100.0

<i>Method of manufacture</i>	<i>Tons</i>	<i>Per cent</i>	<i>Average value \$/ton</i>
Evaporated:			
Bulk:			
Grainers	944,612	6.1	8.69
Vacuum pans	2,001,373	13.0	7.15
Solar	442,112	2.9	3.85
Pressed blocks	242,632	1.6	10.22
Rock:			
Bulk	3,410,929	22.2	3.55
Pressed blocks	94,811	0.6	8.96
Salt in brine	8,257,672	53.6	0.78
	15,394,141	100.0	2.99

### *Mining and Milling of Rock Salt*

Mining methods employed for rock salt are similar to those used for bituminous coal, except that rock salt is hard enough so that pillars can be left, making mine timbering unnecessary. Depths and vein thicknesses vary from mine to mine. At the Retsof (N. Y.) mine the shaft is 1063 feet deep and the salt vein 9 to 10 feet thick, while the shaft of the Morton Salt Company operating in the Grand Saline dome (Texas) enters the salt dome at 213 feet but drops to a working level at 700 feet. Mining at the latter level takes place in rooms or "stopes" 60 feet wide by 80 feet high. The mined salt varies from 18-inch lumps to fines and is brought to the surface in hoist-skips which dump into bins. A coarse screen separates the large lumps from smaller lumps and fines. The large lumps pass through jaw or rotary crushers and all the material then passes through a series of screens and roll crushers to give a product graded in size from 2-mesh to pass 12-mesh. This fine material and discolored salt is made into brine and evaporated. Fines also are compressed at 24,000 pounds per square inch p.s.i. into blocks for cattle licks. Sulfur and other medicants can be added. The purity of rock salt depends on the deposit. The New York-Michigan deposits contain considerable amounts of calcium and magnesium chlorides and gypsum with the salt, while the Gulf salt domes give a product of remarkable purity for a natural product, often greater than 99.8 per cent sodium chloride.

*Brine Wells*

A hydraulic method of mining is used where the salt is desired as a solution for some chemical process or for the production of salt by

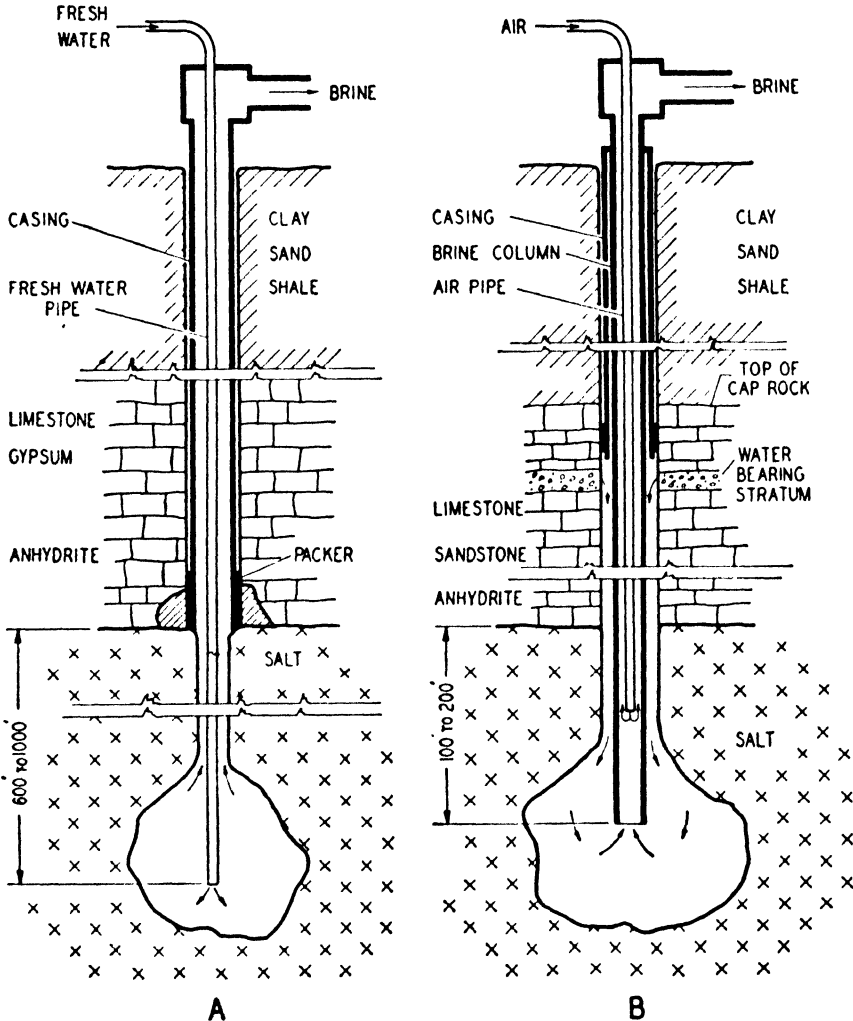

FIGURE 2-5. Hydraulic Mining of Salt (Redrawn from *Trans. Am. Inst. Mining Met. Engrs. (Industrial Minerals—Nonmetallics)* 129, 405-22 (1938) with permission)

evaporation. A typical well might have an 8- or 10-inch casing cemented into the anhydrite or shale formation that overlies the salt bed. Within

this casing is a 6- or 8-inch pipe which has a 3- or 4-inch pipe concentric with it. Fresh water may be introduced either at the top of the well (New York method) or at the bottom of the well (Detroit method). The latter (Figure 2-5A) is used where the salt bed is over 150 feet in thickness. The fresh water is about 20 per cent lighter than the brine and rises slowly through it, so that sufficient contact must be allowed between brine and salt to give saturation. Most of the salt is dissolved near the bottom of the bed. In the New York method the fresh water is introduced at the top of the salt layer and sinks downward as it becomes denser. The saturated brine is withdrawn through the central pipe. If the well passes through a water-bearing stratum (Figure 2-5B) this water may be allowed to flow down into the well and the saturated brine raised to the surface by an air-lift fed with compressed air at 100 p.s.i. which enters through a 1½-inch central air pipe.

As salt is dissolved, a cavity of considerable dimensions forms. When fresh water is introduced at the top the salt there dissolves more rapidly because the denser solution settles and is replaced by a less concentrated solution. Unless the salt vein has a thickness of 200 feet, or unless a structurally rigid roof of limestone is present, the roof may cave in and blanket the floor with mud. In the Trump undercutting method, the water pumped downward is saturated with air, which becomes less soluble as brine is formed, and is released from the solution. The air rises to the top of the cavity and forms an air cushion which holds the water level to the lower few feet of the cavity. This results in an undercut of any desired thickness that can be extended any distance from the well. By allowing the water level to rise, solution takes place from the roof.

At the surface the brine is pumped to storage tanks where solid impurities are allowed to settle. Brine purification is not usually economical, but lime may be added to remove iron and magnesium compounds and make the brine alkaline to reduce corrosion. Sodium carbonate may be added to precipitate calcium carbonate. The degree to which this type of treatment is performed depends on markets and the value of the salt produced. Sodium sulfate is added to remove barium compounds from some of the brines of the Ohio River valley.

In Table 2-5 is given a series of analyses of artificial brines produced in various states. These are not representative of the wells of the entire state for wide variation is found within the state itself. The brines as produced have about 300 grams per liter total salts, of which the ionic composition is shown in the table.

TABLE 2-5 Analyses of Artificial Brines

ION	<i>Radicals in percentage of anhydrous residue</i>						
	1	2	3	4	5	6	7
K	0.10	3.87	0.0	0.0	0.06	0.16	0.09
Na	37.92	34.90	21.99	39.08	38.90	38.02	38.15
Ca	1.06	1.09	11.54	0.19	0.24	0.65	0.67
Mg	0.10	0.45	2.71	0.0	0.0	0.23	0.22
Cl	60.06	58.57	62.35	59.64	58.60	59.61	60.87
SO <sub>4</sub>	0.76	0.77	0.38	1.09	2.20	1.33	0.0
Br	0.0	0.35	0.69	0.0	0.0	0.0	0.0
	100.00	100.00	99.66 <sup>a</sup>	100.00	100.00	100.00	100.00

<sup>a</sup> Balance of analysis: Fe, 0.25; NH<sub>4</sub>, 0.09.

- 1—Worcester Salt Co.  
Silver Springs, N. Y.  
2—International Salt Co.  
Watkins, N. Y.  
3—Dow Chemical Co.  
Midland, Mich.  
4—Worcester Salt Co.  
Ecorse, Mich.

- 5—Columbia Chemical Co.  
Barberton, Ohio  
6—Hutchinson Salt Co.  
Hutchinson, Kansas  
7—Morton Salt Co.  
Grand Saline, Texas

### *Materials of Construction*

Selection of the proper materials of construction is an important factor in maintaining purity and appearance of the product, as rust specks must be kept out of quality grades of salt. Monel metal is usually satisfactory and has become a standard material for use in contact with wet salt. Stainless steel is excellent, but more expensive; however, because of its greater hardness it is used to resist abrasion. Iron castings containing 2 to 4 per cent nickel give excellent service. Surface coatings such as porcelain glaze, rubber, and galvanizing are all used to protect underlying steel. Wood is extensively used throughout plants; brine tanks are made of this material. Salt bins use maple flooring which soon becomes highly polished.

Fortunately much of the equipment in contact with brine becomes coated with a hard calcium sulfate scale which protects the metal, so the equipment can often be made of the most economical material.

## Evaporation of Brines

## PRINCIPLES OF SALT DEPOSITION

A saturated solution is one in which the dissolved salt is in equilibrium with the solid salt. Considering a single pure salt only, the solubility is a function of the temperature, most salts becoming more soluble with increasing temperature, though a few become less soluble, or have an

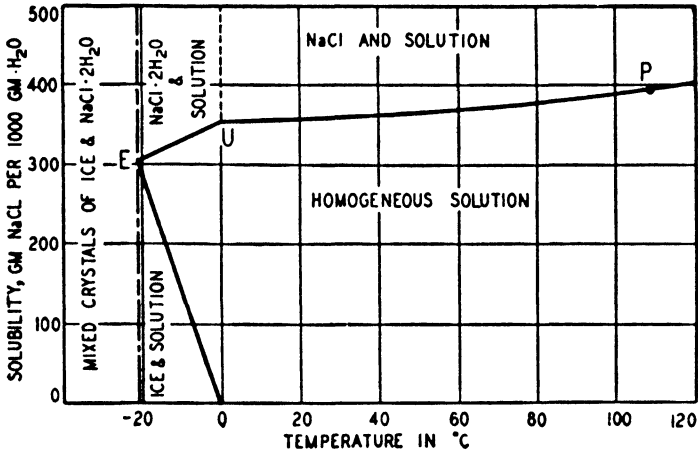

FIGURE 2-6. The System Sodium Chloride—Water

“inverted solubility curve” as does sodium sulfate above 32.4°C. Solubility may be expressed in a number of ways, using either metric or English units. Common methods are:

- (1) Weight of solute in a selected weight of solvent, as grams NaCl in 1000 grams H<sub>2</sub>O
- (2) Moles of solute in a selected weight of solvent, as gram moles NaCl in 1000 grams H<sub>2</sub>O (molality)
- (3) Weight of solute in a selected volume of solution, as grams NaCl per liter of solution, or pounds NaCl per gallon of solution
- (4) Moles (or equivalents) of solute in a selected volume of solution, as gram moles NaCl per liter of solution (molarity or normality)
- (5) Percentage by weight of solute, as a 10 per cent NaCl solution
- (6) Mole fraction of solute, as used in physical chemistry

The solubility relationships in the system sodium chloride—water are shown in Figure 2-6, in which solubility is expressed as grams NaCl per

1000 grams of water or pounds NaCl per 1000 pounds of water. Significant points in this system are:

*E* at  $-21.1^{\circ}\text{C}$ . Eutectic, cryohydric, or freezing point of solution

*U* at  $+0.15^{\circ}\text{C}$ . Transition point between NaCl and  $\text{NaCl}\cdot 2\text{H}_2\text{O}$

*P* at  $+108.7^{\circ}\text{C}$ . Boiling point at 760 mm.

The line  $O-E-U-P$  represents a boundary between a homogeneous solution and a heterogeneous mixture of solid and solution. With this system the solid phase may be any one of three compounds. Along the line  $P-U$  solid NaCl exists in equilibrium with the saturated solution and at any temperature above  $+0.15^{\circ}\text{C}$ . crystallizes or precipitates from the solution. There is not much increase in salt dissolved with increasing temperature, so it is not economical to crystallize sodium chloride from its saturated solution by cooling, but the solution must be evaporated to recover the salt. Along the line  $U-E$  solid  $\text{NaCl}\cdot 2\text{H}_2\text{O}$  exists in equilibrium with the saturated solution and is the solid phase crystallized out between these temperatures. At *U*, NaCl,  $\text{NaCl}\cdot 2\text{H}_2\text{O}$ , saturated solution, and water vapor all coexist in equilibrium. \* The line  $O-E$  is usually called the freezing point curve, for along it ice crystallizes from the solution, which becomes more concentrated in sodium chloride as a result of the loss of water. This line can also be called the solubility curve for ice in the solution. Point *E* is a eutectic point, for aqueous solutions termed the "cryohydric point." At this temperature the entire solution freezes to give a heterogeneous mixture of ice and  $\text{NaCl}\cdot 2\text{H}_2\text{O}$ . Industrially, a solution of the eutectic composition is frozen in a thin sheet on the outside of thin Monel metal bands which are part of a refrigerated drum rotating in the eutectic brine. A change in curvature of the flexible band peels off the solid and breaks it into small pieces suitable for use. This product is marketed as "salt-ice" or "eutectic ice" and is used extensively by fishermen. Its melting point of  $-21.1^{\circ}\text{C}$ . ( $-6^{\circ}\text{F}$ .) and latent heat of melting of 101.5 B.t.u. per lb. (water is 143.5 B.t.u. per lb.) bring it into competition with solid carbon dioxide as a refrigerant, for 3 pounds of salt ice are equivalent to 1 pound of "dry ice" and the former can be produced for  $\frac{3}{4}$  cent per lb.

The steepness of the solubility curve  $U-P$ , or  $E-U$ , indicates the type of equipment which can be used to crystallize the salt. Final selection will depend on an economic balance, which includes many local factors.

\* The student should review the phase rule and its applications, using a physical chemistry textbook.

<i>Temperature Coefficient of Solubility</i>	<i>Equipment</i>	<i>Examples</i>
Large increase in solubility	Vacuum or Flash crystallizers Cooling crystallizers	$\text{KNO}_3$ $\text{Na}_2\text{SO}_4 \cdot 10\text{H}_2\text{O}$ $\text{FeSO}_4 \cdot 7\text{H}_2\text{O}$
Medium increase in solubility	Modified vacuum crystallizers	$\text{KCl}$ $\text{NaNO}_2$ $\text{K}_2\text{CO}_3 \cdot 2\text{H}_2\text{O}$
Small increase in solubility	Salting-out evaporator Evaporator-crystallizer	$\text{NaCl}$
Decrease in solubility (Inverted solubility curve)	Submerged combustion evaporator Forced circulation evaporators	$\text{Na}_2\text{SO}_4$

## PRINCIPLES OF CRYSTALLIZATION

The form and size of the crystals deposited from the brine solution fix the market into which the finished product can go. They are influenced by a number of factors which will be discussed in connection with the general principles of crystallization and the equipment in which it is performed.

The natural or equilibrium form of the crystal is a fixed property of the particular salt and the temperature. Crystallization can occur in six crystal systems of varying degrees of symmetry, as: (1) cubic, (2) tetragonal, (3) hexagonal, (4) rhombic, (5) monoclinic, and (6) triclinic. Sodium and potassium chlorides crystallize in the cubic system, as shown in Figure 2-7. Under conditions found in commercial crystallizers the crystal form may be changed markedly from the equilibrium crystal form.

The formation and growth of crystals has been explained by the supersaturation theory of Ostwald and Miers. The work of the latter showed that definite supersolubility curves could be determined for a variety of compounds. Thus, in Figure 2-8 the branches *ME* and *EV* represent the solubility and normal freezing point curves for the given compound. However, by cooling solutions a definite point was determined at which crystal formation began; this represented a solution



supersaturated with respect to the equilibrium solubility curve. In this way a supersolubility curve  $SH$  was determined which is approximately parallel to the solubility curve, with its undercooled freezing points on  $HR$ . A solution of composition  $a$  cools past its saturation temperature

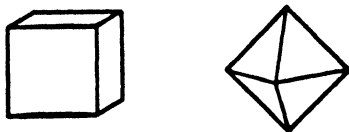

*Courtesy of the Diamond Crystal Salt Company, Inc.*

**FIGURE 2-7.** Forms of Salt Crystals

*Above:* Cube and octahedral forms of salt crystals, both in the cubic system.

*Below:* Granulated salt cubes formed during vacuum evaporation of brine.

at  $b$  without crystal formation until the supersolubility curve is reached at  $c$  where the solution usually crystallizes spontaneously and its composition drops to some point  $d$  just above the solubility curve, which is followed to point  $E$  with decrease in temperature. The region between  $ME$  and  $SH$  is termed the “metastable region” and above  $SH$  the

“labile region.” In the metastable region crystallization is induced only by inoculation with seed crystals (following *a-b-e*) which grow, but new crystal nuclei do not form. In the labile region crystallization can occur with the spontaneous formation of crystal nuclei which then grow in the solution. Recent work has shown that the position of the supersolubility curve is influenced by such factors as method and rate of agitation, mechanical vibrations, and rate of cooling. Thus Ting and McCabe found two supersolubility curves for  $\text{MgSO}_4 \cdot 7\text{H}_2\text{O}$ .

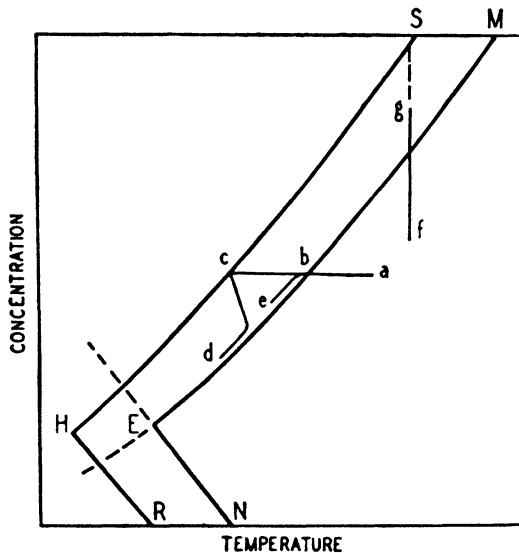
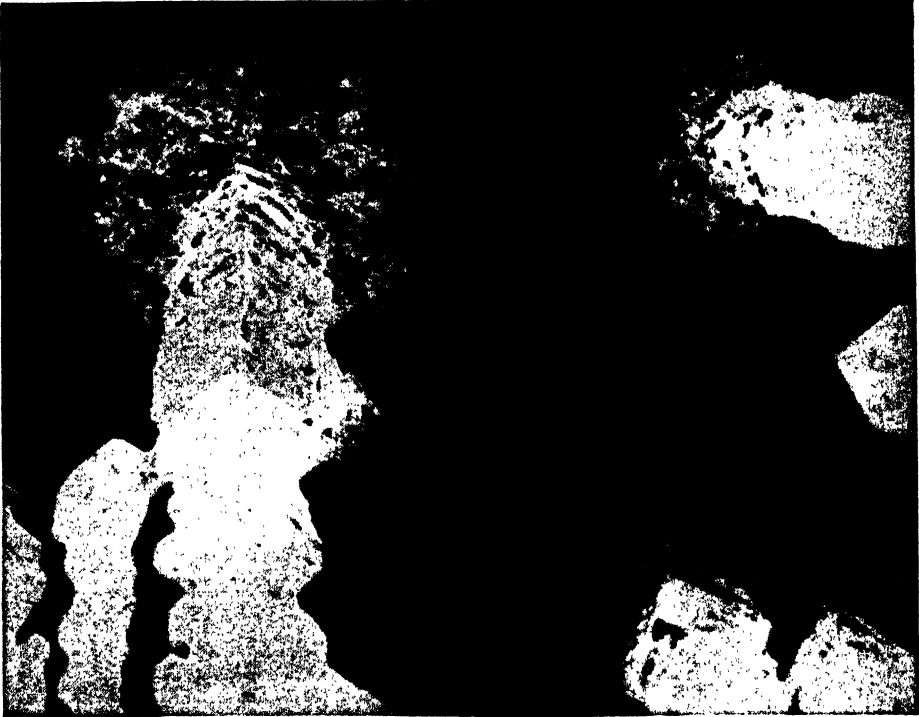

FIGURE 2-8. Supersaturation and Normal Solubility Curves

The more recent Ross theory of crystal formation states that when salts dissolve they form indefinite compounds designated as “molten hydrates,” the composition of which is a function of temperature. Thus crystal formation is merely a process of freezing. When heat is removed from the molten hydrate a few molecules located at the point of heat removal are cooled to their freezing point and form crystal nuclei, which agglomerate and act as points for further crystal growth. The small crystals appear to possess fields of attractive force surrounding their points capable of attracting nuclei (Figure 2-9) which attach themselves in an orderly manner and determine the crystal characteristics. Each crystalline substance appears to have its own characteristic rate of growth, this being higher with more soluble salts. If nuclei are formed more rapidly than the growing crystal can assimilate them, the excess will start other crystals.

Both theories have experimental bases and, despite objections as to results and interpretations, are valuable in predicting crystallization behavior.



*Courtesy Mr. E. T. Ross*

FIGURE 2-9. Growing Potassium Chloride Crystals

Apparent attractive field is shown around the ends of the crystals; nuclei forming in background.

The various factors influencing crystal growth are:

- (1) Temperature and concentration level of crystallization range
- (2) Rate of evaporation or rate of cooling
- (3) Use of seed crystals, their size and number
- (4) Density of crystal slurry maintained
- (5) Period of retention in crystallization zone
- (6) Degree of agitation
- (7) Amount and nature of impurities
- (8) pH of solution
- (9) Constancy of conditions

Because of its relatively flat solubility curve, sodium chloride is not crystallized from solution by cooling, but must be precipitated by evaporation of the water. The size of the deposited crystals depends on the rate of evaporation. If the rate is such that the solution is maintained in the metastable range, crystal growth takes place in crystals already present and these continue to grow as long as they are maintained in the solution. Thus slow evaporation produces large crystals. However, if evaporation is more rapid than crystal growth the concentration of the solution is carried across the supersolubility curve and nuclei precipitate from the solution and grow in the supersaturated solution immediately adjacent to them. Thus rapid evaporation produces fine crystals. By controlling the rate of evaporation and degree of agitation the salt producer is able to vary the size of the crystals produced.

The crystal form depends on the manner in which the crystal is maintained in the solution, whether it is uniformly surrounded by solution, as in an agitated salting-out evaporator, hanging from the liquid surface, as in the grainer, or adhering to a solid surface. Only in the first case does the crystal have perfect form, and even then too vigorous agitation of the crystal slurry may break points from the crystals. The presence of impurities may change the crystal form; thus urea in sodium or potassium chloride solution changes the form from the normal cubic to an elongated octahedral form. Likewise, the crystal form of  $\text{FeSO}_4 \cdot 7\text{H}_2\text{O}$  is affected by the concentration of sulfuric acid in the solution.

### *Solar Evaporation*

Practically all the common salt consumed on or shipped from the Pacific Coast is produced by the solar evaporation of sea water. A solar salt operation requires for its success the combination of availability of a large acreage of land of moderate value, adjacent to the ocean or an ocean bay and of low and essentially constant level, a climate showing high yearly evaporation and low rainfall, a soil of almost zero permeability, and a location reasonably close to principal markets. These conditions are found on San Diego Bay and San Francisco Bay where net evaporation varies between 31 and 43 inches annually. (One inch of evaporation per acre is equivalent to 303,000 gallons or 113 tons of water.) In these areas levees are built around a series of ponds classified as "concentrating" and "crystallizing" ponds. The concentrating ponds should be below high tide level so that sea water can be admitted without pumping. Sea water is admitted at the dry season when its salinity is

greatest. As evaporation occurs the solution is pumped forward from one pond to the next allowing the gypsum to precipitate out. The saturated solution, called "pickle," is pumped to crystallizing ponds, about one tenth the total pond area, where continued evaporation drops the salt crystals to the bottom. More pickle is added until the concentration of other salts has built up to the point where considerable amounts of magnesium salts would crystallize out. At  $18.5^{\circ}\text{Bé.}$ , equivalent to about 4 per cent of the original sea water remaining, the mother liquor, now termed "bittern," is pumped out and processed for bromine and magnesium.\* More pickle is added and crystallization continued until the deposit of salt crystals is from 4 to 6 inches in depth. The pond is then pumped dry and the crop harvested mechanically. Solar salt is marketed in three principal grades: crude grade as taken from stock, a commercial grade made by washing the crude grade and running it through a rotary drier, grinding and screening, and a refined grade made by dissolving the crude and evaporating in vacuum salt evaporators. Solar evaporation of artificial brines is no longer practiced.

At Saltair, Utah, brine is pumped from the Great Salt Lake to ponds at the rate of 5000 gallons per minute for 16 hours per day from the middle of June to the middle of September. Evaporation goes on at approximately the rate of pumping. The brine passes through settling ponds in 5 to 6 days to remove suspended impurities, then to concentrating ponds where it becomes saturated in about three weeks, and then to the final crystallizing ponds where sodium chloride is crystallized to the point where sulfates of sodium and magnesium also would crystallize. This bittern is then rejected. Ponds must be drained in winter to prevent the crystallization of  $\text{Na}_2\text{SO}_4 \cdot 10\text{H}_2\text{O}$  (Glauber's salt). The refinery product has a sodium chloride content of 99.5 per cent or better.

### *Grainer Evaporation*

The grainer process † of evaporation was the next step in development from the now obsolete direct fired kettles and pans. Despite its lower economy of heat and labor compared with the vacuum evaporation system, the salt market has a demand for the particular type of crystal produced in the grainer process, so that approximately one tenth of the solid salt marketed is produced by this process and sold at a price approx-

\* *Chem. & Met.'s Chemical Engineering Flowsheets* (4th Ed.), No. 36.

† *Chem. & Met.'s Chemical Engineering Flowsheets* (4th Ed.), No. 59.

Pictured Flowsheet, *Chem. Met. Eng.*, 47, No. 8, 565-8 (1940).

imately twenty per cent greater than the average for vacuum pan salt. This is indicative of how an uneconomical process can be maintained by buyers' habits.

Grainer pans (Figure 2-10) vary in size up to 150 feet long by 18 feet wide by 24 inches deep and have production capacities up to 80 tons per day. They are constructed of  $\frac{1}{4}$ -inch steel plate. Six to nine inches from the bottom is a row of 4-inch steam pipes about one foot apart running

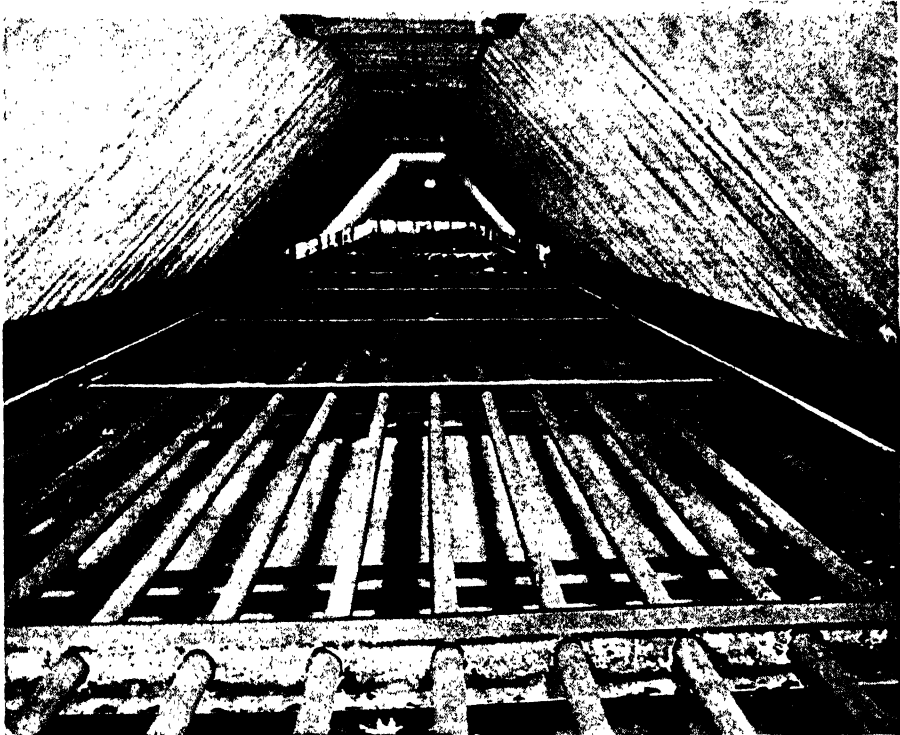

*Courtesy of the Diamond Crystal Salt Company, Inc.*

FIGURE 2-10. Salt Grainer

the length of the grainer and either connected to headers at each end or in a series of several pipes with return bends before returning to the header. A scraping-conveying system is installed in the bottom to move the deposited salt to one end and up a 30-degree inclined drain which allows the mother liquor to drain back into the grainer. The scraper system is hung on angle-irons below the steam pipes. The scrapers are hinged plates the width of the tank and are actuated by a hydraulic ram at the end of the grainer. On the forward stroke the scraper rakes forward

the deposited salt to a position where it can be picked up by the next scraper; thus the salt progresses through the grainer and up the drain at the end. On the backward stroke the hinged scraper swings up and slides over the deposited salt until at the end of its stroke it is in position to pick up the salt raked forward by the preceding scraper. The rate of scraping depends on the rate of evaporation, being one double stroke every two minutes at total capacity.

The pH of the purified feed brine is adjusted to 8.5 with lime to minimize corrosion of the steel. During evaporation the soluble impurities of calcium and magnesium chlorides concentrate in the brine. The calcium sulfate precipitates with the salt in the form of very fine crystals as well as forming scale, due to its inverted solubility curve, on the outside of the steam pipes. This scale formation, up to  $\frac{1}{4}$  inch in thickness, continues to decrease the heat transfer coefficient, already low because of the high resistance of the stationary liquid film, until the grainer is cleaned. Depending on the amount of scale formed, or the amount of calcium and magnesium chloride accumulated in the brine, the grainer is shut down and the brine discarded. The scale is chipped from the pipes by hammering and the grainer is returned to operation on fresh brine. The salt scraped up the inclined drainboard loses most of the mother liquor by drainage, and then is raked onto a rubber conveyor belt or into a Monel-metal trough which carries the moist salt to a washer in which feed brine is used to remove the calcium and magnesium chlorides adhering to the surface as well as approximately 75 per cent of the fine calcium sulfate crystals accompanying the salt. A rotary filter removes excess brine and a rotary kiln drier then reduces moisture to 0.1 per cent. Lumps are broken up between rollers and the product is screened and packed.

The crystal produced by the grainer process is unique because of the method of evaporation and crystal growth. Evaporation occurs only at the surface of the brine and crystal nuclei form in the surface layer. According to the Ross theory these nuclei grow and exert attractive forces which continue their growth; or, supersaturation is in the metastable range where crystal growth occurs and only at intervals does the concentration pass into the labile range where new nuclei can form. The crystal is held in the surface film by surface tension so that crystal growth can occur only around the surface edges of the original cubic crystal. As each crystal mass grows it becomes heavier and sinks slightly in the brine. Continued growth shapes the crystals into hollow pyramids, floating point down, and termed "hoppers" because of their resemblance to

machine hoppers. Finally their increased weight or a surface disturbance causes the crystals to drop to the bottom where the scrapers gather the accumulation. The size of crystals depends on the rate of evaporation, which is controlled by the temperature of the brine. Slow evaporation produces large crystals, though the grainer production capacity is lowered. Grainer crystals are commonly of 10- to 20-mesh size.

Because of the open structure grainer salt dissolves more readily than other salts and is commonly known as "flake salt." It is widely used in making butter, salting fish, and in the production of many food products where form and grade are almost as important as flavor and purity.

### *Vacuum Evaporation*

By far the largest proportion of evaporated salt is produced by boiling the salt brines in an evaporator.\* There may be only one evaporator body (single effect), or up to four evaporators can be connected in series so that the steam produced in the preceding evaporator body is used as the heating steam in the following evaporator (multiple effect evaporation). Thus a quadruple effect evaporator can theoretically evaporate four pounds of water from brine for every pound of steam fed to the first effect. However, thermal losses decrease the steam economy to somewhat over three pounds of water evaporated by each pound of steam. This is approximately equivalent to the production of one pound of salt per pound of steam. Figure 2-11 shows a quadruple effect vacuum evaporator and accessories as used in the salt industry. Vacuum pans vary in size but may be 18 to 22 feet in diameter by 36 to 45 feet high. They usually are made in three sections; the top and bottom are conical while the central section is almost cylindrical, being slightly larger in diameter at the top than the bottom. These sections may be of cast iron and bolted together at flanges, or may be of all steel and welded construction. The central section is the steam chest and contains from 2300 to 2800 copper tubes, each about 5 feet long by 2½ inches in diameter. Forced circulation of the brine through the tubes is obtained by a propeller mounted at the bottom of the downtake. This gives increased liquid velocity upwards through the heater tubes resulting in higher heat transfer coefficients and less deposition of scale or salt on the tubes.

Each vacuum pan is a single evaporator operating under a vacuum which increases from pan to pan. The first effect is fed with low pressure

\* *Chem. & Met.'s Chemical Engineering Flowsheets* (4th Ed.), No. 59.  
Pictured Flowsheet, *Chem. Met. Eng.*, 47, No. 8, 565-8 (1940).



process steam. The water evaporated in the first effect is taken off as steam to heat the second effect, which process continues until the vapor from the fourth effect is taken to a jet or tray condenser, where it is condensed, and thence flows to the hot well of a barometric leg from which it is discharged by gravity. A mechanical vacuum pump removes fixed gases from the condenser and also is connected to the steam chests on the

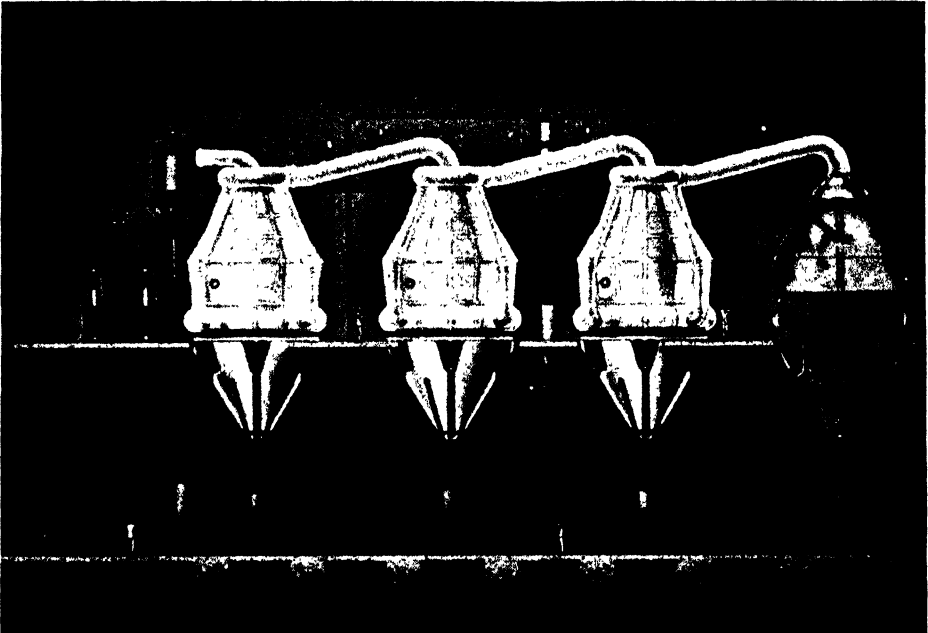

*Courtesy of the International Salt Company*

FIGURE 2-11. Quadruple Effect Salt Evaporator

last three effects to remove the fixed gases driven out of solution as the brine evaporates.

The brine may be introduced into the bottom section of the evaporator, or through the salt leg. In the latter case it serves to wash impurities from the crystals and concentrate them in the evaporator. The salt that crystallizes out settles through the bottom section into a salt drum or "catcher," from which a slurry of brine and suspended crystals is pumped to a separator. The brine overflows at the top and is returned to the evaporator. The salt is removed at the bottom to a centrifuge followed by a kiln drier, or a continuous filter can be used with hot air at 350°F. to dry the crystals; this produces salt ready for screening and packing.

In cases where the brine contains considerable amounts of calcium and magnesium chlorides which are to be recovered the brine feed is not to each pan (parallel flow) but to the last pan, from which it is pumped to the preceding pan (forward flow) until the most concentrated brine is removed from the first effect for further processing.

The salt nuclei produced in the evaporated brine are uniformly surrounded with saturated solution and the crystal grows in its normal cubic shape (Figure 2-7). The size of the crystals is controlled by the speed of evaporation and amount of agitation which keeps the crystal suspended in the solution where growth can occur. Thus the greater the rate of evaporation the larger are the crystals, which is the reverse of the results obtained with the grainer.

“Salting” in an evaporator is the growth of salt crystals in the tube walls, which closes them against circulation of the brine. This obstruction can be minimized by forced circulation of the brine through the tubes, which does not allow the nuclei to attach themselves to the walls. Calcium sulfate scale also is minimized by this process, as well as by proper brine purification; the gypsum precipitates out as very fine crystals which can be separated from the salt by differential settling. At intervals the evaporators are filled with water and the salt and scale deposits boiled out. If necessary the scale is turbinated from the tubes. The brine in which the calcium and magnesium chlorides had concentrated is usually recycled to the purification system.

### *Flash Evaporation*

This process for the production of salt is used by only one company, the Diamond Crystal Salt Company, at its St. Clair (Michigan) plant. However, the principle of flash evaporation is used widely in crystallization processes in various industries. If vacuum is applied to a brine solution until the external pressure is less than the vapor pressure of the solution, boiling occurs. Latent heat of vaporization for the water evaporated must be available, so if no external heat is supplied (an adiabatic process is carried out), the latent heat must be taken from the liquid remaining. Thus evaporation and cooling of the brine occur simultaneously. The Alberger process\* used in the salt industry employs this principle in a rather elaborate system to utilize the steam evolved when the pressure on the brine is reduced. Removal of calcium sulfate is another unique feature.

\* *Chem. & Met.'s Chemical Engineering Flowsheets* (4th Ed.), No. 59. Pictured Flowsheet, *Chem. Met. Eng.*, 47, No. 8, 565-8 (1940).

An Alberger unit consists of a series of five brine heaters through which the brine is pumped. The first three are heated by the steam given off from the three flash evaporators and the last two are heated by exhaust or process steam, so that the brine leaves the heaters under pressure at about 140°C. The brine now is supersaturated with respect to calcium sulfate, the solubility of which decreases with increasing temperature. By providing sufficient time and a large surface covered with calcium sulfate, the calcium sulfate in solution is caused to crystallize out. This is done in a "graveler," a cylindrical vessel filled with stones and having baffles which increase the distance travelled by the liquid in its contact with the stones. The calcium sulfate crystallizes out on these surfaces. Two gravelers are alternated in service to allow for cleaning. The brine then passes to the flashers where the pressure is reduced successively until it is atmospheric in the third flasher. Evaporation occurs in each, and in the third flasher crystal nuclei form and growth begins. The mixture of brine and crystals is discharged beneath the liquid surface into two open pans in series, in which surface evaporation and further crystallization occur. The brine overflow from the pan is pumped back to the first heater and is recycled in the system. The salt deposited is raked to a salt well, then is centrifuged and dried in a rotary drier.

The salt produced in the third flasher consists of cubic crystal nuclei which agglomerate there and in the open pans to form salt particles of high specific surface. In the open pan salt is produced under conditions similar to those in a grainer, so hopper-type crystals form which break to flake grains in the drying and screening operations. The company continues to operate this process, which is uneconomical compared to vacuum evaporation, because of the very desirable salt grain of high purity produced.

### *Marketing of Salt*

#### ECONOMIC FACTORS

The United States salt industry is highly organized with large companies manufacturing salt in most of the producing regions. Of the 58 companies operating 72 plants in 1936, seven large companies produced about 47 per cent of the total, 16 medium-sized companies produced about 44 per cent, and the remaining 35 small companies produced 9 per cent. Supplies are plentiful and modern industrial methods and transportation have made it basically cheap, its almost universal cheapness

being the industry's chief marketing problem. Selection of producing centers depends on the location of marketing centers quite as much as upon the occurrence of deposits. Production facilities in the industry as a whole have been overbuilt and have frequently operated at less than 50 per cent of maximum capacity. A new enterprise must be assured of a near-by market. Expansion by some of the companies is to spread overhead costs over a larger volume of production. Idle equipment is more subject to corrosion and this may explain why profit sometimes may be sacrificed to avoid a shut-down.

For commercial salt there are 10 principal market areas, corresponding roughly to the chief producing states (Table 2-3). In analyzing the American market the matter of competition cannot be overlooked. There is no substitute for salt, so no other industry can compete with it. Thus competition must come from within the industry. Advertising is of doubtful value and is not a factor, compared with its results in a great many other industries, for total consumption is fairly stable and the brands of evaporated salt within their respective grades are fairly uniform. Sales service of the technical staff of the seller may be a competitive factor, but final decisions generally rest on price. The eastern salt producers face competition from cheap salt brought from abroad as ballast by freighters.

The grades and sizes of salt crystals vary from plant to plant, those produced at one plant being:

<i>Coarse grades</i>	<i>Will pass</i>	<i>Retained on</i>
No. 3	1-inch-square	$\frac{3}{4}$ -inch-mesh
No. 2	$\frac{3}{4}$ -inch-mesh	2 $\frac{1}{2}$ -mesh
No. 4	$\frac{7}{8}$ -inch-square	4-mesh
No. 1	2 $\frac{1}{2}$ -mesh	4 $\frac{1}{2}$ -mesh
A	4 $\frac{1}{2}$ -mesh	6-mesh
C	6-mesh	12-mesh

<i>Fine grades</i>	<i>Will pass</i>	<i>Retained on</i>
Special granulated	9-mesh	12-mesh
Granulated	12-mesh	20-mesh
Special fine	20-mesh	45-mesh
Table	24-mesh	45-mesh
Mine fine	everything pass 12-mesh	

Salt is marketed in (1) bulk, and loose salt, or (2) packaged in (a) buyer's sacks, (b) producer's sacks, (c) cartons (square, hexagonal or round), (d) small bags, and (e) pressed blocks. Quantity varies from the 50,000-pound minimum for bulk shipment to the 1½-pound carton of household salt.

The average prices of salt in 1944 are shown in Table 2-4. It is to be emphasized that vacuum evaporation produces the purest salt at the lowest cost.

The uses to which salt is put are given in Table 2-6 with the relative amounts of each type of salt used for each purpose.

TABLE 2-6 Uses for Salt in the United States in 1945

	<i>Evaporated</i>	<i>Rock</i>	<i>Brine</i>
Tonnage used	3,630,729	3,505,740	8,257,672
Per cent of total	23.6	22.8	53.6
INDUSTRY	PER CENT	PER CENT	PER CENT
Chlorine, bleaches, chlorates, etc.	21.9	18.4	13.2
Soda ash	a	0.0	85.9
Dyes & organic chemicals	1.6	1.2	—
Soap (precipitant)	1.4	0.5	—
Other chemicals	2.9	12.6	—
Textile processing	1.0	2.9	—
Hides & leather	2.9	4.6	—
Meat packing	10.0	10.3	—
Fish curing	1.0	2.1	—
Butter, cheese and dairy products	3.1	0.2	—
Canning & preserving	4.3	0.5	—
Other food processing	6.3	0.6	—
Refrigeration	1.3	6.7	—
Livestock	14.9	5.5	—
Highways, railroads, dust & ice control	0.3	8.8	—
Table & household	13.0	6.0	—
Water treatment	4.9	5.7	—
Agriculture	1.2	0.4	—
Metallurgy	0.8	0.8	—
Other uses	7.2	12.3	0.9
	100.0	100.0	100.0

Included under "Other Uses."

## TABLE SALT

Salt to be packaged and sold as table salt is dried in a rotary kiln with hot air to reduce the moisture content to less than 0.1 per cent and then screened to give the desired sizes. Pure sodium chloride will not absorb moisture from the air unless the humidity is over 80 per cent; however, traces of calcium and magnesium chlorides adhering to the crystal surface cause the crystals to be deliquescent and cake together. An inert filler, such as one per cent of tricalcium phosphate or magnesium carbonate, is mixed with the salt to coat the crystal and prevent caking. Iodized salt is made by adding 0.02 per cent potassium iodide to the salt.

## BY-PRODUCTS \*

The presence of comparatively large amounts of bromides in the brine at Midland (Michigan) attracted H. H. Dow, who built the Dow Chemical Company on the diverse chemicals present in this brine (see Table 2-5, analysis 3). With the experience gained on brine the company was able to adapt its processes to extraction of the inexhaustible supply of chemicals in sea water. The present bromine and magnesium industries of the country are based on this work. Their history and technology are recorded in the literature.

*Sodium Sulfate*

The production of sodium sulfate from natural sources has become an increasingly important industry, until in 1945 five companies produced 178,196 tons valued at \$1,525,159, an average value of \$8.56 per ton. Sodium sulfate in the anhydrous form,  $\text{Na}_2\text{SO}_4$ , is known to the trade as "salt cake" because of its production from salt and sulfuric acid. It is used mainly in the production of sulfate (kraft) pulp and glass.

## \* Bromine from sea water:

*Chem. & Met.'s Chemical Engineering Flowsheets* (4th Ed.), No. 11.  
Pictured Flowsheet, *Chem. Met. Eng.*, **46**, No. 12, 771-4 (1939).

## Magnesium products from sea water:

*Chem. & Met.'s Chemical Engineering Flowsheets* (4th Ed.), No. 37, 38.  
Pictured Flowsheet, *Chem. Eng.*, **54**, No. 8, 132-5 (1947).

## Magnesium from sea water:

*Chem. & Met.'s Chemical Engineering Flowsheets* (4th Ed.), No. 34.  
Pictured Flowsheet, *Chem. Met. Eng.*, **48**, No. 11, 130-3 (1941).

## Iodine:

*Chem. & Met.'s Chemical Engineering Flowsheets* (4th Ed.), No. 29, 30, 31.

Sodium sulfate decahydrate, also called Glauber's salt,  $\text{Na}_2\text{SO}_4 \cdot 10\text{H}_2\text{O}$ , is used in small tonnage as a mordant in the dyeing of textiles.

### SOLUBILITY-PHASE RELATIONSHIPS

The system sodium sulfate—water possesses an unusual feature which is of chemical engineering importance. This system is shown in Figure 2-12, plotting solubility as percentage of the total solution against temperature in degrees Centigrade. Significant points in the system are:

*E* at  $-1.10^\circ\text{C}$ . Eutectic, cryohydric, or freezing point of solution

*U* at  $32.48^\circ\text{C}$ . Transition temperature of decahydrate to anhydrous salt,  $\text{S} \cdot 10\text{Aq} \rightarrow \text{S} + \text{solution}^*$

*P* at  $102.8^\circ\text{C}$ . Boiling point at 760 mm.

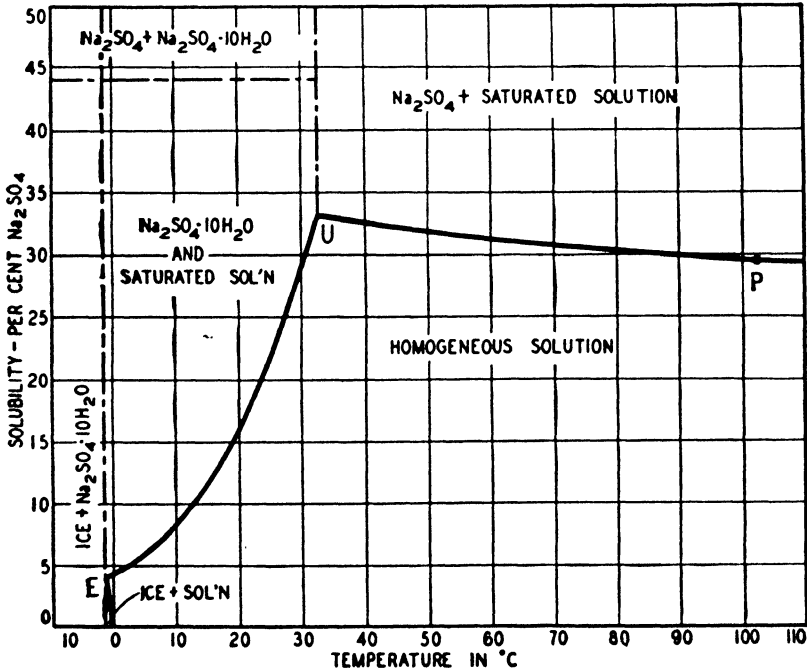

FIGURE 2-12. The System Sodium Sulfate—Water

The line *OE* is the freezing point curve and in the area below *E* between  $-1.10^\circ$  and  $0^\circ$  ice is in equilibrium with the solution. *E* is the cryohydric point and at temperatures below  $-1.10^\circ$  the entire mass

\* The notation of the International Critical Tables uses *S* to designate the anhydrous salt under consideration and *Aq* to represent water. Thus,  $\text{S} \cdot 10\text{Aq}$  is  $\text{Na}_2\text{SO}_4 \cdot 10\text{H}_2\text{O}$ .

is crystals of ice and  $\text{Na}_2\text{SO}_4 \cdot 10\text{H}_2\text{O}$ . The curve  $EU$  is the solubility curve along which  $\text{Na}_2\text{SO}_4 \cdot 10\text{H}_2\text{O}$  is in equilibrium with the saturated solution. Curve  $EU$  has a high temperature coefficient of solubility and  $\text{Na}_2\text{SO}_4 \cdot 10\text{H}_2\text{O}$  is readily crystallized by reducing the temperature of the saturated solution. The composition of  $\text{Na}_2\text{SO}_4 \cdot 10\text{H}_2\text{O}$  is  $\text{Na}_2\text{SO}_4$  44.1%,  $\text{H}_2\text{O}$  55.9%; at compositions above this there is insufficient water and both  $\text{Na}_2\text{SO}_4 \cdot 10\text{H}_2\text{O}$  and  $\text{Na}_2\text{SO}_4$  can exist. Point  $U$  is the transition point at which  $\text{Na}_2\text{SO}_4 \cdot 10\text{H}_2\text{O}$ ,  $\text{Na}_2\text{SO}_4$ , saturated solution, and water vapor are all in equilibrium (an invariant point). Just above this temperature  $\text{Na}_2\text{SO}_4 \cdot 10\text{H}_2\text{O}$  melts "incongruently" to produce  $\text{Na}_2\text{SO}_4$  and a saturated solution. (If all the salt dissolves in the water of crystallization, the melting is termed "congruent.") This is of significance, for if  $\text{Na}_2\text{SO}_4 \cdot 10\text{H}_2\text{O}$  is melted by dropping it into a saturated solution of sodium sulfate kept at  $40^\circ\text{C}$ ., 39 per cent of the sodium sulfate is recovered as anhydrous  $\text{Na}_2\text{SO}_4$  and 61 per cent remains in the saturated solution.

Along the curve  $UP$  anhydrous  $\text{Na}_2\text{SO}_4$  is in equilibrium with the saturated solution. There is a negative temperature coefficient of solubility, or the salt is said to have an "inverted solubility curve." If  $\text{Na}_2\text{SO}_4 \cdot 10\text{H}_2\text{O}$  is added to a boiling saturated solution, 47 per cent of the sodium sulfate is precipitated as anhydrous  $\text{Na}_2\text{SO}_4$ . The decrease in solubility with temperature causes sodium sulfate to crystallize from its solution onto surfaces which are at a temperature above that of the solution. With tube evaporators, as used for sodium chloride, there is a large surface area at a higher temperature so that heat can be conducted to the solution being evaporated. In the liquid film adjacent to the hot tube the solubility is decreased and sodium sulfate forms a hard scale adhering to the tube, just as calcium sulfate forms scale on the steam pipes in the grainer.

These properties of the system shown on the solubility curves are the basis for the recovery of sodium sulfate decahydrate and its dehydration.

#### NATURAL SODIUM SULFATE PROCESSING \*

With the decline in the production of hydrochloric acid from sodium chloride and sulfuric acid, the amount of by-product salt cake available for the chemical industry decreased to such an extent that the demand for sodium sulfate had to be met from other sources. The deficiency has been met by utilizing the natural deposits and brines which occur in the

\* *Chem. & Met.'s Chemical Engineering Flowsheets* (4th Ed.), No. 65.



western states. These deposits are of two kinds: those of the warmer southwest are anhydrous sodium sulfate (thenardite) and those of the colder northwest and Canada are sodium sulfate decahydrate (mirabilite). The deposits of thenardite have been worked to the greater extent, for they produce a material comparable with salt cake. The deposits of mirabilite have been worked on a smaller scale, owing to the necessity of dehydrating the decahydrate, which contains 55.9 per cent water, before shipment.

The thenardite mined contains considerable clay, sodium chloride, and magnesium salts. These are removed by pulverizing the mine lumps to about 10-mesh size and washing with a saturated sodium sulfate solution maintained at a temperature above 90°F. so that the decahydrate does not form. By this washing the clay is removed and most of the extraneous salts are dissolved. The processed sodium sulfate is centrifuged and dried to give a product sufficiently pure for the sulfate pulp industry.

Sodium sulfate decahydrate is produced by the mining of mirabilite, or by the cooling of sodium sulfate brines. If mined, the crystals must be washed free from adhering clay or mud using a saturated solution of sodium sulfate, which now can be at atmospheric temperature. Decahydrate is produced by refrigeration of brines drawn from Soda Lake in West Texas. Brines are pumped from depths of 30 and 80 feet; those from the shallow wells are weaker. The weak brine is pumped out onto the playa of the lake where it leaches the crystalline surface salts and evaporates under favorable weather conditions. It is then pumped through a series of crystallizers, refrigerated by ammonia, where the  $\text{Na}_2\text{SO}_4 \cdot 10\text{H}_2\text{O}$  crystallizes out. The mother liquor is discarded.

The most successful method for the dehydration of decahydrate has been submerged combustion evaporation. In submerged combustion using natural gas, the gas and required air are pumped under slight pressure to a combustion chamber beneath the surface of the solution. Combustion occurs and the hot products of combustion bubble up through the solution. By having sufficient depth of liquid above the burner, amounting to only two or three feet, the gases and evaporated water leave at the same temperature as the solution, indicating complete heat exchange. Heat transfer takes place directly from the hot gas to the liquid, and since scale formation does not occur on a gas bubble, scaling is no problem. Solid decahydrate can be fed to the tank in which the burner is immersed, or hot liquid can be withdrawn to a melting tank where decahydrate is melted and the solution returned for reheating and evaporation.

This method of heating and evaporating solutions that form scale or are corrosive is a general one. Its usefulness depends on the availability of a low cost gaseous fuel.

### Sodium Carbonate

The production of sodium carbonate from natural deposits and brines has been practiced in the western states where the demand for sodium carbonate has been relatively small and the natural resources are readily available. In 1945, 194,045 tons of natural sodium carbonates were produced by four companies, valued at \$3,034,118, an average value of \$15.64 per ton. The trade name for anhydrous sodium carbonate is soda ash, reminiscent of its preparation by ashing certain vegetable plants.

#### SOLUBILITY-PHASE RELATIONSHIPS

The system sodium carbonate—water (Figure 2-13) is somewhat similar to that of sodium sulfate, but has several additional interesting features. Significant points in the system are:

<i>E</i> at $-2.1^{\circ}\text{C}$ .	Cryohydric point
<i>C</i> at $32.00^{\circ}\text{C}$ .	$\text{S}\cdot 10\text{Aq} \rightarrow \text{S}\cdot 7\text{Aq}$
<i>D</i> at $32.96^{\circ}\text{C}$ .	$\text{S}\cdot 10\text{Aq} \rightarrow \text{S}\cdot \text{Aq}$
<i>G</i> at $35.37^{\circ}\text{C}$ .	$\text{S}\cdot 7\text{Aq} \rightarrow \text{S}\cdot \text{Aq}$
<i>P</i> at $104.8^{\circ}\text{C}$ .	Boiling point at 760 mm.
<i>H</i> at $109^{\circ}\text{C}$ .	$\text{S}\cdot \text{Aq} \rightarrow \text{S}$

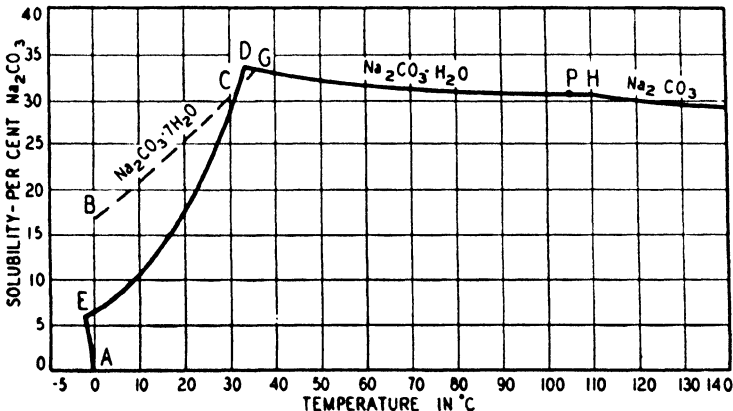

FIGURE 2-13. The System Sodium Carbonate—Water

Between the cryohydric point *E* and point *C* at 32.00°C.,  $\text{Na}_2\text{CO}_3 \cdot 10\text{H}_2\text{O}$  is the stable phase which normally crystallizes from solution. However, another salt, the heptahydrate ( $\text{Na}_2\text{CO}_3 \cdot 7\text{H}_2\text{O}$ ), also can be crystallized under carefully controlled conditions along *BC*. A solution from which the heptahydrate is crystallizing is metastable with respect to the decahydrate, and the introduction of a decahydrate crystal causes the immediate growth of decahydrate crystals and the slow change of all heptahydrate to decahydrate. Point *C* is an invariant point, at which decahydrate, heptahydrate, saturated solution, and vapor are all in equilibrium, or the transition point of decahydrate to heptahydrate. The heptahydrate is the stable phase along *CG*, but at *G* it undergoes transition to the monohydrate. *D* is the transition point of decahydrate to monohydrate but under conditions metastable to the heptahydrate. However, the region of stability of heptahydrate is so small that industrially the decahydrate and monohydrate are considered to be the stable phases. The monohydrate is stable above the boiling point, *P*, of the saturated solution. At approximately 109°C. it changes to the anhydrous form which is the stable form above this temperature. The anhydrous form can be made by evaporating the solution under pressure. The decahydrate melts incongruently at point *D* and about 17 per cent of the sodium carbonate precipitates as the monohydrate, the remainder being in the saturated solution. Melting processes are not satisfactory with the decahydrate and industrial processes attempt to use other chemical or physical principles.

#### SODIUM CARBONATE-BICARBONATE EQUILIBRIUM

The compound usually deposited from natural alkali lakes is  $\text{Na}_2\text{CO}_3 \cdot \text{NaHCO}_3 \cdot 2\text{H}_2\text{O}$ , sodium sesquicarbonate, known as "trona." This is formed because of the equilibrium which exists between the sodium carbonate and bicarbonate in the solution with the carbon dioxide of the air.



The presence of sodium chloride in the solution, and the temperature, influence the solid phase in equilibrium with the solution. Thus when carbon dioxide is passed into a sodium carbonate solution at 20°C. only sodium bicarbonate will form unless sodium chloride is in solution, in which case trona forms. At 25°C., however, only trona forms from the carbonate solution until over half the carbonate has precipitated. The

crystallization rate increases markedly with increased sodium chloride content of the brine, probably due to the greater concentration of sodium ion (common ion effect).

The industrial processes use either a low or high sodium chloride brine and pass in carbon dioxide to produce either bicarbonate or sesquicarbonate.

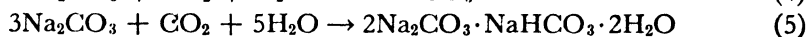

The compound produced is washed free of mother liquor and calcined to remove carbon dioxide and water. Theoretically the necessary carbon dioxide continually recycles in the process, but losses require make-up, produced either from lime kiln gas or ordinary combustion products.

#### NATURAL SODIUM CARBONATE PROCESSING

Production of sodium carbonate at present is largely confined to Owens and Searles Lakes (California). At Owens Lake, the diversion of the Owens River into the Los Angeles aqueduct caused the lake to shrink to but a fraction of its original size and deposit enormous amounts of useful chemicals. Trona deposited as a natural crust which is harvested and calcined to give a relatively impure soda ash (about 70%  $\text{Na}_2\text{CO}_3$ ).

Various methods of plant operation are used to produce a pure soda ash. At the Natural Soda Products Company's plant on Owens Lake the brine is concentrated by solar evaporation and enriched with natural trona dissolved in fresh water. In this way the alkali content is increased sufficiently to render isolation of the bicarbonate efficient. Insufficient supplies of fresh water make it impossible to work with natural trona alone. The sodium chloride content of the brine also decreases the solubility of the bicarbonate. The solution is carbonated in wooden towers, using kiln gas from lime and bicarbonate kilns as a source of carbon dioxide. Sodium bicarbonate precipitates in the solution as a fine granular mass which is filtered off, washed free of foreign salts, and calcined in a rotary kiln to soda ash.

The Pacific Alkali Company\* operating at Owens Lake concentrates the brine by solar evaporation in ponds to 12–14 per cent soda with high sodium chloride content compared to the previous operation. Carbonation duplicates nature's method and trona precipitates out, which is filtered, washed and calcined as was the bicarbonate.

\* Now a division of the Columbia Chemical Division of the Pittsburgh Plate Glass Company.

*Student Exercises*

- A. Prepare a chemical engineering report covering one of these topics:
1. Theories of deposition of rock salt
  2. Composition of and variables in sea water
  3. Deposition of salts from sea water on evaporation
  4. Mining methods in salt mines
  5. Magnesium products from sea water
  6. The natural sodium sulfate industry
  7. The natural sodium carbonate industry
  8. The natural sodium nitrate industry
  9. The borax industry
- B. Plot the complete solubility-temperature relationship to the boiling point for the following system, labeling all points and areas:
- |   |   |
|---|---|
| 1. KCl—H <sub>2</sub> O                             | 6. MgSO <sub>4</sub> —H <sub>2</sub> O  |
| 2. K <sub>2</sub> SO <sub>4</sub> —H <sub>2</sub> O | 7. MgCl <sub>2</sub> —H <sub>2</sub> O  |
| 3. K <sub>2</sub> CO <sub>3</sub> —H <sub>2</sub> O | 8. CaCl <sub>2</sub> —H <sub>2</sub> O  |
| 4. NaNO <sub>3</sub> —H <sub>2</sub> O              | 9. BaCl <sub>2</sub> —H <sub>2</sub> O  |
| 5. KNO <sub>3</sub> —H <sub>2</sub> O               | 10. FeSO <sub>4</sub> —H <sub>2</sub> O |
- C. Prepare flow sheets for the following processes:
1. Salt by the grainer process
  2. Salt by vacuum evaporation
  3. Salt by the Alberger process
  4. Sodium sulfate from natural brines
  5. Sodium carbonate from natural brines
  6. Magnesium sulfate from natural brines
  7. Bromine from sea water and brines
  8. Magnesium from sea water
  9. Iodine from natural brines
  10. Iodine from Chile nitre deposits
  11. Sodium nitrate from Chilean deposits

*Recommended Reading*

## I.

- A.I.M.M.E., *Industrial Minerals and Rocks (Nonmetallics)*, New York, Am. Inst. Mining Met. Engrs., 1937
- Armstrong and Miall, *Raw Materials from the Sea*, Brooklyn, N. Y., Chemical Publishing Co., 1946

- Badger and McCabe, *Elements of Chemical Engineering*, New York, McGraw-Hill Book Company, 1936, chap. V, "Evaporation," and chap. XII, "Crystallization."
- Calvert, *Salt and the Salt Industry*, London, Pitman and Sons, 1929.
- Clarke, *Data of Geochemistry*, U. S. Geol. Survey Bull. 770, 1924
- Furnas, *Roger's Manual of Industrial Chemistry*, New York, Van Nostrand Co., 1942, chap. IX.
- Grabau, *Geology of the Non-Metallic Mineral Deposits*, New York, McGraw-Hill Book Company, 1920, Vol. I.
- Hougen and Watson, *Chemical Process Principles*, New York, Wiley and Sons, 1944, pp. 111-136
- McCabe, "Crystallization": in Perry, *Chemical Engineers' Handbook*, New York, McGraw-Hill Book Co., 1941
- Tressler, *Marine Products of Commerce*, New York, Chemical Catalog Company, 1923, chaps. II-V

## II.

## CRYSTALLIZATION

- Miers, "Growth of Crystals in Supersaturated Liquids,"  
*J. Inst. Metals*, **37**, 331-50 (1927)
- Ross, "Crystallization," *Pacific Chem. Met. Ind.*, **2**, No. 3, 9-20 (1928)
- Ting and McCabe, "Supersaturation and Crystal Formation in Seeded Solutions," *Ind. Eng. Chem.*, **26**, 1201-7 (1934)
- Caldwell, "Application of Vacuum Cooling to Continuous Crystallization,"  
*Chem. Met. Eng.*, **39**, 133-5 (1932)
- Jeremiassen and Svanoë, "Supersaturation Control Attains Close Crystal Sizing," *Chem. Met. Eng.*, **39**, 594-6 (1932)
- Seavoy and Caldwell, "Vacuum and Mechanical Crystallizers,"  
*Ind. Eng. Chem.*, **32**, 627-36 (1940)
- Svanoë, "Krystal Classifying Crystallizer," *Ind. Eng. Chem.*, **32**, 636-9 (1940)
- Caldwell, "Theoretical and Industrial Aspects of Crystallization,"  
*Chem. Met. Eng.*, **49**, No. 5, 116-9 (1942)

## SALT

- Phalen, *Technology of Salt Making in the United States*,  
*U. S. Bur. Mines Bull.* **146** (1917)
- Phalen, *Salt Resources of the United States*, U. S. Geol. Survey Bull. **669** (1919)
- Alling, *Geology and Origin of the Silurian Salt of New York State*,  
*New York State Museum Bull.* **275** (1928)

- Badger, "Salt Manufacture in Michigan," *Chem. Met. Eng.*, **24**, 201-7 (1921)
- Cole, *The Salt Industry of Canada*, *Canadian Dept. Mines Bull.* **716**, (1930)
- Keiser, "Mining and Processing Rock Salt," *Eng. Mining J.*, **130**, 16, 63 (1930)
- Robinson, "Diverse Salt Specifications Met by Modern Manufacture,"  
*Food Industries*, **2**, 244-7 (1930)
- Steinmayer, "Salt-Domes of the United States,"  
*Trans. Am. Inst. Chem. Engrs.*, **25**, 239-49 (1930)
- Seaton, "Bromine and Magnesium Compounds Drawn from Western Bays and Hills," *Chem. Met. Eng.*, **38**, 638-41 (1931)
- Brighton, "Salt-Making on the Great Salt Lake,"  
*J. Chem. Education*, **9**, 407-15 (1932)
- Anon., "Common Salt," *Industrial Chemist*, **8**, 225-8, 247-51 (1932)
- Smith, "Salt—A By-Product of Condenser Cooling,"  
*Ind. Eng. Chem.*, **32**, 547-8 (1932)
- Cooley, "Mining Salt in Texas," *Chem. Met. Eng.* **39**, 390-1 (1932)
- Thompson and Robinson, *Chemistry of the Sea*,  
*National Research Council Bull.* **85** (1932)
- Murphy, "A Pinch of Salt to Tons of Chemicals,"  
*Chem. Markets*, **32**, 311-6 (1933)
- Lee, "Refining the Salt of the Earth," *Chem. Met. Eng.*, **42**, 124-8 (1935)
- Wiegel, *The Salt Industry of Louisiana and Texas*,  
*Am. Inst. Mining Met. Engrs. Tech. Pub.* **620** (1935)
- Crawford, "Salt—Pioneer Chemical Industry of the Kanawha Valley,"  
*Ind. Eng. Chem.*, **27**, 1109-13, 1247-8, 1411-7 (1935)
- LaVigne, *Mining and Preparation of Rock Salt at the Retsof (N. Y.) Mine*,  
*Am. Inst. Mining Met. Engrs. Tech. Pub.* **661** (1936)
- Looker, *Recent Developments in the Use of Sodium Chloride*,  
*Am. Inst. Mining Met. Engrs. Tech. Pub.* **723** (1936)
- Buchen, "Evaporating Salt from the World's Largest Mineral Deposit,"  
*Mining and Metallurgy*, **18**, 335-8 (1937)
- Smith, "Potash in the Permian Basin," *Ind. Eng. Chem.*, **30**, 854-60 (1938)
- Gordy, "Salt," *Excavating Engr.*, **33**, 82-85 (1939)
- Harris, *Marketing of Salt*, *U. S. Bur. Mines Inf. Circ.* **7062** (1939)
- Lee, "A Salt for Every Use," *Chem. Met. Eng.*, **47**, 530-534, 565-8 (1940)
- Looker, "Salt as a Chemical Raw Material,"  
*Chem. Industries*, **49**, 594-601, 790-9 (1941)
- Trump, *Mining Soluble Salines by Wells*,  
*Am. Inst. Mining Met. Engrs. Tech. Pub.* **1733** (1944)  
*Chem. Met. Eng.*, **43**, 364-5 (1936)
- Symposium, "Sodium Chloride versus Construction Materials,"  
*Chem. Eng.*, **54**, No. 10, 211-8, No. 11, 217-20, No. 12, 225-32 (1947)  
*Chem. Eng.*, **55**, No. 1, 223-34 (1948)

## SODIUM SULFATE

- Wells, *Sodium Sulfate; Its Sources and Uses*, *U. S. Geol. Survey Bull.* **717** (1923)
- Cole, *Sodium Sulfate of Western Canada*, *Canadian Dept. of Mines Bull.* **646** (1926)
- Palmer, "Refining Natural Saltcake," *Chem. Met. Eng.*, **32**, 632-4 (1935)
- Rich, "Rhodes Marsh Yields Its Sodium Sulfate,"  
*Chem. Met. Eng.*, **40**, 304-5 (1933)
- Rich, "Sodium Sulfate from Nevada Mine Finds Ready Market,"  
*Eng. Mining J.*, **134**, 252-3 (1933)
- McDermid, "Meeting the Demand for Sodium Sulfate,"  
*Eng. Mining J.*, **135**, 164-5 (1934)
- Tyler, *Sodium Sulfate*, *U. S. Bur. Mines Inf. Circ.* **6833** (1935)
- Kobe, et al., "Evaporation by Submerged Combustion,"  
*Ind. Eng. Chem.*, **28**, 589-94 (1936)
- Pierce, "Dehydration of Natural Sodium Sulfate Crystals,"  
*Trans. Am. Inst. Chem. Engrs.*, **34**, 153-63 (1938)
- Douglass and Anderson, "Submerged Combustion as Applied to Sodium Sulfate Production," *Chem. Met. Eng.*, **48**, No. 5, 135-7 (1941)
- Manning, "Chemicals from California's Desert,"  
*Chem. Met. Eng.*, **48**, No. 9, 96-9 (1941)
- Schultz and Lavine, "Interphase Evaporation of Sodium Sulfate Solution,"  
*Ind. Eng. Chem.*, **34**, 59-64 (1942)

## SODIUM CARBONATE

- Hirschkind, "Alkaline Lake Brines Supply Western Soda Producers,"  
*Chem. Met. Eng.*, **38**, 657-9 (1931)
- Robertson, "California Desert Soda," *Ind. Eng. Chem.*, **23**, 478-81 (1931)
- Dolley, "Absolute Crystallization Rate of Sodium Sesquicarbonate,"  
*Ind. Eng. Chem.*, **29**, 1101-6 (1937)
- Ross, "Saline Lakes of the Southwest,"  
*Pacific Chem. Met. Ind.*, **2**, No. 5, 8-16 (May, 1938)
- Harness and Coons, *Sodium Carbonate*, *U. S. Bur. Mines Inf. Circ.* **7212** (1942)
- Dub, Owens Lake—Source of Sodium Minerals,"  
*Mining Technology*, **2**, No. 5, T. P. 2235 (1947)

## OTHER SALTS AND BRINE CHEMICALS

- Dow, "Economic Trend in the Chemical Industry,"  
*Ind. Eng. Chem.*, **22**, 113-6 (1930)
- Reichart and Schulz, "In the Nitrate Fields of Chile,"  
*Chem. Met. Eng.*, **46**, 464-6 (1939)



- Stine, "Recovery of Bromine from Sea Water,"  
*Ind. Eng. Chem.*, **21**, 434-43 (1929)
- Robertson, "New American Iodine Industry,"  
*Ind. Eng. Chem.*, **26**, 376-8 (1934)
- Stewart, "Commercial Extraction of Bromine from Sea Water,"  
*Ind. Eng. Chem.*, **26**, 361-9 (1934)
- Stewart, "Bromine as a Chemical Raw Material,"  
*Chem. Industries*, **41**, 15-20 (1937)
- Anon., "Bromine from Sea Water," *Chem. Met. Eng.*, **46**, 771-4 (1939)
- Kirkpatrick, "Blowing Bromine from the Sea,"  
*Chem. Met. Eng.*, **41**, 402-4 (1934), **46**, 771-4 (1939)
- Murphy, "Magnesium from the Sea," *Chem. Industries*, **49**, 618-28 (1941)
- Halperin, "Chemicals from the Dead Sea," *Chem. Eng.*, **54**, No. 6, 94-6 (1947)

# CHAPTER 3

## Natural Potassium Salts

---

- I. *Introduction*
    - A. HISTORY
    - B. PRODUCERS
    - C. FLOTATION OF SYLVINITE
    - D. POTASSIUM SULFATE
    - E. RECOVERY OF MAGNESIUM CHLORIDE
  - II. *Natural Deposits*
    - A. STASSFURT
    - B. NEW MEXICO
  - III. *Principles of Salt Separation*
    - A. SYSTEM  $\text{KCl}-\text{NaCl}-\text{H}_2\text{O}$
    - B. SYSTEM  $\text{KCl}-\text{MgCl}_2-\text{H}_2\text{O}$
    - C. SYSTEM  $\text{KCl}-\text{MgSO}_4-\text{H}_2\text{O}$
  - IV. *Operations at Carlsbad*
    - A. MINING
    - B. REFINING SYLVINITE
  - V. *Operations at Searles Lake*
  - VI. *Other Potassium Minerals*
    - A. POLYHALITE
    - B. ALUNITE
  - VII. *Materials of Construction*
  - VIII. *Marketing of Potash*
  - IX. *Student Exercises*
  - X. *Recommended Reading*
- 

THE history of the domestic natural potassium salts industry is one of successful mineral development and application of chemical, engineering and economic principles to free this country of a monopoly exercised by German industry.

Early in its history this country produced and exported "potash" made by burning the hardwoods cleared from the forests to make farm lands. When this source failed the United States became dependent on the German industry which had started to work the Stassfurt deposits and exported potassium salts to this country since about 1870.

The potash made by leaching wood ashes consisted mainly of potassium carbonate and the word "potash" should apply to this carbonate, as "soda ash" does to sodium carbonate. In the fertilizer industry the word "potash" is used to designate any potassium salt, the potassium content of which is expressed as the oxide,  $K_2O$ .

After the German potash salts became available there was little incentive to stimulate domestic production until the blockade of World War I cut off all supplies. The scarcity of potash quickly became a matter of national concern, for maximum production of food crops was demanded. The price of fertilizer-grade potassium chloride skyrocketed from about \$39 to \$500 per ton, with little obtainable at all. All possible sources of potash were developed with varying degrees of success; saline lakes were evaporated and crystallized, distillery slop was evaporated and ashed, potassium-bearing minerals were fused and processed, cement dust was recovered, kelp was burned. Practically all potash produced was of low grade compared to German imports and after the war the American industry became completely disorganized. During the war a seller's market existed; producers could sell anything resembling potash. Most producers expanded as rapidly as possible to increase their profits; few did research to improve their products or amortize their investment against the day of normal prices and foreign competition. Of the 128 plants reporting production in 1918 only one large and one small producer remain.

In 1925 traces of sylvite ( $KCl$ ) were recognized in cuttings from a well in the Permian Basin in southeastern New Mexico, and a five foot seam of polyhalite was located in Midland County, Texas. Core drillings in the Texas-New Mexico area disclosed the existence of a potash basin of sufficient extent to be developed commercially. In 1930 the United States Potash Company completed the first shaft near Carlsbad, New Mexico. Two other companies have since located in this area.

Over 87 per cent of the potassium salts imported or produced in 1940 was used as a fertilizer. Approximately 8 per cent of the salts was used for chemicals and 5 per cent exported. For agricultural use the actual composition of the salts appears to be of little concern except for the soluble potassium content, which is expressed as hypothetical  $K_2O$ .

Of the total potash production in 1943, about 82.5 per cent was mined, 17.5 per cent came from brine and less than 0.1 per cent was by-product. Production and sales of the potash industry in the United States are given in Table 3-1.

TABLE 3-1 Production and Sales of Potash in 1940 and 1945

<i>Production</i>	<i>1940</i>	<i>1945</i>
Potassium salts (merchantable), tons	658,249	1,588,305
Approximate equivalent $K_2O$	379,679	874,243
<i>Sales by producers</i>		
Potassium salts, tons	677,892	1,597,160
Approximate equivalent $K_2O$ , tons	393,058	870,370
Value at plant	\$12,562,050	\$30,313,919
Average per ton	\$18.50	\$18.98

American producers are:

American Potash and Chemical Corporation, which has operated continuously at Searles Lake since 1915.

Bonneville, Ltd., which since 1938 has produced potash by solar evaporation of the brines of the Salerno marsh near the Utah-Nevada border.

North American Cement Corporation, which produces by-product potash from cement kiln dust at Hagerstown, Md.

The United States Industrial Chemicals, Inc., which previously produced by-product potash from molasses distilling waste at Baltimore, Md., ceased this operation in 1943 when grain was substituted for molasses for the manufacture of alcohol.

In the Carlsbad, New Mexico, area, three companies are in operation, the United States Potash Company, Potash Company of America, and the Potash Division of International Minerals & Chemical Corporation (which purchased the Union Potash & Chemical Company).

A new producer in 1945 was Kalunite, Inc., which mined and processed alunite to give potassium sulfate and alumina.

### *Natural Deposits*

Of the various deposits containing potassium salts the one at Stassfurt (Germany) is the best known and has been worked most extensively. From it was produced 80 per cent of the world's potash in 1938. The discovery and exploitation of the geologically similar deposits of the Permian

Basin in the Texas-New Mexico region have followed a technical development similar to that in Germany.

#### STASSFURT DEPOSITS

These cover a potential production area thought to be as much as 24,000 square miles, containing potash salts estimated from 22 to 3,850 billion tons. If the latter estimate is correct the supply would last the world 250,000 years at the present rate of consumption.

These deposits occur in a series of sediments deposited during Permian time in the "Zechstein Sea" which covered what now is northern Germany and Holland. This sea was cut off from the main ocean by a low bar which prevented outflow of the sea water. As the water evaporated in the shallow sea it was replenished by inflows from the main ocean, which came over the bar during storms or at high tides. Thus the concentration of salts gradually increased to the point where deposition of calcium carbonate occurred, followed by calcium sulfate. Inflow of water from the land side brought in more calcium salts and gave rise to much thicker gypsum and anhydrite beds than would sea water alone. Deposition of salt continued (Figure 2-2) until a concentrated bittern remained. Deposition of salts from this bittern was exceedingly complicated and over 30 complex salts were formed. A list of some of the salts formed either by deposition or by secondary reaction is given in Table 3-2. Crystallization from this complex bittern started with the more insoluble salts, as polyhalite, progressed through kieserite, to the more soluble sylvite and carnallite. Many of the minerals now present were formed by metamorphism of the original compounds deposited. The layers of potash salts vary in thickness up to 165 feet.

At this point in the geological period there was a rise in the land and the deposited salts were covered by a layer of wind-blown dust from the mainland which protected the potash deposit from re-resolution when the basin subsided and again was flooded. The cycle was repeated with deposition of calcium salts and sodium chloride. The bittern probably was washed away, for this layer contains no potassium and magnesium salts. These deposits were in turn covered by the clay and limestone strata and sedimentary material that now overlie the deposit.

#### TEXAS-NEW MEXICO PERMIAN BASIN

During Permian time a shallow sea, or succession of seas, covered the area which now is known as the Permian Salt Basin (see Figure 2-3) ex-

tending from Kansas to Texas. Subsidence gradually deepened the southern portion, in what is known as the Delaware Basin, and in this basin final deposition and crystallization of the bittern progressed. Metamorphism and replacement then occurred to change the minerals from those originally deposited to others; in numerous instances polyhalite has replaced anhydrite.

This entire salt area is estimated to underlie 100,000 square miles and to contain 30,000 billion tons of salt. Polyhalite has been found in an area of 40,000 square miles and soluble potash in areas totaling 3000

TABLE 3-2 Some Potash and Associated Minerals

<i>Name</i>	<i>Chemical formula</i>	<i>Per cent K<sub>2</sub>O</i>
Alunite	$K_2SO_4 \cdot Al_2(SO_4)_3 \cdot 2Al_2O_3 \cdot 6H_2O$	11.3
Anhydrite	$CaSO_4$	—
Bischofite	$MgCl_2 \cdot 6H_2O$	—
Burkeite	$2Na_2SO_4 \cdot Na_2CO_3$	—
Carnallite	$KCl \cdot MgCl_2 \cdot 6H_2O$	16.9
Glaserite	$3K_2SO_4 \cdot Na_2SO_4$	37.5
Gypsum	$CaSO_4 \cdot 2H_2O$	—
Halite	$NaCl$	—
Hartsalz	$KCl \cdot NaCl \cdot MgSO_4 \cdot H_2O$	13.9
Kainite	$KCl \cdot MgSO_4 \cdot 3H_2O$	18.9
Kieserite	$MgSO_4 \cdot H_2O$	—
Langbeinite	$K_2SO_4 \cdot 2MgSO_4$	22.7
Leonite	$K_2SO_4 \cdot MgSO_4 \cdot 4H_2O$	25.7
Leucite	$K_2O \cdot Al_2O_3 \cdot 4SiO_2$	21.5
Polyhalite	$K_2SO_4 \cdot MgSO_4 \cdot 2CaSO_4 \cdot 2H_2O$	15.6
Schönite	$K_2SO_4 \cdot MgSO_4 \cdot 6H_2O$	23.5
Sylvite	$KCl$	63.2
Sylvinite	$KCl \cdot NaCl$	30.2
Tachhydrite	$CaCl_2 \cdot MgCl_2 \cdot 2H_2O$	—
Wyomingite	Leucite	—

square miles. The potash content in the latter area is greater than the average potash content in foreign mines and the total reserves were estimated as over 1000 million tons of potash salt, subject to probable increase as more prospect holes are drilled.

### *Principles of Salt Separation*

The deposition of salts from the bittern produced by evaporation and crystallization of sea water is exceedingly complex. Usiglio found that

differences in temperature between day and night caused crystallization of different compounds, which might partially redissolve during the day, and that seasonal temperature changes made tremendous differences in the compounds crystallizing.

The problem was simplified and an understandable explanation was based on the work of J. H. van't Hoff, who made a physical-chemical study, based on the phase rule, of the behavior of pure salts at controlled temperatures and concentrations. By progressing from simple binary systems to the multi-component system of sea water, he was able to give an explanation of the conditions under which deposition occurred. More important from the chemical engineer's viewpoint, he was able to show how the complex salts could be processed to give pure salts. A study will be made of several of the simple systems which are the basis of recovery processes today.

#### SYSTEM KCl—NaCl—H<sub>2</sub>O

This system is one in which one ion is common to the two salts. Hence the solubility of one salt will be decreased in the presence of the other. The solubility data including cryohydric and boiling points are given in Table 3-3. These data are shown in the space model (Figure 3-1). In the

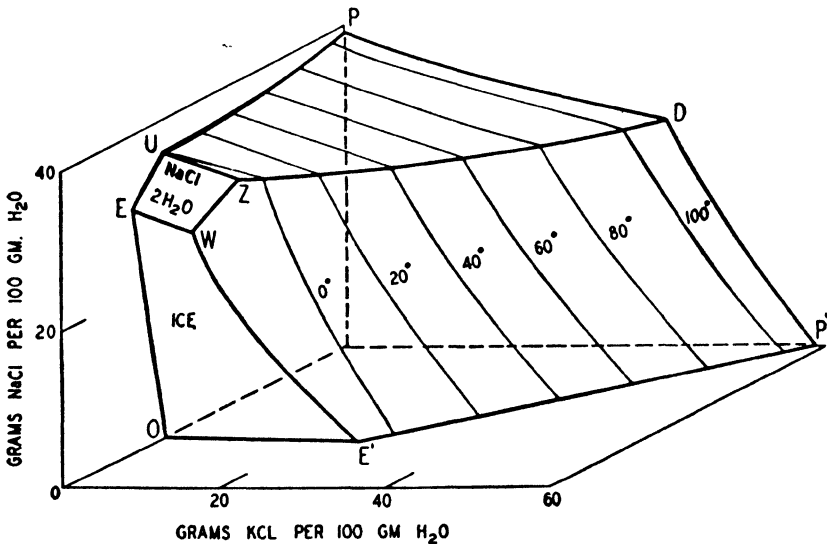

FIGURE 3-1. The System NaCl—KCl—H<sub>2</sub>O

TABLE 3-3 System KCl—NaCl—H<sub>2</sub>O  
Solubilities as grams per 100 grams water.

Point	Cryohydric and transition points			Solid phase
	Temp. C.	KCl	NaCl	
W	-22.9	7.8	27.3	Ice + KCl + NaCl·2H <sub>2</sub> O
E	-21.1	—	30.0	Ice + NaCl·2H <sub>2</sub> O
E'	-10.7	24.3	—	Ice + KCl
Z	-2.3	9.9	32.0	KCl + NaCl + NaCl·2H <sub>2</sub> O
U	+0.1	—	35.6	NaCl + NaCl·2H <sub>2</sub> O

Solubility isotherms			Invariant points		
			KCl	NaCl	
	0	28.1	35.6	10.3	31.8
	20	34.3	35.8	14.8	30.4
	40	40.2	36.3	19.6	29.3
	60	45.5	37.0	24.6	28.4
	80	50.6	37.9	30.0	27.7
	100	55.5	38.9	35.3	27.5

Boiling points			Invariant points	
P'	108.5	57.6	—	
P	118.7	—	39.4	
D	111.9	—	—	38.6
				27.5

vertical plane is shown the system NaCl—H<sub>2</sub>O (Figure 2-6), points *O*, *E*, *U* and *P* being respectively the freezing point of pure water, cryohydric, transition from NaCl·2H<sub>2</sub>O to NaCl, and boiling points. In the horizontal plane is the system KCl—H<sub>2</sub>O with *E'* as cryohydric point and *P'* the boiling point of the saturated solution. Since *W* is the cryohydric point for a solution saturated with both KCl and NaCl·2H<sub>2</sub>O, the area *OEWE'* represents the variation of compositions over which ice crystallizes from the solution. Point *Z* is an invariant point where the solution and vapor are in equilibrium with solid KCl, NaCl, and NaCl·2H<sub>2</sub>O. Over the area *EUZ*W the solution deposits NaCl·2H<sub>2</sub>O. Over the area *PUZ*D the solution deposits NaCl; over *P'E'WZ*D the



solution deposits KCl. The line  $WZ$  represents solutions in equilibrium with both  $\text{NaCl} \cdot 2\text{H}_2\text{O}$  and KCl, while line  $ZD$  represents solutions in equilibrium with NaCl and KCl.

As a basis for crystallization calculations Figure 3-2 is more useful.

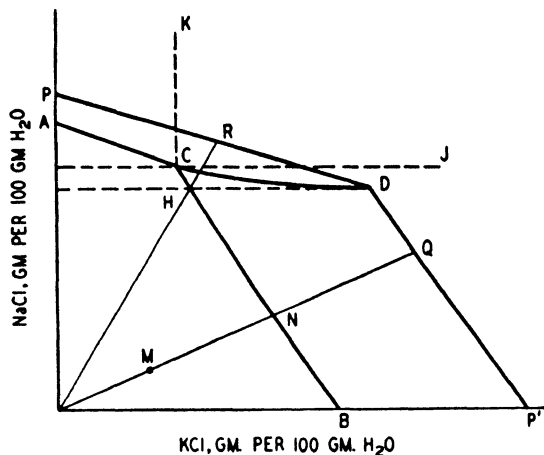

FIGURE 3-2. The System  $\text{NaCl}-\text{KCl}-\text{H}_2\text{O}$ ,  $20^\circ\text{C}$ . isotherm and boiling point isobar

In it are shown the  $20^\circ\text{C}$ . isotherm  $ACB$  and the boiling point isobar  $PDP'$ . Consider the  $20^\circ\text{C}$ . isotherm,  $ACB$ , which represents the boundary between homogeneous solution below and a heterogeneous mixture outside the lines. Within the area  $ACK$  sodium chloride is the solid phase in equilibrium with the saturated solution. Within  $BCJ$  the solid phase is potassium chloride. Within  $KCJ$  the solid phase is a mixture of both salts, in equilibrium with a solution saturated with respect to both and of only one composition at  $20^\circ\text{C}$ . represented by invariant point  $C$ . Similar relationships exist along the isobar  $PDP'$ .

If a solution of composition  $M$  is evaporated the concentrations of both salts increase in the same ratio until  $Q$  is reached. Here the solution is saturated with respect to potassium chloride. Further evaporation precipitates potassium chloride and the composition of the solution moves from  $Q$  to  $D$ . Here the solution is saturated with respect to both potassium and sodium chlorides and continued evaporation would bring down both. However, cooling the solution crystallizes potassium chloride, and the line segment  $DH$  represents the amount of potassium chloride crystallized on cooling to  $20^\circ\text{C}$ . No sodium chloride is crystallized, because of the increased solubility of sodium chloride as potassium chloride is removed from the solution, indicated by the line  $CD$ .

If a solution of composition  $H$  is evaporated it begins to deposit sodium chloride at  $R$  and continues to invariant point  $D$ . If the deposited sodium chloride is filtered off and the solution cooled from  $D$  to  $H$  another crop of potassium chloride crystals can be obtained. In this manner the original solution can be separated into its components potassium chloride, sodium chloride, and water.

SYSTEM  $\text{KCl}-\text{MgCl}_2-\text{H}_2\text{O}$

This system is of importance because carnallite ( $\text{KCl}\cdot\text{MgCl}_2\cdot 6\text{H}_2\text{O}$ ) represents the major potash mineral processed in Germany and is the basis for the production of magnesium chloride which led to the establishment of the magnesium industry.

The  $25^\circ\text{C}$ . isotherm is shown in Figure 3-3. Solubilities are expressed as moles  $\text{MgCl}_2$  and moles  $\text{K}_2\text{Cl}_2$  in 1000 moles of water. The double molecule  $\text{K}_2\text{Cl}_2$  is used to put it on a basis equivalent to  $\text{MgCl}_2$ . The significant points are:

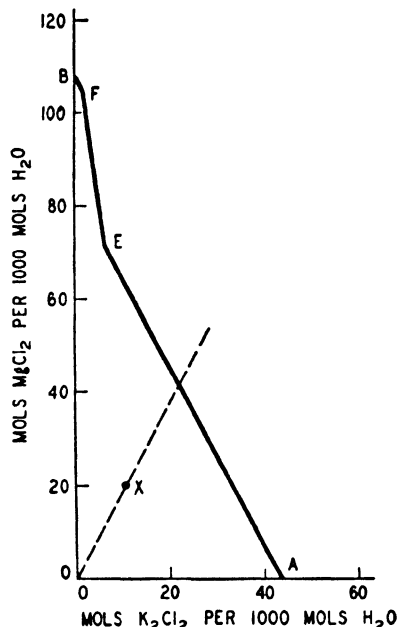

FIGURE 3-3. The System  $\text{KCl}-\text{MgCl}_2-\text{H}_2\text{O}$ ,  $25^\circ\text{C}$ . isotherm

Point	Solid phases	Moles per 1000 moles $\text{H}_2\text{O}$	
		$\text{K}_2\text{Cl}_2$	$\text{MgCl}_2$
A	$\text{KCl}$	44	—
B	$\text{MgCl}_2\cdot 6\text{H}_2\text{O}$	—	108
E	$\text{KCl}$ Carnallite	5.5	72.5
F	$\text{MgCl}_2\cdot 6\text{H}_2\text{O}$ Carnallite	1	105

Within the boundary line  $AEFB$  all solutions are unsaturated, outside are heterogeneous mixtures of salts and solution. If a solution of composition  $X$  is evaporated isothermally at  $25^\circ\text{C}$ . the concentration of the solution increases until line  $AE$  is reached. Further evaporation deposits potassium chloride until the composition of the solution reaches  $E$ , where carnallite forms. If the deposited potassium chloride is not removed, it is dissolved and redeposited as carnallite; the solution at  $E$  is termed

“incongruently saturated.” Carnallite is deposited until  $F$  is reached, where magnesium chloride hexahydrate also is deposited along with the carnallite; the solution at  $F$  is termed “congruently saturated.”

Potassium chloride can be separated from carnallite by adding sufficient water to dissolve all the magnesium chloride and form a solution of composition  $E$ . This dissolves only about 7.5 per cent of the potassium chloride present, and the other 92.5 per cent remains behind as a solid which can be separated.

A three component system, such as this, is frequently shown on a triangular system of coordinates, which has advantages in showing solid phases and allowing more simple crystallization calculations.

#### SYSTEM $\text{KCl}-\text{MgSO}_4-\text{H}_2\text{O}$

This system represents a reciprocal salt pair, for when placed in solution an equilibrium is set up among the ions  $\text{K}^+$ ,  $\text{Mg}^{++}$ ,  $\text{Cl}^-$ ,  $\text{SO}_4^{--}$  so the products of the metathesis likewise represents salts in the system.



Thus the system can be represented by any three of the salts and water and is therefore a four component system. This system can be shown on either of two common figures. Figure 3-4 shows this system at  $25^\circ\text{C}$ . as

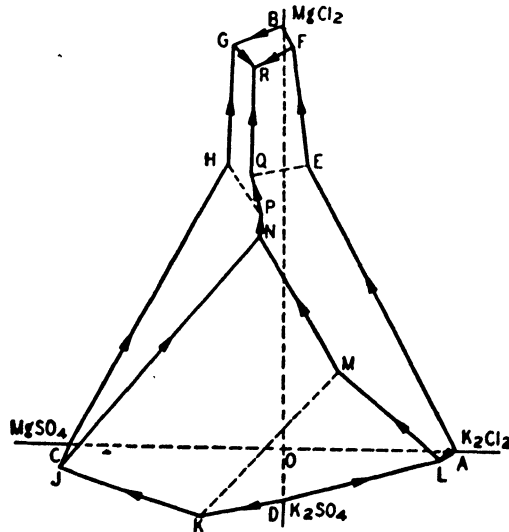

*Redrawn from Findlay and Campbell,  
The Phase Rule, page 307, with permission.*

FIGURE 3-4. The System  $\text{KCl}-\text{MgSO}_4-\text{H}_2\text{O}$ ,  
 $25^\circ\text{C}$ . isotherm

a series of three component systems. In the first quadrant *AEFB* represents the system  $K_2Cl_2-MgCl_2-H_2O$  shown in Figure 3-3. *BGHC* is the system  $MgCl_2-MgSO_4-H_2O$ , *CJKD* is  $MgSO_4-K_2SO_4-H_2O$ , and *DLA* is  $K_2SO_4-K_2Cl_2-H_2O$ . Within these outer boundaries are the invariant points of the four component system, thus point *N* represents a point at which the solid phases are  $KCl$ ,  $MgSO_4 \cdot 7H_2O$ , and schönite ( $K_2SO_4 \cdot MgSO_4 \cdot 6H_2O$ ). Lines connecting these invariant points give areas in which one salt is the stable phase; thus evaporation of a solution the composition of which falls within area *AEQPNML* deposits potassium chloride as the solid phase. When the composition reaches a boundary another solid phase deposits, as along *MN* both potassium chloride and schönite deposit. As evaporation continues the composition makes its way along the line *NPQR*, to *R* which is the end point of crystallization where magnesium chloride hexahydrate, magnesium sulfate hexahydrate, and carnallite deposit. If previous solid phases are not removed they are transformed into these three. At  $100^\circ C$ . schönite is no longer a stable phase and has been replaced by langbeinite, and  $MgSO_4 \cdot 7H_2O$  has been replaced by  $MgSO_4 \cdot H_2O$ .

### Operation at Carlsbad

The three companies operating in the Carlsbad, New Mexico, region in 1945 mined 3,949,983 tons of rich ore from sylvinite and langbeinite beds. Some of this was used as such in fertilizers, but the bulk of the raw ore was processed to yield high grade potassium salts.

### MINING

Underground operations in these mines are similar to the mining of rock salt. Mine shafts are sunk to a depth of 1000 to 1200 feet where they enter the seam of potash which is to be worked. Sylvinite seams being worked are 8 to 14 feet in thickness. The room and pillar method is again used, with a room 60 feet wide between pillars of the potash salts 40 feet square. Primary crushing may be done underground or at the surface, followed by secondary crushing and screening to give particles of 6- to 10-mesh size.

This material may be sold as such, as "manure salts" for fertilizer, or may be processed to obtain a pure potassium chloride. A typical analysis approximates 42.7%  $KCl$ , 56.6%  $NaCl$  and 0.7% insoluble, mainly  $Fe_2O_3$ , which gives the crystals a beautiful red color.

## REFINING SYLVINITE\*

The United States Potash Company makes use of the solubility relationships in the system  $\text{KCl}-\text{NaCl}-\text{H}_2\text{O}$  to crystallize a potassium chloride of 99 per cent purity. A flowsheet for the operations is given in

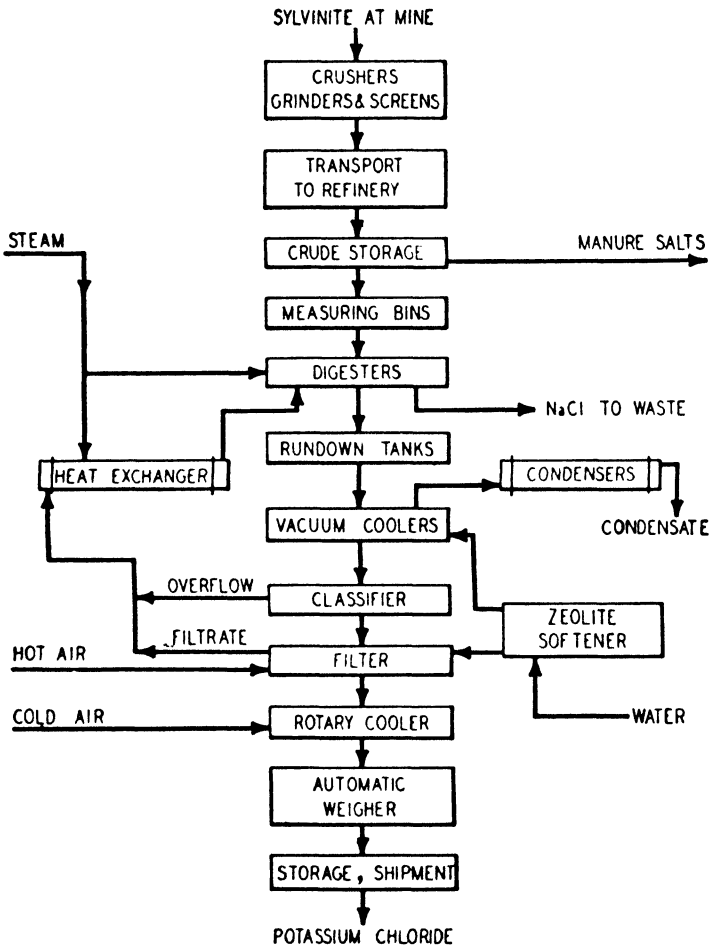

FIGURE 3-5. Crystallization of Potassium Chloride from Sylvinitic Ore

Figure 3-5. The ground ore is charged to digesters and steamed for 30 minutes to raise its temperature, whereupon mother liquor from a previous cycle is admitted. The liquor is circulated through the charge and heated with live steam to maintain the solution at the boiling point,

\* *Chem. & Met.'s Chemical Engineering Flowsheets* (4th Ed.), No. 56.

which is approximately 110°C. at the altitude of the plant. The composition of the mother liquor corresponds approximately to *H* (Figure 3-2), and in contact with the sylvinite it dissolves only potassium chloride to become a solution corresponding approximately to *D*. Thus the sodium chloride of the sylvinite is undissolved and removed from the digesters by pulping in water and pumping as waste to salt flats. The digester cycle requires approximately  $2\frac{3}{4}$  hours. The hot saturated solution from the digester goes to an insulated rundown tank for storage until it is pumped to a series of three cast-iron vacuum crystallizers, provided with propeller type agitator, surface condensers, and steam-jet ejector to provide the vacuum. The temperature of the solution is reduced by steps in the three crystallizers from approximately 110° to 76° to 54° to 32°C., respectively by flash evaporation of the water in the solution. The water evaporated is condensed and used as boiler feed water.

As shown in Figure 3-2, when the solution saturated with both salts at *D* is cooled to *H*, only potassium chloride crystallizes out, as the solution becomes unsaturated with respect to sodium chloride. If evaporation occurs, the solution can become saturated with respect to sodium chloride and crystallize out to contaminate the final product. However, this is prevented in plant operation by injecting into the vacuum coolers an amount of water equal to that evaporated. Hence the concentration of sodium chloride remains unchanged and only potassium chloride crystallizes. The slurry of potassium chloride crystals from the last cooler is thickened, filtered, and dried by hot air blowing through the filter cake. The dried potassium chloride is cooled and then goes to storage for shipment.

#### FLOTATION OF SYLVINITE

The mineral sylvinite is a mechanical mixture of crystals of sodium and potassium chlorides that varies in composition and is not a double salt as indicated by the frequently written formula  $\text{NaCl}\cdot\text{KCl}$ . This fact is employed by the Potash Company of America to separate the salts from one another by a mechanical flotation.

The mill feed goes from storage bins to four ball mills which wet-grind the sylvinite in a brine saturated with both salts at the operating temperature. The ore is ground to about 100-mesh, oversize being recycled in the grinding system. This grinding breaks the larger crystals down to small individual crystals of sodium and potassium chlorides. By using a flotation cell with soap or other anionic detergent as the frother

the sodium chloride crystals are floated off in the froth while the potassium chloride crystals are depressed and remain in the body of the brine. The sodium chloride crystals are separated from the froth and go to waste. The potassium chloride crystals are separated by a thickener and centrifuged and dried. Finest are pelleted wet, dried, and then crushed coarsely to the size desired by the trade. The potassium chloride crystals retain their original pink color. Purity of the product runs 96–99 per cent potassium chloride.

Bonneville, Ltd., produces by solar evaporation (Chapter 2, page 33) a mixed salt containing two parts of sodium chloride and one part of potassium chloride. The mother liquor is removed at the concentration that would begin to deposit carnallite from the magnesium chloride in the bittern. The mixed crystals of sodium and potassium chlorides are harvested and ground to pass a 30-mesh screen. By a flotation process the potassium chloride is floated from the sodium chloride which leaves in the tailings. A long-chain aliphatic amine is the primary flotation reagent used and is selective on the potassium chloride unless the crystal size becomes too small (150-mesh), whereupon selectivity is lost.

#### POTASSIUM SULFATE

A number of processes based on phase rule relationships are being operated at Carlsbad by the International Minerals and Chemical Corporation. This company mines both sylvinites, which is processed by flotation, and langbeinite ( $K_2SO_4 \cdot 2MgSO_4$ ), which is processed to give potassium sulfate. Langbeinite is freed from the halite that accompanies it by washing with water, in which halite dissolves rapidly in comparison with the langbeinite, which is then dried and shipped as a fertilizer mixture.

For the production of potassium sulfate the ore is ground and treated with a potassium chloride solution. The plant term “base-exchange” is used for this metathetical reaction.



If only the stoichiometric amount of potassium chloride were used, the reaction would proceed slowly and not go to completion. An excess of about 25 per cent potassium chloride is used to carry the reaction to completion in three or four hours depending on such factors as particle size and temperature used. This excess of potassium chloride would be lost in the mother liquor with the magnesium chloride if recovery were

not possible. The mother liquor is used to treat charges of langbeinite in succession so that most of the potassium chloride is utilized. The mother liquor from the last treatment is evaporated and the double salts containing potassium, as carnallite, are returned to the leaching system. In this way up to 96 per cent of the potassium is recovered as potassium sulfate, while without evaporation about 85 per cent would be recovered.

The arrangement of treating tanks provides a continuous batch process in which there is a countercurrent flow of langbeinite and potassium chloride solution. Five treating tanks are used, with a piping arrangement that will allow any one of the five tanks to be connected as tank *A* of Figure 3-6. The operation of the system will be discussed for the steady

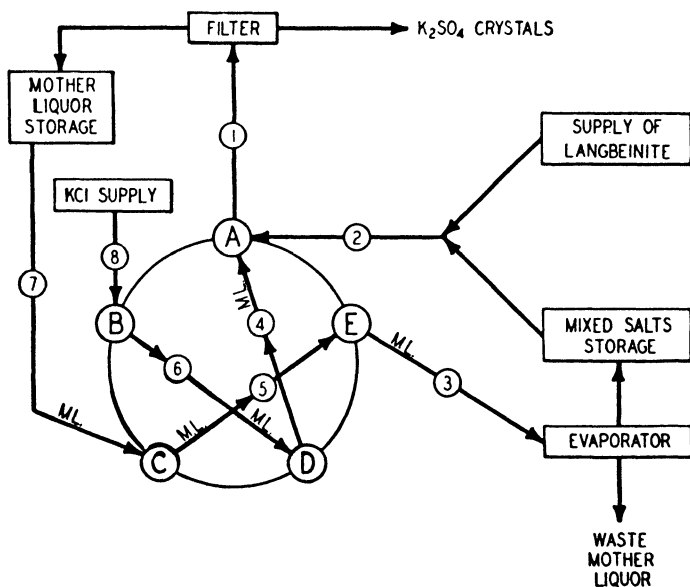

FIGURE 3-6. Production of Potassium Sulfate from Langbeinite

state period in which the operations follow the numbered sequence shown on the figure. At the end of the period of agitation the slurry of mother liquor and potassium sulfate crystals is pumped to the filter and separated. The mother liquor (abbreviated *M.L.* in the figure) goes to a storage tank and the potassium sulfate crystals to a drier and then to storage. A fresh charge of langbeinite and mixed salts from the evaporator is added to tank *A*. The suspended solids in the other tanks having been allowed to settle, the mother liquor in tank *E* is pumped to the



evaporator, the mother liquor in *D* to *A*, in *C* to *E* and in *B* to *D*. Into *C* is charged an equal volume of mother liquor from storage, and into *B* is charged an equal volume of potassium chloride solution containing only that amount of potassium chloride equivalent to the magnesium sulfate in the langbeinite in the charge to *A*. Agitation is now started in all tanks and the partly converted langbeinite in *B* is completely converted by the fresh potassium chloride solution. Tank *B* has now become tank *A* in the cycle, *A* is *E*, *E* is *D*, *D* is *C*, and *C* is *B*. Each time a batch is discharged at *A* the original tank *A* advances one step in the cycle until in the sixth batch it again functions as described. Thus it is seen that as the amount of potassium chloride in solution decreases, it successively meets solids having an increasing content of langbeinite. The excess potassium chloride merely recycles in the process and is recovered in the mixed salts.

#### RECOVERY OF MAGNESIUM CHLORIDE

An ingenious application of phase principles is used to recover both the potassium and magnesium ions in the solution as chlorides.\* The brine from the potassium sulfate plant is evaporated in a triple effect evaporator, in the third effect of which only water removal occurs. When the brine is saturated it advances to the second effect and here is added mother liquor from carnallite crystallization and a slurry of salts which separated in the first effect. Reaction and evaporation occur with the deposition of  $\text{NaCl}$ ,  $\text{KCl}$ , and  $\text{K}_2\text{SO}_4 \cdot 2\text{MgSO}_4$ , which are returned to the potassium sulfate plant. The solution advances to the first effect where evaporation deposits  $\text{NaCl}$ ,  $\text{KCl} \cdot \text{MgCl}_2 \cdot 6\text{H}_2\text{O}$ , and  $\text{MgSO}_4 \cdot \text{H}_2\text{O}$ , which are returned as a slurry to the second effect to react with the solution there. To the hot solution from the first effect are added water and sylvite from the flotation plant. After solution is complete the liquor passes to a batch vacuum crystallizer where the solution deposits pure carnallite. In this way a material is secured which is free from sulfate ion and suitable to produce a pure magnesium chloride for the production of magnesium.

The carnallite is treated with cold water to produce solid potassium chloride and a solution corresponding to point *E* (Figure 3-3). This solution now is concentrated in a submerged combustion evaporator and cooled in vacuum crystallizers to bring it to point *F* and deposit carnal-

\* Pictured Flowsheet, *Chem. Met. Eng.* 51, No. 5, 142-5 (1944).

lite, which is recycled. The solution is spray-dried to give a solid approximating  $\text{MgCl}_2 \cdot \text{H}_2\text{O}$ , which is satisfactory for electrolytic magnesium cell feed. The small amount of potassium chloride (2 moles  $\text{KCl}$  to 105 moles  $\text{MgCl}_2$ ) does not affect the electrolysis.

### Operations at Searles Lake

The American Potash and Chemical Corporation operating at Searles Lake (California) is the only large producer remaining from the World War I potash enterprises. Its survival was made possible by a thorough study of the scientific, technical, and economic factors surrounding such an enterprise at this saline lake.\* An absorbing history of this has been written by Teeple.

Searles Lake is the remnant of a once large lake which received alkaline drainage from the surrounding mountains. Now it has an area of about 12 square miles of hard compact crystal mass, the interstices filled with a saturated solution of highly complex composition. The ionic analysis of the brine has been calculated to show the hypothetical compounds present, Table 3-4.

TABLE 3-4 Compounds Present in Searles Lake Brine  
(Percentage by weight)

$\text{NaCl}$	16.35	$\text{CaO}$	0.0022
$\text{Na}_2\text{SO}_4$	6.96	$\text{Fe}_2\text{O}_3 + \text{Al}_2\text{O}_3$	0.0020
$\text{KCl}$	4.75	$\text{NH}_3$	0.0018
$\text{Na}_2\text{CO}_3$	4.74	$\text{NaI}$	0.0014
$\text{Na}_2\text{B}_4\text{O}_7$	1.51	$\text{Sb}_2\text{O}_3$	0.0006
$\text{Na}_3\text{PO}_4$	0.155	Organic	0.006
$\text{NaBr}$	0.109		
$\text{LiCl}$	0.021	Total solids approximately	34.65
$\text{Na}_2\text{S}$	0.020	Water by difference	65.35
$\text{As}_2\text{O}_3$	0.019		

In addition, the pH of 9.48 indicated bicarbonate, metaborate, and monohydrogen-phosphate ions.

\* *Chem. & Met.'s Chemical Engineering Flowsheets* (4th Ed.), No. 57.  
Pictured Flowsheet, *Chem. Met. Eng.*, 52, No. 10, 134 7 (1945).

Early attempts to obtain potash from Searles Lake were based on solar evaporation of the brine. They resulted in failure, apparent once the phase diagrams for this complex system are examined. Figure 3-7

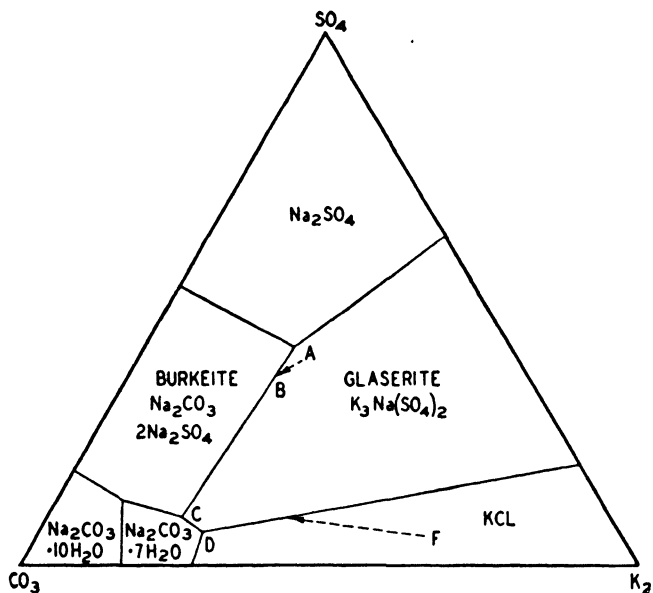

*Redrawn from Ind. Eng. Chem.* 21, 521-2 (1929) with permission.

FIGURE 3-7. Phase Relationships in Searles Lake Brine at 20° C. The system is saturated with sodium chloride at all points.

shows the relationship for the ions  $\text{SO}_4^{--}$ ,  $\text{CO}_3^{--}$  and  $2\text{K}^+$  at 20°C. in a solution saturated with sodium chloride at all points. Other minor ions are ignored at this time. The composition of the brine is roughly point A in a field in which glaserite [ $\text{K}_3\text{Na}(\text{SO}_4)_2$ ] is the stable phase. Solar evaporation at 20°C. first crystallizes glaserite and the ever-present halite and the composition moves away from the  $\text{K}_2$ — $\text{SO}_4$  base line. At point B, burkeite ( $\text{Na}_2\text{CO}_3 \cdot 2\text{Na}_2\text{SO}_4$ ) begins to crystallize and the composition moves to point C where  $\text{Na}_2\text{CO}_3 \cdot 7\text{H}_2\text{O}$  joins the salts, and burkeite ceases to crystallize after C is passed. The composition proceeds to point D, the end-point of crystallization, where continued evaporation brings down KCl,  $\text{Na}_2\text{CO}_3 \cdot 7\text{H}_2\text{O}$  glaserite, and halite. But by the time, point D is reached most of the potash has been lost in the valueless glaserite-halite mixture. Solar evaporation results in failure.

Figure 3-8 shows the same system at 100°C. and it is immediately noticed that the areas of the salt fields have changed considerably and burkeite now dominates the system. Evaporation of the brine of composition *A* in triple effect evaporators deposits only burkeite and halite, and the composition moves away from the  $\text{CO}_3\text{—SO}_4$  base line. At point *E*,  $\text{Na}_2\text{CO}_3 \cdot \text{H}_2\text{O}$  joins in until point *F*, the end-point of crystallization, is reached, where all four salts would crystallize together to give a valueless mixture. However, the temperature is reduced to 20°C. in

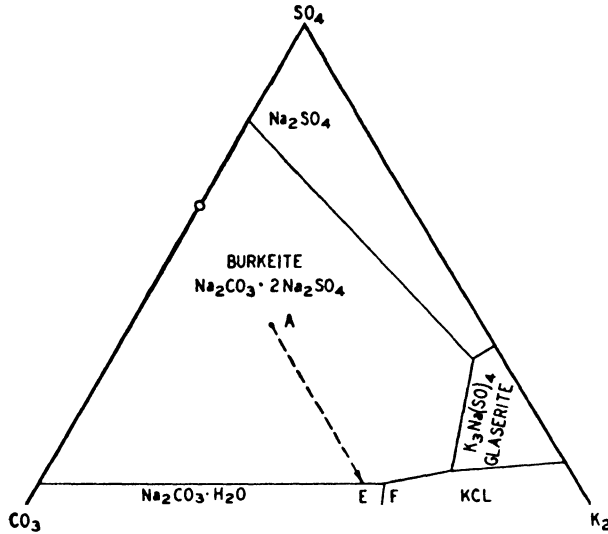

Redrawn from *Ind. Eng. Chem.* **21**, 521-2 (1929) with permission.

FIGURE 3-8. Phase Relationships in Searles Lake Brine at 100° C. The system is saturated with sodium chloride at all points.

vacuum crystallizers and point *F* now appears in the middle of the potassium chloride field (Figure 3-7), but supersaturated with respect to that diagram. As potassium chloride crystallizes out, the solution becomes unsaturated with respect to sodium chloride (Figure 3-2); pure potassium chloride comes out until the composition reaches the glaserite field. Here the potassium chloride is filtered off and the mother liquor recycled in the process.

This explanation has ignored the borax which is present in about one-third the amount of the sylvite. The solution at point *F* is also saturated with borax, but when cooled the rate of crystallization of the potassium chloride is rapid and it separates from the solution whereas the borax forms a supersaturated solution. After the separation of the

potassium chloride the solution is seeded with borax crystals and crystallization readily occurs.

An important application of crystal size is made in the recovery of the burkeite from the halite produced in the initial evaporation of the brines at 100°C. (point *A* to *F*). The evaporation process gives coarse sodium chloride crystals, larger than 50-mesh, whereas the burkeite comes out as fine crystals considerably under 50-mesh. The hot slurry of salts from the evaporators passes to conical separators, known as "salt traps," in which the coarse sodium chloride crystals settle rapidly and the overflow carries the burkeite to clarifiers where it settles out and is filtered on continuous rotary filters, the mother liquor returning to the evaporators.

The burkeite is broken down into its components, sodium sulfate and sodium carbonate, utilizing phase relationships similar to systems previously studied (Figures 2-12 and 2-13), and recovered as decahydrates. The sodium carbonate monohydrate is recrystallized by evaporation of the solution above the transition temperature of the decahydrate. The monohydrate that crystallizes is calcined to remove all water and produce a dense ash. The sodium sulfate decahydrate is dehydrated in a unique manner in which the heat of crystallization of sodium sulfate decahydrate in a vacuum crystallizer is used to melt the decahydrate in the condensers of the apparatus. The transition temperature of the decahydrate is reduced from 32.4° to 17.9°C. by suspending it as a slurry in a saturated sodium chloride solution. In order that the solution may be maintained saturated with sodium chloride as the decahydrate melts, sufficient solid sodium chloride also is maintained in the slurry. This slurry is circulated through the barometric leg of the condenser and condenses the water vapor given off by flash evaporation in the crystallizer. The latent heat of condensation of the water vapor supplies the heat of transition of the decahydrate to the anhydrous salt. The solid sodium chloride in the slurry dissolves in the solution formed and precipitates out additional sodium sulfate. The sodium sulfate is filtered off, washed and dried.

Potassium sulfate is also made by reaction of potassium chloride with burkeite and separated out as glaserite. Potassium bromide crystals are isomorphous with potassium chloride and crystallize out with it. The potassium bromide is then leached from the chloride and the bromine recovered by treating the solution with chlorine and distilling off the bromine. A crude lithium-sodium phosphate is recovered in the process for sodium sulfate and carbonate. It is shipped as a crude salt to various processors.

*Other Potassium Minerals***POLYHALITE** ( $K_2SO_4 \cdot MgSO_4 \cdot 2CaSO_4 \cdot 2H_2O$ )

Polyhalite was the first potassium mineral first found in large quantities in the Texas-New Mexico deposits. Because of its insoluble nature a chemical process must be used to extract the potash. The large amounts of inert salts prevent its shipment as fertilizer. As it is the most abundant potash mineral it remains an important potash reserve.

**ALUNITE** ( $K_2SO_4 \cdot Al_2(SO_4)_3 \cdot 2Al_2O_3 \cdot 6H_2O$ )

Extensive deposits of alunite exist in Utah, containing up to 35 per cent aluminum oxide. Considerable work has been done to process this mineral to obtain both potassium sulfate and alumina for aluminum production. The process of Kalunite, Inc., is to digest the mineral with a solution containing potassium sulfate and sulfuric acid and crystallize out potassium alum to recover the two salts. When heated in an autoclave, the alum hydrolyzes to an insoluble basic salt, freeing sulfuric acid and potassium sulfate, which are returned to the digester. The basic salt is calcined to drive off sulfur oxides (used for sulfuric acid), and the calcine is leached free of potassium sulfate to give an alumina suitable for the manufacture of aluminum.

*Materials of Construction*

The corrosion problem encountered in the potash industry is similar to that in the salt industry, with increased corrosion due to magnesium salts present. Wood is a standard material used extensively for both dry salts and solutions. Dry salts also can be handled in steel, but cast iron resists corrosion from solutions better than does steel. Digesters and vacuum crystallizers (Figure 3-5) are of cast iron construction to resist both corrosion and pressure.

Monel, Inconel, and the stainless steel alloys are used extensively, as in the salt industry. Excellent service has been obtained from castings, as pumps, of Ni-Resist alloy (an iron alloy containing 13 to 15 per cent of nickel and smaller amounts of chromium and manganese). Rubber is used widely to cover materials immersed in the corrosive solution. Rubber-lined hose, supported in V-troughs, gives better service than do metal pipes. Open wooden launders can be lined with old conveyor belting to form an open channel for solution flow. Wood, in the form

of matched maple flooring, has been used to line steel equipment. Although such lining is not impervious to the brine, it does hold in place the crust of corrosion products which form, whereupon further corrosion proceeds quite slowly. Because most of the product goes to the fertilizer industry, these plants do not need to use the care that is exercised in the salt industry to keep the potash free from products of corrosion. Transite board is used successfully for building construction.

Electrolytic corrosion occurs readily in this hot concentrated brine solution, and the chemical engineer must use care in the manner in which he couples together dissimilar metals lest they form a primary cell in which anodic corrosion destroys the more active metal. Cramer reports the movement of copper throughout a brine solution, appearing on a valve interior one day and disappearing again, only to reappear on an agitator propeller several hundred feet away. Copper is introduced into the solution from the blasting caps and lead wires used in the mine. The deposit it forms on a metallic surface is cathodic to the other metal, which becomes anodic and corrodes with the formation of pits around the periphery of the copper deposit.

### *Marketing of Potash*

Inasmuch as the fertilizer industry buys over 87 per cent of the potash production it is interested in buying the material on the basis of the potash, or  $K_2O$ , present. Fertilizer salts are sold on the basis of the "units" of  $K_2O$  present. The unit is defined as one per cent per ton, or a weight of 20 pounds. Thus, a potash salt analyzing 50 per cent  $K_2O$  contains 50 units of  $K_2O$  per ton. At a quoted price of 60 cents per unit this salt would sell at  $(50)(\$0.60) = \$30.00$  per ton.

Prices for the 1945-46 fertilizer season for the various commercial grades were:

	<i>Cents per unit <math>K_2O</math></i>
Muriate of potash (62 to 63% $K_2O$ minimum)	53.5
Muriate of potash (60% $K_2O$ minimum)	53.5
Muriate of potash, granular (50% $K_2O$ minimum)	53.5
Muriate of potash, granular (48% $K_2O$ minimum)	53.5
Manure salts (22% $K_2O$ minimum)	20
Sulfate of potash (90 to 95% $K_2SO_4$ , basis 90% $K_2SO_4$ )	\$36.25 per short ton
Sulfate of potash-magnesia (basis 40% $K_2SO_4$ , 18.5% $MgO$ )	\$26.00 per short ton

These prices were ex-vessel (c.i.f. \*) at Atlantic and Gulf ports and were subject to discounts depending on time of placing order, time of delivery, and tonnage. By this inducement the producer attempts to stabilize the highly seasonal characteristics of the fertilizer industry from congested seasonal demand to an orderly month-by-month delivery throughout the year. This is in keeping with production operations which must be continuous to be most economical and efficient. Other discounts are allowed for shipments f.o.b. Carlsbad or Trona.

The foreign potash industry is an excellent example of a monopoly controlled by the government to prevent overproduction and low prices. The German industry was controlled by the German Potash Syndicate which apportioned production and sales quotas among producers. Less efficient mines were closed, only 63 out of 228 shafts operating. Closed properties retained their sales quotas and sold them to operating companies. The foreign potash industry in 1925 also formed a "cartel" to allocate foreign markets, apportioning 70 per cent to German producers and 30 per cent to French producers. Price fixing was practiced by the cartel. American producers are prohibited by law from joining in such a cartel.

Fertilizers sold to the public usually are mixed fertilizers containing the three elements essential to plant growth, nitrogen, phosphorus, and potassium. These elements may be present in any one of several forms, as potassium may be utilized as manure salts, potassium chloride, or sulfate. However, the potassium content always is expressed as per cent potash,  $K_2O$ . Likewise the nitrogen compounds are expressed as per cent nitrogen (N), and phosphorus as per cent phosphorus pentoxide ( $P_2O_5$ ). In fertilizer formulas these elements always are arranged in the order nitrogen—phosphorus—potassium, so that a 8-6-8 formula represents a fertilizer with 8 per cent N, 6 per cent  $P_2O_5$  and 8 per cent  $K_2O$ .

### Student Exercises

- A. Prepare a chemical engineering report covering one of the following topics:
1. Formation and geology of the Stassfurt deposits
  2. Formation and geology of the Permian basin in Texas and New Mexico
  3. Mining methods in potash mines
  4. Alunite as a source of potash and alumina
  5. Utilization of Wyomingite
  6. Chemical utilization of kelp
  7. Recovery of potash from cement kiln and blast furnace dust

\* c.i.f. is cost, insurance and freight paid.



B. Plot the following system at one temperature and show what will happen when a solution is concentrated. How does crystallization proceed?

- |   |  |
|---|--|
| 1. KCl—K <sub>2</sub> SO <sub>4</sub> —H <sub>2</sub> O                                   | 7. NaCl—K <sub>2</sub> SO <sub>4</sub> —H <sub>2</sub> O                             |
| 2. NaCl—Na <sub>2</sub> SO <sub>4</sub> —H <sub>2</sub> O                                 | 8. NaNO <sub>3</sub> —KCl—H <sub>2</sub> O   |
| 3. NaCl—NaNO <sub>3</sub> —H <sub>2</sub> O   | 9. Na <sub>2</sub> CO <sub>3</sub> —K <sub>2</sub> SO <sub>4</sub> —H <sub>2</sub> O |
| 4. KCl—KNO <sub>3</sub> —H <sub>2</sub> O   | 10. Na <sub>2</sub> CO <sub>3</sub> —KCl—H <sub>2</sub> O                            |
| 5. Ca(NO <sub>3</sub> ) <sub>2</sub> —Sr(NO <sub>3</sub> ) <sub>2</sub> —H <sub>2</sub> O | 11. NaNO <sub>3</sub> —BaCl <sub>2</sub> —H <sub>2</sub> O                           |
| 6. CaCl <sub>2</sub> —MgCl <sub>2</sub> —H <sub>2</sub> O                                 | 12. NaCl—(NH <sub>4</sub> ) <sub>2</sub> SO <sub>4</sub> —H <sub>2</sub> O           |

C. Prepare flowsheets for the following processes:

- Potassium chloride from carnallite
- Boric acid from Searles Lake brine
- Potash and alumina from alunite
- Potash from Wyomingite
- Potash from kelp
- Potash from polyhalite
- Potash from cement kiln dust
- Sodium sulfate and carbonate from burkeite

### *Recommended Reading*

#### I.

- A.I.M.M.E., *Industrial Minerals and Rocks (Nonmetallics)*, New York, Am. Inst. Mining Met. Engrs., 1937.
- Blasedale, *Equilibria in Saturated Salt Solutions*, New York, Chemical Catalog Co., 1927
- Clarke, *Data of Geochemistry*, U. S. Geol. Survey Bull. 770, 1924
- Findlay and Campbell, *The Phase Rule and Its Applications*, London, Longmans, Green and Company, 1938.
- Grabau, *Geology of the Non-Metallic Mineral Deposits*, New York, McGraw-Hill Book Co., 1920, Vol. I
- Hougen and Watson, *Chemical Process Principles*, New York, Wiley and Sons, 1944, pages 111–136
- Stocking, *The Potash Industry—A Study in State Control*, New York, R. R. Smith, Inc., 1931
- Teepie, *Industrial Development of Searles Lake Brines*, New York, Chemical Catalog Co., 1929
- Turrentine, *The American Potash Industry*, New York, Wiley and Sons, 1926
- Turrentine, *Potash in North America*, New York, Reinhold Publishing Co., 1943
- Van't Hoff, *Physical Chemistry in the Service of the Sciences*, Chicago, Univ. of Chicago Press, 1903

## II.

- Anon., "The California Kelp Operations of the Hercules Powder Co.,  
*Chem. Met. Eng.*, **18**, 576-8 (1918)
- Hildebrand, "Extraction of Potash from Sea Water Bitterns,"  
*Ind. Eng. Chem.*, **10**, 96-105 (1918)
- Blasedale, "Equilibria in Solutions Containing Mixtures of Salts,"  
*Ind. Eng. Chem.*, **10**, 344-53 (1918)
- Hoots, *Geology of Western Texas and Southeastern New Mexico*,  
*U. S. Geol. Survey Bull.* **780-B** (1925)
- Wroth, *Commercial Possibilities of the Texas-New Mexico Potash Deposits*,  
*U. S. Bur. Mines Bull.* **316** (1930)
- Rice and Davis, *Potash Mining in Germany and France*,  
*U. S. Bur. Mines Bull.* **274** (1927)
- Ward, "Building a Potash Industry in New Mexico,"  
*Chem. Met. Eng.*, **40**, 172-6 (1933)
- Schoch, "Potassium Sulfate from Polyhalite," *Ind. Eng. Chem.*, **27**, 467-73 (1935)
- Coghill, et al., *Concentration of the Potash Ores of Carlsbad, New Mexico, by Ore-Dressing Methods*, *U. S. Bur. Mines Repts. Investigations*, **3272** (1935)
- Mansfield and Long, "Texas-New Mexico Potash Deposits,"  
*Univ. Texas Bull.* **3401**, 641-832 (1935)
- Novomeysky, "The Dead Sea; A Storehouse of Chemicals,"  
*Trans. Inst. Chem. Engrs.* (London), **14**, 60-84 (1936)
- Smith and Ageton, "Mechanization of the Potash Mines in New Mexico,"  
*Mech. Eng.*, **58**, 418-22 (1936)
- Smith, "Potash in the Permian Salt Basin," *Ind. Eng. Chem.*, **30**, 854-60 (1938)
- Magraw, "New Mexico Sylvinitic," *Ind. Eng. Chem.*, **30**, 861-4 (1938)
- Cramer, "Production of Potassium Chloride in New Mexico,"  
*Ind. Eng. Chem.*, **30**, 865-7 (1938)
- Gale, "Chemistry of the Trona Process," *Ind. Eng. Chem.*, **30**, 867-71 (1938)
- Mumford, "Potassium Chloride from the Brine of Searles Lake,"  
*Ind. Eng. Chem.*, **30**, 872-8 (1938)
- Lodge, "Potash in the Fertilizer Industry," *Ind. Eng. Chem.*, **30**, 878-82 (1938)
- Kirkpatrick, "A Potash Industry at Last," *Chem. Met. Eng.*, **45**, 488-92 (1938)
- Johnson, *The Potash Situation*, *U. S. Bur. Mines Inf. Circ.*, **7117** (1940)
- Huball, "Refining Operations in New Mexico's Newest Potash Plant,"  
*Chem. Met. Eng.* **48**, No. 6, 78-81 (1941)
- Pierce and Anderson, "Potash Co. of America, Producers of Sylvite at Carlsbad," *Eng. Mining J.*, **142**, 37-41 (Dec. 1941); **143**, 38-41 (Jan. 1942)
- Robertson, "The Trona Enterprise," *Ind. Eng. Chem.*, **21**, 520-4 (1929); "Expansion of the Trona Enterprise," *ibid.*, **34**, 133-7 (1942)
- Mansfield, "American Potash Reserves," *Ind. Eng. Chem.*, **34**, 1417-21 (1942)

- Manning and Kirkpatrick, "Better Utilization of Mineral Resources through New Chemical Technology,"  
*Chem. Met. Eng.*, **51**, No. 5, 92-6, 142-5 (1944)
- Reich, "Production of Carbon and Potash from Molasses Distillers' Stillage,"  
*Trans. Am. Inst. Chem. Engrs.*, **41**, 233-52 (1945)
- Gale, "Lithium from Searles Lake,"  
*Chemical Industriss*, **57**, 442-6 (1945)
- Harley and Atwood, "Langbeinite—Mining and Processing,"  
*Ind. Eng. Chem.*, **39**, 43-7 (1947)
- Barr, "Potash Concentration,"  
*Rock Products*, **50**, No. 8, 112-4 (1947)

# CHAPTER 4

## Sodium Carbonate

---

### I. *Introduction*

- A. PRODUCTION AND USES
- B. HISTORY OF THE SODA INDUSTRY

### II. *Leblanc Process*

- A. PRODUCTION OF SODIUM SULFATE
- B. REDUCTION OF SALTCAKE
- C. LEACHING OF BLACK ASH
- D. PROCESSING GREEN LIQUOR TO SODA
- E. UTILIZATION OF WASTES
  - 1. *Weldon Process*
  - 2. *Deacon Process*
  - 3. *Chance-Claus Process*
- F. ECONOMICS OF THE LEBLANC PROCESS
- G. BENEFITS OF THE LEBLANC PROCESS

### III. *Ammonia-Soda Process*

- A. CHEMICAL PRINCIPLES
- B. BRINE AND PURIFICATION
- C. SATURATION WITH AMMONIA
- D. CARBONATION

- E. AMMONIA RECOVERY
- F. CALCINATION OF SODIUM BICARBONATE
- G. MATERIALS OF CONSTRUCTION
- H. SODIUM SULFITE

### IV. *Marketing of Soda Products*

### V. *Chemical Caustic*

- A. CHEMICAL PRINCIPLES
- B. OBJECTIVES AND LIMITATIONS
- C. BATCH AND CONTINUOUS PROCESSES
  - 1. *Batch process*
  - 2. *Continuous process*
  - 3. *Control of operation*
    - a. LIME SLAKING
    - b. CAUSTICIZING
    - c. STRONG LIQUOR DECANTATION
    - d. WASHING LIME MUD

### VI. *Competition among Alkalis*

### VII. *Student Exercises*

### VIII. *Recommended Reading*

PRODUCTION AND USES

IN 1945 sodium carbonate was produced at nine ammonia-soda plants in the amount of 4,375,017 tons. Of this amount 2,285,532 tons was finished light and 1,444,022 tons was finished dense, or a ratio of 61 to 39 per cent. At five plants were produced 174,949 tons of refined sodium bicarbonate. The remainder of the production was used in the manufacture of sodium hydroxide. Sodium carbonate was also produced from natural sources by four plants in the amount of 181,783 tons and one electrolytic plant produced approximately 18,000 tons. The growth of the ammonia-soda (Solvay) industry is shown in Figure 4-1, where the principal products are represented as sodium carbonate sold as such,

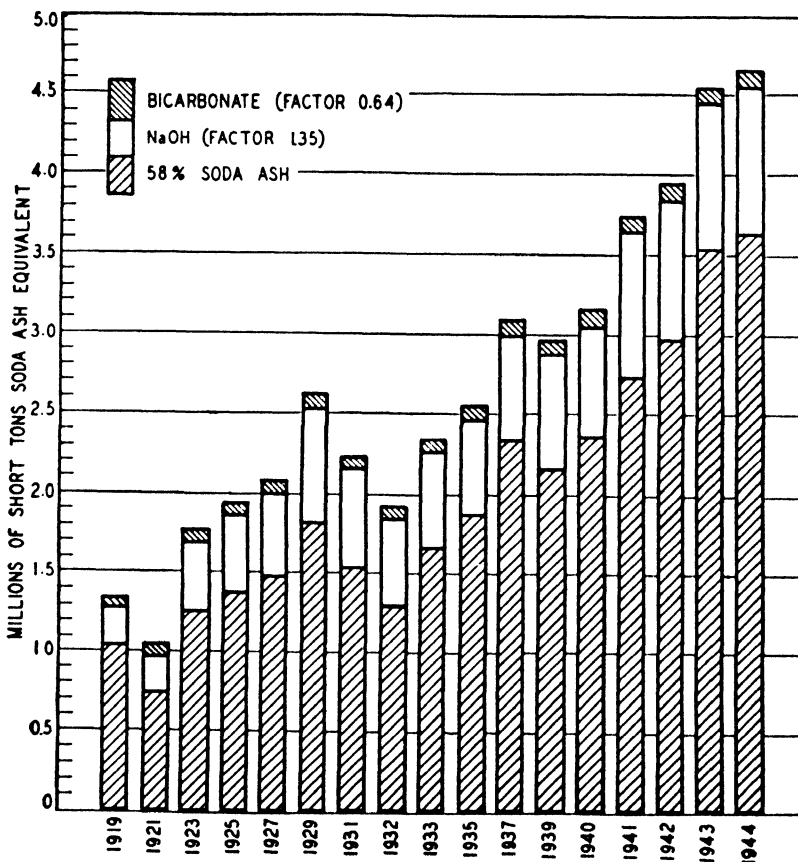

Courtesy of Chemical Engineering

FIGURE 4-1. Production for Sale of Principal Ammonia-Soda Products, Calculated as 58% Soda Ash

sodium hydroxide made from sodium carbonate, and sodium bicarbonate. The steady growth of the industry is apparent.

Sodium carbonate is consumed by a variety of industries, as given in Table 4-1 and shown in Figure 4-2.

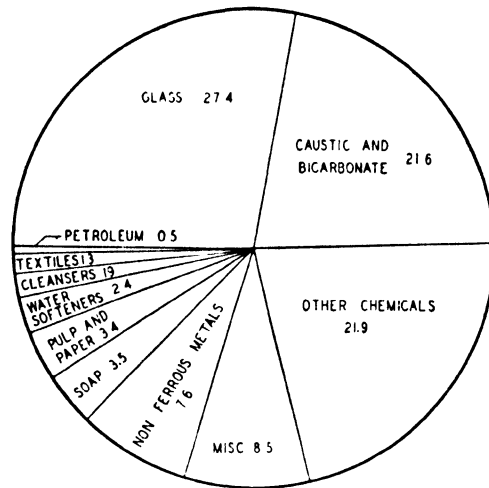

FIGURE 4-2. Consumption of Soda Ash in 1944

TABLE 4-1 Industries that Consumed Soda Ash in 1946  
(Chemical Engineering's Estimate)

<i>Industry</i>	<i>Tons</i>	<i>Per cent</i>
Glass	1,400,000	31.2
Caustic and bicarbonate	1,128,000	25.2
All other chemicals	910,000	20.2
Pulp and paper	190,000	4.2
Non-ferrous metals	140,000	3.1
Cleansers and modified sodas	125,000	2.8
Soap	120,000	2.7
Water softeners	90,000	2.0
Textiles	77,000	1.7
Exports	68,000	1.5
Petroleum refining	20,000	0.4
Miscellaneous	222,000	5.0
	<u>4,490,000</u>	<u>100.0</u>

## HISTORY OF THE SODA INDUSTRY

During the eighteenth century the limited demand for sodium carbonate for the manufacture of soap and glass was supplied from the trona deposits of dry Egyptian lakes and from the ash of the saltwort plant, which contained 15 to 20 per cent of sodium carbonate. Potash, prepared from wood ashes, was cheaper and dominated the alkali market. The investigations of Duhamel in 1736 showed the common basis of soda ash and common salt, and thereafter many efforts were made to prepare the expensive alkali from the relatively cheap salt. None of the early processes was satisfactory.

By 1782 the need for an industrial process for soda ash had become so pressing that the French Academy offered a prize of 12,000 francs for a satisfactory process. Nicholas Leblanc, (1742–1806) physician to the Duke of Orleans, had conducted and published chemical research. Perhaps attracted by the prize, or recognizing the importance of the problem, in 1784 Leblanc commenced work and in 1789 suggested to the Duke that the process be operated on a large scale. In 1791 he received the fourteenth patent under a new French law giving inventors a fifteen-year monopoly, though no disclosure of the details of the process was necessary. Late in 1791 the process was in operation and the factory turning out 500 to 600 pounds of soda ash a day. In 1794 Leblanc was forced to reveal his secret process to the Committee of Public Safety, which then seized and operated his factory. Although it was returned in 1801, Leblanc lacked the capital to continue and after many disappointments committed suicide in 1806. "The two most fruitful inventors of the century are J. Watt and N. Leblanc."\*

Other factories were built in France, but no great progress was made. In England after the repeal of the salt tax in 1822 the Leblanc process was started and grew rapidly, promoting the growth of many other chemical industries. The decline of prices of alkalis made possible an ever-expanding chemical industry. The decline in price in England in dollars per ton was:

	1810	1850	1900
$\text{Na}_2\text{CO}_3$	445	55	13
$\text{K}_2\text{CO}_3$	156	117	90

\* Dumas, *Compt. rend.*, 97, 210 (1883).

Other soda processes were proposed and in 1838 Dyar and Hemming filed for an English patent on a process in which salt solution was reacted with solid ammonium carbonate, separating the sodium bicarbonate formed and recovering the ammonia from the residue by heating with chalk. A later improvement patent in 1840 disclosed a process in which the brine was saturated with ammonia and then with carbon dioxide. Early factories were unsuccessful, mainly due to large losses of ammonia. In 1863 a Belgian, Ernst Solvay, built a factory and by engineering skill made his factory successful where others had failed. By 1869 factory production had increased several fold and other plants were constructed in Europe. In 1874 the process was introduced into England.

In 1881 the Solvay Process Company of Syracuse, New York, was organized to produce soda ash from the salt deposits. This company, now part of Allied Chemical and Dye Corporation, has expanded until it operates three plants (one each in New York, Michigan, and Louisiana) with an aggregate daily capacity of 4,750 tons of soda ash. Four other companies have entered the field and operate seven plants. No Leblanc plant for soda ash was ever built in this country.

### *Leblanc Process*

The series of reactions which Leblanc operated is represented by the equations:

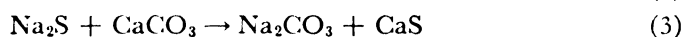
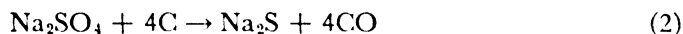
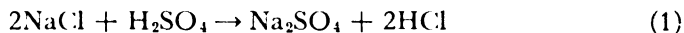

The operation of each stage of this process and the utilization of by-products formed will be discussed from the standpoint of both the Leblanc process and present industrial practice in these particular processes.

### PRODUCTION OF SODIUM SULFATE

The earliest furnaces were of the reverberatory type in which salt and sulfuric acid were mixed on the hearth. The flue gas from an adjacent coal fire passed over the charge, carried the hydrogen chloride up the stack, and distributed it over the surrounding countryside. This simple furnace was superseded by the pot-and-muffle furnace in which the reaction was carried out in two steps:

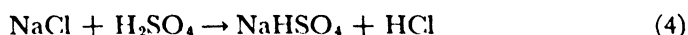



Such an arrangement is shown in Figure 4-3. A charge of 1,000 to 1,500 pounds of salt is shoveled through the door into the pan *A* and the equivalent amount of sulfuric acid is run in through a lead pipe. The first stage of the reaction goes readily at temperatures not exceeding 150°C. above which foaming occurs, and hydrogen chloride ("pan gas") is evolved freely and withdrawn through the flue *B*. When the gas evolution almost ceases the door *C* is raised and the pasty charge is pushed through onto the floor of the muffle *D*, over which it is spread evenly through doors *E*. Here the mass is broken up, stirred every half hour, and finally with-

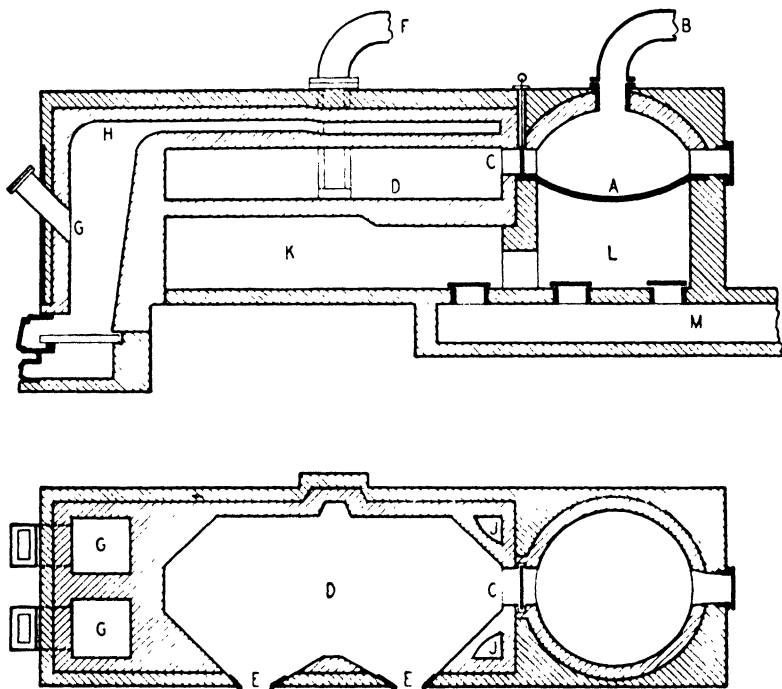

FIGURE 4-3. Saltcake Furnace

drawn in time to receive the next charge from the pot. Each charge takes between two and three hours. The "reactor gas" is more dilute in hydrogen chloride than is the "pan gas" and passes through flue *F* to a separate absorption system. The entire pot-and-muffle is kept under a slight suction to prevent escape of gas fumes. Heating of the muffle and pot is accomplished by hot flue gases from a coal fire at *G*. The hot flue gases pass through the flue *H*, the bottom wall of which radiates heat down on the muffle charge. The gases then pass down through flues *J* to passage ways under the floor of the muffle *K*, to which they give up

heat. The flue gas finally passes out under the pan *L*, and then goes through a flue *M* to the stack. The absorption of hydrogen chloride to form hydrochloric acid is discussed in Chapter 5.

Furnaces may be considerably larger than the one shown, operating several pots on a long hearth down which the charges are pushed until discharged at the end. Part or all of the sulfuric acid may be replaced by  $\text{NaHSO}_4$  produced in the manufacture of nitric acid, and hence called "niter cake." It may be charged cold with the salt, but usually is melted and run in through a cast iron trough.

Mechanical furnaces have been designed to carry out this process. The better known ones are the Mannheim furnace and Laury rotary furnace. In the former, a mechanical scraper works the charge from the center towards the outer edge where the salt cake discharges. The charge enters continuously and may be salt and acid, or salt and niter cake, or mixtures of the three. A furnace with an 11 foot pan produces about 7 tons per day of salt cake. The Laury rotary furnace has two rotary sections and a stationary cylindrical section into which an oil burner fires. The mixture of salt and niter cake is charged into the first section, lined with cast-iron plates, where it is thoroughly mixed and ground together by a frame-work of steel rails that rolls loose on the plates. The mixture passes to the second, or "hot," chamber where reaction is completed. A loose rail keeps the saltcake from forming a crust on the walls. The saltcake discharges continuously from the hot chamber into a closed chute. The gas, containing about 5 per cent hydrogen chloride, is withdrawn to a dust separator and then to the absorption system.

Before 1941, the production of hydrochloric acid and saltcake by this reaction had steadily declined as other processes for these two chemicals appeared, until only about half of the hydrochloric acid marketed was produced in this way. Operation of the pot-and-muffle furnace is a hard, hot, gassy job which men will not perform if other employment is available. Thus these furnaces have largely been abandoned for mechanical furnaces. Competition of the products with hydrochloric acid from chlorine and natural sodium sulfate has likewise diminished the production. However, the war-time demand for chlorine precluded its use for hydrochloric acid, and increased the demand for the acid as well. This demand was met by the installation of more mechanical furnaces. One plant produces potassium sulfate and hydrochloric acid from sylvite.

The *Hargreaves Process* gave sodium sulfate directly from sulfur dioxide by the reaction:

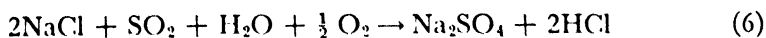

The saltcake formed had less than 0.3 per cent sodium chloride remaining and the exit gas contained 10 to 15 per cent hydrogen chloride. This process was developed at a time when the Leblanc process was declining rapidly, so it was never operated extensively. A modification of this process is operated by one company in Louisiana.

#### REDUCTION OF SALTCAKE

Leblanc's original formula called for 100 parts of saltcake, 100 parts of limestone, and 50 parts of finely divided coal to be mixed and heated together so that the reactions of equations (2) and (3) occur. Again, the early furnaces were of the reverberatory type with hot combustion gases passing over the furnace charge which was stirred and raked forward to the hotter end of the hearth, from which the reduced mass known as "black ash" was withdrawn. Reduction occurs above 884°C., the melting point of sodium sulfate, and at temperatures between 900° and 1000°C. reduction is rapid because the liquid phase wets the coal particles. The gases evolved initially are high in carbon dioxide but the monoxide forms later in the reduction.

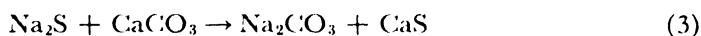

Rotary furnaces were next introduced into the industry. These were refractory-lined steel shells, partially open at the ends. Hot combustion gases from an adjacent furnace passed in one end, heated the contained charge, and passed out the other end to heat recovery units. The charge of two tons of saltcake, two tons of limestone, and one ton of slack coal, was introduced through an opening in the shell. When the reaction was complete the charging opening was stopped at the bottom of the rotation and the molten black ash discharged into iron trucks hauled beneath the furnace.

At the present time, black ash is produced in the recovery of chemicals from the sulfate and soda processes for pulping wood.\* The liquor separated from the wood pulp fibers contains the lignin and other wood constituents combined with the chemicals used for pulping. This liquor is evaporated to 50 to 60 per cent total solids and then burned to give a black ash containing the chemicals. † Both rotary and stationary furnaces

\* Sulfate (kraft) pulps, *Chem. & Met.'s Chemical Engineering Flowsheets* (4th Ed.), No. 105. Pictured Flowsheet, *Chem. Met. Eng.*, **46**, No. 11, 727-30 (1939).

† Black liquor recovery, *Chem. & Met.'s Chemical Engineering Flowsheets* (4th Ed.), No. 108, 109.

are used. The rotary furnace is continuously fed with the "black liquor" which partially burns, driving off the water and leaving a porous black ash. If the black liquor is from a soda process, the ash is leached to recover the sodium carbonate. If from a sulfate process, the ash goes to a smelting furnace from the bottom of which the molten chemicals, sodium sulfide and carbonate, are withdrawn. Recent designs of stationary furnaces are similar to steam boiler installations with tubes in the refractory walls (Figure 4-4). The concentrated black liquor is sprayed in from burners very similar to oil burners, combustion occurs, and the chemicals are tapped from the bottom of the furnace.

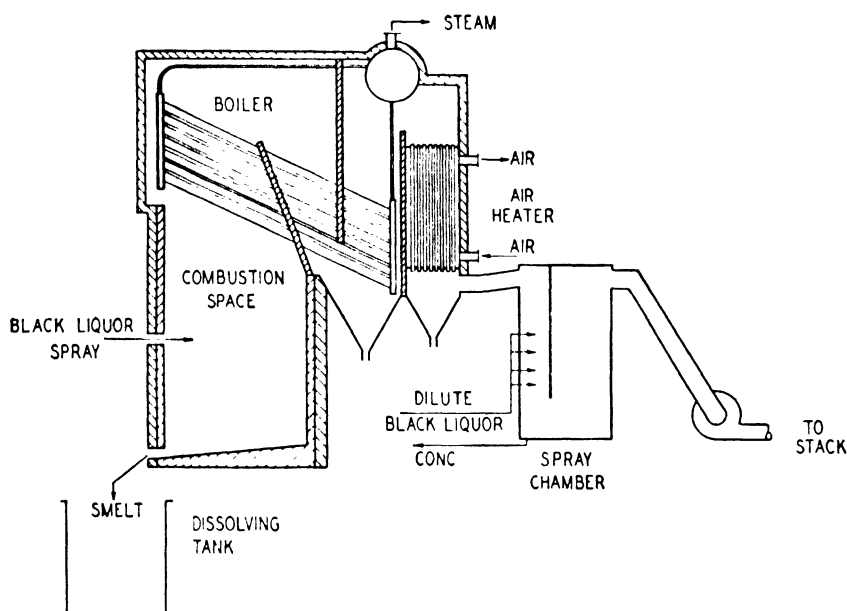

*Redrawn from Trans. Am. Inst. Chem. Engrs. 35, 3 (1939) with permission*

FIGURE 4-4. Black Liquor Combustion Furnace

#### LEACHING OF BLACK ASH

In the Leblanc process the black ash had the approximate percentage composition  $\text{Na}_2\text{CO}_3$  45,  $\text{CaS}$  30,  $\text{CaO}$  10,  $\text{CaCO}_3$  5, ash, etc. 10. For rapid leaching the mass should be porous and contain some lime which hydrates and swells, breaking up the mass and also producing some sodium hydroxide in the solution. Leaching, or lixiviation, was carried out in a series of wooden tanks with false bottoms, known as "Shank's tanks," and connected so that solution from one tank could enter any

other. A discontinuous countercurrent leaching system was used in which the solution leaving the system passed through the richest black ash and the entering water leached the most exhausted ash, somewhat similar to the arrangement shown in Figure 3-6. The solution, known as "green liquor" because of its color, was then processed to obtain the soda ash. The residue left in the tanks was known as "tank waste" and was discarded initially; however, later it was processed to obtain the sulfur.

Present practice in the soda pulp industry is very similar, using either wooden or metal tanks in which the black ash is leached to green liquor. The chemicals in the smelt from the sulfate furnaces need only to be dissolved to produce green liquor. Green liquor in the pulp processes goes directly to causticizing systems to produce "white liquor," or the pulping solution used on the wood.

#### PROCESSING GREEN LIQUOR TO SODA

Due to the lime in the black ash the green liquor always contained considerable sodium hydroxide as well as carbonate, sulfide, some thio-sulfate and unreduced sulfate, and traces of other anions. For soda ash, this liquor was first carbonated with kiln or furnace gas by allowing the liquor to trickle down within tall iron towers.

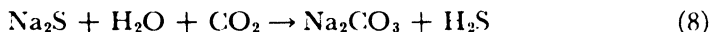
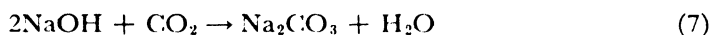

The decrease in alkalinity precipitated the ferric and aluminum oxides and silica held in solution by the hydroxide. The solution was filtered and then evaporated by passing the hot black ash furnace gases over the surface of the solution. This avoided the formation of hard carbonate scale on the bottoms of the tanks (cf. Figure 2-13). When the solution became sufficiently concentrated it was withdrawn and allowed to cool and deposit crystals of sodium carbonate decahydrate. These could be recrystallized to give a better product, or calcined to produce soda ash of low quality compared to the present standard.

In the declining days of the Leblanc process the industry turned to direct causticization of the green liquor to produce sodium hydroxide. In this way the industry survived for a longer time.

#### UTILIZATION OF WASTES

The Leblanc process gave the first excellent example of a chemical industry being forced by legislation to utilize waste products which

formed new and important chemical industries. At first the hydrogen chloride evolved was carried out of the furnace by the combustion gases and distributed over the countryside where it destroyed vegetation. When legislation prohibited this practice, the gas was dissolved in water to form hydrochloric acid and dumped in the streams for disposal, where it killed fish life. When this was prohibited, the factories turned to chemical utilization and produced chlorine for which a considerable demand had arisen for bleaching in the textile industry. In this way a new chemical industry arose, as well as markedly increasing the capacity of the textile mills by providing a rapid bleaching process.

The first process used was the *Weldon Process* in which the hydrochloric acid was added to manganese dioxide:

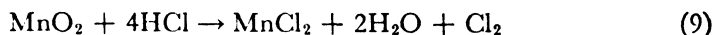

The manganous chloride was regenerated by treating with a lime slurry and blowing with air at about 50°C.

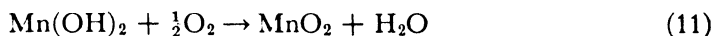
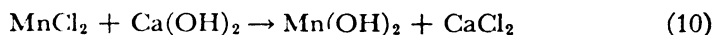

The latter reaction occurs only in the presence of excess lime and the precipitated "Weldon mud," which is recycled in the process, contains some free lime and considerable calcium manganite. Due to the loss of more than half of the hydrochloric acid as calcium chloride the process was uneconomical and was displaced by another. However, it did produce chlorine gas of high concentration.

The *Deacon Process* oxidizes the hydrogen chloride with oxygen of the air, using as a catalyst cupric chloride distributed on pumice stone to give a large surface.



This reaction is exothermic and the application of LeChatelier's principle shows that at equilibrium higher yields of chlorine would be obtained at low temperatures. However, the rate of reaction drops rapidly with decreasing temperature and below about 430°C. the rate is so low that the degree of conversion is not commercial. Increase in temperature increases the rate, but lowers the equilibrium concentration of chlorine. Above about 460°C. the cuprous chloride catalyst volatilizes and is carried away in the gas stream. Hence the process is carried out at 450°C. for optimum conversion in a given time. Despite the beneficial effects of increased pressure, the process operates at atmospheric pressure. About 65 per cent conversion of the hydrogen chloride is obtained

and the converter gases, after passing through a series of cooling tubes, enters a spray tower which condenses the steam and dissolves the hydrogen chloride with only a small amount of chlorine. The exit gas contains only 8 to 12 per cent chlorine.

The Deacon process today is used in organic halogenation reactions to utilize the large amounts of hydrogen chloride produced.



The reaction can be run by passing a mixture of benzene, hydrogen chloride, and air over the catalyst and condensing the reaction products.

The reverse reaction is utilized for the production of hydrochloric acid.



In order to make the reaction go to completion the reaction mixture can be passed through a hot bed of coke whereupon the oxygen unites with the carbon to produce carbon dioxide. At the temperatures used (900° to 1000°C.) no catalyst is necessary.

The anode gas from electrolytic magnesium cells contains chlorine diluted with air. This gas is mixed with steam and methane, which is burned in a refractory brick checkerwork regenerative furnace at about 900°C., thereby forming hydrogen chloride which dissolves in the condensed steam to give hydrochloric acid. Unconverted chlorine is reduced to hydrochloric acid with sulfuric dioxide. The hydrochloric acid solution reacts with magnesium hydroxide to produce magnesium chloride solution which is evaporated and dried to produce more magnesium cell feed.

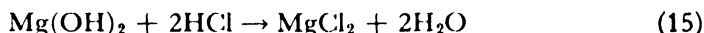
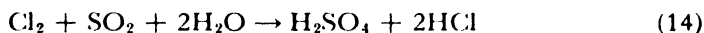

The extraction residue from the black ash or tank waste consists mainly of calcium sulfide and other insoluble materials. At first this was discarded on dumps, but stream pollution by leachings from the dump and atmospheric pollution by hydrogen sulfide evolved again caused prohibition by law. The industry saw that all of the sulfur used in the original sulfuric acid for saltcake was wasted in this way. The *Chance-Claus Process* was operated to recover this sulfur. The tank waste was made into a thin slurry with water and pumped to carbonator tanks into which gas from lime kilns was pumped. The carbon dioxide reacted with the slurry in two steps. In the first, all free lime was carbonated to calcium

carbonate and the sulfide to sulfhydryde. At the completion of this reaction the carbon dioxide liberated the hydrogen sulfide. The gas rich in hydrogen sulfide was mixed with a limited supply of air and burned in a Claus furnace which contains a bed of ferric oxide as the catalyst.



The sulfur formed condensed to liquid sulfur in the following receiver from which it sublimed to a chamber. The sulfur was returned to the sulfuric acid plant to be reused. In this way up to 80 to 90 per cent of the sulfur could be recycled.

#### ECONOMICS OF THE LEBLANC PROCESS

The passing of this process from the industrial soda ash picture leads to an analysis of the factors which caused its demise. A sulfuric acid industry had to be established to enable saltcake to be produced. The need for sulfuric acid for other chemical industries grew and during World War I England had to prohibit the use of sulfuric acid for saltcake in order that the explosives industry could produce at capacity. That ended the Leblanc industry in its last stronghold.

Large quantities of fuel were necessary for the saltcake furnace, as a reducing agent for the saltcake, and as fuel for the reduction furnace. It is estimated that 3.5 tons of coal were used per ton of soda ash. All furnaces were hand fired and hand labor was required to operate the saltcake and reduction furnaces, charge and unload the Shank's tanks, transfer sal soda to the calciner, and pack the product. By comparison, the ammonia-soda process uses gases and solutions which can be pumped, so that labor costs are considerably less.

The purity of soda ash produced was poor and after the entrance of the ammonia-soda process the latter won out where purity was a factor. After the Leblanc process was turned from soda ash to sodium hydroxide a new competitor entered in the form of electrolytic caustic, which again took over the better markets because of its greater purity.

The necessity for recovering by-products caused extensive installations to be built which did not pay when cheaper or superior products came onto the market. The entrance of cheap sulfur obtained by the Frasch process made it uneconomical to operate the Chance-Claus



process, but operations had to continue to prevent pollution. Chlorine from the Deacon process was an important and valuable by-product until electrolytic chlorine appeared and took over the market.

The Leblanc process died because of its high fuel cost, high labor costs and extensive process ramifications that had to be built into an integrated operational and marketing program.

#### BENEFITS OF THE LEBLANC PROCESS

The Leblanc process was the initiation of our present inorganic chemical industries and many of the organic industries. The cheap alkali helped expand the glass, soap, and other chemical industries. The expansion of the sulfuric acid industry to produce saltcake likewise gave for the first time a cheap industrial acid. The production of chlorine and bleaching powder from hydrochloric acid initiated a new industry. This industrial progress stimulated research on competing processes, as electrolytic caustic and chlorine, which developed into new industries. Much of the equipment developed for the Leblanc process was of general utility in the chemical field and was the basis for design of equipment for new processes.

#### *Ammonia-Soda Process*

An inspection of the flowsheet\* (Figure 4-5) shows the process divided into five sections, brine purification, bicarbonate formation, ammonia recovery, soda ash production, and lime production.

The reactions occurring throughout the process are expressed as simple equations.

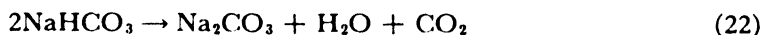
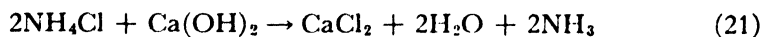
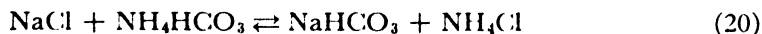

However, the plant operation and control of the process presents a number of mechanical difficulties, as described by Hou:

- a. Ammonia is volatile and losses are expensive.
- b. The brine-ammonia-carbon dioxide combination is highly corrosive.

\* *Chem. & Met.'s Chemical Engineering Flowsheets* (4th Ed.), No. 61.

Pictured Flowsheet, *Chem. Met. Eng.*, **49**, No. 2, 134-7 (1942); **53**, No. 2, 172-5 (1946).

- c. Operation must be continuous, all day every day. Reserve units must be available.
- d. The various sections of the process are so interlocked that operating difficulties in one section cause troubles in other sections.

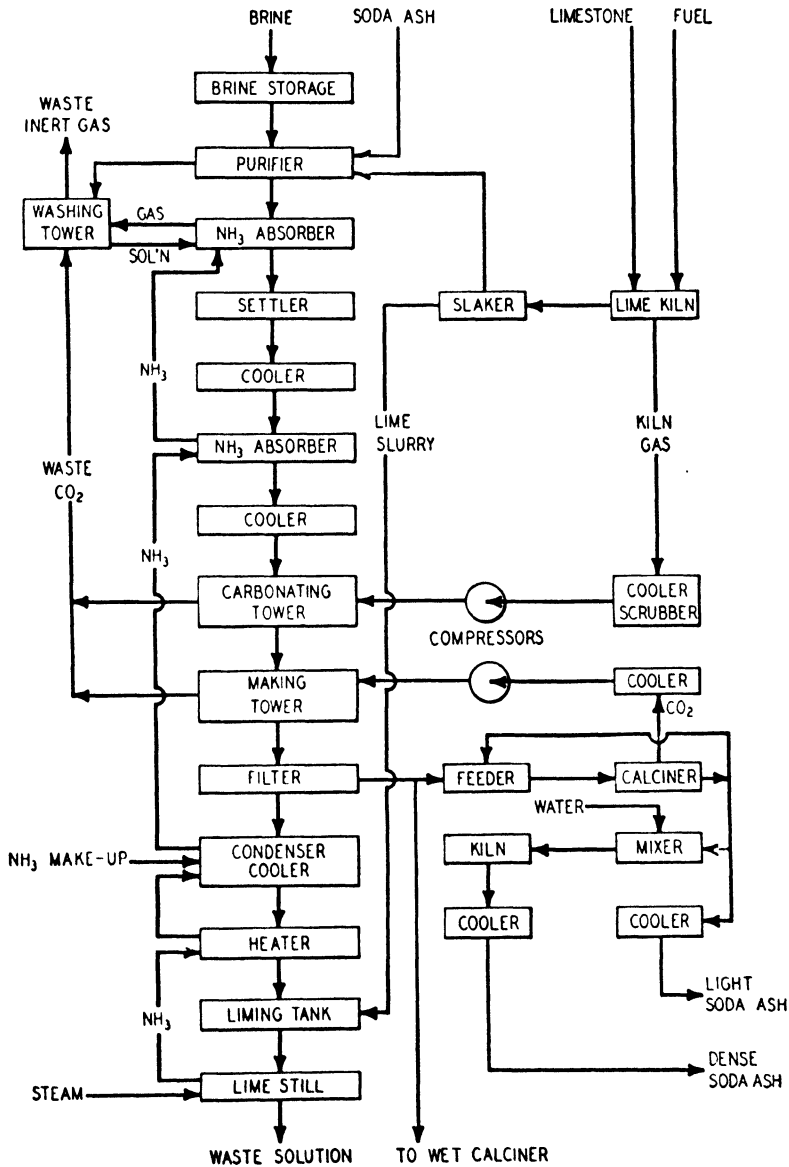

FIGURE 4-5. The Ammonia-Soda Process

## CHEMICAL PRINCIPLES

It is seen that the metathetical reaction of equation (20) represents a reciprocal salt pair, as previously discussed in Chapter 3. If all four solid salts are present and the product of the solubilities of the compounds on the left side of the equation is greater than that on the right, the first pair is in metastable equilibrium with the second and reacts to form the second pair which remain as the solid phases. Solubilities in moles per liter of water are:

$T_{emp.}$ $^{\circ}C$	$(NaCl)$	$(NH_4HCO_3)$	$= K_1$	$(NaHCO_3)$	$(NH_4Cl)$	$= K_2$	$K_1/K_2$
0	6.09	1.51	9.2	0.82	5.50	4.52	2.03
10	6.10	2.00	12.2	0.97	6.23	6.05	2.02
15	6.11	2.32	14.2	1.07	6.58	7.07	2.01
20	6.13	2.66	16.3	1.14	6.95	7.94	2.05

Thus sodium chloride and ammonium bicarbonate cannot remain together as solid phases but react to give the reciprocal salt pair. The system at 15°C. is shown in Figure 4-6. Sodium bicarbonate dominates the

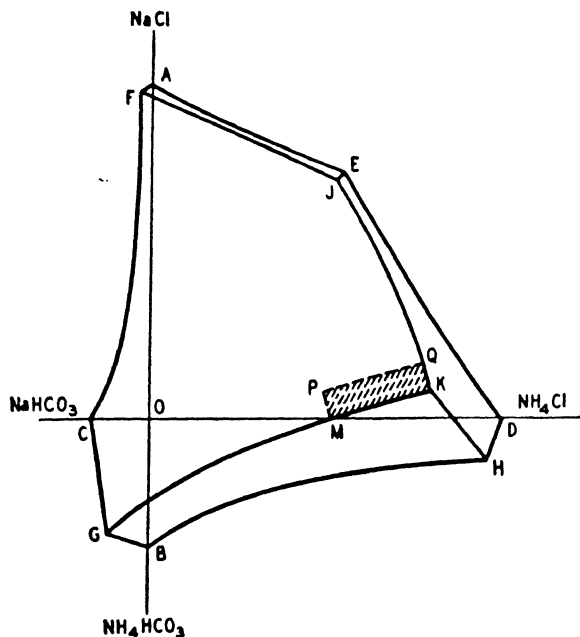

*Redrawn from Hou, Manufacture of Soda, page 199, with permission*

FIGURE 4-6. The System  $NaCl + NH_4HCO_3 \rightleftharpoons NaHCO_3 + NH_4Cl$  at 15°C.

diagram and is the stable phase within the area  $CGKJF$ . If reactants are used which terminate in a solution of composition  $K$ , then 78.8 per cent of the sodium chloride and 85.1 per cent of the ammonium bicarbonate are transformed to sodium bicarbonate. In plant operation initial concentrations are so controlled as to terminate in the area  $PMKQ$ , though the formation of solid ammonium chloride (along  $KQ$ ) is avoided as it would lead to salt in the soda ash on calcining, whereas ammonium



bicarbonate (along  $KM$ ) decomposes completely and the ammonia is recovered with the carbon dioxide. The temperature of operation is

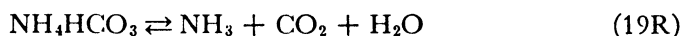

maintained below  $25^\circ\text{C}$ ., and lower if possible, to minimize the ammonia losses.

One of the final products is calcium chloride (equation 21) which usually has no value. Other cycles have been proposed in which the process is operated to produce ammonium salts which can be utilized as fertilizers. Thus for salt could be substituted sodium sulfate or sodium nitrate and the corresponding ammonium salt crystallized from the carbonation tower effluent. These cycles are not known to be in operation, though the former may be in Russia. Sulfur dioxide can replace carbon dioxide in a similar cycle.

#### BRINE AND PURIFICATION

In general, plant locations are near an unlimited supply of brine from salt deposits. With a maximum conversion of 78.8 per cent, and an actual conversion of 70 to 75 per cent, a cheap source of salt must be available. Unconverted salt is lost, whereas ammonium bicarbonate is recovered. The brine usually is pumped from underground or is prepared by dissolving rock or sea salt. The brine is desired as concentrated as possible.

Purification of the brine is necessary to remove calcium, magnesium, and iron compounds. This is usually accomplished before the brine enters the system, by the cold lime-soda process. Both chemicals are plant products and the use of soda ash increases the salt content of the brine. Older practice was to use ammonium carbonate as the precipitant and remove the sludge before entering the regular absorption system. This is subject to two chemical and one mechanical objections. Ammonium carbonate is removed in the sludge as a double compound

$[(\text{NH}_4)_2\text{CO}_3 \cdot \text{MgCO}_3 \cdot 4\text{H}_2\text{O}]$  and the formation of ammonium chloride is a product in equation (20) and hence tends to reverse the reaction and decrease the conversion of salt. A mechanical objection is the deposition and growth of deposits in the pipes through which the suspension is pumped.

#### SATURATION WITH AMMONIA

The purified brine first is distributed to absorbers in which it removes the ammonia from the various exit gases in order to keep down ammonia losses. The brine then goes to the first absorber where it passes down a bubble column countercurrent to ammonia gas rising in the tower. The solution of ammonia and reaction with small amounts of carbon dioxide present are exothermal reactions and the solution must be cooled to increase its ability to dissolve more ammonia. If unpurified brine is used the solution passes to a settler to allow the impurities to separate out. Cooling is also effected and the solution now passes to a second absorber where additional ammonia is dissolved to give a final solution which flows to a vat for cooling and clarifying. Pipe coolers (trombone type) are usually used between towers.

#### CARBONATION

The conversion of the ammonium hydroxide to the bicarbonate is carried out in six towers, from 70 to 90 feet high and 5 to 9 feet in diameter, and divided into sections with a gas distributor between each section (Figure 4-7). Cooling sections are built into the towers, with a series of single tube passes from headers on opposite sides of the tower. In the first tower a more dilute carbon dioxide gas (about 40 per cent  $\text{CO}_2$ ) is used and the reaction is the formation of ammonium carbonate, and some carbamate ( $\text{NH}_4\text{OCONH}_2$ ).



Most of the heat is liberated in this stage and the solution is cooled by water in the cooling sections of the tower. The solution now goes to the following five, or "making," towers into which a high carbon dioxide gas (60 to 70 per cent  $\text{CO}_2$ ) from the bicarbonate kilns is introduced. The ammonium bicarbonate is formed, and then reacts with the salt, forming sodium bicarbonate.

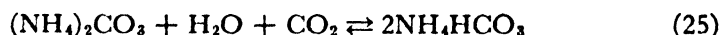

The temperature in the columns is reduced from about  $60^{\circ}$  at about a third of the way down to as low a temperature as possible ( $20^{\circ}$  to  $25^{\circ}\text{C}.$ ) at the bottom where the bicarbonate slurry is withdrawn.

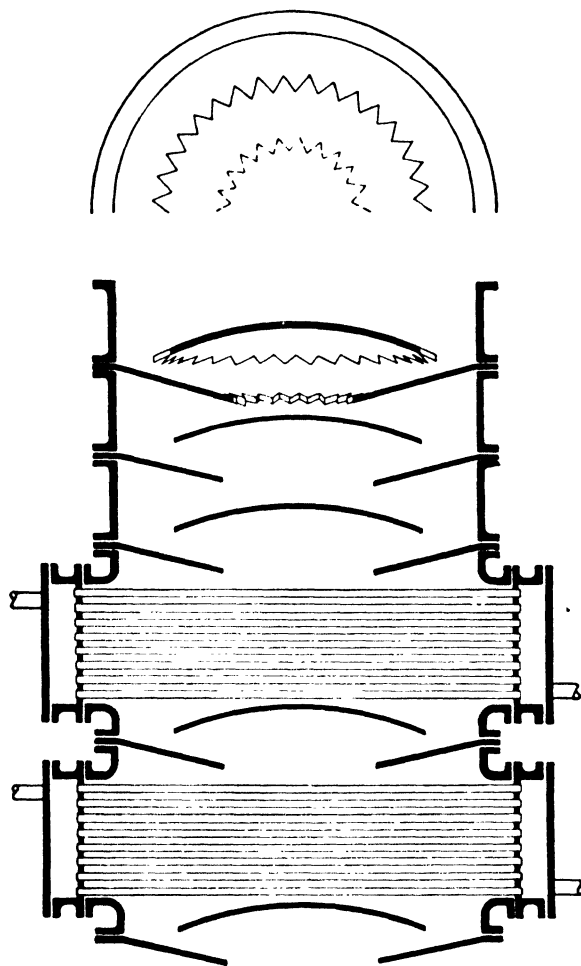

FIGURE 4-7. Carbonation Tower Section, Showing Cooling Boxes and Absorber Sections

By maintaining a proper temperature gradient in the column the size of sodium bicarbonate crystals can be regulated. The higher temperature above the center of the column prevents formation of sodium bicarbonate but as the solution descends through the cooling sections more ammonium bicarbonate is made, sodium bicarbonate crystal nuclei are formed, and growth continues as the slurry descends. If the entire column were

maintained cold there would be a high concentration of ammonium bicarbonate and a rapid formation of sodium bicarbonate in the center section resulting in fine crystals difficult to filter. The high concentration of carbon dioxide in the entering gas insures complete ammonium bicarbonate formation. The top of the column must be kept at about 25°C. in order to minimize ammonia carry-over in the gases, which loss would decrease the final ammonium bicarbonate concentration and the conversion of salt. The exit gases pass through a washer tower to recover the ammonia carried by them.

After operating for several days the making tower has a considerable deposit of sodium bicarbonate within the tower and the cooling pipes will be covered to such an extent that heat transfer is reduced. By changing the flow arrangement this tower is now made the carbonating tower and the entering brine dissolves off the bicarbonate deposits from the tubes and tower. Usual practice is to make this change daily so that one of the making towers becomes the carbonating tower each day.

The slurry of sodium bicarbonate and mother liquor is separated by filtration. The usual type of filter is the continuous rotary vacuum filter. The vacuum sucks inward any ammonia liberated from the ammonium bicarbonate and all gases go through a final washer to recover the ammonia. The passage of air through the filter cake also assists in drying the bicarbonate. An analysis of the crude bicarbonate and mother liquor showed:

<i>Crude bicarbonate</i>	<i>Per cent</i>		<i>Mother liquor grams per liter</i>
Moisture	13.9	NH <sub>4</sub> Cl	193
NaHCO <sub>3</sub>	75.6	NaCl	76.5
Na <sub>2</sub> CO <sub>3</sub>	6.9	NH <sub>4</sub> HCO <sub>3</sub>	48.6
NH <sub>4</sub> HCO <sub>3</sub>	3.4	NaHCO <sub>3</sub>	7.0
NaCl	0.2	(NH <sub>4</sub> ) <sub>2</sub> SO <sub>4</sub>	4.5
	100.0		

#### AMMONIA RECOVERY

The ammonia recovery system is perhaps the most important part of the plant as it represents the connecting link between one cycle of opera-

tions and another. The value of the ammonia in the system is several times the value of the sodium bicarbonate produced per cycle; hence its complete recovery is essential. Present losses are only two to three pounds per ton of bicarbonate.

The mother liquor from the filters, diluted with some wash water, goes to the ammonia recovery system. Also sent to ammonia recovery is the sludge which separates out after ammoniation of the brine, for it contains combined ammonia in the form of double salts.

The ammonia still is somewhat similar to the ammonia absorption and carbonation towers and consists of three sections: the condenser-cooler, the heater, and the lime still. These may be placed one on top another to give a column 100 feet high and 6 to 8 feet in diameter. The upper section is the condenser-cooler for the outgoing ammonia gas and steam arising from the heater section. This section consists of a number of cooling units similar to those of the carbonation tower. The liquid used for cooling is the incoming mother liquor which is preheated from about 25° to about 75°C. before it enters the heater section. The condensers remove from the ammonia most of the water vapor which otherwise would dilute the brine in the absorbers. The ammonia and carbon dioxide gases leave saturated with water at about 55° to 60°C.; a lower temperature might plug the condenser with ammonium carbonate and carbamate.

The middle section is the heater into which the preheated liquor discharges. This section may be a column packed with small tile or coke or may be a bubble-cap column. The ammonia and steam rising from the lime still pass countercurrent to the descending liquor. Ammonium bicarbonate and carbonate decompose completely and sodium bicarbonate forms the carbonate.

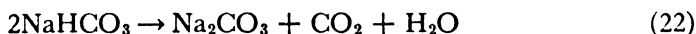
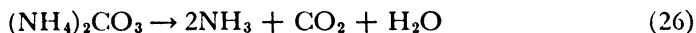

The bottom and longest section is the lime still. A tank between the heater section and lime still is used to mix the lime slurry with the solution containing the fixed ammonia. Here also is added the sludge from the settlers which may contain fixed ammonia. After a short retention time to allow reaction in this tank, the solution containing some suspended solids descends the lime still, passing countercurrent to the ascending steam which strips the ammonia from solution. Distiller sections with outside overflow are shown in Figure 4-8. Steam at 10 p.s.i.



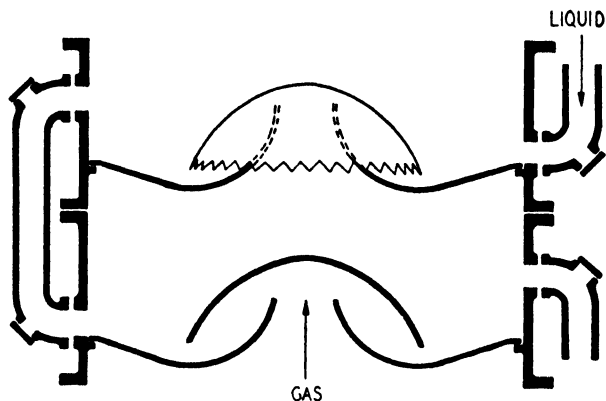
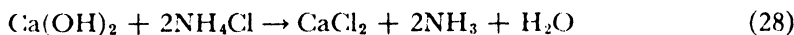
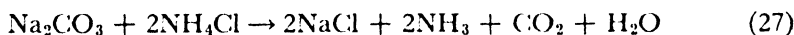

FIGURE 4-8. Distiller Sections, External Overflow Type

gage is introduced into the bottom section to furnish the heat. The reactions are:



Ammonium sulfate may be added in the lime tank to supply make-up ammonia, or ammonia liquor from coke oven plants can be used. An excess of 2 to 3 grams per liter of lime should remain in the effluent solution to insure completeness of the reaction. An average composition of distiller waste is:

$\text{CaCl}_2$	90 - 95 grams per liter
$\text{NaCl}$	40 - 45
$\text{Ca}(\text{OH})_2$	2 - 3
$\text{CaCO}_3$	6 - 15
$\text{CaSO}_4$	3 - 5
$\text{Mg}(\text{OH})_2$	3 - 10
$\text{R}_2\text{O}_3 + \text{SiO}_2$	2 - 7
Total $\text{NH}_3$	0.006 - 0.012

Ordinarily this effluent is run to waste, but it can be evaporated to recover the calcium chloride and salt.

#### CALCINATION OF SODIUM BICARBONATE

The decomposition of the moist sodium bicarbonate is accomplished in externally heated rotary kilns, 6 to 8 feet in diameter by 60 to 80 feet

long, with closed ends, turning at 4 to 6 revolutions per minute. The entire kiln, except for the ends, is within a brick housing which contains the furnace at the front end. Thus the flow of bicarbonate through the kiln and of the hot gases outside are in the same direction, or concurrent flow. One plant uses a rotary kiln containing pipes with steam at 400 p.s.i. for better efficiency. The moist bicarbonate is mixed with a portion of the calcined soda ash to prevent formation of lumps and sticking to the kiln walls, the percentage of soda ash varying from 20 to 50 depending on the moisture content of the bicarbonate. Calciner temperatures range from 600° to 800°C. at the feed end to about 150°C. at the discharge end. The hot soda ash discharges to a rotary cooler where it is cooled with air. The principal reactions in the calciner are:

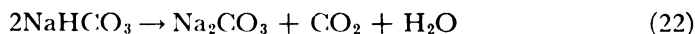

The gas leaving the calciner may be as high as 90 per cent carbon dioxide and goes to the making tower for carbonation. Low strength gas from the calciners decreases the conversion in the tower.

The sodium bicarbonate can be suspended in water as a slurry and decomposed with steam ("wet calcination") in a stripping column. A sodium carbonate solution results which can be used for causticizing, production of refined bicarbonate, or evaporated to give a dense ash.

The soda ash from the calciner usually has a specific gravity of about 0.5 which is too low to suit many processes where a light ash would be blown from a furnace. The light ash is moistened with water to form the monohydrate and recalcined. The product then has a density of 60 to 65 pounds per cubic foot and is a dense ash.

Sodium bicarbonate is made by dissolving the soda ash from the calciner and recarbonating with washed carbon dioxide. The precipitated bicarbonate is centrifuged and dried by blowing it up a long tube using air at 90° to 150°C. By treating sodium carbonate in this manner no ammonia is lost, as would be the case if the crude bicarbonate from the filter were used, and a final product of purity over 99.8 per cent is made.

#### MATERIALS OF CONSTRUCTION

Corrosion in the Solvay process must be reduced to a minimum to keep iron out of the product. Salt brines, containing ammonia and carbon dioxide, are highly corrosive and only selected materials give service under such conditions. Ammonia readily attacks copper, brass,

bronze, and Monel, so that valves and fittings of these materials cannot be used. Steel and wrought iron corrode quite rapidly in contact with the solutions. Cast iron, particularly with low nickel content, has excellent resistance and is used wherever possible. High silicon cast irons of the Duriron type likewise have excellent resistance but are too brittle and difficult to work to find wide use. The stainless steels (18% Cr, 8% Ni plus other elements) are excellent in the various brines. As in the salt industry, nickel and Monel can be used to handle salt and brines not containing ammonia.

Corrosion of the steel in the brine systems is reduced by the presence in the circulating brine of sulfides which form an insoluble coating of ferrous sulfide to protect the underlying metal. In the ammonia still the ammonium sulfide is decomposed and recycled with the other gases.



Make-up sulfide usually is introduced with ammonia liquor from coke oven plants or may be introduced as hydrogen sulfide.

#### SODIUM SULFITE

Ammonium chloride and sodium sulfite are produced by a series of reactions similar to those of the ammonia-soda process, though the process is operated quite differently as a batch process.

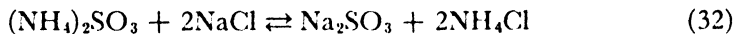
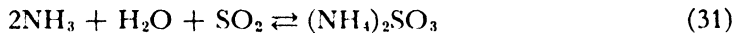

The mother liquor from a previous batch is placed in a 7000-gallon brick-lined tank and calculated quantities of sulfur dioxide and ammonia are added at such a rate that the solution always remains acid to prevent the escape of ammonia. Solid salt is added during and after the addition of the gases. The temperature due to the reaction of the gases is allowed to rise to 60°C. and is maintained there during the reaction and afterwards until equilibrium is attained. The solid phase is sodium sulfite, which separates out and is separated by passing the suspension through centrifuges. The solution is pumped to a vacuum crystallizer in which the solution is evaporated and its temperature reduced to 20°C. Ammonium chloride crystallizes from the solution and is separated by decanting and centrifuging. The mother liquor recycles in the process with the addition of the wash water from the centrifuges.

*Marketing of Soda Products*

Soda ash was long marketed on a purity basis expressed as percentage  $\text{Na}_2\text{O}$  calculated on the "New York and Liverpool test" in which an incorrect atomic weight for sodium was used. Pure sodium carbonate corresponds to a true value of 58.5 per cent  $\text{Na}_2\text{O}$ , but on the old basis it was 60.4 per cent  $\text{Na}_2\text{O}$ . Minimum  $\text{Na}_2\text{O}$  specified was 58 per cent, corresponding to 96 per cent sodium carbonate. Since 1923 the percentage of sodium carbonate in soda ash is specified, thus 58 per cent  $\text{Na}_2\text{O}$  is regarded as 99.2 per cent sodium carbonate. The normal product from the calciner has this sodium carbonate content, the balance being salt, moisture, and some insoluble material containing calcium, magnesium, and iron compounds.

Both light and dense soda ash are sold to meet the demand of consuming industries. The light ash weighs about 35 pounds per cubic foot and the dense ash from 50 to 65 pounds per cubic foot. The light ash is desired by the detergent industry where its low specific gravity keeps up the package size of cleaner compounds. Dense ash is desired by such consumers as the glass industry where light ash would be blown from the glass furnace. In 1944 the relative amounts of light and dense soda ash for sale were:

	<i>Tons</i>	<i>Per cent</i>
Finished light	2,455,575	62.7
Finished dense	1,461,832	37.3
	3,917,407	100.0

Soda ash may be crystallized and sold as the decahydrate ( $\text{Na}_2\text{CO}_3 \cdot 10\text{H}_2\text{O}$ ) (sal soda), or the monohydrate ( $\text{Na}_2\text{CO}_3 \cdot \text{H}_2\text{O}$ ) (crystal carbonate), usually for use in cleaning compounds. Sodium bicarbonate is marketed in the food industry and as an alkali of low pH value. Sodium sesquicarbonate, or trona ( $\text{Na}_2\text{CO}_3 \cdot \text{NaHCO}_3 \cdot 2\text{H}_2\text{O}$ ), is used as an alkali of lower pH value in cleaners. It is made by adding an excess of sodium bicarbonate to a heated carbonate solution; on cooling trona separates out.

Soda ash is shipped in containers ranging from 100-pound paper bags, burlap bags of 100 to 400 pounds, barrels of 200 to 400 pounds, to 50,000-pound bulk box-car shipments. Storage represents a problem due to the rapidity with which moisture and carbon dioxide are absorbed

from the air. An ash after six months storage has gained over ten per cent moisture and a bicarbonate content of five per cent. Increase in volume frequently breaks paper bags.

Prices of soda ash depend on the location of the buyer, as five roughly concentric price zones have been established radiating from New York City. Zone 5 (West Coast) prices are about 25 per cent higher than Zone 1 prices. Price range since 1914 is tabulated showing the average spot price, in carloads at works, per 100 pounds.

<i>Year end</i>	<i>1914</i>	<i>1918</i>	<i>1929</i>	<i>1933</i>	<i>1945</i>
Dense ash					
Bags	\$0.70	\$3.45	\$1.40	\$1.25	\$1.15
Bulk			1.25	1.10	0.95
Light ash					
Bags	0.60	2.15	1.34	1.23	1.10
Bulk			1.17	1.05	0.90

In connection with the soda ash operations the plant frequently operates an electrolytic caustic-chlorine plant (described in Chapter 5) which gives a variety of products to be sold.

Exports of sodium carbonates and caustic soda from the United States are controlled by the U. S. Alkali Export Association, Inc., which represents most domestic producers, to eliminate competition among United States producers in foreign markets. It controls percentage-allocation to the producer, the prices, shipment, distribution, exchange transactions, etc.

As seen from the flowsheet the operation of a lime plant is an essential part of the operations. In fact, the soda ash industry is the largest user of lime. Thus lime in its various forms of quicklime and hydrated lime is marketed. The need for coke and ammonia liquor forced the Solvay Process Company to install coke ovens to produce its own materials, which lead to the formation of subsidiary organizations, all of which are now combined in a parent organization, the Allied Chemical and Dye Corporation. Other companies have entered the soap and detergent field to market their products.

An interesting example of intercommodity competition is given by saltcake and "synthetic saltcake." When a scarcity of saltcake for the production of kraft pulp developed, a synthetic saltcake was made by sintering together approximately equimolar proportions of soda ash and

sulfur. At first, this material was introduced into the black ash furnace in the same way as make-up saltcake, however, it later was introduced into the green liquor to give pulping liquor of higher sulfidity. The amount of heat required in the furnace for reduction of sulfate to sulfide is decreased. Thus, what started as a substitute made an established market on its own merits because of processing advantages. It was withdrawn from the market during the war because of the great demand for soda ash and has remained off the market because of the continuing high post-war demand.

### Chemical Caustic

Just as the Leblanc plants in their declining years turned to the production of sodium hydroxide, so have many ammonia-soda plants turned to chemical caustic to add another outlet for soda ash. The equation for the reaction is:



The ammonia-soda plants have a lime slurry section already in operation so this process fits with their operations. It likewise is used by many chemical plants that desire their caustic in the form of a solution containing up to 15 per cent sodium hydroxide. Some, like the sulfate and soda pulp mills, regenerate sodium carbonate which must be re-formed to sodium hydroxide, or causticized, before reuse.

### CHEMICAL PRINCIPLES

The causticizing reaction is a metathesis in which two solid phases are present,  $\text{Ca}(\text{OH})_2$  and  $\text{CaCO}_3$ . Each obeys its own solubility product equation, though the values for  $K_1$  and  $K_2$  are not those for the single solid phase in contact with pure water, for here a rather concentrated caustic solution is present.

$$K_1 = (\text{Ca}^{++})(\text{OH}^-)^2$$

$$K_2 = (\text{Ca}^{++})(\text{CO}_3^{--})$$

The calcium ions in solution must be in equilibrium with both solid phases, hence:

$$(\text{Ca}^{++}) = \frac{K_1}{(\text{OH}^-)^2} = \frac{K_2}{(\text{CO}_3^{--})}$$

$$K_s = \frac{K_1}{K_2} = \frac{(\text{OH}^-)^2}{(\text{CO}_3^{--})}$$

This shows that concentration of carbonate ion in solution increases as the square of the hydroxide ion concentration, or the conversion of sodium carbonate to sodium hydroxide decreases rapidly as the concentration of solution increases. This can be seen in Figure 4-9 in which

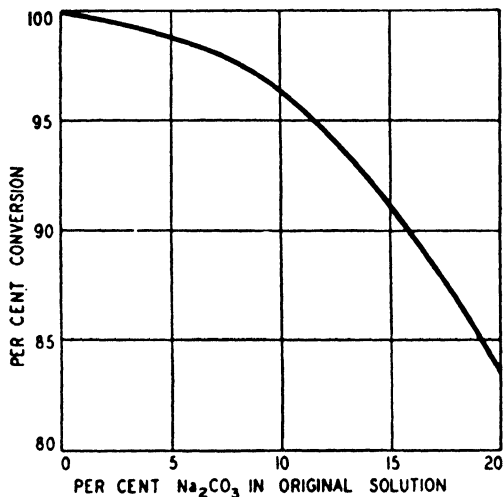

FIGURE 4-9. Conversion of Sodium Carbonate to Hydroxide

percentage conversion is plotted against sodium hydroxide concentration. It also is apparent that an excess of calcium hydroxide does not influence the point of equilibrium, but only the rate at which equilibrium is attained, by presenting more surface to the solution. The equilibrium constant of a reaction is a function of temperature as given by the Van't Hoff equation:

$$\frac{\partial \ln K_e}{\partial T} = \frac{\Delta H}{RT^2}$$

where  $\Delta H$  is the heat of reaction at the absolute temperature  $T$ . In the causticizing reaction the heat of reaction is almost zero, hence temperature has but little effect on the equilibrium other than the change in solubilities of the solid phases. Ordinarily the reaction is carried out at temperatures of 80° to 95°C. to increase slightly the rate of reaction, but more important, to decrease the viscosity of the solution and increase the rate of settling of the precipitated calcium carbonate. This temperature is also above that at which double compounds are formed, as gaylussite ( $\text{Na}_2\text{CO}_3 \cdot \text{CaCO}_3 \cdot 5\text{H}_2\text{O}$ ).

A more complete conversion of the carbonate could be obtained by the use of strontium or barium hydroxide. These are considerably more soluble than calcium hydroxide, and the carbonate produced is more insoluble, thus leading to a higher conversion. Their cost prohibits their use in industrial practice.

In the green liquor made from the smelt in the sulfate pulp industry the solution contains both sodium carbonate and sodium sulfide. The presence of the sulfide decreases the conversion of carbonate to hydroxide because of its hydrolysis, though the decrease is greater than accounted for by hydrolysis.



Historically the Löwig process is of interest, having as its basis the displacement of the carbon dioxide by an insoluble amphoteric oxide by heating in a rotating kiln. When the sodium ferrite is leached with water, hydrolysis is complete and the sodium hydroxide solution is separated from the oxide sludge which is reused.

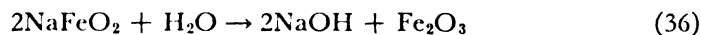
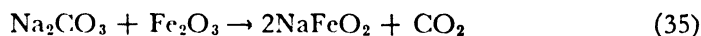

## OBJECTIVES AND LIMITATIONS

From the conversion curve (Figure 4-9) and theoretical considerations it is seen that completeness of conversion must be balanced against a number of factors. The objectives of causticizing are:

- (1) The highest possible conversion consistent with solution strength, per unit of time
- (2) As clear a solution of caustic soda as possible
- (3) The highest possible recovery of soda from the sludge, consistent with the amount of wash solution that can be used in the cycle

Against these objectives must be balanced certain technical and economic limitations which govern the operation, such as:

- (1) The degree of conversion is definitely tied to solution strength, so the stronger the sodium hydroxide solution the less will be the conversion.
- (2) The degree of clarification of the solution depends on the settling time allowed. The rate of settling of the calcium car-



bonate depends on the particle size, temperature and concentration of the solution, being best with coarse crystals, high temperature and low strength (low viscosity) of solution.

- (3) The degree of recovery of soda from the sludge depends directly upon the amount of wash water that can be used in the process cycle and the density to which the sludge settles, being best with large volumes of wash water and a dense sludge.
- (4) The rate of reaction is directly proportional to the excess of lime used, but this excess is lost in the sludge.

#### BATCH AND CONTINUOUS PROCESSES

The production method used depends on the amount of caustic needed and may be either a batch or a continuous process.

*Batch Process* The batch process (Figure 4-10) is a relatively simple

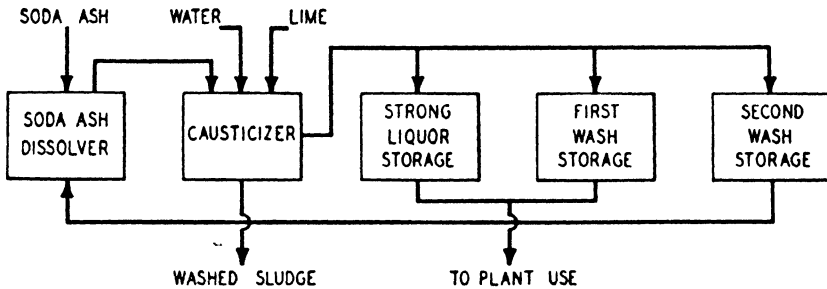

FIGURE 4-10. Batch Causticizing

one in which soda ash solution and either burnt or hydrated lime are agitated in a steel tank. The solution may be heated by blowing steam into the tank. After the reaction is complete the agitator is stopped, the calcium carbonate slurry allowed to settle, and the supernatant liquid is drawn off to strong liquor storage. The sludge is repulped with wash water which gives a weaker caustic soda solution, which goes to a separate storage. A second wash gives a very dilute solution which usually is used to dissolve the soda ash for the next batch. The sludge is then flushed from the tank and a new batch started.

*Continuous Processes* Various continuous cycles are in operation for the production of sodium hydroxide. Every sulfate and soda pulp mill, as well as various chemical plants,\* operate such a system. In Figure 4-11

\* *Chem. & Met.'s Chemical Engineering Flowsheets* (4th Ed.), No. 17.

is shown the cycle of operations at a sulfate pulp mill, which is somewhat more complicated than a system using a pure soda ash. The smelt from the black ash furnace consists of sodium carbonate and sulfide, carbonaceous material, and refractory spalled from the furnace lining. The salts are dissolved using the weak wash liquor from the lime mud and dregs washers. The solutions and solids go to a green liquor clarifier in which

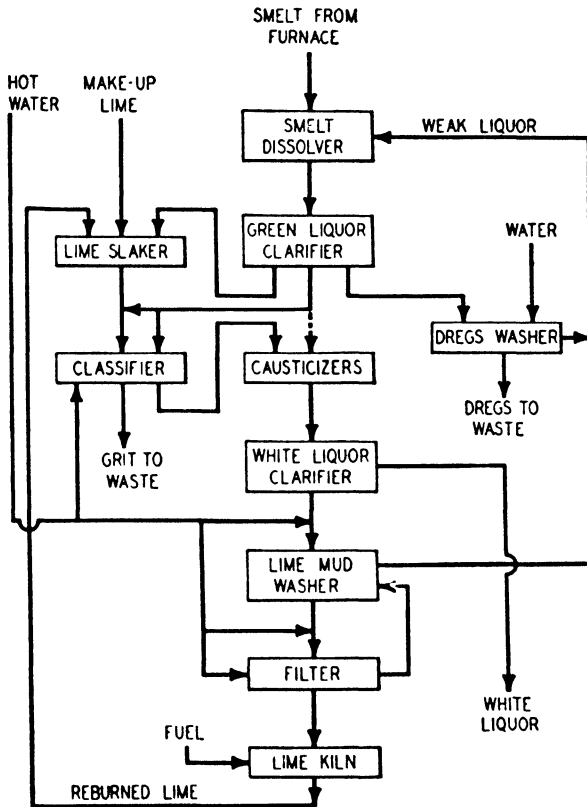

FIGURE 4-11. Continuous Causticizing System for Sulfate Pulp Mill

the solid dregs are separated and removed to a dregs washer. Part of the clarified green liquor is used to slake the lime, and the remainder may go to the classifier. Practice varies depending on the type of equipment in use. In some installations approximately a third of the liquor goes into each, the slaker, the classifier, and the causticizers. If the combination slaker-classifier, such as the Dorrco slaker, is used, all green liquor is fed into the slaker. Into the lime slaker is fed the reburned lime and fresh

make-up lime, which after slaking go through the classifier to remove any large pieces of grit formed in the lime kiln. Part of the green liquor is added to the lime slurry coming from the slaker in the classifier. The grit is washed with a small amount of hot water before going to waste. The bulk of the causticizing reaction occurs in a series of agitated vessels (Figure 4-12) and the slurry then goes to a clarifier (Figure 4-13) which separates the sodium hydroxide solution (white liquor) from the calcium carbonate mud. The mud is repulped with hot water and filtrate and passes to a washer which removes most of the soluble sodium compounds. It again is repulped with hot water, filtered on a continuous rotary filter and the cake washed with hot water. The calcium carbonate is returned to lime in a rotary gas- or oil-fired kiln.

When sodium carbonate is used in place of the smelt, the green liquor clarifier and dregs washer are not needed. The white liquor may be sent to an evaporator system and processed for fused sodium hydroxide. These operations will be discussed in the next chapter.

*Control of Operation* The successful operation of this system depends on the control given to the unit processes and operations involved in the cycle. These are:

**LIME SLAKING** The lime and its slaking determine the particle size of the hydrate which persists throughout the causticizing stage and greatly influences the decantation and washing operations. Every lime has individual properties and these properties persist throughout the process. The amount of exposure of the lime to air prior to slaking is important, for the greater the exposure the more rapidly does the hydrate or carbonate settle. The use of large amounts of water gives a finely divided calcium carbonate precipitate that settles at a low rate. The fastest settling carbonate is formed from a lime slaked with twice the theoretical amount of water, though the ratio of green liquor to lime is usually about 4 to 1. The rate of slaking decreases with the sodium carbonate content of the solution used and more time must be allowed. By using the green liquor for slaking no additional water is introduced into the system and the particle size is increased.

**CAUSTICIZING** The concentration of sodium hydroxide is set by process requirements or by cost of evaporation if the caustic is to be marketed. Concentrations of 10 to 12 per cent are considered about the maximum economical concentrations. Increasing the temperature increases slightly the rate of reaction up to 85°C. The rate also can be increased by using two stages in the causticizer. In the primary stage the rate is increased by the use of a heavy excess of lime, which is recovered in a secondary

causticizing stage using sufficient soda ash to recover the lime. This dilute liquor is used as make-up solution for soda ash and lime slaking. Long and violent agitation during the reaction is detrimental to the rate of settling of the sludge and should be avoided. A causticizer is shown in Figure 4-12 in which a tilted turbo-agitator rotates in a tank provided

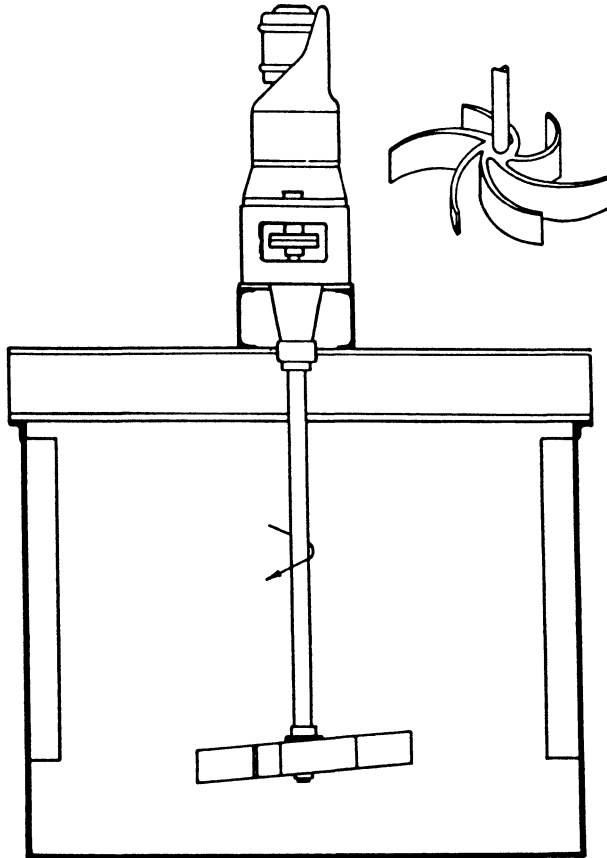

*Courtesy of the Dorr Company*

FIGURE 4 12. Turbo-Causticizer

with baffles. The speed of rotation (30 to 70 revolutions per minute) is such that the desired caustic conversion is obtained without breaking the calcium carbonate particles into a suspension difficult to filter. The tank is of steel or is lined with concrete in which limestone is used instead of sand.

**STRONG LIQUOR DECANTATION** The rate of decantation depends directly on the particle size of the calcium carbonate precipitate and the

density and viscosity of the solution. Operations preceding decantation must be controlled as indicated to give a precipitate that settles rapidly to a dense compact sludge.

**WASHING OF LIME MUD** Soluble sodium compounds can be washed more readily from a granular precipitate than from a colloidal one. The volume of wash water used is limited to that amount which can be used again in the cycle for dissolving soda ash or preparing milk of lime, which in turn is limited by the strength fixed for the finished caustic. In pulp mill practice it is usual to reject about ten per cent of the calcium carbonate sludge to prevent building up of impurities in the reburned lime. This loss is made up with fresh lime added at the slaker.

A thickener of the Dorr type used as a white liquor clarifier is shown in Figure 4-13, with the modification that for hot or caustic solutions the

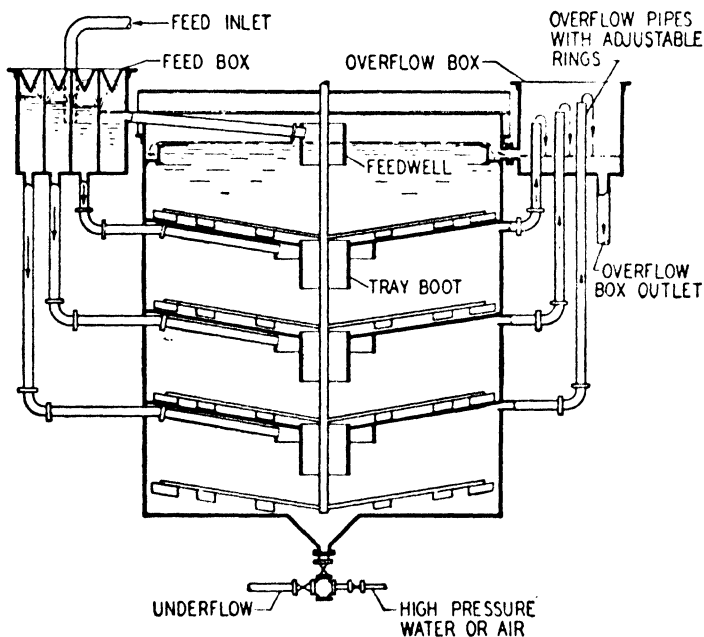

*Courtesy of the Dorr Company*

FIGURE 4-13. Balanced Tray Clarifier

tank and overflow box are normally covered and the overflow control consists of adjustable sleeves operated by handwheels on top of the box. The suspension is introduced on each tray in the feedwell and the suspended solids settle. The clear overflow from each compartment is the caustic solution, or white liquor. On each tray is a series of arms attached

to a central shaft driven by a mechanism (not shown) on the top of the thickener. On the arms are rakes which push the sludge towards the sump in the center as the arms move slowly around the tank, so slowly that no agitation of the sludge occurs. The sludge is withdrawn from the sump on the bottom tray through the underflow line by a diaphragm pump, the stroke of which can be regulated to give a sludge of maximum density.

The sludge is repulped with hot water and filtrate and pumped to a lime mud washer, which is identical with the thickener. The dregs washer is a washing-thickener similar in form but has the four compartments connected in series so that all of the feed enters the top compartment and the wash water enters the fourth compartment. The overflow from the fourth compartment is reintroduced at the feedwell on the third and continues to flow in series through the compartments until removed from the top compartment. The washed dregs are pumped from the fourth compartment to waste.

### *Competition among Alkalis*

When a variety of compounds all react in a similar manner and may be interchanged in a chemical reaction, an intercommodity competition is set up which results in the use of that compound with the most favorable chemical properties for the price which must be paid. Thus the alkali market is not merely a competition between soda ash and caustic soda, but is a competition among all alkalis. The cost to the consumer of the individual alkali is determined by a number of factors, such as: contract or open market purchase, annual demand, size of each delivery, water or rail shipment, nearness of other competitors, ability to use other alkalis, particular specifications as size, purity, concentration, package, etc., and certainly not least, governmental regulations.

Limestone is the cheapest alkali, its cost depending on the nearness of the deposit quarried or particular specifications. Thus if the limestone must be low in magnesium carbonate, sources are more limited than if any grade can be used. Prices may range from \$1.00 to \$4.00 per ton. Limestone has the disadvantage of insolubility, or low rate of solution except in acid solutions. Lime is the next cheapest, ranging from \$4.00 to \$8.00 per ton for burnt lime. If this lime is ground and bagged, prices are higher. Likewise, if the lime plant is to hydrate the lime before bagging, this cost is passed along. Ordinarily chemical plants are large users and hydrate the lime and make it into a slurry for the chemical process in the

same operation. Lime is the cheapest hydroxide and as such is in demand in industries producing a low cost chemical or processed commodity, as production of chemical caustic, magnesium hydroxide from sea water, calcium hypochlorite for bleaching, etc. The position of calcium bases may be encroached upon by magnesium hydroxide and magnesite, for one large pulp producer has announced that it will change from calcium base sulfite pulping liquor to magnesium base with a complete recovery cycle. The greater solubility of most magnesium salts is another factor.

Soda ash represents the cheapest sodium alkali, with a price about \$1.15 per cwt. Little competition exists between Solvay process and natural soda, for the latter dominates the Pacific coast market where no ammonia-soda plant exists. Sodium bicarbonate is used in only relatively small amounts, in industrial operations where an alkali of lower pH is desired. The price of caustic soda varies with the specifications. Flake caustic is quoted at \$3.70 per cwt, solid fused at \$2.30, and liquid 50 or 70 per cent at \$1.95–\$2.00. The shipment of 50 and 70 per cent caustic solution in tank cars has become standard practice. Iron-free caustic for the rayon industry sells at a somewhat increased price. Potash and caustic potash are not used extensively except for the production of potassium compounds.

Not to be overlooked is the one gaseous alkali, ammonia. Anhydrous ammonia is quoted at 4.5 cents per pound in tank car lots, though as aqua ammonia the price is down to about 3 cents. An over-expanded ammonia industry probably will reduce this in order that their output may be absorbed into peace-time industrial channels.

The effect of changing technology on prices and markets is illustrated by the price war which took place a number of years ago. A caustic-chlorine plant had marketed both products to an organic chemical industry, which found that the sodium hydroxide could be replaced by calcium hydroxide. The chlorine demand remained unchanged, so the producer had to dispose of the caustic to buyers already supplied. This led to a price war within the industry until markets were readjusted.

*Student Exercises*

A. Prepare a chemical engineering report covering one of the following topics:

1. The natural sodium carbonate industry
2. The ammonia-soda process using sodium sulfate
3. The ammonia-soda process using sodium nitrate
4. Preparation and utilization of calcium chloride from ammonia-soda waste
5. The Leblanc process in the kraft pulp mill
6. Equipment for continuous causticization
7. Equipment for saltcake production
8. The Deacon process
9. The Chance-Claus process
10. Causticization of sodium sulfate
11. Causticization of sodium sulfide
12. Hargreaves process
13. Synthetic saltcake (soda ash-sulfur)
14. Calculation of washing in continuous thickeners

B. Prepare a solubility study on the system:

1.  $\text{Na}_2\text{CO}_3\text{—NaHCO}_3\text{—H}_2\text{O}$
2.  $\text{Na}_2\text{CO}_3\text{—CO}_2\text{—H}_2\text{O}$
3.  $\text{K}_2\text{CO}_3\text{—KHCO}_3\text{—H}_2\text{O}$
4.  $(\text{NH}_4)_2\text{CO}_3\text{—NH}_4\text{HCO}_3\text{—H}_2\text{O}$
5.  $\text{Na}_2\text{SO}_4\text{—NaHCO}_3\text{—H}_2\text{O}$
6.  $(\text{NH}_4)_2\text{SO}_4\text{—NH}_4\text{HCO}_3\text{—H}_2\text{O}$

C. Prepare flowsheets for the following processes:

1. Hydrochloric acid from salt
2. Hargreaves process
3. Leblanc process for soda ash
4. Leblanc process for caustic soda
5. Deacon process
6. Weldon process
7. Chance-Claus process
8. Kraft pulp recovery cycle
9. Soda pulp recovery cycle



### Recommended Reading

#### I.

- Hou, *Manufacture of Soda*, New York, Reinhold Publishing Corp., 1942
- Furnas, *Rogers' Manual of Industrial Chemistry*, New York, Van Nostrand Co., 1942, Chapter X.
- Laury, *Hydrochloric Acid and Sodium Sulfate*, New York, Chemical Catalog Company, 1927
- Lunge, *The Manufacture of Sulfuric Acid and Alkali*, Volumes II and III, Third Edition, London, Guerney and Jackson, 1909
- Martin, *Industrial Chemistry*, Part II Inorganic, New York, Appleton and Company, 1920
- Partington, *The Alkali Industry*, London, Van Nostrand Company, 1925
- T.A.P.P.I., *The Manufacture of Pulp and Paper*. New York, McGraw-Hill Book Co., 1937, Vol. III, Section 5

#### II.

##### LEBLANC PROCESS

- Patterson, "Nicholas Leblanc and the Founding of the Soda Industry," *Chemistry and Industry*, **62**, 174-7 (1943)
- Anon., "New Efficiency Record, Established in Chemical Reclaiming," *Chem. Met. Eng.*, **38**, 440-4 (1931)
- Gregg, "Modern Alkali Recovery Systems," *Paper Trade J.*, **95**, No. 5, 29-33 (1932)
- Millidge, et al., "Recovery of Soda from Spent Liquor," *Paper Trade J.*, **98**, No. 26, 57-9 (1934)
- Wilcoxson, "Results from the B and W — Tomlinson Process for Recovery of Chemicals and Heat from Kraft Black Liquor," *Paper Trade J.*, **100**, No. 24, 72-7 (1935)
- Wilcoxson, "Burning of Waste Liquor in Kraft and Soda Paper Industries," *Trans. Am. Soc. Mech. Engrs.*, **60**, 25-35 (1938)
- Wilcoxson and Ely, "Recovery Unit Performance in Burning Kraft Process Black Liquor," *Paper Trade J.*, **110**, No. 19, 30-6 (1940)
- Gillespie, "Operation of Sulfate Pulp Recovery Units on Soda Ash-Sulfur Mixtures," *Paper Trade J.*, **111**, No. 26, 36-8 (1940)
- Rosencrants, "Modern Recovery Unit for Sulfate Process," *Paper Trade J.*, **112**, No. 8, 120-6 (1941)
- Gardner and Whitney, "Chemical Stack Losses from Soda Recovery Furnaces," *Trans. Am. Inst. Chem. Engrs.*, **35**, 1-16 (1939); *Ind. Eng. Chem.*, **31**, 181-4 (1939)

- White and White, "Manufacture of Sodium Sulfide,"  
*Ind. Eng. Chem.*, **28**, 244-6 (1936)
- Iler and Tauch, "Sodium Silicate and Hydrochloric Acid from Sand, Salt and Steam," *Trans. Am. Inst. Chem. Engrs.*, **37**, 853-77 (1941)
- Hirschkind, "Manufacture of Hydrochloric Acid from Chlorine,"  
*Ind. Eng. Chem.*, **17**, 1071-3 (1925)
- Oldershaw, et al., "Absorption and Purification of Hydrogen Chloride from the Chlorination of Hydrocarbons,"  
*Chem. Eng. Progress*, **43**, 371-8 (1947)
- Armstrong, "Construction Materials in Mannheim HCl Plant,"  
*Chem. Eng.*, **54**, No. 8, 96-8 (1947)

## AMMONIA-SODA PROCESS

- Hughes, "Modern Ammonia-Soda Plants Capitalize on Economics of Mechanical Handling," *Chem. Met. Eng.*, **37**, 232-3 (1930)
- Lynn, et al., "New Method of Producing Hydrogen Sulfide and Thiosulfates,"  
*Ind. Eng. Chem.*, **25**, 916-8 (1933)
- Trump, "Looking Back at 50 Years in the Ammonia Soda Alkali Industry,"  
*Chem. Met. Eng.*, **40**, 126-9 (1933)
- Wilson and Ch'iu, "Brine Purification," *Ind. Eng. Chem.*, **26**, 1099-1104 (1934)
- Ahlquist, "Alkali Industry," *Ind. Eng. Chem.*, **27**, 627-31 (1935)
- Ahlquist, "Alkali Industries Girdle the Globe,"  
*Chem. Met. Eng.*, **43**, 278-81 (1936)
- Haynes, "Rowland Hazard — Father of the American Alkali Industry,"  
*Chem. Industries*, **47**, 248-53 (1940)
- Anon., "A Saga of Salt," *Chem. Industries*, **50**, 184-93 (1942)
- Aronson, "Twenty Years Progress in Alkali Technology,"  
*Chem. Industries*, **50**, 324-31 (1942)

## CHEMICAL CAUSTIC

- Goodwin, "The Equilibrium in the Causticizing Process,"  
*J. Soc. Chem. Ind.*, **45**, 360-4 T (1926)
- Don and Bull, "Some Variables Affecting the Behavior of Lime in Causticizing," *Ind. Eng. Chem.*, **19**, 558-61 (1927)
- Anable and Knowles, "Continuous Recausticizing for Sulfate Pulp Mills,"  
*Paper Trade J.*, **85**, No. 1, 55-8 (1927)
- Knowles, "Continuous Recausticizing in Pulp and Paper,"  
*Paper Trade J.*, **84**, No. 14, 59-64 (1927)
- Anable, "A Complete Sludge Washing Plant in a Single Unit,"  
*Ind. Eng. Chem.*, **21**, 223-6 (1929)
- Piper, "Recent Advances in Causticizing Theory and Practice,"  
*Trans. Am. Inst. Chem. Engrs.*, **24**, 1-15 (1930);  
*Chem. Met. Eng.*, **37**, 362-5 (1930)

- Stewart, "The Application of Continuous Methods of Operation to Causticizing by the Lime-Soda Method," *Industrial Chemist*, **6**, 194-8 (1930)
- Knowles, "Studies of Plant Design Factors in Soda and Sulfate Reausticizing Practice," *Paper Trade J.*, **90**, No. 15, 60-3, No. 23, 84-9 (1930)
- Billington, et al., "Converting Sodium Sulfide to Sodium Carbonate," *Paper Trade J.*, **101**, No. 11, 44-6 (1935)
- Lammers, "Continuous Causticizing System at Crossett Paper Mills," *Paper Trade J.*, **104**, No. 22, 39-42 (1937)
- Knowles, "How to Control the Continuous Reausticizing System," *Paper Trade J.*, **106**, No. 9, 33-8 (1938)
- Rubush, "Causticizing and Lime Recovery at Bogalusa," *Paper Trade J.*, **107**, No. 4, 39-40 (1938)
- Knowles, "Progress in Kraft Reausticizing," *Southern Pulp and Paper J.*, **3**, No. 2, 10-3 (1940)
- Olsen and Direnga, "Settling Rate of Calcium Carbonate in the Causticizing of Soda Ash," *Ind. Eng. Chem.*, **33**, 204-18 (1941)
- Hughey, et al., "Causticizing, Reburning and Settling in Sulfate Lime Recovery," *Paper Trade J.*, **114**, No. 9, 25-32 (1942)
- Grunbery, "Losses in Recovery of Sodium Hydroxide in Causticizing Operations," *Industrial Chemist*, **19**, 628-32 (1943)
- Cook, "The Ammonium Chloride — Sodium Sulfite Process," *Can. Chem. Process Ind.*, **29**, 221-5 (1945)
- Taylor, "Precipitated Calcium Carbonate Becomes a Fine Chemical," *Chem. Industries*, **60**, 954-7 (1947)

## MISCELLANEOUS

- Editorial Staff, "Price and Process Determines Choice of Alkalis," *Chem. Met. Eng.*, **38**, 32-4 (1931)
- Kirkpatrick, "Why These New Chemical Industries 'Went South,'" *Chem. Met. Eng.*, **41**, 400-13 (1934)
- Conroy, "The Alkali and Associated Industries — A Retrospect," *J. Soc. Chem. Ind.*, 121-7 (1935)
- Coates, "Soda Ash and Caustic Soda," *Southern Power and Industry*, **57**, No. 10, 45-50 (1939)
- Harness and Crons, *Sodium Carbonate*, *U. S. Bur. Mines Inf. Circ.*, **7212** (1942)
- Everhart, "Materials That Resist Alkali Corrosion," *Chem. Met. Eng.*, **39**, 88 (1932)

# CHAPTER 5

## Electrolytic Caustic and Chlorine

---

- I. *Introduction*
    - A. PRODUCTION AND CONSUMPTION
    - B. HISTORY
  - II. *Electrolytic Cells*
    - A. CHEMICAL PRINCIPLES
    - B. TYPES OF CELLS
      - 1. *Diaphragm cell*
      - 2. *Mercury cell*
    - C. OPERATION OF CELLS
  - III. *Electrolytic Caustic*
    - A. EVAPORATION OF CELL LIQUOR
    - B. PURIFICATION OF CAUSTIC SOLUTION
    - C. FUSED CAUSTIC
    - D. MATERIALS OF CONSTRUCTION
    - E. MARKETING OF CAUSTIC
  - IV. *Liquid Chlorine*
    - A. LIQUEFACTION
    - B. MATERIALS OF CONSTRUCTION
    - C. MARKETING
  - V. *Bleaching Agents*
    - A. SODIUM HYPOCHLORITE
    - B. CALCIUM BLEACH SOLUTION
    - C. BLEACHING POWDER
    - D. CALCIUM HYPOCHLORITE
    - E. CHLORITES
  - VI. *Hydrochloric Acid*
    - A. GASES USED
    - B. CHEMICAL PRINCIPLES
    - C. REACTION CHAMBERS
    - D. ABSORPTION SYSTEMS
    - E. MATERIALS OF CONSTRUCTION
    - F. MARKETING
  - VII. *Sodium Chlorate*
  - VIII. *Student Exercises*
  - IX. *Recommended Reading*
- 

### PRODUCTION AND CONSUMPTION

IN 1945 sodium hydroxide was produced at 39 electrolytic plants and 9 lime-soda plants. The production in 1945 of sodium hydroxide by the electrolytic process was 1,342,761 tons and by the lime-soda process

979,008 tons, or a percentage ratio of 57.8 to 42.2. Of the electrolytic caustic 213,449 tons, or 16 per cent, was finished as solid caustic, whereas 244,015 tons, or 25 per cent, of the caustic made by the lime-soda process was finished as solid. The remainder was used or shipped as caustic solutions of various strengths. In Figure 5-1 is shown the increase in

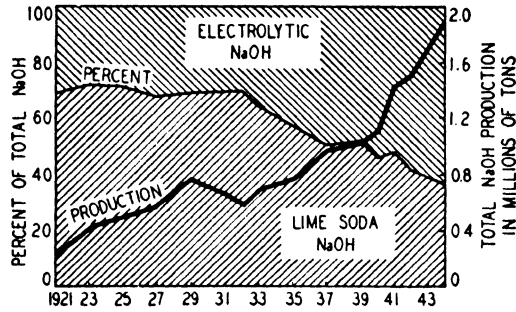

FIGURE 5-1. Production of Caustic Soda, and Division between Electrolytic and Soda-Lime Processes

total production of caustic soda since 1921 and the percentage division between the two production methods.

Sodium hydroxide is consumed by a variety of industries as given in Table 5-1 and shown in Figure 5-2.

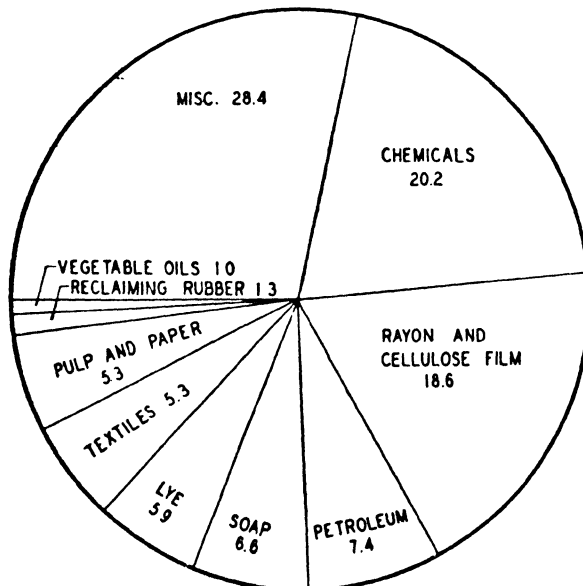

FIGURE 5-2. Consumption of Caustic Soda in 1944

TABLE 5-1 Industries that Consumed Caustic Soda in 1946  
(Chemical Engineering's Estimate)

<i>Industry</i>	<i>Tons</i>	<i>Per cent</i>
Rayon and transparent film	408,000	22.0
Chemicals	405,000	21.9
Petroleum refining	150,000	8.1
Lye and cleansers	110,000	6.0
Pulp and paper	110,000	6.0
Textiles	108,000	5.8
Soap	90,000	4.8
Exports	62,000	3.4
Rubber reclaiming	26,000	1.4
Vegetable oils	18,000	1.0
Miscellaneous	363,000	19.6
	1,850,000	100.0

Chlorine was produced in 1945 in 46 plants in the amount of 1,192,081 tons, a decrease from 1944 when 51 plants (excluding government ordnance plants) produced 1,262,362 tons. In 1944 the production methods were distributed among the various plants as follows:

	<i>Tons</i>	<i>Per cent</i>
Plants finishing the caustic soda	1,070,000	86
Plants not finishing the caustic soda	50,000	4
Other processes, as KOH, metallic Na, synthetic NaNO <sub>3</sub> , electrolytic Na <sub>2</sub> CO <sub>3</sub>	130,000	10
	1,250,000	100

The distribution of consumption of chlorine is not definitely known but is believed to be approximately 75 per cent to chemicals, 10 per cent to pulp bleaching, 4 per cent to textile bleaching, 5 per cent to sanitation and water treatment, and 6 per cent to miscellaneous uses.

## HISTORY

The first commercial installation of electrolytic cells in this country was made in 1890 based on the work of LeSuer. In 1898 the plant was

moved to the Brown Company at Berlin, N. H., where it has operated ever since.

The effect of electrolytic chlorine and caustic on the decline of the Leblanc process in England is noteworthy. When Solvay soda and chemical caustic made from it began to undersell Leblanc soda and caustic, the producers of the latter formed the Bleaching Powder Association to regulate the price of bleaching powder from Deacon process chlorine and increase profits here to offset losses on caustic. The appearance of the electrolytic caustic-chlorine cell broke this final monopoly held by the Leblanc process.

### *Electrolytic Cells*

#### CHEMICAL PRINCIPLES

An aqueous solution of sodium chloride contains the sodium, hydrogen, chloride, and hydroxyl ions.

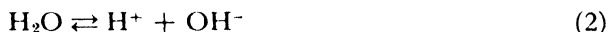

When the direct electric current is passed through this solution ordinarily the hydrogen and chloride ions are discharged at the electrodes, leaving the sodium and hydroxyl ions in the solution to form sodium hydroxide. Cathode (negative electrode, reduction):



Anode (positive electrode, oxidation):

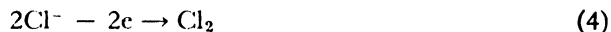

Solution:



Other electrode reactions can occur and will be discussed later.

The reactions at the electrodes depend on the relative concentrations of ions, the reversible electromotive force of the element in contact with its ions, and the degree of irreversibility of the electrode reaction or overvoltage of the element at the electrode. The electromotive force of the above elements at reversible electrodes in contact with their solutions in which the ionic activity is unity (approximately one molar) at 25°C. is given in Table 5-2.

TABLE 5-2 Standard Electrode Electromotive Force at 25°C

<i>Electrode</i>	<i>Electrode reaction</i>	<i>E°</i>
Na, Na <sup>+</sup>	Na(s) ⇌ Na <sup>+</sup> + e	+2.71
Pt, H <sub>2</sub> , H <sup>+</sup>	H <sub>2</sub> (g, 1 atm) ⇌ 2H <sup>+</sup> + 2e	0.00
Pt, OH <sup>-</sup> , O <sub>2</sub>	4OH <sup>-</sup> ⇌ O <sub>2</sub> (g, 1 atm) + 2H <sub>2</sub> O + 4e	-0.40
Pt, Cl <sup>-</sup> , Cl <sub>2</sub>	2Cl <sup>-</sup> ⇌ Cl <sub>2</sub> (g, 1 atm) + 2e	-1.36

From this it might appear that on electrolysis only hydrogen and oxygen should be liberated, but due to the low concentration of hydroxyl ions and the overvoltage of oxygen on the electrode, chlorine is formed at the anode.

On a platinized platinum electrode hydrogen deposits reversibly, but at other electrodes voltages higher than the equilibrium voltage are required. This excess voltage is the hydrogen overvoltage of the electrode. Oxygen, chlorine, and other elements likewise require overvoltages for their deposition on electrodes. Overvoltage values on a few common electrodes are given in Table 5-3. From this it is apparent that, due to the low concentration of hydroxyl ion ( $C_{\text{OH}^-} = 10^{-7}$  in neutral solution, which would increase the e.m.f. required at a reversible electrode to -0.83 volts) and the high oxygen overvoltage, the chloride ion is deposited at the anode. Because of its good mechanical properties and low hydrogen overvoltage iron is the usual cathode material in diaphragm cells.

TABLE 5-3 Overvoltage of gases on electrodes at 25°C. with current density at 10 amperes per square decimeter

	<i>Hydrogen from 2<i>N</i> H<sub>2</sub>SO<sub>4</sub> solution</i>	<i>Oxygen from 1<i>N</i> KOH solution</i>	<i>Chlorine from saturated NaCl solution</i>
Platinized platinum	0.04	0.64	0.03
Smooth platinum	0.29	1.28	0.05
Copper	0.80	0.66	—
Iron	0.82	—	—
Graphite	0.98	1.09	0.25
Mercury	1.07	—	—
Cadmium	1.22	—	—
Tin	1.22	—	—



It is possible to arrange the conditions within the cell so that the sodium ion, rather than the hydrogen ion, is discharged. This can be done in a cell which uses a mercury cathode. The electromotive force required to deposit the sodium ion is reduced because of the high concentration of sodium ions in the brine, and the formation of a sodium-mercury compound dissolved in the mercury. The electromotive force required to deposit the hydrogen ion is raised because of its high overvoltage on the mercury, made higher by the presence of the sodium in the mercury and the high current density used in the cell. The slight reaction of sodium in the mercury with the adjacent solution produces an alkaline layer in which the concentration of hydrogen ions is greatly depressed. Under these conditions the cathode reaction is:



A variety of side reactions occurs during the electrolysis of sodium chloride, usually at the anode, which decreases the yields of chlorine. These reactions may be either chemical or electro-chemical.

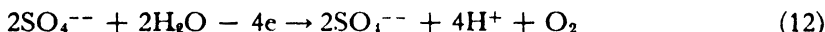
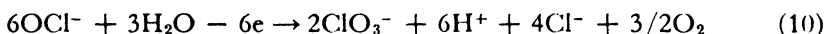
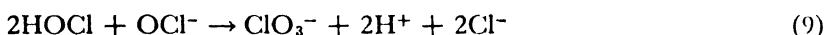

The reaction shown in equation (7), in which dissolved chlorine is hydrolyzed, causes an acid solution to form in the anode compartment, thereby reducing the concentration of hydroxyl ions and raising the electromotive force required for their discharge. Equations (7) and (8) show the origin of hypochlorite in the solution; (9) and (10) represent chemical and electrochemical formation of chlorate. In reactions (11) and (12) oxygen is liberated on the graphite surface of the anode, thereby causing oxidation, with the formation of carbon dioxide and disintegration of the electrode.

The efficiency of the electrolytic cell can be calculated in a variety of ways. The "current efficiency" is based on Faraday's laws, or the deposition of one equivalent of the element for each 96,500 coulombs (1 faraday) passed through the system. Due to secondary reactions the product desired does not appear in the amount predicted by Faraday's laws. Cathode and anode current efficiencies are different.

$$\text{Current efficiency (per cent)} = \frac{(\text{Amount of product formed})(100)}{\text{Theoretical amount of product}}$$

The "voltage efficiency" is calculated from the theoretical decomposition voltage and the actual cell voltage used to operate the process. The theoretical decomposition voltage  $E_t$  is calculated from thermochemical data by the Gibbs-Helmholtz equation:

$$E_t = \frac{-\Delta F}{n F_v} = \frac{-\Delta H}{n F_v} + T \frac{\partial E}{\partial T}$$

where  $\Delta F$  = Change in free energy of the system  
 $\Delta H$  = Change in heat content of the system  
 $-\Delta H = Q$ , the heat of reaction  
 $F_v$  = the faraday, 23,060 calories per volt  
 $n$  = Number of faradays consumed in the reaction  
 $T$  = degrees Kelvin  
 $\partial E/\partial T$  = Change in voltage with temperature.

The theoretical decomposition voltage of sodium chloride solution is calculated to be 2.3 volts; therefore

$$\text{Voltage Efficiency (per cent)} = \frac{(2.3)(100)}{\text{Actual cell voltage}}$$

The electrical energy used in the process is the product of voltage and current ( $E I$ ), which taken over a period of time is electrical power ( $E I \theta$ ). The "power efficiency" is the product of current efficiency times voltage efficiency. In a particular test a Vorce caustic-chlorine cell showed a current efficiency of 94.8 per cent, voltage efficiency of 65.5 per cent, and a power efficiency of 62.1 per cent.

#### TYPES OF CELLS

Electrolytic cells can be classified as (1) diaphragm cells, (2) mercury cathode cells, (3) bell-jar cells, and (4) fused-salt cells. Of these classes the diaphragm cells are most popular and are usually described as rectangular or cylindrical cells.

*Diaphragm Cells* Certain constructional features are common in all diaphragm cells. Anodes are of graphitic carbon which has a low chlorine overvoltage. Cathodes are made of iron because it is cheap, has a low hydrogen overvoltage and resists corrosion by the caustic-salt solution. The diaphragm cell uses a porous membrane to separate the anode and cathode solutions, thus minimizing the secondary reactions (7) to (11).

The diaphragm must have a low resistance to the passage of the electric current and to the flow of solution to the cathode chambers from the anode chamber under the slight hydrostatic head maintained there. This rate of flow is sufficient to sweep back hydroxyl ions migrating to the anode. The diaphragm must retain this low resistance over a long period of use, as well as being inert to the caustic-salt solution in contact with it. However, periodic replacement is necessary and the diaphragm should be easily replaceable. Diaphragms are of asbestos which is used either in sheet form or as a pulped suspension in water and sucked onto the retaining cathode.

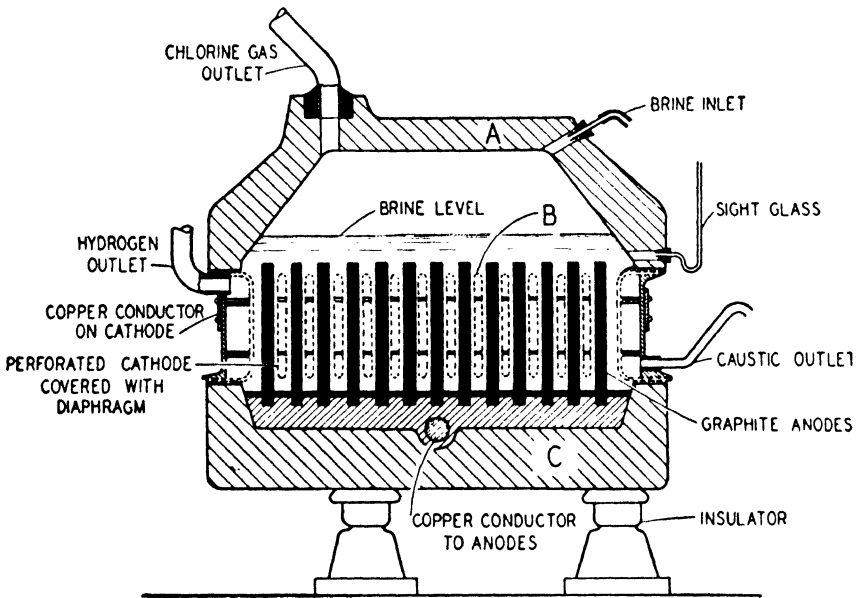

*Courtesy of the Hooker Electrochemical Company*

FIGURE 5-3. Diagrammatic Section of a Hooker Type-S Cell

Since its introduction in 1929 the *Hooker type "S"* cell has gone into more new installations than any other cell. This cell is nearly cubical in shape, as this has a smaller ratio of surface area to volume than the rectangular cells previously used, being 5 feet long by 4.5 feet wide by 3.5 feet high. A diagrammatic cross-section is shown in Figure 5-3. The cell is made in three parts, the top and bottom (*A* and *C*) being of cast concrete for heat insulation. The anodes are parallel flat plates of graphite with their lower ends embedded in a lead slab resting on the concrete bottom. The lead and concrete are covered with a heavy layer

of pitch to prevent their contact with the brine. The cathodes *B* are parallel hollow flat plates of heavy iron screen so spaced that they alternate with the anodes which project through from the bottom section. The cathodes are attached to a header formed within a "channel section" shaped to fit onto the concrete bottom. The diaphragm consists of asbestos fibers sucked onto the wire mesh, much as an asbestos mat is put onto a Gooch crucible. In Figure 5-4 is shown a partially assembled cell

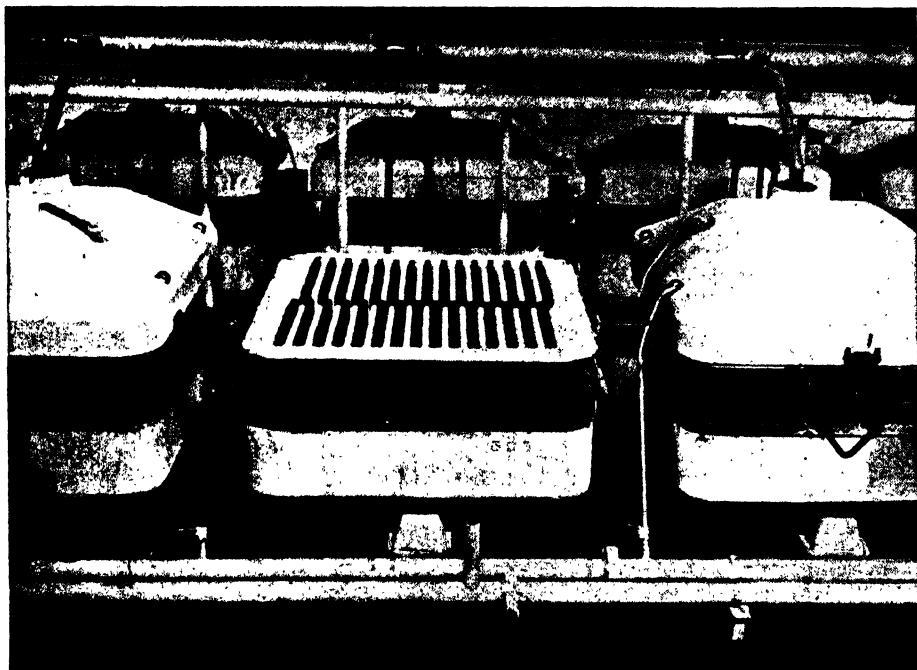

*Courtesy of the Hooker Electrochemical Company*

FIGURE 5-4. Partially Assembled Hooker Type-S Cell

with the cathode section resting on the anode section. The white layers projecting towards the center are the asbestos-covered cathodes, between which are the graphite anodes. The adjacent cells show the concrete cover in place with the chlorine take-off pipe leading to the common exhaust pipe. In operation, the level of the brine is above the cathodes and the brine flows slowly through the diaphragm as electrolysis occurs. The caustic-salt solution passes from the cathode chamber into the header in the channel section and flows out through a pipe which is adjusted so that the chamber within the cathode is nearly filled with electrolyzed brine. The hydrogen passes out along the top of the chamber

into the header and is removed at the back of the cell. This type of cell operates at 7000 amperes or more, which is considerably higher than for other types of diaphragm cells.

Cylindrical cells commonly used are the Gibbs, the Vorce, and the Wheeler cells, all evolving from the original Gibbs cell patented in 1907, and differing only slightly in structural features. The latest development is the Vorce double cathode cell shown in Figure 5-5. The cell is 26

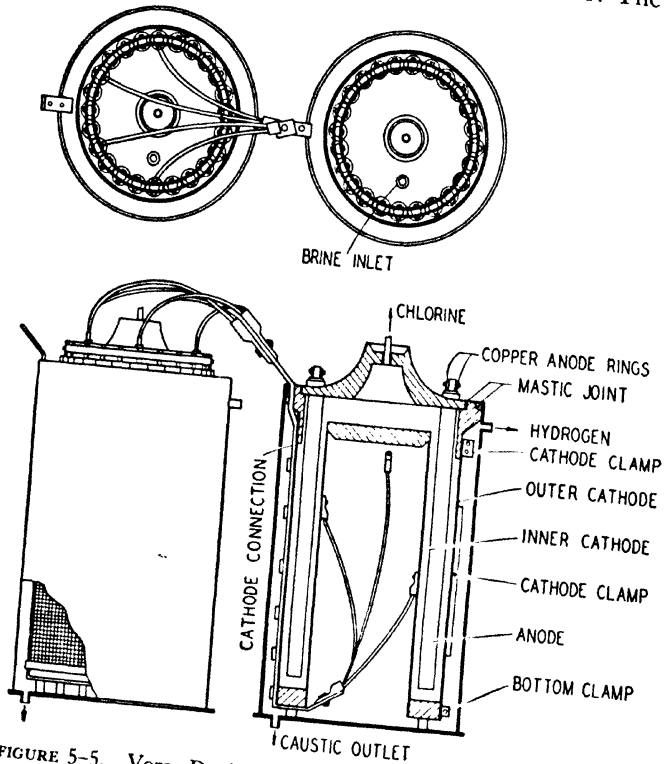

FIGURE 5-5. Vorce Double Cathode Cell

inches in diameter by 42 inches high, with a steel shell. The inner and outer cathodes of slotted  $\frac{1}{8}$ -inch steel plate support concrete covers, and in turn are separated by a concrete spacer ring at the bottom, which rests on a number of supporting blocks. There are 24 graphite anodes, 2 inches square by 36 inches long, with the head machined to slip through a hole in the concrete cover and threaded to receive a lead nut to hold each in place. The tops of the anodes are connected electrically by heavy copper strips bolted to each anode. The annular chamber be-

tween the two cathodes tapers from about 3.0 inches at the top to 2.5 inches at the bottom, thus making the distance between the cathode and anode 0.5 inches at the top and 0.25 inches at the bottom. In this way uniform current density is secured over the anode surface. The diaphragm is asbestos paper, resting on a thin screen separator which lies against the cathode. This gives more avenues of flow for brine percolating through the diaphragm and allows more metal surface in the cathode proper. The double cathode arrangement decreases the volume of brine in the cell to about 10 gallons compared with 40 gallons in the single cathode cell. The brine percolates through the diaphragm and is electrolyzed to form sodium hydroxide and hydrogen. The diaphragms are not submerged in brine on the cathode side, but the electrolyzed solution immediately is withdrawn through the caustic outlet in the base of the cell. The hydrogen is withdrawn at the upper end of the outside shell. The chlorine from the anodes is withdrawn at the top of the cell. Individual cells are connected in series by flexible cables so that no exact alignment for bus bars is necessary. The number of cells in series is such that each bank has a voltage drop equal to the voltage being supplied, as 250 volts. A number of banks are connected in parallel to utilize the current supplied on the bus bars to the cell house. Whereas the single cathode cell used about 1000 amperes per cell with a voltage drop of 3.5 volts, the double cathode cell draws 2000 to 2500 amperes with a voltage drop of about 3.0 volts per cell.

A rectangular cell of particular interest is the *Hargreaves-Bird* cell in which the caustic-brine solution passing the cathode is immediately carbonated to form sodium carbonate. Thus hydroxyl ions are immediately removed and reactions (7) to (11) prevented. The one installation is operated by a wood-pulp mill which is able to use the sodium carbonate in its process.

*Mercury Cells* Mercury cells represent a radically different type of cell which has remained in use since the early cell of Castner in 1894. No diaphragm is used and the brine is electrolyzed directly between the graphite anode and a mercury cathode. It was previously shown that under the conditions of operation which exist here the sodium and chloride ions are discharged and the sodium dissolves in the mercury to form a dilute amalgam. In one type of cell, as the Sorensen cell, the amalgam is withdrawn and decomposed by setting up a voltaic cell between the amalgam and a graphite cathode, using the sodium hydroxide solution formed as the electrolyte. In the other type, as the Castner cell, the mercury acts as a bipolar electrode, being the cathode in the brine

chamber and the anode in the caustic chamber. The amalgam is moved from one chamber to the other by a gentle rocking of the cell. In either type the reactions are:

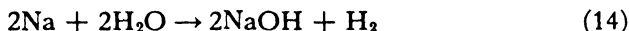

The disadvantages of the mercury cell are the higher cost of installation, greater sensitivity to operating conditions, loss of mercury (2 to 4 per cent per year), and lower energy efficiency or higher power costs. The advantages are the large size to which the cells can be expanded, drawing up to 15,000 amperes per cell, and the direct production of sodium hydroxide in concentrations up to 60 per cent without salt contamination. Thus when a chemical company can use a caustic solution in its operations or can market caustic at this concentration, the mercury cell may be preferable. Only five installations of mercury cells are operated in this country, two by large chemical companies.

An increasing advantage is the production in the cell of sodium amalgam which can be used as a reducing agent in organic reactions or production of sodium compounds. Sodium methylate is produced by the reaction of the amalgam with methyl alcohol.

#### OPERATION OF CELLS

A saturated sodium chloride solution is used, obtained either from brine wells or made-up by dissolving salt in water. This brine must be purified to remove calcium, magnesium, and iron compounds. If allowed to remain in the brine these elements would be precipitated in the diaphragm by the sodium hydroxide formed at the cathode. This would increase both the electrical and hydraulic resistance of the diaphragm and mean frequent replacements. Purification is carried out by a lime-soda treatment of the brine. At plants where the cell liquor is evaporated the precipitated salt returned to the dissolvers carries sufficient sodium hydroxide to precipitate the magnesium and iron. Flue gas is then bubbled through the solution to form sodium carbonate which precipitates the calcium. The precipitate is allowed to settle out and the clear brine pumped to the cell house.

The flow of brine into a cell usually is in a broken stream to avoid a current leak out through the solution. With a diaphragm cell, the rate should be such that the desired hydrostatic head is maintained in the

anode chamber. This varies with the porosity of the diaphragm and the caustic content desired in the cell effluent. Thus in the Hooker type "S" cell, as the diaphragm becomes less porous the level of the brine in the top section can be raised so that a constant flow results.

The brine may be preheated, though usually its temperature is raised sufficiently in the cell house. The power loss ( $I^2R$ ) within the cell is sufficient to raise the operating temperature to 50°–60°C. Cells are operated at this temperature because of the increased conductivity of the brine and lower overvoltages at the electrodes which allow a lower cell voltage. The solubility of the chlorine in the brine also decreases.

Current density, cell voltage, daily production, and concentration of caustic in the cell effluent must be balanced to give the desired production in the most economical manner. High current density at the anode increases the evolution of oxygen and thus decreases the life of the graphite anodes. At the cathode the concentration of caustic in the effluent is directly proportional to the current density and inversely proportional to the rate of flow of the brine through the diaphragm. For a given rate of flow the current efficiency is low at low current densities due to chemical reaction of dissolved chlorine with the caustic formed; it increases, passes through a maximum of 94 to 96 per cent, and decreases at high current densities due to hydroxyl ion migration from the cathode and discharge at the anode. Thus rate of flow and current density must be balanced, usually to give 40 to 50 per cent decomposition of the salt in the brine.

TABLE 5-4 Operating Results on Chlorine-Caustic Cells

	Hooker "S" cell	Force	
		Single Cathode	Double Cathode
Volts per cell	3.45	3.5	3.45
Amperes	7000	948	2550
NaOH in cell liquor, per cent	11.2	8.6	8.6
grams per liter	138	105	105
Temp. of effluent, °C	87	64	—
Cl <sub>2</sub> in gas, per cent	97.0	98.3	99.0
Current efficiency, per cent	95.5	94.8	97
Voltage efficiency, per cent	67	66	67
Power efficiency, per cent	64	62.3	65



The power efficiency of the cell is affected mainly by the voltage efficiency, which varies inversely as the voltage impressed on the cell. The higher the current densities the higher must be the voltage used to supply the necessary current and the lower is the voltage efficiency. Thus a Hooker type "S" cell drawing 5000 amperes requires 3.28 volts and at 7000 amperes requires 3.45 volts. The increased production must be balanced against increased power costs and cell maintenance.

The operating results on the Hooker "S" cell and Vorce cell are given in Table 5-4.

### *Electrolytic Caustic\**

#### EVAPORATION OF CELL LIQUOR

The liquor coming from the electrolytic diaphragm cell varies from 100 to 135 grams per liter of sodium hydroxide and 170 to 130 grams per liter of sodium chloride, with small amounts of sodium carbonate, chlorate, and sulfate. This solution must be evaporated to recover the salt and produce a commercial caustic. Multiple effect (usually two or three) evaporators are used to concentrate the cell liquor to 50 per cent caustic. Evaporator construction and operation vary with the age of the unit. Older practice was to use cast iron bodies and natural circulation in the evaporator. Due to the increasing demand for iron-free caustic for the rayon and other industries, present practice is to construct the body of nickel cast iron or nickel-clad steel and the heater tubes of nickel. Evaporator capacity is increased by using forced circulation of the solution within the evaporator. At the plant of Westvaco Chlorine Products Corporation the cell liquor, containing about 8 per cent caustic and 18 per cent salt, is concentrated in a double effect evaporator to about 30 per cent caustic. Salt is less soluble in the concentrated caustic solution and begins to precipitate after evaporation begins. The solution from each effect circulates to a cone-bottom settling chamber in which the salt settles out and from which the clear overflow returns to the evaporator body. The liquor from the second effect passes through a series of three settling tanks to separate the fine salt crystals which settle slowly in the viscous solution. The clarified solution goes to storage, from which it is pumped through a preheater to a single effect evaporator which concentrates the caustic to 50 per cent, with the separation of more salt.

\* *Chem. & Met.'s Chemical Engineering Flowsheets* (4th Ed.), No. 16.

Pictured Flowsheet, *Chem. Met. Eng.*, 49, No. 12, 114-7 (1942) 53, No. 2, 172-5 (1946).

The suspended salt and about half the dissolved salt are separated out in a continuous crystallizer. This final caustic solution can be shipped as such or further evaporated to a fused caustic.

#### PURIFICATION OF CAUSTIC SOLUTION

The demand for a salt-free caustic containing practically no iron has increased rapidly as the rayon and wood pulp industries have become more exacting. Caustic solutions made from the effluent of mercury-type cells meet these specifications, but do not supply the demand. Purification processes are necessary for the 50 per cent caustic prepared from diaphragm-type cells.

Iron, alumina, and silica compounds are removed by treating the 50 per cent caustic with finely ground natural strontium sulfate.\* This adsorbs the impurities on the surface of the particle as it slowly settles through the caustic solution.

The solubility of salt in the 50 per cent caustic solution at 20°C. is 13.9 grams per liter, which gives 1.78 per cent salt in the fused caustic. This is the lower limit, but not achieved due to the slowness with which the suspended salt crystals separate from the viscous solution, so that about two per cent salt is in the fused caustic. Many users demand lower salt content than this; thus purification processes must be used. Using the Pritchard † process the dissolved salt can be reduced in this solution until less than 0.2 per cent remains in the fused caustic. Up to 50 grams of sodium sulfate are added per liter of caustic solution. On cooling and settling a triple salt of composition  $\text{NaOH} \cdot \text{NaCl} \cdot \text{Na}_2\text{SO}_4$  separates out leaving but a small amount of dissolved salt.

Another process is to crystallize a hydrated sodium hydroxide from the caustic solution. The crystalline hydrate leaves the impurities in the mother liquor, which is sold to users not needing high purity. The caustic solution may be cooled, or diluted to 30 to 35 per cent caustic and cooled, to produce various hydrates as  $\text{NaOH} \cdot 2\text{H}_2\text{O}$ ,  $\text{NaOH} \cdot 3\frac{1}{2}\text{H}_2\text{O}$ , and  $\text{NaOH} \cdot 4\text{H}_2\text{O}$ , depending on the dilution and temperature. This hydrate is separated from the mother liquor, melted, and reconcentrated to give a 50 to 65 per cent solution or fused caustic. This process is expensive due to refrigeration and reconcentration costs, but produces a pure caustic.

A recent purification process is the ammonia extraction process used by the Columbia Alkali Division of the Pittsburgh Plate Glass Company

\* H. G. Elledge and A. Hirsch, U. S. Patent 2,030,694 (Feb. 11, 1936).

† D. A. Pritchard, U. S. Patent 1,888,886 (Nov. 22, 1933).

(Figure 5-6) \* The liquid 50 per cent caustic is introduced at the top of an extraction tower, or reactor, and flows downward countercurrent to a 75 per cent ammonia-25 per cent water solution with which it is immiscible. Sodium chloride and chlorate are extracted from the caustic solution by the ammonia solution. In this way a 50 per cent caustic containing 1.03 per cent sodium chloride and 0.45 per cent sodium chlorate is reduced to 0.04 and 0.00 per cent respectively. Common practice is to reduce the salt content to 0.1 per cent. The remainder of the equipment is a recovery system for the ammonia used in the extraction, for like the ammonia-soda process, the value of the ammonia is greater

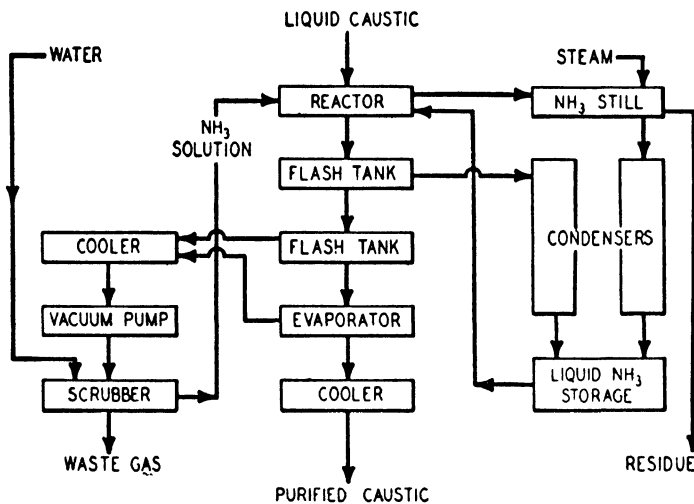

FIGURE 5-6. Purification of Caustic by Extraction with Ammonia

than that of the caustic it is treating. If anhydrous ammonia is used in the process, rather than aqueous ammonia, water is extracted from the caustic layer and a more concentrated caustic produced. Caustic hydrates or anhydrous caustic can be produced by variations of this method.

#### FUSED CAUSTIC

In order to produce solid caustic the 50 per cent solution usually is evaporated to 65 to 75 per cent in single effect evaporators using high pressure steam or Dowtherm (diphenyl-diphenyl oxide mixture) as the source of heat. This concentrated solution is pumped to the caustic pots,

\* I. E. Muskat, U. S. Patent 2,196,595 (Apr. 9, 1940).

which are hemispherical nickel cast iron pots approximately 10 feet in diameter by 6 feet deep with a wall thickness of 3 inches. Each pot holds about 20 tons of fused caustic. They are mounted in refractory brick settings and fired with oil or gas in such a manner that the flame does not strike the metal, but hot flue gases circulate around the pot. The temperature of the molten caustic is raised to 500°C. to drive off the last traces of water. If the caustic is clear in color no further treatment is required, but if colored due to iron it is treated with 5 to 15 pounds of sulfur per pot to reduce and precipitate the iron as ferrous sulfide. The molten charge is allowed to stand and cool to about 350°C. (melting point of NaOH is 318.4°C.). During this time the precipitated compounds, including sodium carbonate, settle to the bottom of the pot.

The molten caustic is pumped by a nickel centrifugal pump directly into sheet steel drums to give a solid mass when cool. Or the molten caustic can be pumped to a flaker and produce a flake form which can be handled more readily. The flaker is a water cooled nickel cast iron roll, the bottom of which dips into a bath of molten caustic. The thickness of the sheet depends upon the temperature of the caustic and the rate of revolution of the roll (usually 20–40 r.p.m.). The film of caustic cools as the roll revolves and after about three quarters of a revolution a “doctor blade” breaks the sheet from the surface and allows it to fall through a hopper with a device to break the sheet into small flakes. The flakes are then packed in steel drums.

#### MATERIALS OF CONSTRUCTION

Although iron and steel are used extensively in contact with caustic solutions with good results, corrosion occurs rapidly if the contact with caustic is interrupted by exposure to air, water, or neutral solutions; or if the caustic solution is hot and concentrated. Iron contamination is of no consequence in many industries, e.g., the refining of petroleum. Iron equipment can be used provided iron content in the caustic up to 0.001 per cent is not objectionable. In other industries, as rayon and chemicals, even traces of iron are objectionable, and nickel equipment is used. In order to decrease the expense of equipment using nickel in contact with the solution a nickel-clad steel plate may be used. A nickel-clad plate is made by rolling at high temperature a nickel plate onto a steel plate until the two have united. The nickel cladding may be as little as 10 per cent of the plate thickness. Nickel-clad plate is used for the fabrication of tanks, tank-cars, evaporator bodies, and similar equipment. The

corrosion rate, expressed as milligrams of metal lost per square decimeter of surface per day of exposure, is given in Table 5-5 for a number of metals.

TABLE 5-5 Corrosion Rate of Metals by Caustic Solution  
(In milligrams per square decimeter per day)

	A <sup>b</sup>	B <sup>c</sup>	C <sup>d</sup>
Nickel	0.13	0.6	0.97
Monel <sup>a</sup>	0.33	—	7.14
Inconel <sup>a</sup>	0.19	1.6	2.00
Cast iron	41	109	—
+ 2% Ni	—	44	—
+20% Ni	—	14	—
Ni-Resist <sup>a</sup>	15	22	—
Mild steel	45	—	311.4
Stainless steel (18 Cr + 8Ni)	—	—	147.6

<sup>a</sup> Percentage composition of alloys is:

Monel = Ni 67, Cu 30, Fe 1.4 + C, Si

Inconel = Ni 80, Cr 13, Fe 6.5 + C, Cu, Mn

Ni-Resist = Ni 14, Cu 6, Cr 2, Mn 1.5, C 3 + Fe

<sup>b</sup> A. Plant test in first evaporator effect on 14 per cent electrolytic caustic soda, average temperature 190°F., duration 90 days.

<sup>c</sup> B. Plant test in evaporator concentrating caustic soda to 50 per cent, duration 38 days.

<sup>d</sup> C. Plant test in 70 per cent caustic soda in receiving tank, temperature 195 — 240°F., duration 90 days.

Data from *International Nickel Company Bulletin T-6* (July 1939).

It is apparent that the presence of nickel in cast iron greatly reduces the corrosion rate. Stainless steel usually does not give good resistance, for the chromium appears to be attacked. Nickel alloys cannot be used for fusion pots because of the attack on them by the sulfur used for purification. A typical composition of a cast caustic fusion pot is: carbon 3.30 per cent, manganese 0.05, silicon 0.70, chromium 0.60, nickel 1.50, balance iron. Materials that are seriously attacked by caustic soda solutions and should not be exposed to it are: copper, brass, bronze, silicon-iron alloys, aluminum and its alloys, hard rubber, phenol-formaldehyde and ester-type plastics.

#### MARKETING OF CAUSTIC

Prior to 1923 caustic soda was sold on the New York and Liverpool test basis, but since then has been sold on the basis of the true sodium hydroxide content, or the basis of 76 per cent Na<sub>2</sub>O. The latter basis

considers 76.0 per cent  $\text{Na}_2\text{O}$  (98.06 per cent  $\text{NaOH}$ ) to be commercial caustic soda. In the trade, sodium hydroxide refers to the true  $\text{NaOH}$  content whereas caustic soda refers to the total alkali content expressed on a 76%  $\text{Na}_2\text{O}$  basis.

For many years the caustic soda produced from the diaphragm cell was inferior in quality to the caustic produced from soda ash by causticization, or caustic produced in a mercury-type cell. However, purification processes and control of product have improved so that caustic from all processes can meet specifications of any consumer. Thus the caustic from soda ash and from electrolytic cells compete in all fields.

Caustic soda produced in electrolytic cells may be considered a by-product and chlorine the primary product. The demand for chlorine has usually exceeded that for caustic, and the producer has had to make every effort to prevent accumulation of caustic. Thus the demand for chlorine is able to unbalance caustic prices.

Caustic soda is sold either as the solid or a solution. The solid fused caustic usually is marketed in 700-pound drums, though 100-pound drums are available. The flake caustic is packaged in 50-, 100-, 400-, 425-, and 500-pound drums. Ground or powdered caustic is made by grinding solid caustic, and commands a higher price. It is packaged in 100- and 475-pound drums. Solid stick and pellet forms are cast from molten caustic and likewise command higher prices.

The big change in the method of shipping caustic is the rapid increase in shipment in the liquid form to large consumers. Caustic solution is shipped in 8,000- and 10,000-gallon tank cars at a concentration of 50 or 73 per cent sodium hydroxide. With the higher concentration less water is shipped but certain disadvantages arise. The 73 per cent caustic solidifies at about 144°F. whereas 50 per cent caustic remains liquid above 51°F. Tank-cars carrying the former are loaded hot and are insulated to prevent cooling below 144°F. Tank-cars for either concentration must have internal steam lines to allow remelting of solidified caustic. The 73 per cent caustic also should be diluted to about 50 per cent before storage to prevent solidification, which requires a dilution chamber and cooling coils to remove the heat. Iron pick-up can occur at this point. The 50 per cent caustic can be shipped in iron tank-cars, but for 73 per cent a nickel lining, or special plastic lining, must be used. Mathieson Alkali's "Dolomite IV" was a tank-ship especially designed for the shipment of liquid caustic in nickel-lined tanks. Practice on the Pacific Coast is for oil tankers delivering fuel to the Puget Sound region to carry 50 per cent caustic in their tanks on the return trips.

## Liquid Chlorine

The gaseous chlorine is withdrawn from the electrolytic cells under slight suction. The concentration of chlorine ranges from 30 per cent to 99 per cent depending on the type of cell used. A Vorce cell on test gave a gas which analyzed  $\text{Cl}_2$  98.3%,  $\text{CO}_2$  0.7%, air 1.0%. Gas of such high purity is desired where the chlorine is to be liquefied. If the chlorine is to be used within the plant for the manufacture of bleach solution, as at pulp and paper mills, the gas of lower concentration is satisfactory.

### LIQUEFACTION\*

The gas from the electrolytic cell is saturated with water vapor at about  $60^\circ\text{C}$ . and must be carried in stoneware pipes to avoid corrosion. Part of the water present is removed by passing the gas through stoneware pipes having cooling water flowing down the outside. The temperature is not reduced below  $9.6^\circ\text{C}$ . ( $50^\circ\text{F}$ .) to avoid the formation of chlorine hydrate ( $\text{Cl}_2 \cdot 8\text{H}_2\text{O}$ ). The dehydration process is completed by scrubbing the chlorine with concentrated sulfuric acid by counter-current flow in a packed stoneware tower. The anhydrous chlorine is not corrosive and can be handled in iron pipes and equipment.

The critical point of chlorine is at  $144.0^\circ\text{C}$ . and 76.1 atmospheres. The boiling point of liquid chlorine is at  $-34.6^\circ\text{C}$ . Thus chlorine is normally below its critical temperature and can be liquefied by either compression or refrigeration. In practice both are used, and the degree of each is governed by the amount of inert gas accompanying the chlorine and utilization of the "tail gases" from the liquefaction. Where liquid chlorine is the only product the cell gas should be as pure as possible, for dilution with air decreases the partial pressure of the chlorine and increases the total compression that must be applied to obtain a particular value for the chlorine. The presence of inert gases also increases the loss of chlorine in tail gases; however, if these are scrubbed with alkali to make bleach solution the chlorine is not lost. Compression is usually applied by means of a Nash Hytor type compressor operating to 15 to 30 p.s.i. or reciprocating pumps which operate at 75 p.s.i. or above. Both types use concentrated sulfuric acid as the contained sealing and lubricating liquid. The gas at pressures usually about 25 p.s.i. goes to heat exchangers where it is cooled in two stages, as to  $-15^\circ\text{C}$ . and then

\* *Chem. & Met.'s Chemical Engineering Flowsheets* (4th Ed.), No. 16.  
Pictured Flowsheet, *Chem. Met. Eng.*, 49, No. 12, 114-7 (1942).

—25°C. Condensation occurs and the liquid chlorine is run to insulated storage tanks.

Small amounts of impurities are present in the chlorine due to reaction with organic material in the water and within the equipment, as well as ferric chloride. These impurities may cause trouble in chlorination systems where a constant flow of chlorine must be maintained. A typical analysis before and after purification shows:

	<i>Per cent by weight</i>	
	BEFORE	AFTER
Total impurities	0.0748	0.0097
Bromine	0.0095	0.0019
Chloroform	0.0668	Trace
Chloroform soluble	0.0326	—

The impurities are removed from the chlorine by passing it through a fractionating column of the tray and bubble cap type in which descending liquid scrubs out the impurities from the ascending chlorine gas. The impurities accumulate in the heating kettle at the bottom of the system and are discarded periodically.

#### MATERIALS OF CONSTRUCTION

Dry chlorine is handled without difficulty in steel equipment. However, wet chlorine, particularly at higher temperatures, is extremely corrosive because of its oxidizing action and the hydrochloric acid formed as a reaction product. Under such conditions chemical stoneware or fused silica is commonly used. Wet chlorine at ordinary temperatures also can be handled in silicon-iron pipes. Chemical lead and silver are used to some extent; a surface coating of the chloride forms a protective layer on the metal. The stainless steels are used in bleaching equipment where metal contacts chlorine solution. Rubber covered metal equipment is used extensively and bleach tanks usually are of vitrified brick or concrete covered with tile. Tantalum is entirely resistant to chlorine, but is too expensive except for speciality uses.

#### MARKETING OF CHLORINE

As discussed with production statistics, about 75 per cent of the chlorine produced is used in the manufacture of chemicals and 10 per



cent in pulp bleaching. Much of this chlorine is consumed in the plant where it is made, or adjacent to it, so that the dry compressed gas is piped to the point of utilization.

Chlorine is shipped in steel cylinders containing 10, 15, 25, 100, and 150 pounds of chlorine. These cylinders are closed with a needle valve (Figure 5-7), a part of which is a fusible plug which melts about 160°F.

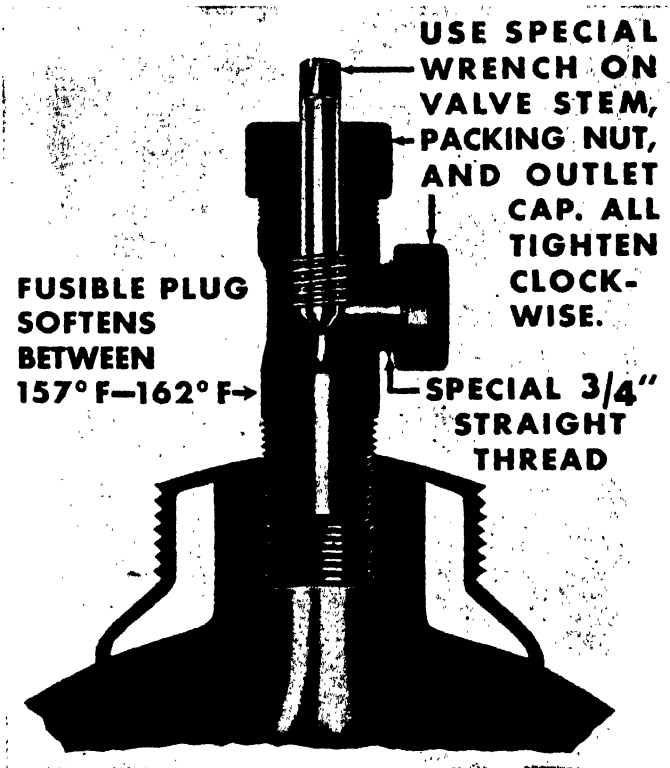

*Courtesy of the Pennsylvania Salt Manufacturing Company*

FIGURE 5-7. Cross-section of a Standard Chlorine Cylinder Valve

and releases the chlorine, rather than allowing the cylinder to explode. Large cylinders holding 2000 pounds are shipped as multiple-unit cars by placing up to 15 such cylinders on a special flat car. Single unit tank-cars contain 16, 30, or 55 tons of chlorine. A one-ton cylinder is shown in Figure 5-8. Care must be used in handling chlorine because of its toxic nature.\*

\* Division of Labor Standards, U. S. Department of Labor, *Chlorine* (1945).

The price of chlorine has steadily declined with the increased competition in the field as new plants locate in new consuming areas. From a price of about \$120 per ton in 1921 chlorine has dropped to about \$35 per ton at the present time.

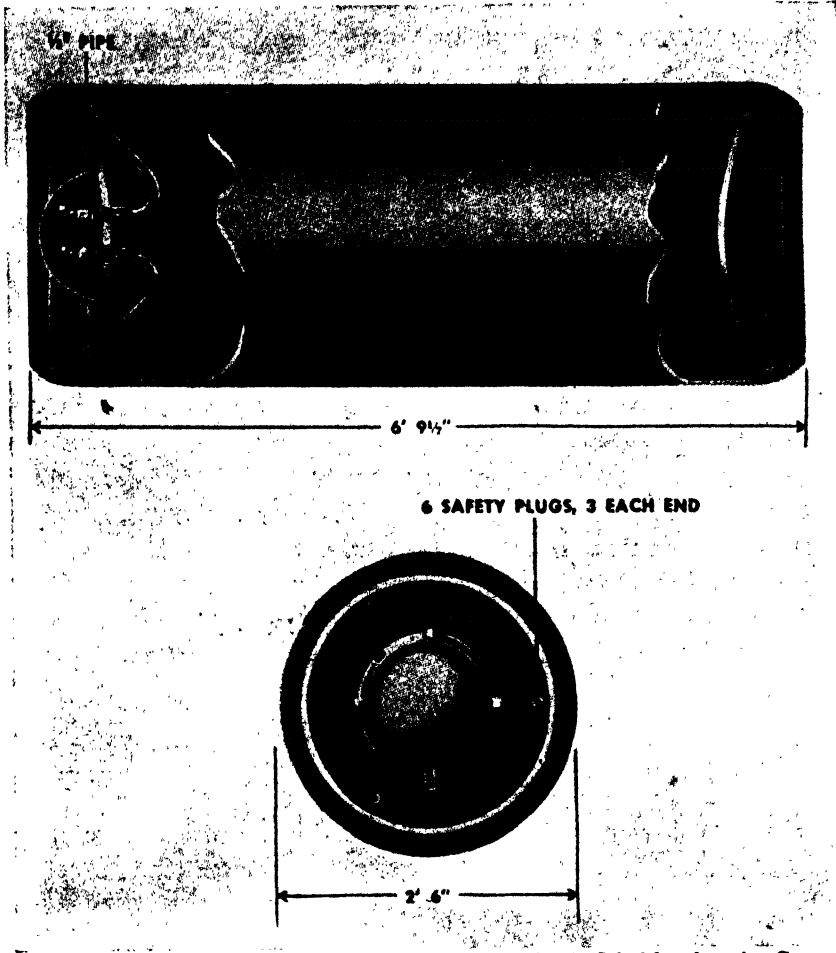

*Courtesy of the Pennsylvania Salt Manufacturing Company*

FIGURE 5-8. Cross-section of a One Ton Container

It was pointed out in the discussion of caustic soda that chlorine represents the main product and caustic the by-product produced in an equal amount. Considerable development work has been done to produce chlorine from salt independent of caustic. This has been done by the Atmospheric Nitrogen Corporation, tied with the Solvay Process

Company in the Allied Chemical and Dye Corporation. The over-all reactions are:

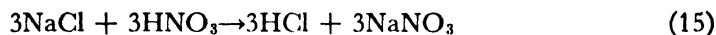

The sodium nitrate finds a ready market and the chlorine is separated from the nitrosyl chloride which is processed to recover its nitrogen and chlorine values (*cf.* Ch. 9, Fig. 9-6).

### *Bleaching Agents*

Older practice was to fix chlorine for shipment in the form of bleaching powder which could be handled as a solid. This has been displaced largely by the production and shipment of liquid chlorine. Plants generating chlorine for use as a bleach prepare hypochlorite solutions for use at some stage in the process.

In marketing or reporting the strength for bleaching, the amount of chlorine usually is reported in terms of "available chlorine," which can be expressed as percentage of the solid compound or in grams per liter for bleach solutions. Available chlorine represents the oxidizing value of the chlorine-containing compound calculated as free chlorine. Thus when the reduction product is a chloride, the oxidizing value of one  $\text{OCl}^-$  ion is equivalent to one  $\text{Cl}_2$  molecule, and one  $\text{ClO}_2$  molecule is equivalent to 2.5 molecules of  $\text{Cl}_2$ , or pure  $\text{ClO}_2$  has 250 per cent available chlorine.

### SODIUM HYPOCHLORITE

Solutions of this compound are prepared by reacting caustic solution with chlorine gas.



In chlorine plants the gas used for this purpose usually is the tail gas from the liquefaction system. Chlorine can be bubbled through the cooled caustic solution (Figure 5-9), or passed upwards in a packed tower countercurrent to the descending caustic solution. The solution is allowed to remain quite alkaline to increase the stability of the hypochlorite. The presence of iron and other heavy metal salts is to be avoided as it catalyzes the decomposition.



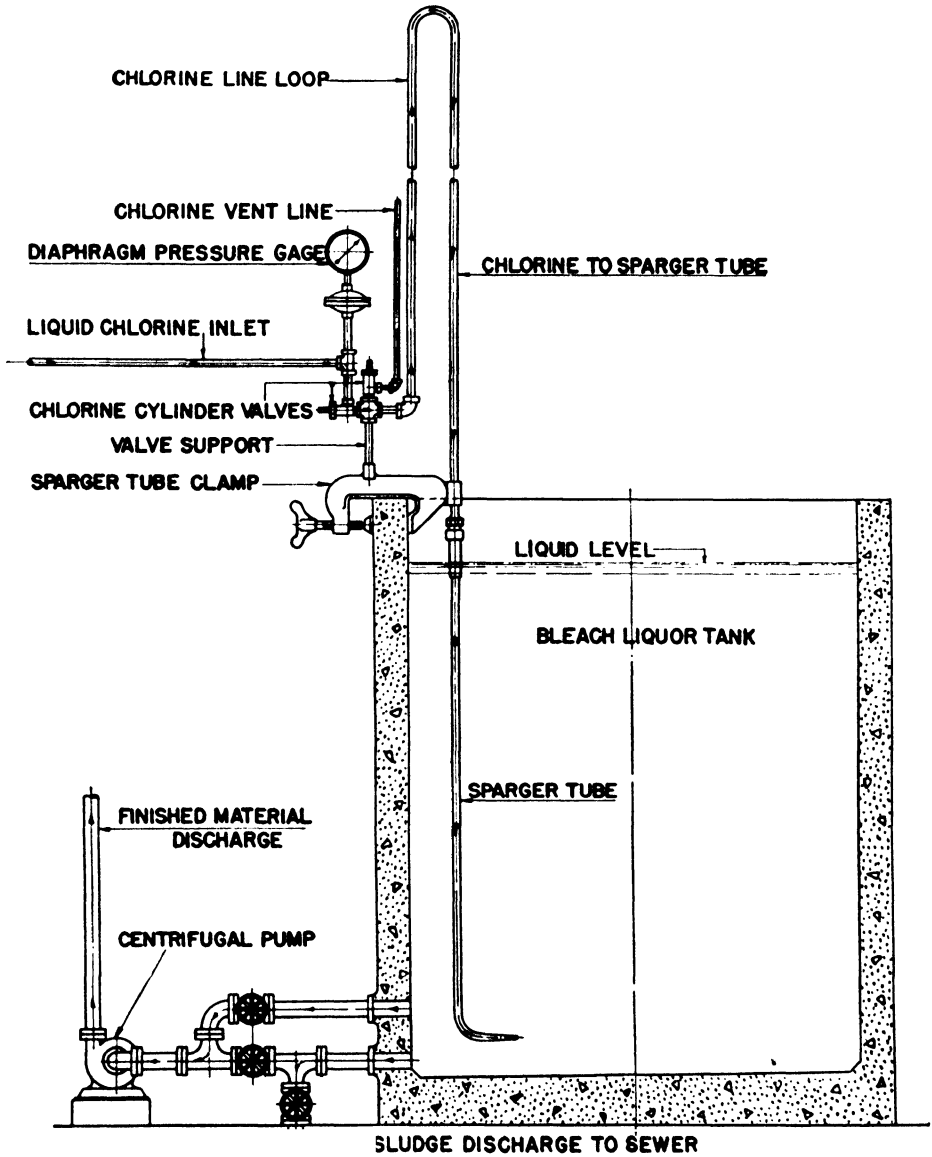

*Courtesy of the Mathieson Alkali Works*

FIGURE 5-9. Manufacture of Sodium Hypochlorite by Direct Chlorination

For commercial laundry trade the solution contains about 15 per cent available chlorine and is marketed in 1-, 5-, and 12-gallon glass bottles and in 30- or 50-gallon rubber-lined steel drums. The household product marketed under such names as Clorox, Purex, etc., contains about 5.0

per cent available chlorine. Here the price is dependent upon merchandising costs, including advertising, rather than the cost of the raw materials.

#### CALCIUM BLEACH SOLUTION

This solution is prepared in large quantities in pulp and paper mills for bleaching the paper stock. A slurry of slaked lime, low in iron, is made and chlorination conducted in any one of several types of systems. A chlorination tower can be used with the chlorine rising against the descending milk of lime, which is recirculated through the tower until the desired concentration is obtained, usually about 30 grams per liter of available chlorine. Absorption of chlorine is so rapid that a tower need not be used. The milk of lime can be agitated in a tank and chlorine admitted at the bottom through a perforated ("sparger") pipe. The depth of liquid must be sufficient for complete absorption. The paddle agitator can be omitted and the suspension circulated from the bottom of the tank, through a cone aspirator where chlorine is admitted, and back to a point near the bottom of the tank. Such an arrangement is shown in Figure 5-10. In all cases the final solution is allowed to stand to settle suspended material and the clear solution decanted. An excess of lime must be present, for at low pH values the solution decomposes spontaneously:

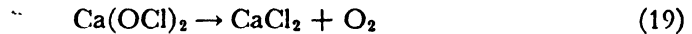

#### BLEACHING POWDER

In 1798 Charles Tennant made calcium bleach liquor and in 1799 took out his patent for absorbing chlorine in dry hydrated lime to give bleaching powder, which sold as high as \$700 per ton. Until after World War I bleaching powder remained the popular method of supplying chlorine, but its use now is decidedly limited.

Chlorine does not react with dry calcium hydroxide, but in the presence of about 4 to 5 per cent moisture a reaction (equation 20) occurs in which both the chloride and hypochlorite ions are in the same hydrated compound.

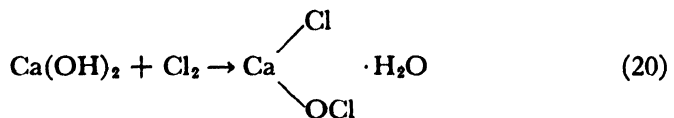

Chlorination is not continued until all lime is converted, but from 12 to 25 per cent free lime remains, or unslacked lime is added to the product to remove moisture and increase stability. A chemical-grade lime should be used which is low in magnesia and free from iron, for the chlorine compound of magnesium is unstable and the iron catalyzes the decom-

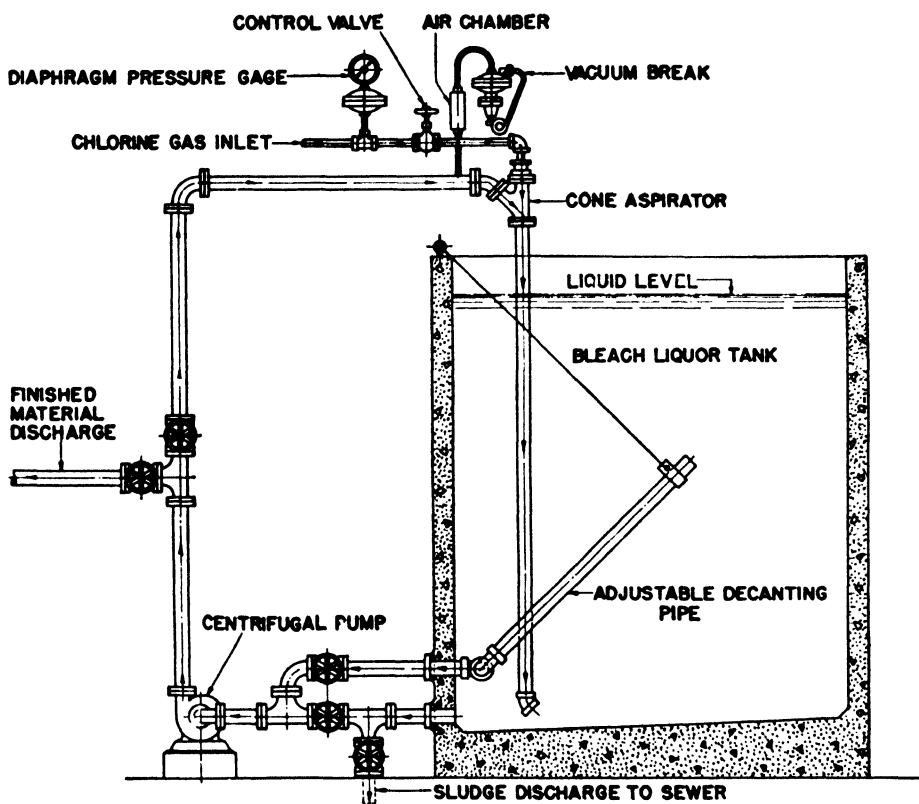

*Courtesy of the Mathieson Alkali Works*

FIGURE 5-10. Manufacture of Calcium Hypochlorite Using the Ejector System

position to oxygen. The reaction temperature must be kept below 40°C. to avoid the formation of chlorate.

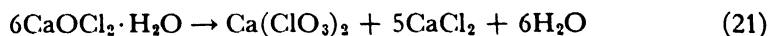

The amount of available chlorine usually specified for bleaching powder is 35 per cent.

The original process for bleaching powder was to pass chlorine diluted with air over slacked lime spread in thin layers on the floors of

concrete or lead chambers 20 feet wide by 100 feet long by 6 feet deep. A number of these chambers was connected in series so that all chlorine was absorbed. The reaction is exothermic and the output varied with the season of the year. Present practice is to use continuous mechanical chlorinators with means for removing the heat liberated. The Rudge machine is a horizontal cylinder, 65 feet long by 3 feet in diameter, and may be lined with tile. Slacked lime is fed in at the upper end and flows countercurrent to the cooled diluted chlorine, at 5°C. and containing 12% Cl<sub>2</sub> gas, entering at the lower end. Six spiral helices extend the length of the cylinder to lift the lime and drop it through the gas. The heat of reaction is removed by spraying cooling water over the surface of the cylinder. The gases leave at about 60°C. Speed of rotation varies with production desired, from 20 to 50 revolutions per hour.

#### CALCIUM HYPOCHLORITE\*

Since about 1923 true calcium hypochlorite [Ca(OCl)<sub>2</sub>] has been on the market under a variety of trade names.†

The available chlorine content of this product is specified as 70 per cent. Shipping costs on this solid are less than on bleaching powder per pound of available chlorine, and for many uses it has displaced bleaching powder in spite of its higher cost. Sodium hypochlorite solution can be made by reacting a suspension of the calcium hypochlorite with an equivalent amount of soda ash and filtering or decanting the precipitated calcium carbonate.

If a thick lime slurry is chlorinated under pressure at 30° to 40°C. a reaction occurs (equation 22) in which a calcium hypochlorite dihydrate is precipitated from the solution.

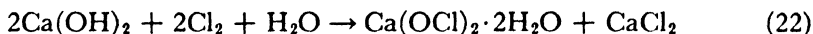

This slimy precipitate is filtered off and dried to about 2 per cent water. It may contain lime and basic salts. If equivalent amounts of lime and caustic soda are used the reaction is:

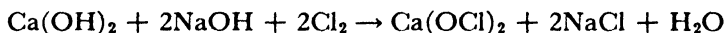

Below 16°C. the stable solid phase is the triple salt Ca(OCl)<sub>2</sub> · NaOCl · NaCl · 12H<sub>2</sub>O, which is crystallized out in high yield by cooling to -10°C. The solid crystals are made to react with a chlorinated lime

\* Pictured Flowsheet, *Chem. Met. Eng.*, 52, No. 4, 130-3 (1945).

† H. T. H. — (High Test Hypochlorite) Mathieson Alkali Works. *Perchloron* — Pennsylvania Salt Mfg. Co. *Pittchlor* — Pittsburgh Plate Glass Co., Columbia Chemical Division.

slurry which contains just sufficient calcium chloride to react with the sodium hypochlorite in the triple salt (equation 24).

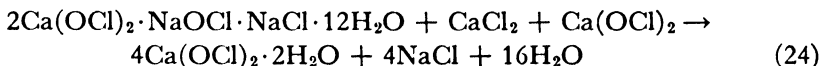

The slurry is filtered and the paste dried in vacuum to produce a granular product, or spray-dried in air to produce the powdery form.

An entirely different process uses a relatively concentrated solution of hypochlorous acid to neutralize the lime and give a precipitate that is filtered and spray-dried. The reactions are:

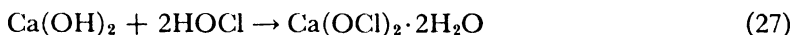

#### CHLORITES

Sodium chlorite,  $\text{NaClO}_2$ , was put on the market in 1940 by the Mathieson Alkali Works. The commercial salt contains about 80 per cent  $\text{NaClO}_2$  which is equivalent to 125 per cent available chlorine for bleaching purposes.

Lime slurry is first chlorinated to calcium chlorate at high temperature and then cold-treated with hydrochloric acid to form a mixture of chlorine and chlorine dioxide gases.

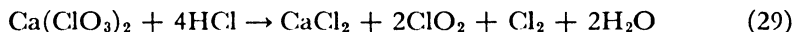
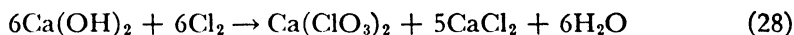

The mixture of gases is diluted with air and contacted with lime to remove the chlorine, which goes to make more chlorate. The chlorine dioxide is absorbed in caustic soda solution in the presence of a reducing agent such as sugar or animal charcoal.

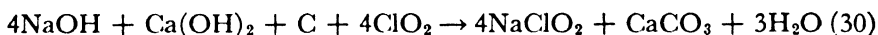

The precipitated calcium carbonate is filtered off and the solution evaporated and dried to produce the commercial compound. It is used as a bleaching agent for textiles and paper pulp, where it gives an excellentness with little loss in strength.

The dioxide,  $\text{ClO}_2$ , is generated by passing chlorine mixed with air through sodium chlorite containing 2 to 5 per cent moisture.

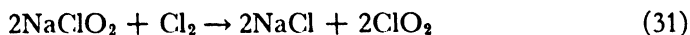

The air containing not over 4 per cent chlorine dioxide is used mainly for the bleaching of flour, though other bleaching and oxidizing uses are



suggested. The oxidizing value of chlorine dioxide is 2.5 times that of chlorine when the reduction product is a chloride.

### *Hydrochloric Acid*

Hydrochloric acid was produced in 1945 in 51 plants in an amount calculated as 407,551 tons of 100% HCl. The present distribution among the three important processes is not available, though the largest proportion is from salt and sulfuric acid, with relatively smaller proportions as by-product of chlorination reactions and from the direct combination of chlorine and hydrogen. The latter two processes have increased in importance in recent years.

The production of hydrochloric acid from chlorine and hydrogen will be discussed here.† The manufacture from salt and sulfuric acid was discussed previously, Chapter 4, page 85. The absorption systems are similar in all methods of manufacture.

#### GASES USED

Hydrogen is withdrawn from the electrolytic cells in the same manner as chlorine. The gas may be vented to the atmosphere or burned in the boiler plant if no utilization process is available. If a utilization process, as hydrogenation of vegetable and fish oils, ammonia synthesis, or hydrochloric acid synthesis, is available, the hydrogen is stored in a large gas holder and allowed to come to outdoor temperature and deposit excess moisture.

Chlorine may be taken from the tail gas of the liquefaction system, or is vaporized from liquid chlorine in the storage tank. In the former case the chlorine is less than half the total gas, and in the latter case it is pure chlorine.

#### CHEMICAL PRINCIPLES

The reaction between hydrogen and chlorine is well known as a chain reaction. At relatively low temperatures and pressures the chain propagation is accounted for by the formation of atoms, as:

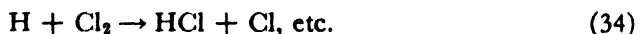

† *Chem. & Met.'s Chemical Engineering Flowsheets* (4th Ed.), No. 26.

At higher temperatures and pressures this reaction becomes explosive, usually considered due to branching chains, which can be explained by an energy chain, as:

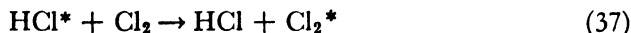

Thus every activated chlorine molecule ( $\text{Cl}_2^*$ ) forms two activated hydrogen chloride molecules which in turn activate two chlorine molecules, and the chains grow so fast that the reaction is explosive. The atomic chain mechanism can account for branching chains by thermal initiation of new chains by undissipated heat of reaction. Thus the reaction must be controlled carefully in order to avoid explosions.

The reaction is highly exothermal, and a theoretical flame temperature of about  $2100^\circ\text{C}$ . would result.

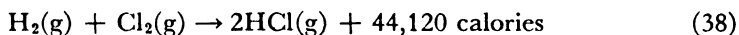

Dilution of the gases or cooling is used to reduce the reaction temperature. The absorption of hydrogen chloride in water also is exothermic, as shown in Table 5-6, and adequate cooling must be employed to remove the heat.

TABLE 5-6 Heat of Solution of Hydrogen Chloride in Water at  $18^\circ\text{C}$ .

<i>Moles H<sub>2</sub>O per Mole HCl</i>	<i>4</i>	<i>5</i>	<i>6</i>	<i>10</i>	<i>25</i>	$\infty$
Per cent HCl	33.6	31.3	25.2	16.9	7.5	0
Calories per gram mole HCl	14.38	15.04	15.46	16.29	16.97	17.63

#### REACTION CHAMBERS

One of the early systems was operated by H. K. Moore who used as the reaction furnace a steel shell lined with refractory brick. The entering chlorine gas as drawn from the cells contained 20 to 30 per cent chlorine and the hydrogen was pure. The furnace was brought up to reaction temperature by burning hydrogen and air, and then the chlorine gas was admitted, replacing the air. The furnace operated at about  $800^\circ\text{C}$ . By the use of a large excess of hydrogen the operating temperature was reduced to that safe for the materials used in the equipment. The inlet and outlet

pipes were of fused silica, with a safety seal in the inlet that would blow off in case of an explosion.

The Hooker system is one in which chlorine is burned in an atmosphere of hydrogen. The burner is shown in Figure 5-11. The chamber

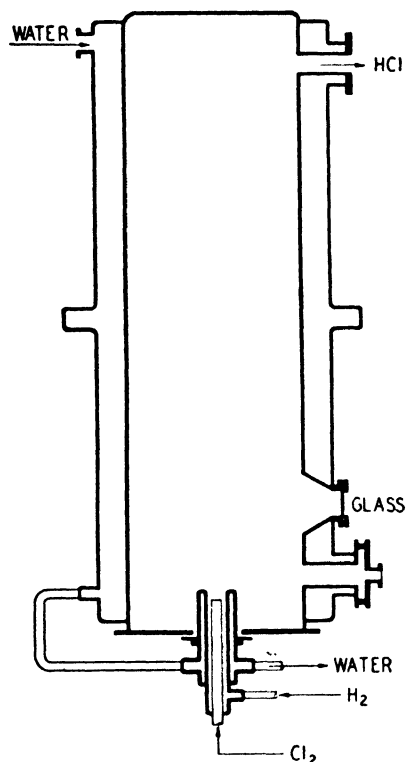

*Redrawn from Trans.  
Am. Inst. Chem. Engrs.  
38, 874 (1942) with permission*

FIGURE 5-11. Combustion Chamber for Production of Hydrogen Chloride

consists of a water-cooled shell constructed of steel, or copper-lined, about 12 feet in height by 3 feet in diameter. Water temperatures are adjusted so that the gases are never cooled below their dew point, where corrosive hydrochloric acid would be deposited. A cooling water jacket surrounds the burner to prevent it from overheating. The reaction is started by means of an air-hydrogen torch inserted through a packing gland on the side of the chamber. The top of the tower is covered with a frangible disk that ruptures if an explosion occurs. The hot gases pass to the cooling and absorption system. The amount of hydrogen is regulated so that it is only slightly in excess of the chlorine, and the hydrogen chloride in the product from pure gases is as high as 99.0 per cent.

#### ABSORPTION SYSTEMS

The hot, corrosive gases must be cooled before absorption. The concentration of hydrogen chloride in the gas varies from 98 per cent for direct combination, 30 per cent for Mannheim and hearth type furnaces, down to 5 per cent in the Laury rotary furnace. Temperatures of the gas vary from 1500°F. for direct combination, 840°F. for Mannheim, down to 300°F. for the Laury. If the gas has been made from salt and sulfuric acid, a filter is necessary to remove any solid material or sulfuric acid fog carried over. The hot gases then pass to a series of S-bends made of fused silica. The first few are air-cooled, but the final section is cooled by water running over the outside. The cooled gases then pass through the absorp-

tion system which may be any one of several types. Because of the corrosiveness of the hydrochloric acid, the systems, until recently, were constructed of silica or ceramic material. The rate of absorption of hydrogen chloride by water is exceedingly rapid and the problem is to remove the heat of solution rapidly enough. The rate of absorption of the strong gas passing countercurrent to the concentrated hydrochloric acid is kept low by passing the gas over the surface of the solution, and only near the end of the absorption process is the gas passed through the solution in a packed tower.

Early equipment were Wolff bottles, merely a ceramic enlargement of the type used in the laboratory, and Cellarius tourills. The latter (Figure 5-12) expose a considerable surface for the volume of solution.

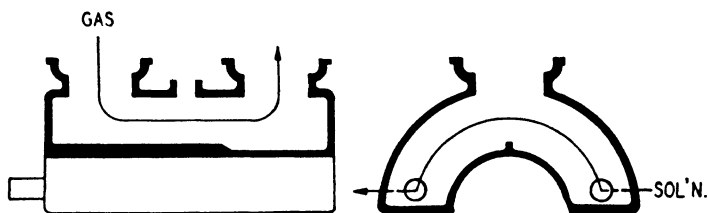

FIGURE 5-12. A Tourill

They may be cooled merely by exposure to the atmosphere, or cooling water run over them. This system has been improved by modifying the silica S-bends into absorbers. Fused silica has a greater thermal conductivity and can be made much thinner than ceramic ware. The shape (Figure 5-13) has been broadened to expose more surface. At the lower end is a ridge which retains a quantity of solution on the bottom of the vessel. A downward sloping of the roof deflects the gas against the liquid. Cooling water flows over the outside to remove the heat of absorption. With low concentration gas, such as the 5 per cent HCl gas from the Laury furnace, a series of packed towers usually is used. Weaker acid, up to 31.5 per cent HCl, is produced from such a dilute gas.

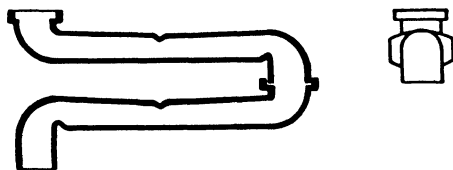

FIGURE 5-13. A Silica Absorber

With the high strength gas, up to 98 per cent HCl, from the direct combination of chlorine and hydrogen, a rapid absorption to high strength acid can be carried out in an absorption tower made of tanta-

lum, which is completely resistant to hot concentrated hydrochloric acid. It consists essentially of a tapered packed column the outside wall of which is tantalum. Being of metal, the wall can be thin and give a high rate of heat transfer to the cooling water flowing through the surrounding steel jacket. With high concentration gas, an acid as strong as 40 per cent HCl can be produced.

#### MATERIALS OF CONSTRUCTION

Because of the corrosive action of hydrochloric acid, particularly when hot or when containing some free chlorine, non-metallic materials of construction have been used extensively. Chemical stoneware, fused silica, glass, or enamelled metal, carbon or graphite (as Karbate), phenolformaldehyde plastics (as Haveg), hard, soft, or gum rubber-coated materials are all used. Of the metals, the platinum group and gold are resistant, but too expensive. Tantalum is growing in its industrial use. A few alloys are resistant to hydrochloric acid, the degree of resistance depending on the concentration of the acid, its temperature and oxygen concentration. Such alloys are Durichlor, Hastelloy A and C, and Monel metal. Monel metal is satisfactory in dilute hydrochloric acid under non-oxidizing conditions. Hastelloy A and C (Ni—Mo—Fe—Cr alloys) are quite resistant to all concentrations and temperatures of acid. Durichlor (81% Fe, 14.5% Si, 3.5% Mo, 1% Ni) is highly resistant to hydrochloric acid, but like the silicon-iron alloys, it cannot be machined. Shapes must be cast and ground to size.

#### MARKETING

Hydrochloric acid, commonly called muriatic acid, is sold in four grades:

16°Bé.	25 per cent HCl
18°	28
20°	32
22°	36

Shipment may be in glass carboys, tank-trucks, or tank-cars. Carboys contain about 12 gallons or 120 pounds of acid, but breakage is high. Delivery by tank-truck over short distances is feasible; capacity is about 1200 gallons or six tons of acid. Tank-car delivery of 8000 gallons is maximum size. Tanks are rubber-covered steel and the same type of tank is used in the plant for storage.

Anhydrous hydrogen chloride (boiling point — 85°C.) is shipped in steel cylinders similar to chlorine.

Hydrochloric acid is used for the production of chlorides and other chemical reactions, pickling steel, etc. Large volumes of acid containing an inhibitor to prevent attack on steel are used in the Dowell process for dissolving limestone from oil wells.

### Sodium Chlorate

Sodium chlorate is used extensively as an herbicide (weed killer). Potassium and barium chlorates are used in the manufacture of matches and pyrotechnics.

The electrolytic production of sodium chlorate\* is of interest because the conditions are reversed from those in the caustic-chlorine cell and those reactions which then were suppressed are now favored. By omitting the diaphragm the anode and cathode products are completely mixed to form sodium hypochlorite.

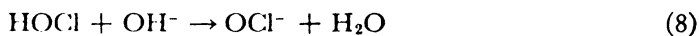
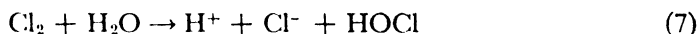

But if the solution is made slightly acid with hydrochloric acid there is sufficient hypochlorous acid for the reaction:

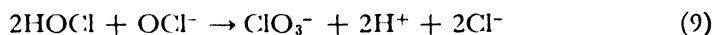

These reactions are chemical, following the primary electrochemical reaction forming chlorine and hydrogen; however, if the electrochemical reaction (equation 10) occurs due to discharge of hypochlorite ions at the anode the current efficiency for chlorate formation is lowered due to the evolution of oxygen.

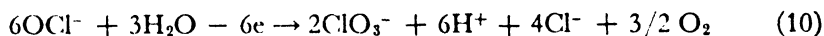

Reduction of chlorate or hypochlorite by hydrogen evolved at the cathode also reduces the yield. This is suppressed by adding as an inhibitor 5 to 10 grams per liter of sodium dichromate.

The Barker chlorate cell is a rectangular steel tank, approximately 6 feet by 1 foot, by 3 feet high. The bottom and lower part of the walls are covered with concrete and the tank is covered by a length of asbestos board. Two rows of graphite rods are suspended from this cover and between the rows is a steel cathode attached to cooling pipes. A 25 to

\* *Chem. & Met.'s Chemical Engineering Flowsheets* (4th Ed.), No. 63. Pictured Flowsheet, *Chem. Met. Eng.*, 51, No. 11, 130-3 (1944).

30 per cent salt solution is made slightly acid, 0.05N, with hydrochloric acid, and electrolyzed at 40°C. Salt is added as electrolysis proceeds to build up a high concentration of sodium chlorate in the solution. The system  $\text{NaClO}_3\text{—NaCl—H}_2\text{O}$  is similar to  $\text{KCl—NaCl—H}_2\text{O}$  (Figure 3-2), except that the sodium chlorate is much more soluble than the potassium chloride. Separation by crystallization is similar.

### *Student Exercises*

- A. Prepare a chemical engineering report covering one of the following topics:
1. Principles of sodium chloride electrolysis
  2. Metallic sodium-chlorine cells
  3. Industrial uses of metallic sodium
  4. Purification of caustic
  5. Safe handling of caustic
  6. Utilization of by-product hydrogen
  7. Chlorine liquefaction, storage and transportation
  8. Sodium hypochlorite
  9. Chloramines
- B. Prepare a solubility study of the system:
1.  $\text{NaCl—NaOH—H}_2\text{O}$
  2.  $\text{NaCl—Na}_2\text{SO}_4\text{—NaOH—H}_2\text{O}$
  3.  $\text{Cl}_2\text{—H}_2\text{O}$
  4.  $\text{ClO}_2\text{—H}_2\text{O}$
  5.  $\text{Cl}_2\text{O—H}_2\text{O}$
  6.  $\text{NaClO}_3\text{—NaCl—H}_2\text{O}$
- C. Prepare flow sheets for:
1. Manufacture of bleaching powder (chamber system)
  2. Manufacture of bleaching powder (mechanical system)
  3. Manufacture of sodium chlorite
  4. Bleaching of kraft pulp
  5. Chlorination of methane
  6. Electrolytic hypochlorite production
- D. Prepare a diagrammatic sketch and explain the important constructional and operational features of the following electrolytic cells:
- |                |                     |
|----------------|---------------------|
| 1. Castner     | 6. Vorce            |
| 2. Townsend    | 7. Krebs            |
| 3. Allen-Moore | 8. LeSueur          |
| 4. Nelson      | 9. Giordani-Pomilio |
| 5. Gibbs       | 10. Hargreaves-Bird |

E. Prepare a plant layout and make cost estimate for:

1. Manufacture and bottling of 100 gallons per day of 5 per cent sodium hypochlorite solution
2. Manufacture of 10 tons per day of sodium chlorate
3. Manufacture of 10 tons per day of sodium hydroxide, as 25 per cent solution, using the lime-soda process

### Recommended Reading

I.

Furnas, *Rogers' Manual of Industrial Chemistry*, New York, Van Nostrand Co., 1942, Chapters X and XI.

Kochler, *Electrochemistry*, New York, Wiley & Sons, 1944, Vol. II, Applications  
Lunge, *The Manufacture of Sulfuric Acid and Alkali*, Third Edition, London, Guernsey & Jackson, 1909, Vol. II and III

Mantell, *Industrial Electrochemistry*, New York, McGraw-Hill Book Co., 1940

Hou, *Manufacture of Soda*, New York, Reinhold Publishing Co., 1942

Partington, *The Alkali Industry*, London, Van Nostrand Co., 1925

Pennsylvania Salt Mfg. Co., *Chlorine*, Philadelphia, Pa., 1941

II.

#### HISTORICAL

Mond, "History of the Manufacture of Chlorine,"

*J. Soc. Chem. Ind.*, **15**, 713-9 (1896)

Moore, "The Production of Hydrochloric Acid,"

*Trans. Am. Inst. Chem. Engrs.*, **14**, 91-123 (1922)

Baldwin, "History of the Chlorine Industry," *J. Chem. Education*, **4**, 313-9 (1927)

Pritchard, "Development and Progress of the Alkali-Chlorine Industry,"

*Trans. Electrochem. Soc.*, **51**, 153-64 (1927)

LeSueur, "Inception and Development of Electrolytic Alkali Manufacture,"

*Trans. Electrochem. Soc.*, **63**, 187-95 (1933)

#### ELECTROCHEMICAL

Pritchard and Gollop, "The Canadian Salt Company's Process for the Manufacture of Alkali-Chlorine Products,"

*Ind. Eng. Chem.*, **16**, 1056-62 (1924)

Jenks, "Electrolytic Chlorination at Sacramento Filtration Plant,"

*J. Am. Water Works Assoc.*, **17**, 514-37 (1927); **18**, 1929-35 (1927)

Kirkpatrick, "Worthwhile Economies in Producing Chlorine and Caustic Soda," *Chem. Met. Eng.*, **35**, 158-61 (1928)



- Mantell, "Electrolytic Cells," *Chem. Met. Eng.*, **38**, 88-90 (1931)
- Manning, "Chemical Plant Combines Beauty and Efficiency,"  
*Chem. Met. Eng.*, **38**, 380-3 (1931)
- Baker, "Serving the Northwest with Alkalis," *Chem. Met. Eng.*, **40**, 177-9 (1933)
- Gutzwiller, "Rectifiers Succeed in Westvaco's Caustic Soda Plant,"  
*Chem. Met. Eng.*, **43**, 434-5 (1936)
- Levy, "Choosing Conversion Units for Electrochemical Plants,"  
*Chem. Met. Eng.*, **43**, 658-61 (1936)
- Lee, "Chlorine Is Produced in the Southwest,"  
*Chem. Met. Eng.*, **45**, 296-9 (1938)
- Stuart, et al., "The Story of the Hooker Cell," *Chem. Met. Eng.*, **45**, 354-8 (1938)
- Mantell, "Modern Chlorine Practice," *Chem. Met. Eng.*, **47**, 166-8 (1940)
- Murray, "Growth of the Electrolytic Alkali and Chlorine Industry in the U. S.  
— Development and Importance of the Deposited Diaphragm Cell,"  
*Trans. Am. Inst. Chem. Engrs.*, **36**, 445-62 (1940)  
*Chem. Met. Engr.*, **47**, 396-9 (1940)
- Symposium, "The Electrolytic Production of Caustic and Chlorine,"  
*Trans. Electrochem. Soc.*, **86**, 51-168 (1944)
- Anon., "Germany's Vertical Rotating Cathode Mercury Cell,"  
*Chem. Met. Eng.*, **53**, No. 1, 113-5 (1946)
- Gardiner, "Basic Principles and Operating Characteristics of Mercury Cells,"  
*Chem. Eng.*, **52**, No. 7, 110-3 (1945)
- Macmullin, "Diaphragm vs. Amalgam Cells,"  
*Chemical Industries*, **61**, 41-50 (1947)
- Gardiner, "New Mercury Cell Makes Its Bow," *Chem. Eng.*, **54**, 108-12 (1947)
- Hammond and Johnson, "Factors Affecting Anode Consumption in Chlorine Cells," *Chem. Eng.*, **53**, No. 9, 94-6 (1946)
- Wenzell, et al., "Economic Factors in Operation of Cylindrical Chlorine Cells,"  
*Trans. Electrochem. Soc.*, **89**, 181-81 (1946)

## CAUSTIC SODA

- Badger, et al., "Evaporation of Caustic Soda to High Concentrations by Means of Diphenyl Vapors," *Ind. Eng. Chem.*, **22**, 700-7 (1930)
- Lee, "Westvaco Sets New Record in Evaporating Electrolytic Caustic,"  
*Chem. Met. Eng.*, **37**, 404-8 (1930)
- Anon, "Checking Caustic Corrosion with Nickel and Its Alloys,"  
*Chem. Met. Eng.*, **40**, 528-30 (1933)
- Hubel and Sweetland, "Removal of Salt from Caustic Soda Produced by Diaphragm Cells," *Can. Chem. Met.*, **17**, 52 (1933)
- Othmer and Jacobs, "Anhydrous Sodium Hydroxide by Partial-Pressure Evaporation," *Ind. Eng. Chem.*, **32**, 154-60 (1940)

- Lilliard, "Alkalies in Cleaning Processes,"  
*Chemistry & Industry*, **1941**, 480-2, 684-8, 713-6
- Caldwell and Boyd, "Adsorption by Strontium Salts of Traces of Iron from Caustic Soda Solutions," *Ind. Eng. Chem.*, **34**, 230-3 (1942)
- Vincent, "Proper Methods of Handling Caustic Soda,"  
*Chemical Industries*, **51**, 728-31 (1942)
- Pritchard, "Economics of the Chlorine Industry,"  
*Chem. Met. Eng.*, **33**, 350-3 (1926)  
*Trans. Electrochem. Soc.*, **49**, 29-41 (1927)

## CHLORINE

- Pritchard and Hubel, "Liquid Chlorine — Its Manufacture and Use,"  
*Can. Chem. Met.*, **11**, 81-5 (1927)  
*Chemistry & Industry*, **46**, 231-3, 253-7 (1927)
- DeJahn, "Is There a Profit in Chlorine and Nitrate from Salt?"  
*Chem. Met. Eng.*, **42**, 537-8 (1935)
- Holt, "The Handling and Use of Liquid Chlorine,"  
*Chemistry & Industry*, **1936**, 245-55, 269-72
- Keene, "The Manufacture and Uses of Chlorine,"  
*Paper Trade J.*, **109**, No. 11, 86-92 (1939)
- Penfield and Cushing, "Purification of Chlorine,"  
*Ind. Eng. Chem.*, **31**, 377-81 (1939)
- Braillier, "Economics of Chlorination Processes,"  
*Ind. Eng. Chem.*, **33**, 152-5 (1941)
- Hixon and Tenny, "Chlorine and Saltcake from Salt and Sulfur,"  
*Ind. Eng. Chem.*, **33**, 1472-84 (1941)
- Quinn, "Handling Shipments of Liquid Chlorine,"  
*Chemical Industries*, **51**, 872-6 (1942)
- Magee, "Liquid Chlorine Systems," *Chem. Met. Eng.*, **50**, No. 8, 102-3 (1943)
- Chem. & Met. Report, "Chlorine Industry Plants for Markets in Postwar Pintad," *Chem. Met. Eng.*, **51**, No. 7, 115-22 (1944)
- Symposium, "Wet and Dry Chlorine vs. Materials of Construction,"  
*Chem. Eng.*, **54**, No. 1, 211-4; No. 2, 219-34; No. 3, 213-20 (1947)

## BLEACHING AGENTS

- O'Connor, "The Composition of Bleaching Powder,"  
*J. Chem. Soc.*, **1927**, 2700-10
- Ochi, "Chemistry of Bleaching Powder,"  
*Trans. Electrochem. Soc.*, **49**, 75-84, 246 (1926)
- Urano, "High Test Bleaching Powder,"  
*Trans. Electrochem. Soc.*, **49**, 65-74, 246 (1926)
- Tyler, "Laundry Bleach," *Soap*, **13**, No. 7, 24-7 (1937)

- Taylor, et al., "Sodium Chlorite — Properties and Reactions,"  
*Ind. Eng. Chem.*, **32**, 899–903 (1940)
- White, et al., "Chemistry of Chlorites," *Ind. Eng. Chem.*, **34**, 782–92 (1942)
- Woodward, et al., "New Dry Process for Making Chlorine Dioxide,"  
*Chemical Industries*, **55**, 58–61 (1943)
- Avery and Evans, "Modified MgO Process Yields MgCl<sub>2</sub> and Calcium Hypochlorite," *Chem. Met. Eng.*, **52**, No. 4, 94–6, 130–3 (1945)

#### HYDROCHLORIC ACID

- Schein, "Storing, Distribution and Using HCl in the Plant,"  
*Chem. Met. Eng.*, **35**, 673–6 (1928)
- Rohrman, "Resisting HCl Corrosion with Metals,"  
*Chem. Met. Eng.*, **40**, 646–8 (1933)
- Hunter, "Absorption of Hydrochloric Acid Gas with Tantalum Equipment,"  
*Ind. Eng. Chem.*, **30**, 1214–9 (1938)
- Laury, "Hydrochloric Acid 1918–1938," *Chemical Industries*, **43**, 485–90 (1938)
- Peck, "Hydrochloric Acid Absorption," *Industrial Chemist*, **14**, 445–8 (1938)
- Hunter, "Absorption of Hydrogen Chlorine,"  
*Trans. Am. Inst. Chem. Engrs.*, **37**, 741–62 (1941)
- Maude, "Anhydrous Hydrogen Chloride Gas,"  
*Trans. Am. Inst. Chem. Engrs.*, **38**, 865–82 (1942)
- Lippman, "Solving the Heat Exchange Problem in Cooling Hot HCl,"  
*Chem. Met. Eng.*, **52**, No. 3, 112–4 (1945)

#### CHLORATES

- Groggins and Amcintes, "Electrochemical Production of Sodium Chlorate,"  
*Chem. Met. Eng.*, **44**, 302–7 (1937)
- Pitman, et al., "Sodium Chlorate Production,"  
*Chem. Met. Eng.*, **45**, 692–6 (1938)
- Groggins, et al., "Sodium Chlorate Cell Design,"  
*Chem. Met. Eng.*, **47**, 468–70 (1940)
- Hampel and Leplla, "Production of Potassium Perchlorate,"  
*Trans. Electrochem. Soc.*, **92**, 251–9 (1947)

# CHAPTER 6

## Sulfur Dioxide and Chamber Sulfuric Acid

---

### I. *Introduction*

- A. PRODUCTION
- B. CONSUMING INDUSTRIES
- C. NOMENCLATURE
- D. HISTORY

### II. *Raw Materials*

- A. SULFUR
- B. PYRITES
- C. SULFIDE MINERALS
- D. HYDROGEN SULFIDE
- E. GYPSUM
- F. WASTE PRODUCTS

### III. *Sulfur Dioxide*

- A. SULFUR BURNERS
  - 1. *Principles*
  - 2. *Pan burner*
  - 3. *Rotary burner*
  - 4. *Spray burner*

### B. PYRITES

- 1. *Mechanical burners*
- 2. *Flash roaster*

- C. BURNER GAS
- D. DUST AND FUME REMOVAL
- E. LIQUID SULFUR DIOXIDE
- F. MARKETING

### IV. *Chamber Process*

- A. GENERAL OPERATION
- B. OXIDES OF NITROGEN
- C. PROCESS REACTIONS
- D. GLOVER TOWER
- E. CHAMBERS
- F. GAY-LUSSAC TOWER
- G. COOLER
- H. ACID PUMPS
- I. HIGH CAPACITY CHAMBERS
- J. PURIFICATION OF CHAMBER ACID

### V. *Student Exercises*

### VI. *Recommended Reading*

---

## PRODUCTION

**I**N 1945 sulfuric acid was produced at 190 commercial plants, production being divided between chamber and contact plants.

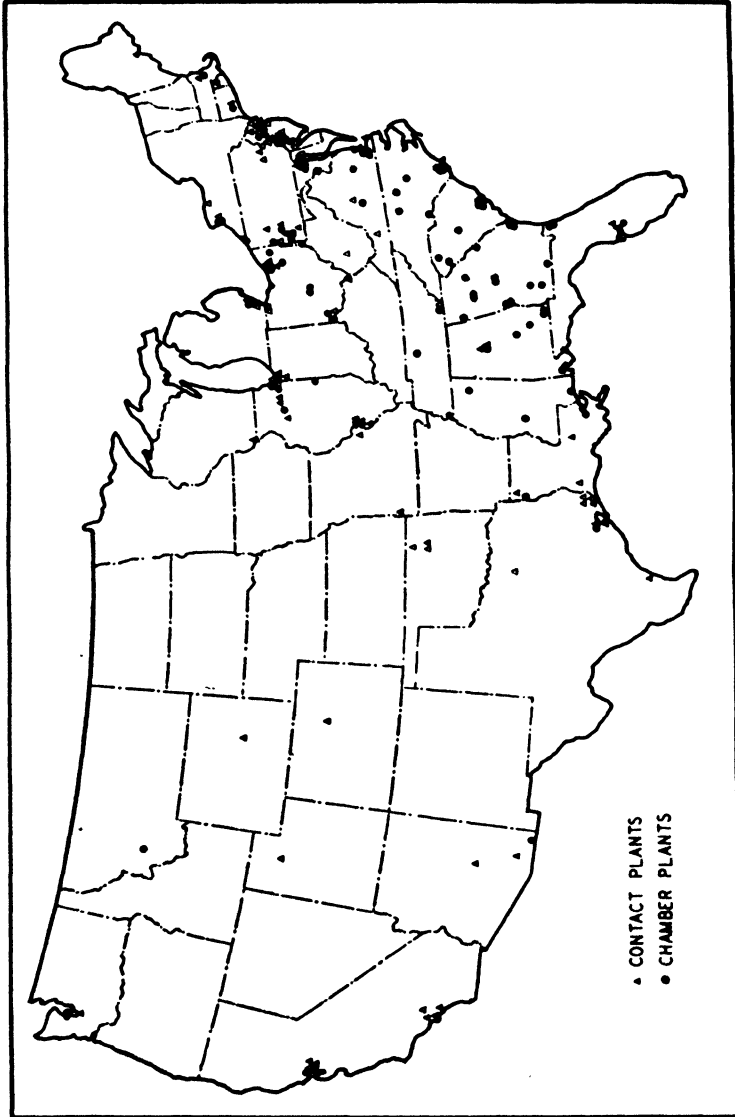

FIGURE 6-1. Distribution of Sulfuric Acid Manufacture, 1944

<i>Process</i>	<i>Tons of 100% H<sub>2</sub>SO<sub>4</sub></i>	<i>Per cent</i>	<i>Plants</i>
Chamber	3,169,197	36	101
Contact (gross)	6,352,939	—	89
(new)	5,517,873	64	—

The actual number of operating plants is 174, for at 15 plant locations both chamber and contact processes operate. Some chamber acid is fed to absorber towers in contact plants, which accounts for the gross and net production of contact acid. The locations of sulfuric acid plants in 1944 when there were 177 plants are shown on Figure 6-1, from which can be judged the density of chemical industry in general.

#### CONSUMING INDUSTRIES

The consumption of sulfuric acid is so widely spread over such a variety of industries that its consumption is considered an accurate barometer of business conditions.

Its demand by the fertilizer industry is indicative of agricultural buying, by the iron and steel industry is indicative of construction and heavy manufacturing, by the petroleum industry is indicative of general industrial and consumer buying, with similar indications by the other consumers. Whereas the solid raw materials can easily be stockpiled, the liquid sulfuric acid cannot be conveniently stored in large amounts, so that the production of acid responds rapidly to buyers' demands and hence to business conditions.

The way in which sulfuric acid accurately represents general industrial production is shown in Table 6-1. It is seen that, except for wartimes, the agreement is excellent. The increase in the production of sulfuric acid since 1910 is shown in Figure 6-2.

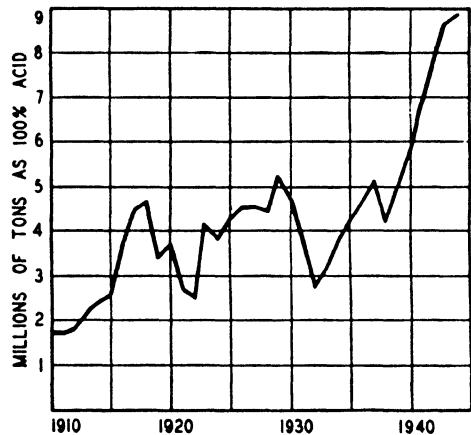

*Courtesy of Chemical Engineering*

FIGURE 6-2. Production of Sulfuric Acid in the United States since 1910. Calculated to the Basis of 100% H<sub>2</sub>SO<sub>4</sub>.

The consuming industries are shown in Table 6-2 and in Figure 6-3, though the war-time distribution to consuming industries is not a normal one.

TABLE 6-1 Sulfuric Acid as an Index of Business Activity  
(Comparison with the Federal Reserve index for industrial production. Basis: production during 1935 to 1939 = 100)

<i>Year</i>	<i>F.R. Index</i>	<i>H<sub>2</sub>SO<sub>4</sub> Index</i>
1914	58	50
1915	64	55
1916	75	84
1917	76	95
1918	75	98
1919	72	73
1920	75	73
1921	58	57
1923	88	86
1924	82	81
1925	90	92
1926	96	94
1927	95	96
1928	99	91
1929	110	112
1930	91	100
1931	75	77
1932	58	58
1933	69	71
1934	75	81
1935	87	88
1936	103	100
1937	113	118
1938	89	89
1939	109	107
1940	125	120
1941	162	143
1942	199	164
1943	239	183
1944	235	190
1945	203	200
1946	170	182
1947	187	208

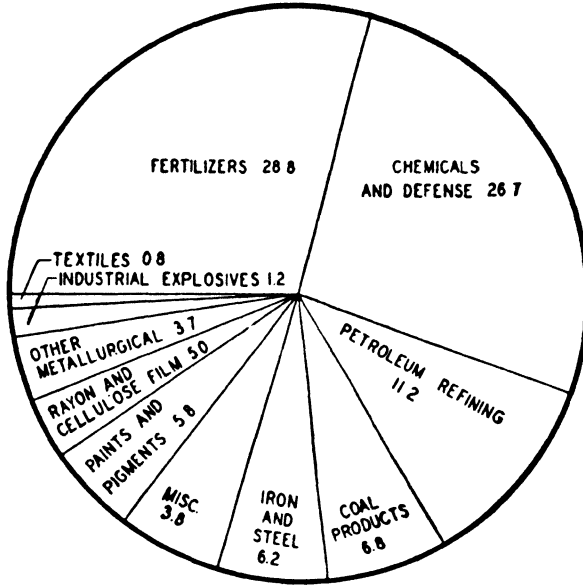

FIGURE 6-3. Consumption of Sulfuric Acid in 1944

TABLE 6-2 Industries that Consumed Sulfuric Acid in 1946 (Chemical Engineering's Estimate)

<i>Industry</i>	<i>Tons of 100% <math>H_2SO_4</math></i>	<i>Per cent</i>
Fertilizers	3,020,000	34.7
Chemicals	1,780,000	20.4
Petroleum refining	1,000,000	11.5
Rayon and cellulose film	556,000	6.4
Paint and pigments	550,000	6.3
Coal products	510,000	5.9
Iron and steel	475,000	5.5
Other metallurgical	280,000	3.2
Industrial explosives	105,000	1.2
Textiles	75,000	0.9
Miscellaneous	345,000	4.0
	8,696,000	100.0



## NOMENCLATURE

Because aqueous sulfuric acid is a liquid, its specific gravity can be determined more easily than its acid content, so that tables have been prepared that give the relationship between the specific gravity and the strength. In the industry the specific gravity is usually determined in degrees Baumé, and hence the strength of acid is usually gauged in terms of degrees Baumé. However, above 93 per cent acid, the specific gravity changes but slightly with concentration, so that concentrations in this region are reported in percentage of acid. These relationships are shown in Table 6-3.

TABLE 6-3 Commercial Concentrations of Sulfuric Acid

<i>Common name</i>	<i>Bé°</i>	<i>Per cent H<sub>2</sub>SO<sub>4</sub></i>
Chamber Acid	50	62.18
Tower Acid	60	77.67
Oil of Vitriol	66	93.19
	—	98.00
Monohydrate	—	100.00
Fuming—20% oleum	—	104.49
40% oleum	—	109.00
65% oleum	—	114.63

When free sulfur trioxide is dissolved in the monohydrate to form “fuming” acid the strength may be reported in either percentage of free sulfur trioxide present, or the percentage of the weight of the original acid which would be produced if all sulfur trioxide were hydrated to form 100 per cent sulfuric acid. Thus fuming acid containing 20 per cent sulfur trioxide has with it 80 per cent of monohydrate, and if sufficient water were added to form monohydrate there would result 104.49 per cent of the original weight.

## HISTORY

Sulfuric acid was known to the alchemists and probably prepared by them by heating alum or copperas to form sulfur trioxide which was

absorbed in water, though the burning of sulfur is mentioned. In the early part of the eighteenth century sulfur was burned in the neck of a closed vessel and the fumes allowed to react with moist air to form sulfuric acid. In 1749 there was patented an earlier known process of mixing about 5 per cent of niter with the sulfur to give increased yields. All manufacturing was done in glass until a lead chamber was erected in 1746. These increased in size until the sulfur and niter could be run into the chamber in small wagons, and by 1790 sulfuric acid was marketed by the ton. By 1810 the sulfur burner appeared and sulfur dioxide and air were fed continuously to the chamber. The batch process was displaced by the continuous process. Economies were introduced by Gay-Lussac, who perfected in 1827 his tower for the recovery of the oxides of nitrogen which previously had been allowed to escape. Despite its economy, the Gay-Lussac tower did not come into general use until about 1870 when a scarcity of sodium nitrate made economy a necessity. The Glover tower was introduced in 1859 and gave further economy of operation as well as production of a more concentrated acid, though it was not generally adopted until about 1890. Thus by 1890 sulfuric acid plants came to comprise the various parts used today. Sulfuric acid had become a low priced chemical commodity of wide utilization. The increased yield and efficiency of the plants are reflected in the declining price of acid made in England, as given in Table 6-4.

TABLE 6-4 Price for Chamber Sulfuric Acid in England

---

About 1700, H <sub>2</sub> SO <sub>4</sub> from alum	\$14,400. per ton
Early 1700, H <sub>2</sub> SO <sub>4</sub> from sulfur	960.
1797, lead chambers	270.
1878	15.
1882	10.

---

The first sulfuric acid manufacture in the United States was by John Harrison at Philadelphia in 1793. Growth was slow until after the Civil War when the need for phosphate fertilizer for cotton caused a demand for acid, which led to the construction of numerous new plants. The growth of the industry since 1865 is shown in Table 6-5, as well as on Figure 6-2.

TABLE 6-5 Production of Sulfuric Acid in the U. S.<sup>1</sup>

<i>Year</i>	<i>Production tons 100% H<sub>2</sub>SO<sub>4</sub></i>	<i>Value<sup>2</sup>/ton</i>	<i>No. of plants</i>
1865	37,000	\$77.70	—
1870	65,000	52.10	—
1880	93,000	23.30	49
1889	201,000	15.70	105
1899	373,000	14.80	127
1909	487,223	9.80	183
1914	2,339,471	11.40	194
1919	3,452,595	17.40	216
1929	5,279,775	12.50	170
1933	3,404,000	10.30	112
1939	4,795,002	—	165
1943	8,597,736	—	170

<sup>1</sup> Recalculated from Kreps, *The Economics of the Sulfuric Acid Industry*.

<sup>2</sup> To nearest 10 cent figure.

### *Raw Materials*

The sulfuric acid industry is characterized by its use of a variety of primary raw materials and secondary waste materials. The primary material used has varied with its price, availability, and process used for acid manufacture. Plant location has been dictated by the necessity of ocean-borne shipment or the utilization of a waste product, as sulfur dioxide, which otherwise would be released to the atmosphere with destructive effect on surrounding vegetation. The effect of monopolies, as Sicilian sulfur, their mitigation due to development of other equally satisfactory raw materials, as pyrites, the ascendancy of the use of pyrites, the breaking of the Sicilian monopoly by the introduction of the Frasch process in the United States, the gradual rise of the use of sulfur, the technical readjustments necessitated by lack of ocean shipping facilities for pyrites during World War I, as well as technical advances within the industry and changing demands by the using industries, all make the sulfuric acid industry and its raw materials a fascinating study of economic and technical history.

Sulfuric acid made in the United States in 1946 was distributed among the various raw materials as shown in Table 6-6.

TABLE 6-6 Raw Materials Used for Sulfuric Acid Production in 1946  
(Chemical Engineering's Estimate)

Sulfur	6,880,000	79.1
Pyrites	1,160,000	13.3
Sulfide Ores	600,000	6.9
Hydrogen Sulfide	60,000	0.7
	8,700,000	100.0

## SULFUR

Combined sulfur is widely distributed in nature as sulfides and sulfates, but free sulfur occurs in commercial quantities in a few countries. These deposits usually are associated with past volcanic activity, though the gypsum type deposits of Sicily and our Gulf Coast region are of entirely different origin. The distribution of world production of sulfur in 1937 is shown in Table 6-7.

TABLE 6-7 World Production of Sulfur in 1937

	<i>Long tons</i>	<i>Per cent</i>
United States	2,741,970	83.6
Italy	338,101	10.3
Japan	138,283	4.2
Spain	27,151	0.8
Chile	16,766	0.5
8 Others	18,749	0.6
	3,218,020	100.0

Prior to 1900 the world's needs were supplied from the deposits in Sicily. Crude methods and much manual labor kept the price relatively high, while monopolistic control had varied the price from \$25 to \$70 per ton. The increasing demand for sulfuric acid to produce sodium sulfate for the Leblanc soda process necessitated a competitive source of sulfur at a steady price. This was supplied by pyrites and by 1860 in Europe and 1900 in this country the sulfuric acid industry operated almost com-

pletely on pyrites as the source of sulfur dioxide. Only those plants that had to produce an arsenic-free acid continued to operate on sulfur.

The sulfur deposits in Louisiana were known as early as 1865, and

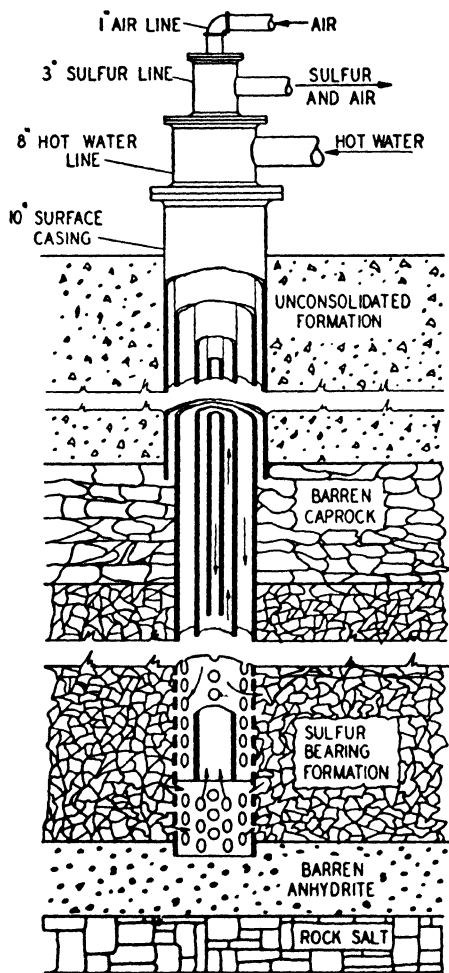

FIGURE 6-4. Frasch Process for Sulfur (redrawn from A.I.M.M.E., *Industrial Minerals and Rocks*, page 851, with permission)

subsequent exploration in oil drilling located a number of sulfur deposits in conjunction with the salt domes of the Gulf Coastal Plains (Figure 2-4). The sulfur occurs in the gypsum and limestone cap on the dome. The native sulfur is distributed throughout the gangue, with occasional pockets of sulfur in cavities in the gangue. The deposits may be from 400 to 2,000 feet in depth and overlaid with pack sands and loose clay formations. Under-ground methods of mining were attempted, but the loose and porous nature of the overlying formation, and the hydrogen sulfide encountered caused the failure of the usual mining methods. These difficulties were solved in 1894 when the now famous Frasch hot-water process\* produced its first sulfur.

The process operates on the principle of supplying the heat necessary to melt the sulfur (molten at 120°C.) from the gangue by means of high pressure steam and pumping the molten sulfur and water to the surface. Mechanical pumps gave so much trouble in early installations that air-lifts were adopted to raise the liquids to the surface. A typical sulfur well is shown in Figure 6-4. The well is drilled with oil-field type of equipment and a 10-inch casing is set and securely cemented into the cap rock

Under-ground methods of mining were attempted, but the loose and porous nature of the overlying formation, and the hydrogen sulfide encountered caused the failure of the usual mining methods. These difficulties were solved in 1894 when the now famous Frasch hot-water process\* produced its first sulfur.

\*"Sulfur mining," Pictured Flowsheet, *Chem. Met. Eng.*, **48**, No. 3, 104-7 (1941).

in order to seal off the overlying formations from which cold water might seep into the well. Drilling is then continued and the well extended to the top of the anhydrite formation which underlies the sulfur-bearing formation. An 8-inch line is run to the anhydrite and securely cemented to it. Approximately 35 feet of the lower end of the pipe is perforated to permit hot water to pass out into the sulfur bearing formation and to allow the molten sulfur to flow back into the well. A 3-inch line for molten sulfur is run concentric with the 8-inch line and bottomed against a flange welded to the 8-inch line. A 1-inch line for compressed air is concentric within the 3-inch line and extends to within about 200 feet of the bottom. In starting up, hot water is pumped down both the 8- and 3-inch lines. The water must be kept at 160–163°C. because if cooler, it does not supply enough heat, and if hotter, it increases the viscosity of the molten sulfur. The molten sulfur drains through the porous formation and collects in a pool at the base of the well. When the hydrostatic head on the well forces sulfur up to the end of the air line, compressed air at 500 p.s.i. is admitted to the 1-inch line and the sulfur is brought to the surface by the air-lift. The sulfur-air mixture is pumped through steam-heated lines to a separator, from which the sulfur goes to a storage vat. It is estimated that one well removes the sulfur from about a half acre of deposit. With a number of wells operating, each forcing 7 to 8 million gallons of hot water per day into the deposit, arrangements must be made to withdraw some of the cooled water from underground. This is done by placing wells or using exhausted sulfur wells, to act as "bleeder wells" and withdraw water.

Storage vats contain upwards from 500,000 tons of sulfur and are allowed to stand for 6 to 12 months so that all molten sulfur solidifies, and to maintain an adequate reserve supply above ground. The purity is from 99.5 to 99.9 per cent sulfur and is free from selenium, tellurium, and arsenic.

Considerable amounts of by-product sulfur now reach the market, either in competition with commercial sulfur, or in a special form that makes it more satisfactory for insecticides. Hydrogen sulfide may be removed from natural or manufactured gas by absorption in alkaline solutions of certain salts in which the hydrogen sulfide is oxidized to sulfur when treated with air.\* This sulfur usually has colloidal properties which make it of special value in preparing insecticides, or the sulfur can be melted and sold as commercial sulfur. The sulfur dioxide from smelter or

\* *Chem. & Met. Chemical Engineering Flowsheets* (4th Ed.), No. 80, "Thylox."  
Pictured Flowsheet, *Chem. Met. Eng.*, 51, No. 7, 130-3 (1944). "Thylox."

furnace stack gas can be removed by absorption in ammonium sulfite solutions and recovered by regenerating the solution. At the smelter at Trail, B. C., the sulfur dioxide is reduced by passing it through a bed of hot coke in a gas producer. The reaction is:



The sulfur vapor coming off is condensed out and run to storage vats. This by-product sulfur is small in tonnage, but represents a technical solution to an important industrial problem.

Sulfur is used extensively for purposes other than the manufacture of sulfuric acid. The distribution by industries for 1945 is shown in Table 6-8.

TABLE 6-8 Industries that Consumed Sulfur in 1945  
(Chemical Engineering's Estimate)

<i>Industry</i>	<i>Long tons</i>	<i>Per cent</i>
Chemicals	1,605,000	54.2
Fertilizers and insecticides	600,000	20.3
Pulp and paper	297,000	10.0
Paint and varnish	94,000	3.2
Explosives	90,000	3.0
Dyes and coal-tar products	75,000	2.5
Rubber	58,000	2.0
Food products	7,000	0.2
Miscellaneous	135,000	4.6
	2,961,000	100.0

The price of sulfur has remained constant for some years at \$16.00 per long ton at the mines. To assist in export selling, the Sulfur Export Corporation (Sulexco) was formed by domestic producers to fix foreign prices, allocate foreign markets, etc. In this capacity Sulexco entered into trade agreements with the Italian monopoly to allocate world sales.

## PYRITES

Iron pyrites when pure corresponds to the formula  $\text{FeS}_2$  and contains 53.4 per cent sulfur. As mined it is never pure, but contains other sulfides and silicates. Arsenic may be present in considerable amount

and requires purification of the combustion gases before being used in the process.

In 1944 the United States produced 788,530 long tons of pyrites, averaging 42.2 per cent sulfur, valued at \$2,598,000 (equivalent value of the sulfur is about \$7.80 per long ton). Principal production is in Tennessee and Virginia where pyrites is mined by underground methods for production of sulfuric acid. Copper is also produced with the Tennessee pyrites.

In 1937 the United States imported 524,430 tons of pyrites, mainly from Spain, the leading world producer. Spanish pyrites has been imported mainly at Atlantic seaboard ports and acid plants have been located there to take advantage of this cheap form of sulfur.

Extensive deposits of pyrrhotite exist in Virginia and it is used in the manufacture of sulfuric acid by one company there. The composition approximates  $\text{FeS}$  and is variously given as  $\text{Fe}_5\text{S}_8$  to  $\text{Fe}_{16}\text{S}_{17}$ . The ore averages 25 to 35 per cent sulfur.

Pyrites usually is sold on the "unit" basis, which is 1 per cent of a short ton of sulfur content. At the current price of approximately 12 cents per unit, pyrites containing 41.8 per cent sulfur costs  $(41.8)(0.12) = \$5.02$  per short ton, or \$5.60 per long ton. Purchases are usually under long-term contract in order to secure a supply of uniform quality. Specifications usually provide for (a) specified content of sulfur, (b) a specified content of materials recognized as injurious, and (c) a specified content of materials that retard or prevent combustion. Penalties are exacted if the content of sulfur falls below that specified or deleterious materials exceed specified values. A premium may be paid on higher content of valuable components, as copper. Pyrites is sold in two sizes: lumps, which exceeds 2-inch size, and fines, which must pass a half-inch screen. Foreign pyrites frequently is shipped to this country as ballast and as such obtains a low freight rate, usually being c.i.f. and delivery is made from the ship to consumer's dock.

#### SULFIDE MINERALS

Copper and zinc ores are mainly sulfide ores which must be roasted to produce the metallic oxide. The sulfur dioxide formed in this process formerly was allowed to go to waste, but now is used for the production of sulfuric acid and other chemicals based on this industry. The plant of the Consolidated Mining and Smelting Co. of Canada, at Trail, B. C., is an excellent illustration of such a chemical growth, producing sulfuric



acid, ammonium sulfate, sulfur, superphosphate fertilizers, and other chemicals. This splendid development resulted from damage suits filed by surrounding landowners in both Canada and the United States.

In this country about a quarter of the sulfuric acid from by-product gases is from copper sulfide ores and the remainder is from zinc sulfide ores. As shown in Table 6-6 about 13 per cent of the acid produced is from sulfide ores.

#### HYDROGEN SULFIDE \*

Both natural and manufactured gases contain sulfur, usually as hydrogen sulfide. In the latter the amount is small and is removed by oxidation, either by ferric oxide in dry boxes or by air in wet processes, as the Thylox process. In both cases sulfur is obtained. In natural gas the hydrogen sulfide may be as high as 10 per cent, and refinery gases run up to 6 per cent. The hydrogen sulfide is absorbed from the gas in alkaline salt solutions (potassium phosphate, sodium phenolate) or organic bases (ethanolamines) and regenerated by heating the solution. The nearly pure hydrogen sulfide can be burned to sulfur dioxide, or by controlled catalytic oxidation, sulfur can be produced. A natural gas containing 4250 grains hydrogen sulfide per 100 standard cubic feet (6.7 per cent by volume) is purified to 0.05 grains by the Girbotol process. The gas containing hydrogen sulfide and carbon dioxide is piped to a neighboring plant which oxidizes the hydrogen sulfide to produce 50 to 60 tons of sulfur per day.

#### GYPSUM

Although not used in this country, gypsum ( $\text{CaSO}_4 \cdot 2\text{H}_2\text{O}$ ) or anhydrite ( $\text{CaSO}_4$ ) is used in Germany as a source of sulfur dioxide. Gypsum is used instead of limestone in a cement kiln, and a mixture of gypsum, clay, and ground coke is charged into the rotary kiln. The partial reaction is:

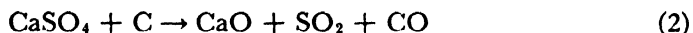

The carbon monoxide burns to the dioxide in the oxidizing atmosphere of the kiln, and the lime combines with the clay to form cement. The exit gases contain 6 to 7 per cent sulfur dioxide. Dust and fumes are

\* *Chem. & Met.'s Chemical Engineering Flowsheets* (4th Ed.), No. 78, 79, "Girbotol and sodium phenolate processes."

Pictured Flowsheet, *Chem. Met. Eng.*, 47, No. 1, 37-40 (1940) "Girbotol."

removed, air is added to supply oxygen, and this gas is used in a standard contact process to form sulfur trioxide.

#### WASTE PRODUCTS

Two waste products, other than hydrogen sulfide, are used for the production of sulfuric acid in special plants.

“Acid sludge” is formed in considerable quantities at petroleum refineries where sulfuric acid treatment is used to remove unsaturated compounds and color bodies from petroleum products. This acid usually is separated, concentrated, fortified with sulfur trioxide or oleum, and reused. The sludge may also be burned to produce a gas containing sulfur dioxide which can be reconverted to sulfuric acid. Spent alkylation acid can likewise be used to produce sulfur dioxide.

Ferrous sulfate is produced in large tonnage in the iron and steel industry, where sulfuric acid is used to remove the oxide coating from the metal, and in the titanium pigment industry, where the iron compounds are dissolved from the titanium compounds with sulfuric acid. Excess acid is neutralized with ferric oxide cinder and the solution dehydrated in a rotary kiln. The dehydrated ferrous sulfate is mixed with powdered coal and roasted to produce sulfur dioxide gas which can be used for acid production.\*

#### *Sulfur Dioxide*

Sulfur dioxide is produced for a variety of purposes other than for sulfuric acid. Approximately 10 per cent of the sulfur produced is used in the pulp and paper industry where it mainly is burned to sulfur dioxide and reacted with lime or limestone to produce the calcium bisulfite cooking liquor used to pulp wood by the sulfite process.† Sulfur dioxide is separated from the burner or smelter gases and liquefied. The liquid sulfur dioxide is used as a refrigerant, and as a selective solvent in the Edeleanu process for petroleum refining. Sulfurous acid formed by dissolving the sulfur dioxide in water is used extensively for the production of sulfites, for leaching metallic oxides from ores, as a bleaching agent, and as a reducing agent. In 1943 sulfur dioxide was produced for sale in 8 establishments in the amount of 19,028 tons.

\* *Chem. & Met.*, *Chemical Engineering Flowsheets* (4th Ed.), No. 69.

† *Chem. & Met.*'s *Chemical Engineering Flowsheets* (4th Ed.), No. 106.  
Pictured Flowsheet, *Chem. Met. Eng.* 48, No. 8, 106-9 (1941).

## SULFUR BURNERS

The reactions occurring in the sulfur burner are:

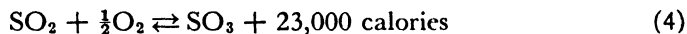
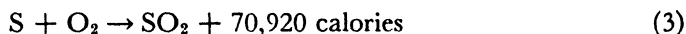

In a chamber sulfuric acid plant the formation of sulfur trioxide in the burner is of no consequence; however, for the contact process, and particularly for the sulfite pulp process, the formation of sulfur trioxide is undesirable, and in the latter case is wasteful of both sulfur and lime as well as being deleterious towards the pulp.

To produce a good gas the sulfur burning system must (a) mix the sulfur with the correct amount of air, (b) completely burn this mixture at a sufficiently high temperature to prevent formation of an appreciable amount of sulfur trioxide, and (c) cool the gas rapidly to prevent formation of more sulfur trioxide. To meet these demands the system consists of three parts: (a) a burner in which the sulfur is vaporized, mixed with air and partially burned, (b) a combustion chamber in which the burner gas and additional air are mixed and combustion carried to completion, and (c) a cooler in which the temperature of the gas is reduced and where sulfuric acid fog may be removed. The spray and drip types of burners combine in one chamber the functions (a) and (b).

The combustion of sulfur liberates about a third as much heat as coal. Much of this heat is absorbed by the molten sulfur (boiling point is 444.6°C.) which is vaporized, and by the sulfur vapors carried along with the gas. The amount of sulfur vaporized depends on (a) the amount of agitation, (b) the area of liquid sulfur exposed, (c) the temperature of the sulfur, and (d) the amount of air admitted over the sulfur. For a given installation the agitation and surface are constant, so the variable factors are the temperature and air admitted. In an uninsulated system the temperature fluctuates with atmospheric conditions, and hence for proper control the air admitted to the burner must be varied accordingly. Increasing the amount of air over the burner increases the combustion there and hence increases the amount of sulfur vaporized. The secondary air for the combustion of the sulfur vapor is admitted at the entrance of the combustion chamber and oxidation is completed there.

The amount of sulfur trioxide formed depends on the temperature and excess oxygen. It is seen in equation (4) that sulfur trioxide formation is decreased with higher temperature and smaller amounts of excess oxygen. After the combustion reactions are completed the gas must be

cooled quickly to "freeze" the equilibrium and prevent formation of more sulfur trioxide at the more favorable lower temperatures.

The sulfur trioxide reacts with the moisture brought in with the air to form a sulfuric acid fog, which is difficult to remove completely. This fog can be prevented by predrying the air and sulfur used in the combustion. Drying the air is accomplished by scrubbing with concentrated sulfuric acid in a packed tower. Pre-drying is used only for those burners which are under positive air pressure, rather than under a reduced pressure or draft as is the case with open types of burners.

The *pan burner* is the simplest type of sulfur burner. It consists of a shallow cast iron or firebrick pan surrounded by firebrick walls and top arch. Sulfur is shoveled in through charging doors in the front of the furnace. Primary air is admitted through dampers in the doors and flows over the pans. Secondary air is admitted to this gas and combustion of the sulfur vapor occurs in the combustion chamber following the burner. The Vesuvius burner consists of a number of circular pans arranged one above another and a tank for molten sulfur at the top, so the hearths are supplied by gravity flow from the tank. Pan burners range in size from about 4 feet by 8 feet, burning 50 pounds of sulfur per hour, down to extremely small sizes. One of the latter is constructed of pipe fittings, is electrically heated to maintain its temperature, and burns as little as two or three ounces of sulfur per hour. These small burners frequently are used to produce sulfur dioxide which is absorbed in alkaline boiler feed-water to produce sodium sulfite for the removal of dissolved oxygen.

The *rotary burner* has been used most extensively in the past and is the favorite in smaller installations because of its simplicity and low maintenance requirements. The Glens Falls burner (Figure 6-5) consists of a horizontal steel cylinder with conical cast iron ends which is revolved on rolls at a rate of about  $\frac{1}{2}$  r.p.m. The sizes vary from 10 inches in diameter by 20 inches long with capacity of 15 pounds of sulfur per hour, to 4 feet in diameter by 24 feet long with capacity of 2000 pounds per hour. Solid sulfur is fed in at one end by means of a screw feeder, a vibrating feeder, or the sulfur is melted and allowed to flow in. The rotation of the cylinder carries a film of sulfur around on the inside and combustion occurs here as well as on the surface of the liquid sulfur at the bottom. Some variation in the burning surface exposed and hence in the rate of combustion can be obtained by changing the level of the liquid sulfur within the cylinder. The A.P.M.E.W. rotary burner has a cylindrical rotating agitator with longitudinal fins which dip into the molten sulfur

and carries a burning film of it up into a combustion space. The conical discharge end of the Glens Falls burner rotates at an adjustable distance from the entrance to the combustion chamber. Through this space secondary air is admitted to burn the vaporized sulfur and dilute the burner gases to the desired final composition.

The *spray burner* has become increasingly popular for larger installations. The system can be totally enclosed and put under a positive pressure, so the air can be predried and the sulfur is predried by melting it. The molten sulfur is atomized by air in a steam jacketed nozzle and combustion occurs in a refractory-lined chamber. The combustion tem-

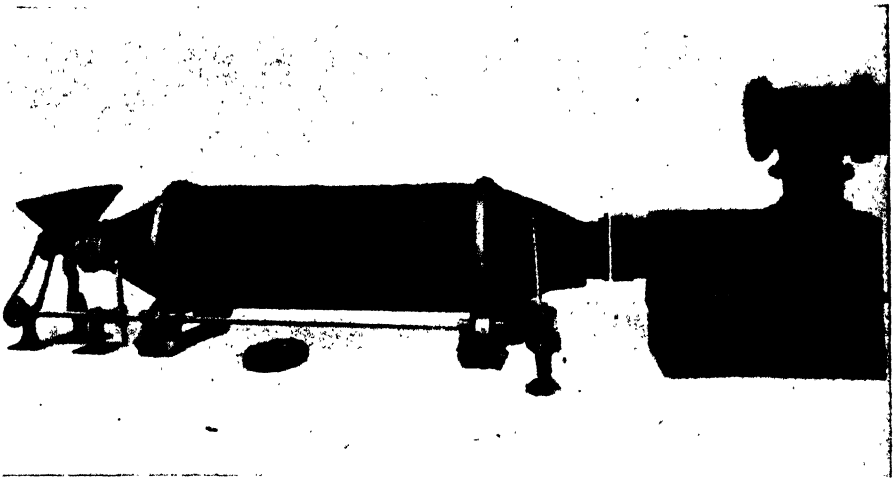

*Courtesy of the Glens Falls Machine Works*

FIGURE 6-5. Glens Falls Rotary Sulfur Burner

perature depends on the amount of excess air, but the gases leave at about 800° to 1100°C., pass to a waste heat boiler where they are reduced to about 425°C., thus utilizing the sensible heat content of the gases. Additional air can be added after cooling in order to secure the correct composition, and some hot gas may be by-passed around the boiler to regulate the temperature of the gas going to contact converters. Close control in the combustion chamber is possible by varying the rate of supply of the sulfur and air. A diagrammatic sketch of the "Chemico" equipment is shown in Figure 6-6.

Another type (Leonard Construction Co.) which can operate under pressure consists of a vertical steel cylinder (13 feet diameter by 25 feet high, capacity 100 tons of sulfur per day) lined with firebrick. The upper

third of the chamber has a brick checkerwork pyramid supported by arches. Molten sulfur is pumped in and falls on the brick checkerwork. Primary air enters close to the sulfur inlet and partially burns and vaporizes the sulfur. Secondary air is admitted at the height of the arch and combustion is completed in the bottom space which also contains a

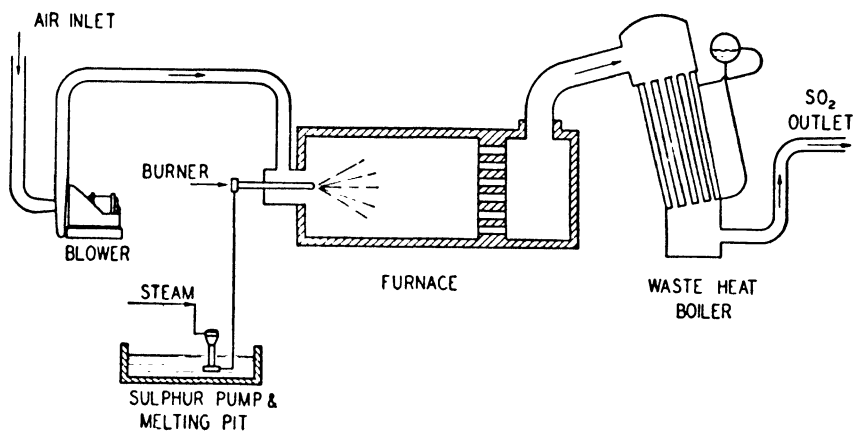

*Courtesy of the Chemical Construction Company*

FIGURE 6-6. "Chemico" Spray Type Sulfur Burner

brick checkerwork pyramid to provide combustion surface for molten sulfur coming down from above. A clean-out door at the bottom permits removal of ash and dirt. When starting up, the brick checkerwork is heated with an oil burner. The burner operates at pressures up to five pounds p.s.i.g.\*

#### PYRITES BURNERS

The combustion of solid sulfides is carried out mainly in two types of systems, the mechanical furnace or the flash roaster. In a mechanical burner operating on pyrites the reaction is:



The heat liberated is sufficient to raise the temperature of the products to about 800°C. with 8 per cent sulfur dioxide in the gas. At temperatures above this, slagging of the pyrites is rapid and corrosion is serious. At temperatures below about 600°C. combustion is not sufficiently rapid and considerable sulfate is formed which is lost in the cinders. The temperature must be controlled between these limits.

\* p.s.i.g. is pounds per square inch gage pressure, or pressure above atmospheric.

The *mechanical furnace* is of the multiple hearth type which operates on small sizes of ore. This furnace is known as the "Herreshoff(-Nichols)" or "Wedge(-Bethlehem)" type; the former is shown in Figure 6-7. It has a vertical cylindrical steel shell 10 to 25 feet in diameter lined with firebrick and supported above the floor to permit a drive mechanism to operate. Within the furnace are a number of firebrick hearths, usually 8 to 16 in number. A central rotating shaft is a vertical cast iron column constructed in sections. The portion within the furnace has two pipes, the inner one being the cold air tube and the outer annular space being the hot air compartment. Two or more hollow rabble arms are attached to the shaft at each hearth and a pipe conducts air from the cold air tube to the end of inside of the rabble arm, from which it flows back to the hot air compartment. Cold air from a fan comes to an air housing surrounding the revolving lower shaft section which is an extension of the cold air tube. The hot air from its compartment is at 200° to 250°C. and may be discharged from the top to waste, or discharged into the furnace on one or more hearths to aid combustion of sulfur-poor ore. Air for combustion is admitted mostly at the bottom, with additional hot air from the rabbles or cold air from doors on each hearth, in order to maintain proper temperature control.

The ore usually is delivered from a storage hopper to a feeding plate located on the upper framework. An adjustable feeding knife revolves with the shaft and scrapes from the feed plate a regulated amount of ore, which falls to the top hearth. Here it is spread and mixed by the teeth on the rabble arms and dried by the hot gases on the hearth beneath. The ore flow is towards the outer periphery, at several points on which the ore drops through to feed plates which seal off the upper hearth and prevent the leakage of gas from the furnace or air from the outside. On the first hearth the rabble teeth move the ore towards the center where it drops through a large circular opening to the second hearth, on which the ore is moved towards the outer periphery and drops through ports to the third hearth. Thus the ore is rabbled across the various hearths until discharged as cinder from the bottom hearth. On the first hearth the pyrites is raised to the combustion temperature and combustion then occurs on the following hearths, maximum temperature being attained on the fifth hearth of a twelve hearth furnace. Near the bottom combustion is complete and the hot cinder is cooled by the entering air which in turn is preheated.

The *flash roaster* operates quite similarly to a powdered coal instal-

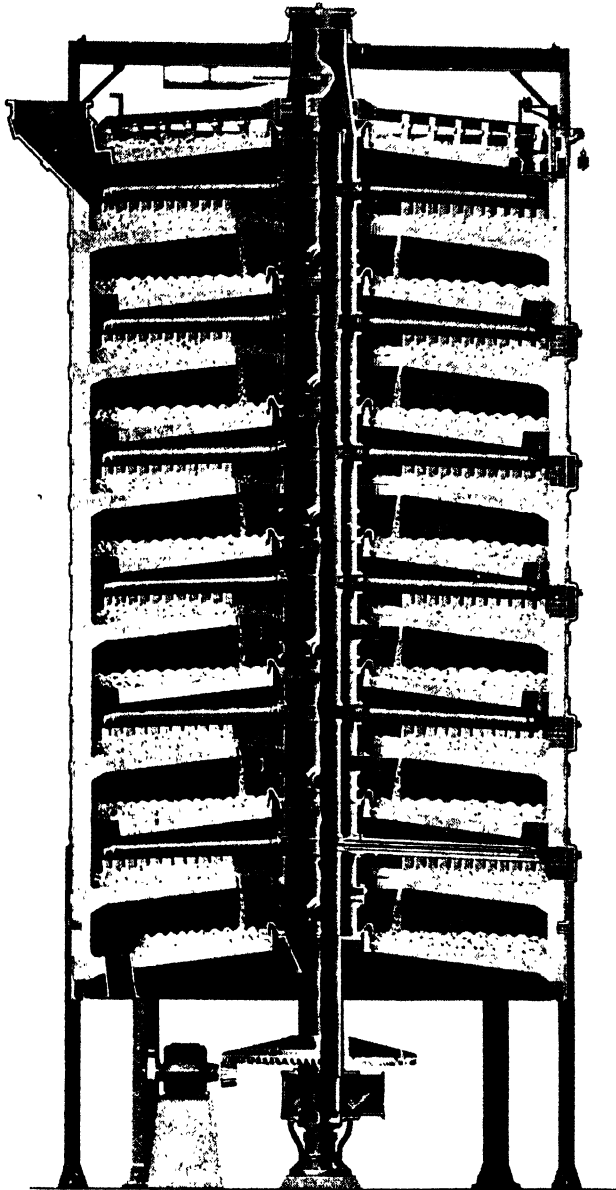

*Courtesy of the Nichols Engineering and Research Corporation*

FIGURE 6-7. Herreshoff-Nichols Multiple Hearth Furnace

lation. In Figure 6-8 is shown the Nichols-Freeman system. Pyrites flotation concentrate is added to the feed hopper from which it is fed at



a uniform rate to a ball mill to break up the agglomerated particles. Air from the top fan sweeps out the particles smaller than 60-mesh and blows them into a refractory lined combustion chamber, 12 feet in diameter by 32 feet high, with a conical bottom. Only part of the air needed for combustion is added at the top and the remainder enters at the bottom of the chamber. The suspended pyrites is blown in below the level of the gas out-take which is a large diameter tangential pipe at the top of the

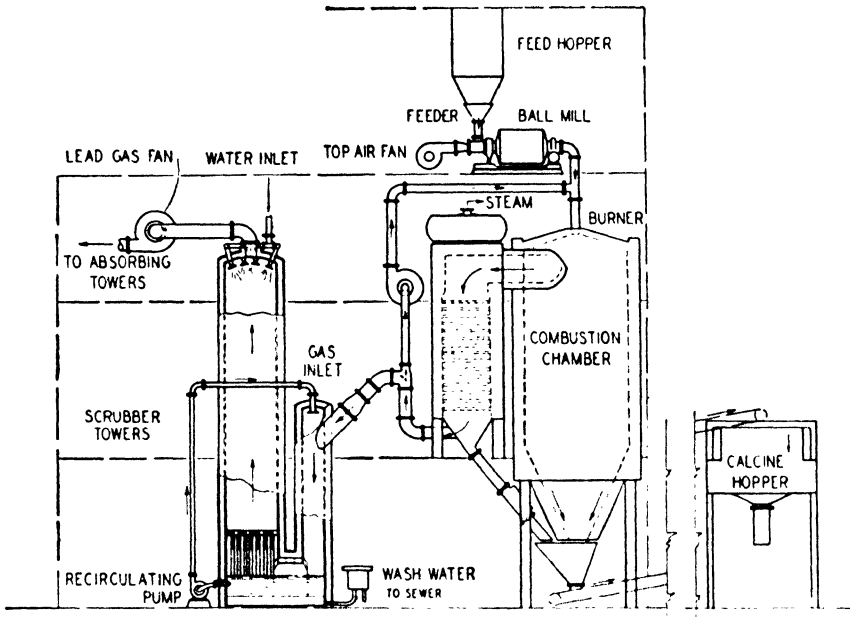

*Courtesy of the Nichols Engineering and Research Corporation*

FIGURE 6-8. Nichols-Freeman Flash Roaster for Pyrites

cylinder. As the pyrites is exposed to the radiation from the hot walls it reaches the combustion temperature and burns instantaneously to sulfur dioxide and hollow spherical-shaped shells in which the iron is combined about equally as  $\text{Fe}_2\text{O}_3$  and  $\text{Fe}_3\text{O}_4$ . These particles separate out into the calcine hopper at the bottom and the hot gases rise along the walls and pass into a down draft tube boiler. Here the temperature of the combustion gases is reduced from about  $1000^\circ\text{C}$ . to  $350^\circ\text{C}$ . The high combustion temperature allows very little sulfur trioxide formation and the rapid cooling freezes the equilibrium. The dust which settles out here is collected with the calcine from the combustion chamber. In order to prevent too high temperatures in the combustion chamber a part of the cooled gas is recirculated to maintain the temperature at  $1000^\circ\text{C}$ . Final cooling

and cleaning is accomplished in two scrubbing towers, the second one of which is a packed tower to give a large wetted surface. A lead-lined exhaust fan blows the gas to the calcium bisulfite-liquor system. If the gas is to be used for sulfuric acid manufacture, water vapor and low temperature are undesirable so the gas is cleaned in cyclone dust collectors or electrostatic precipitators. These units are very flexible in combustion rate. Pyrrhotite and other sulfides can also be flash roasted.

#### BURNER GAS

The concentration of sulfur dioxide desired in the burner gas depends on the purpose for which the gas is to be used. For preparing calcium bisulfite pulping liquor the gas is desired as high as possible in sulfur dioxide, as 18 per cent or even higher for gas made from sulfur. If the gas is made from pyrites the maximum sulfur dioxide content attainable is less, due to the combination of part of the oxygen with the iron to form ferric oxide. As a result a 12 per cent gas is obtained and colder absorbing water must be used to attain the same concentration of dissolved sulfur dioxide. For the contact process a sulfur burner gas containing about 8 per cent sulfur dioxide is desired. This gas can be produced in the burner, or the burner gas diluted to this concentration. From a pyrites burner the gas should contain about 7.5 per cent sulfur dioxide in order to have sufficient oxygen for conversion. The chamber process operates satisfactorily over wide ranges of sulfur dioxide concentration, and it can operate at somewhat higher concentrations due to the lower temperatures and longer time.

#### DUST AND FUME REMOVAL

From the combustion of metallic sulfides the gas carries fine dust particles and volatilized metals or compounds. Although these can be tolerated in a chamber plant making poor quality of acid, a contact plant cannot tolerate these impurities and most chamber plants remove as much as possible. Older plants used mechanical separation methods, as large dust chambers in which the reduced velocity of the gas permits the fine particles to settle out, baffle walls and plates, wire and rod collectors, and the standard type cyclone dust separator.

The most efficient type, though the most expensive, is the Cottrell electrostatic precipitator, which removes 95 per cent or more of colloidal dust, fumes, or fog particles from the gas. It usually is used for dust removal only when the dust is of value, as zinc oxide dust from roasting zinc sulfide ores. The impure gas is passed through a large number of

small vertical metal pipes down the center of each of which hangs a wire. The pipe is grounded electrically and the wire is the negative side of 50,000 to 80,000 volts direct current. The dust and smoke particles are charged negatively by electrons emitted from the wire and are attracted to the positively charged pipe where they discharge and agglomerate into larger particles. At intervals the voltage and gas flow are discontinued and the pipe rapped to cause the particles to fall into a hopper below. Dry gases can be handled under pressure and at temperatures to 600°C. Cottrell precipitators are regularly used before the converters in the contact system to remove the sulfuric acid fog carried by the burner gases. Here the pipes and wires are lead covered to resist corrosion.

#### LIQUID SULFUR DIOXIDE \*

For the manufacture of liquid sulfur dioxide the burner gas usually is made by the combustion of sulfur so that a high concentration, 16 to 18 per cent, of sulfur dioxide is in the gas. The sulfur dioxide is absorbed from the cooled burner gas by water, using countercurrent flow in two to five towers. The solution is stripped of its sulfur dioxide under vacuum with steam. The bulk of the moisture is removed from the gas in a condenser, with final drying in a scrubbing tower with concentrated sulfuric acid, or adsorption driers are used. The dry gas now is liquefied. The critical point is at 157.2°C. and 77.7 atmospheres (*cf.* chlorine). The gas is compressed to 100 to 125 p.s.i.g. and cooled to produce the liquid sulfur dioxide.

#### MARKETING

Liquid sulfur dioxide is marketed in two grades, industrial and refrigeration. The specifications of one company for these two grades are:

---

Commercial grade (over 99.9%SO <sub>2</sub> )	
Moisture	—not more than 0.01%
Non-condensable gases	—not more than 0.02%
Residue	—0.05%
Oil	—trace
Sulfate, arsenic, lead	—nil
Refrigeration grade	
Moisture	—not more than 0.005%
Non-condensable gases	—not more than 0.02%
Acidity as H <sub>2</sub> SO <sub>4</sub>	—nil
Sediment	—nil

---

\* *Chem. & Met.'s Chemical Engineering Flowsheets* (4th Ed.), No. 68.

The refrigeration grade is supplied in cylinders containing 5, 10, 25, 70, 150, or 2,000 pounds. The commercial grade is supplied in 150- and 2,000-pound cylinders, multiple-unit cars holding 15 one-ton cylinders, and tank-cars containing 20 tons. The cylinders used are identical with those for chlorine (Figures 5-7 and 5-8).

The Chamber Process

In the chamber process the combination of sulfur dioxide, oxygen, and water to form sulfuric acid is brought about by oxides of nitrogen

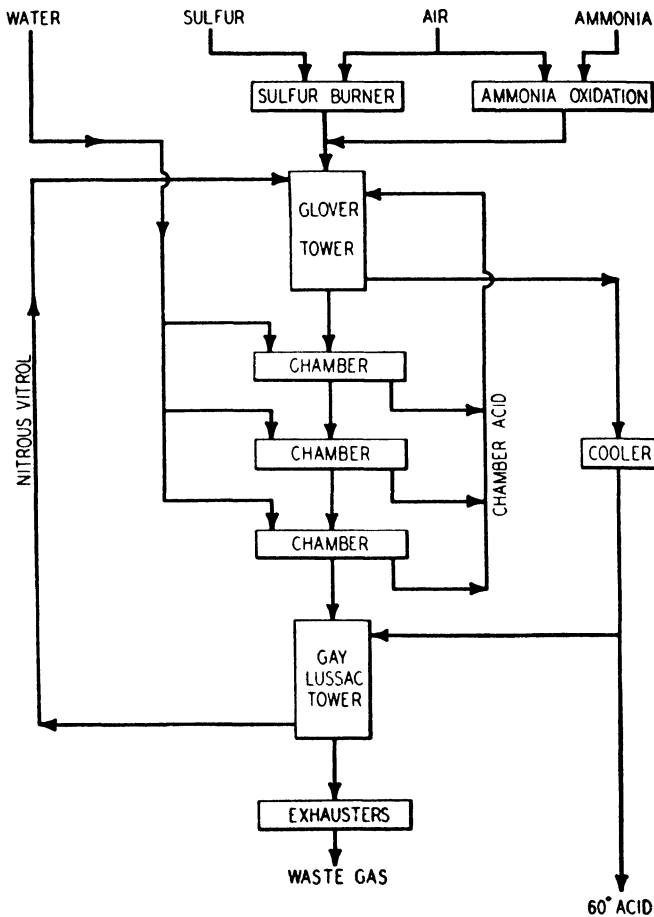

FIGURE 6-9. Chamber Process for Sulfuric Acid

acting as a homogeneous catalyst for the reaction. The function of the equipment is to produce the reactants and catalyst, bring them together

until reacted, separate and recover the catalyst and product at the desired concentration. A generalized flowsheet\* is shown in Figure 6-9. Sulfur dioxide is produced and purified as previously described. To the burner gas is continuously added a volume of nitric oxide sufficient to make up for that lost in the waste gas. The gas mixture passes into the base of the Glover tower and rises against a descending stream of 50°Bé. chamber acid and nitrous vitriol from the Gay-Lussac tower. The oxides of nitrogen are stripped from the nitrous vitriol and water is evaporated from the chamber acid. These acids, now mixed together and with acid made in the Glover tower, go to a cooler for storage. The gases leaving the Glover tower are at a lower temperature and carry more oxides of nitrogen and water vapor. They progress slowly through the chambers, three to six in number, in which the sulfur dioxide conversion is completed and the acid removed as chamber acid. The gases enter the Gay-Lussac tower and rise against a descending stream of cold, concentrated sulfuric acid which absorbs almost all of the oxides of nitrogen to form nitrous vitriol, and the spent gases pass to waste. The movement of gases through the system may be due to air pressure on the burner, a blower after the burner pushing the hot gases, an exhauster after the Gay-Lussac tower putting a suction on the system, or a furnace stack supplying a natural draft. The individual pieces of equipment will be studied in more detail as to construction, operation, and reactions occurring.

#### OXIDES OF NITRÖGEN

The gaseous catalyst used for this reaction is the series of oxides of nitrogen, commonly called "niter." The old method of introduction was to react sodium nitrate with sulfuric acid in a cast iron pot which was set in the flue carrying the burner gas to supply the heat for the reaction. The evolved nitric acid was reduced by the sulfur dioxide. Though no longer used in this manner, niter is sometimes added to boost capacity by running nitric acid or even sodium nitrate solution into the Glover tower, but this is not recommended practice.

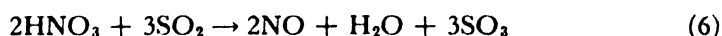

This system has been replaced by ammonia oxidation units in which gaseous ammonia and air are mixed and passed through a heated platinum gauze catalyst which causes the oxidation (*cf.* Chapter 9). The

\* "Sulfuric acid (chamber)" *Chem. & Met.'s Chemical Engineering Flowsheets* (4th Ed.), No. 70.

ammonia may be supplied from cylinders of the anhydrous liquid or

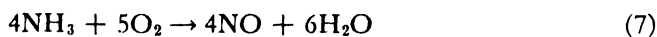

stripped by the entering air from aqueous ammonia solutions supplied in tank-cars. A diagrammatic sketch of the latter system is shown in Figure 6-10. The stripping column is an iron pipe about 12 inches in diameter by 15 feet high and packed with small Raschig rings. The ammonia solution is pumped from the storage tank to the top of the stripping tower, descends countercurrent to the air blown in at the base of the column, and the ammonia-free water is discharged to waste. The rates of flow are regulated to give an air mixture containing about 10 per cent ammonia. The ammonia-air mixture is preheated by passing

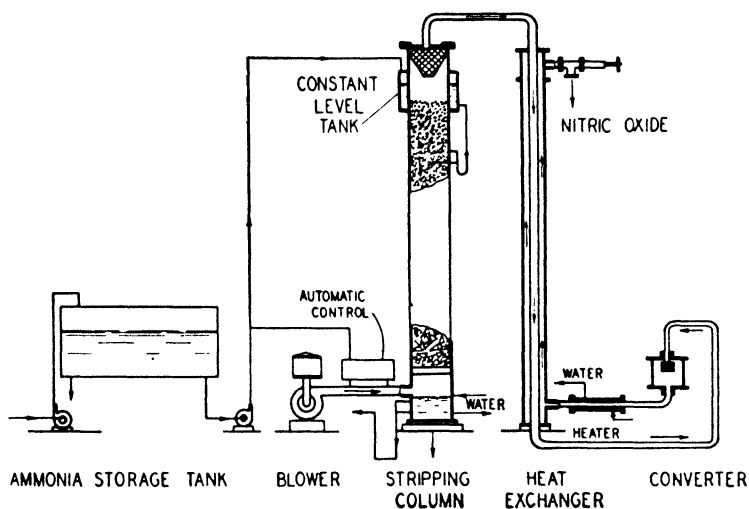

*Courtesy of the Chemical Construction Company*

FIGURE 6-10. "Chemico" Ammonia Oxidation Process to Supply Oxides of Nitrogen

countercurrent to the hot oxidation products, is oxidized in the converter, and the oxidation products pass out to mix with the sulfur burner gases. A water jacket on the pipe following the converter heats almost to boiling the water in the base of the stripping column, thus securing a greater removal of ammonia from the solution. The heat exchanger is constructed of aluminum which is unaffected by the nitric oxides and does not catalyze the dissociation of ammonia as does iron. However, silicon-iron or chrome-steel pipes are used to convey the gas from the apparatus to the burner gas flue.

The loss of oxides of nitrogen, which must be replaced, depends on the rate at which the plant is operated. High capacity brings about higher losses of niter so that a balance of capacity versus operating costs must be made. The amount of niter lost depends upon the amount in circulation in the system, which is about 20 per cent of the weight of the sulfur burned per day for sulfur systems, 25 to 35 per cent for pyrites, and up to 45 per cent for metallurgical gases. The niter loss is from 10 to 15 per cent of the oxides in circulation, so runs 2 to 3.5 per cent of the weight of the sulfur burned in sulfur systems, 2.5 to 5.5 per cent in pyrites and metallurgical gas systems.

#### PROCESS REACTIONS

The reactions occurring in the process have been classified by E. Berl as those which occur in the homogeneous gas phase, those which occur at the gas-liquid interface, and those which occur in the homogeneous liquid phase. Homogeneous in the gas phase:



Heterogeneous at gas-liquid interface:

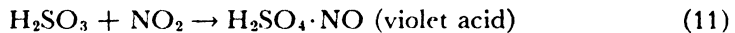

Violet acid is a loose molecular compound written by Berl as  $(\text{H}_2\text{SO}_4)\text{NO}$  to emphasize the loose binding.

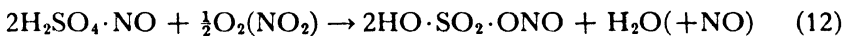

$\text{HO} \cdot \text{SO}_2 \cdot \text{ONO}$  is nitrosyl sulfuric acid or "chamber crystals" sometimes found in the chamber when the water supplied has been insufficient.

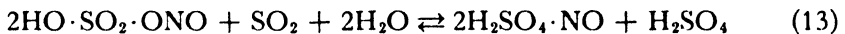

Homogeneous in the liquid phase:



The nitrosyl sulfuric acid, formed from violet acid, is the pivot of the entire reaction. If dissolved in strong sulfuric acid it becomes very stable. The stability decreases with increasing water content, and at concentrations from 60 to 82 per cent sulfuric acid (48° to 62°Bé.) occurs the optimum for the oxidation of sulfur dioxide by equation (13).

Various mechanisms postulate nitrogen sesquioxide,  $N_2O_3$ , as a reactant. Nitric oxide (NO) is oxidized (equation 8) to nitrogen dioxide, which polymerizes (equation 9) to nitrogen tetroxide. An equilibrium:  $NO + NO_2 \rightleftharpoons N_2O_3$  exists, but lies far on the side of the two oxides.

GLOVER TOWER

This usually is a tower of square cross-section, 10 feet to 17 feet on a side by 25 to 50 feet in height. The construction is shown in Figure 6-11. The walls *A* 18 inches or more in thickness, are of "chemical" brick

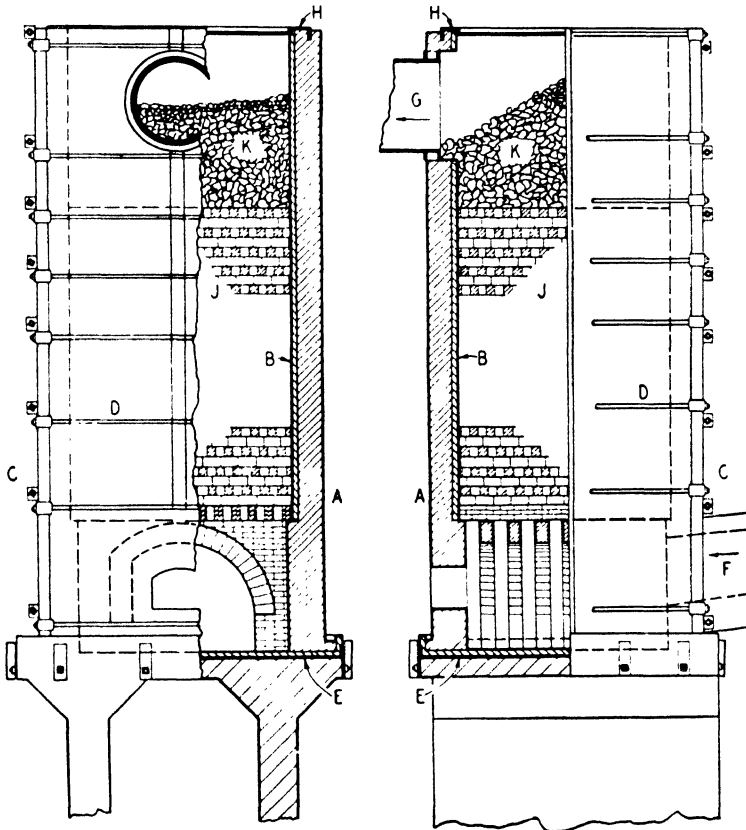

Courtesy of the Chemical Construction Company

FIGURE 6-11. Glover Tower

set with "acid-proof" cement and lined on the inside with two layers of flat chemical tile *B*. The corners of the tower are braced by lead-covered angle irons *C* connected by tie rods *D*. The tower rests on a concrete base about 10 feet from the ground which is covered by a heavy



lead pan *E* on which is laid several courses of chemical brick. The tower is built on the pan, the outer edges of which are turned up to make a tight seal with the masonry. The inlet flue *F* is of brick and the outlet flue *G* to the chambers is of lead cemented to the brick. The top of the tower is of sheet lead *H* hung from steel supports. The outside of the tower may or may not be covered with sheet lead. Within the bottom of the tower a series of arches (*cf.* Figure 7-6) support a masonry grid on which the tower packing is laid. This may be chemical brick checkerwork *J*, broken quartz lumps *K*, or special ceramic shapes. The function of the packing is to give a large gas-liquid interface at which those particular reactions occur, as well as the evaporation of water.

The gases from the sulfur burner, or dust removal system if pyrites or metallurgical gas is used, to which has been added the niter from the ammonia oxidation unit, enter at the base of the tower at a temperature of 425° to 650°C. Lower temperatures do not liberate niter from the nitrous vitriol (equation 15) nor concentrate the chamber acid sufficiently. Higher temperatures may damage the tower. The hot gases rise countercurrent to the downward flow of chamber acid and nitrous vitriol distributed over the packing at the top of the tower. The various functions of the Glover tower are:

1. Denitration of the nitrous vitriol. This is the most important and characteristic function of the Glover tower. The chamber acid added dilutes the nitrous vitriol from the Gay-Lussac tower until the acid concentration is not over 72 per cent. The dilution and heat cause reaction (15), with liberation of niter. This occurs in the upper part of the tower.

2. Concentration of chamber acid. The hot burner gas evaporates water from the dilute (50°Bé.) chamber acid, raising it to 60°Bé., or even higher, depending on the gas temperature. The evaporated water now accompanies the burner gas into the chambers where it is used for the sulfuric acid production there.

3. Cooling of the burner gas. The temperature of the burner gas is reduced to 70° to 110°C. before it enters the chambers.

4. Production of sulfuric acid. In the upper part of the tower where the gases are cooler and there is dilute nitrous vitriol, reaction (13) occurs with the production of sulfuric acid. As high as 20 per cent of the total production may occur here, though usually 12 to 15 per cent.

5. Cleaning of the burner gas. Dust and fumes not previously removed are washed out by the descending acid. Arsenic and selenium fumes dissolve in the acid.

6. Reduction of nitric acid. If nitric acid is added from niter pots or sodium nitrate, it is reduced to nitric oxide (equation 6).

## CHAMBERS

These are box-like rooms made of sheet lead. The size varies from 50 to 150 feet long by 20 to 40 feet wide by 20 to 30 feet high. The chamber is supported about 12 feet from the ground to allow gravity flow of acid from it. The sides and top are of 6-pound (per square foot) sheet lead and the bottom 12-pound sheet. The top and sides are suitably supported by a steel framework to which the lead sheet is tied by lead strips "burned" to the lead sheet. Variations in temperature and pressure within the chamber cause movement which must be allowed for in construction by adequate attachment to the framework and at corners. The top and sides are open to air circulation, but a roof over the chamber prevents rainfall on the top.

The number of chambers varies considerably and ranges from 3 to 12. Present practice is to use more chambers of smaller dimensions to secure more surface exposed to the air. The total volume of chamber space is based on the weight of sulfur burned per day; this "space rate" was 24 cubic feet of volume per pound of sulfur in early plants but has decreased to 7 cubic feet in summer and 6 cubic feet in winter for plants with adequate cooling surface, as  $\frac{1}{8}$  square foot of surface per cubic foot of volume, when operated with a high concentration of niter.

The gases entering the first chamber are at about 90°C. and contain all the niter in circulation as well as the water vapor from the concentration of the chamber acid in the Glover tower. The rate of flow of the gases now is greatly reduced and water begins to condense out as a fog due to the decreasing temperature. This increases the gas-liquid interface and reactions (10), (11), and (12) occur. Reactions (14) and (15) occur to some extent within these fog droplets, but the impingement of these droplets against the cool walls of the chamber cause them to coalesce to a liquid film which is diluted by condensing water vapor, and the hydrolysis to sulfuric acid is completed.

The functions of the chambers are:

1. To afford space and time for the mixing of the gases and conversion of the sulfur dioxide. The space rate was previously discussed, and is such that the gases remain in the chambers for a period of one to two hours. Practically all the active work of an ordinary system is performed

within the first 30 per cent of its chamber space and the remainder is relatively less efficient unless special means are employed to mix the gases and permit condensation of vapors or mist; hence small diameter packed towers to aid mixing are sometimes interposed between chambers.

2. To radiate heat produced by the chemical reaction.

3. To furnish surfaces for condensation of the acid mist formed. The inefficiency of a large chamber with its relatively small surface for contained volume has led to the introduction of special systems with higher capacities, which will be considered later.

The operation of the chambers can be controlled in a number of ways all of which are used and correlated for a particular plant:

1. Temperature control. The reactions are strongly exothermic and the heat must be removed as fast as possible. The gases enter at about 90°C. and leave at about 35°C., though the second chamber may operate at a higher temperature than the first due to the heat of reaction. A variation of less than 3° between selected points in a chamber indicates a change in conditions that can cause trouble. Fairlie recommends a temperature difference between two chambers selected because of their sensitivity to operating conditions, as 1 and 3 in a 4 chamber plant, or 1 and 4 or 2 and 5 in a 9 chamber plant. A smaller temperature difference indicates a lack of niter, which must be increased, whereas a higher value indicates too much niter.

2. Color of chamber gas. The color of the gases within the chamber can be observed at the sight ports, small windows placed in the corners of chambers or in flues. The color deepens as the gas passes through the chambers, decreasing in temperature and increasing in content of NO<sub>2</sub> which is red-brown in color. Hence at a given point a skilled operator can judge the condition of the niter supply.

3. Gas analysis. Fairlie recommends the correlation of gas analyses between the gas entering the Glover tower and that entering the first or second chamber under correct operating conditions. The niter supply is adjusted to maintain this correct ratio.

4. Acid drips. The addition of water, as a cold spray, is controlled by the concentration of acid (degrees Baumé) in the drip cup on the side of the chamber. Too little water causes the formation of chamber crystals on the lead walls, which leads to corrosion. Too much water gives a dilute acid and causes the formation of nitric acid, which results in corrosion of the lead.

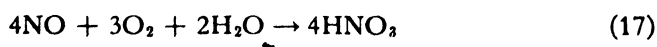

## GAY-LUSSAC TOWER

The construction of this tower is essentially the same as the Glover tower. It usually is filled with special tile packing which gives the maximum area of wetted surface with free volume. The lower temperature and concentration of oxides of nitrogen require more reaction surface, so that usually two Gay-Lussac towers the size of the Glover tower are required, though more may be necessary if high-niter gases are used.

The sole function of the Gay-Lussac tower is the recovery of the oxides of nitrogen from the gases leaving the last chamber. With several towers the cooled concentrated 60°Bé. acid at not over 40°C. enters the top of the last tower and progresses countercurrent to the gases until removed at the bottom of the first tower, into which the chamber gases enter at not over 60°C. The reaction occurring is the reverse of equation (15), so that nitrosyl sulfuric acid is now formed in the solution.

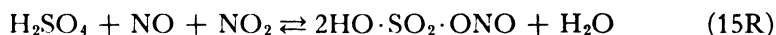

The presence of some sulfur dioxide (0.05 to 0.12 per cent) in the gas is desirable to reduce excess  $\text{NO}_2$  to  $\text{NO}$  so that equivalent amounts of each are present for absorption. Too much sulfur dioxide causes the reactions of equations (13) and (14) to occur with loss of niter. Some loss always occurs due to this reaction, to the low solubility of  $\text{NO}_2$  in sulfuric acid, and to incomplete absorption.

## COOLER

This consists of a number of tanks (usually three or more) in series, all of sheet lead, with the first one or two lined with chemical brick to prevent attack of the hot acid on the lead. Lead pipe coils through which cooling water flows are submerged in the acid. The acid from the Glover tower enters the first cooler at 130° to 150°C. and leaves the last cooler at 30° to 40°C. In some plants the cooling from 65° to 30°C. is accomplished in trombone (return-bend) coolers in which the acid flows inside iron pipes with cooling water flowing down over the series of pipes.

## ACID PUMPS

The movement of large quantities of acid of various concentrations is usually accomplished by centrifugal pumps in which the parts in contact with the acid are lead-covered or of special resistant alloy.

## HIGH CAPACITY CHAMBERS

Inasmuch as 70 per cent of the sulfuric acid is made in the Glover tower and first chamber, various methods have been used to decrease the amount of space needed to complete the reaction. In the ordinary chamber the movement of gases is slow and a relatively small ratio of wetted wall surface for impingement and cooling is supplied. Various modifications of chambers have been suggested to increase the speed of the process.

The Mills-Packard water-cooled chamber is a truncated cone with a height of 40 to 50 feet, bottom diameter of 20 to 35 feet, and top diameter of 10 to 20 feet. Cooling water flows down the outside of the surface so it is completely covered. This gives more rapid cooling and condensation, so is able to operate with a space rate of 3 to 4 cubic feet per pound of sulfur burned.

The Gaillard-Parrish system uses a turbo-dispenser to cause a shower of cooled chamber acid to descend against the walls and through the chamber gas. These can be installed in existing chambers, but the special tower is usually a cylindrical lead tower. The space rate is about 3 cubic feet.

Various systems have been used in which the chamber has been replaced by a tower similar to the Glover tower. The Opl system used six packed towers in series, the first three acting as Glover towers and the last three as Gay-Lussac towers. The Larison or Anaconda packed cell process uses packed towers rather than chambers, though the packed towers are built as one common block of acid proof brick. The niter in circulation is increased from 20 per cent to 70 per cent. Cooled dilute acid is circulated through the packed towers to remove the heat of reaction. Thus the velocity of the cycle of reactions is increased by (a) vigorous mixing of the gases, (b) causing them to impinge frequently on wet surfaces, (c) increasing the niter content, and (d) providing the cooling necessary for the increased liberation of heat. This system operates at a space rate of 1 to 1.5 cubic feet.

## PURIFICATION OF CHAMBER ACID

Chamber acid is usually made and used for purposes where an acid of high purity is not needed, as the manufacture of superphosphate fertilizer, pickling iron and steel, and the like. If the chamber acid has been made from sulfur the amount of impurities is low and consists of lead sulfate, dissolved oxides of nitrogen, and some dissolved sulfate of iron,

and alumina from metal and ceramic materials which have been in contact with the acid. When gas from pyrites or metallurgical ores has been used there are various amounts of arsenic and selenium dissolved in the acid as well as considerable suspended dust. The latter is removed by settling or filtration through a sand filter. Arsenic can be removed from chamber acid ( $50^{\circ}$  to  $53^{\circ}\text{Bé.}$ ) by treating it with hydrogen sulfide, filtering out the precipitated arsenic trisulfide, and then concentrating the acid. Dissolved oxides of nitrogen are removed by adding 0.2 to 0.5 per cent ammonium sulfate and heating the acid to  $100^{\circ}\text{C.}$

### Student Exercises

A. Prepare a chemical engineering report covering one of the following topics:

1. Alchemical production and uses for sulfuric acid
2. Production, processes, prices, and consumption trends of sulfuric acid
3. Production of sulfur in Sicily
4. Sources and production of natural sulfur (non-dome) in the United States
5. Production of sulfur from sulfur dioxide
6. Water problems of sulfur mining
7. Deposits and production of pyrites in the United States
8. Removal of hydrogen sulfide from gas
9. Production of sulfur dioxide from gypsum
10. Solubility of sulfur dioxide in water and other solvents
11. Recovery of sulfur dioxide from waste gases
12. Flash roasting of sulfide minerals
13. Reactions in the chamber process
14. Special type chamber processes:
  - a. Falding
  - b. Pratt
  - c. Larison
  - d. Opl
  - e. Petersen
  - f. Mills-Packard
  - g. Gaillard-Parrish
  - h. Schmiedel-Klencke
15. Production of calcium bisulfite pulping liquor
16. Control methods for the chamber process
17. Production of sulfur from hydrogen sulfide

B. Prepare flowsheets for:

1. Production of superphosphate fertilizer
2. Production of phosphoric acid (wet process)
3. Production of alumina from clay using sulfuric acid

4. Recovery of sulfur dioxide from smelter gas
  5. Production of sulfur from sulfur dioxide
  6. Production of sulfur from pyrites
- C. Prepare an illustrated problem showing the method of making a material, and heat balances over a:
- |                   |                       |
|-------------------|-----------------------|
| 1. Sulfur burner  | 3. Jensen tower       |
| 2. Pyrites burner | 4. Chamber acid plant |
- D. Prepare a complete design for a sulfur burner that will burn the following number of pounds of sulfur per hour:
- |           |             |             |
|-----------|-------------|-------------|
| 1. 1 lb.  | 3. 25 lbs.  | 5. 500 lbs. |
| 2. 5 lbs. | 4. 100 lbs. |             |

### *Recommended Reading*

#### I.

- A.I.M.M.E., *Industrial Minerals and Rocks*, New York, American Institute of Mining and Metallurgical Engineers, 1937
- Auden, *Sulfuric Acid and Its Manufacture*, London, Longmans, Green & Co., 1930
- DeWolf and Larison, *American Sulfuric Acid Practice*, New York, McGraw-Hill Book Co., 1921
- Fairlie, *Sulfuric Acid Manufacture*, New York, Reinhold Publishing Co., 1936
- Furnas, *Rogers' Manual of Industrial Chemistry*, New York, Van Nostrand Co., 1942, Chapter VII
- Haynes, *The Stone That Burns — The Sulfur Industry*, New York, Van Nostrand Co., 1942
- Kreps, *Economics of the Sulfuric Acid Industry*, Stanford University Press, 1938
- Miles, *Manufacture of Sulfuric Acid — Contact Process*, London, Van Nostrand Co., 1925
- Parkes, *Concentration of Sulfuric Acid*, London Van Nostrand Co., 1925
- Parrish and Snelling, *Sulfuric Acid Concentration*, London, Van Nostrand Co., 1925
- Wells and Fogg, *The Manufacture of Sulfuric Acid in the United States*, U. S. Bur. Mines Bull. **184**, 1920
- Wyld, *Raw Materials for Sulfuric Acid and Sulfur Dioxide*, London, Van Nostrand Co., 1923

## II.

## SULFUR AND PYRITES

- Frasch, "History of the Exploitation of the Sulfur Deposits of Louisiana,"  
*Ind. Eng. Chem.*, **4**, 131-47 (1912)
- Ridgeway, *Sulfur — General Information*, U. S. Bur. Mines Inf. Circ. **6329** (1930)
- Ridgeway, *Pyrites — General Information*, U. S. Bur. Mines Inf. Circ. **6523** (1931)
- Reid, "Producing Sulfur at Newgulf," *Chem. Met. Eng.*, **37**, 668-72 (1930)
- Editorial Staff, "Mining Sulfur for World Consumption,"  
*Chem. Met. Eng.*, **39**, 392-5 (1935)
- Taylor, "Economic Position of Sulfur," *Ind. Eng. Chem.*, **24**, 1116-21 (1932)
- Hotchkiss, "Sulfur vs. Pyrites," *Chemical Markets*, **31**, 217-9 (1932)
- O'Donnell, "Mining Sulfur Underwater in Louisiana,"  
*Chem. Met. Eng.*, **40**, 454-8 (1933)
- Applebey, "Recent Developments in the Chemistry of Sulfur,"  
*Chemistry & Industry*, **53**, 1097-1101 (1934)
- Lundy, "Grande Ecaille Sulfur Development Overcomes Marsh Conditions,"  
*Chem. Met. Eng.*, **41**, 116-20 (1934)
- Burns, "Building Grande Escaille," *Chemical Industries*, **34**, 503-6 (1934)
- Cunningham, "Sulfur," *J. Chem. Education*, **12**, 17-23, 83-7, 120-4 (1935)
- O'Donnell, "Jefferson Island Salt Dome,"  
*Bull. Am. Assoc. Pet. Geol.*, **19**, 1602-44 (1935)
- Orr, "Power and Heat Problems in the Sulfur-Mining Industry,"  
*Mech. Eng.*, **58**, 359-62 (1936)
- Bacon, "Sulfur as a Chemical Raw Material,"  
*Chemical Industries*, **40**, 465-9 (1937)
- Duecker, "New Applications of Sulfur," *Mining & Metallurgy*, **19**, 473-6 (1938)
- Mason, "The Sulfur Industry," *Ind. Eng. Chem.*, **30**, 740-6 (1938)
- Butterworth and Schwab, "Sulfur Mining as a Processing Industry,"  
*Ind. Eng. Chem.*, **30**, 746-51 (1938)
- Powell, "Recovery of Sulfur from Fuel Gases,"  
*Ind. Eng. Chem.*, **31**, 789-96 (1939)
- Duecker, "Sulfur and National Defense,"  
*Chem. Met. Eng.*, **48**, No. 3, 70-4 (1941)
- Bacon and Fanelli, "Purification of Sulfur," *Ind. Eng. Chem.*, **34**, 1043-8 (1942)
- Druecker and Eddy, "Sulfur's Role in Industry,"  
*Chemical Industries*, **50**, 174-82 (1942)
- Wells, "The Use of Sulfur in the Manufacture of Paper Pulp,"  
*Paper Trade J.*, **119**, No. 21, 107-11 (1944)
- Doumani, et al., "Recovery of Sulfur from Sulfur Dioxide in Waste Gases,"  
*Ind. Eng. Chem.*, **36**, 329-32 (1944)
- Love, "Desulfurization of Gas in the McKamie Field, Arkansas,"  
*Petroleum Engineer*, **15**, No. 9, 55-8 (1944)



Duecker, "Common Forms of Sulfur in the World Markets,"

*Chemical Industries*, **56**, 596-600 (1945)

Weber, "Sulfur from Sour Gas," *Oil & Gas J.*, **45**, No. 44, 58-9, 84-5 (1947)

## SULFUR DIOXIDE

Landolt and Sultzter, "Sulfur Dioxide Gas Cleaning for Sulfite Liquor Production from Pyrites," *Trans. Am. Inst. Chem. Engrs.*, **18**, 223-30 (1926)

Johnston, "Liquid Sulfur Dioxide," *Chemical Markets*, **23**, 476-9 (1928)

Healy, "Some Experiences with Cottrell Precipitators in the Purification of Burner Gases," *Trans. Am. Inst. Chem. Engrs.*, **24**, 37-43 (1930)

*Chem. Met. Eng.*, **37**, 366-8 (1930)

Adams, "Combustion of Pyrites in a Herreshoff Furnace,"

*Chem. Met. Eng.*, **38**, 337-8 (1931)

Freeman, "Flash Combustion Reacting of Iron Pyrites,"

*Trans. Am. Inst. Chem. Engrs.*, **26**, 148-57 (1931)

*Chem. Met. Eng.*, **38**, 334-6 (1931)

Hitchcock and Scribner, "Anhydrous Liquid Sulfur Dioxide,"

*Ind. Eng. Chem.*, **23**, 743-9 (1931)

Aasen, "Sulfur Burning Equipment for Sulfite Mills,"

*Paper Trade J.*, **94**, No. 15, 39-42 (1932)

Bacon, "A New Sulfur Burner," *Paper Trade J.*, **94**, No. 13, 31-5 (1932)

Copson and Payne, "Recovery of Sulfur Dioxide as Dilute Sulfuric Acid,"

*Ind. Eng. Chem.*, **25**, 909-16 (1933)

Browning and Kress, "A Study of Some Factors Influencing the Formation and Dissociation of Sulfur Trioxide in Sulfur Burner Gases for Sulfite Pulping," *Paper Trade J.*, **100**, No. 19, 31-43 (1935)

Firket, "Fog along the Meuse Valley," *Trans. Faraday Soc.*, **32**, 1192-7 (1936)

Freeman, "Use of Pyrites Concentrates in Sulfite Pulp Manufacture,"

*Trans. Am. Inst. Chem. Engrs.*, **33**, 180-8 (1937)

*Chem. Met. Eng.*, **44**, 311-3 (1937)

Othmer, "Modern Sulfur Burning Approaches Ideal Performance,"

*Chem. Met. Eng.*, **42**, 374-7 (1935)

Milliken, "Flash Roasting and Its Applications,"

*Mining and Metallurgy*, **18**, 279-82 (1937)

Cain and Chatelain, "New Low-Capacity Sulfur Burner,"

*Chem. Met. Eng.*, **46**, 637-9 (1939)

Harvey, "Sulfur as a Fuel," *Power Plant Engineering*, **44**, No. 10, 76-7 (1940)

Lepsoe, "Chemistry of Sulfur Dioxide Reduction,"

*Ind. Eng. Chem.*, **32**, 910-8 (1940)

Setterstrom, "Effect of Sulfur Dioxide on Plants and Animals,"

*Ind. Eng. Chem.*, **32**, 473-9 (1940)

Johns, "Miniature Sulfur Burner Treats Feedwater," *Power*, **85**, 118-20 (1941)

Johnstone, "Sulfur Dioxide," *Ind. Eng. Chem.*, **34**, 1017-28, 1444 (1942)

Willson, et al., "Liquid Sulfur Dioxide," *Chem. Industries*, **52**, 178-86 (1943)

Keyes, "Oxidation Process for Sulfuric Acid and Sulfate Production,"

*Chem. Met. Eng.*, **53**, No. 5, 126-30 (1946)

#### CHAMBER PROCESS

Larison, "The Packed Cell Process for Sulfuric Acid,"

*Chem. Met. Eng.*, **26**, 830-7 (1922)

Killeffer, "Ammonia as a Source of Nitrogen Oxides for Chamber Acid Plants,"

*Ind. Eng. Chem.*, **19**, 1153-6 (1927)

Newell, "High Points in Operating a Chamber Sulfuric Acid Plant,"

*Chem. Met. Eng.*, **34**, 607-9 (1927)

Spangler, "Ammonia Oxidation Replaces Niter for Chamber Acid Plants,"

*Chem. Met. Eng.*, **35**, 342-4 (1928)

Harvey, "Comparison of Modern Chamber Sulfuric Acid Plants,"

*Chem. Met. Eng.*, **36**, 402-6 (1929)

Olive, "Ammonia Oxidation Makes Further Gains in Chamber Plants,"

*Chem. Met. Eng.*, **36**, 614-7 (1929)

Parrish, "Liquid Phase Operation of Sulfuric Acid Chambers Gains Significance in Europe," *Chem. Met. Eng.*, **36**, 68-72 (1929)

Perley, "Intensive Production of 60° Bé. Sulfuric Acid,"

*Ind. Eng. Chem.*, **21**, 202-5 (1929)

Fairlie, "Europe Replacing Old Chambers with Modern High-Capacity H<sub>2</sub>SO<sub>4</sub> Systems," *Chem. Met. Eng.*, **37**, 468-72 (1930)

Parrish, "Thermal Aspect of Liquid Phase Sulfuric Acid Production,"

*Chem. Met. Eng.*, **37**, 93-5 (1930)

Larison and Christie, "Adapting Packed-Cell Operation to a Byproduct Sulfuric Acid Plant in the Chilean Andes,"

*Chem. Met. Eng.*, **39**, 66-70 (1932)

Berl, "Studies of the Lead Chamber Process,"

*Trans. Am. Inst. Chem. Engrs.*, **31**, 193-227 (1934-5)

*Chem. Met. Eng.*, **41**, 571-5 (1934)

Gleeson, "Operating a Mills-Packard Plant under Tropical Conditions,"

*Chem. Met. Eng.*, **42**, 379-81 (1935)

Parrish, "The Gaillard-Parrish Liquid Phase System of Sulfuric Acid Manufacture," *Industrial Chemist*, **11**, 300-5 (1935)

Fairlie, "Mills-Packard Sulfuric Acid Chambers,"

*Trans. Am. Inst. Chem. Engrs.*, **33**, 563-78 (1937)

*Chem. Met. Eng.*, **44**, 728-32 (1937)

Parrish, "Some Modern Developments of Sulfuric Acid Manufacture,"

*Chemistry & Industry*, **1940**, 836-44

Peakin, "The Kinetics of the Chamber Process for Sulfuric Acid,"

*J. Soc. Chem. Ind.*, **60**, 251-4 T (1941)

Fairlie, "Building the World's Largest Mills-Packard Acid Plant,"

*Chem. Met. Eng.*, **50**, No. 9, 103-5 (1943)

# CHAPTER 7

## Contact Sulfuric Acid

---

### I. *Introduction*

- A. PRODUCTION
- B. HISTORY

### II. *Theory of the Reaction*

- A. EQUILIBRIUM
- B. RATE OF REACTION

### III. *Catalysts*

- A. PLATINUM
- B. FERRIC OXIDE
- C. VANADIUM
- D. CATALYST EFFICIENCY
- E. CATALYST POISONS
- F. VANADIUM VS. PLATINUM

### IV. *Plant Operation*

- A. GENERAL OPERATION
- B. GAS TO CONVERTERS
- C. HEAT EXCHANGERS AND CONVERTERS
- D. ABSORBERS

### E. OLEUM

- F. CONTACT PROCESS CONTROL
- G. SLUDGE CONVERSION PROCESS

### V. *Concentration of Acid*

- A. CASCADE SYSTEM
- B. TOWER SYSTEM
- C. DRUM TYPE
- D. VACUUM CONCENTRATION

### VI. *Resistance of Materials*

- A. GENERAL RULE
- B. LEAD
- C. IRON
- D. SPECIAL ALLOYS
- E. NON-METALS

### VII. *The Sulfuric Acid Industry*

### VIII. *Student Exercises*

### IX. *Recommended Reading*

---

## PRODUCTION

THE production of sulfuric acid by the contact process has steadily increased in its importance until in 1936 over 50 per cent of the total

production was contact acid (Figure 7-1). This value has continued to increase to 65 per cent in 1944, for most installations in war industries were contact plants. The 1944 production came from 103 contact acid plants, some of which produced oleum. The number of plants and production figures are given in Table 7-1, in which the production of all grades has been calculated to 100 per cent sulfuric acid.

## HISTORY

It is possible that fuming sulfuric acid was the first produced for sale in continental Europe, for "Nordhausen" acid was produced by 1778. A natural slate containing pyrites was allowed to oxidize in the air to ferric sulfate, which was separated and heated in small retorts to produce sulfur trioxide. This was absorbed in water or sulfuric acid until a fuming acid of the desired concentration was produced. The cost in 1792 was about \$500 per ton of fuming acid.

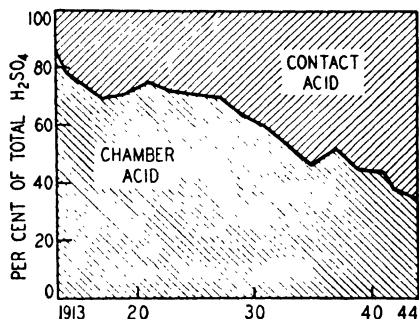

FIGURE 7-1. Division of Production of H<sub>2</sub>SO<sub>4</sub> between Chamber and Contact Process

TABLE 7-1 Production of Contact Sulfuric Acid in 1944\*  
(Short tons 100% H<sub>2</sub>SO<sub>4</sub>)

	Tons	Plants
20% oleum	407,382	28
40% oleum	816,538	40
60% oleum	71,297	7
Acid, 100% or less	4,712,073	102

\* U. S. Bureau of the Census data.

The contact process has evolved from a basic British patent issued in 1831 to P. Phillips, a vinegar manufacturer at Bristol, "for certain improvements in manufacturing sulfuric acid, commonly called oil of vitriol." He specified that the gases in proper proportion be drawn through a tube or tubes of platinum, porcelain, or other material not affected by the gases, and contained within the tube was platinum wire

or finely divided platinum. The tubes were heated to a strong yellow heat, preferably in a reverberatory furnace. Phillips' second improvement was for the absorption of the sulfur trioxide in a packed absorption column through which sulfuric acid was circulated by means of a lead pump.

No immediate commercial development was made of this process, though considerable experimental work was done on other catalysts for the reaction. No large market demand for fuming acid existed and the small demand was supplied by Nordhausen acid. The discovery in 1869 of a process for synthesizing alizarine, followed by other synthetic dye-stuffs, created a large market for fuming sulfuric acid to be used to sulfonate various aromatic compounds. The industry turned anew to the catalytic process. Various processes were used to produce equimolar mixtures of sulfur dioxide and oxygen, believed to be necessary for successful reaction, as thermal decomposition of chamber acid and removing the water, dissolving sulfur dioxide from burner gas in water under pressure, recovering the gas and mixing with oxygen, and others.

In 1901 the German chemist Knietzsch described the work done at the Badische Anilin und Soda Fabrik, which resulted in a successful contact process. He pointed out the errors of the earlier investigators and showed the important points necessary to successful plant operation. The patents granted to various workers during 1898 to 1902 placed the process on a sound industrial basis. The Mannheim, Schröder-Grillo, and Tentelaw processes were developed. The first plant constructed in the United States was a small experimental plant in New Jersey erected in 1898 by Badische. In 1900 the General Chemical Company erected a plant which was the first to burn arsenical pyrites.

### *Theory of the Reaction*

The reaction is a heterogeneous catalytic reaction. The factors of importance are those which influence the position of the equilibrium and the rate with which the reaction occurs.

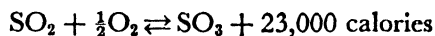

### EQUILIBRIUM

✓ The application of LeChatelier's principle to this exothermic reaction shows that conversion to sulfur trioxide decreases with increasing

temperature, so that the process should operate at the lowest temperature that gives a satisfactory rate of conversion. The application of pressure would give a higher equilibrium conversion, though industrially this has not been found to be an economical practice. The equilibrium constant ( $K_p$ ) for this reaction is:

$$K_p = \frac{P_{\text{SO}_3}}{P_{\text{SO}_2} \cdot P_{\text{O}_2}^{1/2}} \quad \text{or,}$$

$$P_{\text{SO}_3} = K_p \cdot \sqrt{P_{\text{O}_2}} \cdot P_{\text{SO}_2}$$

The presence of an inert gas, such as the nitrogen of the air used to burn the sulfur or carbon dioxide produced in the combustion of acid sludge, decreases the partial pressure of all components and is equivalent to a decrease in pressure on the reaction. This is deleterious and was the cause of early attempts to use mixtures of sulfur dioxide and oxygen only in the reaction. It must be remembered that the equilibrium conversion is not influenced by the catalyst, which acts only to increase the rate of

TABLE 7-2 Equilibrium in  $\text{SO}_2 + \frac{1}{2}\text{O}_2 \rightleftharpoons \text{SO}_3$  with Varying Concentrations and Temperatures\*

	Gas analysis in per cent			Conversion in per cent at temperatures in °C.					
	SO <sub>2</sub>	O <sub>2</sub>	N <sub>2</sub>	400	500	600	700	800	900
Stoichiometric ratio of SO <sub>2</sub> to O <sub>2</sub> with varying N <sub>2</sub>	67.7	33.3	0	98.1	91.3	76.3	51.5	30.1	16.0
	14.0	7.0	79.0	96.3	84.7	62.2	35.2	18.3	8.4
	7.0	3.5	89.5	95.2	81.2	55.5	28.5	12.9	6.0
	2.0	1.0	97.0	92.7	73.2	43.0	18.4	7.5	3.3
Pure gas mixtures of SO <sub>2</sub> + O <sub>2</sub>	67.7	33.3	0	98.1	91.3	76.3	51.5	30.1	16.0
	33.3	67.7	0	97.7	97.3	88.5	66.8	40.4	22.0
	14.0	86.0	0	99.8	97.9	90.3	69.8	43.9	24.4
	7.0	93.0	0	99.8	98.1	90.5	70.7	44.9	25.3
	2.0	98.0	0	99.8	98.2	90.8	71.2	45.5	25.6
Roaster gas with increasing excess air	10.10	5.05	84.85	96.2	83.2	59.1	31.9	15.0	7.0
	7.0	10.0	83.0	99.3	93.4	73.3	42.5	20.5	9.8
	4.0	14.6	81.4	99.4	94.9	78.3	48.1	24.2	11.7
	2.0	18.0	80.0	99.5	95.6	80.5	51.3	26.3	12.9

\* Holluta, *Die technischen Anwendungen der physikalischen Chemie*, Stuttgart, 1934; Ann Arbor. Edwards Bros., 1944.



In Table 7-2 is given the equilibrium conversions of various gas mixtures at temperatures from 400° to 900°C. The effect of dilution with nitrogen is apparent, and becomes a more important factor as the equilibrium temperature increases. With roaster gas, part of the oxygen has combined with the iron making the nitrogen content higher than with gas from a sulfur burner. In Figure 7-2 is shown the equilibrium conversions at varying temperatures for a number of gas compositions. It is seen that the temperature of the process must be carefully controlled in the neighborhood of 450°C. to secure commercial conversions.

The conversion at any temperature and concentration can be calculated from the equilibrium constant ( $K_p$ ) and the initial composition. The value of the equilibrium constant is a function of temperature only, where  $T$  = degrees Kelvin.

$$\log K_p = \frac{5186.5}{T} + 0.611 \log T - 6.7497$$

temp°C	200	300	400	450	500	600	700	800	1000
$K_p$	701,600	9652	482	148	52.9	9.71	2.54	0.861	0.166

The equilibrium constant can be determined from known equilibrium concentrations and temperatures, and from this the other equilibrium concentrations can be determined.

Basis: 100 moles gas to converter at constant pressure of 1 atmosphere.

100x = percentage conversion of  $\text{SO}_2$  to  $\text{SO}_3$

Components	Moles entering	Moles at equilibrium
$\text{SO}_3$	—	ax
$\text{SO}_2$	a	$a(1 - x)$
$\text{O}_2$	b	$b - \frac{ax}{2}$
$\text{N}_2$	c	$\frac{c}{2}$
Total	100	$100 - \frac{ax}{2}$

$$K_p = \frac{P_{\text{SO}_3}}{P_{\text{SO}_2} \cdot P_{\text{O}_2}^{1/2}} = \frac{ax}{a(1-x) \left( \frac{2b-ax}{200-ax} \right)^{1/2}}$$



This equation can be transformed to:

$$x = \frac{K_p}{K_p + \frac{1}{\left(\frac{2b - ax}{200 - ax}\right)^2}}$$

Thus the degree of conversion at a particular temperature can be calculated from the equilibrium constant and gas concentrations by a trial and error method. If only a trace of sulfur dioxide is present in air, the equation approximates

$$x = \frac{K_p}{K_p + \frac{1}{\sqrt{0.21}}} = \frac{K_p}{K_p + 2.2}$$

and the degree of conversion depends on the magnitude of  $K_p$  compared with 2.2.

#### RATE OF REACTION

Equilibrium in the reaction is attained very slowly when no foreign material is present. The function of the catalyst is to accelerate this rate to such an extent that the reaction becomes commercially feasible. The succession of steps in the process is: (a) diffusion of the reactants to the catalytic surface, (b) their adsorption on the catalytic surface, (c) their reaction, (d) desorption of the products from the surface, and (e) diffusion of the products away from the catalyst. The efficiency of the catalytic surface depends on its ability to adsorb the reactants and "activate" them so that reaction occurs at relatively low temperatures, then promptly desorb the products so that the surface again is available to adsorb more reactants. The effect of temperature on the rate is thus primarily one of affecting the rate of adsorption and desorption on the catalytic surface. The rate of oxidation of sulfur dioxide by oxygen has been studied\* on a platinum surface and found to vary directly as the distance to equilibrium and inversely as the square root of the sulfur trioxide concentration

$$\frac{d(\text{SO}_3)}{d\theta} = k \frac{S - S_e}{\sqrt{S_0 - S}}$$

where

$S$  = moles  $\text{SO}_2$  at time  $\theta$

$S_e$  = moles  $\text{SO}_2$  at equilibrium

$S_0$  = moles  $\text{SO}_2$  in entering gas

\* Taylor and Lenher, *Z. phys. Chem. Bodenst. Festschrift*, 1931, 30-43.

Thus the distance from equilibrium,  $S - S_0$ , represents the driving force for the reaction, but the rate is retarded by the strong adsorption, or slow desorption, of sulfur trioxide  $S_0 - S$ , on the catalytic surface. When sulfur trioxide gas is passed over a catalyst and dissociated to sulfur dioxide and oxygen, the rate is directly proportional to the distance from equilibrium, for the products now are readily desorbed from the surface and do not retard the dissociation reaction.

### Catalysts

It is noteworthy that the original patent of 1831 to Phillips specified the catalytic agent, platinum, which for a century stood as the commercial catalyst for this reaction. Considerable experimentation was carried out on other catalysts and since about 1930 the vanadium catalyst has become of equal or greater importance.

#### PLATINUM

The original Badische process used platinum black supported on asbestos to give a greater contact surface, thus decreasing the quantity of platinum necessary. The asbestos, after purification by boiling in hydrochloric and nitric acids and washing, is impregnated with a platinic chloride ( $PtCl_4$ ) solution containing a small amount of reducing agent, as glucose, and heated. The platinum content of the asbestos usually is 7 to 8 per cent of its weight.

The Schröder-Grillo process uses as the carrier for the catalyst magnesium sulfate which, when properly calcined, forms a hard but very porous mass more porous than pumice stone. Lumps passing  $\frac{3}{4}$ -inch but retained on  $\frac{1}{2}$ -inch screens are sprayed with platinic chloride solution and placed in the converter. Air heated to  $350^\circ C.$  is first passed through the catalyst mass to dry it and remove hydrochloric acid fumes. Dilute burner gas is then passed through and the heat of reaction finishes the decomposition of platinic chloride to platinum.

Silica gel made by the Davison Chemical Company and platinized by Baker and Company has become increasingly popular in this country. Silica gel is made by treating a solution of sodium silicate with hydrochloric or sulfuric acid, and allowing the silicic acid formed to set to a gel. The gel is broken into small pieces and washed with warm water to remove any excess acid and the salt formed. It is then dried slowly at about  $100^\circ C.$  and finally at  $300^\circ$  to  $400^\circ C.$  Silica gel has hard particles

resembling clear silica, but is extremely porous and possesses an enormous surface area per unit volume. Hydrogen or sulfur dioxide is absorbed by the silica gel and when treated with a platonic chloride solution the salt is reduced to metallic platinum. After drying, the catalyst is ready for use. The silica gel then contains 0.125 per cent platinum, and but 2 to 4 ounces of platinum are required per ton of sulfuric acid produced per day. This is considerably below that necessary with the other platinum catalysts.

#### FERRIC OXIDE

The reaction is catalyzed by ferric oxide, but a higher temperature is required and a lower conversion is obtained. In the Mannheim process, which was little used in this country, the gases from pyrites burners were passed through pyrites cinder at 700°C. to filter out all dust and fumes from the pyrites and to secure 40 to 50 per cent conversion. After absorption of the sulfur trioxide formed, the gases were passed over a platinum catalyst at 400°C. for conversion of the remaining gas. This represented a simple purification process for pyrites burner gas.

#### VANADIUM

Catalysts containing this metal had been suggested at various times but no commercial use was made until after 1926 when the Monsanto Chemical Company introduced its catalyst "containing zeolites in which vanadium is combined in a non-exchangeable form." In the manufacture of this catalyst sodium vanadate and silicate are neutralized to produce a gel, which then is treated like silica gel. The gel also can be precipitated on carriers as pumice, diatomaceous earth, etc. Thus the gel can be mixed with diatomaceous earth and made into pellets which are baked for use in the converter. In 1927 the Selden Company, now an American Cyanamid Company unit, introduced a catalyst "containing at least one catalytically active base-exchange body containing vanadium in non-exchangeable form." In the manufacture of this catalyst, solutions of vanadyl sulfate and potassium vanadate are mixed together with diatomaceous earth, or small pieces of diatomite brick, then filtered and dried. The dried catalyst is charged to the converter and treated with diluted burner gas at 400° to 500°C. to activate the catalyst. Despite the seeming similarity of these two catalysts the courts have held that a patentable difference exists. The catalyst of the Calco Chemical Com-

pany, now an American Cyanamid Company unit, has compounds of vanadium and alkali metals impregnated in pieces of natural diatomite brick which had been calcined at 1000°C. to give greater mechanical strength.

#### CATALYST EFFICIENCY

The comparison of various types of platinum catalysts as to efficiency is based on the amount of platinum necessary to produce one ton of sulfuric acid per day. With the Badische catalyst about 7 ounces are required whereas with platinized silica gel 2 to 4 ounces are required. Catalysts may be compared on the basis of the percentage of sulfur dioxide in the burner gas for equal percentage conversions and space velocities. The catalyst that can convert the stronger gas permits a given plant to produce more acid per day. The rate of passage of a gas mixture through a catalyst is usually expressed in terms of the "space velocity," defined as the volume of exit gas at standard conditions per hour per unit volume of catalyst.

#### CATALYST POISONS

The activity of a catalyst is affected greatly by the presence of foreign materials which attach themselves to the surface of the catalyst and decrease its activity. These substances are called catalyst poisons. Fine solid particles, as dusts, decrease the activity of a catalyst mass by mechanically covering the surface of the catalyst, but the activity can be restored by screening the catalyst to remove the dust. Certain compounds are adsorbed so strongly on the catalyst that this active surface is no longer available for the desired reaction. Arsenic was the first to be recognized and guarded against, but compounds of selenium, tellurium, antimony, lead, and other metalloids act as poisons. The halogens and haloacids, as chlorine and hydrochloric acid, are poisons, though the catalyst can be reactivated by heating to a somewhat higher temperature in gas free from these compounds. In order to maintain the life of the platinum catalyst an extensive purification system is necessary for gases from the burning of pyrites and sulfide ores. The vanadium catalyst is not poisoned by arsenic so can operate on metallurgical gas with little or no purification. Platinized silica gel shows an immunity to arsenic poisoning as great as that of the vanadium catalyst.

## VANADIUM VS PLATINUM

Certain advantages and disadvantages are found with each catalyst and a considerable controversy arose over the merits of the two. On the basis of cost of the catalyst the vanadium has a considerable lower initial cost, but 90 per cent of the platinum can be salvaged from the spent mass to reduce the over-all cost of platinum. Vanadium maintains its conversion efficiency longer than platinum and the average conversion efficiency at normal rates is higher. Platinum catalysts have a greater activity at lower temperatures than do vanadium catalysts and cause conversion at about 370°C., whereas vanadium catalysts require about 400°C. to cause the reaction to start. Platinum catalysts suffer a decline in activity over a period of years and their lives may be shorter than those of vanadium catalysts. If poisoned, the platinum catalyst must be replaced. Even though adequate purification systems are available for metallurgical gases the vanadium catalyst may be used in preference to platinum solely for the peace of mind of the management.

Vanadium catalysts have been developed to operate on wet gases so that drying is not necessary. For a given plant, these and other local factors must be considered in selecting the most economical catalyst.

### *Plant Operation*

The type of equipment and operation varies widely from plant to plant. The various pieces of equipment and their operation will be discussed later, but an over-all picture can be secured from the generalized flowsheet,\* Figure 7-3. Sulfur dioxide may be produced by any of the processes previously discussed. The flowsheet assumes that sulfur is melted and burned in a spray-type burner using dried air in but slight excess. The hot combustion gases are cooled using a waste-heat boiler and additional dried air added to give the desired concentrations of sulfur dioxide and oxygen. The gas may be further cooled in acid spray towers and filtered through coke-packed towers to remove any dust and acid mist carried by the gas. The conversion is usually carried out in two stages with cooling of the reacted gas by the entering gas to remove the heat of reaction and maintain the correct temperature. The cooled and filtered gas passes through two heat exchangers in series and enters the first converter at a temperature of about 400°C. The temperature rise due to the reaction is controlled by the amount of catalyst in the con-

\* *Chem. & Met.'s Chemical Engineering Flowsheets* (4th Ed.), No. 71.

verter. The exit gas at a temperature as high as 600°C. passes to the second heat exchanger and is cooled to slightly more than 400°C. before entering the second converter. Here the conversion is completed with considerably less temperature rise, as to 460°C., corresponding to a more favorable equilibrium conversion. This gas passes through the first heat

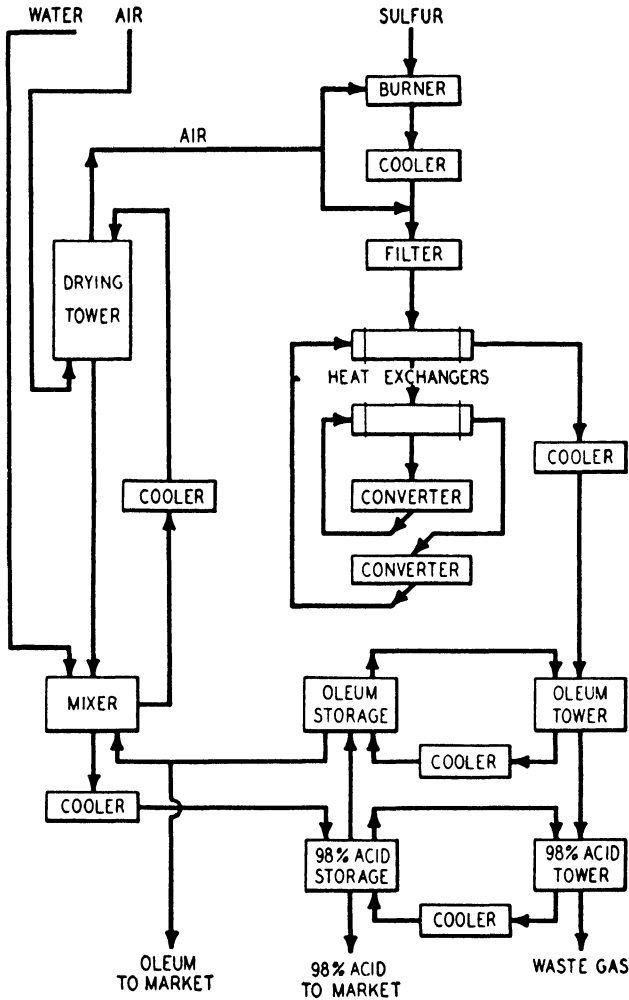

FIGURE 7-3. The Contact Process

exchanger and is cooled to about 250°C. before going to the absorption system. The absorption system may consist of one or more towers depending on the concentration of acid to be made. If 98.5 per cent acid is to be made, the system can operate with one tower. If oleum is to be made,

at least two towers are necessary. The cooled converted gas enters the oleum absorber where it comes in contact with acid of approximately the desired concentration. The flow of absorber acid is such that the concentration increase is only about one per cent so that the temperature rise of the acid will not be excessive. The gas then passes to the second absorber where the remainder of the sulfur trioxide is absorbed in 98 per cent acid. The waste gas may be passed through a Cottrell electrostatic precipitator to remove any unabsorbed sulfuric acid mist before releasing it to the atmosphere. The absorber acids are cooled before going to storage tanks. The dilution of the oleum or concentrated absorber acid is accomplished in a mixing tank to which is returned the diluted acid from the drying tower which removes the moisture from the entering air. Additional water is added if necessary. This acid, at a concentration of about 97 per cent, is returned to the 98 per cent acid storage where it mixes with the 99 per cent acid coming from the absorber to maintain the desired acid concentration.

#### GAS TO CONVERTERS

For the contact process a rigorous purification of the gases from pyrites and sulfide ores is carried out, comprising the steps: (a) removal of dust, (b) cooling the gas, (c) scrubbing the gas, (d) filtering the gas, and (e) drying the gas. Dust may be removed by the methods described for pyrites burner gas. The gas may be cooled first by passing through a waste heat boiler, as with sulfur spray burner gases, or return-bend coolers. By keeping the temperature above the dew point of the sulfuric acid present, about 275°C., cast iron equipment can be used. Final cooling may be carried out in water-cooled lead pipes or by scrubbing with dilute acid. Ordinarily burner gas is cooled to 75°C. or below before being scrubbed.

Scrubbing of the gas is carried out in packed towers similar to Glover towers in which the gas rises against descending acid, or spray towers may be used. Final impurities are removed in the first tower and this acid usually is sold separately. The acid used in a series of scrubbing towers may be increased in strength from tower to tower to aid in the removal of impurities and also to assist in the cooling of gas in the first tower by evaporation of water from the acid. Final removal of fumes and acid spray is made by filtering the gas through beds of pea-size coke, usually contained in large boxes. Final drying of the gas is accomplished by scrubbing with cold concentrated sulfuric acid in packed towers.

Purification systems for a number of actual installations are described by Fairlie. A 52-ton-per-day plant roasting zinc ore concentrates and using vanadium catalyst cools its gas in steel pipe to 350°C. before passing through a Cottrell precipitator, the gas from which is scrubbed with 60°Bé. acid. Further cooling is effected in two tanks of water-cooled lead pipe gas coolers, filtered through two coke filters, dried in 2 scrubbing towers and again filtered through mineral wool. A 32-ton-per-day plant burning sulfur cools the gas in air-cooled cast iron pipe followed by water-cooled lead pipe, filters through a coke box, scrubs in one tower with 60°Bé. acid, filters again in a coke box and mineral wool filter.

#### HEAT EXCHANGERS AND CONVERTERS

In the flowsheet (Figure 7-3) are shown two heat exchangers through which the cold unconverted gas passes before entering the converters. These heat exchangers are similar to fire-tube boilers, for the hot gas from the converter enters a header at the end of the exchanger and then passes through small pipes and into another header at the opposite end. A typical exchanger might have from 100 to 600 tubes of 1¼- to 2½-inch diameter and 10 to 17 feet long. The cold gas passes outside the tubes, or on the shell side, and to secure higher velocities of the gas past the tubes several baffles are interposed between the inlet and outlet pipes. These cause the gas to take a zigzag path normal to the tubes and result in better heat transfer coefficients. This type of external exchanger is used in the Badische and similar systems.

The importance of exact control of temperature in the catalyst bed caused the combination of heat exchanger and converter into one apparatus, Figure 7-4, which shows the Jaeger type converter. The converter consists of a cylindrical cast iron vessel containing two layers of catalyst. The unconverted gas enters at *A* and passes up through the inner tube and down through the outer annular space where it removes heat from the catalyst bed. The heated gas passes out into a layer of crushed quartz which supports the catalyst bed and up through the catalyst where reaction occurs and heat is released. The temperature of the reacting gas drops as it progresses upward, but due to imperfect heat transfer, it leaves the lower catalyst bed at too high a temperature for satisfactory conversion. The smaller catalyst bed in the top layer is cooled by air which enters at *C*, passes downward in the outer annular spaces and upwards in the inner pipes, leaving at the top of the converter *B*. The converted gas leaves at *D*. The temperature distribution in the



catalyst beds is shown on the curve beside the converter. The first 10 per cent of the catalyst converts about 80 per cent of the sulfur dioxide, and the lower layer converts about 96 per cent, leaving but 2 per cent for the air cooled upper layer.

A Chemico tray type converter assembly having one heat exchanger is shown in Figure 7-5. The sulfur dioxide gases from the purification system pass first through the shell side of a large heat exchanger, downward through the two beds of catalysts and then through the tubes in the

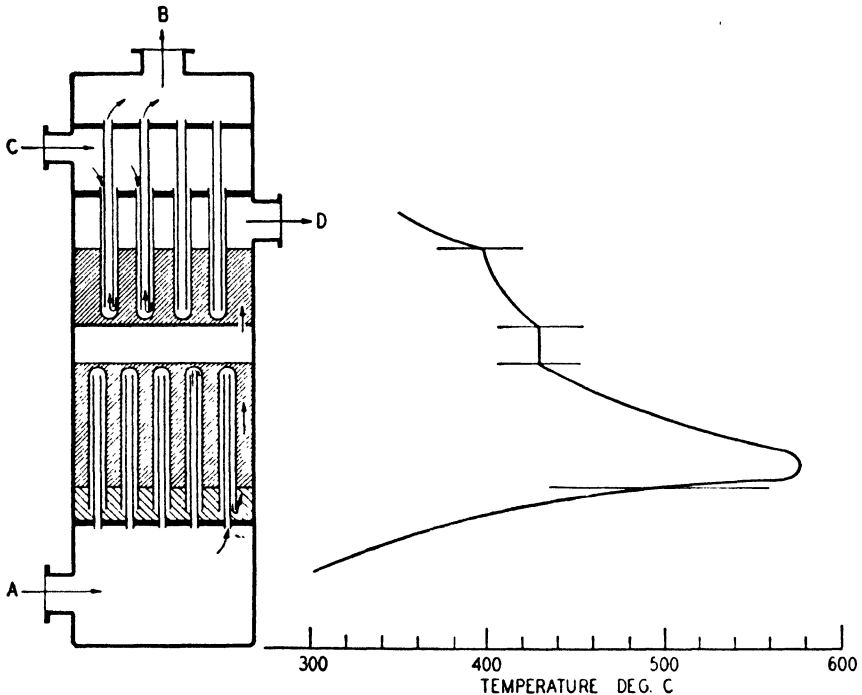
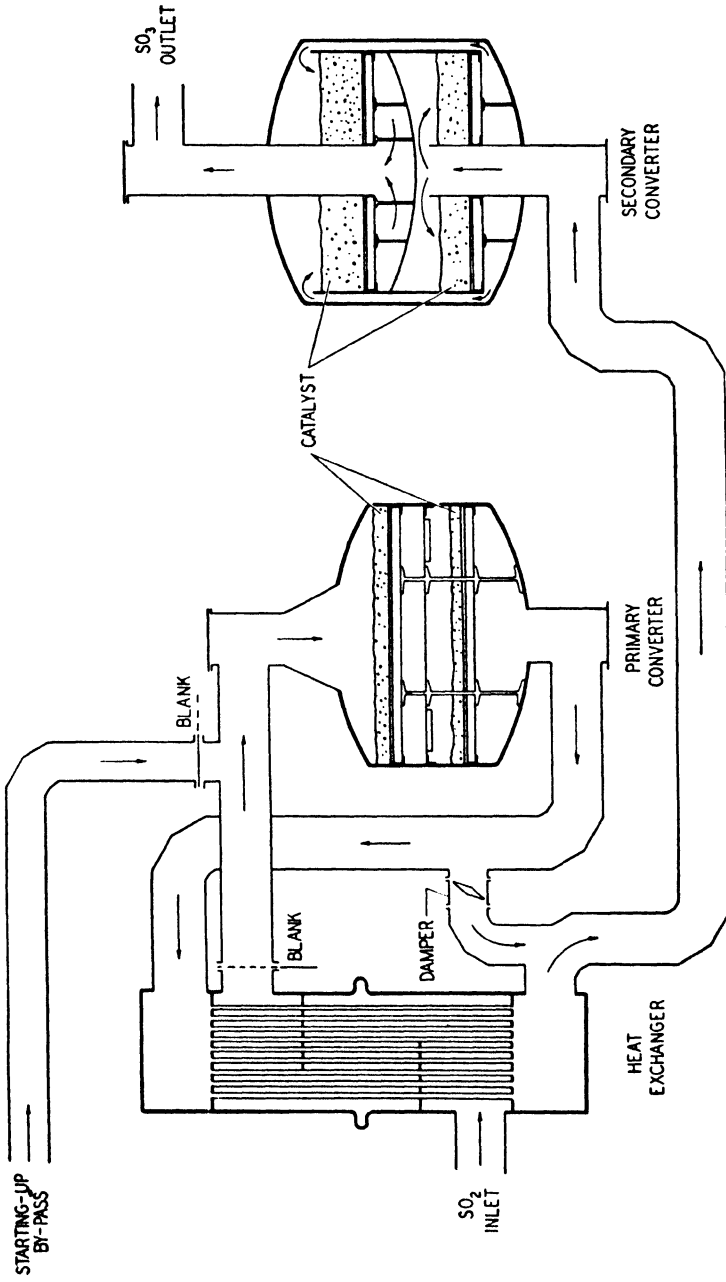

FIGURE 7-4. A Jaeger Converter, showing Temperature Distribution in the Catalyst Bed

heat exchanger. The temperature of the gas can be regulated by means of a damper which can by-pass part of the gas past the heat exchanger. The gas passes to the secondary converter in which the gas passes downward through the first catalyst bed, upwards along the outer shell of the converter and downward through the second bed of catalyst.

Various combinations of external heat exchangers and converters of the simple tray type or internally cooled are in use, so that considerable variation may be found among various installations.



*Courtesy of the Chemical Construction Company*

FIGURE 7-5. Tray Type Converter Assembly

~~A~~BSORBERS

It might appear that the absorption of sulfur trioxide in water to form sulfuric acid would be carried out. However, if the sulfur trioxide first comes in contact with water vapor it reacts with the vapor to form a fog of minute droplets of sulfuric acid. Attempts to dissolve these droplets of sulfuric acid are unsuccessful because the gas film around the

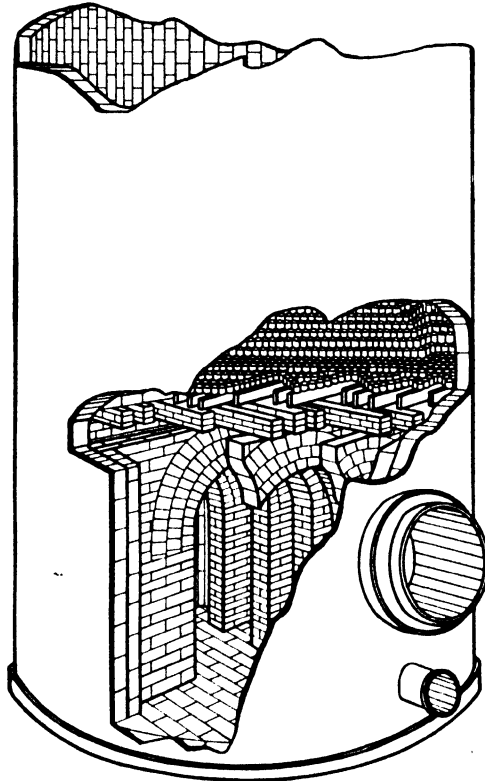

*Courtesy of the Chemical Construction Company*

FIGURE 7-6. Absorber or Scrubber, with Metal Shell and Chemical Brick Lining Showing Construction of Arches

droplet prevents it from coming in contact with the absorbing liquid. Thus, the absorber liquid must be sulfuric acid of such strength that the partial pressure of water vapor above it is negligible. This calls for acid 97 per cent  $H_2SO_4$  or more. Absorber acid usually is adjusted to 98.5 per cent  $H_2SO_4$ , for this concentration has the lowest vapor pressure of water

and sulfur trioxide. Higher concentrations allow sulfur trioxide to go through unabsorbed.

The gas to the absorbers is not cooled sufficiently in the heat exchangers and additional cooling is provided in air cooled tubes. The final gas temperature depends on the acid being made, and usually is about 100°C.

The absorbers are packed towers (10 feet in diameter by 30 feet high) constructed of an outer steel shell lined with acid-resistant brick (Figure 7-6). The packing is a special ceramic shape to give large surface area and low resistance to gas flow. The absorbers producing oleum are smaller in diameter (as 3 feet or larger) and consist of an inner cast iron tube and an outer steel shell, with the annular space filled with acid-resistant cement.

The concentration of the absorber acid is adjusted by the addition of dilute acid. This dilute acid may be formed in sufficient quantity by the removal of water vapor from the air used in the sulfur burner. Additional water is added to give the final desired concentration. The temperature of the absorber acid must be controlled, as it affects both the rate of absorption and final concentration of oleum. With converter gas containing 6 per cent sulfur trioxide oleum containing 42 per cent free sulfur trioxide can be obtained with absorber acid at 40°C., but only 13 per cent free sulfur trioxide with absorber acid at 90°C. If 98 to 100 per cent sulfuric acid is being made the absorber acid is usually maintained at 50° to 80°C.

Because of the large amount of heat liberated by the reaction of sulfur trioxide with water, and the dilution of concentrated sulfuric acid, the diluted acid must be cooled before being reused in the absorbers or stored. Coolers of the return-bend type with water flowing down the outside are frequently used. The required number of banks is connected in parallel, with large inlet and outlet manifolds, thus decreasing the fluid resistance.

## OLEUM

Because of the high vapor pressure of sulfur trioxide in oleum it is necessary to have several absorbers, the number depending on the strength of acid being made. For the production of oleum with 20 per cent free sulfur trioxide one oleum tower followed by an absorber using 98.5 per cent sulfuric acid is sufficient. For oleum up to 40 per cent free sulfur trioxide more towers must be used because of the slow rate at

which sulfur trioxide in the gas absorbs in the oleum. For the production of oleum with 60 per cent free sulfur trioxide the oleum with 20 to 30 per cent free sulfur trioxide is charged into a steel still, and the sulfur trioxide distilled over and condensed. The liquid sulfur trioxide is then mixed with 30 per cent oleum to produce 60 to 66 per cent oleum. The depleted acid from the still is returned to the absorbers.

#### CONTACT PROCESS CONTROL

The successful operation of a contact plant depends on the maintenance of constant temperatures and compositions at various points in the process. The percentage of sulfur dioxide in the gas to the converters is checked by an automatic gas analysis recorder. If the sulfur dioxide content is too high, part passes through unconverted; if too low, the output of the plant is decreased and the converter temperature may drop to such an extent that all gas is not converted. If high strength burner gas is produced, the proportioning of air is made automatically to maintain the desired concentration to the converter. Temperatures of gas to the converter and within the converter are of great importance. The entering gas must be of the proper temperature to start the reaction. The temperature gradient within the catalyst bed shows the activity of the catalyst. As pointed out previously, 80 per cent of the conversion occurs in a layer containing but 10 per cent of the catalyst, and this layer is indicated by the peak in the temperature curve (Figure 7-4). As this peak moves upwards in the catalyst bed it indicates the loss of catalytic activity in the lower layers and increased load on the upper catalyst bed. At that point indicated as the optimum for economic operation the fouled catalyst is removed and replaced. The temperatures of the gases and acids to the absorbers must be properly regulated to prevent undue wear on the towers. The concentration of absorber acid must be controlled exactly for the final absorber at 98.0 to 98.5 per cent, which is accomplished by determining the electrical conductivity of the acid. Dilution acid or water can be added automatically by such a control instrument to maintain a constant concentration to the absorber. Similar conductivity control methods are used to maintain constant oleum strength from absorbers.

#### SLUDGE CONVERSION PROCESS

In Figure 6-2 it is seen that the petroleum industry is one of the large users of sulfuric acid for the refining and alkylation of petroleum prod-

ucts. Much difficulty was encountered in reconcentrating used acid or disposing of acid sludge. This material now is reconverted to sulfuric acid.\* Acid sludge is mixed with petroleum coke and heated slowly in a rotary kiln. The hydrogen of the hydrocarbons in the sludge reduces the sulfuric acid to sulfur dioxide and leaves the carbonaceous residue as coke. Alkylation acid residue is burned directly in a refractory combustion chamber which also is adapted to burn hydrogen sulfide and sulfur. Sulfur may be burned simultaneously to maintain a higher percentage of sulfur dioxide in the gas. After suitable purification the gas passes to the usual heat exchangers, converters, and absorbers.

A similar process is used to regenerate sulfuric acid from waste pickle liquor (ferrous sulfate solution).† The neutralized liquor is mixed with ferric oxide cinder and dried to anhydrous ferrous sulfate in a rotary kiln. Fine coal and pyrites are added to the mixture and calcined in a second rotary kiln. The ferrous sulfate is thermally decomposed and the sulfur trioxide reduced to dioxide by the coal present. The pyrites furnish the make-up sulfur for additional acid. After purification the gas is converted in a typical installation.

### *Concentration of Acid*

Much of the sulfuric acid used in the petroleum industry, the coal products industry, and for the production of nitro compounds is recovered in a dilute form. Thus in the petroleum industry the concentrated sulfuric acid is used to remove color bodies and unsaturated compounds from various petroleum fractions. The acid sludge removed is treated in various ways to recover as much of the acid as possible. One process is to burn the sludge and prepare new acid, as previously described. The more usual procedure is to dilute the sludge with water, agitate, and heat with steam until the emulsion is separated. The acid layer is withdrawn at a concentration of 35 to 60 per cent. This acid is then reconcentrated for reuse in the process. An acid of about 87 per cent is as far as concentration is carried due to reaction of acid on suspended carbon. Higher strengths are made by adding oleum or fortifying directly with sulfur trioxide.

\* *Chem. & Met.'s Chemical Engineering Flowsheets* (4th Ed.), No. 72. Pictured Flowsheet, *Chem. Met. Eng.* **48**, No. 5, 144-7 (1941).

† *Chem. & Met.'s Chemical Engineering Flowsheets* (4th Ed.), No. 69. Pictured Flowsheet, *Chem. Met. Eng.* **53**, No. 7, 138-41 (1946).

### CASCADE SYSTEM

This method, now obsolete, represents the common procedure of taking the laboratory method of the chemist, expanding it in size, and using it to treat tons of acid rather than grams. Dishes of fused silica, 12 to 18 inches in diameter, or pans of hard lead or silicon-iron, 7 feet by 3 feet by 8 inches, are set in a refractory brick housing within which fuel is burned, and the hot flue gases pass upwards beneath the vessels.

Each dish is above the previous one and the dilute acid introduced at the top flows, or cascades, downward from dish to dish. The upper third of the cascade is uncovered, for only water vapor is given off, but the lower section is covered and the acid fumes may be run through absorbers for recovery of acid.

### TOWER SYSTEMS

In the chamber process the dilute acid is concentrated in the Glover tower by downward flow against the hot burner gases. This principle has been applied using flue gas from the combustion of oil or gases as fuel. Such systems work well on clean sulfuric acid, but with acid containing dissolved hydrocarbons difficulty arose at that concentration at which the acid oxidized the hydrocarbon, producing gases that cause excessive foaming. This problem was successfully solved by a continuous two-stage process (Chemico or Heckenbleikner) in which the hot flue gas is blown through a bath of acid. The gases leaving consist of flue gas and water vapor, the latter in equilibrium with the acid solution. If the total, or atmospheric pressure, is one atmosphere, Dalton's law states:

$$P_{\text{total}} = p_{\text{gas}} + p_{\text{H}_2\text{O}}$$

The partial pressure of the water vapor corresponds to a vapor pressure at a temperature considerably below that at which the vapor pressure is one atmosphere. Thus such evaporation is equivalent to evaporation under a partial vacuum. Water, when evaporated by bubbling such combustion products through it, evaporates at a temperature of about 90°C., corresponding to a partial pressure of water of about 480 mm. The system consists of two units supplied with flue gas at about 600°C. from one oil or gas-fired furnace operated under pressure. The hot gas is released under the surface of the acid, bubbles up and passes into the tower where it preheats the descending supply of feed acid. In the first stage the acid is concentrated from about 35 per cent to 65 per cent and

much of the hydrocarbon content is removed by volatilization or oxidation. Carbonaceous matter is removed before this acid is fed to the second unit where the acid is concentrated to about 87 per cent acid. Clean dilute acid can be concentrated to 93 per cent, or 66°Bé., when it does not contain reducing agents, as does oil refinery acid. The waste gases from both units pass through a Cottrell electrostatic precipitator to remove sulfuric acid mist, which is returned to the first-stage concentrator.

### DRUM TYPE

The drum type of concentrator is used extensively. Its operation can be seen in Figure 7-7. In this the two towers previously described are

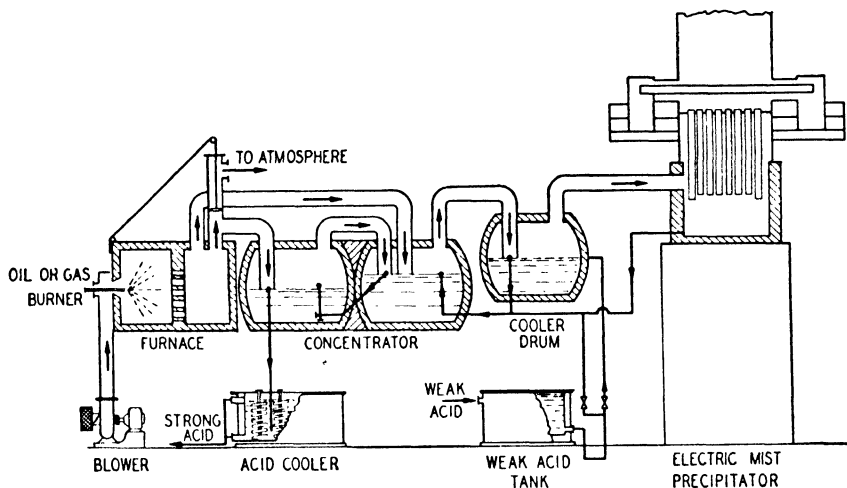

*Courtesy of the Chemical Construction Company*

FIGURE 7-7. Drum Type Acid Concentrator

replaced by the two compartments in the concentrator. The apparatus is a long horizontal steel drum divided into three compartments, the first for combustion and the other two for acid. The furnace section is lined with refractory brick and the air for combustion is supplied under sufficient pressure to force the combustion products through the remainder of the system. The acid sections are lined with heavy sheet lead covered by acid-resistant brick. The hot combustion gases at about 600°C. are released beneath the surface of the acid in the first concentrator drum and remove water to give the final desired concentration of acid. The exit



gases at about 230°C. bubble up through the more dilute acid in the second concentrator drum. Flue gas directly from the burner also is used here, being proportioned between the first and second drum to give the desired final concentration. The exit gas at about 200°C. is bubbled through the dilute acid in the cooling drum and leaves at 90° to 150°C. The acid mist is removed in a Cottrell electrostatic precipitator. The dilute acid enters the cooling drum and flows forward countercurrent to the hot gases. If considerable carbon or sludge forms in the second concentrator it is removed by skimming or settling before going to the first drum. It is seen that the excellent heat transfer by bubbling gases through the liquid due to the large surface of myriads of small bubbles obviates the need for towers for the final cooling of the gas.

#### VACUUM CONCENTRATION

In order to reduce the temperature at which concentration is carried out, the dilute acid can be concentrated under reduced pressure. This reduces corrosion and loss of acid by reaction with contained organic material. In the Simonson-Mantius evaporator this is carried out by supplying steam at 45 p.s.i.g. to lead coils submerged in the acid. The evaporator body consists of a lead-lined steel shell lined with one or two courses of acid-resistant brick. A vacuum is maintained by means of a barometric leg and small steam ejector to remove fixed gases. In this, dilute acid can be concentrated to 80 per cent (61°Bé.). To obtain higher concentration, steam at 100 p.s.i.g. is supplied to silicon-iron tubes arranged radially around the shell. The clarified 80 per cent acid is used as the feed and concentrated in batches to 93 per cent (66°Bé.) acid. In the "flash-film" type concentrator the dilute acid flows rapidly through a steam-jacketed heat exchanger and discharges to a tank maintained under a vacuum. Here "flash" evaporation occurs to give an acid of the desired concentration.

#### *Resistance of Materials*

The materials chosen for use in sulfuric acid depend primarily on the concentration of the acid and its temperature. Secondary factors are dissolved oxygen or oxidizing agents, the movement of acid past the metal whereby the protective films can be removed, and the purpose for which the acid is to be used. Dilute sulfuric acid is a strong acid, usually

in which the sulfates formed are soluble. Concentrated sulfuric acid, particularly when hot, is a strong oxidizing agent, one in which the sulfates formed are not particularly soluble.

A general rule is that oleum is handled in steel, acid from 93 to 100 per cent is handled in cast iron if hot, or steel if cold; hot acid from 75 to 93 per cent is handled in cast iron or steel, or if cold, in lead; below 75 per cent acid lead usually is used. This general rule represents the choice of materials least expensive, but not necessarily used because of other factors. A few of the important materials will be discussed in greater detail.

## LEAD

Lead can be used for cold acid up to 93 per cent concentration, and for hot acid up to 80 per cent. Concentrated acid and oleum attack lead more rapidly due to the increased solubility of the protective lead sulfate coating, presumably due to the formation of bisulfates. Tellurium lead (0.05 to 0.10 per cent Te) is much stronger and tougher than pure lead. It has been used for one chamber plant and is used in other places where these special properties are desired. Antimonial lead (5 to 15 per cent Sb) is harder than pure lead, so is used for parts such as valves, pumps, blowers, etc. It is less resistant to corrosion than pure lead, the resistance decreasing with the antimony content.

## IRON

Cast iron and steel are attacked by dilute acid, but concentrated acid forms a sulfate coating which protects the metal, unless the coating is broken or washed away by agitation. Acid about 75 per cent is handled and stored in steel at temperatures up to 50°C. Cast iron resists acid better than steel, but does not have the mechanical strength of the latter. Special cast irons containing nickel are of merit. Silicon-iron alloy (15 per cent Si, as Duriron and Corrosiron) are highly resistant to all concentrations of acid below 98 per cent at all temperatures. It is used extensively, particularly when niter fumes are present, for pipes and for mechanical equipment. It is brittle and cannot be machined. Cast iron and the high silicon-irons are not suitable for oleum or exposure to free sulfur trioxide, which cause them to crack badly.

## SPECIAL ALLOYS

The iron-chromium-nickel alloys (18 per cent Cr and 8 per cent Ni) of the stainless-steel type gives excellent protection in aerated acid; however, failure occurs in air-free or boiling acid. Hastelloy D alloy (85 per cent Ni) is highly resistant, but is brittle and cannot be machined. Monel metal withstands corrosion well in the lower concentrations and is used for baskets containing steel or brass articles to be pickled in hot dilute (10 per cent) acid. Monel metal is used for equipment to handle weak acid and weak acid sludge. Worthite, Durimet, and Alloyco 20 are alloys suitable for acid from 75 per cent upward through all strengths of oleum.

## NON-METALS

Wood withstands dilute (2 to 10 per cent) acid at temperatures up to 80°C. For hot concentrated acids, the best service is obtained from the acid-resistant ceramic materials, such as used in the Glover tower and elsewhere. This type of ceramic ware is high in silica and low in other soluble oxides. Cements for laying this type of brick are of powdered silica wet with sodium silicate solution, from which the alkali later is dissolved by the acid, leaving only silica. Fused silica ware is used for laboratory equipment and small cascade concentrator dishes. Hard rubber pipes or rubber lined or coated materials are used in dilute acid. Carbon pipes are inert except under oxidizing conditions. A synthetic resin base material, Haveg, also is satisfactory under these conditions. Pyrex glass pipe and fittings are also used.

### *The Sulfuric Acid Industry*

About 85 per cent of the sulfuric acid shipped is in steel tank-cars of capacity up to 12,000 gallons. Because of the weight of the acid compared to the sulfur required to make it, the shipment of tank cars of acid beyond a 200-mile limit on regular contracts is unusual. Acid plants are constructed close to the place where needed, unless other factors as by-product utilization enter into consideration. Because of this shipping difficulty, the construction of acid plants has followed the shift in chemical industry from the northeastern states to the south and middle west with abandonment of surplus capacity. Also, the price in one locality bears little relationship to that in another locality outside of shipping

range. Other factors, as supply and demand, availability of by-product acid, legal necessity of converting waste sulfur dioxide, operate to fix the price of acid.

Sulfuric acid is produced by a variety of companies whose main product is other than the acid. Surplus capacity usually is installed to care for future growth of the company and the surplus acid is marketed to others in the surrounding territory. Some petroleum refiners, producers of explosives, coal-tar products, fertilizers, etc., have installed acid plants and compete for the available acid market. In those areas producing sulfide minerals, legal action has forced the manufacture of acid from roaster gases. Costs under such circumstances are a matter of bookkeeping and the necessity of disposal of the acid has usually forced a low price. Such necessity has also caused the enlargement of the plant into an integrated chemical enterprise for utilization of the acid formed. Thus the Tennessee Copper Company, the Ducktown Chemical and Iron Company, the Anaconda Copper Mining Company, and the Consolidated Mining and Smelting Company of Canada are some of the companies forced into a profitable chemical industry by legal action. The Consolidated, at Trail, B. C., roasts lead and zinc ores and from the sulfur dioxide produces sulfuric acid, sulfur, ammonium sulfate, as well as other chemicals as ammonia, phosphoric acid, and phosphate fertilizers.

The chemical industry is a most progressive industry and each producer of chemicals has striven to increase his field of products to lessen the risk on any one. Chemicals beget chemicals, and the general industrial field for utilization increases. Many companies which started as small producers of sulfuric acid now have expanded to large producers of many chemical products, as the General Chemical Company and the Grasselli Division of E. I. du Pont de Nemours and Company.

*Student Exercises*

- A. Prepare a chemical engineering report covering one of the following topics:
1. Production of oleum from sulfates
  2. Production of 60% oleum
  3. Electrostatic precipitators in the sulfuric acid industry
  4. Preparation of metallized silica gel
  5. Preparation and revivification of platinum catalysts
  6. Monsanto vanadium catalyst and converter system
  7. Selden vanadium catalyst and converter system

8. Production of sulfuric acid from wet gases
9. Other catalysts (than Pt and V) for the conversion of sulfur dioxide
10. Equilibrium conversion calculation for sulfur dioxide
11. Kinetics of the conversion of sulfur dioxide
12. Special type processes:
  - a. Badische
  - b. Grillo-Schroeder
  - c. Mannheim
  - d. Tentelew
  - e. Chemico sludge process
  - f. Chemico pickle liquor process
  - g. Hydrogen sulfide processes
13. Concentration processes:
  - a. Cascade
  - b. Kessler
  - c. Gaillard
  - d. Kalbperry
  - e. Skoglund
  - f. Trepex
  - g. Chemico tower
  - h. Chemico drum
  - i. Flash-film
  - j. Simonson-Mantius
14. Control methods for the contact process
15. Report of suitability of the following materials as to resistance to sulfuric acid (all concentrations and temperatures):
  - a. Lead
  - b. Cast iron
  - c. Wrought iron
  - d. Steel
  - e. High silicon irons
  - f. Cr — Ni steels
  - g. Ni alloys
  - h. Cr alloys
  - i. Carbon
  - j. Wood
  - k. Silica
  - l. Ceramics

**B. Prepare flowsheets for:**

1. Mannheim process
2. Chemico sludge process
3. Chemico pickle liquor process
4. Trinitrotoluene
5. Picric acid
6. Acid treatment of petroleum oils

**C. Prepare an illustrated problem showing the method of calculating:**

1. Mixed acid fortification
2. Material and heat balances in a drum concentrator
3. Material and heat balances in an absorption and dilution system
4. Theoretical conversion from equilibrium data

## Recommended Reading

## I.

See list at end of Chapter VI

## II.

## CONTACT PROCESSES

- DeBlois, "The Contact Process for Sulfuric Acid,"  
*Can. Chem. & Met.*, **11**, 57-62 (1927)
- Holmes, et al., "Platinized Silica Gels as Catalysts for the Oxidation of Sulfur Dioxide," *Ind. Eng. Chem.*, **21**, 850-3 (1929)
- Jaeger, "A New Contact Sulfuric Acid Process,"  
*Ind. Eng. Chem.*, **21**, 627-32, (1929)
- Parrish, "Production of H<sub>2</sub>SO<sub>4</sub> from Anhydrite,"  
*Industrial Chemist*, **5**, 491-3 (1929)
- Holmes and Elder, "Vanadium Compounds as Catalysts for the Oxidation of Sulfur Dioxide," *Ind. Eng. Chem.*, **22**, 471-3 (1930)
- Thompson, "Platinum vs. Vanadium Pentoxide as Catalysts for Sulfuric Acid Manufacture," *Trans. Am. Inst. Chem. Engrs.*, **28**, 264-309 (1931)
- DuBois and Harvey, "Contact and Sulfuric Acid Converters,"  
*Ind. Eng. Chem.*, **24**, 1091-6 (1932)
- Doggett, "Smelter Gas Purification for Contact Process,"  
*Can. Chem. & Met.*, **18**, 196-200 (1934)
- Woisin, "Strong Sulfuric Acid from Wet Sulfur Dioxide,"  
*Chem. Met. Eng.*, **43**, 301-2 (1936)
- Olsen and Maisner, "Vanadium Catalysts," *Ind. Eng. Chem.*, **34**, 254-67 (1937)
- Mahr, "Catalyst Costs Determine Economy in Contact Process,"  
*Chem. Met. Eng.*, **45**, 313-7 (1938)
- Hougen and Watson, "Solid Catalysts and Reaction Rates,"  
*Ind. Eng. Chem.*, **35**, 529-45 (1943)

## CONTACT PLANTS

- Dinsmoor, "A Modern Contact Sulfuric Acid Plant,"  
*Trans. Am. Inst. Chem. Engrs.*, **26**, 158-65 (1931)  
*Chem. Met. Eng.*, **38**, 330-3 (1931)
- Spangler, "Sulfuric Acid Produced from Heavy Refining Sludge by Use of Improved Contact Process," *Oil and Gas J.*, **32**, No. 23, 76-7 (1933)
- Diamond, "The Trail Heavy-Chemical Plants,"  
*Trans. Can. Inst. Mining Met.*, **1934**, 442-60

- Spangler, "New Process Converts Waste Ferrous Sulfate to Sulfuric Acid,"  
*Chem. Met. Eng.*, **42**, 139-41 (1935)
- Stagner, "Sulfur Dioxide and Fresh Sulfuric Acid from Refinery Acid Sludge,"  
*Ind. Eng. Chem.*, **28**, 171-5 (1936)
- Craize and Brown, "Oil Refinery Hydrogen Sulfide Found to Be Economical  
Sulfuric Acid Source," *Chem. Met. Eng.*, **44**, 376-79 (1937)
- Spangler, "Modified Acid Recovery Process Treats Troublesome Acid Sludges,"  
*Chem. Met. Eng.*, **44**, 368-70 (1937)
- Carvlin, "35 Tons H<sub>2</sub>SO<sub>4</sub> per Day from Refinery Gases,"  
*National Petroleum News*, **30**, No. 22, R-268-274 (1938)
- Kirkpatrick, "Trail Solves Its Sulfur Problem,"  
*Chem. Met. Eng.*, **45**, 483-5 (1938)

#### CONCENTRATION

- Kaltenbach, "Concentration of Sulfuric and Nitric Acids,"  
*Industrial Chemist*, **13**, 176-8 (1937)
- Oliver and Spangler, "Sulfuric Acid Sludges and Recovery,"  
*The Science of Petroleum*, Oxford Press, 2764-71 (1938)
- Bransky and Diwoy, "Bubble Phase Absorption of Sulfuric Acid Fog,"  
*Chem. Met. Eng.*, **47**, 541-2 (1940)
- Parrish, "Modern Developments in the Design of Plant for the Concentration of  
Sulfuric Acid," *Trans. Inst. Chem. Engrs. (London)*, **19**, 1-24 (1941)
- Kalous, "Improvements in Concentrating Sulfuric Acid,"  
*Ind. Eng. Chem.*, **35**, 387-90 (1943)
- Chambers and Peterson, "Sulfuric Acid Concentration — DuPont Falling-  
Film Process," *Chem. Eng. Progress*, **43**, 219-24 (1947)
- Berger and Gloster, "Chemico Drum-Type Sulfuric Acid Concentrator,"  
*Chem. Eng. Progress*, **43**, 225-36 (1947)
- Burke and Mantius, "Concentration of Sulfuric Acid Under Vacuum,"  
*Chem. Eng. Progress*, **43**, 237-46 (1947)

#### MATERIALS AND EQUIPMENT

- Healy, "Corrosion Looms Large in Sulfuric Acid Plant,"  
*Chem. Met. Eng.*, **39**, 492-3 (1932)
- Hedberg, "Design of Gas-Cleaning Installations,"  
*Ind. Eng. Chem.*, **29**, 406-13 (1937)
- Kingsbury, "Ceramic Linings for Chemical Equipment,"  
*Ind. Eng. Chem.*, **29**, 402-5 (1937)
- Mantius and Freicherr, "Lead-Lined Equipment,"  
*Ind. Eng. Chem.*, **29**, 373-7, (1937)
- Friend, "Protection against Sulfuric Acid," *Chem. Met. Eng.*, **46**, 260-2 (1939)

Pratt, "Selection of Pumps for Oleum and Strong Sulfuric Acid,"

*Chem. Met. Eng.*, **50**, No. 1, 86-91 (1943)

Wilkinson, "Mechanical and Metallurgical Control of Sulfuric Acid Corrosion in Petroleum Processes," *Corrosion*, **3**, 252-62 (1947)

#### ECONOMICS, MARKETING

Editorial Staff, "Three-Cornered Competitive Battle Centers About Sulfuric Acid," *Chem. Met. Eng.*, **38**, 35-8 (1931)

Fairlie, "Sulfuric Acid — to Buy or to Build," *Ind. Eng. Chem.*, **26**, 1280-3 (1934)

Talbot, "Sulfuric Acid — Estimated Supply and Requirements,"

*Chem. Met. Eng.*, **51**, No. 11, 104-7 (1944)

White, "Sulfuric Acid — Current Position and Outlook,"

*Chem. Eng. News*, **23**, 1154-9, 1334-5 (1945)

Lee, "Recovering Alkylation Spent Acid,"

*Chem. Met. Eng.*, **53**, No. 7, 102-5, 138-41 (1946)



# CHAPTER 8

## Nitrogen Fixation Processes

---

- I. *History*
  - II. *Utilization*
  - III. *Arc Process*
    - A. CHEMICAL PRINCIPLES
    - B. PRODUCTS
    - C. ECONOMICS
  - IV. *Cyanamide Process*
    - A. RAW MATERIALS
    - B. CHEMICAL PRINCIPLES
    - C. NITRIFICATION
    - D. ECONOMICS
  - V. *Synthetic Ammonia Process*
    - A. RAW MATERIALS
      - 1. *Hydrogen from water*
      - 2. *Hydrogen from water gas*
      - 3. *Hydrogen from coke oven gas*
      - 4. *Hydrogen from natural gas*
      - 5. *By-product hydrogen*
      - 6. *Nitrogen production*
    - B. AMMONIA SYNTHESIS
    - C. CHEMICAL PRINCIPLES
    - D. CATALYSTS
    - E. CONVERTERS
    - F. PROCESS MODIFICATION
      - 1. *Haber-Bosch*
      - 2. *Casale*
      - 3. *Fausser*
      - 4. *Mont Cenis*
      - 5. *Claude*
      - 6. *Nitrogen Engineering Corporation*
    - G. MATERIALS OF CONSTRUCTION
  - VI. *Marketing of Ammonia*
  - VII. *Student Exercises*
  - VIII. *Recommended Reading*
- 

### *History*

THE biochemical nitrogen cycle is well known to all students of chemistry. The unbalancing of the natural cycle by intensive cultivation and shipment of products to other localities made necessary the application of artificial fertilizers. During the latter part of the nineteenth century

these were supplied mainly by sodium nitrate obtained from the natural deposits in Chile. In 1898, Sir William Crooks predicted the ultimate starvation of a large portion of the world's population due to the exhaustion of these nitrate deposits. This prediction provoked discussion and an awareness of the situation which led to research and commercial ventures in the fixation of atmospheric nitrogen.

The arc process was in commercial operation in Norway by 1905, the cyanamide process in Italy in 1905, and the direct synthesis of ammonia in Germany in 1913. The total plants in operation in the world in 1913 were:

<i>Process</i>	<i>Plants</i>	<i>Capacity per year</i>
Arc	7	22,000 tons nitrogen
Cyanamide	15	66,000
Synthetic ammonia	1	7,000

World War I skyrocketed the demand for nitrates and ammonia for the manufacture of explosives, as well as increased the demand for fertilizers. Each belligerent realized its dependency on Chile nitrate and strove to make itself self-sufficient in nitrogen. The end of the war in 1918 found the world capacity to be:

<i>Process</i>	<i>Plants</i>	<i>Capacity per year</i>
Arc	12	40,000 tons nitrogen
Cyanamide	35	350,000
Synthetic ammonia	3	330,000

As a result of this war-time expansion most of the industrial countries possessed a larger capacity for the fixation of nitrogen than they could utilize in peaceful pursuits. Attempts to dispose of the surplus production abroad met with embargoes and high tariffs. After some years of disastrous competition an international cartel was formed, excluding producers in the United States, to allocate markets, and fix production and prices. This cartel operated for several years until competition with the reorganized Chile nitrate industry caused its collapse.

The U. S. Tariff Commission listed the world installations and capacities for production in January 1934 as:

<i>Process</i>	<i>Plants</i>	<i>Capacity</i>
Arc	1	275 tons nitrogen
Cyanamide	42	539,000
Synthetic ammonia	99	3,231,525
Chile nitrate	—	690,000
By-product ammonia	—	621,500
Total		5,082,300

The inter-relationships of the processes and products of the industry are shown in a chart of the U. S. Tariff Commission (Figure 8-1).

### *Utilization*

Synthetic ammonia production in the United States reached a new all-time high in 1944 with a total of 1,450,000 tons of nitrogen. This was divided about equally between privately owned plants and government owned plants. The locations of these plants are in widely scattered states (Table 8-1):

TABLE 8-1 Synthetic Ammonia Plants in 1943

<i>State</i>	<i>Private plants</i>	<i>Gov't. plants</i>
Alabama	1	—
Arkansas	—	1
California	3	—
Kansas	—	1
Kentucky	—	1
Louisiana	—	2
Michigan	2	—
Missouri	—	1
New York	2	1
Ohio	—	1
Virginia	1	—
West Virginia	1	—
	10	8
Capacity, tons per year	700,000	750,000

The considerations that governed the locations of these plants make an interesting study. Likewise, the story of their conversion to peace-time utilization or stand-by plants will be an interesting picture of economic

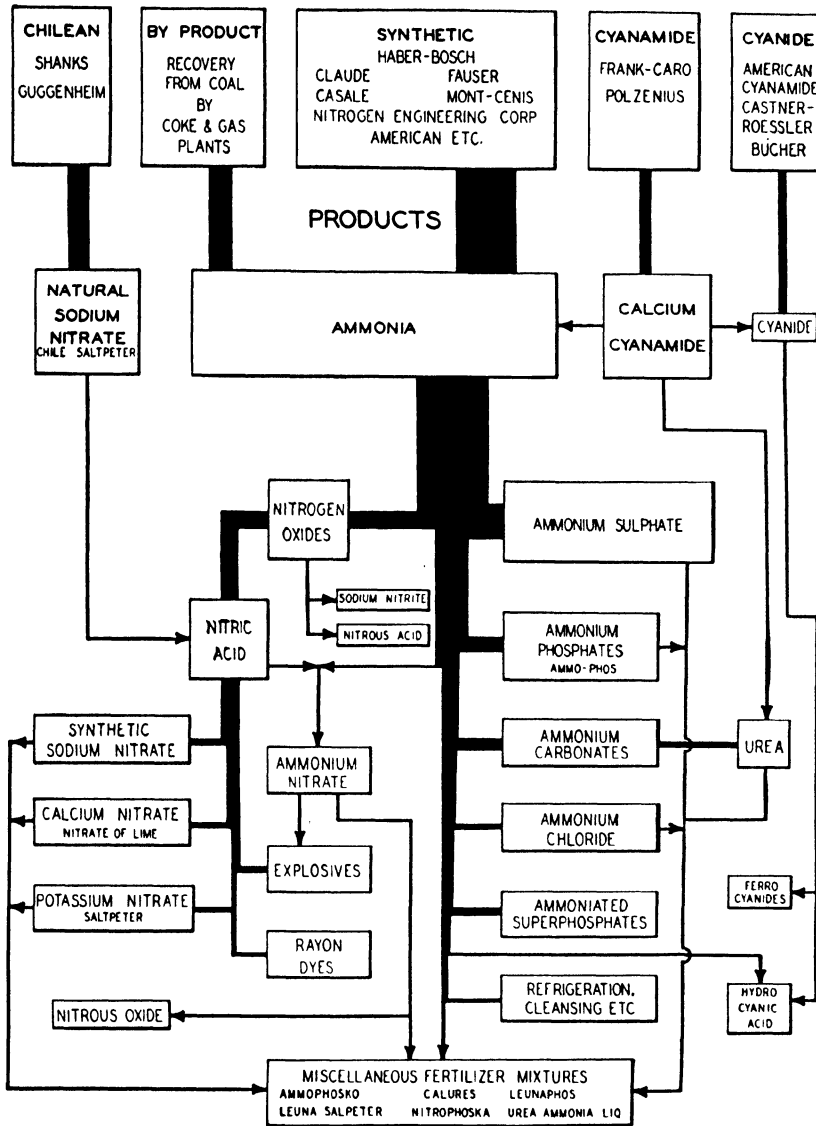

U. S. Tariff Commission Report 114

FIGURE 8-1. Process-Product Relationships in the Nitrogen Industry

and political forces. The Tennessee Valley Authority (T.V.A.) represents such a growth from the government-owned cyanamide plant erected during World War I.

Despite the industrial importance of ammonia and nitrates it is seen

in Figure 8-2 that the bulk of the nitrogenous compounds has been used as fertilizer. Practically all by-product ammonium sulfate is used

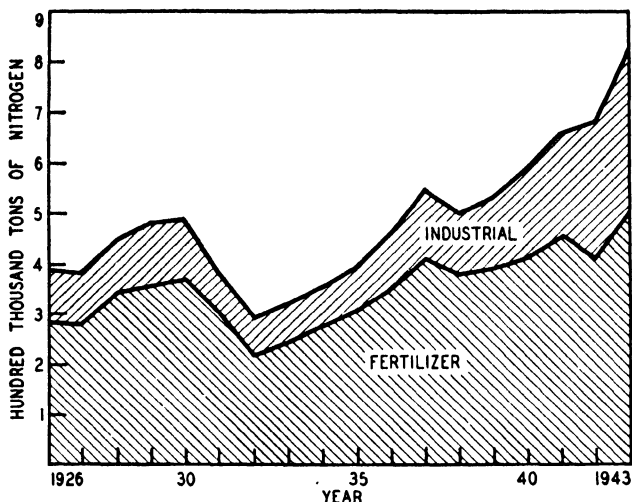

FIGURE 8-2. Domestic Consumption of Nitrogen, 1926-43

for this purpose. No recent data have been released as to production and consumption; however, Table 8-2 gives such data for 1939-40.

TABLE 8-2 Sources and Consumption of Nitrogen Materials,  
July 1, 1939 to June 30, 1940

<i>Sources</i>	<i>Equivalent tons of Nitrogen</i>
Domestic production	
At by-product plants	159,900
At synthetic plants	247,500
Sub-total	407,400
Imports	
Ammonium sulfate	21,200
Chilean nitrate	118,300
Cyanamide	35,500
Other of chemical origin	24,000
Sub-total	199,000
Natural organics used for fertilizer	42,500
Grand total	648,900

<i>Consumption of Synthetic Ammonia</i>		<i>Per cent</i>
By agriculture as		
Ammonia, nitrogen—containing solutions and ammonium phosphates	52,500	21
Sodium nitrate	25,200	10
Ammonium sulfate	13,400	6
By industry as		
Sodium nitrate	16,300	7
Ammonia and miscellaneous	113,500	46
Exported as		
Sodium nitrate	20,600	8
Ammonia	6,000	2
	247,500	100

*Arc Process*

Although the arc process now is obsolete, its rise and fall represent an interesting example of the application of chemical facts to an industrial process, of changing economic factors, and inter-process competition, which resulted in its elimination. Priestley, in 1779, observed that the electric spark in air produced an acid, which he mistook for carbonic acid. Cavendish in 1784 showed the acid to be a mixture of nitric and nitrous acids. Lord Rayleigh revived this work in 1897 to remove the nitrogen from air in the isolation of argon and the other inert gases. In 1902 the Atmospheric Products Company put into operation the Bradley-Lovejoy arc process at Niagara Falls. Although nitric acid was successfully produced, the operating and maintenance costs were too high to compete with nitric acid from Chile nitrate, and the plant closed in 1904. A commercially successful plant was put in operation in 1903 in Norway using the Birkeland-Eyde arc process. The Norwegian plants expanded to an output of 38,000 tons of fixed nitrogen per year with a consumption of 320,000 horsepower, but were replaced by synthetic ammonia units consuming less power. The only commercially successful arc plant in the United States was the American Nitrogen Products Company at La Grande, Washington, which operated from 1917 to 1927, when it was destroyed by fire. Their product was sodium nitrite rather than nitric acid.

## CHEMICAL PRINCIPLES

The arc process utilizes the electrical energy of the arc to heat to a high temperature the air passing through the arc and setting up equilibrium in the reaction:

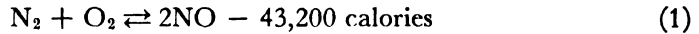

The equilibrium constant  $K = \frac{(\text{NO})^2}{(\text{N}_2)(\text{O}_2)}$  shows that a greater yield can be expected in equimolar amounts of oxygen and nitrogen than in air. The equilibrium yields for air and equimolar mixture are shown in Table 8-3:

TABLE 8-3 Equilibrium Yield of Nitric Oxide

<i>Temp.</i> °C	<i>Air</i>	<i>Per cent NO from</i> <i>0.5N<sub>2</sub> + 0.5O<sub>2</sub></i>
1538	0.37	—
1760	0.64	0.80
1922	0.97	—
2307	2.05	2.62
2927	4.27	5.51
3227	5.52	7.23

Although these equilibrium conversions give the impression that considerable nitric oxide could be formed in the arc, the commercial process

TABLE 8-4 Rates of Formation and Decomposition of Nitric Oxide

<i>Temp.</i> °C.	<i>Time for formation</i> <i>half of equil. NO</i>	<i>Time for decomposition</i> <i>half of pure NO</i>
627		123 hours
727	81 years	
1227	30 hours	3 minutes
1427	1 hour	15 seconds
1627	2 minutes	1 second
1827	5 seconds	0.07 seconds
2027	0.2 seconds	0.005 seconds
2227	0.01 second	
2627	0.00003 second	

operated with between one and two per cent nitric oxide in the exit gas from the arc. The rate at which equilibrium was reached and rate of decomposition of the product were equally important and their effect had to be considered. Table 8-4 shows the time required to produce one half of the equilibrium concentration of nitric oxide and the time for decomposition of half of pure nitric oxide to the elements.

Thus the rate of decomposition of the nitric oxide is so much greater than the rate of formation that it is necessary to cool quickly the gases from the arc chamber to freeze the equilibrium. This can be done by injecting sufficient cold air to reduce the temperature to approximately 1000°C. and blowing the hot mixed air directly into waste heat boilers where the temperature is reduced to approximately 200°C. From the boilers the gases go to the absorbers.

The distribution of the energy from the electric arc is approximately:

To chemical reaction	3 per cent
Cooling electrodes and furnace radiation	17
Supplied to the boiler	60
To gas coolers and towers	20
	100

In the fixation of one ton of nitrogen by this process only 0.205 kilowatt-years are required to supply the heat of reaction, whereas the furnace requirements are about 7.5 kilowatt-years.

## PRODUCTS

From the nitric oxide produced in the arc various chemicals can be made. The absorption of nitrogen oxides will be discussed in Chapter 9 under ammonia oxidation. The reactions are:

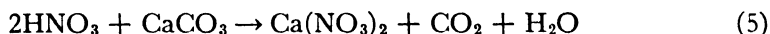
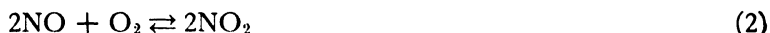

Nitric acid was the product usually desired because of its greater usage. The strength of acid produced in the arc process was about 30 per cent, whereas commercial acid usually contains about 60 per cent nitric acid. The Norwegian plants also produced calcium nitrate or "Norwegian saltpeter" for fertilizer purposes. The La Grande plant produced only sodium nitrite that was sold to the dye industry for diazotization. In the



nitrite absorption system the gas at 200°C. from the boilers was blown directly to the absorption towers and scrubbed with a sodium carbonate solution (equation 3). A constant loss of about 30 per cent of the nitric oxide was apparently due to the formation of a nitric acid mist which passed through unabsorbed. Thus almost pure sodium nitrite with but little nitrate was formed.

## ECONOMICS

The arc process passed from the fixed nitrogen field due to inter-process competition. The oxidation of ammonia gave the same products at less cost. The arc process represented a high investment cost and a high operating cost. The former is estimated as \$450 per ton of fixed nitrogen per year, and the latter depends largely on the cost of electric power. The La Grande plant initially paid \$10 per kilowatt-year (about 0.15 cent per k.w.h.) and operated continuously on dump power. As domestic and industrial loads paying a higher price for power increased, the arc plant operated at decreased capacity. Only such a low power cost justified operation. With only 3 per cent of the electrical energy being converted to chemical energy and 97 per cent to thermal energy, electrical energy is too expensive. Possibly the use of new types of arcs which produce large amounts of chemical activation at relatively low temperatures (such as used in the Schoch acetylene process) can revise the arc process not only for the formation of nitric oxide but also other nitrogen compounds.

## *Cyanamide Process*

The cyanamide process is another of the many important processes discovered when the inventor was seeking something else. In 1895, Professors Frank and Caro were studying the formation of cyanides from alkali metals and turned to the cheaper alkaline earth compounds. The theory that the metal carbide was an intermediate in the cyanide formation led to the study of the action of nitrogen on calcium carbide. The compound formed was calcium cyanamide ( $\text{CaCN}_2$ ). This process was put in operation in Italy and Germany in 1905. The American Cyanamid Company started operations in 1909 at Niagara Falls, Canada. The cyanamide process reached its peak in 1918 with 36 plants, due to the wartime demand for ammonia. At this time the cyanamide process was

well known, whereas the direct synthesis of ammonia was not. After the war the trend was towards synthetic ammonia.

#### RAW MATERIALS

Four steps are involved in the production of calcium cyanamide. These are the production of (1) lime, (2) calcium carbide, (3) nitrogen, and (4) calcium cyanamide. The operations subsequently described are those of the American Cyanamid Company.\*

Lime is produced by the calcination of limestone, essentially:

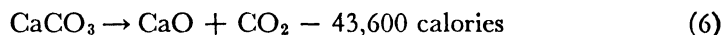

For carbide manufacture the limestone should be low in magnesia, which raises the melting point of the calcium carbide. Phosphorus, from calcium phosphate, must be absent, for it would be reduced to calcium phosphide and form phosphine ( $\text{PH}_3$ ) when treated with water. Thus phosphine would occur in ammonia generated from calcium cyanamide and poison the catalyst in an ammonia oxidation process. A limestone containing an average of 98.5 per cent calcium carbonate and crushed to  $\frac{1}{2}$ - to 2-inch size is calcined in a horizontal rotary kiln using powdered coal as the fuel. The hot lime is cooled and stored until it is mixed with powdered coke.

Calcium carbide is produced by heating in an electric arc furnace a mixture of approximately 10 parts of lime with 6.5 parts of coke. The carbide furnace is a rectangular steel shell lined with firebrick which in turn is lined with carbon brick. The carbide furnace has no top and the electrodes are suspended from above the furnace, three electrodes for operation on three-phase power. The electrodes extend only to about the center of the furnace and are completely surrounded by the charge of lime and coke. This charge further protects the sides and bottom of the furnace. Thus the furnace is of the "smothered arc" type and arcing occurs between electrodes. The arcs heat the charge immediately surrounding them to a temperature of  $1800^\circ$  to  $2000^\circ\text{C}$ . and the formation of calcium carbide takes place.

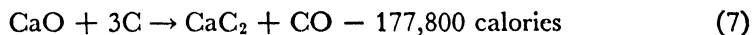

The carbide is molten at this temperature and is tapped through a hole in the front of the furnace into cast iron chill-buggies. Furnaces at American Cyanamid Company draw 30,000 horsepower and produce

\* *Chem. & Met.'s Chemical Engineering Flowsheets* (4th Ed.), No. 87.  
Pictured Flowsheet, *Chem. Met. Eng.* 47, No. 4, 253-6 (1940).

185 tons per day of carbide. The cooled carbide pigs are crushed and ground to 100-mesh. About 2 per cent of calcium fluoride is added and ground with the carbide. To prevent reaction of atmospheric moisture with the calcium carbide and the formation of an explosive acetylene-air mixture, the grinding is done in an atmosphere of dry nitrogen.

Nitrogen is prepared by fractionating it from liquid air made by the Claude process.

#### CHEMICAL PRINCIPLES

The reaction for the nitrification of calcium carbide is:

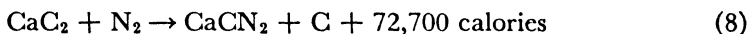

From the structure of free cyanamide,  $\text{H}_2\text{N}-\text{C}\equiv\text{N}$ , it is seen that the calcium-carbon bond has been broken during the introduction of the nitrogen. The reaction temperature must be high enough ( $1000^\circ$  to  $1100^\circ\text{C}.$ ) to cause the dissociation of calcium carbide to carbon and calcium, which react with the free nitrogen to form calcium nitride, which in turn reacts with carbon to form calcium cyanamide.



These reactions are quite slow unless a catalyst is used, such as calcium chloride or fluoride. The latter is used due to the hygroscopic nature of the chloride, which would cause caking and hydrolysis of the final product.

#### NITRIFICATION

This is carried out as a batch process in a nitrifying oven, shown in Figure 8-3. A steel shell *A* is lined with a refractory brick *B* in such a manner that it tapers slightly outward from bottom to top. The top of the furnace *C* is of steel lined with refractory and has a depending rim which dips into a sand seal to prevent the escape of gases around this rim. Molded in the inside face of the brick refractory is a series of projections *E* which are sufficiently close together to support the layer of paper *F* placed on them, and to allow circulation of the nitrogen. In operating the furnace a layer of heavy paper *F* covers the refractory on the sides and bottom. A paper cylinder *G* is placed in the center of the furnace and a tube of corrugated paper *H* is laid on the bottom to connect the nitrogen

inlet *N* with the control tube. The charge of finely ground carbide, as much as 8000 pounds, is poured into the oven. The cover is placed on the oven and the carbon resistor *R* put in place. Nitrogen gas, at a pressure head of a few inches of water, is admitted at the bottom *N*. The percentage of nitrogen supplied which is actually used in the chemical reaction is small, but the cost of all the nitrogen is relatively small in comparison with the other materials. The electric current is passed through the electrode which is heated to incandescence. The paper tube

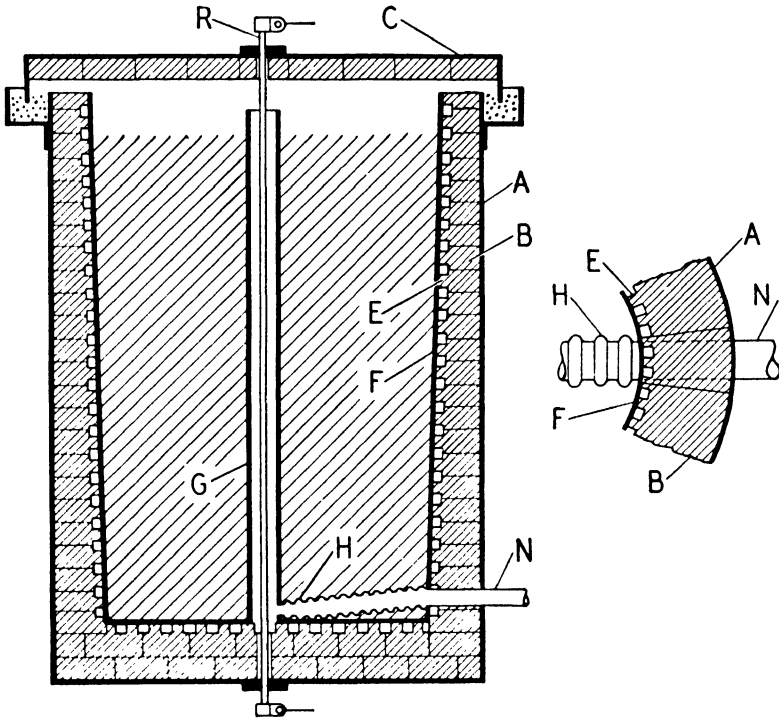

FIGURE 8-3. A Nitrifying Oven for Cyanamide

is burned away and the surrounding carbide charge is heated to a temperature of about  $1000^{\circ}\text{C}$ ., at which the nitrogen reacts with the carbide to form cyanamide. The reaction is exothermic, so it maintains itself once it is started, and slowly extends through the charge as nitrogen diffuses to the point of reaction. The time required for the reaction is about one day per ton of charge. Due to the heat of reaction the cyanamide sinters to a solid cake that shrinks away from the sides of the oven. The cake is removed by an overhead crane using special tongs that fit in the

hole in the center where the carbon electrode had been. The ingot of cyanamide is carried to a cooling room until it is ready to be crushed. It is broken up and then crushed in hammer mills.

The product contains about 24 to 25 per cent nitrogen, giving a typical analysis of:

---

CaCN <sub>2</sub>	70 per cent
Graphite	12
CaO	12
CaC <sub>2</sub>	2
Inerts	4
	100

---

The carbide present must be decomposed to prevent the formation of explosive concentrations of acetylene when cyanamide is stored. When the product is to be used for chemical purposes this is done by adding a small amount of water in a mixing type screw conveyor. For agricultural purposes sufficient water is added in a more elaborate mixing system to hydrate the lime as well as decompose the carbide. Sufficient oil, about 4 per cent, is also added to prevent the product from dusting. It then is passed through a rotary cooling cylinder and sent to storage.

A continuous type of nitrifying oven has been used in Sweden. It is somewhat similar to the Herreshoff furnace (Figure 6-7). Calcium carbide enters at the top and passes down countercurrent to a rising flow of nitrogen. The reaction is started on the top two hearths by means of electric arcs.

#### ECONOMICS

The cyanamide process has a number of advantages and disadvantages which explain the present status of the process. It is the only process which gives directly a solid nitrogenous fertilizer. This same product can be used to give ammonia, cyanides, urea, free cyanamide, melamine, and other unusual organic products not otherwise obtainable. It also is a defoliant used to kill the leaves on cotton plants prior to picking the cotton. Against these advantages are the disadvantages of a relatively high consumption of electric power, about 1.5 horsepower-years per ton of fixed nitrogen. Likewise, the capital investment per ton-year of fixed nitrogen is high. The materials handled are solids carried through a

number of different operations. This disadvantage has already been discussed in the Leblanc process.

In 1934 there were 42 cyanamide plants throughout the world, of which the one at Niagara Falls is the largest single plant. No new plants have been installed, and all recent construction has been for synthetic ammonia. Most of these older cyanamide plants have been completely amortized so that only replacement and modernization is carried out. Larger units operating more efficiently have replaced the older, less efficient units. Intensive research aimed at the development of new products from cyanamide that are non-competitive with those from ammonia has led to large scale production of numerous compounds which have put the American Cyanamid Company in new fields, as melamine and synthetic resins.

### *Synthetic Ammonia Process*

The direct production of ammonia from the elements is based on the equilibrium:

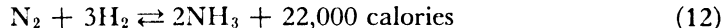

Patents were issued as early as 1865 for the production of ammonia by the passage of nitrogen over iron to form the nitride, followed by hydrogen to reduce the nitride to ammonia and re-expose fresh iron surface. In 1901 LeChatelier patented the direct union of nitrogen and hydrogen to form ammonia, and specified catalysts and high pressures up to 100 atmospheres. In 1884 Ramsey and Young, in their study of the rate of decomposition of ammonia, noted that all the ammonia was not decomposed and concluded that recombination of the elements took place. This point was argued until the researches in Germany of Haber, Nernst, and their co-workers, beginning in 1904, determined the equilibrium concentrations and constants from which calculations could be made. In 1908 the large German chemical company, Badische Anilin und Soda Fabrik, began to finance and commercialize Haber's work, which was put in the pilot plant stage in 1910 and plant stage by 1913 for the production of 8500 tons of ammonia per year. During World War I another large plant was constructed to fix up to 150,000 tons of ammonia per year. After that war other countries installed the direct ammonia synthesis (commonly called the "Haber Process") because of its lower costs than the other existing processes.

## RAW MATERIALS

The manufacture of synthetic ammonia involves the preparation of hydrogen and nitrogen in a pure state and their subsequent combination. The cost of the production and purification of hydrogen and nitrogen is estimated to be as much as 75 per cent of the total cost of ammonia. The production of hydrogen is a process of importance in chemical industries other than the ammonia industry, as hydrogenation of petroleum, coal, vegetable oils, etc. Hydrogen is produced from a number of basic raw materials. These are:

1. Water, by electrolysis
2. Coal, by the water gas reaction
3. Coal, by coking and separating from the coke-oven gas
4. Natural gas, by cracking with or without steam
5. By-product gases from fermentation, caustic-chlorine production, etc.

These processes will be discussed because of their general importance.

*Hydrogen from Water.* The electrolysis of water produces an exceedingly pure hydrogen which needs no further purification.

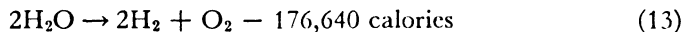

In addition, by-product oxygen is available for use in other plant processes. Electrolysis requires cheap electric power, though it can operate intermittently to take advantage of off-peak load rates.

The cells used for the electrolysis of water can be classified into two groups: (a) diaphragm cells, and (b) bell-jar cells (Figure 8-4). In the

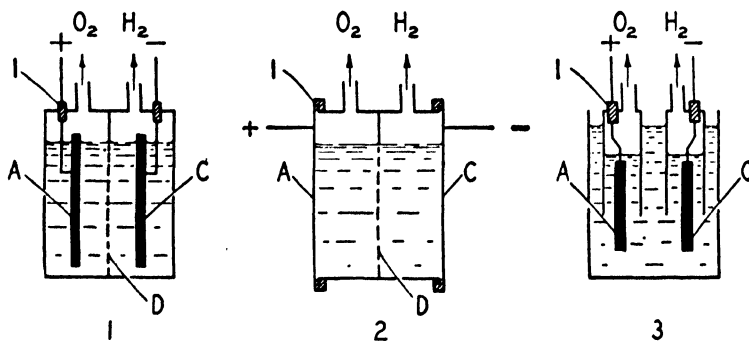
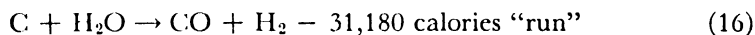
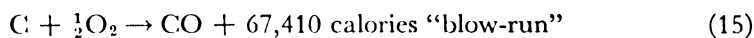
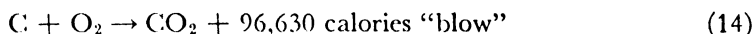

FIGURE 8-4. Electrolytic Hydrogen Cells. (1) Diaphragm cell with separate electrodes; (2) Diaphragm cell in which the walls act as electrodes; (3) Bell-jar cell.

former there is a diaphragm separating the anode and cathode chambers, the principle being similar to the diaphragm type caustic-chlorine cells. In the bell-jar cell a collecting bell, open at the lower end, surrounds the electrode so that the gas liberated at each electrode rises in the surrounding bell and is kept separate from the other gas. The Pechkranz and Shriver cells are commonly-used diaphragm cells and the Knowles cell is a bell-jar cell. The Noeggerath cell is a diaphragm cell which operates at pressures up to 200 atmospheres and produces gas that can be placed directly in cylinders with no further compression. The electrolyte usually used in these cells is either 20 per cent sodium hydroxide or 25 per cent potassium hydroxide solution. The large ammonia plant of Consolidated Mining and Smelting Company at Trail, B. C., produces its hydrogen by electrolysis of water.

*Hydrogen from Water Gas.* Prior to the construction of new plants for World War II, approximately 90 per cent of the synthetic ammonia was made from hydrogen produced from water gas. This process uses coke and steam as its raw materials, hence the major factor in plant location is the availability of low-cost coking coal. The process described here is that used at the new Tennessee Valley Authority plant at Muscle Shoals, Alabama. The flowsheet for this process is shown in Figure 8-5.\*

The first step of the process is the production of hydrogen and carbon monoxide from coke. This is done in standard water gas sets in the usual "blow" and "run" procedure.



Air is blown through the coke bed and the heat liberated in the first reaction raises it to incandescence at 1000° to 1100°C. Steam then is admitted and the third reaction occurs with absorption of heat decreasing the temperature to a final value of about 900°C. When this temperature is reached, the cycle is repeated with an air blow of about 2 minutes followed by a steam run of five or six minutes. For hydrogen for ammonia synthesis, the necessary nitrogen is added in the form of blow-run gas composed of carbon monoxide and nitrogen produced from air at the high temperature existing in the fuel bed at the end of the blow. Sufficient of this blow-run gas is mixed with the gas from the run so the final purified gas mixture will be  $3\text{H}_2 + \text{N}_2$ . The hot gas from the generators

\* Pictured Flowsheet, *Chem. Met. Eng.* 50, No. 11, 152-5 (1943).



passes through waste-heat boilers for the production of steam for other plant processes. The blow gas is discharged to the air, whereas the mixed run gas passes to a water scrubber to remove dust and to reduce the gas temperature to about 65°C. The sulfur in the gas is removed by

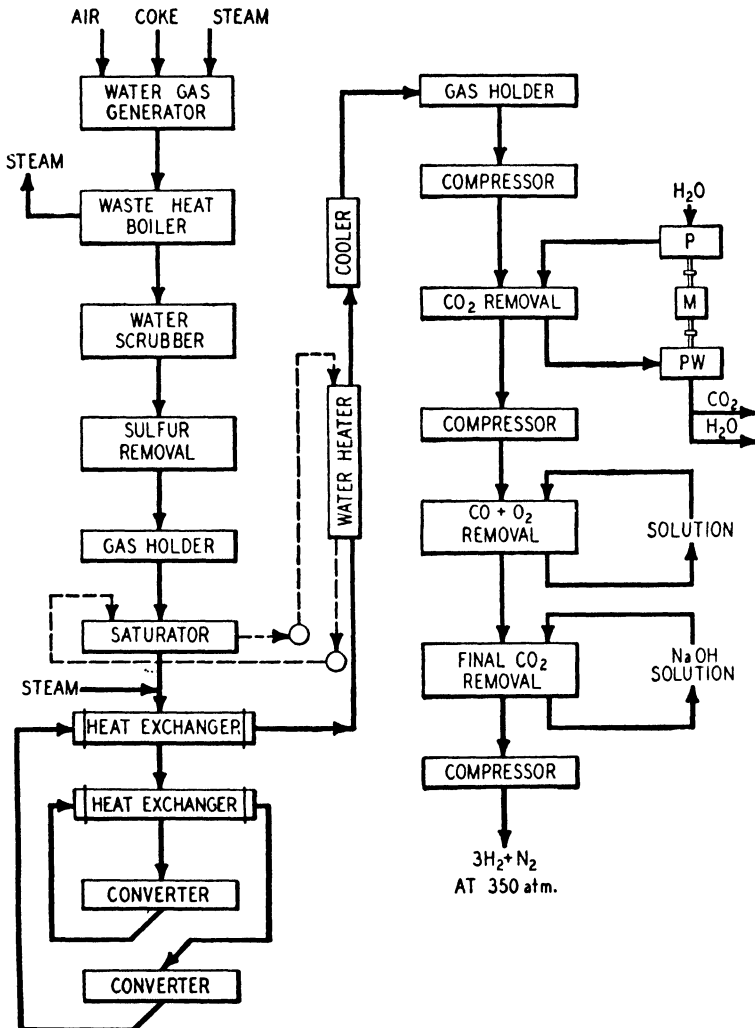
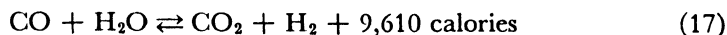

FIGURE 8-5. Hydrogen by the Water-Gas Process

scrubbing with sodium carbonate solution in a Seaboard process apparatus. The gas then goes to a gas holder for storage before conversion to hydrogen-nitrogen mixture.

The conversion is based on the process known as the "water gas reaction."



Two important considerations dictate operating conditions. They are the equilibrium conversion of carbon monoxide, and the rate at which equilibrium is attained. The equilibrium constant is:

$$K_p = \frac{P_{\text{CO}_2} \cdot P_{\text{H}_2}}{P_{\text{CO}} \cdot P_{\text{H}_2\text{O}}}$$

It is apparent that the only feasible way to influence the equilibrium at any given temperature is by increasing the amount of steam present in the reacting mixture. This amount is dictated by an economic balance of cost of steam against the value of the hydrogen produced, and usually is about five or six times the stoichiometric amount. LeChatelier's principle shows that lower temperatures favor completeness of conversion; however, the decreased rate of reaction must be considered. Thus the temperature is kept as low as possible, consistent with the activity of the catalyst, to cause the reaction to approach the equilibrium point.

The mixed gas from the gas holder is passed upwards through a saturator tower countercurrent to hot water. This raises the temperature of the gas to about 75° to 85°C. and adds considerable water vapor. The additional water vapor required to increase the excess is added as steam before the gas enters the first heat exchanger. The gas-steam mixture passes outside the tubes through two shell-and-tube heat exchangers before it enters the first converter at about 475°C. The heat of reaction liberated in this converter is sufficient to raise the temperature of the gas by about 100°C. and thus the rate of reaction in this converter is rapid. The gases leaving still contain 4 to 6 per cent carbon monoxide on the dry basis. The gases now pass through the tubes in the second heat exchanger and are cooled to about 425°C. before entering the second converter where the carbon monoxide is reduced to 2 to 3 per cent. The hot gases leave through the tubes in the first heat exchanger and pass to a water heating tower in which unreacted steam is condensed and the gas cooled to about 85°C. The water formed in this tower is circulated to the saturator tower. A final cooling tower reduces the temperature of the gas to about 30°C. before it goes to the converted gas holder.

The catalytic converters are of the tray-type similar to those used in the sulfuric acid industry. In fact, the equipment and process are similar in principle except that in the water gas conversion it is possible to add large

and that an excess of steam drives the reaction towards the right. Inasmuch as these reactions are endothermic the necessary heat must be supplied. This can be done by heating externally the tubes in which the reaction occurs, mixing air with the gas so that partial combustion of the gas supplies the necessary heat, or use an alternating blow-and-run cycle in which the catalyst bed is heated with combustion products and this followed by the methane and steam for conversion. The usual practice in operation is to make the first reaction go rapidly by use of a high temperature and then convert the carbon monoxide to the dioxide by the water gas reaction. The heat necessary is supplied for the first reaction but the water gas reaction is sufficiently exothermic to maintain itself.

Practice of the Standard Oil Company (La.) to produce hydrogen for hydrogenation of oil is to pass the natural gas or refinery gas, plus 50 per cent excess steam, through a catalyst bed at about 900°C. contained in alloy steel tubes heated externally. The catalyst is a nickel- or cobalt-promoted catalyst. The U. S. Bureau of Mines uses pure nickel stampings  $\frac{1}{4}$  by  $\frac{1}{8}$  inch. To this gas is added additional steam to reduce the temperature to about 300°C. and the gas is passed over a water gas catalyst at 450°C. to convert the carbon monoxide to the dioxide. The resulting gas contains about two per cent unconverted methane. More complete conversion necessary for ammonia synthesis can be secured by using a higher temperature and lower space velocity through the catalyst bed. The carbon dioxide is removed by the Girbotol process in which the gas is scrubbed at a pressure of about 17 atmospheres with a solution of a weak organic base, such as ethanalamine or triethylene-tetramine. The carbon dioxide, being an acid anhydride, combines with the base and is removed completely. The organic base is regenerated by heating the solution, which completely hydrolyses the salt formed from the weak acid and weak base, and the carbon dioxide is removed by blowing the solution with steam. The solution is cooled in heat exchangers and returned to the absorption system. The hydrogen produced in this way is sufficiently pure for the hydrogenation of petroleum or coal, but further purification is required before ammonia synthesis, as is given with hydrogen from coke.

Hydrogen also is produced by the thermal decomposition or "cracking" of natural gas. The reaction is:

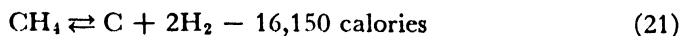

This process is used by the Shell Chemical Company in its California plant. The furnaces are steel shells lined with insulating and refractory

brick and containing a refractory brick checkerwork. This is first heated to about 1100°C. by a gas-air flame. Then natural gas alone is passed in and cracked until the temperature has dropped to about 900°C., at which the rate of reaction is too low. Part of the carbon is deposited on the brick checkerwork and this is burned off with a blast of air, the reaction giving off enough heat to bring the brick back to 1100°C. The gas, containing about 70 per cent hydrogen, is passed through a water scrubber to remove carbon and tar and further cleaned in the conventional equipment of the manufactured gas industry. After removal of all vapors and carbon dioxide the gas is passed to a Linde type apparatus where everything but the hydrogen is liquefied. Carbon monoxide is scrubbed out with liquid nitrogen. Sufficient nitrogen is vaporized to give a  $3\text{H}_2 + \text{N}_2$  mixture.

In another type of apparatus used elsewhere the natural gas is introduced instead of steam during the run in the conventional gas producer. The incandescent coke supplies the heat to crack the natural gas.

*By-product Hydrogen* Considerable amounts of hydrogen are available as by-products in several industries. In the caustic-chlorine industry one mole of hydrogen is produced for each mole of chlorine. This pure electrolytic hydrogen is used for the production of ammonia in five plants.

When grain mashes are fermented to produce acetone and butanol the gases evolved analyze 60 per cent carbon dioxide and 40 per cent hydrogen. The Commercial Solvents Corporation removes the carbon dioxide from this gas at 17 atmospheres pressure by scrubbing with water followed by sodium hydroxide solution. Although ammonia synthesis was originally planned and the plant was designed for the purpose, the production of methanol by the reaction:

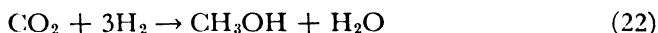

represents the present product, because the methanol produced fits into the field of organic solvents produced by this company.

*Nitrogen Production* The nitrogen necessary for ammonia synthesis is obtained by any one of three methods. Nitrogen from producer gas, or blow-run gas, can be mixed in the water gas and carried through the conversion and purification process, as the T.V.A. process described. When hydrogen is cheap, sufficient air can be mixed with the hydrogen, and the oxygen burned out to give a  $3\text{H}_2 + \text{N}_2$  gas mixture. The usual method of production is to liquefy air by either the Linde or Claude process, and fractionate the liquid air to remove the nitrogen from the other gases. In this process a nitrogen of high purity is obtained.

## AMMONIA SYNTHESIS

A number of variations of the original Haber process have been developed to suit the needs of a particular plant, or use certain types of hydrogen-nitrogen mixtures. These differences will be discussed later. The sequence of operations in the new T.V.A. plant is shown in Figure 8-6.\* The purified mixture of  $3\text{H}_2 + \text{N}_2$  at 350 atmospheres pressure (see Figure 8-5) is added to the unconverted gas mixture and ammonia circulating through the converter. This fresh mixture passes through a filter to remove any oil and other liquids or solids carried by the gas;

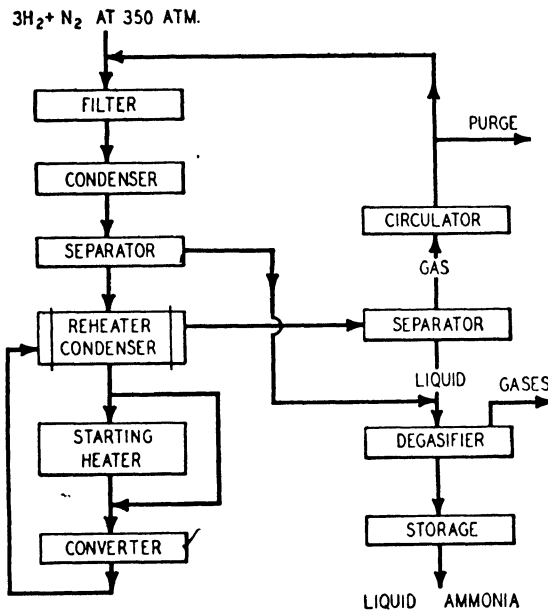

FIGURE 8-6. Ammonia Synthesis

in this way the oil content of the ammonia is kept below two parts per million. The filtered gas goes to a condenser of the submerged hairpin tube type containing liquid ammonia on the outside. This cools the gas to about the boiling point of liquid ammonia ( $-33.4^{\circ}\text{C}.$ ) and condenses practically all of the ammonia still carried by the gas. The liquid ammonia and gas are separated in an entrainment separator unit and the cold gas passes to a reheater which returns the gas temperature to about  $20^{\circ}\text{C}.$  When starting the process the gas is preheated in a gas-fired heater, which is by-passed after the converter heats up to the operating

\* Pictured Flowsheet, *Chem. Met. Eng.* 50, No. 11, 152-5 (1943); 52, No. 12, 134-7 (1945).

temperature. The gas now enters the converter, is further heated by flowing countercurrent to the hot outgoing gases, passes through the catalyst bed, and leaves with exchange of heat with the entering gas. The amount of conversion per pass depends on a number of factors, but is about 12 per cent of the gas. Beyond the converter, the gas, now containing ammonia, is further cooled in a water cooled condenser, the warm water from which is used in the gas reheater. A portion of the ammonia condenses out and is separated from the gas. The gas pressure at this point has dropped due to the friction loss through the apparatus. The gas is recompressed to 350 atmospheres in a compressor and to this gas is added fresh gas mixture to maintain the quantity of gas. A certain fraction of the gas is purged to keep down the quantity of inert gases, as methane and argon, that otherwise would accumulate in the system. The liquid ammonia from the two separators is piped to weighing tanks and a degassifier which allows the escape of the dissolved hydrogen and nitrogen. The ammonia in this gas and the purge gas is absorbed in nitric acid or water. The liquid ammonia is stored in spherical tanks.

#### CHEMICAL PRINCIPLES

The ammonia synthesis is based on the equilibrium:

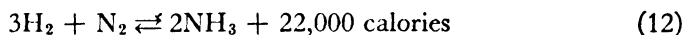

The equilibrium constant is:

$$K_p = \frac{P_{\text{NH}_3}^2}{P_{\text{N}_2} \cdot P_{\text{H}_2}^3}$$

The application of LeChatelier's principle shows that this exothermic reaction should be conducted at as low a temperature as possible consistent with the rate of conversion. The volume decrease from 4 moles of reactants to 2 moles of product indicates that the application of high pressure will give a higher conversion of ammonia at equilibrium. It is not desired to convert one reactant completely, as in the water gas reaction, so the reactants are maintained in the stoichiometric ratio to give the highest equilibrium concentration of ammonia.

These relationships have been calculated from Haber's data\* and are shown in Figure 8-7. In this figure the ammonia concentration in volume (mole) per cent is plotted against (1) temperature at a constant pressure of 100 atmospheres, (2) pressure at a constant temperature of 500°C., both (1) and (2) being with  $\text{N}_2 + 3\text{H}_2$  gas mixture, (3) the

\* Tour, *Ind. Eng. Chem*, 13, 298 (1921).

ratio  $x = N_2/(N_2 + H_2)$  in the equilibrium gases, where  $x = 0.25$  for the stoichiometric mixture  $N_2 + 3H_2$ , and (4) the effect of inert gases in a

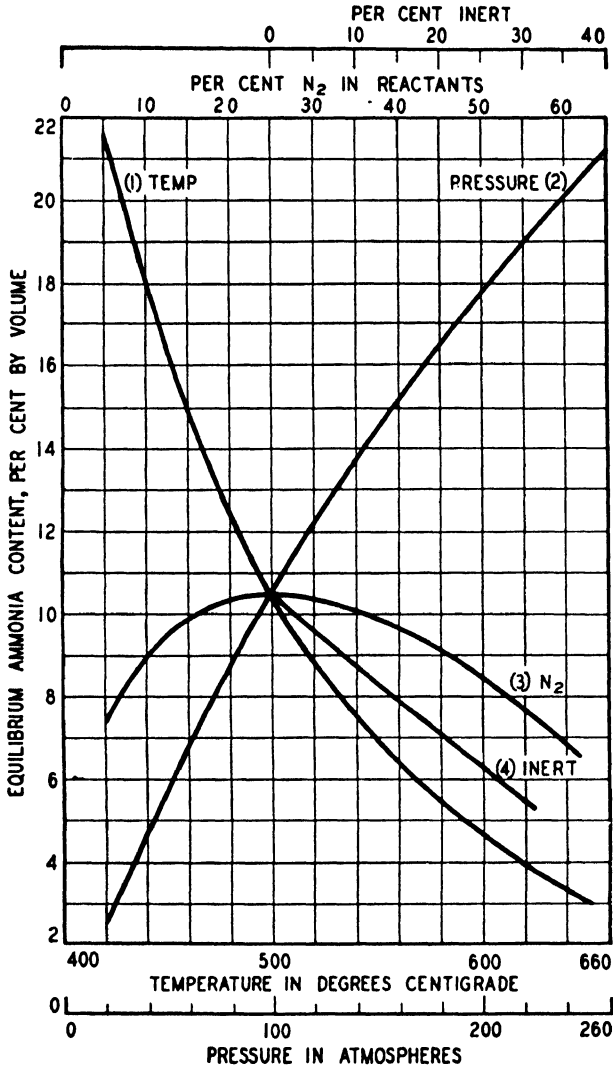

FIGURE 8-7. Equilibrium Relationships for the Reaction  $3H_2 + N_2 \rightleftharpoons 2NH_3$  (Redrawn from *Ind. Eng. Chem.* 13, 298 (1921) with permission)

$N_2 + 3H_2$  mixture, both (3) and (4) being at 100 atmospheres and  $500^\circ\text{C}$ . More recent data\* at higher pressures are shown in Figure 8-8.

\* Larson, *J. Am. Chem. Soc.* 46, 367-72 (1924).

The effects of these variables may be considered. The effect of temperature is very marked, particularly at the lower temperatures. Although a decrease in temperature greatly increases the equilibrium concentration, the rate of attainment of equilibrium decreases very rapidly. At lower pressures the increased equilibrium concentration is almost linear with pressure, but this decreases at high pressures. Changes from the stoichiometric  $\text{N}_2 + 3\text{H}_2$  ratio ( $x = 0.25$ ) do not have a marked effect on concentration; however, an inert gas causes a rapid decrease. This decrease is not merely one of decreasing the effective pressure of the reaction, but because of the partial pressures being raised to the third or second power the effect is magnified. Thus the presence of 10 per cent inert gas causes a decrease in concentration about equal to a 20 per cent decrease in

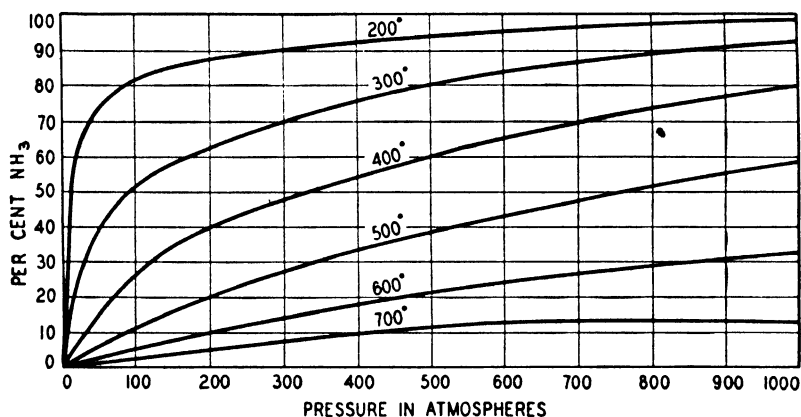

FIGURE 8-8. Effect of Temperature and Pressure on the Ammonia Equilibrium

pressure. For this reason, in a circulation system using nitrogen prepared from producer gas, a fraction of the gas must be discarded or purged to maintain the concentration of inert gas at a predetermined low value.

In commercial production it is not economical to achieve equilibrium conditions. This would require an infinitely small space velocity of the gas through the catalyst. Instead, the optimum conditions must be determined for each plant at which the maximum profits (or production) are obtained. The effect of space velocity on the ammonia content of the exit gas is shown in Figure 8-9 at  $475^{\circ}\text{C}$ . and various pressures. Although the ammonia concentration in the exit gas decreases, the total amount of ammonia formed increases. Thus at 600 atmospheres the amount of ammonia formed is increased by about 3 times when the space velocity



is increased from 10,000 to 50,000 (cu. ft. gas at 0°C. per cu. ft. of catalyst). There is a limit to increase in space velocity; limiting factors

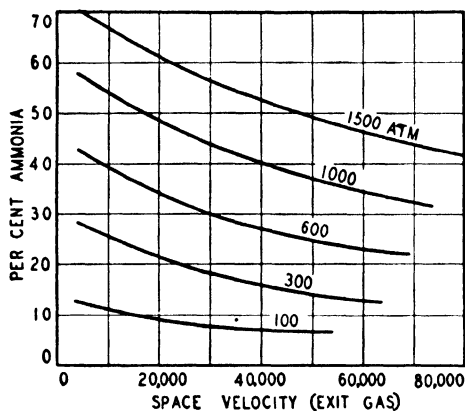

FIGURE 8-9. Effect of Space Velocity on the Conversion to Ammonia at 475°C. and Various Pressures for a Doubly Promoted Catalyst

are heat available from the reaction to heat the incoming gas to the proper temperature, the cost of removing the smaller amount of ammonia in the gas, and the cost of recompression of the gas in the circulation system. Commercial operation is with space velocities from 20,000 to 40,000 cu. ft. per hour.

#### CATALYSTS

The search for a catalyst that will cause a sufficiently high rate of reaction has yielded several suitable for industrial use; however, the search continues for new ones which are more reactive and more resistant to catalyst poisons. The first catalysts used by Haber were osmium and uranium, but these metals were too expensive and too easily poisoned by traces of carbon monoxide and hydrogen sulfide which might be in the hydrogen. Further work showed the activity of iron, nickel, and manganese catalysts. It has been found that the addition of small amounts of various compounds to the catalyst mass increases the activity over that of either substance above. Such substances present in small amounts are termed "promoters."

A suitable catalyst could be prepared by the reduction of the iron oxide, magnetite. Research showed that the activity increased when alkali was present and certain other oxides. Under comparable conditions an iron catalyst containing  $\text{Al}_2\text{O}_3$  gave 8 per cent ammonia, one containing  $\text{K}_2\text{O}$  gave 5 per cent and one containing both  $\text{K}_2\text{O}$  and  $\text{Al}_2\text{O}_3$  in the form of potassium aluminate gave 14 per cent. A satisfactory industrial catalyst may contain about 1 per cent potassium oxide and 3 per cent alumina. This effect of two materials or agencies working together so that the total effect is greater than the sum of the two effects taken independently is termed synergism. Almost innumerable combinations of catalysts and promoters have been patented and the search continues.

In the initial phase of testing new catalysts a very pure  $N_2 + 3H_2$  mixture is needed. This is prepared by dissociating, or cracking, ammonia which contains practically no impurities.

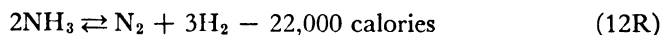

Thus the ammonia equilibrium is reversed by changing the conditions to high temperature, low (atmospheric) pressure, and a suitable catalyst. The heat of dissociation must be supplied externally. The undecomposed ammonia is washed from the gases with water and after drying, the gas mixture is compressed for use. This process is used industrially for the preparation of hydrogen to be used where the 25 per cent nitrogen content is immaterial. In this way one cylinder containing 100 pounds of ammonia produces as much hydrogen as is contained in 17 cylinders each containing 200 cu. ft. of hydrogen.

The mechanism by which the iron catalyst causes the combination of nitrogen and hydrogen has been investigated. The rate-controlling reaction appears to be the activated adsorption of the nitrogen by the iron to form a surface nitride ( $Fe_2N$ ) which then is reduced by the hydrogen to ammonia.

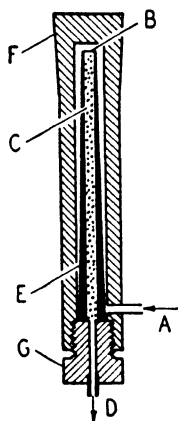

FIGURE 8-10. Claude Ammonia Converter. (Redrawn from Curtis, *Fixed Nitrogen*, page 234, with permission)

#### CONVERTERS

The converter for ammonia, like that for sulfur trioxide, functions both as a catalyst holder and a heat interchanger. The mechanical problems are troublesome because of the high pressures and temperatures. For this reason the gases entering the converter pass along the inner wall of the steel shell and maintain it at a relatively low temperature. This is illustrated in a simple Claude converter (Figure 8-10). The gases enter at *A* and pass upwards around the catalyst tube which they enter at *B*, pass downwards through the catalyst *C* and out at *D*. The thickness of the insulated catalyst tube wall *E* varies so that at the top, where most of the reaction of the entering gases occurs, the wall is thin to allow rapid heat flow; whereas at the bottom heat flow is retarded to maintain the temperature of the reacting gases. The converter body *E* is bored out of a nickel-chrome ingot and is about 9 inches outside diameter by 4 inches

long. The catalyst is contained in a tube of iron or steel which is lined with a thin layer of nickel-chrome. The catalyst is contained in a tube of iron or steel which is lined with a thin layer of nickel-chrome. The catalyst is contained in a tube of iron or steel which is lined with a thin layer of nickel-chrome.

inside diameter by 7 feet long. The head *G* seats against a copper gasket and is fitted in a manner similar to the breech-locking and -opening mechanism of an artillery piece. This type of converter is simple, but because of the high pressures employed and the direct radiation of heat from the catalyst tube to the converter wall, special materials of construction must be used.

In the converters used in the other processes the gases not only pass along the converter wall but also pass along several shells interposed as radiation screens between the catalyst tube and the converter wall, so that better heat transfer to the incoming gas is insured. In the Casale converter shown in Figure 8-11 the gas enters at *A*, passes down along the converter wall, up the inside of a thin shell at *B*, and into a central tube at *C* in which additional heat can be supplied to the gas if necessary by electric resistances. The hot gas now enters the catalyst zone at *D* and leaves at *E*, flows downward around the catalyst tube and leaves the converter at *F*. Thus two thin walls are interposed between the catalyst tube wall and the converter wall, thereby allowing the latter to be at a lower temperature. Many other designs embodying these principles have been patented and described in the literature.

In Figure 8-12 is shown the Brown ammonia converter which was installed in several of the ammonia plants constructed during the war. It is four feet internal diameter by fifty feet in height, as shown in the assembly view besides the cross-sectional view, and has a capacity of 150 tons per day of ammonia when operated at 350 atmospheres pressure. High pressure reactors, such as this, are either forged from a single ingot or made of laminated steel construction. The size of ingot that can be forged is limited, so this method is used in the smaller reactors. In the laminated construction layers of sheet steel, about one-quarter of an inch in thickness, are wrapped around a central cylinder and the joints are welded. Any size vessel can be made by this process. The inner cylinder can be made of special resistant alloy while the wrappings are of steel which gives a lower cost. The laminated steel shell, *A*, of the converter is lined with a high chromium alloy which resists the embrittling action of the hydrogen gas. The shell, *A*, is welded to the bottom, *B*, and top, *C*. The top is closed by a plug, *D*, which is held by a ring, *E*, which is tightened against the plug and gasket seal by means of stud bolts. Within the converter is a central assembly supported on a tapered gland at the bottom and aligned by a central pipe at the bottom and thermocouple wells at the top. This entire assembly is insulated from the converter shell by thermal insulation *W*. The assembly consists

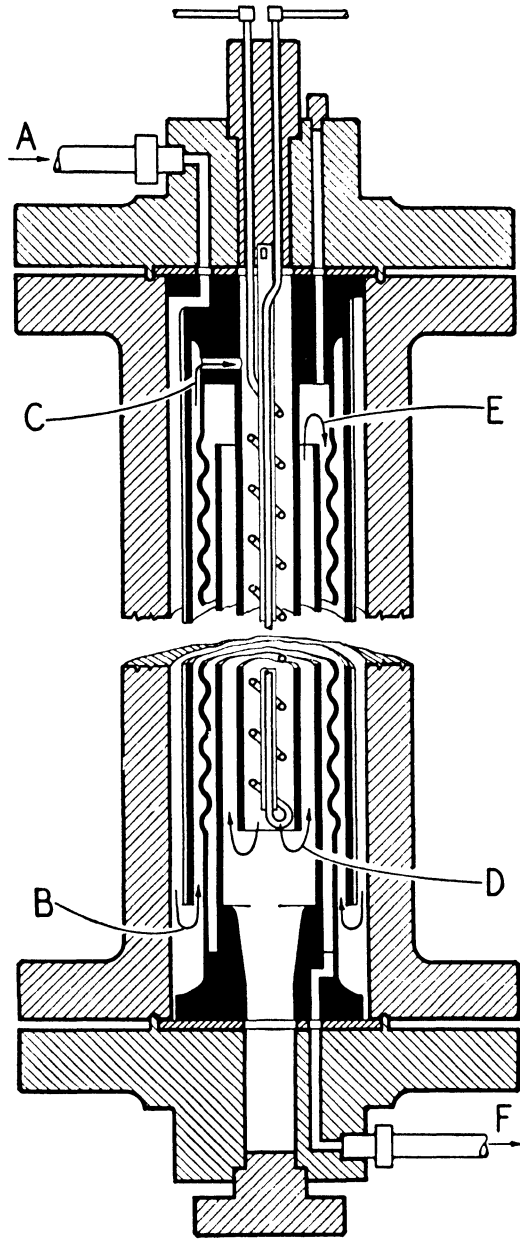
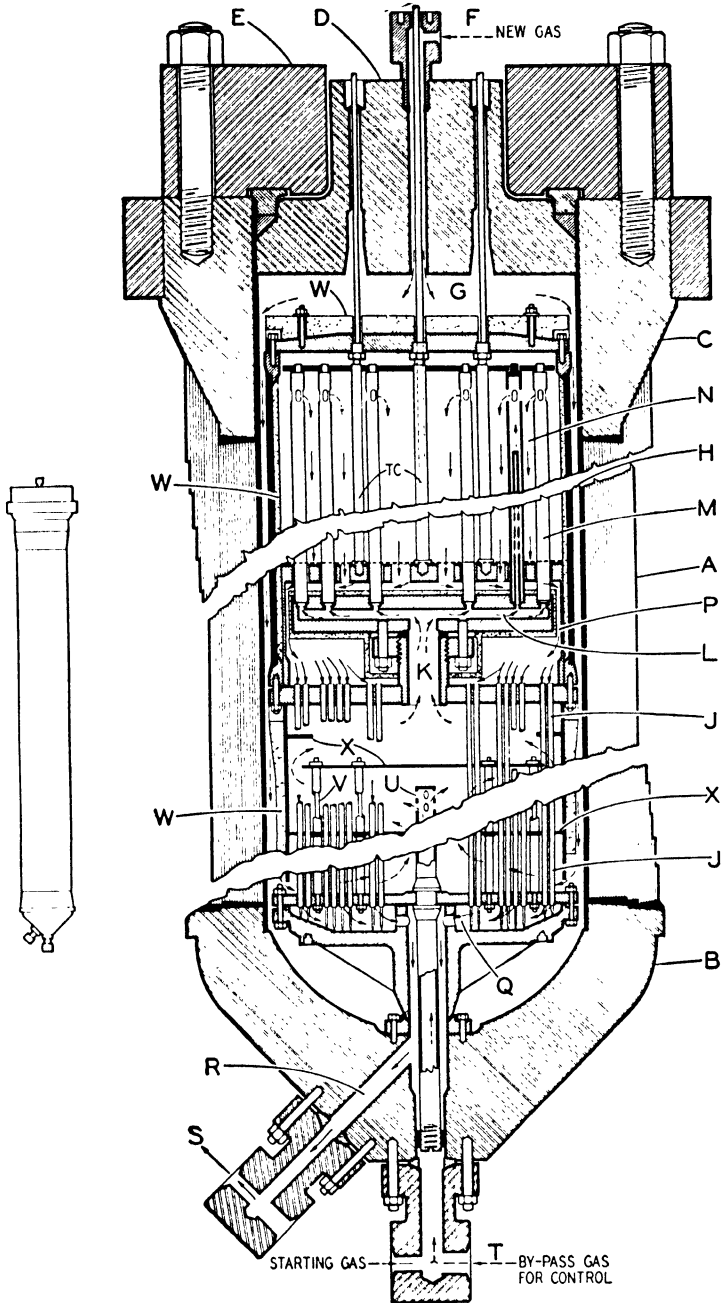

FIGURE 8-11. Casale Ammonia Converter (Redrawn from *Trans. Am. Inst. Chem. Engrs.*, 29, 95 (1933) with permission)

of two parts, a heat exchanger in the lower section and the catalyst basket in the upper section, each of which is about 20 feet in length. This arrangement allows relatively cool gases to be handled outside the converter and keeps the steel converter shell at a much lower temperature and hence preserves its strength. Fresh synthesis gas (shown by dotted arrows) enters at  $F$  through an annular space surrounding a thermocouple well,  $TC$ , and into a gas space,  $G$ , above the assembly. The gas passes down the entire length of the converter in the space  $H$  between the assembly and the lining of the converter shell. This flow of gas picks up heat that leaks from the central assembly and helps cool the converter shell. The gas then passes upward around the tubes  $J$ , being directed across the tubes by a series of baffles,  $X$ , which are supported by bolts,  $V$ . This arrangement is similar to the tube and shell heat exchangers in which the shell contains baffle plates to direct the fluid at right angles to the tubes and increase the heat transfer coefficients. The gas passes upwards through the central opening  $K$  and into a gas space  $L$  below a tube sheet into which are set annular tubes,  $M$ . The gas enters the central portion of tubes  $M$  (see cut-away tube) and leaves the central tube through a number of holes and impinges against the outer wall of the tube where it absorbs heat from the conversion reaction occurring on the outside of the tube. The gas leaves the tubes through openings near the top and starts downward through the catalyst. The catalyst rests on a screen supported on a perforated plate which is above the tube sheet. Catalyst fills space  $N$  up to the top openings in tubes  $M$ . The synthesis gas, heated to the proper temperature by its passage through the lower heat exchanger and the tube in the catalyst bed, is converted to ammonia as it passes downwards through the catalyst (the gas now is represented by solid lines). The temperature within the catalyst bed is recorded by three thermocouples,  $TC$ . The hot converted gas passes out through openings in the bottom of the catalyst support plate and into the heat exchanger section through the annular space  $P$ . Note that the tube sheet and structural members are protected from the hot gas by thermal insulation. The gas then enters the heat exchanger tubes  $J$  at the top and leaves at the bottom. The tubes  $J$  contain a solid central rod so that the gas must pass through annular spaces at a higher velocity and hence higher heat transfer rates than if the tubes were open. The gas from the tubes enters a header space  $Q$  from which it passes into a central annular opening through the bottom at  $R$  and is removed at  $S$ . When a cold converter is started the preheated starting gas is brought in at  $T$ . During normal operation of



Courtesy of Mr. Charles O. Brown

FIGURE 8-12. Brown Ammonia Converter

the converter by-pass gas is admitted at  $T$  to control the temperature of the synthesis gas going to the catalyst. The heat exchanger must be designed for the worst possible conditions, such as low catalyst activity, that will require a higher temperature of the gas admitted to the catalyst. In order to regulate this temperature a portion of the synthesis gas is not admitted at  $F$ , but is by-passed to  $T$  where it enters the exchanger at  $U$ . Thus it does not come in contact with as much heat exchanger area as does the gas entering at  $F$  and permits close control of the temperature of the gas going to the catalyst.

#### PROCESS MODIFICATIONS

A large number of process and equipment modifications of the original Haber, or Haber-Bosch, process have been patented. These are usually known by the name of the inventor or company constructing the plants.

The *Haber-Bosch* process in its original form operated at a pressure of 200 atmospheres and temperature of 500° to 600°C. The space velocity was such that about 8 per cent ammonia was in the exit gases. The ammonia was removed by scrubbing with water and the dried gas was recirculated through the converter. The Imperial Chemical Industries (England) use a modification of this process. Before the war this process accounted for about 40 per cent of the world's synthetic ammonia.

The *Casale* process uses a converter of special design (Figure 8-11) operating at 500°C. and about 600 atmospheres pressure, with about 15 per cent ammonia in the exit gases which are recirculated after ammonia removal. The converter has excellent temperature control which gives the catalyst a long life (6 to 10 months). This process accounted for 16 per cent of the world's synthetic ammonia.

The *Fausser* process operates at 200 atmospheres and 500°C. with about 12.5 per cent ammonia in the exit gases. Hydrogen for this process is produced in the Fausser electrolytic cell so that the very pure gases used allow the use of an active catalyst. The ammonia plant at Trail, B. C., uses this process. This process accounted for about 10 per cent of the world's synthetic ammonia.

The *Mont Cenit* process is distinguished by its low operating pressure (100 atmospheres) and low temperature (425°C.) This necessitates an extremely active catalyst so that the gases used must be highly purified. The Shell Chemical Company and Pennsylvania Salt Manufacturing

Company use this process. This process accounted for about 8 per cent of the world's synthetic ammonia.

The *Claude* process is radically different from the above processes. It operates at the high pressure of 1000 atmospheres and temperatures of 500° to 650°C. This high pressure makes the gas volume very small and gives high space velocities through the catalyst bed. The exit gases contain as much as 25 per cent ammonia, the formation of which liberates considerable heat and allows a simple heat exchanger to be used (Figure 8-10). The ammonia is condensed from the gas which continues to flow through a series of converters, with ammonia removal after each converter. The unconverted gas after the last ammonia separator is scrubbed with water and discarded. This amounts to about 20 per cent of the gas introduced. Despite the greater simplicity of design the equipment is more expensive to construct to withstand the higher pressures and the *Claude* plant is more expensive. This process accounted for about 9 per cent of the world's synthetic ammonia.

Many plants have been designed by the *Nitrogen Engineering Corporation*,\* or its successor, the Chemical Construction Company unit of the American Cyanamid Corporation, which use a modified Haber-Bosch process operating at about 300 atmospheres. Design features and operating conditions are to give maximum economy under the local conditions. This design accounted for about 8 per cent of the world's synthetic ammonia.

#### MATERIALS OF CONSTRUCTION

The reaction of hydrogen and nitrogen at high pressures and temperatures called for new alloys to meet the severe service conditions. The two main problems are (a) strength reduction and (b) hydrogen corrosion.

High temperatures reduce both the elastic limit and ultimate strength of metals. This effect is not serious up to 300°C., but beyond this the decrease is rapid. Thus a low chromium steel at 550°C. had its elastic limit lowered to about one quarter of its value at 300°C. Therefore, wall temperatures in converters must be maintained below 300°C. to avoid this serious loss in strength. Metals subject to these high temperatures do not behave in an elastic manner even though stressed below the elastic limit. The metal under load continues to extend or deform with time. This is known as "creep."

\* *Chem. & Met.'s Chemical Engineering Flowsheets* (4th Ed.), No. 9.



Hydrogen, nitrogen, and ammonia at high temperatures attack the various components of the metal and hence change its properties. Hydrogen changes the properties of ferrous alloys in a number of ways. It combines with iron to form a hard brittle hydride, and reacts with carbon in the steel to form methane. This causes the formation of cracks or fissures in the steel along grain boundaries. Nitrogen, and particularly ammonia, form nitrides which break open the crystal structure and allow deeper penetration of gases.

These extreme service conditions call for special alloys. The Claude process at 1000 atmospheres and 550°C. represents the most extreme condition. For the converter a ferrous alloy containing 60 per cent nickel, 12 per cent chromium, and 2.5 per cent tungsten is used. The converters are cast as solid cylinders, bored out, and heat treated. Their life is from 2,000 to 20,000 hours depending on the properties of the individual piece and the care taken in its use. For lower temperatures and pressures other steel alloys can be used which contain much less alloying elements. One alloy used contains 2 per cent chromium, 0.20 per cent vanadium, and 0.30 per cent carbon, which gives an ultimate tensile strength of 70,000 to 105,000 p.s.i. and elastic (or proportional) limit of 35,000 to 75,000 p.s.i.

### *Marketing of Ammonia*

Ammonia can be marketed in two forms, as aqueous ammonia solution and as anhydrous liquid ammonia. The aqueous solution can be obtained in variety of concentrations from 16°Bé. (10.3%  $\text{NH}_3$ ) to 26°Bé. (29.4%  $\text{NH}_3$ ), the latter being the usual commercial concentration. Shipping containers are 5- and 12-gallon glass carboys, 55- and 110-gallon steel drums, tank-trucks of various capacities, and railroad tank-cars carrying 6,000, 8,000, or 10,000 gallons of solution. The purity of the solution depends on the source of the ammonia, that from synthetic ammonia being pure. However, ammonia solutions made from coke-oven by-product ammonia may contain considerable amounts of impurities, as sulfides and cyanides, unless the solution has been purified. Aqueous ammonia usually is handled in iron, which is not corroded by the ammonia, or chromium alloys, as the stainless steels, which are entirely resistant. Aluminum also is resistant and can be used unless salts are present. The specifications for anhydrous and aqueous ammonia are given in Table 8-5. The aqueous ammonia here specified has been prepared from coke-oven gas, which is the source of pyridine, naphthalene,

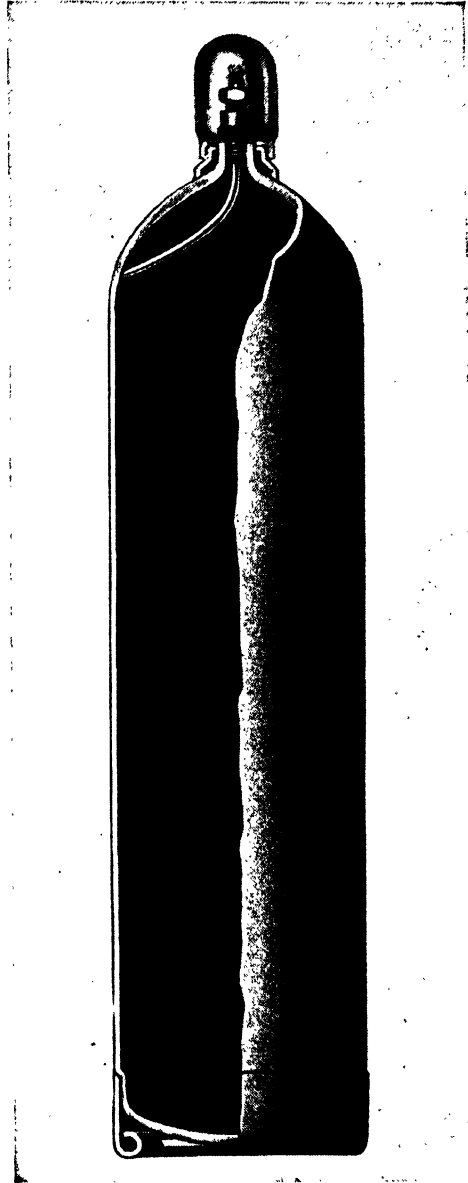

*Courtesy of the Pennsylvania  
Salt Manufacturing Company*

FIGURE 8-13. Ammonia Cylinder of the  
Bottle Type

organic matter, and tar. Aqueous ammonia prepared from synthetic ammonia is free from these components.

TABLE 8-5 Specifications for Ammonia of the Barrett Company

Anhydrous ammonia, grade	R	LF	
NH <sub>3</sub> , per cent, not less than	99.95	99.5	—
Non-basic gas, cc. per gram NH <sub>3</sub> , not to exceed	0.20	—	—
Moisture, cc. per 100cc. NH <sub>3</sub> , less than	0.01	—	—
Residue on evaporation, parts by weight less than	1/6000	—	—
Pyridine	none	—	—
Ammoniacal liquor, grade	A	B	C
NH <sub>3</sub> , per cent, not less than	29.4	25	15
Gravity, °Bé, not less than	26	—	—
Color	water	0.06	—
	white	—	—
H <sub>2</sub> S	none	none	none
Pyridine, grams per liter, less than	1	2	—
Organic matter, less than	50	100	—
Naphthalene, per cent, not over	—	0.03	—
Tar	—	—	free as possible

The equipment is steel designed to withstand the pressures encountered. Ammonia cylinders are of the bottle type (Figure 8-13), or the older cylinder type. An internal dipper-pipe allows the removal of either gaseous or liquid ammonia depending on the position of the cylinder. To maintain a constant supply of large amounts of gaseous ammonia heat must be supplied to the cylinder for the latent heat of vaporization.

Anhydrous ammonia has a boiling point of  $-77^{\circ}\text{C}$ . at atmospheric pressure and at  $70^{\circ}\text{F}$ . exerts a pressure of 144 p.s.i. gage. It is sold in a commercial grade (LF) and a refrigeration grade (R). Only the refrigeration grade is sold in cylinders containing 50, 100, or 150 pounds of ammonia; both grades are sold in tank-cars containing 50,000 pounds.

A detail view of the valve used for an ammonia cylinder is shown in Figure 8-14. The cylinder can be connected to the receiver by means of a standard  $\frac{3}{8}$  inch steel pipe, or a special fitting can be clamped into the 1-inch opening. Whereas the valve stem on a chlorine cylinder (Figure 5-7) is tapered to give flow control, very little control is possible with the shoulder type seat of the ammonia valve.

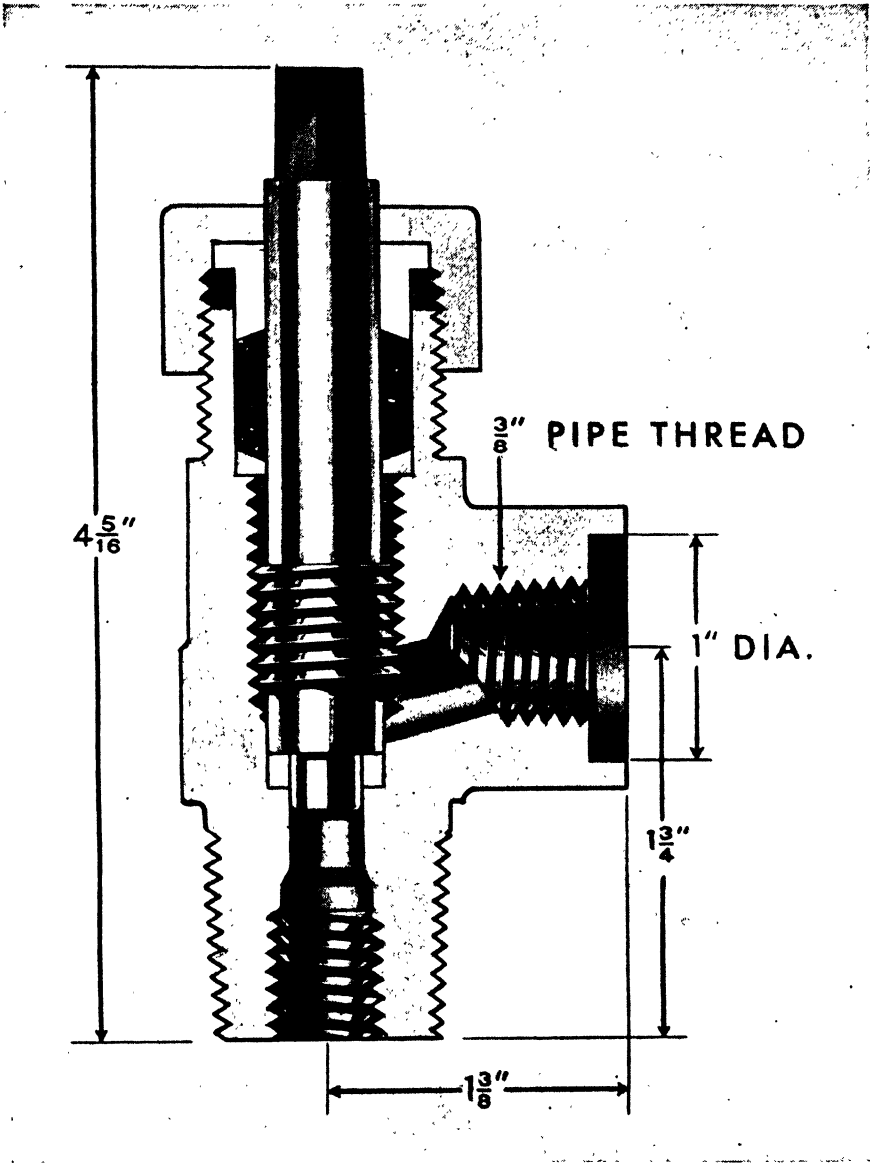

*Courtesy of the Pennsylvania Salt Manufacturing Company*

FIGURE 8-14. Valve Detail on an Ammonia Cylinder

*Student Exercises*

- A. Prepare a chemical engineering report covering one of the following topics:
1. Consumption of fixed nitrogen in the fertilizer industry in the United States
  2. Consumption of ammonia for industrial purposes in the United States
  3. Economics of the arc nitrogen process
  4. Operation of the arc process
    - a. Bradley-Lovejoy
    - b. Berkeland-Eyde
    - c. Schonherr
    - d. Pauling
    - e. Wielgolaski
    - f. Moscicki
    - g. Guye
    - h. Cotton
  5. Economics of the cyanamide process
  6. Production of hydrogen from:
    - a. Water gas
    - b. Natural gas and steam
    - c. Natural gas by thermal decomposition
    - d. Coke-oven gas
    - e. Water by electrolysis in:
      1. Diaphragm type cells
      2. Bell-jar type cells
      3. Filter-press type cells
      4. High pressure type cells
  7. Removal of carbon dioxide from gases
  8. Removal of carbon monoxide
  9. Production of nitrogen:
    - a. Claude process
    - b. Linde process
    - c. From air by combustion
  10. Synthetic ammonia processes:
    - a. Haber-Bosch
    - b. Casale
    - c. Fauser
    - d. Claude
    - e. Mont Ceniz
    - f. Hecker
    - g. Imperial Chemical Industries
    - h. General Chemical Company
    - i. American
    - j. Nitrogen Engineering Corp.
    - k. Atmospheric Nitrogen Corp.
  11. Fixation of nitrogen as nitrides
  12. Fixation of nitrogen as cyanides
  13. Fixation of nitrogen by bacteria
  14. Properties of alloy steels at high temperatures
  15. Ammonia plant locations: their selection

**B. Prepare flowsheets for:**

1. Arc process for nitric acid
2. Arc process for sodium nitrite
3. Calcium carbide production
4. Calcium cyanamide production
5. Hydrogen from natural gas and steam
6. Hydrogen from thermal decomposition of natural gas
7. Hydrogen from water gas
8. The Haber-Bosch process
9. The Claude process

**C. Prepare an illustrated problem showing the method of making a material and energy balance for:**

1. A nitrogen arc furnace
2. A calcium carbide furnace
3. A calcium cyanamide oven
4. A water gas converter
5. An ammonia converter
6. An ammonia stripper

**D. Prepare equilibrium curves showing the effect of:**

1. Temperature on water gas conversion
2. Excess steam on water gas conversion
3. Temperature on ammonia conversion
4. Pressure on ammonia conversion
5. Gas composition on ammonia conversion
6. Temperature on methane-steam reaction
7. Excess steam on methane-steam reaction
8. Pressure and temperature on the solubility of carbon dioxide in:
  - a. Water
  - b. Ethanolamine solutions
9. Pressure and temperature on the molal volume of:
  - a. Hydrogen
  - b. Nitrogen
  - c.  $3\text{H}_2 + \text{N}_2$
  - d. Ammonia
  - e. Carbon dioxide
  - f. Methane

*Recommended Reading*

## I.

- Cottrell, *Manufacture of Nitric Acid and Nitrates*, New York, Van Nostrand Co., 1923
- Curtis, *Fixed Nitrogen*, New York, Chemical Catalog Co., 1932
- Ernst, *Fixation of Atmospheric Nitrogen*, New York, Van Nostrand Co., 1928
- Furnas, *Rogers' Manual of Industrial Chemistry*, New York, Van Nostrand Co., 1942, Chapter VIII
- National Research Council, *Twelfth Report of the Committee on Contact Catalysis*, New York, Wiley & Sons, 1940
- Nitrate Division, Ordnance Office, War Department, *Report on the Fixation and Utilization of Nitrogen*, Washington, Government Printing Office, 1922
- Ruhemann, *The Separation of Gases*, London, Oxford U. Press, 1940
- Taylor, *Industrial Hydrogen*, New York, Chemical Catalog Co., 1921
- Tongue, *The Design and Construction of High Pressure Chemical Plant*, London, Chapman & Hall, 1934
- U. S. Tariff Commission, *Chemical Nitrogen, Report No. 114*, 1937
- Yost and Russell, *Systematic Inorganic Chemistry*, New York, Prentice-Hall, 1944

## II.

## HISTORY

- Ernst, "Twenty-five Years of Atmospheric Nitrogen Fixation," *Trans. Electrochem. Soc.*, **51**, 183-92 (1927)
- Landis, "Twenty-five Years of Progress in the Cyanamide Industry," *Trans. Electrochem. Soc.*, **51**, 65-72 (1927)
- Mittasch and Frankenburger, "The Historical Development and Theory of Ammonia Synthesis," *J. Chem. Education*, **6**, 2097-2103 (1929)
- Witherspoon, "Pioneering in Electrochemistry," *Can. Chem. Process Ind.*, **26**, 395-400 (1942)

## ARC PROCESS

- Scott, "Nitrogen Fixation Furnaces," *Chem. Met. Eng.*, **19**, 710-5, 757-61 (1918)
- Westby, "Western Nitrogen Fixation Plant," *Ind. Eng. Chem.*, **22**, 1099-1103 (1930)
- Loew and Beuschlein, "The Production of Sodium Nitrite from Arced Nitrogen," *University of Washington Engineering Experiment Station Bulletin* **73** (1933)

- Cotton, "Electric Activation of Chemical Reactions. Nitrogen Fixation by a New Type of Electric Discharge,"  
*Trans. Electrochem. Soc.*, **91**, 489–500 (1947)

## CYANAMIDE PROCESS

- Fairlie, "Muscle Shoals Nitrate Plant," *Chem. Met. Eng.*, **20**, 8–17 (1919)  
Jones, "Cyanamide Process Plant at Muscle Shoals,"  
*Chem. Met. Eng.*, **23**, 182–7 (1920)  
Lee, "Cyanamide Production Costs Reduced by Modern Equipment,"  
*Chem. Met. Eng.*, **38**, 564–7 (1931)  
Reinberg, "Small-Scale Production of Carbide,"  
*Chem. Met. Eng.*, **42**, 150–3 (1935)  
Baughen, "Cyanamide: Properties, Reactions, and Applications,"  
*Can. Chem. Process Ind.*, **23**, 805–11 (1944)

## HYDROGEN PRODUCTION

- Noeggerath, "Pressure Electrolysis of Water Eliminates Need for Compressors,"  
*Chem. Met. Eng.*, **35**, 421–3 (1928)  
Westman, "Production of Electrolytic Hydrogen and Oxygen,"  
*Can. Chem. Met.*, **14**, 338–45 (1930)  
Anon., "Natural, Refinery, and Water Gas as Hydrogen Sources,"  
*Chem. Met. Eng.*, **38**, 30–1 (1931)  
Armstrong, "Hydrogenation in Practice and Theory and the Manufacture of Hydrogen," *Trans. Inst. Chem. Engrs.* (London), **9**, 139–57 (1931)  
Elworthy, "Electrolytic Hydrogen with the Pechkranz Electrolysis,"  
*Chem. Met. Eng.*, **38**, 714–5 (1931)  
Anon., "Knowles Hydrogen Plant," *Chemistry and Industry*, **1932**, 355–8  
Byrne, et al., "Recent Progress in Hydrogenation of Petroleum,"  
*Ind. Eng. Chem.*, **24**, 1129–35 (1932)  
Hawk, et al., "Conversion of Methane to Carbon Monoxide and Hydrogen,"  
*Ind. Eng. Chem.*, **24**, 23–7 (1932)  
Brewer and Reyerson, "Production of High-Hydrogen Water Gas from Younger Coals," *Ind. Eng. Chem.*, **26**, 734–40 (1934)  
Karzhavin, "Natural Gas Conversion to Carbon Monoxide and Hydrogen,"  
*Ind. Eng. Chem.*, **28**, 1042–4 (1936)  
Laupichler, "Producing Hydrogen by Catalytic Water Gas Reaction,"  
*Chem. Met. Eng.*, **43**, 122–6 (1936)  
Brownlie, "Bulk Production of Hydrogen," *Ind. Eng. Chem.*, **30**, 1139–46 (1933)  
Hawes, "Pyrolysis of Gaseous Hydrocarbons," *Science of Petroleum*, London, Oxford University Press, Vol. III, 2007–29 (1938)



- Stanley, "The Production of Water Gas from Methane and Other Hydrocarbons," *Science of Petroleum*, London, Oxford University Press, Vol. III, 2164-73 (1938)
- Scott, "Mechanism of the Steam-Carbon Reaction," *Ind. Eng. Chem.*, **33**, 1279-85 (1941)
- Dotterweich, "Natural Gas as a Raw Material in the Production of Synthetic Ammonia," *Petroleum Refiner*, **21**, No. 3, 63-7 (1942)
- Ruhemann, "The Separation of Gases," *J. Inst. Petroleum*, **28**, 215-38 (1942)
- Sutherland, "Electrolytic Hydrogen Cell of Trail Design," *Can. Chem. Process Ind.*, **28**, 812-14, 821 (1944)  
*Trans. Electrochem. Soc.*, **85**, (1944)
- Reed, "The Commercial Production of Pure Hydrogen from Hydrocarbons and Steam," *Trans. Am. Inst. Chem. Engrs.*, **41**, 453-61 (1945)
- Ortner and Robinson, "Nitrogen Production from Waste Nitric Acid Plant Tail Gas," *Chemical Industries*, **57**, 80-2 (1945)
- Anon., "Hydrogen by the Steam — Hydrocarbon Process," *Chem. Met. Eng.*, **53**, No. 5, 122-3, 162-5 (1946)

#### AMMONIA SYNTHESIS

- Tour, "The German and American Synthetic-Ammonia Plants," *Chem. Met. Eng.*, **26**, 245-8, 307-11, 359-62, 411-5, 463-5 (1922)
- Larson, et al., "Ammonia Catalysts," *Chem. Met. Eng.*, **26**, 493-7, 555-60, 588-93, 647-54, 683-5 (1922)
- Ernst, et al., "A Direct Synthetic Ammonia Plant," *Ind. Eng. Chem.*, **17**, 775-88 (1925)
- Larson, et al., "Ammonia Catalysts," *Ind. Eng. Chem.*, **18**, 1305-9 (1926)
- Woodruff, "Synthetic Methanol and Ammonia from Butyl Fermentation Gases," *Ind. Eng. Chem.*, **19**, 1147-50 (1927)
- Anon., "High Pressure in the Manufacture of Synthetic Ammonia," *Chemistry and Industry*, **1929**, 591-8
- Pallemaerts, "Synthetic Ammonia Plant at Ostend," *Ind. Eng. Chem.*, **21**, 22-9, (1929)
- Anon., "Pressure-Synthesis Operations of the Du Pont Ammonia Corporation," *Ind. Eng. Chem.*, **22**, 433-7 (1930)
- Berliner and Burke, "Low-Cost Hydrogen Produced by Ammonia Dissociation," *Chem. Met. Eng.*, **37**, 751-4 (1930)  
*Trans. Am. Inst. Chem. Engrs.*, **25**, 42-57 (1930)
- Emmett, "Studies on the Mechanism of Ammonia Synthesis over Iron Catalysts," *J. Chem. Education*, **7**, 2571-83 (1930)
- Kirkpatrick, "Pioneering Chemical and Fertilizer Production in Western Canada," *Chem. Met. Eng.*, **38**, 626-31 (1931)

- Rosenstein, "Why Shell Built Its Ammonia Plant in California,"  
*Chem. Met. Eng.*, **38**, 636-7 (1931)
- Scholvien, "Ammonia Synthesis by the Low-Pressure Mont Cenis Process,"  
*Chem. Met. Eng.*, **38**, 82-6 (1931)
- Brunauer and Emmett, "Chemisorptions of Gases on Iron Synthetic Ammonia Catalysts," *J. Am. Chem. Soc.*, **62**, 1732-46 (1940)
- Miller and Junkins, "Nitrogen Fixation at the TVA Ammonia Plant,"  
*Chem. Met. Eng.*, **50**, No. 11, 119-25 (1943)
- Brown, et al., "Analytical Control for Ammonia Synthesis,"  
*Ind. Eng. Chem., Anal. Ed.*, **17**, 273-89 (1945)
- Lec, "Synthetic Ammonia Produced from Natural Gas,"  
*Chem. Met. Eng.*, **52**, No. 12, 94-6 (1945)
- Mitchell, "Ammonia: Its Production from Natural Gas,"  
*Petroleum Refiner*, **25**, No. 6, 245-59 (1946)
- Van Denberg, "West Meets East in Unique Engineering Project,"  
*Chem. Eng.*, **54**, No. 8, 93-5 (1947)
- Bridger, et al., "Production and Performance of Ammonia Synthesis Catalyst,"  
*Chem. Eng. Progress*, **43**, 291-302 (1947)

## MATERIALS

- Thompson, "Materials of Construction for Nitrogen Fixation,"  
*Trans. Electrochem. Soc.*, **50**, 101-16 (1926)
- Cox, "Metallurgical Problems in Handling Hydrogen under High Pressures and Temperatures," *Trans. Am. Inst. Chem. Engrs.*, **29**, 43-87 (1933)
- Kleinschmidt, "Mechanical Features of Synthesis at High Pressures,"  
*Trans. Am. Inst. Chem. Engrs.*, **29**, 88-99 (1933)
- Seibel, "Factors in High-Pressure Design, *Ind. Eng. Chem.*, **29**, 414-20 (1937)

## ECONOMICS AND MARKETING

- Tyler, "World Nitrogen Developments," *Chem. Met. Eng.*, **37**, 28-32 (1930);  
**38**, 42-6 (1931); **39**, 44-6 (1932); **40**, 36-7 (1933); **41**, 30-2 (1934)
- Ernst, "Ammonia Production and Conversion Costs,"  
*Trans. Am. Inst. Chem. Engrs.*, **17**, 1-26 (1925)
- Tour, "Synthetic Ammonia Costs in America,"  
*Trans. Am. Inst. Chem. Engrs.*, **20**, 213-49 (1927);  
*Chem. Met. Eng.*, **35**, 89-91, 162-4, 236-8 (1928)
- Crane, "Development of the Synthetic Ammonia Industry in the United States," *Ind. Eng. Chem.*, **22**, 795-9 (1930)
- McMichael, "Cheaper Ammonia with Off-Peak Electric Power,"  
*Chem. Met. Eng.*, **37**, 484-7 (1930)

- Breslauer, "World Nitrogen Industry Survives International Crisis,"  
*Chem. Met. Eng.*, **43**, 282-5 (1936)
- Catts, "Household Ammonia," *Soap*, **13**, No. 7, 28-32 (1937)
- Brandt, "Cracked Ammonia," *Chem. Industries*, **48**, 186-8 (1941)
- Brandt, "Storage and Handling of Anhydrous Ammonia in Tank Car Quantities," *Chem. Industries*, **53**, 200-6 (1943)
- Quinn, "Applications and Handling of Liquid Synthetic Anhydrous Ammonia," *Chem. Industries*, **52**, 58-60 (1943)
- Anon., "Nitrogen: Competition or Not," *Fortune*, **29**, No. 2, 128-31 (1944)
- Cope, "Capacity to Produce Nitrogen Compounds,"  
*Chem. Eng. News*, **23**, 243-6 (1945)

# CHAPTER 9

## Nitrogen Products

---

### I. Nitric Acid

#### A. AMMONIA OXIDATION

1. *Chemical principles*
2. *Catalysts*
3. *Converters*
4. *Process*

##### a. UNDER PRESSURE

##### b. AT ATMOSPHERIC PRESSURE

#### B. NITRIC ACID FROM SODIUM NITRATE

#### C. CONCENTRATION OF NITRIC ACID

#### D. LIQUID NITROGEN DIOXIDE

#### E. CHLORINE AND NITRATES

#### F. MATERIALS OF CONSTRUCTION

#### G. MARKETING NITRIC ACID

### II. Ammonium Salts

#### A. AMMONIUM SULFATE

1. *By-product*
2. *Wet process*
3. *Dry process*
4. *From gypsum*
5. *From the sulfite*

#### B. AMMONIUM NITRATE

1. *Wet process*
2. *Others*

#### C. AMMONIUM CHLORIDE

#### D. AMMONIUM PHOSPHATES

### III. Urea

#### A. DIRECT SYNTHESIS

### IV. Cyanamide Derivatives

#### A. AMMONIA

#### B. CYANIDES

#### C. ORGANIC CHEMICALS

1. *Urea*
2. *Cyanamide*
3. *Dicyandiamide*
4. *Guanidines*
5. *Melamine*

### V. Other Products of High Pressure Technology

#### A. METHANOL

#### B. OTHER COMPOUNDS

1. *Higher alcohols*
2. *Organic acids*
3. *Formates and oxalates*
4. *Fischer-Tropsch process*

### VI. Student Exercises

### VII. Recommended Reading

## Nitric Acid

IN 1944 there were produced in 23 plants 471,717 tons of nitric acid calculated as 100 per cent acid. Of this amount 413,201 tons, or 87.5 per cent were consumed in the producing plant. This excludes government owned and operated arsenals and ordnance works, but includes production at T.V.A. Practically this entire amount was used for the production of nitrates and nitro compounds. These were consumed largely by the fertilizer and explosives industries. The nitric acid was produced by two processes: (a) from sodium nitrate and sulfuric acid and (b) by the oxidation of ammonia. The former process was used exclusively in this country before World War I, during which several ammonia oxidation plants were constructed. After the war these plants could not compete with nitric acid from Chilean nitrate. However, producers of synthetic ammonia developed the oxidation process and since about 1930 it has rapidly taken over the largest proportion of acid production. Now less than 10 per cent of the commercial production of nitric acid is from sodium nitrate.

### AMMONIA OXIDATION

Nitric acid was produced in small laboratory quantities by Kuhlmann in 1839 by the oxidation of ammonia in air over a heated platinum catalyst. This is still another example of a scientific discovery being almost a century ahead of the technical and economic conditions necessary for its commercial development. These experiments were reworked by Ostwald in 1900 and a small commercial factory built in 1909. This process was expanded and used for the production of nitric acid during World War I. In 1916 the first plant in the United States was constructed by the American Cyanamid Company.

*Chemical Principles* The process is divided into two sections: (a) the oxidation of ammonia and (b) the oxidation and absorption of the nitrogen oxides. A number of reactions occur in the oxidation section:

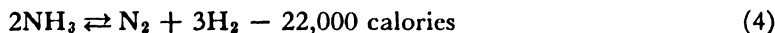
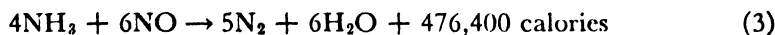
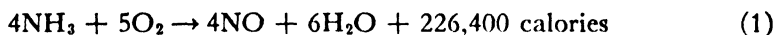

The first reaction is desired and the others represent reactions which cause the loss of fixed nitrogen due to the formation of free nitrogen. The

first three equations represent irreversible reactions rather than equilibria, so that LeChatelier's principle is not applicable. Thus the process must be carried out under such conditions that reaction (1) is accelerated while the others are retarded. At temperatures as low as 500°C. nitrogen only is formed, probably due to the dissociation of the ammonia, (equation 4) followed by combustion of the hydrogen. Reaction (1) is best carried out at high temperatures with very rapid passage through the platinum catalyst gauze. The temperature of 1000°C. is higher, and the time of contact with the catalyst, 0.0001 second, is shorter than for any other known case of contact catalysis.\* If the velocity through the catalyst is too high, ammonia passes through and reacts with nitric oxide (equation 3). The platinum gauze undergoes a characteristic change during the process. The platinum wire changes to a dull gray color which is due to the surface formation of sponge platinum, which eventually forms throughout the wire and causes it to disintegrate. In the absorption section the reactions are:

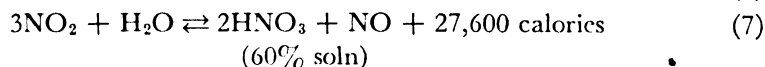
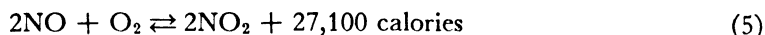

The application of LeChatelier's principle to reaction (5) indicates that best conditions for oxidation of the nitric oxide are low temperature, higher pressures, and an excess of oxygen. Above 600°C. there is practically no oxidation of nitric oxide; at about 225°C. equimolar amounts of nitric oxide and nitrogen dioxide exist. This mixture is equivalent to nitrogen trioxide ( $\text{N}_2\text{O}_3$ ) or nitrous anhydride, which exists in low equilibrium concentration in the mixture. This gas dissolved in alkaline solutions, as sodium carbonate solution, produces nitrites only, as was done at the La Grande arc nitrogen plant.



At temperatures below 100°C. the equilibrium gas is practically all nitrogen dioxide. The rate at which equilibrium is established is given by the equation:

$$\frac{d(\text{NO}_2)}{d\theta} = k(\text{NO})^2(\text{O}_2) \quad (9)$$

This reaction is one of the few trimolecular reactions and is unusual in that the velocity increases with a decrease in temperature. Thus sufficient

\* Taylor, *Ind. Eng. Chem.* 19, 1250-2 (1927).



*Courtesy of Baker and Company*

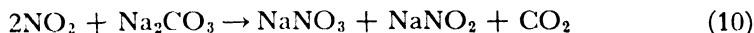

FIGURE 9-1. Platinum + 10% Rhodium Ammonia Oxidation Gauze Catalyst ( $\times 75$  diameters). Left: before use; right, after use

time must be allowed for the formation of nitric oxide before it is absorbed. The nitrogen dioxide is in equilibrium with its polymer, nitrogen tetroxide (equation 6); however, this reaction is a rapid one which does not control the rates in subsequent reactions of nitrogen dioxide.

It is apparent from equations (5) and (9) that an increase in pressure not only increases the equilibrium concentration of nitrogen dioxide but also increases the rate at which equilibrium is attained. The gas need not be compressed until after the ammonia oxidation has occurred; however, mechanical factors favor compressing the air and adding the ammonia previous to conversion.

The absorption of the nitrogen dioxide in water to form nitric acid (equation 7) is an exothermic reaction, hence is favored by lower temperatures, and cooling must be provided in the absorption towers in order that a concentrated nitric acid can be made. The reaction is one which would theoretically require an infinite reaction space, for the nitric oxide liberated in the reaction must be reoxidized (reaction 5) before undergoing absorption. At atmospheric pressure this rate of oxidation is the controlling factor in the absorption, so that tower sizes and gas velocities must be adjusted to allow time for this oxidation to proceed. Intermediate chambers may be installed for this purpose. To limit the number of towers used the last two towers may circulate a solution of sodium carbonate to absorb the final small amount of nitrogen dioxide as sodium nitrate and nitrite.



In pressure systems this rate becomes rapid enough so that reaction (7) becomes the controlling reaction and hence tower volumes are considerably less.

*Catalysts* The catalyst used in this country usually is a wire gauze of 80- by 80-mesh wire of 0.003 inch diameter in which the metal is a 90% platinum-10% rhodium alloy. With use the original smooth surface of the platinum wire soon becomes covered with a gray coating of sponge platinum (Figure 9-1) which eventually disintegrates the wire. This spongy platinum is dusted off by the gases passing through the converter so that replacement is necessary at intervals. With platinum alone, the loss amounts to 5 per cent per month under conditions which give 95 per cent conversion at atmospheric pressure. If the catalyst temperature is raised 100°C. the conversion can be increased to 98 per cent, but the platinum loss is more than doubled. Thus catalyst replacement cost must be figured against ammonia conversion and the optimum



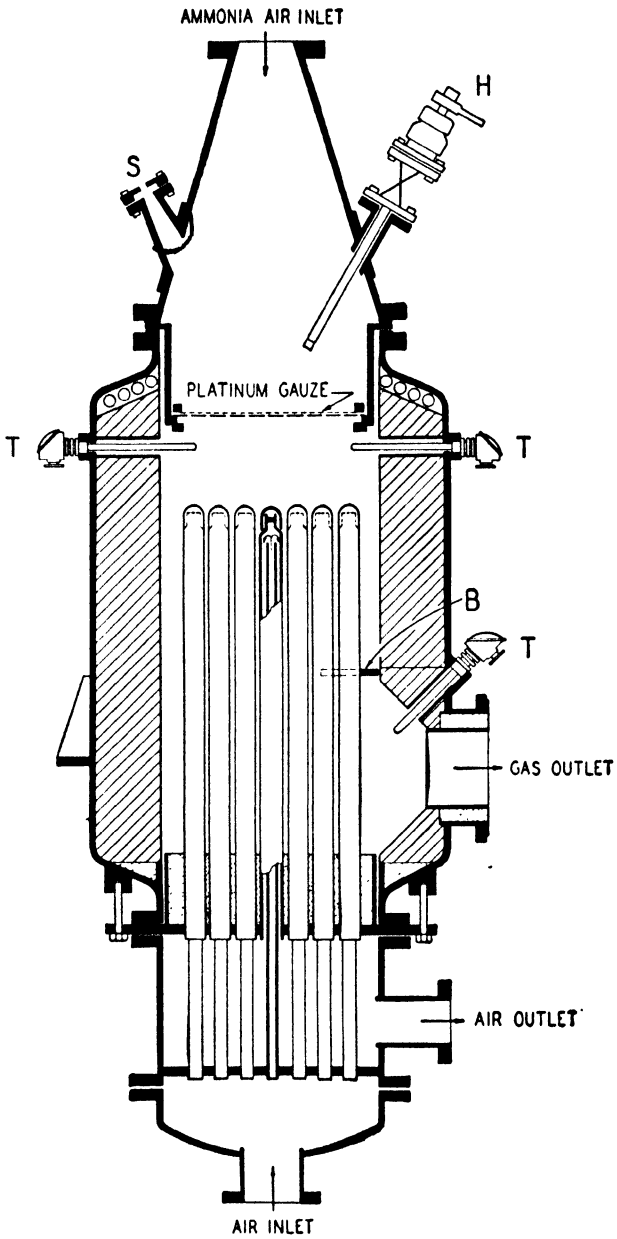

*Courtesy of the Chemical Construction Company*

**FIGURE 9-2. Ammonia Oxidation Converter**

temperature determined for each plant, usually between 800° and 900°C. The loss from the platinum-rhodium alloy is about half that from platinum. Operation of the catalyst on gases under pressure showed 7 per cent less conversion using platinum but this was reduced to 4 per cent with the alloy catalyst. The linear velocity of the ammonia-air mixture through the catalyst is maintained approximately the same under pressure operation, so that the weight of catalyst used per pound of ammonia oxidized is inversely proportional to the pressure.

The platinum and alloy catalysts are subject to poisoning by certain impurities. Originally, difficulties were encountered due to phosphine in ammonia from cyanamide and sulfur compounds in coke-oven ammonia. Purification methods produce satisfactory ammonia. Oil from the compressors or carried with the ammonia must be removed entirely.

*Converters* Early converters were refractory-lined chambers in which the heat of reaction maintained the catalyst at the desired temperature, or an electrically heated catalyst was used. These have been displaced by systems in which ammonia is added to preheated air, and the mixture passed through the catalyst contained in a converter as shown in Figure 9-2. The ammonia-air mixture enters at the top of the converter and passes down through the catalyst, which consists of 10 to 30 layers of gauze supported on a heavy wire screen. The temperatures of the converted gas and exit gas are determined by thermocouple wells. A baffle *B* is used to create a turbulence in order that the lower thermocouple will give a correct reading. The reactivity of the gauze can be observed through a sight glass *S* in the inlet section. When starting a cold converter the catalyst is heated by an oxygen-hydrogen flame inserted at *H*. The air preheater section is lined with refractory brick and refractory cement. The air preheater tubes are made of stainless steel, as is the conical inlet section.

*Process\** Plants for nitric acid production by ammonia oxidation operate either at atmospheric pressure or under a pressure of about 100 pounds per square inch. A few plants combine oxidation at atmospheric pressure with absorption at 100 p.s.i.g., but compression difficulties on oxide gases have prevented much use of this combination.

The flowsheet for the pressure process is shown in Figure 9-3. Air is compressed to 100 p.s.i.g. and filtered to remove oil or suspended dust. The air is preheated to a temperature of 250° to 300°C. by passing countercurrent to the hot oxidation gases leaving the converter. The liquid ammonia is vaporized by steam heat and is mixed with the heated

\* *Chem. & Met.'s Chemical Engineering Flowsheets* (4th Ed.), No. 40.

air to give about 10 per cent ammonia in the gas mixture. This is oxidized in the converter at a temperature of about  $900^{\circ}\text{C}$ . and the hot gases pass out through the air heater, a waste gas heater, and a condenser-cooler.

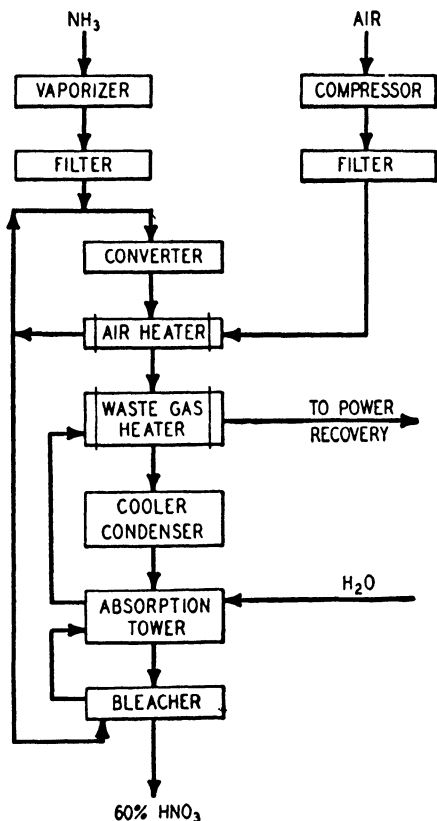

FIGURE 9-3. Ammonia Oxidation Process

The latter is a return-bend cooler which reduces the gas temperature to  $20^{\circ}$  to  $30^{\circ}\text{C}$ . by external water cooling. The water formed in the oxidation is condensed out and forms dilute nitric acid and the nitric oxide is oxidized to nitrogen dioxide. The gas is introduced at the bottom of an absorption section in a tower and passes upwards countercurrent to water introduced at the top. The dilute nitric acid from the condenser is introduced at a midpoint in the tower. The tower is a plate column constructed of chromium-iron alloy; contact between the descending liquid and ascending gases is by bubble caps on each plate (Figure 4-8). The heat of reaction is removed at each plate by coils through which cooling water is circulated. The concentrated nitric acid formed in the tower is delivered to a bleacher where a small amount of the preheated air is introduced to strip out any dissolved oxides of nitrogen.

The air and oxides then pass into the absorber for recovery. The bleacher may be a short stripping section on the lower end of the absorption column. The nitric acid produced is 60 per cent or more  $\text{HNO}_3$ . The waste gas from the absorber is passed through a heat exchanger where it aids in reducing the temperature of the oxide gases from the converter. The reheated gas is then expanded through a turbine to atmospheric pressure to recover power to assist in compression of the air.

A plant producing 25 tons per day of 60 per cent nitric acid has one converter about 2 feet in diameter delivering oxides to a single column

5 feet in diameter by 40 feet high. The over-all yield from ammonia to nitric acid is about 93 per cent, with not more than 2 per cent oxide losses in the waste gases. Recovery of this amount of oxide by alkali scrubbing is not usually economical.

Operation at atmospheric pressure demands a considerably larger plant. The significant difference is in the absorption section where reaction (5) rather than (7) controls the rate of absorption. The towers may be ceramic ware in small towers, or chrome-iron in larger sizes. The towers are packed with spiral tile packing. The number of towers varies from 4 to 12. In the last tower, or last two towers, sodium carbonate solution is circulated to absorb all oxides by reaction (10). Water is introduced in the tower ahead of the alkali section. In each tower are circulated large amounts of the nitric acid solution in equilibrium with the gas passing through the tower. Thus only a relatively small amount of solution is progressively advanced from tower to tower to be withdrawn from the first tower as 50 per cent nitric acid. A plant of this type which produced 25 tons per day of nitric acid had 8 small tanks with intermediate coolers in series to allow oxidation of the nitric oxide. The gases then entered 10 absorption towers, 10 by 50 feet, the last two of which circulated alkali.

In comparing the atmospheric and pressure processes, it is obvious that the pressure operation produces an acid containing 10 per cent more nitric acid in a much smaller plant, the construction cost of which is only about half that of the other plant. The increase in acid strength from 50 to 60 per cent decreases by almost half the cost of dehydration to 90 per cent nitric acid. As disadvantages, the cost of power for compression and slightly lower conversion efficiency are not serious.

#### NITRIC ACID FROM SODIUM NITRATE

The sodium nitrate used for this process originally came from Chile, but synthetic sodium nitrate produced through ammonia oxidation has been able to compete so is used in the process. The reaction is:



The sodium hydrogen sulfate, or bisulfate, produced is known as "niter cake." Because of the scarcity of niter cake some plants continue to produce by this method. The amount of acid actually used is 5 to 10 per cent less than that called for by the equation, so that both  $\text{Na}_2\text{SO}_4$  and  $\text{NaHSO}_4$  are present in the niter cake. The reaction cannot be continued as with salt to produce only sodium sulfate because at the higher temper-

atures used on the hearth the nitric acid formed would be completely dissociated into nitrogen oxides. The heating is regulated to maintain the temperature below  $140^{\circ}\text{C}$ . for most of the distillation, with a final temperature near  $200^{\circ}\text{C}$ . to increase the fluidity of the niter cake.

The process consists of three steps: (a) decomposition of the sodium nitrate by the addition of sulfuric acid, (b) condensing and bleaching of the nitric acid formed, (c) absorption of nitrogen oxides in the gas. This is shown in Figure 9-4. The retort consists of a cast iron pot with hemi-

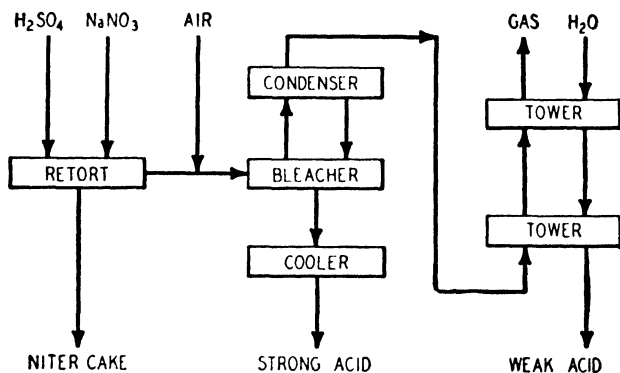

FIGURE 9-4. Nitric Acid from Sodium Nitrate

spherical bottom provided with a bottom outlet and pipe for withdrawing the liquid niter cake. It is set in a brick housing with a firebox that allows the hot combustion products to pass up around the retort without flame impingement on it. The retort is charged through an opening in the cover with sodium nitrate, which may be dried in a rotary drier to remove moisture and thus produce a stronger acid. The sulfuric acid is run into the retort through a separate pipe connection in the cover. The "cooking-off" time varies from 8 to 11 hours.

The vapors leave the retort and enter the bleacher, where they rise countercurrent to nitric acid descending from the condensers. The heat in the vapors, plus air which may be introduced ahead of the bleacher, removes the oxides of nitrogen dissolved in the nitric acid and thereby lightens its color. The nitric acid then flows through a cooler and is run to storage. The bleacher is merely an acid-proof iron or ceramic tower packed with ceramic spiral tile packing. The condenser is of the trombone-type with acid-proof iron pipe, over the outside of which cooling water flows. The condenser pipes are sloped so that all acid condensed runs back into the bleacher. The nitrogen oxides and air pass into a

series of absorbing towers packed with ceramic spiral tile packing. A battery of retorts is served by one series of 6 to 18 towers. Water enters the last tower and is recirculated in each tower as it slowly progresses forward until it is removed from the first tower as 50 per cent nitric acid. The over-all production of nitric acid is as high as 92 per cent of theoretical. By using 95 per cent sulfuric acid rather than 66°Bé. acid, the dilute acid can be introduced into the retort and recovered as strong acid.

#### CONCENTRATION OF NITRIC ACID

Most of the nitric acid produced is for nitration processes. These require an acid of at least 90 per cent  $\text{HNO}_3$  concentration rather than the 50 or 60 per cent acid made by ammonia oxidation processes. Although the boiling point of 100 per cent nitric acid is  $86^\circ\text{C}$ . it is not possible to separate it from water by fractional distillation due to the formation of a maximum boiling mixture at  $122^\circ\text{C}$ . which contains 68 per cent acid. The vapor-liquid equilibrium at 760 mm. is shown in Figure 9-5. \* Below

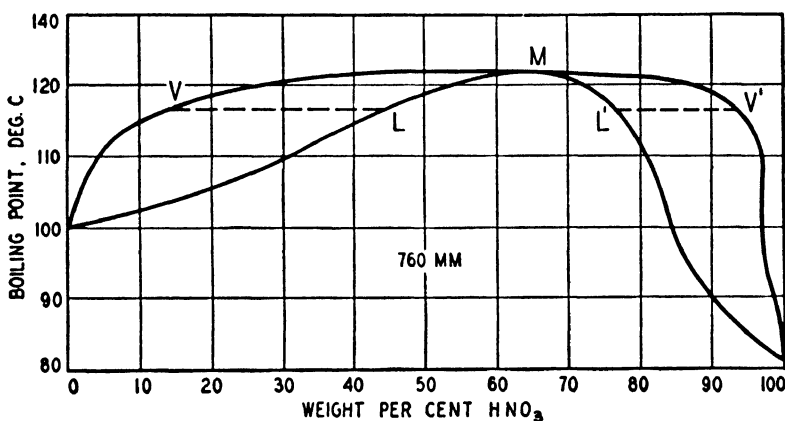
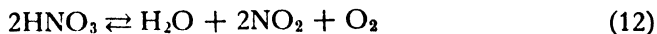

FIGURE 9-5. Vapor-Liquid Equilibrium for Aqueous Nitric Acid. M is maximum boiling point at  $122^\circ\text{C}$ . and 68% nitric acid.

68 per cent nitric acid, at point *M*, the liquid *L* gives off a vapor *V* more dilute in nitric acid, and the concentration of the residual acid rises to 68 per cent. Above 68 per cent, the liquid *L'* gives off a vapor *V'* more concentrated in nitric acid and the concentration of the residual acid decreases to 68 per cent. The boiling point at 100 per cent nitric acid is below  $86^\circ\text{C}$ . due to the presence of oxides of nitrogen from the dissociation:



\* Pascal, *Chem. Met. Eng.* 25, 1149 (1921).

A concentrated nitric acid is made by removing the water with concentrated sulfuric acid. The nitric and sulfuric acids are run into the top of a silicon-iron tower. Heat is supplied at the bottom of the tower in the form of live steam, or in more modern equipment, by steam-jacketed tubes which cause the nitric acid and some water to distill out and pass upwards through the tower. The water condenses and is carried out at the bottom by the sulfuric acid, whereas the nitric acid vapors and nitrogen dioxide pass off at the top to a condenser, bleacher, and absorber (Figure 9-4). The diluted sulfuric acid is reconcentrated in a standard type apparatus (Figure 7-7).

#### LIQUID NITROGEN DIOXIDE

Some European nitric acid plants are designed to produce nitric acid from liquid nitrogen dioxide. Ammonia is oxidized with pure oxygen using steam as the diluent to reduce the combustion temperature. The gas temperature is reduced from 850°C. to 165°C. in a waste heat boiler. Most of the water is then condensed out and discarded. The gases are further cooled and the nitric oxide oxidized to nitrogen dioxide in a gas cooler and oxidation tower where the remainder of the water is removed as nitric acid. The gas now contains practically pure nitrogen tetroxide (boiling point 21.3°C.) which is condensed in a brine cooled liquefier. The liquid nitrogen tetroxide is mixed with aqueous nitric acid in those proportions needed in the equation:

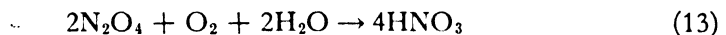

The mixture is pumped into an autoclave and treated with oxygen at 50 atmospheres pressure for about four hours. The temperature of the charge rises to 70°C. during the reaction. When the reaction is completed the charge is forced out to a storage tank from which it is fed to a bleaching column to remove unreacted nitrogen dioxide. In this process an acid of 90 to 98 per cent  $\text{HNO}_3$  can be produced. The need for an oxygen plant, considerable refrigeration, and corrosion at high pressure are some of the disadvantages of the process.

#### CHLORINE AND NITRATES

In Chapter 5 it was pointed out that chlorine and caustic are tied together and that the caustic must meet inter-process competition from soda-lime caustic. In order to produce more marketable products the

Atmospheric Nitrogen Corporation has developed a process whereby chlorine and sodium nitrate are produced.\* It has the advantage of using salt as the source of alkali, and ammonia oxidation gases for the nitrate.

The process is shown in Figure 9-6. Salt is fed into a reaction tower which contains a solution having at least 40 per cent nitric acid at a temperature of about 60°C. At this temperature and concentration no hydrogen chloride is evolved. The solution from the reactor is withdrawn to a cooler where the temperature is reduced to 30°C. The sodium nitrate that crystallizes out is filtered off and the filtrate returned to the reaction tower. The gas evolved from the reactor is mainly nitrosyl chloride (NOCl), which passes to a condenser in which it is cooled to 0°C. to dry it.

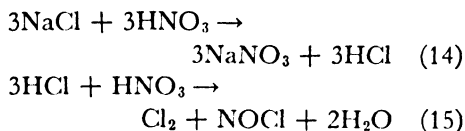

The moisture condensed out is returned to the reactor. If the amount of moisture in the gas is maintained below 0.1 per cent the corrosion is greatly reduced. The dried nitrosyl chloride is mixed with oxygen in the ratio of 2 to 1 and the mixture is passed into an oxidizer in which it is contacted at an elevated temperature with a catalyst to promote the reaction.



An alternative method is to liquefy the nitrosyl chloride and conduct the oxidation in the liquid phase at 60°C. and a pressure of 400 p.s.i. The gaseous products of the former method are liquefied at -50°C. and separated from the oxygen, which is recirculated to the oxidizer. The liquid, containing chlorine, nitrogen dioxide, and some unoxidized nitrosyl chloride is pumped to a fractionation column, from which the chlorine is taken overhead and the nitrogen compounds removed as

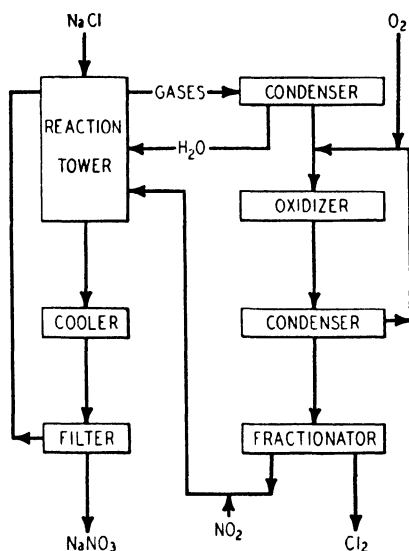

FIGURE 9-6. Chlorine from Salt and Nitrogen Dioxide

\* H. A. Beckhuis, U. S. Patents 2,296,328, 2,296,762, 2,296,763 (Sept. 22, 1942), 2,297,281 (Sept. 29, 1942).



bottoms which contain about 25 per cent by weight of nitrosyl chloride. This mixture is vaporized and to it is added additional nitrogen dioxide from an ammonia oxidation system. This gas is admitted to the reaction tower to produce additional nitric acid to continue the process. The nitric oxide unites with chlorine to produce nitrosyl chloride.



This is equivalent to the over-all reaction (equation 18) which indicates that the gas from the reactor should be largely nitrosyl chloride.

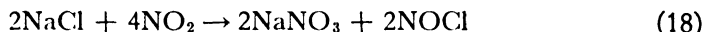

The reaction is exothermic, so that higher temperatures decrease the conversion; thus the reaction temperature should be maintained at about 60°C. Likewise, the oxidation of nitrosyl chloride is exothermic and cooling must be supplied if liquid phase oxidation is used. Unoxidized nitrosyl chloride merely circulates in the system at the concentration corresponding to the conversion in equation (16).

This process is operated by only one company which has been granted patents covering its invention. It is seen that many corrosion difficulties are inherent in the process. Nickel and its alloys are used extensively for the gases when dried to less than 0.1 per cent moisture. Ceramic material is used for solutions and wet gases. This process is not a serious competitor of the production of chlorine and caustic by electrolysis, but illustrates how chemical industry can expand and give rise to inter-process competition.

#### MATERIALS OF CONSTRUCTION

Nitric acid is both a strong acid and a vigorous oxidizing agent. Special materials of construction must be chosen to withstand various concentrations of the acid. In general, for plant construction silicon-iron and chromium-iron alloys are used most extensively.

The silicon-iron alloys containing 15 per cent silicon (Duriron type) are entirely resistant to hot concentrated nitric and sulfuric acid mixtures, so are used extensively in concentrators. These alloys are brittle and have good strength only under compression, so are not used for pressure vessels.

Alloys high in chromium are used for the pressure equipment. An alloy containing 16 per cent chromium is satisfactory and is used extensively. The 18-8 stainless steels of 18 per cent chromium and 8 per cent

nickel are usually satisfactory, though more expensive than the chrome iron.

Aluminum is resistant to hot concentrated nitric acid because of the formation of an oxide film that protects the underlying metal. Aluminum is frequently used for heat exchanger equipment conveying oxides of nitrogen.

Ceramic materials of a nonporous nature are resistant to nitric acid and are used in plants operating at atmospheric pressure.

Nickel is used in contact with hot ammonia gas as it causes less dissociation of the ammonia than steel or alloys.

If the nitric acid is mixed with sulfuric acid as "mixed acid" for nitration purposes, the mixture can be handled in ordinary iron equipment as with sulfuric acid.

#### MARKETING NITRIC ACID

Nitric acid usually is marketed in strengths from 36° (52%) to 42°Bé. (67%  $\text{HNO}_3$ ). Small amounts of acid are shipped in glass carboys (12 gallons). Larger shipments usually are of 90 to 95 per cent nitric acid and are made in aluminum or stainless steel drums of 30 or 50 gallon capacity, or tank-cars of 10,000 gallons capacity. Mixed sulfuric and nitric acids for nitration purposes are sold and shipped in steel tank-cars.

#### *Ammonium Salts*

A number of ammonium salts are of importance in various industries. Ammonium sulfate is used extensively in the fertilizer industry. Ammonium nitrate is the most concentrated nitrogen fertilizer and has both ammonia and nitrate nitrogen available for plant life. It is also used extensively as an explosive. Ammonium chloride is used in the manufacture of dry batteries. Ammonium phosphates are a concentrated fertilizer material.

#### AMMONIUM SULFATE

A variety of processes are used to produce ammonium sulfate. The largest amount results as a by-product of the coking of coal or manufacture of coal gas.\* In 1945 the coke industry produced 746,298 tons of ammonium sulfate valued at \$26.00 per ton. The gas is first cooled, the

\* *Chem. & Met.'s Chemical Engineering Flowsheets* (4th Ed.), No. 77.

tar and other suspended material removed. The gas is then passed through a saturator in which it reacts with dilute sulfuric acid in a saturated ammonium sulfate solution from which the salt formed is crystallized out.

Ammonium sulfate from synthetic ammonia was produced at 5 plants in 1945 in the amount of 177,726 tons. The wet process for manufacture from synthetic ammonia uses a 4 to 7 per cent sulfuric acid solution. Crystal size decreases as acid concentration increases, and the trade demands coarse crystals. The process is shown in Figure 9-7.

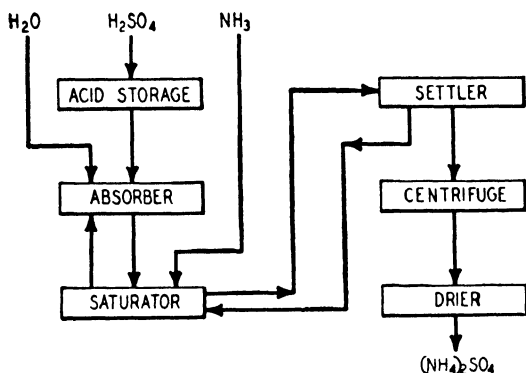

FIGURE 9-7. Wet Process for Ammonium Sulfate

Gaseous ammonia is passed into the acid solution saturated with ammonium sulfate which is maintained at the boiling point by the heat of neutralization. The evolved vapors contain some ammonia which is scrubbed out by passing upward through an absorber countercurrent to the 60°Bé. sulfuric acid entering the saturator. The saturated solution is withdrawn to a settler where the suspended ammonium sulfate crystals are allowed to settle out and the solution is returned to the saturator. The crystals are centrifuged and dried in a rotary drier.

The dry process is due to Fauser, who utilizes the heat of reaction to dry the salt. The process is shown in Figure 9-8.



The gaseous ammonia enters the reaction chamber through a series of perforations near the bottom of the chamber. Acid of minimum concentration 52°Bé. (65.5 per cent) is sprayed into the ammonia. The heat of reaction evaporates the water and the vapors pass out through an absorber where ammonia is recovered. This process can also be used on

mixed sulfuric-nitric and sulfuric-phosphoric acids to produce fertilizer salts.

American practice has favored the use of low cost or by-product sulfuric acid, whereas European practice has sought other sources of sulfate

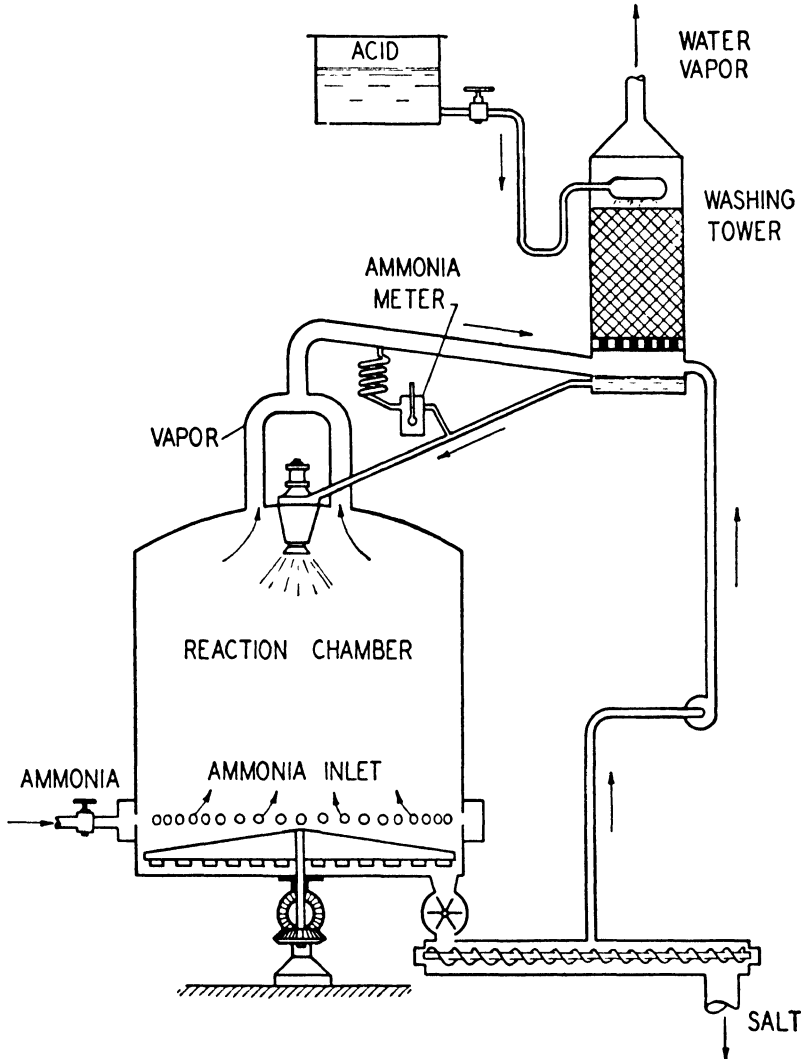
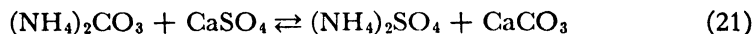
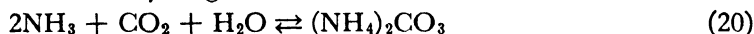

FIGURE 9-8. Fauser Dry Process for Ammonium Sulfate and Other Salts (Redrawn from *Chem. Met. Eng.* 38, 457 (1931) with permission)

radical. This is available in the form of calcium sulfate occurring as gypsum or anhydrite. The finely ground calcium sulfate is agitated in about twice its weight of water, and ammonia and carbon dioxide passed

in. The carbon dioxide is available from the water gas conversion after it is separated from the hydrogen. The reactions are:



The solubility product of the calcium carbonate is less than that of the calcium sulfate so the more insoluble product is formed. The time required is from 6 to 10 hours. The slurry is filtered to give a solution containing about 25 per cent ammonium sulfate. Any unreacted ammonia is stripped from the solution, which is then evaporated to crystallize out the ammonium sulfate.

Another process utilizing by-product sulfur dioxide is of interest. Ammonium sulfite is produced by the reaction of ammonia and sulfur dioxide in water. The sulfite is readily oxidized to the sulfate by atmospheric oxygen, and the ammonium sulfate is separated by evaporation and crystallization.

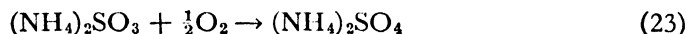

#### AMMONIUM NITRATE

The production of ammonium nitrate is complicated by the fact that it is extremely soluble and the boiling point of the saturated solution is greater than that of nitric acid. Hence, the process used for ammonium sulfate is not feasible. A 40 per cent nitric acid is neutralized in a saturator with gaseous ammonia. The heat of reaction causes some concentration by evaporation to give a solution containing 45 to 68 per cent ammonium nitrate. This solution is fed to an open evaporation pan fitted with stainless steel or aluminum heating coils. Here the solution is evaporated down to about 2 per cent water and transferred to a graining bowl. In it the wet salt is stirred by slowly revolving stainless steel paddles until the grained ammonium nitrate is dried to 0.10 per cent moisture. The size of the crystal is controlled by the temperature and rate of precipitation. Grain size is important in determining the rate of flame propagation in the explosive. Ammonium nitrate is hygroscopic and the grains must be coated to prevent them from picking up moisture from the atmosphere and forming a solid cake. One coating consists of 80 per cent rosin and 20 per cent petrolatum. For fertilizer purposes the saturated solution can be mixed with calcium carbonate and the slurry spray-dried.

Other processes are used for ammonium nitrate. Fauser uses a large

hydrostatic head of ammonium nitrate solution above the point at which the ammonia and 60 per cent nitric acid are mixed, to prevent boiling of the nitric acid solution at the point of mixing. During World War I ammonium nitrate was made by metathesis in solution between sodium nitrate imported from Chile and ammonium sulfate.



The ammonium nitrate was fractionally crystallized from the solution. The use of a process similar to the ammonia-soda process has been reported in which sodium nitrate solution is treated with ammonium bicarbonate.



Ammonium nitrate is used extensively as an ingredient of explosives. Amatol consists of either 50 or 80 per cent ammonium nitrate with 50 or 20 per cent trinitro-toluene. Ammonium nitrate as an explosive has an excess of oxidizing power but by itself is very difficult to detonate. For use it is combined with other more sensitive organic explosives in which an excess of reducing elements is present. The many new installations for ammonium nitrate have given a large capacity to produce it as a fertilizer, so that it will be used more extensively than in the past.

#### AMMONIUM CHLORIDE

This is produced chiefly in connection with the ammonia-soda process. The final brine containing calcium and sodium chlorides is evaporated and most of the sodium chloride crystallized out. The resulting 50 per cent calcium chloride solution is placed in an autoclave and saturated with ammonia and carbon dioxide. The precipitated calcium carbonate is filtered off and the solution evaporated.

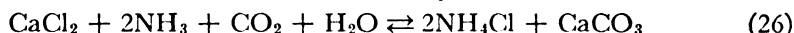

The ammonium chloride is crystallized from the solution.

The production of ammonium chloride and sodium sulfite by a process similar to the ammonia-soda process was described in Chapter 4, page 104.

#### AMMONIUM PHOSPHATES

The wet process\* can be used to produce mono-ammonium phosphate because of the nonvolatile nature of phosphoric acid. If the

\* *Chem. & Met.'s Chemical Engineering Flowsheets* (4th Ed.), No. 86.

phosphoric acid is produced by the sulfuric acid treatment of phosphate rock it has sulfuric acid mixed with it, so both ammonium phosphate and sulfate appear in the product. Such a product is on the market as "Ammono-Phos."

### *Urea*

Urea is not only a concentrated fertilizer but also an important basic material for the manufacture of plastics. As a fertilizer, urea contains 46 per cent nitrogen with no substance to form acidic or basic residues in the soil.

#### DIRECT SYNTHESIS

Urea is produced directly from ammonia and carbon dioxide by introducing these compounds as liquids, in the ratio of two to one, into an autoclave where the reaction takes place at 375 atmospheres pressure and a temperature of 200°C. The reaction first forms ammonium carbamate which decomposes to water and urea on further heating.

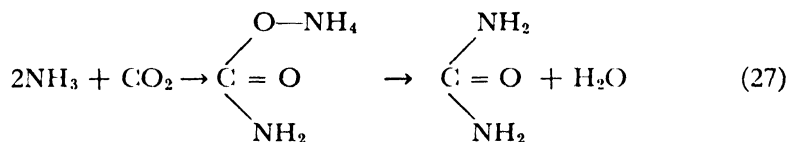

The autoclave charge is released into a still where the ammonium carbamate and carbonate are decomposed and the ammonia and carbon dioxide recovered for reuse. The urea can be recovered from the solution remaining. The still residue containing about 35 per cent ammonia, 45 per cent urea, and 20 per cent water is sold as urea-ammonia liquor for the ammoniation of superphosphate fertilizers. The presence of the urea increases the amount of nitrogen that can be added to the fertilizer.

Urea also can be produced from calcium cyanamide and will be discussed in connection with it.

### *Cyanamide Derivatives*

Although calcium cyanamide is used extensively as a fertilizer containing 21 to 22 per cent nitrogen, it also is an important starting material for the production of numerous inorganic and organic compounds used

extensively in other industries. Due to a research program aimed at extending the chemical utilization of calcium cyanamide, the American Cyanamid Company has developed from a company interested in fertilizers to one of wide diversification in the field of chemicals.

#### AMMONIA

Before the advent of the Haber process considerable ammonia was made by the hydrolysis of calcium cyanamide in a hot 3 per cent sodium hydroxide solution in an autoclave, into which steam is introduced to keep up the temperature and strip out the ammonia.

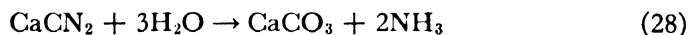

#### CYANIDES

If the calcium cyanamide is mixed with a flux of sodium chloride and fused in an electric furnace, cyanides are formed.

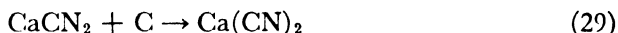

In this process about equal weights of crude cyanamide and salt are mixed and heated in a single arc furnace in which the carbon lining of the furnace acts as a conducting hearth. At the reaction temperature of 1300°C. the reaction mass is liquid and is tapped from the furnace. It is cooled quickly to freeze the equilibrium and prevent re-formation of cyanamide. This crude mixture of cyanides is used extensively in the cyanide process for the extraction of gold.

Hydrocyanic acid is produced by acidifying the cyanide in water. The hydrocyanic acid gas evolved can be liquefied and stored, or used in other chemical reactions. Sodium cyanide is formed by reacting the calcium cyanide solution with sodium carbonate to precipitate calcium carbonate.

#### ORGANIC CHEMICALS

A series of related organic chemicals is prepared from calcium cyanamide. When this salt is placed in water it is hydrolyzed to the acid salt.

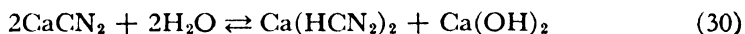

The hydrolysis can be completed by removing the calcium hydroxide with sulfuric or carbonic acid. Cyanamide ( $\text{H}_2\text{NCN}$ ) can be recovered from the filtered solution by acidifying and evaporating under vacuum.

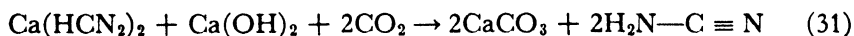



If the acidified solution (pH less than 4) is heated under pressure, urea is formed. It is recalled that hydrolysis in strongly basic solution (pH of 12) yields ammonium carbonate which is decomposed to ammonia.

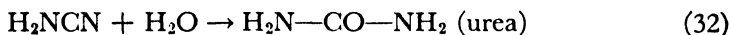

The dimer of cyanamide, dicyandiamide ( $\text{H}_2\text{N}-\text{C}=\text{NH}-\text{NH}-\text{CN}$ ) is an important intermediate in the production of derivatives. The pH of the cyanamide solution is adjusted to 8.5 with calcium cyanamide, and the solution heated in a closed vessel to  $80^\circ\text{C}$ . for 2 to 3 hours to cause polymerization. The hot liquor is pumped through a filter press into a vacuum crystallizer in which slow flash evaporation reduces the temperature to  $7^\circ\text{C}$ . in 3 to 4 hours. This slow cooling allows time to produce coarse crystals rather than the mass of fine crystals that would form on rapid cooling. The crystals are centrifuged and dried in a drum drier.

Melamine and guanidine are the more important derivatives produced from dicyandiamide. When dicyandiamide is heated with ammonium nitrate and liquid ammonia under pressure, guanidine nitrate is formed.

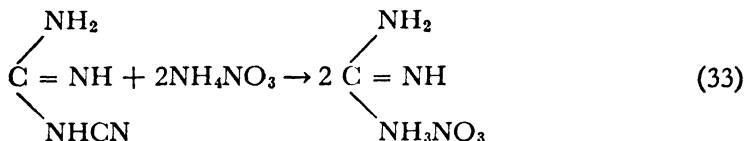

When heated with concentrated sulfuric acid, the nitrate forms nitroguanidine, an important military explosive characterized by its low explosion temperature and safety in handling.

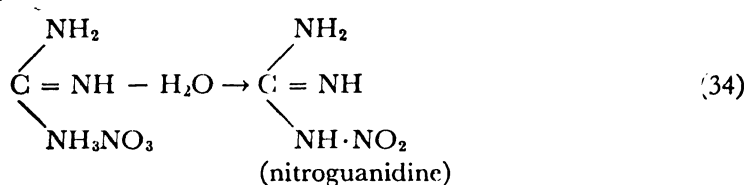

Melamine is produced by heating dicyandiamide with anhydrous ammonia under pressure at  $100^\circ$  to  $400^\circ\text{C}$ .

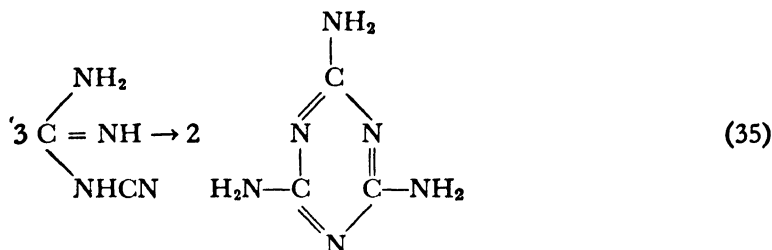

Melamine represents an important intermediate in the preparation of synthetic resins.

Numerous other compounds can be prepared from the primary derivatives of calcium cyanamide and cyanide; however, the examples given show the diversification and extension into many new lines of a chemical industry that began primarily as a fertilizer industry.

### *Other Products of High Pressure Technology*

The synthetic ammonia industry pioneered the way in a new field of chemical engineering. The development of equipment, materials of construction, catalysts, and techniques in which pressures ranging up to 1000 atmospheres are used has likewise been the starting point of other new industries. Some of these industries which depend on high pressure technology are synthetic methanol and higher alcohols, cracking of petroleum, hydrogenation of petroleum and coal, and the synthesis of numerous other chemical compounds. Of these industries, the production of methanol and related chemicals will be discussed because of their direct connection with the synthetic ammonia industry and the economic significance this inter-process competition had in the wood alcohol industry.

#### METHANOL

Early in 1925 the wood distillation industry was thrown into confusion by the importation from Germany of a large quantity of methanol sold in competition with the "wood alcohol" produced by the destructive distillation of hardwoods. This industry produced as primary products acetic acid, methanol, acetone, and charcoal. It had already met inter-process competition from acetic acid produced from acetylene, acetone produced from corn by fermentation, and now another synthetic challenged the methanol. Production of methanol by the synthetic process soon was started in this country, and as a result of further research on utilization of methanol the present market is considerably larger than the market for wood alcohol. Automobile anti-freeze is one such market developed. In 1944 synthetic methanol production amounted to 71,280,000 gallons of 100 per cent methanol, whereas natural wood alcohol production amounted to 4,196,032 gallons of 80 per cent methanol. The present price of wood alcohol remains approximately the same at 60 cents per gallon as this product is specified as a denaturant

for industrial ethyl alcohol. Synthetic methanol sells at approximately 30 cents per gallon and goes into the industrial field as a chemical raw material. Formaldehyde for use in plastics is made from methanol.

Because of the similarity of the processes for ammonia and methanol, producers of ammonia have also entered the methanol field to utilize their equipment as fully as possible. This gives a flexibility which enables the producer to operate at plant capacity. A plant that can make 100 tons per day of ammonia should be able to make about 9,000,000 gallons per year of methanol. It is expected that the plants devoted entirely to the production of ammonia during war-time will make methanol as one of their peace-time products. Lowered prices and increased total demand for methanol are anticipated.

The process used for the synthesis is similar to that used for ammonia (Figure 8-6).

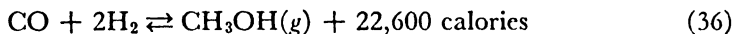

The carbon monoxide and hydrogen in the stoichiometric ratio are compressed to 150 to 200 atmospheres, passed through an oil separator and then to the catalyst chamber. The catalyst usually is a zinc chromate catalyst, promoted by various oxides in minor amounts. The catalyst temperature is 300° to 400°C. About 15 to 25 per cent of the carbon monoxide is converted to methanol during each pass through the catalyst. The methanol is condensed out by cooling the gases which are then recirculated through the catalyst. Because of the formation and accumulation of inert gases, as methane, in the gas mixture, a fraction of the gas must be purged each time to prevent its accumulation in the gas mixture. It has already been mentioned that carbon monoxide can be removed from a hydrogen-nitrogen mixture by passing it through a methanol catalyst rather than absorbing it in ammoniacal cuprous formate solution. Thus the methanol converter acts as a purification system which not only removes carbon monoxide but also other catalyst poisons and gives the ammonia catalyst a longer life. Carbon dioxide can be used instead of the monoxide, as is done with the gases produced in the fermentation process for acetone and butanol.

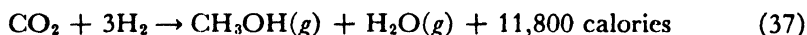

#### OTHER COMPOUNDS

Because they are not direct reduction products of carbon monoxide, a mixture of various aliphatic alcohols, aldehydes, ketones, and acids can

be formed in the methanol process by varying the composition of the catalyst. If a zinc-magnesium-potassium chromate catalyst or alkali-promoted methanol catalyst is used there results a mixture of higher boiling alcohols with the methanol. A relatively large proportion of the higher alcohols consists of n-propanol, isobutanol, and 2-methyl-1-butanol, with smaller amounts of other straight and branched chain alcohols.

Acids can be formed by the reaction of alcohols with carbon monoxide under conditions similar to that used in the methanol synthesis. An acid phosphate catalyst is used.



Methyl formate is produced using a different catalyst and reaction conditions.



Formates and oxalates can be produced by the reaction under pressure of carbon monoxide with hot concentrated sodium hydroxide solution. When the solid is heated, the oxalate is formed. The direct synthesis of formic acid from carbon monoxide and water has been reported at pressures above 1000 atmospheres.



A 46 per cent solution of formic acid was produced at 2000 atmospheres, 160°C., using sulfuric acid in the solution as a catalyst.



The Fischer-Tropsch synthesis of hydrocarbons in the gasoline range was developed from the methanol synthesis.

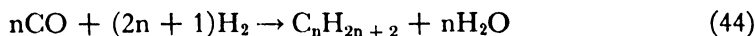

By using more active catalysts of the cobalt oxide type this reaction can be carried out at approximately atmospheric pressure. As developed in this country by the M. W. Kellogg Company under the name "Synthol" process, carbon monoxide and hydrogen are made from natural gas and then reconverted to hydrocarbons by passage through the catalyst. Some oxygen-containing compounds are produced, but these are separated in the distillation process. The hydrocarbons are separated into a gasoline and diesel fuel fraction and the oxygenated compounds are used for chemical purposes.

The future of high pressure technology is unlimited. By the use of high pressures and high temperatures favorable equilibrium conditions can be set up for a reaction. The proper catalyst must be found which accelerates the rate of the desired reaction without changing the undesirable competing reactions. The search for these is continuous.

### *Student Exercises*

A. Prepare a chemical engineering report covering one of the following topics:

1. The mechanism of the oxidation of ammonia
2. Equilibrium and kinetics of the oxidation of ammonia
3. Equilibrium and kinetics of the oxidation of nitric oxide
4. Equilibrium and kinetics of the formation of nitric acid from nitrogen dioxide
5. Commercial dissociation of ammonia
6. Production of ammonium sulfate:
  - a. In the coke industry
  - b. By neutralization (wet process)
  - c. By neutralization (dry process)
  - d. From gypsum
  - e. From sulfur dioxide
7. Urea by direct synthesis
8. Production from calcium cyanamide of:
  - a. Ammonia
  - b. Cyanides
  - c. Ferro- and ferri-cyanides
  - d. Urea
  - e. Thiourea
  - f. Melamine
  - g. Isourea ethers
  - h. Guanidine derivatives
9. Synthetic methanol processes
10. Higher alcohols by high pressure synthesis
11. Organic acids by high pressure synthesis
12. Ammoniated phosphate fertilizers
13. Ammonium nitrate by a modified ammonia-soda process
14. Potassium nitrate from sodium nitrate and potassium chloride

B. Prepare flowsheets for:

1. Nitric acid from ammonia at atmospheric pressure
2. Nitric acid from ammonia by oxidation under pressure
3. Nitric acid from ammonia by the Fauser process

4. Ammonium sulfate from gypsum
  5. Ammonium sulfate from the sulfite
  6. Ammonium chloride from the ammonia-soda process
  7. Ammonium nitrate by neutralization
  8. Ammonium nitrate from sodium nitrate
  9. Urea from calcium cyanamide
  10. Dicyandiamide from calcium cyanamide
- C. Your company desires to produce as a new product a compound listed below. Prepare an economic and market survey of this compound:
- |                        |                                  |
|------------------------|----------------------------------|
| 1. Ammonium sulfate    | 9. Urea                          |
| 2. Ammonium nitrate    | 10. Methanol                     |
| 3. Ammonium chloride   | 11. n-Propanol                   |
| 4. Ammonium phosphates | 12. iso-Propanol                 |
| 5. Ammonium carbonate  | 13. Acetic acid                  |
| 6. Sodium cyanide      | 14. Propionic acid and its salts |
| 7. Potassium cyanide   | 15. Ethyl acetate                |
| 8. Thiourea            | 16. Formic acid and its salts    |
- D. Prepare an equipment design to produce ten tons per day of the following salt by neutralization of the corresponding acid:
1. Ammonium sulfate
  2. Ammonium nitrate
  3. Ammonium chloride
  4. Mono-ammonium phosphate
  5. Sodium nitrate

### Recommended Reading

I.

See I in Chapter 8

II.

#### AMMONIA OXIDATION

Parsons, "Commercial Oxidation of Ammonia to Nitric Acid,"

*Ind. Eng. Chem.*, **11**, 541-52 (1919)

Krase, "Separating Nitrogen Oxides from Ammonia Oxidation Gas,"

*Chem. Met. Eng.*, **33**, 674-9 (1926)

Parsons, "Nitric Acid from Ammonia," *Ind. Eng. Chem.*, **19**, 789-94 (1927)

- Scott and Leech, "Catalytic Oxidation of Ammonia,"  
*Ind. Eng. Chem.*, **19**, 170-3 (1927)
- Taylor, "Oxidation of Ammonia," *Ind. Eng. Chem.*, **19**, 1250-2 (1927)
- Toniolo, "Absorption of Nitrogen Oxides from Ammonia Oxidation,"  
*Chem. Met. Eng.*, **34**, 92-5 (1927)
- Fausser, "Concentrated Nitric Acid Directly Attained in Pressure Synthesis,"  
*Chem. Met. Eng.*, **35**, 474-8 (1928)
- Fausser, "Nitric Acid Produced from Ammonia by Modified Pressure System,"  
*Chem. Met. Eng.*, **37**, 604-8 (1930)
- Taylor, et al., "Manufacture of Nitric Acid by the Oxidation of Ammonia,"  
*Ind. Eng. Chem.*, **23**, 860-5 (1931)
- Webb, "Capacity of a Platinum Catalyst in Ammonia Oxidation,"  
*J. Soc. Chem. Ind.*, **50**, 128-31T (1931)
- Fausser, "Concentrated Nitric Acid by Direct Synthesis Avoids Absorption,"  
*Chem. Met. Eng.*, **39**, 430-2 (1932)
- Handforth and Tilley, "Catalysts for Oxidation of Ammonia to Oxides of Nitrogen," *Ind. Eng. Chem.*, **26**, 1287-92 (1934)
- Bodenstein, "The Mechanism of the Catalytic Combustion of Ammonia,"  
*Trans. Electrochem. Soc.*, **71**, 353-73 (1937)
- Chambers and Sherwood, "Absorption of Nitrogen Dioxide by Aqueous Solutions," *Ind. Eng. Chem.*, **29**, 1415-22 (1937)
- Jones, "Ammonia and Nitric Acid 1918-38,"  
*Chemical Industries*, **42**, 142-6 (1938)
- Morrow, "Compressed Air for Ammonia Oxidation,"  
*Trans. Am. Inst. Chem. Engrs.*, **38**, 377-86, 889 (1942)
- Manning, "The Production of Concentrated Nitric Acid,"  
*Chemistry and Industry*, **1943**, 98-104

#### AMMONIUM SALTS

- Symmes, "The Manufacture of Ammonium Nitrate,"  
*Chem. Met. Eng.*, **26**, 1069-74 (1922)
- Ernst and Edwards, "A Sulfate of Ammonia Plant,"  
*Ind. Eng. Chem.*, **19**, 768-73 (1927)
- Ross, et al., "Preparation and Properties of the Ammonium Phosphates,"  
*Ind. Eng. Chem.*, **21**, 286-9 (1929)
- Fausser, "Producing Dry Salt by Diverting Heat of Reaction,"  
*Chem. Met. Eng.*, **38**, 456-7 (1931)
- Freitag, "Manufacture of Sal Ammoniac," *Ind. Eng. Chem.*, **24**, 1235-7 (1932)
- Berkhoff, "Ammonium Sulfate Crystallization Benefits from Simple Inexpensive Process," *Chem. Met. Eng.*, **44**, 366-7 (1937)
- Reed and Clark, "Potassium Nitrate from Potassium Chloride and Nitrogen Peroxide," *Ind. Eng. Chem.*, **29**, 333-6 (1937)

- Falk, "Ammonium Nitrate," *Chem. Met. Eng.*, **48**, No. 2, 120-1 (1941)
- Woodward, "Significance of Ammonia in the National Defense,"  
*Chem. Met. Eng.*, **48**, No. 2, 117-20 (1941)
- Hazel, "Production of Ammonium Sulfate by the Crystallization Method,"  
*Blast Furnace and Steel Plant*, **32**, 1445-50 (1944)
- Miller and Sawman, "Continuous Vacuum Crystallization of Ammonium Nitrate," *Chem. Eng. Progress*, **43**, 667-90 (1947)

## UREA, ETC.

- Landis, "Production of Ammonia from Cyanamide,"  
*Ind. Eng. Chem.*, **8**, 156-60 (1916)
- Landis, "A New Cyanide," *Chem. Met. Eng.*, **22**, 265-8 (1929)
- McBride, "Manufacture of Fertilizer Urea on a Tonnage Basis,"  
*Chem. Met. Eng.*, **32**, 791-3 (1925)
- Krase, et al., "A Direct Synthetic Urea Process,"  
*Ind. Eng. Chem.*, **22**, 289-93 (1930)
- Parker and Keenen, "Urea-Ammonia Liquor — A New Fertilizer Material,"  
*Chem. Met. Eng.*, **39**, 540-1 (1932)
- Berliner, "Crystal Urea — Its Industrial Uses,"  
*Chemical Industries*, **38**, 237-42 (1936)
- Berliner, "Crystal Urea," *Ind. Eng. Chem.*, **28**, 517-22 (1936)
- Jones and Aldred, "Guanidine from Cyanamide,"  
*Ind. Eng. Chem.*, **28**, 272-4 (1936)
- McClellan, "Melamine Preparation," *Ind. Eng. Chem.*, **32**, 1181-6 (1940)
- Baughen, "Properties, Reactions and Applications of Cyanamide,"  
*Can. Chem. Process Ind.*, **28**, 805-11 (1944)

## MATERIALS OF CONSTRUCTION

- Thompson, "Resistance of Metals to Nitric Acid,"  
*Chem. Met. Eng.*, **33**, 614-6 (1926)
- Mitchell, "Stainless-Iron Nitric Acid Equipment,"  
*Ind. Eng. Chem.*, **21**, 442-5 (1929)  
*Chem. Met. Eng.*, **35**, 734-6 (1928)
- McKnight, "Modern Nitric Acid Production Demands Special Alloys,"  
*Chem. Met. Eng.*, **39**, 490-2 (1932)
- Maxwell, "Stainless Steels for Use in Chemical Equipment,"  
*Trans. Am. Inst. Chem. Engrs.*, **35**, 159-68 (1939)

## METHANOL

- Lormand, "Industrial Production of Synthetic Methanol,"  
*Ind. Eng. Chem.*, **17**, 430-2 (1925)
- Audibert and Raineau, "A Study of the Synthesis of Methanol,"  
*Ind. Eng. Chem.*, **20**, 1105-10 (1928)



- Lewis and Frolich, "Synthesis of Methanol from Carbon Monoxide and Hydrogen," *Ind. Eng. Chem.*, **20**, 285-90 (1928)
- Frolich, et al., "Catalysts for the Formation of Alcohols from Carbon Monoxide and Hydrogen," *Ind. Eng. Chem.*, **20**, 694-8, 1327-30 (1928); **21**, 109-11, 867-71, 1052-5 (1929)
- Frolich, "The Role of Catalysts in High-Pressure Synthesis from Water-Gas," *J. Soc. Chem. Ind.*, **47**, 173-9T (1928)
- Huffman and Dodge, "Decomposition of Methanol over Catalysts Composed of Oxides of Zinc and Chromium," *Ind. Eng. Chem.*, **21**, 1056-61 (1929)
- Krase, "High-Pressure, High-Temperature Technology," *Chem. Met. Eng.*, **37**, 530-3 (1930)
- Graves, "Higher Alcohols Formed from Carbon Monoxide and Hydrogen," *Ind. Eng. Chem.*, **23**, 1381-5 (1931)
- Morgan, et al., "Methanol Condensation as Modified by Alkalised Catalysts," *J. Soc. Chem. Ind.*, **51**, 1-7T (1932)

# CHAPTER 10

## Phosphorus Products

---

- I. *Introduction*
  - II. *Phosphate Rock Industry*
    - A. PHOSPHATE DEPOSITS
    - B. FORMATION OF DEPOSITS
    - C. MINING
    - D. PROCESSING
    - E. MARKETING
  - III. *Phosphate Fertilizers*
    - A. SUPERPHOSPHATE
      - 1. *Den process*
      - 2. *Granulation process*
    - B. DOUBLE SUPERPHOSPHATE
    - C. AMMONIATED SUPERPHOSPHATE
    - D. DEFLUORINATED PHOSPHATE ROCK
      - 1. *Calcination*
      - 2. *Calcium metaphosphate*
    - E. COMPLETE FERTILIZERS
    - F. MARKETING
  - IV. *Phosphoric Acid and Phosphorus*
    - A. WET PROCESS
    - B. THERMAL PROCESSES
      - 1. *Electric furnace*
      - 2. *Phosphorus*
      - 3. *Blast furnace*
    - C. MATERIALS OF CONSTRUCTION
    - D. MARKETING
  - V. *Phosphates*
    - A. PHOSPHORIC ACIDS
    - B. CALCIUM PHOSPHATES
      - 1. *Production*
      - 2. *Baking powder*
    - C. SODIUM PHOSPHATES
      - 1. *Orthophosphates*
      - 2. *Pyrophosphates*
      - 3. *Tripolyphosphate*
      - 4. *Metaphosphates*
      - 5. *Water conditioning*
    - D. OTHER PHOSPHATES
    - E. ORGANIC PHOSPHATES
  - VI. *Student Exercises*
  - VII. *Recommended Reading*
- 

THE importance of phosphorus in the biochemical cycle is no less than that of nitrogen. Its necessity in the diet for bone building is well known.

The value of phosphorus as a fertilizer was known early, and ground bone was one of the first materials to be sold extensively as a fertilizer. In 1840 Liebig showed that the fertilizing value of bones could be increased by treatment with sulfuric acid. In 1842 J. B. Lawes took out an English patent for a similar treatment of ground phosphate rock and in 1843 began the manufacture of superphosphate fertilizer. Superphosphate, probably made from bones, was first produced in the United States in 1852. This industry has increased (Figure 10-1) to a consump-

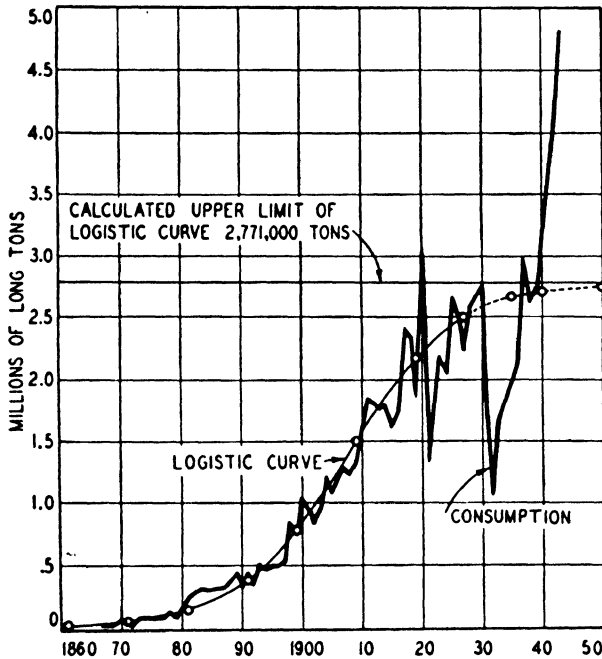

FIGURE 10-1. Consumption of Phosphate Rock in the United States, 1867-1944 (Redrawn from the *Minerals Yearbook*, 1944)

tion in 1945 of over 5 million tons of phosphate rock valued at nearly \$24,000,000.

The phosphate industry long was tied with the sulfuric acid industry, which produced the acid necessary for the conversion of the phosphate rock to superphosphate fertilizer, phosphoric acid, and phosphates. This linkage of two industries proved advantageous to smelters which produced by-product sulfuric acid that had to be utilized. Superphosphate production served as the simplest outlet. In some cases, as at Trail, B. C., this has led to an integral chemical industry of considerable magnitude.

The application of chemical engineering to the phosphate industry has expanded the industry and its products in the last 20 years. The development of electric furnace phosphorus and phosphoric acid, calcined phosphate rock, calcium metaphosphate, and glassy sodium metaphosphates has increased the value of the products from this industry and increased the fields of utilization.

### Phosphate Rock Industry

Phosphate rock represents one of the most important non-metallic minerals mined in this country. In 1945, 5,399,739 long tons of phosphate rock were mined; 5,806,723 long tons having a value of \$23,951,077 (or \$4.12 per ton) were sold or used by the producer. The increase in consumption of phosphate rock in the United States is shown in Figure 10-1,\* which predicts an average annual consumption of 2,771,000 long tons. However, such predictions of production ceilings have been notoriously unsuccessful and it is doubtful that peacetime consumption will decline to this predicted level.

#### PHOSPHATE DEPOSITS

The deposits of phosphate rock in the United States are shown in Figure 10-2. Florida is by far the greatest producer because of its nearness to ocean shipping and the users in the cotton producing states. Production for 1945 is given in Table 10-1.

TABLE 10-1 Sources of Phosphate Rock Sold or Used by Producers in 1945

	<i>Long tons</i>	<i>Per cent</i>	<i>Average value \$/ton</i>
Florida			
Land pebble	4,103,022	70.7	3.80
Soft rock	71,715	1.2	4.09
Hard rock	63,491	1.1	6.71
Total Florida	4,238,228	73.0	3.85
Tennessee and Virginia	1,294,297	22.3	4.68
Idaho	123,340	2.1	5.46
Montana	150,858	2.6	6.07
	<hr/> 5,806,723	<hr/> 100.0	<hr/> 4.12

\* *Minerals Yearbook* 1943, p. 1418.

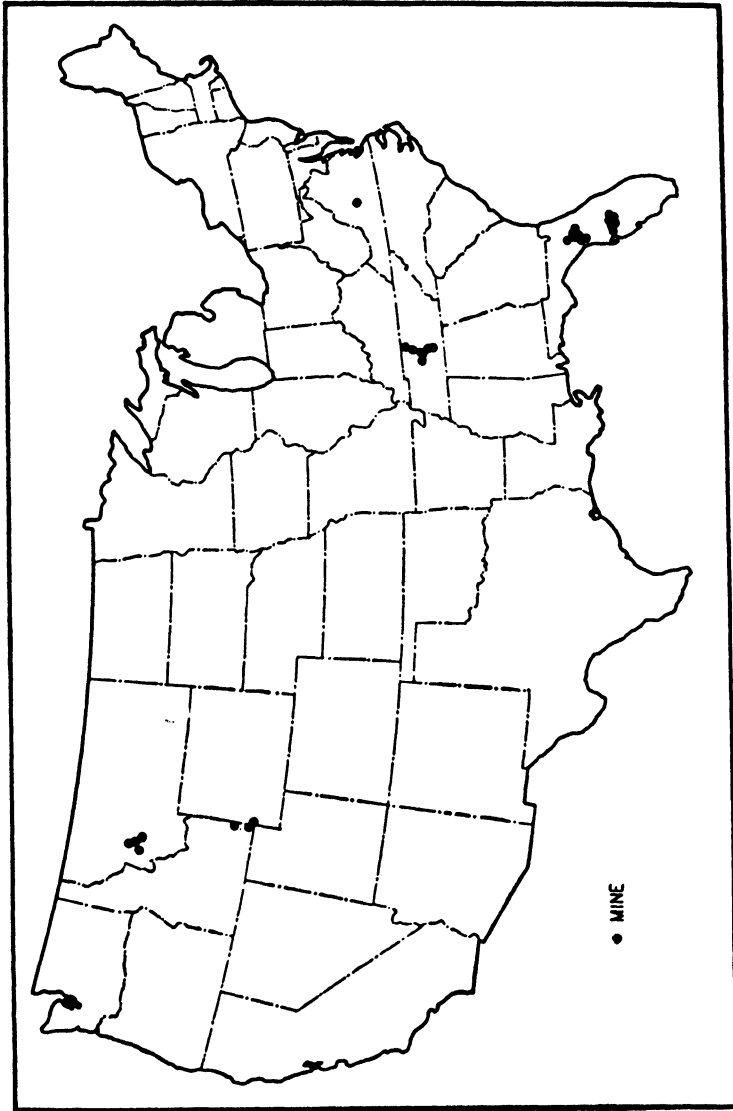

FIGURE 10-2. Deposits of Phosphate Rock in the United States

Despite these large mining operations the reserve of phosphates has been estimated by Mansfield as being sufficient for over 3,000 years at the present rate of consumption. The phosphate reserves of the United States are given in Table 10-2.

TABLE 10-2 Phosphate Reserves of the United States  
(In thousands of long tons)

<i>Eastern states</i>		<i>Western states</i>	
Florida	5,081,839	Idaho	5,736,335
Tennessee	194,468	Montana	391,323
South Carolina	8,798	Utah	1,741,480
Kentucky	863	Wyoming	115,754
Arkansas	20,000		
	5,305,968		7,984,892
		Grand total	13,240,860

Of the world's phosphate rock reserves the United States possesses 50 per cent, distribution being shown in Figure 10-3.

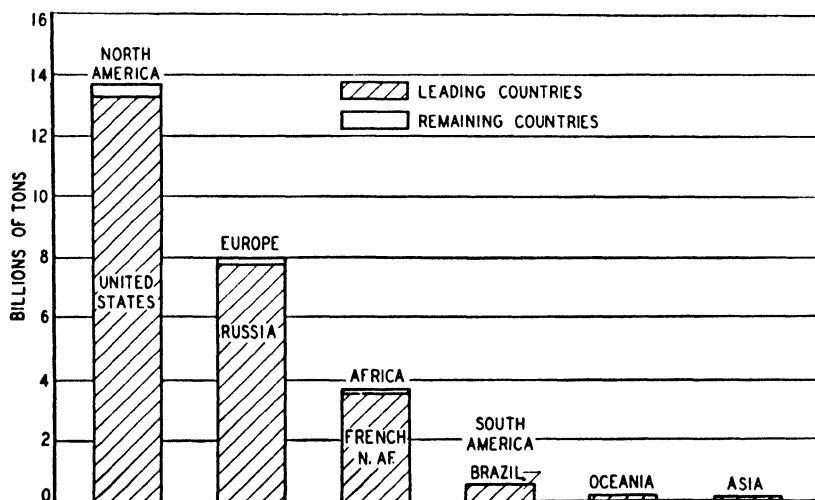

FIGURE 10-3. Phosphate Rock Reserves of the World (Redrawn from the *Minerals Yearbook*, 1941)

## FORMATION OF DEPOSITS

Phosphate rock deposits are sedimentary in nature and have formed from original outcroppings of apatite in igneous rocks. Apatite exists in several forms, of which the most prevalent is fluorapatite,  $3\text{Ca}_3(\text{PO}_4)_2 \cdot \text{CaF}_2$ , or  $\text{Ca}_5\text{F}(\text{PO}_4)_3$ . In a similar manner, the chloride, hydroxide, or carbonate ion can be associated with the calcium phosphate to produce a chlor-, hydroxy-, or carbon-apatite. These compounds are considerably more insoluble than tricalcium phosphate, an important factor in the formation of the sedimentary deposits. Waggoner states that no mineral is found at a greater number of geologic horizons, occurs under a wider range of natural conditions, and varies more in its physical properties than phosphate rock. It occurs in seams which are mined like coal or limestone, as pebbles or nodules imbedded in a loose matrix, and as a soft clay-like material. It varies in color from almost jet black to white rock; some is hard and dense while other is soft and porous. Thus it is apparent that no single explanation can account for all the deposits and their variations.

Apatite slowly dissolves in water bearing carbon dioxide or humic acids from the soil. In this way the phosphate was leached from the igneous apatite and carried to the sea, or retained in the soil to be extracted by plants and thence to animals. In this geologic period higher atmospheric temperature and concentration of carbon dioxide favored luxuriant plant growth and likewise increased solution of the apatite. The phosphate carried into the sea water was concentrated into the bodies of marine animals, particularly the bones and shells. The remains of these animals on the sea bottom form deposits with low phosphate content. The calcium phosphate content of the deposit increased as the carbonate, with which it was co-mingled, was partially removed due to its greater solubility. The calcium phosphate removed fluoride ions from the water with the formation of an amorphous fluorapatite of lower solubility. After the marine sediments had been elevated into land surfaces atmospheric agencies attacked them with the further removal of calcium carbonate, leaving the residuary deposit of phosphate, varying greatly in purity.

The brown rock phosphate deposits of Tennessee are the product of the weathering of phosphatic limestones which probably were deposited from waters relatively high in phosphate. Subsequent percolation of phosphate-rich water through this limestone gradually replaced the carbonate with the phosphate.

The fluorine-phosphorus pentoxide ratios in various phosphate rocks is approximately constant, except in Florida land-pebble phosphate in which the fluoride varies inversely with the phosphoric oxide present. The ratios for domestic rock vary from about 0.107 to 0.117, which is higher than the ratio 0.089 calculated from the mineralogical formula, or 0.097 found in some crystal specimens of fluorapatite.

## MINING

From the Florida pebble deposits is removed about 70 per cent of the domestic production. The deposits range from several feet to more than 30 feet in thickness, with an average of about 12 feet. The pebbles vary in size from grains like sand to small nodules, and in color from light cream to black. The matrix contains varying amounts of phosphate up to about 35 per cent. Over the phosphate matrix is a layer of overburden from several to 35 feet in thickness, with an average of about 15 feet. The overburden is stripped from the matrix by an electrically-operated dragline, which dumps the spoil into a mined-out area. The dragline also removes some of the matrix and piles it on top of undisturbed material. Hydraulic mining methods are used to remove the matrix. Hydraulic "guns" direct streams of water, about 2000 gallons per minute at 200 p.s.i.g. at the nozzle, against the matrix at distances from 25 to about 150 feet. The force of the water breaks up the matrix which is washed through shallow ditches to a sump, from which the pulp is pumped by a centrifugal sand pump through a 12-inch pipe to the washer or recovery plant.

A change in mining practice is to use dry mining, in which the matrix is dug by the dragline and piled near the sump into which it is washed hydraulically and from which it is pumped to the recovery plant.

The Tennessee deposits are usually mined by a dragline which strips the overburden from the deposit and then loads the phosphate rock and "muck" into narrow gage dump cars or large dump trucks, to be hauled to the washer.

## PROCESSING

The Florida washer or recovery plants vary in their flowsheet, but operate to separate the phosphate particles from the clay and sand present in the matrix. The slurry is partly de-watered on slotted screens



and the de-watered material delivered to a series of log washers and screens. In the log washers the agitation and attrition separate the clay from the phosphate, aided by sprays of high pressure water. Phosphate is separated from the sand by screening at about 20-mesh, the screen size being adjusted so that the phosphate retained on the screen contains about 6 per cent acid-insoluble matter in the finished product. Since 1927 the undersize phosphate has been separated from the waste material by flotation.\* Both washer rock and flotation concentrate are hauled to a central drying plant and dried at about 300°F. in an oil-fired rotary kiln.

Further processing may be conducted to meet requirements of certain buyers. The rock may be calcined at temperatures of about 800°C. for a short period of time to burn out the 1 to 3 per cent of organic matter present in the rock. In order to use the fine material in furnaces its size is increased by sintering the particles together, or nodulizing. The washed phosphate sand and unwashed matrix are mixed with coal or coke dust and sintered on a bed-type sintering machine (Dwight-Lloyd). In another process the wet fines are sintered at 1200° to 1300°C. in a rotary cement kiln fired with oil or powdered coal.

Some high grade rock is ground to 85 per cent through 300-mesh. This is used for direct application to the soil and releases its phosphate slowly.

## MARKETING

Phosphate rock usually is sold on the long ton (2240 pounds) basis, f.o.b. cars for railroad shipment, or c.i.f. for ocean shipment. The price paid is determined by the content of tri-calcium phosphate, known as bone phosphate of lime (B. P. L.), iron and aluminum oxides,  $\text{Fe}_2\text{O}_3 + \text{Al}_2\text{O}_3$  (I. & A.), acid insoluble matter, and moisture. Standard Florida grades are 68/66, 70, 72, 75/74, and 77/76 per cent B.P.L. The double figure represents the basis per cent and absolute minimum per cent of B.P.L. Of the 1945 sales 21 per cent was 72% minimum B.P.L., 20 per cent was 75/74% B.P.L., and 15 per cent was 77/76% B.P.L. The maximum I. & A. is 4.0 per cent and the moisture is 3.0 per cent. The I. & A. content is of importance where the B.P.L. is to be used for the manufacture of phosphate fertilizer, but may not be specified for rock to be used for furnace production of phosphoric acid. Values of I. & A. above the specified maximum are deducted double from the

\* *Chem. & Met.'s Chemical Engineering Flowsheets* (4th Ed.), No. 88.

B.P.L. content. B.P.L. content above the basis figure is paid for at a predetermined rate. Domestic sales are made by the producer or his agent but export sales are handled through the Phosphate Export Association.

### Phosphate Fertilizers

In 1945 the phosphate rock sold or used by producers was utilized as follows:

TABLE 10-3

<i>Uses</i>	<i>Long tons</i>	<i>Per cent</i>
Superphosphates	3,945,009	68
Phosphates, phosphoric acid, phosphorus, ferro-phosphorus	816,843	14
Direct application to the soil	411,543	7
Fertilizer filler	14,493	—
Stock and poultry feed	63,525	1
Miscellaneous	65,744	1
Exports	489,566	9
	5,806,723	100

As shown in the above table, finely ground phosphate rock can be applied directly to soils with beneficial results as a fertilizer. However, this is done only in small amounts because the contained phosphate is only slowly dissolved into the soil and used by the plants growing in it. For most fertilizer purposes the phosphate must be readily soluble. In this country the availability of the phosphate is determined by its solubility in 2 per cent ammonium citrate solution under a rigidly specified set of conditions. This "citrate-soluble" or "available  $P_2O_5$ " is used to fix the grade of fertilizer. Although the citrate-insoluble phosphate does not become part of the specified fertilizer content, it has value as a fertilizer as does the ground phosphate rock.

#### SUPERPHOSPHATE

When the B.P.L. is changed to available phosphate with sulfuric acid the product is known as superphosphate. The principal reaction is the

conversion of B.P.L. to monocalcium phosphate, along with a number of minor reactions depending on the impurities present.

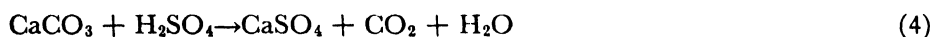
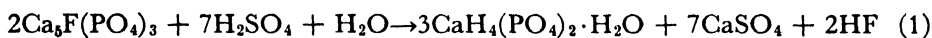

Only about half of the fluoride content of the phosphate rock is evolved from the superphosphate in the form of silicon tetrafluoride (equation 2) which is scrubbed from the exit gases with water (equation 3) and usually wasted, or used in some plants for the manufacture of fluosilicate salts. It is doubtful that iron and alumina (I. & A.) react in any appreciable amount when the theoretical amount of sulfuric acid is used.

It might appear that acid could be saved by converting the B.P.L. to the dicalcium phosphate ( $\text{CaHPO}_4 \cdot 2\text{H}_2\text{O}$ ) in which the phosphate is available. However, the addition of this smaller amount of acid does not convert all B.P.L. to this one compound, but producing both the mono- and dicalcium phosphates, leaving some B.P.L. unconverted. For this reason sufficient acid is used to convert the B.P.L. to the monocalcium phosphate.

The rate of this heterogeneous reaction between the B.P.L. and sulfuric acid depends mainly on the fineness to which the rock is ground. Present practice is to grind the rock and separate the fines by air flotation to give a material of which about 90 per cent will pass a 100-mesh screen and half of this a 200-mesh screen. Usually the grinding is done at the fertilizer works, though small plants prefer to buy their rock ground to size before shipment.

Other factors affecting the rate of reaction are the concentration of acid used and the temperature. The acid usually used is chamber acid of  $50^\circ$  to  $55^\circ\text{Bé}$ . (62 to 70%  $\text{H}_2\text{SO}_4$ ). If strong sulfuric acid were used it would have such a small volume that it would be difficult to mix uniformly with the ground rock, and the calcium sulfate formed would tend to coat the particles and prevent complete reaction due to its decreased solubility in the strong acid. If too dilute acid is used the volume is large and the mass does not heat up sufficiently to cause complete reaction; also, the product has so much moisture that it is in poor mechanical condition. Operation usually is at atmospheric temperature, though heated acid may be used and the Oberphos process heated the reacting mixture with steam in an autoclave to increase the rate of reaction.

The *den process* is most commonly used for the production of superphosphate. The sequence of operations is shown in Figure 10-4. This is a batch process in which a weighed quantity of finely ground phosphate

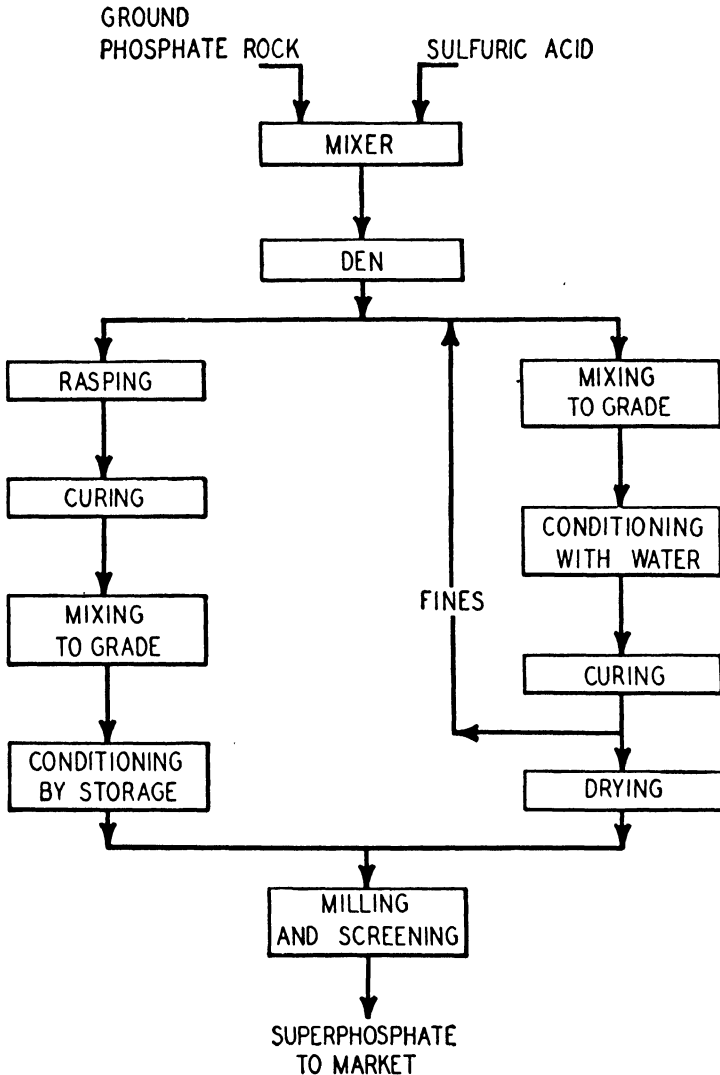
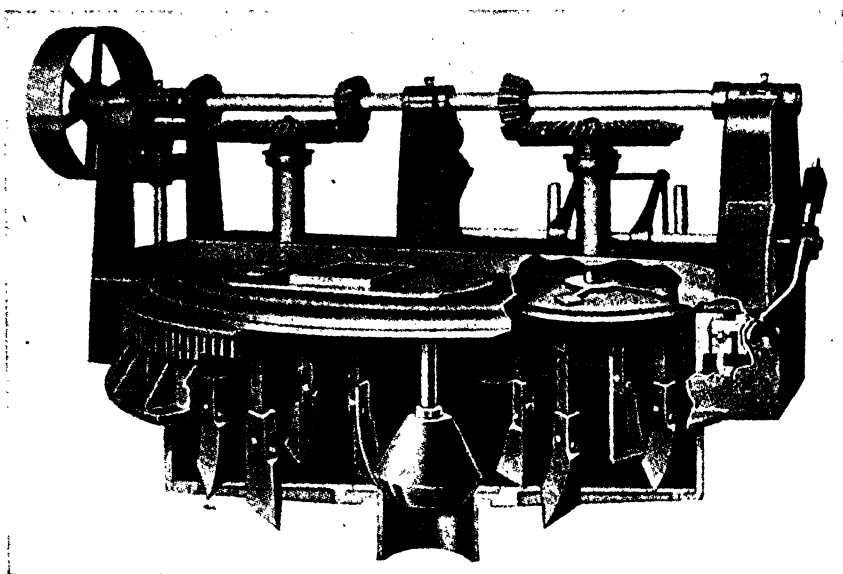

FIGURE 10-4. Superphosphate Production. Left, den process; right, granulation process.

rock and the measured amount of sulfuric acid are charged together into a mixing pan. The Stedman two-ton mixer (Figure 10-5) is a covered cast iron pan 8 feet in diameter by 2½ feet in depth. The pan revolves at

$4\frac{1}{4}$  r.p.m. and internal steel plows revolve at 50 r.p.m. The mixing of rock and acid is completed within two minutes and the soupy mixture drained from the pan into the den below by raising the plug and lowering a discharge scraper against the bottom of the pan. The den may be a series of rectangular rooms adjoining one another, or adjoining cylindrical silos. The capacity of the den is from 100 to 400 tons. The mixing equipment can be moved from one den to the next. The gases evolved in the mixing pan and den are exhausted to scrubbers where reaction (3) occurs. Most small plants discard the fluosilicic acid but large plants recover the acid and prepare various metal salts. The soupy mixture



*Courtesy of Stedman's Foundry and Machine Works*

FIGURE 10-5. Stedman Two-Ton Mixer

dumped into the den sets to a solid within a few minutes. The various exothermic reactions started in the mixer continue in the den and the temperature of the mass rises to above  $100^{\circ}\text{C}$ . Carbon dioxide, steam, and fluorine compounds are evolved to complete the reaction and leave the superphosphate as a relatively dry and porous mass. These reactions go on for several hours, depending on the temperature, and the material is left in the den for 6 to 24 hours, after which it is removed from the top of the den by a clamshell bucket or from below by special unloaders. At the Davison Chemical Company the unloaded material is put through a rapidly rotating star-knife arrangement, known as "rasping," which

breaks up the mass to fine particles which are then stockpiled. In the stockpile curing takes place; the reactions are completed with the combination of all free sulfuric acid with the B.P.L., usually a matter of weeks. If rasping is not carried out, and many plants do not do so, the stockpiles are moved several times to break up and aerate the material. The superphosphate can be mixed with other fertilizers to make specified grades of complete fertilizer.

The *granulation process* is used by the Davison Chemical Company to produce a uniform superphosphate or mixed fertilizer in less time.\* The superphosphate removed from the den is dumped into a feed hopper from which it is fed to a pan conveyor. Dry dust separated from furnace gases is fed into the moist superphosphate; the dust being 10 to 20 per cent of the total. Other fertilizer compounds can be added to the moist mass to give a final product having all fertilizer elements present. The mixture is fed into a rotating conditioning cylinder where it is subjected to fine water sprays that raise the moisture content to 18 to 20 per cent and the mass is converted by the rotation into a globular or granular form. Constant control by an experienced operator is required to maintain the correct moisture content and form of discharged material. The granular form is fixed by passage through a rotary kiln drier fired with oil. The hot gases pass through a cyclone separator which removes any phosphate dust, which is reprocessed with the unconditioned superphosphate. The dried material is stored for a minimum of 10 days to allow final curing, a considerable reduction over the usual den process. Analyses at various points in the process show:

	<i>From den</i> PER CENT	<i>From granulator</i> PER CENT	<i>Shipments</i> PER CENT
Moisture	10.56	5.15	1.67
Total P <sub>2</sub> O <sub>5</sub>	20.03	21.08	21.44
Insoluble P <sub>2</sub> O <sub>5</sub>	3.04	2.75	1.18
Available P <sub>2</sub> O <sub>5</sub>	16.99	18.33	20.26
Conversion	84.7	87.0	94.5

The sized granulated material has several advantages, such as non-caking during storage and shipment, nonsegregation in mixture, and ease and uniformity of distribution on the field; the latter is an important advantage to the farmer.

\* Pictured Flowsheet, *Chem. Met. Eng.* 50, No. 4, 132-5 (1943).

The *Broadfield process* is a continuous process, both in the mixer and den. Sulfuric acid and phosphate rock in the correct proportions are fed continuously into the mixer. The mixer is a horizontal cast iron trough, built in sections, within which rotates a shaft on which are mounted paddles so arranged that they give an alternate advancing and retarding action. The mixing operation continues for 2 to 4 minutes and thus gives a more intimate contact of rock and acid, thereby speeding up the conversion reactions. A suction fan withdraws the gases evolved. The reaction mass is discharged as a pasty liquid just mobile enough to level itself on the continuous conveyor in the den below. The den consists of a moving endless conveyor with two similar conveyors forming side walls housed within a steel box. Steel slats with rounded edges form the conveyor floor. The three conveyors move towards the discharge end at the same speed, giving a retention time of about 70 minutes in the den. At the end a set of revolving blades trims the superphosphate from the conveyor floor, a cutting operation similar to the rasping described above. The superphosphate falls to a conveyor system which removes it from the den, and elevates it to a belt conveyor which distributes it in the storage building.

#### DOUBLE SUPERPHOSPHATE

It is apparent from equation (1) that a considerable portion of superphosphate fertilizer is calcium sulfate, which is inert as a fertilizer. If the phosphate rock is treated with phosphoric acid rather than sulfuric acid a product results in which no inert material is formed.



The available phosphate content of such a fertilizer is 40 to 48 per cent  $\text{P}_2\text{O}_5$ , which is about double the 18 to 20 per cent usually found in ordinary superphosphate. Because of the lower phosphate content of early superphosphate, this concentrated material was called "triple" or "treble" superphosphate, names still found in the chemical literature.

The method of operation depends on the concentration of phosphoric acid, the production of which will be discussed later. If the wet process is used the acid concentration is 40 to 45 per cent; if the electric furnace process is used the acid can have any concentration.

At Trail, B. C., the dry, ground phosphate rock is mixed with 39 per cent phosphoric acid to give a fluid mixture which flows in series through 3 more tanks agitated with propeller stirrers. The desired tem-

perature and fluidity are obtained by the exothermic reaction, which can be controlled by admitting air or steam to the liquid. The slurry is continuously removed from the last agitator with a diaphragm pump and delivered to a mixer or "blunger" in which a predetermined amount of dried product is mixed with it to reduce the moisture content of the whole before passing through a hot air dryer. The dried product is screened, fines being recirculated to the slurry and oversize reduced and rescreened. The recirculation of dried product to reduce the moisture content of wet feed is a device frequently used when the feed otherwise would adhere to the walls of the dryer.

Phosphoric acid produced in the electric furnace can be diluted to any concentration desirable for reaction with phosphate rock. The T.V.A. process mixes a 76 to 80 per cent acid with the rock in either a mixer of the kneading type or a continuous mixer which has two shafts revolving at different speeds, one shaft with two rows and the other with three rows of paddles. The material discharged from this mixer is stockpiled for curing, during which time the reaction is completed and moisture hydrates the monocalcium phosphate or evaporates.

It is estimated that phosphoric acid produced by the wet process is used for about two thirds the double superphosphate, and electric furnace acid for about one third. The production in 1944 in the United States was 281,076 tons, relatively small in comparison to the superphosphate production. Double superphosphate is used (1) to increase the grade of ordinary superphosphate; (2) to make high-analysis grades of mixed fertilizers; (3) to serve as a fertilizer in certain regions where freight costs are high; (4) to adjust the  $P_2O_5$  content of goods already mixed.

#### AMMONIATED SUPERPHOSPHATE \*

Any unreacted sulfuric acid in the superphosphate is harmful in that it causes rotting of the bags in which the fertilizer is shipped. This acid can be neutralized by the addition of ammonia to the superphosphate. An additional reaction is the formation of monoammonium phosphate (equation 6). The dicalcium phosphate formed has the phosphate in available form, but if more ammonia is added B.P.L. is formed in which the phosphate is not available.

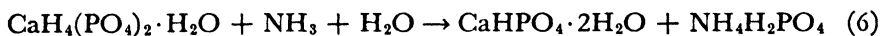

\* *Chem. & Met.'s Chemical Engineering Flow sheets* (4th Ed.), No. 85.



If the acid is to be neutralized, an excess can be used to acidify the phosphate rock, whereby the initial reaction and curing time are speeded up.

Superphosphate is charged into a rotating drum, aqueous or liquid ammonia is sprayed in, and the charge rotated for several minutes. The ammonia is rapidly absorbed and the batch is then discharged from the drum. The ammonia content is about 2 per cent of the total weight. The nitrogen content of the product can be increased by using an ammonia solution of urea instead of ammonia alone. By ammoniation the cheapest form of nitrogen is used to give a fertilizer of better mechanical condition and storing qualities.

#### DEFLUORINATED PHOSPHATE ROCK

Investigators in the U. S. Department of Agriculture have shown that the  $P_2O_5$  in phosphate rock can be made available by a process of defluorination. If finely divided phosphate rock, containing sufficient silica, is heated to about  $1400^\circ C.$  and treated with steam the fluorine is removed almost completely and up to 85 per cent of the  $P_2O_5$  becomes available. The fluorine is removed in two stages; in the first the fluorapatite  $[3Ca_3(PO_4)_2 \cdot CaF_2]$  loses half its fluorine to form a hydroxyfluorapatite, which is practically citrate-insoluble. Further treatment with water vapor forms hydroxyapatite, which has a low citrate solubility, but at  $1400^\circ C.$  in the presence of silica the phosphate becomes citrate-soluble. The process as developed by T.V.A. fuses the rock and heats to  $50^\circ$  to  $170^\circ C.$  above the fusion temperature, under which conditions defluorination is rapid. Water vapor in the combustion products from hydrocarbon fuels is sufficient to cause defluorination. The compounds formed appear to be  $\alpha-Ca_3(PO_4)_2$  in a slag of  $CaFeSi_2O_6$ . This method of rendering the  $P_2O_5$  in phosphate rock available represents a low cost process. A new plant having a capacity of 120 tons per day has been put in operation by T.V.A.

Phosphate rock can be defluorinated and converted to calcium metaphosphate by reaction with moist gases containing phosphorus pentoxide, formed by the combustion of phosphorus in moist air



The products of combustion from a phosphorus burner are passed up through a tower containing phosphate rock at about  $1000^\circ C.$  The reaction occurs and the molten calcium metaphosphate runs to a sump

at the base of the furnace, from which it is withdrawn. In order to use phosphate fines, a system has been devised in which these are blown into the gases containing phosphorus pentoxide. The proportion of fluorine volatilized increases with the moisture content of the combustion products and goes as high as 90 per cent. Phosphate absorption is practically complete, production figures showing 99.8 per cent. Practically all this  $P_2O_5$  is citrate-soluble. This process represents one in which a high  $P_2O_5$  fertilizer material is produced directly from phosphorus and phosphate rock.

#### COMPLETE FERTILIZERS

The three most important elements necessary for plant life are nitrogen, phosphorus, and potassium. The content of a complete fertilizer mixture, as 4-8-2, containing all three is expressed as percentage of  $N_2-P_2O_5-K_2O$ . In order to adjust the content of the various elements to the desired final value many blending agents are used to contribute to the fertilizer value and give bulk to final product, such as fish meal, cottonseed meal, ground bone, slaughter house tankage, sewage sludge, gypsum, ground limestone and magnesite, sand, and others. A partial tabulation of fertilizer materials consumed in the United States in 1944 is given in Table 10-4.

#### MARKETING

Superphosphate, like potash, is sold on the basis of the unit short ton. Thus each per cent of available  $P_2O_5$  in the fertilizer is one unit. Prices for run-of-pile material are slightly less than when a specified  $P_2O_5$  content must be made. Granulated phosphate is quoted at 2 cents per unit higher. The lowest price is in Florida and prices elsewhere are determined by the freight rates of phosphate from the Florida fields. Standard grades of mixed fertilizers are made by most companies, the prices being fixed by the various ingredients. Formerly burlap sacks were used to contain fertilizer not shipped in bulk. Now the 100-pound multiple-wall paper bag is used.

The fertilizer industry is highly seasonal, with the bulk of the production being moved within two months in the early spring and another smaller buying period in the late fall. Such buying habits necessitate that the producer have available a large storage capacity to enable plant operations to run uniformly throughout the year.

TABLE 10-4 Fertilizer Materials Consumed in the United States, 1944\*

	<i>Mixed, tons</i>	<i>As such, tons</i>	<i>Total, tons</i>
Normal superphosphate	4,292,000	1,578,000	5,870,000
Double superphosphate	58,500	81,000	139,500
Rock phosphate	28,000	196,290	224,290
Basic slag	0	91,000	91,000
Ammonium phosphates	29,300	34,300	63,600
Muriate of potash	756,000	40,000	796,000
Sulfate of potash and K-Mg	114,400	7,400	121,800
Manure salts	214,000	26,000	240,000
Nitrate of soda + K-Na	12,600	837,900	850,500
Sulfate of ammonia	576,000	139,000	715,000
Ammonium nitrate	90,000	162,000	252,000
Ammonia and solutions	322,000	15,000	337,000
Cyanamide	9,000	81,000	90,000
Manganese sulfate	13,000	1,000	14,000
Miscellaneous inorganic	84,000	91,600	175,600
Sewage sludge	91,000	41,000	132,000
Cottonseed meal	35,000	18,000	53,000
Process tankage	108,200	800	109,000
Miscellaneous organics	376,300	72,100	448,400
Gypsum	80,000	138,000	218,000
Dolomite and limestone	445,000	0	445,000
Sand and other filler	711,000	0	711,000
<b>Total</b>	<b>8,445,300</b>	<b>3,651,390</b>	<b>12,096,690</b>

\* U. S. Department Agriculture Circ. 756 (1946).

### *Phosphoric Acid and Phosphorus*

Phosphoric acid is produced by two methods, the wet process in which phosphate rock is reacted with sulfuric acid and the thermal process in which the phosphate rock is reduced to phosphorus which is oxidized to the pentoxide and absorbed in water. In 1945 there were 19 plants making phosphoric acid, 7 used the wet process, 11 used the thermal process and 1 used both processes. The production by these two methods is approximately equal.

	<i>Tons of 50% H<sub>3</sub>PO<sub>4</sub></i>
Wet process	366,093
Thermal process	364,850
<b>Total</b>	<b>730,943</b>

WET PROCESS

What originally was a batch process has been advanced by chemical engineering methods to give a continuous process. The reaction involved is a simple one.

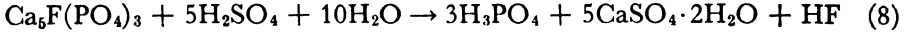

The original installation of the Dorrco process at Trail, B. C., has been described in the literature.\* Considerable change has been made in

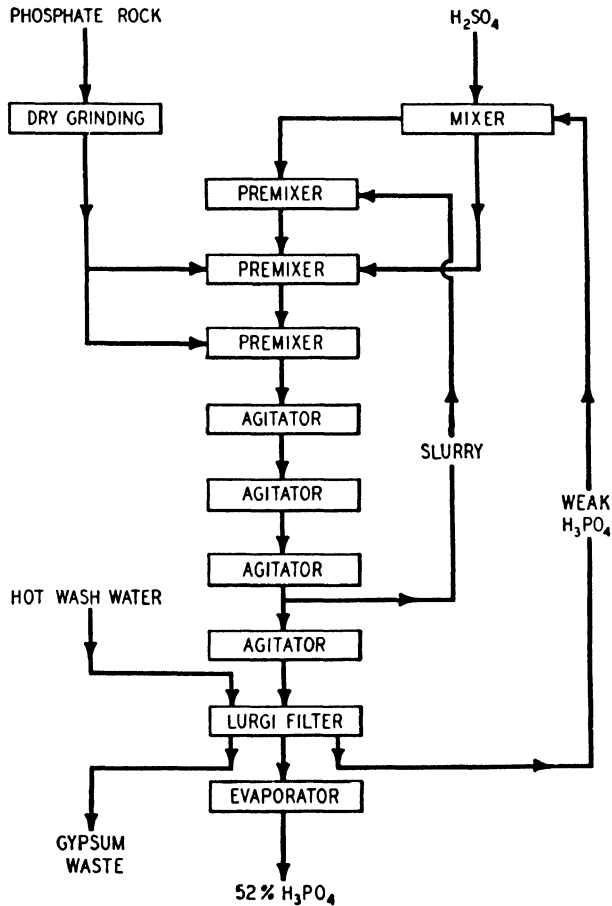

FIGURE 10-6. Dorr Strong Acid Process for Phosphoric Acid

more recent installations, as shown in Figure 10-6. The small pebble or ground phosphate rock is further ground in a Raymond mill so that

\* Chem. & Met.'s Chemical Engineering Flowsheets (4th Ed.), No. 48.

90 per cent will pass a 100-mesh screen. This fine rock can be added to either the second or third pre-mixer, or divided between them. Concentrated sulfuric acid is diluted to about 30 per cent with the weak wash solution and the resulting hot acid added to either the first or second pre-mixer, or divided between them. The pre-mix and agitator tanks are constructed of wood, lined with sheet lead and then acid-resistant brick. The agitator parts are rubber-covered steel. The tanks are covered, and wood ducts conduct the fumes from the tanks to a scrubber where fluorine compounds are removed. Cooling is required and air is blown through the slurry in each tank, all evolved vapors going off together. In this way considerable water is evaporated, which allows the use of more wash water on the filter. Following the third agitator tank a portion of the slurry is returned to the first pre-mix tank, which further dilutes the hot acid from the acid mixer. This recirculation feature is important, as it introduces into the second pre-mixer a slurry that is dilute in sulfuric acid and already contains many crystal nuclei of gypsum ( $\text{CaSO}_4 \cdot 2\text{H}_2\text{O}$ ). These crystals grow in the solution to form large, easily filtered crystals, whereas a direct reaction forms many fine crystals difficult to filter and wash. The addition of phosphate fines and dilute sulfuric acid at two points permits the maintenance of the desired excess of sulfate throughout the system. The concentration of sulfate is of vital importance, since variations beyond closely prescribed limits affect the crystal structure adversely, lower the extraction, and give poorer capacity and washing efficiency. The concentration of total sulfate and of phosphoric acid in solution, and the ratio of solids to liquids in the system are controlled closely. Sulfate is maintained at about 2 per cent total sulfate (free sulfuric acid and dissolved calcium sulfate), the solution is maintained at about 40 per cent phosphoric acid, and the slurry at 35 per cent solids in suspension. The slurry is filtered on a continuous filter of the horizontal Lurgi type.

The Lurgi horizontal belt type filter\* (Figure 10-7) consists of an endless belt passing over two horizontal drums. The belt is made up of three layers: an endless rubber transport belt which carries a perforated rubber belt and on top of this a filter cloth. Underneath the belt are several suction boxes *B* slotted in the top to allow the filtrate to enter through the perforations in the center of the transport belt. The filtrate drains into receivers *R* which are connected to a vacuum pump *V* suitably protected by a surge tank *T*; the system operates under a vacuum of 600 to 650 mm. The feed *F* is spread evenly on the belt by

\* J. G. Wallny, U. S. Patent 2,034,784 (March 24, 1936).

maintaining an overflow to remove excess feed. A layer up to 4 inches thick can be made, depending on the ease of washing the filter cake. The sections are separated from one another by adjustable dams *D*. Wash water *W* is used in the last section, the filtrate from which is used as the wash solution for the second section. The weak phosphoric acid from this section is used in the process (Figure 10-6) to dilute the sulfuric acid. The washed gypsum cake *G* drops off as the belt goes over the end roll, and the filter cloth is cleaned by a spray of water on the underside of the filter.

The acid obtained from the filter is about 40 to 44 per cent phosphoric acid and usually must be concentrated before being used for the manufacture of double superphosphate or phosphate salts. This can be

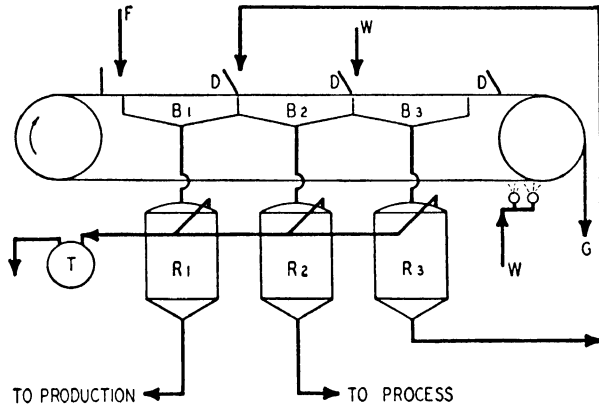
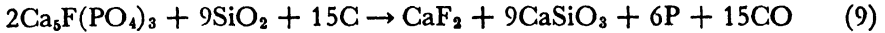

FIGURE 10 7. Lurgi Continuous Belt Filter

done in tube evaporators or by submerged combustion evaporation. The former are single-effect vacuum evaporators in which all parts in contact with acid are covered with lead. A product containing 55 per cent phosphoric acid is obtained. The latter (cf. Ch. 2-46) operates a burner of stainless steel in a lead-lined cone-bottom tank. The concentration usually produced is that necessary to operate satisfactorily in the subsequent double superphosphate process. Acid made by the wet process is used almost entirely for the production of fertilizer ingredients so that the purity is of no great concern. Before the advent of thermal processes the dilute acid was purified by removing arsenic, fluorine, iron, and other contaminants by treatment with hydrogen sulfide and limestone, after which the acid was concentrated.

## THERMAL PROCESS

The recovery of phosphoric acid, phosphorus pentoxide, or elemental phosphorus is based on a simple series of reactions.



When phosphate rock is treated with silica, an acid anhydride, under reducing conditions, phosphorus is formed as a reduction product. The elemental phosphorus can be condensed and separated from the furnace

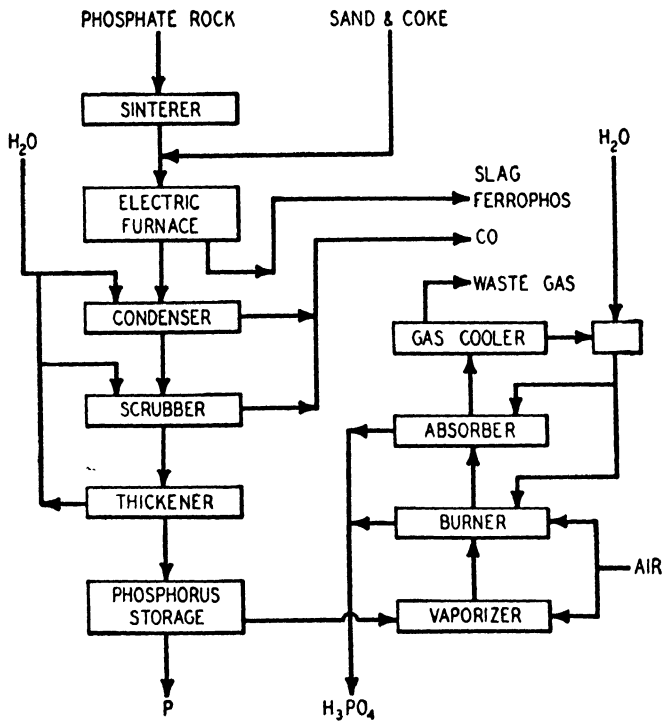

FIGURE 10-8. Electric Furnace Process for Phosphorus and Phosphoric Acid

gas, or air can be admitted and phosphorus pentoxide formed, which can be dissolved in water to form phosphoric acid. An advantage of the thermal reduction processes over the wet process is that low grade phosphate rock can be used. Inasmuch as silica must be added to the charge, a low grade phosphate rock with a higher content of sand and clay can be

used, but the phosphorus pentoxide content should be at least 25 per cent. In order that the fine phosphate rock shall not be blown out of the furnace it is nodulized by heating in a rotary kiln or it is passed through a sintering machine and the sintered rock screened to remove particles passing a 4-mesh screen.

In the electric furnace process\* (Figure 10-8) a typical charge would be 2000 pounds phosphate rock (31 to 33%  $P_2O_5$ ), silica 610 pounds, and coke breeze 360 pounds. The silica rock is between  $\frac{3}{8}$  inch and 2 inches. The silica-to-lime ratio of 1, shown in equation (8), is never used, but a ratio of from 0.75 to 0.90 gives lower melting slags. The amount of carbon used in the coke is in excess of that required in equation (9) because of the reduction of any iron oxide to iron, and mechanical losses of carbon in the slag. If a higher yield of ferrophosphorus is desired, scrap iron is added to the charge.

A sectional view of an electric phosphate furnace is shown in Figure 10-9. This is a cylindrical furnace with a maximum inside diameter of

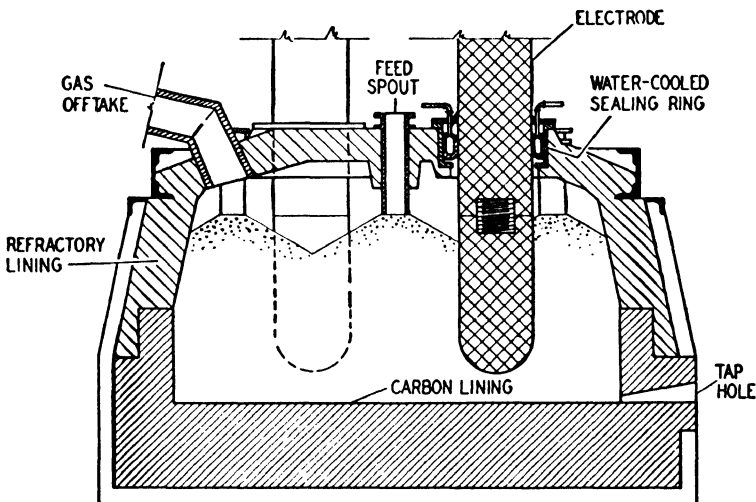

FIGURE 10-9. Electric Phosphate Furnace (Redrawn from *Chem. Met. Eng.* 45, 375 (1938) with permission)

15 ft. 4 in. and depth of 8 ft. 3 in., lined with carbon blocks to a depth of  $3\frac{1}{2}$  feet and refractory brick above this. The exterior is of steel plate and is water-cooled. It operates on 3-phase alternating current and uses 3 carbon electrodes 30 inches in diameter, located at the corners of an

\* *Chem. & Met.'s Chemical Engineering Flowsheets* (4th Ed.), No. 47. Pictured Flowsheet, *Chem. Met. Eng.* 45, No. 5, 269-72 (1939).



equilateral triangle 5 ft. 9 in. on a side. The electrodes enter the furnace through water-cooled packing glands in the furnace roof. Normal power load is 5,500 kilowatts, drawing 18,800 amperes with 192 volts between phases. Such a furnace will reduce from 20 to 25 tons per day of  $P_2O_5$  in the charge (8 to 10 tons phosphorus). The distribution of charge and output is given in Table 10-5. In later designs the three electrodes are in line in a furnace the hearth of which measures 27 feet by 13 feet with an 11 foot depth from the roof. Such a furnace operates with a 9000 kilowatt load at a 96 per cent power factor, reducing 45 to 50 tons per day of  $P_2O_5$  in the charge (18 to 20 tons phosphorus).

TABLE 10-5 Material Balance over Electric Furnace Operating on Sintered Tennessee Muck

<i>Input, tons</i>		<i>Output, tons</i>		<i>P<sub>2</sub>O<sub>5</sub> balance, tons</i>	
Rock	3.961	Slag	3.000	Charged	1.000
Silica	0.150	Metal	0.220	Output	—
Coke	0.523	Gases	1.502	In slag	0.024
Electrode	0.002			In metal	0.130
Air leakage	0.093			In gases	0.846
	<hr/> 4.684		<hr/> 4.722		<hr/> 1.000

<i>Temperatures</i>	
Slag	1610°C.
Gases	344°C.

In operation the slag and ferrophosphorus are continuously tapped from the furnace into skimming pots. The metal alloy sinks to the bottom and the slag overflows into a slag ladle or pit. The ferrophosphorus is recovered and sold to the metallurgical industry, where it is used in the manufacture of sheet steel, pipe, and alloys. The slag, which contains approximately 0.5 per cent  $P_2O_5$ , can be granulated readily with high pressure water jets to give a product which passes a 6-mesh screen. It is used as a soil conditioner, particularly on heavy clay soils. The calcium silicate acts as a neutralizing agent in acid soils but remains inert in neutral or alkaline soils. A fluorine balance shows that over 75 per cent of the fluorine is removed in the slag.

Operation of the furnace can be carried out to produce either phosphoric acid or phosphorus. The former is the simpler, for it is necessary only to admit the excess air to the furnace gases in a combustion chamber and absorb the phosphorus pentoxide in water or dilute acid circulated through packed towers.

Because of the value of elemental phosphorus for various purposes, and the fact that it is equivalent to 229 per cent  $P_2O_5$ , it can be shipped to the point of utilization more cheaply and there oxidized to phosphoric acid. One problem in the condensation of phosphorus is the removal of dust and fumes from the gases leaving the furnace. This difficulty can be minimized by proper control of the furnace charge as to size and kind of phosphate rock used. Fumes of potassium, sodium, fluorine, and silica compounds, as well as dust, are in the gases. These can be removed to a large extent by means of dust collectors, or completely by electrostatic precipitators before the gas temperature drops to the dew point of phosphorus. The furnace dust contains approximately 15 per cent each of  $K_2O$  and  $P_2O_5$  when Tennessee rock is used as the furnace charge. The dust is agglomerated and used as a fertilizer material. The gas contains 2.5 to 3.2 pounds of phosphorus per 100 cu. ft. (at  $0^\circ C.$  and 760 mm. Hg) which is condensed out by water sprays in a packed tower condenser and scrubber. Phosphorus has a melting point of  $44.1^\circ C.$  so that all equipment in which it is handled must be maintained above this temperature. The exit gas from the condenser contains about 96 per cent carbon monoxide and is used for fuel. Phosphorus is slightly soluble in water, so that condenser water must be recycled.

For the oxidation of phosphorus the liquid is sprayed into a vaporizing chamber into which sufficient air is admitted to give enough heat of oxidation to vaporize the remaining phosphorus. A large part of the impurities present in the phosphorus is fused to a slag which is removed at intervals. The gases from the vaporizer pass to the burner into which air is blown to complete the oxidation. Water sprays in the lower part of this tower hydrate the phosphorus pentoxide to phosphoric acid and cool the gases before entering the absorber tower. This is a coke-packed tower into which dilute acid is sprayed at the top against the rising acid mist. The acid collected from the bottoms of the two towers contains about 80 per cent phosphoric acid. The gas from the absorber passes through three tubular coolers in series in which most of the water vapor and any remaining acid mist are condensed. The waste gas is then exhausted to a stack. In some plants a Cottrell precipitator is used to remove the acid mist. An efficient installation introduces phosphorus and

a controlled quantity of air directly into an externally water-cooled graphite chamber to produce  $P_2O_5$ , which is hydrated in a graphite spray tower and the acid mist recovered in an electrostatic precipitator. Although the initial cost is high, the acid resistant graphite reduces operation and maintenance costs to a minimum. Dry phosphorus can be burned with dry air in cooled combustion chambers constructed of mild steel. No phosphoric acid mist is formed, so corrosion difficulties are absent. The dry phosphorus pentoxide is then absorbed in controlled aqueous solutions containing about 85 per cent phosphorus pentoxide, known as "superphosphoric acid." This solution is a viscous liquid that can be diluted with water to form either pyro- or orthophosphoric acid. Such operation is reminiscent of sulfur trioxide absorption.

A thermal process in which the phosphate rock was reduced in a blast furnace\* was operated successfully by the Victor Chemical Works for a period of ten years. The furnace charge was briquets of phosphate rock with half the coal needed for reduction, sand, and coke. The blast furnace gas was split into three parts; from one elemental phosphorus was condensed, the second was burned under steam boilers to supply power for the air blowers, and the third was burned in the hot blast stoves that preheated the air supplied to the blast furnace. The oxidized gases were passed to a hydrator and sprayed with water, followed by a Cottrell precipitator in which the phosphoric acid fog was removed. Recovery of phosphorus equalled the electric furnace; however, the blast furnace gas is much more dilute in phosphorus.

#### MATERIALS OF CONSTRUCTION

Both wet and thermal process plants encounter corrosion at many points due to impurities, concentration, or temperature. Hot, concentrated phosphoric acid represents a difficult corrosion problem best solved with acid-resistant ceramic material. Wooden, metal, or concrete tanks are prepared for such lining by treating with asphalt, covered with a lead sheath, and then the layer of acid-resistant brick. Rubber-covered steel equipment gives good service and rubber hose is used to convey acid. Wood is satisfactory for dilute (15 per cent) phosphoric acid at not too high temperatures. Lead-sheathed wooden tanks are used for the storage of cold, concentrated phosphoric acid; however, lead fails rapidly when the acid is hot. Silicon-iron alloys, as Duriron, are

\* *Chem. & Met.'s Chemical Engineering Flowsheets* (4th Ed.), No. 46.  
Pictured Flowsheet, *Chem. Met. Eng.* 46, No. 5, 269-72 (1939).

satisfactory for warm, concentrated acid. The nickel-silicon alloys, as Hastelloy D, and nickel alloys high in chromium or molybdenum show a low corrosion rate. The stainless steels with 26–30 per cent chromium, or nickel-chromium-molybdenum, are resistant under particular conditions and fail under others. Carbon, as graphite or Karbate, is resistant to all concentrations and temperatures.

## MARKETING

Elemental phosphorus exists in three forms, white or yellow phosphorus, red phosphorus, and black phosphorus. The yellow phosphorus is the form condensed from the electric furnace. It melts at 44.1°C., so above this temperature it can be pumped as any other liquid. Because of its extreme flammability it must be covered with water at all times to protect it from the air. Containers are filled with liquid phosphorus (density 1.75 gm. per cc.) by displacement of water. The liquid solidifies in the container, and is then ready for shipment. Tank-cars contain pipe coils in the bottom through which cooling water is circulated during loading to solidify the molten phosphorus. At the unloading point steam is admitted to the coils to melt the phosphorus, which is forced out through the exit line by water pumped into the top of the tank. Yellow phosphorus is produced in the form of 2.5-pound cakes, and 5- or 10-pound wedges which are packed in drums containing 240, 325, or 400 pounds net weight, being covered with water to exclude air. The tank-car of phosphorus contains approximately 100,000 pounds net weight. As phosphorus is equivalent to 229 per cent phosphorus pentoxide, the element can be shipped more cheaply than acid. At the point of utilization it can be converted into phosphorus pentoxide, phosphoric acid, halides, and other commercial compounds. Red phosphorus is made by heating yellow phosphorus at 240° to 250°C. until all is converted. A trace of iodine may be used to catalyze the reaction at lower temperatures. The red form is stable in air and nonpoisonous, so is used for most industrial purposes. It is marketed in tins containing 11 pounds and in full open-head steel drums containing 100 pounds. Black phosphorus is only of scientific interest.

Phosphoric acid is usually marketed as the aqueous solution in three grades: technical, food, and U.S.P. The technical grade is usually sold in 50, 75, and 85 per cent concentrations, though the 100 per cent acid can be obtained. The food grade is 50 and 75 per cent; the U.S.P. is 85 and 10 per cent acid. No specifications are usual for technical acid,

other than  $P_2O_5$  content, as most of this grade is used to manufacture superphosphate and other fertilizer salts. Acid to be used for food and pharmaceutical purposes has definite specifications limiting the heavy metal content, as lead and arsenic, and the fluoride content. Phosphoric acid is used in the food industry to impart tartness to soft drinks and flavoring syrups. All grades of acid can be obtained in all size containers from the 1-pound bottle up to the 8,000-gallon tank-car. The usual containers are 13-gallon glass carboys, 50-gallon wax-lined wooden barrels, 10-ton rubber-lined tank-trucks and 8,000-gallon (50-ton) rubber-lined tank-cars.

### Phosphates

A large number of salts of the phosphoric acids are of commercial importance as chemicals. The sodium salts are used most extensively, followed by the calcium, and ammonium salts (not for fertilizer use). Phosphates of most of the common metals are articles of commerce manufactured by chemical companies. Production of some of these salts in 1944 is given in Table 10-6.

#### PHOSPHORIC ACIDS

A number of phosphoric acids exist, related to orthophosphoric acid ( $H_3PO_4$ ) by having less water in the molecule. These acids are:

<i>Name</i>	<i>Formula</i>	<i>Per cent P<sub>2</sub>O<sub>5</sub></i>
Orthophosphoric acid	$H_3PO_4$	72.7
Pyrophosphoric acid	$H_4P_2O_7$	82.5
Triphosphoric acid	$H_5P_3O_{10}$	79.8
Metaphosphoric acid	$(HPO_3)_n$	88.7

A number of salts of these acids in which one or more of the hydrogen atoms have been replaced with a metal atom are marketed. A series of salts of the glassy metaphosphoric acid is available. Yost and Russell state: "No other element exists in a single-valence stage in such a variety of acids having so many puzzling properties as does phosphorus."

Ortho- and pyrophosphoric acids ionize stepwise so that any number

of the hydrogen atoms can be replaced, and all the possible sodium salts of these two acids have been prepared.

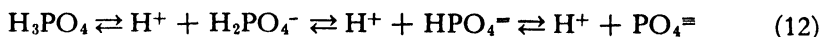

The ionization constants are:

	$\text{H}_3\text{PO}_4$ (25°C.)	$\text{H}_4\text{P}_2\text{O}_7$ (18°C.)
$\text{H}^+ \text{K}_1$	$7.5 \times 10^{-3}$	0.14
$2\text{H}^+ \text{K}_2$	$6.2 \times 10^{-8}$	0.011
$3\text{H}^+ \text{K}_3$	$1 \times 10^{-13}$	$2.1 \times 10^{-7}$
$4\text{H}^+ \text{K}_4$		$4.06 \times 10^{-10}$

TABLE 10-6 Production of Phosphate Salts for Chemicals in 1945\*

<i>Compound</i>	<i>Basis</i>	<i>Production, tons</i>	<i>Number of Plants</i>
Calcium phosphate:			
Monobasic	100% $\text{CaH}_4(\text{PO}_4)_2$	31,363	5
Dibasic	100% $\text{CaHPO}_4$	29,466	8
Sodium phosphate:			
Monobasic	100% $\text{NaH}_2\text{PO}_4$	14,783	7
Dibasic	100% $\text{Na}_2\text{HPO}_4$	62,673	8
Tribasic	100% $\text{Na}_3\text{PO}_4$	88,731	9
Pyro	100% $\text{Na}_4\text{P}_2\text{O}_7$	27,925	4
Meta	100% $\text{NaPO}_3$	43,447	7

\* Bureau of the Census Figures.

## CALCIUM PHOSPHATES

The three calcium orthophosphates are of chemical importance. Monocalcium phosphate is marketed as the monohydrate [ $\text{CaH}_4(\text{PO}_4)_2 \cdot \text{H}_2\text{O}$ ] and in the anhydrous form. It is made by mixing the calculated amounts of lime and phosphoric acid in a mixer, allowing the product to age to complete the reaction, and drying. A coated anhydrous salt is made by reacting lime and strong phosphoric acid containing minor amounts of metal compounds, as potassium, originating in the phosphate rock, at 140° to 175°C. drying at 200° to 220°C. to give minute crystals having a surface glaze that retards the rate of solution and reaction with alkaline solutions. These compounds are used extensively in baking powders, so meet specifications of purity necessary for foodstuffs.

Dicalcium phosphate is marketed as the dihydrate ( $\text{CaHPO}_4 \cdot 2\text{H}_2\text{O}$ ) and in the anhydrous form. It is made in a manner similar to the monocalcium phosphate. Two grades are the technical and dentifrice. The former meets pure food laws and is used to add calcium and phosphorus to the diet in bread and other foods. The latter grade is an impalpable powder used as a polishing agent in nonalkaline tooth pastes and powders. The anhydrous compound is used extensively to enrich stock feed.

A free-flowing mono- or dicalcium phosphate can be assured by milling the freshly reacted compound in a cage mill prior to drying. This operation forms the product in round pellets rather than individual crystals. The size of the pellets is regulated by the water content of the product before milling. The heat of reaction, with proper control of acid concentration and mixing time, is sufficient to do the preliminary drying of the product.

When tricalcium phosphate is precipitated by the addition of phosphoric acid to a milk of lime suspension the compound is a hydroxyapatite [ $\text{Ca}_5(\text{OH})(\text{PO}_4)_3$ ] though a standardized method recently developed produces the true compound. Three grades are available, U.S.P., dentifrice, and granular. The U.S.P. grade is used as a conditioner for salt, soda, and sugar to prevent caking of crystals, as well as for mineral fortification of foods. The dentifrice grade is used as a polishing agent in tooth pastes and powders. The granular grade is used as an adsorbent to remove fluorine from water, refining vegetable oils, and purifying air and gases. All grades of all three are supplied in 100-pound bags, drums, and slack barrels up to 350 pounds.

*Baking Powders* Large quantities of phosphate chemicals are consumed in baking powders. A baking powder is defined by the U. S. Department of Agriculture as: "The leavening agent produced by the mixing of an acid-reacting material and sodium bicarbonate, with or without starch or flour. It yields not less than 12 per cent available carbon dioxide. The acid-reacting materials in baking powders are: (1) tartaric acid or its acid salts, (2) acid salts of phosphoric acid, (3) compounds of aluminum, or (4) any combination in substantial proportions of the foregoing." Calcium monophosphate is supplied in various grades, mixed with starch and calcium sulfate, to give a definite neutralizing value. Reactions which may occur under favorable conditions are given by equations (13), (14), and (15); the last one represents the probable reaction under conditions of baking.

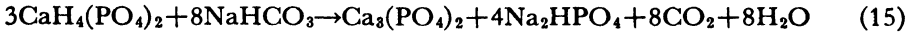
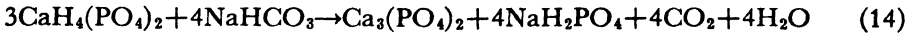
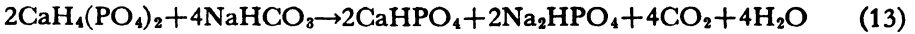

Sodium acid pyrophosphate ( $\text{Na}_2\text{H}_2\text{P}_2\text{O}_7$ ) is used in baking powders consumed by bakers who mix together the acid salt and bicarbonate before using.

SODIUM PHOSPHATES

*Sodium Orthophosphates* The three sodium salts of orthophosphoric acid are all important industrial chemicals (Table 10-5). A generalized flowsheet for the manufacture of sodium phosphates is given in Figure 10-10. For the monosodium phosphate, the reaction of equation (16) is

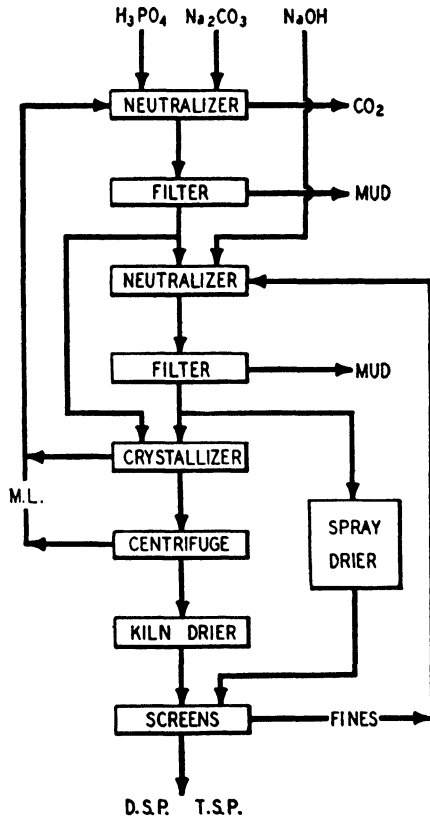
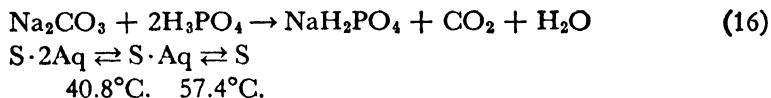

FIGURE 10-10. Production of Di- or Tri-Sodium Phosphate



carried out. The commercial forms of the monosodium phosphate are the monohydrate and anhydrous salts.



When monosodium phosphate is crystallized from a phosphoric acid solution there is formed the compound  $\text{NaH}_2\text{PO}_4 \cdot \text{H}_3\text{PO}_4$ , or  $\text{NaH}_5(\text{PO}_4)_2$ , called "hemisodium phosphate."

The disodium phosphate (D.S.P.) likewise can be made from sodium carbonate (equation 17). The commercial forms of the disodium phosphate are the dodecahydrate, the heptahydrate, and the anhydrous salt.

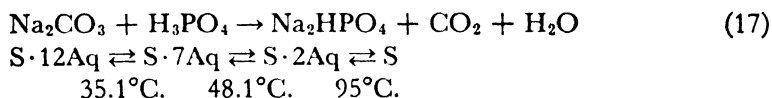

Trisodium phosphate (T.S.P.) is the large tonnage chemical of the phosphate group. In its preparation\* disodium phosphate solution is first prepared from sodium carbonate and phosphoric acid, using a slight excess of phosphoric acid so that all carbonate is decomposed. The solution is boiled to drive off all carbon dioxide. If the phosphoric acid is prepared by the wet process a precipitate of iron, aluminum, and calcium compounds forms, which is filtered off, washed and discarded. From this solution can be crystallized disodium phosphate. Sodium carbonate is not sufficiently basic to neutralize the third hydrogen atom in the acid, which must be done with sodium hydroxide solution. To the D.S.P. solution is added a solution containing the required amount of sodium hydroxide. The hot solution is again filtered to remove any precipitate and is sent to the crystallizers containing about 25 per cent of dissolved salt. In the series of continuous crystallizers the temperature is reduced from  $60^\circ$  to  $30^\circ\text{C}$ . at a uniform rate to produce a uniform crystal of the desired size. About 70 per cent of the T.S.P. is crystallized out, the rest being recirculated in the mother liquor. The wet crystals are centrifuged and then dried in a rotary kiln dryer. The dry crystals are screened to give the desired sizes, any fines or dust being returned to the neutralizer to be dissolved and recrystallized. Instead of crystallizing, the solution can be spray-dried by spraying the solution of the proper concentration into the top of a tall tower. The fall through the hot air circulated in the tower dries the spherical droplets to a globular form.

\* *Chem. & Met.'s Chemical Engineering Flowsheets* (4th Ed.), No. 73.

A flake form is prepared by passing the concentrated solution over a chilled roll.

Because of the impurities present in phosphoric acid prepared by the wet process, acid prepared from electric furnace phosphorus is now used more frequently. This is particularly true where the manufacture of the salts is at a distance from the source of phosphoric acid, so that shipment of phosphorus is more economical. To avoid crystallization operations the anhydrous salts can be produced by fusing together in a furnace the correct proportions of sodium carbonate, sodium hydroxide, and high strength phosphoric acid. The same mixture will give  $\text{Na}_2\text{HPO}_4$  or  $\text{Na}_4\text{P}_2\text{O}_7$  depending on the temperature used. The fusion mass is ground to give the anhydrous powder.

The T.S.P. crystallized from the solution as described does not yield  $\text{Na}_3\text{PO}_4 \cdot 12\text{H}_2\text{O}$ . It has been shown that this salt does not crystallize from solution, but that a certain amount of sodium hydroxide exists in solid solution in the crystals to give a ratio of  $\text{Na}_2\text{O}$  to  $\text{P}_2\text{O}_5$  varying from 3.0 to 3.22. A commonly assigned formula is  $\text{Na}_3\text{PO}_4 \cdot \frac{1}{4}\text{NaOH} \cdot 12\text{H}_2\text{O}$ , though it is understood that this fraction can vary from approximately  $\frac{1}{11}$  to  $\frac{1}{5}$ . As these crystals deplete the solution of alkali the point is reached where disodium hydrogen phosphate also crystallizes from the solution along with T.S.P. to maintain a constant alkalinity. In many of the so-called neutral cleaners on the market D.S.P. is added to neutralize the excess alkali in the T.S.P. used. Various patents claim a T.S.P. free from alkali, by crystallization of  $\text{Na}_3\text{PO}_4 \cdot 10\text{H}_2\text{O}$  and other means. The monohydrate  $\text{Na}_3\text{PO}_4 \cdot \text{H}_2\text{O}$  and anhydrous salts are commercial grades.

The monosodium phosphate is used mainly for water treatment, boiler compounds, and as an electroplating reagent. The standard grade passes 20-mesh and is retained on a 60-mesh screen. The hemisodium phosphate is used as an additive to ensilage, in contact tinning of brass, or wherever a strong acid is desired in solid form. It is packed only in drums or barrels with moisture-proof liners. The disodium phosphate is available in technical and U.S.P. grades, the latter being used in food preparations. It is used in water conditioning, pharmaceuticals, tin weighting of silk, dyeing, and food preparations. The standard grade of dodeca- or heptahydrate passes 10-mesh and is retained on a 50-mesh screen. The anhydrous salt is finer, 50 per cent passing 100-mesh. Trisodium phosphate is used most extensively in detergent compounds and water treatment. T.S.P. is available in a number of commercial grades, coarse (pass 10-, on 20-mesh), medium (pass 16-, on 30-mesh),

fine (pass 20-, on 80-mesh), powder (pass 40-mesh, 40% pass 100-mesh), flake (pass 2-, on 20-mesh), and globular in similar sizes. All three of these phosphates are available in 100-pound multiwall moisture-proofed paper bags, 125-pound fiber or plywood drums, and slack barrels containing 200, 300, 325, 350, or 400 pounds, depending on the particle size and state of hydration. T.S.P. can be obtained in 25- and 50-pound fiber drums.

*Sodium Pyrophosphates* Pyrophosphoric acid is formed by evaporating orthophosphoric acid at 255° to 260°C. The sodium acid phosphates can be converted to pyrophosphates by heating.



As indicated by the ionization constant, pyrophosphoric acid is a strong acid in which all four hydrogen ions can be replaced stepwise. The di- and tetrasodium pyrophosphates are the most important salts. The former is used in baking powders and as a peptizing agent. The latter (T.S.P.P.) is used extensively in detergents and as a peptizing agent to control the viscosity of oil well drilling muds. The  $\text{Na}_2\text{H}_2\text{P}_2\text{O}_7$  is available as a powder (95% pass 100-mesh, 80% pass 200-mesh),  $\text{Na}_4\text{P}_2\text{O}_7 \cdot 12\text{H}_2\text{O}$  as crystals (pass 20-, 20% pass 80-mesh), anhydrous  $\text{Na}_4\text{P}_2\text{O}_7$  as granules (pass 20-, on 100-mesh), and powder (95% pass 100-mesh). All are packaged in 100-pound paper bags, 125-pound drums, and 325- or 350-pound slack barrels.

The sodium iron pyrophosphate [ $\text{Na}_8\text{Fe}_4(\text{P}_2\text{O}_7)_5 \cdot 6\text{H}_2\text{O}$ ] is a compound, insoluble in water but soluble in dilute hydrochloric acid, used as a source of iron in the manufacture of enriched flour and other foods.

*Sodium Tripolyphosphate* The polyphosphates are of the general formula  $\text{Na}_{n+2}\text{P}_n\text{O}_{3n+1}$ , so include the pyrophosphates. The sodium tripolyphosphate ( $\text{Na}_5\text{P}_3\text{O}_{10}$ ) is the only other member definitely characterized. It is prepared by fusing together mixtures of the mono- and di-sodium phosphates



When prepared in this way the salt is an anhydrous nonhygroscopic crystalline powder or glass, depending on the rate at which the melt is cooled. It is soluble in water and can be crystallized as  $\text{Na}_5\text{P}_3\text{O}_{10} \cdot 6\text{H}_2\text{O}$ . That this compound is the only one existing between  $\text{NaPO}_3$  and  $\text{Na}_4\text{P}_2\text{O}_7$  is shown by the phase diagram (Figure 10-11). It is used in

soaps and detergent compounds and as a deflocculating agent. It is marketed as a powder (95% pass 100-mesh) and granules (pass 20-, on 100-mesh). It is available in 100-pound paper bags, 125-pound drums and 350-pound slack barrels.

*Metaphosphates* These are the salts of metaphosphoric acid ( $\text{HPO}_3$ ) which probably does not exist as such, but as a series of polymers  $(\text{HPO}_3)_n$  in the form of a glassy solid. A number of polymetaphosphates has been reported in the literature and discussed by Yost and Russell. If monosodium phosphate is fused and rapidly chilled the resulting product is a metaphosphate glass, commonly, though erroneously, known as "sodium hexametaphosphate." If a predetermined amount of alkali is

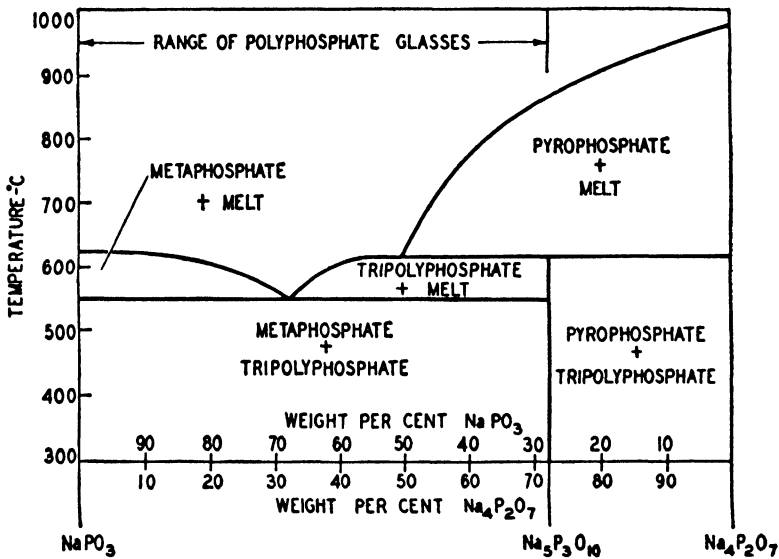

FIGURE 10-11. Phase Diagram of the System  $\text{NaPO}_3$ - $\text{Na}_4\text{P}_2\text{O}_7$  (Redrawn from *Ind. Eng. Chem.* 34, 34 (1942) with permission)

added with the monosodium phosphate, the mixture fused and rapidly chilled, a series of glasses with varying alkali content is obtained. Thus with a  $\text{Na}_2\text{O}$ -to- $\text{P}_2\text{O}_5$  ratio of 1.5 the resulting mixture has the analytical formula  $\text{Na}_6\text{P}_4\text{O}_{13}$  and is commonly called "sodium tetraphosphate," and is sold under various trade names. However, inspection of the phase diagram (Figure 10-11) shows no such compound is possible. An entire series of molecularly dehydrated phosphate glasses of varying alkali content can be made in this manner, the water solutions of which will give varying pH values, solubilities, and rates of reversion to the ortho-

or pyrophosphates. The first commercial material in this group was a glassy metaphosphate given the trade name of "Calgon,"  $\text{Na}_2\text{O}$ -to- $\text{P}_2\text{O}_5$  ratio about 1.1, and is used extensively for water treatment. For use with soaps a compound can be added to the glassy phosphate to "adjust" the pH of its solution from 7 to 8.5, the approximate pH of neutral soap solutions. These materials are marketed as hygroscopic glassy particles or powder, or in the form of beads. Grades are fine powdered (pass 40-mesh, 45% pass 100-mesh), powdered (pass 10-mesh, 30% pass 100-mesh), coarse (pass 10-mesh, on 100-mesh), and lumps (walnut size). They are marketed in drums or barrels containing 10, 25, 100, and 375 pounds.

*Water Conditioning* The most extensive use of phosphate chemicals is in the field of water conditioning. Trisodium phosphate has been used for boiler water conditioning since the work of R. E. Hall in 1925. The formation of scale in boilers is attributed to the formation of calcium sulfate and silicate which have inverted solubility curves (cf. Figure 2-12) and hence are less soluble in the liquid film adjacent to the hot tube wall. Hall showed that if the ratio of  $\text{CO}_3^{--}$  to  $\text{SO}_4^{--}$  in the water within the boiler were maintained at a sufficiently high value, calcium would be precipitated as a soft nonadherent carbonate sludge rather than as a hard adherent calcium sulfate scale. This works satisfactorily in low pressure boilers, but at high pressures and temperatures sodium carbonate is extensively hydrolyzed to sodium hydroxide, which can give rise to caustic embrittlement and corrosion. The sodium orthophosphates can replace sodium carbonate to form a nonadherent calcium phosphate sludge. A lower ratio of  $\text{PO}_4^{---}$  to  $\text{SO}_4^{--}$  can be maintained due to the greater insolubility of the calcium phosphate precipitated. The alkalinity of the resulting water can be controlled by use of D.S.P. rather than T.S.P.; M.S.P. can be used but its acidity gives rise to corrosion troubles. Thus many proprietary boiler compounds contain D.S.P. and T.S.P. These two salts can also be used for external treatment of water before it is introduced into the boiler; usually they are used on waters not hard enough for lime-soda softening.

The molecularly dehydrated sodium phosphates (metaphosphate, tripolyphosphate and pyrophosphate) have the unique property of tying up calcium, magnesium, iron, and other heavy metal ions in the form of soluble complex salts in which the heavy metal is held in the anion. This phenomenon is known as "sequestration." Metaphosphate can sequester calcium and hold it so strongly that sodium oxalate or soap will not precipitate the calcium from the solutions. In this way water

which is "hard" can be made "soft" by the addition of a molecularly dehydrated phosphate. In their ability to form complexes the metaphosphate glasses are most effective, then the tripolyphosphate, with the pyrophosphate being least effective. By the use of these compounds for boiler water conditioning, the heavy metal ions are held in solution through feed lines and economizers but in the boiler hydrolysis to the orthophosphate occurs with precipitation of the heavy metal as the phosphate. Excess alkalinity within the boiler also is decreased due to the formation of an acid salt.



Corrosion and scale formation in pipes are alleviated by the use of glassy phosphates. Water containing calcium bicarbonate deposits calcium carbonate scale as carbon dioxide is lost from the water. If from 0.5 to 5 parts per million of glassy phosphate are added to the water no precipitation occurs. This is known as "threshold treatment" because apparently the molecularly dehydrated phosphate acts to remove crystal nuclei from contact with the solution on the threshold of the crystallization process. The phosphate also acts as an inhibitor of corrosion of the iron pipe surface, apparently due to the adsorption of the phosphate, or a complex of it, on the metal or metal oxide surface. This treatment is used in municipal water supplies to minimize scale deposition in the distribution system and household water heaters. In industrial process water this treatment is used for cooling water in many types of systems.

Phosphates are extensively used in admixture with detergents to give better washing at less cost. Many household cleaning and washing powders are high in T.S.P. content. The beneficial effect of alkalinity on detergency is well known, but must be controlled to prevent damage to the material being washed. The pH values of sodium phosphates and some other commonly used compounds are given in Table 10-7. T.S.P. has a high pH value, frequently reduced with D.S.P., and is sufficiently well buffered to maintain its pH value. It also softens the water by precipitation of the heavy metal ions that otherwise would combine with soap. Tetrasodium pyrophosphate (T.S.P.P.) is used extensively because of its lower pH value, its ability to sequester heavy metal ions and its action as a dispersing agent. In many washing operations such precipitation is undesirable, so that molecularly dehydrated phosphates, particularly the glassy phosphates, are used to sequester the heavy metal ions and give a soft water. Glassy phosphates when compounded directly in the detergent mixture decrease the amount of mixture necessary for the

desired result. The elimination of the lime film on mechanically washed dishes not only gives a brighter dish but reduces the number of bacteria found on the washed dish.

The molecularly dehydrated phosphates have a specific effect as peptizing or dispersing agents. As mentioned before, T.S.P.P. has a peptizing action on insoluble soap precipitates. The glassy phosphate called "sodium tetraphosphate" is used extensively in drilling muds for oil wells to give better fluidity.

TABLE 10-7 Properties of Various Sodium Phosphates  
(pH values compared with other common chemicals)

	<i>Ratio</i> <i>Na<sub>2</sub>O to P<sub>2</sub>O<sub>5</sub></i>	<i>P<sub>2</sub>O<sub>5</sub></i> <i>Per cent</i>	<i>pH</i> <i>1% soln</i>
NaH <sub>2</sub> PO <sub>4</sub> · H <sub>3</sub> PO <sub>4</sub>	0.5	65.1	2.2
NaH <sub>2</sub> PO <sub>4</sub>	1.0	59.2	4.6
Na <sub>2</sub> HPO <sub>4</sub>	2.0	50.0	8.9
Na <sub>3</sub> PO <sub>4</sub>	3.0	43.3	12.1
NaPO <sub>3</sub>	1.0	69.6	—
Hexameta	1.0	69.6	6.5
Tetra (Na <sub>6</sub> P <sub>4</sub> O <sub>13</sub> )	1.5	60.0	7.4
Na <sub>6</sub> P <sub>3</sub> O <sub>10</sub>	1.67	57.9	10.0
Na <sub>4</sub> P <sub>2</sub> O <sub>7</sub>	2.0	53.4	10.2
Na <sub>2</sub> H <sub>2</sub> P <sub>2</sub> O <sub>7</sub>	1.0	64.0	4.2
NaHCO <sub>3</sub>	—	—	8.3
Na <sub>2</sub> CO <sub>3</sub>	—	—	11.5
NaOH	—	—	13.3

#### OTHER PHOSPHATES

Phosphates of ammonium,\* magnesium, aluminum, and many other metals are commercial items. The mono- and diammonium phosphates are used extensively as fire-retardent agents for fabrics and wood. The copper compounds are fungicides. Many other metal phosphates are used as components of glasses, glazes, and enamels. From aluminum metaphosphate can be produced a glass which transmits considerably greater amounts of ultraviolet light than silicate glasses. Phosphate glass is markedly superior to ordinary glass in corrosion resistance.

\* *Chem. & Met.'s Chemical Engineering Flowsheets* (4th Ed.), No. 86.

## ORGANIC PHOSPHATES

The organic derivatives of the phosphoric acids have become important industrial chemicals, particularly the aryl and alkyl esters of phosphoric acid. Triphenyl, tricresyl, and tributyl phosphates are important plasticizers for lacquers and plastics. They are prepared by the reaction of the appropriate phenol or alcohol with phosphorus oxychloride

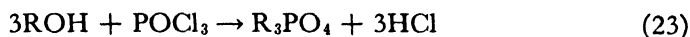

Many uses have been patented for these compounds. Alkyl acid phosphates and their salts are of importance as wetting agents to reduce surface tension of aqueous solutions.

*Student Exercises*

A. Prepare a chemical engineering report covering one of the following topics:

1. Geological theory of the phosphate deposits in:
  - a. Florida
  - b. Tennessee
  - c. Montana and Idaho
2. Mining and processing of phosphate:
  - a. Florida pebble rock
  - b. Tennessee
  - c. Western deposits
3. Superphosphate manufacture by:
  - a. The den process
  - b. Continuous processes
  - c. The Oberphos process
  - d. The granulation process
4. Recovery of fluorine compounds
5. Double superphosphate manufacture
6. Ammoniation of superphosphate
7. Defluorination of phosphate rock
8. Production of calcium metaphosphate
9. Wet process for phosphoric acid
10. Purification of phosphoric acid
11. Concentration of phosphoric acid
12. Electrothermal manufacture of phosphorus
13. Chemical and physical properties of phosphorus
14. Combustion of phosphorus
15. Absorption of phosphorus oxides
16. Blast furnace process for phosphoric acid
17. Formulation of baking powders



18. Water treatment with phosphates
  19. Threshold treatment of water with phosphates
  20. Phosphates for detergency
- B. Report all specifications available for the following chemicals:
1. Monosodium phosphate
  2. Disodium phosphate
  3. Trisodium phosphate
  4. Tetrasodium pyrophosphate
  5. Disodium pyrophosphate
  6. Monocalcium phosphate
  7. Dicalcium phosphate
  8. Tricalcium phosphate
  9. Monoammonium phosphate
  10. Diammonium phosphate
  11. Monopotassium phosphate
  12. Orthophosphoric acid
- C. Prepare a chemical engineering report on the manufacture, properties, marketing, and utilization of a compound listed in 1 to 12 above, also:
13. Phosphorus trioxide
  14. Phosphorus acid
  15. Phosphites
  16. Phosphorus halides
  17. Phosphorus sulfides
  18. Phosphorus nitrides
- D. Prepare a survey of all patents issued since 1907 on a compound listed in 1 to 11 above. Prepare a quantitative flowsheet for the manufacture of 2 tons per day of this compound.
- E. Prepare an illustrated problem with calculations for:
1. Wet process for phosphoric acid
  2. Electrothermal process for phosphoric acid
  3. Blast furnace process for phosphoric acid
  4. Concentration of phosphoric acid
  5. Manufacture of T.S.P.

### *Recommended Reading*

#### I.

A.I.M.M.E., *Industrial Minerals and Rocks*, New York, American Institute of Mining and Metallurgical Engineers, 1937, Chap. 33  
Gray, *Phosphates and Superphosphate*, London, Heron and Co., 1944

- Parrish and Ogilvie, *Calcium Superphosphate and Compound Fertilizers*, London, Hutchinson's Publications, 1939
- Sauchelli, *Manual on Fertilizer Manufacture*, Baltimore, Davison Chemical Corp., 1947
- Waggaman and Easterwood, *Phosphoric Acid, Phosphates and Phosphatic Fertilizers*, New York, Chemical Catalog Co., 1927
- Yost and Russell, *Systematic Inorganic Chemistry*, New York, Prentice-Hall, 1944

## II.

## PHOSPHATE DEPOSITS AND MINING

- Waggaman, "Phosphate Rock Industry of the United States,"  
*J. Chem. Education*, **10**, 391-5, 476-83 (1933)
- Becker, *Drying and Processing of Pebble Phosphate in the Florida Field*,  
*Am. Inst. Mining Met. Engrs. Tech. Pub.* **677**, (1936)
- Fulton, *Mining Practice in the Florida Pebble Phosphate Field*,  
*Am. Inst. Mining Met. Engrs. Tech. Pub.* **662**, (1936)
- Kirkpatrick, "Phosphorus for Progress," *Chem. Met. Eng.*, **44**, 644-50 (1937)
- Curtis, "Western Phosphate Deposits," *Ind. Eng. Chem.*, **30**, 973-9 (1938)
- Tyler and Mosley, *Recent Developments in the Tennessee Phosphate Industry*,  
*Am. Inst. Mining Met. Engrs. Tech. Pub.* **1053** (1939)
- Mansfield, "Phosphate Deposits of the United States,"  
*Economic Geology*, **35**, 405-29 (1940)
- Hubbell, "Phosphate — the Vital Non-Metallic,"  
*Eng. Mining J.*, **141**, No. 9, 49-56, No. 10, 39-42, No. 11, 52-7,  
No. 12, 53-9 (1940); **142**, No. 1, 48-52, No. 3, 56-61 (1941)
- Norberg, "Nodulizing Phosphate in Kilns,"  
*Rock Products*, **44**, No. 9, 37-40, 46 (1941)
- Hubbell, "International's New Phosphate Mine and Recovery Plant in Florida  
Pebble Field," *Eng. Mining J.*, **143**, No. 9, 43-8 (1942)
- Mansfield, "Phosphate Deposits of the World,"  
*Ind. Eng. Chem.*, **34**, 9-12 (1942)
- Fuller and Casler, "Mining Pebble Phosphate Rock in Florida,"  
*Mining and Met.*, **25**, 466-8 (1944)
- Gilbert, "Operations of Montana Phosphate Products Company,"  
*Mining and Met.*, **25**, 486-7 (1944)
- Griscom, "Mining and Washing of Phosphate Rock in Tennessee,"  
*Mining and Met.*, **25**, 477-80 (1944)
- Johnson, "Economic Factors in the United States Phosphate Industry,"  
*Mining and Met.*, **25**, 455-65 (1944)
- Kibler, "Mining and Preparation of Florida Hard-Rock Phosphate,"  
*Mining and Met.*, **25**, 475-6 (1944)

- Noyes, "Phosphate Rock Industry of Foreign Countries,"  
*Mining and Met.*, **25**, 495-506 (1944)
- Norris, "Underground Mining of Phosphate Rock at Conda, Idaho,"  
*Mining and Met.*, **25**, 481-5 (1944)
- Swainson, "Washing and Concentrating Florida Pebble Phosphate,"  
*Mining and Met.*, **25**, 469-74 (1944)
- Wustrack, "Phosphate Production Problems,"  
*Rock Products*, **47**, No. 11, 52-5; No. 12, 60-1, 109 (1944); **48**, No. 1,  
196-7, 221-2; No. 2, 82-4, 99; No. 4, 71-3 (1945)
- Felton, "Centralized Washing for Hard-Rock Phosphate,"  
*Eng. Mining J.*, **146**, No. 5, 81-5 (1945)

#### PHOSPHATE FERTILIZERS

- Larison, "Manufacture of High-Analysis Phosphates,"  
*Ind. Eng. Chem.*, **21**, 1172-5 (1929)
- Keenen, "Reactions Occurring during the Ammoniation of Superphosphate,"  
*Ind. Eng. Chem.*, **22**, 1378-82 (1930)
- Weber, "Making Phosphate Fertilizers at Trail,"  
*Chem. Met. Eng.*, **40**, 72-5, (1933)
- Shoeld, "New Process (Oberphos) Gives Improvement in Superphosphate Quality," *Chem. Met. Eng.*, **41**, 178-82 (1934)
- Reynolds, et al., "Phosphate Fertilizers by Calcination Process,"  
*Ind. Eng. Chem.*, **26**, 406-12 (1934); **27**, 87-91, 205-9 (1935); **28**,  
678-82 (1936); **29**, 1294-1304 (1937)
- Curtis, "Making Concentrated Superphosphate at T.V.A. Fertilizer Works,"  
*Chem. Met. Eng.*, **42**, 488-91 (1935)
- Marshall, et al., "Phosphate Fertilizers by Calcination Process,"  
*Ind. Eng. Chem.*, **27**, 205-9 (1935)
- White, et al., "Ammoniation of Double Superphosphate,"  
*Ind. Eng. Chem.*, **27**, 562-7 (1935)
- Copson, et al., "Superphosphate Manufacture,"  
*Ind. Eng. Chem.*, **28**, 923-7 (1936)
- Curtis, et al., "T.V.A. Estimates Favorable Costs for Concentrated Superphosphate," *Chem. Met. Eng.*, **43**, 583-7, 647-50 (1936)
- Curtis, et al., "Metaphosphate Investigation Aims at Cheaper Phosphates,"  
*Chem. Met. Eng.*, **44**, 140-2 (1937)
- Curtis, et al., "Fertilizer from Rock Phosphate — Conversion by Fusion and Treatment with Water Vapor," *Ind. Eng. Chem.*, **29**, 766-70 (1937)
- Morris, et al., "Fluorine Control and Recovery,"  
*Can. Chem. Process Ind.*, **21**, 271-4 (1937)
- Packard, "Superphosphate: Its History and Manufacture,"  
*Trans. Inst. Chem. Engrs. (London)*, **15**, 21-44 (1937)

- Curtis, et al., "Full-Scale Production of Metaphosphate Achieved at Wilson Dam," *Trans. Am. Inst. Chem. Engrs.*, **34**, 287-313 (1938)  
*Chem. Met. Eng.*, **45**, 318-22 (1938)
- Mackall and Shoeld, "Granulating Phosphate Fertilizer,"  
*Chem. Met. Eng.*, **47**, 102-5 (1940)
- McBride, "Fertilizer Practice at Curtis Bay," *Chem. Met. Eng.*, **47**, 4-9 (1940)
- Copson, et al., "Development of Processes for Metaphosphate Production,"  
*Ind. Eng. Chem.*, **34**, 26-32 (1942)
- Elmore, et al., "Defluorination of Phosphate Rock in the Molten State,"  
*Ind. Eng. Chem.*, **34**, 40-8 (1942)
- Rockwood, "Cement Plant Making Bone Meal,"  
*Rock Products*, **47**, No. 7, 44-7 (1944)
- Bridger, et al., "Continuous-Mixing Process for Manufacture of Concentrated Superphosphate," *Ind. Eng. Chem.*, **39**, 1265-72 (1947)

## PHOSPHORIC ACID

- Meckstroth, "Manufacture of Phosphoric Acid and Phosphates,"  
*Chem. Met. Eng.*, **26**, 77-9 (1922)
- Hill, "Composition of Crude Phosphoric Acid Prepared by Sulfuric Acid Process," *Ind. Eng. Chem.*, **24**, 1064-8 (1932)
- Klugh, "Thermal Production of Phosphoric Acid,"  
*Ind. Eng. Chem.*, **24**, 371-4, (1932)
- Roysten and Turrentine, "Thermal Efficiency of the Phosphate Blast Furnace," *Ind. Eng. Chem.*, **24**, 223-6 (1932)
- Weber, "Making Strong Phosphoric Acid at Trail,"  
*Chem. Met. Eng.*, **39**, 659-62 (1932)
- Easterwood, "Manufacture of Phosphoric Acid by the Blast Furnace Method,"  
*Trans. Am. Inst. Chem. Engrs.*, **29**, 1-20 (1933)  
*Chem. Met. Eng.*, **40**, 283-7 (1933)
- Curtis, "The Manufacture of Phosphoric Acid by the Electric Furnace Method,"  
*Trans. Am. Inst. Chem. Engrs.*, **31**, 278-95 (1935)  
*Chem. Met. Eng.*, **42**, 320-4 (1935)
- Curtis and Miller, "Operating Observations in T.V.A. Fertilizer Plant,"  
*Chem. Met. Eng.*, **43**, 408-12 (1936)
- Durgin, et al., "Chemical and Physical Properties of Strong Phosphoric Acids,"  
*Trans. Am. Inst. Chem. Engrs.*, **33**, 643-68 (1937)  
*Chem. Met. Eng.*, **44**, 721-7 (1937)
- Moore and Barton, "The Concentration of Phosphoric Acid,"  
*J. Soc. Chem. Ind.*, **56**, 273-8T (1937)
- Carothers, "Phosphoric Acid 1918-38," *Chemical Industries*, **42**, 523-8 (1938)
- Curtis, et al., "T.V.A. Reviews Its Experience in Phosphate Smelting,"  
*Chem. Met. Eng.*, **45**, 116-20 (1938)

- Curtis, et al., "Process Developments at T.V.A. Phosphoric Acid Plant,"  
*Chem. Met. Eng.*, **45**, 193-7 (1938)
- Curtis and Heaton, "Design for a Phosphate Furnace,"  
*Chem. Met. Eng.*, **45**, 536-40 (1938)
- Killeffer, "What's New in Phosphorus," *Ind. Eng. Chem.*, **30**, 967-72 (1938)
- Newton, "T.V.A.'s Phosphate Smelting Results,"  
*Chem. Met. Eng.*, **45**, 374-9 (1938)
- Junkins and Newton, "Instrumentation of T.V.A. Electric Phosphoric Acid Plant," *Instruments*, **12**, No. 6, 161-5 (1939)
- Baskervill, "The Packed-Tower Collection of Phosphoric Acid,"  
*Trans. Am. Inst. Chem. Engrs.*, **37**, 79-94 (1941)
- Brunauer and Schultz, "Oxidation of Phosphorus with Steam,"  
*Ind. Eng. Chem.*, **33**, 828-32 (1941)
- Walthall and Striplin, "Superphosphoric Acid by Absorption of  $P_2O_5$  Vapor,"  
*Ind. Eng. Chem.*, **33**, 995-1000 (1941)
- Zergiebel and Lucas, "Phosphorus Furnace Reactions,"  
*Trans. Electrochem. Soc.*, **81**, 97-102 (1942)

#### MATERIALS OF CONSTRUCTION

- Kosting and Heins, "Corrosion of Metals by Phosphoric Acid,"  
*Ind. Eng. Chem.*, **23**, 140-50 (1931)
- Weber, "Phosphoric Acid Imposes Severe Corrosion Burden,"  
*Chem. Met. Eng.*, **39**, 542-5 (1932)
- Rohrman, "Corrosion of Metals by Phosphoric Acid,"  
*Chem. Met. Eng.*, **42**, 368-9 (1935)
- Hartford and Copson, "Corrosion of Metals in the Manufacture of Phosphoric Acid by the Electric Furnace Process,"  
*Ind. Eng. Chem.*, **31**, 1123-8 (1939)
- Zinn, et al., "Heat Transfer Film Coefficients for Liquids in Karbate Exchangers," *Trans. Am. Inst. Chem. Engrs.*, **37**, 399-413 (1941)
- Symposium, "Phosphoric Acid vs. Materials of Chemical Plant Construction,"  
*Chem. Eng.*, **53**, No. 7, 221-30; No. 8, 203-16; No. 9, 203-14 (1946)

#### PHOSPHATE CHEMICALS

- Snell, "Trisodium Phosphate — Its Manufacture and Use,"  
*Ind. Eng. Chem.*, **23**, 470-4 (1931)
- Solberg and Adams, "A New Boiler Water Treatment for the United States Navy," *Combustion* **5**, No. 6, 24-9; No. 7, 32-7 (1933-4)
- Gilmore, "Prevention of Calcium Deposits in Process Waters,"  
*Ind. Eng. Chem.*, **29**, 584-90 (1937)
- Hall and Schwartz, "Sanitary Value of Sodium Metaphosphate in Dishwashing," *Ind. Eng. Chem.*, **29**, 421-4 (1937); **30**, 23-6 (1938)

- Hatch and Rice, "Surface-Active Properties of Hexametaphosphate,"  
*Ind. Eng. Chem.*, **31**, 51-7 (1939)
- Rice and Partridge, "Threshold Treatment — Elimination of Calcium Carbonate Deposits from Industrial Waters,"  
*Ind. Eng. Chem.*, **31**, 58-63 (1939)
- Bailey, *Baking Powder*, U. S. Dept. Agriculture Circ. **138** (1940)
- Gilmore, et al., "Sodium Metaphosphate in Laundering,"  
*Ind. Eng. Chem.*, **32**, 1233-7 (1940)
- Hatch and Rice, "Corrosion Control with Threshold Treatment,"  
*Ind. Eng. Chem.*, **32**, 1572-9 (1940)
- Kobe and Leipper, "The System Trisodium Phosphate — Sodium Carbonate — Water," *Ind. Eng. Chem.*, **32**, 198-203 (1940)
- Crass, "The Match Industry," *Chemical Industries*, **48**, 424-33, 575-9 (1941)
- Logue, "The Family of Phosphates," *Chemical Industries*, **49**, 302-5, 456-9 (1941)
- Partridge, et al., "A Thermal, Microscopic and X-Ray Study of the System  $\text{NaPO}_3$  —  $\text{Na}_4\text{P}_2\text{O}_7$ ," *J. Am. Chem. Soc.*, **63**, 454-66 (1941)
- Adler and Woodstock, "Alkyl Esters of Phosphoric Acid,"  
*Chemical Industries*, **51**, 516-21 (1942)
- Easterwood, "Recent Developments in the Phosphate Field,"  
*Ind. Eng. Chem.*, **34**, 13-19 (1942)
- Hochwalt, et al., "Alkyl Esters of Phosphoric Acid,"  
*Ind. Eng. Chem.*, **34**, 20-5 (1942)
- Jones, "Estimation of Ortho-, Pyro-, Meta-, and Polyphosphates in the Presence of One Another," *Ind. Eng. Chem., Anal. Ed.*, **14**, 536-42 (1942)
- Schwartz and Munter, "Phosphates in Water Conditioning,"  
*Ind. Eng. Chem.*, **34**, 32-40 (1942)
- Davies, "Industrial Applications of Organic Compounds of Phosphorus,"  
*Industrial Chemist*, **19**, 7-12 (1943)
- Morgen and Swope, "Useful Life of Pyro-, Meta-, and Tetrphosphates,"  
*Ind. Eng. Chem.*, **35**, 821-4 (1943)
- Mehring, *Double Superphosphate*, U. S. Dept. Agriculture Circular **718** (1944)
- Marshall, et al., "Composition and Properties of Superphosphate,"  
*Ind. Eng. Chem.*, **32**, 1631-6 (1940)
- Maas, "Phosphate Philosophy," *Chem. Met. Eng.*, **52**, 112-4 (1945)

# Appendix

---

## *What Do Inorganic Chemicals Cost?*

The following quotations are taken by permission from the copyrighted publication "Oil, Paint and Drug Reporter" for July 7, 1947, and are first-hands on large lots, f.o.b. New York, unless designated from works. Contract prices would be less than these figures.

### ABBREVIATIONS USED

Anhyd—anhydrous	E. works—Eastern works
bbls—barrels	frt.—freight
bgs—bags	frt. alld—freight allowed
cal.—calcined	frt. equald—freight equalized
cbys—carboys	gran.—granulated
c.l.—carload	lb—pound
cns—cans	l.c.l.—less than carload
coml.—commercial	N.F.V.—National Formulary Vth Edition
C.P.—chemically pure	pwd—powder
cs.—case	ref.—refined
cyls.—cylinders	tech.—technical grade
dbl.—doubly	U.S.P.—United States Pharmacopoeia
djns—demijohns	wks.—works
dlvd.—delivered	W. works—Western works
dms—drums	
dom.—domestic	

### Acid, hydrochloric

18°, cbys, c.l., E. works, 100 lbs	\$1.50 - 1.70
18°, cbys, l.c.l., E. works, 100 lbs	1.90 - 2.90
18°, tanks, l.c.l., E. works, ton	18.00 -18.20
20°, cbys, c.l., E. works, 100 lbs	1.85 - 2.00
20°, tanks, c.l., E. works, ton	20.00 -21.00

*What Do Inorganic Chemicals Cost?*

351

22°, cbys, c.l., E. works, 100 lbs	2.35 - 2.50
22°, tanks, c.l., E. works, ton	22.00 - 26.00
C.P., U.S.P., consumers, cbys extra, lb	0.08
Acid, hydrofluoric	
Anhydrous, cyls., works, lb	0.19 - 0.19½
60%, rubber dms, works, lb	0.13½
Acid, nitric	
36°, cbys, c.l., E. works, 100 lbs	5.00
38°, cbys, c.l., E. works, 100 lbs	5.50
38°, cbys, c.l., W. works, 100 lbs	5.75
40°, cbys, c.l., E. works, 100 lbs	6.00 - 6.50
42°, cbys, c.l., E. works, 100 lbs	6.50 - 7.00
C.P., U.S.P., consumers, cbys extra, lb	0.13
Acid, phosphoric, food grade	
50%, bbls, c.l., works, frt. equald, 100 lbs	4.50
50% cbys, c.l., works, frt. equald, 100 lbs	5.00
50%, cbys, l.c.l., works, frt. allid, 100 lbs	6.00 - 7.50
75%, bbls, c.l., works, frt. equald, 100 lbs	5.25
75%, tanks, works, frt. equald, 100 lbs	\$ 4.65
U.S.P., 100 lb cbys, c.l., lb	0.10½
dilute, 10%, cbys, djns, lb	0.07 - 0.07½
Acid, sulfuric	
60°, cbys, c.l., E. works, 100 lbs	1.35 - 1.40
60°, tanks, c.l., E. works, ton	13.00 - 13.50
66°, tanks, c.l., E. works, ton	16.50 - 17.50
98°, tanks, c.l., E. works, ton	17.50 - 18.56
fuming, 20%, c.l., E. works, ton	19.50 - 20.50
Alum, soda	
bbls, c.l., works, 100 lbs	3.25
Aluminum chloride	
anhydrous, coml., dms, c.l., lb	0.10 - 0.11
Aluminum sulfate	
coml., bgs, c.l., works, frt. equald, 100 lbs	1.15 - 1.30
Ammonia	
anhydrous, fertilizer, tankcars, works, frt. equald, ton	\$59.00
anhydrous, pure, cyls., lb	0.16
anhydrous, refrigeration, tanks, works, ton	61.50



aqua, 26°, dms, c.l., lb	0.03 - 0.03 $\frac{1}{4}$
aqua, 26°, dms, l.c.l., lb	0.03 $\frac{1}{2}$
aqua, 26°, tanks, works (NH <sub>3</sub> content) ton	65.00
<b>Ammonium chloride</b>	
grey, bbls, c.l., works, 100 lbs	7.00
white, gran., bbls, c.l., works, 100 lbs	4.75
white, gran., bbls, l.c.l., works, 100 lbs	5.15 - 5.00
<b>Ammonium phosphate</b>	
dibasic, N.F.V., bbls, kgs, lb	0.37 - 0.39
dibasic, tech, bgs, c.l. works, lb	0.07
monobasic, pure, bbls, lb	0.39 - 0.41
monobasic, tech, bgs, c.l., works, lb	0.07
<b>Ammonium nitrate</b>	
fertilizer grade, Canadian, 32.5%N, bags, c.l., shipping point, ton	4.35 - 8.50
<b>Ammonium sulfate</b>	
bulk, producing ovens, ton	30.00 - 35.00
<b>Barium carbonate</b>	
precip., bags, 10 tons and up, works, ton	67.50 - 75.00
<b>Barium chloride</b>	
C.P., crystals, bbls, lb	0.25 - 0.27
pure crystals, bbls, kegs, lb	0.10 - 0.12
tech., crystals, bags, c.l., works, ton	85.00
tech., crystals, bags, l.c.l., works, ton	78.00 - 95.00
<b>Barium sulfate</b>	
water-grd., paper bags, c.l., St. Louis, ton	31.10
Southern, off-color, bags, mines, ton	19.00
Southern, off-color, 95.75%, bags, mines, ton	20.00
ore, approx. 94%, bulk, mines, ton	8.50 - 12.50
X-ray, bbls, lb	0.10 - 0.10 $\frac{1}{2}$
<b>Bleaching powder</b>	
dms, c.l., works, 100 lbs	2.75 - 3.00
dms, l.c.l., works, 100 lbs	3.25 - 3.75
<b>Bromine</b>	
purified, cs., c.l., frt. alld, E. of Rockies, lb	0.21

**Calcium carbide**

drums, c.l., works, ton	50.00
drums, c.l., delivered, ton	87.00 - 90.00

**Calcium chloride**

flake, 77-80%, paper bags, c.l., dlvd., ton	\$21.50 - 38.00
liquor, basis 40%, tanks, works, ton	8.50

**Calcium phosphate**

feeding grade, bgs, works, ton	75.00
food grade, bbls, 10 or over, lb	0.07 - 0.07 $\frac{3}{4}$
medicinal, dibasic, bgs, 100 lbs	11.40 - 19.00
monobasic, cryst., bgs, c.l., works, frt. equald, lb	0.05 $\frac{3}{4}$

**Chlorine, liquid**

cyls, c.l., del., lb	0.06 $\frac{3}{4}$
cyls, c.l., contract, del., lb	0.06 $\frac{3}{4}$
cyls, l.c.l., del., lb	0.09 - 0.10 $\frac{1}{2}$
tanks, single units, works, frt. equald, 100 lbs	2.00
tanks, multiple units, 3 or over, works, frt. equald, 100 lbs	2.30
tanks, multiple units, 2 or over, works, frt. equald, 100 lbs	2.90
tanks, multiple units, 1 or over, works, frt. equald, 100 lbs	3.50

**Copper carbonate**

52-54%, bbls, lb	0.24 - 0.26
------------------	-------------

**Copper sulfate**

99%, crystals, bags, c.l., works, 100 lbs	7.60
---	------

**Cyanamide**

fertilizer mixing grades, 20.6% N., gran., bulk, Niagara Falls, Ontario, contracts, unit-ton	2.00
--	------

**Ferric sulfate**

anhydrous, bags, c.l., works, ton	35.00
-----------------------------------	-------

**Ferrous sulfate (copperas)**

crystals, gran., bags, c.l., works, ton	17.00
---	-------

**Iodine**

crude 150 lb kegs, ex-whse., Staten Island, lb	1.729
resublimed, 5 lb jars, lb	2.35 - 2.45

**Lead acetate**

crystals, bbls, lb	0.19 $\frac{1}{4}$
--------------------	--------------------

## Lime, chemical

lump, pebble, bulk, at plant, ton	7.00 -10.25
lump, pebble, bulk, hydrated, paper bags, at plant, ton	8.00 -12.14

## Magnesium carbonate

tech., bags, c.l., frt. equald, lb	0.07½
------------------------------------	-------

## Magnesium chloride

flake, bbls, c.l., at works, ton	37.00
----------------------------------	-------

## Magnesium sulfate

tech., crystals, bags, c.l., 100 lbs	2.05
U.S.P., crystals, bags, c.l., 100 lbs	2.25

## Magnesite

cal., pwd, bags, mines, Calif., ton	60.00
dead-burnt, bulk, c.l., f.o.b., Chewelah, Wash., ton	24.00

## Manganese dioxide

African, battery, 84-87%, bbls, 28-40 tons, works, ton	74.00
--	-------

## Manganese sulfate

fertilizer grade, 65%, bags, c.l., dlvd., East, ton	56.00
---	-------

## Mercuric chloride

gran., pwd, dms, 50 lbs or more, lb	1.78
-------------------------------------	------

## Phosphorous

red, amorphous, cs., lb	0.33 - 0.35
red, amorphous, tins, export, lb	0.40 - 0.45
yellow, cns, lb	0.25 - 0.27
yellow, dms, c.l., lb	0.22

## Phosphorous pentoxide

dms, c.l., wks., lb	0.12
---------------------	------

## Potassium carbonate

cal., bbls, c.l., works, lb	0.07½
hydrated, 83-5%, bbls, c.l., works, lb	0.05¾

## Potassium hydroxide

low chloride, 90% basis, flake, dms, c.l., works, 100 lbs	9.50
low chloride, liquid, c.l., works, 100 lbs (drums)	8.75
regular, flake, 88-92%, dms, c.l., works, lb	0.07½

## Potassium chloride

tech. cryst., 98%, bags, lb.	0.08
------------------------------	------

Potassium nitrate

cryst., bbls, 10 tons, 100 lbs 12.40

Potassium sulfate

tech., dom., bulk, basis 90–95%, min. 90%, ex-vessel, ton 36.25

Sodium bicarbonate

tech., bags, c.l., works, 100 lbs 1.85

U.S.P., gran., bags, c.l., works, 100 lbs 2.25

Sodium carbonate (soda ash)

ash, dense, 58%, bgs, c.l., works, 100 lbs. 1.28

ash, dense, 58%, bbls, l.c.l., dlvd., zone 1, 100 lbs 2.63

ash, dense, 58%, bbls, l.c.l., dlvd., zone 2, 100 lbs 2.78

ash, dense, 58%, bbls, l.c.l., dlvd., zone 3, 100 lbs 3.13

ash, dense, 58%, bbls, l.c.l., dlvd., zone 4, 100 lbs 3.73

ash, dense, 58%, bulk, c.l., works, 100 lbs 1.08

ash, light, 58%, bgs, c.l., zone 1, 100 lbs 1.20

ash, light, 58%, bulk, c.l., zone 1, 100 lbs 1.00

ash, extra light, bags, c.l., works, 100 lbs 1.30

Sodium chloride

rock salt, bags, c.l., ton 17.50

vacuum, common, fine, bags, c.l., ton 18.60

Sodium hydroxide (caustic soda)

flake, pwd, 76%, dms, c.l., works, 100 lbs 2.90 – 3.00

liquid, 50%, buyer's tanks, works, dry basis, 100 lbs 2.00

liquid, 50%, seller's tanks, works, dry basis, 100 lbs 1.95 – 2.10

liquid, 70%, seller's tanks, works, dry basis, 100 lbs 2.10

solid, 76%, dms, c.l., works, 100 lbs 2.50 – 2.75

solid, 76%, dms, l.c.l., zone 1, dlvd., 100 lbs 3.85 – 3.95

solid, 76%, dms, l.c.l., zone 2, dlvd., 100 lbs 4.00 – 4.10

solid, 76%, dms, l.c.l., zone 3, dlvd., 100 lbs 4.35 – 4.45

solid, 76%, dms, l.c.l., zone 4, dlvd., 100 lbs 4.95 – 5.05

Sodium nitrate

crude, dom., 100 lb bags, c.l., works, ton 35.50

crude, dom., bulk, c.l., works, ton 32.00

Sodium nitrite

96–8%, bbls, c.l., works, frt. equald, lb 0.0675

Sodium phosphates

dibasic, tech., anhyd, bags, c.l., works, 100 lbs 6.25

monobasic, tech., anhyd, bags, c.l., works, 100 lbs 7.25 – 8.25

tribasic, tech., anhyd, bags, c.l., works, 100 lbs	7.00
tribasic crystals, anhyd, bags, c.l., works, 100 lbs	3.50
pyrophosphate, tetra-basic, anhyd, bgs, c.l., works, frt. equald, 100 lbs	6.00
<b>Sodium sulfate</b>	
saltcake, dom. bulk, works, ton	20.00 - 26.00
tech. anhyd, bags, c.l., works, 100 lbs	2.10
<b>Sodium sulfite</b>	
cryst, bgs, c.l., wks., 100 lbs	2.60
pwd., bbls, c.l., wks., 100 lbs	5.25
<b>Sodium thiosulfate</b>	
cryst., bgs, c.l., wks., frt. equald, 100 lbs	2.75
U.S.P., cryst., bbls, lb	0.19 - 0.12
<b>Strontium carbonate</b>	
90%, bbls, lb	0.14 - 0.16
98%, bbls, lb	0.23 - 0.25
<b>Strontium nitrate</b>	
bbls, c.l., works, lb	0.07 $\frac{3}{4}$
<b>Zinc chloride</b>	
tech., fused, dms, c.l., works, 100 lbs	6.25
<b>Zinc oxide</b>	
pigment, dom., American process, coml., lead-free, bags, c.l., f.o.b., ship't point, frt. alld, lb	0.09 $\frac{1}{2}$

Check these prices against the latest quotation in the "Oil, Paint and Drug Reporter"!

Liquids Heavier than Water  
(Aqueous Solutions of Acids and Bases)

<i>Degrees Baume<sup>a</sup></i>	<i>Specific Gravity</i>	<i>Pounds per gallon</i>	<i>H<sub>2</sub>SO<sub>4</sub> at 60°F<sup>b</sup></i>	<i>HCl at 60°F<sup>b</sup></i>	<i>HNO<sub>3</sub> at 60°F<sup>b</sup></i>	<i>NaOH at 60°F<sup>c</sup></i>
0°	1.000	8.328	—	—	—	—
1	1.007	8.385	1.02	1.40	—	0.60
2	1.014	8.445	2.08	2.82	—	1.25
3	1.021	8.504	3.13	4.25	—	1.8
4	1.028	8.565	4.21	5.69	—	2.4
5	1.036	8.625	5.28	7.15	—	3.1
6	1.043	8.688	6.37	8.64	—	3.7
7	1.051	8.750	7.45	10.17	—	4.4
8	1.058	8.814	8.55	11.71	—	5.1
9	1.066	8.879	9.66	13.26	—	5.9
10	1.074	8.945	10.77	14.83	12.86	6.6
11	1.082	9.012	11.89	16.41	14.13	7.3
12	1.090	9.078	13.01	18.01	15.41	8.1
13	1.099	9.148	14.15	19.63	16.72	8.8
14	1.107	9.218	15.25	21.27	18.04	9.6
15	1.115	9.289	16.38	22.92	19.36	10.3
16	1.124	9.361	17.53	24.57	20.69	11.0
17	1.133	9.434	18.71	26.22	22.04	11.9
18	1.142	9.508	19.89	27.92	23.42	12.7
19	1.151	9.584	21.07	29.65	24.82	13.5
20	1.160	9.660	22.25	31.45	26.24	14.3
21	1.169	9.739	23.43	33.31	27.67	15.1
22	1.179	9.818	24.61	35.21	29.07	16.0
23	1.189	9.898	25.81	37.14	30.49	16.9
24	1.198	9.979	27.03	39.41	31.94	17.8
25	1.208	10.063	28.28	41.72	33.42	18.7
26	1.219	10.148	29.53	—	34.94	19.6
27	1.229	10.233	30.79	—	36.48	20.5
28	1.239	10.321	32.05	—	38.06	21.5
29	1.250	10.410	33.33	—	39.66	22.5
30	1.261	10.501	34.63	—	41.30	23.4
31	1.272	10.592	35.93	—	43.00	24.5
32	1.283	10.686	37.26	—	44.78	25.5
33	1.295	10.781	38.58	—	46.58	26.5
34	1.306	10.879	39.92	—	48.42	27.6
35	1.318	10.978	41.27	—	50.32	28.6
36	1.330	11.079	42.63	—	52.30	29.8
37	1.343	11.181	43.99	—	54.36	30.9
38	1.355	11.285	45.35	—	56.52	32.1
39	1.368	11.392	46.72	—	58.82	33.4
40	1.381	11.501	48.10	—	61.38	34.6
41	1.394	11.611	49.47	—	64.20	35.9
42	1.408	11.724	50.87	—	67.18	37.3

Liquids Heavier than Water—Continued  
(Aqueous Solutions of Acids and Bases)

Degrees Baume <sup>a</sup>	Specific gravity	Pounds per gallon	H <sub>2</sub> SO <sub>4</sub> at 60°F <sup>b</sup>	HCl at 60°F <sup>b</sup>	HNO <sub>3</sub> at 60°F <sup>b</sup>	NaOH at 60°F <sup>c</sup>
43	1.422	11.839	52.26	—	70.33	38.6
44	1.436	11.956	53.66	—	73.67	40.0
45	1.450	12.076	55.07	—	77.17	41.5
46	1.465	12.197	56.48	—	81.08	43.0
47	1.480	12.322	57.90	—	85.70	44.6
48	1.495	12.449	59.32	—	91.35	46.2
49	1.510	12.579	60.75	—	—	47.8
50	1.526	12.711	62.18	—	—	49.5
51	1.543	12.847	63.66	—	—	51.2
52	1.559	12.984	65.13	—	—	—
53	1.576	13.126	66.63	—	—	—
54	1.593	13.270	68.13	—	—	—
55	1.611	13.417	69.65	—	—	—
56	1.629	13.568	71.17	—	—	—
57	1.648	13.722	72.75	—	—	—
58	1.667	13.880	74.36	—	—	—
59	1.686	14.041	75.99	—	—	—
60	1.706	14.207	77.67	—	—	—
61	1.726	14.376	79.43	—	—	—
62	1.747	14.549	81.30	—	—	—
63	1.768	14.726	83.34	—	—	—
64	1.790	14.908	85.66	—	—	—
64.5	—	—	—	—	—	—
65	1.813	15.094	88.65	—	—	—
65.5	—	—	—	—	—	—
66	1.835	15.285	93.19	—	—	—

<sup>a</sup> For liquids heavier than water the relationship between specific gravity and degrees Baume is given by:

$$^{\circ}\text{Bé} = 145 - \frac{145}{\text{Sp.G.}}$$

<sup>b</sup> Data from Manufacturing Chemists' Association Manual Sheets T-3, T-5, T-7.

<sup>c</sup> Data from Caustic Soda Handbook of Dow Chemical Company.

Liquids Lighter than Water  
(Aqueous Ammonia Solution<sup>a</sup>)

<i>Degrees Baume<sup>b</sup></i>	<i>60°F/60°F Specific gravity</i>	<i>Pounds per gallon</i>	<i>% NH<sub>3</sub> by weight</i>
10.0	1.0000	8.328	0.00
10.5	0.9964	8.298	0.80
11.0	0.9929	8.269	1.62
11.5	0.9894	8.240	2.46
12.0	0.9859	8.211	3.30
12.5	0.9825	8.182	4.16
13.0	0.9790	8.153	5.02
13.5	0.9756	8.125	5.88
14.0	0.9722	8.096	6.74
14.5	0.9689	8.069	7.61
15.0	0.9655	8.041	8.49
15.5	0.9622	8.013	9.38
16.0	0.9589	7.986	10.28
16.5	0.9556	7.958	11.18
17.0	0.9524	7.931	12.10
17.5	0.9491	7.904	13.02
18.0	0.9459	7.877	13.96
18.5	0.9428	7.851	14.90
19.0	0.9396	7.825	15.84
19.5	0.9365	7.799	16.80
20.0	0.9333	7.772	17.76
20.5	0.9302	7.747	18.72
21.0	0.9272	7.721	19.68
21.5	0.9241	7.696	20.64
22.0	0.9211	7.670	21.60
22.5	0.9180	7.645	22.56
23.0	0.9150	7.620	23.52
23.5	0.9121	7.595	24.50
24.0	0.9091	7.570	25.48
24.5	0.9062	7.546	26.46
25.0	0.9032	7.522	27.44
25.5	0.9003	7.498	28.42
26.0	0.8974	7.473	29.40
26.5	0.8945	7.449	30.38
27.0	0.8917	7.425	31.36
27.5	0.8889	7.402	32.34
28.0	0.8861	7.378	33.32
28.5	0.8833	7.355	34.30
29.0	0.8805	7.332	35.28

<sup>a</sup> Data from Manufacturing Chemists' Association Manual Sheet T-1.

<sup>b</sup> For liquids lighter than water the relationship between specific gravity and degrees Baume is given by:

$$^{\circ}\text{Be} = \frac{140}{\text{Sp.G.}} - 130$$



## Tyler Standard Screen Scale Sieves

MESH	Tyler standard screen scale <sup>a</sup> OPENING IN INCHES	Close sizing series <sup>b</sup>	Approx. clear opening INCHES	Diameter of wire INCHES
—	—	3	3	0.207
—	—	2	2	.192
—	—	1.5	1½	.162
—	1.050	1.050	1	.148
—	—	0.883	7/8	.135
—	0.742	.742	3/4	.135
—	—	.624	5/8	.120
—	.525	.525	1/2	.105
—	—	.441	7/16	.105
—	.371	.371	3/8	.092
—	—	.312	5/16	.088
2½	—	.263	1/4	.070
3	.263	.263	1/4	.070
3½	—	.221	7/32	.065
4	.185	.185	3/16	.065
5	—	.156	5/32	.044
6	.131	.131	1/8	.036
7	—	.110	7/64	.0328
8	.093	.093	3/32	.032
9	—	.078	5/64	.033
10	.065	.065	1/16	.035
12	—	.055	—	.028
14	.046	.046	3/64	.025
16	—	.0390	—	.0235
20	.0328	.0328	1/32	.0172
24	—	.0276	—	.0141
28	.0232	.0232	—	.0125
32	—	.0195	—	.0118
35	.0164	.0164	1/64	.0122
42	—	.0138	—	.0100
48	.0116	.0116	—	.0092
60	—	.0097	—	.0070
65	.0082	.0082	—	.0072
80	—	.0069	—	.0056
100	.0058	.0058	—	.0042
115	—	.0049	—	.0038
150	.0041	.0041	—	.0026
170	—	.0035	—	.0024
200	.0029	.0029	—	.0021
250	—	.0024	—	.0016
270	.0021	.0021	—	.0016
325	—	.0017	—	.0014
400	.0015	.0015	—	.001

The Tyler standard scale uses as a basis or starting point the 200 mesh screen which has an opening of 0.0029 inches with a wire diameter of 0.0021 inches (total = 0.005 =  $1/200$ ). In the standard screen scale the adjacent screen openings differ by  $\sqrt{2} = 1.414$ . In the fine series used for closer sizing the adjacent screen openings differ by  $\sqrt[4]{2} = 1.189$ .

<sup>a</sup> (Screen opening) (1.414) = Screen opening for next larger size.

<sup>b</sup> (Screen opening) (1.189) = Screen opening for next larger size.



# Index

---

## A

- Absorption,
    - hydrogen chloride, 152
    - nitrogen oxides, 282
    - sulfur trioxide, 216
  - Abstract journals, 5
  - Acetic acid, 299
  - Acid sludge, 175, 219
  - Alberger process, 39
  - Alcohols, 299
  - Alkalis, competition among, 115
  - Alunite, 57, 59, 75
  - Ammonia,
    - "cracked," 257
    - cyanamide process, 238
    - cylinders, 266
    - density of solutions, 359
    - oxidation, 276
      - catalyst, 279
      - chemical principles, 276
      - converter, 281
      - flow sheet, 187, 282
      - for chamber  $\text{H}_2\text{SO}_4$  process, 186-8
      - pressure process, 281
    - production, 232-5
    - stills, 101
    - synthetic, 243, 252
      - Brown converter, 258
      - Casale process, 259, 262
      - catalysts, 256
      - Chemical Construction Co., 263
      - chemical principles, 253
      - Claude process, 263
      - competition among alkalis, 115
      - convertors, 257
      - equilibrium, 254
      - Fausser process, 262
      - flow sheet, 252
      - from cyanamide, 295
      - Haber-Bosch process, 262
      - marketing, 264
      - materials of construction, 263
      - Mont Ceniz, 262
      - Nitrogen Engineering Corporation, 263
      - preparation of synthesis gas, 246
      - raw materials, 244
      - space velocity, 255
      - specifications, 266
      - utilization, 232
  - Ammonia purification of caustic soda, 135
  - Ammonia-soda process (see Sodium carbonate), 94
  - Ammoniated superphosphate, 319
  - Ammonium chloride, 104, 293
  - Ammonium nitrate, 292
  - Ammonium phosphates, 293
  - Ammonium salts, 289
  - Ammonium sulfate,
    - ammonia-soda process, 102
    - manufacture, 289
  - Ammonium sulfite, 292
  - Apatite, 310
  - Arc process, nitrogen fixation, 235
    - chemical principles, 236
    - economics, 238
    - products, 237
  - Available chlorine, 144
  - Available  $\text{P}_2\text{O}_5$ , 313
- ## B
- Baking powders, 334
  - Baumé scale, definition, 358, 359
  - Black ash, 88
  - Black liquor, 89
  - Blast-furnace process for phosphoric acid, 330
  - Bleaching agents, 144
    - available chlorine, 144
    - bleaching powder, 146
    - calcium bleach, 146
    - calcium hypochlorite, 148
    - chlorine, 140
    - sodium chlorite, 149
    - sodium hypochlorite, 144
  - Bone phosphate of lime, 312

- Borax, 73  
 Brine wells, 24  
   Detroit method, 25  
   New York method, 25  
 Broadfield process, 318  
 Bromine, 43  
 Brown ammonia converter, 258  
 Burkeite, 59, 72-4  
 Business activity, 164
- C**
- Calcium bleach solution, 146  
 Calcium carbide, 239  
 Calcium chloride, 39, 102  
 Calcium cyanamide, 238  
   ammonia from, 295  
   derivatives from, 294  
   fertilizer, 242  
 Calcium hypochlorite, 148  
 Calcium nitrate, 237  
 Calcium phosphates, 333  
   di-, 334  
   meta-, 320  
   mono-, 333  
   tri-, 32, 334  
 Calcium sulfate (see Gypsum)  
 Calgon, 340  
 Caliche, 14  
 Carbon dioxide, removal from gas, 248  
 Carbon monoxide,  
   reaction with  $H_2O$ , 247  
   removal from gas, 248  
 Carlsbad, New Mexico, 56, 57, 65  
 Carnalite, 59, 63, 70  
 Casale process for ammonia, 262  
 Catalyst,  
   ammonia oxidation, 279  
   ammonia synthesis, 256  
   poisoning, 209  
   promoters, 256  
   sulfur dioxide oxidation, 207  
 Caustic pots, 136-7  
 Caustic soda, (see Sodium hydroxide), 107,  
   134  
 Causticizing, 108, 112  
 Cellarius tourills, 153  
 Chain reaction, 150  
 Chance-Claus process, 92  
 Chemical Abstracts, 5  
 Chemical Construction Co. (Chemico), 178,  
   179, 187, 189, 215, 216, 220, 221, 263,  
   280  
 Chemical literature, 1  
 Chemico concentrator, 220, 221  
 Chile saltpeter (see Sodium nitrate)  
 Chlorates, formation of, 126, 155  
 Chloride of lime (see Bleaching powder), 146  
 Chlorine, 140  
   available, 144  
   consuming industries, 123  
   cylinders for, 142  
   Deacon process, 91  
   electrolysis of NaCl, 124  
   from NaCl and  $NO_2$ , 144, 286  
   hydrochloric acid from, 150  
   liquefaction of, 140  
   marketing, 141  
   materials of construction, 141  
   production, 123  
   purification of, 141  
   shipment, 142  
   uses, 123  
   Weldon process, 91  
 Chlorine dioxide, 149  
 Claude process for ammonia, 263  
 Coke-oven gas, 249  
    $H_2$  from, 249  
 Competition among alkalis, 115  
 Concentration of  
   nitric acid, 285  
   phosphoric acid, 325  
   sulfuric acid, 219  
 Congruent, 45, 64  
 Consolidated Mining and Smelting Co. of  
   Canada, Ltd. (Trail, B.C.), 172, 173,  
   225, 245, 262, 306, 318, 323  
 Cost of inorganic chemicals, 350-6  
 Cottrell precipitator, 183, 222, 329  
 "Creep" in steel, 263  
 Cryohydric point, 28  
   sodium carbonate-water, 47  
   sodium chloride-water, 28  
   sodium sulfate-water, 44  
 Crystal systems, 29  
   growth factors, 32  
 Crystallization,  
   fractional, 62  
   principles of, 29, 60  
   Ross theory, 31  
   supersaturation theory of Ostwald and  
   Miers, 29  
 Current efficiency, 126  
 Cyanamide (see Calcium cyanamide), 295  
   derivatives, 294  
 Cyanamide process, nitrogen fixation, 238  
   chemical principles, 240  
   economics, 242  
   nitrification, 240  
   raw materials, 239  
 Cyanides, 295
- D**
- Deacon process, 91  
 Decomposition voltage, 127  
 Defluorination of phosphate rock, 320  
 Den process for superphosphate fertilizer, 315

Density of solutions, 357-9  
 Diaphragm caustic cells, 127  
 Dicalcium phosphate, 334  
 Dicyanidiamide, 296  
 Disodium phosphate, (D.S.P.), 335-7  
 Dorr Company, (Dorrco), 111, 113, 114, 323  
 Dorr thickener, 114  
 Double superphosphate, 318  
 Dowtherm, 136  
 D.S.P., 335-6  
 Durichlor, composition of, 154  
 Duriron, composition of, 223

**E**

Electric furnaces for  
   calcium carbide, 239  
   phosphorus, 327  
 Electrolysis of salt solution, 124  
 Electromotive force, 125  
 Encyclopedias, 3  
 Engineering reports, 11  
 Eutectic point, 28  
   ice, 28  
 Evaporators,  
   caustic soda, 134  
   multiple effect, 37  
   salt, 37  
   salt removal from, 38  
   "salting," 39  
   submerged combustion, 46, 70, 325

**F**

Faraday's laws, 126  
 Fauser process,  
   ammonia synthesis, 262  
   ammonium sulfate, 290-1  
 Ferrophosphorus, 328  
 Ferrous sulfate, 175, 219  
 Fertilizer,  
   calcium cyanamide, 242  
   complete, 77, 321  
   materials consumed, 322  
   phosphate, 313  
   potash, 76  
 Fischer-Tropsch synthesis, 299  
 Fixed nitrogen production, 233  
 Flakers, 137  
 Flash evaporation, salt, 39  
 Flotation, separation of NaCl and KCl, 67  
 Fluorine in phosphate rock, 311  
 Fluosilicic acid, 314  
 Formic acid, 299  
 Frasch process, 170

**G**

Gaillard-Parrish system, 194  
 Gay-Lussac tower, 193  
 Gaylassite, 108

Gibbs-Helmholtz equation, 127  
 Glaserite, 59, 72-4  
 Glauber's salt, 34, 45  
 Glover tower, 189  
 Grainer process, salt, 34  
 Granulation process, 317  
 Great Salt Lake, 21, 34  
 Green liquor, 90, 111  
 Guanidine, 296  
   nitrate, 296  
   nitro-, 296  
 Gypsum, 174, 324  
   ammonium sulfate from, 291  
   scale, 39

**H**

Haber-Bosch process for ammonia, 262  
 Hargreaves-Bird cell, 131  
 Hargreaves process, 87  
 Hastelloy, composition of, 154  
 High pressure technology, 297  
 Hooker type-S cell, 128  
 Hopper crystals, 36  
 Hydrochloric acid, 150  
   absorption of, 152  
   corrosion, 154  
   Deacon process, 91  
   density of solutions, 357  
   from hydrogen, 150  
     chemical principles, 150  
     reaction chambers, 151  
   from salt, 85  
   grades, 154  
   Hargreaves process, 87  
   heat of solution, 151  
   Laury furnace, 87  
   Mannheim furnace, 87  
   marketing, 154  
   materials of construction, 154  
   Pot-and-muffle furnace, 85  
   production, 150  
   reversed Deacon process, 92  
   S-bend absorbers, 153  
   salt cake furnace, 85  
   shipping, 154-5  
   synthetic, 150  
   tantalum absorber, 153-4  
   tourill absorbers, 153  
   uses, 155  
   Wolff bottles, 153  
 Hydrocyanic acid, 295  
 Hydrofluoric acid, 314  
 Hydrogen,  
   equilibrium with nitrogen, 253-6  
   from by-product gases, 251  
   from coke-oven gas, 249  
   from natural gas, 249  
   from water, by electrolysis, 244

- Hydrogen (*cont.*)  
 from water gas reaction, 245  
 flow sheet, 246  
 hydrogen chloride, 150  
 production, 244  
 Hydrogen chloride (see Hydrochloric acid),  
 150  
 Hydrogen sulfide,  
 Chance-Claus process, 92  
 production, 174  
 sulfur from, 95, 171  
 Hypochlorites, 126, 144-9

## I

- Inconel, composition of, 138  
 Incongruent, 45, 64  
 Industrial and Engineering Chemistry, 6  
 Industrial journals, 6

## J

- Journals,  
 abstract, 5  
 chemical, 7  
 engineering, 8  
 industrial, 6  
 review, 7

## K

- Kieserite, 59

## L

- Langbeinite, 59, 65, 68  
 Larison system, 194  
 Laury furnace, 87  
 Leblanc process, 85  
 LeChatelier principle, 202, 247, 249, 277  
 Lime, 239  
 competition among alkalis, 115  
 equilibrium with  $\text{Na}_2\text{CO}_3$ , 108  
 slaking, 112  
 Limestone, competition among alkalis, 115  
 Liquefaction of gases, 140, 184  
 Literature search, 2  
 Lithium-sodium phosphate, 74  
 Löwig process, 109  
 Lurgi belt-type filter, 324

## M

- Magnesium, 43  
 Magnesium bases, 116  
 Magnesium chloride, 39  
 recovery from potash, 70  
 system,  $\text{KCl}-\text{MgCl}_2-\text{H}_2\text{O}$ , 63  
 Magnesium sulfate  
 system  $\text{KCl}-\text{MgSO}_4-\text{H}_2\text{O}$ , 64  
 Mannheim furnace, 87  
 Manure salts, 65, 76  
 Melamine, 296

- Mercury caustic cell, 131  
 Metaphosphoric acid, 332  
 Methanol, 249, 251, 297-8  
 Methyl formate, 299  
 Mills-Packard system, 194  
 Mirabilite, 46  
 Mixed acid, 289  
 Monel metal, composition of, 138  
 Monocalcium phosphate, 333  
 Monographs, 4  
 Mont Cenis process for ammonia, 262  
 Muriatic acid (see Hydrochloric acid)

## N

- Natural gas, hydrogen from, 249  
 Natural sodium salts, 13  
 New York and Liverpool test, 105, 138  
 Ni-Resist, composition of, 138  
 Niter, 186  
 Niter cake, 87  
 Niter supply for chambers, 186  
 Nitric acid,  
 absorption system, 282, 285  
 ammonia oxidation, 276, 281  
 (see also Ammonia oxidation)  
 arc processes, 235  
 concentration of, 285  
 condensers, 284  
 density of solutions, 357-8  
 dissociation, 285  
 from sodium nitrate, 283  
 marketing, 289  
 materials of construction, 288  
 production, 276, 283  
 uses, 276  
 vapor-liquid equilibrium, 285  
 Nitric oxide, 236, 276  
 Nitrogen,  
 consumption, 235  
 equilibrium with hydrogen, 253-6  
 fixation, 230  
 ammonia synthesis process, 243  
 arc processes, 235  
 cyanamide processes, 238  
 synthetic ammonia, 243  
 history, 230  
 oxides,  
 absorption towers, 238, 282, 285  
 arc process, 235  
 from air, 235  
 from ammonia, 186-7  
 nitric acid from, 276  
 oxidation to  $\text{HNO}_3$ , 277  
 preparation, 240, 251  
 process-product relationship, 233  
 utilization, 232  
 Nitrogen dioxide, 277, 287  
 liquid, 286

- Nitrogen Engineering Corp. process for ammonia, 263
- Nitrogen production, 251
- Nitrogen tetroxide, 277
- Nitrogen trioxide, 277
- Nitrosyl chloride, 287
- Nitrosyl-sulfuric acid, 188, 193
- Numerical data, 4
- O**
- Oil of vitriol, 166
- Oleum, 166, 217
- Opl system, 194
- Organized information, 2
- Overvoltage of gases, 125
- Oxalic acid, 299
- P**
- Patents, 9
- foreign, 10
- United States, 9
- Permian basin, 18, 56, 57-9
- Phosphate fertilizers, 313
- ammoniated superphosphate, 319
- complete, 77, 321
- consumption, 306
- defluorinated phosphate rock, 320
- double superphosphate, 318
- marketing, 321
- superphosphate, 313
- den process, 315
- flow sheet, 315
- reactions, 214
- triple superphosphate, 318
- Phosphate rock, 307
- defluorinated, 320
- deposits, 307-8
- formation of, 310
- industry, 307
- marketing, 312
- mining, 311
- phosphoric acid from, 322
- processing, 311
- Phosphate salts, production, 333
- Phosphates, organic, 343
- Phosphoric acids,
- blast-furnace process, 330
- concentration of, 325
- electric-furnace process, 326
- flow sheets, 323, 326
- from phosphorus, 329
- grades, 331
- marketing, 331
- materials of construction, 330
- ortho-, 332
- production, 322
- purification, 325
- pyro-, 332
- super-, 330
- thermal process, 326
- tripoly-, 332
- uses, 332
- wet process, 323
- Phosphorus, 326
- blast-furnace process, 330
- flow sheet, 326
- marketing, 331
- oxidation, 329
- red, 331
- Phosphorus pentoxide, 326
- Pickling wastes, 175, 219
- Platinum catalyst,
- ammonia oxidation, 279
- sulfur dioxide oxidation, 207, 210
- Polyhalite, 56, 59, 75
- Potash, 56
- corrosion, 76
- fertilizer, 76
- marketing, 76
- materials of construction, 75
- mining, 65
- producers, 57
- production and sales, 57
- unit, 76
- Potassium bromide, 74
- Potassium chloride (see Potash),
- carnallite, 64
- flotation process, 67-8
- separation from sylvinitic, 66
- System,
- KCl—NaCl—H<sub>2</sub>O, 60
- KCl—MgCl<sub>2</sub>—H<sub>2</sub>O, 63
- KCl—MgSO<sub>4</sub>—H<sub>2</sub>O, 64
- Potassium salts, natural, 55
- Potassium sulfate, 68, 74
- system, K<sub>2</sub>SO<sub>4</sub>—MgCl<sub>2</sub>—H<sub>2</sub>O, 64
- Power efficiency, 127
- Promoters, catalyst, 256
- Propionic acid, 299
- Public documents, 8
- Pyrites, 172
- burners, 179
- Herreshoff (-Nichols), 180, 181
- mechanical, 180
- Wedge (-Bethlehem), 180
- flash roaster, 180
- Nichols-Freeman, 182
- in contact process, 212
- unit, 173
- Pyrophosphoric acid, 332
- Pyrrhotite, 173, 183
- R**
- Rasping, 316
- Recipes, 5
- Ross crystallization theory, 31



## S

- Sal soda, 105
- Salt,
- Alberger process, 39
  - blocks, 23
  - brine wells, 24
  - brines, composition, 21, 26
  - by-products, 43
  - crystal structure, 33, 36, 39, 40
  - crystallization principles, 29
  - deposition of, 16
  - deposits, distribution in U.S., 18
    - origin of, 17
  - domes, 17, 20
  - electrolysis of, 124, 132
  - evaporation of, 27
  - flash evaporation process, 39
  - grades, 41
  - grainer evaporation process, 34
  - hopper crystals, 36
  - hydrochloric acid from, 85
  - ice, 28
  - industrial position of, 15
  - marketing of, 40
  - materials of construction, 26
  - mining and milling, 23
  - occurrence of, 14
  - production methods, 22
    - statistics, 21-23
  - removal from evaporators, 38
  - sea water, 14
  - solar evaporation process, 33
  - system:  $\text{NaCl}-\text{H}_2\text{O}$ , 27
  - table salt, 43
  - uses of, 42
  - vacuum evaporation process, 37
    - wells, 24
- Salt brines, composition, 21, 26
- Salt cake, (see Sodium sulfate)
- synthetic, 106
- Salt domes, 17, 20
- Salts, deposition of, 16
- Saltpeter,
- Chile (see Sodium nitrate), 14, 286
  - Norwegian (see Calcium nitrate), 237
- Scale formation, 39
- Screen scale sieves, 360-1
- Sea water, composition of, 14
- Seaboard process, 246
- Searles Lake, Calif., potash from, 71
- Sequestration, 340
- Shanks tanks, 89
- Sieves, Tyler standard screen scale, 360-1
- Silica gel, 207
- Sludge acid, 175, 218
  - concentration, 219
- Soda ash (see Sodium carbonate)
- Sodium bicarbonate, 98
- calcination, 102
  - formation, 98
  - pH of solution, 342
  - production, 82
  - system,  $\text{NaHCO}_3-\text{NH}_4\text{Cl}-\text{H}_2\text{O}$ , 96
- Sodium carbonate,
- ammonia—soda process, 94
  - ammonia recovery, 100
  - brine purification, 97
  - carbonation, 98
  - chemical principles, 96
  - flow sheet, 95
  - saturation with ammonia, 98
  - Solvay, 85
- caustic soda from, 107
  - consumption, 122
  - competition among alkalis, 115
- equilibrium with  $\text{NaOH}$ , 108
- from burkeite, 74
- from sodium bicarbonate, 102
- grades, 105
- history, 84
- Hargreaves-Bird cell, 131
- Leblanc process, 85
  - benefits of, 94
  - economics of, 93
  - leaching, 89
  - processing, 90
  - production of  $\text{Na}_2\text{SO}_4$ , 85
  - utilizing wastes, 90
- marketing, 105
- material, 47
- pH of solution, 342
- production, 82
- sodium hydroxide from, 107
- Solvay, 85
- synthetic saltcake, 106
- system:  $\text{Na}_2\text{CO}_3-\text{H}_2\text{O}$ , 47
- trona, 48
- uses, 83
- Sodium chlorate, 155
- Sodium chloride (see Salt)
- system,
    - $\text{NaCl}-\text{H}_2\text{O}$ , 27
    - $\text{NaCl}-\text{KCl}-\text{H}_2\text{O}$ , 60
- Sodium chlorite, 149
- Sodium cyanide, 295
- Sodium formate, 299
- Sodium hydroxide
  - causticizing sodium carbonate, 108
    - batch process, 110
    - chemical principles, 108
    - continuous process, 110
    - control of operation, 112
    - causticizing, 112
    - decantation, 113
    - lime slaking, 112

- washing, 114
- equilibrium, 108
- flow sheet, 110, 111
- limitations, 109
- objectives, 109
- chemical caustic, 108
- competition among alkalis, 115
- consumption, 121-3
- corrosion, 138
- density of solutions, 357, 358
- electrolytic process, 121
  - chemical principles, 124
  - corrosion, 138
  - current efficiency, 126
  - diaphragm cells, 127
  - evaporation, 134
  - Hargreaves-Bird cell, 131
  - history, 123
  - Hooker cell, 128
  - mercury cells, 131
  - operation of cells, 132
  - power efficiency, 127
  - purification, 135
  - types of cells, 127
  - voltage efficiency, 127
  - Vorce cell, 130
- evaporation of solutions, 134
- flakers, 134
- fused, 136
- Löwig process, 109
- marketing, 138
- materials of construction, 137
- pH of solution, 342
- production, 121
- shipping, 139
- Sodium hypochlorite, 144
- Sodium iron pyrophosphate, 338
- Sodium nitrate, 14, 286
- Sodium oxalate, 299
- Sodium phosphates, 335
  - dibasic- (D.S.P.), 335-7
  - hemi-, 336
  - hexameta-, 339
  - monobasic-, 337
  - pH of solutions, 342
  - pyro- (T.S.P.P.), 335, 338
  - tetra-, 339
  - tribasic- (T.S.P.), 335-8
  - tripoly-, 338
- Sodium salts, natural, 13
  - carbonate, 47
  - chloride, 13
  - sulfate, 43
- Sodium sesquicarbonate, 49, 105
- Sodium sulfate, 43, 74
  - decahydrate, 34, 35, 46, 74
  - dehydration of, 46, 74
  - from burkeite, 74
- Hargreaves process, 87
  - natural, 43
  - production from salt, 85
  - production, natural sources, 43
  - reduction of, 88
  - system:  $\text{Na}_2\text{SO}_4-\text{H}_2\text{O}$ , 44
- Sodium sulfide, 88
- Sodium sulfite, 104
- Solar evaporation, 33
- Solubility
  - composition of solutions, 27
  - inverted solubility curve, 45
  - temperature coefficient, 29
- Solvay process (see Sodium carbonate)
- Specific gravity tables, 357-9
- Strassfurt, Germany, 58
- Submerged combustion, 45, 70, 325
- Sulfide minerals, 173
- Sulfur, 169
  - burners
    - A.P.M.E.W., 177
    - chemical principles, 176
    - Chemico, 178
    - Glens Falls, 177-8
    - Leonard Construction Co., 178
    - pan, 177
    - rotary, 177
    - spray, 178-9
    - Vesuvius, 177
  - Chance-Claus process, 92
    - consumption, 172
  - Frasch process, 170
    - from  $\text{H}_2\text{S}$ , 92, 171, 174
    - from  $\text{SO}_2$ , 172
    - world production, 169
- Sulfur dioxide, 177
  - burner gas, 183
  - dust and fume removal, 183
  - equilibrium with  $\text{SO}_3$ , 202-6
  - liquid, 184
  - marketing, 184
  - reduction to sulfur, 172
  - specifications, 184
  - uses, 175
- Sulfur trioxide,
  - absorption in  $\text{H}_2\text{SO}_4$ , 216
  - formation, 202, 210
- Sulfuric acid
  - acid sludge, 175
  - burner gas, composition, 183
  - business index, 164
  - catalysts, 207
    - efficiency, 209
    - ferric oxide, 208
    - platinum, 207, 210
    - poisons, 209
    - vanadium, 208, 210
  - chamber process, 185

- Sulfur acid (*cont.*)  
 acid pumps, 193  
 chambers, 191  
 coolers, 193  
 dust and fume removal, 183  
 flow sheet, 185  
 Gaillard-Parrish system, 194  
 Gay-Lussac tower, 193  
 Glover tower, 189  
 high capacity systems, 194  
 Larison system, 194  
 Mills-Packard system, 194  
 niter, 186  
 nitrosyl sulfuric acid, 188, 193  
 Opl system, 194  
 oxides of nitrogen, 186  
 purification, 194  
 pyrites burners, 179  
 reactions, 188  
 sulfur burners, 176  
 concentration of, 219  
 cascade system, 220  
 drum type, 221  
 tower system, 220  
 vacuum, 222  
 consumption of, 163, 165  
 contact process, 200  
 absorption system, 216  
 Badische process, 207  
 equilibrium in, 202  
 filters, 212  
 flow sheet, 211  
 heat exchanger, 213  
 history, 201  
 purification system, 212  
 rate of reaction, 206  
 theory, 202  
 control, 218  
 converters, 213  
 Chemico, 215  
 Jaeger, 214  
 corrosion, 222  
 alloys, 224  
 iron, 223  
 lead, 223  
 non-metals, 224  
 density of solutions, 357-8  
 distribution of manufacture, 162  
 ferrous sulfate, 175  
 grades, 166  
 history, 166  
 index to business activity, 164  
 industry, 224  
 monohydrate, 166  
 nomenclature, 162  
 oil of vitriol, 166  
 oleum, 166, 217  
 plant operation, 210  
 production, 161  
 pumps for, 193  
 raw materials, 168  
 sludge conversion, 175  
 Superphosphate (*see* Phosphate fertilizers),  
 313  
 ammoniated, 319  
 Sylvite, 56, 59, 73  
 Sylvinite, 59, 65  
 flotation, 67, 68  
 refining, 66  
 Synergism, 256  
 Synthol, 299  
 Systems,  
 binary,  
 KCl—H<sub>2</sub>O, 60  
 NaCl—H<sub>2</sub>O, 27, 60  
 Na<sub>2</sub>CO<sub>3</sub>—H<sub>2</sub>O, 47  
 Na<sub>2</sub>SO<sub>4</sub>—H<sub>2</sub>O, 44  
 ternary,  
 KCl—NaCl—H<sub>2</sub>O, 60, 62  
 KCl—MgCl<sub>2</sub>—H<sub>2</sub>O, 63  
 KCl—MgSO<sub>4</sub>—H<sub>2</sub>O, 64  
 K<sub>2</sub>SO<sub>4</sub>—MgCl<sub>2</sub>—H<sub>2</sub>O, 64  
 NaCl—NH<sub>4</sub>HCO<sub>3</sub>—H<sub>2</sub>O, 96  
 NaClO<sub>3</sub>—NaCl—H<sub>2</sub>O, 156  
 NaHCO<sub>3</sub>—NH<sub>4</sub>Cl—H<sub>2</sub>O, 96  
 complex,  
 K<sup>+</sup>—SO<sub>4</sub><sup>2-</sup>—CO<sub>3</sub><sup>2-</sup>—Na<sup>+</sup>—Cl<sup>-</sup>, 72-3
- T**
- Table salt, 43  
 Tantalum absorber, 153-4  
 Tennessee Valley Authority (T.V.A.), 245,  
 251, 252, 319, 320  
 Thenardite, 46  
 Threshold treatment of water, 341  
 Thylox process, 174  
 Tourills, 153  
 Towers  
 for absorption of  
 hydrochloric acid, 152-4  
 nitrogen oxides, 193, 238, 282, 284  
 sulfur trioxide, 216  
 for ammonia-soda process, 98-102  
 Trade literature, 10  
 associations, 10  
 Trail, B. C. (*see* Consolidated Mining &  
 Smelting Co. of Canada, Ltd.)  
 Tricalcium phosphate, 320, 334  
 Triple superphosphate, 318  
 Tripolyphosphoric acid, 322  
 Trisodium phosphate, 335-6  
 Trona, 48, 105  
 T.S.P., 335-6  
 Tyler standard screen scale sieves, 360-1  
 T.V.A. (*see* Tennessee Valley Authority)

**U**

Urea,  
  direct process, 294  
  from cyanamide, 296

**V**

Vacuum Evaporation,  
  of caustic soda solutions, 134  
  of salt solutions, 37  
Vanadium catalysts, 208, 210

Voltage efficiency, 127  
Vorce cell, 130

**W**

Water conditioning, 340  
Water, electrolysis of, 244  
Water gas, 245  
  reaction, 247  
Weldon process, 91  
White liquor, 90, 111  
Woulff bottles, 153



