

**BIRLA CENTRAL LIBRARY**

PILANI (Rajasthan)

Class No...*570*....

Book No...*W.86.A*

Accession No...*5.277.0*



Acc. No. 58770

**ISSUE LABEL**

**Not later than the latest date stamped below.**

--	--	--



# ANIMAL BIOLOGY



THE MACMILLAN COMPANY  
NEW YORK • BOSTON • CHICAGO  
DALLAS • ATLANTA • SAN FRANCISCO

MACMILLAN AND CO., LIMITED  
LONDON • BOMBAY • CALCUTTA  
MADRAS • MELBOURNE

THE MACMILLAN COMPANY  
OF CANADA, LIMITED  
TORONTO



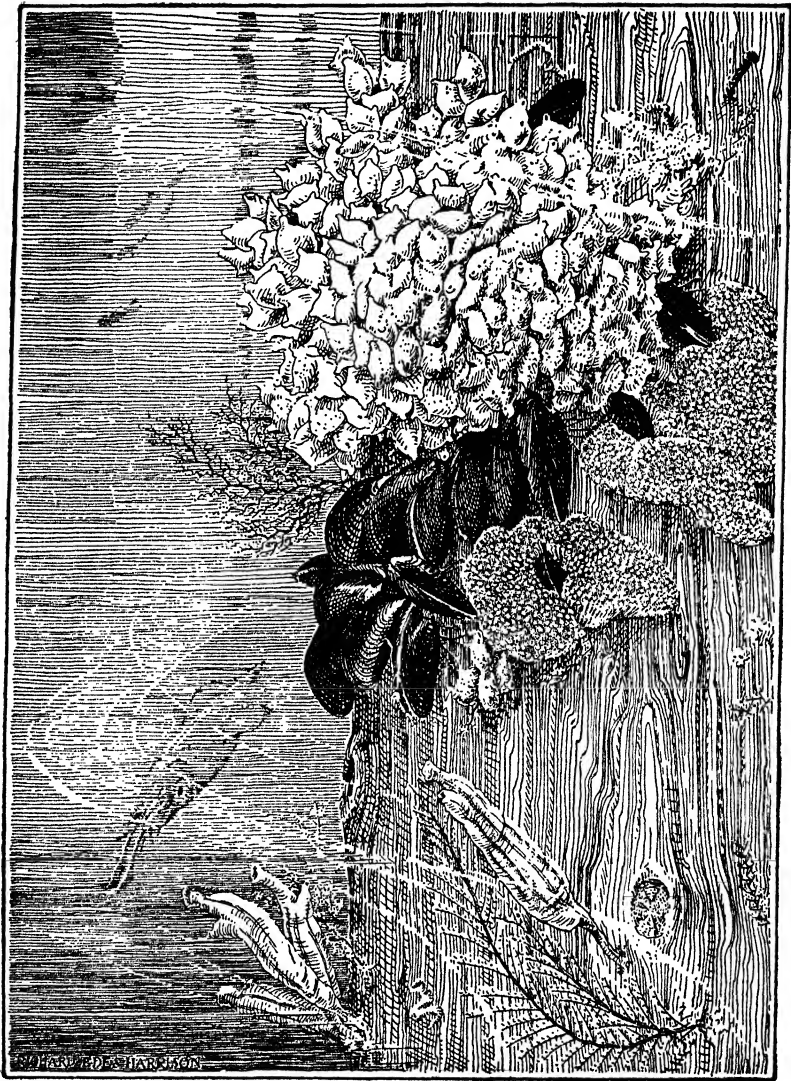

**A MARINE BIOCOENOSIS**

Coelenterates, Molluscs, and Chordates on a wharf pile. (From Baitsell.)

# **ANIMAL BIOLOGY**

---

BY

**LORANDE LOSS WOODRUFF**

*Professor of Protozoology in Yale University*

*Second Edition*

---

NEW YORK

**THE MACMILLAN COMPANY**

1946



SECOND EDITION COPYRIGHTED, 1938,  
BY THE MACMILLAN COMPANY

---

ALL RIGHTS RESERVED—NO PART OF THIS BOOK MAY BE  
REPRODUCED IN ANY FORM WITHOUT PERMISSION IN WRITING  
FROM THE PUBLISHER, EXCEPT BY A REVIEWER WHO WISHES  
TO QUOTE BRIEF PASSAGES IN CONNECTION WITH A REVIEW  
WRITTEN FOR INCLUSION IN MAGAZINE OR NEWSPAPER

---

Printed in the United States of America

Set up and electrotyped. Published April, 1938

Reprinted April, 1939  
Reprinted December, 1942.  
Reprinted March, 1945  
Reprinted March, 1946

First edition copyrighted and published, 1932,  
By The Macmillan Company

## PREFACE TO SECOND EDITION

This revised edition of the *Animal Biology* incorporates numerous changes suggested by experience and the development of the science, especially in the field of genetics. Growing interest in man's past has led to the introduction of a chapter on the human background.

Withal, the page and figure numbers remain unaltered in the sections referred to in Professor Baitzell's *Manual of Animal Biology*, so that book is still available for the details of the morphology and physiology of selected types, as well as for laboratory directions, which obviously would be out of place in the present volume.

For suggestions in regard to the new chapter I am indebted to my colleagues, Professor R. S. Lull and Doctor G. E. Lewis; and my thanks are due Professor J. H. McGregor of Columbia University, the University of Chicago Press, William Wood and Co., and the Yale University Press for permission to reproduce figures from their publications. Miss E. L. Gelback has assumed efficiently much of the editorial work involved in seeing the book through the press. And, finally, I wish to express my appreciation of the continued hearty coöperation afforded by The Macmillan Company.

L. L. WOODRUFF

YALE UNIVERSITY,  
March, 1938.

## FROM PREFACE TO FIRST EDITION

The present volume is published in response to a demand for a special adaptation of the author's *Foundations of Biology*, Fourth Edition, designed especially for use in courses in animal biology and general zoölogy in which plants are considered only incidentally in their relations with animals. The essential plan as well as much of the material is, with purpose, the same in both books since the author is apparently far from alone in the conviction that the general biological viewpoint affords the natural approach to an introductory survey of either animal or plant science.

The author continues to be indebted to his colleagues in the Osborn Zoölogical Laboratory at Yale University and to many others, including his wife, who by suggestions and constructive criticism aided in the development of the book. Special mention is gladly made of the interest expressed by Professor J. W. Buchanan of Northwestern University, Professor D. B. Casteel of the University of Texas, Professor W. B. Unger of Dartmouth College, and by Professors W. R. Coe, G. A. Baitzell, J. S. Nicholas, and D. A. Kreider of Yale.

The author has had again at his disposal the interest and skill of Mr. R. E. Harrison who has drawn a large number of new figures and revised old ones especially for this book. Acknowledgments are also due to the authors and publishers of the following works, who have supplied additional illustrations: Chapman's Handbook of Birds of Eastern North America (D. Appleton & Co.); Folsom's Entomology (P. Blakiston's Sons & Co.); Hough and Sedgwick's The Human Mechanism, Linville and Kelly's General Zoölogy (Ginn & Co.); Martin's Human Body, Sedgwick and Wilson's General Biology (Henry Holt & Co.); Metcalf and Flint's Destructive and Useful Insects, Noble's Biology of the Amphibia (McGraw-Hill Book Co.); Romanes' Darwin and After Darwin (Open Court Publishing Co.); Conklin's Heredity and Environment in the Development of Men (Princeton University Press); Conn and Budington's Advanced Physiology and Hygiene (Silver, Burdett & Co.); Kudo's Protozoölogy (C. C. Thomas); Chandler's Animal Parasites and Human Disease, Curtis and

Guthrie's General Zoölogy (John Wiley & Sons); Wilson's Physical Basis of Life (Yale University Press); and Hegner's College Zoology, Lindsey's Evolution and Genetics, Lull's Organic Evolution, Metcalf's Organic Evolution, Newman's Vertebrate Zoölogy, Parker and Haswell's Textbook of Zoölogy, Peabody and Hunt's Biology and Human Welfare, Scott's The Theory of Evolution, Shipley and McBride's Zoölogy, Walter's Genetics (The Macmillan Co.).

Furthermore, the author is indebted, of course, to innumerable sources for the facts and principles outlined and for suggestions for figures adaptable to present needs. Many of these references are specifically mentioned in the preface to the *Foundations of Biology* and are listed in the bibliography of the present volume. Finally, to The Macmillan Company the author is grateful for its hearty and generous coöperation in all the arrangements incident to publication.

L. L. WOODRUFF

YALE UNIVERSITY,  
February, 1932.



# CONTENTS

CHAPTER		PAGE
I.	THE SCOPE OF BIOLOGY . . . . .	1
	A. Origin of Life Lore . . . . .	2
	B. Biological Sciences . . . . .	3
	C. Biology and Human Progress . . . . .	5
II.	CELLULAR ORGANIZATION OF LIFE . . . . .	7
	A. The Cell . . . . .	9
	B. Cell Division . . . . .	12
III.	THE PHYSICAL BASIS OF LIFE . . . . .	14
	A. The Protoplasm Concept . . . . .	15
	B. Unique Characteristics of Living Matter . . . . .	18
	1. Organization . . . . .	18
	2. Chemical Composition . . . . .	20
	3. Metabolism . . . . .	23
	4. Maintenance and Growth . . . . .	25
	5. Reproduction . . . . .	26
	6. Irritability and Adaptation . . . . .	26
IV.	METABOLISM OF ORGANISMS . . . . .	30
	A. Green Plants . . . . .	30
	1. Protococcus . . . . .	30
	2. Food Making . . . . .	31
	3. Respiration . . . . .	33
	B. Animals . . . . .	35
	1. Amoeba . . . . .	35
	2. Food Taking . . . . .	36
	3. Respiration and Excretion . . . . .	37
	C. Colorless Plants . . . . .	37
	1. Bacteria . . . . .	38
	2. Cycle of the Elements in Nature . . . . .	39
	3. The Hay Infusion Microcosm . . . . .	43
V.	SURVEY OF UNICELLULAR ANIMALS . . . . .	46
	A. Sarcodina . . . . .	47
	B. Mastigophora . . . . .	50
	C. Sporozoa . . . . .	52
	D. Infusoria . . . . .	53
VI.	THE MULTICELLULAR ANIMAL . . . . .	57
	A. Development . . . . .	57
	B. Tissues . . . . .	61
	C. Organs and Organ Systems . . . . .	65
VII.	SURVEY OF INVERTEBRATES . . . . .	67
	A. Sponges . . . . .	67
	B. Coelenterates . . . . .	71

CHAPTER	PAGE
C. Flat Worms . . . . .	78
D. Round Worms . . . . .	79
E. Segmented Worms . . . . .	81
F. Rotifers, Bryozoans, and Brachiopods . . . . .	82
G. Echinoderms . . . . .	83
H. Molluscs . . . . .	86
I. Arthropods . . . . .	90
 VIII. THE INVERTEBRATE BODY . . . . .	 98
A. Hydra . . . . .	98
B. Earthworm . . . . .	100
1. Body Plan . . . . .	101
2. Tissues and Organs . . . . .	104
C. Crayfish . . . . .	104
 IX. SURVEY OF VERTEBRATES . . . . .	 111
A. Fishes . . . . .	112
1. Sharks and Rays . . . . .	113
2. Bony Fishes . . . . .	115
3. Lung Fishes . . . . .	116
B. Amphibians . . . . .	117
1. Salamanders and Newts . . . . .	117
2. Toads and Frogs . . . . .	118
C. Reptiles . . . . .	120
1. Turtles and Tortoises . . . . .	120
2. Crocodiles and Alligators . . . . .	121
3. Lizards and Snakes . . . . .	121
D. Birds . . . . .	123
E. Mammals . . . . .	126
1. Monotremes . . . . .	127
2. Marsupials . . . . .	127
3. Placentals . . . . .	128
 X. THE VERTEBRATE BODY . . . . .	 132
A. Body Plan . . . . .	132
B. Skin . . . . .	134
C. Muscles . . . . .	135
D. Skeleton . . . . .	138
E. The Human Body . . . . .	143
F. Distinctive Vertebrate Characters . . . . .	145
 XI. NUTRITION . . . . .	 150
A. Buccal Cavity, Pharynx, and Esophagus . . . . .	151
B. Stomach . . . . .	153
C. Small Intestine . . . . .	153
1. Liver and Pancreas . . . . .	154
2. Absorption . . . . .	157
3. Distribution . . . . .	157
D. Large Intestine . . . . .	158
E. Food Use . . . . .	159
F. Ductless Glands . . . . .	160

# CONTENTS

xi

CHAPTER		PAGE
XII.	RESPIRATION . . . . .	161
	A. Lungs . . . . .	162
	B. Respiratory Mechanism . . . . .	164
	C. Respiratory Interchange . . . . .	166
XIII.	CIRCULATION . . . . .	168
	A. Circulation in the Lower Vertebrates . . . . .	171
	B. Circulation in the Higher Vertebrates . . . . .	174
XIV.	EXCRETION . . . . .	180
	A. Gills and Lungs . . . . .	181
	B. Skin . . . . .	181
	C. Liver . . . . .	182
	D. Kidneys . . . . .	182
	1. Urine . . . . .	182
	2. Evolution of Kidneys . . . . .	183
XV.	REPRODUCTION . . . . .	188
	A. Invertebrates . . . . .	188
	B. Vertebrates . . . . .	189
	1. Uterine Development . . . . .	191
	2. Hormones . . . . .	192
	3. Urogenital System . . . . .	193
XVI.	COÖRDINATION . . . . .	196
	A. Chemical Coördination . . . . .	196
	B. Coördination by the Nervous System . . . . .	198
	1. Brain and Spinal Cord . . . . .	200
	2. Cranial and Spinal Nerves . . . . .	205
	3. Autonomic System . . . . .	208
	C. Sense Organs . . . . .	209
	1. Cutaneous Senses . . . . .	210
	2. Sense of Taste . . . . .	211
	3. Sense of Smell . . . . .	211
	4. Ear . . . . .	212
	5. Eye . . . . .	213
XVII.	ORIGIN OF LIFE . . . . .	218
	A. Biogenesis and Abiogenesis . . . . .	218
	B. Origin of Life on the Earth . . . . .	221
	1. Cosmozoa Theory . . . . .	223
	2. Pflüger's Theory . . . . .	224
	3. Moore's Theory . . . . .	225
	4. Allen's Theory . . . . .	225
	5. Troland's Theory . . . . .	226
	6. Osborn's Theory . . . . .	226
	7. Huxley's Statement . . . . .	227
XVIII.	CONTINUITY OF LIFE . . . . .	229
	A. Reproduction . . . . .	229
	B. Origin of the Germ Cells . . . . .	238
	1. Mitosis . . . . .	239
	2. Chromosomes of the Germ Cells . . . . .	243



CHAPTER		PAGE
	3. Spermatogenesis . . . . .	244
	4. Oögenesis . . . . .	246
	5. Chromosome Cycle . . . . .	249
<b>XIX.</b>	<b>FERTILIZATION . . . . .</b>	<b>251</b>
	A. Gametes . . . . .	251
	B. Union of Gametes. . . . .	253
	1. Synkaryon . . . . .	254
	2. Significance of Fertilization . . . . .	255
	Protozoa . . . . .	255
	Metazoa . . . . .	258
<b>XX.</b>	<b>DEVELOPMENT . . . . .</b>	<b>263</b>
	A. Embryology of the Earthworm . . . . .	263
	B. Embryology and Metamorphosis of the Frog . . . . .	267
	C. Embryonic Membranes of the Higher Vertebrates . . . . .	271
	D. Problems of Development . . . . .	274
<b>XXI.</b>	<b>INHERITANCE . . . . .</b>	<b>281</b>
	A. Heritability of Variations . . . . .	283
	1. Modifications . . . . .	285
	2. Recombinations . . . . .	287
	3. Mutations . . . . .	287
	B. Mendelian Principles . . . . .	288
	1. Monohybrids . . . . .	288
	2. Dihybrids . . . . .	292
	3. Trihybrids . . . . .	294
	4. Summary . . . . .	294
	C. Alterations of Mendelian Ratios . . . . .	297
	D. Mechanism of Inheritance . . . . .	301
	1. Sex Determination . . . . .	304
	2. Linkage . . . . .	307
	3. Crossing-over . . . . .	308
	4. Mutations . . . . .	309
	E. Nature and Nurture . . . . .	312
<b>XXII.</b>	<b>ORGANIC ADAPTATION . . . . .</b>	<b>316</b>
	A. Adaptations to the Physical Environment. . . . .	316
	1. Adaptations Essentially Functional . . . . .	317
	Food . . . . .	317
	Temperature . . . . .	318
	Pressure . . . . .	320
	2. Adaptations Essentially Structural . . . . .	320
	Adaptive Radiation of Mammals . . . . .	320
	Animal Coloration . . . . .	324
	Legs of the Honey Bee . . . . .	329
	B. Adaptations to the Living Environment . . . . .	335
	1. Communal Associations . . . . .	336
	2. Symbiosis . . . . .	337
	3. Parasitism . . . . .	339
	4. Immunity . . . . .	342
	C. Individual Adaptability . . . . .	343

# CONTENTS

xiii

CHAPTER		PAGE
XXIII	DESCENT WITH CHANGE . . . . .	349
	A. Evidences of Organic Evolution . . . . .	351
	1. Classification . . . . .	352
	2. Comparative Anatomy . . . . .	354
	3. Paleontology . . . . .	358
	4. Embryology . . . . .	364
	5. Physiology . . . . .	366
	6. Distribution . . . . .	368
	B. Factors of Organic Evolution . . . . .	373
	1. Lamarckism . . . . .	373
	2. Darwinism . . . . .	374
	3. Genetics and Evolution . . . . .	377
	Selection . . . . .	378
	Method of Evolution . . . . .	382
XXIV.	BIOLOGY AND HUMAN WELFARE . . . . .	386
	A. Medicine . . . . .	389
	1. Microorganisms and Disease . . . . .	389
	Malaria . . . . .	392
	Yellow Fever . . . . .	393
	Syphilis . . . . .	394
	2. Parasitic Worms . . . . .	396
	Trematodes . . . . .	396
	Cestodes . . . . .	398
	Nematodes . . . . .	400
	3. Health and Wealth . . . . .	401
	B. Biology and Agriculture . . . . .	403
	1. Plant and Animal Food . . . . .	403
	2. Insects Injurious to Animals . . . . .	405
	3. Insects Injurious to Plants . . . . .	408
	4. Beneficial Insects . . . . .	413
	C. Conservation of Natural Resources . . . . .	417
	D. Constructive Biology . . . . .	420
XXV.	THE HUMAN BACKGROUND . . . . .	426
	A. The Prehuman Lineage . . . . .	426
	B. Fossil Man . . . . .	431
	1. Java Man . . . . .	432
	2. Peking Man . . . . .	433
	3. Piltdown Man . . . . .	433
	4. Heidelberg Man . . . . .	434
	5. Neanderthal Man . . . . .	435
	6. Crô-Magnon Man . . . . .	436
	C. Cultural Development . . . . .	437
	1. Paleolithic Culture . . . . .	438
	2. Mesolithic Culture . . . . .	441
	3. Neolithic Culture . . . . .	442
	4. Age of Metals . . . . .	444
XXVI.	DEVELOPMENT OF BIOLOGY . . . . .	446
	A. Greek and Roman Science . . . . .	446
	B. Medieval and Renaissance Science . . . . .	449

CHAPTER	PAGE
C. The Microscopists . . . . .	452
D. Development of the Subdivisions of Biology . . . . .	455
1. Classification . . . . .	455
2. Comparative Anatomy . . . . .	457
3. Physiology . . . . .	459
4. Histology . . . . .	464
5. Embryology . . . . .	466
6. Genetics . . . . .	468
7. Organic Evolution . . . . .	471

## APPENDIX

I. A BRIEF CLASSIFICATION OF ANIMALS . . . . .	477
II. BIBLIOGRAPHY . . . . .	481
III. GLOSSARY . . . . .	492
INDEX . . . . .	515

# ANIMAL BIOLOGY



# ANIMAL BIOLOGY

## CHAPTER I

### THE SCOPE OF BIOLOGY

Science is, in its source, eternal; in its scope, unmeasurable; in its problem, endless; in its goal, unattainable. — *von Baer*.

THE oldest as well as the most obvious classification of the objects composing the world about us is into non-living and living; and the knowledge accumulated during many centuries in regard to the former is to-day represented in the physical sciences, while that of the latter comprises the content of BIOLOGY, the science of matter in the living state. Biology, like all science, has as its ultimate object the description of its phenomena in terms of what may be regarded as basic concepts — matter and energy acting in space and time; but it is needless to say that the attainment of this object is not imminent in any department of knowledge, and least so in the science of living things. These exhibit a state of matter and energy which altogether transcends the classifications of physicist and chemist to-day — a condition which expresses in its highest manifestations what we call our 'life.'

Whether the 'riddle of life' will ultimately be solved is a question which everyone would like to answer but only the rash would attempt to predict. Suffice it to say that biologists who are on the firing line of progress to-day are directing their attention solely to the description and measurement of the phenomena exhibited by living things — those phenomena which distinguish life from lifeless — in an attempt to relate them to the familiar and more readily accessible phenomena of which we have some exact knowledge in the realm of the non-living. But this should by no means be taken to indicate that biologists do not recognize the stupendous problems they face, or do not appreciate to the full — indeed more fully than others — the enormous gap that separates even the simplest forms of life from the inorganic world.

Our present interest, however, is not in discussing the theoretical goal of biology, but in drawing in bold strokes an outline picture of the present-day knowledge of the subject which represents the cumulative results of the application of the scientific method to problems of life. This method is not peculiar to science, but is merely a perfected concentration of our human resources of observation, experimentation, and reflection. Thus far this has been a most productive method and certainly has given no evidence that its usefulness is being exhausted. But, of course, "in ultimate analysis everything is incomprehensible, and the whole object of science is simply to reduce the fundamental incomprehensibilities to the smallest possible number."

#### A. ORIGIN OF LIFE LORE

The foundations of the scientific study of living nature were laid by Aristotle and Theophrastus over 2000 years ago. On the basis of collecting, dissecting, classifying, and pondering they reached generalizations, many of which have but recently been put on a firm basis of fact. Indeed, they seem to have raised nearly all the broad questions which are fundamental to-day; but from the Greeks until about the fifteenth century there is little to record. There were many additions to the body of knowledge during this long slumber period, but fact and fancy were so intermingled that the truth was largely obscured. (Figs. 288, 289.)

The feeling that, though Man is of nature, he is still apart, was expressed at the revival of learning, during the sixteenth century and later, in the broad classification of all knowledge as history of nature and history of Man; the former recording the "history of such facts or effects of nature as have no dependence on Man's will, such as the histories of metals, plants, animals, regions, and the like"; the latter treating of the voluntary actions of men in communities. Thus all record of facts was either NATURAL HISTORY or civil history. From this general field of natural history the present-day sciences of astronomy, physics, chemistry, geology, and biology became separated as relatively independent bodies of facts as each gained content, clearness, and individuality. Astronomy, physics or natural philosophy, and chemistry were set apart first owing to the fact that their material was more readily susceptible to mathematical and experimental treatment, thus leaving

the histories of the Earth, animals, and plants, or so-called observational sciences, as the residue for natural history.

It remained, however, for Lamarck in particular, during the opening years of the nineteenth century, to attain a vision of the unity of animal and plant life and to express it in the term **BIOLOGY**. But biology is something more than a union of plant science — **BOTANY** — and animal science — **ZOÖLOGY** — under one name; for it endeavors, in addition to describing the characteristics of plants and animals, to unfold the general principles underlying both. Accordingly **ANIMAL BIOLOGY**, the subject of the present volume, is the study of the basic principles of life with especial reference to animals, including Man.

### B. BIOLOGICAL SCIENCES

Thus the biologist has as his field the study of living things — what they are, what they do, and how they do it. He asks, how this animal or that plant is constructed and how it works — and this he attempts to answer. He would like to ask, and often does ask, why it is so constructed and why it works the way it does, but then he passes beyond the scope of science into the realm of philosophy.

These queries of the biologist reflect the two primary viewpoints from which biological phenomena may be approached: the *morphological* in which interest centers upon the form and structure of living things; and the *physiological* in which attention is concentrated upon the functions performed — the mechanical and chemical engineering of living machines. Clearly, however, it is impossible to draw a hard and fast distinction between morphology and physiology because in the final analysis structure must be interpreted in terms of function, and vice versa. But again, the fields of morphology and physiology naturally resolve themselves into special departments of study, depending on the level of analysis of structure or of function which is emphasized. Thus **MORPHOLOGY** stresses the general form of the animal or plant; **ANATOMY**, the gross structure of individual parts, or *organs*; **HISTOLOGY**, the microscopic structure of organs, or *tissues*; **CYTOLOGY**, the component elements of tissues, or *cells*, and the physical basis of life, or *protoplasm*. Similarly, **PHYSIOLOGY** investigates the activities of animals and plants, the functions of organs, the properties of tissues, the phases of cell life, and finally the physico-chemical



characteristics of protoplasm. So much for the study of the **adult** individual animal or plant — but this is not all. The origin and development of the individual, **GENETICS** and **EMBRYOLOGY**; and the origin and development of species, **ORGANIC EVOLUTION**, are other wide fields which must be approached from both the struc-

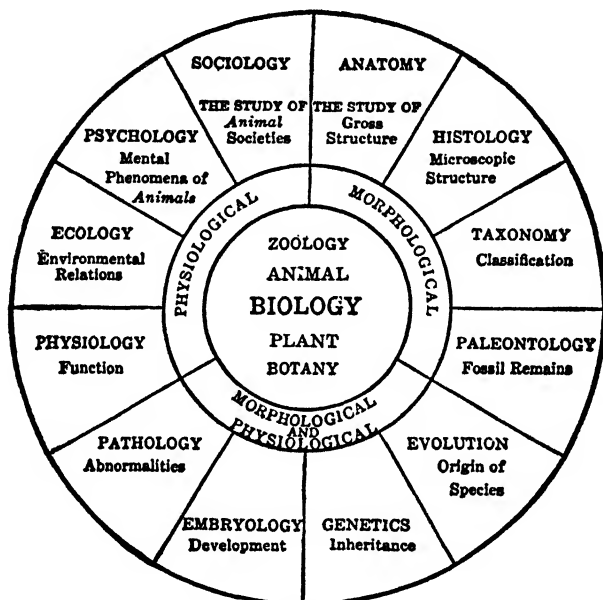

FIG. 1. — The chief divisions of Biology.

tural and functional aspect if any real advance is to be made toward a comprehensive appreciation of life. (Fig. 1.)<sup>1</sup>

Thus, just as the various physical sciences have expanded and become specialized until they are beyond the grasp of a single man, so biology and its subdivisions, or the **BIOLOGICAL SCIENCES**, are now distributed among many specialists. Although specialization results in a narrowing and isolating of the fields of study, as deeper levels of investigation have been reached in all the sciences there has been a tendency for the basic phenomena to meet on the common ground of the fundamental sciences, physics and chemistry — for in the last analysis the biologist must assume, as a *working hypothesis*, that the properties of protoplasm are the re-

<sup>1</sup> In order not to interrupt the continuity of the narrative, formal definitions of technical terms are usually omitted from the text. See the **GLOSSARY**, Appendix III.

sultant of the properties and interrelationships of the chemical elements which compose it. But he must not suppose that physics and chemistry when added up fulfil the rôle of biology. Rather he must grip the cardinal fact that with new relations the properties of things change—the properties of protoplasm depend on and emerge from those of its chemical constituents only when the latter are actually in protoplasm.

Thus “in one direction, supported by chemistry and physics, biology becomes biochemistry and biophysics. In another direction it becomes the basis of the psychical sciences which relate to human nature, of psychology and sociology,” etc. Indeed, it is not an exaggeration to regard all knowledge as really biological, since the process of knowing is a life process which is basal to every art and its practice, to every science and its application, and to every philosophy and its exposition.

### C. BIOLOGY AND HUMAN PROGRESS

Probably the value of a knowledge of biological principles, and of the order of nature in general, cannot be better emphasized than in the words of the founder of modern methods of biological teaching. Huxley wrote: “Suppose it were perfectly certain that the life and fortune of every one of us would, one day or other, depend upon his winning or losing a game of chess. Don't you think that we should all consider it to be a primary duty to learn at least the names and the moves of the pieces? . . . Do you not think we should look with disapprobation upon the parent who allowed his child, or the state that allowed its members, to grow up without knowing a pawn from a knight? Yet it is a very plain and elementary truth that the life, the fortune, and the happiness of every one of us, and, more or less, of all who are connected with us, do depend upon our knowing something of the rules of a game infinitely more difficult and complicated than chess. It is a game which has been played for untold ages, every man and woman of us being one of the two players in a game of his or her own. The chessboard is the world, the pieces are the phenomena of the universe, the rules of the game are what we call the laws of Nature. The player on the other side is hidden from us. . . . To the man who plays well, the highest stakes are paid with an overflowing generosity. And one who plays ill is checkmated.” (Fig. 298.)

The contributions of the biological sciences to human welfare — the rules of the game of life — we shall consider later more fully. At this point it is merely necessary to emphasize that biology affords certain fundamental principles which are of universal application — principles of so great importance that they have revolutionized modern thought and action in nearly every field of human endeavor, and color civilized Man's entire mental outlook on the world about him. Biology is the supreme agent of adjustment of human life to human life-conditions, and life goes on solely by reason of the adequacy of such adaptations. Specifically, of course, biology forms the indispensable foundations of medicine — health, and of agriculture — food and raiment. Together these spell wealth: without them we would be poor indeed.

Thus biology meets many of the physical needs of mankind and so adds enormously to the basis of human welfare, but it also has another equally important aspect. The appeal of biology for its high place as a contributor to the progress of humanity *combines* its practical gifts with the more subtle development of aesthetic values which naturally flow from the pregnant thought of the unity of nature — the oneness of life — based on the firm and ever-increasing sense of control as knowledge grows, which “robs life of none of its mystery but rather serves to link it securely with the larger mystery of the universe and the Infinite back of it all.” Man, though one with all living beings, has the unique and all-important power consciously to study the ways, to direct the forces of nature, and to adapt himself to them.

## CHAPTER II

### CELLULAR ORGANIZATION OF LIFE

Science never destroys wonder, but only shifts it, higher and deeper. — *Thomson.*

WITH a synoptic view of the scope and importance of biology before us, we now turn directly to the study of life itself in the only form it is known — the bodies of plants and animals.

A thin slice of material from the surface of the skin of a Frog or the leaf of a Buttercup when examined under the microscope shows the same general structure. Each appears to be composed of innumerable small bodies, no two of which are exactly alike even in the same piece, though all are similar enough to be one and

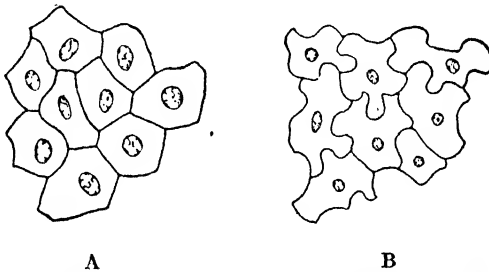

FIG. 2. — Cells, highly magnified, from the surface of a Frog's skin (A), and a plant leaf (B).

the same type of unit. And if we extend our study to other parts of the Buttercup or the Frog or, indeed, to any part of any familiar plant or animal — or to the human body — we find essentially similar units of structure in every case. In fact, the bodies of all living things either consist of a single organic unit or of millions of essentially similar units called **CELLS**. (Figs. 2, 3, 4.)

Each cell is itself the theater of all the fundamental vital processes — each is alive. This, of course, is obvious when a cell forms the whole body of a **UNICELLULAR** plant or animal, but not so apparent when it is only one of myriads forming a **MULTICELLULAR** organism. But actually the life of the organism as a whole is, in

final analysis, the product of the life of the component cells: the expression of their harmonious coöperation. Accordingly the cells are the basic units of the actual living matter, termed PROTOPLASM.

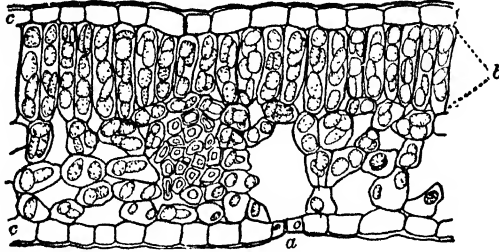

FIG. 3. — Vertical section (highly magnified) of a leaf to show its cellular structure. *a*, guard cells, at opening (stoma) through epidermis; *b*, cells containing chlorophyll; *c*, upper and lower epidermal cells. (From Bailey.)

Such being the case, we reach the first great biological generalization: all animals and plants have the same elementary cellular structure. Indeed, the specific local differentiations in the living

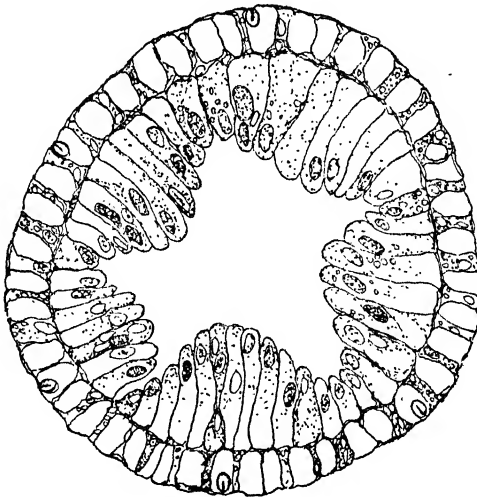

FIG. 4. — Transverse section (highly magnified) of a simple animal (*Hydra*) to show the cellular structure. Outer layer, ectoderm; inner layer, endoderm; central cavity, enteric cavity.

materials of the various parts of animals and plants are made possible largely because the protoplasm is disposed in microscopic unit masses, or cells.

## A. THE CELL

With the diversity of gross structure of animals and plants in mind, one is not surprised that there are considerable, even great, variations in their component cells. In fact, the characteristics of an organism or part of an organism are determined by those of the cells. But there are certain fundamental cell characters which are common to all cells — by virtue of which they are cells — and it is important to emphasize these. (Fig. 5.)

In its simplest form a cell is a small, more or less spherical mass of protoplasm. Such are the eggs of various animals and the com-

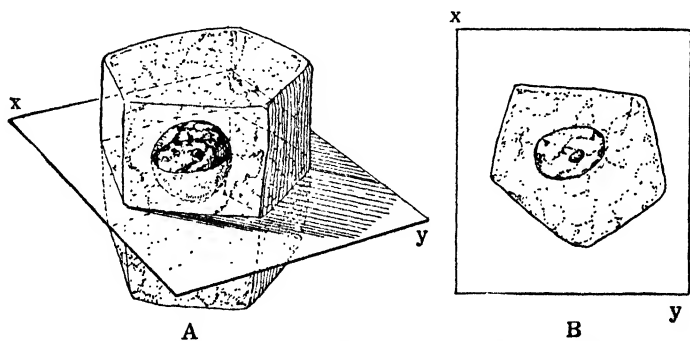

FIG. 5. — Diagram of a cell shown (A) as a solid body, and (B) in optical section, through plane x-y, as it appears under the microscope.

plete body of some of the lowest plants and animals. Cells forming the units of multicellular organisms, however, frequently exhibit more or less hexagonal surfaces on account of stresses and strains incident to their position among other cells; while specializations and differentiations, for one purpose or another, produce forms which are characteristic of different parts of the organism, as, for example, the long spindle-shaped cells of certain muscles, and the widely branching cells of parts of the brains of animals. Broadly speaking, the greater diversity of cell form is found in animals, while in plants, owing to the more general presence of rigid CELL WALLS about the protoplasm, the cells more frequently present symmetrical, angular outlines. (Figs. 6, 7.)

The term cell is a relic of the time when the cell wall was regarded as the most important part, and its protoplasmic contents, if observed at all, were considered as only of secondary importance, if not waste material. Now we recognize many cells which are

essentially naked masses of protoplasm, such as *Amoeba* and white blood cells. In other words, the protoplasm is the actual living part — the cell wall typically being a non-living accessory which more or less sharply separates one unit mass of protoplasm from another and lends rigidity and form to the group of cells as a whole.

The living material of cells is highly organized into various complex structures, some of which are present in all cells and others only in cells adapted for special functions. For the present,

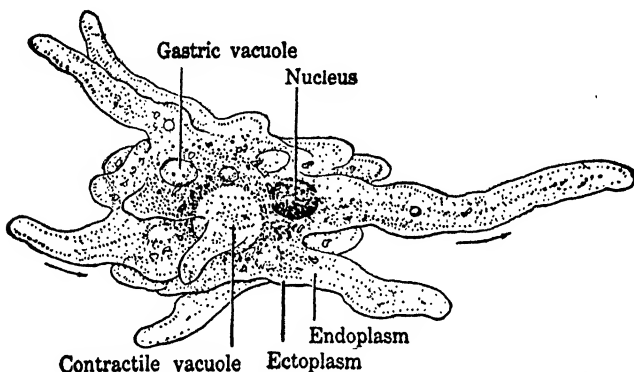

FIG. 6. — A simple animal (*Amoeba proteus*) which consists of a single cell (highly magnified). Locomotion is by streaming of the protoplasm forming temporary protrusions, or pseudopodia.

however, it is only necessary to emphasize that the protoplasm of all typical cells is differentiated into two chief parts: the **CYTOPLASM**, or general groundwork which makes up the bulk of the cell; and the **NUCLEUS**, a more or less clearly defined spherical body, situated near the center of the cytoplasmic mass.

Cytoplasm and nucleus, looked at from the functional viewpoint, represent a *physiological division of labor* within the confines of the cell. Experiments have shown that they are mutually necessary for cell life; the removal of the nucleus putting an end to constructive processes — assimilation, repair, and growth — and thus leading rapidly to death. Accordingly the nucleus may be considered as the center of the synthetic activities of the cell, and the cytoplasm, if not as the area in which destructive processes are chiefly involved, at least as the region in which the results of the nuclear activity become realized. It seems clear that the nucleus is the controlling agent in cell activity, and hence a

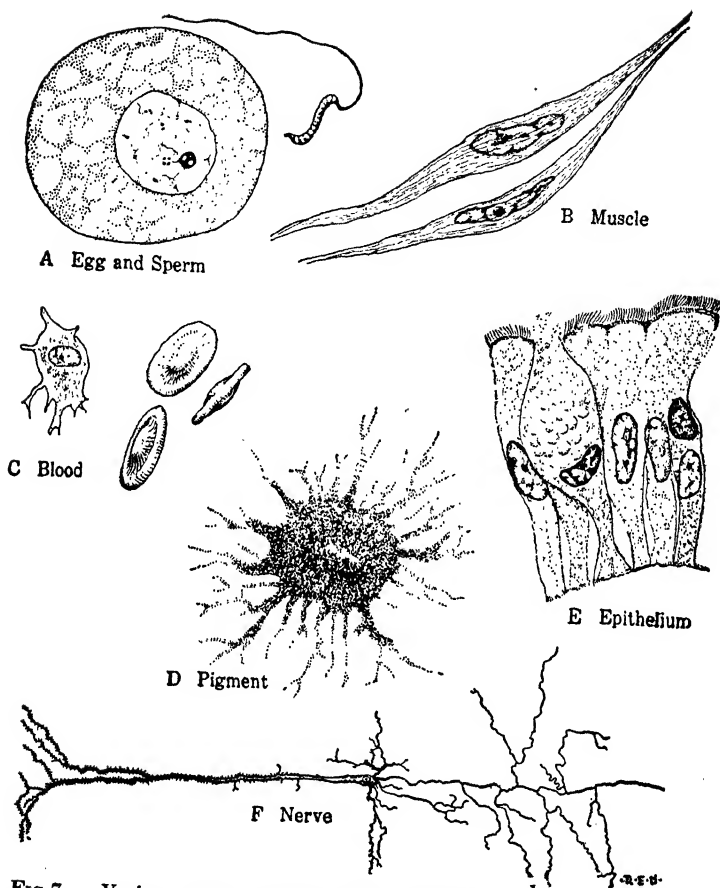

FIG 7. — Various types of cells, highly magnified. A, egg and sperm of Segmented Worm; B, muscle cells (unstriated) from bladder of Frog; C, one white and three red blood cells of Frog; D, pigment cell from skin of Fish; E, epithelial cells (ciliated), including a gland cell, from intestine of Dog; F, nerve cell (neuron) from brain of Mouse.



primary factor in growth, development, and transmission of specific qualities from cell to cell, and so from one generation to the next.

### B. CELL DIVISION

All the evidence indicates that, at the present time at least, living matter never arises except under the influence of preëxisting living matter. That is, protoplasm grows — cells grow and, having attained a certain size, reproduce by dividing into two essentially equal parts. Then there are two cells — the parent cell

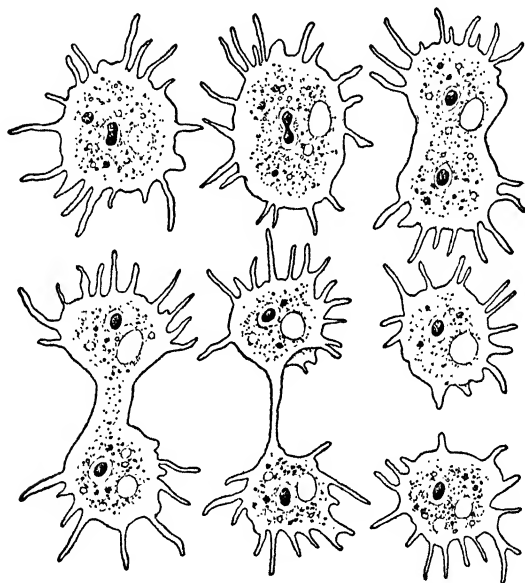

FIG. 8. — An Amoeba in six successive stages of division. The dark body surrounded by a clear area is the nucleus. (Modified, after Schultze.)

has lost its identity in its offspring. Cell division is reproduction. Indeed, in final analysis reproduction is always cell division, through this primary fact is largely obscured by accompanying phenomena in higher animals and plants. (Fig. 8.)

The process of cell division involves the division of both cytoplasm and nucleus, and therefore we must enlarge our conception of a cell as a small mass of protoplasm differentiated into cytoplasm and nucleus, by adding that both cytoplasm and nucleus arise through the division of the corresponding elements of a preëxisting cell.

We shall later have occasion to make a study of the details of cell division, known as **MITOSIS**, but from what has been said it must occur to the reader that, since cells arise only by division, those of the present day, whether complete free-living organisms or units composing the bodies of higher plants and animals, including Man, are actually lineal descendants in unbroken series from the beginning of cellular life on the Earth. (Fig. 164.)

## CHAPTER III

### THE PHYSICAL BASIS OF LIFE

Over the structure of the chemical molecule rises the structure of the living substance as a broader and higher kind of organization.

— *Hertwig.*

THE realization that all animals and plants possess a fundamentally similar organization — the structural and physiological units, or cells — leads quite naturally to an intensive study of the material of which the cells are composed — the physical basis of life itself. Accordingly we must now consider more specifically the characteristics of this actual life-stuff — protoplasm.

The old saying that the materials forming the human body change completely every seven years is a tacit recognition that lifeless material, in the form of food, is gradually transformed into living matter under the active influence of the body. Indeed, just as a geyser retains its individuality from moment to moment though it is at no two instants composed of the same molecules of water identically placed, so the living individual is a focus into which materials enter, play a part for a time, and then emerge to become dissipated in the environment. But here the analogy stops. For in the living organism the materials which enter as food, endowed with POTENTIAL ENERGY, are arranged and rearranged until specific molecular combinations result, which in turn are transformed into integral parts of the organization of life itself. However, to live is to work, and to work means expenditure — the transformation of the potential into KINETIC energy — with the result that materials in relatively simple form and largely or entirely devoid of energy are returned to the realm of the non-living. And note, the living organism must continuously utilize energy in order merely to maintain itself. Cessation is death.

Thus we reach a fact of prime importance: so far as we know, living matter — protoplasm — is merely ordinary matter that has assumed, for the time being, unique physico-chemical relationships that display the remarkable series of phenomena which we recognize as LIFE.

But non-living matter is always closely associated with living matter in the bodies of animals and plants. Indeed, the two are so intimately related that it is frequently difficult to distinguish sharply between them. Obviously, in the human body, for instance, the visible parts of hair and nails, a large part of bone, and the liquid part of blood are non-living material. But the non-living is not confined to gross structures, for the dead among the living is still revealed until the penetrating power of the microscope fails us.

### A. THE PROTOPLASM CONCEPT

Although there is a continuous stream of matter and energy flowing through the living individual, nevertheless the physical and chemical study of living matter from whatever source we take it — Mold or Elm, Amoeba or Man — reveals a striking similarity in its fundamental factors, and this is the basis of the protoplasm concept held by modern biologists.

As the finer structure of animals and plants came within the range of vision through improvements in microscope lenses, it was gradually recognized that the ultimate living part appeared to be a granular, viscid fluid. This started a long series of studies on the materials of the bodies of unicellular organisms similar to Amoeba and of the cellular elements of higher animals and plants, which finally led, about the middle of the last century, to the complete demonstration of the full morphological and physiological significance of protoplasm. There is, in truth, an essentially similar, fundamental, living material of both animals and plants — a common physical basis of life. This reduction of all life phenomena to a common denominator laid the foundations for — indeed, actually established — the life-science, biology. (Figs. 6, 9.)

Although we speak of a common 'physical basis of life,' it is of paramount importance to bear in mind that the protoplasm of no two animals or plants or, indeed, of different parts of the same animal or plant is exactly the same. Identity of protoplasm would mean identity of structure and function — identity of life itself. The concept protoplasm merely emphasizes that, after allowances are made for all the variations, we still have the similarities far outnumbering the dissimilarities in the 'agent of vital manifestations.'

The physical chemists tell us that protoplasm consists of matter

in the colloidal state — a condition of matter that chemists have long been familiar with in the inorganic world. A COLLOID has been described as matter divided into particles larger than one molecule and suspended in a medium of different matter. Therefore butter and cream are each colloids: the former consisting of water finely divided and suspended in oil, and the latter essentially of finely divided oil in water. But protoplasm is a stupendously more complex colloidal system. It comprises not two, but very many substances, some in simple and others in highly complex molecular form, so finely divided that they are invisible with the ordinary microscope.

Now colloidal systems in general are characterized by tremendous surface activity — the result of energy relations between the contact surfaces of the particles of the different component substances. This being so, and protoplasm being a colloid composed of very many different kinds of materials, the total surface area between suspended substances and suspending media is very great, and thus affords the requisite conditions for an exceedingly intricate system of energy relations. And when we add to this the fact that at such surfaces chemical changes, some involving changes in electrical potential, occur; and also that mechanical changes are induced by precipitation, coagulation, and constant redistribution between the suspending media and the substances in suspension, we begin to get at least a glimpse of the exceedingly intricate and delicate *energy-transforming system* that protoplasm really is. To work out these intricacies is one of the imposing tasks still before the biologist, chemist, and physicist.

But the statement that protoplasm is a colloidal system — roughly speaking, a rather fluid sort of jelly — leaves the reader without any clear conception of the appearance of protoplasm. As a matter of fact it is as difficult to describe the appearance of protoplasm as it is to define it. Protoplasm must be seen under the microscope to be appreciated. With a moderate magnification, it presents a fairly characteristic picture, appearing like a translucent, colorless, viscid fluid containing many minute granules as well as clear spaces or vacuoles. If it is examined in water it exhibits no tendency to mix with the surrounding medium, though investigations show that OSMOTIC interchanges are constantly going on. For this reason it is impossible to consider protoplasm except in connection with its surroundings, whatever

they may be — variations in its environment and variations in its activities being reflected directly or indirectly in its appearance. (Fig. 6.)

Under the highest magnifications, not only does the finer structure of protoplasm differ in various specimens, but also in the same cell under slightly different physiological conditions. At one time it presents the appearance of a fairly definite net-like structure, or

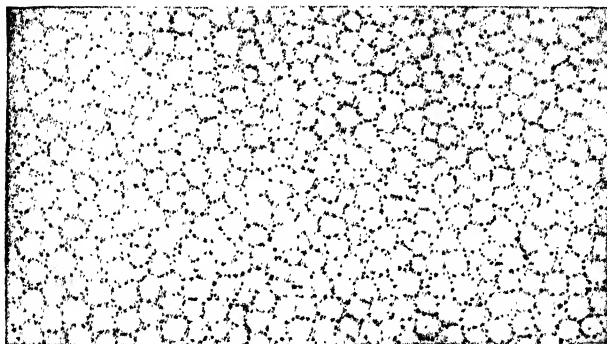

FIG. 9. — Protoplasm of the living Starfish egg (highly magnified), exhibiting alveolar, or foam-like, structure. This arises by the appearance, growth, and crowding together of minute bodies in a homogeneous ground substance. (From Wilson.)

*reticulum*, the meshes of which enclose a more fluid substance; at another, a frothy, or *alveolar*, appearance due to a more liquid substance scattered or emulsified as spherical bodies in a less liquid medium. Again, at other times, the denser portion seems to take the form of minute threads, or *fibers*, or of tiny *granules* distributed in a somewhat fluid matrix. (Fig. 9.)

These appearances have given rise to various theories which emphasize one or another as the universal formula for the physical structure of protoplasm, from which the other appearances are merely secondarily derived. But the trend of recent work has been to indicate that although the general similarity of protoplasmic activity, wherever we find it, might lead us to expect to find also a visible fundamental structural basis, such does not exist within the range of magnifications at our command. Reticular, alveolar, and other structures which our microscopes reveal are, as it were, merely surface ripples from underlying physico-chemical changes in the colloidal system which, thus far, are unfathomable.

## B. UNIQUE CHARACTERISTICS OF LIVING MATTER

Since the phenomena of life are without exception the results of protoplasmic activity, it is obvious that we must look to protoplasm for the primary attributes of living matter. The properties which are absolutely characteristic of living matter are its specific *organization, chemical composition, metabolism* involving the power of *maintenance, growth, and reproduction, and irritability* resulting in the power of *adaptation*.

### 1. Organization

It must be emphasized that living things are not homogeneous, but possess structural and physiological ORGANIZATION. Animals and plants are made up of various parts adapted for certain purposes. They exhibit 'a viable unity' and so stand in sharp contrast with objects comprising the inorganic world as, for instance, rocks and rivers. Accordingly animals and plants are referred to as ORGANISMS. Moreover, as we have seen, the organizational units of all living things are cells, and so it follows that cell structure is a direct or indirect expression of all the unique life characteristics that we are about to survey. A few of the details of cell structure are necessary for an appreciation of the organization of organisms.

It will be recalled that the protoplasm of all typical cells is differentiated into two chief parts: the *cytoplasm*, or general groundwork which makes up the bulk of the cell; and the *nucleus*, a more or less clearly defined spherical body, situated near the center of the cytoplasmic mass.

CYTOPLASM. The cytoplasm may be considered the less specialized protoplasm of the cell, and its appearance and other characteristics are those which have been outlined in our discussion of protoplasm. With that in mind, for the sake of definiteness, we may consider its basis as consisting of a meshwork, composed of innumerable, minute granules which permeate an apparently homogeneous ground-substance, or *HYALOPASM*. Distributed throughout the cytoplasm are usually various lifeless inclusions such as granules of food, droplets of water or oil, vacuoles of cell sap, crystals, etc., representing materials which are to be, or have been, a part of the living complex, or are by-products of the vital processes. This passive material is frequently referred to as **META-**

PLASM, but it is quite evident that such a term stands for no essential morphological part of the cell, and we have no absolute criterion to distinguish between some granules which are regarded as metaplastic in nature and others which are ordinarily considered active elements of the cytoplasm. But there are various undoubtedly active bodies besides the nucleus in the cytoplasm. Chief among these are the CENTROSOME which plays an essential part in cell reproduction, and the PLASTIDS, MITOCHONDRIA, and GOLGI BODIES which apparently are the seat of various special physiological activities. (Fig. 10.)

The cytoplasm, since it forms the general groundwork, is that part of the cell which comes most closely into relations with the environment, and accordingly near the surface it is frequently

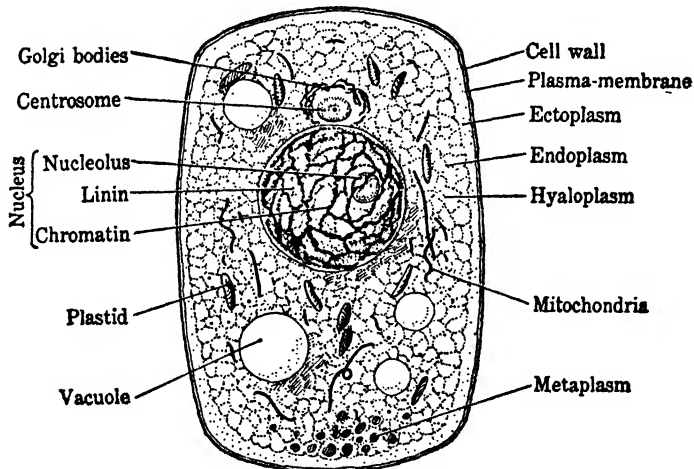

FIG. 10. — Diagram of a cell.

modified somewhat in texture and consistency so that a definite outer region, or **ECTOPLASM**, may be distinguished from an inner, or **ENDOPLASM**. The ectoplasm is limited externally by a **PLASMA-MEMBRANE** just beneath the cell wall. The plasma-membrane is certainly a part of the living cytoplasm, while the cell wall must be regarded as non-living, though in many cases it is a direct transformation of the living material which grows and plays, in connection with the plasma-membrane, an important part in controlling the flow of matter and energy to and from the cell and its surroundings.



NUCLEUS. As already mentioned, within the cytoplasmic mass there is an area of clearly differentiated material which typically has a rounded form, bounded by a membrane, so that it appears as a definite body of protoplasm called the nucleus. The structural basis of the nucleus consists of a homogeneous ground-substance, or KARYOLYMPH, which is permeated by a meshwork that usually appears to consist of two substances, LININ and CHROMATIN, which are probably chemically closely related. Chromatin is the highly characteristic nuclear material which takes various forms during different phases of cell activity but generally gives the appearance of a network of tiny granules with one or more dense 'knots' of chromatin. Frequently there are one or more conspicuous, round bodies within the nucleus known as NUCLEOLI. Later it will be necessary to describe some of the important changes in chromatin arrangement that occur during various phases of cell activity, especially during cell division, but it is sufficient at this moment to emphasize that the nucleus is a differentiated area of the cell protoplasm which is the arena of the chromatin. Indeed, the nucleus probably represents the highest type of organization in the organism. (Fig. 164.)

## 2. Chemical Composition

It is impossible to make an analysis of living matter because the 'disturbance of its molecular organization by chemical reagents kills it. Therefore our knowledge of its chemical composition has of necessity been derived from a study of dead protoplasm. However, since in the transformation from the living to the non-living state there is clearly no loss of weight, it follows that the complete material basis of life is still present for examination. In other words, the death of protoplasm is a result of *disorganization*.

Chemical analysis of protoplasm shows that it invariably comprises the elements OXYGEN, CARBON, HYDROGEN, NITROGEN, PHOSPHORUS, SULFUR, CALCIUM, MAGNESIUM, SODIUM, POTASSIUM, IRON, and CHLORINE. Probably other elements are always present; certainly some others are found normally in the protoplasm of certain parts of various species of animals and plants. Thus in addition to the elements just mentioned which form by far the larger part of the human body, there are also present traces of several other elements, such as iodine, copper, manganese, and fluorine.

The average composition of the human body, including cellular and intercellular material, is about as follows:

Oxygen.....	65.00%
Carbon.....	18.00
Hydrogen.....	10.00
Nitrogen.....	3.00
Calcium.....	2.00
Phosphorus.....	1.00
Potassium.....	0.35
Sulfur.....	0.25
Sodium.....	0.15
Chlorine.....	0.15
Magnesium.....	0.05
Iron.....	0.004

At first glance there is nothing very striking about this list of elements. They are all common ones with which the chemist is familiar in the non-living world. The materials of Man's body are worth less than one dollar! Furthermore, quantitatively the most important compound is nothing more complex than WATER ( $H_2O$ ). It composes more than two-thirds of the human body. But there are *combinations* of the elements which are highly significant and characteristic, and result from the capacity of carbon, hydrogen, and oxygen, or carbon and hydrogen together, to form the numerous complex compounds which in turn supply the basis for intimate associations with other elements. As a matter of fact, the bulk of protoplasm is composed of carbon, oxygen, hydrogen, and nitrogen associated with each other in an apparently infinite series of relationships, in which the carbon seems to play the leading rôle — the indispensable bond that links all other elements in organic unity. Some of these compounds are relatively simple, but the majority consist of elaborate atomic arrangements and not a few represent molecular complexes of hundreds and even thousands of atoms.

The COMPOUNDS OF CARBON which are characteristic of protoplasm fall into three chief groups: proteins, carbohydrates, and fats.

PROTEINS invariably consist of the elements carbon, oxygen, hydrogen, nitrogen, and usually sulfur, and frequently phosphorus, iron, etc. Examples are ALBUMIN of the white of egg, CASEIN of milk, GLIADIN of wheat, and MYOSIN of lean meat. The *nitrogen* particularly distinguishes proteins from the other compounds of the

living complex and, as we shall see later when considering the chemical processes in animals and plants, is largely responsible for their commanding position as "the chemical nucleus or pivot around which revolve a multitude of reactions characteristic of biological phenomena." Study of the relationship of nitrogen to the other chemical elements of proteins has revealed that the protein molecule is a huge complex of linked AMINO ACIDS — an amino acid being an organic acid in which one hydrogen atom is replaced by the amino group,  $\text{NH}_2$ . The amino acids are the nitrogenous units with which organisms deal physiologically, rather than the proteins themselves. An animal, for example, with various proteins available in its food, chemically disrupts them into their amino acid constituents, and then takes an amino acid here and another there and synthesizes the specific proteins it demands. And further, if individual amino acids are supplied, the animal employs them.

Although there are less than two dozen amino acids, the number of proteins is legion. Furthermore, besides the so-called simple proteins composed solely of amino acids, there are many which comprise in addition other radicals, such as the hemoglobins which contain hematin and the nucleoproteins with nucleic acid. It appears that the specific structure of an organism depends upon the chemical specificity of its proteins, but for our purposes it is sufficient to recognize that the presence of proteins and the power of forming them is a prime chemical characteristic of living matter. Apparently these huge, complex molecules with their high lability and, therefore, tendency to chemical change are fundamentally associated with the plasticity and responsiveness of protoplasm.

CARBOHYDRATES consist of various combinations of carbon, hydrogen, and oxygen, the latter elements typically being present in the proportion found in water ( $\text{H}_2\text{O}$ ). Though more simple in chemical structure than proteins, they range in complexity from the simple sugars, or monosaccharides such as GLUCOSE and FRUCTOSE, to polysaccharides such as STARCH, GLYCOGEN, and CELLULOSE.

FATS are composed of the same elements as the carbohydrates, but in quite different arrangements. The proportion of oxygen is always less, and therefore they are more oxidizable and richer in potential energy. Fats represent the union of an acid (fatty acid) and glycerol. Examples are butter and oils of plant or animal origin.

Thus proteins, carbohydrates, and fats represent large classes of substances which are distinctly characteristic of living matter, not being found in nature except as the result of protoplasmic activity; although biochemists now can artificially construct certain fats and carbohydrates as well as the amino acid constituents of some proteins. Proteins undoubtedly play the most important part in the organization of protoplasm, while the carbohydrates and fats contribute largely to the supply of available energy. However, it is impossible to draw a hard and fast distinction in regard to their respective contributions because, for example, as we shall see later, carbohydrates form the foundation upon which proteins are built by green plants.

Proteins, carbohydrates, and fats are frequently referred to as the foodstuffs, but it will be recognized that while, in a way, they constitute the chief groups, all the constituents of protoplasm must be available. Accordingly, inorganic salts, water, and free oxygen are really foodstuffs. Furthermore, recent investigation has disclosed another class of organic substances which are absolutely necessary and are known as VITAMINS. These accessory food substances are referred to as vitamin A, B, C, etc., though now the chemical constitution of some of them is known. Scurvy, for instance, is a disease induced by the lack of vitamin C which has proved to be a hexuronic acid. Finally must be mentioned a great group of organic catalyzers, called ENZYMES. These are not food substances but special proteins formed in organisms where they play a major part in chemical processes. However, when all is said, our knowledge of the chemical complexities of protoplasm affords no adequate conception of how they are related to life.

### 3. *Metabolism*

We have emphasized that living matter is continually changing, and this fundamental fact is reflected in nearly all attempts to define life. Aristotle described life as "the assemblage of operations of nutrition, growth, and destruction"; deBlainville, as a "twofold internal movement of composition and decomposition"; and Spencer, as "the continuous adjustment of internal relations to external relations."

This interaction consists of chemical and physical processes in which combustion, or oxidation, plays the chief rôle. Over a century ago it was shown that animal heat results from a slow burning of

the materials of the body, involving the consumption of oxygen and the liberation of carbon dioxide; and further, that for a given consumption of oxygen and liberation of carbon dioxide, about the same amount of heat is produced by an animal as by a burning candle. In other words, the oxidation of the complex compounds which enter the body as food is definitely proportional to the amount of energy which the body gives out, just in the same way as the amount of work performed by a steam engine and the amount of heat it liberates bear a strict proportion to its consumption of fuel.

This is an important discovery, because it goes far toward establishing the fact that at least certain characteristic vital phenomena are in accord with the laws which hold in the non-living world. But the processes of METABOLISM are not so simple as perhaps might be imagined from the results just mentioned. Heat represents but one of the many energy transformations within the organism, and biologists are at work trying to interpret one after another in terms that are equally applicable in the realms of the living and the lifeless. "The symbol of the organism is the burning bush of old."

One naturally asks whether living matter possesses some special form of energy — 'vital force' — which is quite different from chemical and physical energy. This is the philosophically important question of VITALISM. From the standpoint of biology we may say that no instrument ever devised has detected such energy, and until some unique vital energy can be made evident to one of the human senses, it does not fall within the scope of science — science can neither deny nor affirm its existence. Perhaps for the present it is sufficient to realize that unique phenomena may emerge from new relationships — relationships change the properties of things. The properties of molecules are those which the atoms have when they are in the molecule, and the phenomena of life depend on — emerge from — the physico-chemical constituents of protoplasm when, and only when, they are in protoplasm. A living cell exhibits "many unpredictable properties beyond those of the mere sum of its individual constituent molecules and compounds, or the additive resultants to be derived from any arrangement of them."

However, it is important to note that many of the grosser phenomena of life are being gradually restated in terms of the physical

sciences. So it appears clear that the organism is a system for transforming energy into work performed — transforming the potential energy stored in chemical complexes of its own substance into the various vital processes of life. And it is in this transfer of energy from one kind to another that we find exhibited the activities which are most distinctive of living things. In these processes of metabolism many complex substances rich in potential energy, which have entered as food and have been, in whole or part, added to the protoplasmic system, are reduced to simpler and simpler conditions and finally, with their energy content nearly or entirely exhausted, are eliminated as EXCRETIONS. Obviously, if life is to persist, this continual waste must be counterbalanced by a proportionate intake of food in order to renew the supply of energy and to provide the materials which, after preliminary changes, are made into an integral part of the living organism.

#### 4. *Maintenance and Growth*

Thus in living the animal or plant is partially consuming and rebuilding itself continually — metabolism is a dual process. When constructive metabolism, ANABOLISM, keeps pace with destructive metabolism, KATABOLISM, the individual remains essentially unchanged — it balances its account physiologically — and this MAINTENANCE is the normal condition of adult life. But one of the most obvious results of metabolism is growth, or permanent increase in the size of the individual. As a rule growth is most rapid during the early part of the individual's existence, or youth. Indeed, at birth a child is about a billion times larger than the egg cell from which it has developed. Later in life, when a certain physiological balance, or maturity, is attained, growth chiefly occurs in making good, in so far as may be, the wear and tear incidental to living, and in providing for reproduction.

Growth, as well as maintenance, means that the organism takes the materials which it receives in the form of food, transforms them and fits them into the protoplasmic organization here and there throughout as needed. This INTERSTITIAL GROWTH by chemical synthesis is in striking contrast to the growth, for example, of crystals that increase in size merely by the addition to the surface of new material of the same kind from the saturated solution, the mother liquid, in which they are suspended. Crystal growth is passive; organic growth is active. Protoplasm, with materials

and energy taken from its environment, constructs more protoplasm — endows the non-living with its own unique organization. It makes more life-stuff. And, if the available materials are adequate, the living substance tends to increase indefinitely, or until the specific limits of the cell or organism are attained.

### 5. *Reproduction*

So far as is known, living matter arises only by the activities of preëxisting living matter. We have seen that this transformation is continually going on in anabolic processes in the animal or plant, and brings about repair and growth of the individual; but it is in reproduction that what may be termed the overgrowth of the individual results in the production of a new one.

Thus reproduction and growth are phenomena which are intrinsically the same — both are the result of a preponderance of the constructive phase of metabolism. The single cell, whether a whole organism or a single unit of a complex body, increases in volume up to a certain limit and then divides. In the former case two new individuals replace the parent cell; in the latter, the complex body has been increased to the extent of one cell. In both cases cell division has resulted in cell reproduction. Thus cell division is always reproduction, though it is customary and convenient to restrict the term reproduction to cell divisions which result in the formation of new individuals — single cells or groups of cells which sooner or later separate from the parent organism. They are the new generation. This is a unique characteristic of living things which provides for the continuation of the race. (Figs. 8, 164.)

### 6. *Irritability and Adaptation*

The discussion of metabolism has emphasized the close interrelationship between the living organism and its surroundings, and the dependence of life upon the interplay and interchange between protoplasm and its environment. As a matter of fact the plant or animal retains its individuality — lives — solely by its powers of developing and maintaining exquisite adjustments to its surroundings. This results from the **IRRITABILITY** of living substance: its inherent capacity of reacting to environmental changes by changes in the equilibrium of its matter and energy. The inciting changes, known as **STIMULI**, may be chemical, electrical, thermal, photic,

or mechanical, but the nature of the response is determined rather by the fundamental character of protoplasm itself than by the nature of the stimulus. Thus muscle cells respond by contracting, regardless of the nature of the stimulus.

The reactions of organisms usually result in **MOVEMENT**, one of the most obvious manifestations of life. Movement depends in every instance upon tumultuous ultramicroscopic physico-chemical changes of protoplasm itself. Thus it is to these changes that, in the last analysis, we must turn for the energy which brings about the visible movements in animals and plants.

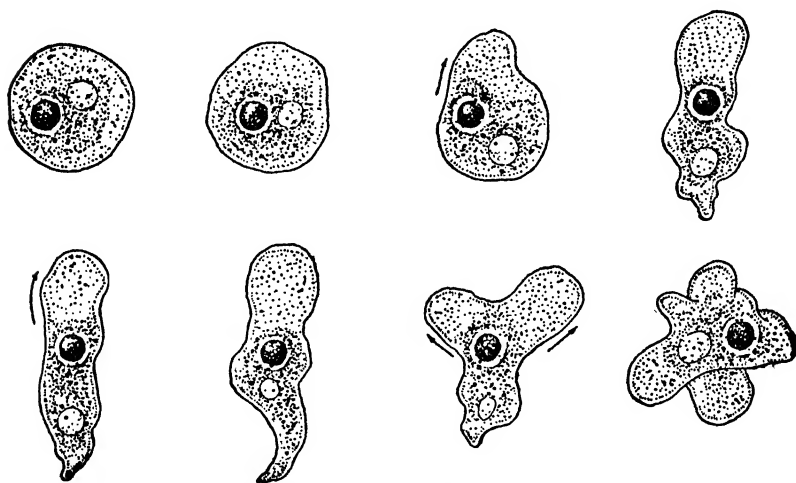

FIG. 11. — Amoeboid movement. Successive changes in form assumed by an Amoeba. The clear ectoplasm flows forward, followed by the granular endoplasm with the nucleus (darker) and contractile vacuole (lighter). See Fig. 6. (Modified, after Verworn.)

The obvious movement of the higher animals is, of course, the result of the contraction (shortening and broadening) of the individual muscle cells forming the muscular system, but movements of other cells of the body occur as, for example, the flowing movement of the white blood cells which is similar to that of certain unicellular animals, the Amoebae, and so is known as **AMOEBOID** movement. The protoplasm of an active Amoeba is one of the most striking and beautiful sights under the microscope; the cell ceaselessly changing its form as one outflowing, or **PSEUDOPodium**, follows another and the whole cell advances in the direction of the main stream. When particles of food are met. the pseudopodia



flow around them, and when they have been digested within the cell, the protoplasm moves onward leaving the waste material behind. In many other unicellular animals, such as *Paramecium*, an active, internal circulation, or *CYCLOSIS*, of the protoplasm is visible, and the cells of certain multicellular plants, such as *Nitella* and *Tradescantia*, afford remarkable exhibitions of rotation and circulation of protoplasm.

Moreover, locomotion in *Paramecium* and related Infusoria is effected by myriads of short, vibratile, thread-like prolongations of the cytoplasm, termed *CILIA*; while other unicellular forms, such as *Euglena*, move by long whip-like processes, or *FLAGELLA*. Finally, ciliated cells form membranes, or *CILIATED EPITHELIA*, that serve various purposes in the bodies of higher animals. Thus the food and respiratory currents of Molluscs, such as the Clam, are induced by ciliary action, and certain internal passages of the human body are provided with cilia for the transport of materials. (Figs. 6, 7, 11, 22, 27.)

These and all other reactions of living matter are results of its irritability and involve not only *response* to a stimulus but also *conduction* so that the cell, or group of cells, as a whole is directly or indirectly influenced — a condition which attains its fullest expression in the higher animals with a nervous system. Every organism responds as a coördinated unit — an individual. It adapts itself structurally and functionally to the necessities of its existence. This power of *ADAPTATION*, as exhibited in active adjustment between internal and external relations, overshadows every manifestation of life and contributes, more than any other factor, to the enormous gap that separates even the lowest forms of life from the inorganic world.

The characteristics which we have described — specific organization, chemical composition, metabolism involving the power of maintenance, growth, and reproduction, and irritability resulting in the power of adaptation — individually and collectively are characteristic of living matter. Any formal objections that may be raised to the diagnostic character of one or another only serve to emphasize the unique conditions which obtain in life.

In our discussion thus far, we have endeavored to describe the characteristics of life in terms of its organizational units — cells, and of its physical basis — protoplasm. But we have not attempted

formally to define 'life' or 'protoplasm' because, since they are unique, it is impossible to resort to the trick of comparing them with something else; and because the expressions 'protoplasm' and 'life' are generalizations. The former indicates that all animals and plants have an essentially similar foundation, and the latter that they exhibit certain characteristic actions and reactions. The living organism exhibits a permanence and continuity of individuality correlated with specific behavior, and this it transmits to other matter which it makes a part of itself, and to its offspring at reproduction. The organism regarded as a whole is, indeed, a unique phenomenon: one whose fundamental nature is as essential as any of the concepts of physics.

## CHAPTER IV

### METABOLISM OF ORGANISMS

Nature, which governs the whole, will soon change all things which thou seest, and out of their substance will make other things and again other things from the substance of them, in order that the world may be ever new. — *Marcus Aurelius*.

LIFE is only known to us in the form of individual organisms, so we turn now to concrete examples of unicellular plants and animals which present, in relatively simple form within the confines of a cell, the essentials of all the fundamental life processes, many of which we shall later have occasion to study in their complex expressions in the higher animals. Our present interest in these simple forms is chiefly to illustrate the complex nutritional interdependence of three great groups of organisms — green plants, animals, and colorless plants. Animals cannot exist without plants.

#### A. GREEN PLANTS

Unicellular green plants are distributed all over the world and adapted to a great variety of conditions. We find them, for example, forming green coatings on the bark of trees, scums on puddles and ponds, or being blown about in dust by wind. Of the many hundreds of species we select *Protococcus vulgaris* because of the simplicity of its structure and life history, and because it is readily obtained for study.

##### 1. *Protococcus*

A single *Protococcus* is invisible to the naked eye, but like many another microscopic form, it makes up in numbers for the small size of the individual, and frequently gives a greenish color to moist surfaces of rocks, tree trunks, fence posts, and flower pots.

Examined under the microscope, the organism is seen to consist of a spherical mass of protoplasm with a nucleus centrally located. Most of the cytoplasm surrounding the nucleus is specialized to form a PLASTID which contains a green pigment. The whole organism is enclosed within a distinct, rigid cell wall which has been

secreted by the protoplasm and is composed of CELLULOSE: a carbohydrate especially characteristic of plants. It is evident that the organism is a single cell. (Fig. 12.)

Since *Protococcus* is a single cell, we find reproduction presented in its simplest terms: under favorable conditions the cell divides and the two resultant cells sooner or later separate. Sometimes, however, several divisions occur before the cells are separated and thus there is formed, as it were, a temporary multi-

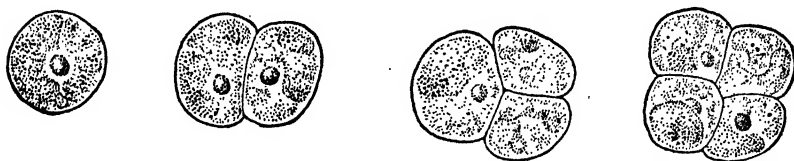

FIG. 12. — *Protococcus vulgaris*, a unicellular green plant. Separate individual and temporary cell groups formed by cell division.

cellular body, but one without any physiological division of labor between the cells because all are independent in their vital activities. Moreover, this tendency to form temporary cell groups suggests the type of step that was taken when the multicellular body was established during plant evolution.

We may now turn our attention to the point *Protococcus* was chosen especially to illustrate — the characteristic life processes of green plants. At first glance it may appear that a multicellular plant, such as a tree or shrub, would afford a more suitable example, but since the fundamental distinction between plants and animals is chiefly a question of metabolism, there are advantages in studying it in a single cell, where one's attention is not distracted by root, stem, and leaf.

## 2. Food Making

Since *Protococcus* lives, grows, and multiplies in moisture exposed to sunlight, it is to this environment that we must look for the materials with which it constructs protoplasm, and the energy which it employs in the process. And, furthermore, since the organism is enclosed within a cell wall, its income and outgo must be materials in solution in order to pass through to the living protoplasm.

In short, *Protococcus* takes materials from its surroundings in the form of simple compounds, as carbon dioxide, water, and mineral salts, which are relatively stable and therefore practically

devoid of energy, and, through the radiant energy of sunlight, shifts and recombines their elements in such a way that products rich in potential energy result. *Protococcus* thus exhibits the prime distinguishing characteristic of green plants — the power to construct its own foodstuffs.

The key to this power of chemical synthesis by light — PHOTOSYNTHESIS — resides in a complex chemical substance called CHLOROPHYLL which consists of two very similar but distinct pigments. Chlorophyll is segregated in special cytoplasmic bodies, the plastids, and gives to *Protococcus* during its active phases and to the foliage of plants in general their characteristic green color. Plastids bearing chlorophyll are known as CHLOROPLASTS. The chlorophyll arrests and transforms a small part of the energy of the sunlight which reaches it, in such a way that the protoplasm can employ this energy for food synthesis.

The first great step in the constructive process is a combination of carbon with hydrogen and oxygen to form a carbohydrate. *Protococcus* gets these elements from carbon dioxide and water by a process of molecular disruption. We know that when charcoal, for instance, is burned, carbon and oxygen *unite* to form carbon dioxide, and energy in the form of light and heat is liberated. Obviously *Protococcus* must employ an equal amount of energy in separating the carbon and oxygen of carbon dioxide; that is, in overcoming their chemical affinity. And this kinetic energy which the plant employs is then represented in the chemical potential which exists between the oxidizable carbon and free oxygen — it has become potential energy. Thus the plant in sunlight is continually separating the carbon from the oxygen of carbon dioxide. The oxygen is liberated as free oxygen, while the carbon which has been separated from the oxygen is combined with molecules of water to form a carbohydrate — grape sugar (glucose).

The conventional equation for this reaction is:

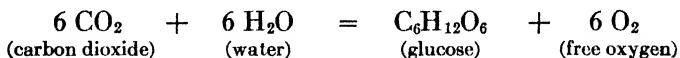

However, the processes involved are by no means so simple as is implied above. It is probable that a relatively simple compound, such as formaldehyde ( $\text{CH}_2\text{O}$ ), is first produced from carbon dioxide and water, and that molecules of this substance are then united to form glucose. Although there is little conclusive data in

regard to the details of the intermediate stages, the equation stated affords a satisfactory expression of the end result of photosynthesis that is adequate for the present discussion.

The first great step in food synthesis, the formation of a *sugar*, having been accomplished, the green plant usually transforms the sugar and stores it as *starch* for future use as fuel or as the basis of further synthesis. Starch is the first visible product of photosynthesis.

We have seen that the chief characteristic of proteins as compared with carbohydrates (sugars, starches) is the presence of nitrogen, and this element must be added to the CHO basis already constructed as the next step toward protein synthesis. The green plant not only can, but must employ nitrogen in simple combinations, chiefly *nitrates*, and this is a fact of prime importance, for typically, as will appear later, animals and most colorless plants require nitrogen in more complex combinations. Thus by the addition of nitrogen to the carbohydrate basis relatively simple nitrogenous compounds, *amino acids*, are built, which in turn form the foundation for the synthesis of the immense variety of proteins. Little is known of the complex chemical processes involved in protein construction, and nothing about the actual incorporation of the proteins as an intrinsic part of the architecture of the living matter itself. But it is evident that synthesizing *enzymes* play a crucial rôle. These are special proteins which are known only as products of living protoplasm and are the activating agents (catalytic agents) for chemical transformations in which, however, they themselves take no integral part.

Protococcus thus takes the raw elements, so to speak, of living matter and by the radiant energy of sunlight, which its chlorophyll traps, constructs carbohydrate, protein, protoplasm. In other words, the green plant is a synthesizing agent, building up highly complex and unstable molecular aggregates brimming over with the energy received from the Sun. So the green plant, whether Protococcus or Elm, by this AUTOTROPHIC method manufactures its own food for itself — and incidentally, as it were, for the living world in general, including Man.

### 3. *Respiration*

As we have already stated, protoplasm is always at work — to live is to work — and this means expenditure of energy: the same

energy that chlorophyll has secured for the plant and stored away in its food. Therefore the food must be oxidized — burned — in order to release the energy, and for this the plant must have available a supply of free oxygen. *Protococcus* obtains this oxygen dissolved in water and also, in sunlight, from that liberated through photosynthesis. The process involved, for the sake of simplicity, may be represented by the equation:

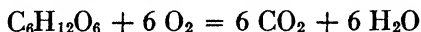

which, it will be noted, is the reverse of the equation for photosynthesis. This intake of free oxygen by the cell and outgo of carbon dioxide and water, the chief products of combustion, is known as RESPIRATION. It is essentially the securing of energy from food, involving the exchange of carbon dioxide for oxygen by protoplasm. And this interchange of gases between the living matter and its surroundings is not only characteristic of *Protococcus* and all green plants, but of all living things. Plants respire just as truly as animals, though the more active life and complex bodies of most of the latter require an elaborate respiratory apparatus in order that an adequate gaseous interchange may be effected with the necessary rapidity.

Thus the green plant may be regarded as a chemical machine for the transformation of energy — the radiant energy from the Sun — into lifework; the matter and energy which enters, forms, and leaves the organism obeying, to the best of our knowledge, the fundamental laws of matter and energy of the non-living world.

We have now obtained some idea of one living organism, *Protococcus vulgaris*, a green plant reduced to the simplest terms — a single cell provided with chlorophyll. And we have seen that this chlorophyll is the key to the photosynthetic activity of the green plant. In other words, the expression 'green plant' does not refer specifically to the color of a plant (in some cases it may appear red or brown), but to the fact that there is present a complex pigment functionally similar to chlorophyll by virtue of which the plant is a constructive agent in nature. It has the power to manufacture its own foodstuffs from relatively simple compounds largely devoid of energy and, in particular, is able to utilize nitrogen in the form of nitrates.

We pass now from the essential constructive agents in nature

to the destructive agents; from the collectors of energy to the energy dissipators; from the green plants to animals and then to 'colorless' plants.

## B. ANIMALS

There is probably no better introduction to the study of the biology of an animal than that afforded by an Amoeba such as *Amoeba proteus*, a common organism of ponds, ditches, and decaying vegetable infusions. Amoebae, frequently referred to as the simplest animals, are representatives of the great group of single-celled animals, or Protozoa. Members of this group are found in almost every niche in nature and, like the Protophyta, as the unicellular plants are sometimes called, are important because, although small in size, the number of individuals is inconceivably large. Collectively they produce profound changes in their environment.

### 1. *Amoeba*

In order to study Amoeba it is necessary to magnify it several hundred times. This done, it appears as a more or less irregular mass of granular jelly-like material, rather slowly changing its shape and thereby moving along. As a matter of fact it is essentially a naked bit of protoplasm, without obviously specialized parts. However, careful study reveals that the organism really consists of a single protoplasmic unit differentiated into cytoplasm and nucleus—it is a cell: an animal. (Fig. 11.)

But there are no specialized locomotor organs—merely now and again the clear outer layer of protoplasm, or ECTOPLASM, flows out, followed by the internal granular ENDOPLASM, so that a projection, or PSEUDOPODIUM, is formed. There is no permanent mouth, food being engulfed by the protoplasm flowing about it as opportunity offers. There is no permanent digestive or excretory apparatus. (Figs. 6, 13.)

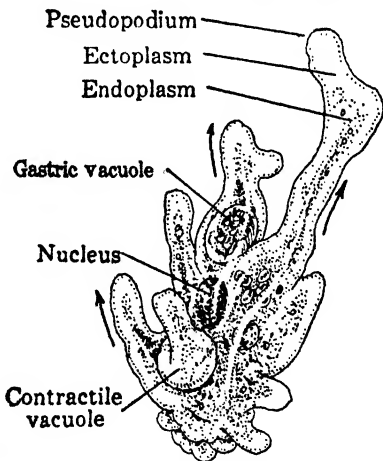

FIG. 13. — *Amoeba proteus*.



Amoeba, under favorable conditions, grows rapidly and, when it has attained the size limit characteristic of the species, cell division, termed BINARY FISSION, takes place, with the result that from the single large cell there are formed two smaller individuals which soon become complete in all respects. These, in turn, grow and repeat the process so that, as in the case of Protococcus, within a few days the original Amoeba has divided its individuality, so to speak, among a multitude of descendants. (Fig. 8.)

Clearly Amoeba performs all the essential vital functions that become an animal. Such being so, it is important to compare the metabolism of Amoeba, the animal, with that of Protococcus, the green plant.

## 2. Food Taking

The food of Amoeba is chiefly other microscopic animals and plants that it meets in its environment of pond water or vegetable infusion. Coming in contact with its prey, pseudopodia are extended about it and soon the prospective food material is enclosed with the endoplasm of its captor. Here the food is surrounded by a droplet of fluid, a GASTRIC VACUOLE, into which the endoplasm secretes chemical substances (enzymes, etc.) which gradually simplify — digest — the complex proteins, carbohydrates, etc., of the food. Finally, this material, which shortly before was the protoplasm of another organism, is incorporated into Amoeba protoplasm — matter and energy is supplied and the animal lives and grows.

This is, in most respects, a strikingly different condition from that which we have seen in Protococcus. In Amoeba solid particles of food — tiny animals and plants — are taken into the cell, and since the chief organic constituents of protoplasm are proteins, associated with carbohydrates and fats, it is clear that the income of the animal organism is, unlike that of the green plant, chiefly ready-made complex foodstuffs. In other words, Amoeba, like all animals, requires relatively complex chemical compounds rich in potential energy: proteins, carbohydrates, and fats. Of these, proteins or their constituent amino acids are absolutely indispensable because it is only from this source that nitrogen is available for the animal. But the green plant, through its chlorophyll apparatus, is able to take materials largely devoid of energy and to rearrange them and endow them with potential energy which it has received in the kinetic form from sunlight.

### 3. *Respiration and Excretion*

Of course, during life the Amoeba, like Pleurococcus, is continually breaking down its food and its own protoplasm by a process of combustion which involves an intake of free oxygen and the liberation of carbon dioxide and water. Nitrogenous wastes, chiefly URIC ACID or UREA, as well as inorganic salts are also excreted. This interchange takes place over the entire surface of the animal, aided by a CONTRACTILE VACUOLE that expels fluid from the cell. So the animal, like the plant, returns to its environment the elements in simple combinations which are devoid or nearly devoid of energy. We have stated that green plants are essentially constructive and animals destructive agents in nature. It is apparent, of course, that green plants are both constructive and destructive, but the constructive processes of green plants are necessary and sufficient not only for themselves but for all living things.

A little consideration of the income and outgo of green plants and animals will show that, although the animals are dependent on the plants for their complex foodstuffs, they do not return, for example, the nitrogen to the outer world in a form simple enough to be available for green plants. For example urea,  $(\text{NH}_2)_2\text{CO}$ , which still has a little energy left that the animal is unable to extract, must be transformed into nitrates.

Furthermore, since plants die, which are not consumed by animals, and animals die, which are not devoured by other animals, large stores of matter and energy are locked up in the complex compounds of their dead tissues. Clearly, there must be some way of completing the cycle of the elements, for if there were not, life, as we know it, could not have continued long on the Earth. This gap is filled by the so-called COLORLESS PLANTS; that is, plants which, because chlorophyll is not present, lack the power of photosynthesis and so in most cases are dependent for food on more complex substances than green plants demand, though not so complex as animals require.

#### C. COLORLESS PLANTS

As representative of the diverse types of colorless plants which, lacking chlorophyll or a functionally similar pigment, are without the power of photosynthesis, we select the vast group known as

the BACTERIA. For reasons that will appear later, it is not practical to focus attention on one particular species of Bacteria, as we have just done in considering green plants and animals. Instead we shall discuss in very general terms the group as a whole, referring now and then to special kinds of Bacteria to illustrate particular points.

### 1. *The Bacteria*

The wide distribution of the Protozoa is exceeded by the Bacteria. Representatives are literally found everywhere: floating with dust particles in the air, in salt and fresh water, in the water of hot springs, frozen in ice, in the upper layers of the soil, and in the bodies of plants and animals. Bacteria have received a considerable notoriety under the names of 'microbes' and 'germs,' owing to the fact that certain types subsist within the human body as parasites and bring about disturbances, chiefly chemical, which we interpret as disease. But aside from these forms which, though all too many, are relatively few in number, human life and life in general on the Earth could not long continue without their services. Indeed, the Bacteria have practically ruled the world since they first secured a foothold when the Earth was young. It is this aspect of the Bacteria which concerns us at present.

Among the Bacteria are the smallest organisms known. Some species are less than one fifty-thousandth of an inch in length and much less in breadth. None of the typical forms comes within the range of unaided vision, while some are not revealed by the highest powers of the microscope — indeed there is room and to spare for thousands of millions of Bacteria to live in a thimblefull of sour milk. The small size and similarity of structure of many of the Bacteria render their study particularly difficult, and accordingly they are grouped and classified largely on the basis of chemical changes which they produce in their surroundings, rather than on structural characteristics. However, there are three chief morphological types: the rod-like forms or BACILLI; the spherical forms or COCCI; and the spiral forms or SPIRILLA. Either bacilli or cocci may be associated in linear, branching, or plate-like series, or grouped together in colonies. (Fig. 14.)

The individual bacterium is regarded as a single cell, though in most species there is no definite nuclear body; the chromatin material being distributed in the form of granules throughout the

cytoplasm. A cell wall chemically similar to protein is usually present. Some forms show active movements by means of thread-like prolongations of the cytoplasm, or **FLAGELLA**, as in the case of the common *Spirillum* of decaying vegetable infusions.

Reproduction is by a process of cell division which, under very favorable conditions, may occur as often as every fifteen minutes.

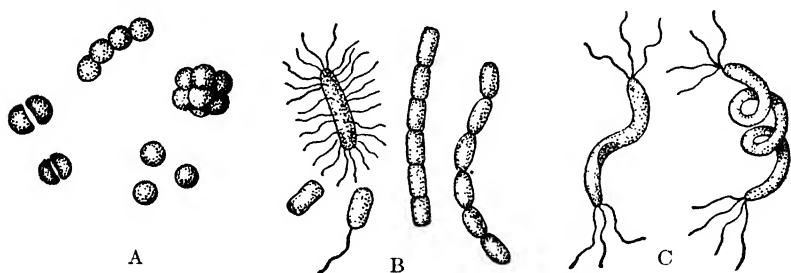

FIG. 14. — Chief types of Bacteria. A, cocci; B, bacilli; C, spirilla.

The vast multitude of cells thus produced before long exhaust the food supply and contaminate with excretion products the medium in which they are living, so that further growth is inhibited. In many species, under these circumstances the protoplasm within the cell wall assumes a spherical form and secretes a protecting coat about itself, and thus enters upon a resting state. In this **SPORE** form the Bacteria can withstand drying, variations in temperature, and other conditions — in certain cases even strong carbolic acid — to which in the active state they would readily succumb, and thereby the organisms tide over periods of unfavorable conditions and are ready to start active life again when the opportunity occurs. It is certainly fortunate for Man that the great majority of disease-producing Bacteria are unable to form spores. (Fig. 200.)

## 2. *Cycle of the Elements in Nature*

We have seen that carbon dioxide is the source from which green plants derive the carbon which they synthesize into carbohydrates, fats, and proteins. Animals directly or indirectly feed on plants, so that the ultimate source of the carbon of animals is likewise the carbon dioxide of the atmosphere. Although both plants and animals by their respiratory process are continually

returning to the outer world some of this carbon as carbon dioxide, it is evident that relatively enormous amounts of carbon are nevertheless being taken out of circulation and locked up in the bodies of the plants and animals. For example, it has been estimated that about one-half the weight of a dried tree trunk is contributed by carbon.

The same general segregation is going on in regard to nitrogen. The green plants take it in the form of nitrates, for instance, and store it away in the proteins; and again animals get their nitrogen from plant proteins, so that the ultimate source of the animal nitrogen is the same. In a somewhat similar manner we might trace the fate of the other chemical elements necessary for protoplasm, but that of carbon and nitrogen is particularly striking and

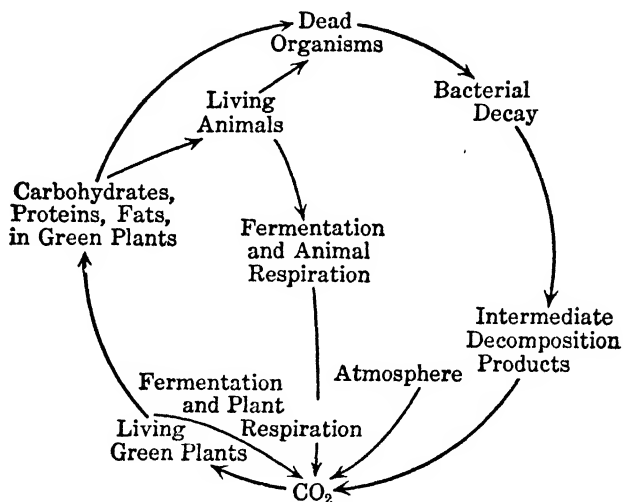

FIG. 15. — The Carbon Cycle. A schematic representation of the circulation of carbon in nature.

instructive, and is sufficient to illustrate the fact that although both green plants and animals are continually taking elements from and returning them to their environment, nevertheless more is taken away than is returned. (Figs. 15, 16.)

The agents which restore to the inorganic world the elements removed by green plants and animals are the colorless plants, such as the Bacteria, Molds, Yeasts, etc. As we know, when an animal or plant dies, DECAY sets in almost immediately; that is, the complex chemical compounds are slowly but surely reduced to simpler

and simpler forms until 'dust' remains. Although undoubtedly many of these compounds would automatically, so to speak, tend to simplify, nevertheless this is not only hastened, but chiefly carried out by organisms of decay such as the Bacteria. Through

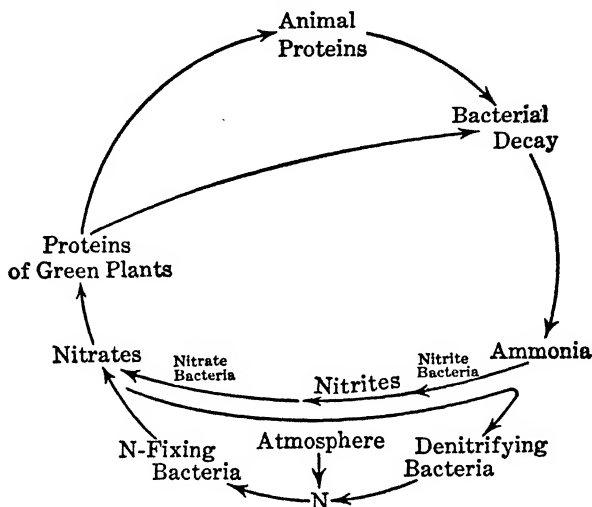

FIG. 16. — The Nitrogen Cycle. A schematic representation of the circulation of nitrogen in nature.

enzymes, or ferments, which they form, FERMENTATION occurs. The carbohydrates and fats are resolved into carbon dioxide and water, and the proteins are reduced to carbon dioxide, water, and ammonia ( $\text{NH}_3$ ) or free nitrogen, while the nitrogenous waste (urea, etc.) of animals is similarly broken down. (Fig. 17.)

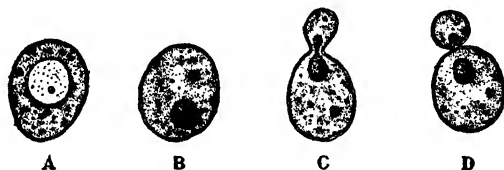

FIG. 17. — Yeast, a unicellular colorless plant, very highly magnified. A, cell showing granular cytoplasm and a large vacuole; B, showing nucleus; C, cell budding; D, mother cell and bud after division is completed.

Practically all of these long series of chemical reactions are carried on by different kinds of Bacteria. Most green plants, however, take their nitrogen chiefly in the form of nitrates, and accordingly we find that another type of Bacteria (NITRITE BAC-

TERIA) acts upon the ammonia and transforms it into nitrous acid ( $\text{HNO}_2$ ). After certain chemical reactions in the soil, forming, *e.g.*, potassium nitrite or ammonium nitrite, still another type (NITRATE BACTERIA) oxidizes the nitrites into nitrates (*e.g.*,  $\text{KNO}_3$  or  $\text{NH}_4\text{NO}_3$ ), so that again this nitrogen is in a form which is available for green plants.

But, still confining our attention to the nitrogen, it is obvious that there is a leak from this cycle, since some of the nitrogen in the form of ammonia or free nitrogen escapes to the atmosphere. The greatest loss, however, is brought about by a group of DENITRIFYING BACTERIA whose activities are largely spent in changing nitrates into gaseous nitrogen which escapes into the air, and so is placed beyond the reach of green plants and animals. But fortunately there are many kinds of NITROGEN-FIXING BACTERIA which rescue the nitrogen from the atmosphere and return it to the cycle of elements in living nature. These organisms are widely distributed, some living freely in the soil and others in tiny nodules which they produce on the rootlets of higher plants, such as Beans, Clover, and Alfalfa; and this accounts for the fact, long known but not understood, that these plants when plowed under are particularly efficient in enriching the soil.

In brief, there is a cycle of the elements in nature through green plants and animals and back again to the inorganic world through the Bacteria and other colorless plants. Such is the reciprocal nature of the nutritive processes of living organisms.

It is hardly necessary to state that the chemical changes produced by the Bacteria are either the direct results of, or are incidental to the process of nutrition in these organisms. Therefore the material taken as food by certain groups is relatively complex: for example, by those which bring about the early putrefactive changes in proteins; while that employed by others is very simple since they find adequate chemical combinations less complex than those needed by green plants. Indeed, certain Bacteria are able to utilize carbon dioxide and water just as do green plants, but instead of obtaining energy for the synthesis from sunlight, these AUTOTROPHIC forms derive it from chemical energy liberated by the oxidation of inorganic substances in their environment. Such a process possibly represents the most primitive method of nutrition from which all the others have been derived in the evolution of life.

### 3. *The Hay Infusion Microcosm*

The importance of the complex nutritional interdependence of organisms in general as well as the cosmical function of green plants — the link they supply in the circulation of the elements in nature — may be emphasized and summarized by a brief description of a ‘hay infusion.’

Probably nowhere is the ‘web of life’ more conveniently or convincingly exhibited than in the kaleidoscopic sequence of events — physical, chemical, and biological — which are initiated when a few wisps of hay are added to a beaker of water. Apparently the chief components of a hay infusion are hay and water, but these merely supply the matter and energy for the interplay of various forms of life. Most of these are beyond the scope of unaided vision though chiefly responsible for the obvious changes which occur from day to day in their environment.

Ordinary tapwater, for instance, contains free oxygen and various inorganic salts in solution, and not infrequently different species of Bacteria, unicellular green plants, and Protozoa. The hay soaking in the water contributes soluble salts, carbohydrates, proteins, etc. It also supplies many microscopic animals and plants which have adhered to it in dormant form and are only awaiting suitable surroundings to assume active life again. (Fig. 18.)

A microscopical examination of an infusion when it is first made shows very few active organisms, but within a day or so, depending largely on the temperature, it reveals countless numbers of Bacteria which have arisen by division from the relatively small number of dormant and active specimens originally present. At first the Bacteria are fairly evenly distributed in the infusion, but as conditions change, largely through the chemical and physical transformations which they themselves bring about, those species which can employ oxygen in combined form (that is, in chemical compounds) find existence possible and competition less keen at the bottom of the beaker, while those types of Bacteria which are dependent upon free oxygen gather nearer the surface where the supply is being replenished constantly from the atmosphere.

Up to this point the life of our microcosm is largely bacterial — unicellular **SAPROPHYTIC** plants which employ as food the complex decomposition products of the proteins, etc., of the hay. The proc-



ess is essentially destructive and the simplified products are represented in the relatively simple excretions of the Bacteria.

But during bacterial ascendancy another factor has been gradually intruding itself almost imperceptibly into the drama. This is the microscopic animal life which has been multiplying with increasing rapidity as conditions became more favorable, and forthwith assumes the dominant life phase in the infusion. Among the animal forms, the first to appear are exceedingly minute flagellated Protozoa, known as Monads, many species of which absorb products of organic disintegration brought about by the Bacteria, while others exhibit HOLOZOIC nutrition, ingest solid

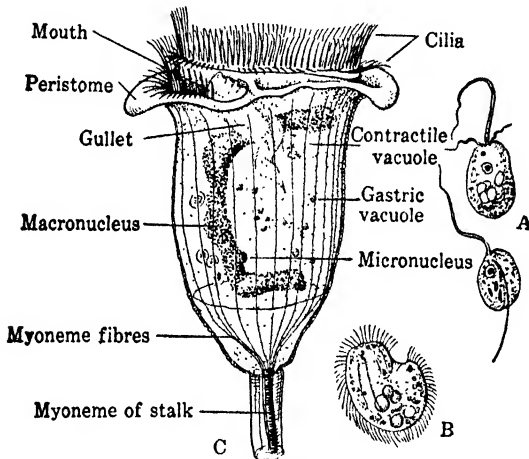

FIG. 18. — Some types of Protozoa found in infusions. A, two species of flagellated Monads (Mastigophora); B, Colpoda, a small Ciliate (Infusoria); C, Vorticella, one of the most complex Ciliates.

food — the Bacteria themselves. Then tiny ciliated Protozoa, probably Colpidium and Colpoda, appear in untold numbers and feed upon the Bacteria. The dominance of these smaller Ciliates is brought to an end after a few days by the ascendancy of larger Ciliates which, though feeding to a certain extent upon the already greatly depleted bacterial population, obtain most of their food by eating the smaller Ciliates. And so the cycle of life continues — saprophytic forms gradually being replaced in dominance by herbivorous and these in turn by carnivorous organisms. In truth, nothing lives or dies to itself. (Figs. 18, 23, 26.)

But obviously this chain of events must sooner or later come to an end through the dissipation of energy brought about by the metabolic processes of the colorless plants and animals. Sooner or later the supply of potential energy stored up in the chemical compounds of the hay will have become nearly or completely exhausted — transformed into the kinetic form and expressed in the life activities of the plant and animal population.

Thus, after a few weeks, the hay infusion world has reached a standstill — extermination faces the population and inevitably occurs unless microscopic green plants, close relatives of *Proto-coccus*, find opportunity to develop in the energy-exhausted environment and proceed to entrap the kinetic energy of sunlight, store it up in carbohydrates and proteins, and thus restore energy in the potential form to the hay infusion.

If such occurs, the hay infusion world is a microcosm indeed — green plants, colorless plants, and animals gradually become reciprocally adjusted so that a self-perpetuating condition of practically stable equilibrium is established; in other words, what is termed a 'balanced aquarium.' The rise and fall of teeming populations, made possible by the rapidly changing environmental conditions which the bringing together of hay and water initiated, is replaced by an apparently harmonious interdependence of organisms demanding different food conditions, such as we are familiar with in the world at large.

## CHAPTER V

### SURVEY OF UNICELLULAR ANIMALS

The most important discoveries of the laws, methods, and progress of Nature have nearly always sprung from the examination of the smallest objects which she contains, and from apparently the most insignificant enquiries. — *Lamarck*.

THE invention of aids to the human senses, in particular the microscope, has made us aware of a "world of the infinitely little," whose representatives — *Protococcus*, *Bacteria*, and *Amoeba* — have been used in our study of the nutritional interdependence of organisms: animals cannot live without plants. We turn now to a brief survey of the close allies of *Amoeba* in the great group of unicellular animals, the *PROTOZOA*.

The *Protozoa* are the simplest forms of animal life, each individual comprising typically but a single unit of living matter, a cell. But it does not follow that they are devoid of complex organization. Indeed some *Protozoa* exhibit a complexity of structure within the confines of a single cell that is not exceeded, perhaps not equalled, in the cells of higher animals. The *Protozoa* are the simplest, but by no means simple animals.

Because these microscopic forms afford the nearest available approach to primitive animal life, innumerable studies on their physiology have been made in the hope that they would more readily supply the key to life processes — *e.g.*, nutrition, growth, reproduction, sex — that find such complex and bewildering expression in higher animals. Furthermore, not a few of the *Protozoa* live as parasites in Man and beast and cause some of the most serious diseases and greatest economic loss. So on both the theoretical and practical side, *PROTOZOÖLOGY* claims attention.

In any survey of animals or plants, first of all it is necessary to arrange the various kinds, or *SPECIES*, in some order — to classify them. To place nearer together those that appear related in structure and function and separate farther those that seem to be less related. And if *relationship* is the basis of classification, we should

know what the biologist means by relationship. The answer is: 'blood relationship,' descent with change 'from a common ancestor — organic evolution. But this large subject must be left until much later in our study; merely stating now that although the object of a *natural* classification is to express the pedigrees of the organisms, most classifications are, at best, still very far from realizing this ideal. With probably a million known species of animals on the Earth to-day, classification is a stupendous problem; it is not a small problem even with the fifteen thousand known species of Protozoa. For our purpose, however, classification can be reduced to a minimum — to a mere skeleton outline, — to facilitate a synoptic view of the diversities of animals. (See page 352 and Fig. 313.)

The first great subdivision, or PHYLUM, of the Animal Kingdom is the Protozoa. All of the Protozoa, since they are single cells, demand for active life a more or less fluid medium, and are typically aquatic animals. However, different species exhibit all gradations of adaptation to variations in moisture from those that thrive in oceans and lakes, or pools and puddles, to those which find sufficient the dew on soil or grass blade, or the fluids within the tissues and cells of higher animals and plants.

The phylum Protozoa is divided, largely on the basis of the locomotor organs, into four chief groups, or CLASSES: the SARCODINA, Mastigophora, Sporozoa, and Infusoria. In general, we may regard the SARCODINA as forms, like Amoeba, that move about by means of pseudopodia; the MASTIGOPHORA as cells with flagella as locomotive organs, such as Euglena; and the INFUSORIA as organisms, like Paramecium, that swim by cilia. The SPOROZOA, all of which are parasitic, such as the organisms causing malaria, possess no characteristic type of organ for locomotion though many are motile. (Figs. 13, 22, 27, 223.)

#### A. SARCODINA

Amoeba, which we have already studied, may be visualized as the type of the Sarcodina since all members of this class are, broadly speaking, 'amoebae,' but there are numerous species of the GENUS Amoeba itself. The common, relatively large fresh-water species, usually called *Amoeba proteus*, has as associates many other fresh-water and some salt-water species. Again, numer-

ous species of Amoeba, such as those comprising the genus *Endamoeba*, live within the bodies of Man and other animals. Fur-

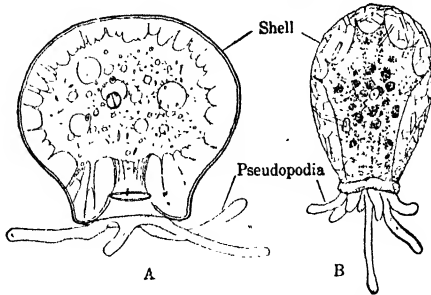

FIG. 19. — A, *Arcella* showing the protoplasm through the transparent shell and also protruding as pseudopodia; B, *Difflugia* showing the same.

thermore, there are many common fresh-water genera, such as *Arcella* and *Difflugia*, that have resistant protective coverings, or shells. The shells have an opening through which the pseudopodia are protruded so that locomotion, securing of food, etc., can be performed. But all of these animals, whether free-living or parasitic, naked or provided with a shell, are creeping cells with more or less broad or blunt finger-form pseudopodia and comprise the first ORDER of the Sarcodina known as the AMOEBAEA. (Figs. 6, 11, 19, 245.)

An immense group of chiefly marine Protozoa, the FORAMINIFERA, constitutes the second order of the Sarcodina. Most species have quite complex shells of calcium carbonate, with one or many openings through which delicate pseudopodia emerge, branch, and flow to-

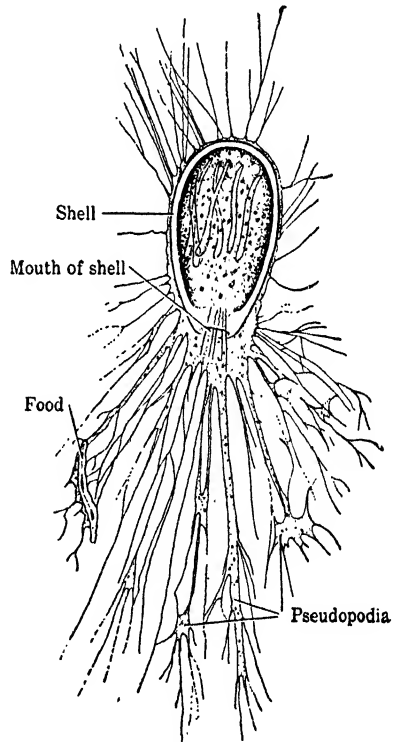

FIG. 20. — *Allogromia*, one of the few fresh-water Foraminifera. Note the pseudopodial mass emerging from, and surrounding the shell. (Modified, after Cambridge Natural History.)

gether so that the shell becomes essentially an internal structure. The almost incalculable number of Foraminifera constitutes an important source of marine food for small animals which, in turn, are the food of economically important fishes. The more resistant Foraminifera shells sinking to the sea-bottom cover vast areas with the so-called Globigerina ooze, accumulation of which in the geologic past is evidenced to-day by the chalk cliffs of England. The Pyramids and the Sphinx are built of Foraminiferous rock. (Figs. 20, 244.)

The final two orders of the Sarcodina, known as the HELIOZOA and RADIOLARIA, are characterized by unbranched, radiating pseudopodia, each supported by a core of more dense protoplasm. Most species are floating, spherical forms and the pseudopodia,

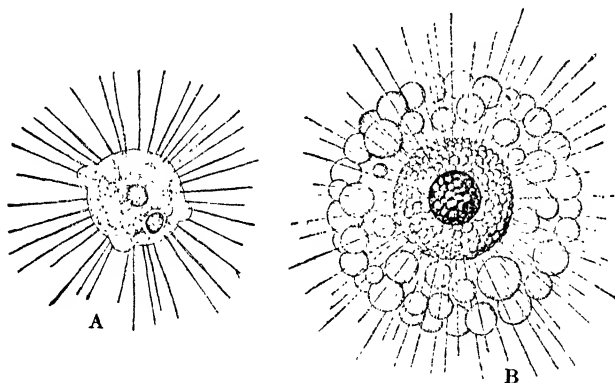

FIG. 21. — A, Heliozoön, *Actinophrys sol*; B, Radiolarian, *Thalassicolla nucleata*. (From Kudo.)

protruding from the entire surface of the cell, give the appearance of the conventional figure of the Sun. Accordingly the fresh-water forms are commonly called Sun Animalcules, or Heliozoa. The Radiolaria are all marine and are more complex than the Heliozoa, the protoplasm being differentiated into several layers, enclosing a dense, perforated CENTRAL CAPSULE, and usually supported by an elaborate skeleton of silica. The Radiolaria vie in numbers and importance with the Foraminifera in the economy of the sea; the deposits of their skeletons forming the Radiolarian ooze. Certain rock strata hundreds of feet thick are contributions to the Earth's surface made by the Radiolaria during bygone ages. (Fig. 21.)

## B. MASTIGOPHORA

The popular phrase "from Amoeba to Man" would lead one to believe that Amoeba and its allies clearly represent the lowest

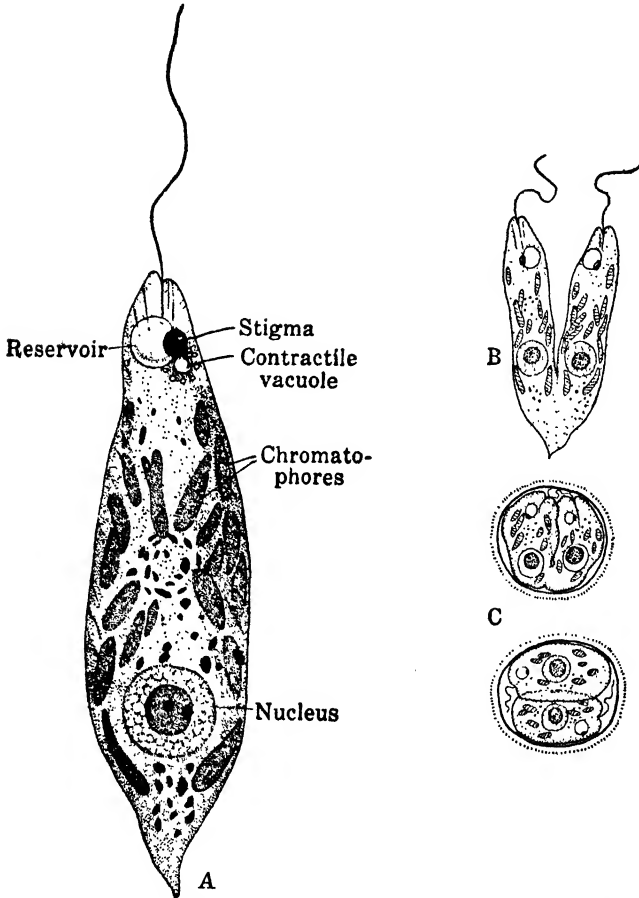

FIG. 22. — *Euglena viridis*. A, free-swimming individual showing details of structure (from Doflein); B, reproduction by longitudinal binary fission; C, two stages of fission within a cyst.

group of Protozoa. However, biologists are not sure that such is the case because the great group of flagellated Protozoa, the class Mastigophora, includes many forms that are not only exceedingly simple in structure but also are plant-like in that they possess chlorophyll and so are able to perform photosynthesis. For in-

stance, *Euglena* is an organism that is claimed by both zoologists and botanists: by the former because it can employ complex food materials, and by the latter because in the presence of sunlight it can manufacture its own food. Such forms attest the fact that it is impossible to distinguish sharply the so-called animal and plant kingdoms — one merges into the other when the primitive forms of life are approached. Our classifications fail at the lowest level

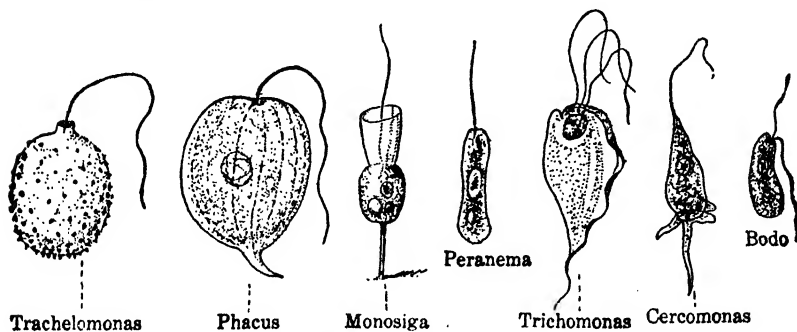

FIG. 23. — Common flagellated Protozoa (Mastigophora).

of life: all living nature is one. Moreover it is not possible to draw a hard and fast line between the Mastigophora and the Sarcodina because certain organisms possess both flagella and pseudopodia during various phases of their life. (Figs. 18, 22, 23.)

The Mastigophora are very widely distributed in sea, pond, and infusions of organic matter. An immense order, the DINOFLAGELLIDA, constitutes not a small part of the microscopic life of the sea, competing with the Sarcodina and microscopic plants in variety of species and number of individuals — numbers so immense that wide areas of the sea may become discolored or appear phosphorescent. Others, such as the TRYPANOSOMES, have invaded the field of parasitism, living in the digestive tract and blood stream of higher animals. (Figs. 24, 224.)

The versatility of the Mastigophora in mode of life and nutrition apparently implies a high potential of adaptation and evolution. Indeed, it is among them that certain interesting associations, or COLONIES, of

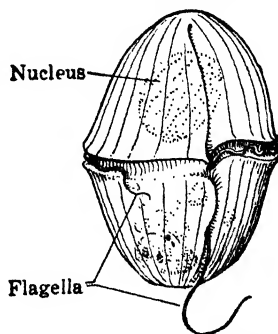

FIG. 24. — A Dinoflagellate, *Gymnodinium*.



individuals occur that suggest a possible method of origin of the multicellular body of higher animals. (Figs. 29, 30.)

### C. SPOROZOA

Although parasitic species are found in all four classes of Protozoa, the Sporozoa have the distinction of living solely at the

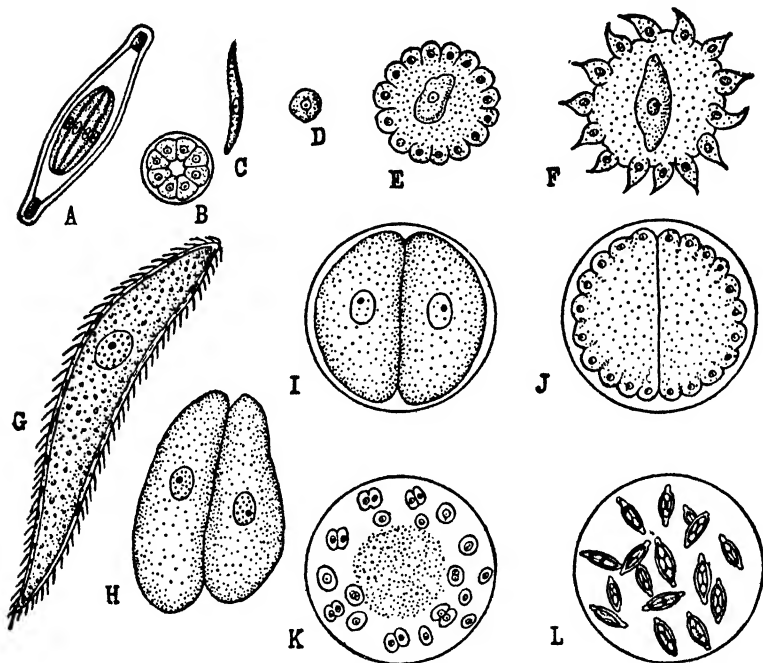

FIG. 25. — Life cycle of a Sporozoon, *Monocystis*. A, spore consisting of a spore case enclosing eight sporozoites; B, transverse section of same; C and D, liberated sporozoites; E, sporozoite after entering 'sperm-sphere' of Earthworm; F and G, growth until fully developed trophozoite is formed surrounded by the degenerate remains of sperm-sphere with flagella of sperm; H, two trophozoites that have become free from degenerate sperm-sphere and united as gametocytes; I, encystment of gametocytes; J, division of nuclei and cytoplasm to form gametes; K, union of the gametes to form zygotes, residual cytoplasm of gametocytes in center of cyst; L, cyst containing many sporozoites formed by secretion of a spindle-shaped spore case around each zygote which then divides to form eight sporozoites. These become arranged as in A and are ready to be transferred to another host. (From Curtis and Guthrie.)

expense of other organisms, their hosts, in which they create disturbances of more or less severity which frequently result in disease. The successful attempt to get a living with little expenditure

of energy has in the Sporozoa, as elsewhere in the Animal Kingdom, resulted in a degeneration of structures necessary for a free life, and an elaboration of the reproductive processes to ensure that the parasite secures access to the proper host. For, in general, each Sporozoön is adapted to live in one (or two) particular species of animal—indeed probably every species of higher animal has at least one Sporozoön specially fitted to live at its expense.

Monocystis is a common Sporozoön that spends its entire life in the body of an Earthworm. The 'adult' Monocystis is an elongated cell living in a part of the reproductive system (seminal vesicles) and securing its nourishment from the developing germ cells of the worm. Here food is plentiful, and accordingly much is stored for use during the complex reproductive changes which terminate in the production of resistant SPORES. These eventually are discharged from the body of the worm, and trust to chance that entrance may be gained to the body of another worm in order that the life cycle may be repeated. (Fig. 25.)

Malarial fevers would seem to be of more importance than diseases of the Earthworm, though our knowledge of the Sporozoa that are responsible for these human maladies has been made possible by basic studies on the Protozoa as a whole. Malaria is transmitted to Man solely by diseased female Mosquitoes that inoculate into the blood stream a Sporozoön of the genus Plasmodium. Once in the human blood, the parasite enters a red blood cell and begins its complicated life history. Multiplication of the parasite until thousands are present results in the periodic liberation of poisonous material in the blood which produces the alternate chills and fever. In order to complete its life history the parasite must again be taken into the body of a Mosquito by the latter biting an infected person. (Figs. 223, 246, 247.)

#### D. INFUSORIA

The ciliated Protozoa, constituting the class Infusoria, probably represent the most complex development of the unicellular plan of animal structure. Infusoria have afforded ready material for the study of various physiological problems, not only because some of the species are relatively large, but also because, in general, they lend themselves most readily to experiment. Most of the Infusoria are free-living in fresh and salt water, though not a few

are parasitic: there is a highly complex fauna in the digestive tract of horses and cattle, and Man is not immune. (Figs. 18, 26.)

The organization of the group may be illustrated by *Paramecium* which is a giant among the Protozoa, being just visible to the naked eye as a whitish speck if the water in which it is swimming is

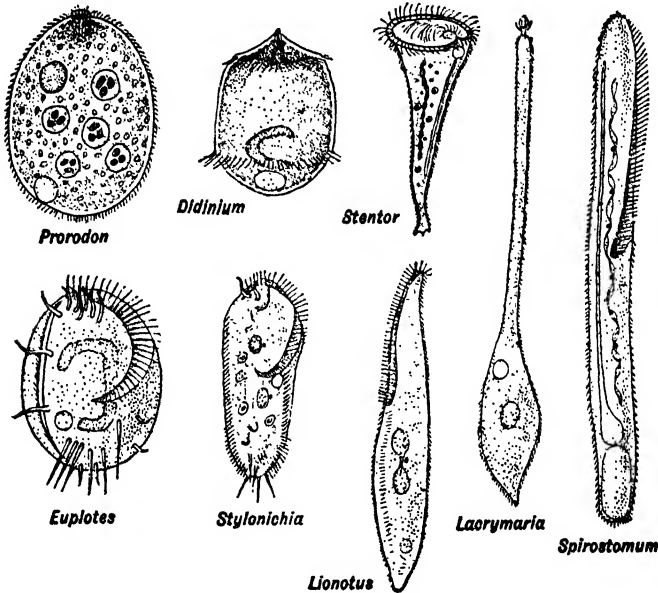

FIG. 26. — Common ciliated Protozoa (Infusoria) from fresh water. (From Curtis and Guthrie.)

properly illuminated. When magnified several hundred times it appears as a more or less slipper-shaped organism which one would not consider, at first glance, a single cell because it shows highly specialized parts. However, careful study shows that it really consists of a single protoplasmic unit differentiated into cytoplasm and nucleus. (Fig. 27.)

The nuclear material in *Paramecium*, instead of forming a single body as it does in most cells, is distributed in two parts: a larger body, or **MACRONUCLEUS**, and a smaller body, or **MICRONUCLEUS**.<sup>1</sup> Strictly speaking, the macronucleus and micronucleus

<sup>1</sup> The several species of *Paramecium* differ in regard to micronuclear number; e.g., *P. caudatum* has one micronucleus, *P. aurelia* and *P. calkinsi* have two, and *P. polycaryum* and *P. woodruffi* have several micronuclei.

together constitute the nucleus of the cell, and represent a sort of physiological division of labor of the chromatin complex.

But it is in the cytoplasm that specialization is most conspicuous. Not only are there general differentiations into ectoplasm and endoplasm, but these regions also have local specializations such as thousands of hair-like, vibratile CILIA for locomotion and securing food, TRICHOCYSTS for defense, PERISTOME, MOUTH, and GULLET for the intake of solid food, GASTRIC VACUOLES for digestion, and CONTRACTILE VACUOLES for excretion. And withal, recent investigations indicate that various parts of the cell may be coördinated by a NEUROMOTOR apparatus. (Figs. 27, 135, 225, 226.)

Paramecium, under favorable conditions, grows rapidly and, when it has attained the size limit characteristic of the species, cell division takes place. This process of multiplying by dividing can go on indefinitely under favorable environmental conditions. But periodically Paramecium undergoes an internal nuclear reorganization process (ENDOMIXIS). Also now and then individuals temporarily fuse in pairs and interchange nuclear material (CONJUGATION) — an expression of fundamental sex phenomena, involving FERTILIZATION, which we shall have occasion to consider later. (Figs. 28, 170, 171.)

Indeed the Infusoria seem, so to speak, to have made the most of their unicellular plan of structure, for Paramecium is fairly representative: it is not the most simple nor yet the most complex. Specialization of one part and another of the cell has produced in the Infusoria a group of animals that, judged by distribution and numbers, is highly successful in the microscopic world of life.

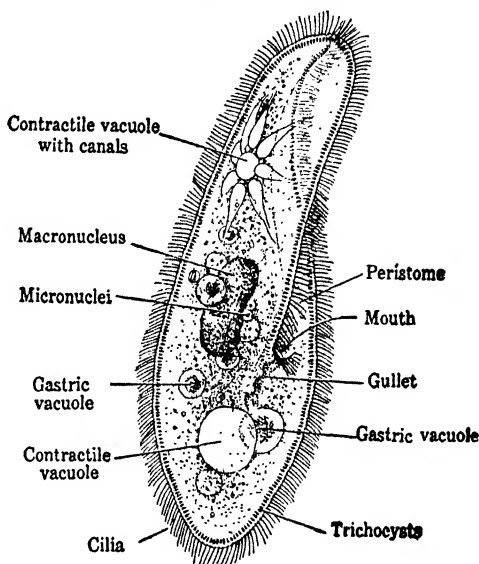

FIG. 27. — *Paramecium aurelia*.

In this necessarily cursory survey of the Protozoa, at least one major point must be forced upon our attention — the versatility of form and function exhibited by these unicellular animals — their ADAPTATION to many and varied modes of life in the most diverse environmental conditions. But their unicellular plan of structure, permitting only cytological differentiation, has obvious

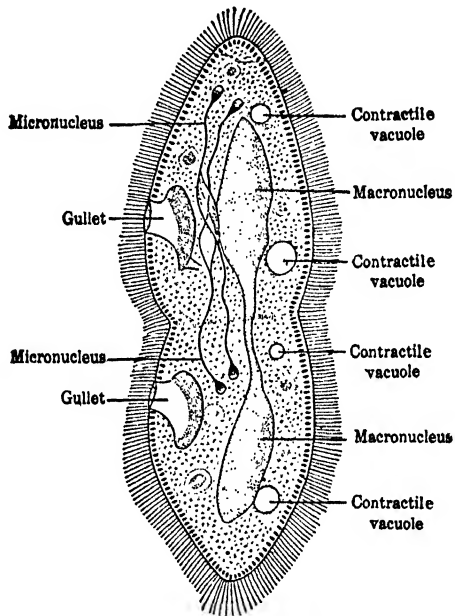

FIG. 28. — *Paramecium aurelia* dividing by binary fission. (From Lang.)

inherent limitations which adaptation cannot surmount, while the multicellular type of organization characteristic of all other animals affords, as we shall presently see, opportunities which almost transcend imagination. It makes possible both cytological and histological — tissue — differentiation. However, the potential of evolution of the protozoan type *was* expressed, it is believed, when it gave rise in the geological past to the stock from which the higher animals have developed. This allowed the powers of adaptation pent up, so to say, in the single cell to find expression in specialization and coöperation in the individual of another and higher order, which multicellular animals represent.

## CHAPTER VI

### THE MULTICELLULAR ANIMAL

Over the structure of the cell rises the structure of plants and animals, which exhibit the yet more complicated, elaborate combinations of millions and billions of cells coördinated and differentiated in the most extremely different ways. — *Hertwig*.

It has been pointed out that all organisms consist either of one free-living cell or of many cells, and some idea has been gained of unicellular animals from our survey of the Protozoa, so we are now in a position to consider the origin and organization of the individual in the METAZOA, as the multicellular animals are sometimes called.

Every Metazoan individual, with exceptions to be noted later, begins its existence as a single cell which has been set free as such from the parent, or which has been formed by the fusion of two cells, or GAMETES, each typically derived from a separate parent individual: one MALE, the other FEMALE. (The former method is known as UNIPARENTAL, or ASEXUAL, reproduction and the latter as BIPARENTAL, or SEXUAL, reproduction.) The union of male and female gametes (SPERM and EGG) in sexual reproduction to form the ZYGOTE is termed FERTILIZATION. Both asexual and sexual methods are common in many of the lower animals, but in higher forms, including Man, only sexual reproduction prevails, so emphasis at present will be placed on the latter. (Fig. 133.)

The most remarkable fact about the zygote (fertilized egg) is its power to develop into an organism similar to the parents from which its components, the gametes, have separated. The zygote is set, one may say, to go through a series of changes which transform an apparently simple cell into an obviously complex multicellular animal with all the characteristics of the species. It is important, at this point, to review the typical method by which the development of the adult is accomplished.

#### A. DEVELOPMENT

Briefly, the general method of animal development is cell division accompanied by growth and differentiation. The zygote

by a succession of cell divisions, termed **CLEAVAGE**, passes from the single-cell stage to a two-cell stage and then, with more or less regularity, to four-cell, eight-cell, sixteen-cell stages, etc. If these cells separated after each division, the same general condition would occur here which has been seen in the Protozoa, where each organism is a complete free-living cell. Or again, if cleavage merely resulted in a group of so many exactly similar cells, there would arise a **COLONY** of unicellular individuals rather than a multicellular organism.

Such colonial forms are, in fact, numerous among the lower plants and animals, and show nearly all grades of complexity from

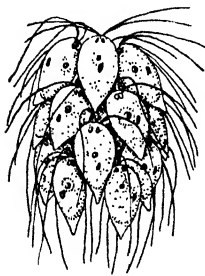

FIG. 29. — A simple colony of unicellular organisms (*Spondylomorom quaternarium*) each of which carries on all the functions of life, including reproduction.

simple associations of a few identical cells, as for example in *Spondylomorom*, to groups of many thousands of cells in which some of the individuals are specialized for certain functions. *Volvox* affords an instructive example of the latter condition. The majority of the cells, ten thousand or more, that form the relatively large spherical colony are flagellated, *Euglena*-like individuals, each of which lives a practically independent existence in organic union with its fellows. The chief contribution of each of these cells to the economy of the whole results from the lashing of its flagella, which helps to propel the colony through the water. But, under certain conditions, some of the cells become specialized

for reproduction, both asexual and sexual, and form new colonies which sooner or later are set free. Thus we have a differentiation of reproductive (**GERM**) cells from body (**SOMATIC**) cells, and a foreshadowing of that further specialization and physiological division of labor between cells which is the most characteristic feature of the higher organisms. (Figs. 29, 30, 154.)

Indeed, the complex bodies of multicellular organisms are made possible by cell differentiation and cell coöperation. All protoplasm possesses, for instance, the primary attribute of contractility, but in the muscle cells of animals we find the capacity for contraction very greatly developed, and to a certain extent at the expense of other powers. But this differentiation would be ineffective were not innumerable similarly specialized cells grouped together —

marshalled to perform a certain function. The power of a muscle results from the combined action of its component muscle cells. Differentiation without coöperation between cells we have seen in unicellular organisms. Paramecium has highly specialized parts; other Protozoa have still more — perhaps the limit of possi-

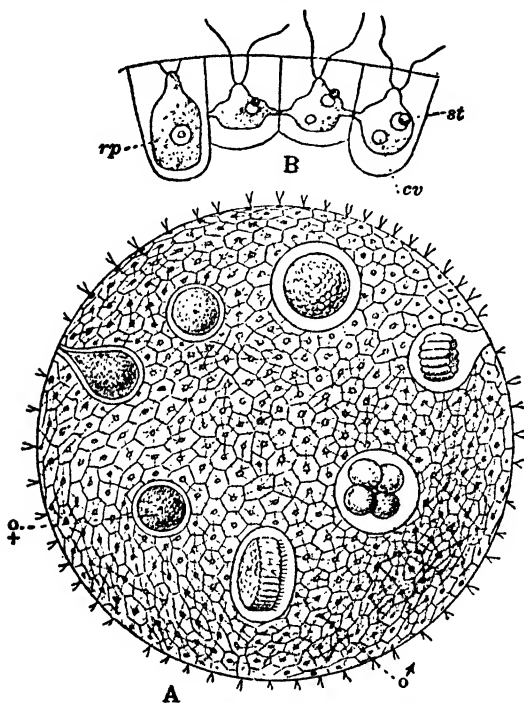

FIG. 30. — *Volvox globator*, a large colony of flagellated unicellular organisms in which the various cells have become organically connected, and certain cells specialized for reproduction. (Highly magnified.) A, mature colony (highly magnified) showing sperm, ♂, and eggs, ♀, in various stages of development; B, four cells (more highly magnified) showing the connections between three 'somatic' cells, and the early differentiation of a reproductive cell, *rp*. *cv*, contractile vacuole; *st*, 'eyespot' or stigma. (From Kölliker.)

bilities of the single cell. But the multicellular body solves the difficulty by removing the limit — by assigning special functions to groups of cells rather than to parts of one cell.

Thus cell division (cleavage) involving growth, differentiation, and its attendant physiological division of labor is the keynote of development in the higher animals and plants. Among animals, the cells which arise from the cleaving egg (zygote) usually become



arranged so that they form the surface of a hollow sphere of cells known as a **BLASTULA**. All the cells at first appear essentially similar, but soon those at one side of the blastula become in-

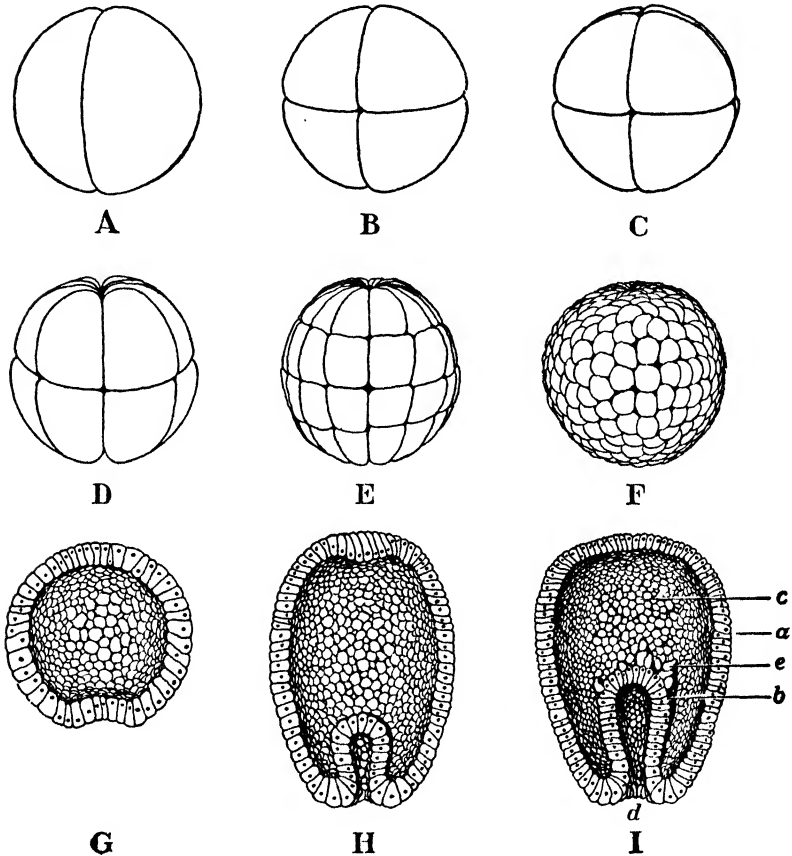

FIG. 31.—Early stages in the development of the egg of an animal. A-F, cleavage and formation of the blastula; G, section of blastula showing the beginning of gastrulation; H-I, early and later gastrula stages. *a*, ectoderm; *b*, endoderm; *c*, blastocoel; *d*, blastopore, leading into the enteric cavity; *e*, cells, arising from the endoderm, destined to form the mesoderm.

vaginated until the central cavity, termed the **BLASTOCOEL**, is largely obliterated. Accordingly there results the **GASTRULA** stage, which may be roughly compared to a sac, composed of two layers of cells with an opening to the exterior termed the **BLASTOPORE**. The outer layer is known as the **ECTODERM**, and the inner, which

lines the gastrula cavity (ENTERIC CAVITY), as the ENDODERM. The ectoderm comprises cells which are already somewhat differentiated among themselves for special purposes, but which, as a whole, form a primary tissue with general functions of its own, chiefly sensory and locomotor. Similarly the endoderm consists of cells which, as a group, form the nutritive cells of the embryonic animal. (Fig. 31.)

In the gastrula stage of most animals, a third layer of cells arises from the endoderm and becomes disposed between the ectoderm and endoderm. This new middle layer is the MESODERM. In this way the so-called three PRIMARY GERM LAYERS are established which are characteristic of the developing animal, and from these are derived the specialized tissues which compose the various organs of the adult. For example, the ectoderm by cell division and differentiation gives rise to the outer skin and central nervous system; the mesoderm to muscular and supporting tissues and the blood vascular system; while the endoderm forms the layer of cells which lines the alimentary canal of the adult organism.

## B. TISSUES

This grouping of more or less similar cells into functional systems, or TISSUES, is at the basis of the architecture of multicellular organisms, and thus we have now reached another level in the analysis of their structure. Although the unit of organization is the cell, these are associated in groups, or tissues, which represent a morphological unit of a higher order — a division of labor among the cells that makes possible the multicellular body with its attendant complexity. A tissue may be defined as a group of essentially similar cells specialized to perform a certain function. It is convenient to distinguish six main groups of animal tissues: epithelial, supporting, muscular, nervous, circulating, and germinal. (Figs. 4, 32, 34.)

The importance of EPITHELIAL TISSUES is evident from the fact that the body is covered and lined with these cellular membranes so they form the point of contact between the organism and its environment. For example, food before it is really inside the body must pass through an epithelium lining the digestive tract, and before it can do that it must be digested by enzymes secreted by epithelial cells. Furthermore, the waste products of metabolism must be excreted and pass from the body through epithelial mem-

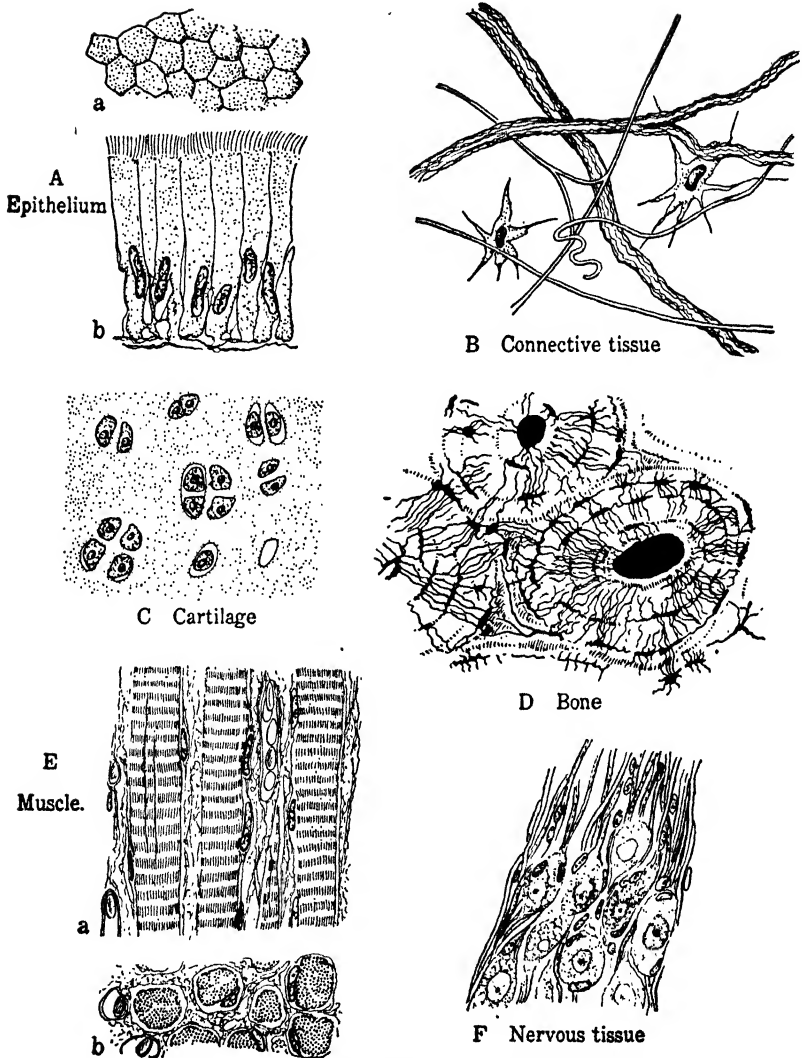

FIG. 32. — Various Vertebrate tissues. A, Epithelium (simple ciliated) from human intestine; *a*, surface view; *b*, longitudinal section; B, Connective tissue (subcutaneous) from Rabbit, showing cells and fibers (elastic and fibrillated); C, Cartilage, showing cells in spaces in hyaline matrix; D, Bone: section of human humerus showing many spaces in matrix in which the bone cells lie; E, Muscle (striated) from Man; *a*, longitudinal section; *b*, cross section; F, Nervous tissue: bipolar nerve cells from ganglion of auditory nerve of Cat.

branes. Specialization for secretion and excretion leads to GLAND formation. Glands may be unicellular and scattered here and there in the surface of the cellular membrane, or they may be grouped at certain points of vantage. Just as often, however, many cells combine to form multicellular glands, which sink, as it were, below the surface as simple or complex tubes or sacs of secreting cells, and thus amplify many-fold the effective surface within a given space. And finally, specialized epithelial cells form important elements of sense organs — the outposts of the nervous system. (Fig. 33.)

Obviously the larger and more complex the organism, the greater is the necessity for sustaining and binding material; and therefore as we ascend the animal scale we find, in general, an increase in SUPPORTING TISSUE. Whereas in epithelia the cells themselves form the major part of the tissue, in supporting tissues it is direct or indirect products of the cells, known as intercellular material,

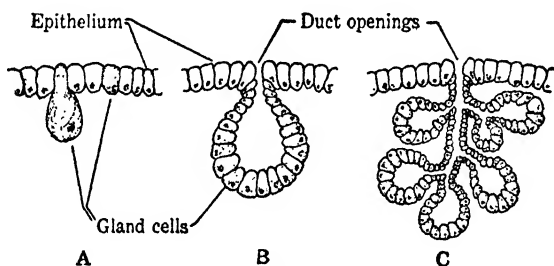

FIG. 33. — Diagram of glands.

or matrix, that gives character to the tissue. Thus the function of *connective tissue* is performed chiefly by intercellular bundles of fibers, and the same principle is true for the *cartilage* and *bone* forming the internal skeletons of higher animals.

MUSCULAR TISSUE is responsible for the power of motion and locomotion so characteristic of most animals, and also for the necessary movements performed by the internal organs in carrying on the various life processes. Muscle cells have in a highly developed and specialized form a fundamental property of all protoplasm, contractility, which they exhibit by shortening and broadening when stimulated by impulses coming chiefly through the nervous system. A muscle is a coöperating group of muscle cells, usually bound together by connective tissue and richly supplied with blood vessels and nerves. (Figs. 7, 32, 98, 99.)

All protoplasm is irritable — it responds to stimuli — but obviously the larger and more complex the body becomes, the more necessary it is that the actions and reactions of its component cells be instantly coördinated so that the parts act as a whole — an organism. This function is performed by **NERVOUS TISSUE** composed of nerve cells, or **NEURONS**, whose long fibers are bound together by connective tissue into cables, or **NERVES**. (Fig. 138.)

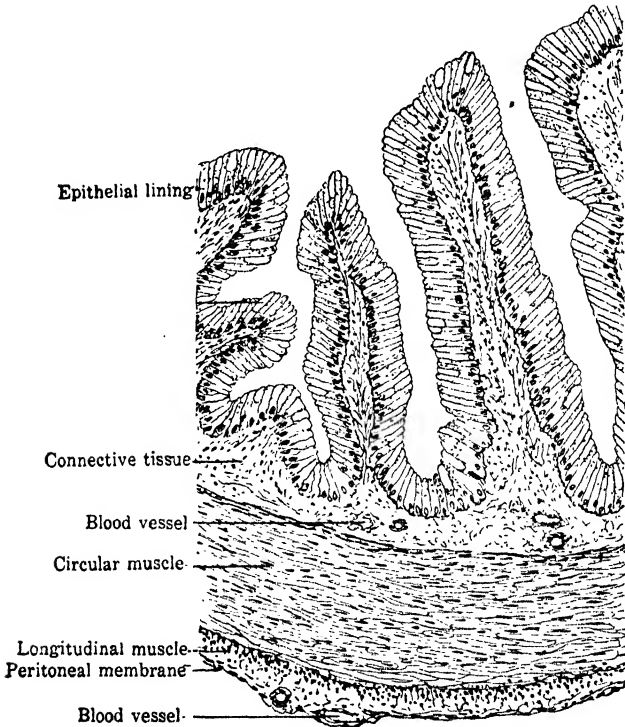

FIG. 34. — Portion of a transverse section of the small intestine of the Frog, highly magnified, to show cellular differentiation, and tissues combined to form an organ.

One seldom thinks of **BLOOD**, **LYMPH**, and other fluids that transport materials in the body, as tissues, but in truth they must be regarded as **CIRCULATING TISSUE** in which the living cells, or **CORPUSCLES**, are suspended in a fluid matrix, the **PLASMA**. Circulating tissues minister to, and are in intimate contact with, every tissue and cell of the organism.

And finally, within the body — though perhaps not of the body — is the **GERMINAL TISSUE** destined to contribute not to the individual but to the propagation of the race during reproduction.

So the multicellular animal — the organism as a whole — is a multitude of coöperating protoplasmic units: upward of one hundred thousand billions in Man. However, we must not overlook the whole which is greater than its parts. The cells merge their individuality in that of the entire organism, and as long as its cells remain associated they are to be regarded, not as individuals, but as specialized centers of action and reaction of the living body itself, by means of which physiological division of labor is made possible.

### C. ORGANS AND ORGAN SYSTEMS

Since the similar cell components of multicellular organisms are grouped to form tissues, it follows that the major working units, or **ORGANS**, of the animal body as a whole are formed of tissues. In other words, an organ is a complex of tissues which has assumed a definite form for the performance of a certain function — a major division of the body which allows the tissues and, therefore, the cells devoted to a special function to play their part under the most suitable relations to internal or external conditions: for example, the human hand composed of bone, muscle, nerve, etc. (Figs. 34, 125.)

As one would naturally expect, among the lowest Metazoa there are forms in which the body is relatively simple, without highly specialized tissues and organs, but in most animals specialization is carried still another step forward by the grouping of organs devoted to the performance of some one general function into an **ORGAN SYSTEM**.

The organ systems may be classified as the **INTEGUMENTARY** and **SUPPORTING SYSTEMS** which constitute the covering and the framework of the individual; the **ALIMENTARY**, **RESPIRATORY**, **CIRCULATORY**, and **EXCRETORY SYSTEMS** which directly or indirectly are concerned with nutrition; the **NERVOUS SYSTEM** which, in coöperation with the system of **SENSE ORGANS**, the **MUSCULAR SYSTEM**, etc., not only coördinates the various parts of the individual, but also orients the whole with respect to its environment; and, finally, the **REPRODUCTIVE SYSTEM** which makes possible the continuation of the race. The fundamental life processes for which

these systems provide must be carried on by all animals, and the chief differences in the structure of animals, from the lowest to the highest, are the result of the means adopted to serve these essential functions under different conditions imposed by the environment and mode of life. It is on the basis of these fundamental structural characteristics that the Metazoa are classified.

The Metazoa may be divided into two large groups known as **INVERTEBRATES** and **VERTEBRATES**. The former group, frequently referred to as the lower animals, comprises nearly a million known species and exhibits an enormous variety of form and complexity of structure ranging from the lowly Sponges to the highly successful Insects. On the other hand, the Vertebrates, or higher animals, form a relatively homogeneous group of about fifty thousand species, including the Fishes, Amphibians, Reptiles, Birds, and Mammals. It is to a survey of the Metazoa that we now turn. (Fig. 297.)

## CHAPTER VII

### SURVEY OF INVERTEBRATES

It seems as if Nature had essayed one after the other every possible manner of living and moving, as if she had taken advantage of every permission granted by matter and its laws. — *Gide*.

THE stupendous group of multicellular animals constituting the Invertebrates presents a bewildering array of forms adapted to nearly every conceivable environment. Some are smaller than many of the Protozoa and others much larger than certain Vertebrates. Some are aquatic, others are terrestrial, and still others spend most of their life in the air. Most possess the power of locomotion, but many are fixed, or sessile. And not a few — perhaps the majority — live as parasites in or on the bodies of other animals. (See Appendix I.)

The fact that there are nearly a million known species, and probably twice as many yet to be discovered, at once suggests that our survey must be confined to a relatively few representatives from each of the major Invertebrate phyla; enough to place the three forms we have selected for special study later — Hydra, Earthworm, and Crayfish — in proper perspective.

#### A. SPONGES

One is not surprised that the Sponges which constitute the PORIFERA, the lowest phylum of multicellular animals, show certain relationships with the Protozoa. Specialization of cells and physiological division of labor, though carried far beyond the most complex colonial forms, such as Volvox, nevertheless have not suppressed the individualities of the coöperating cells to the extent that occurs in most higher forms. Witness the fact that when certain Sponges are gently squeezed through the meshes of fine silk cloth, so that the tissues are resolved into separate cells, these cells will gather together in small groups and each group will grow into a Sponge. In brief, the Sponge is an individual animal, but its organization is loose and the dependence of one part upon another



is relatively slight. However, the Sponge dominates its tissues. Just so long as the component cells of the Sponge remain associated, they are not to be regarded as individuals, but as specialized centers of action and reaction of the Sponge's body, by means of which physiological division of labor is made possible.

At first glance, indeed, one would not recognize a Sponge as an animal at all. Thus the common *Leucosolenia* of the New England coast appears to be a group of tiny tubes, or sacs, per-

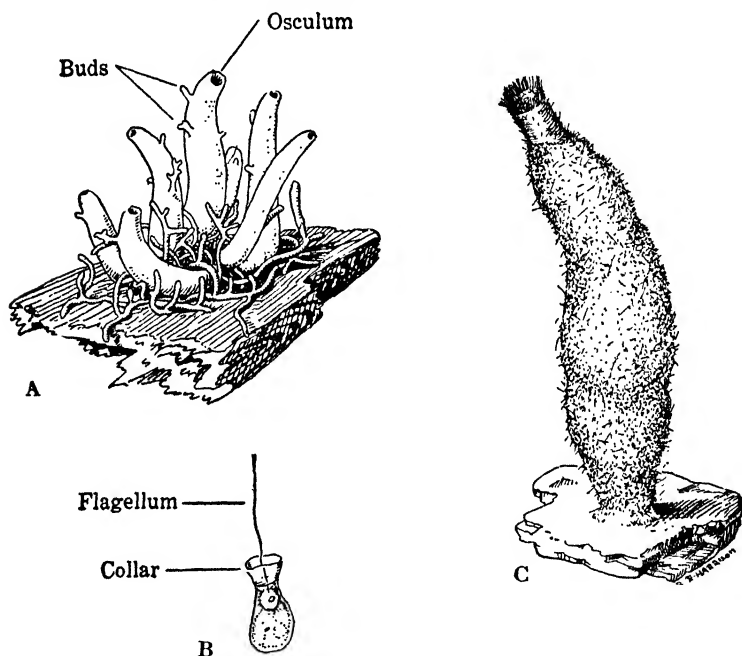

FIG. 35. — A, small colony of *Leucosolenia*; B, a collar cell; C, *Grantia*.

manently attached at the base to a rock just below low-tide mark. It is without the power of locomotion and does not visibly respond in any way when touched. However, if it is examined under a lens, it will be found that the whole surface of each sac-like body is dotted with innumerable pores, or OSTIA, through which water is being drawn into the GASTRAL CAVITY and passed on out through a sieve-like membrane at the top, or OSCULUM. The name of the phylum, Porifera, refers to the pores. (Fig. 35.)

A section of the body wall of *Leucosolenia* shows that it is supported by a skeleton, composed of a network of three-pronged

SPICULES of calcium carbonate, embedded in the tissue. The latter consists of two chief layers of cells: an outer, or DERMAL EPITHELIUM, and an inner, or GASTRAL EPITHELIUM, separated by a jelly-like material containing many amoeboid wandering cells.

The gastral epithelium is of particular interest because it consists chiefly of a layer of COLLAR CELLS, each provided with a flagellum, and resembling certain flagellated Protozoa from which, indeed, it is probable that the Sponges have descended. It is the constant lashing of the flagella that creates the current of water, laden with food and oxygen, through the pores into the gastral cavity, and on out through the osculum, bearing excretions. It is also the collar cells that capture, engulf, and digest particles of food in typical unicellular fashion (intracellular digestion) and pass the products on to the other cells. Similarly, respiration and excretion are carried on by the individual cells.

Such is the essential plan of structure of a simple Sponge, but there are more complex forms which, in general, can be derived from this so-called ASCON type by a thickening of the body wall, and then either the restriction of the collar cells to canals embedded in it in close proximity to the gastral cavity (SYCON type), or their segregation in tiny cavities more remotely situated in the tissues but still in communication with the gastral cavity by long canals (RHAGON type). The sycon type is represented by *Grantia*, and the rhagon type by the common Fresh-water Sponge, *Spongilla*, and the Bath Sponge, *Euspongia*. (Fig. 36.)

But one must not gain the idea that all Sponges are quite similar in outward appearance. As a matter of fact some are no larger than a pin head, others are six feet or more tall. Some are branched, fan-shaped, or cup-shaped. Most are white or gray though many contribute brilliant colors to the picture presented by the sea floor.

Among all this variety of Sponges, however, certain species, chiefly of the genus *Euspongia*, stand out as of high economic importance because their flexible, fibrous skeleton of SPONGIN, when cleaned and dried, is the familiar bath sponge of commerce. These Sponges, long gathered by diving and dredging, are now also farmed. Live Sponges are cut into very small pieces, wired to cement plates and then sunk to favorable places for sponge growth. After several years the pieces have become Sponges of sufficient size for the crop to be marketable.

Sponges reproduce both asexually and sexually: asexually by **BUDS** and by the liberation of groups of cells called **GEMMULES** possessing the power to form new individuals; and sexually by eggs and sperm. The zygote develops into a tiny ciliated embryo which after a short free-swimming existence settles down, becomes permanently attached, and soon attains the adult structure.

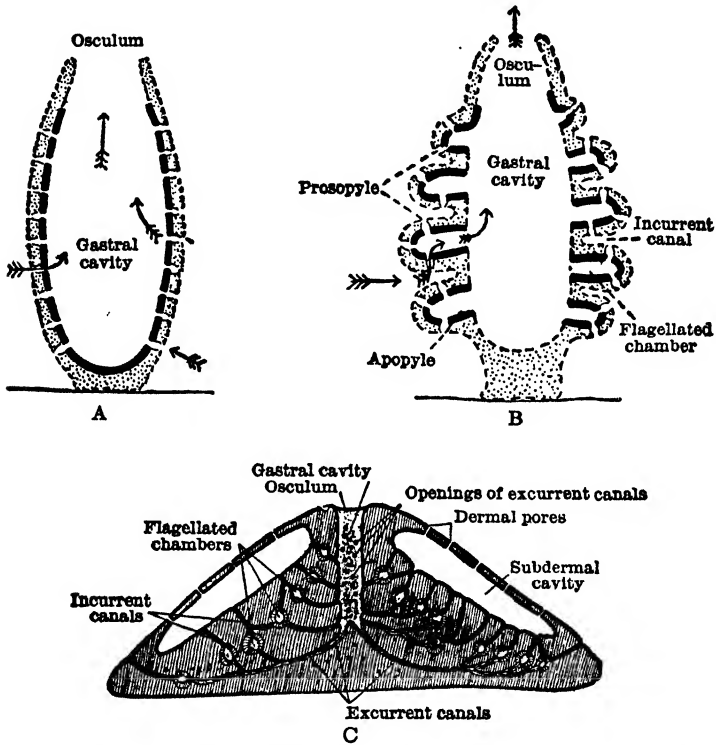

FIG. 36. — Types of canal systems of Sponges. A, ascon type (*Leucosolenia*); B, sycon type (*Grantia*); C, rhagon type (*Spongilla*, *Euspongia*). The arrows indicate the direction of the current of water. The thick black line in A and B represents the gastral layer; the dotted portion, the dermal layer. (From Minchin, and Parker and Haswell.)

The relationship of the Porifera to the series of Invertebrates raises an interesting problem. The tissues of Sponges are, as we have seen, not only too complex to be considered colonies of Protozoa, but they also are much less complex than those of the higher multicellular animals. And they are organized in a radically different way as well, including an apparent reversal of the two primary

cell layers which are not homologous with the ectoderm and endoderm of higher animals. All considered, Sponges probably represent a side branch of the Animal Kingdom that went up, so to say, an evolutionary blind alley, and remained only Sponges! (Fig. 313.)

## B. COELENTERATES

With the large group of aquatic animals comprising the COELENTERATA — the Polyps, Jellyfish, Sea-anemones, and Corals — we reach the basic phylum of the Invertebrates because, with a mouth opening into a digestive cavity and with specialized body parts coördinated by a simple nervous system, they institute the plan of structure that proves to be the fruitful one for the derivation of certain features exhibited in all higher animals. Our review of the phylum will merely serve to indicate some of the chief forms assumed by the POLYP type of individual in the highly diversified classes known as Hydrozoa, Scyphozoa, and Anthozoa.

HYDROZOA. One of the few Coelenterates inhabiting fresh water is the common polyp, Hydra. Like all polyps its body is essentially a sac composed of two cell layers — ectoderm and endoderm — separated by a jelly-like non-cellular layer known as the MESOGLOEA. The opening of the sac is the mouth which leads into the digestive cavity, or ENTERIC CAVITY. The mouth is surrounded by a circle of TENTACLES well supplied with nettle cells, or NEMATOCYSTS. Obviously the polyp exhibits RADIAL symmetry — right and left sides do not exist. It has no internal organs and so, of course, no organ systems. The adult Hydra now and again produces on its body-surface male and female sexual organs that liberate sperm and eggs and, after fertilization, the zygote develops into another Hydra. Furthermore, Hydra reproduces asexually by BUDS: small outpocketings from the body wall grow into small Hydras and then separate as independent polyps. (Figs. 57, 135-137, 155.)

However, the life history of Hydra is not representative of the many kinds of marine Hydrozoa that commonly grow on submerged objects, such as the piles of piers, because most of them consist of large colonies of Hydra-like individuals organically connected; somewhat as though a Hydra formed many buds that remained attached. Moreover, the colony is only one phase of the life history of a Hydroid, for it develops special buds, known as MEDUSAE, which become separated from the colony as inde-

pendent free-swimming individuals. At first glance a medusa bears little resemblance to a polyp, though it is essentially a sexual polyp that has been produced on the colony by budding and then liberated. Accordingly the complete life history of a typical Hydrozoön involves an ALTERNATION OF GENERATIONS consisting of the asexual

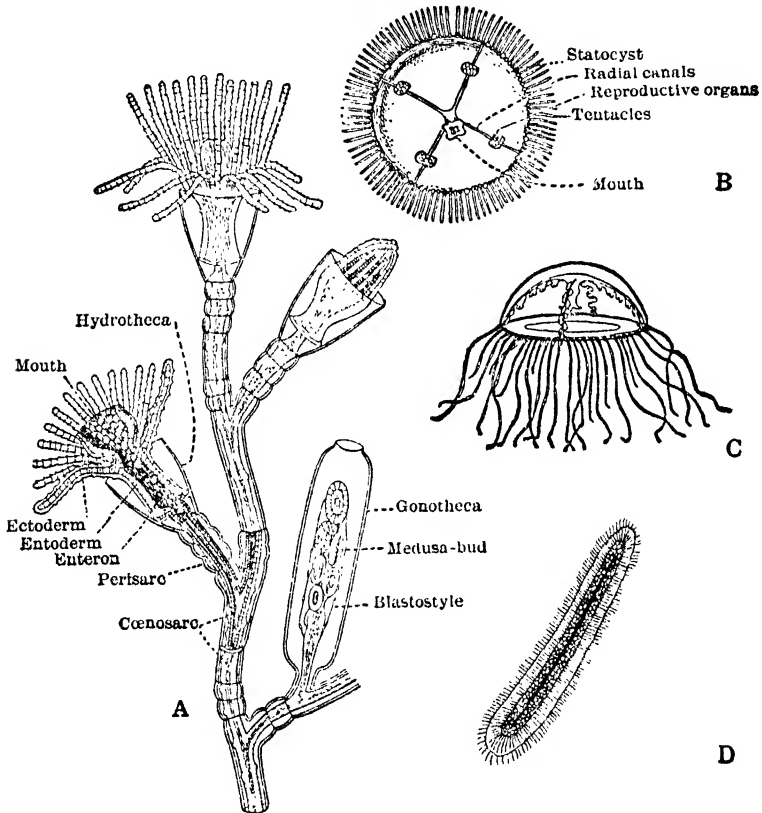

FIG. 37. — Life history of a Hydroid, *Obelia*. A, portion of the asexual colony showing three hydranths and a gonangium; B, free-swimming sexual medusa, oral view; C, medusa, side view; D, ciliated larva. (C and D of closely related species.) (From Hegner, after Allman, and Hargitt.)

colony and the sexual medusae that swim away and disseminate the species. Hydra is apparently a specialized form in which the medusa generation is suppressed. (Figs. 37, 38.)

The Hydroid colonies exhibit some interesting examples of physiological division of labor between the component individuals. Thus in *Bougainvillea* there are two kinds of polyps: the typical

feeding polyps, or **HYDRANTHS**, and the **MEDUSOID** polyps which later, with some structural changes, are set free. Again in *Obelia*, another common Hydroid, there are also highly modified individuals, or **GONANGIA**, that produce by budding the medusa generation. In still other Hydrozoa this **POLYMORPHISM** is carried even further. Thus *Physalia*, the Portuguese Man-of-War, is a floating Hydroid colony consisting of an air-filled bag, or float, with a sail-like crest, from which are suspended a large number of polyps. These individuals are very diverse: some are nutritive, others are tactile, and still others bear batteries of nematocysts. Furthermore, there are male reproductive polyps and others that give rise to egg-

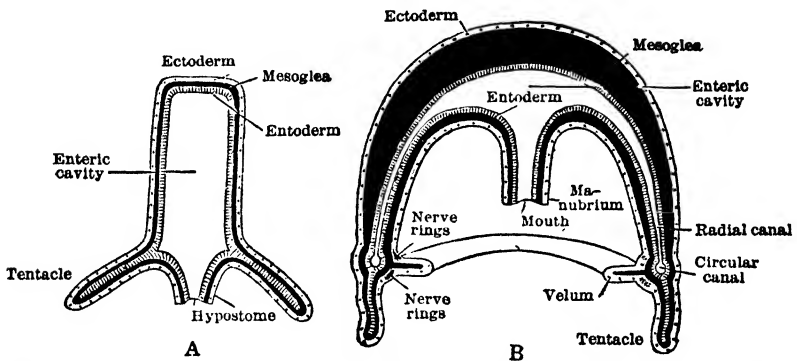

FIG. 38. — Diagram showing the fundamentally similar structure of Hydra or a hydranth of *Obelia* (A) and of a medusa (B). (From Parker.)

producing medusae. Obviously an animal such as *Physalia* suggests that in many of the lower forms the **INDIVIDUAL** is not so sharply defined, and is more difficult to define, than in the more familiar animals. Indeed, individuality in the Animal Kingdom is a problem in itself; one the reader might well keep in mind as we ascend the scale of animal life.

**SCYPHOZOA.** The second great class of the Coelenterates comprises chiefly large medusae, such as the common saucer-shaped *Aurelia* of the Atlantic coastal waters or its giant relative, *Cyanea*, which may attain a diameter of eight feet; each and all well-named Jellyfish since their soft tissues are more than 99 per cent water.

The structure of *Aurelia* is basically the same as that of the medusa generation of the Hydroids; the most obvious difference being an excessive development of the mesoglea between ecto-

derm and endoderm so that the body wall is relatively thick. The mouth is in the center of the under (oral) surface, opening into a large enteric cavity which branches into RADIAL CANALS that run to the circumference, or 'rim,' where they merge into a CIRCULAR CANAL. Thus digested food is carried directly to all parts of the animal without the necessity of a special circulatory system. Surrounding the mouth are four ribbon-like ORAL ARMS which, to-

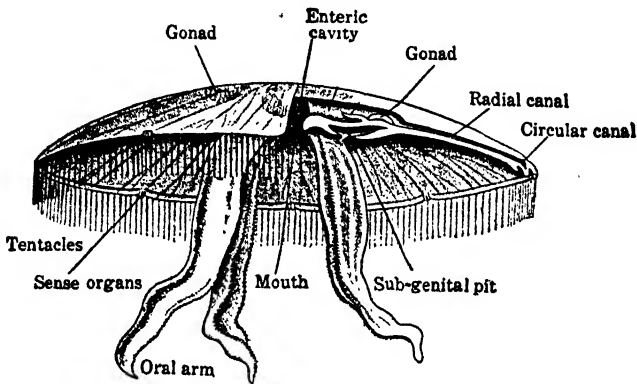

FIG. 39. — Aurelia, lateral view; one quadrant shown in section. (From Parker and Haswell.)

gether with the fringe of tentacles about the rim of the animal and certain filaments in the radial canals, are well supplied with nematocysts for stinging the prey. (Fig. 39.)

Among the tentacles on the rim are small rounded SENSE ORGANS which control, through the underlying nerve cells and muscle bands, the movements of the animal. Contraction of the rim of the bell, slowly and rhythmically, presses the water within the bell against that without and so forces the animal along. But Aurelia is largely at the mercy of wind and wave — few being destined to reproduce before dissolution, and all being destroyed by winter.

The reproductive organs of Aurelia consist of four large U-shaped GONADS which shed their products, either eggs or sperm, into the radial canals and so to the outer world through the mouth. Fertilization takes place in the open water to form a zygote that develops into a free-swimming larva. This soon settles to the bottom, becomes attached, and assumes a polyp-like form which is comparable to the hydroid generation of the Hydrozoa. After

wintering in this form, however, the fixed individual proceeds, as it were, to slice itself up in orderly fashion into a series of saucer-like embryo medusae which, one by one, separate, swim away, and eventually attain the adult, sexual Aurelia form. (Fig. 40.)

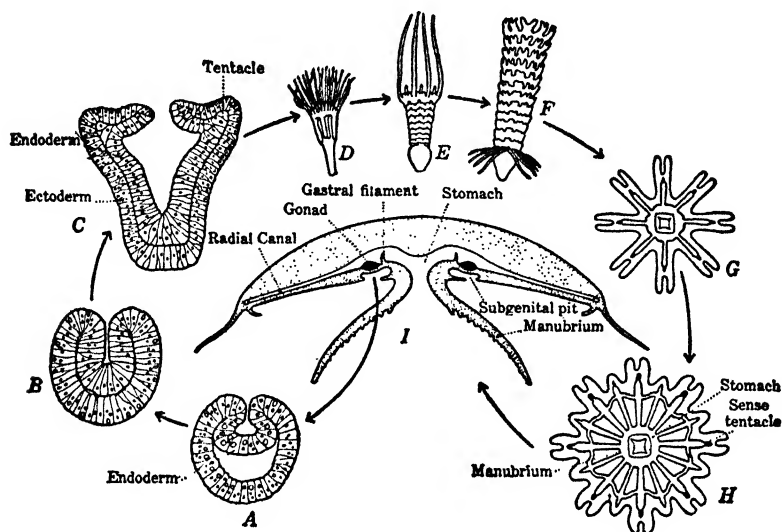

FIG. 40. — Aurelia, life-history. A, B, C, longitudinal sections through gastrula stages; D, scyphistoma; E, F, strobila; G, H, ephyra, I, vertical section through adult. A, B, and C are more highly magnified than the other figures. (From Hegner, after Kerr.)

**ANTHŌZOA.** So far our survey of the Coelenterata has shown that all are polyp-like animals, and the final class to be considered, the Anthozoa, is no exception, comprising, as it does, the Sea Anemones and the Corals.

Metridium, the well known Sea-anemone of the North Atlantic coast, is common in tide pools or attached to piers of wharves; its slight powers of creeping being seldom exerted. It is apparently a ruggedly built polyp, nearly cylindrical in form, with the upper end disclosing the mouth in the midst of a crown of numerous tentacles. (Fig. 41.)

The mouth opens into a large gullet which leads down into the enteron. The latter is quite complex because its walls give rise to several series of vertical, radially arranged partitions, or **MESENTERIES**, thereby increasing the functional digestive and respiratory surface. Within the enteric cavity are peculiar, long,



coiled, nematocyst-bearing threads that can be protruded in profusion through both the mouth and numerous pores in the body wall, and so are efficient offensive and defensive weapons. Furthermore, the tentacles of *Metridium* are not only well supplied with nematocysts, but also with a coat of cilia that plays a crucial part in the ingestion of food. Once the prey has been paralyzed by the

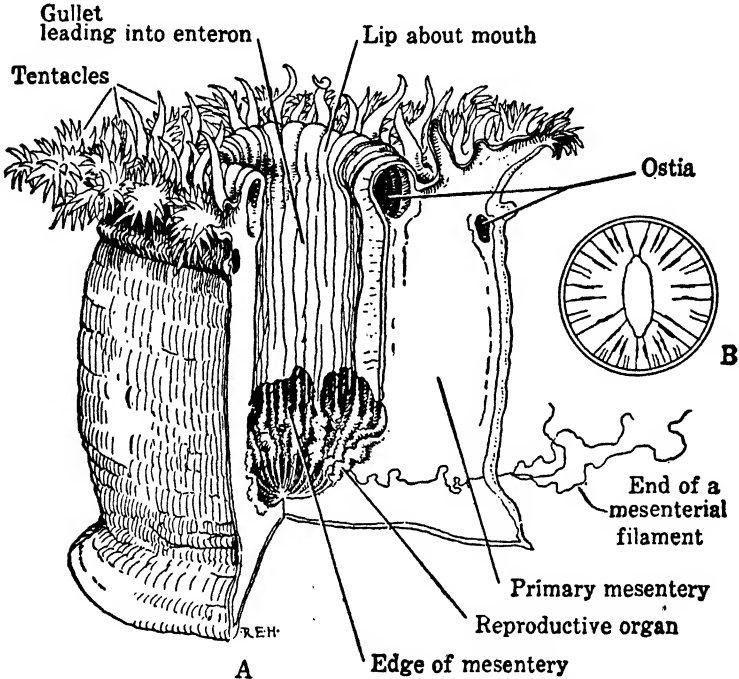

FIG. 41. — Sea Anemone, *Metridium marginatum*. A, View of polyp with one quadrant removed; B, Diagram of transverse section showing mesenteries.

discharge of the nematocysts, the tentacles bend inward and over so that ciliary action sweeps the food slowly but surely toward the mouth. Here other cilia, aided by muscular contractions, carry it on down into the enteron.

*Metridium* typically reproduces sexually, though asexual reproduction by budding may also occur. The reproductive organs are within the enteric cavity where, in the case of females, the eggs are fertilized, and the embryo develops into a ciliated larva before making its exit to settle down and assume the adult characters.

*Metridium*, then, may serve to illustrate the general type of

polyp structure exhibited by the Anthozoa, and it is only necessary to relate this to the Corals which are essentially Metridium-like polyps that secrete, under and about themselves, more or less complex skeletons, chiefly of carbonate of lime. As the polyp continues to secrete the coral, it actually pushes itself farther and farther away from the surface to which it became attached. This growth process, together with multiplication by budding, gradually builds up considerable masses of coral about larger and larger colonies of polyps — the arrangement of the polyps and the dis-

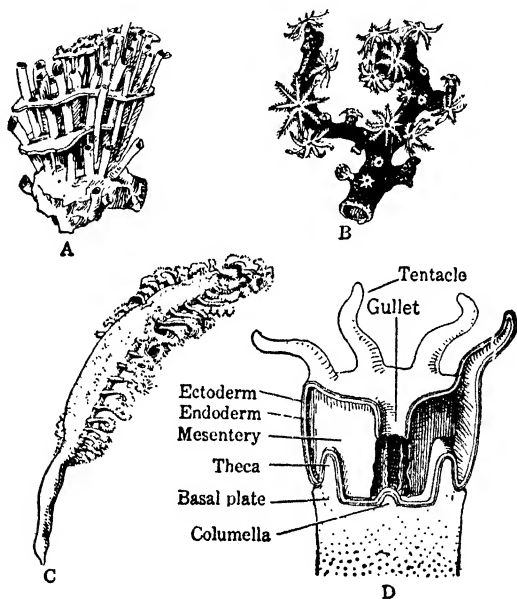

FIG. 42. — Coral. A, Skeleton of a young colony of Organ-pipe Coral, *Tubipora musica*; B, small branch of Red Coral, *Corallium rubrum*, showing living polyps; C, Sea Pen, *Pennatula phosphorea*; D, diagrammatic section of a single coral polyp.

position of the coral being characteristically different in the numerous species of Coral animals. Certain kinds of Corals, acting through long periods of time, are responsible for building not only atolls and islands but also fringing reefs and barrier reefs; the Great Barrier Reef of Australia is over a thousand miles long and fifty broad. (Fig. 42.)

From the Hydroid polyps to polyps building coral islands, from the tiny medusae of *Obelia* to the giant *Cyanea*, we gain at least a

glimpse of the basic group of Coelenterates and what it has accomplished with the simple radially symmetrical body plan, with two primary tissue layers, and an enteric cavity. The polyp type is successful in its way, but its chief contribution was apparently in affording the stem from which higher forms started along their main path of ascent. (Fig. 297.)

### C. FLATWORMS

Passing over a small phylum of marine Coelenterate-like animals, the CTENOPHORA, popularly called Sea-walnuts and Comb-jellies, that have made a somewhat abortive attempt to establish a body on the three primary layer plan, we come directly to the first great group of TRIPLOBLASTIC animals, the Flatworms, constituting the phylum PLATYHELMINTHES. (Fig. 43.)

On the lower surface of submerged stones near the edges of ponds are usually many tiny black, gray, or white Flatworms, creeping by cilia, known as Planaria. They are obviously radically different in structure from a polyp since they exhibit BILATERAL instead of radial symmetry: they have a broad anterior end with simple eyes and brain, and a narrower posterior end, and so have right and left sides. Strange to say, however, the mouth is situated not in the 'head,' but behind the middle of the ventral surface of the body, and functions both for the intake of food and the exit of waste. The mouth, instead of opening into a sac-like enteron, leads into a long, protrusible pharynx and this, in turn, into an extremely branched intestine which extends throughout the body. Somewhat similarly extend the excretory system, the male and female reproductive systems, as well as the web-like nervous system; each and all embedded in a continuous spongy mass of tissue which is derived from a third primary germ layer, the mesoderm. Thus the organ systems do not actually lie in a definite body cavity. Since nearly every organ system extends throughout the body, no circulatory system is required, and apparently oxygen sufficient for the animal's need can diffuse through the tissues. (Figs. 156, 161.)

The genus *Planaria* is a member of the first class of the phylum, known as the TURBELLARIA, the other classes being the TREMATODA, or Flukes, and the CESTODA, or Tapeworms. Both of the latter have departed superficially somewhat widely in structure from the free-living Planarians and also have developed ex-

traordinarily complex life histories, involving alternation of generations, in becoming adapted to various parasitic modes of life. The study of Flukes and Tapeworms constitutes a major part of the science of PARASITOLOGY because they inhabit Man and beast

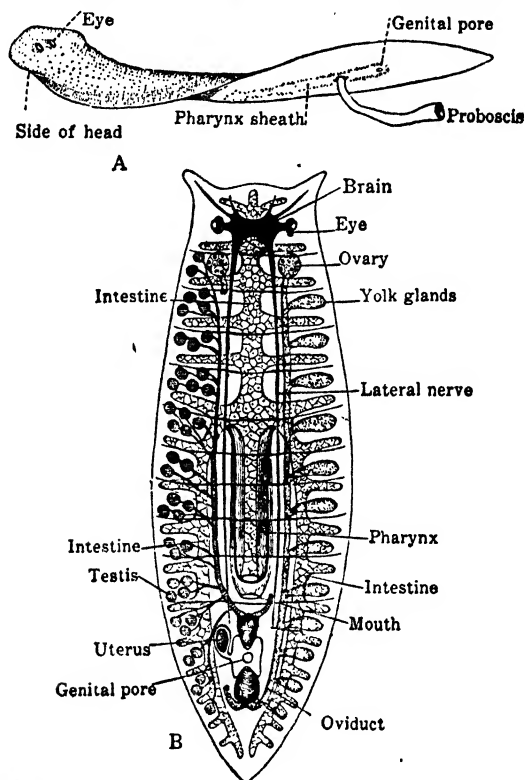

FIG. 43. — A, *Planaria polychora*, a fresh-water Flatworm; B, diagram of internal organs of a Flatworm. (From Hegner, after Shipley and MacBride, and von Graff.)

and produce various important diseases. Accordingly we can more advantageously consider their life histories later when discussing the relations of biology to human welfare. (Figs. 251-253.)

#### D. ROUNDWORMS

If either number of species or number of individuals were the sole criterion of a phylum's importance, unquestionably the lowly NEMATHELMINTHES, or Roundworms, would rank high in the

Animal Kingdom. They live literally everywhere from hot springs to Arctic ice, from desert sand to bottom mud of lakes and seas, from the roots of plants to the blood of Man. A thimbleful of soil may contain hundreds, even thousands, of Roundworms. Estimates indicate that there are upward of twenty thousand species parasitic on Vertebrates alone, and twice as many more if all the other parasitic and free-living species were catalogued.

The Roundworms are slender, cylindrical worms as is indicated by other common names, such as Threadworms and Hairworms. Their body plan shows, in general, considerable advance over that of the Flatworms, because the simple intestine has two openings to the exterior, mouth and anus; the nervous system consists of a nerve ring about the pharynx from which arise large nerves, extending the length of the body; the excretory system is well

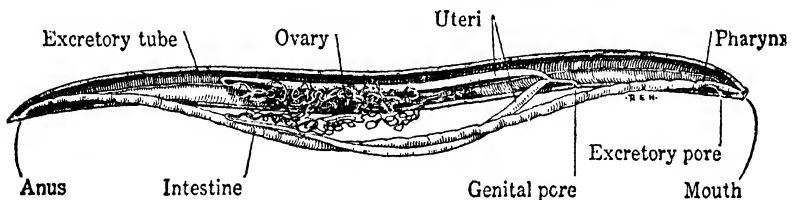

FIG. 44. — Roundworm, *Ascaris lumbricoides*: diagram of dissection from right side.

developed; and the male and female reproductive systems are usually in separate individuals. Furthermore the various organs lie in a spacious body cavity. However, there are no special circulatory or respiratory systems. (Fig. 44.)

Naturally the Roundworms that have been most studied are parasites of Man and domestic animals. The Guinea worm is sometimes several feet long, and spends its adult life just under the human skin and its youth in a Water-flea. The various species of *Ascaris* are relatively large intestinal worms, the females attaining a length of more than a foot and producing some fifteen thousand eggs a day. But two of the most dreaded parasites are the tiny *Trichinella*, the cause of the often fatal TRICHINOSIS contracted by eating infected pork, and *Necator*, notorious as the HOOKEWORM. All considered, the Roundworms are hardly second to the Flatworms from the standpoint of medical zoölogy and, like them, tax the ingenuity of biologists in ferreting out their complex reproductive processes and life histories that have been evolved

to insure entrance to the proper host. Before a parasite can enjoy Utopia, it must get there. (Figs. 44, 254, 255.)

### E. SEGMENTED WORMS

The Segmented Worms form a relatively straightforward phylum, the ANNELIDA, that carries us on apace in the development of the more complex animal body: conspicuously by definitely introducing the principle of SEGMENTATION. Well-known representatives of the chief groups are the marine Sandworms and Tubeworms, or POLYCHAETA; the Earthworms, or OLIGOCHAETA, of soils the world over; and the Leeches, or HIRUDINEA, such as the Medicinal Leech, so popular when blood-letting was in vogue. (Figs. 45, 60.)

The body of the Sandworm, *Nereis*, consists of a linear series of some fifty units, or SEGMENTS. Several of the anterior ones form the HEAD, with sense organs, notably rather complex EYES, mouth, and chitinous jaws; while most of the rest are provided with paddle-like, bristled PARAPODIA that act both as respiratory and swimming organs. The anus opens on the terminal segment.

The Earthworms show a simplification of the external structures present in Sandworms, because the head is far smaller and simpler and lacks specialized sense organs. Moreover the bristles (SETAE) are all that remain of the conspicuous locomotor organs of the Sandworm. The largely sedentary and nocturnal life of Earthworms renders highly specialized locomotor, respiratory, and sense organs unnecessary. But the internal organs of both follow the same general plan, and since we shall have occasion later to study those of the Earthworm somewhat in detail, it will suffice now merely to emphasize the essential progressive features. (Fig. 45.)

The principle of segmentation, as already mentioned, is probably the most significant advance made by the phylum. At all events, it is the plan of organization exemplified by the most successful of the higher groups — the Arthropods and Vertebrates. Apparently the segment is an adaptable unit of organization that makes possible local specialization in higher forms, and so contributes in an important way to their response to various environmental changes. Furthermore, in Segmented Worms the coelom first attains high structural significance and affords ample space for the disposal of more elaborate organ systems. Thus we find a complete circula-

tory system of blood vessels that propels and distributes blood to all parts of the body: an efficient transport system for carrying absorbed food to every organ, waste products to the excretory organs, and carbon dioxide to, and oxygen from the respiratory surface. And when we add the advances in digestive, nervous, and excretory systems, the Segmented Worms approach more nearly the popular

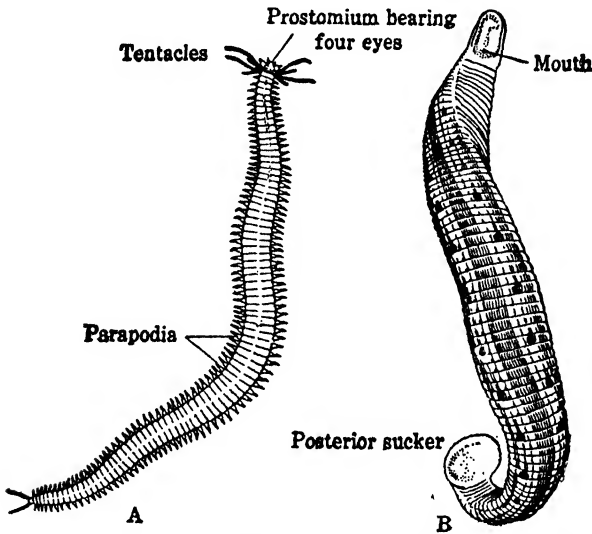

FIG. 45. — A, Sandworm, *Nereis virens*; B, Medicinal Leech, *Hirudo medicinalis*.

concept of an animal than the Invertebrates we have heretofore met.

And withal, in variety and numbers the phylum is second to few. Some idea of the importance of Earthworms may be gathered by Darwin's estimate that in many soils they annually bring to the surface some eighteen tons of earth per acre. Not unimportant transformations of the surface soil is thus effected: indeed Earthworms, unseen and unheard, perform a vitally important part in loosening and aërating — in plowing — the soil.

#### F. ROTIFERS, BRYOZOANS, AND BRACHIOPODS

At this point in our survey of the Invertebrates it is opportune to take merely a passing glance at several aberrant groups whose position in the series is decidedly uncertain, and which contribute little of theoretical or practical importance.

The ROTIFERA, or Wheel-animalcules (TROCHELMINTHES), constitute an immense group of tiny animals commonly found in fresh and salt water, in association with the Protozoa. Microscopic though they are, they possess a highly complex series of internal organs, in spite of which they can withstand slow drying in mud. In this condition Rotifers may be blown about until they happen again upon moisture, whereupon they gradually 'swell up' and assume active life and reproduction.

The BRYOZOA are frequently referred to as Moss-animals because most of them are mat-like fixed colonies growing on submerged objects in sea or pond. A superficial examination of the common fresh-water *Plumatella*, for example, might suggest that it is a Hydroid, but closer scrutiny reveals a very different structural plan, including complex internal organs. In addition to reproducing sexually and by typical budding, *Plumatella* develops peculiar internal buds, or STATOBLASTS, enclosed within a chitinous shell. In the event that the pond dries up or the colony is frozen, the resistant statoblasts survive to start a new colony upon the return of favorable conditions.

The BRACHIOPODA, or Lamp-shells, at first glance look like Clams, and so bear no obvious resemblance to the colonial Bryozoa. However, Brachiopods are actually related to the Bryozoa, as is evidenced by their internal structure which approaches rather closely to that of *Plumatella*. Brachiopods constitute one of the older marine groups, their shells constituting conspicuous and characteristic fossils in the more ancient rock strata. Those living to-day are merely little-changed survivors of a successful group of yesterday — perhaps nearly a billion years ago in the early Paleozoic seas. Indeed, the genus *Lingula* has persisted without change, to be well dubbed the "senior genus of the world of animal life." (See: Appendix I.)

#### G. ECHINODERMS

Everyone who has spent a summer at the seashore is certainly familiar with the Starfish and Sea Urchin, common examples of the marine phylum of spiny-skinned animals, the ECHINODERMATA. All members of the group have radially symmetrical bodies — a condition we have not seen since we left the Coelenterata. However, the symmetry indicates no direct relationship with the Coelenterates, because during early embryonic life an Echinoderm



is actually bilaterally symmetrical and the radial form is only secondarily assumed — it masks the basic structure. Indeed “Nature’s pentagonal experiment” has produced a series of bizarre forms that have been successful from early geologic time to the present, though they bear little resemblance to other animals. Witness the structure of a common Starfish. (Fig. 46.)

The body of the Starfish consists of a CENTRAL DISK from which radiate five ARMS. It is protected by calcareous plates embedded in the tissue, and by short, blunt spines. About the latter are tiny pincers, or PEDICELLARIAE, that keep the surface free from debris

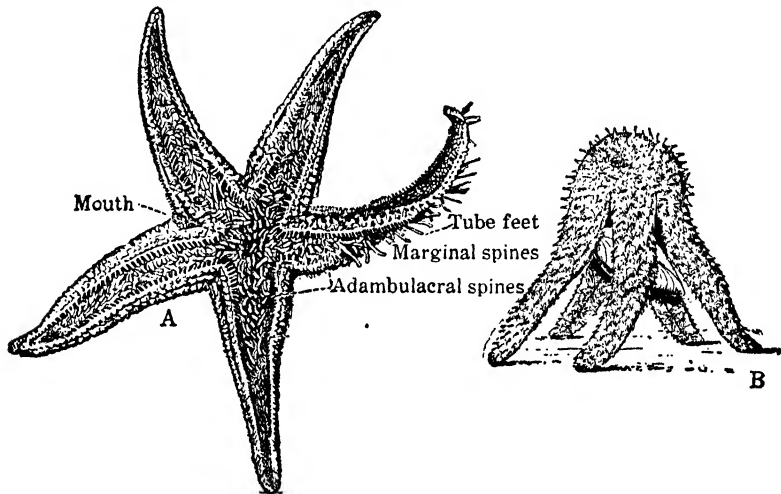

FIG. 46. — Starfish, *Asterias*. A, oral view; B, devouring a Clam.  
(From Cambridge Natural History.)

and protect the delicate, protruding DERMAL BRANCHIAE. The mouth is situated in the disk on the surface that is ventral as the animal crawls along, and the anus on the opposite surface. Near the anus is a small, porous plate, the MADREPORITE, that admits water to a system of tubes, or WATER-VASCULAR SYSTEM, that terminates along the AMBULACRAL GROOVE on the ventral surface in myriads of TUBE FEET: the unique hydraulic locomotor and food capturing organs.

The mouth opens into a large stomach that leads into the PYLORIC SAC from which large, glandular PYLORIC CAECA extend into each arm. Above the stomach is a small rectum that passes to the aboral surface, but waste materials are ejected through the mouth.

The nervous system is essentially a nerve ring encircling the mouth, with a branch extending into each arm, but there is no central, dominating nerve mass that is comparable to a brain, and only

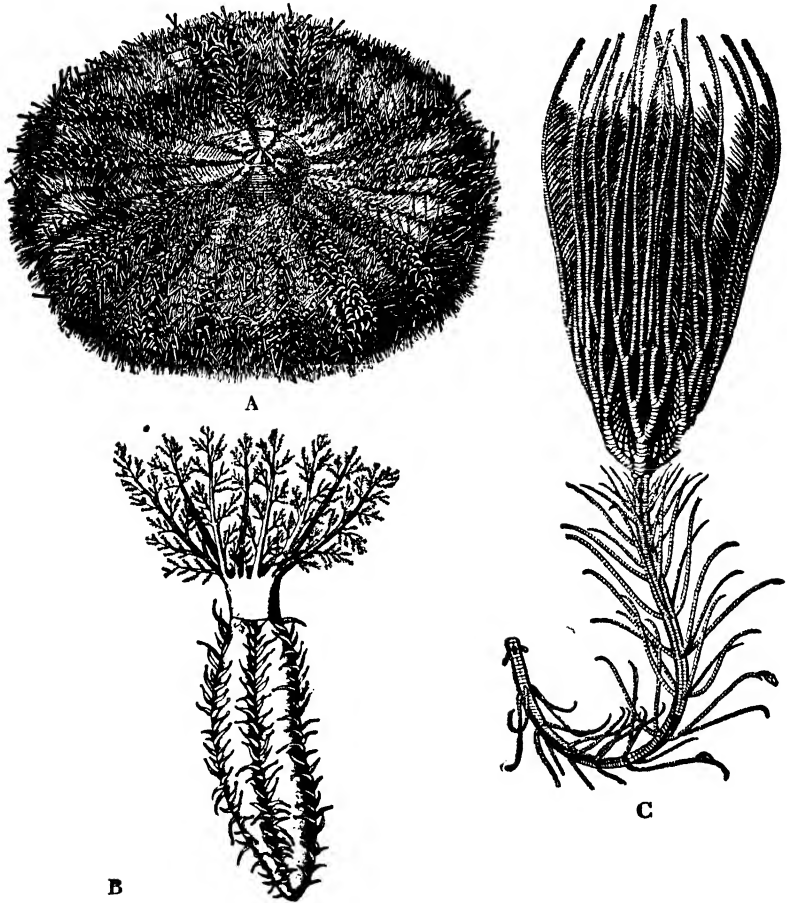

FIG. 47. — A, Sea Urchin, *Asthenosoma*, oral view; B, Sea Cucumber, *Cucumaria*; C, Sea Lily, *Metacrinus*. (From Thomson, Ludvig, and Carpenter.)

the simplest sense organs, the tube feet acting largely in the latter capacity. The functions of a circulatory and respiratory system are carried on by the coelomic fluid — mostly sea-water in which amoeboid cells float — that fills the large body cavity, or coelom, circulates through the dermal branchiae, and bathes all the organs, including the male or female reproductive organs.

The Starfish is a member of the first class, the ASTEROIDEA, of the phylum, and serves to give some idea of the fundamental anatomical plan of the several other classes. True, members of most of the other classes bear little obvious resemblance to the Starfish. Most similar are the Brittle Stars (class OPHIUROIDEA) with flattened central disk and long, slender, and sometimes branched arms that are fragile and readily discarded when injured. But the Sea Urchins and Sand Dollars (class ECHINOIDEA) are without arms; the more or less spherical body being enclosed within a hard shell composed of a multitude of closely fitting plates and covered with a forest of spines. Then the Sea Cucumbers (class HOLOTHUROIDEA) are essentially elongated, flexible, muscular sacs with contractile tentacles, representing modified tube feet, about the mouth. They seem to be little inconvenienced if they eject most of their internal organs, because a period of rest suffices for their regeneration. And finally, the Sea Lilies (class CRINOIDEA), apparently the antithesis of the Sea Cucumbers, are temporarily or permanently attached, usually by a jointed stalk from which extend their much-branched arms in plume-like fashion, and so some are called Feather Stars. (Fig. 47.)

Still, with all this diversified array of Echinoderms, it is, we repeat, true that all are basically similar in structure and development — they have almost surely been derived in a round-about way from a primitive worm-like ancestor.

## H. MOLLUSCS

The great phylum MOLLUSCA, which includes not only such well-known edible 'shell-fish' as the Clams, Oysters, Scallops, and Snails, but also the Cuttle-fish, Devil-fish, Nautili, etc., presents a considerable departure in bodily plan from that exhibited by the Segmented Worms, and constitutes another large and remarkable branch of the Invertebrate 'tree.' However, from certain structural features exhibited by the lowest class, the AMPHINEURA represented by Chiton, and particularly the developmental stages of various Molluscs, it appears clear that, like the Echinoderms, they have arisen from a worm-like ancestral type which, instead of adopting segmentation, became otherwise specialized to form a unique and highly successful group. (Fig. 48.)

The most characteristic structures of Molluscs are the external skeleton, or SHELL; a fleshy muscular organ, the FOOT, typically

for locomotion; and a MANTLE CAVITY between the main body and an enclosing envelope, the MANTLE. Among the five classes of Molluscs only three are of sufficient general interest to command our attention here: the Gastropoda, Pelecypoda, and Cephalopoda.

**GASTROPODA.** One usually thinks of Molluscs as sea-dwelling animals but among the some sixteen thousand species of Snails, Slugs, and other similar Gastropods, more than one-third are terrestrial. Everyone is familiar with the spirally-coiled Snail's shell into which the animal can completely retire when disturbed, but many close relatives, such as the Limpets, have shells that are merely simple flattened cones, while most of the Slugs have no shell at all. The shell when present is secreted chiefly by the in-

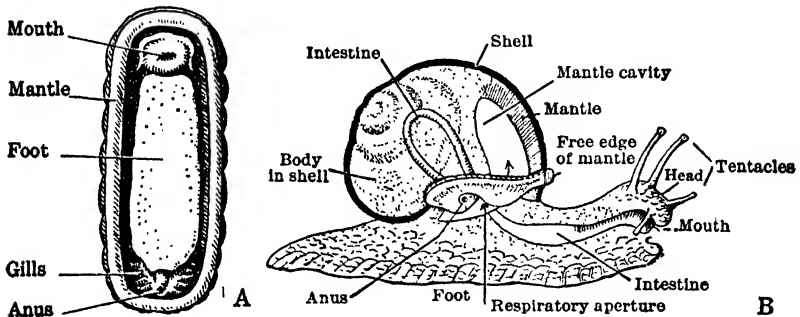

FIG. 48. — A, Chiton, ventral view; B, Snail, diagrammatic side view.

conspicuous mantle. The common Snails and Slugs glide along on a path of slime by muscular contractions of the foot which forms the entire ventral part of the body, but some of the marine species actively swim by means of delicate, undulating expansions of the foot.

The Snails and their allies have a well-developed head with tentacles and eyes, and a mouth, supplied with a unique rasping tongue-like organ, the RADULA, that leads into a complicated digestive tract. Add to the digestive organs the complex blood vascular system, excretory system, nervous system, and reproductive system, and it becomes evident that even the lowly Garden Slug belies its soft slimy body. (Fig. 48.)

**PELECYPODA.** However, the Mollusca is a phylum of surprises, for the Pelecypoda is a class of headless animals that for the most part have taken to a sedentary life within a shell composed of two VALVES hinged together: they are Bivalves. The adult Oysters are permanently attached and therefore footless; the Clams are

sluggish, sand-burrowing creatures; the Shipworms riddle wharves with their tunnels, while the Scallops swim about by rapidly opening and clapping together the valves of the shell. (Fig. 49.)

The most distinctive feature of the Bivalves, aside from the shell, is their peculiar method of securing food from a current of water that is kept in motion by the activity of cilia on the GILLS, mantle surface, and about the mouth. In brief, water laden with oxygen and microscopic animals and plants is drawn through an opening, the INHALENT SIPHON, into the mantle cavity where the

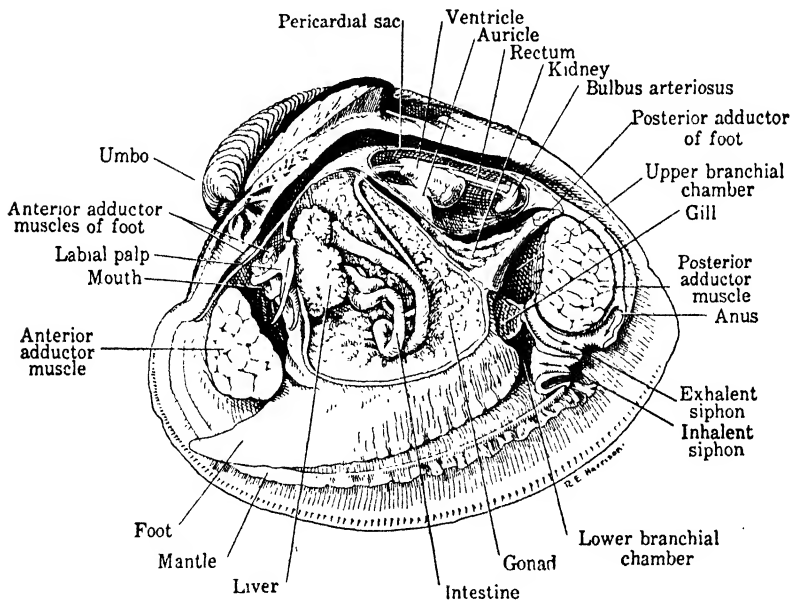

FIG. 49. — Hard-shell Clam, or Quahaug, *Venus mercenaria*. Dissection showing structures visible when left valve, mantle, and gills are removed.

sieve-like gills are suspended. Passing through the gills the food is picked out and carried by ciliary action to the mouth, while at the same time the blood in the gills is aerated. From here the water current passes on out by the EXHALENT SIPHON, carrying with it various waste products.

The reproductive process varies considerably in different Bivalves. Oysters spawn in the spring, liberating the sperm and eggs, and the zygotes develop into microscopic free-swimming larvæ. Within a week these sink to the bottom and become at-

tached to whatever object they happen to touch and, if fortunate, gradually develop into adult Oysters. Fortunate, because it is estimated that a larva has less than one chance in a million of surviving to attain maturity and the qualities that appeal to the human palate. But one female may contain nearly half a billion eggs.

The eggs of the Fresh-water Clams, or Mussels, are fertilized by sperm entering the mantle cavity with the food current, and the larvae develop in the gills which act as temporary brood-

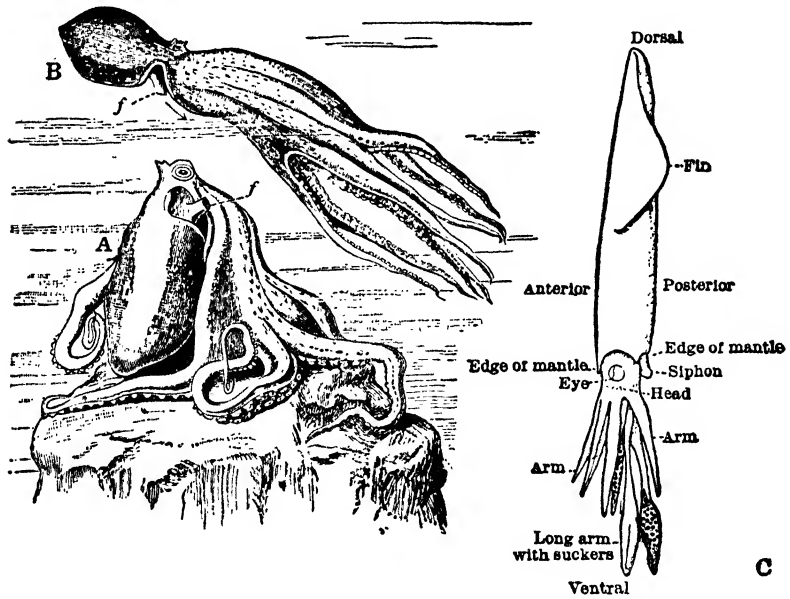

FIG. 50. — A, B, Octopus, at rest and in motion. f, siphon. C, Squid, side view. (From Hegner, after Merculiano and Williams.)

pouches. Eventually as tiny clams, known as GLOCHIDIA, they escape, settle on the bottom of the pond or river, and die unless a Fish rubs against them. In this event each glochidium becomes attached to the fish and as a parasite obtains free food and transportation for several weeks until it has developed sufficiently to shift for itself.

The economic importance of the Bivalves hardly need be mentioned. Oyster-farms in America alone produce an annual crop valued at many millions of dollars. Fresh-water Mussels are the basis of the pearl button industry of the Mississippi Valley. And,

finally, pearls produced by the irritated mantle tissue of several species of Bivalves are perhaps the most highly prized and priced jewels.

**CEPHALOPODA.** The Squids, Cuttle-fish, Devil-fish, and their close allies present in many ways a marked contrast with the rest of the Molluscs, being relatively active, aggressive animals that have in most cases practically discarded the shell and developed a highly specialized 'head' apparently by combining head and foot — hence the class name Cephalopoda. (Fig. 50.)

The head, surrounded by arms, or tentacles, is provided not only with parrot-like beak and rasping tongue, but also with a rather large brain, and efficient eyes that superficially are very like those of Fishes. As a matter of fact some of the Cephalopods are in many respects more capable than some of the lower Vertebrates. They apparently exhaust the possibilities of the Molluscan body plan both in complexity and in size. Indeed, the Giant Squid is the largest Invertebrate, for when measured to the tip of the extended arms it exceeds in length any living Vertebrate except the largest Whales.

## I. ARTHROPODS

From our detour through the unsegmented Molluscan phylum, we now turn to the more orthodox — because dominant — phylum of segmented Invertebrates with jointed appendages, the **ARTHROPODA**. The most important classes of the Arthropoda are the Crustacea, Myriapoda, Insecta, and Arachnoidea: the first chiefly aquatic and breathing by means of **GILLS**, and the rest typically terrestrial with **TRACHEAE** or equivalent air-breathing organs. (Fig. 116.)

**CRUSTACEA.** A varied multitude of marine and a relatively small number of fresh-water animals constitute the class Crustacea. Among its approximately twenty thousand species, probably the best known, because they are among the largest and some are edible, are the Lobsters, Crayfishes, and Crabs. The latter appear unique because the posterior part of the body (**ABDOMEN**) is permanently bent forward under the **CEPHALOTHORAX**. Then at the other extreme, as it were, are the little-known Woodlice, or Pill-bugs, that live in damp places, even in our gardens. All of these and their many close relatives form one of the two Crustacean subclasses, the **MALACOSTRACA**. The other great subclass, the **ENTOMOSTRACA**, includes even greater diversity of structure.

There are the Cirripedes, or Barnacles, that early in their youth settle down permanently to a sedentary existence, and thereby foul the hulls of ships and encrust driftwood and stones on the seashore. Then unrecognized by other than specialists are the many kinds of microscopic Crustaceans, such as *Daphnia*, *Cyclops*, and their allies. These so-called Water-fleas vie in numbers with the Protozoa and microscopic plants in the vastness of open seas as well as in many lakes. Thus they form a crucial part of the food of larger animals, including Fishes, and so indirectly of Man. (Figs. 51, 62-64.)

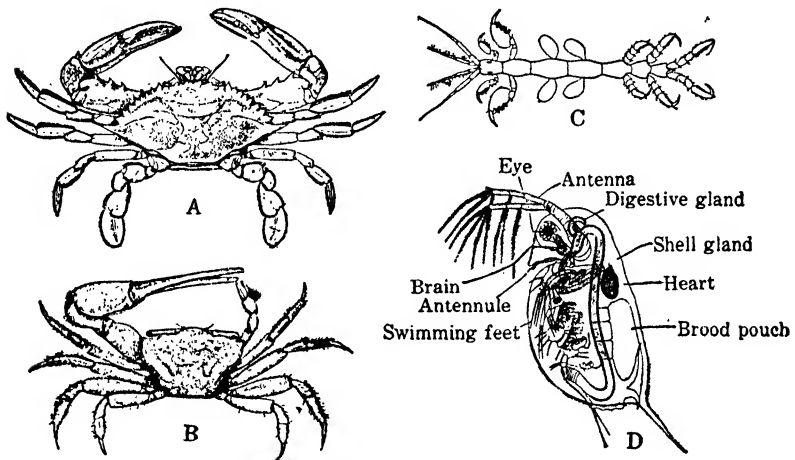

FIG. 51. — Crustaceans. A, Edible Blue Crab, *Callinectes*; B, Fiddler Crab, *Gelasimus*; C, Caprella; D, *Daphnia*, a Water-flea. (From Paulmier and Claus.)

**MYRIAPODA.** Passing to the Myriapoda we reach the terrestrial Arthropods with long serpentine bodies, such as the more or less flattened Centipedes and the rounded Millipedes, the latter with the body segments united in pairs, so that there seem to be four legs on each segment. But, as their names indicate, legs are plentiful, in some Millipedes reaching well on toward two hundred. Centipedes are carnivorous forms with poisonous jaws but Millipedes are destructive vegetarians. (Fig. 52.)

**INSECTA.** Everyone knows various members of the Insecta, familiarly represented by that most domestic of animals, the House Fly, but probably few realize that the species of Insects outnumber all the other species of the Animal Kingdom. (Figs. 53, 258.)



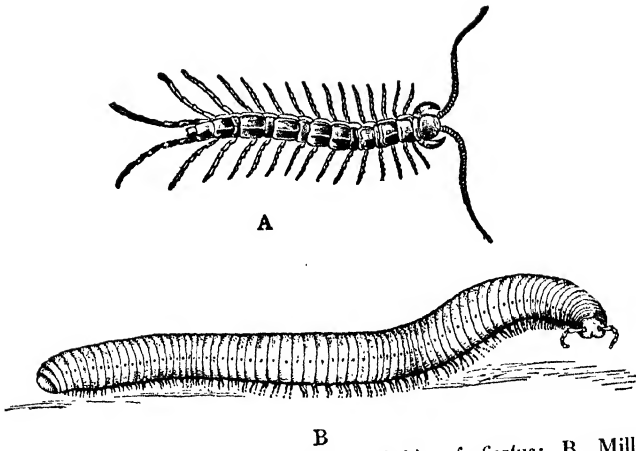

FIG. 52. — Myriapods. A, Centipede, *Lithobius forficatus*; B, Millipede *Julus*. (Modified, after Koch.)

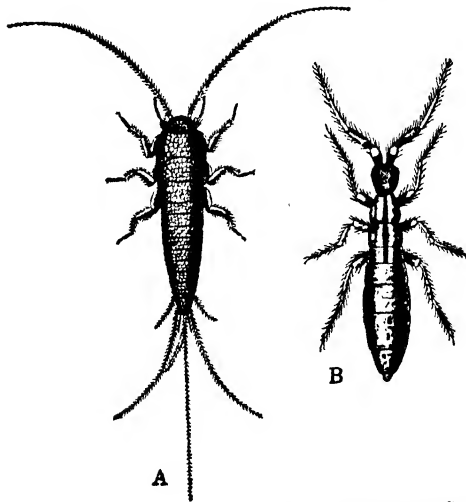

FIG. 53. — Primitive Insects. A, Silver-fish, *Lepisma*; B, Springtail, *Podura*. (From Parker and Haswell.)

A typical Insect is characterized by a body divided into three major parts: head, thorax, and abdomen. The head bears a pair of compound eyes, usually one to three simple eyes (OCELLI), a pair of 'feelers' (ANTENNAE), and the mouth parts: the LABRUM, MANDIBLES, MAXILLAE, and LABIUM. (Figs. 54, 116, 215.)

The thorax is composed of three segments, each of which typically bears a pair of legs. The legs of Insects in most cases perform many functions in addition to locomotion: they are really a set of tools. Witness the legs of the Honey Bee. Usually two of the three thoracic segments each bear a pair of wings, but the House Fly, of course, has but one pair and the Flea none at all, though the Fly's 'balancers' are remnants of its missing pair. The wings of Insects are entirely dissimilar in origin and structure from the legs and therefore bear no relation to the paired append-

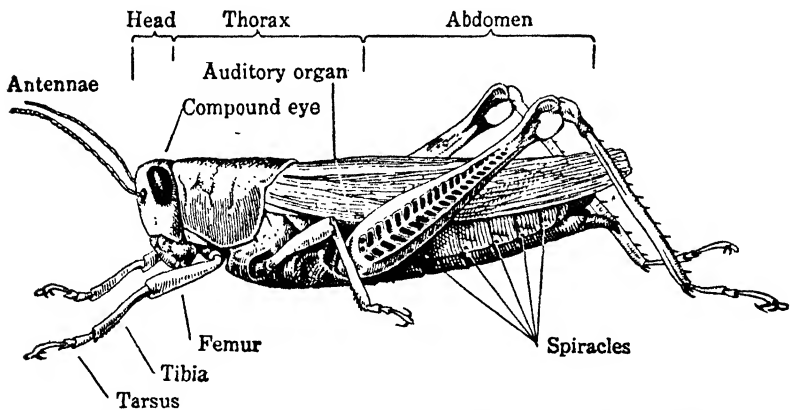

FIG. 54A. — Grasshopper, or Locust, *Melanoplus differentialis*.

ages of other Arthropods. They are new structures that confer upon them the honor of being the only Invertebrates to conquer the air. Indeed, their adaptive radiation to all sorts of habitats and modes of life exhibits a versatility that somewhat parallels that of the highest Vertebrates, the Mammals. (Figs. 53, 208, 257, 258, 261.)

And moreover, certain Insects excel all the rest of the whole living world, except Man, in the remarkable development of communal organization. This involves specialization of individuals for definite contributions to the economy of the social unit, such as the Ant nest or the Bee hive. (Figs. 214–219, 222.)

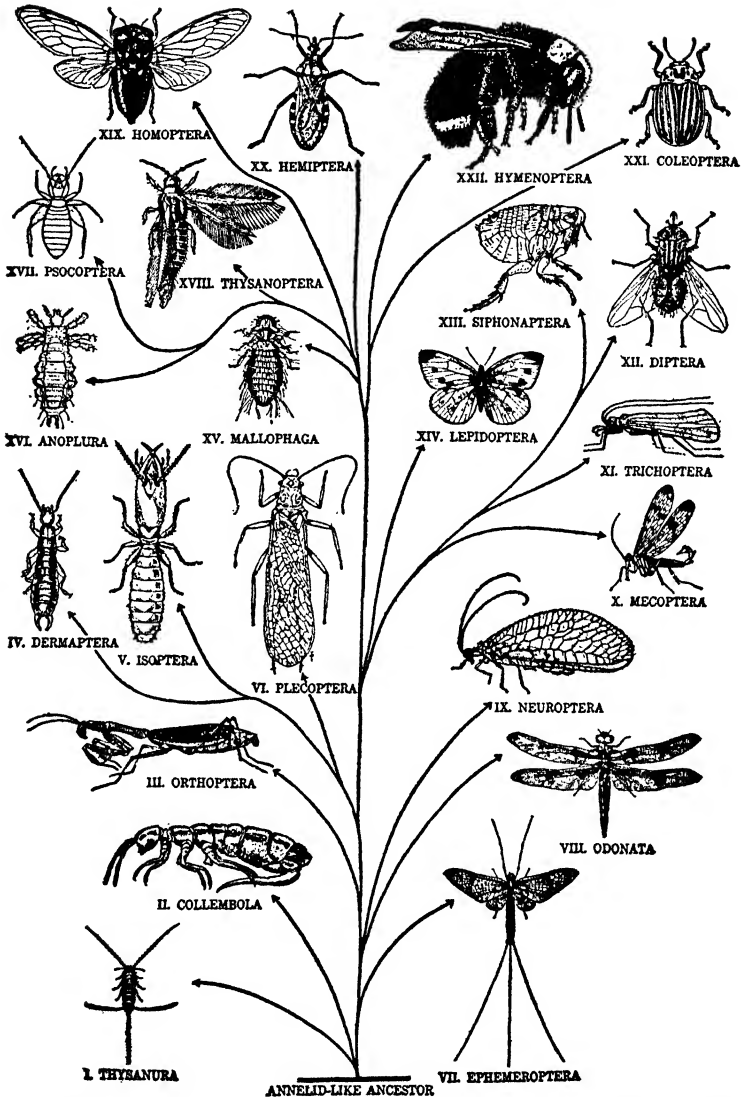

FIG. 54B. — General relationships of the chief orders of the class INSECTA. I, Silver-fish; II, Springtail; III, Praying mantis; IV, Earwig; V, Termite; VI, Stonefly; VII, Mayfly; VIII, Dragonfly; IX, Lacewing fly; X, Scorpion fly; XI, Caddice-fly; XII, Stable fly; XIII, Flea; XIV, Butterfly; XV, Bird louse; XVI, Cootie; XVII, Book louse; XVIII, Thrips; XIX, Cicada; XX, Triatoma kissing bug; XXI, Potato beetle; XXII, Bumble bee. In general, the classification is based on the presence or absence of wings, the structure of the mouth parts, and the character of the life history. See page 478. (From Hegner.)

**ARACHNOIDEA.** We conclude the Arthropod phylum with the class Arachnoidea: the Spiders, Ticks, Mites, Scorpions, and their close relatives. These are frequently confused with Insects, but the more common forms, such as the Spiders and Ticks, are readily distinguished by the possession of eight legs. (Fig. 55.)

Spiders are carnivorous animals that capture their prey by elaborately constructed webs, or by stalking and pouncing upon it. Some Spiders are poisonous and their reputation has served to malign many harmless relatives. But the Scorpions are in general

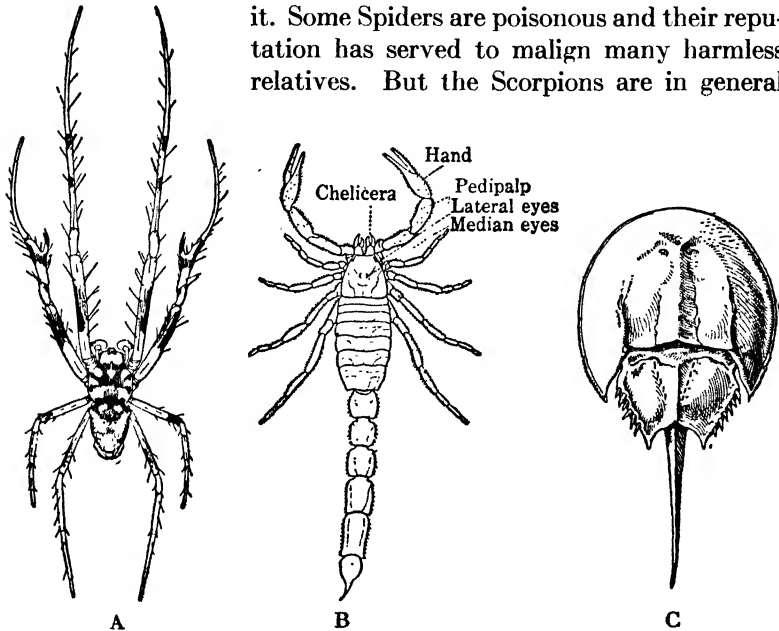

FIG. 55. — A, Spider, *Epeira verrucosa* (from Emerton); B, Scorpion, *Buthus occitanus* (from Krapelin); C, King-crab, *Limulus polyphemus*.

poisonous, and the Mites and Ticks are injurious to Man in many ways. Some bite and others burrow into our bodies and those of our domestic animals; the common Rabbit frequently harbors several thousand Ticks. Even our garden crops and forests suffer. Unfortunately certain species infect their hosts with various Bacteria and Protozoa and so produces serious diseases. But there are many harmless forms, represented by the well-known red Harvest Mites.

And then appended to the Arachnoidea is the peculiar marine King-crab, or *Limulus*, that is of considerable theoretical interest to students of evolution. (Fig. 55, C.)

This welter of Arthropod forms, as already suggested, is built on the plan of a chain of segments; two or more of the anterior segments constituting the head, with the mouth, and the posterior one containing the anus. In the simplest Arthropods there is relatively little differentiation between either the segments or the characteristic pair of jointed appendages that each bears; but proceeding to more complex forms, one finds a progressive union and specialization of segments in certain regions of the body and a shifting and transformation of their appendages and internal organs for one function or another. Indeed it would seem that all the possible changes are rung on the pervading segmental chain: a fact to be illustrated later when we study the Crayfish. (Figs. 62, 63.)

Another conspicuous feature of the phylum is the presence of a hard, unyielding external armor, or EXOSKELETON, with flexible joints moved by attached muscles. This skeleton hampers the increase in size of the inhabitant, so periodically it is shed — the animal MOULTS. Seizing the opportunity, so to speak, the animal rapidly increases in size at the expense of material stored for this purpose, and also secretes a new skeleton. Of course, a 'soft-shelled' Crab is one which has recently moulted and has been taken at a disadvantage before the newly secreted skeleton has had time to harden.

The life history of many of the Arthropods is so surprisingly complex, involving such radical form changes, that it is termed a METAMORPHOSIS. Thus the embryo of certain Crustacea may be hatched as an unsegmented larva, then after moulting assume a segmented larval form, and so on until the adult state is attained. In other Crustacea one or more of these stages may be briefly summarized, as it were, in the egg before hatching. Finally, animals like the Crayfish hatch with essentially the adult form. And this series of metamorphic stages in the development of the higher Crustacea is of considerable theoretical interest, because they are very similar to the larval or adult forms of certain other Crustacea that are regarded as more primitive in organization. Thus it would seem that individual development in the higher Crustacea briefly and very broadly and incompletely summarizes — RECAPITULATES — the ancestral, or evolutionary, history of the race.

However, metamorphosis is called to our attention more promi-

nently in the Insects. It is common knowledge that caterpillars are the larval, worm-like feeding forms of Butterflies and Moths. The winged adult condition is attained by a final moult that takes place while the larva is in a 'resting' condition, the PUPA, made necessary by the radical structural changes which are involved. Perhaps it is not such common knowledge that even Locusts, or Grasshoppers, undergo metamorphosis, because no one moult results in such marked changes. The young Locust is similar in form to the adult, but after each moult it is larger than before, and finally is a fully winged adult. Such a transformation not involving a pupal stage is frequently referred to as incomplete metamorphosis. (Figs. 257-260.)

So we conclude for the present our necessarily limited view of the Arthropods, but as we proceed with our study we shall frequently have occasion to discuss special representatives. Judged by the stupendous number of species and individuals, or by variety

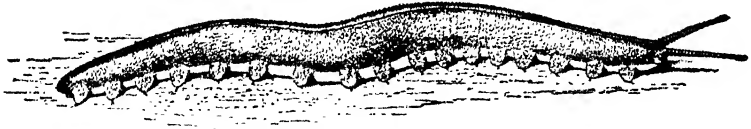

FIG. 56. — *Peripatus*, *Peripatus capensis*. An interesting Arthropod that seems to link the Arthropods with the Segmented Worms. (From Sedgwick.)

of form, or by sheer success in competition with both lower and higher animals in air, water, and on the ground, they are "Nature's most successful Invertebrate experiment." The segmental plan begun in a small way in some of the lower worms, is definitely established in the Segmented Worms, and is made the most of in the Arthropods. (Fig. 56.)

However, Arthropods are hampered by inherent structural limitations. The hard, dead, external skeleton imparts certain mechanical restrictions on size and freedom of action that are removed in Vertebrates by an internal living skeleton. And small size precludes a constant body temperature greater than the surroundings, so they cannot achieve the constancy of living possible to the warm-blooded Birds and Mammals. Nevertheless it has been suggested as not beyond the range of possibility that Insects may yet dominate the Earth!

## CHAPTER VIII

### THE INVERTEBRATE BODY

Nature is so varied in her manifestations that many must unite their knowledge and efforts in order to comprehend her. — *Laplace*.

FROM our survey of the Invertebrates it is obvious that the highly complicated and varied organization of animals renders it impossible to present a concise and adequate plan of a typical animal body. It is therefore necessary in the present work to select one group of animals as the basis of study and then to compare with this, in so far as comparisons are possible without confusion, a few of the most significant morphological and physiological variations presented by other groups. We naturally select the group of Vertebrates for chief consideration not only because its relative homogeneity renders it the most available, but because it includes Man. However, even before we focus attention on the Vertebrates, it is necessary to bring into clear relief certain structural principles that we have seen exhibited among the Invertebrates — selecting as types the Hydra, Earthworm, and Crayfish — in order to afford a background for the consideration of Vertebrate structure and function.

#### A. HYDRA

In discussing the development of animals, it was pointed out that the dividing egg typically forms first a blastula which, in turn, becomes transformed into the gastrula stage. The gastrula is essentially a sac composed of two layers of cells: an outer, or ectoderm, and an inner, or endoderm, layer. Although no adult animals retain this simple gastrula form, those composing the group known as the Coelenterates are to all intents and purposes permanent gastrulae since their bodies are built on the plan of a two-layered sac. This is well exhibited in Hydra, the almost microscopic, fresh-water polyp which is commonly found attached to submerged vegetation or stones in brooks and ponds. (Fig. 31.)

The body of Hydra somewhat resembles a long narrow sac, the base constituting the foot, and the opening at the opposite end

forming the mouth. Surrounding the mouth is a circle of outpocketings of the body wall, termed tentacles. The main axis of the body extends from foot to mouth, and every plane passing through this axis divides the body into symmetrical halves. In other words, the parts of the body are symmetrically disposed about, or radiate from the main axis, and so *Hydra* affords an example of **RADIAL SYMMETRY**. (Figs. 38, 57, 155.)

The body wall of *Hydra* is composed of two distinct cell layers, ectoderm and endoderm, separated by a thin non-cellular support-

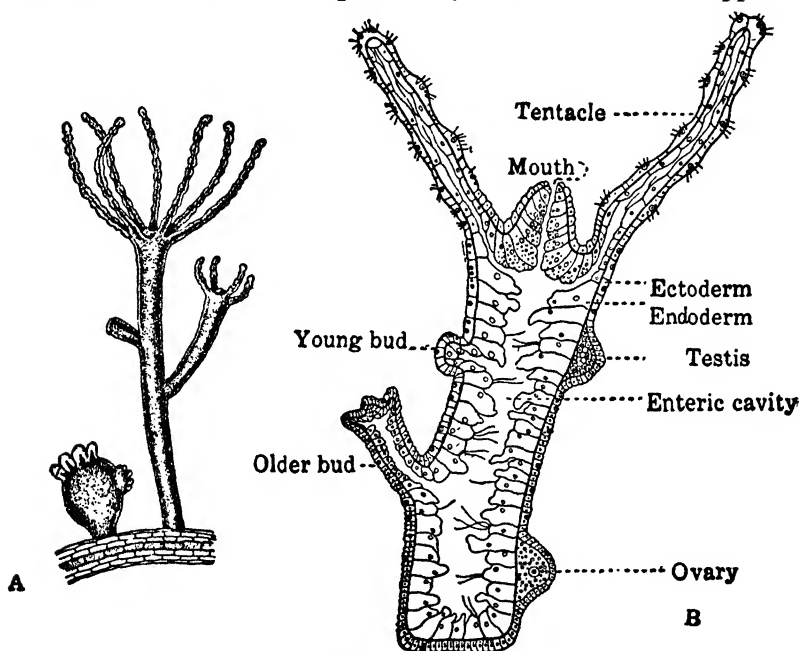

FIG. 57. — *Hydra*. A, two specimens with buds, one contracted; B, diagrammatic longitudinal section. (From Newman, after Pfuertscheller, and Parker.)

ing layer of jelly-like material (**MESOGLOEA**) secreted by the cells of both ectoderm and endoderm. *Hydra* thus illustrates a simple type of Metazoan structure in which but two primary tissues exist; such specializations as are necessary for the performance of the essential life functions being confined to the various cells that compose these layers. The majority of the cells of the endoderm which line the **ENTERON**, enclosing the **ENTERIC CAVITY**, are concerned with the digestion of solid food taken in through the mouth,



while those of the ectoderm are variously modified for protection, and the other relations of the individual to its surroundings, as well as for reproduction.

In short, in the organization of Hydra the *primary* tissues (ectoderm and endoderm) have not become differentiated into *secondary*

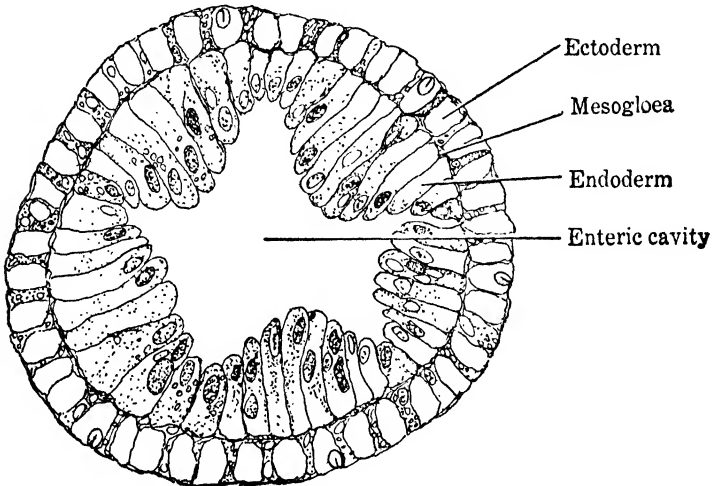

FIG. 58. — Hydra. Transverse section highly magnified.

specialized tissues (muscular tissue, nerve tissue, etc.) for one function or another — the simple life processes of the animal are adequately provided for by the specialization of isolated cells or small cell groups within ectoderm and endoderm. (Fig. 58.)

## B. EARTHWORM

The bodies of all animals above the Coelenterates are built of three primary layers, which, as development of the individual proceeds, give rise to the secondary tissues and thereby form a relatively complex body. This third primary layer (tissue), the **MESODERM**, typically is developed, as we have described earlier, from the endoderm and comes to occupy the position held by the mesogloea of Hydra; that is, between the ectoderm and the endoderm.

The development of the mesoderm is the key to the advance in body organization of higher animals, because it makes possible a radical change in plan that involves the establishment of a body

cavity, or COELOM, in which are disposed many of the chief organs. Accordingly the Coelenterates, with an enteron but no coelom, are referred to as ACOELOMATES, and the animals above the Coelenterates, since they possess the coelom, are known as the COELOMATES. The difference in structure can best be made clear by comparing the body plan of a higher Invertebrate, such as the common Earthworm, with that of Hydra. (Fig. 313.)

### 1. Body Plan

Whereas the Hydra body is essentially a sac composed of two layers of cells surrounding the enteric cavity, the body of the Earthworm is built on the plan of a tube within a tube — the

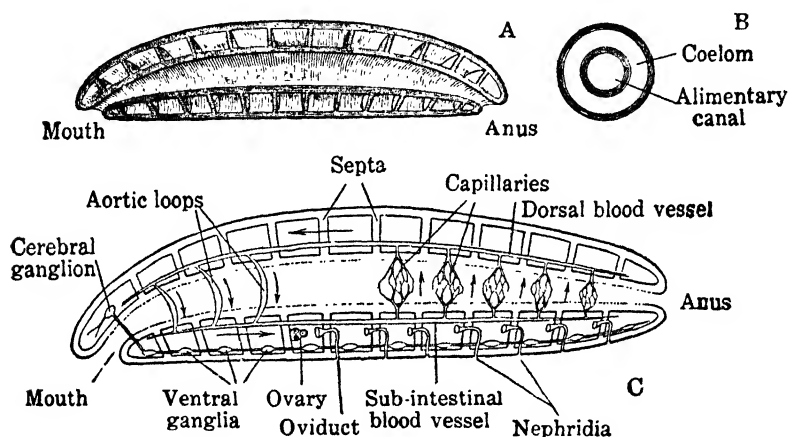

FIG. 59. — Diagrams of the body plan of the Earthworm. A and C, longitudinal sections; B, transverse section. (From Sedgwick and Wilson.)

outer tube forming the body wall, and the inner, the wall of the digestive tract, or alimentary canal. The walls of these tubes merge into each other at both ends, and thus together they enclose a space, the coelom. Or, to state it another way: the outer tube, or body wall, surrounds a space, the coelom, in which is suspended a second tube, the alimentary canal, which opens to the exterior at either end forming the mouth and anus. (Figs. 59, 60.)

The coelom of the Earthworm is divided by a large number of transverse partitions, called SEPTA, which extend from the inner surface of the body wall to the outer surface of the alimentary canal. The result is that the worm's body cavity is not a continuous

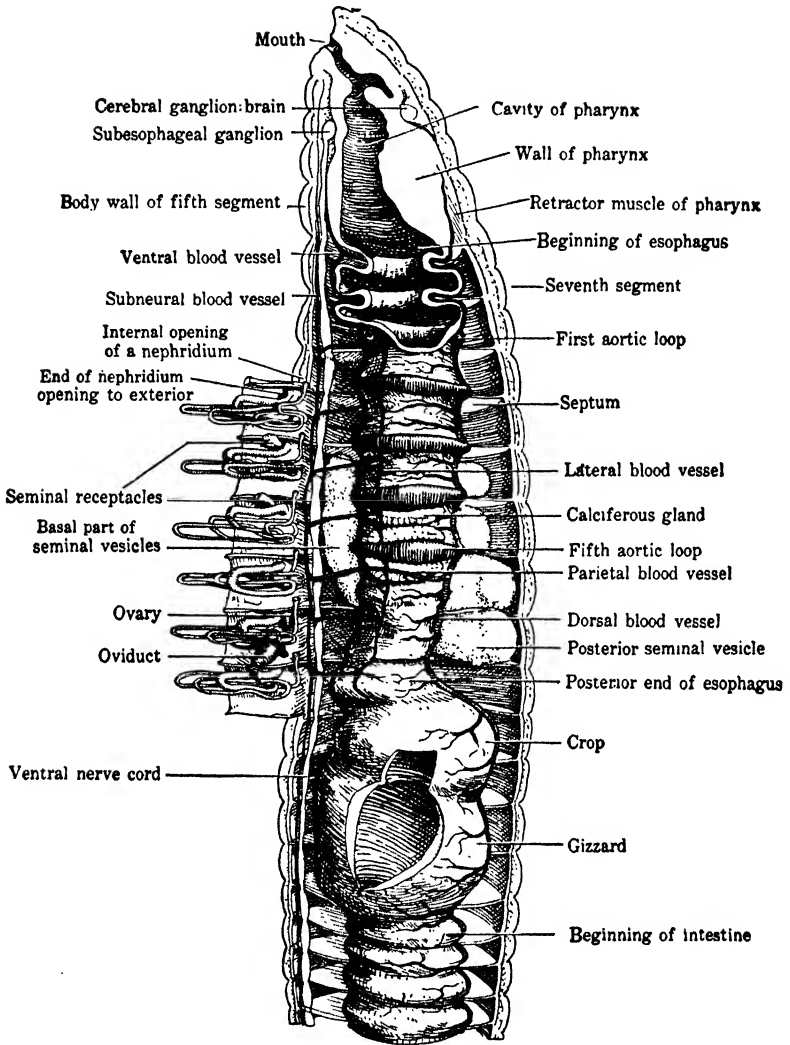

FIG. 60. — Earthworm. Diagram of a dissection, lateral view. (Modified, after Linville and Kelly.)

space running from one end of the animal to the other, but consists of a linear series of chambers through the center of which runs the alimentary canal. The limits of these chambers are indicated on the outside of the worm by a series of grooves which encircle the body wall. In short, the body is made up of a series of essentially similar units known as SEGMENTS, and thus affords a simple example of SEGMENTATION, which is a characteristic expressed in varying degrees in nearly all the higher animals.

Many of the chief organs of the Earthworm are developed as outgrowths from the walls enclosing the coelom, so that it is in

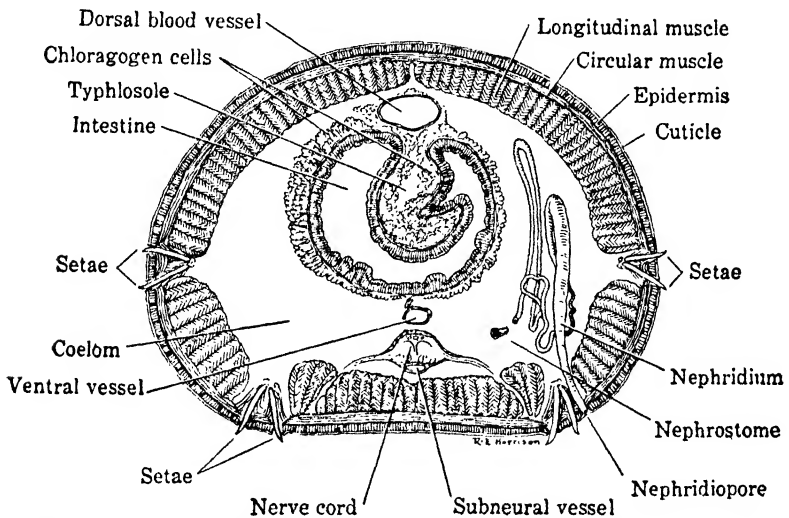

FIG. 61. — Transverse section through the middle region of the body of an Earthworm.

this cavity that we find, for example, the main organs devoted to circulation, excretion, coördination, and reproduction. Moreover, the organs are symmetrically arranged with respect to the long axis of the body which passes from mouth to anus. For instance, the chief blood vessels and the nerve cord lie in the long axis and extend from end to end, while the excretory and reproductive organs are disposed in pairs on either side of this axis. Thus there may be passed through the main axis a single plane which divides the body into symmetrical halves, each of which is a 'mirror image' of the other. The main axis, therefore, extends from the mouth (anterior end) to the anus (posterior end), and the plane

which divides the body into right and left sides passes through the upper (dorsal) and lower (ventral) side: the body exhibits **BILATERAL SYMMETRY** which is characteristic of higher animals. (Fig. 61.)

## 2. *Tissues and Organs*

Bilateral symmetry practically implies the existence of definitive parts of the body, or organs and organ systems, and these we find highly developed in the Earthworm. Again, the presence of organs demands a much greater differentiation of tissues than occurs in Hydra where local modifications of ectoderm and endoderm serve the purposes of its relatively simple organization. Accordingly in the Earthworm and in all higher forms the mesoderm is added to the two primary cell layers, and from these three there is developed a great variety of special tissues: epithelial, supporting, muscular, circulating, nervous, and germinal. Finally, the coöperation of tissues to form organs demands the further coöperation of organs to form organ systems, each of which plays its part in the economy of the whole organism. (Figs. 32, 34.)

Thus it is clear that the body plan of the Earthworm and all higher forms is radically different from that of Hydra, exhibiting as it does such essential new features as mesoderm, coelom, bilateral symmetry, segmentation, specialized tissues, definitive organs, and complex organ systems. The persistence and development of this basic plan from Earthworm to Man is interpreted by biologists as evidence of evolution.

## C. CRAYFISH

Bearing in mind the general plan of the body of the Earthworm, we must next consider briefly the main principle underlying the

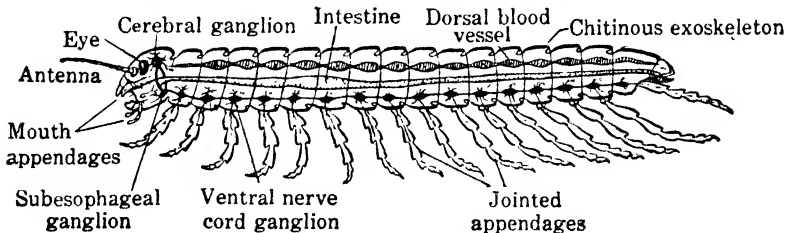

FIG. 62. — Diagrammatic representation of the structure of an ideal primitive Arthropod in which very little specialization of the segments has occurred. (From Schmeil.)

changes in this plan which give rise to many of the diverse forms among the higher animals.

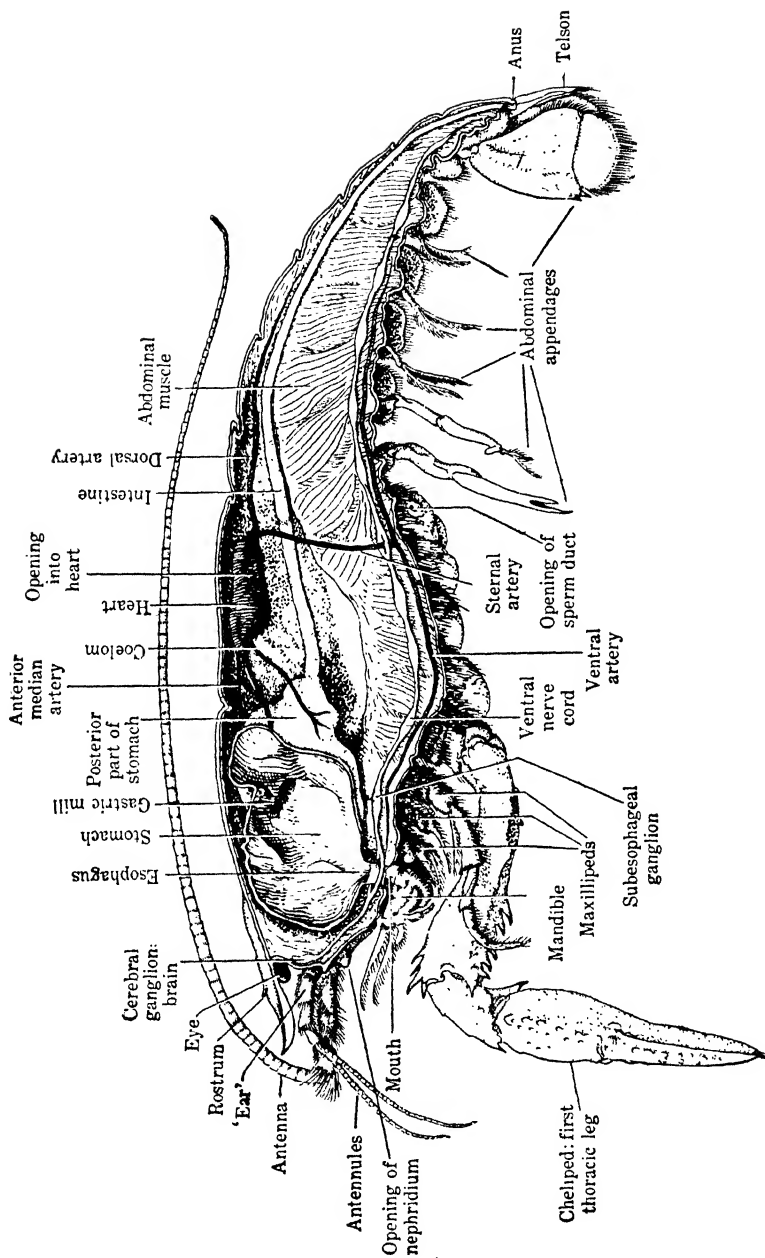
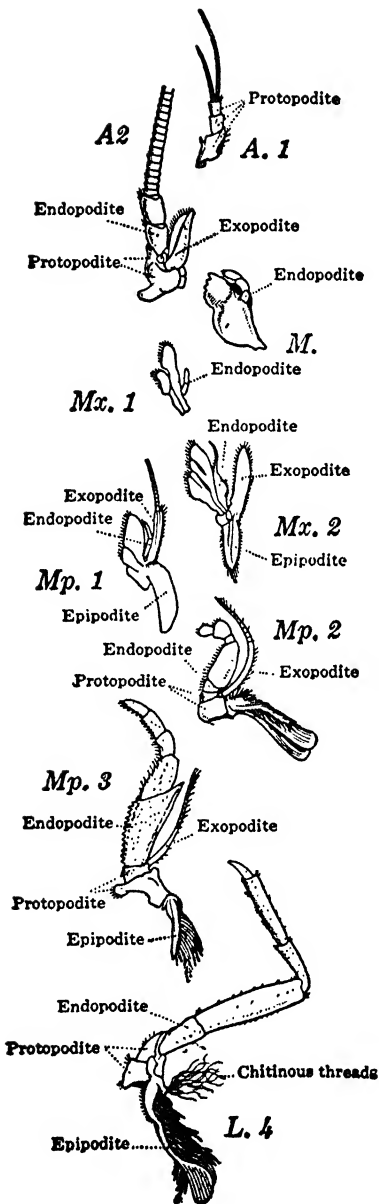

FIG. 63. — Crayfish, *Cambarus affinis*. Dissection, lateral view.



The body of a primitive Arthropod differs from that of the Earthworm chiefly in the reduction of the number of segments and the development of paired jointed appendages as outgrowths from the body in each segment. From such a primitive type all the multitude of diverse forms of Arthropod bodies can be derived. For instance, in the Crayfish, which is essentially a fresh-water Lobster, the body consists of twenty-one segments, of which segments 1 to 6 together form the HEAD; segments 7 to 14, the THORAX; and segments 15 to 21, the ABDOMEN. In other words, by the union or complete fusion of certain segments, the body has become divided into more or less distinct regions. (Figs. 62, 63.)

Furthermore, the primitive locomotor appendages of the respective segments have become modified into organs for widely different functions: those of the head, as sensory organs, jaws, etc.; those of the thorax, as organs for grasping, offense and defense, and walking; and those of the abdomen for swimming, etc. Thus change in structure has gone on

FIG. 64. — Typical appendages of a Crayfish. All have been derived from a simple biramous appendage. Protopodite, endopodite, and exopodite are homologous throughout the series. A. 1,

antennule; A. 2, antenna; L. 4, fourth walking leg; M., mandible; Mp. 1, first maxilliped; Mp. 2, second maxilliped; Mp. 3, third maxilliped; Mx. 1, first maxilla; Mx. 2, second maxilla. (From Hegner, after Kerr.)

hand in hand with change in function, so that although there is no obvious resemblance between the jaws of the Crayfish and the legs employed for swimming, nevertheless a study of their development shows beyond doubt that they owe their origin to modifications of one primary type. Accordingly the various appendages are said to be **HOMOLOGOUS**, signifying a fundamental similarity of structure based on descent from a common antecedent form. (Figs. 64, 65.)

On the other hand, organs of fundamentally dissimilar structure, which nevertheless perform the same function, are called **ANALO-**

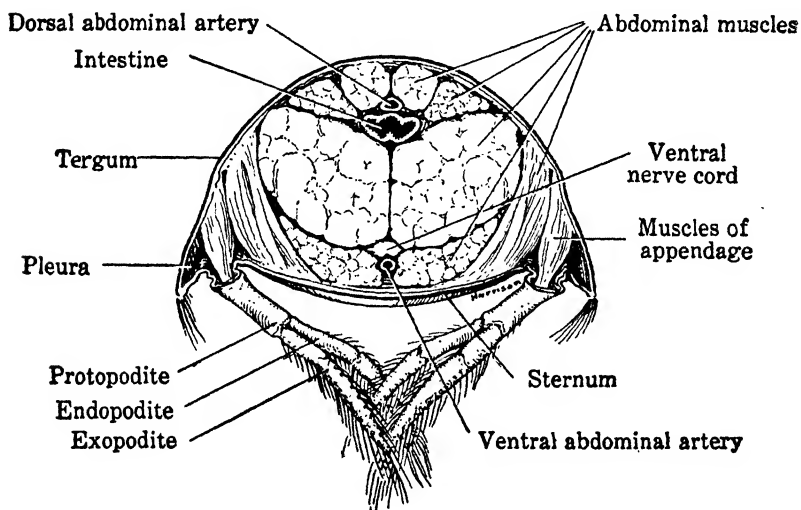

FIG. 65. — Crayfish. Transverse section of fifth abdominal segment.

**GOUS**. In Insects the series of head appendages and the legs are homologous with those of the primitive Arthropod type, while the wings are new, unrelated structures and not modifications of the primitive serial appendages of the ancestral form. However, as we shall see later, the wing of a Bird and the arm of Man are homologous, while the wing of an Insect and the wing of a Bird are analogous structures. One of the chief tasks of the branch of biology known as **COMPARATIVE ANATOMY** is to determine the various parts of animals which are homologous, and to study the adaptive changes which are associated with change of function. (Fig. 227.)



We have considered the principle of specialization and fusion of the segments of the higher Arthropods in so far as it affects external structures, but profound modifications of the internal organs also occur. In the first place, the partitions between the various segments which are present in the Earthworm have disappeared in the Crayfish. Again, the alimentary canal of the Earthworm is a nearly straight tube extending through the body, with relatively slight modifications in certain segments for the elaboration of the

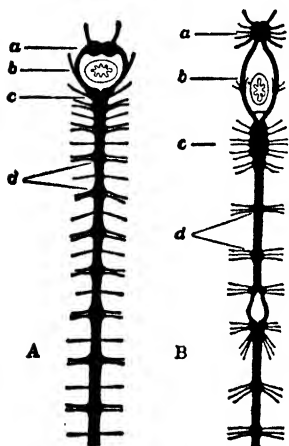

FIG. 66. — Diagram of the anterior portion of the central nervous system of an Earthworm (A) and a Crayfish (B). *a*, brain (cerebral, or supraesophageal, ganglion); *b*, nerve commissures, encircling the pharynx (shown in section); *c*, subesophageal ganglion; *d*, ganglia of the ventral nerve cord, with nerves emerging.

food material as it passes along from mouth to anus; while in the Crayfish we see the accentuation of such modified regions, and the development of large outpocketings, or glands, which are specialized for the formation of chemical substances to DIGEST the food material. That is, to change the food into a soluble form so that it can pass through the cellular membrane which lines the digestive tract and thus actually pass to the circulatory system for distribution to the tissues of the animal.

As a final illustration we may take the nervous system. In the Earthworm this consists of a NERVE CORD which runs along the body in the mid-ventral line below the digestive tract. At the anterior end, it divides into two branches which encircle the digestive tract and unite above in a relatively large body of nervous tissue which constitutes the cerebral ganglion, or BRAIN. In each segment the nerve cord also is somewhat enlarged to form masses of nerve tissue (GANGLIA) from which NERVES pass to the organs in the vicinity. The nervous system of the Crayfish exhibits the same general plan as that of the Earthworm, but certain modifications have been brought about by the uniting of segments in the region of the head and thorax. This process has resulted in the fusion of the segmental ganglia in this region into larger ganglionic masses. The brain of the Crayfish, for example, comprises the

primitive ganglia of the segments which have united to form the head. (Fig. 66.)

We have now reviewed and emphasized the body plan of Hydra, Earthworm, and Crayfish as representative Invertebrate types that illustrate several of the fundamental structural principles which are to be found in the Vertebrate body. But it will be recalled that certain other Invertebrates exhibit body plans that superficially at least depart very widely from the types described, although it is believed that these forms do not break the general evolutionary continuity of the Animal Kingdom.

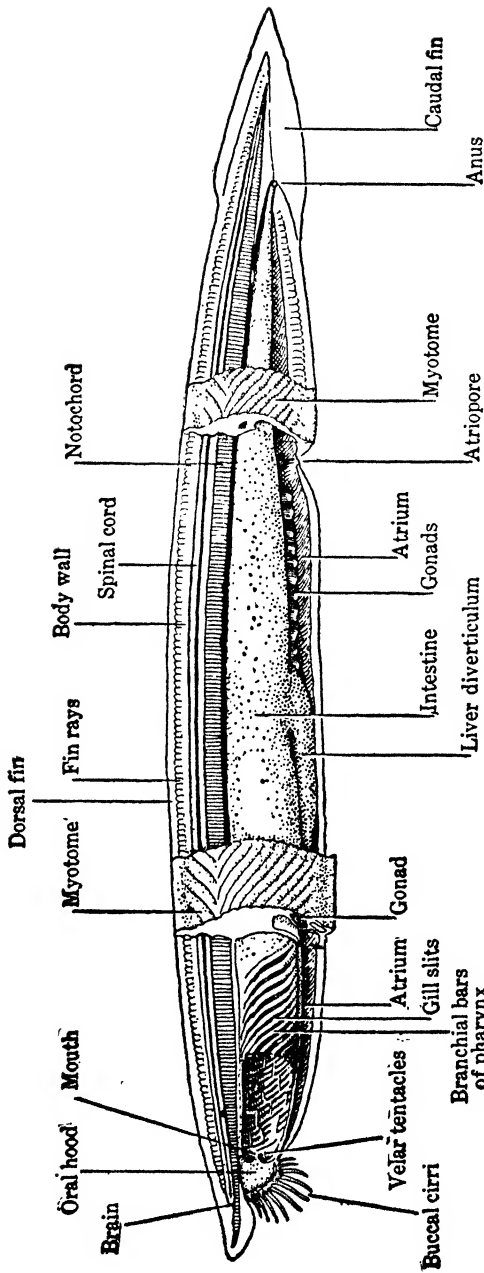

FIG. 67. — General anatomy of a primitive Chordate, Amphioxus, *Branchiostoma lanceolatus*, a near relative of the lowest Vertebrates. Lateral view with most of the left body wall removed. Magnified about three times.

## CHAPTER IX

### SURVEY OF VERTEBRATES

The wise man wonders at the usual. — *Emerson.*

Now that we have viewed the important phyla of the lower animals, it remains to survey the highest and concluding phylum of the Animal World, technically known as the CHORDATA, which for all practical purposes is synonymous with the VERTEBRATA. The only Chordates that are not Vertebrates, or BACKBONED animals, are a few lowly creatures apparently having Invertebrate and certainly Vertebrate affinities; the latter chiefly evidenced by the presence of a NOTOCHORD which is the forerunner of the backbone, a dorsal NERVE TUBE, and GILL SLITS for respiration. Among these primitive Chordates the most interesting is Amphioxus because it is most closely related to the Vertebrates. (Fig. 67.)

It will suffice for us, then, to proceed directly to the true Vertebrates, and since emphasis is later to be placed on the anatomy and physiology of the Vertebrate body because Man is a Vertebrate, our immediate attention can be largely confined to their classification.

The Vertebrates include all the larger and more familiar animals — Fishes, Amphibians, Reptiles, Birds, and Mammals — so that in the popular mind the words animal and Vertebrate are essentially synonymous. A Fish, as everyone knows, is an aquatic backboned animal which breathes by means of gills and moves by fins. An Amphibian, such as a Frog, may, in a general way, be thought of as a Fish which early in life — at the end of the tadpole stage — discards its gills, develops lungs, substitutes five-toed limbs for fins, and takes up a terrestrial existence. Similarly, a Reptile, say a Lizard, may be pictured as an Amphibian which has relegated, as it were, the tadpole stage to the egg, and therefore emerges with limbs and lungs. Birds and Mammals may be regarded as separate derivatives of the reptilian stock which have transformed the scales of the Reptile into feathers and hair respectively, and have developed a special care for their young: the Birds by incubation of the eggs and the Mammals by retention of the young

essentially as parasites within the body of the female until birth occurs. (See: Appendix I.)

It will be appreciated, of course, that other important characteristics — many of which will be apparent as we proceed — delineate these chief Vertebrate groups; but, in fact, the Vertebrates as a whole are remarkably homogeneous both structurally and functionally, the most obvious external differences to the contrary. Some of the *outstanding characters* typical of Vertebrates, in addition to the unique notochord, living endoskeleton, dorsal nerve tube (spinal cord), and gill slits, are bilateral symmetry, traces of segmentation, coelom, red blood corpuscles, brain encased in a skull, paired appendages (fins or limbs), and a tail. (Fig. 94.)

Vertebrates are *the* modern animals: the “athletes of the Animal Kingdom.” They have parcelled out, as it were, the available environment amongst themselves. The Fishes dominate the waters, the Birds, the air, and the Mammals, the land. To be sure, the Amphibians waver between water and land, and the Reptiles are chiefly terrestrial; but both are minor groups to-day: the supremacy of the Reptiles passed to the Mammals in the geological yesterday. Man is a Mammal.

#### A. FISHES

Living as they do in an aquatic environment, Fishes find at least two problems of large-bodied, active, terrestrial animals considerably simplified. In the first place, the density of water makes less necessary either supports to raise the body or sturdy muscles to move them. Thus the paired appendages, FINS, and the tail of Fishes are adapted solely for propulsion and steering. In the second place, although an efficient respiratory apparatus is required, no special provision is needed to maintain the respiratory membranes moist. The water merely passes into the mouth, over the gills, and then out through the gill slits. (Fig. 117.)

Fishes are cold-blooded since they possess no mechanism to maintain a constant body temperature — a character they share with the Amphibians and Reptiles. Most species are OVIPAROUS — the eggs are shed; but some, such as the well-known Guppy, are VIVIPAROUS — the eggs develop within the mother's body and the young are born.

If we neglect the primitive fish-like creatures devoid of true jaws and paired fins, known as CYCLOSTOMES, and the peculiar

LUNG-FISHES to be mentioned later, the Fishes fall into two main groups: the Sharks and Rays with an internal skeleton of gristle, or CARTILAGE, and the Bony Fishes in which the cartilaginous

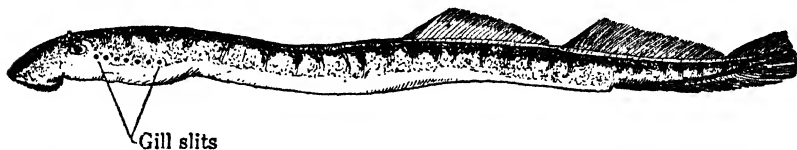

FIG. 68. — A Cyclostome. Lamprey, *Petromyzon marinus*. (Redrawn, after Dean.)

skeleton is largely replaced by one of BONE. The latter group comprises the dominant Fish population of the Earth to-day, represented, for example, by the Mackerel and Perch, Goldfish and Guppy, and a Goby less than one-third of an inch long — the smallest known Vertebrate. (Figs. 68, 75.)

### 1. Sharks and Rays

The most primitive of the true Fishes are the Sharks and Rays, or ELASMOBRANCHS: a small remnant of a once dominant group

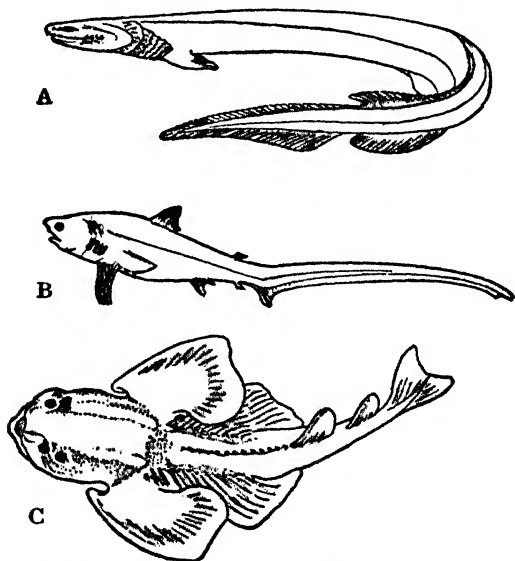

FIG. 69. — Sharks. A, Frilled Shark, *Chlamidoselachus anguineus*; B, Thresher Shark, *Alopias vulpes*; C, Angel Shark, *Rhina squalina*. (From Newman.)

of Vertebrates. They differ from higher Fishes chiefly by a cartilaginous skeleton, by gills communicating directly with the

body surface by several gill slits, and by a skin roughened by small tooth-like projections.

Sharks are confined to marine waters and are most abundant in the tropics. The most common species off our coasts are the

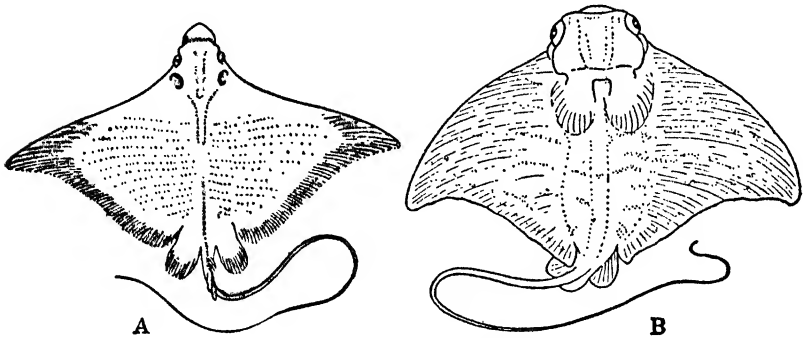

FIG. 70. — A, Sting Ray, *Stoasodon narinari*; B, Eagle Ray, *Myliobatis aquila*. (From Newman, after Jordan and Evermann, and Bridges.)

small Dogfish Sharks, notorious pests to fishermen but favorites for dissection in zoölogical laboratories. (Figs. 69, 120.)

Whereas the Sharks have the typical stream-line body of swift swimmers, the Rays, or Skates, are bottom-dwellers, and have a

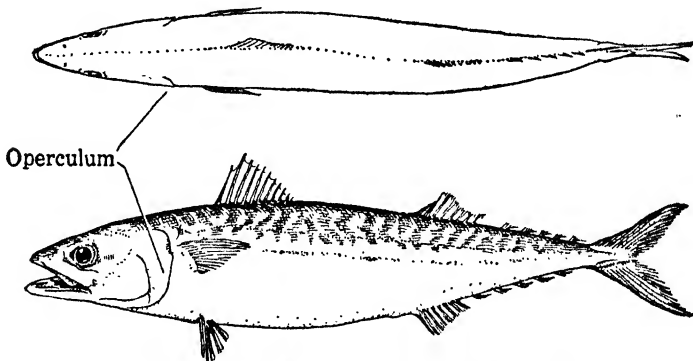

FIG. 71. — Mackerel, *Scomber scombrus*.

greatly flattened body with eyes on the dorsal, and mouth and gill slits on the ventral surface. The most famous of the Rays are the Torpedoes, so-called because they are able to give a severe electric shock. (Fig. 70.)

## 2. Bony Fishes

All of the fresh-water Fishes, as well as the great majority of those dwelling in the sea — indeed, what we usually think of as Fishes — typically have a skeleton of bone, and a body-covering of scales. They are Bony Fishes, or TELEOSTS. True, the more primitive forms have partially cartilaginous skeletons, and bony plates instead of scales, as represented by the Garpikes and Sturgeons, but they are exceptions forming less than five per cent of the group. All Teleosts have the external openings of the gill slits covered by a protecting flap, or OPERCULUM, so that water bathing the gills leaves the body by a single opening at the posterior edge of the operculum on either side of the head. (Figs. 71, 100, 106.)

Modifications of the typical fish-like form of swift-swimming Fishes that have been assumed by various species in adaptation to different habitats and modes of life are legion. One immediately thinks of the snake-like body of the Eels, the grotesque form of the Sea-horses, and the compressed body of the Flat-fishes, such as the Flounders and Halibuts. But Flat-fishes are

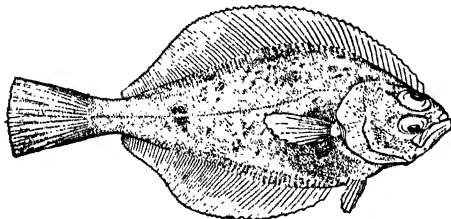

FIG. 73. — A Flat-fish.

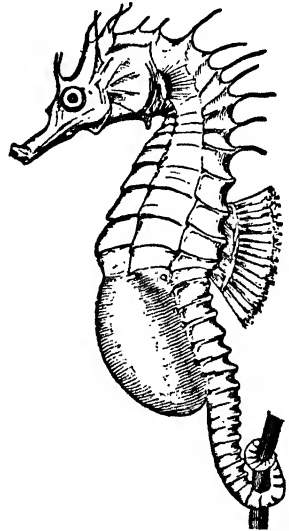

FIG. 72. — Sea-horse, *Hippocampus antiquorum*. Male showing brood pouch formed from combined pelvic fins. (From Doflein.)

hatched with typical fish form; and it is only as the animals settle down on one side that the 'under' eye moves up and over so both are on top. Even the bizarre form exhibited by the Flying-fishes that jump and sail

above the water is exceeded by the denizens of the ocean's deepest reaches, where sunlight never penetrates, no plant life grows, the pressure is tremendous, and the temperature is only slightly



above the freezing point. In such surroundings some possess luminous organs, some have immense eyes to make the most of little light, some are blind and so depend upon tactile organs, some have an immense mouth and an enormous stomach capa-

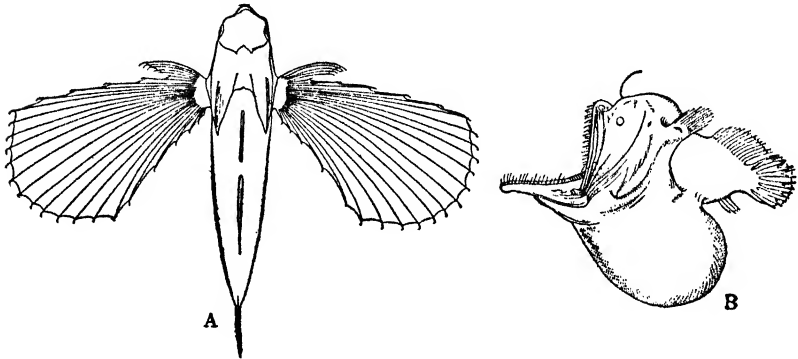

FIG. 74. — A, a Flying-fish; B, a deep-sea Fish. (From Gunther and Lull.)

ble of digesting a fish nearly their own size, and so on and on — adaptations seemingly endless — a Fish for every condition of life in water. (Figs. 72-74.)

### 3. Lung-fishes

Finally, mention must be made of a group that flourished in the geological past but is represented to-day by only five fresh-water species. They are known as Lung-fishes, or DIPNOANS,

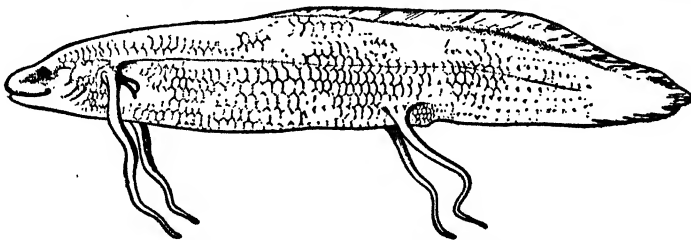

FIG. 75. — African Lung-fish, *Protopterus annectens*. (From Dean.)

because an AIR SAC, which in most other Fishes acts as a hydrostatic organ, here opens into the pharynx and functions as a LUNG when sufficient water is lacking during a drought. Lung-fishes have been regarded as intermediate between Fishes and Amphibians, but they have many structures that are similar to those of the lower Fishes. They are an interesting and puzzling remnant. (Fig. 75.)

So much for the Fishes — a group that is of such great economic importance that the governments of progressive countries spend vast sums for their study, protection, and propagation. The important food and game Fishes are almost without exception representatives of the higher Bony Fishes — relatively modern forms that did not exist during the Age of Fishes, when Fishes were the only Vertebrates, but appeared later during the Age of Reptiles. (Fig. 232.)

## B. AMPHIBIANS

The members of the class AMPHIBIA, commonly represented by the Frogs and Salamanders, made a great forward step in Vertebrate evolution by adopting — if somewhat falteringly — the land-habit. This opened up to them a vast environment closed to Fishes and demanded lungs and supporting limbs. The limbs apparently were derived from the paired fins of Fishes and built on the plan that persists in all the higher Vertebrates. (Figs. 102, 103.)

True, most Amphibians are cold-blooded, slimy-skinned animals that spend the early part of their life with fins, tail, and gills and only substitute, or add, limbs and lungs when finally they emerge on dry land. But they do make the change, and during this metamorphosis from the larval to the adult form they apparently recapitulate broadly their evolutionary history.

Nearly all Amphibians return to water to breed, and many spend the cold months in a dormant condition buried in mud at the bottom of ponds and streams. During this HIBERNATION period the metabolic processes are greatly reduced, and the temperature is little above the surroundings. However, Frogs cannot survive being actually frozen although they may remain alive when embedded in a solid block of ice.

Those Amphibians that retain the tail throughout adult life constitute the order CAUDATA, and those deprived of this structure during metamorphosis, the order SALIENTIA. *See also*

### 1. Salamanders and Newts

The tailed Amphibians, or Caudata, such as the Salamanders and Newts, though hatched as aquatic larvae, known as TADPOLES, undergo a relatively inconspicuous metamorphosis that varies considerably in different species. Thus some retain their gills

throughout life, though functional lungs are developed; others resorb the gills but retain the gill slits; and still others lose all traces of both gills and gill slits. In fact, some even go to the extreme and lose their lungs, thus depending solely upon the moist

skin to act as a respiratory membrane. Obviously the lung-breathing method is not consistently adopted.

Common tailed Amphibians are *Necturus* (the 'Mud-puppies'), *Cryptobranchus* (the 'Hell-benders'), *Amblystoma* (the Blunt-nosed and Tiger Salamanders), and *Triturus* (the Newts).

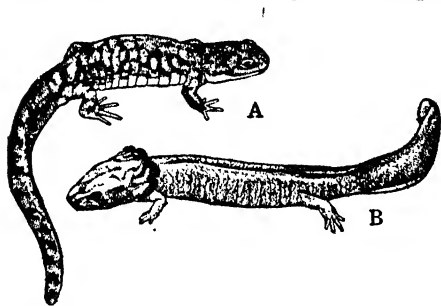

FIG. 76. — A, *Amblystoma*, *Amblystoma tigrinum*; B, *Necturus*, *Necturus maculosus*. (From Noble.)

Several species of *Amblystoma* have recently proved a boon to biologists interested in fundamental problems of growth, vieing in this field with the lowly Flatworms, such as *Planaria*. From tadpole to adult they possess remarkable powers of REGENERATION: they repair minor and major mutilations, restoring excised eyes and amputated limbs and even appropriating the limbs of other species that are grafted. Ingenious experiments have given an entirely new conception of the marvelous plasticity possessed by at least some of the lower Vertebrates. (Figs. 76, 77.)

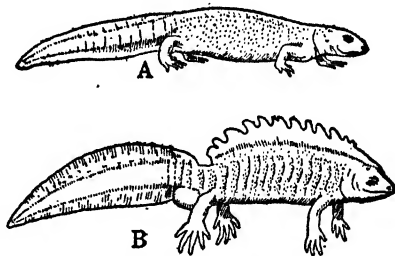

FIG. 77. — A Newt, *Triturus cristata*. A, female; B, male during the breeding season. (From Gadow.)

## 2. Toads and Frogs

The majority of Amphibians, some nine hundred species of the order Salientia, are Toads and Frogs with a relatively clear-cut metamorphosis from tadpole to limbed, lung-breathing, tailless adult. The common Toads, such as *Bufo americanus*, hop about chiefly after dusk devouring Worms, Snails, and Insects and so render a considerable service. In fact, someone has estimated that

the gardener owes a Toad on his premises nearly twenty dollars at the end of the season. Moreover, the Toad is much maligned by having attributed to it the power to produce warts on the human skin.

Tree Frogs and Tree Toads are tiny arboreal forms with soft, adhesive pads on the toe tips. Many of them, such as the common

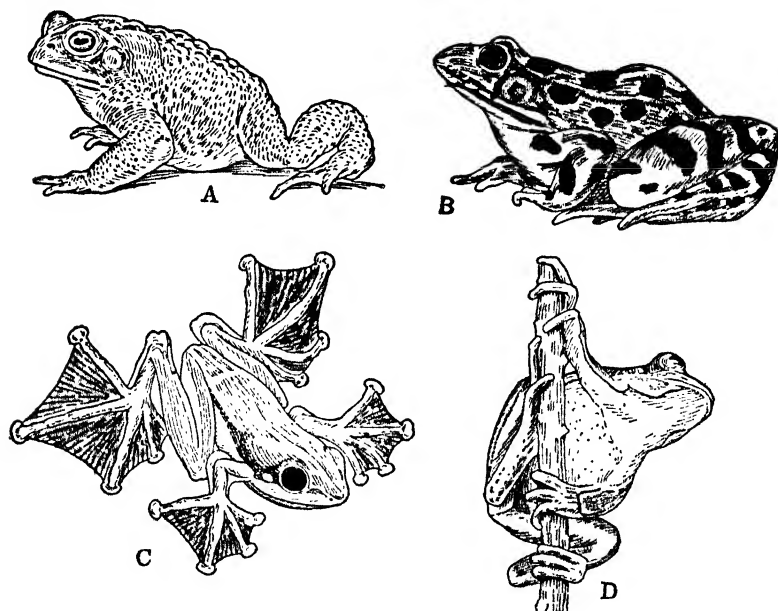

FIG. 78. — A, Toad, *Bufo americanus*, stalking prey; B, Leopard Frog, *Rana pipiens*; C, Javan Flying Frog, *Rhacophorus pardalis*; D, Tree Frog, *Hyla versicolor*. (From Newman, after Dickerson and Lydekker.)

Tree Frog, *Hyla versicolor*, are able to change their color through various shades of gray, brown, and green, and so are rendered inconspicuous in their natural surroundings. (Fig. 78.)

The true Frogs are represented by several well-known species in the United States: among them the Leopard Frog (*Rana pipiens*), the Bull Frog (*Rana catesbeiana*), and the Green Frog (*Rana clamitans*). More need not be said about Frogs at this point because they will be referred to again. As a matter of fact they are in many ways ideal subjects for anatomical and physiological investigations and therefore have contributed considerably to the advancement of biological science. (Figs. 107, 175.)

## C. REPTILES

Apparently descended from primitive Amphibians, the Reptiles met new and more favorable land conditions with progressive structural and physiological features: for example, they skipped metamorphosis and so started out from the egg with functional lungs and on four feet. So the Reptiles very soon, geologically speaking, became the dominant Vertebrates on the Earth, flourishing both in number of individuals and variety of species adapted

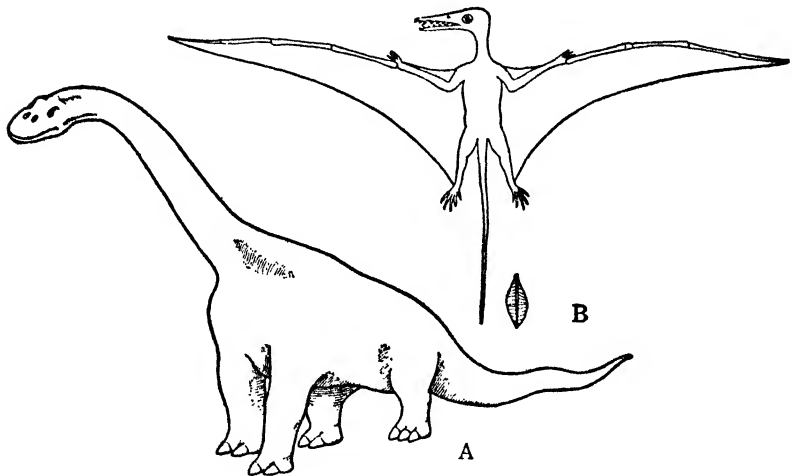

FIG. 79. — Reptiles of the past. A, a Dinosaur, *Branchiosaurus* (length about 80 feet); B, a Pterodactyl, *Rhamphorhynchus*. (From Lull.)

to all sorts of land and swamp conditions, and even, secondarily, to aquatic and aërial life. Probably the best known representatives of the extinct population of the Age of Reptiles are some of the giant Dinosaurs. (Figs. 79, 232.)

Although the supremacy of the Reptiles eventually passed to the Mammals, there are still some five thousand species living to-day. These are arranged in three chief orders: the TESTUDINATA, CROCODILIA, and SQUAMATA, represented by the Turtles and Tortoises, the Crocodiles and Alligators, and the Lizards and Snakes, respectively.

### 1. Turtles and Tortoises

Typically encased in a shell composed of bony plates firmly fixed to the backbone and to the ribs, the Turtles and Tortoises

— some land-dwellers, others aquatic — depend upon this rather than speed for protection. In fact a few, like the Box Turtle, can completely seal themselves up, as it were, between the dorsal CARAPACE and the ventral PLASTRON. The tortoise-shell of commerce is the horny outer layer of the carapace of the Hawk's

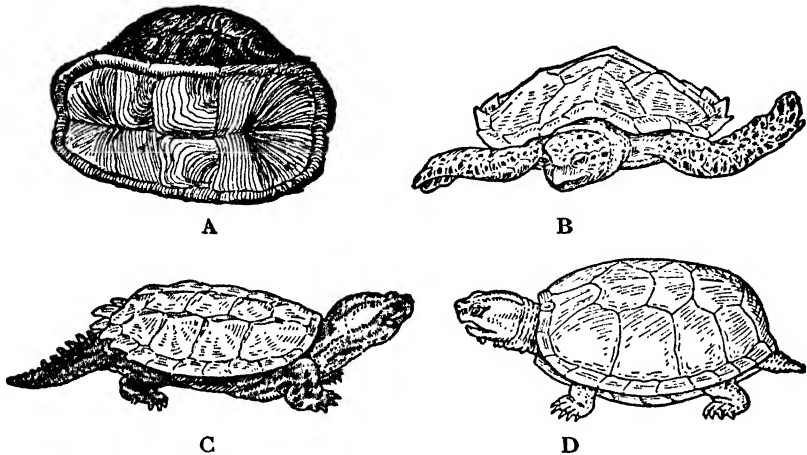

FIG. 80. — Turtles. A, Box Turtle enclosed within carapace and plastron; B, Tortoise-shell Turtle, *Eretmochelys imbricata*; C, Snapping Turtle, *Chelydra serpentina*; D, Mud Turtle, *Cinosternum pennsylvanicum*. (A from Bamford; B, C, D from Newman, after Lydekker.)

bill, or Tortoise-shell, Turtle. Probably the protective shell also, in part, accounts for the fact that the jaws of Turtles and Tortoises are toothless. Nevertheless, many can inflict severe wounds — witness the beaked jaws of the Snapping Turtle. (Fig. 80.)

## 2. Crocodiles and Alligators

Predatory inhabitants of tropical rivers, Crocodiles and Alligators are lizard-like in form with long, gaping jaws well armed with teeth, and with a thick, leathery skin covered with horny scales. Alligator skin has long been popular for the manufacture of leather goods.

## 3. Lizards and Snakes

The Lizards form a highly diversified group, typically with scaly skin and well-developed limbs and long tail. Representative Lizards are the common Iguana, the Gila-monster, and the Horned-

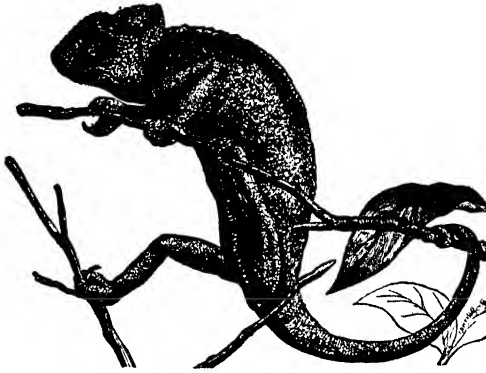

FIG. 81. — Chameleon, *Chamaeleon vulgaris*. (From Gadow.)

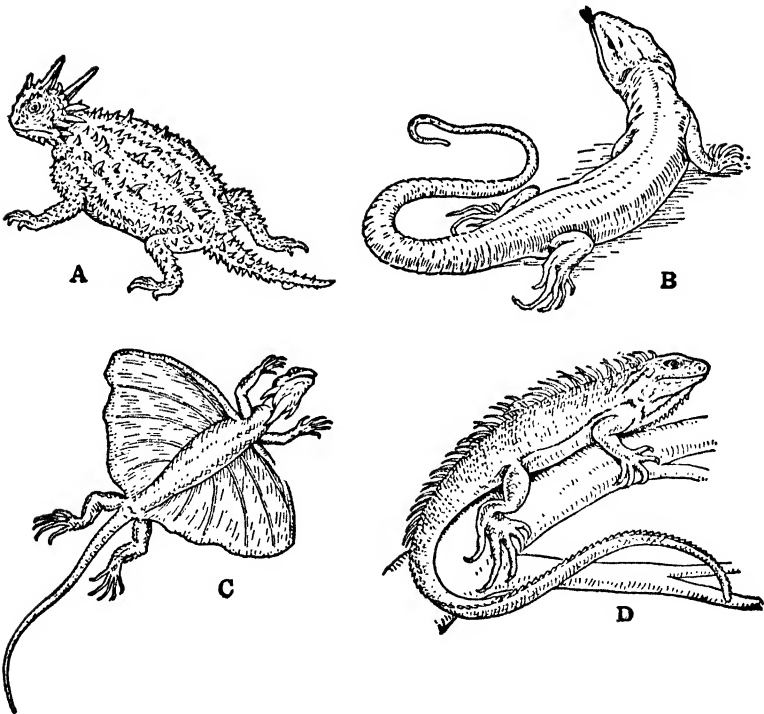

FIG. 82. — Lizards. A, Horned-toad, *Phrynosoma cornutum*; B, European Lizard, *Lacerta viridis*; C, Flying Dragon, *Draco volans*; D, Iguana, *Iguana tuberculata*. (From Newman, after Gadow and Lydekker.)

'toad.' Closely related to the true Lizards are the Chameleons, famous for their ability to change color rapidly in response to various stimuli. (Figs. 81, 82.) }

Snakes are essentially limbless Lizards in which even the internal supporting structures of the fore limbs have disappeared. Most species of Snakes, in common with the great majority of Vertebrates except the Mammals, are OVIPAROUS (egg-laying), but a few are VIVIPAROUS (bring forth 'living' young). And it is hardly necessary to say that a few have poison glands associated with special teeth, or fangs. The Rattlesnakes, Copperheads,

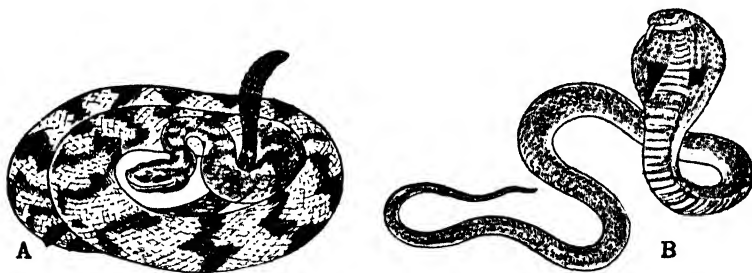

FIG. 83. — A, Rattlesnake, *Crotalis durissus*; B, Cobra, *Naja tripudians* (From Newman, after Lydekker.)

Water-moccasins, and Cobras are among the most notorious in this respect. However, many species crush their prey as do the Boa-constrictors, Pythons, and Kingsnakes. (Figs. 83, 230, 231.)

#### D. BIRDS

The Birds, constituting the class AVES, are the warm-blooded (HOMOTHERMAL) animals that have made the air their own by the development of fore limbs into wings, scales into an insulating blanket of feathers, and other bodily adaptations. And not the least of their progress is probably due to instinctive care of their eggs and young. That Birds are an offshoot from the Reptilian stock, probably the Dinosaurs, is attested by the fossil remains of a Bird, known as Archaeopteryx, with characteristic feathers but lizard-like tail and teeth. (Figs. 232, 233.)

The Birds to-day form a remarkably homogeneous group, probably due to restrictions imposed by the mechanical problems in-



volved in flight. Sustained exercise in the air necessitates an exceptionally efficient heart to rush supplies to the various parts of the body, and coöperating lungs that communicate with a system of air spaces among the viscera and in the hollow bones. Withal, the plumage not only provides an efficient heat-retaining coat but the feathers of wings and tail also are well adapted for propulsion and steering. Minimum weight with maximum strength characterizes these living heavier-than-air flying machines.

Birds usually are arranged in two very unequal divisions, the RATITAE and CARINATAE. The first includes a few species without a keel-like breast-bone to support strong wing muscles, as illustrated by the flightless Apteryx and Ostriches; and the second divi-

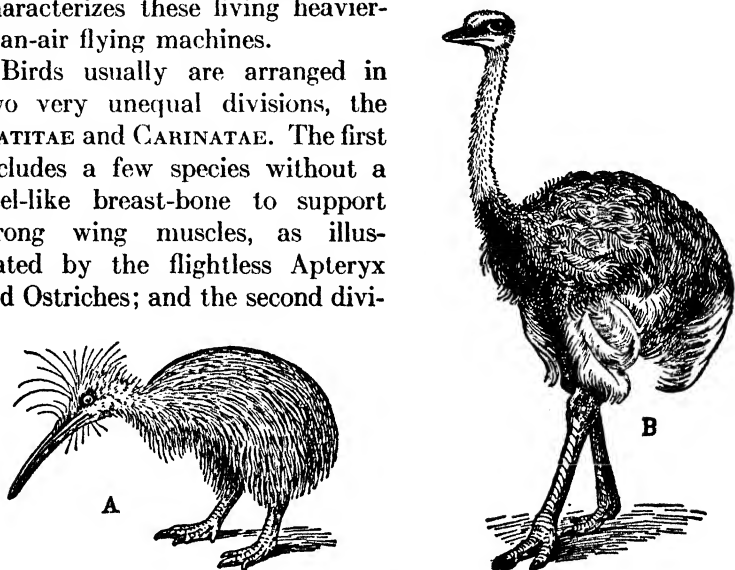

FIG. 84. — A, Kiwi, *Apteryx australis*; B, Ostrich, *Struthio camelus*.  
(From Newman, after Evans.)

sion comprises those with the 'keel' which is all the rest of the bird population — about twenty thousand species. These are differentiated by relatively minor anatomical variations, particularly in regard to wings, feet, and horny beaks ensheathing toothless jaws, in adaptation to various habitats and ways of life. (Figs. 84-86.)

A consideration of the classification of the Carinatae would carry us too far into details, but ORNITHOLOGY is of very high interest and greatest economic value. Birds contribute in large measure, both directly and indirectly, to the human food supply: directly as domestic and game birds, and indirectly because they make successful agriculture possible by eating almost

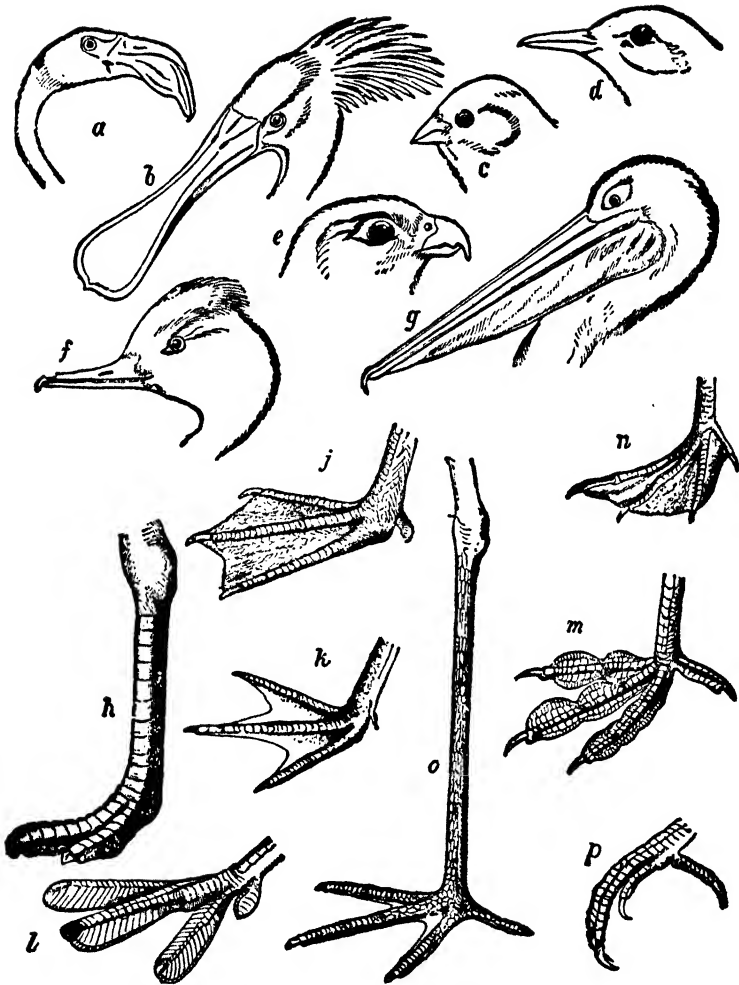

FIG. 85. — Representative adaptations of the beaks and feet of Birds. *a*, Flamingo; *b*, Spoonbill; *c*, Bunting; *d*, Thrush; *e*, Falcon; *f*, Duck; *g*, Pelican; *h*, Ostrich (running); *j*, Duck (swimming); *k*, Avocet (wading); *l*, Grebe (diving); *m*, Coot (wading); *n*, Tropic Bird (swimming); *o*, Stork (wading); *p*, Kingfisher (grasping). (From Hegner, after several authors.)

inconceivable numbers of destructive Insects and weed seeds. (Figs. 236, 239, 266.)

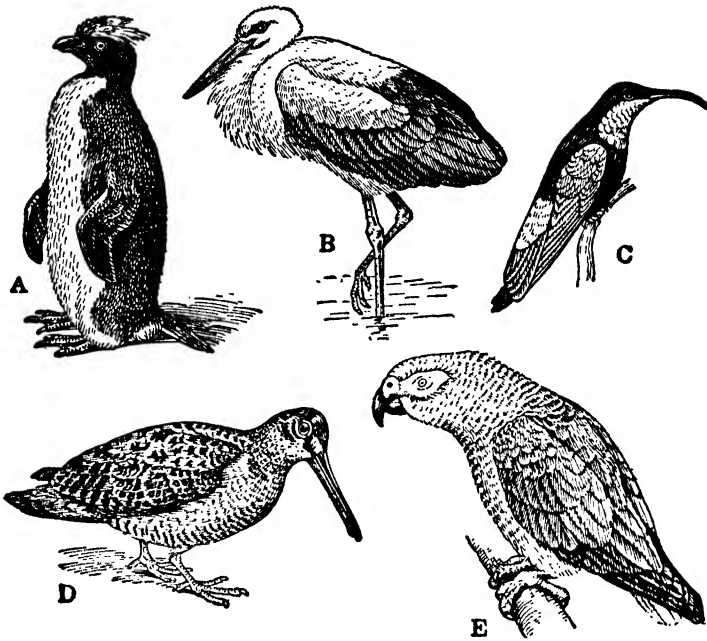

FIG. 86. — Carinate Birds. A, Penguin, *Eudyptes chrysocoma*; B, Stork, *Ciconia alba*; C, Hummingbird, *Eulampis jugularis*; D, Woodcock, *Scolopax rusticula*; E, Parrot, *Psittacus erithacus*. (From Newman, after Lydekker and Evans.)

### E. MAMMALS

With the class MAMMALIA we reach the highest forms of life on the Earth, culminating in Man, so here naturally our interest is chiefly focussed. But since considerable attention is to be given a little later to their anatomy and physiology with special reference to the human body, only the essential Mammalian characters and classification are now in point.

In brief, Mammals are warm-blooded, lung-breathing, hairy Vertebrates. The young of all but the very lowest Mammals develop before birth at the expense of food derived from the mother's blood. All immediately after birth receive milk from special MAMMARY GLANDS. Mammals are classified under three main subdivisions: Monotremes, Marsupials, and Placentals.

1. *Monotremes*

The primitive egg-laying Mammals living to-day, known as MONOTREMES, quite evidently point to a Reptilian ancestry for the class. Although they are oviparous, the young when hatched

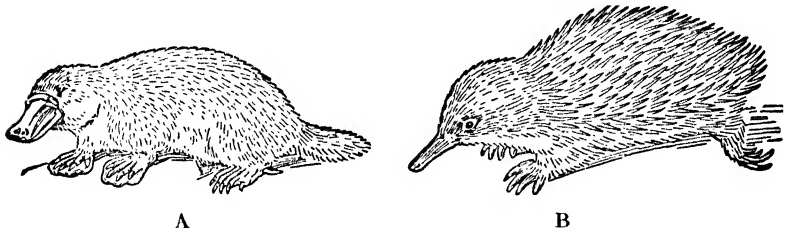

FIG. 87. — Monotremes. A, Duckbill, *Ornithorhynchus anatinus*; B, Echidna, *Echidna aculeata*. (From Newman.)

are nourished by milk. There are only three species, each about the size of a Rabbit: the Duckbill (*Ornithorhynchus*) and the Spiny Anteaters (*Praechidna* and *Echidna*) found in Australia, Tasmania, and New Guinea. (Fig. 87.)

2. *Marsupials*

The pouched Mammals, or MARSUPIALS, occur chiefly in Australia and neighboring islands where they are the characteristic

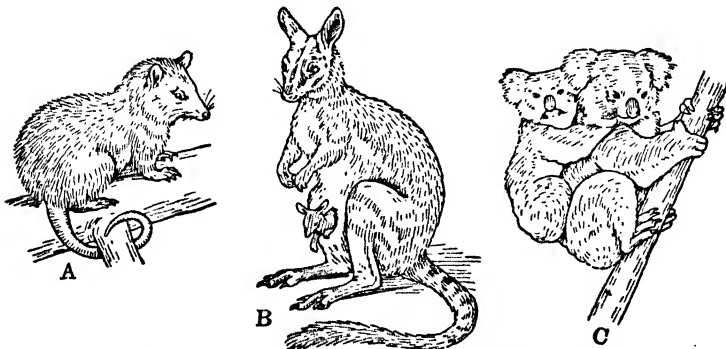

FIG. 88. — Marsupials. A, Virginia Opossum, *Didelphys virginiana*; B, Wallaby, *Petrogale xanthopus*; C, Koala, *Phascolarctos cinereus*. B and C carrying young. (From Newman, after Vogt and Specht, and Brehm.)

Mammalian fauna: a primitive one that has flourished there isolated from keen competition, but is now rapidly dying out since Man has imported the higher Mammals. The Kangaroos and

Wallabies are the best known examples of the Australian Marsupials, and the Virginia Opossum is one of the few scattered survivors in America of a group once widely distributed over the Earth. (Fig. 88.)

The method of reproduction of the Marsupials is unique. The eggs hatch, as it were, within the mother's body where development proceeds for a short time, nourishment being provided through an atypical or very simple placenta. Then the young are born in an exceedingly immature condition and make their way to a pouch on the abdomen of the mother. Here they attach themselves to the teats of the mammary glands and are nourished by milk. Even after the young are well-developed the pouch serves as a refuge.

### 3. Placentals

The PLACENTALIA, or Eutheria, comprises all the rest of the Mammals from the lowly Insectivora, such as Gymnura and Hedgehog, to the Primates, including Man. All nourish their young before birth by means of a highly complex PLACENTA that makes possible the protracted development of the embryo under

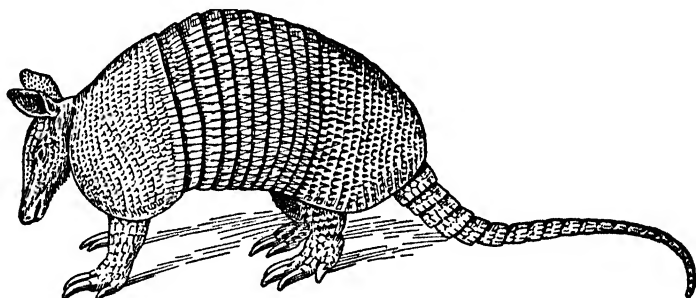

FIG. 89. — An Edentate. Texas Nine-banded Armadillo, *Dasypus novemcinctus texanus*. (From Newman.)

ideal conditions for nutrition and protection within the mother's body: conditions necessary for the establishment of niceties of structure and function as exemplified, for instance, by a larger and better brain. Thus it is fair to say that the placenta and associated embryonic membranes are in no small degree responsible for the commanding position of the group in competition with other forms of life. (Fig. 134.)

The adaptive radiation of Placentals to nearly all types of environments and modes of life — from Whales to Bats, and Moles

to Men — is an expression of their success which elsewhere in the animal world is not reached even by the Insects. But it makes their classification a difficult problem. However, for our purpose the Placental Mammals may conveniently be grouped in four great LEGIONS, chiefly on the basis of the structure and function of their limbs and teeth.

The first is the immense assemblage of clawed mammals, or UNGUICULATES. This is represented by the INSECTIVORA, or

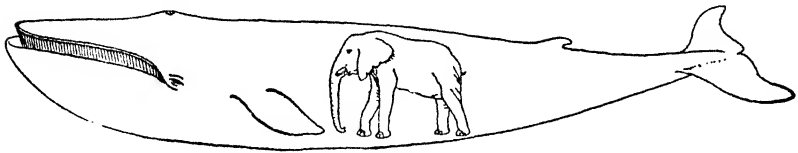

FIG. 90. — Sulfur-bottom Whale, *Sibbaldus sulfurous*, and African Elephant, *Loxodonta africana*, drawn to scale. (Modified, after Lull.)

insect-eating mammals — such as *Gymnura*, the Hedgehogs, and Moles (Figs. 201, 205); the EDENTATES, or toothless mammals — Sloths, Anteaters, and Armadillos (Figs. 89, 204); the CHIROP-TERA, or flying mammals — the Bats (Figs. 207, 227); the RODENTIA, or gnawing mammals — Squirrels, Rabbits, Guinea-pigs,

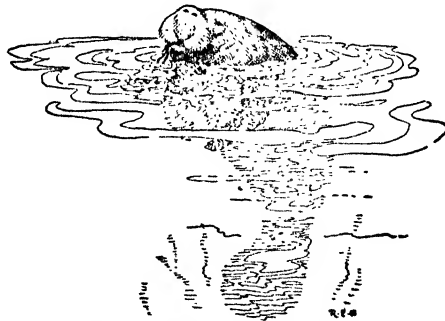

FIG. 91. — Florida Manatee, *Manatus americanus*.

Rats, Mice, Porcupines, and Beavers (Figs. 108, 187); and finally the CARNIVORA, or beasts of prey — Cats, Dogs, Bears, Seals, etc. (Fig. 104.)

Another legion includes the completely aquatic CETACEANS — Whales, Porpoises, and Dolphins. (Figs. 90, 206, 227.)

The hoofed mammals, or UNGULATES, form a great legion of herbivorous animals: important subdivisions being the ARTIO-

DACTYLS, or even-toed Pigs, Hippopotami, Camels, Oxen, Sheep, Deer, Giraffes, etc.; the PERISSODACTYLS, or odd-toed Horses, Tapirs, and Rhinoceroses; and the PROBOSCIDIANS, or Elephants. Closely related are the aquatic SIRENIANS, or Manatees. (Figs. 91, 92, 227, 238.)

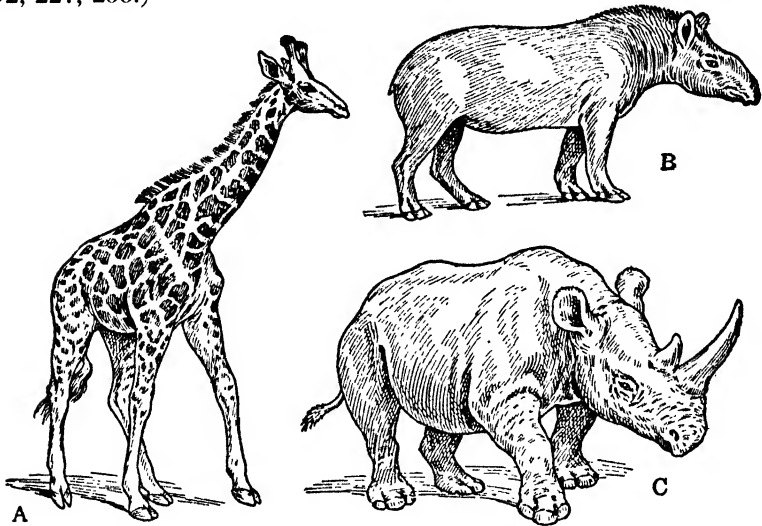

FIG. 92. — Ungulates. A, Giraffe, *Giraffa camelopardalis*; B, American Tapir, *Tapirus terrestris*; C, African Rhinoceros, *Rhinoceros bicornis*. (From Newman, after Beddard and Lydekker.)

The PRIMATES form the concluding legion and include Lemurs, Monkeys and Apes, and Man. They are predominant chiefly by virtue of their mobile, grasping hands, and their intelligence. Quite appropriately Primates have been called “the inquisitive Mammals.” (Figs. 93, 228, 272–274.)

So is completed our glance at the chief types — phyla — in the varied panorama of animal life from Protozoön to Mammal. Necessarily brief, it is adequate for our purpose if we are impressed with certain outstanding facts, not the least significant being the versatility and prodigality of life. Nature has tried, as it were, one experiment after another: some phyla have prospered and then waned; some have gone up blind alleys and stayed there; some have met the conditions of life to the full and have flourished: two in outstanding fashion — Arthropods and Vertebrates. Only some, then, and not all, have made a real contribution, but this has been

tenaciously conserved and appears again and again in 'higher' phyla. So there is a trace of structural and physiological continuity woven in the picture of animal life that is interpreted as evidence

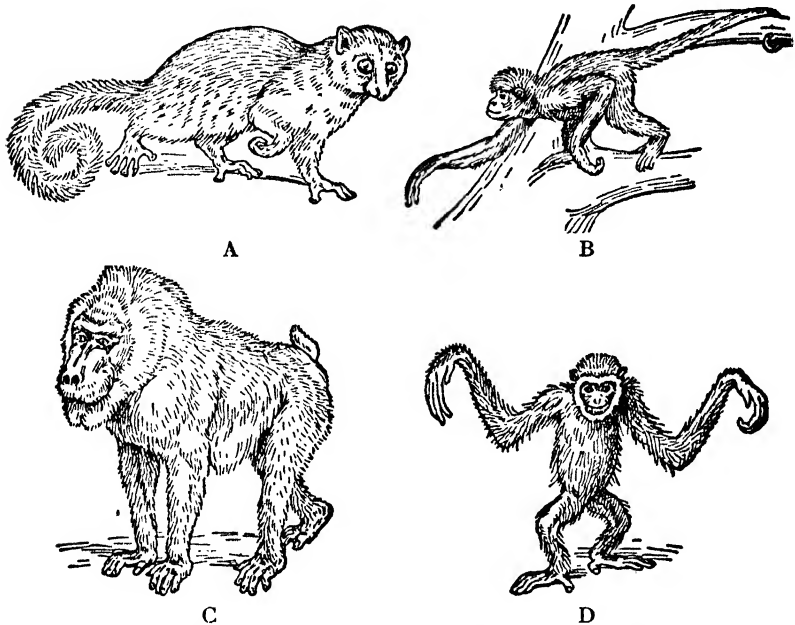

FIG. 93. — Primates. A, Dwarf Lemur, *Microcebus smilhii*; B, Spider Monkey, *Ateles ater*; C, Baboon, *Papio leucophoeus*; D, Gibbon, *Hylobates lar*. (From Newman, after Beddard and Lydekker.)

of descent with change, or evolution. The appreciation of this unity in diversity will contribute toward the proper perspective for a more detailed consideration of the Vertebrate body and a presentation of certain general biological principles.



## CHAPTER X

### THE VERTEBRATE BODY

If we contemplate the method of Nature, we see that everywhere vast results are brought about by accumulating minute actions.

—*Spencer.*

As we know from our survey of the Animal Kingdom, the Vertebrates form one of the most clearly defined divisions and include all the larger and more familiar forms — Fishes, Amphibians, Reptiles, Birds, and Mammals. There is, in fact, less diversity in structure among the Vertebrates as a whole than is present, for example, in the one subdivision of the Arthropods, the Crustacea, of which the Crayfish is a member. Accordingly we shall confine our attention largely to a description of the structure and physiology of an 'ideal' Vertebrate, and mention incidentally some of the chief modifications of general significance which appear in the different groups, and specifically in Man.

#### A. BODY PLAN

The ideal Vertebrate body is more or less cylindrical in form, and is bilaterally symmetrical with respect to a plane passed vertically through the main axis which extends from the anterior to the posterior end. Three regions of the body may be distinguished, HEAD, TRUNK, and TAIL. Frequently there is a narrow NECK between the head and trunk. (Figs. 67, 94, 95.)

The head forms the anterior end and contains the brain, eyes, ears, and nostrils, or ANTERIOR NARES, as well as the mouth and throat, or PHARYNX. On either side of the head, behind the mouth, is a series of openings, or GILL SLITS, leading into the pharynx which, however, in air-breathing Vertebrates disappear before the adult condition is attained.

The trunk forms the body proper and contains the coelom, and the major part of the alimentary canal leading posteriorly to the exterior by the anus, as well as the chief circulatory, excretory, and reproductive organs.

In most aquatic Vertebrates the trunk very gradually merges into a large muscular **TAIL**: the region posterior to the coelom and anus. Thus the Vertebrate tail is a unique structure — the tail

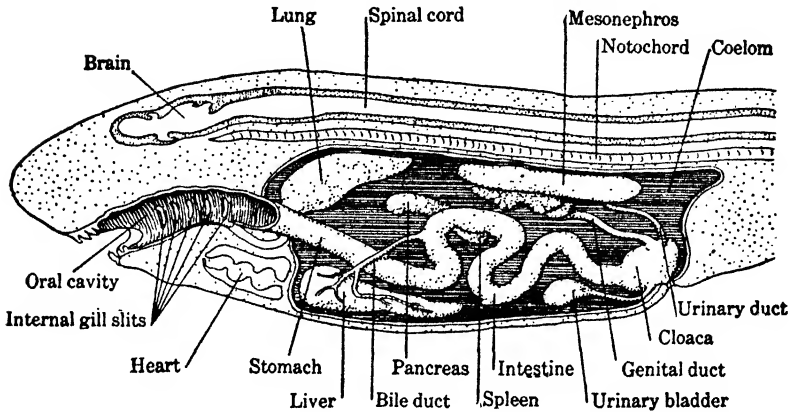

FIG. 94. — Body plan of an ideal Vertebrate. Longitudinal section of female.

of Invertebrates terminating with a segment bearing the anus. In many terrestrial Vertebrates the tail has become practically an inconsequential unpaired appendage.

The Vertebrate coelom comprises two chief parts — a large **ABDOMINAL** chamber and a small anterior chamber. The latter con-

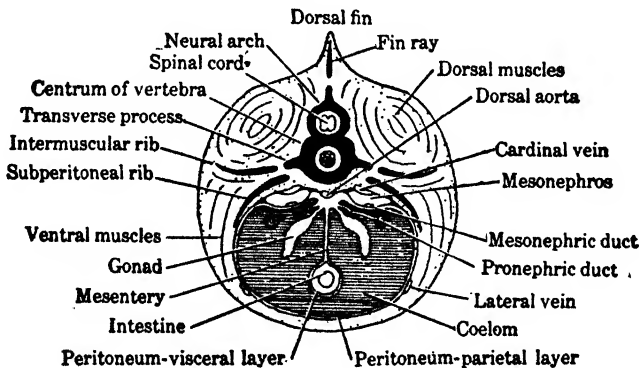

FIG. 95. — Body plan of an ideal Vertebrate. Transverse section.

stitutes the **PERICARDIAL** chamber in Fishes but in higher forms it is divided into two parts, one (pericardial) investing the heart and the other (pleural) investing the lungs. The lining membrane

of the coelom, known as the PERITONEUM, forms the innermost layer of the body wall, covers the organs, and in certain regions forms broad folds, or MESENTERIES, in which they are suspended. In the Mammals the organs of the chest, or THORAX, are separated from those of the abdomen by a muscular partition, or DIAPHRAGM. (Figs. 106-109.)

In aquatic forms thin extensions from the trunk and tail form median FINS. Paired fins, developed from the trunk, comprise the PECTORAL fins, situated near the junction of head and trunk, and the PELVIC fins, just lateral to the anus. The pectoral and pelvic fins, or the FORE LIMBS and HIND LIMBS which replace them in all forms above the Fishes, are the only lateral appendages typically found in Vertebrates.

### B. SKIN

The surface of the body which comes in direct contact with the environment is covered by an integument, or SKIN, which, though

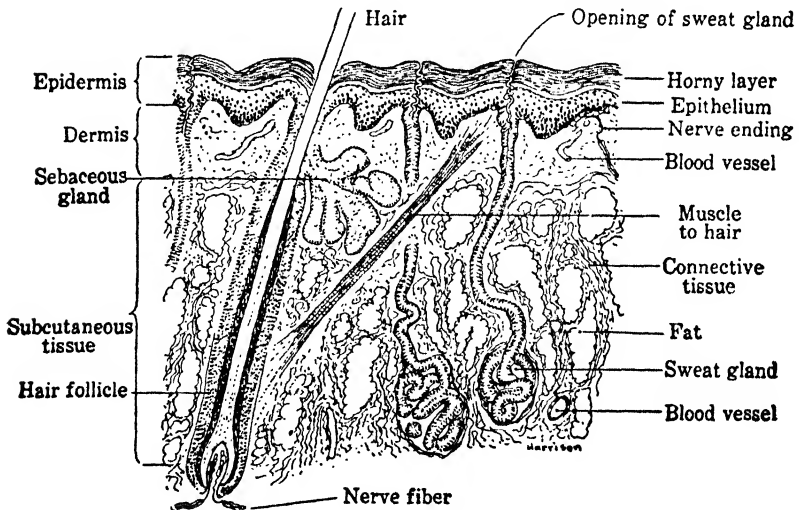

FIG. 96. — Diagram of section through the human skin, highly magnified.

primarily protective and sensory in function, takes part to a greater or less degree in respiration, excretion, and secretion. Scales, feathers, claws, horns, hoofs, nails, teeth, etc., are derivatives of the skin. The skin, unlike that of the Invertebrates, is formed of

two chief layers: an outer epithelial tissue, the EPIDERMIS, derived from the ectoderm, and an inner DERMIS from the mesoderm of the embryo.

The epidermis itself always consists of several layers of cells: the lower comprising actively dividing cells whose products gradually are moved up to form the superficial layers of flattened, horny cells.

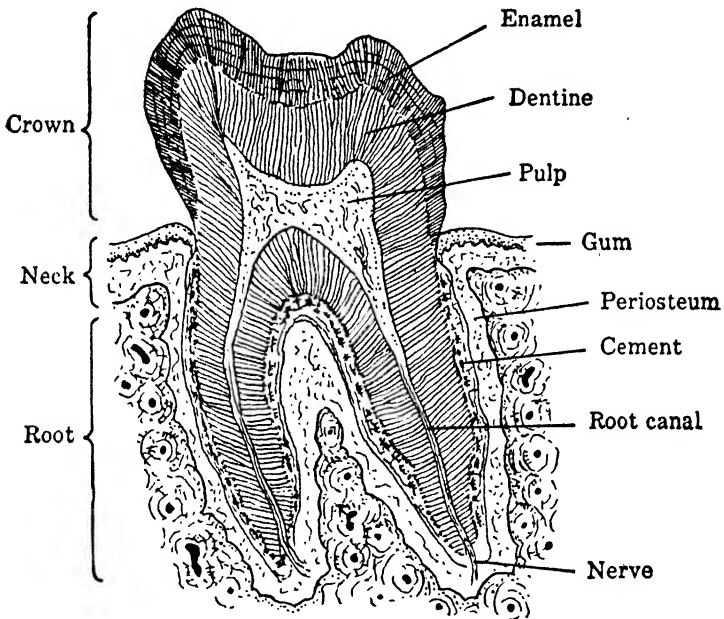

FIG. 97. — Human tooth, longitudinal section.

Thus this layer is not directly converted into the cuticle, as is the case, for example, in the Arthropods. The dermis is a connective tissue layer, with glands, blood vessels, etc., between the epidermis and the muscular layer of the body wall. (Figs. 96, 97.)

### C. MUSCLES

The body wall proper is chiefly composed of muscular tissue, commonly spoken of as flesh, which varies in thickness in different parts of the body. In the mid-dorsal region it surrounds the brain and spinal cord (CENTRAL NERVOUS SYSTEM) and the axial supporting structure (NOTOCHORD), while ventrally it forms the wall of the coelom. In the lower Vertebrates and the embryonic

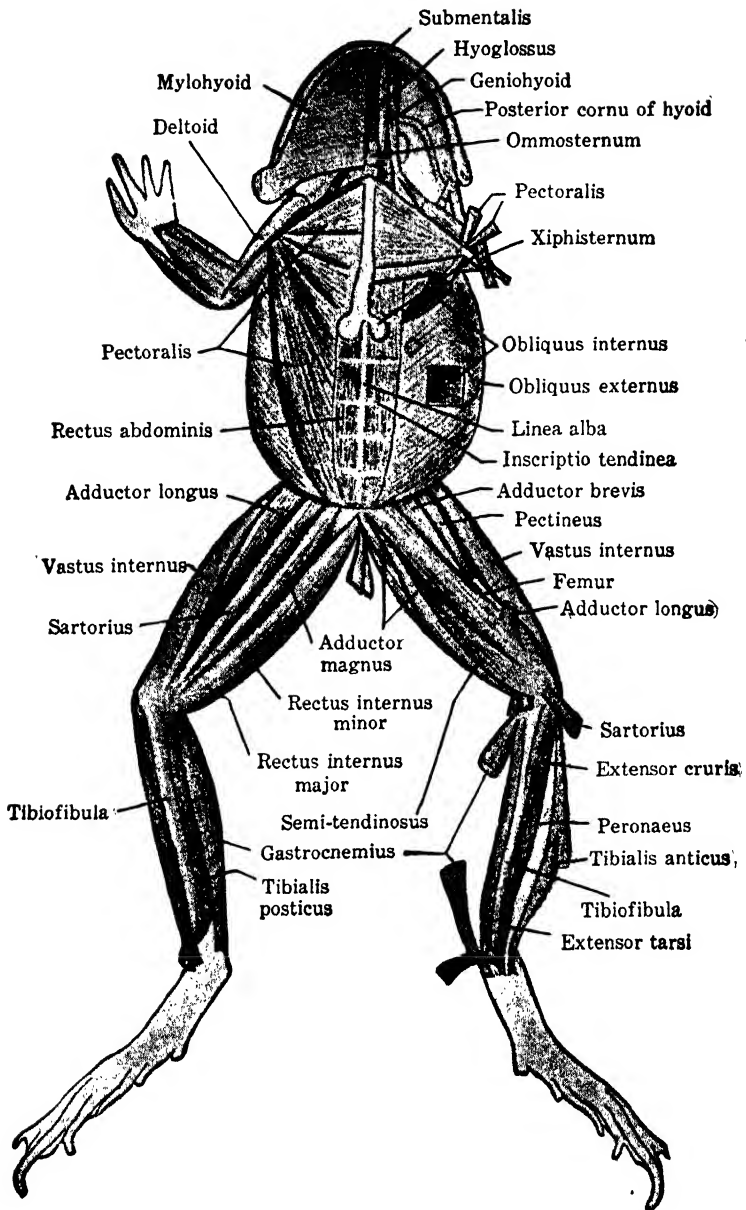

FIG. 98.—Muscles of the Frog, ventral view. (From Hegner, after Parker and Haswell.)

stages of higher forms the muscular layer is composed of segments known as MYOTOMES. But in the adult stage of the latter this evidence of Vertebrate segmentation largely disappears, since the muscular tissue for the most part assumes the form of highly

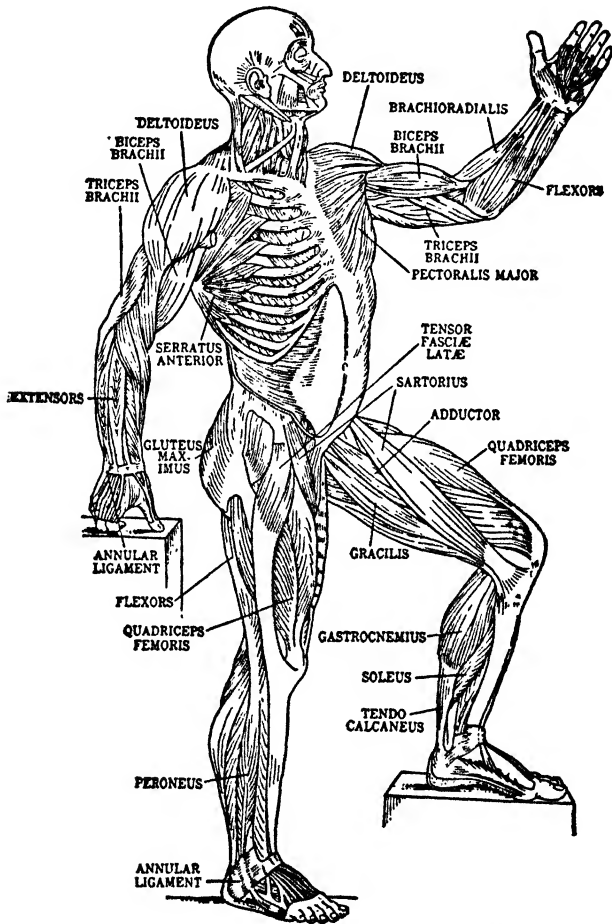

FIG. 99. — Muscles of Man. (Courtesy William Wood and Co.)

complex longitudinal bands, extensions from which pass into the paired appendages. (Figs. 94, 95.)

Muscles, such as those attached to the bones, in which contraction can be brought about at will, are termed **VOLUNTARY** muscles, while those which cause most of the movements of the viscera are

known as INVOLUNTARY muscles. From the standpoint of their microscopic structure, muscle cells are of three kinds. Voluntary muscles consist of STRIATED muscle cells, and involuntary muscles, except those of the heart, are composed of UNSTRIATED muscle cells. The cells of the heart approach somewhat in structure those of voluntary muscles and are known as CARDIAC muscle cells. (Figs. 7, 32, 98, 99.)

#### D. SKELETON

The form of the Vertebrate body is maintained by a system of supporting and protecting structures, termed the SKELETON. Although various outgrowths of the skin, such as scales, feathers,

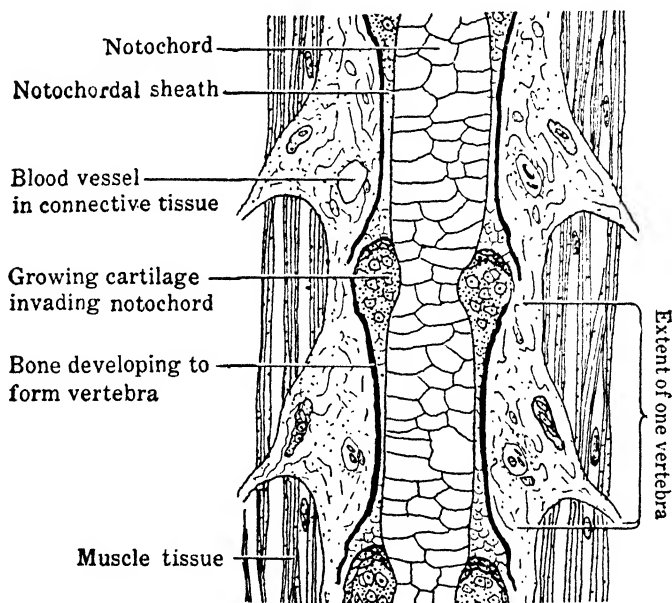

FIG. 100. — Diagram of a longitudinal section through a developing vertebral column to show the invasion of the notochordal sheath by cartilage to form the centra of the vertebrae.

and hair, form a part of the skeletal system known as the EXOSKELETON which is comparable to the protective coverings of the Invertebrates, it is a bony ENDOSKELETON which is characteristic of the higher animals. This internal skeleton, which is largely mesodermal in origin, exhibits such great diversity and complexity

that its study, known as **OSTEOLOGY**, forms an important subdivision of comparative anatomy.

In the lower Fishes the endoskeleton is composed of a firm elastic tissue, **CARTILAGE**, or gristle, but from the higher Fishes to Man most of the cartilage becomes **OSSIFIED**: that is, impregnated with lime salts and transformed into **BONE**. The human skeleton is formed of about 200 separate bones, but the number varies at different periods of life, because some bones which at first are distinct later become fused. (Figs. 103-105.)

While it is true that the bones constitute the main supporting framework of the body, they are entirely inadequate to knit together the organism into a working unit. We find therefore various kinds of connective tissue interwoven between the integral parts of the body. These tissues form sheaths about most of the organs and also supply the connecting links between muscle and muscle, muscle and bone — **TENDONS**; and bone and bone — **LIGAMENTS**. Supporting tissues, of which bone, cartilage, and connective tissue form the chief groups, are characterized by the development of large amounts of resistant non-living material in or between the

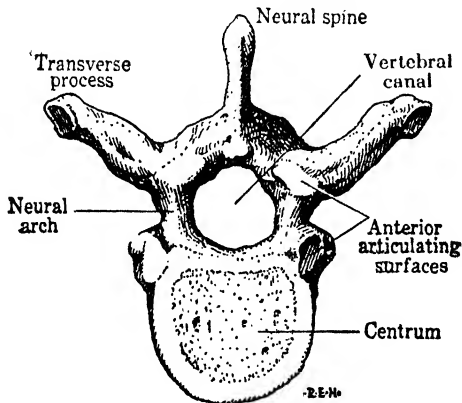

FIG. 101. — A typical human vertebra (tenth thoracic).

component cells themselves; the character of the tissue being determined chiefly by the nature of this matrix. (Fig. 32.)

The primitive axis of the skeleton consists of a cylindrical cord or rod of cells (**NOTOCHORD**), which lies in the mid-dorsal line of the body wall just below the brain and spinal cord and above the coelom. In most Vertebrates, however, the notochord in its



original form is only a temporary structure, being partially or completely replaced during later development by a linear series of cartilaginous or bony elements, known as VERTEBRAE, which form the VERTEBRAL COLUMN, or backbone. This is one of the most characteristic structures of Vertebrates as compared with Invertebrates, or backboneless animals. (Figs. 94, 95, 100.)

A typical vertebra of the higher animals consists of a basal portion, known as the CENTRUM, and a NEURAL ARCH which it supports. These form a protecting ring of bone about the spinal

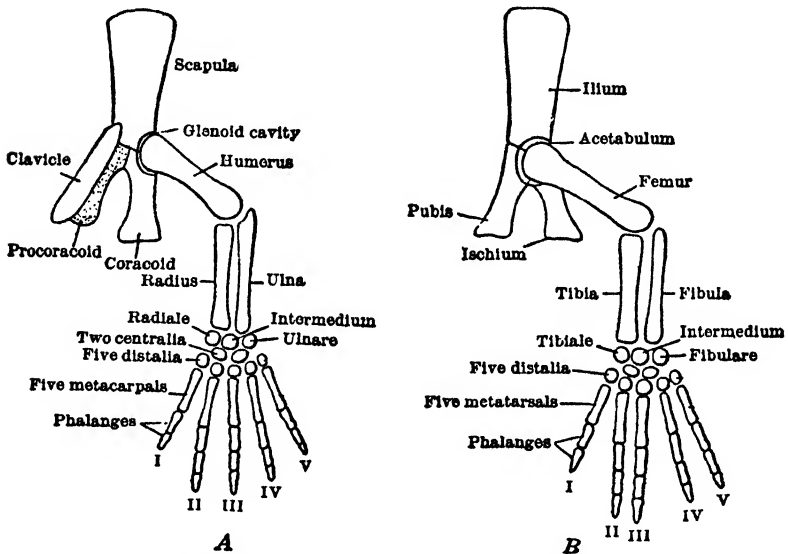

FIG. 102. — Diagram of the plan of the Vertebrate limbs. A, fore limb and pectoral girdle; B, hind limb and pelvic girdle. (From Hegner, after Parker and Haswell.)

cord. From various parts of the vertebra as a whole arise PROCESSES for movable articulation with its neighbors, the attachment of muscles, etc. Between the vertebrae of the Mammals are cushions of cartilage which absorb shock. (Fig. 101.)

In some forms, RIBS are attached to the transverse processes of certain vertebrae. These extend outward and downward within the body wall, and usually are attached in the ventral line to the breast bone (STERNUM). Thus, in the adult of the higher Vertebrates, the series of centra of the vertebrae come to occupy the position formerly held by the notochord; while above, the neural

arches form the VERTEBRAL CANAL containing the spinal cord; and below, the transverse processes, ribs, and sternum surround the anterior portion of the coelom. (Figs. 95, 101, 105.)

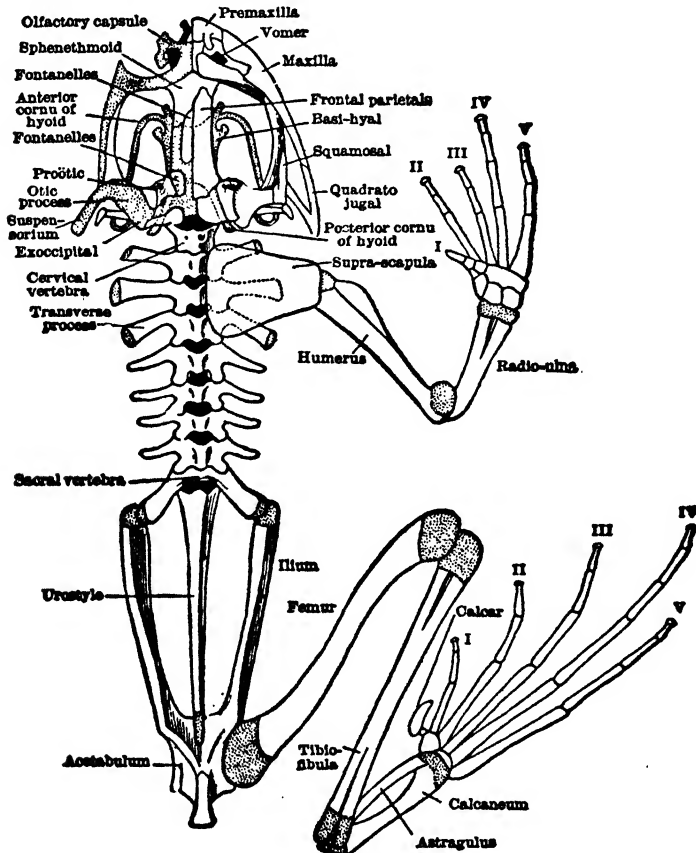

FIG. 103. — Skeleton of the Frog. Dorsal aspect; the left half of the shoulder girdle and the left fore and hind limbs are removed, as also are the membrane bones on the left side of the skull. Permanently cartilaginous parts dotted. (After Howes, slightly altered.)

The Vertebrate head, containing the anterior end of the alimentary canal and respiratory passages, and also the brain and chief sense organs, is protected in the lower Fishes by a case of cartilage. In higher forms the cartilage is replaced by a bony SKULL which articulates with the first vertebra of the backbone. JAWS, or supporting structures of the mouth, are attached to the skull.

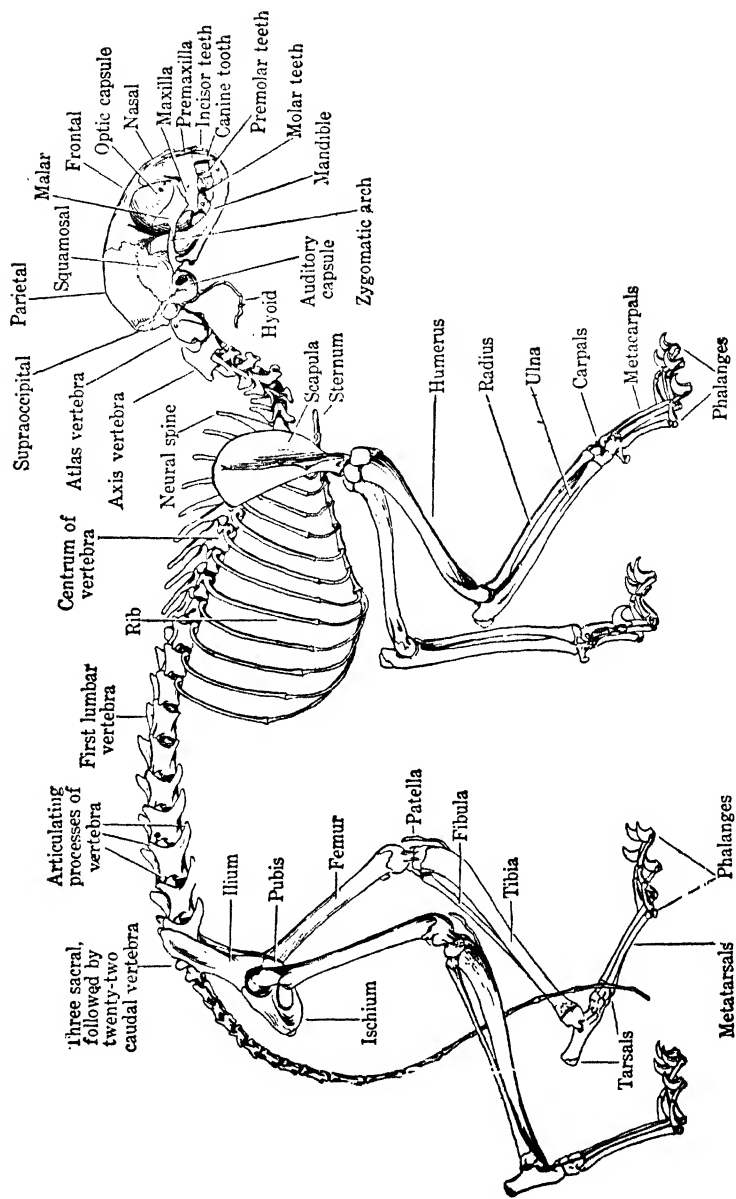

FIG. 104. — Skeleton of Cat.

The skull and vertebral column form the main SKELETAL AXIS from which is suspended the APPENDICULAR skeleton, or bony framework of the paired appendages (FINS or LIMBS) and their supporting structures (GIRDLES). This is relatively simple in the anterior (pectoral) and posterior (pelvic) paired fins of Fishes, which merely act as paddles; but when these are modified into paired limbs for progression on land, the mechanical problems involve the development of complex limb skeletons to support the body, and to act as levers for the limb muscles to move in locomotion. In response to this need an elaborate series of bones is developed which, in all cases, however, may be referred to a common plan, known as the PENTADACTYL LIMB in allusion to the five digits (FINGERS and TOES) in which it usually terminates. The limbs are attached directly or indirectly to the vertebral column by groups of bones which form respectively the PECTORAL and PELVIC GIRDLES. (Figs. 102-104, 227, 228.)

#### E. THE HUMAN BODY

Considering specifically the human body, we find that its outstanding characters are largely the result of Man's erect posture. True it is that the body is not perfectly adapted to its upright position, but this is more than compensated for by the complete division of labor between the upper and lower limbs that liberated the former from contributing to locomotion and gave the opportunity for the pentadactyl plan to attain its highest development in the human HAND. With its completely opposable thumb, the hand is directly or indirectly responsible for more of Man's unique characters than one usually realizes. It is an efficient grasping organ — a battery of tools that makes possible the use of artificial tools which, in a way, may be regarded as accessory organs, devised by the brain and appropriated or discarded at will.

But the hand is also a delicate 'sense organ' since touch is "the great confirmatory sense" underlying many of our sensory experiences with the world about us. "Tactile fingers are continually learning." Indeed, it is largely upon a basis of conscious and sub-conscious tactile sensations that much of the superstructure of the higher mental processes is reared. It seems clear that the erect posture and the facile hand have contributed in no small way to the supremacy of the brain and so to Man's outstanding position above the beasts. (Figs. 105, 125.)

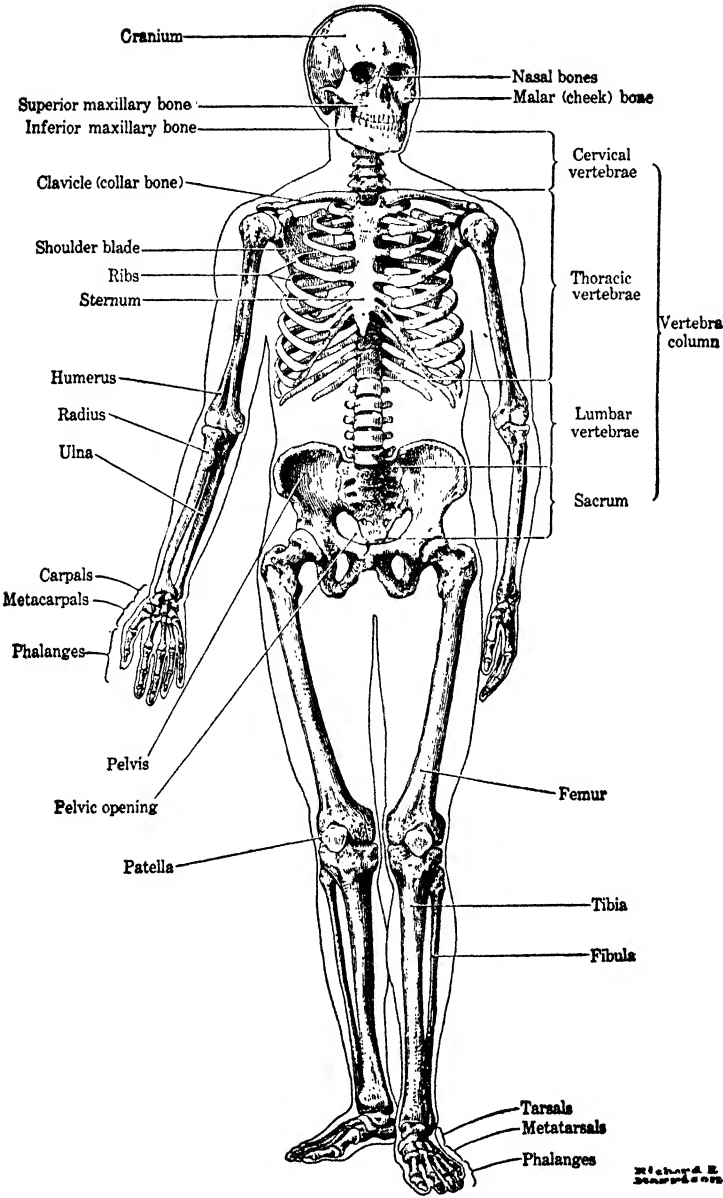

FIG. 105. — Skeleton of Man.

## F. DISTINCTIVE VERTEBRATE CHARACTERS

As a summary of this general outline of the structure of the Vertebrate body, we may emphasize three characters which are of prime diagnostic importance.

In the first place, whereas the skeletal structures of Invertebrates typically consist, as in the Crayfish, of an exoskeleton of hard non-living materials deposited on the surface of the body, the chief function of which is protection, the Vertebrate skeleton is primarily a living endoskeleton. It is an organic part of the organism which, although it affords protection for delicate parts, provides adequately for support and supplies muscle levers, and thus makes practicable the relatively large bodies of the higher animals. The notochord is at once the foundation and axis of the Vertebrate internal skeleton and either persists throughout life as such, or simply long enough to function as a scaffolding about which the vertebral column is built. In recognition of the prime importance of the notochord, the Vertebrates and their nearest allies (*e.g.*, the Tunicates and Amphioxus) are technically known as CHORDATES. (Fig. 67; Appendix I.)

In the second place, it will be recalled that the central nervous system of the Earthworm and Crayfish consists of a ventral nerve cord running along in the coelom below the digestive tract, except at the anterior end where it encircles the pharynx to form a dorsal brain. The position of the Vertebrate brain is similar, though the spinal cord is not a 'cord' but a nerve tube which lies in the vertebral canal embedded in the muscles of the body wall *above* the digestive tract and, of course, outside of the coelom. Thus the spinal cord itself and its location are highly characteristic.

The third fundamental characteristic is a series of perforations or slits through the throat and body wall. In the lower forms the gill slits provide an exit for the current of water entering by the mouth and, being richly supplied with blood, afford the chief means of respiratory interchange between the animal and the surrounding medium. In the higher Vertebrates the gill slits are present merely during a transient phase in the development of the individual, since the function of aërating the blood is taken over by the lungs. (Figs. 94, 117, 235.)

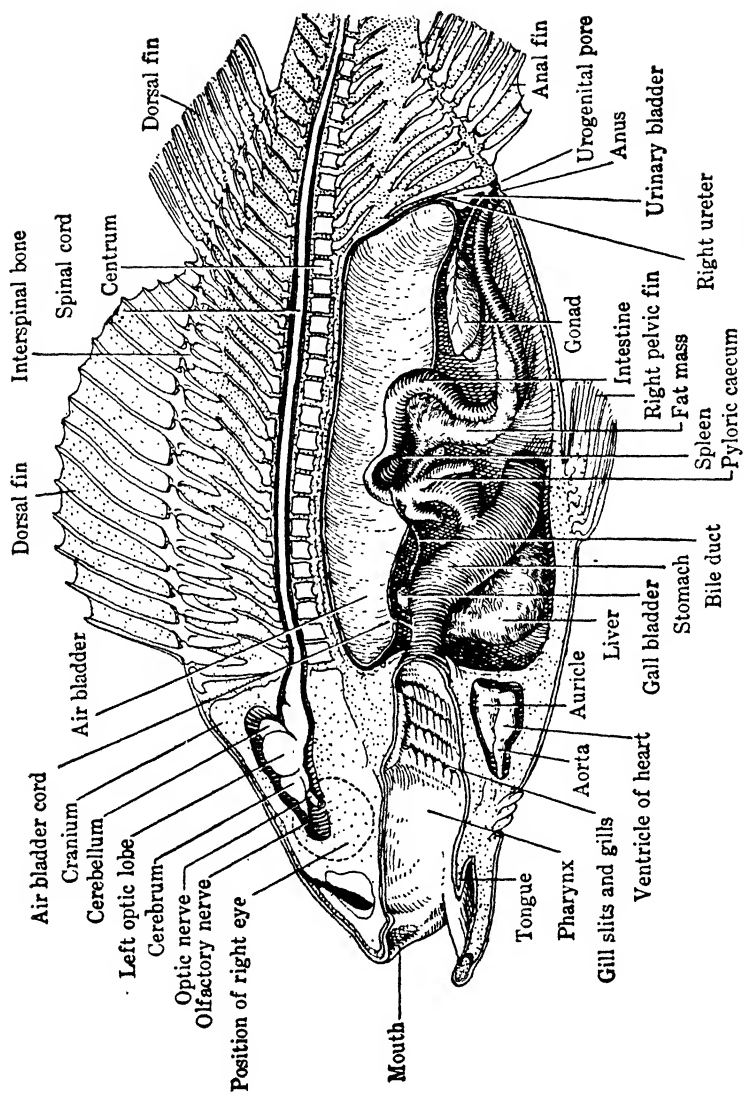

FIG. 106. — Dissection of a bony Fish, the Yellow Perch, *Percas flavescens*.

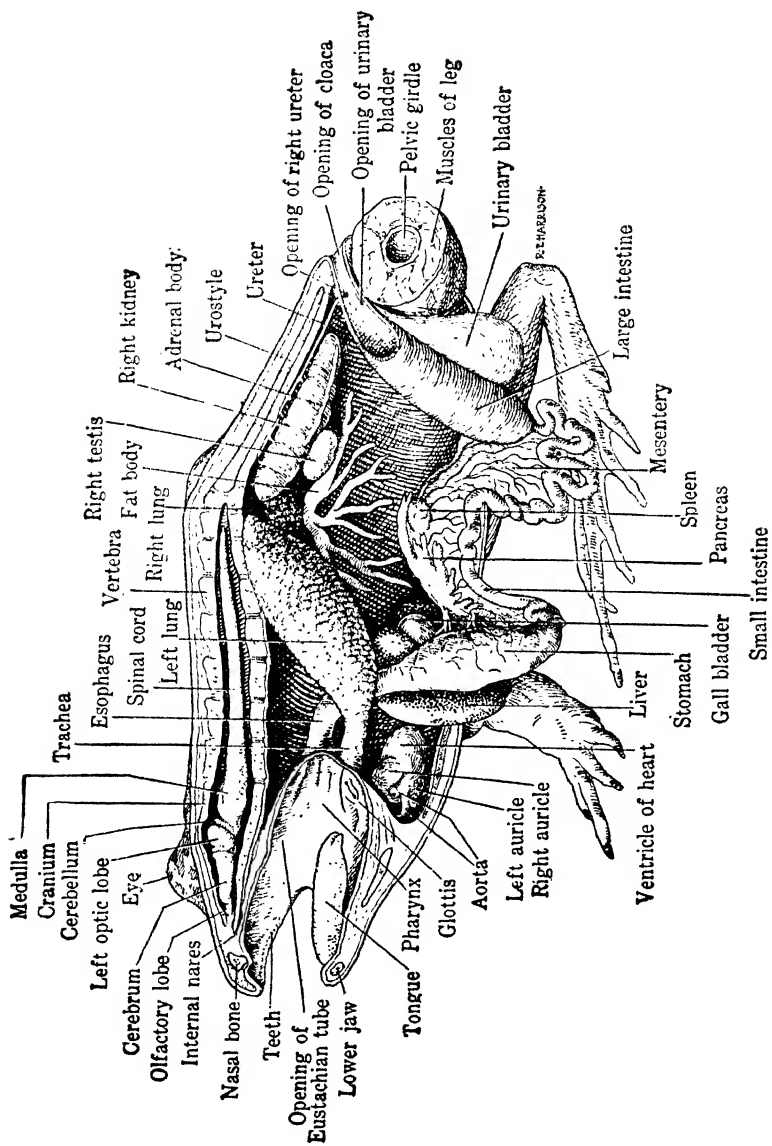

FIG. 107. — Dissection of an Amphibian, the Frog, *Rana clamitans*.



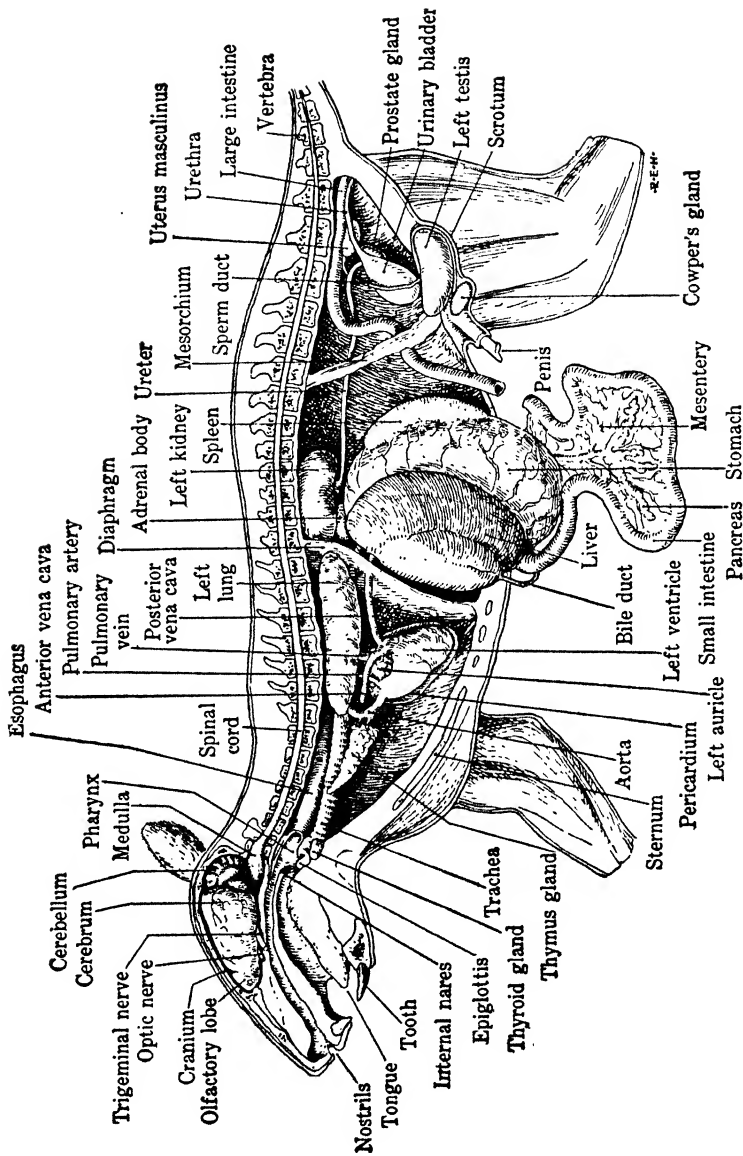

FIG. 108. — Dissection of a Mammal, the Gray Squirrel, *Sciurus carolinensis*. (Modified, after Linville and Kelly.)

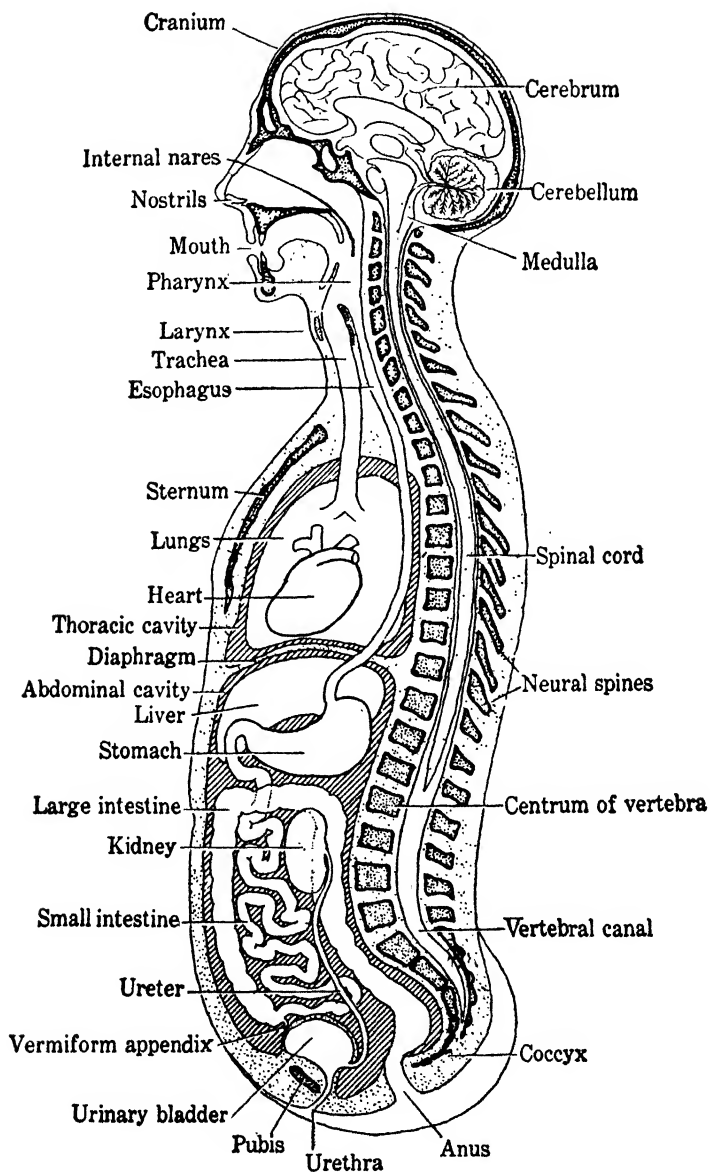

FIG. 109. — Diagrammatic median section of the human body.

## CHAPTER XI

### NUTRITION

It is a great satisfaction for me to know when regaling on my humble fare that I am putting in motion the most beautiful machinery with which we have any acquaintance. — *Dickens*.

AMONG the single-celled animals, such as Amoeba and Paramecium, nutrition is reduced to its simplest terms. The food material enters the cell and is acted upon by substances formed by the protoplasm in its vicinity: the food is chemically changed, or digested, so that it becomes available for the use of the cell. In Hydra a special layer of cells, the endoderm, is largely devoted to digestion. Although some of the endoderm cells actually engulf small particles of food and digest them within the cell (INTRACELLULAR DIGESTION), the major part of digestion is brought about within the enteric cavity by secretions from the endoderm cells. Digestion of the latter type (INTERCELLULAR) is characteristic of the Earthworm and all higher animals.

We have considered the form and supporting structures of the body wall of a typical Vertebrate — the outer tube which surrounds and contains the viscera — and therefore we recall that through this outer tube, just as in the case of the Earthworm and Crayfish, there runs from mouth to anus a second or inner tube, the digestive tract, or ALIMENTARY CANAL.

The alimentary canal is essentially a tubular chemical laboratory which passes the food on by its own muscular activity from one part to another. Each of these regions, in turn, supplies the chemical reagents which it uses both for changing the food into a soluble form so that it can pass through the walls and be distributed to the cells of the organism as a whole, and also for making it suitable for use by these cells. Indeed, the complex food materials which enter the human mouth run the gauntlet of a whole series of digestive fluids.

Although the various kinds of food eaten by animals differ widely in their chemical composition, nevertheless the process

of digestion is basically similar in every case: it is a process of **HYDROLYSIS**. This is a chemical reaction in which a molecule of the substance to be digested combines with a molecule of water to form a new compound. Then this splits into two or more simpler molecules and, by repeated hydrolyses, exceedingly complex food substances become relatively simple ones. Hydrolyses are brought about through the activities of special catalytic agents, the ferments, or **ENZYMES** — a special enzyme for each kind of chemical reaction being supplied by the alimentary canal. Moreover, the diverse enzymes, carrying out chemical simplification of various foodstuffs, produce just a few relatively simple substances: **AMINO ACIDS** from proteins, **FATTY ACIDS** and **GLYCEROL** from fats, and **SIMPLE SUGARS** from carbohydrates. (Fig. 113.)

The wall of the alimentary canal consists of three chief cellular layers: a lining epithelium, a connective tissue layer, and a muscular layer. The epithelium which lines the alimentary canal and its derivatives is the digestive tract proper in the sense that it is of basic functional importance in secreting the digestive fluids and in absorbing the products of digestion. The other layers perform accessory functions such as support, conduction of blood vessels, and movements of the canal. (Fig. 34.)

#### A. BUCCAL CAVITY, PHARYNX, AND ESOPHAGUS

The entrance to the alimentary canal is the mouth, a transverse aperture in the head, which leads into the mouth-chamber, or **BUCCAL CAVITY**, supported by the jaws. The buccal cavity gradually merges into the throat, or **PHARYNX**, which in the Vertebrates acts as a passage both for the food and the respiratory gases. The respiratory current of water in aquatic forms soon passes to the exterior by a series of perforations, the **GILL SLITS**, through the pharynx and body wall; while the respiratory current of air in higher forms enters the **LUNGS**. On the other hand, in all Vertebrates the preparation of the food for its passage through the alimentary canal starts in the buccal cavity. (Figs. 110, 117.)

The human buccal cavity is lined with a membrane, continuous at the **LIPS** with the outer skin, which is provided with unicellular glands that secrete **MUCUS**. This and **SALIVA**, secreted by three pairs of large **SALIVARY GLANDS**, lubricate the food so that it may be more readily moved about by the **TONGUE** for mastication by the teeth and passed on toward the **ESOPHAGUS**.

Furthermore, saliva contributes to the digestion of starches by an enzyme termed **PTYALIN**, which in the alkaline medium converts starch into a sugar, **MALTOSE**. But only a small proportion of the starch is digested by ptyalin during the rapid passage of

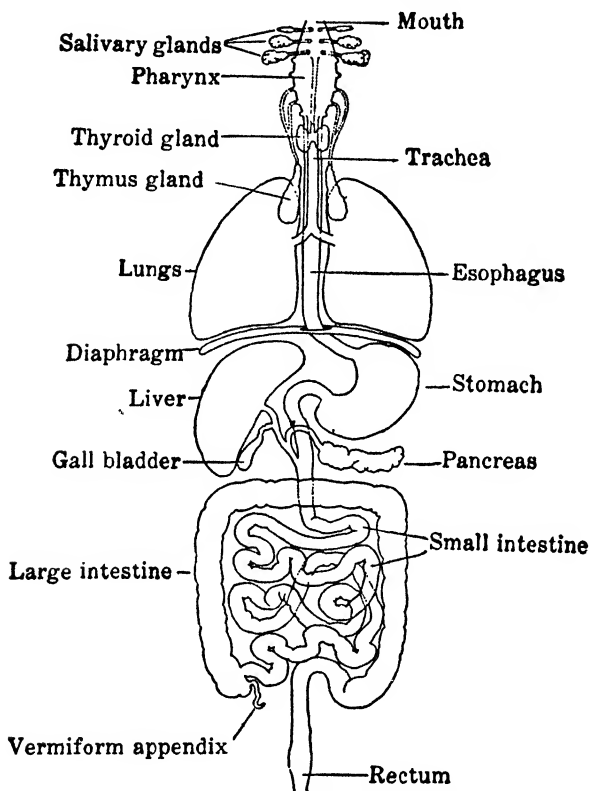

FIG. 110. — Diagram of the human alimentary canal and its derivatives. The pharynx shows the embryonic position of five pairs of gill pouches, the second pair probably giving rise to the tonsils, and the third and fourth to the thymus glands.

food through the mouth region, and the activity of the enzyme ceases soon after it reaches the stomach where the alkaline reaction of the mouth gives place to an acid reaction.

So the mouthful of food, masticated, moistened, and with some of its starch digested, is rolled by the tongue and passed along the pharynx into the **ESOPHAGUS**. Henceforth it is beyond voluntary recovery, because it is pushed along by involuntary rhythmical

contractions, **PERISTALSIS**, of the digestive tract wall. The esophagus is a muscular tube which passes posteriorly through the thorax, and rapidly delivers the food without further digestion to the **STOMACH**.

### B. STOMACH

The stomach, really the first stopping place of food that has been swallowed, is a thick-walled sac situated just below the diaphragm in Mammals. In common with most of the viscera, the stomach is suspended in the abdominal cavity by broad loops of a membrane, the **MESENTERY**, which is continuous with the peritoneal membrane lining the cavity. Within the mesentery, blood vessels, nerves, etc., pass to the stomach. (Figs. 106-110.)

Here the work of the digestive tract actively progresses by the action of specific chemical substances present in the **GASTRIC JUICE** which is secreted by innumerable **GASTRIC GLANDS**. The latter are tiny pits in the stomach wall lined with special glandular cells. Human gastric juice is a complex fluid comprising water — over 99 per cent; a protein-splitting enzyme, **PEPSIN**; a milk-curdling enzyme, **RENNIN**; common salt, **NaCl**; and a free acid, **HCl**. This array of components of gastric juice softens the food mass, gives it an acid reaction, curdles the milk, and simplifies the proteins — transforms, with the assistance of slow churning movements of the stomach wall, the average meal in the course of an hour or so into **CHYME** which gradually passes through the **PYLORIC VALVE** into the **INTESTINE**.

### C. SMALL INTESTINE

The human intestine is a much coiled tube, nearly twenty-five feet in length, that extends from the stomach to the anus, and it is in the upper part, known as the **SMALL INTESTINE**, that not only the most radical changes in the food take place — digestion is essentially completed; but also most of the products of digestion pass through its walls into the body proper — absorption occurs. Thus we find various glands to elaborate and secrete the digestive fluids — cells that take from the circulatory system not only the materials necessary for their own life but also other substances which they transform chemically for the use of the organism as a whole. Some are unicellular or simple multicellular tubular glands embedded in the intestinal wall; others are highly complex and far removed

from the intestine into which they pour their products through long ducts. But, as we know, even in the latter case the glands are really derivatives of the intestine — cellular areas sunk, as it were, below the membrane to which they really belong — because

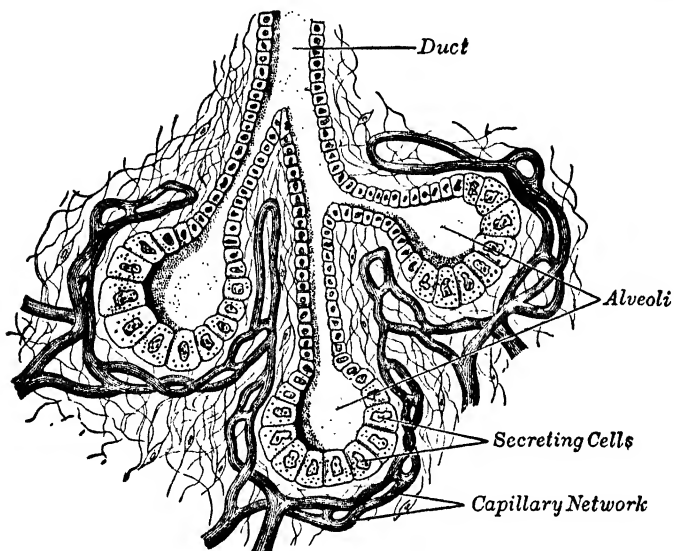

FIG. 111. — Diagram of a gland, in section, together with the surrounding tissues. Highly magnified. See Fig. 33. (From Hough and Sedgwick.)

they arise during development as outpocketings of its wall: the ducts being the sole remaining connection with the point of origin. (Figs. 111, 112.)

### 1. *Liver and Pancreas*

The largest gland in the body, the LIVER, and an equally important one, the PANCREAS, pour their secretions into ducts which unite to form a single duct. This carries the secretions to the upper part of the small intestine. The secretion of the liver, termed BILE, which is constantly formed but may be stored until needed in the GALL BLADDER, is a highly complex mixture of substances. Some of them are waste products on their way out of the body through the intestine, while others contribute to digestion by cooperating with an enzyme from the pancreas. Thus bile salts aid in the emulsification of fats and the absorption of fatty acids. However, the liver is still more versatile, as will appear beyond.

The pancreas, or sweetbread, may be regarded as the chief digestive gland in the Vertebrate body though it also performs additional functions. The gland lies just below the stomach in Man, and each day secretes into the small intestine nearly two pints

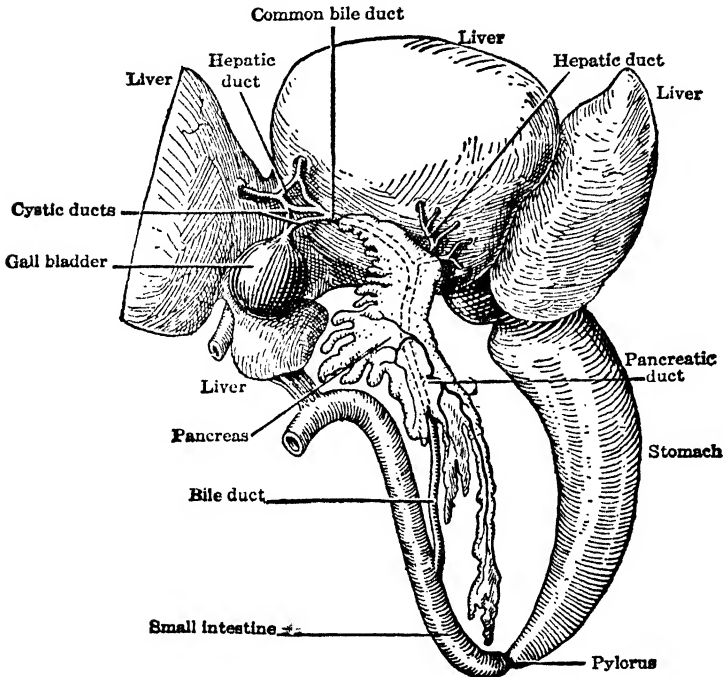

FIG. 112. — Liver and pancreas of the Frog, showing their ducts. Lobes of liver turned forward. The cystic ducts unite with hepatic ducts and finally lead into the common bile duct. The latter passes through the pancreas, receives further hepatic ducts and the pancreatic duct and leaves the pancreas, opening into the upper part of small intestine.

of strongly alkaline PANCREATIC JUICE containing three enzymes — TRYPSIN acting on proteins, AMYLASE on starches, and LIPASE on fats. (Fig. 113.)

Thus food that has run the gauntlet of the enzymes of the upper digestive tract is now attacked by the pancreatic juice. But this is not all: the process of progressive simplification of the food is carried on by the secretions of innumerable minute glands embedded in the intestinal wall. This INTESTINAL JUICE supplies several enzymes — the EREPSIN group to change the protein products into amino acids, and the others to convert complex sugars into simple



sugars. And, as in the stomach, digestion is facilitated by muscular contractions of the intestinal wall. There are slow swayings of entire loops of the intestine; there are local 'segmentation' contractions; and finally there are peristaltic waves that pass the material along for absorption or elimination.

One naturally wonders how it is that the living tissues of the digestive tract, and especially of the glands themselves, withstand

LOCATION	SECRETIONS	ENZYMES	SUBSTANCES CHANGED	INTER-MEDIATE PRODUCTS	PRODUCTS READY FOR ABSORPTION
Mouth	Saliva	Ptyalin	Starch	Maltose	
Stomach	Gastric juice	Pepsin Rennin	Protein Protein of milk	Proteoses Peptones Casein	
Small intestine	Pancreatic juice	Amylase	Starch	Maltose	
		Lipase	Fats		Fatty acids and Glycerol
		Trypsin	Proteins		Amino acids
	Intestinal juice	Erepsin group	Proteoses Peptones Casein		Amino acids
		Maltase Sucrase Lactase	Maltose Cane sugar Milk sugar		Simple sugars

FIG. 113. — Chief chemical activities of the human digestive tract.

the digestive activities of their own enzymes, although the stomach or intestine of an animal killed during active digestion will begin self-digestion. A partial explanation of immunity during life appears to be that the enzymes are not in an active form while they are within the glands, but are later activated by certain conditions that they meet in the digestive tract when food is actually present.

## 2. Absorption

The purpose of digestion is, first, to make the food soluble so that it may enter the body proper: pass through the epithelium lining the digestive tract wall; and, second, to put it into a chemical form that can be used by the cells. The passage into the body, or **ABSORPTION**, occurs chiefly in the small intestine, the walls of which are lined with millions of minute projections, or **VILLI**, that bring tiny vessels into intimate contact with the absorptive membrane while greatly increasing the effective absorptive surface. Apparently absorption is not merely the result of simple physical processes such as diffusion and osmosis, but is largely the function of the actual living cells forming the epithelium of the villi. (Figs. 114, 144.)

## 3. Distribution

The transportation system of vessels in the villi consists of **BLOOD** vessels which take up the absorbed products of protein and carbohydrate digestion, and **LYMPH** vessels, here called **LACTEALS**, which receive the derivatives of the fats. Both also take absorbed water and salts.

Accordingly the path through which the proteins and carbohydrates are transported differs from that of the fats. The blood vessels returning blood from the digestive organs finally merge to form a large vessel, the **PORTAL VEIN**, which proceeds to the liver to allow that organ to regulate certain of the blood constituents — in particular to store up sugar, in the form of **GLYCOGEN**, after a meal and later dole it out to the blood as conditions demand. On the other hand, the lacteals merge into larger and larger lymph vessels and finally into the **THORACIC DUCT** which empties into the blood vascular system — the fats being switched, as it

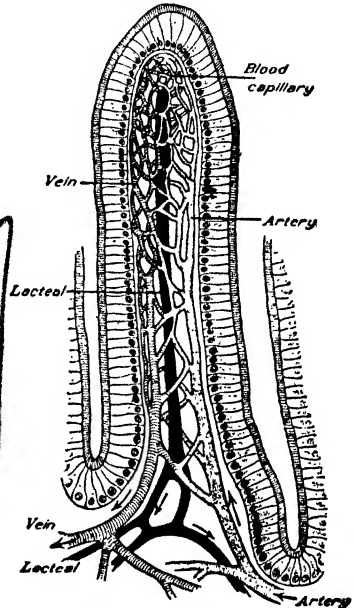

FIG. 114. — Diagram of a section through a villus. (From Peabody and Hunt.)

were, around the liver so that they do not directly enter the blood supply to that organ. (Fig. 115.)

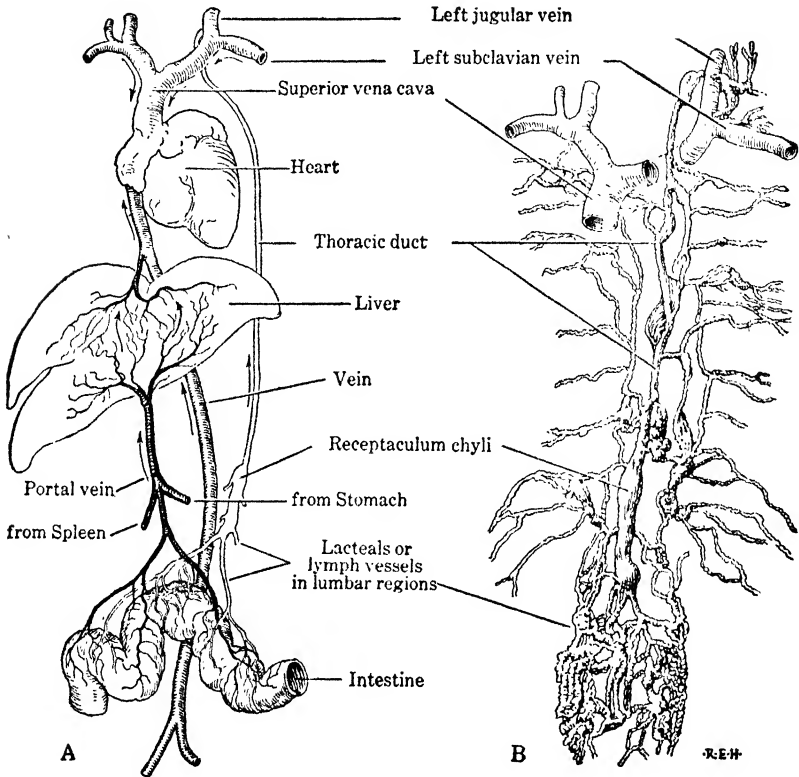

FIG. 115. — A, diagram of paths of absorbed food from the human digestive tract. Proteins and carbohydrates by veins; fats by lymphatics. B, plan of distribution of the chief lymphatic vessels in the human body.

#### D. LARGE INTESTINE

During the passage of food through the small intestine, digestion is practically completed and absorption has progressed far. The remaining material is carried through a constriction into the LARGE INTESTINE, or COLON, where the activities of Bacteria bring about various chemical changes apparently incidental to the slow passage of the residue. Furthermore, water is gradually absorbed — water that up to this point has been necessary to keep the materials fluid to facilitate digestion. Then the useless undigested

materials, or **FECES**, are carried to the exterior either through a terminal cavity, the **CLOACA**, into which also open the urogenital ducts, or directly out through the anus as in most Mammals.

### E. FOOD USE

Digestion, absorption, and distribution completed, the actual food supplying matter and energy is at the disposal of the various cells for carrying on the essential metabolic processes. Since the daily energy output of the average man not carrying on heavy physical labor is about 3000 calories, and the energy yield per gram for proteins and carbohydrates is about 4.1 calories, and for fats about 9.3 calories, it is not difficult to determine from these fuel values how much of each foodstuff, or mixture of them, is required to supply the necessary energy. But, of course, provision must also be made for tissue maintenance and this draws upon the proteins with their nitrogen constituent. In general it may be said that, since carbohydrates and fats adequately supply the energy demands, protein consumption need not greatly exceed the nitrogen required for tissue maintenance.

Moreover the body also requires small amounts of certain so-called accessory food substances, or **VITAMINS**, which are usually present in sufficient quantity in a normal mixed diet. Vitamins are organic substances, not related chemically to one another, that do not supply energy or structural material, but are necessary for cell metabolism. The exact chemical constitution of most vitamins is unknown.

**VITAMIN A** has an effect on many of the membranes of the body, a deficiency resulting in glandular disturbances and in lowered resistance to infection. Rich sources are cod liver oil, carrots, and butter. **VITAMIN B<sub>1</sub>** prevents an inflammation of the peripheral nerves and paralysis known as *beri-beri*, as well as disturbances of the functions of the intestine and kidneys. Excellent sources are whole grain cereals, milk, and liver. **VITAMIN B<sub>2</sub>** is usually associated with **B<sub>1</sub>**. Inadequate amounts give rise to the disease called *pellagra*, of which brown pigmentation of the skin, general weakness, digestive disturbances, and paralysis are symptoms. It is readily available in egg-white, milk, lean meat, and green vegetables. **VITAMIN C** prevents *scurvy*, a disease marked by loosening of the teeth and hemorrhages in the joints. It has proved to be a hexuronic acid that is present in most citrus fruits and green

vegetables. VITAMIN D in inadequate amounts results in *rickets*, a disease characterized by various skeletal deformities. Oil from the liver of the cod and halibut are rich sources, and the action of ultra-violet rays on certain sterols produces the vitamin, so the exposure of the human body to sunlight, within reasonable limits, is beneficial.

#### F. DUCTLESS GLANDS

Finally, we must not overlook certain accessories of the alimentary canal which lose all direct connection with it as development proceeds — really glands that have carried, as it were, the process of outpocketing from the digestive tract to the breaking point and become DUCTLESS GLANDS. Such, for instance, are the THYROID and THYMUS glands near the anterior end of the esophagus. The thymus in Man regresses during early childhood, while the thyroid delivers its secretion, a HORMONE, directly into the blood stream as an INTERNAL, or ENDOCRINE SECRETION. We shall have occasion later to discuss the important coördinating functions carried out by hormones secreted by ductless glands and other endocrine organs. At the moment we may merely remark that the pancreas is stimulated to secrete its digestive enzymes by a hormone, known as SECRETIN, brought to it by the blood. Secretin is liberated into the blood by special gland cells in the wall of the small intestine when food enters. (Fig. 110.)

Certainly, at first glance, the complicated digestive system of the Vertebrate may seem to have little in common with that of the Earthworm, but as a matter of fact the fundamental plan is the same. The differences which are present are chiefly the result of an increase of the area of the alimentary canal, not only to afford greater secretive and absorptive surface and a larger variety and amount of digestive substances, but also to prolong the length of time the food is subjected to treatment. This increase in area has been effected by folds and elevations of the inner surface of the tract; by outpushings of limited areas of the tube to form large glands which in most cases contribute their products to their point of origin through ducts; and by increasing the length of the inner tube as compared with the outer tube, or body wall, which results in throwing the intestine into various convolutions within the body cavity. Thus is met the increasingly complex nutritional demands of more highly organized animals.

## CHAPTER XII

### RESPIRATION

The living body is the theatre of many chemical and physical operations in line with those of the inorganic domain. — *Thomson.*

As we have seen, the essential factor of respiration is an interchange of gases between protoplasm and the environment: an intake of free oxygen for combustion, and an outgo of the waste products, chiefly carbon dioxide and water. In the unicellular organisms, such as *Protococcus* and *Amoeba*, and in simple multicellular animals like *Hydra*, this appears to be a relatively simple process since an elaborate mechanism is not necessary to facilitate the interchange. But with the establishment of a highly differentiated multicellular body, fewer and fewer cells are in direct contact with the aërating medium and so various provisions are necessary to transfer the gases to and from the outer world and the individual cells themselves.

In all forms the SKIN functions to some extent; in the Earthworm, in fact, it acts as the chief respiratory membrane since a profuse supply of blood vessels to the moist surface of the body effects a sufficiently rapid gaseous interchange for the relatively inactive life of the organism. The Crayfish meets the problem of respiration by finger-form outpocketings of the body wall, the GILLS: a method of bathing a large area of the respiratory membrane in the respiratory medium, the surrounding water. Insects, however, instead of bringing the blood to the surface, develop a network of tubes, or TRACHEAE, which ramify throughout the body tissues and conduct air directly to the cells. (Fig. 116.)

Among the lower Vertebrates, as has been indicated, the anterior end of the digestive tract functions as a common food and respiratory passage. In Fishes, the respiratory water current which enters the mouth makes its exit by way of the gill pouches and gill slits; the lining of the pouches — outpocketings of the lining of the alimentary canal — functioning as the respiratory membrane. (Fig. 117.)

Among the air-breathing Vertebrates there are the added

problems of protecting and keeping moist the greatly increased respiratory surface which their more active metabolism — proportionally greater energy requirements — demands. Accordingly the gill slits persist merely as transient embryonic reminders of evolutionary history; the function of the gill pouches being taken over by a huge outpocketing of the ventral wall of the pharynx into the anterior portion of the body cavity, which constitutes the

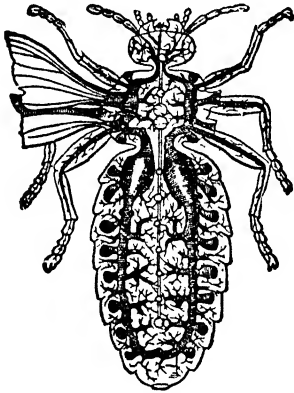

FIG. 116. — Diagram of the respiratory (tracheal) system of an Insect. The other internal organs are omitted.

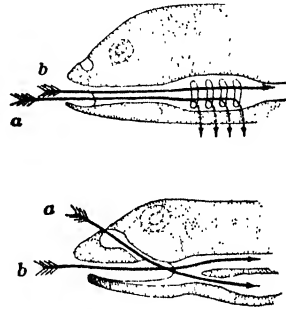

FIG. 117. — Diagram of a vertical section through the head region of Fish (above) and Reptile or Bird (below) to show the paths of the respiratory currents (a) and food (b). See Fig. 109.

**LUNGS.** Thus, even in Man, the respiratory membrane which lines the lungs is, from the standpoint of development, a specialized part of the epithelium of the alimentary canal. Furthermore, the establishment of lungs entails, in turn, a complex respiratory mechanism so that the air within them may be changed at frequent intervals. (Fig. 235.)

#### A. LUNGS

In the human respiratory process, air after entering the nostrils, **ANTERIOR NARES**, passes along the nasal passages and out the **POSTERIOR NARES** into the lower part of the pharynx. Air may also enter through the mouth. From the pharynx it passes over the **EPIGLOTTIS**, and through the slit-like **GLOTTIS** into the **LARYNX**, or so-called Adam's apple, and then down the windpipe, or **TRACHEA**. Within the larynx are the **VOCAL CORDS** which vibrate in response to air currents; the amplitude of the vibrations and the tension of the cords being responsible for the **VOICE**. (Fig. 109.)

As the lower end of the trachea enters the chest, or **THORAX**, it divides into right and left branches, the **BRONCHIAL TUBES**, which thereupon directly enter the lungs, each of which is a bag of elastic, spongy tissue. Within the lungs, the bronchial tubes divide into smaller and again smaller branches, until finally they form microscopic twigs, each ending in one or more tiny air sacs, or **ALVEOLI**. Thus there are many thousands of alveoli in the human lungs,

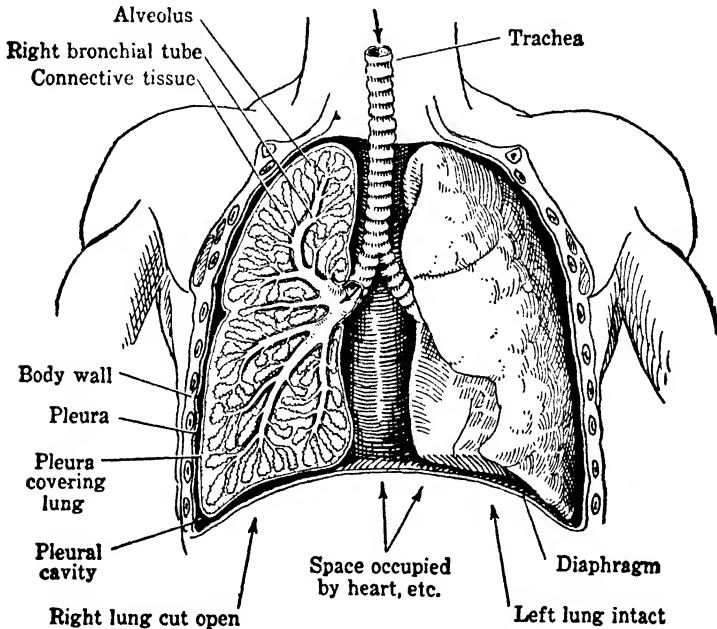

FIG. 118. — Diagram of a vertical section through the human thorax, showing lungs and associated structures.

everyone in direct communication with the outer air. Furthermore, each alveolus is profusely supplied with tiny thin-walled blood vessels, or **CAPILLARIES**, through which flows blood sent by the heart and soon to return to the heart so that it may be distributed to every part of the body. It is while the blood is in the capillaries of the alveoli that it gives up to the air in the alveoli carbon dioxide, water, and heat taken from the tissues, and at the same time receives oxygen. This is effected through the delicate walls of the capillaries and alveoli. So the alveoli are really the effective surface of the lungs. (Fig. 118.)



## B. RESPIRATORY MECHANISM

In order for the lungs to play their part in respiration, it is evident that the air within them must be periodically renewed, and this rhythmical process of **INHALATION** and **EXHALATION** is what one usually refers to as breathing. The complex mechanism involved and its method of operation may be briefly outlined.

The lungs are elastic sacs suspended in an air-tight cavity, the thorax, which can be enlarged by raising the **RIBS** and lowering the **DIAPHRAGM**, a muscular partition between the thoracic and

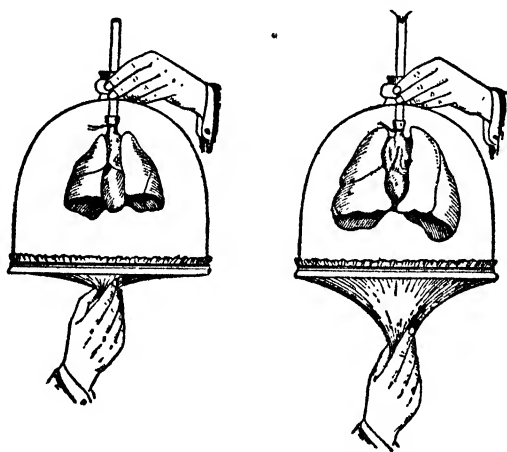

FIG. 119A. — Diagram to illustrate the mechanism of diaphragm breathing. The lungs of a Mammal are enclosed in a bell-jar. As the rubber membrane below (representing the diaphragm) is pulled down enlarging the cavity, air enters through the tube (trachea) and expands the lungs. (From Conn and Budington, after Tigerstedt.)

abdominal cavities. The sole entrance to the lungs is through the trachea, and accordingly an atmospheric pressure of approximately fifteen pounds to the square inch is exerted down through the trachea on the inner walls of the lungs and keeps them constantly in close contact with the walls of the thoracic cavity — otherwise there would be a vacuum between the lungs and the thoracic wall. Therefore when the thoracic cavity is enlarged by contraction of the muscles of the ribs and diaphragm, the elastic lungs expand in maintaining contact with its walls — inspiration takes place; and when the thoracic cavity is decreased, by relaxation of the same muscles, expiration occurs. The lungs play an entirely passive

part in the process. Of course, if through injury the thorax is punctured, then there is equal atmospheric pressure on both sides of the walls of the lungs, and they collapse. (Fig. 119A.)

Since the rhythmical respiratory movements are due to the contractions of muscles, it follows that stimuli reach the muscles from the nervous system; because muscles, excepting those of the heart and alimentary canal, do not contract automatically. Now we know that nerve impulses arise in the so-called RESPIRATORY CENTER in the lower part (MEDULLA) of the brain, just before it merges into the spinal cord, and pass by nerves to the muscles involved. Usually it is the oxygen-carbon dioxide content of the blood reaching the respiratory center which determines the rate of the respiratory movements that it induces; though there are nerves that carry nerve impulses from the lungs which contribute to the rhythm of breathing by holding in check the activities of the center itself. Indeed, the center can be influenced by stimuli

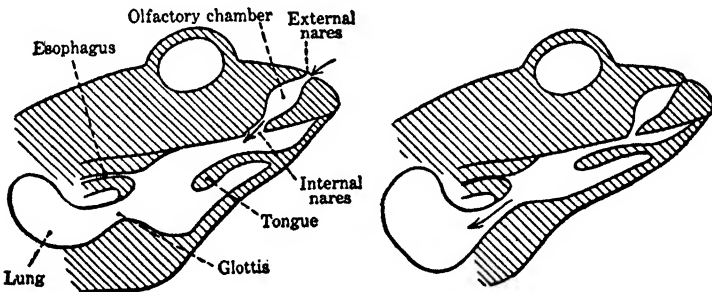

FIG. 119B. — Diagram to illustrate the respiratory movements of the Frog. At left, the external nares are open and air enters the buccal cavity. At right, the external nares are closed and the floor of the buccal cavity raised, forcing air into the lungs. Note that absence of diaphragm and air-tight thoracic cavity necessitates an entirely different mechanism from that in Mammals. (From Hegner.)

from nearly any part of the body: witness the effect of a cold plunge on breathing. The action of the center is, of course, chiefly involuntary since we breathe when we are asleep; but obviously it can be controlled to a considerable extent by the will because we can 'hold the breath' for some time by sending impulses to the respiratory center which inhibit its discharge. If this center is destroyed or the nerves are severed, respiratory movements immediately and permanently cease.

## C. RESPIRATORY INTERCHANGE

The respiratory mechanism has attained its objective when air and blood are brought into such close relationship in the lungs that gaseous interchange can occur, and heat be transferred. Inhaled air varies very widely in temperature but in our homes is perhaps most frequently about 20° C. (70° F.). Exhaled air is about 36° C., or very nearly the same as that of the human body. Thus under usual circumstances the exhaled air is warmer than when it entered the lungs — the blood has lost heat. Again, the amount of water in the inhaled air is variable, being low on a dry day and high on a wet day; but the exhaled air is practically saturated with water vapor — the blood has lost water. Furthermore, the inhaled air contains merely a trace of carbon dioxide, while when it leaves the lungs it bears about 4 per cent — the blood has given up carbon dioxide. And finally, air entering the lungs comprises approximately 20 per cent oxygen, while when exhaled there is only about 16 per cent — the blood has received oxygen. In short, the blood by its traffic with the air in the lungs gives up heat, moisture, and carbon dioxide, and takes up oxygen.

One naturally is interested to know how the blood while passing through the lungs acquires the oxygen, since this is the element demanded by every cell in its life processes. At least two phenomena are involved. In the first place, the air contains a considerable amount of oxygen under relatively high pressure and therefore some oxygen passes into the liquid plasma of the blood where the oxygen conditions are just the opposite. But the amount of oxygen gained in this way by the blood is by no means equal to the demands of the tissues, and so the emergency is met by special blood cells, known as **RED BLOOD CORPUSCLES**, of which there are many trillions in the human body. These carry a complex chemical substance, **HEMOGLOBIN**, which has a high chemical affinity for free oxygen: it is oxidized to form an unstable chemical compound, **OXYHEMOGLOBIN**. Accordingly the millions of red blood corpuscles leave the lungs with the oxygen affinity of the hemoglobin satisfied and return to the heart to be distributed throughout the body.

The oxygen is actually delivered to the tissue cells through the capillaries in the tissues where the oxygen content is low — just the opposite of the condition in the lungs — because the various cells use the oxygen nearly as rapidly as it is received. So the

corpuscles give up their oxygen — oxyhemoglobin is reduced to hemoglobin — and the blood receives in exchange, as it were, carbon dioxide, and also water and heat resulting from oxidative processes — combustion — in the tissue cells. The carbon dioxide is carried by the red blood corpuscles, and also by the blood plasma in combination with sodium as sodium bicarbonate. (Fig. 126.)

And now the blood, after its passage — lasting about two seconds — through the capillaries, proceeds on its way back to the heart which sends it to the lungs so that it can transfer to the air in the alveoli water, heat, and carbon dioxide. The latter passes to the air because it is under higher tension in the blood than in the air. The respiratory cycle is complete.

Such, in brief, is the elaborate apparatus present in the higher animals, and Man, to provide for the new conditions arising because of the removal of many of their component cells further and further from the source of oxygen, and the demand for more and more facilities for securing it as their life processes increased in activity. We shall have occasion later to consider the attendant changes in the blood vessels; but now it is only necessary to be sure that the mechanism does not obscure its object — to reiterate that, although one ordinarily thinks of the movements involved in the renewal of the air in lungs as respiration, it is neither inhalation and exhalation, nor the interchange of gases between blood and air or between blood and tissue cells. The essential feature of respiration is the same here as it is in unicellular plants and animals: the protoplasm of each and every cell of the body securing energy from food by combustion, involving the appropriation of oxygen and the liberation of carbon dioxide. All else is accessory — though necessary.

## CHAPTER XIII

### CIRCULATION

I finally saw that the blood, forced by the action of the left ventricle into the arteries, was distributed to the body at large, and its several parts, in the same manner as it is sent through the lungs, impelled by the right ventricle into the pulmonary artery, and that it then passed through the veins and along the vena cava, and so round to the left ventricle . . . which motion we may be allowed to call circular.

— *Harvey*, 1628.

IN the Protozoa and many of the lowest Metazoa, the transport of materials to and from the various parts of the organism is obviously a simple problem compared to that presented by animals with deeply-hidden tissues, each and every cell of which must be served. Indeed a complex body is impossible without a complex CIRCULATORY SYSTEM, and we now proceed to a summary of how the problem is met, particularly in the Vertebrates.

The crucial points of contact between the higher animal and its environment, in so far as the intake of matter and energy is concerned, are the membranes which line the digestive tract and a large diverticulum from it, the lungs. Through the former must pass all the materials which are to be assembled as integral parts of the organism and the fuel which is to supply the energy for the vital processes, while through the latter must pass the oxygen which is to release this energy. Only when these membranes have been passed are the materials really within the body and at its disposal for distribution by the circulatory system to the individual cells of the various organs which are to use them.

In addition to carrying the fuel and the oxygen, the circulatory system must remove the waste products of metabolism from the cells and deliver them to the proper excretory organs, such as the lungs or kidneys, to be passed to the outside world. The circulatory system is therefore the essential connecting link between the points of intake, utilization, and outgo of materials.

And incidentally, as it were, the circulatory system is also a coördinating agent of crucial importance, because it distributes

complex chemical substances, known as **HORMONES**, from their specific points of origin in the various endocrine glands to the particular tissue or organ where their regulatory influence is to be effected. So the circulatory system is a distributing system which not only maintains a suitable environment for the myriads of cells of the body, but also, in coöperation with the nervous system, unifies the organs into an organism. (Fig. 126.)

Various stages in the development of a circulatory system can be traced in the Invertebrates. In some it consists merely of a single cavity or several connected cavities filled with a fluid containing various types of cells, while in others more and more of the spaces are replaced by definite tubes, or **VESSELS**, for the conduction of the fluid. With the establishment of closed vessels, the contractions of various organs and the movements of the body as a whole can no longer be entirely depended on for the movement of the fluid, and accordingly, in certain regions, a *muscular layer* is developed in the walls of the vessels, which by rhythmic pulsation forces the fluid along. Thus, for example, in the Earthworm there is a fluid (**COELOMIC FLUID**) within the body cavity, which is forced about by the movements of the worm and bathes most of the internal organs; and also a system of vessels (**VASCULAR SYSTEM**), a part of which contracts rhythmically and distributes the **BLOOD** to the individual cells. (Figs. 59, 60.)

In the Vertebrates circulation is effected by two systems, the **BLOOD VASCULAR** and the **LYMPHATIC** systems. The blood vascular system consists of vessels which distribute the blood composed of a liquid plasma, in which float various formed elements, chiefly **RED** and **WHITE** cells. The lymphatic system comprises spaces, channels, and vessels in the lower Vertebrates, but in the Mammals, including Man, it is essentially a network of vessels so that in higher animals the so-called *closed* circulatory system gradually takes the ascendancy over the predominately *open* circulatory system of lower forms. The lymphatics carry **LYMPH** which consists of a liquid plasma with white cells. Both systems are closely associated, but the lymphatic plays a relatively passive rôle, so it is the blood vascular system that one ordinarily has in mind when speaking of 'the circulatory system.' (Figs. 7, 114, 115, 120, 125, 126.)

The essential elements of the blood vascular system are, first, a muscular organ for propulsion of the blood, the **HEART**, which lies near the mid-ventral line in the anterior part of the coelom; and,

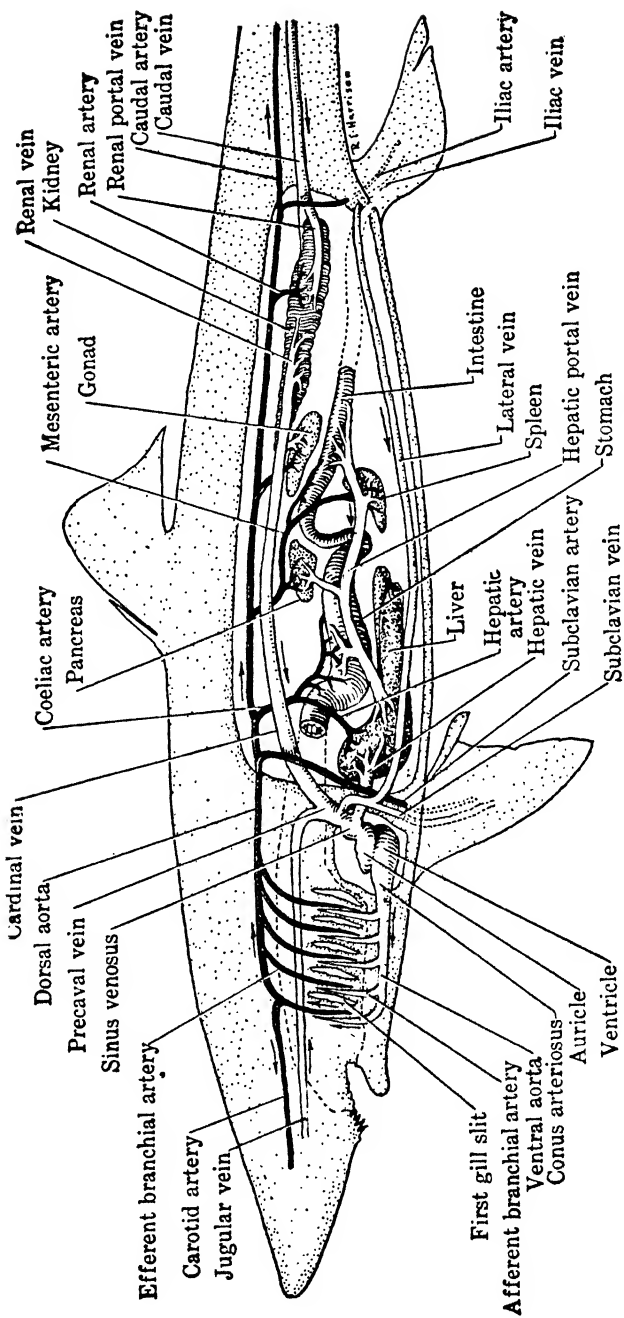

FIG. 120. — Diagrammatic lateral view of the vascular system of a Shark (Dogfish). Vessels carrying oxygenated ('pure') blood shown in black; non-oxygenated ('impure'), in white. Arrows indicate direction of blood flow.

second, tubes which convey the blood to the heart, the VEINS, and away from the heart, the ARTERIES. The arteries divide and subdivide to form smaller and smaller arteries which finally merge into exceedingly delicate tubes (CAPILLARIES) that permeate the tissues of the body. The capillaries, in turn, deliver the blood to tiny VEINS which pass it on through larger and larger veins to the heart. Consequently the blood flows in a circle from heart to heart again, through a closed system of vessels. Indeed, in the meshes of a network of blood-streams all the life of our bodies goes on. About one-twentieth of the weight of the normal human body is blood. (Figs. 120, 124.)

#### A. CIRCULATION IN THE LOWER VERTEBRATES

The heart represents that part of the vascular system in which the power of rhythmic contraction is concentrated, and it can be regarded as a blood vessel whose walls have become highly modified by an excessive development of muscular tissue. In the lowest Vertebrates and in embryonic stages of higher forms the heart consists typically of two chief chambers, an AURICLE and a VENTRICLE, fitted with muscular flaps, or VALVES, which allow the blood to flow in one direction only; that is, from auricle to ventricle. An enlargement, the SINUS VENOSUS, connects the veins (VENOUS SYSTEM) with the auricle, and there is frequently another, called the CONUS ARTERIOSUS, in a similar position at the arterial end. The heart is thus essentially a linear series of chambers. The sinus venosus and auricle function mainly as reservoirs to fill rapidly the especially muscular ventricle. The latter, acting both as a suction and force pump, passes the blood on to the conus arteriosus and from there to the ARTERIAL SYSTEM as a whole. For our purposes, however, we may consider the heart in the lowest Vertebrates (Fishes) as composed of the two chambers, auricle and ventricle. (Fig. 121.)

The arterial system is the distributing system of vessels which carries the blood to all regions of the body. Soon after its origin at the heart, the circuit in the aquatic forms is temporarily interrupted to allow the blood to pass through the GILLS and exchange carbon dioxide for a supply of oxygen. To facilitate this gaseous interchange, the arteries (AFFERENT BRANCHIAL) as they enter the gill membrane break up into smaller and smaller vessels which finally are of microscopic caliber and consist of but a single layer



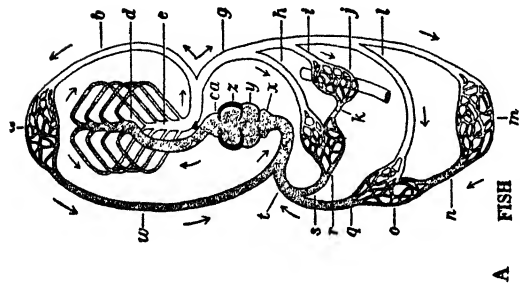

A FISH

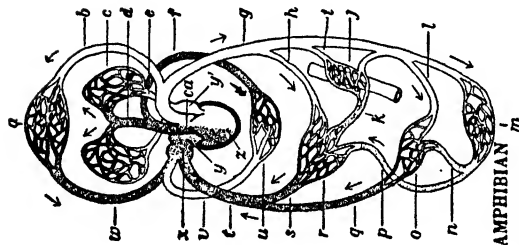

B AMPHIBIAN

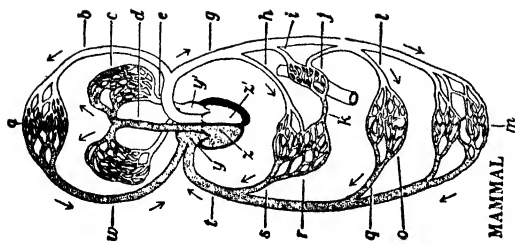

C MAMMAL

FIG. 121. — Plan of the vascular system of a Fish, Amphibian, and Mammal. 'Pure' blood, unshaded; 'impure' blood, shaded. *a*, capillaries of head region; *b*, chief arteries leading to head region; *c*, capillaries of lungs; *ca*, conus arteriosus; *d* (in A), vessel from heart dividing up into the afferent branchial arteries of gills; *d* (in B and C), pulmonary artery to lungs; *e* (in A), artery from gills formed by union of afferent branchial arteries (capillaries of gills, connecting afferent and efferent branchial arteries, not shown); *e* (in B and C), pulmonary vein to left auricle; *f*, artery from ventricle to skin; *g*, chief artery (dorsal aorta) to posterior parts of body; *h*, hepatic artery to liver; *i*, arterial blood supply to stomach, intestine, etc.; *j*, capillaries of stomach, intestine, etc.; *k*, portal vein; *l*, blood supply to kidneys by renal arteries; *m*, capillaries of posterior extremities; *n*, renal portal vein; *o*, capillaries of the kidneys; *p*, abdominal vein; *q*, renal veins; *r*, capillaries of liver; *s*, hepatic vein; *t*, main venous current from posterior parts of body to heart; *u*, capillaries of skin; *v*, cutaneous vein; *w*, return venous current from the head region; *x*, sinus venosus; *y*, auricle in A, right auricle in B and C; *y'*, left auricle; *z*, ventricle in A and B, right ventricle in C; *z'*, left ventricle. Arrows indicate direction of blood flow.

of cells. These capillaries, in turn, merge into larger vessels (EFFERENT BRANCHIAL ARTERIES) which finally lead into the chief artery of the body, the DORSAL AORTA. This extends along the median dorsal line of the body, just below the vertebral column, and sends branches to the various organs.

The branches of the dorsal aorta, on reaching the location which they supply with arterial blood, break up into capillaries similar to those in the gills, so the blood can deliver food, oxygen, etc., to the tissues. The blood receives in return various waste products of metabolism, including carbon dioxide and, in certain cases, absorbed food materials from the intestine, and special secretions chiefly from endocrine glands. The fine capillaries lead into veinlets and these into veins of constantly increasing caliber which sooner or later complete the circuit by returning the blood to the heart.

The return current, however, is not quite so simple as would appear from the above statement because, just as all the outgoing stream is interrupted for the respiratory interchange in the gills, so a part of the return current is temporarily side-tracked through the liver. The veins returning blood from the digestive organs merge to form the PORTAL VEIN which proceeds to the liver, where it resolves into capillaries to allow that organ to regulate certain of the blood constituents. From the capillaries the blood then passes into the HEPATIC VEIN which conveys it toward the heart. Thus the liver receives blood from two sources: an artery providing blood primarily for the use of the organ itself, and a vein (portal vein) delivering blood, containing a large amount of food material, solely to receive special treatment before being sent back to the heart and then all over the body. This special arrangement for a venous blood supply to the liver is known as the HEPATIC PORTAL SYSTEM.

Moreover, in Vertebrates lower than the Birds, the venous blood from the posterior part of the body makes a detour through the capillaries in the kidneys on its way back to the heart. This constitutes what is termed the RENAL PORTAL SYSTEM. Therefore in these forms the kidneys as well as the liver receive blood from two sources, an artery and a vein. It will be noted that both the hepatic portal vein and the renal portal vein arise in capillaries and terminate in capillaries. (Figs. 115, 120, 121.)

Such is the general plan of the blood vascular system of the

lower Vertebrates. The modifications of this which occur in higher forms are related chiefly to changes in the respiratory mechanism necessitated by abandoning an aquatic for a terrestrial mode of life, with consequent dependence on the free oxygen of the atmosphere instead of that dissolved in the water.

### B. CIRCULATION IN THE HIGHER VERTEBRATES

We may now note some of the far-reaching changes that the blood vascular system undergoes as a result of the substitution of lungs for gills. In the first place the series of paired branchial arteries, which formerly supplied the gills, no longer break up into capillaries, but instead lead directly into the dorsal aorta, and accordingly are termed AORTIC ARCHES. Thus Fishes bequeath, as it were, to higher forms a series of pairs of aortic arches which, though they are no longer of use in their former capacity, appear in the developmental stages. Some disappear at that time and others are modified and diverted to various uses in the adult. (Fig. 122.)

For our purpose it is sufficient to emphasize that in Man's body one aortic arch continues to carry blood directly from the heart to the dorsal aorta, while parts of another deliver blood from the heart to the lungs and back again to the heart. Thus there is established a second current of blood through the heart, which necessitates a median partition in both the auricle and ventricle in order to keep the two currents separate.

In this way a four-chambered heart arises which consists of right and left auricles and ventricles. The RIGHT AURICLE receives blood from the venous system of the body and passes it through the TRICUSPID VALVE into the RIGHT VENTRICLE to be pumped through the PULMONARY ARTERY to the lungs. After traversing the capillaries of the lungs, the blood is returned by the PULMONARY VEIN to the LEFT AURICLE, thence through the MITRAL VALVE into the LEFT VENTRICLE, which forces it into the AORTA and so on its way about the body as a whole. To all intents and purposes, the higher Vertebrates have two hearts which act in unison — a right, or pulmonary, heart receiving non-aërated blood from the entire body and pumping it to the lungs, and a left, or systemic, heart receiving aërated blood from the lungs and delivering it to the body as a whole. Thus the blood vessels of the primitive aquatic respiratory apparatus are transformed by gradual additions and

subtractions into the PULMONARY SYSTEM of the higher Vertebrates, including Man. (Figs. 121, C; 123.)

The vascular system is, in truth, a highly efficient apparatus. Day in and day out throughout life the human heart, beating

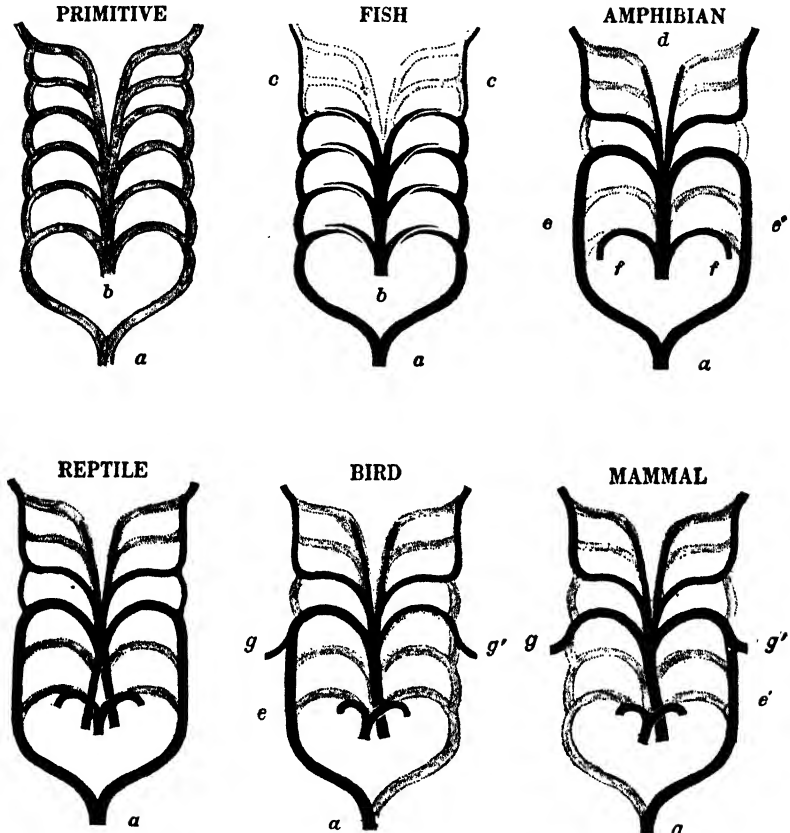

FIG. 122. — Diagram to show the transformation of the six pairs of primitive gill arteries (aortic arches) in the ascending series of Vertebrates. *a*, dorsal aorta; *b*, ventral artery from heart; *c*, internal carotids; *d*, external carotids; *e*, *e'*, right and left aortic arches; *f*, pulmonary arteries; *g*, *g'*, subclavian arteries to fore limbs.

rhythmically at an average rate of 70 times per minute, does about 300,000 foot-pounds of work. This power is expended in moving the weight of the blood, in imparting to it the velocity of its motion, and in maintaining pressure in the aorta and pulmonary artery. In its circulation through the body of a man, the blood

passes through a series of vessels that, if they could be arranged continuously, would, it has been estimated, encircle the Earth!

The RATE of flow is greatest when the blood leaves the heart and gradually diminishes until, in the capillaries of both the pulmonary and systemic systems, it is reduced to a minimum. On the return trip from the capillaries through the veins the rate of flow gradually increases, though it reënters the heart at a slower rate than it departed. Thus of the 23 seconds which it takes a unit of blood to make the complete circuit in Man, about two seconds are spent in the capillaries — a relatively long time when it is realized that the average length of the capillary path is about one-fiftieth of an inch. The chief factor underlying the change in rate is simple. The blood, driven throughout its course by the same force — the heart beat — varies in rate with the width of the bed through which it is flowing. Although the area afforded individually by the arteries and veins is greater than that by any single capillary, nevertheless the total area afforded by the capillary system is enormously greater than that by either the arterial or venous system. The total surface of the capillaries of a man has been stated to be about equal to the area of a city block.

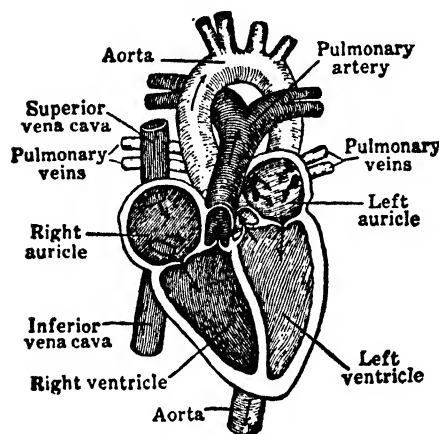

FIG. 123. — Diagram of human heart and associated blood vessels. The direction of blood flow is indicated by arrows. (From Peabody and Hunt.)

Moreover, since a liquid in a closed system of tubes must flow from a region of high to one of low pressure, the blood PRESSURE continuously diminishes from heart back to heart again. But it

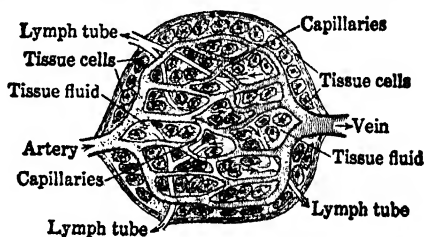

FIG. 124. — Diagram of the intimate relations between capillaries, lymphatics, and tissue cells. (From Peabody and Hunt.)

But it

should be noted that although the pressure in the capillaries of any region as a whole is greater than in the veins which they supply, nevertheless the pressure in a single capillary is very low, as is demanded by its delicate wall.

Thus in the capillaries the blood moves very slowly under low pressure and here the blood does its work — contributes to the **TISSUE FLUID** and interchanges materials with it. All the rest of the vascular system — heart, arteries, and veins — is arranged to give the blood just this opportunity in the capillaries.

The tissue fluid is essentially some of the blood plasma, with white cells, that has passed through the walls of the capillaries, carrying along food materials, oxygen, etc., to be exchanged for the various waste products of metabolism of the cells which it bathes. Thus there is a continuous drainage of fluid from the capillaries into intercellular spaces. Some of this tissue fluid, with waste products, etc., passes immediately into the capillaries again, but the excess passes into small **LYMPH VESSELS**. Thus lymph is essentially excess tissue fluid with white cells augmented from lymph

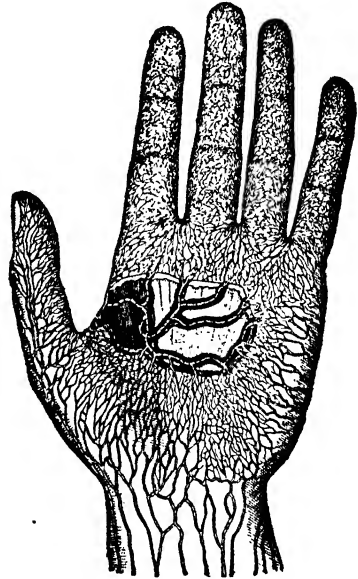

FIG. 125. — The superficial and some of the deeper lymphatics of the human hand. (From Hough and Sedgwick.)

glands, etc., which passes through larger and larger lymphatic vessels until it is finally delivered to veins in the region of the neck, and the materials are restored to the blood. (Figs. 115, 124–126.)

With such a marvellously complex transportation system, clearly some provision must exist for regulating the blood flow in order to meet the varying local demands of the organs of the body under different physiological conditions. This is attended to chiefly by nerve impulses which are conducted by a system of **VASOMOTOR** nerves and bring about the dilation or contraction of the smaller arteries leading to an organ, and also by chemical substances in the

blood inducing similar changes in the capillaries that penetrate the tissues. Since the total volume of blood in the body is practically constant, an extra supply to one part necessitates a slightly reduced supply to another. So it happens, for instance, that after a hearty meal more blood is sent to points where digestion is going on, leaving less for other organs — the reduced supply to the brain probably resulting in the proverbial drowsiness at such times.

Moreover, of course, the blood itself undergoes various changes during its course through the body as it receives or delivers food substances, secretions, and excretions. And furthermore, for in-

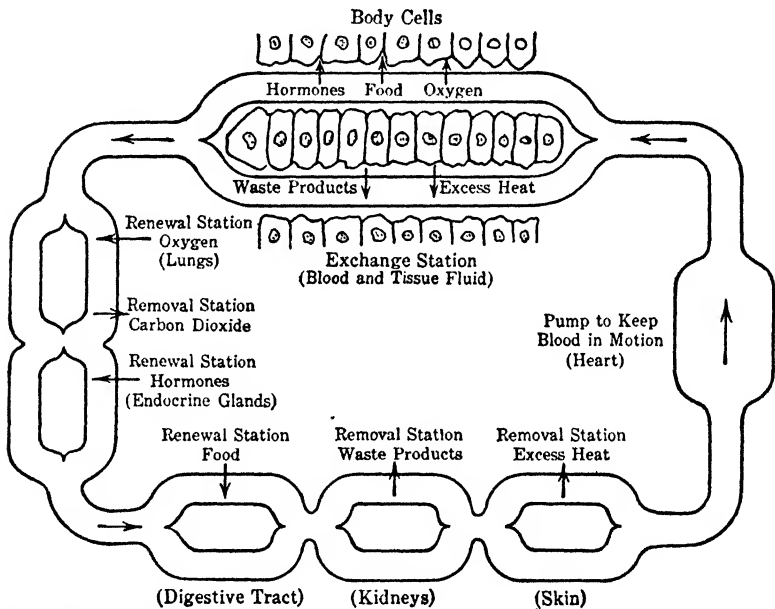

FIG. 126. — Diagram illustrating how a suitable environment is maintained by the flow of blood. (From Martin.)

stance, its supply of red blood cells is replenished from the bone marrow and stabilized, in part, by a vascular organ, the SPLEEN, which is situated in the abdomen behind the stomach. (Figs. 106-108, 114.)

The elaborate mechanism in HOMOTHERMAL animals (Birds and Mammals) that maintains a practically constant body temperature is largely dependent upon heat distribution, heat loss, and heat conservation by the blood vascular system. At rest, a gentle

stream of blood flows through the capillaries of a man's muscles; in violent exercise, a great torrent, impelled by increased heart action, brings food and oxygen and carries away waste products and heat. This superfluous heat is carried by the blood to the lungs and skin for elimination. The skin becomes flushed by the distension of its blood vessels and heat is radiated, usually aided by perspiration. Thus the body is losing heat, but we 'feel warm' because the sense organs that make us aware of temperature are situated in the skin. We 'feel cold' when blood is withdrawn from the skin to the internal organs and heat is being conserved. This makes clear the apparent paradox — one is apt to 'feel warm when catching cold.'

So much for the paths and duties of the blood and lymph that circulate through the body — just enough, perhaps, to emphasize that with increase in size and complexity of the animal body there goes hand in hand an elaboration of the transportation system. It is gradually transformed to meet the new demands made upon it, and so leaves in higher animals evidence of their origin.



## CHAPTER XIV

### EXCRETION

The mathematically accurate end-reaction of a chain of known and unknown causes and effects. — *Noyes*.

PROVISIONS for eliminating from the organism the waste products of metabolism are not less important than those for supplying the matter and energy by which the vital processes are carried on. In many of the unicellular forms the whole surface of the organism functions as an excretory organ, but it will be recalled that even in some of these, such as *Amoeba* and *Paramecium*, contractile vacuoles facilitate the removal of useless metabolic products. Indeed, in all but a few of the lowest Metazoa there are highly specialized organs for excretion. In the Vertebrates we find the KIDNEYS and the GILLS or the LUNGS devoted largely to excretion, and the SKIN and LIVER acting in subsidiary capacities. Each receives a profuse blood-supply from which it takes the waste products that are to leave the body as an excretion. Usually the effective surface of an excretory organ consists of gland cells. (Figs. 6, 27, 111.)

There is therefore an essential distinction between an excretion, which represents chemical waste from the vital processes, and the major part of the material which is ejected from the digestive tract as feces. The latter is almost entirely indigestible material taken in with the food which has not directly contributed to the metabolic processes of the organism, though some of it may have acted temporarily in an accessory capacity. Accordingly the digestive tract is not included in the list of excretory organs, though it will be recalled that certain waste products excreted by the liver reach the outside world with the feces.

The nature and amount of the material eliminated by the excretory organs is, of course, determined by what is brought to them by the blood, and this, in final analysis, is dependent upon the food — the fuel that has been burned — and the disintegration of protoplasm from the wear and tear of life. Carbohydrates and fats yield carbon dioxide and water, while proteins give in addi-

tion UREA, URIC ACID, CREATININE, AMMONIA, etc., the products of nitrogenous metabolism.

### A. GILLS AND LUNGS

We have already emphasized the elimination of carbon dioxide by the gills or the lungs. Here the cells of the respiratory membranes play essentially a passive rôle in excretion, since the carbon dioxide, which is under higher tension in the blood than in the water or air, follows the physical laws of diffusion of gases and passes from the blood. In addition to carbon dioxide, the blood of homothermal animals loses a large amount of water and heat; the amount depending on the moisture and temperature of the air which enters the lungs. When the air is exhaled, its temperature is very nearly that of the body and it is saturated with water vapor. In Man about one-third of the water eliminated is excreted by the lungs. (Fig. 118.)

### B. SKIN

The skin of some of the lower Vertebrates, for instance the Frog, is an exceedingly important excretory organ, because more carbon dioxide is eliminated through it than through the lungs; but in most of the higher forms, including Man, excretion by the skin is confined to the SWEAT GLANDS. There are nearly three millions of them, with a total length of several miles, opening on the surface of the human body. They take from the blood, in addition to large quantities of water, traces of nitrogenous waste or urea, fatty acids, and salts, which form a residue on the surface of the skin when the PERSPIRATION evaporates. However, most of the water may be regarded as a secretion rather than an excretion because it is of use to the body, being employed in regulating the body temperature. Everyone knows that evaporation of perspiration accelerates the loss of heat by the skin. In addition to sweat glands, the skin is provided with SEBACEOUS GLANDS which open, as a rule, at the base of hairs

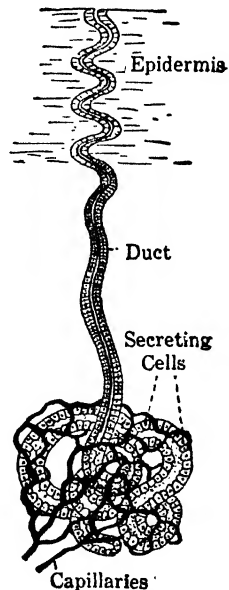

FIG. 127. — Diagram of a sweat gland.

and deliver a true secretion — a lubricant for hair and skin, and a conserver of body heat. (Figs. 96, 127.)

### C. LIVER

The liver, in addition to its various other functions, aids in no small way in excretion. On the one hand, the liver removes deleterious compounds of ammonia from the blood and converts them into urea. Then it secretes the urea into the blood from which it is later removed by the kidneys. On the other hand, the liver collects other waste products, etc., from the blood, which form the bile. This passes to the GALL BLADDER for temporary storage, or directly to the intestine. (Fig. 112.)

### D. KIDNEYS

The kidneys, in coöperation with the liver, are the chief excretory organs, and any serious interference with their activity leads to a poisoning of the body with waste products. However, excretion is but one function of the kidneys — they act as a blood-regulator to maintain a proper balance of the chemical constituents of the blood plasma. A large amount of water and various salts, urea, etc., pass from the blood through the GLOMERULI into the TUBULES. Here such materials as are of value in the economy of the organism are absorbed by the tubules and returned to the blood, while the rest passes to the pelvis of the kidney and eventually out of the body. In Man about 90 per cent of the nitrogenous waste is eliminated as urea. (Figs. 130–132.)

#### 1. *Urine*

The total excretion of the kidneys, known as URINE, passes from the kidneys through the URETERS to the URINARY BLADDER where it is stored temporarily until passed to the exterior through the URETHRA. Since urine is the medium for the elimination not only of nearly all the normal products of katabolism, but also of the majority of abnormal substances that may enter or be formed by the organism, there is no better indication of the general metabolic condition of the human body than that afforded by a chemical and microscopical analysis of the urine. Thus in Bright's disease protein appears; in diabetes, glucose (grape sugar) and other abnormal substances; while in gout, uric acid is present in abnormal quantity in the urine.

However, the interpretation of the analysis is of first importance in every case because the urine rapidly reflects normal changes in the physiological condition as well as those that are abnormal: even the nervous tension of an examination may well be evidenced by the appearance of grape sugar. Again, the amount of urine excreted depends upon many factors. Under normal conditions with a given intake of water, the volume of urine varies chiefly with the temperature and moisture of the atmosphere. For instance, when the atmosphere is hot and dry, a relatively large amount of water is eliminated as perspiration. Accordingly the intake of water should be greater in order to carry off readily the waste products of metabolism through the kidneys. One is apt to think of the kidneys as essentially passive organs that merely drain materials from the blood. But, as a matter of fact, a grain of kidney tissue consumes, on the average, more oxygen per unit of time than the same weight of the beating heart. The kidneys work.

## 2. Evolution of Kidneys

Aside from their functional importance, the kidneys are of considerable interest to the comparative anatomist because of their complicated evolutionary history throughout the Vertebrate series. Indeed the basic elements of the vertebrate kidney may be most readily interpreted with the excretory system of the Earthworm in mind. (Figs. 59-61, 128.)

The chief excretory organs of the Earthworm consist of pairs of coiled tubes, or NEPHRIDIA, segmentally arranged in the coelom on either side of the alimentary canal. Each nephridium begins as an open funnel in the coelom of one segment, passes through the partition to the next posterior segment and there, after coiling, passes to the ventral surface and opens to the exterior by a pore. Thus, reduced to its simplest terms, a nephridium is a tube communicating between

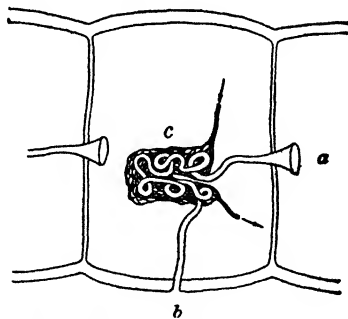

FIG. 128. — Diagram to show the general structural plan of a nephridium of an Earthworm, anterior end toward the right. *a*, internal opening of nephridium; *b*, external opening; *c*, capillary network about the coiled, glandular portion in the coelom.

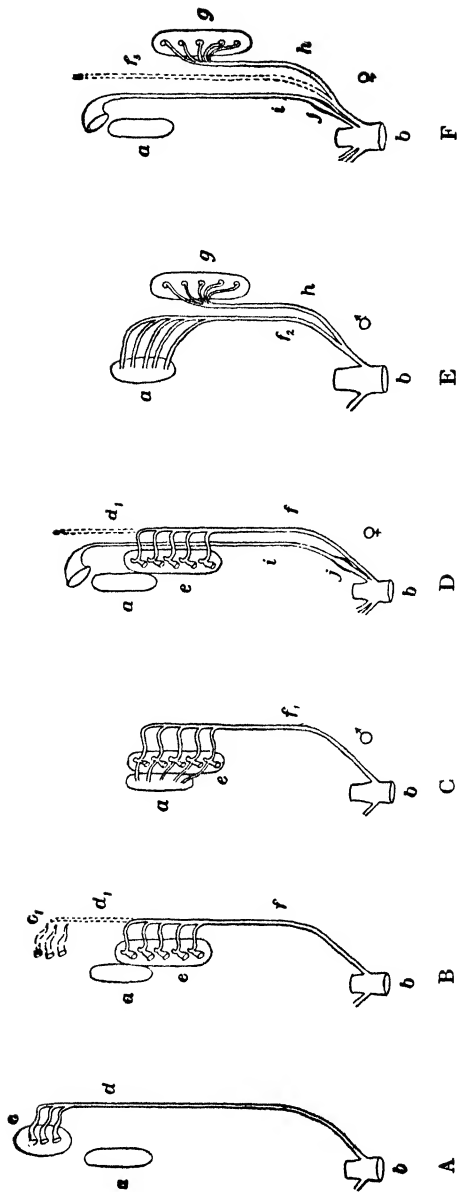

FIG. 129. — Diagram of the fundamental plan of the urogenital system of Vertebrates. A, Pronephric system — primitive and early embryonic type in all Vertebrates; functional in the Frog tadpole. B, Mesonephric system — embryonic type in all Vertebrates, and adult type in the lowest Vertebrates (Cyclostomes). C, Mesonephric system and the male ( $\sigma$ ) reproductive system in adult Fishes and Amphibians (Frog). D, the same, female ( $\varphi$ ). E, Metanephric system, and male ( $\sigma$ ) reproductive system in adult Reptiles, Birds and Mammals. F, the same, female ( $\varphi$ ). a, gonad; testis in male, ovary in female; b, cloaca or terminal portion of alimentary canal; c, pronephros, e<sub>1</sub>, the same, vestigial; d, pronephric duct, d<sub>1</sub>, the same, vestigial; e, mesonephros; f, mesonephric duct (originally posterior portion of pronephric duct); f<sub>1</sub>, mesonephric duct acting also as sperm duct; f<sub>2</sub>, mesonephric duct acting solely as sperm duct; f<sub>3</sub>, mesonephric duct, vestigial; g, metanephros; h, metanephric duct; i, oviduct; j, uterus. See Figs. 106–109.

the coelom and the outer world, and affording a path of egress for the waste matter in the coelomic fluid. But in addition, the blood vascular system carries nitrogenous waste, inorganic salts in solution, etc., to the coiled part of the nephridial tube where special cells take them from the blood and deliver them to the interior of the tube to be passed out of the body. Thus the nephridia of the Earthworm remove waste material from both the coelomic fluid and the blood.

Although the primitive segmentation of the coelom has disappeared in the Vertebrates, nevertheless there are good grounds for believing that the ancient, segmentally arranged nephridia are the basis of the essential excretory elements of the kidneys. Thus in the lowest Vertebrates the primitive type of kidney, or PRONEPHROS as it is called, consists of a series of segmentally arranged nephridia in the dorsal part of the anterior end of the coelom. These, however, instead of opening independently to the exterior, discharge their products into a common tube (PRONEPHRIC DUCT) which passes them to the outside. In higher forms the pronephros disappears, and its function is taken over by another series of nephridia which appears in the coelom posterior to the pronephros. This series constitutes the MESONEPHROS, and opens into the pronephric duct which accordingly now is called the MESONEPHRIC DUCT. Finally, in still higher Vertebrates this second urinary organ is replaced by a third, the kidney proper (METANEPHROS) and its special duct, the ureter. (Fig. 129.)

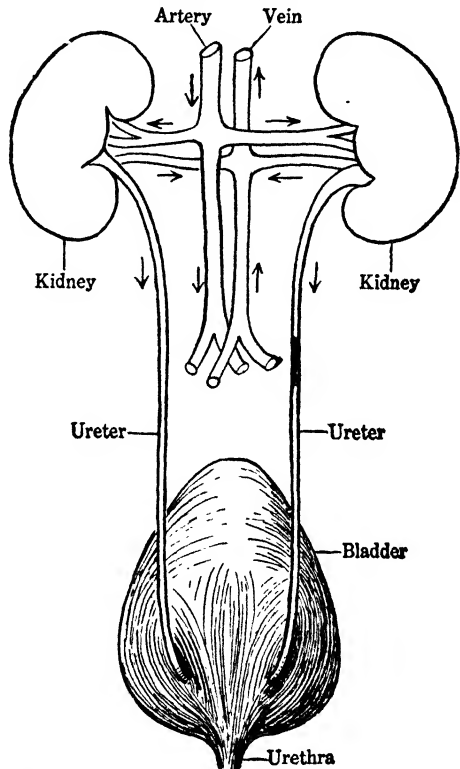

FIG. 130. — Diagram of the human urinary system, posterior view. See Fig. 134B.

Thus as we ascend the Vertebrate series three distinct kidney systems appear, in each case by the development and grouping of nephridium-like elements into a definitive organ. In this process the primitive communication of the individual nephridia with the body cavity is lost and the functions of the tubular portion increased, until, in the higher forms, all the waste products are taken solely and directly from the blood. It is therefore apparent that each of the relatively large, compact kidneys of the higher Vertebrates consists essentially of an enormous number of nephridium-

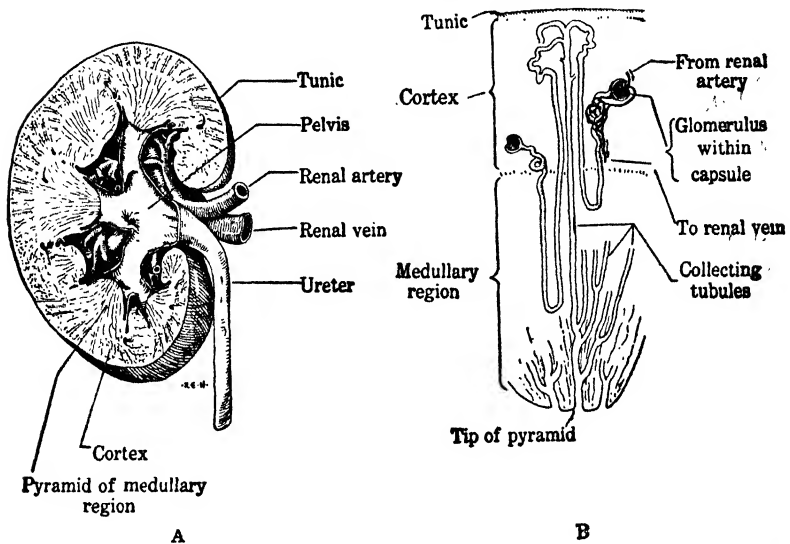

FIG. 131. — Human kidney. A, longitudinal section; B, diagram of the course of the tubules in the kidney. The cortex is the region in which the tubules come into functional association with the capillaries. Tubules extend through the medullary region to open on the summits of the pyramids.

like elements, the tubules, bound together by connective tissue and covered with a protective coat. The tubules within the kidney deliver the materials taken from the blood, the urine, to the pelvis of the kidney, from which it passes down the ureter, into the urinary bladder, and finally to the exterior. (Figs. 130, 131.)

Such, in broad outline, is the historical viewpoint from which the kidneys of Man must be interpreted. As a matter of fact, however, the evolutionary transformation is still further complicated by anatomical, though not physiological, relations with the

reproductive system. As will be pointed out later, this neighboring system now and again foists, as it were, some of its accessory responsibilities upon parts of the excretory (urinary) system, and even takes over portions and makes them integral parts of its own when they have been permanently abandoned by the urinary system in its development.



## CHAPTER XV

### REPRODUCTION

**Let us first understand the facts, and then we may seek the cause.**  
— *Aristotle.*

REPRODUCTION, as we know, is in the final analysis cell division, whether it is binary fission in unicellular forms such as *Amoeba* and *Paramecium*, or the setting free by the multicellular organism of cells with the power of going through a complex series of changes by which they rapidly become transformed into the complex individual, similar to the parent. In most animals this process is complicated at the start by sexual phenomena: the fusion of two germ cells, the male and female GAMETES, to form the fertilized egg, or ZYGOTE. Indeed, sex is fundamentally a physiological difference between gametes, which, however, so profoundly influences the body that we recognize it as male or female. (Figs. 8, 31, 168.)

Disregarding for the time being the actual origin of the germ cells in the body, we find in the Metazoa special organs in which the germ cells reside and undergo changes preparatory to their liberation. Such reproductive organs, or GONADS, ordinarily contain germ cells of one kind, and accordingly are either OVARIES (egg-producing organs) or TESTES (sperm-producing organs).

#### A. INVERTEBRATES

In many of the simpler animals, the gonads are merely temporary structures which appear during certain seasons of the year when conditions favor sexual reproduction. In some species the same individual produces both eggs and sperm, in which case the sexuality of the germ cells is not reflected back, so to speak, to the organism as a whole, which accordingly is known as an HERMAPHRODITE. Such frequently is the condition in *Hydra* where the testes appear as small swellings in the ectoderm a little below the circle of tentacles, and the ovary, which is usually single, is a somewhat larger projection near the opposite end of the animal. Both the testis and the ovary at first appear to be a group of

ectoderm cells, which in one case gives rise to many sperm and in the other to a single egg. The mature sperm are set free from the testis and swim about in the water, but sooner or later one enters the now ruptured covering of the ovary and fuses with the egg. With the conclusion of fertilization the zygote begins to divide and forms an embryo which at an early stage becomes detached from the parent. Thus in Hydra there is no complicated apparatus for sexual reproduction; merely now and again the temporary development of the primary sex organs, ovaries and testes. (Fig. 57.)

The complex bodies of most animals, however, demand more or less permanent gonads, as well as means for transferring the gametes directly or indirectly to the exterior. This is brought about by the fact that in coelomate animals the gonads come to lie, not on the outside of the body, but within the coelom. In the Earthworm, which also is hermaphroditic, the testes and ovaries are permanent organs attached to the partitions between certain segments. The sexual products are set free in the coelom where they are taken up by SPERM DUCTS and OVIDUCTS and carried to the outside. Although each Earthworm possesses both male and female reproductive organs, two worms pair and exchange the sperm which are stored in the respective sperm receptacles. Later, when the eggs pass to the exterior, the 'foreign' sperm are shed on them. Thus cross-fertilization is insured in this hermaphroditic form. In the Crayfish the sexes are represented by separate individuals, males and females, and the appendages of the first and second abdominal segments of the male are modified into copulatory organs for the transfer of the sperm to the body of the female, where they are retained until egg-laying. (Figs. 60, 63.)

## B. VERTEBRATES

Throughout all the chief Vertebrate groups the sexes are distinct, although in rare instances abnormal hermaphroditic individuals occur. The definitive primordial germ cells first appear as localized areas of the epithelium lining the coelom, on either side of the vertebral column. As the germ cells develop they become associated with connective tissue, blood vessels, and nerves and form the paired gonads. In the most primitive Vertebrates a condition more simple than in the Earthworm is found, for both male and female gametes merely break out of the gonads and

find their way to the exterior by a pair of minute ABDOMINAL PORES. In higher forms, however, special sperm ducts and oviducts are developed in close relationship with the urinary system. (Fig. 132.)

In some aquatic, and most terrestrial Vertebrates, fertilization occurs while the eggs are still within the oviducts; the copulatory organ transferring the sperm directly to the terminal portion of

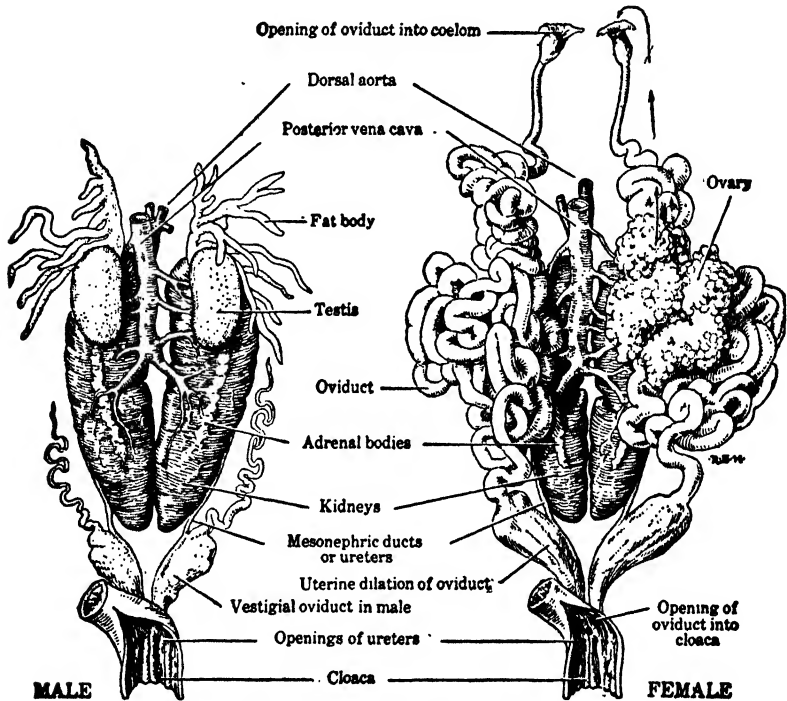

FIG. 132. — Urogenital organs of the Frog.

the ducts through which they make their way up to meet the descending eggs. After fertilization the zygote may soon pass to the exterior; usually, as in the case of the familiar hen's egg, after being wrapped up in nutritive and protective coats secreted about it during its passage down the oviduct. Or, as is the case rarely among lower forms and the rule among all Mammals except the Monotremes, the zygote on reaching the lower part of the oviduct becomes attached to the wall of an enlargement of the oviduct, or of a chamber formed by the union of the two oviducts, called

the UTERUS. Here the embryo proceeds far along in development before birth occurs. (Figs. 133, 134, 169.)

### 1. Uterine Development

In the human body, the attachment of the fertilized egg in the uterus is followed by the very rapid development of what may be regarded as a new uterine lining, profusely supplied with blood

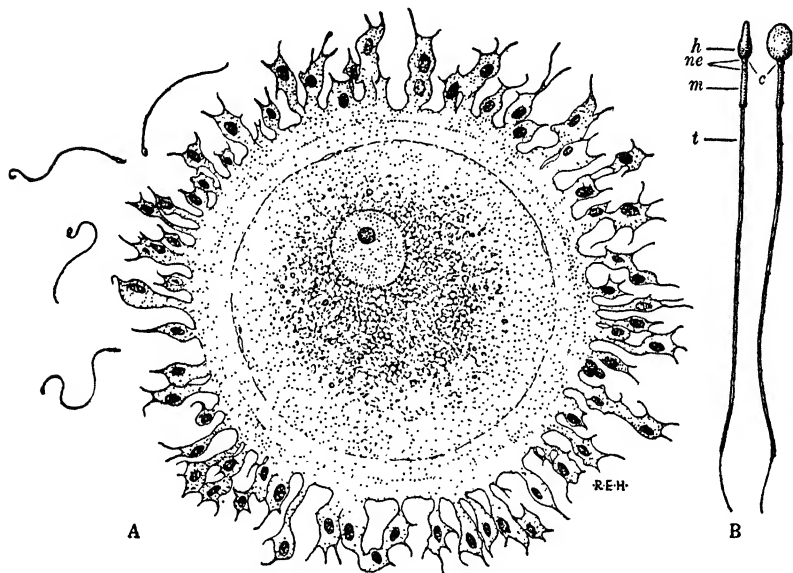

FIG. 133. — Human egg and sperm. A, four sperm (left); and egg (right) just removed from the ovary, surrounded by follicle cells of the ovary and a clear membrane. The central part of the egg contains metaplastic bodies and the large nucleus. Superficially there is a clear ectoplasmic region. (Magnified about 400 times.) B, two views of the human sperm, *c*, centrosome; *h*, head consisting of the nucleus surrounded by a cytoplasmic envelope; *m*, *ne*, middle piece; *t*, tail or flagellum. (Magnified about 2000 times.)

vessels. This soon surrounds the embryo and, as pregnancy proceeds, the embryo protected by EMBRYONIC MEMBRANES projects into, and finally completely fills the gradually increasing uterine cavity. As the uterus enlarges, it exerts increasing pressure on the adjacent organs, and later shifts higher up in the abdominal cavity where the flexible body wall more readily accommodates it. Throughout the entire period of pregnancy the embryo leads essentially a parasitic existence at the expense of the mother's

body which supplies it with food and oxygen, and removes carbon dioxide, urea, and other metabolic wastes. This, of course, imposes a considerable amount of extra work on the various maternal organs, especially the lungs, kidneys, and digestive system, and therefore special provisions must be made for this intimate interchange of materials between the blood vascular systems of mother and offspring. (Fig. 134A.)

The embryo at first is nourished by materials absorbed from the rich blood supply of the uterine wall, but soon this proves inadequate for the rapidly increasing demands of the growing embryo, and a new structure, the **PLACENTA**, is formed jointly by the tissues of the uterus and embryo to meet the need. The connection of the embryonic body with the placenta is by the **UMBILICAL CORD**. The blood of the embryo passes by its arteries through the umbilical cord to capillaries in the placenta, and after interchanging wastes for food and oxygen by diffusion with the maternal blood, returns by veins to the embryo. Accordingly there is no direct intermixture of maternal and embryonic blood: the embryo from the beginning is a separate organism whose blood supply interchanges materials with that of the mother through the placenta. This temporary dependence is terminated when the child is expelled from the uterus, or born.

## 2. *Hormones*

Thus, except in the simplest animals, there is a special reproductive system: a series of organs connected with the reproductive function. But it must be emphasized that the essential organs are the gonads themselves and all the rest are accessory. Furthermore, in relation to the sexual differentiation of male and female individuals, many so-called **SECONDARY SEXUAL CHARACTERS** arise which are not directly connected with the reproductive organs, but nevertheless depend very largely for their development upon **HORMONES** liberated by the gonads. For example, early castration of the Stag inhibits the growth of a distinctive male secondary sexual character, the antlers; while if performed later when the antlers are full grown, they are shed and abnormal ones take their place.

Indeed, the sexual life of the Vertebrates, including Man, is largely controlled by hormones. Thus after the release of the egg from the human ovary, its former location is filled by the **CORPUS**

**LUTEUM** which secretes several hormones that prepare the uterus, both structurally and physiologically, for the reception of the egg and the attachment of the embryo. Moreover, certain hormones secreted by the ovary during pregnancy directly influence the **PITUITARY GLAND** which in turn induces the development and func-

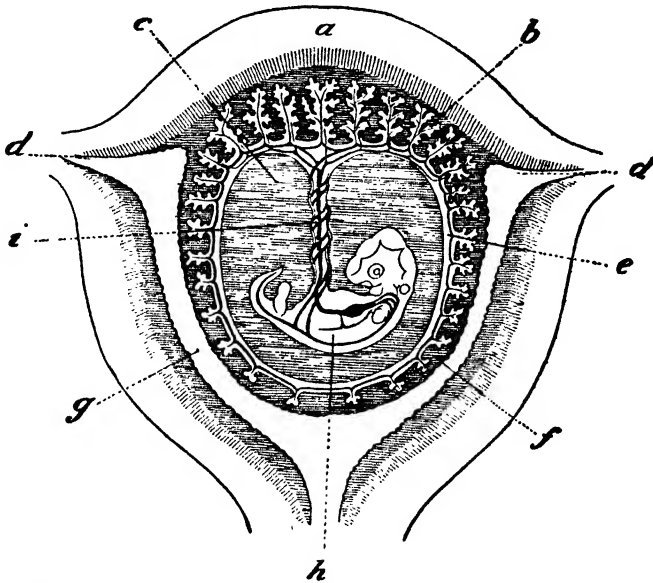

FIG. 134A. — Diagrammatic section of the human uterus with developing embryo. The embryo (*h*) is suspended in a fluid-filled cavity (*c*) surrounded by embryonic membranes (*e*) and by tissue (*f*) from the uterus itself. The sole path of communication between embryo and mother is by blood in vessels passing up through the umbilical cord (*i*), spreading out into capillaries in the placenta (*b*) and there coming into close relations with the maternal blood supply. The openings of the oviducts (*d*) into the uterus become closed during the development of the embryo. *a*, dorsal wall of uterus; *b*, placenta; *c*, fluid-filled cavity of amnion; *d*, openings of oviducts (Fallopian tubes); *e*, embryonic membranes; *f*, uterine tissue; *g*, uterine cavity; *h*, embryo; *i*, umbilical cord.

tioning of the **MAMMARY GLANDS**. At least two hormones are involved; one directly stimulates the development of the mammary glands, while another prevents their functioning until it is inactivated at the birth of the offspring.

### 3. The Urogenital System

We must now outline the structural interrelations of the urinary and reproductive organs forming the **UROGENITAL SYSTEM**. It has

been pointed out that the nephridia, which combine to form the kidneys in some of the lower Vertebrates, retain their funnel-like openings into the coelom and therefore afford a direct exit for waste material in the coelomic fluid. It is some of these nephridia which are employed in the lower Fishes for the transfer of the germ cells to the outside. The testes of the male, which lie close to the kidneys, become connected with the nephridia (mesonephros) by a series of short delicate tubes. Through these tubes the SPERMATIC FLUID, containing the sperm from the testes, is transferred to the nephridia and by them to the kidney (mesonephric) ducts and so to the exterior with the urinary waste. In this way, during

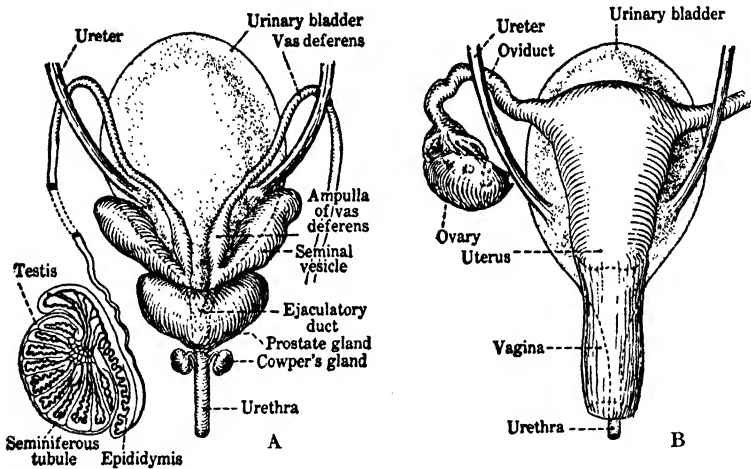

FIG. 134B. — Diagrams of the human urogenital organs. Posterior view. A, male; B, female. (From Hegner.)

the period of sexual activity of the male, the kidney tubules satisfactorily perform two functions, and the mesonephric ducts become UROGENITAL CANALS. (Fig. 129, C.)

Turning to the female, we find that the ovaries, which are situated in about the same position with relation to the kidneys as the testes in the male, do not enter into communication with a set of nephridia of the kidneys (mesonephros); probably because the eggs are too large to pass through the tubules. Instead, what appears to be the coelomic opening of a single nephridium-like structure on either side (which fails, so to speak, to enter the kidney complex) enlarges and becomes the funnel which connects

up with a new duct opening into the cloaca. Thus there arises from the female urinary system a pair of entirely distinct oviducts. An egg, liberated from the ovary into the coelom, finds its way into one of the oviducts and descends directly to the outside, or into an enlargement (uterus) of the terminal portion of the duct where development proceeds until birth occurs. (Figs. 129, D; 132.)

The female reproductive system, though derived from the mesonephric system, has become entirely independent of it. Accordingly the disappearance of the mesonephros and duct in higher Vertebrates, when it is replaced by the metanephros and the ureter as the functional urinary system, has little effect on the female reproductive system. As a matter of fact, the abandoned mesonephros and duct degenerate and disappear in the female, while in the male the mesonephric duct remains and becomes completely appropriated by the reproductive system. The sperm now pass directly into the former mesonephric duct, which thereby becomes solely a sperm duct. (Fig. 129, E, F.)

Such is the historical origin of the foundations of the reproductive system as it occurs in the Reptiles, Birds, and Mammals. Each of these groups, building on this foundation, has developed modifications and additions demanded by its special lines of evolution. It appears again that, whenever possible, structures at hand are employed to construct what is to be, and thus is woven in the woof and warp of higher forms a partial record of their ancestry. (Fig. 134B.)



## CHAPTER XVI

### COÖRDINATION

It seems that Nature, after elaborating mechanisms to meet particular vicissitudes, has lumped all other vicissitudes into one and made a means of meeting them all. — *Mathews*.

SINCE a primary attribute of protoplasm is irritability — the power of responding to environmental changes by variations in the equilibrium of its own matter and energy — it is not strange that the cells of an organism mutually influence each other's activities and reciprocal interrelationships have been established during their long evolutionary history. The various cells, tissues, organs, and organ systems are unified into an organism by what may be called the chemical interplay between its various parts, which is made possible by the facilities for distribution afforded by the circulatory system; and also by the directing influence of the nervous system which supplies a central station with lines for instantaneous intercommunication with every part of the body.

#### A. CHEMICAL COÖRDINATION

It is only with the recent increase in knowledge of the general problem of metabolism that the far-reaching importance of the chemical control of bodily processes has gradually been brought to the fore. Although we may properly think of the various chemical regulators, or HORMONES, as forming a coördinating system in so far as their collective action has such a result, in the present stage of our knowledge it is possible to do little more than cite the specific action of individual hormones as examples of the general method of chemical regulation which their study, ENDOCRINOLOGY, is revealing. (Pp. 159, 169, 192.)

Certain hormones are elaborated by special cells embedded in organs, such as the pancreas, intestine, and reproductive organs, largely devoted to other functions. Other hormones are secreted by organs whose sole function is their production, such as the various ductless, or endocrine, glands.

As an example of a hormone secreted by specialized cells within the tissue of an organ devoted primarily to other functions, we may

select **INSULIN** which reaches the blood directly from the **pancreas**, and is not delivered with the other secretions of this organ to the intestine through the pancreatic duct.

**DIABETES** has long been known to be the result of a deficiency of a pancreatic function leading to a lack of coördination of the chemical processes by which the body uses carbohydrates to supply energy. The storage of sugar by the liver is unregulated. Evidences of this disease are chiefly an increase in the sugar content of the blood and the presence of sugar in the urine. Now we know that a close approach to the normal metabolic condition can be attained by administering to diabetics the hormone **insulin** extracted from the pancreas of sheep or other animals. Insulin thus takes the place of the secretion which the pancreas fails to afford, and so removes the pall of hopelessness from many of the most acute and desperate cases of diabetes.

Turning now to a gland devoted solely to the secretion of a hormone, we may select the thyroid which, as has been seen, arises as an outpocketing of the digestive tract in the neck region and finally loses all connection with its point of origin and becomes a ductless gland. (Fig. 110.)

The general effect of the thyroid hormone, **THYROXINE**, on metabolism is a regulation of the rate of oxidation in the body to meet changing physiological demands. An excess of thyroxine induces such vigorous fuel consumption that no surplus remains in the body to be stored as fat; while a deficiency in the glandular secretion results in a tendency toward fat formation. The administration of thyroid extract or thyroxine is often an efficient, though dangerous, means of reducing fat by increasing the oxidative processes of the body. A deficiency of the hormone during adult life frequently results in a pathological condition called **MYXEDEMA**. Children in whom the development of the thyroid is suppressed become dwarfish idiots known as **CRETINS**, while overdevelopment of the gland induces increased nervous activity and mental disorders. Feeding with thyroid material prevents or retards the development of cretinism and cures myxedema, while a surgical removal of part of the gland may cure the nervous instability and other symptoms due to an excessive amount of the hormone. **GORTER** is a pathological enlargement of the thyroid due to a deficiency in iodine needed to manufacture its iodine-containing thyroxine.

The almost uncanny potency of hormones in general will be evident from the fact that about 1/1,000th of a gram of thyroxine is sufficient to induce a 2 per cent increase of the total oxidation of the resting adult human body. The amount of thyroxine required by the body during a whole year is probably about 2½ grams, while the amount in use at any one time is approximately 2/10th of a gram. "But this pinch of material spells all the difference between complete imbecility and normal health" — a fact that should give pause not only to the biologist but also to the sociologist.

Moreover, as a further indication of the nicety of the reciprocal adjustments within the organism, it may be mentioned that the thyroid gland itself is affected by regulating stimuli reaching it through the nervous system, and also by a hormone derived from the PITUITARY GLAND which is another endocrine organ situated in conjunction with the lower surface of the brain.

Finally, the ADRENAL GLANDS, one situated in close proximity to each of the kidneys, are endocrine organs of high significance that secrete at least two hormones. One, known as ADRENALINE, is poured into the blood when the glands are stimulated by the nervous system. Adrenaline has its most marked effect when muscular exertion is at a premium. It accelerates heart action, increases blood pressure, reduces muscular fatigue, stimulates the liver to give up its stored glycogen, retards the activities of the alimentary canal, dilates the eyes, etc. It is essentially a chemical whip which makes various organs play their part in the general mobilization. Glimpses of such interrelationships are being gradually afforded as one hormone after another is discovered and studied — chemical coördination is indeed a fact. (Figs. 107, 108, 132.)

## B. COÖRDINATION BY THE NERVOUS SYSTEM

Although hormones are indispensable as a means of regulating many of the processes of the organism, they are entirely inadequate for the instantaneous correlation of diverse parts of an animal and also for the adjustment of the whole animal to its surroundings. This need is supplied in the Metazoa by the NERVOUS SYSTEM: a complicated arrangement of cellular elements in which irritability and conduction are highly developed. The study of the nervous system constitutes the science of NEUROLOGY.

Even in some unicellular organisms certain portions of the protoplasm are especially differentiated for receiving and conducting stimuli, and others for making effective such stimuli by contractions of the whole or parts of the cell. Indeed, *Paramecium* and other Infusoria possess a NEUROMOTOR system which apparently consists of a coördinating center, or MOTORIUM, from which conductile paths extend through the cell to the cilia, etc. But it is in the lower Metazoa, such as *Hydra* and its allies, that we find the establishment of definite NERVE CELLS, some of which are specialized for re-

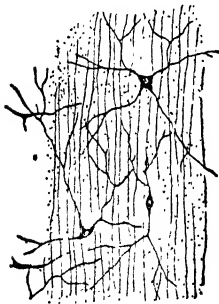

FIG. 135. — Nerve cells in the ectoderm of *Hydra*. The parallel lines represent muscle fibers. (After Schneider.)

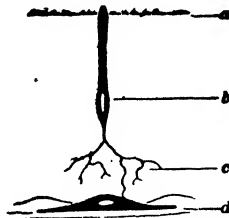

FIG. 136. — Diagram of a simple type of receptor-effector system found in some *Hydra*-like animals. It comprises receptors (*b*), or sense cells, reaching to the body surface (*a*), with basal nerve net (*c*) connecting with muscle cells (*d*). (Slightly modified, after Parker.)

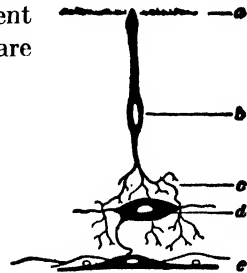

FIG. 137. — Diagram of a more complex type of receptor-effector system, found in some *Hydra*-like animals. It comprises, in addition to the receptor (*b*) with nerve net (*c*) and the muscle cells (*e*), another nerve (ganglion) cell (*d*) interpolated in the nerve net. *a*, body surface. (From Parker.)

ceiving stimuli and others for conducting the excitation to cells specialized for contracting (muscle cells), etc. Thus a simple RECEPTOR-EFFECTOR system arises which may be regarded as the basis for the development of the elaborate NEUROMUSCULAR MECHANISM of higher forms, with RECEPTORS, or sense organs, CONDUCTORS, or nerves, and EFFECTORS, or muscles and glands. Although from the functional point of view it is difficult to differentiate the receptors, conductors, and effectors in the economy of the organism, from the standpoint of anatomy the conductors constitute a definite entity, the nervous system proper. (Figs. 135–137, 144, 145.)

The structural elements of the nervous system of all animals consist of cells known as nerve cells, or NEURONS. In the lower

forms these cells are apparently united so that they form **NERVE NETS** which surround and permeate the tissues which they stimulate to action. In more highly developed animals the net arrangement is relegated to the control of relatively minor functions, while the main nervous system consists of numerous neurons arranged in groups, or **GANGLIA**, and prolongations of the neurons, or **NERVE FIBERS**, bound together into cables, or **NERVES**. The neurons, which are embedded in protective sheaths of connective tissue in

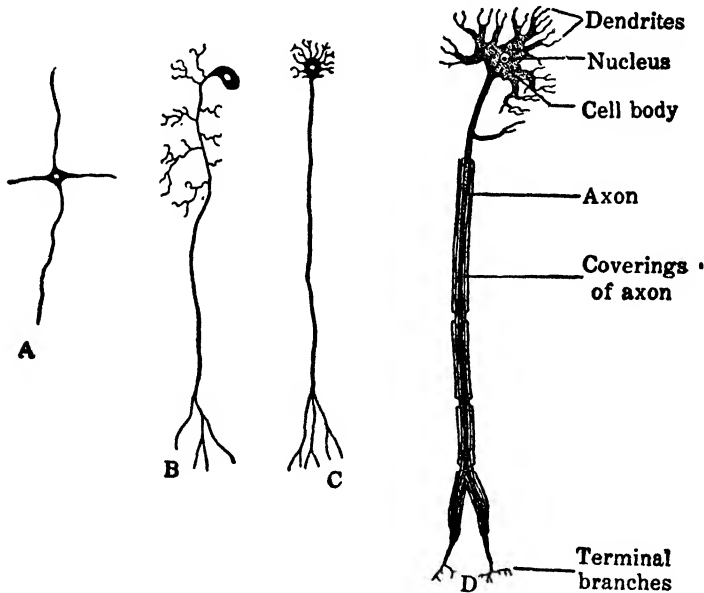

FIG. 138. — Neurons. Stages in the differentiation of nerve cells. A, primitive neuron from the nerve net of Hydra-like animals; B, motor neuron of the Earthworm; C, D, primary motor neurons of a Vertebrate.

the ganglia, are in physiological continuity one with another by 'transmitting contacts,' or **SYNAPSES**; but each neuron, it is believed, remains structurally distinct. (Figs. 138, 139, 143.)

### 1. Brain and Spinal Cord

It will be recalled that the first great differentiation during the development of a multicellular animal establishes an outer ectoderm and inner endoderm, and thus separates the functions of protection and general reactions to the environment from that of nutrition. It is natural therefore that the ectoderm should be-

come the seat of those specializations which have evolved into the nervous system and sense organs. Such is the case in all forms from the lowest to the highest, and thus the development and comparative anatomy of the nervous system of Vertebrates, in particular, affords strong evidence of the genetic continuity of the whole series.

In the development of a Vertebrate, the first indication of the nervous system is a longitudinal *groove* in the ectoderm along the dorsal surface, which soon becomes converted into a *tube* by the

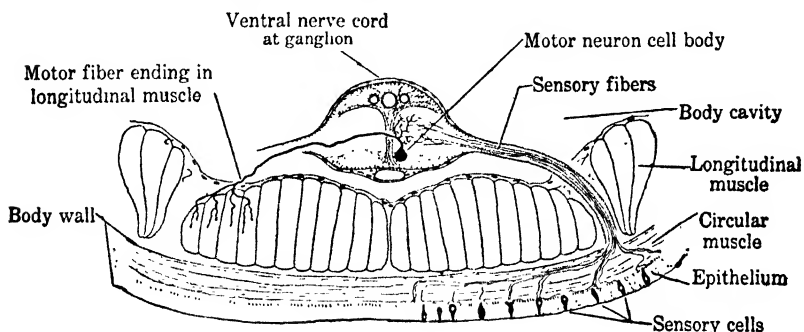

FIG. 139. — Diagram of primary sensory and motor neurons of the ventral nerve cord of an Earthworm, showing their connections with the skin and the muscles to form a simple reflex arc. See Fig. 61.

apposition and, finally, the fusion of its edges. This NEURAL TUBE then becomes separated from, and sinks below the surface ectoderm, and in time forms the CENTRAL nervous system consisting of the BRAIN and SPINAL CORD. As development proceeds, out-growths from the central nervous system establish the PERIPHERAL and the AUTONOMIC nervous systems, so that structurally as well as physiologically the whole nervous system represents a unit; a single organ, as it were, which secondarily becomes closely identified here and there with sense organ, muscle, or gland, as the case may be. (Figs. 142, 174.)

The first marked structural modifications in the developing central nervous system of Vertebrates are two constrictions of the enlarged anterior end of the neural tube, which establish the three primary brain vesicles: FORE-BRAIN, MID-BRAIN, and HIND-BRAIN. Thus very early in embryonic development, one end of the neural tube is molded into the brain, leaving the rest to become the spinal cord. (Fig. 140.)

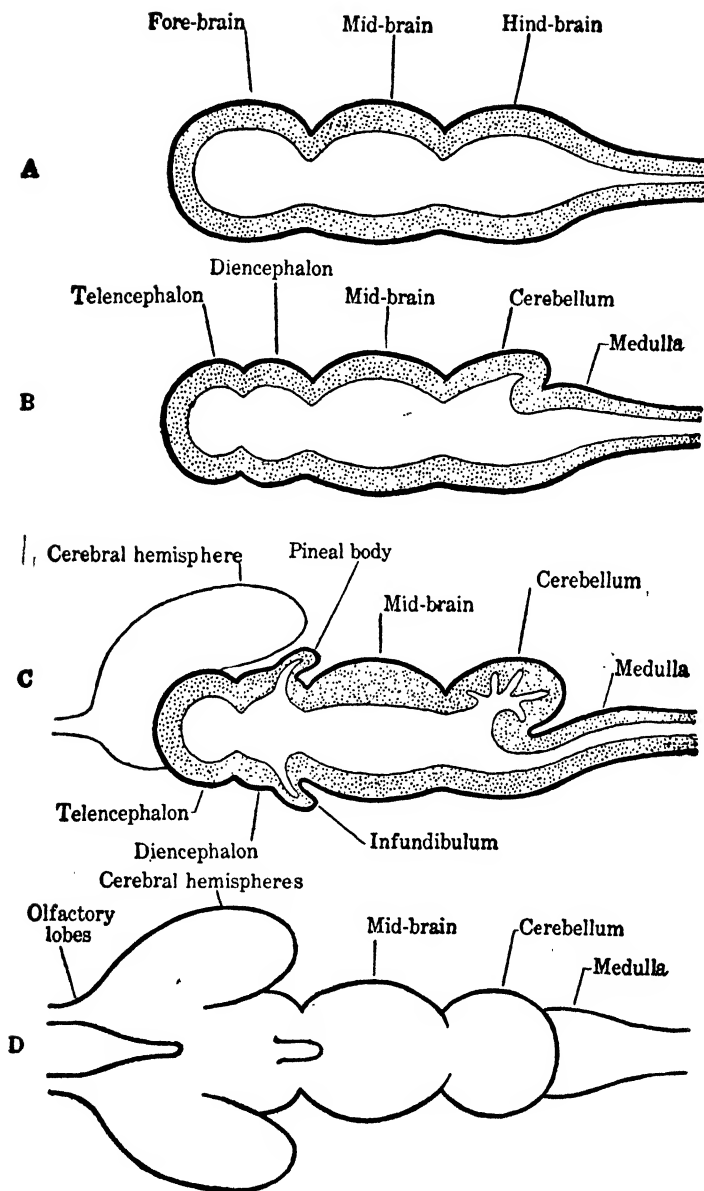

FIG. 140. — Diagrams to illustrate the general method of transformation of the anterior end of the neural tube into the brain. A, B, C, median vertical sections; D, dorsal view of C.

The three-vesicle brain now becomes transformed into one of five vesicles by a hollow outpocketing from the anterior end of the fore-brain and a dorsal outpocketing from the hind-brain. In the lowest forms the brain throughout life consists essentially of these divisions, known as TELEENCEPHALON, DIENCEPHALON, MID-BRAIN, CEREBELLUM, and MEDULLA OBLONGATA; the latter merging into the spinal cord. Usually, however, the telencephalon gives rise to a pair of CEREBRAL HEMISPHERES which are destined gradually to overshadow in size and significance all the other parts of the brain. Then the development from the telencephalon or its derivatives, the cerebral hemispheres, of a pair of OLFACTORY LOBES completes the establishment of the chief brain chambers.

The further changes which transform the more or less linear series of vesicles into the increasingly complex and compact brain of higher forms are due to bendings, or FLEXURES, and to unequal thickenings and outgrowths of the chamber walls. For instance, the upper and lower surfaces of the diencephalon give rise to the PINEAL BODY and the INFUNDIBULUM respectively, while from similar regions of the mid-brain are developed the OPTIC LOBES and CRURA CEREBRI. Hand in hand with these changes the primary cavities of the chambers undergo a gradual restriction, but throughout all there persists at least a remnant of the original tubular cavity which is continuous with that of the spinal cord. (Figs. 109, 141.)

The CEREBRUM, or cerebral hemispheres, is considerably the largest and most important part of the human brain since it is the center of perceiving, thinking, voluntary motion, and even consciousness — the seat of the higher mental life in general. These primary activities are performed by neurons, the cell bodies being located in the CORTEX, the outer layer of GRAY MATTER, while the nerve fibers from the neurons extend deeper to form the inner WHITE MATTER. These fibers transmit nerve impulses to and from the cell bodies in the cortex.

Next in importance is the cerebellum which, of course, also consists of neurons. Their functions are subsidiary to those of the cerebrum since initiative resides in the cerebrum, but messages from this director are coördinated by the cerebellum on their way to various parts of the body. Thus, one may consciously extend an arm, but the various compensating movements of other parts of the body that are necessary to maintain equilibrium are at-



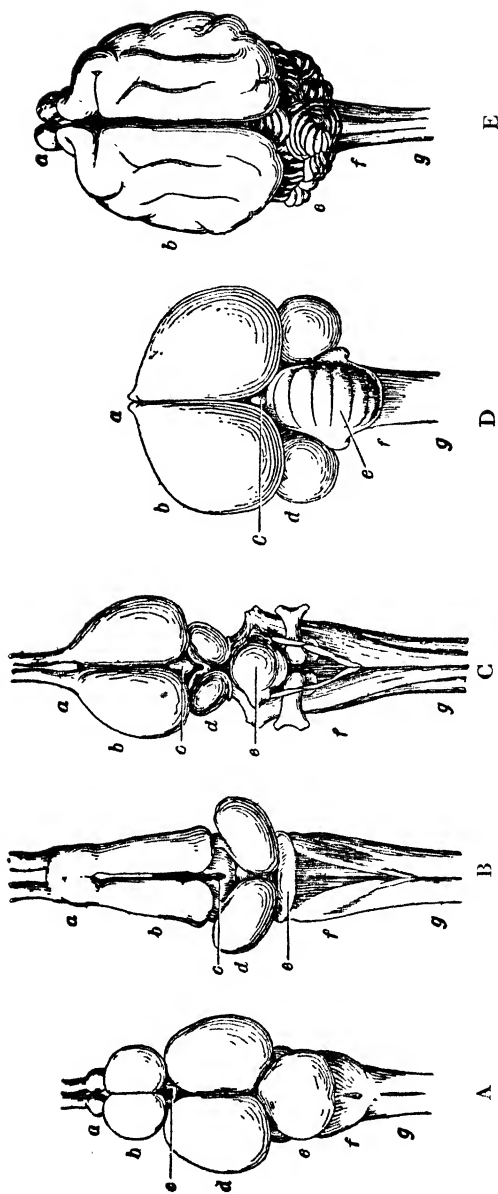

FIG. 141. — Dorsal view of the brain of A, bony Fish (Perch); B, Amphibian (Frog); C, Reptile (Alligator); D, Bird (Pigeon); E, Mammal (Cat). a, olfactory lobes; b, cerebral hemispheres; c, pineal body; d, optic lobes; e, cerebellum; f, medulla; g, spinal cord.

tended to by the cerebellum. It is discriminating but not conscious.

Finally, in the medulla, nerve fibers are in the ascendancy since all nerve impulses to and from the cerebrum and cerebellum and the spinal cord are transmitted through the medulla. The *crura cerebri* are large bundles of fibers extending from the medulla to the cerebrum. However, nerve cells are also prominent in the medulla: some of them give rise to CRANIAL NERVES, and some form functional groups, or centers of actions for regulating the respiratory and circulatory organs, known as the RESPIRATORY CENTER, VASOMOTOR CENTER, etc.

## 2. Cranial and Spinal Nerves

The brain and spinal cord are, as we know, protected and isolated by a cartilaginous or bony tube, formed by the skull and neural arches of the vertebrae, which is embedded in the muscles forming the dorsal part of the body wall. The sole paths of nervous communication between the central system and the rest of the organism and its surroundings are a series of pairs of CRANIAL and SPINAL NERVES. These arise at fairly regular intervals from one end of the brain and cord to the other, and pass out through openings in the skull and between or through the vertebrae to constitute the peripheral nervous system. (Figs. 109, 142.)

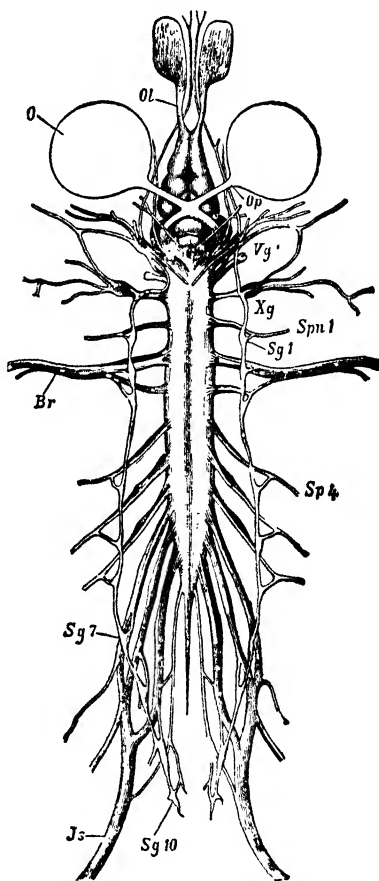

FIG. 142. — Ventral view of the nervous system of the Frog. *Br*, second and third spinal nerves (brachial plexus); *Js*, sciatic nerve leading from the sciatic plexus; *O*, eye; *Ol*, olfactory nerve; *Op*, optic nerve; *Sg 1-10*, ten ganglia of autonomic system; *Spn 1*, first spinal nerve; *Sp 4*, fourth spinal nerve; *Vg*, trigeminal ganglion; *Xg*, ganglion of 10th cranial nerve, or vagus. (From Ecker.)

It is usually considered that the primitive segmental condition of the Vertebrate body is well exhibited in the arrangement of the cranial and spinal nerves, and that the origin of the cranial nerves from the brain affords a partial index to the primary series of segments which apparently have been merged to form the Vertebrate head. Conditions as they exist at the present time can perhaps be most readily understood by imagining a simple, ancestral, segmented worm-like form in which the dorsal neural tube gives off a pair of nerves to each segment of the body. As the result of a gradual shifting forward, union, and finally complete fusion of certain segments near the anterior end, there is formed a head region with its brain, battery of sense organs, and skull, more or less distinct from a trunk region with its spinal cord, vertebral column, paired limbs, etc. This CEPHALIZATION naturally involves a shifting and modification of the primitive condition of the paired nerves; especially since the innervation of a group of cells in normal development is apparently rarely changed — a nerve following the part which it originally supplied through many of the transformations and even migrations of the latter.

If this point of view is accepted, the cranial and spinal nerves are, historically considered, similar structures. But the former, synchronously with the changes in the head region, have departed somewhat widely from their ancestral condition and have even been augmented by nerves of diverse origin. The spinal nerves, on the other hand, continue to issue from the cord at about equal intervals and in segmental arrangement as indicated by muscle segments and skeletal structures, although those of certain regions unite in the body cavity to form groups, or PLEXUSES, to afford an adequate nerve supply to the appendages. (Fig. 142.)

From the standpoint of function the nerves are of three classes: SENSORY, MOTOR, and MIXED. Sensory nerves are the paths over which excitations (NERVE IMPULSES) due to stimuli are conducted to the cord and brain, while motor nerves are the paths for distributing impulses from the brain and cord to muscle cells, gland cells, etc., and thus induce the response of the organism. But the great majority are mixed nerves which afford paths for sensory as well as for motor impulses and so perform both functions.

It is important to note that a nerve is actually a bundle of nerve fibers; the fibers themselves in turn being prolongations of nerve cells, the cell bodies of which are usually in groups, or ganglia.

Moreover, nerve impulses are not transmitted by a nerve as a whole, but by one component cell process, a nerve fiber; that is, by way of a definite cell path through the nerve. The same is equally true of the cord and the brain, which differ from nerves largely in

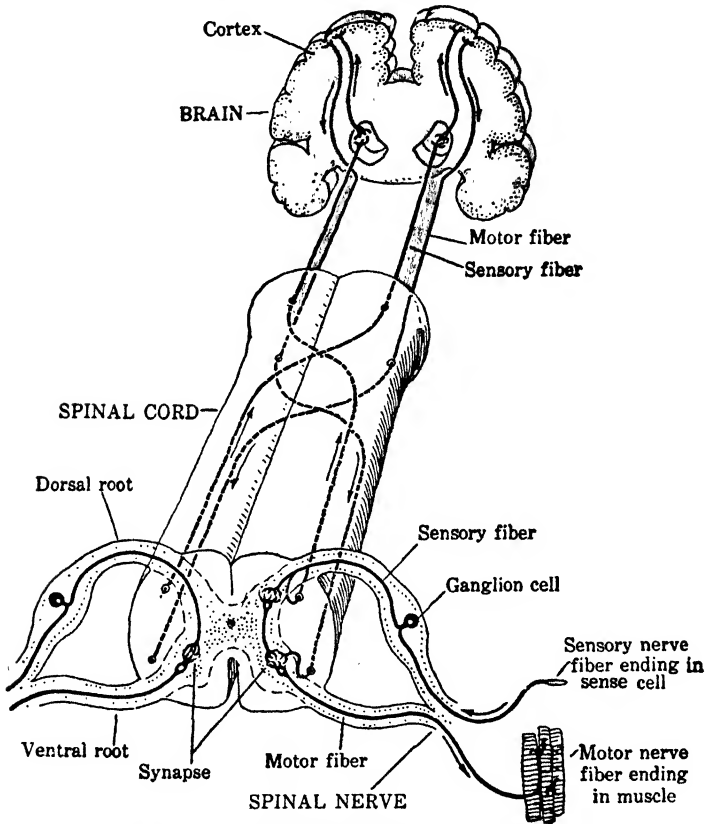

FIG. 143. — Diagram of the paths of sensory and motor nerve fibers. A reflex arc from sense cell via spinal cord to muscle cell is shown at lower right.

that they comprise more cell processes and also the cell bodies themselves. In other words, the brain and cord comprise the elements of both ganglia and nerves.

A mixed nerve conducts impulses both to and from the central organ because it contains both sensory and motor cell paths, or fibers. All peripheral nerves are primarily mixed nerves, because typically they arise by two roots from the central organ; the **DORSAL ROOT** containing only sensory (afferent) fibers and the **VENTRAL**

ROOT only motor (efferent) fibers. This condition is preserved by the spinal nerves of higher forms since each arises by two roots. But some of the cranial nerves, in response to the profound modifications that have been wrought in the head region, have only one root, and so are either solely sensory, as those to the sense organs, or only motor, as those innervating the muscles which move the eye. (Fig. 143.)

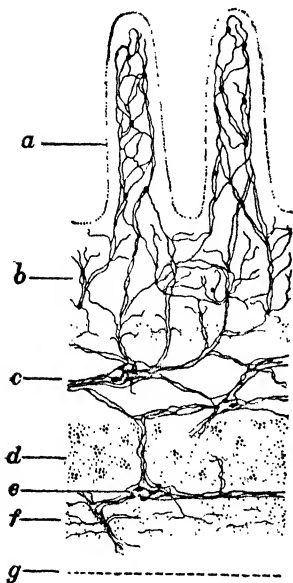

FIG. 144. — Diagram of a section (highly magnified) of the wall of the intestine of a Vertebrate to show its *intrinsic* nervous organization which brings about the movements of the tube. The two plexuses consist essentially of simple neurons arranged as nerve nets. *a*, food absorbing surface of the intestine; *b*, mucous layer; *c*, plexus of neurons (submucous); *d*, circular muscle; *e*, plexus of neurons (myenteric); *f*, longitudinal muscle; *g*, serous layer. (From Parker, after Lewis.)

Many nerve impulses set up by sensory stimuli are, in part, shunted directly from sensory to motor nerve paths in the spinal cord itself. One removes his finger from the pin-point before he is conscious of the prick. Thus so-called REFLEX ARCS bring about the multitude of REFLEXES which relieve the brain of much unnecessary labor, and are the basis of the behavior of animals. Many reflexes apparently are inherited, but others, known as *CONDITIONED REFLEXES*, are established as the result of experience. (Figs. 139, 143.)

### 3. Autonomic System

So far we have considered the central system — the brain and spinal cord; and its lines of communication with the body as a whole, the peripheral system — the cranial and spinal nerves. In point of fact, however, the peripheral system gives rise to an auxiliary series of ganglia and nerves which are charged with the regulation of practically all of the functions of the body that are not under voluntary control, such as the circulatory system and alimentary canal. This *AUTONOMIC SYSTEM* in the higher Vertebrates consists essentially of a double nerve chain, situated chiefly in the body cavity just ventral to the verte-

bral column, from which branches proceed to innervate the nearby organs. It communicates with the central system by way of the sensory roots of the spinal and some of the cranial nerves. (Figs. 142, 144.)

Such, in essence, is the distribution throughout the body of the nervous system which, although it arises as an infolding of the ectoderm and therefore is primarily external, comes to be internal and so chiefly dependent upon more or less isolated groups of SENSORY cells for the reception of stimuli. Some of these, termed EXTERNAL RECEPTORS, remain at the surface to receive stimuli from the outer world, while others, known as INTERNAL RECEPTORS, are situated within the body for the reception of stimuli arising there. The external receptors are what one ordinarily thinks of as sense organs.

### C. SENSE ORGANS

Although among some of the Protozoa certain regions of the cell are specialized so that they are more sensitive to one or another kind of stimulation, the great majority show no trace of sense organs. Nevertheless all forms, in common with all protoplasm, possess the power of receiving and responding to environmental changes. Thus Paramecium reacts to mechanical, thermal, chemical, and electrical stimulation: the entire surface of the cell is sensitive to stimuli, and the excitations are conducted from one part to another essentially by the protoplasm as a whole, aided apparently by the neuromotor apparatus. In some Invertebrates, such as Hydra and the Earthworm, the entire surface of the body is still depended upon as a receiving organ for all kinds of stimuli, and only simple sense cells are developed. In the majority of animals, however, although all the cells, of course, retain to some extent their power of irritability, environmental changes exert their influence chiefly upon complex receptors which are specialized to respond most readily to particular forms of energy. The energy, for example of heat or light, is transformed by appropriate mechanisms into the energy of a nerve impulse, and accordingly the sense organs constitute the outposts of the nervous system. (Figs. 22, 135-137, 139, 225.)

Since we necessarily gain our knowledge of the outside world solely through the data afforded by our sense organs, it follows

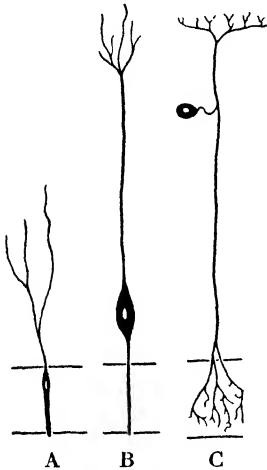

FIG. 145. — Diagram of stages in the differentiation of sense cells. A, primitive sensory neuron of Hydra-like animals; B, sensory neuron of a Mollusc; C, primary sensory neuron of a Vertebrate. In each case the sensory surface is represented below, and therefore the nerve impulse passes upward. (From Parker.)

that we judge the capacity of the sense organs of other animals merely by comparing them with our own. This is a safe procedure only in the case of sense organs that more or less correspond in structure to those which we possess. In the Crayfish, for example, we find complex sense organs which, without doubt, are eyes, and others which are ears, or at least perform one of the functions of our ears, equilibration; while some of the head appendages are particularly adapted to receive sensations of touch. The senses of smell and taste are also probably present, but here we are on less sure ground. It is, indeed, almost certain that environmental changes which are without effect on the sense organs of the human body, and so play no recognizable part in the 'world' of Man, may stimulate receptors in lower organisms. But Man's ingenuity has in certain cases devised apparatus to minimize his limitations: witness the radio receiver. (Figs. 54, 63.)

The simplest form of sense organ in Vertebrates is a single epithelial cell for the reception of stimuli, connected with a nerve fiber for the conduction of the nerve impulse to a sensory center. Usually, however, many associated cells are arranged to respond and are aided by accessory structures for intensifying the stimulus, protection, etc., so that the whole forms a highly complex sense organ. (Figs. 145, 150.)

### 1. Cutaneous Senses

Confining our attention to the Vertebrates, we find that practically the entire surface of the body constitutes a sense organ, because the skin is permeated with a network of sensory nerves. Certain regions are supplied with special **PRESSURE RECEPTORS**, which may take the form of a regular system of sense organs, such as the **LATERAL LINE ORGANS** of Fishes and Amphibians, or of groups of **TACTILE CORPUSCLES** as in Man. In addition to pressure

receptors, most of the surface of the human body is provided with PAIN, HEAT, and COLD SENSE SPOTS.

## 2. Sense of Taste

In the higher Vertebrates the sense of taste is restricted to the cavity of the mouth, particularly to the tongue, where special receptors known as TASTE BUDS are in communication with the

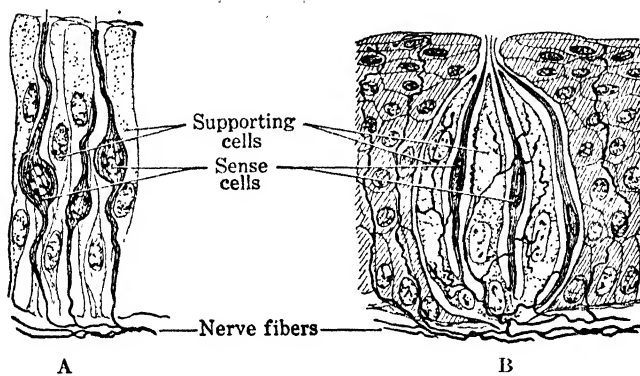

FIG. 146. — A, Cells of olfactory epithelium from human nose. B, Cells of a taste bud in epithelium of tongue. The sensory cells terminate externally in hair-like processes which are activated by the chemical stimuli that produce odor or taste.

brain by two of the cranial nerves; but in some Fishes similar organs are scattered quite generally over the surface of the body. (Fig. 146.)

## 3. Sense of Smell

The special sense organs of smell, or OLFACTORY CELLS, reside in the membrane which lines a pair of invaginations of the anterior end of the head, termed OLFACTORY POUCHES. The cells are in communication with the brain by the olfactory, or first pair of cranial nerves. The pouches constitute relatively simple sacs in the lower Vertebrates, but in the air-breathing forms, and especially in the Mammals, the walls of the pouches are thrown into folds, ridges, and secondary pouches. This is necessitated by the concentration of the olfactory surface to the air passages of the NOSE which lead to the lungs. However, the human olfactory apparatus has fallen somewhat from the complexity which it attains in the lower Mammals, as is attested not only by its



structure in the adult but also by transient remnants in the human embryo. (Fig. 146.)

#### 4. The Ear

The EARS, or organs of hearing and equilibration, arise as paired depressions of the ectoderm of the head, which, in all Vertebrates above the lower Fishes, lose their connection with the exterior and form the so-called INNER EAR, or LABYRINTH. This becomes divided into two chief parts, the SACculus and the UTRICULUS, from which

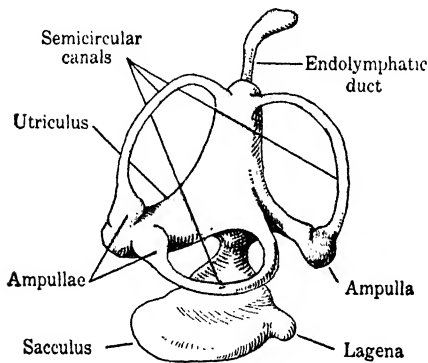

FIG. 147. — Diagram of the left membranous labyrinth of a lower Vertebrate, showing the sacculus, utricle, and the three semicircular canals. The lagena is a derivative of the sacculus which becomes the cochlea in higher Vertebrates.

are developed three SEMI-CIRCULAR CANALS, one in each plane of space. The saccule is largely devoted to the reception of vibrations of the surrounding medium, that is to hearing in the usual sense of the word. Accordingly the saccule becomes progressively differentiated as we ascend the Vertebrate scale — a complex derivative in the Mammalian ear being the COCHLEA. (Fig. 147.)

On the other hand, the utricle and the semicircular canals provide for sensations of loss of equilibrium, or orientation of the body in space, and show far less change. It is probable that equilibration is the chief function of the entire labyrinth in Fishes, as it is of the so-called auditory organs of many Invertebrates, such as the Crayfish. With the progressive specialization of the labyrinth, the essential sensory cells, which are in communication with the brain by the eighth, or AUDITORY NERVE, become limited to a few definite areas. These sensory cells are provided with auditory hairs which project into the cavity of the labyrinth and so are stimulated by movements of the fluid which fills it.

The ears of Fishes lie immediately below the skull roof where they are readily accessible to vibrations transmitted by the water. But with the substitution of air for water as the surrounding medium, there arises the necessity of a more delicate method for

conducting and also for collecting and augmenting the sound waves. The result is that, in ascending the Vertebrate series, we find the ear proper receding farther and farther below the surface.

Soon, between the labyrinth, or inner ear, and the surface of the head, a simple resonating chamber is added which is provided with a vibrating TYMPANIC membrane, or EAR DRUM, situated just under the skin. Then this is improved by the development of a bony transmitting mechanism between the tympanic membrane and the inner ear. This consists of a single bone until we reach the Mammals, when two more bones are added by being diverted from their

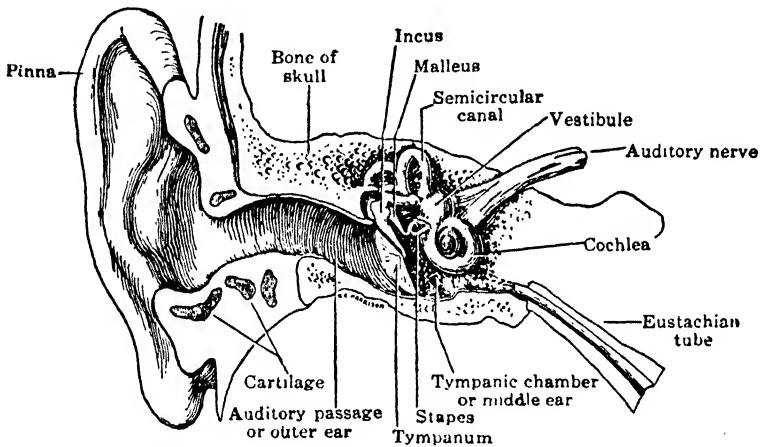
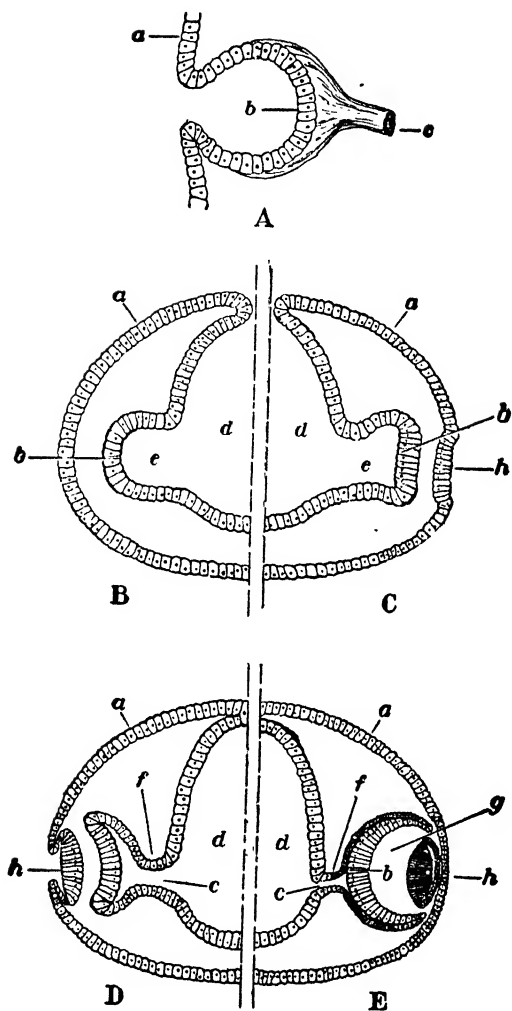

FIG. 148. — Front view of a vertical section of the human ear, right side. Note the transmitting mechanism of three bones: malleus, incus, and stapes.

earlier function of articulating the jaws with the skull. Finally, the resonating (tympanic) chamber recedes farther below the surface and becomes the MIDDLE EAR to which sound waves are conducted through a tubular passage, the OUTER EAR. In some forms the latter is provided with an external funnel-like expansion, the PINNA. Apparently much is accomplished by accumulating minute changes during the ages. (Fig. 148.)

### 5. The Eye

The organs of sight are the most complex sense organs of animals and reach a very high degree of specialization even in some of the Invertebrate forms. Among the latter the essential sensory element (RETINA) of the eye usually arises by the invagination of



**FIG. 149.** — Diagrams illustrating the method of formation of the eye of an Invertebrate (A) and a Vertebrate (B, C, D, E, — successive stages). Note that the *opposite* surface of the retinal cells is exposed to the light rays in the Vertebrates as compared with the Invertebrate eye. *a*, ectoderm; *b*, retinal area; *c*, future position of optic nerve; *d*, cavity of the diencephalon; *e*, optic vesicle; *f*, stalk of optic vesicle, later replaced by the optic nerve; *g*, vitreous chamber within optic cup; *h*, developing lens.

a limited area of ectoderm, the cells of which become differentiated for receiving the photic stimuli that produce nerve impulses to be transmitted to the central nervous system. Among Vertebrates the sensory cells are also of ectodermic origin, but only secondarily so, since the OPTIC VESICLES arise as outpocketings directly from the sides of the diencephalon. (Fig. 149.)

A retina alone, such as exists in some of the lower Invertebrates, can afford no visual sensations other than light and darkness, and perhaps in some cases the ability to distinguish light of one color

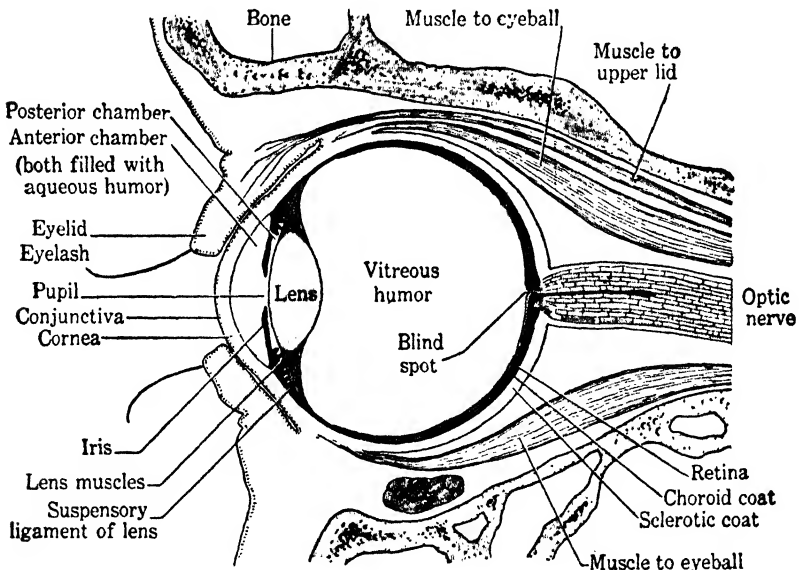

FIG. 150. — The Vertebrate eye (human). Vertical section of the eye and associated structures.

from that of another. In order that not merely degrees of the intensity of light may be perceived, but that objects may be seen, many of the higher Invertebrates have developed various kinds of complicated apparatus for bringing the rays from a given point to a focus at one point on the retina. These culminate, on the one hand, in the compound eye of the Arthropods; and on the other, in the 'camera' eye of certain Molluscs such as the Squid. In the latter case the mechanism is very much like that found in the Vertebrates, but since it occurs in Molluscs which cannot be considered in the direct evolutionary line of the Vertebrates, it

affords an example of similar responses of different organisms to similar needs giving rise to *analogous* structures. (Figs. 50, 150.)

The wall of the Vertebrate eye, or **EYEBALL**, forms a more or less hollow sphere which can be rotated by several relatively large muscles. The anterior exposed part of the eyeball consists of two transparent layers: the delicate **CONJUNCTIVA**, continuous with the inner lining of the eyelid, and the rigid **CORNEA** beneath. The sides

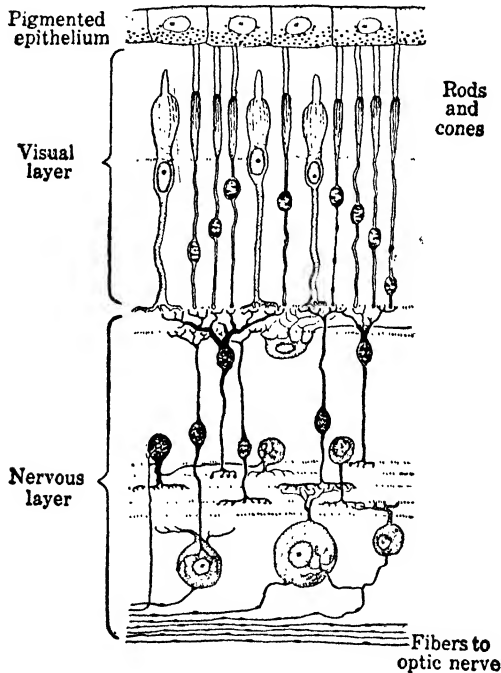

FIG. 151. — Diagram of a vertical section of the Vertebrate retina (human). The pigmented epithelium is the retinal layer farthest from the vitreous chamber, and in contact with the choroid coat.

and posterior part are also composed of two layers, the outer **SCLEROTIC** coat and the inner **CHOROID** coat. Suspended within the eyeball is the **LENS** which divides the cavity into two chief parts; the one posterior to the lens, known as the **VITREOUS CHAMBER**, being lined by the retina whose nerve cells supply the nerve fibers forming the **OPTIC**, or second cranial nerve.

The Vertebrate eye is an optical apparatus that may be compared roughly with a camera, but this conspicuous difference

must be noted. A camera is focussed by altering the distance between the lens and the film, whereas the eye is focussed by changing the curvature of the lens. Thus light waves passing through the conjunctiva, cornea, and an opening (PUPIL) in a regulating diaphragm (IRIS) reach the lens and are focussed on the retina. The sensory stimulation of the RODS and CONES of the retina thus brought about is transmitted by the optic nerve to the brain. The brain itself interprets the nerve impulses and composes — sees — the picture. How this is done, nobody knows. (Fig. 151.)

A broad survey of the sense organs of Vertebrates from the lowest to the highest impresses one with the fact that, taken by and large, the improvements, though considerable, are not so marked as one might expect when the great development of the nervous system, particularly the brain, is considered. The brain increases enormously in volume and complexity from Fish to Man. In many Fishes it seems to be little more than a slight modification of the anterior end of the spinal cord, while in the Frog the brain and cord weigh about the same. But the human brain weighs about three pounds, nearly fifty times as much as the cord, and comprises many billions of nerve cells. So it would seem that we must look to the general influence of the sensory stimuli themselves for the underlying factors in the development of the brain during its long evolutionary history — the brain, in turn, being enabled to make more out of the same stimuli and create in Man the higher mental life with all that it implies. It is, indeed, an appalling thought that all human mental states are represented by a few thimblefuls of cells constituting the cerebral cortex.

## CHAPTER XVII

### ORIGIN OF LIFE

The mystery of life will always remain. Science is not the death, but the birth of mystery, awe, and reverence. — *Donnan*.

A GENERAL background of biological facts and principles has now been established, and we are therefore in a position to take up from an advantageous viewpoint some of the broad questions raised by the science. For its antiquity as well as its universal interest, the problem of the origin of life takes precedence.

#### A. BIOGENESIS AND ABIOGENESIS

It must seem strange to the reader, with some of the complexities of organisms before him, that the best minds up to the seventeenth century saw nothing more remarkable in the spontaneous origin of plants and animals of all kinds from mud and decaying matter, than does the boy of to-day who believes that horse hairs soaked in water are transformed into worms. As a matter of fact, we find that even Aristotle, who laid such broad foundations for the science and philosophy of the organism, believed that certain of the Vertebrates, such as eels, arose spontaneously.

Similar ideas are voiced repeatedly through more than twenty centuries by scientists and philosophers, poets and theologians. Van Helmont, one of the founders of chemical physiology during the seventeenth century, gives particularly specific directions for the experimental production of scorpions and mice; while Kircher actually figures animals that he states arose under his own eyes through the influence of water on the stems of plants. The following ironical reflections, aroused by Sir Thomas Browne's doubts in regard to mice arising by putrefaction, are quite typical of opinion of the time: "So we may doubt whether, in cheese and timber, worms are generated or if beetles and wasps in cow dung, or if butterflies, shellfish, eels, and such life be procreated of putrefied matter. To question this is to question reason, sense, and experience. If he doubts this, let him go to Egypt, and there he

will find the fields swarming with mice begot of the mud of the Nile, to the great calamity of the inhabitants."

Naturally, with the gradual increase in knowledge of the complexity of organisms, the idea of ABIOTENESIS, or SPONTANEOUS GENERATION, was restricted more and more to the lower forms. It remained, however, for Francisco Redi during the latter part of the seventeenth century to question seriously the general proposition, and to substitute direct experimentation for discussion and hearsay. By the simple expedient — it seems simple to-day — of protecting decaying meat from contamination by flies, he demonstrated that these insects are not developed from the flesh and that the apparent transformation of meat into maggots is due solely to the development of the eggs deposited thereon by flies.

One may imagine that the practical man of affairs scoffed at Redi toiling under the Italian sun with meat and maggots to satisfy a scientific curiosity, and little dreamed that the practical results which germinated from this 'folly' would be among the most important factors in twentieth-century civilization. Indeed, it is difficult to overestimate the importance of Redi's conclusion from either the theoretical or practical viewpoint, for with it was definitely formulated the theory that matter does not assume the living state, at the present time at least, except from preëxisting living matter.

The influence of this work gradually became evident in scholarly literature. One author during the next century states that "spontaneous generation is a doctrine so generally exploded that I shall not undertake to explode it. It is so evident that all animals, yea and vegetables, too, owe their production to parent animals and vegetables, that I have often admired the sloth and prejudices of ancient philosophers in taking it upon trust." Another writes that he "would as soon say that rocks and woods engender stags and elephants as affirm that a piece of cheese generates mites."

But it is not to be supposed that the time-honored doctrine of spontaneous generation actually had been so easily relegated to the myths of the past, Redi's work and these eighteenth-century opinions to the contrary. Indeed, the history of the establishment of BIOTENESIS — all life from life — extends down almost to the present time, for no sooner had experiment apparently disposed of spontaneous generation than it arose again with fresh vigor in a slightly different form demanding further investigation.



The difficulties came from two chief sources. In the first place, Redi himself had been baffled by the presence of parasites within certain internal organs of higher animals, such as the brains of sheep. How did they get there if not by spontaneous generation? The answer to this had to await the working out of the marvelously complex life histories of the parasitic worms and allied forms which showed that they all arise from parents like themselves. In the second place, improvements in microscope lenses contributed to the discovery of smaller and smaller living creatures. Countless numbers and myriads of kinds of "animalcules" appearing almost overnight in decaying organic infusions aroused widespread interest and amazement, and proved to be the chief riddle. The plausible explanation seemed to be spontaneous generation. (Figs. 14, 18, 26, 251, 252.)

Among others, Needham studied the problem and believed that he had demonstrated the spontaneous origin of minute organisms in infusions that he had boiled and sealed in flasks. His results attracted considerable attention because the famous French naturalist, Buffon, found in them support for his theory that the bodies of all organisms are composed of indestructible living units, which upon the death of the individual are scattered in nature and later brought together again to form the units of new generations.

Needham's and similar results, however, were shown by Spallanzani and others to be inconclusive because they were obtained by insufficient sterilization and sealing of the flasks containing the infusions. But at this point objections came from another source: the chemists who had recently discovered the important part played by free oxygen for life processes and for the putrefaction and fermentation of organic substances. They argued that the treatment to which Spallanzani and other experimenters subjected the infusions might well have changed the organic matter, excluded oxygen, etc., so that it was impossible for life to be produced.

This objection was met by a long series of experiments by various investigators during the first half of the last century, which showed conclusively that thoroughly sterilized infusions never developed living organisms even when air was admitted, provided the latter had been rendered sterile by heat or by having all suspended 'dust' particles removed. Thus the chemists were answered — the infusions possessed all the conditions necessary to support life — but life did not arise. The biologist who contributed most to

the establishment of this conclusion was Pasteur. His masterly and comprehensive work was not only convincing and final, but it also demonstrated the source of the life that so rapidly appeared in infusions that are exposed to the air. It is the air. A considerable part of so-called dust is made up of microorganisms in a dormant state ready to resume active life when moisture and other suitable conditions are encountered.

Furthermore, these organisms are not the result, but the cause of decay — their own activities bring about chemical changes: putrefaction, fermentation, and, in the bodies of higher organisms, disease. And this is amply attested by the methods now universally used in food preservation and

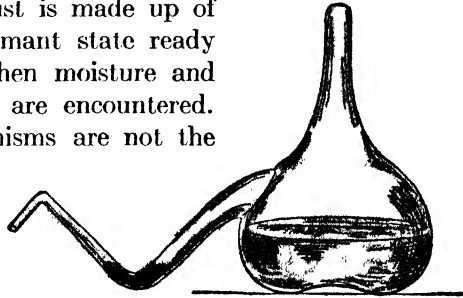

FIG. 152. — Flask used by Pasteur in his experiments on spontaneous generation. After the contents were poured in, the top of the flask was sealed. The opening at the end was sealed against the entrance of germs, but not oxygen, etc., by the water of condensation that accumulated at the bend. Life did not develop in the flask.

aseptic surgery — to mention but two instances. (Figs. 152, 153, 278).

But, though highly improbable, of course it is not impossible that simple life is even at the present time arising spontaneously under special environmental conditions, perhaps in the ocean depths, though unable to come to fruition in competition with existing highly specialized protoplasm of ancient pedigree. Indeed, if such living matter is arising, it must be very simple compared with protoplasm as we know it to-day; so simple, in fact, that we would not recognize it as such, because the protoplasm of even the simplest organisms has had a long evolutionary history.

So we may consider it firmly established that, so far as human observation and experiment go, no form of life arises to-day except from preëxisting life by reproduction. The evidence from innumerable sources converges overwhelmingly to the support of biogenesis. There is no evidence in support of abiogenesis.

## B. ORIGIN OF LIFE ON THE EARTH

If we accept the testimony of astronomer and geologist, the Earth was at one time in a condition in which life could not exist,

and so we are face to face with the problem of how it came to be established on the Earth in the past — the remote past, since the geological record affords convincing proof that life has existed continuously on the Earth for some hundreds of millions of years.

Accordingly, unless one is willing to ascribe life's origin to **SPECIAL CREATION** — which at once removes it from the sphere of

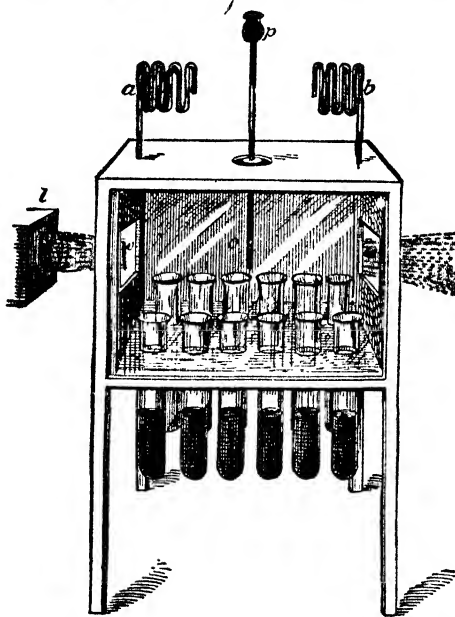

FIG. 153. — Apparatus used by Tyndall in his experiments on spontaneous generation. The front and side windows (*w*, *w*) of the cabinet are made of glass. Air can enter through the two tubes (*a*, *b*). The optical test for the purity of the atmosphere within the cabinet was made by passing a powerful beam of light from the lamp (*l*) through the side windows. When the atmosphere contained no suspended 'dust' particles, the tubes (*c*) within were filled, through the pipet (*p*) with sterile culture medium suitable for the growth of germs, but none developed. (After Tyndall.)

science and so beyond the present discussion — we have the following alternatives: either life came to this planet from some other part of the universe; or it arose spontaneously from non-living matter at one period at least in the past as a natural result of the evolution of the Earth and its elements. With these in mind, a review may be made of several modern theories of the origin of life. It is nearly, if not quite, as important to define our area of ignorance as to extend our area of knowledge.

### 1. *Cosmozoa Theory*

The establishment of biogenesis and the dawning realization of the unique complexity of the structure of matter in the living state have led several scientists to suggest that life has *never* arisen *de novo* on the Earth but has been carried hither from elsewhere in the universe — the so-called COSMOZOA theory.

On the assumption that some of the heavenly bodies have always been the abode of life, and from the fact that small solid particles, which presumably have been a part of such bodies, are moving everywhere in space, these particles have been pictured as the vehicles which disseminate the simplest forms of life through interstellar space to find lodgment and development upon such planets as afford a suitable environment. Clearly, from this point of view, life may be as old as the universe itself.

The plausibility of the cosmozoa theory depends on two assumptions: that life exists elsewhere in the universe, and that life can be maintained during the interstellar voyage. Neither assumption has, of course, any foundation of established fact whatsoever, though the second offers at least something tangible for discussion.

As we know, many of the Bacteria and Protozoa, especially when under the influence of unfavorable surroundings, have the power of developing protective coverings about themselves and of assuming a dormant condition in which all the metabolic activities are reduced to the lowest ebb. In this spore or encysted state they can endure extremes of temperature and dryness which would quickly prove fatal during active life. For instance, it seems clear that the spores of certain kinds of Bacteria can survive a temperature approaching that below which no chemical reactions are known to occur, and others can endure as high as 140° C. for a short time. The cysts of some relatively highly specialized Protozoa can retain their vitality for at least half a century, while the seeds of some plants have been found to retain the power of germination for nearly a century; though statements that grain from ancient Egyptian tombs still maintains its power of growth has been positively disproved. (Fig. 200.)

But the hardships to which living matter would be exposed when started on its interstellar journey are not to be minimized. Meteors in their fall through the Earth's atmosphere become heated to incandescence and, if they are the vehicle of transfer,

it would only be conceivable for life to survive far below their surface where the temperature is lower. To avoid this and other difficulties it has been suggested that the radiant pressure of light is sufficient to overcome the attraction of gravitation for particles of the extraordinary minuteness of some of the lower forms of life, and that isolated germs might make the journey to the Earth. But on the assumption that an organism were forced out into space by the mechanical pressure of light waves from the sun of the nearest solar system, it would require many thousand years for it to reach the Earth. However, it has been suggested that, owing to the exceedingly low temperature and absence of water vapor which must prevail in cosmic space, there is no reason why spores should lose appreciably more of their germinating power in ten thousand years than in six months.

Without further discussion, it is apparent that the cosmozoa theory is one which cannot be proved or disproved. It removes the origin of life to a "conveniently inaccessible corner of the universe where its solution is impossible." Although at first thought it seems almost absurd, with its strictly scientific formulation by recent physicists and biologists, and especially in view of our increasing knowledge of the powers of life in the latent state, we are justified, perhaps, in seriously wondering whether after all life has ever arisen, whether it may not be as old as matter, and whether its germs, passing from one world to another, may not have developed where they found favorable soil.

But the majority of biologists undoubtedly would agree that, "knowing what we know, and believing what we believe, as to the part played by evolution in the development of terrestrial matter, we are, without denying the possibility of the existence of life in other parts of the universe, justified in regarding cosmic theories as inherently improbable." Accordingly we may turn to theories which attempt to picture the evolutionary origin of life from the inorganic upon the Earth.

## 2. *Pflüger's Theory*

Assuming that the Earth was at one time in an incandescent condition, Pflüger imagines that there arose from this superheated mass a combination of carbon and nitrogen to form the radical **CYANOGEN**, CN. This union involves the taking up of a large amount of energy in the form of heat, and therefore cyanogen

contributes energy to organic compounds and, in particular, to proteins of which he believes it to be the unique life-principle. Accordingly the problem of the origin of life is essentially the origin of cyanogen, and since cyanogen and its compounds arise only at exceedingly high temperatures, Pflüger holds that life is essentially derived from fire.

Thus, if Pflüger's hypothesis is valid, once the cyanogen has energized organic compounds they are on their way to proteins and protoplasm, and finally to the evolution of the highly specialized protoplasm of organic life to-day.

### 3. *Moore's Theory*

Moore essays to picture with rather bold strokes the origin of life from the inorganic elements of the cooling Earth, by a continuation of the process of complexification which he sees inherent in the nature of matter. This he expresses in a general way as a "law universal in its application to all matter, and holding throughout all space as generally as the law of gravitation — a law which might be called the LAW OF COMPLEXITY — that matter, so far as its energy environment will permit, tends to assume more and more complex forms in labile equilibrium. Atoms, molecules, colloids, and living organisms arise as a result of the operations of this law, and in the higher regions of complexity it induces organic evolution and all the many thousands of living forms." In this manner he conceives that the chasm between non-living and living things can be bridged over, and that life arose as an orderly development, which comes to every earth in the universe in the maturity of creation when the conditions arrive within suitable limits.

### 4. *Allen's Theory*

Allen maintains that it is simplest to believe that life arose when the physical conditions of the Earth came to be nearly what they are at present, and therefore does not attempt to trace it to actual Earth beginnings. If life formerly existed actively outside of the range of the freezing and boiling points of water, it must, he says, have been quite different from life as we know it. Allen imagines some such reactions as the following to have occurred: solar energy, acting on the water or damp earth containing the raw materials, caused dissociation and rearrangement of the atoms; the nitrogen

abstracting oxygen from its compounds with carbon, hydrogen, sulfur, and other elements and delivering it to the atmosphere. Not much energy would be absorbed by a transparent liquid; but such reactions would occur particularly in water containing compounds of iron in solution or suspension since these compounds would absorb the solar energy. In this way compounds of nitrogen, carbon, etc., accumulated in the water or damp earth; and further reactions, anabolic and katabolic, occurred among them by virtue of the lability of the nitrogen compounds. Life at this stage was of the humblest kind since there were no definite organisms, only diffuse substances trading in energy, and between this stage and the evolution of cellular organisms an immense period elapsed.

#### 5. *Troland's Theory*

With the increasing realization of the importance of enzymes in the economy of organisms, it is not strange that in these chemical bodies has been sought the key to life's origin, and accordingly we find Troland stating that life is something which has been built up about the enzyme. This author assumes that, at some moment in Earth history, a small amount of a certain autocatalytic enzyme suddenly appeared at a definite point within the yet warm ocean waters which contained in solution various substances reacting very slowly to produce an oily liquid which did not mix with water. If, when this occurred, the enzyme became related to the reaction in such a way as to greatly increase its rate, Troland believes it is obvious that the enzyme would become enveloped in the oily material resulting from the reaction, and the little oil drop would increase until it was split into smaller globules, provided the original substances which combined were soluble in oil as well as in water. Thus arose, according to Troland, the first and simplest life-substance, possessing the power of indefinitely continued growth.

#### 6. *Osborn's Theory*

Starting with the assumption that the primal earth, air, and water contained all the chemical elements and three of the more simple but important chemical compounds — water, nitrates, and carbon dioxide, Osborn suggests that an initial step in the origin of life was the bringing of these elements into combined action. This took place when the Earth's surface and waters had

temperatures between 6° and 89° C. and before the atmospheric vapors admitted a regular supply of sunlight. The earliest function of living matter, he thinks, was to capture and transform the electric energy of the chemical elements characteristic of protoplasm, and this power probably developed only in the presence of heat energy derived from the Earth or the Sun.

An early step then, in the organization of living matter, was the assemblage of several of the 'life-elements,' and next their grouping in a state of colloidal suspension — "they were gradually bound by a new form of mutual attraction, whereby the actions and reactions of a group of life elements established a new form of unity in the cosmos, an organic unity, or organism, quite distinct from the larger and smaller aggregations of inorganic matter previously held or brought together by the forces of gravity."

#### 7. *Huxley's Statement*

Such is an outline of some of the foremost attempts of scientists to conceive the origin of the living state of matter from the elements of the Earth. It will be noted that all, except the cosmozoa theory, have one assumption in common — the 'chance' assemblage of the various elements of protoplasm: an assumption regarded by some as not unreasonable when the stupendous duration of time and the almost infinite variations in conditions that were at the disposal of nature are appreciated. According to the statistical theory of probability, if we wait long enough, anything that is possible, no matter how improbable, will happen. Obviously this leaves out of the picture the marginally probable 'nature' which many modern biologists and physiologists would be thought of as emerging from the fortuitous combination of the respective theories necessarily having been arrived at here as hardly to be fair to their authors. It is not attained if they provide an instrument of investigation of an evolutionary trend which biologists have followed, but also of the divergent lines of investigation and imagination when it has followed the same trend. So we may more profitably study the manifold day manifestations of life on the earth, than the origin of life on the earth, which is expounded more than half a century ago through the prodigious



commencement of life, and therefore I am devoid of any means of forming a definite conclusion as to the conditions of its appearance. Belief, in the scientific sense of the word, is a serious matter, and needs strong foundations. To say, therefore, in the admitted absence of evidence, that I have any belief as to the mode in which existing forms of life have originated, would be using words in a wrong sense. But expectation is permissible where belief is not; and if it were given to me to look beyond the abyss of geologically recorded time to the still more remote period when the Earth was passing through physical and chemical conditions, which it can no more see again than a man can recall his infancy, I should expect to be a witness of the evolution of living protoplasm from not living matter. . . . That is the expectation to which analogical reasoning leads me; but I beg you once more to recollect that I have no right to call my opinion anything but an act of philosophical faith." (Fig. 298.)

## CHAPTER XVIII

### THE CONTINUITY OF LIFE

Owing to the imperfection of language the offspring is termed a new animal, but is in truth a branch or elongation of the parent.

— *Erasmus Darwin.*

SINCE so far as is known all life now arises from preëxisting life and has done so since matter first assumed the living state, it apparently follows that the stream of life is continuous from the remote geological past to the present and that all organisms of to-day have an ancient pedigree. It is to the establishment of this as the reasonable conclusion from the data accumulated during recent years, that from now on our attention is somewhat more particularly directed; and accordingly it is necessary first of all to consider in some detail the relation of parent to offspring in present-day forms as exhibited by reproduction.

#### A. REPRODUCTION

The power of producing new individuals specifically similar to the parent is, as has been seen, one of the most important characteristics of living in contrast with lifeless matter. Furthermore, reproduction is typically cell division. This is quite evident in unicellular plants and animals, but by no means so obvious in higher organisms where, as we know, special gonads and highly complex accessory organs are developed in furtherance of reproduction.

It will be recalled that in *Paramecium*, for example, the nucleus and cytoplasm divide into two parts, so that by cell division, here called **BINARY FISSION**, the identity of the parent organism is merged into the two new cells. Simple as this seems, the fission of *Paramecium* actually involves considerably more than the halving of the original cell, because, as a matter of fact, each half must *reorganize* into a complete new individual with all parts characteristic of the parent. (Figs. 8, 28.)

Among some unicellular animals (*e.g.*, the Sporozoa) the parent cell, instead of merely forming two cells by binary fission, becomes resolved into many cells by a series of practically simultaneous

divisions known as **MULTIPLE FISSION**, or **SPORULATION**. This is usually preceded by a considerable growth of the parent cell and its enclosure in a protective covering, or **CYST**, which ruptures to liberate the spores. Other unicellular forms, such as the Yeasts—colorless plants chiefly responsible for alcoholic fermentation—exhibit a modified form of fission in which the parent cell forms one or several outgrowths, or **BUDS**, which gradually assume the characteristic adult form and sooner or later become detached as complete similar individuals. (Figs. 17, 25, 200, 223.)

In a considerable number of instances, however, the cells arising by multiple fission or budding remain closely associated or organically connected so that they form a **COLONY**. In some colonial organisms the component cells are all alike and each retains its

**A. Paramecium.**

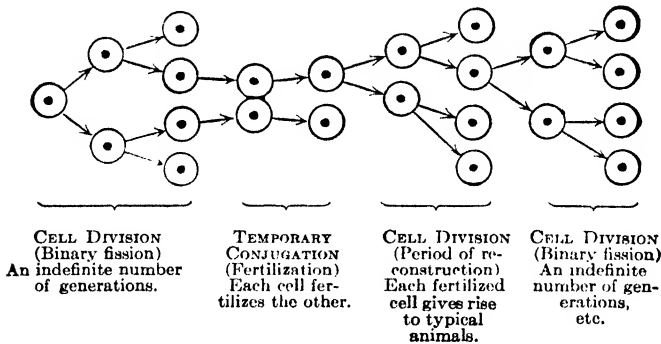

**B. Volvox.**

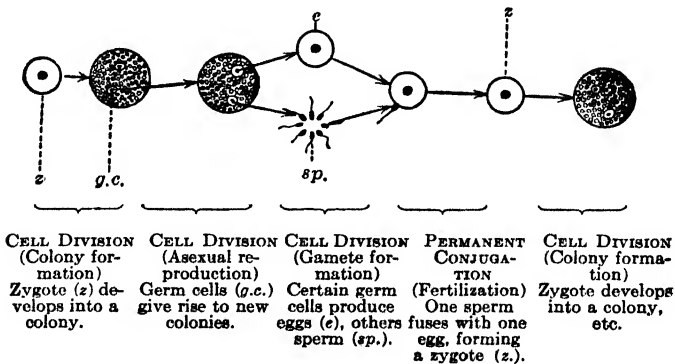

C. Hydra.

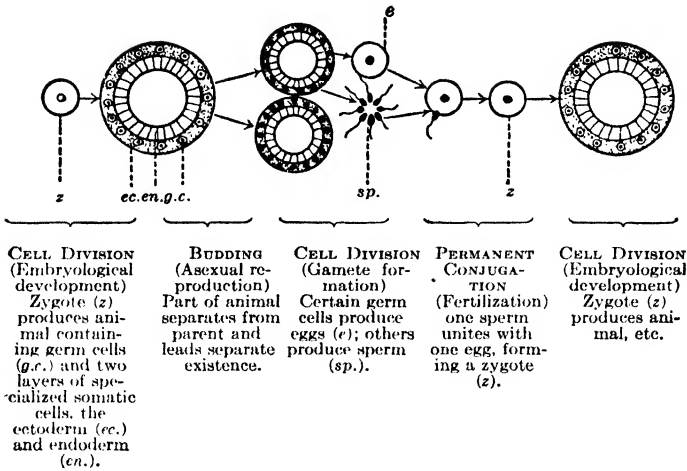

D. Earthworm.

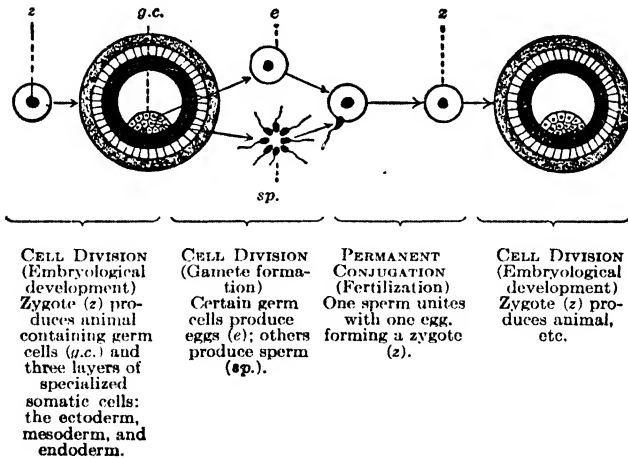

FIG. 154. — Diagrams to illustrate the general reproductive cell cycle in A, a unicellular organism (*Paramecium*); B, a colony of cells (*Volvox*); C, a simple Metazoön (*Hydra*); and D, a more complex Metazoön (*Earthworm*). (Modified, from Hegner.)

individuality, while in others certain cells are restricted more or less in their functions, so that a physiological division of labor is established which involves the shifting of individuality from the cells to the colony as a whole. This specialization is exhibited chiefly with regard to reproduction and reaches its highest expression among colonial Protozoa in *VOLVOX*, where among ten thousand or so cells, perhaps a score are specialized for reproduction and the rest are somatic. Usually each of the reproductive cells (germ cells) divides to form a group which is set free as a miniature colony; but in certain cases some of the reproductive cells become transformed into male and others into female gametes. After fertilization of the eggs, usually by sperm from another colony, the zygotes develop into new colonies which eventually are liberated from the parent colony. (Figs. 29, 30.)

As has been previously suggested, the physiological division of labor in the colonial Protozoa, involving, as it does, a segregation of reproductive from somatic structures, affords a logical transition from the unicellular condition to that characteristic of the multicellular forms. These, to all intents and purposes, may be considered highly complex colonies of cells in which specialization, no longer confined merely to demarking germinal and somatic regions, has transformed the latter into a complex of tissues and organs, the body (*SOMA*) of the individual, while the germinal tissue (*GERM*) is confined to the essential reproductive organs.

It is customary, therefore, to draw a more or less sharp distinction between the soma and germ — to consider the soma the individual which harbors, as it were, the germ destined to continue the race. This theory of *GERMINAL CONTINUITY*, which is chiefly associated with the name of Weismann, recognizes that the germ contains living material which has come down in unbroken continuity ever since the origin of life and which is destined to persist in some form as long as life itself. On the other hand, the soma may be said to arise anew in each generation as a derivative or offshoot of the germ; and, after playing its part for a while as the vehicle of the germ, to pass the germ on at reproduction, and then die. The germinal continuity concept has altered the attitude of biologists toward certain fundamental questions in heredity and evolution, as will be apparent when these subjects are considered. (Figs. 154, 162, 180, 305.)

Though *Volvox* and other colonial forms afford a glimpse of the

conditions which probably prevailed when the evolutionary bridge from unicellular to multicellular organisms was crossed, the varied methods of reproduction of the latter by no means indicate the early establishment of a hard and fast boundary between soma and germ. Many of the Invertebrates, such as Hydra and various types of worms, reproduce not only sexually by eggs and sperm, but also by strictly ASEXUAL processes which are known as FISSION and BUDDING. These processes are comparable merely in a superficial way with the similarly named methods in the Protozoa. In some forms the whole complex body divides into two or more parts, each of which reforms — REGENERATES — what was lost and so becomes a complete though a smaller individual. In other species,

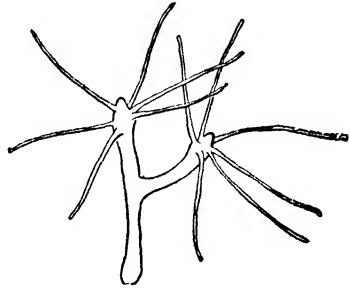

FIG. 155. — Hydra reproducing asexually by fission. (From Koelitz.)

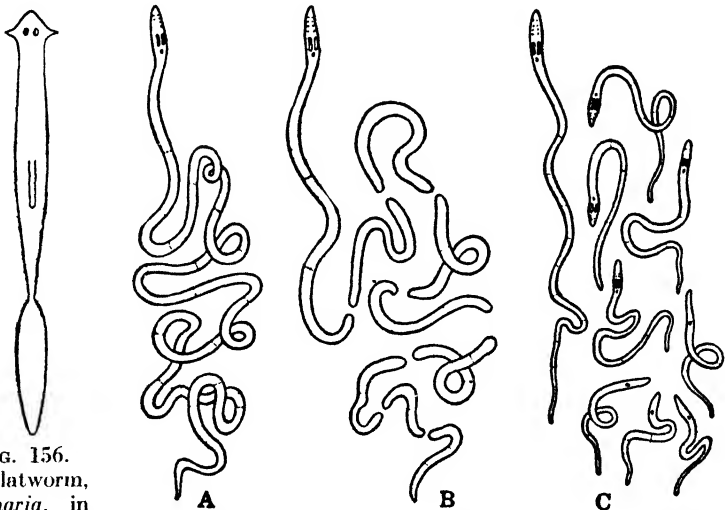

FIG. 156.  
A Flatworm, *Planaria*, in the process of fission. (From Child.)

FIG. 157. — Reproduction of a Flatworm, *Lineus socialis*, by fission. A, mature worm; B, same, in nine parts; C, regeneration of each resulting in normal smaller worms. (From Coe.)

as well as in Hydra itself, buds arise as outgrowths from the body and assume the form of the parent either before or after becoming detached. (Figs. 155–157.)

In many of the nearest allies of Hydra, it will be recalled that the buds remain permanently attached so that eventually a large colony of organically connected polyps is developed. Moreover, this condition leads to a physiological division of labor between the various polyps which may become more or less changed in structure so that, for instance, feeding, protective, and reproductive individuals are established, and thereby the Hydroid colony exhibits polymorphism. Our present interest is confined to the *reproductive* polyps, which in many of the Hydroids are so modified that they are dependent upon the colony as a whole for all the necessities of life and are merely bodies which form asexually by budding other individuals known as MEDUSAE. The medusae liberate their sexual products in the water where fertilization occurs, and the zygote gives rise to a free-swimming embryo which soon becomes attached to some submerged object and develops into a hydroid colony. (Figs. 37, 57.)

Thus the common Hydroids, such as Obelia, exhibit two distinct phases, or generations, in their life history — the fixed, polymorphic colony of polyps which is produced sexually but is itself asexual; and the free-swimming medusae which are produced asexually but are themselves sexual. The asexual and sexual generations alternate with each other in regular sequence, so that an ALTERNATION OF GENERATIONS OCCURS.

Alternation of asexual and sexual methods of reproduction, attended by more or less difference in structure of the individuals of the generations, is fairly widespread among the Invertebrate groups, particularly in forms which have adopted a parasitic mode of life as, for example, the Liver Fluke. Frequently the life histories are exceedingly complicated: several asexual, sexual, and parthenogenetic generations succeeding one another in response to the special conditions imposed by adaptation to a life within another animal or series of animals. (Fig. 251.)

It is clear from such life histories that the conception of special germ *cells* early set aside, as it were, from the somatic cells must not be taken too literally. The same point is emphasized by the power exhibited by plants and animals in restoring parts lost by mutilations of one kind or another. Among many plants, pieces of the root, stem, or, in special cases, of the leaf may give rise to individuals complete in every respect. Until the middle of the eighteenth century this was considered a property peculiar to

plants, and soon after Hydra was discovered experiments were made to determine whether the organism was a plant or an animal. Specimens were cut into several pieces and it was found that each piece developed into a complete Hydra. This result, from the ideas of the time, should have led to the conclusion that Hydra is a plant, but additional characteristics were observed which outweighed all other considerations. Accordingly Hydra was recognized as an animal with the power of replacing lost parts. (Fig. 158.)

Since the classic work on Hydra the power of regeneration has come to be recognized as a fundamental property of all animals. It is exhibited to the greatest degree among the lower animals, while in the higher Vertebrates it is confined chiefly to the replace-

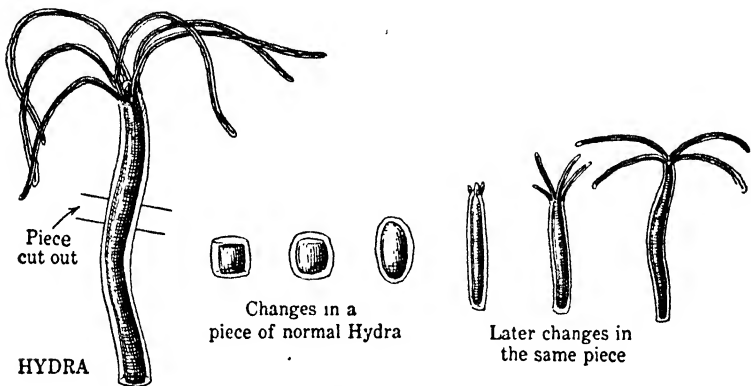

FIG. 158. — Regeneration in Hydra.

ment of cells which especially suffer from wear and tear, such as those forming the outer layers of the skin. Regeneration is one phase of a fundamental property of protoplasm, namely growth, whether it consists in restoring a part of a Paramecium, transforming a bit of a Flatworm into a complete animal, or replacing half of an Earthworm, the head of a Snail, the claw of a Crayfish, or the leg of a Salamander. But, it will be recognized that associated with growth there are complex processes of simplification (dedifferentiation) of tissues and organs, and later a rebuilding (differentiation) in order that a part may become again a normally organized whole. Witness certain marine Flatworms that can be cut down to less than one two-hundred-thousandth of their original size and still become miniature worms like the original.

The experimental study of regeneration phenomena has opened



up a new vista of the regulatory powers of living things from Protozoön to Vertebrate and from egg to adult, and has afforded a means of approach to some fundamental biological problems. And withal it has a practical value. The surgeon now knows more about the regeneration of tissues in general and of nerves in particular in wound healing, and the oysterman knows — or should know — that his attempt to destroy Starfish by tearing them up and throwing the pieces overboard may serve merely to increase this enemy of the Oyster. (Figs. 46, 159-161.)

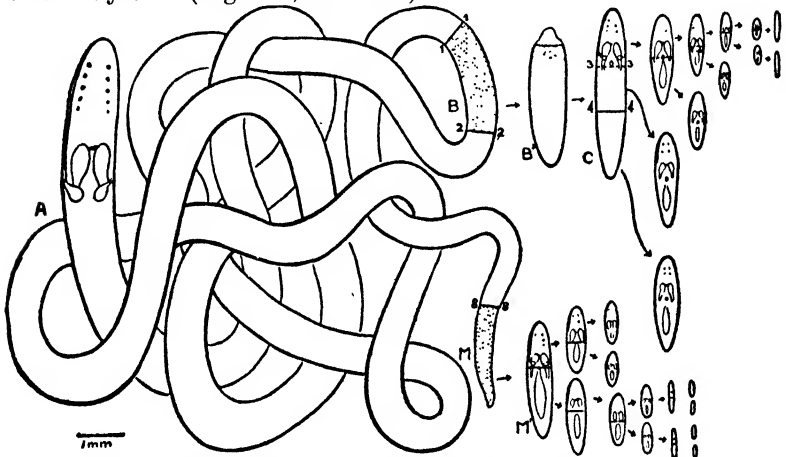

FIG. 159. — Regeneration in a Flatworm, *Lineus socialis*. A, normal worm; B, B', section cut from body and its appearance after twelve days; C, same after thirty days, cut in planes 3-3 and 4-4. Successive cuttings and regenerations indicated by arrows. M, M', similar experiments and results on posterior end of body. (From Coe.)

The power of fragments of distinctively somatic tissue, as in many lower animals and plants, to form a complete organism including the reproductive organs and germ cells, indicates that we must postulate at least a potential supply of the germ residing in the somatic tissue, which can make good the definitive germ cells when they are lost. At first glance this may seem to be a far cry to save an idea, but it is a fact that there is a continuity of the nuclear complex (GERM PLASM) whether the germ cells are set aside early in individual development, or later by the transformation of what seem to be typical somatic cells. That this is really the crux of the question will be appreciated after the details of cell division have been discussed.

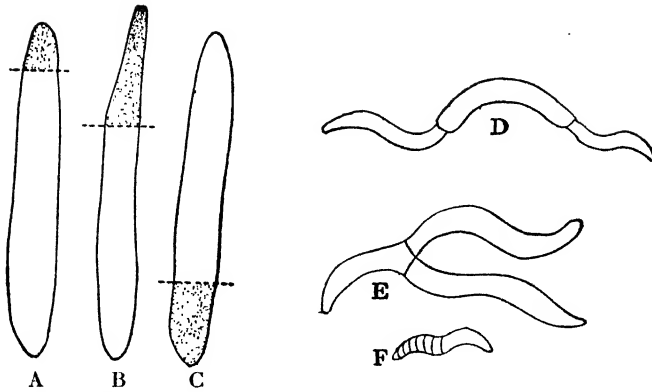

FIG. 160. — Regeneration and grafting in the Earthworm. A, regeneration of removed anterior segments by the posterior piece. B, regeneration of posterior segments by the posterior part, so that the worm has a 'tail' at either end. C, regeneration of removed posterior end by the anterior piece. D, three pieces grafted together to make a long worm; E, two pieces grafted to form a worm with two 'tails'; F, short anterior and posterior pieces grafted together. Regenerated portions are dotted. (From Morgan.)

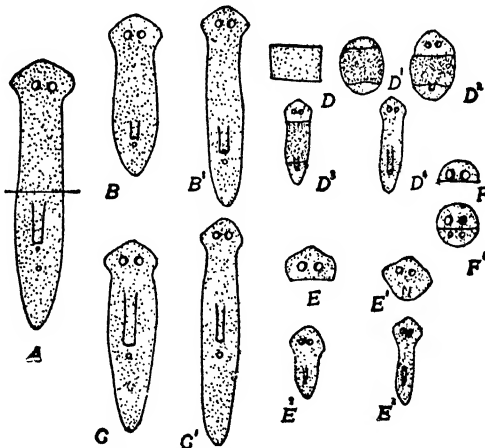

FIG. 161. — Regeneration of a Flatworm, *Planaria maculata*. A, normal worm; cut across at line indicated. B, B', and C, C', regeneration of anterior and posterior parts of A to form complete worms. D, piece cut from a worm; D<sup>1</sup>, D<sup>2</sup>, D<sup>3</sup>, D<sup>4</sup>, successive stages in the regeneration of D. E, 'head' from which rest of animal has been cut off. E<sup>1</sup>, E<sup>2</sup>, E<sup>3</sup>, successive stages in the regeneration by E of a complete body. F, similar experiment to E, but a new 'head' in reversed position is regenerated instead of a body, F<sup>1</sup>. (From Morgan.)

## B. ORIGIN OF THE GERM CELLS

Among the Vertebrates, as previously described, the germ cells reside during adult life in definite organs, the ovaries and testes, and upon these cells the power of reproduction of the individual is solely dependent. It seems clear, however, that the primary germ cells do not arise as such by division in the tissues which during

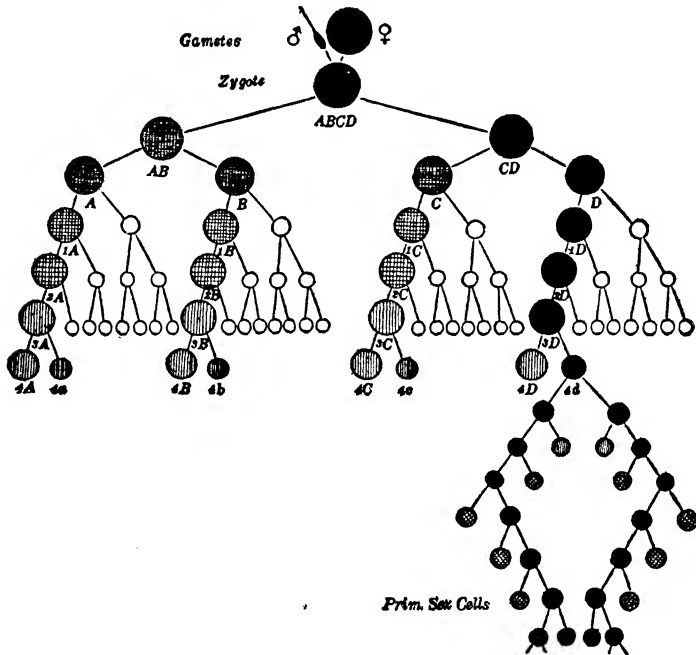

FIG. 162. — Diagram of the lineage of the body cells and germ cells in a Worm or Mollusc. Lineage of germ cells shown in black, of ectoderm in white, and of endoderm and mesoderm in shaded circles. (From Conklin.)

development form the ovaries and testes. Just when the germ cells are set aside in Vertebrates is uncertain, but it would seem to occur very early in embryonic life, perhaps during the cleavage of the egg. Then by shiftings of the tissues during growth, and possibly also by amoeboid movements of the germ cells themselves, they finally reach definite positions in the epithelium lining the dorsal wall of the coelom, which becomes an integral part of the gonads as development proceeds. (Fig. 162.)

With regard to the fate of the PRIMORDIAL GERM CELLS, once they

have reached testis or ovary, we are on surer ground and can trace with considerable exactness their divisions and transformations which give rise to the gametes: sperm and eggs. In the first place the primordial germ cells proceed to divide in the testis and ovary so that they produce a large number of germ cells known as SPERMATOGONIA and OÖGONIA respectively. (Fig. 165, A, B.)

Thus, for instance, the ovary of an adult female Frog shows oögonia in various stages of development. The eggs of the next breeding season are the largest cells; those of intermediate size

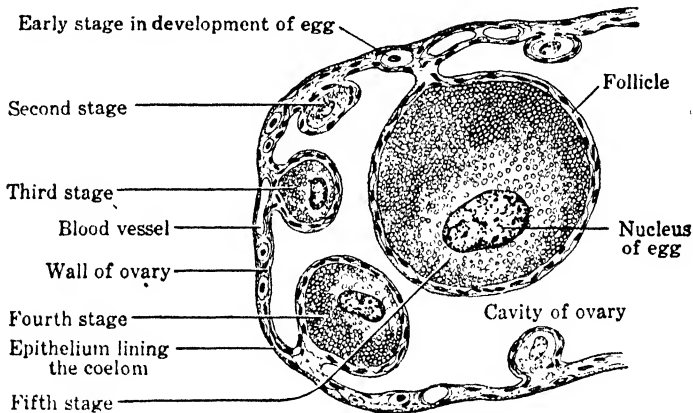

FIG. 163. — Diagram of a section through a lobe of the ovary of a Frog, showing several stages in egg development.

represent approximately those of the following year; and many smaller cells are the oögonia from which the eggs of later years will arise. Furthermore there are other cells that form a matrix of supporting and nutritive tissue (FOLLICLE CELLS, etc.) in which the germ cells are embedded. The Mammalian ovary presents a similar picture, except that since fewer eggs are produced at each breeding period, the supply of oögonia is less numerous. Nevertheless, even in the human ovary there are potentially many thousands of eggs. The testis shows a similar condition, but since so many more sperm than eggs are produced, the spermatogonia divide much more actively. (Figs. 133, 163.)

### 1. *Mitosis*

Before taking up the origin of the gametes by division from the spermatogonia and oögonia, it will be necessary to describe in

some detail the complicated internal process involved in all typical cell divisions, known as MITOSIS, which was dismissed when considering the origin of cells until the reader would be in a position to appreciate to the full its significance. (Fig. 10.)

Reduced to its simplest terms, a typical resting cell, that is one which is not dividing, consists of a mass of CYTOPLASM surrounding a NUCLEUS; the latter with its chromatin distributed so that it presents a net-like appearance. In addition to the nucleus, it will be recalled that there is present another important cell organ, the CENTROSOME, which appears like a tiny body enclosing a granule and is situated in the cytoplasm near the nucleus. For practical purposes we may consider the cytoplasm as the arena in which mitosis takes place, the centrosome as the dynamic agent, and the nucleus, or more specifically its CHROMATIN, as the essential element which the complicated process is to distribute with exactness to the daughter cells that are about to be formed. With this in mind we may proceed to an outline of the chief stages of mitosis, though perhaps it should be emphasized that variations in the details are as numerous as the different types of cells, and that any general account can do no more than present the fundamental plan of operations.

Broadly speaking, mitosis can be divided into four chief stages: PROPHASE, METAPHASE, ANAPHASE, and TELOPHASE, during each of which characteristic changes take place in the nucleus, cytoplasm, and centrosome. (Fig. 164.)

At the beginning of the prophase, or earlier, the centrosome divides to form two, each of which becomes surrounded by what appears to be a halo (ASTER) of radiating fibers, the nature of which is unknown, that are the visible expression of physico-chemical forces. The centrosomes and asters now proceed to move apart, take up positions at opposite sides of the nucleus, and the astral fibers between lengthen until they form a CENTRAL SPINDLE. While these changes are going on, the nucleus is not inactive. The nuclear membrane gradually disappears and the chromatin granules, originally presenting a net-like appearance, now become visibly resolved into a number of split threads of chromatin, termed CHROMOSOMES, which by chromatin concentration gradually become shorter and thicker and so distinctly individual. The number of chromosomes varies greatly in different species, but is typically an even number and the same for all the cells of a given species.

When the chromosomes have assumed definitive form, the preliminary events which constitute the prophase of mitosis are

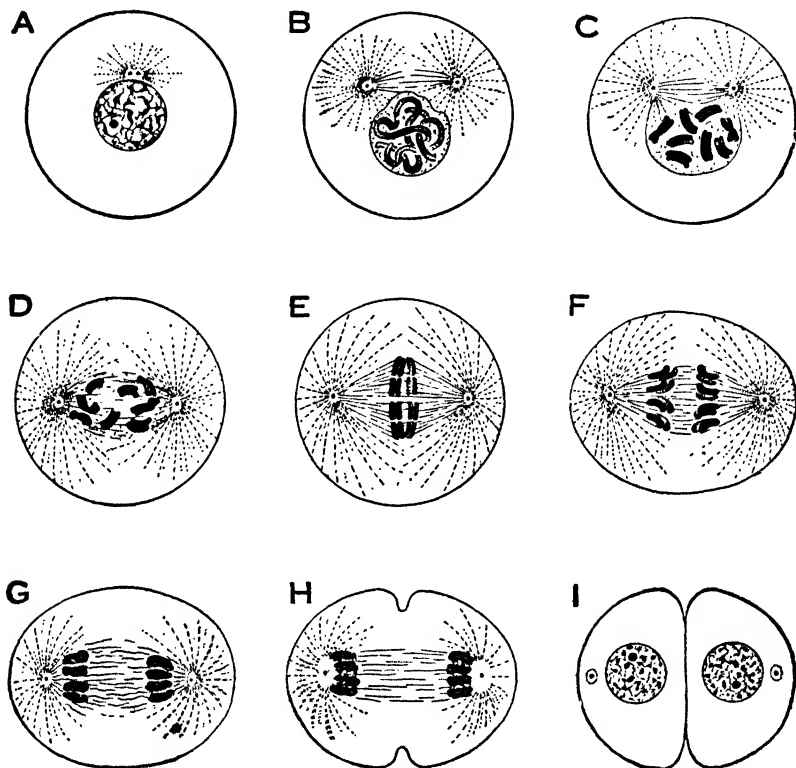

FIG. 164. — Typical stages of mitosis (somatic) in which the chromosome number is assumed to be eight. A, prophase (start): chromatin still exhibiting net-like appearance, centrosome divided and surrounded by aster; B, prophase (early): chromosomes visible as long split threads of chromatin, centrosomes moving apart and spindle arising between; C and D, prophases (later): nuclear membrane disappearing, chromosomes shorter and thicker; E and F, metaphase and anaphase (early): chromosomes arranged in equatorial plate and each separating into two along the longitudinal split; G, anaphase (later): a set of eight chromosomes approaching each aster; H, telophase: gradual loss of visibility of distinct chromosomes, asters and spindle disappearing, division of cytoplasm beginning; I, mitosis completed, two cells.

brought to a close by the chromosomes being drawn to the center of the spindle. Here they are arranged in a plane at right angles to the long axis of the central spindle, midway between the two centrosomes, and form the **EQUATORIAL PLATE**.

And now the stage is set for what is apparently the climax of mitosis, designated the metaphase. Each of the chromosomes separates into two parts along the line of the *longitudinal* split already present, in such a manner that each of the thousands of chromatin granules which make up a chromosome is equally divided. Two sets of similar daughter chromosomes are thus formed.

With chromosomal division consummated, the metaphase merges into the anaphase which is devoted to a shifting of a daughter set of chromosomes along the fibers to either end of the spindle. In this way each centrosome becomes associated with one set of daughter chromosomes.

The last stage, or telophase, is one of nuclear reconstruction and division of the cytoplasm. The chromosomes become indistinct as they spin out to form the net-like appearance of the chromatin in the nucleus of each daughter cell; a nuclear membrane arises; and the nucleus again assumes the form of a definite spherical body characteristic of the resting cell. It must be emphasized, however, that although the chromosomes usually disappear from view as definitive entities in the resting nucleus, nevertheless the individuality of each persists and the same chromosomes emerge from the nuclear complex at the next division period.

Simultaneously with these nuclear changes, and before the spindle and asters — the machinery of mitosis — disappear, the division of the cytoplasm is initiated as indicated by an indentation of the cell wall, encircling the cell at the equator. This becomes deeper as it gradually extends through the cytoplasm in the same plane which the equatorial plate formerly occupied, until the cytoplasm is cut into two separate masses, each containing one of the daughter nuclei and centrosomes. Thus one cell has merged its individuality into two daughter cells by mitotic division. Cell division — reproduction — has occurred.

What is the main thought that we carry away from this brief view of a phenomenon that has been going on for untold ages; is going on in various cells of our own bodies this very instant? Surely it seems that whereas the mitotic process apparently results in merely a mass division of the cytoplasm, the chromatin material is rearranged and distributed in a manner which makes it possible for each cell to receive a very definite share. Each daughter cell receives the same number of chromosomes, although in many cases there is a very great difference in the size of the

resulting cells. Indeed, exactness of chromatin distribution appears to be the primary object of mitosis.

The significance of the nicety of chromatin distribution lies in the fact that not only are the various chromosomes qualitatively different but also each chromosome is qualitatively different from one end to the other, and these different parts of the chromosomes, known as GENES, are the determiners of characters which are handed on from cell to cell. And since cell division is reproduction, the chromosomes are the chief agents in the transmission of characters from parent to offspring in inheritance. We shall consider this important fact when we discuss heredity, but now we must return to the origin of the gametes.

## 2. *Chromosomes of the Germ Cells*

It is clear that the spermatogonia and oögonia in the reproductive organs, together with all the cells forming the body proper, are direct descendants by mitotic cell division from the fertilized egg which gave rise to the individual organism. This, we have just seen, is equally true of the chromosomes and, therefore, every cell of the animal body has the same number of chromosomes as the fertilized egg. Furthermore, since fertilization always consists in the fusion of two gametes — a fusion of nucleus with nucleus and cytoplasm with cytoplasm to form a zygote — one of two things must happen. Either the zygote, which is one cell reconstructed from two, must have double the chromosome number, that is, a set contributed by both egg and sperm; or some method must exist by which the chromosomes of the gametes are reduced in number to one-half that characteristic of the somatic cells. As a matter of fact, a reduction of the number of chromosomes always does take place in animals during the final stages in the development, or MATURATION, of the gametes.

The maturation or 'ripening' of the germ cells of animals involves two cell divisions by which each spermatogonium gives rise to four sperm, and each oögonium to one functional egg and three tiny, abortive cells known as POLOCYTES; each and all with one-half the number of chromosomes of the somatic cells and of the germ cells up to this point in their development. Consequently these two divisions, termed MATURATION DIVISIONS, must be examined in some detail if we are to appreciate the nicety of the process by which the chromosome number is reduced one-half



without impairing the chromatin heritage from cell to cell. We shall describe first the origin of the sperm, or SPERMATOGENESIS, and then proceed to the fundamentally similar origin of the egg, or OÖGENESIS. (Fig. 165.)

### 3. *Spermatogenesis*

A given SPERMATOGONIUM, with, let us say, eight chromosomes characteristic of the species, proceeds to increase in size preparatory to the first maturation mitosis, and is designated a PRIMARY SPERMATOCYTE. At the close of the growth period, when this cell is preparing to divide, the chromosomes are arranged in pairs by a process termed SYNAPSIS. The number of such pairs will obviously be half that of the chromosome number. The SYNAPTIC PAIRS are then distributed in the equator of the spindle exactly as the single chromosomes are in ordinary mitosis. But in the early anaphase the members of each pair are separated, one synaptic mate going to each pole of the spindle. Thus each of the daughter cells — SECONDARY SPERMATOCYTES — receives half the total number of chromosomes that were present in the primary spermatocyte. It will be noted that the essential difference between this type of mitosis (REDUCTION DIVISION, or MEIOSIS) and that of typical nuclear divisions lies in the *separation* of entire chromosomes (SYNAPTIC MATES) instead of the splitting of each chromosome. Reduction thus involves the SEGREGATION of synaptic mates in separate cells.

Both the secondary spermatocytes now divide by typical mitosis, including chromosomal division, and so each of the resulting cells (SPERMATIDS) receives half the somatic number of chromosomes. The spermatids are presently transformed into sperm, and thus each spermatogonium with eight chromosomes (diploid group) gives rise to four sperm with four chromosomes (haploid group) apiece. (Fig. 165.)

It may be mentioned in passing that the chromosomal division just described as taking place in the secondary spermatocytes usually occurs precociously in the primary spermatocyte while the chromosomes are in synapsis. Thus each synaptic pair is resolved into a group known as a *tetrad*, the four components of which are thereafter distributed by the two maturation divisions, and accordingly either or both of these divisions may be involved in segregation. However, for simplicity of exposition we may dis-

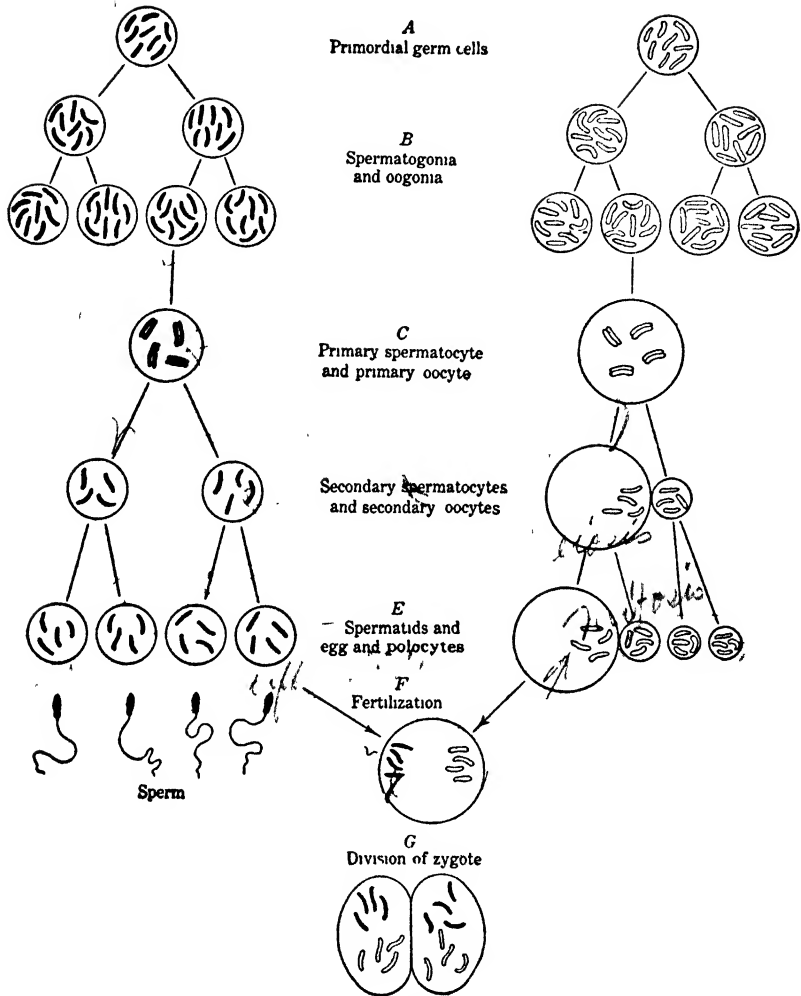

FIG. 165. — Diagram of the general plan of spermatogenesis and oögenesis in animals. Tetrad formation is disregarded. The somatic, or diploid, number of chromosomes is assumed to be eight. Male, to the left; female, to the right. A, primordial germ cells; B, spermatogonia and oögonia, many of which arise during the period of multiplication; C, primary spermatocyte and oöcyte, after the growth period, with chromosomes in synapsis; D, secondary spermatocytes and oöcytes; E, spermatids (which become transformed into sperm) and egg and three polocytes, each with the haploid number of chromosomes; F, union of sperm and egg (fertilization) to form zygote with diploid number of chromosomes; G, chromosome complex of cells after first division of the zygote, and of all subsequent somatic cells, and germ cells until maturation.

regard tetrad formation since it in no wise alters the basic results attained by spermatogenesis or oögenesis.

#### 4. Oögenesis

The maturation of the egg, as already intimated, follows the same plan as that of the sperm, and the reduction of the chromosomes is the same. Such modifications as occur are related to the fact that the egg is usually a relatively large, passive cell stored with nutritive materials for use during the developmental process, while the sperm is among the smallest of cells — essentially a nucleus surrounded with a delicate envelope of cytoplasm. Accordingly it is only necessary to emphasize that the growth period of egg formation, in which the OÖGONIUM becomes transformed into the PRIMARY OÖCYTE, is characterized by a much greater increase in size than is the case in the corresponding period in spermatogenesis; and that the following two cell divisions (maturation divisions) involving chromosome reduction result in very unequal division of the cytoplasm. Thus one SECONDARY OÖCYTE is very large, while the other is a tiny cell termed the FIRST POLOCYTE.

Both the large secondary oöcyte and first polocyte now divide again; the former giving rise to a large cell, the mature EGG, and a tiny SECOND POLOCYTE; while the first polocyte divides equally to form two polocytes. In this way arise the four cells, comparable to the four sperm in spermatogenesis, each with half the somatic number of chromosomes. But only one of these, the egg, functions as a gamete. The three polocytes, although possessing a similar chromosome complex, are sacrificed in providing one cell, the egg, with its special cytoplasmic equipment. The polocytes get just enough cytoplasm to be regarded as cells, and soon degenerate and disappear. (Figs. 165, 166.)

Such is the outline of the essentials of spermatogenesis and oögenesis in animals; processes which involve at one stage a modification of ordinary mitosis to give each gamete half the somatic number of chromosomes characteristic of the species. It is clear that this is not merely a mass reduction of chromatin material, but is a separation and *segregation* after synapsis of definite chromatin entities, the chromosomes, so that the gametes receive the reduced number.

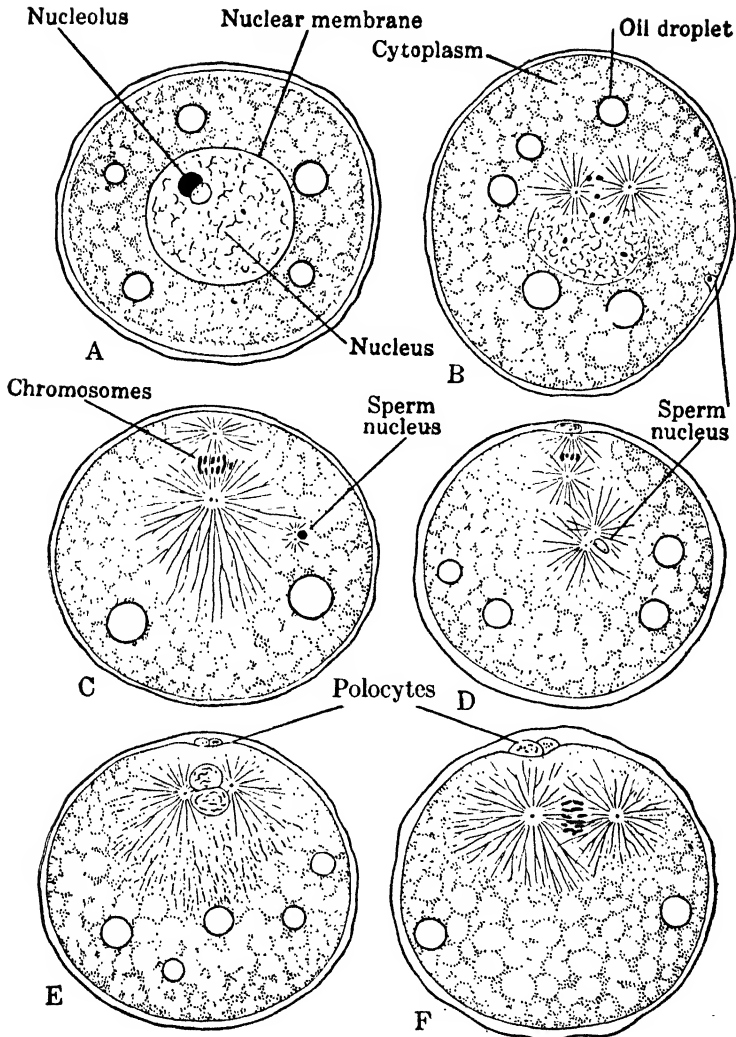

FIG. 166. — Maturation and fertilization of the egg of the Sandworm, *Nereis*. A, egg (oöcyte) before start of maturation; B, first polocyte spindle forming, sperm just entering; C, first polocyte spindle established; D, first polocyte formed, second polocyte spindle near; spindle with sperm nucleus; E, second polocyte formed, union of egg and sperm nucleus; F, spindle for first division of fertilized egg. Note that in *Nereis*, as in many other animals, maturation of the egg is deferred until the time of fertilization. (From Wilson.)

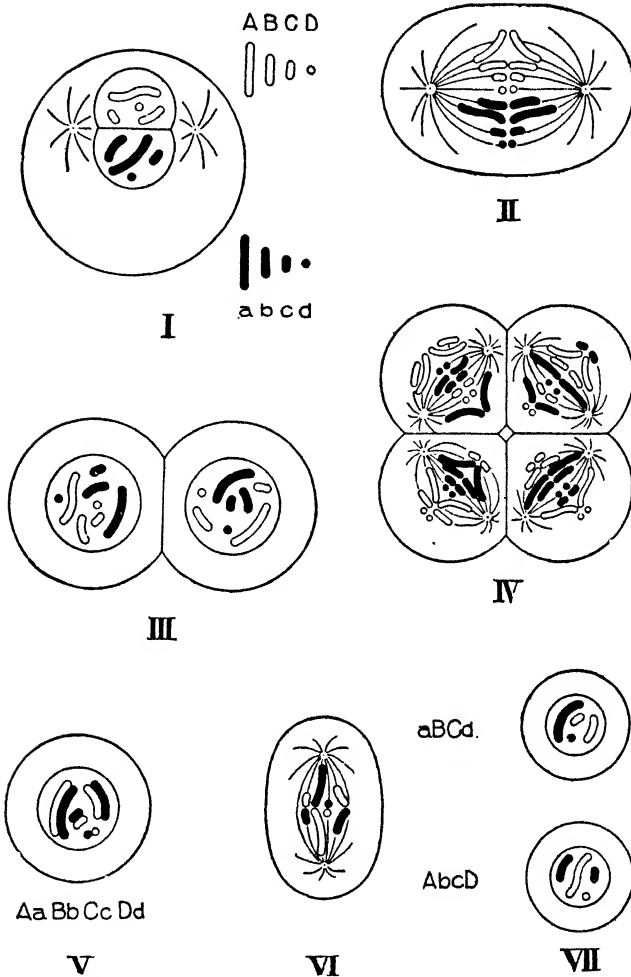

FIG. 167. — Diagram of the chromosome cycle of an animal. Somatic (diploid) chromosome number assumed to be eight. Paternal chromosomes (from sperm) = A B C D; maternal (from egg) = a b c d. I, union of nuclei of gametes, each with a simplex group (haploid number) of chromosomes, in the zygote at fertilization to form a duplex group (diploid number) of chromosomes. II, III, IV, somatic divisions or divisions of germ cells before maturation (duplex groups of chromosomes). V, synapsis, involving pairing of homologous paternal and maternal chromosomes to give the haploid number of paired chromosomes. VI, reduction division — separation of pairs into single chromosomes again. VII, two gametes, with simplex groups (haploid number) of chromosomes; there are 14 more possible combinations of the chromosomes, or types of gametes, which are not shown. See: Fig. 189. (After Wilson.)

Throughout the animal kingdom, wherever sexual reproduction occurs, phenomena which can be interpreted as nuclear reduction have been observed in the formation of gametes. In some of the Protozoa this seems to be merely an extrusion of a certain amount of chromatin, but since whenever chromosomes can be observed and counted the process has been found to follow in principle essentially the same lines described above, we have every reason to believe that it is never a haphazard mass reduction, and that the ripe gametes emerge with a definite chromatin heritage, relatively simple as this may be in the lowest forms.

### 5. *The Chromosome Cycle*

We have now surveyed the *germ cell cycle* from the fertilized egg through the germ plasm in the adult to the gametes again, but before proceeding to consider the details of the fusion of egg and sperm — the fertilization process — it may clarify matters to glance back to the *chromosome* condition in the fertilized egg at the *beginning* of the cycle that has just been considered.

Obviously this fertilized egg (zygote) contained two groups of chromosomes, one of which belonged to the egg and therefore may be termed MATERNAL, and one which was derived from the sperm and thus is PATERNAL. When the zygote divided by mitosis to form the body and germ, every cell received two groups of chromosomes directly derived from these two original groups in the zygote. It logically follows, and all observations indicate, that each and every cell, both of the body and of the germinal tissue, possesses two groups of chromosomes, one of maternal and one of paternal origin — in other words, direct lineal descendants of the combined set formed at fertilization.

So it happens that each body cell really has a *double* set (diploid number) — two complete sets — of chromosomes, and the same is true of the germ cells until maturation. Then at synapsis corresponding (HOMOLOGOUS) maternal and paternal chromosomes pair and, after the maturation divisions the gametes have a single set (haploid number). (Fig. 167.)

Thus far we have emphasized chromosome reduction as the main result of the complicated maturation phenomena. The question now arises: Is this chromatin distributed so that all the gametes receive the same heritage?

As already stated, the evidence indicates not only that chromo-

somes differ qualitatively one from another, but also that the various parts of each chromosome are qualitatively distinct. And further that these qualitative differences are the physical basis of inheritance — the determiners (genes) of characters which will be realized in the individual or the race to which the cell containing them contributes. Such being the case, the chromosomal complex of each of the nuclei which arises after synapsis — the nuclei of the gametes — depends on how the various chromosomes happen to be distributed during the two maturation divisions. As a matter of fact, all the chromosomal combinations occur that are mathematically possible with the available number of chromosomes in a given species, but with one limitation: every cell must receive one member of each synaptic pair of chromosomes, so that each and every gamete receives a complete haploid group of chromosomes, but rarely the same groups (maternal and paternal) which existed before maturation. For example, if the somatic (diploid) number of chromosomes is eight, sixteen different types of gametes are possible. In Man with 48 somatic chromosomes and after synapsis 24 pairs of paternal and maternal chromosomes, there are  $2^{24}$ , or about seventeen million possible types of gametes in each sex; and since these combine at random at fertilization, the possible number of different types of zygotes from one parental pair mounts far up in the trillions. No wonder the children of a family differ — there is *variation!* (Fig. 193.)

In a way, therefore, fertilization is not consummated, so far as its influence on the race is concerned, until the maturation of the gametes in the new generation to which it has given rise. We must defer until later the consideration of the significance of these facts in BIPARENTAL inheritance, and merely emphasize again that the continuity of life implies not only the continuity of cells but also of their nuclear elements, the chromosomes — the genes.

## CHAPTER XIX

### FERTILIZATION

The entire organism may be compared to a web of which the warp is derived from the female and the woof from the male. — *Huxley*.

Now that we are familiar with the method of gamete formation and its contribution to the continuity of life, it is in order to consider some important details of the structure of the gametes themselves, and the significance of the complex series of phenomena that they initiate at fertilization. The biological importance of fertilization and the part it plays in the life of the individual organism and the race has aroused the interest of philosophers and scientists since the time of Aristotle, but it is only within the past half-century that at least a partial answer has been forthcoming from a critical analysis of the gametes and their product, the zygote.

#### A. GAMETES

The gametes, while exhibiting in certain cases peculiar adaptations to special conditions, are remarkably similar in general structure throughout the animal series. It is possible to arrange a series of lower forms which shows various stages in sex differentiation. Beginning with those in which both gametes are structurally similar, we pass by slow gradations to others in which the egg is a relatively large, passive, food-laden cell and the sperm a minute, active, flagellated cell.

As a matter of fact, the egg is subject to somewhat more variation in size and general appearance than the sperm, for after fertilization it must be adapted to meet the special conditions of development peculiar to the species. Thus, for instance, the actual size of the egg in animals is determined chiefly by whether the developing embryo is in the main dependent upon food stored in the cytoplasm of the egg itself, or upon some outside source, such as the sea water in which it floats, or the tissues of the parent. The first case is well illustrated by a Bird's egg in which the so-called **YOLK** is the egg cell proper, hugely distended by stored food, and



surrounded by nutritive and protective envelopes consisting of the 'white of the egg,' shell membranes, and shell which are formed by secretion from the walls of the oviduct during the passage of the egg to the exterior. On the other hand, the eggs of Mammals, for instance of the Rabbit and Man, are very small — the human egg being less than  $1/125$ th of an inch in diameter — since their

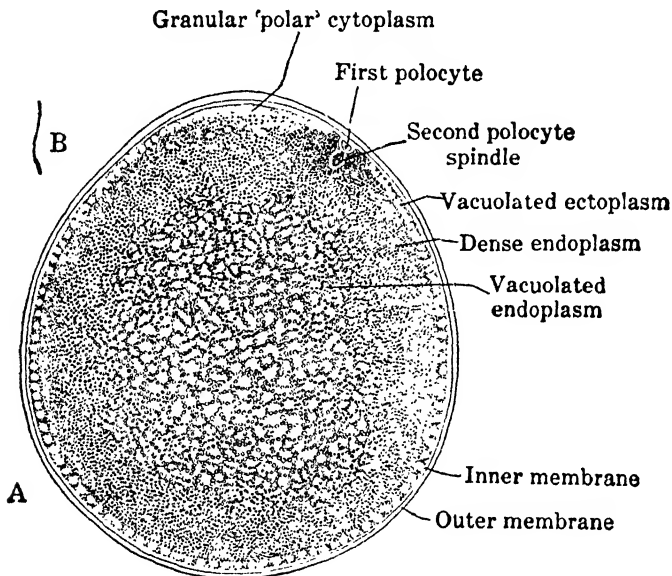

FIG. 163. — A, section through the egg of a primitive Vertebrate, the Lamprey. B, sperm of the same species, drawn to scale. (From Kellicott, after Herfort.)

essentially parasitic method of development in the uterus renders superfluous the storage of any considerable amount of food material in the egg cytoplasm. (Figs. 7, 133, 168, 177.)

With the specialization of the egg along lines which render it non-motile, it has devolved upon the sperm to assume the function of seeking out the egg for fertilization. It does this in most cases by active lashing of its flagellum. This necessitates a fluid medium in which the sperm can swim, and such is provided by the environment in which the organism lives or, in the case of most higher animals, where fertilization takes place within the oviduct, by special fluids secreted for the purpose.

A question of much interest is how the actual meeting of the

gametes is brought about. In many cases it is undoubtedly merely by chance: the random swimming of the sperm sooner or later bringing one in contact with an egg. In other cases the movements of the sperm seem to indicate a definite attraction by the egg. Thus the sperm of some of the lower animals apparently are attracted by substances eliminated by the egg at maturation. In such instances there can be but little doubt that chemical stimulation of the sperm by specific substances plays a part in bringing the gametes together. This is an example of CHEMOTROPISM: a phenomenon of considerable importance, especially in the behavior of free-living cells.

### B. UNION OF GAMETES

Once a single sperm has come into functional contact with the egg, it initiates a chain of events which constitutes fertilization.

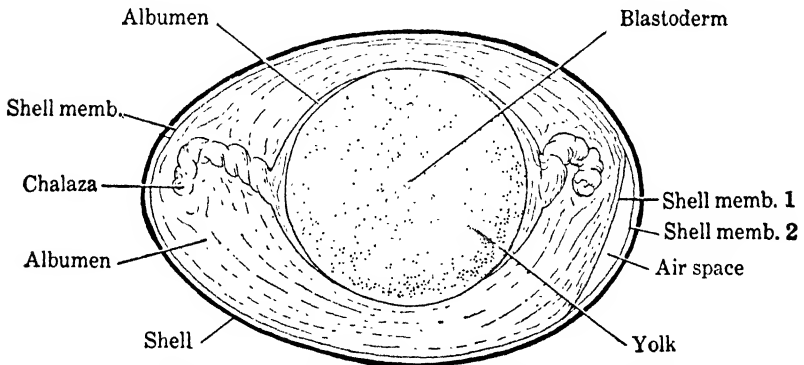

FIG. 169. — Diagram of the egg of the domestic Fowl, before incubation.

Although, as might be expected, the variations in details are legion, they do not obscure the main facts. The first reaction on the part of the egg is to prevent the entrance of other sperm and thereby to insure a free field for the operations of the first arrival. Frequently a jelly-like layer is formed about the egg, or if a membrane is already present this may be rendered impermeable or still another formed. In cases where the egg is surrounded originally by a dense and resistant wall, the tiny opening provided for the entrance of the sperm is closed. However, the accessory wrappings about certain eggs, such as those of Birds, have no relation to the present subject since they are secreted, not by the egg itself, but

by glands in the wall of the oviduct, some time after fertilization has occurred, when the egg is passing down. (Fig. 169.)

The reactions of the egg cytoplasm that exclude accessory sperm are overshadowed in importance by others which upset the stable equilibrium of the egg and render its surface permeable, so that extensive osmotic interchanges take place between the cytoplasm of the egg and its surroundings. Most often this is visible merely in a shrinkage of the cytoplasm due to loss of water, but sometimes contractions, amoeboid movements, or flowing of special cytoplasmic materials to definite regions of the egg are visible. In any event it is certain that profound changes occur in the cytoplasm — its organization as a gamete soon gives place to a reorganization that establishes the general outlines of its subsequent development as a new individual. (Fig. 177, A, B.)

### 1. *Synkaryon*

Turning now to the nuclei, known as male and female GAMETIC NUCLEI, the union of which to form the single nucleus (SYNKARYON) of the zygote is the climax of fertilization. Disregarding the flagellum of the sperm, which disappears as it enters the egg, we find that the sperm nucleus moves through a quite definite path toward the center of the egg where it is met by the egg nucleus. Both the gametic nuclei now become resolved into chromosomes which lie free in the cytoplasm, while two centrosomes, each surrounded by an aster, appear and take up positions on either side of the chromosomes to form a typical mitotic figure. The two sets of chromosomes form an equatorial plate at the center of the spindle, thus establishing at once not only the mitotic apparatus for the first division of the egg, but also the intimate association on equal terms of chromosomes, with their potentialities from the two parents, to form a common structure — the nuclear complex of the new individual. (Figs. 166, 167, I, II.)

Such are the outstanding facts of fertilization which a host of investigators have brought to light chiefly within the past sixty years. It was not until 1839 that Schwann, with the establishment of the cell theory, recognized the egg as a cell, and sixteen years more before the sperm was similarly understood; while the first realization that fertilization is an orderly fusion of two cells to form one came during the seventies of the past century. Then it became evident that in sexual reproduction each individual con-

tributes to the formation of the offspring a single cell, in which must be sought the solution of the problems of sex, fertilization, development, and inheritance. However, the concentration of attention on the cell has not simplified the solution of these fundamental problems; but rather it has contributed to an ever-increasing appreciation of the complexities of cell phenomena and the difficulties of formulating them in general terms. (Fig. 303.)

## 2. *Significance of Fertilization*

Quite naturally the original view was that fertilization fundamentally is reproduction — the mature egg pauses in development and usually comes to naught unless a sperm enters. However, as we know, reproduction is cell division or the detachment of a portion of a living organism to form another, whereas fertilization is the union of two cells to form one cell. The erroneous idea that fertilization is reproduction is due to the fact that in higher organisms, if fertilization is to occur at all, it must take place at the period in the life history when the individual is but a single cell detached from the parent — that is, at reproduction. With this point clear, we may briefly discuss the significance of fertilization, first on the basis of evidence derived from the Protozoa.

**PROTOZOA.** The life histories of nearly all Protozoa that have been carefully studied include a period in which fertilization occurs. Under favorable environmental conditions, *Paramecium*, for instance, reproduces by binary fission two or three times a day so that in a remarkably short period the one cell is replaced by a host of descendants. Sooner or later, however, the individuals exhibit a tendency to unite temporarily in pairs, or **CONJUGATE**. During conjugation complicated changes take place in the nuclei of the cells, involving chromosome reduction and the formation of two gametic nuclei in each individual of the pair of conjugants. Then one of the gametic nuclei in each conjugant migrates over and fuses with the stationary gametic nucleus of the other to form a synkaryon, or fertilization nucleus, in each cell. After this the two *Paramecia* separate, reconstruct their characteristic vegetative nuclear apparatus, and proceed to reproduce by division as before. (Fig. 170.)

This is fertilization in *Paramecium*, and on the assumption that the primary significance of synkaryon formation should be most evident in unicellular forms, of which, of course, this animal

is an example, a large amount of experimental breeding has been carried out on *Paramecium* and its allies. The earlier results seemed to demonstrate conclusively that *Paramecium* can divide only a limited number of times, say a couple of hundred, after which the cells die from exhaustion or SENILE DEGENERATION unless fertilization takes place. In other words, it was believed that periodic REJUVENATION by fertilization is a necessity for the continuance of the life of the race. And therefore, so the natural conclusion ran, protoplasm is unable to grow indefinitely; there is an inherent tendency for the destructive phases of metabolism to gain ascendancy over the constructive, and fertilization serves to maintain or restore the youthful condition and thus secure the continuance of the race.

In this connection, the life history of *Paramecium* from one period of fertilization to the next is often compared to the life of a multicellular organism from its origin as the fertilized egg, through youth and adult life to old age. The striking difference is that, in the case of *Paramecium*, the products of division of an animal which has conjugated (EXCONJUGANT) separate as so many independent cells, all of which are alike and, in later generations, capable of fertilization; while all the products of division of the fertilized egg of multicellular forms remain together as a unit and become differentiated for particular functions in the individual, except a few, the germ cells, which retain the power of forming new individuals. Pushing this comparison a little further, it is stated that after fertilization in *Paramecium* we have the period of greatest cell vigor, or youth, followed by maturity when the cells are ripe for fertilization again, and in the absence of fertilization — and only then — the onset of old age, and death. Thus death has no normal place in the life history of *Paramecium*, for all the cells at the period of maturity are capable of fertilization. On the other hand, in multicellular forms only some of the cells, the germ cells, retain this power — the somatic cells have paid the penalty of specialization and must die. Thus death of the individual except by accident does not occur among unicellular forms because fertilization 'rejuvenates' the cell, and the cell and the individual are one and the same. With the origin of multicellular forms, involving the segregation of soma from germ, death became possible, and was established — it is the 'price paid for the body.' (Figs. 154, C, D; 180.)

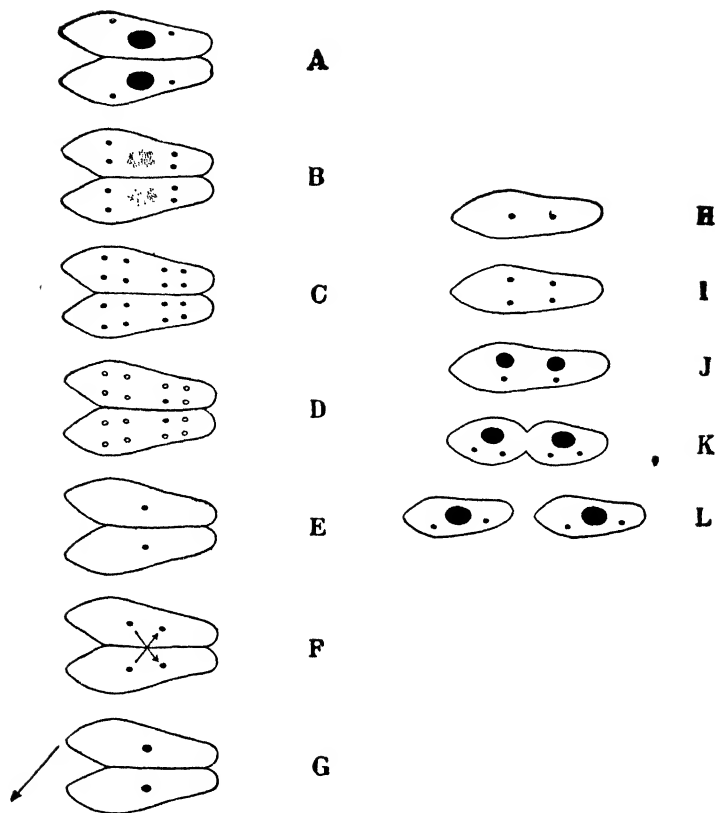

FIG. 170. — Diagram of the nuclear changes during fertilization (conjugation) in *Paramecium aurelia*. A, union of two individuals along the peristomal region; B, degeneration of macronucleus and first division of the micronuclei; C, second division of micronuclei; D, seven of the eight micronuclei in each conjugant degenerate (indicated by circles) and disappear; E, each conjugant with a single remaining micronucleus; F, this nucleus divides into a stationary micronucleus and a migratory micronucleus — the gametic nuclei. The migratory micronuclei are exchanged by the conjugants and fuse with the respective stationary micronuclei to form the synkarya. This is fertilization. G, conjugants, with synkarya, separate (only one is followed from this point); H, first division of synkaryon to form two micronuclei; I, second reconstruction division; J, transformation of two micronuclei into macronuclei; K, division of micronuclei accompanied by cell division; L, typical nuclear condition restored.

Suggestive as is this comparison and contrast — and it is not without some justification — the cardinal fact remains that recent work has demonstrated that *Paramecium* and some closely related forms, when bred under favorable environmental conditions, can continue reproduction indefinitely, at least in one case for more than thirty years and some twenty thousand generations, without fertilization and without any signs of degeneration. Moreover in many unicellular forms fertilization has never been observed and perhaps does not occur in the life history. In other words, fertilization is not a necessary antidote for inherent senescence, and this, taken in connection with other data which point in the same direction, such as the unlimited reproduction of many plants by asexual processes, and the recent discovery that certain tissue cells removed from the Vertebrate body will live, grow, and divide apparently indefinitely if given favorable conditions, renders it fairly safe to make the general statement that senescence is not inherent in protoplasm — the need of fertilization is not a primary attribute of living matter. Reproduction and fertilization are intrinsically separate processes which, however, have become closely associated, especially in higher forms.

So far our conclusion is entirely negative — fertilization is not reproduction and is not intrinsically necessary for reproduction. What then is its significance? Though fertilization may not be necessary in the life of simple organisms under favorable conditions, this does not indicate that it may not be a stimulus to protoplasmic activity when it does occur — perhaps a very important factor under special environmental conditions. Indeed it appears certain that conjugation in many cases directly results in stimulating the vital processes of the cell, including reproduction. But it would seem that the essential factor in this stimulation is not the essence of fertilization, which is synkaryon formation. In *Paramecium*, for example, an internal nuclear reorganization process known as *ENDOMIXIS* occurs periodically, which is carried on by each individual, without a nuclear contribution from another. Nevertheless it frequently effects a physiological stimulation similar to that which follows synkaryon formation during fertilization. Accordingly the factor common to both fertilization and endomixis, that is general nuclear reorganization, apparently is responsible for the 'dynamic' effects. (Fig. 171.)

**METAZOA.** Turning from *Paramecium* and its allies, we may

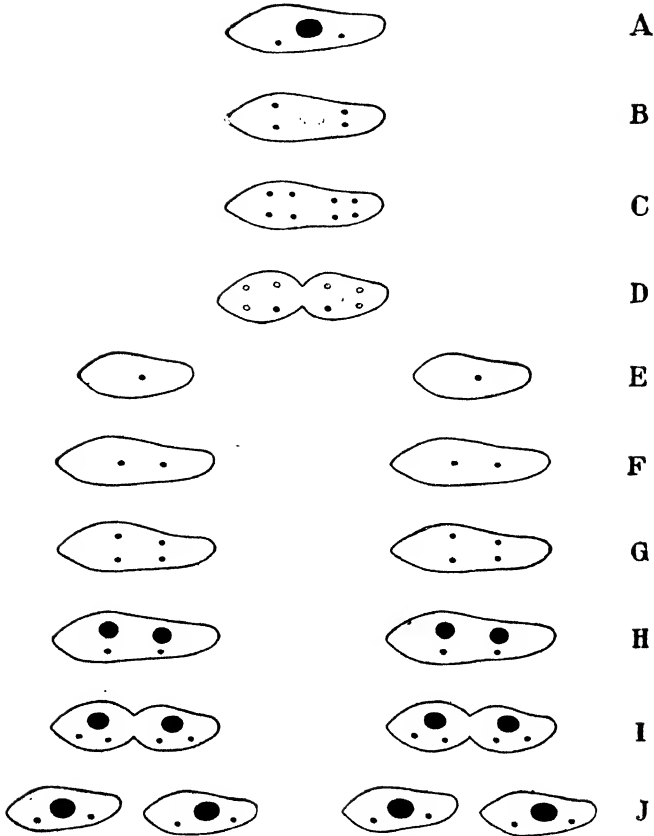

FIG. 171. — Diagram of the nuclear changes during endomixis in *Paramecium aurelia*. A, typical nuclear condition; B, degeneration of macronucleus and first division of micronuclei; C, second division of micronuclei; D, degeneration of six of the eight micronuclei; E, division of the cell; F, first reconstruction micronuclear division; G, second reconstruction micronuclear division; H, transformation of two micronuclei into macronuclei; I, micronuclear and cell division; J, typical nuclear condition restored.



consider some evidence among higher forms in regard to the dynamic influence of fertilization. Although fertilization is usually necessary for the resumption of the series of cell divisions which paused after the maturation divisions, and which are to transform egg into adult, there are many exceptional but entirely normal cases where the egg proceeds to divide of its own accord. Such PARTHENOGENETIC eggs are formed like other eggs, though sometimes without chromosome reduction. Thus the eggs of the Honey Bee, to cite the most interesting case, develop either with or without fertilization — fertilized eggs forming females and unfertilized eggs, males. Certain species of Rotifers and Roundworms apparently reproduce solely by parthenogenesis, males not being known. Leaving out of the question the effect on the chromosome complex, it is at once apparent that the mere fact that an egg divides without the influence of a sperm indicates clearly that, in such cases at least, neither structural additions nor physiological influences of the sperm are necessary to initiate development.

It may with justice be urged, however, that such cases of normal parthenogenesis are special adaptations to peculiar conditions in which the egg has usurped, as it were, the usual sperm function, and that therefore the evidence is of little weight in determining the primary significance of fertilization. Accordingly the data from so-called ARTIFICIAL PARTHENOGENESIS are particularly cogent. Within recent years it has been found that the eggs of a considerable number of Invertebrates and even of Vertebrates, such as some Fishes and Frogs, which normally require fertilization, can be induced to start development parthenogenetically by various artificial means such as subjection to certain chemicals, unusual temperature changes, shaking, or the prick of a needle — the effective stimulus varying with different species.

Just what happens in the egg as a result of such treatment is open to discussion, but for our purposes it is sufficient to know that the egg begins to divide in normal fashion. This shows conclusively that even eggs which normally require fertilization are intrinsically self-sufficient at least to start to develop, and therefore this strongly indicates that an incidental and not the main function of fertilization is to stimulate cell division.

Restating the evidence in its bearings on the meaning of fertilization, we may say that fertilization is not fundamentally an

indispensable event in the life history of the Protozoa living under favorable environmental conditions. Certain species have been bred for thousands of generations without conjugation, and, indeed, without endomixis. Similarly in the Metazoa, both normal and artificial parthenogenesis indicate that the egg itself comprises a mechanism which is capable of initiating and carrying on development. From this viewpoint, fertilization may be satisfactorily interpreted as a means of insuring under special or unfavorable environmental conditions in unicellular organisms, and under usual conditions in the eggs of multicellular forms, a suitable stimulus which otherwise might be unavailable at the proper time.

Granting then that fertilization may afford a stimulus to development, is this its chief significance? Many lines of evidence surely converge toward the view that the opportunities which fertilization affords for changes in the complex of the germ are of paramount importance. Fertilization establishes new diploid groups of hereditary characters by combining diverse haploid groups from the two gametes. It makes possible the shuffling of germinal variations so that they are presented in new combinations. It is the pooling of the germinal changes of two lines of descent. Some of the new combinations may more effectually meet — be better adapted to — the exigencies of the environment, and so have a survival value for the organism in the struggle for existence. So whatever the primary meaning of fertilization may be, its importance in establishing the essentially dual nature of every sexually produced organism is settled beyond dispute, and it is the cardinal fact of heredity. No wonder is it that from the lowest to the highest animals provisions are made for a process which multiplies many-fold the opportunities for descent with change. (Fig. 189.)

In passing, it should be emphasized that provisions to ensure fertilization have had a profound influence on the morphology and physiology of organisms. Sex of the gametes and sex of the individual body are, of course, radically different, although the latter is indirectly an outcome of the former. The evolution of the gametes themselves is relatively simple: from those alike so far as structure is concerned, though physiologically different, to those in which one sex is smaller and more motile and the other larger and usually non-motile. But the sexual evolution of the individual body in the Metazoa presents amazing phenomena. Witness the

biological and physiological contrast of individuals that bear sperm and eggs respectively. Sex, indeed, becomes largely a dominating factor in the life of the lower animals, and even of Man, where the primary function of somatic sexual differentiation to ensure fertilization appears to become largely submerged. "It is as though variety and beauty had become ends in themselves in the evolution of secondary sex characters, as exemplified in the plumage of birds, and in the strife and amenities of human social relations."

## CHAPTER XX

### DEVELOPMENT

The student of Nature wonders the more and is astonished the less, the more conversant he becomes with her operations; but of all the perennial miracles she offers to his inspection, perhaps the most worthy of admiration is the development of a plant or animal from its embryo. — *Huxley*.

THE new individual, established by the orderly merging of a cell detached from each parent in sexually reproducing species, has before it first of all the problem of assuming the adult form by a complicated developmental process. As we have seen, this involves cleavage of the egg, followed, in the Metazoa, by blastula and gastrula stages during which the primary germ layers are established — the fundament out of which the definitive form, organs, and organ systems of the adult are evolved. The description and comparison of these processes in different organisms constitute the content of one aspect of EMBRYOLOGY. (Fig. 288.)

It is unnecessary — indeed, it is impossible — for us to survey the immense field included under embryology. We must be satisfied with the realization that animal development, though it varies widely in producing the immensely diverse body forms, exhibits throughout a thread of similarity in its fundamental features; and the appreciation of the marvellous intricacy of the developmental process even in the lowly animals. This perhaps may be gained by concrete examples — first the embryological development of the Earthworm from the zygote to the establishment of the general body plan.

#### A. EMBRYOLOGY OF THE EARTHWORM

The egg of the Earthworm, after fertilization, proceeds to divide first into two cells, then four cells, eight cells, and so on, with more or less regularity, until a condition is attained in which many relatively small cells are arranged about a central cavity. This stage of the embryo will be recognized as the blastula.

The various cells of the blastula appear essentially the same except that those at one end are somewhat larger than at the other.

The larger cells now sink into and nearly obliterate the central cavity of the blastula, thus forming a typical gastrula stage composed of two layers of cells, ectoderm on the outside and endoderm on the inside. The infolded enteric pouch, or enteron, enclosing

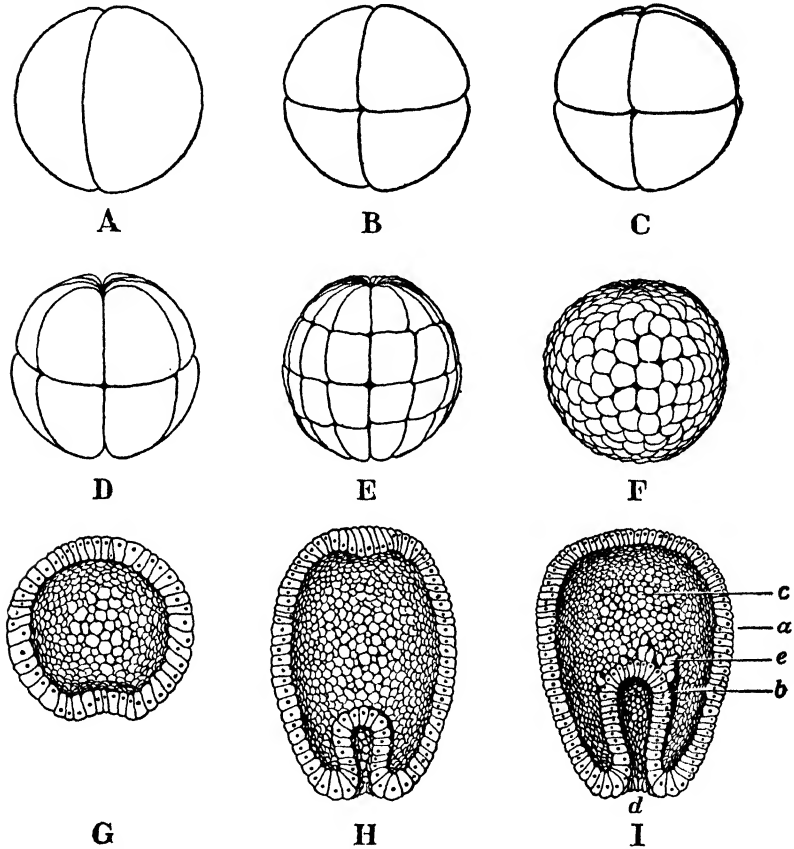

FIG. 172. — General plan of the early development of the egg of an animal. A-F, cleavage and formation of the blastula; G, section of blastula showing the beginning of gastrulation; H-I, early and later gastrula stages. *a*, ectoderm; *b*, endoderm; *c*, blastocoel; *d*, blastopore, leading into the enteric cavity; *e*, cells, arising from the endoderm, destined to form the mesoderm.

the enteric cavity, eventually becomes the main part of the alimentary canal of the worm; its present opening to the exterior, or blastopore, forming the mouth. So the developing worm has now reached a transient state which is broadly comparable to the permanent adult condition of *Hydra*. (Figs. 172, 173.)

While these two primary germ layers are being established, the developing embryo shows the rudiments of the third primary germ layer (mesoderm) in the form of two **MESOBLAST CELLS** which leave their original position in the wall of the embryo and take up a place between the ectoderm and endoderm; that is, in the remnant of the cavity of the blastula which the invagination process during gastrulation has not completely obliterated. Here the two cells, by division, form on either side of the enteric pouch a linear series, or band, of mesoderm cells. These mesoderm bands gradually increase in size and spread out until finally they unite above and below, that is encircle, the enteric pouch. Thus they form a continuous mesoderm layer between ectoderm and endoderm. Simultaneously with the growth of the mesoderm bands to form a definite middle layer, a linear series of spaces appears in each band which presages the future segmentation of the worm's body. These cavities increase in size and, when the bands unite around the enteric pouch, the corresponding cavities of each band also become continuous in the same regions. (Fig. 173, C-H.)

In this way the mesoderm itself becomes divided into what are essentially two cellular layers, an outer, or **SOMATIC LAYER**, next to the ectoderm, and an inner, or **SPLANCHNIC LAYER**, in contact with the endoderm. The space between these layers of the mesoderm is the body cavity, or coelom. The coelom, however, is not a continuous cavity from one end of the embryo to the other, because the mesodermal cells which separate the linear series of cavities in the respective mesodermal bands persist. These cells form a regular series of connecting sheets of tissue between the somatic and splanchnic mesoderm layers and thus divide the body of the worm into a series of essentially similar segments, the limits of which are indicated on the outside by a series of grooves which encircle the worm's body. (Fig. 173, I, J.)

While these processes are transforming the two-layered gastrula into an embryo composed of three primary layers, and exhibiting segmentation, coelom, etc., — in short, the 'tube within a tube' body-plan characteristic of higher forms — the embryo is gradually increasing in size and elongating. The mouth, representing the blastopore, remains at one end, which is therefore designated as anterior, while growth is chiefly in the opposite direction or toward the posterior. At this end (the blind end of the enteric pouch formed at gastrulation) an opening to the exterior, the

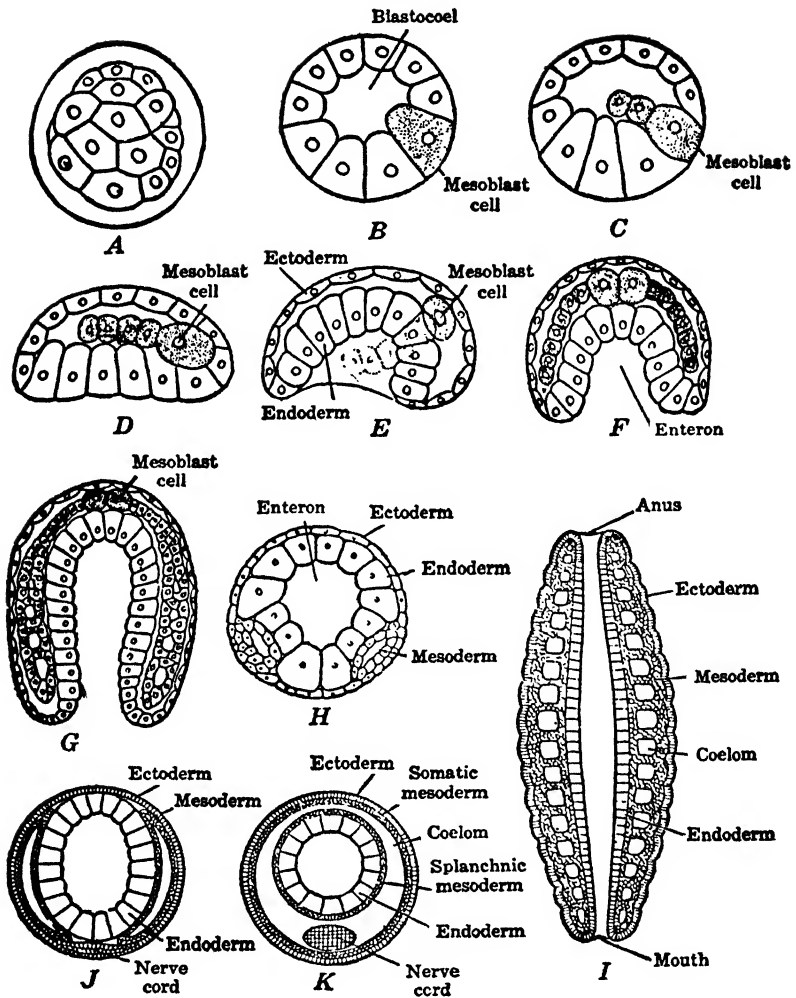

FIG. 173. — Diagrams of stages in the development of the Earthworm. A, blastula (surrounded by a membrane); B, section of a blastula showing blastocoel and one of the primary cells (mesoblast cells) of the mesoderm; C, later blastula with developing mesoderm bands; D, start of gastrulation; E, lateral view of gastrula showing invagination, which as it proceeds leaves the mesoderm bands on either side of the body as indicated by the cells represented with dotted outline; F, section of E, to show mesoblast cells, mesoderm bands, and enteric cavity. G, later stage showing cavities in the mesoderm bands; H, the same (G) in transverse section; I, diagram of a longitudinal section of a young worm after formation of mouth and anus; J, the same in cross section; K, later stage in transverse section. (After Sedgwick and Wilson.)

anus, is formed so that the enteric pouch now communicates with the exterior at both ends and becomes the alimentary canal. Thus antero-posterior differentiation is clearly established.

A cross section perpendicular to the main axis of the developing worm at this stage presents the appearance of a circle within a circle. The smaller circle surrounds the enteric cavity and is the wall of the alimentary canal. It is separated by a space, the coelom, from the larger circle, or body wall. Moreover, each of these circles is composed of two tissue layers: the alimentary canal, formed internally of endoderm and externally of splanchnic mesoderm; and the body wall, internally of somatic mesoderm and externally of ectoderm. Thus the coelomic cavity is entirely enclosed by mesoderm. (Fig. 173, K.)

It is from these three primary layers of cells (ectoderm, somatic and splanchnic mesoderm, and endoderm) that all of the tissues and organs of the adult worm arise through later differentiation, thickenings, foldings, outgrowths, etc. For example, the nervous system is formed by the ingrowth of a thickened region of the ectoderm; the blood vascular system develops by a specialization of cells throughout the mesoderm; while the reproductive system first appears as thickenings of the somatic mesoderm which, as development proceeds, become largely separated from it as independent organs in the coelom. (Figs. 60, 61.)

## B. EMBRYOLOGY AND METAMORPHOSIS OF THE FROG

As an example of Vertebrate development we may take that of the Frog, though it must be borne in mind that just as other Invertebrates differ in their embryology from the Earthworm, so the embryology of other Vertebrates departs widely from that of the Frog — chiefly fundamental and highly significant similarities persisting.

The fertilized egg of the Frog contains a large amount of stored food material, or yolk, which influences the character of the cleavage of the egg. Thus cell division is progressively more rapid, and accordingly the cells smaller, in the region with little yolk, the upper (animal) pole, than in the yolk-laden lower (vegetal) pole. The first and second division planes are from pole to pole, and give rise to four cells of equal size. The third division plane is just above the equator of the egg, at right angles to the former planes, and establishes four dark, pigmented cells above, and four



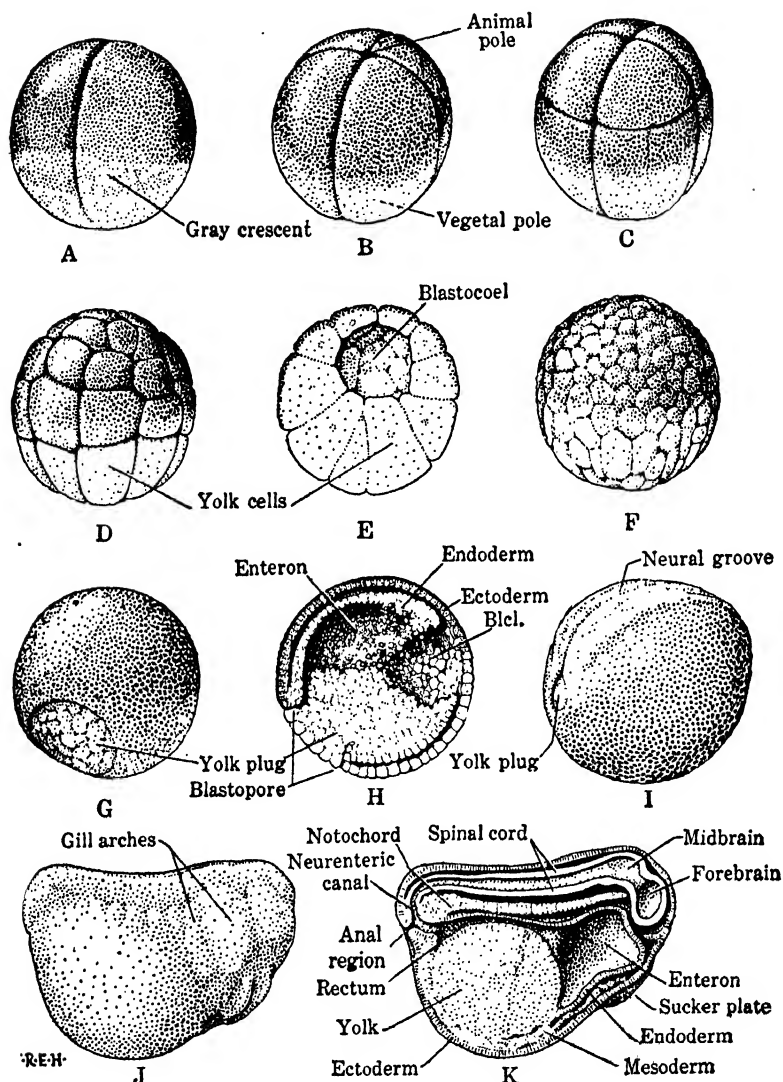

FIG. 174. — Early development of the Frog. A, B, C, egg at two-, four-, and eight-cell stage; D, early blastula; E, section of D; F, late blastula; G, early gastrula: overgrowth of ectoderm (cells of ectoderm now too small to be shown in figure); H, section of G showing germ layers, etc. (*Blcl.*, blastocoel); I, late gastrula: formation of neural groove and folds representing the foundations of the nervous system; J, older embryo, with neural groove closed, assuming tadpole form; K, section of J. See Fig. 175.

larger pale, yolk-laden cells below the equator. As division proceeds, soon there are many cells arranged in the form of a hollow sphere which will be recognized as the blastula. (Fig. 174.)

The transformation, in due course, of the blastula into the gastrula by typical invagination is somewhat obscured by the large amount of yolk in the prospective endoderm cells. In fact, the endoderm is formed by a flat infolding of cells, just below the edge of the small dark cells, that finally results in a crescentic groove on the surface, which is the edge of the blastopore. But gastrulation is not completed until all the large endoderm cells are enclosed by ectoderm cells, and this is accomplished chiefly by the latter gradually creeping and folding over the exposed, pale endoderm cells (YOLK PLUG) until merely a small blastopore remains leading into the enteron.

The development of the third germ layer, or mesoderm, takes place by the ingrowth of a layer of cells between ectoderm and endoderm along the edge of the blastopore where these two layers merge. When the mesoderm has grown forward and spread out between the ectoderm and endoderm, the lower portion (LATERAL PLATE) splits into a somatic and splanchnic layer and thus gives rise to the coelomic cavity between. The upper portion of the mesoderm (VERTEBRAL PLATE) exhibits traces of primitive segmentation as it forms a series of muscle plates, or MYOTOMES, on either side of the NOTOCHORD which, in the meantime, has arisen from an axial, dorsal strip of cells above the enteron.

During the later stages of gastrulation, the foundations of the central nervous system are established by the differentiation of a plate of ectoderm cells, the MEDULLARY PLATE, on the dorsal surface of the embryo. Then a groove appears in the medullary plate which is finally completely enclosed by the growth upward, over, and then fusion of the edges of the medullary plate. Thus the open groove is converted into the NEURAL TUBE which is soon to be differentiated into fore-brain, mid-brain, hind-brain, and spinal cord.

Simultaneously with the establishment of the central nervous system, the differentiation of the enteron into the alimentary canal, opening by mouth and anus, and also various other internal transformations have proceeded apace. Furthermore, the embryo has been gradually elongating so that it is nearly twice as long as broad by the time it begins locomotion by means of cilia distributed

over the body surface. And soon thereafter the larva, or TADPOLE, assumes a somewhat fish-like form, with a vertically flattened tail edged by a fin which provides for locomotion during the rest of the animal's purely aquatic life. (Fig. 175.)

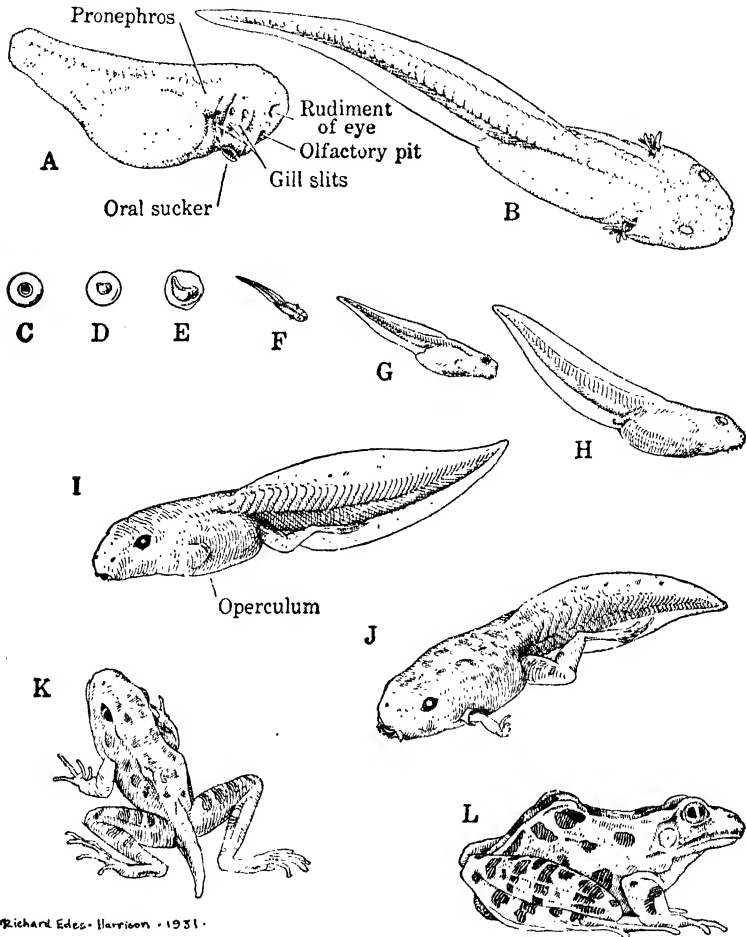

Richard Edes Harrison • 1931 •

FIG. 175. — Development and metamorphosis of the Frog. A, B, stages closely following K in Fig. 174. C-L, stages from egg to adult drawn to scale.

Independent existence demands sense organs, and these are already functioning in the head region. It also demands the intake of food which earlier was supplied by the yolk stored in the egg, and so the mouth develops a hard rim for scraping food m<sup>at</sup> .

rial from the surface of aquatic plants. Moreover, increased respiration is necessary, and this is met by the appearance of branched external gills on the sides of the head, which are the first of a series of three different respiratory organs that succeed one another during the life history. Indeed, these external gills are soon covered over by a fold of the skin, the OPERCULUM, which finally leaves but a single opening, the SPIRACLE, to the exterior. And no sooner is the operculum fully developed, than the external gills are resorbed and a new set of fish-like internal gills take their place in the gill slits. Then hind legs slowly make their appearance, followed by the fore legs, already developed under the operculum.

Now the larva is ready for METAMORPHOSIS — its transformation from a gill-breathing tadpole to a lung-breathing juvenile Frog. During metamorphosis one stage melts rapidly into the next: the tail is resorbed, the legs increase in size, the long coiled intestine becomes shorter and specialized to digest animal food, the internal gills are resorbed, and lungs are developed which make it necessary for the tadpole to come to the surface of the water for air. Finally, as a juvenile Frog, the animal transfers its abode largely to land, and grows.

The process of metamorphosis varies in length from a few weeks to several years in different species of Frogs. In all cases it is some time after metamorphosis before sexual maturity arises. Preceding the first breeding season, the gonads develop rapidly, their ducts become fully differentiated, and adult male and female individuals are established. (Figs. 132, 163.)

### C. EMBRYONIC MEMBRANES OF THE HIGHER VERTEBRATES

The embryological development of the higher Vertebrates departs rather widely in certain ways from that of the Earthworm and the Frog. Thus the eggs of Reptiles and Birds contain much more yolk than the egg of the Frog, with a consequent greater obscuring — though not obliteration — of the characteristic blastula, gastrula, etc. (Fig. 169.)

Furthermore, in the Frog the whole egg becomes converted into the body of the tadpole, whereas in Reptiles, Birds, and Mammals a part of the egg forms a hood-like membrane, the AMNION, about the embryo. This is cast off at birth and with it another membrane, the ALLANTOIS, which extends into the am-

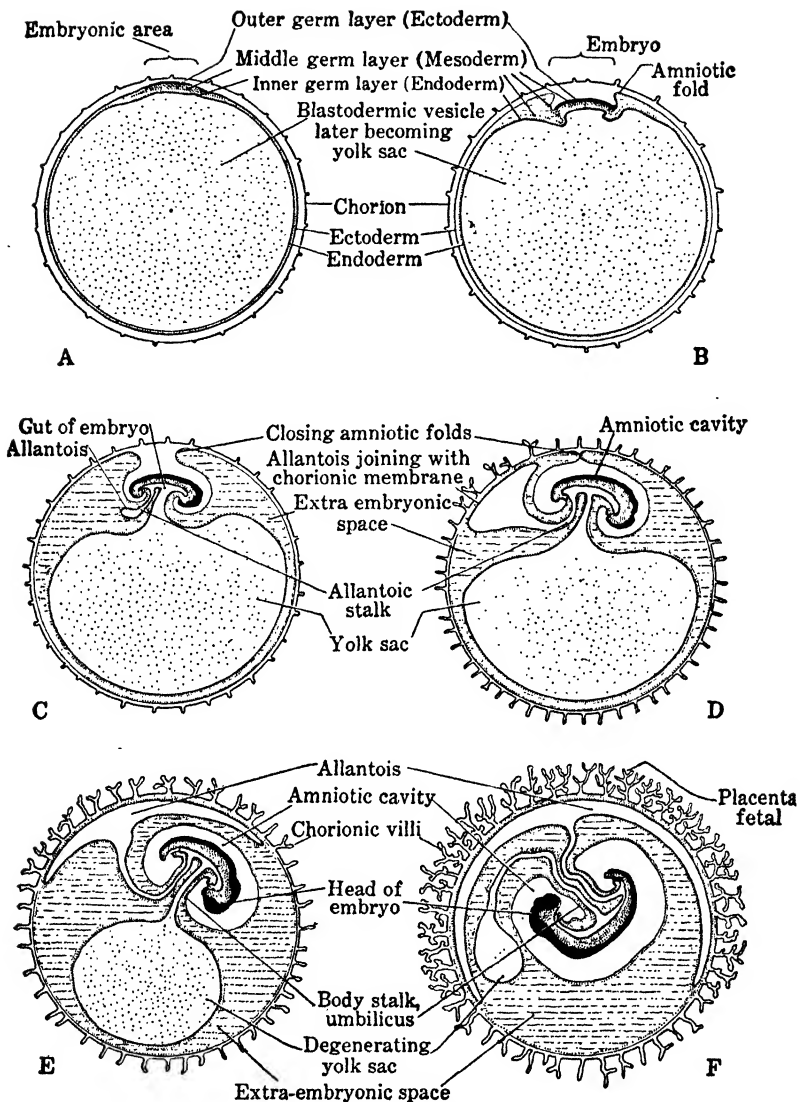

FIG. 176. — Diagrammatic sections showing the development of the egg and embryonic membranes of a Mammal. A, blastula showing fundament of embryo at top, before the appearance of the amnion. B, embryo outlined, with developing amnion and yolk sac. C, embryo with amnion further developed and allantois appearing. D, embryo with amnion closing, and allantois joining with outer membrane, or chorion. E, F, embryos in which the vascular layer of the allantois is applied to the chorion and growing into the villi of the latter to form the fetal placenta; yolk sac reduced; amniotic cavity increasing; mouth and anus established.

nion and has served temporarily as a respiratory membrane. The development of these two EMBRYONIC MEMBRANES, to meet new conditions of embryonic existence, makes possible not only a more rapid and sure interchange of materials between the embryo and its surroundings, but also affords greater protection for the growth of complicated structures. (Fig. 176.)

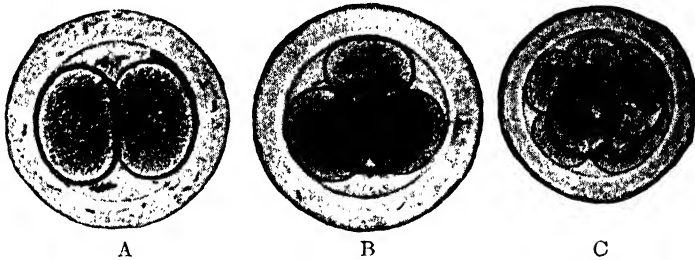

FIG. 177A. — Photographs of early stages in the development of the egg of the Rabbit. A, two-cell stage, 24 hours after fertilization, in thick surrounding membrane (zona pellucida); B, four-cell stage, 29 hours; C, eight-cell stage, 32 hours. Highly magnified. (After Streeter.)

Finally, the eggs of typical Mammals, including Man, though not provided with so large an amount of yolk because food is

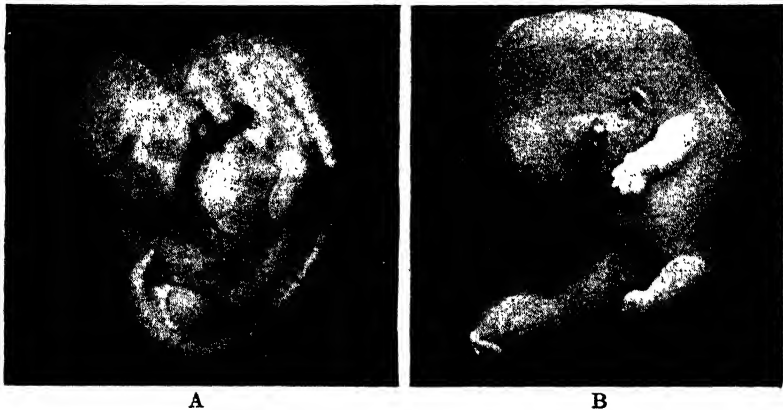

FIG. 177B. — Human embryos. A, one month old (6.7 mm.), showing arm and leg buds, caudal end, umbilical cord, heart, gill slits, olfactory pit, and eye; B, six weeks old (19 mm.), showing developing hands and feet, elbow and knee, nose, eye, and ear. See Fig. 235. (After Streeter.)

supplied to the developing embryo by the blood vascular system of the mother, nevertheless inherit from lower forms the embryonic

membranes. These contribute to the formation of the **PLACENTA** and are modified and diverted to meet new conditions demanded by the uterine life of the Mammalian embryo. (Figs. 133, 134.)

With merely this outline of some of the chief features of the embryology of the Earthworm, Frog, and higher forms before us, it is possible to gain some appreciation of the similarity of the basic method of development which is ever present in the Animal Kingdom — cleavage, blastula, gastrula, primary germ layers, etc. In general, it may be said that in all the higher animals the ectoderm forms the outer skin and nervous system; the endoderm supplies the lining membrane of the major part of the alimentary tract; while the mesoderm contributes muscles, blood vessels, reproductive organs, and the membrane lining the coelom. This similarity in origin of the organ systems from the primary germ layers, throughout the animal series above the Coelenterates, is of the highest significance because it indicates a fundamental structural similarity in the body plan of all these forms. It is exhibited in the developmental process in each generation, even though the adult body in the various groups differs widely in form and arrangement of organs. Such a state of affairs clearly suggests an hereditary relationship throughout the animal series — the origin of the diverse forms by gradual change. (Figs. 172, 174.)

#### D. PROBLEMS OF DEVELOPMENT

Embryology is something more than the description of the kaleidoscopic series of stages which seem to melt one into the other as development progresses. It attempts, especially at the present time, to look below and beyond structure to the processes involved, and to determine how the sequence of events is brought about. This is but a repetition of the stages of progress in all science; a passage from the *descriptive* to the *experimental*. The results thus far secured have raised many, and answered some problems of development of great practical importance and theoretical interest. The outline of one broad problem may serve as an example.

From what the pioneer students of embryology during the seventeenth and eighteenth centuries saw, or thought they saw, with simple lens and newly invented compound microscope, there were gradually formulated two opposing views of development

which, though long since swept aside in their original form as a result of the increase of knowledge, raised a problem that is still before the embryologist to-day.

In brief, one view virtually denied development by maintaining that the adult organism is nearly or completely formed within the germ, either in the egg or the sperm, which merely by expansion, unfolding, and growth gives rise to the new generation. In this first crude form the PREFORMATION theory demanded the 'encasement' of all future generations one within another in the germ of existing organisms, so that when it was computed that the progenitor of the human race must have contained some two hundred million homunculi (a conservative estimate, to say the least) the *reductio ad absurdum* was irresistible.

The other view was reached by careful studies on the transformation of the Hen's egg into the chick which soon made it clear that the chick is not preformed in the egg. The embryo arises by a gradual process of progressive differentiation from an apparently simple fundament — it is a true process of development, or EPIGENESIS. But the upholders of epigenesis versus preformation were before long beyond their depth and in danger of attempting to get something out of nothing — lost in the miraculous.

A statement in such succinct form tends to accentuate the crudities of these two conflicting views — "preformation explaining development by denying it and epigenesis explaining development by reaffirming it" — and it may be well to remark that the early embryologists with the means at their command faced a stupendous task of which only recent work has brought a full appreciation.

The path to progress cleared by the realization that adult structures are not preformed as such in the egg, and that development is not an expansion but the formation — the 'becoming' — by an orderly sequence of events of structures of great complexity out of apparent simplicity, the problem of the embryologist was to determine what the egg structure actually is, and how it is related to that of the adult. To trace the development of these studies would involve the history of embryology since the formulation of the cell theory. We must confine ourselves to the bare statement of the new guise in which the old theories of preformation and epigenesis confront us to-day as a result of recent research.

The reader already recognizes the fertilized egg as a cell, with its nucleus comprising a complex of quite definite elements — the



chromosomes — contributed jointly by the two gametes. To this extent, then, the nucleus and therefore the egg exhibits a ready-formed structural basis which (as we have already suggested, and will have occasion to elaborate later) certainly is definitely related to characters which appear in the offspring.

Turning to the egg cytoplasm, we are confronted with conditions which are not so uniform but nevertheless highly suggestive. In

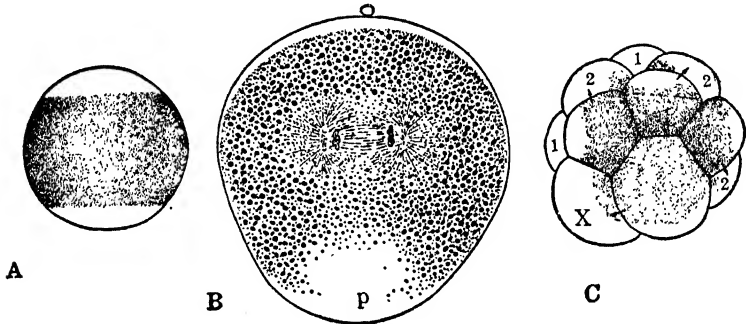

FIG. 178A. — Egg of a Mollusc, *Dentalium*, showing cytoplasmic differentiation. A, egg, shortly after being extruded and before maturation is completed, showing three differentiated regions; B, section through an egg after fertilization, showing cytoplasmic rearrangement involving the segregation of clear polar lobe at p; C, normal sixteen-cell stage, with materials of polar lobe now in cell X. Removal of the polar lobe results in an abnormal embryo. (After Wilson.)

the first place, before fertilization the egg possesses a definite POLARITY, expressed, for example, by the position of the nucleus and the distribution of food material (yolk), pigment granules, and vacuoles. This polarity is traceable, in part at least, to the polarity of the oögonia, and through them to the germinal epithelium. In brief, the egg as a whole is *organized*; the invisible organization of the fundamental matrix of the cytoplasm being revealed, in part, by the disposition of various elements of the cell. Now this cytoplasmic organization undergoes more or less profound changes in establishing that of the new individual. In some cases the reorganization occurs at fertilization, while in others it is somewhat deferred. And herein, apparently, is to be sought the explanation of the difference in behavior — in potentialities — of various types of eggs during cleavage stages. Two contrasting examples will serve to bring the main facts before us.

The first type is well illustrated by the egg of a Mollusc, *Den-*

talium, and a primitive Chordate, *Styela*. \*The egg of the latter shows at the first division five clearly differentiated cytoplasmic regions. For the sake of simplicity these may be described as white, light and dark gray, and light and dark yellow. As cleavage proceeds, these substances are distributed with great regularity to definite cell groups, which in turn form special organs or organ systems of the animal. Thus cells which receive the white region form the ectoderm; those which receive the dark gray, the endoderm; while the cells with light or dark yellow form mesodermal structures, and so on. And further, the experimental removal of a cell or cell group in which a certain substance is segregated results in an embryo deficient in the very structures which this normally forms. In other words, the egg cytoplasm seems to be a mosaic of organ-forming substances which possibly themselves directly, but probably through more fundamental conditions of which they are but the visible expression, have a causal relation to definite adult structures. Just in so far as this is true, the adult is *pre-delineated* in bold lines, though not actually preformed, in the egg. (Fig. 178.)

Passing now to the second type, represented, for example, by the eggs of some Sea Urchins, the results which we obtain seem to be diametrically opposite. Although more or less clearly differentiated cytoplasmic regions appear to exist, frequently the removal of a part of the egg before division, or the separation of the cells at the two-cell stage, and sometimes even at the four-cell stage, has no permanent effect on the structural integrity of the developing embryo. Each of the cells has the power to develop into an embryo complete in every respect, but smaller than the normal. Or, to put it another way: at the four-cell stage, a single cell which normally forms, let us say, one-fourth of the embryo, if isolated with one other cell, may form one-half of a normal embryo and, if isolated with two other cells may form one-third. And apparently the same phenomenon occurs in the case of human identical twins. The egg becomes separated into two parts during early development and results in two individuals with identical hereditary basis. Indeed identical quintuplets, all from one zygote, have become famous. In all such cases one may ask, what has become of the egg organization?

At first glance the behavior of these two classes of eggs seems to afford results which are irreconcilable — the former supporting the doctrine of preformation in a refined form, and the latter its

antithesis, epigenesis.\* But an explanation is not far to seek. The difference apparently depends, as already suggested, upon the time when chemical differentiation of the egg cytoplasm occurs and the products are localized in special regions. If this occurs before or at fertilization, so that the early divisions give rise to dissimilarly organized cells, then each of the cells is not TOTIPOTENT and the mosaic type of development results; but if the initial differentiation and localization is delayed until later, or is relatively slight so that the cells of the early stages are all essentially similar, then during this period each cell is totipotent — the whole forms an EQUIPOTENTIAL SYSTEM — as exhibited by the early stages of the Sea Urchin. Thus we may bring under one viewpoint the apparently contradictory behavior of the two classes of eggs, for it turns out to be reducible to a common factor: the time of differentiation and localization of the products. In one case this has progressed further than in the other during the early embryonic stages. In both cases, therefore, development is epigenetic in its obvious features.

However, since cytoplasmic differentiation is a fact whether it appears early or late, we have merely pushed the solution of the problem further back and the question becomes: Is there a primary differentiation and, if so, where? It is not possible to present here the specific evidence on this point, but the reader's knowledge of the nucleus, and particularly its definite chromosomal architecture, will lead him to anticipate that modern research tends more and more to emphasize the gene as representing a material configuration — apparently it is a protein molecule — which is transmitted, in a way, 'preformed' from generation to generation and determines the cytoplasmic characteristics of the cells. As to how the specific physical basis of inheritance, the genes constituting the chromosomes, is related to cytoplasmic organization and to characters which arise later, we can offer no satisfactory explanation or even guess. We must be content with a discussion, in the next chapter, of some of the facts of heredity which show that certain chromosomes are causally related to the inheritance of certain characters.

But in so far as the nucleus possesses an organization which is definitely related to differentiations of the cytoplasm, organ-forming substances, or characters of embryo and adult, we may look upon the chromatin to this extent as representing a sort of primary preformation which is realized by a process of building

up — epigenesis — as one character after another becomes established in the development of the individual. This is the guise in which the old problem of preformation versus epigenesis faces the biologist to-day.

So the early embryologists were right when, studying the egg of the Frog or Hen, they maintained that development is develop-

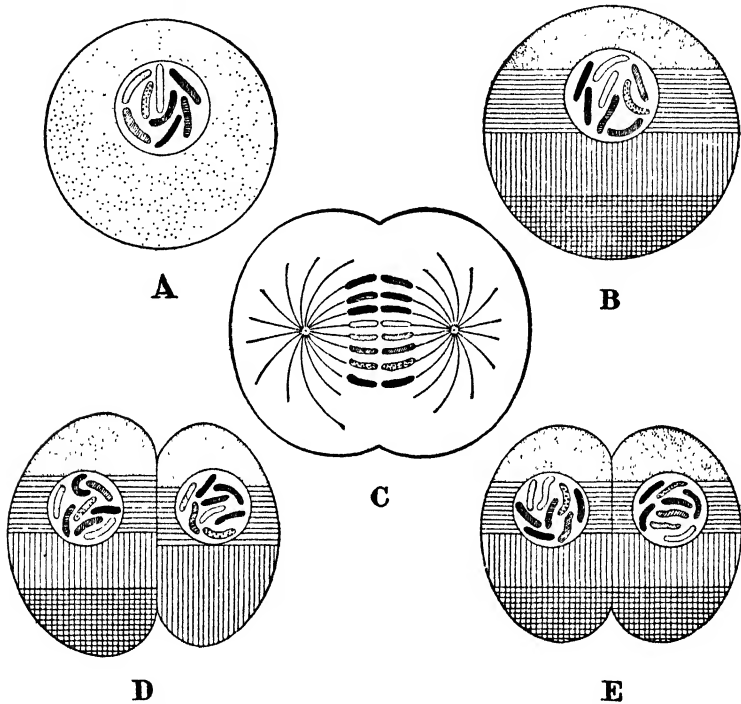

FIG. 178B. — Diagram to illustrate how the character of the first division of an egg may influence the distribution of the products of cytoplasmic differentiation and therefore the potentialities of the resulting cells. A, immature egg, assumed to have no definite segregation of cytoplasmic stuffs; B, mature egg, with cytoplasmic zones established; C, first division of egg; D and E, two types of two-cell stages; D, type with one cytoplasmic zone entirely distributed to one of the cells, and therefore each of the two cells, if separated, gives rise to an abnormal larva; E, type with equal distribution of the zones to both cells, and therefore, if separated, each of the two cells gives rise to a normal larva. (From Wilson.)

ment and not merely the unfolding of an organism already fashioned in more or less definite adult form. But it took two centuries of research to reveal the fact that, below and beyond its superficial aspects, there is a germ of truth in the principle of preforma-

tion deeply hidden in the nuclear architecture, the enormously complex physico-chemical structure of the genetic basis, or genes, and therefore the origin of the individual, though obviously through epigenesis, is fundamentally from a sort of preformed basis. We no longer bother ourselves with the old conundrum as to which is more complex, the egg or the adult, but recognize that each is complex in its way — the simplicity of the egg being more apparent than real, as is convincingly attested by every endeavor to analyze cytoplasm, nucleus, chromosomes, genes, and beyond.

## CHAPTER XXI

### INHERITANCE

So careful of the type . . .  
So careless of the single life. — *Tennyson*.

THE old adage that 'like begets like' expresses the general fact of HEREDITY. Everyone recognizes that parent and offspring agree in their fundamental characteristics: they 'belong to the same species.' And everyone realizes that the resemblance may be strikingly exact even in details of form or behavior. Family traits reappear. The mere statement of striking resemblances among the individuals of a family is a tacit admission that no two individuals are exactly alike; in other words, heredity is organic *resemblance* based on descent — inheritance of the characters exhibited by the parents is not complete, there is VARIATION. Indeed "variation is the most invariable thing in nature," but one must guard against the impression that there is an antithesis between heredity and variation. "Living beings do not exhibit unity and diversity, but unity in diversity. Inheritance and variation are not two things, but two imperfect views of a single process."

We may now address ourselves to the problems of heredity and variation which are at the basis not only of what organisms have been in the past and are at the present, but also of whatever the future may have in store for them. Variations are the raw materials of evolutionary progression or regression. From a broad point of view, the origin of species and the origin of individuals are essentially the same question. If we can solve the relations of parent and offspring, the origin of species will largely take care of itself. As a matter of fact, historically the question of species origin was approached first, and through the work of Darwin became of paramount interest in the latter half of the nineteenth century. The twentieth century finds the individual — the hereditary relation of parent and offspring — the center of investigation, and it forms the science of genetics. ORGANIC EVOLUTION attempts to establish the general fact that all organisms are related by descent; GENETICS attempts to show how specific individuals are related.

Even further has the pendulum swung from the general to the particular. To-day the most intense investigation is centered not on the heritage of the individual as a whole, but on particular characters of the individual. An immense amount of experimental work has demonstrated that, for practical purposes, the individual may be regarded as an aggregate of essentially separate characters, both structural and physiological, that are relatively stable and may be inherited more or less as units. But the analysis does not stop even at this level. Each character is regarded as represented in

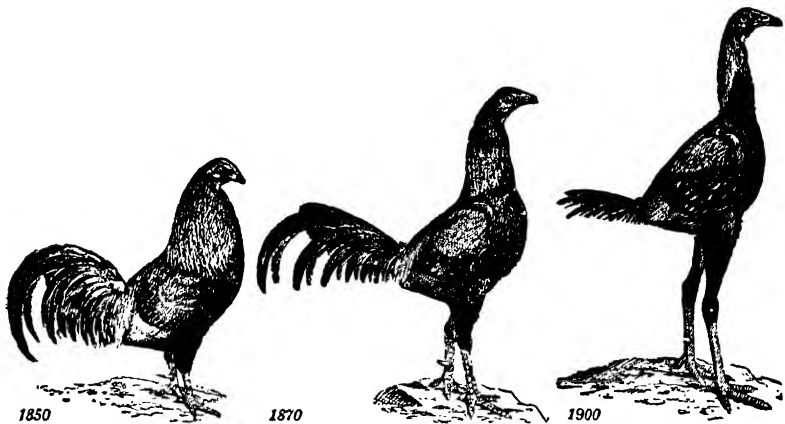

FIG. 179. — The evolution of the Game Cock. Results produced largely by selection before our present knowledge of the mechanism of inheritance. (From Metcalf, after Wright.)

the chromosomes of the germ cells by one or more determining factors, or GENES; and whether or not a given character will be present in a tree or a man depends upon whether the genes for this particular character entered into the nuclear complex of the fertilized egg which formed the individual. Therefore, geneticists are now studying the relative positions which the genes occupy on certain chromosomes; how they may cross-over from one chromosome to the other of a synaptic pair; how they mutually influence one another, etc. (Fig. 196.)

At present we are witnessing great advances in knowledge of the underlying factors of heredity, and the data recently accumulated are so vast that we can attempt here no more than to indicate the character and promise of the principles already discovered.

We may glimpse the field before us by a concrete example.

About thirty-five years ago, just at the opening of the modern concentrated attack on genetic problems, an association of British millers awoke to the fact that some active means must be taken to offset the increasingly great deficiency in quantity and quality of the wheat yield. Accordingly they commissioned a specially trained biologist to investigate the matter. He collected many different varieties of domestic and foreign Wheat, each known to have one or more good qualities, and studied how these were inherited. Making use of the data thus secured, in the course of a few years he produced a wheat which combined the good qualities of several varieties; including high content of gluten, beardlessness, immunity to Rust, and large yield, and this 'made to order' wheat proved successful in the British Isles. But with the opening up of new territory in western Canada another obstacle was encountered: the growing season was too short for the finest varieties of wheat. This condition was quickly met by transferring the quality of early ripening from an inferior grade of wheat to a wheat possessing several other valuable characters.

In a similar fashion, a host of workers have performed the impossible of a few years ago. Corn of desirable percentage content of starch or sugar; cotton with long fibers of foreign varieties and quick maturing qualities to escape insect ravages; Sheep combining choice mutton qualities of one breed with the fine wool of another and the hornlessness of a third; and so on almost without end. Furthermore, there is no limit in sight to the new stable races of plants and animals which are forthcoming as the principles already known are applied, and subsidiary ones are discovered. And last but not least, Man has begun to study himself as a product of heredity and the process of evolution — to determine the distribution of characters in the family, and the consequences of their combinations in the physical and mental make-up of the individual.

#### A. HERITABILITY OF VARIATIONS

What then are the basic principles of heredity which are to-day at the command of the scientific breeder? To answer this question it is necessary to go into some details because no real appreciation of the underlying principles involved is otherwise forthcoming. Most of these details have been acquired through patient investigations made from the standpoint of so-called pure science — one



more proof of the indebtedness of the 'practical man of affairs' to the biological laboratory.

In the Protozoa the problems of heredity confront us in their simplest, though by no means simple form. Amoeba or Paramecium,

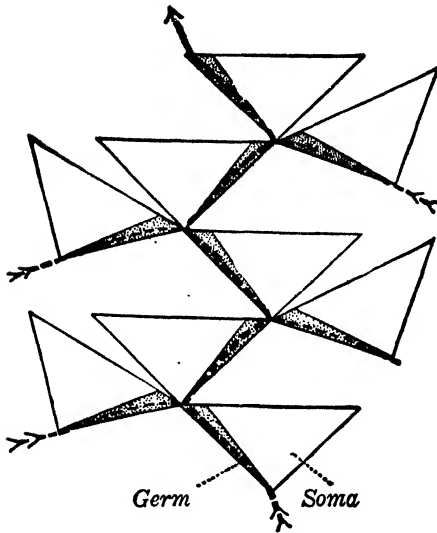

FIG. 180. — Scheme to illustrate the continuity of the germ. Each triangle represents an individual composed of germ (dotted) and soma (clear). The beginning of the life cycle of each individual is at the apex of the triangle where both germ and soma are present. In biparental (sexual) reproduction the germ cells of two individuals become associated in a common stream which is the germ and gives rise to the soma and germ of the new generation. This continuity is indicated by the heavy broken line and the collateral contributions at each succeeding generation by light broken lines. (From Walter.)

as we know, divides into two cells which through growth and reorganization soon are to all intents and purposes exactly similar to the parent cell. The parent has merged its individuality into that of its offspring. Thus stated, one does not wonder that parent and offspring are alike — each is composed of essentially the same protoplasm. But when we come to multicellular forms in which reproduction is restricted to special germ cells which involve fertilization, confusion is apt to arise unless one keeps clearly in mind — and perhaps exaggerates for the sake of concreteness — the distinction between germ and soma which has been previously discussed. Since in higher forms, to which brevity demands that our attention be confined, the

sole connection between parent and offspring is through the germ cells, it follows that they must be the sole path of inheritance. In other words, whatever characters the body actually *inherits* must have been represented by genes in the fertilized egg from which it arose; and furthermore, any characters which the individual can transmit must be represented in its germ cells. (Figs. 8, 28, 180.)

### 1. *Modifications*

Every individual organism — a man, for instance — is a composite not only of inherited characters, but also of MODIFICATIONS of the soma produced by external conditions during embryonic development or later. The individual's environment, food, friends, enemies, the world as he finds it, on the one hand, and on the other his education, work, and general reactions to this environment, all have their influence on body and mind and determine to a considerable extent the realization of the possibilities derived from the germ — what he makes of his endowment. He acquires, let us say, the strong arm of the blacksmith, the sensitive fingers of the violinist, or the command of higher mathematics. In other words, what he *is* depends on his heritage and what he does with it. Now, if he does develop an inherited capacity, can he transmit to his offspring this talent in a more highly developed form than he himself received it? Or must his children begin at the same rung of the ladder at which he started and make their own way up in the world? This is the old question of the inheritance of modifications, or so-called ACQUIRED CHARACTERS. (Fig. 198.)

Is the great length of the Giraffe's neck, to take a classic though crude example, due to a stretching toward the branches of trees during many successive generations, with the result that a slightly longer neck has been gained in each generation and inherited by the following? If so, it is a result of the inheritance of modifications because the changes were somatic in origin. Or is the length of the neck the result of the survival in each generation of those individuals which 'happened to be born' with longer necks and accordingly were better adapted to foliage conditions than those which varied toward shorter necks? If so, it is not the result of modifications but of changes having their origin in the germ cells. (Fig. 92.)

To-day biologists almost unanimously deny the former and accept the latter interpretation — the consensus of opinion is certainly that modifications, or changes in the individual body due to nurture, use, and disuse, are not transmitted as such. This conclusion is held chiefly because there is no positive evidence of the inheritance of modifications while there is much negative evidence; and also because there is no known mechanism by which a specific modification of the soma can so influence the germ com-

plex that this modification will be reproduced as such or in any representative degree. However, it should be emphasized that biologists in general recognize the potent influence of environment and the organism's reactions to the environment on the destinies of the race, even though they see, at present, no grounds for a belief that any specific modification can enter the heritage and so be reproduced. (Fig. 199.)

In this connection the question of the inheritance of disease will undoubtedly arise in the reader's mind. But this is really not a special case. If the disease is the result of a defect in the germinal constitution, it may be inherited just as any other character, physiological or morphological, that has a germinal basis. But if the disease is a disturbance set up in the body by some accident of life or through infection by specific microorganisms, before birth or later, it is a modification and inheritance does not occur. Of course, the well known fact that susceptibility or immunity to disease-producing organisms — the 'soil' for their development — may be inherited is not an exception to this statement. It may, however, be suggested in passing that from the standpoint of the individual born malformed, structurally or mentally, as a result of parental alcoholism, syphilis, or other obliquities, it probably will not appear of the first moment that the sins have been visited otherwise than by actual inheritance. (Fig. 250.)

The whole question of the non-heritability of modifications, or acquired characters, is a relatively new point of view which has been fostered by the elusiveness of crucial experimental evidence, by an ever-increasing knowledge of the details of the chromosome mechanism of inheritance, and by the general influence of Weismann's contrast of the soma and germ. Indeed, Lamarck did not question the inheritance of acquired characters and made it the corner-stone of his theory of evolution, while some have even gone so far as to say that either there has been inheritance of acquired characters, or there has been no evolution. However, the question is not so serious as that, as will be seen later on; though it obviously is profoundly important from many viewpoints, biological, educational, and sociological. In passing, it may be mentioned for those who would like to believe that acquired characters are inherited, that if desirable modifications were inheritable, undesirable ones would be also. Perhaps Nature is merciful! (Figs. 305, 309.)

## 2. *Recombinations*

Turning from modifications, which appear to be useless to the geneticist, we find that the most common inherited differences which appear in offspring are RECOMBINATIONS which owe their origin to new groupings of the germinal factors, or genes.

Everyone is familiar with some of the more obvious hereditary differences following fertilization which are the result of new combinations of parental characters represented in the egg and sperm: that is, cases in which nothing is apparent which is not clearly related to the conditions expressed in the ancestors. In the first place the offspring may exhibit a character, eye color, let us say, of one parent to the exclusion of that of the other — the character appearing unmodified. This is termed ALTERNATIVE inheritance. Or the offspring may seem to be a sort of MOSAIC of the characters of its progenitors, each parent contributing a certain character but not to the exclusion of that of the other. Sometimes the parental traits seem to fuse so that the progeny exhibit a more or less intermediate and different condition, as in the color of the skin of mulattoes, frequently called BLENDING inheritance. And as a final example, characters of grandparents or more remote ancestors may crop out, and constitute REVERSION.

## 3. *Mutations*

But quite different results now and then occur. Characters which have no place in the ancestry appear and are transmitted to the descendants. Sometimes these new inherited variations, or MUTATIONS, are only slight departures from the parental condition, while in other instances they are quite abrupt. But the significant fact is that mutations result from relatively radical alterations in the gene complex and so afford new opportunities for variation.

Thus combinations and mutations contrast sharply with modifications which are not transmitted to the offspring; the latter being merely the results of enviroing conditions on the soma during embryonic development or later. The importance of this distinction can hardly be over emphasized because it makes comprehensible many of the inconsistencies of earlier work on genetics.

## B. MENDELIAN PRINCIPLES

The statistical treatment of biological data as a method of studying inheritance was first brought prominently to the attention of biologists by the work of Galton, a cousin of Darwin, during the closing decades of the last century and started the widespread investigation of genetic problems. In particular, his work on the inheritance of characters in Man, such as stature and intellectual capacity, is a biological classic judged by the momentous consequences which followed from the discussion it evoked. But it was reserved for Mendel to apply statistical methods to facts observed in the progeny derived from carefully controlled experiments in breeding. Mendel's studies that founded the modern science of genetics actually were made more than a score of years before Galton's, but failed to reach the attention of the biological world engrossed in the evolution theory; in fact were not known by Darwin to whom they would have meant so much in his work to secure experimental data on heredity. We can with advantage introduce the survey of genetic principles by a study of examples from Mendel's own work. (Fig. 290.)

Mendel chose seven pairs of ALTERNATIVE characters which he found were constant in certain varieties of edible Peas, such as the form and color of the seeds, whether round or wrinkled, yellow or green; and the length of the stem, whether tall or dwarf, and these he studied in the HYBRIDS. One ordinarily thinks of a hybrid as a cross between two species or, at least, two characteristically distinct varieties of animals or plants; but as a matter of fact the offspring of all sexually reproducing organisms are really hybrids because two parents seldom, if ever, are exactly the same in all of their germinal characters. Consequently the offspring are hybrids with respect to the characters in which the parents differ; but in the following exposition the terms hybrid and pure are used solely in regard to the particular characters under analysis.

1. *Monohybrids*

Mendel found, in crossing pure tall and dwarf varieties of Peas, that all of the progeny of this PARENTAL (P) generation, in the FIRST FILIAL ( $F_1$ ) generation, were tall like one parent, there being no visible evidence of their actual hybrid character. Accordingly tallness was designated a DOMINANT (D) and dwarfness a RECESSIVE (d) character.

Mendel's next step was to follow the behavior of these characters in succeeding generations. Therefore the tall hybrids ( $F_1$ ) were inbred (self-fertilized) and their offspring, the **SECOND FILIAL** ( $F_2$ ) generation, were found to be tall and dwarf in the ratio of three to one (3D : 1d). This is now a broadly established Mendelian ratio. But, of course, in dealing with a small number of individuals this ratio is merely approximate; the greater the number of offspring, the closer it is approached. In this particular case Mendel obtained 787 dominant and 277 recessive individuals: a ratio approximating 3 : 1. (Fig. 181A.)



FIG. 181A. — Inheritance of size in a cross between a tall and a dwarf race of the edible garden Pea. The small circles represent the genes involved.

Continuing the work, Mendel found that the dwarfs (recessives) when inbred gave only recessives generation after generation, and accordingly were pure. On the other hand, the tall plants (dominants) when inbred proved to be of two kinds: one-third pure dominants which bred true indefinitely, and two-thirds hybrids like their parents, giving when inbred the same ratio of three dominants to one recessive in the **THIRD FILIAL** ( $F_3$ ) generation.

Aside from his masterly foresight in realizing that success depended on simplifying the problem by dealing with definite alternative characters, Mendel's claim to fame lies chiefly in his discovery of a simple principle by which the results may be explained. Since the hybrids when inbred always give rise to hybrids and also to each of the parental types in a *pure* form, it must be that the factors (genes) which determine the characters in question are sorted out, or SEGREGATED, in the ripe germ cells, or gametes.

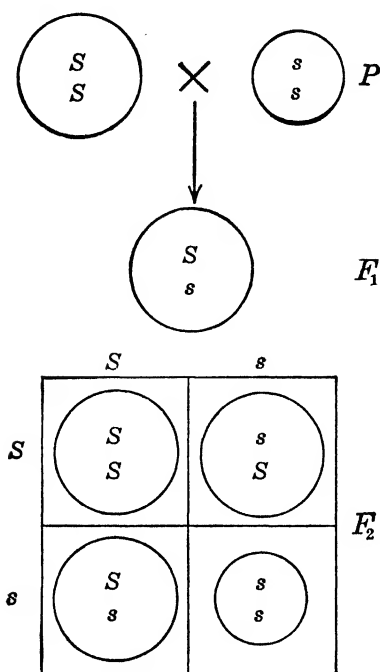

FIG. 181B. — Diagram of a Mendelian monohybrid. Results of crossing tall (S) and dwarf (s) Pea plants. The circles represent the zygotes and the characters of the soma (phenotype); the letters within the circles, the germinal constitution (genotype). The letters outside the recombination square represent the gametes. Note that each of the parents (P) represents a different phenotype and genotype; all the  $F_1$  (one shown) belong to the same phenotype and genotype; while the  $F_2$  represent two phenotypes and three genotypes. The relative number of individuals composing the  $F_2$  phenotypes is 3 : 1.

Assuming for illustrative purposes that a single gene determines a given character, it follows that after segregation the genes are distributed so that some gametes bear the gene for one character and other gametes bear the gene for the other character, but *no gamete ever bears the genes for both characters*. If the gametes of the original tall parent contained the gene for tallness (S), and those of the dwarf parent the gene for dwarfness (s) — then the hybrids will arise from a zygote which combines both genes (Ss), and since tallness is dominant over dwarfness all will be tall. Further, when the germ cells of this hybrid (Ss) mature, and these genes are segregated so that half of the gametes bear S and half bear s, then when such plants, each with

this germinal constitution, are inbred there will be equal chances for gametes bearing the same and for gametes bearing different genes to meet in fertilization.

The zygotes are 1 SS : 2 Ss : 1 ss. But, since S is dominant, the resulting organisms will be in the ratio of 3 tall to 1 dwarf, which is the familiar 3 : 1 Mendelian ratio of dominants to recessives in the F<sub>2</sub> generation. The important point, however, is that these tall plants, although they all *appear* alike and therefore belong to the same PHENOTYPE, are actually different with respect to their germinal constitution; because one-third bear gametes all of which contain the gene S, and two-thirds bear gametes half of which contain S and the other half s. Consequently the tall phenotype is

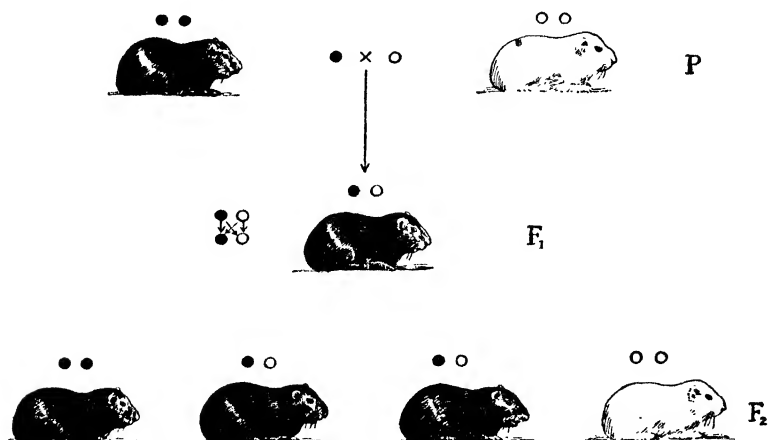

FIG. 182. Inheritance of color in a cross between pure black (pigmented) and white (albino) Guinea-pigs. The small circles represent the genes involved.

composed of two GENOTYPES which are distinguishable only by what they *produce*. (Figs. 181, 182.)

It is thus apparent why the pure tall plants always breed true, and why the dwarfs (necessarily pure) do the same — all the gametes of one bear S and those of the other, s. The pure plants are HOMOZYGOUS with respect to the characters in question. It is also clear why the hybrids give rise to hybrids and pure dominants and recessives — half of their gametes bear S, and half bear s. The hybrid plants are HETEROZYGOUS.

The real difference then between the F<sub>2</sub> hybrids (Ss) and the pure dominants (SS) is that the former are heterozygous and the latter are homozygous. In order to tell which is which, since they are phenotypically the same, it is necessary to breed them. When self-fertilization can be practiced, as in the case of most plants,



we get the result directly; that is an individual's progeny are either all dominants or dominants and recessives in 3 : 1 ratio, and thus the gametic constitution of the parent is immediately known. However, in the case of animals, where self-fertilization is impossible, the determination can be made by mating the dominants with recessives; for a homozygous (pure) dominant then will give all dominants, while a heterozygous (hybrid) dominant will give half dominants and half recessives. Thus:

Gametes	=	$\begin{array}{c} D & & D \\   & &   \\ \diagdown & & / \\ d & & d \end{array}$	$\begin{array}{c} D & & d \\   & &   \\ \diagdown & & / \\ d & & d \end{array}$
Gametes	=		
Possible zygotes	=	100% Dd	50% Dd+50% dd

So far we have considered inheritance in MONOHYBRIDS, that is cases involving one pair of alternative characters that can be interpreted as the resultant of one pair of genes termed ALLELOMORPHS, but now we proceed to cases where two, three, or more pairs of genes are concerned, known as DIHYBRIDS, TRIHYBRIDS, etc.

## 2. Dihybrids

Mendel investigated inheritance in dihybrids by crossing, for example, a Pea producing yellow round seeds with one producing green wrinkled seeds. The plants in the  $F_1$  generations bear only yellow round seeds, and therefore yellow and round are each dominant characters when paired with green and wrinkled. After self-fertilization such hybrid plants produce offspring ( $F_2$ ) with seeds showing all the possible combinations of the four characters, and in the ratio of 9 yellow round to 3 yellow wrinkled to 3 green round to 1 green wrinkled. (Fig. 183A.)

This logically can only be interpreted as indicating that one of the original parent plants bore gametes all containing the genes for yellow and for round peas (YR), while the other parent plant bore gametes all containing the genes for green and for wrinkled (yr). Such being the case, the resulting zygote is YRyr, and the hybrid which it forms develops gametes with all the possible combinations of these genes (except, of course, Rr and Yy) which are YR, Yr, yR, and yr — there is an INDEPENDENT ASSORTMENT of the genes as evidenced by the new combinations Yr and yR. Now,

in turn, at fertilization there are sixteen possible combinations of gametes, since there are four different kinds of sperm and four different kinds of eggs with respect to the characters in question. Accordingly the  $F_2$  generation, which is produced by the union of these gametes, is represented by one pure dominant (YR<sup>2</sup>YR), one pure recessive (yr<sup>2</sup>yr), four homozygotes including the two just mentioned, and twelve heterozygotes. These sixteen individuals form nine genotypes but, since only the dominant character is expressed when dominant and recessive genes combine, they are resolvable into four phenotypes (YR, Yr, yR, yr) in the ratio 9 YR : 3 Yr : 3 yR : 1 yr. Thus the 9 : 3 : 3 : 1 Mendelian ratio for two pairs of alternative characters is merely the monohybrid 3 : 1 expanded. Both rest on the same fundamental assumption that the genes for alternative characters are segregated during gamete formation — both members of a pair of allelomorphs never occur in the same gamete. (Fig. 183B.)

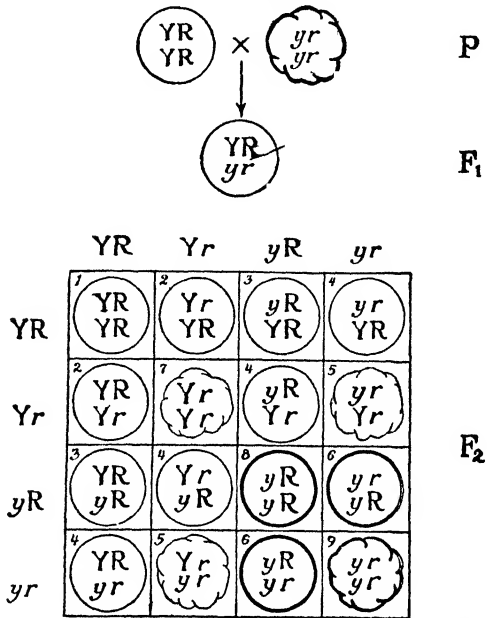

FIG 183A. - Diagram of a Mendelian dihybrid. Results of crossing yellow round seeded (YR) Peas with green wrinkled seeded (yr) The circles represent the zygotes and the characters of the soma (phenotype); the letters within the circles, the germinal constitution (genotype) The letter groups outside the recombination square represent gametes. The hybrids of the  $F_1$  generation are all yellow round seeded since green and wrinkled are recessive. The  $F_1$  plants form four types of gametes which afford sixteen possible types of zygotes, representing four phenotypes (shown graphically) and nine genotypes (numbered). There is one pure dominant (1) and one pure recessive (9). The zygotes numbered 4 are identical with the  $F_1$  generation. Four are homozygotes (1, 7, 8, 9) and the rest are heterozygotes. Those numbered 7 and 8 are new homozygous combinations resulting from independent assortment. The relative number of individuals composing the phenotypes is 9 : 3 : 3 : 1.

are segregated during gamete formation — both members of a pair of allelomorphs never occur in the same gamete. (Fig. 183B.)

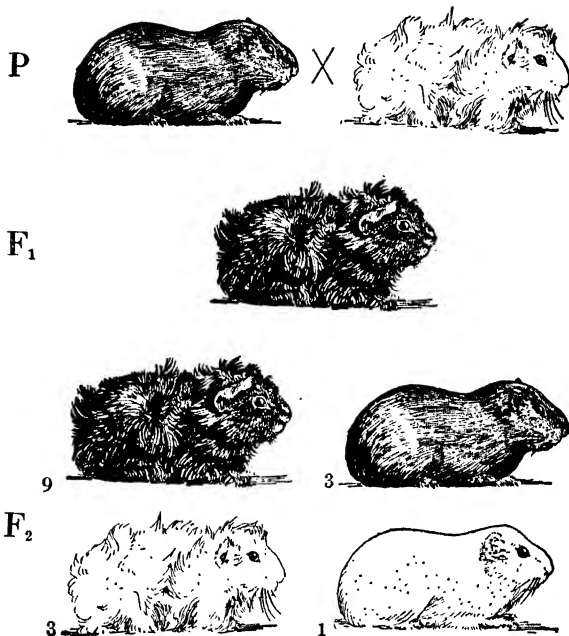

FIG. 183B. — Result of crossing pure smooth black with rough white Guinea-pigs. Rough and black (pigmented) are dominant. Note that each parent (P) bears both a dominant and a recessive character. The F<sub>2</sub> illustrates the principle of independent assortment.

### 3. Trihybrids

Similarly, Mendelian trihybrids, for example the cross between pure tall Peas bearing yellow round seeds and dwarfs bearing green wrinkled seeds, or the cross between pure Guinea-pigs with long, rough, black hair and those with short, smooth, white hair give in the F<sub>2</sub> generation 27 genotypes and 8 phenotypes; the number of individuals in the phenotypes being in the ratio 27 : 9 : 9 : 9 : 3 : 3 : 3 : 1. Of course, in nature there are few instances in which parents and offspring differ by only one, two, or three characters, but since characters arising from each pair of allelomorphs can usually be treated singly, convenience demands that the analysis be made with respect to one or two pairs at a time, which therefore is the usual method of procedure. (Figs. 184, 185.)

### 4. Summary

Before passing to certain extensions of these established hereditary principles, it may serve to clarify the subject if we restate

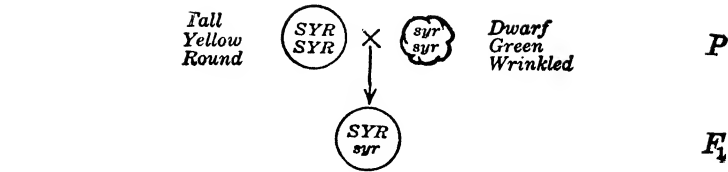

	<i>SYR</i>	<i>sYR</i>	<i>SyR</i>	<i>syR</i>	<i>SYr</i>	<i>sYr</i>	<i>Syr</i>	<i>syr</i>	
<i>SYR</i>									
<i>sYR</i>									
<i>SyR</i>									
<i>syR</i>									
<i>SYr</i>									
<i>sYr</i>									
<i>Syr</i>									
<i>syr</i>									

**F<sub>2</sub>**

FIG. 184. — Diagram of a Mendelian trihybrid. Results of crossing tall Peas bearing yellow round seeds (*SYR*) with dwarf Peas bearing green wrinkled seeds (*syr*). The circles represent the zygotes and the characters of the soma (phenotype); the letters within the circles, the germinal constitution (genotype). The letter groups outside the recombination square represent the gametes. The *F<sub>1</sub>* hybrids form eight types of gametes, giving sixty-four possible types of zygotes, representing eight phenotypes (shown graphically) and twenty-seven genotypes. There is one pure dominant (in upper left corner) and one recessive (in lower right corner). Eight are homozygotes (diagonal from upper left to lower right corner) and the rest are heterozygotes. The zygotes in the diagonal from upper right to lower left are identical with the *F<sub>1</sub>* generation. The relative number of individuals composing the phenotypes is 27 : 9 : 9 : 9 : 3 : 3 : 3 : 1.

it in slightly different form and thus emphasize the essential facts thus far discussed chiefly on the basis of Mendel's own work.

Every cell of the soma of an individual may be regarded as bearing a pair of genes for each alternative character (*e.g.*, size in

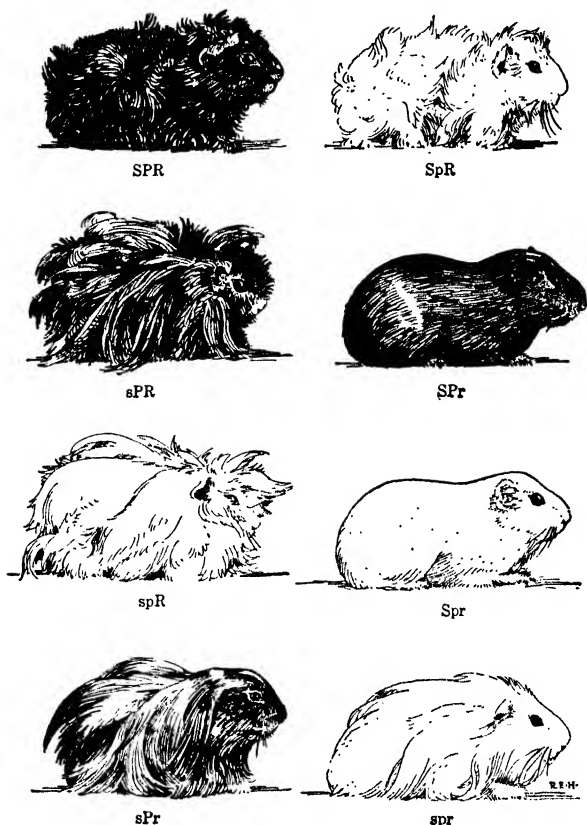

FIG. 185. — The eight phenotypically different kinds of Guinea-pigs in the  $F_2$  generation of a trihybrid. S = short hair, s = long hair, P = pigmented coat, p = non-pigmented coat or albino, R = rough coat, r = smooth coat. The hybrid parents ( $F_1$ ) were phenotypically SPR.

the case of the garden Pea), one member of each pair having been derived from each gamete which contributed to the individual's make-up. When both genes are identical (*e.g.*, either SS or ss) they are expressed in the soma (*e.g.*, the plant is tall or dwarf). The individual is homozygous with respect to size. But when the two genes are not identical (*e.g.*, Ss), the one, the dominant (S),

is expressed in the soma (the plant is tall), while the other, the recessive (s), is not expressed. The individual is heterozygous with respect to the character in question (*e.g.*, size).

After synopsis during the maturation of the germ cells of the individual, *segregation* of the genes occurs with the result that each gamete receives only one gene for each character. Thus the gametes of homozygous individuals are all alike with respect to the gene in question (*e.g.*, all bear either S or s), while the gametes of heterozygous individuals are of two numerically equal classes (*e.g.*, 50 per cent bear S and 50 per cent bear s).

Finally, there is an *independent assortment* of the genes for different characters, as evidenced by new combinations of characters in the progeny of dihybrids, etc. For example, size and color are independently inherited. This depends, as we shall see later, upon the genes involved being in different pairs of chromosomes.

The principles of segregation and independent assortment are usually known as Mendel's laws.

### C. ALTERATIONS OF MENDELIAN RATIOS

The immense amount of experimental breeding that has been carried on since Mendel's time has accentuated the significance of the principles of segregation and independent assortment, but has revealed that dominance is by no means universal. A few examples will bring the main facts before us.

The seven pairs of alternative characters in Peas which Mendel studied showed essentially complete dominance of one character in each pair, but we now know a great many cases in which the hybrid ( $F_1$ ) shows a different condition from either of the parents. For instance, on crossing homozygous *red* and *white* races of the Four-o'clock, all the progeny in the heterozygous ( $F_1$ ) generation bear *pink* flowers, or, we may say, flowers intermediate in color between the two parents. Neither red nor white is dominant: the result is BLENDING inheritance. But inbreeding the hybrids gives a  $F_2$  of 1 red : 2 pink : 1 white. Thus the typical Mendelian 3 : 1 ratio is, so to speak, automatically resolved into the 1 : 2 : 1 ratio which, when one character is dominant, is evident only on further breeding. Segregation actually occurs as usual, because the homozygous progeny of the hybrid exhibit the original parental characters unmodified. (Fig. 186.)

In certain other cases, the hybrids, instead of being true inter-

mediates, really exhibit the characters of *both* parents: neither character is recessive. Thus in Shorthorn cattle, red and white when mated give roan, a color effect resulting from a close intermingling, or MOSAIC, of red and white hairs in the coat. Accordingly roan Shorthorns are always heterozygous, but their offspring give

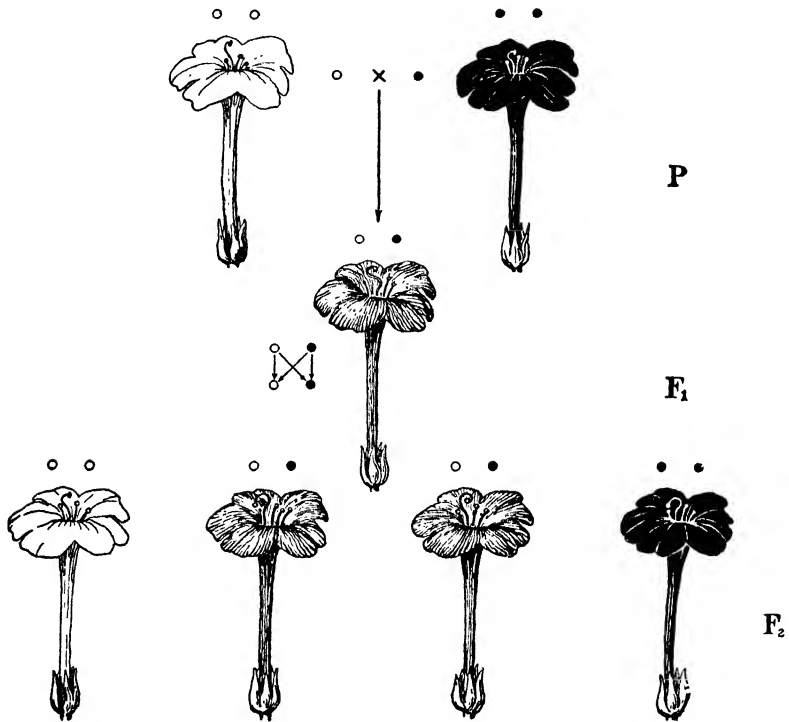

FIG. 186. — Diagram to illustrate the results from crossing white and red flowered races of Four-o'clocks, *Mirabilis jalapa*. The somatic condition (phenotype) is shown graphically; the small circles represent the genes which are involved.

the expected ratio of 1 red : 2 roan : 1 white which is clear evidence of segregation. Another example is the well-known blue Andalusian fowl. This will not breed true — it is a hybrid in which the characters of both parents are exhibited, apparently not blending though giving a somewhat intermediate effect. Its offspring show the ratio of 1 black : 2 blue Andalusian : 1 white-splashed-with-blue. In order to obtain all blue Andalusians — the type recognized by poultrymen — it is necessary to mate black with white-splashed-

with-blue birds. So again it is clear that segregation is involved, as it is in innumerable instances where no sharp distinction can be made between *complete* and *incomplete* dominance. (Fig. 187.)

Illustrations of some of the complications are afforded by cases of blending inheritance that result from the CUMULATIVE action of

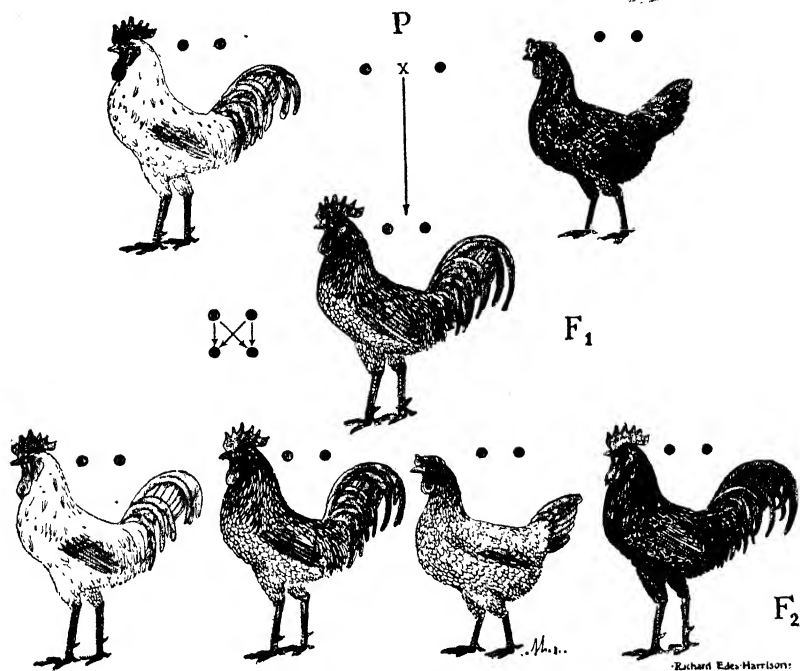

FIG. 187. — Cross of white-splashed-with-blue and black fowls, giving in the F<sub>1</sub> all blue Andalusians, and in the F<sub>2</sub> one white-splashed-with-blue to two blue Andalusians to one black.

several pairs of genes (MULTIPLE GENES) as in the cross of white and black human races. The mulatto (F<sub>1</sub>), from a cross between an individual homozygous for white and an individual homozygous for black, is intermediate in skin color between the parental types, and in the F<sub>2</sub> and later generations gives a series of gradations between white and black but rarely pure white or black offspring. Assuming that three pairs of genes for *color* are involved, the genetic constitution of the black race may be represented by AABBCc and that of the white race by aabbcc. Accordingly the hybrid, or mulatto, has the genetic constitution AaBbCc and is intermediate in color since only half of the genes for black pig-



mentation are present. Furthermore, the progeny ( $F_2$ ) of mulattoes show different degrees of color ranging from pure white to pure black owing to the sixty-four possible recombinations of genes

according to the trihybrid formula: the more 'black' genes present, the darker the pigmentation of the skin. The infrequent appearance of pure whites or blacks in the  $F_2$  generation is because the chances are slight that, through segregation and independent assortment, all the separate genes for black or white will be brought together in a single gamete and, further, that such a gamete at fertilization will meet another similarly endowed. (Fig. 188.)

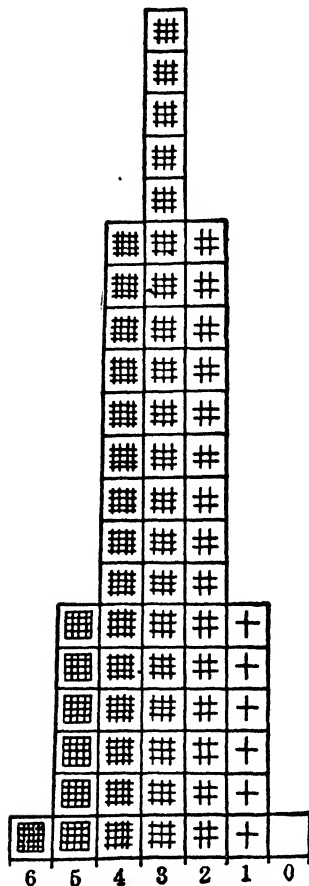

FIG. 188. — The distribution of the sixty-four possible recombinations in the  $F_2$  generation when three pairs of similar genes, cumulative in action, produce a character; e.g., the offspring of mulattoes. The figures indicate the number of genes (e.g., for black) present in the individuals represented by the column above. (From Walter.)

From these few examples, selected almost at random from the wealth of data at hand, it is apparent that the various types of inheritance can be satisfactorily interpreted on the fundamental principles of segregation and independent assortment. It is merely necessary to bear in mind that it is the genes, which condition the development of characters, and not the characters themselves that behave as units; for now we know that most characters are determined by multiple genes, and that even in cases where one gene seems to produce a character, other MODIFYING genes, COMPLEMENTARY genes, etc., may affect its development. Genes are units in inheritance but are not units in development.

Within the past few years geneticists have been able by the multiple gene, modifying gene, and similar concepts to bring the inheritance of

a large number of characters into line with the principles presented. Thus stature, proportions of the parts of the body, build, as well as nearly all of the physiological and mental characteristics in Man are evidently dependent upon multiple genes. In certain Fruit Flies eye color may be influenced by more than forty pairs of genes and the wings by upward of ninety. Thus it is becoming increasingly clear that what a given gene will produce is determined by the constitution of the gene plus its interaction with many, if not all of the other genes of the complex, although, of course, as we have seen, the single gene pair, in many or most cases, does have its most conspicuous effect on a certain character of the organism. And, furthermore, what the gene complex will produce bears an intimate relationship to the environment. For instance, in Fruit Flies the abnormal condition of extra legs is inherited in typical Mendelian manuer when the flies are reared at a low temperature; whereas supernumerary legs do not appear in flies with the *same* gene heritage when bred at a higher temperature. In short, the environment, in certain cases at least, may act as a differential intensifying or diminishing gene action.

So it happens, as is usually the case, the more a problem is studied the more complex it appears to become. Suffice it to say that although our knowledge of inheritance is to-day very much broader than Mendel conceived on the basis of his classic experiments, it is evident that he supplied us with basic principles which are affording a common denominator for an ever-increasing number of facts in genetics.

#### D. MECHANISM OF INHERITANCE

With this general outline of genetic principles before us, it is now necessary to bring them into relation with the facts so far discovered in regard to the structure of the germ cells. In other words, we have assumed, on the basis of the experimental results derived from breeding plants and animals, the existence of genes, the occurrence of segregation, etc., but has the actual study of cells (CYTOLOGY) by means of the microscope given any evidence of the physical basis of genes and of a segregating mechanism? The reader will at once answer this in the affirmative on the basis of our discussion of the origin and structure of the germ cells and their behavior in fertilization. Accordingly the essential facts may now be restated from this viewpoint. (Fig. 165.)

The egg and sperm each carry a definite number of chromosomes and consequently after fertilization the zygote contains a double set. For each chromosome contributed by the sperm there is a corresponding, or **HOMOLOGOUS**, chromosome contributed by the egg. In other words, there are two chromosomes of each kind which may be considered as pairs. When division of the zygote takes place each chromosome splits into two chromosomes, so that each daughter cell receives a daughter chromosome derived from each of the original ones. Since all the cells of the organism are lineal descendants by similar mitotic cell divisions, all of its cells contain the double set of chromosomes — half paternal and half maternal; and since the primordial germ cells have a similar origin, they also have a double set of chromosomes. But during the maturation process **SYNAPSIS** occurs: that is, homologous chromosomes of paternal and maternal origin unite in pairs — the process of fertilization which gave rise to the individual being consummated in the ripening of its own germ cells. But this union is only temporary; during the maturation process the maternal and paternal chromosomes of each synaptic pair are separated and one of each (though very rarely all of the same maternal or paternal set) passes to the daughter cells — segregation occurs. Thus each mature germ cell, or gamete, contains one member of every chromosome pair and the number of chromosomes is reduced one-half. (Figs. 167, 189.)

It has been assumed that the genes for alternative characters segregate in the formation of the gametes of hybrids so that a single gamete bears one and not both genes of a pair of allelomorphs. That is the genes, which come together in the zygote that forms the hybrid, separate again in the formation of its own gametes. This is just what cytological studies show. Chromosome behavior exactly parallels the typical behavior of the 'Mendelian' gene, because after synapsis, during spermatogenesis and oögenesis, each chromosome of paternal origin separates from the corresponding chromosome of maternal origin. Moreover, since the genes similarly situated on homologous maternal and paternal chromosomes are **HOMOLOGOUS GENES**, or allelomorphs, it follows that homologous genes are segregated in separate gametes during maturation — the two members of a pair of allelomorphs pass to different gametes. This is the basis of the so-called purity of the gametes.

Furthermore, in considering dihybrids we found, for instance, that genes for yellow and round, and green and wrinkled seeds were inherited in a fashion which indicated that yellow and round are segregated independently of each other — there is an *independent assortment* because all possible combinations with green and wrinkled occur. This clearly is fully accounted for, provided the gene for color and the gene for form are not in the same pair of

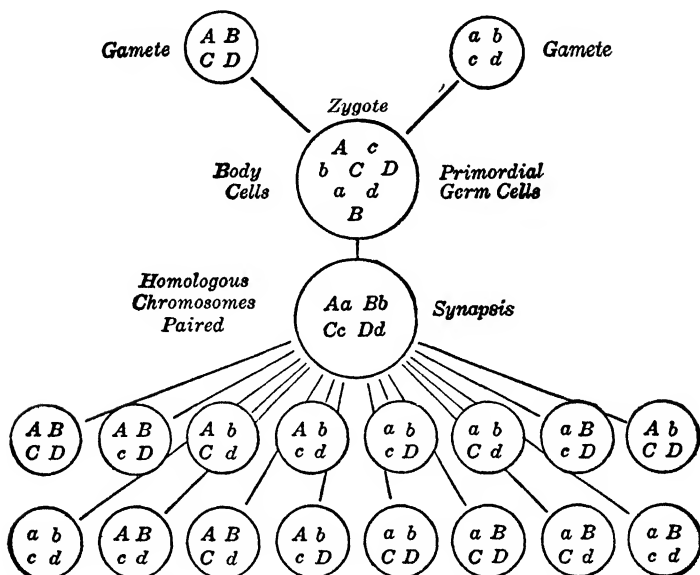

FIG. 189. — Diagram to show the union of haploid groups of either the chromosomes or of the genes of the gametes to form the diploid condition of the zygote, body cells, and primordial germ cells. Finally their pairing at synapsis, and segregation in the gametes. With four pairs of chromosomes or of genes (*Aa, Bb, Cc, Dd*) there are sixteen possible types of gametes.

chromosomes. Moreover, following synapsis the gametes secure one of each pair of homologous chromosomes (a haploid group), but not necessarily — indeed very rarely — all of maternal or paternal origin. (Figs. 183A, 189.)

In short, when two gametes unite, each contributes to the zygote a homologous haploid group of genes with the result that the offspring is of diploid gene constitution. Similarly, each gamete contributes a homologous haploid chromosome group so that the zygote is of diploid chromosome constitution. Thus both the *chromosomes* and the *genes* (characters) are in the haploid condi-

tion in the gametes and the diploid in the zygote. This close parallelism of character and chromosome behavior affords further proof that the chromosomes through their constituent genes determine the physical basis of inheritance, and that segregation and related phenomena are facts. For all practical purposes, A, B, C, D, and a, b, c, d, in Figures 167 and 189 may be interpreted either as chromosomes or as characters (genes).

Turning now to the inheritance of characters whose genes are borne by the *same* chromosome: these would seem to be indissolv-

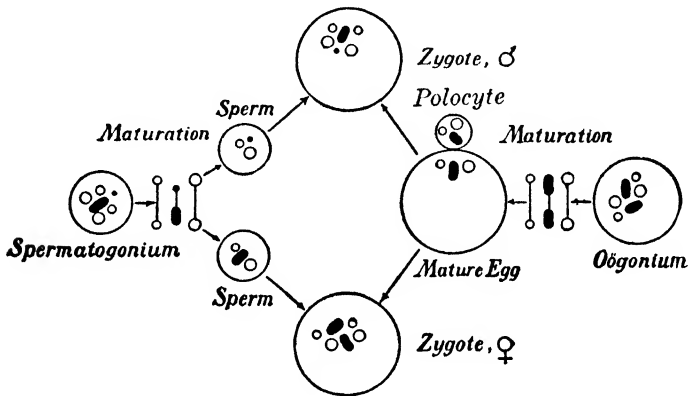

FIG. 190. — Diagram to show the relation of the two classes of sperm in fertilization. The formation of gametes in the male is shown at the left, in the female at the right; fertilization, producing the male or female zygote, in the center. Somatic chromosome number assumed to be six. X chromosome (large) and Y chromosome (small) in black.

ably linked together. And since the chromosome number is usually not large — there are twenty-four chromosomes in the gametes of Man — compared with that of heritable characters, we would expect sometimes to find characters linked together. That is, not separately inherited, or independently assorted, as are yellow and round in our example. In reality many cases are known in which characters are usually inherited together. The inheritance of sex and sex-linked characters will make the main point clear, and at the same time serve to bring before us the essential facts in regard to the determination of sex.

### 1. Sex Determination

Intensive studies of the chromosomes in the somatic cells and in the germ cells before the maturation divisions have shown that

usually in *male* animals two members of a certain pair of homologous chromosomes (synaptic mates) differ recognizably one from the other in size or form or both. For example, one member, referred to as the X chromosome, may be similar in size to the other chromosomes, while its mate, called the Y chromosome, may be atypical in form, or much smaller or, indeed, not present at all in certain species. Furthermore, it has been found that in corresponding cells of *females* there are two X chromosomes. Thus the chromosome groups of males possess an X-Y pair, and those of females, an X-X pair. This difference between the chromosomes of the sexes naturally suggests that the X chromosome bears essential determiners for sex, and this appears to be the case. (Fig. 190).

During spermatogenesis the maturation divisions following synapsis segregate the synaptic mates (X-Y) in the regular way, so that two classes of sperm result: half the sperm bear the X chromosome and half bear the Y chromosome. Furthermore, in oögenesis the maturation divisions distribute an X chromosome (from the X-X pair) to each cell, and accordingly every egg bears an X chromosome. Thus, in Man the somatic number of chromosomes is 48; males having 46 plus an X-Y pair, and females 46 plus an X-X pair. Half the sperm bear 23 plus X, and half bear 23 plus Y; while all the eggs bear 23 plus X. (Figs. 191, 193.)

Since there are equal numbers of sperm with and without the X chromosome, on the average as many eggs will be fertilized by one class of sperm as the other, with the result that half of the zygotes will contain one X and half two X chromosomes. The former will develop into males and the latter into females, since the somatic cells of males have one X chromosome and similar cells of females have two.

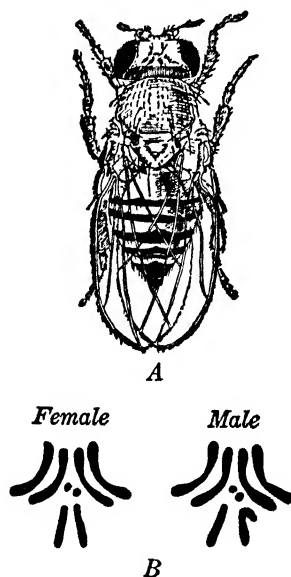

FIG. 191. — A, Fruit Fly, *Drosophila*, the study of which has contributed greatly to our knowledge of inheritance. B, Chromosomes of male and female: the lower pair in the female is the X-X, and in the male is the X-Y. (From Bridges.)

So it seems clear that sex is typically determined in many animals, including Man, at the time of fertilization by the same fundamental mechanism that controls inheritance in general. Moreover, multiple genes are involved. The decision is given by certain genes in the X chromosomes, acting in connection with genes in other chromosomes. The genes in the X chromosomes

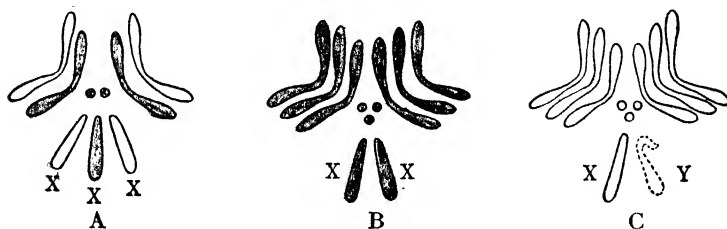

FIG. 192. — Influence of the balance between X chromosomes and the other chromosomes on sex in *Drosophila*. A, 'super female'; B, 'intersex'; C, 'super male.' See Figs. 191, 197.

turn the balance under the usual conditions of development so that a series of processes is initiated, involving the action and interaction of hormones, nutritional factors, and various environmental conditions, that lead to the sex *differentiation* of the adult.

But many unusual cases, some normal and others abnormal, occur particularly among the lower animals. Thus it has been

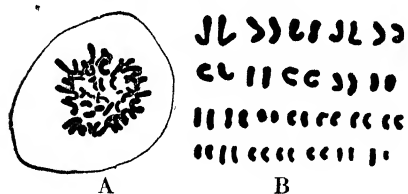

FIG. 193. — A, Human spermatogonium with 48 chromosomes; B, chromosomes arranged to show the 24 pairs of synaptic mates. The X-Y pair is at lower right. (From Painter.)

found that INTERSEXES, individuals exhibiting varying degrees of male and female characters, may result from abnormal sets of chromosomes in which the balance between the X and the other chromosomes is upset, as is well illustrated by studies on *Drosophila*. Or hormones may have a modifying influence.

Thus a male twin in cattle may render abnormal the development of its female twin in the uterus, so that a sterile 'free-martin' results. Or still again, SEX REVERSAL may occur through environmental factors acting on the early embryo, as in the case of the Frog. And finally, the sex of the adult may change, sometimes

periodically as in the Oyster. Such marked departures from typical sex differentiation serve to emphasize that the final establishment of sex is indeed a resultant of many complex factors. (Fig. 192.)

2. Linkage

Since the basic mechanism that regulates sex is the same as that which determines the distribution of other characters

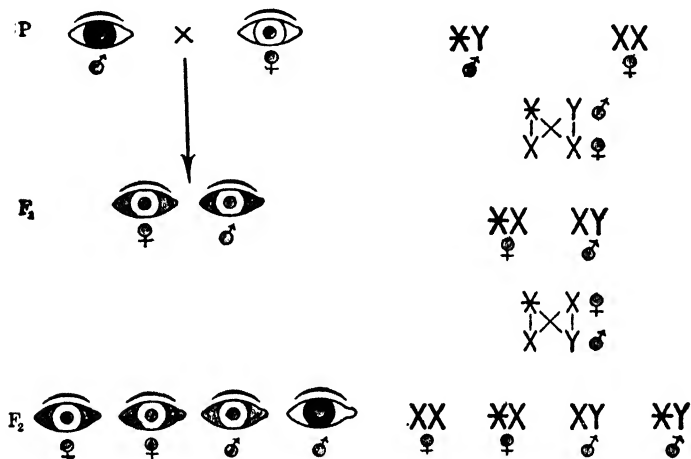

FIG. 194. — Diagram to show the inheritance of color-blindness from the male. A color-blind man (shown in black) transmits the character through his daughters (carriers) to half of his grandsons.  $\times$  indicates the X chromosome with the gene for color-blindness.

in inheritance, it might be supposed that the genes of other characters as well are carried in the X chromosome. As a matter of fact the behavior in inheritance of certain characters is such that it can only reasonably be explained on this assumption. Accordingly such characters are known as **SEX-LINKED**. This brings us again to the point at which we digressed to consider sex — the discussion of genes associated in the same chromosome.

The best known examples of sex-linked characters in Man are **COLOR-BLINDNESS** in which the affected individual is unable to distinguish red from green, and **HEMOPHILIA** in which the individual's blood has little tendency to clot so that bleeding from even a slight wound may be serious. Both abnormalities have long been known to be inheritable, and in the same peculiar *criss-cross* way. Thus color-blindness is usually transmitted from a color-blind man



through his daughters, who are normal, to half of his grandsons; and from a color-blind woman to all of her sons and none of her daughters. When both parents are color-blind, all the children show the defect. This behavior is readily accounted for if we assume that the gene for color-blindness when present is associated with the factors for sex on the X chromosome, and that color-blindness develops in males

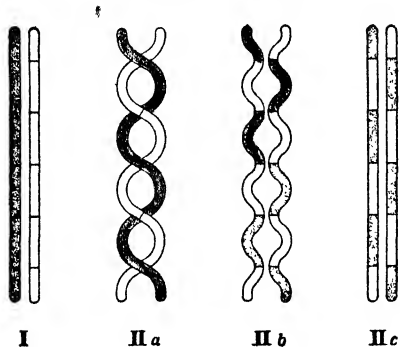

FIG. 195. — Diagram showing a possible mechanism of crossing-over during synapsis of homologous paternal and maternal chromosomes. The segments indicate the assumed linear arrangement of the genes with allelomorphous genes opposite each other. I, pair of chromosomes which have entered and emerged from the synaptic state without any crossing-over; IIa, chromosomes winding about each other at synapsis; IIb, separation of these chromosomes, involving breaking at the points of crossing; IIc, their emergence from synapsis with the members of the pairs of allelomorphous genes interchanged. (From Wilson.)

develops in males when it is received from one parent, and develops in females when it is received from both parents. Thus a color-blind man is always heterozygous for the character, while a color-blind woman is homozygous. A woman who is heterozygous has normal vision, but is a 'carrier,' that is, produces gametes half of which carry the gene for color-blindness. It is obvious why color-blindness is very much less frequent in women than in men. (Fig. 194.)

Color-blindness and hemophilia thus serve to illustrate the association of genes of different characters in the same chromosome and the association later of their respective characters in the adult — independent assortment does not occur. Incidentally, it also clearly shows that whatever characters are borne by the X chromosome are not transmitted by a father to his sons, and so perhaps minimizes, from the standpoint of heredity, the importance usually ascribed to descent in the direct male line.

### 3. Crossing-over

However, the presence of different genes in the same chromosome — we know that chromosomes are really linkage groups of genes — by no means indicates that such genes must always be

distributed together. Thus during synapsis homologous genes (allelomorphs) often reciprocally CROSS-OVER from one synaptic mate to the other, and so become separated from their former gene associates in the same chromosome. When such occurs the exchanged genes are segregated independently of their former associates in the same chromosome, and accordingly a greatly increased flexibility is afforded the genetic mechanism. (Fig. 195.)

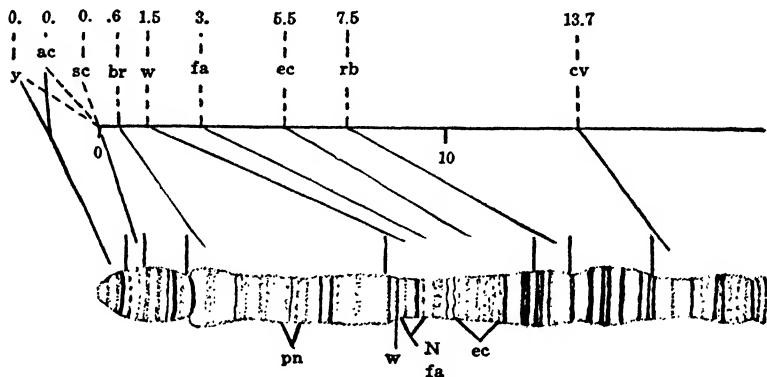

FIG. 196. — Cyto-genetic map. Terminal portion of the X chromosome from the salivary gland of *Drosophila*, with the locations of some of the genes indicated. ac, achaete; br, broad; cv, cross-veinless; ec, echinus; fa, facet; N, notch; pn, prune; rb, ruby; sc, scute; w, white; y, yellow. (After Painter.)

In addition to its great importance in bringing about genetic change, crossing-over affords the geneticist an opportunity to determine the relative positions of different genes in a chromosome. It has been found that the distance between two genes in a chromosome is, in general, proportional to the percentage of crossing-over which occurs between these genes at synapsis — the longer the distance, the more likely is crossing-over to occur. Accordingly, in very extensive breeding experiments it is possible to construct so-called chromosome maps by plotting the relative positions of the various genes in the chromosomes. In the case of *Drosophila* the genes for more than six hundred characters have already been mapped. (Fig. 196.)

#### 4. Mutations

But the possibilities of genetic change are not necessarily limited by the typical chromosome groups or to crossing-over that usually

afford the material for recombinations. Not infrequently relatively radical alterations, or **MUTATIONS**, occur, usually just before or during the maturation of the germ cells, which thereupon are at the disposal of the usual genetic mechanism for segregation, etc.

Mutations may be broadly classified as chromosomal aberrations and intrinsic changes in the individual gene. Indeed some geneticists restrict the term mutation to gene changes. A few illustrations from the wealth of available data must suffice.

**CHROMOSOMAL ABERRATIONS** consist of departures from the normal number and arrangement of the chromosomes, and of their parts. Thus many cases are known in which the whole normal chromosome set (diploid number) has been increased to some multiple of the typical haploid number. Such symmetrical changes in the chromosome groups are termed **PLOIDY**, and appear to be more frequent in plants than in animals. Thus the haploid sets of three well-known varieties of Wheat consist of 7, 14, and 21 chromosomes respectively.

Some marked instances of the origin of new types have recently been observed in the Jimson weed (*Datura*). In one case the plants differ in size and several other characters that clearly are attributable to the doubling of the diploid number of chromosomes. They have 24 pairs of chromosomes instead of the typical 12 pairs. Equally interesting are certain observations on *Drosophila* which typically has 4 pairs of chromosomes. Individuals have appeared that differ markedly from the normal flies and possess 12 chromosomes as a result of the addition of another haploid set.

Another type of chromosome mutation, known as **HETERO-PLOIDY**, involves only one, or rarely two, chromosomes, and not an entire set. Thus again in *Drosophila*, the failure of the X chromosomes to separate after synapsis (**NON-DISJUNCTION**) gives rise to individuals with nine chromosomes, including one Y and two X chromosomes. This may be regarded as a 'male' complement of chromosomes plus another X chromosome, with the result that flies so endowed are females with an altered heredity visible chiefly as larger size. (Fig. 197.)

Still other irregularities may involve only a portion of one chromosome. Thus part of a chromosome may be lost, or duplicated, or attached to another chromosome. For example, a race of *Drosophila* has been obtained in which a part of the Y chromosome has become transferred (**TRANSLOCATED**) to the end of an X

chromosome; and another race in which one of the X chromosomes has been broken into two nearly equal parts — one part being united to one of the other chromosomes. Moreover, recent work emphasizes the significance of the order of arrangement of the genes in a chromosome; alterations of the usual order resulting in hereditary changes referred to as POSITION EFFECTS.

All such chromosomal aberrations, rare and radical as most of them are, may be regarded, in a way, as a broad extension of the principal of recombination. They exert their influence by new relations and proportions of the genetic material, and offer new hereditary possibilities in the event that they are not lethal.

GENE MUTATIONS apparently involve intrinsic alterations in the individual genes themselves or even the origin of new genes, and probably are the most significant changes in the hereditary complex. They presumably are a result of an alteration in the physico-chemical constitution of the gene; although some would assign them mostly to position effects. It appears that usually only one of a pair of homologous genes mutates at a given time so the change is extremely localized, and most frequently takes place just before or during maturation. Although gene mutations occur relatively rarely, several hundred examples have been identified in *Drosophila*, chiefly by the elaborate studies of Morgan and his collaborators — studies involving upward of 25 million fruit flies. These experiments have made this tiny insect the greatest contributor to our knowledge of genetics since Mendel's experiments with peas, and justified the award of a Nobel Prize to Professor Morgan.

Perhaps the best-known example of gene mutation in carefully pedigreed animals is the sudden appearance, at long intervals, of a single white-eyed *Drosophila* in a true-breeding red-eyed stock. The white-eyed mutant breeds true from its origin, and the genetic data indicate that a specific point on one chromosome — it has been mapped — suddenly changed so that the developmental processes that formerly gave rise to the usual red eyes thereafter produced white eyes. And similar evidence of so-called 'point changes' has been obtained in a number of other kinds of animals and in plants that have been bred under controlled experimental conditions.



FIG. 197. — Duplication of the X chromosome in *Drosophila* as a result of non-disjunction. See Fig. 191. (From Coe, after Morgan.)

Such are a few of the types of mutations in the nuclear complex of the germ cells that we now know give rise to genetic variations. Chromosomal aberrations afford new relations and proportions of their constituent genes, whereas gene mutations actually determine the nature of the chromosomal elements themselves. In many instances, probably the majority, mutations produce lethal combinations in the gametes or zygotes — the altered hereditary constitution renders development or survival impossible. In other cases, individuals with the mutant characters become established and produce offspring with these new characters and so supply the material for descent with change.

Finally, in passing, it should be mentioned that mutations may also occur in somatic cells. Such SOMATIC MUTATIONS give rise to changes in the individual body which, of course, cannot be transmitted by the germ cells, but may be perpetuated by vegetative reproduction. Thus many desirable types of fruit are produced solely by tissue, descended from the original plants in which the mutations occurred, that has been grafted on other plants.

Important as is the recently acquired knowledge of some of the nuclear changes at the basis of mutations, we still do not know the fundamental factors underlying their origin. However, recent experiments have afforded a most valuable clue. It has been found possible to induce mutations in certain animals and plants by subjecting their germ cells to unusual conditions — the most effective so far employed being irradiations (X-rays, etc.) and certain temperature changes. Thus since mutations can be induced by controlled and measured external agents, the way seems to be opening for an experimental attack on the problem of the origin of mutations in nature that apparently is at the basis of organic evolution.

#### E. NATURE AND NURTURE

Even after making due allowance for the possibilities of genetic change involved in mutations, the individual still may be considered as a composite of very many characters which usually behave in a definite way in inheritance. Expressed somewhat fancifully, individuals may be regarded as temporary kaleidoscopic recombinations of the various genes belonging to the species; the act of reproduction, especially the maturation divisions, involving segre-

gation, and subsequent fertilization, providing the new turn of the kaleidoscope.

But since the life of an organism is one continuous series of reactions with its surroundings, it follows that nurture plays an immensely important part in molding the individual on the basis of its heritage. Indeed we are apt to overlook the fact, already mentioned, that every character is a product both of factors of the



FIG. 198. — Corn of a single variety (Leaming dent): at the left, grown well spaced; at the right, badly crowded. The heredity of each plot of corn is the same; the striking differences in growth are therefore solely due to environment. They are modifications. (From Blakeslee.)

heritage and of the environment and can be reproduced only when both are present. Those characters that appear regularly in successive generations are those whose development depends upon factors always present in the normal surroundings. Other characters, potentially present, do not become realized unless the unusual environmental conditions necessary for their development happen to be met. Heredity and environment are collaborating artists with different rôles to play as molders of the individual.

To disentangle the closely interwoven influences of heredity and

environment is one of the most important and perplexing problems of the science of genetics. This is especially true in the case of Man. Development is a form of behavior, and how a child develops physically and mentally is determined not by its heritage alone nor by its enviring conditions alone, but by both, in intricate combination. (Fig. 198.)

Although apparently we do not inherit the effects on our forebears of their surroundings and training, nevertheless we are the

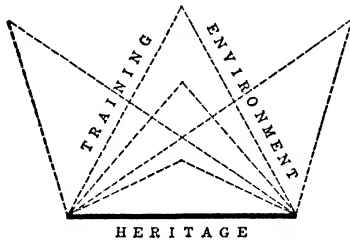

FIG. 199. — Scheme to illustrate the contributions of nature and nurture to the make-up of the individual. The triangles represent various types of individuals which may be produced by the same germ cells (heritage) if environment and training are variable. The foundation of the 'triangle of life' is heritage. (After Conklin.)

heirs to their customs — each generation builds upon the intellectual and material foundations of all of its predecessors — and this entails added responsibilities as well as opportunities for each succeeding generation. Already in certain

fields the applications of science to human affairs tax the ability of Man to use them wisely. Thus 'social heredity' bids fair to outstrip our conservative and essentially unchanging inherited nature. The EUTHENIST emphasizes nurture, the EUGENIST emphasizes nature. As is so often the case, how-

ever, when doctrines are opposed, the truth combines both; though we cannot doubt, knowing what we know of the genetic constitution of organisms, that from the standpoint of permanent advance — racial rather than individual — the path to progress is chiefly through EUGENICS, the science of being well born. (Fig. 199.)

This distinction between heritage and acquirements leaves a fatalistic impression in many minds, which to a slight extent is justified. We cannot get away from inheritance. On the other hand, although the organism changes slowly in its heritable organization, it is very modifiable individually; and this is Man's particular secret — to correct his internal organic inheritance by what we may call his external heritage of material and spiritual influences. It is therefore clear that the problem of human improvement has two aspects: in the first place, the effects of culture on the individual which, though not inherited, are cumulative from generation to generation through training; and

secondly, racial betterment through breeding the best. (Pages 420–425, 437, 444.)

Summarizing our survey of inheritance, in the first place, it is evident that the basis of inheritance is in the germinal rather than in the somatic constitution of the individual. A character to be inherited must be represented by one or more genes in the germ cells, although the environment is not unimportant in the development of the character from the gene complex. Secondly, there is no satisfactory evidence that modifications of the body, 'acquired characters,' can be transferred from the body to the germ complex and so be inherited. And thirdly, the germinal basis of characters, genes, may be dealt with essentially as units. The chromosomes — linkage groups of genes — undergo segregation and independent assortment during the development of the gametes of an individual, so that paternal and maternal contributions may be re-adjusted in all the possible combinations. Finally, mutations afford still further changes in the gene complex for distribution by the genetic mechanism, and so provide crucial opportunities for variation — for descent with change.



## CHAPTER XXII

### ORGANIC ADAPTATION

Every creature is a bundle of adaptations. Indeed, when we take away the adaptations, what have we left? -- *Thomson and Geddes.*

SINCE organisms are dependent for their life processes upon energy liberated by physico-chemical processes in protoplasm, any and all influences which induce changes in the structure or functions of an organism must initially modify the underlying metabolic phenomena. In other words, organic response is a problem of metabolism. Although it is highly important that this cardinal fact be clearly grasped, the science of biology to-day is not in a position to interpret the responses of organisms in these fundamental terms. Accordingly we can merely present some representative instances to illustrate the fact that the response of organisms, as exhibited in active adjustment — ADAPTATION — of internal and external relations, overshadows in uniqueness all other characteristics of life and at one stroke differentiates even the simplest organism from the inorganic.

Overwhelmingly striking as is the fitness of organisms to their physical surroundings, we must not lose sight of the fact that the environment itself presents a reciprocal fitness. This results from the "unique or nearly unique properties of water, carbonic acid, the compounds of carbon, hydrogen, and oxygen. . . . No other environment consisting of primary constituents made up of other known elements, or lacking water and carbonic acid, could possess a like number of fit characteristics, or in any manner such great fitness to promote complexity, durability, and active metabolism in the organic mechanism which we call life." (Henderson.)

#### A. ADAPTATIONS TO THE PHYSICAL ENVIRONMENT

In any consideration of the reciprocal relations which must exist between organisms and their surroundings, of first importance is the inconstancy of the latter. Uncertainty is the one certainty in nature and accordingly the response of living things — their

adaptability to environmental change — is at once the most striking and indispensable adaptation.

### 1. *Adaptations Essentially Functional*

Although the changes of the environment are almost inconceivably complex — witness the kaleidoscopic series of events exhibited in the hay infusion microcosm — there are certain general conditions which every environment must supply, and without which life cannot exist. These are food, including water and oxygen, and certain limits of temperature and pressure. (Fig. 18.)

**Food.** As we know, food represents the stream of matter and energy which is demanded for the metabolic processes of living matter. And each and every element which forms an integral part of protoplasm must be available. Since all protoplasm consists chiefly of a dozen chemical elements, these, of course, must be present; and further, since protoplasm is a colloidal complex in which water plays a fundamental rôle, life processes without water are impossible. But the old adage that what is food for one is another's poison has a broader significance than is immediately apparent. Although it is true there are general 'food-elements' which all life demands, it is equally true that the combinations in which these elements must be presented to the organism, in order to be available for its metabolic processes, are subject to the widest variation.

We have emphasized and contrasted the nutrition of a typical animal, green plant, and colorless plant, and have seen the reciprocal part which they play in the circulation of the elements in nature; so it is hardly necessary, with these facts in mind, to cite special cases in order to illustrate the adaptation of organisms to special nutritional conditions. Perhaps the demands of the Yeasts, that affect human life from so many angles, will suffice. (Fig. 17.)

The Yeasts include a host of microscopic colorless plants which play an important part in the simplification of organic compounds. An ounce of "brewers' yeast" contains about five billion cells. Since they are devoid of chlorophyll, Yeast cells, of course, lack photosynthetic powers, though like many other colorless plants they are not dependent upon proteins for nitrogen but obtain it in less complex form. But the essential fact of interest at present is the chemical changes associated with Yeast metabolism — the transformation of a large proportion of the sugar content of the

medium in which they live into alcohol and carbon dioxide. This process of ALCOHOLIC FERMENTATION may be approximately expressed by the formula:

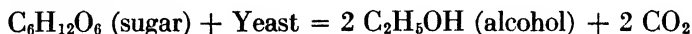

The explanation is not far to seek. Deprived of an adequate supply of air, Yeasts resort to the energy released when, with the decomposition of the sugar, the carbon and oxygen unite as  $CO_2$ . The formation of alcohol by the remnants of the sugar molecules is, from the standpoint of the Yeasts, a mere incidental factor which is, so to speak, unavoidable. On the other hand, from the broad viewpoint, the waste products of the action of the Yeast plants' enzymes represent an important phase in the general simplification of organic compounds in nature. And Man turns to account in numerous ways both products of the Yeasts' destructive powers — the alcohol and the carbon dioxide.

Thus the Yeasts are practically independent of free oxygen and in this they agree with many kinds of Bacteria as well as some animals, chiefly parasitic worms, which are able to secure the necessary energy by the rearrangement of the atoms within, or the disruption of molecules containing oxygen. Indeed, certain species of Bacteria not only do not need free oxygen at all, but are killed when it is present in any considerable amount. All such organisms are termed ANAEROBES. A common example is *Clostridium tetani* which inhabits garden soil and street dust and produces TETANUS, or lockjaw, in Man and certain domesticated animals when it gains entrance and develops in the tissues.

TEMPERATURE. Although protoplasmic activity is restricted to ranges of temperature which do not seriously interfere with the chemico-physical processes involved, it is a commonplace that various species are adapted to different degrees of temperature. The great majority of organisms, however, find their optimum temperature between  $20^\circ C.$  and  $40^\circ C.$ , though species inhabiting the polar and tropical regions show adaptations to the temperature extremes of their surroundings. As a matter of fact, it is not possible to state the upper and lower limits beyond which active life ceases, but some Protozoa are known to multiply in the water of hot springs, certainly at temperatures higher than  $50^\circ C.$ , and others in water until freezing actually occurs.

Many of the Bacteria and Protozoa develop protective cover-

ings and assume a resting condition in which the metabolic processes are reduced to the lowest terms. In this spore, or encysted state they are immune to extremes of temperature and of dryness to which they succumb during active life. Thus some Bacteria can withstand nearly  $-200^{\circ}$  C. for six months, and about  $-250^{\circ}$  C. for shorter periods, while others can endure  $140^{\circ}$  C. for a short time. (Fig. 200.)

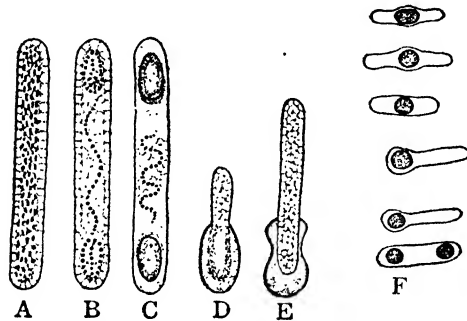

FIG. 200. — A-E, *Bacillus bütschlii*: A, cell structure; B, C, spore formation; D, E, germination of a spore; F, various types of spore formation occurring among bacilli. (From Smith and others; A-E after Schaudinn.)

It is clear that the great majority of organisms are at the mercy of environmental temperatures. This is true of all except the Birds and Mammals. These homothermal animals possess a complex mechanism which maintains their body temperature practically constant; *e.g.*, in Man at  $37^{\circ}$  C.

The heat regulatory mechanism represents, so to speak, the final result of the assembling and elaborating, throughout Vertebrate evolution, of elements that appear in the Fishes. In the Mammals it comprises insulation by the skin, a closed blood vascular system, power of rapid oxidation, endocrinal and other glandular products, evaporation surface of the lungs and skin, 'trophic' and 'temperature' nerves, coördinating centers, etc., — the whole complex rendering its possessors largely independent of the surrounding temperature and making possible the carrying on of the various functions with such nicety as the life of these forms demands. Indeed, this mechanism makes it possible for a man to stay in a hot dry chamber sufficiently long to see a chop cooked. It is hardly probable that the human brain could have developed to function as it does if its cells were subject to wide temperature variations.

**PRESSURE.** The metabolism of organisms, in common with chemical processes in general, is influenced by the surrounding mechanical pressure. Therefore it is evident that the pressure of either the water or air plays an important part in the operation of the life functions. We find organisms adapted to the greatest depths of the ocean where the pressure is several tons to the square inch — so great that some forms burst when rapidly brought to the surface; while others are adapted to live at high altitudes where the air pressure is relatively low. And again, the higher Vertebrates present an adaptive mechanism which renders them less dependent on a constant atmospheric pressure.

These few examples must suffice to emphasize the general environmental conditions which are necessary for life, as we know it, to exist, and to suggest that within these broad limits organisms are adapted to special environmental conditions so that there is scarcely a niche in nature untenanted.

## 2. *Adaptations Essentially Structural*

We may now broaden our view of the plasticity of organisms by a brief consideration of adaptations which are essentially struc-



FIG. 201. — *Gymnura*. (From Horsfield and Vigors.)

tural. But here as elsewhere it is absolutely impossible to distinguish sharply between structure and function which, obviously, are only reciprocal aspects of the fitness of living creatures.

**ADAPTIVE RADIATION OF MAMMALS.** In the group of Mammals, forms are to be found which are extraordinarily modified in adaptation to the most diverse environmental conditions. From a more or less primitive type, or focus, there radiate, as it were, types which are specialized for very different habitats and modes of

life. We may select from the Placental Mammals a small Malayan insectivorous animal known as *Gymnura*, which is allied to the Hedgehogs, as most similar among living Mammals to the generalized or focal type of terrestrial Mammal. *Gymnura* has relatively short pentadactyl limbs with the entire palms and soles resting flat upon the ground (PLANTIGRADE) and therefore essentially adapted for comparatively slow progression. (Figs. 201, 202.)

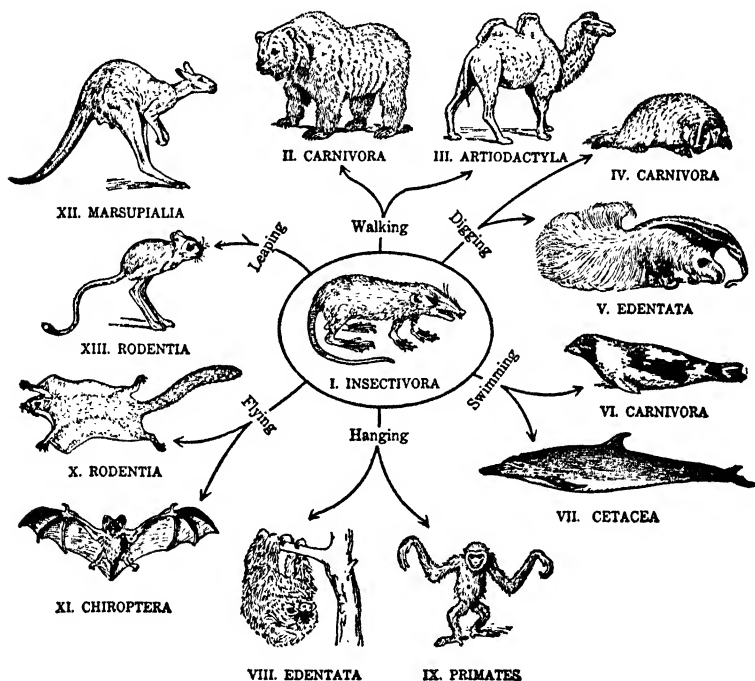

FIG. 202. — Diagram of parallelism in evolution and adaptive radiation in Mammals. I, *Gymnura*; II, Bear; III, Camel; IV, Badger; V, Anteater; VI, Seal; VII, Dolphin; VIII, Sloth; IX, Gibbon; X, "Flying" Squirrel; XI, Bat; XII, Kangaroo; XIII, Jerboa. (From Hegner, after Newman and others.)

Radiating from this focus, adaptations for rapid running (CURSORIAL adaptations) are chiefly evident in a lengthening of the limbs. Thus, for example, in the Dogs, Foxes, and Wolves, the effective limb length is increased by raising the wrist and heel from the ground and walking merely upon the digits (DIGITIGRADE); while in Antelopes, Horses; and hoofed runners in general, the

chief limb bones themselves are lengthened, subsidiary ones are suppressed, and the wrist and ankle are raised still further from the ground, so that merely the tips of one or two digits of each

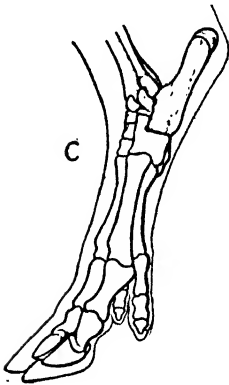
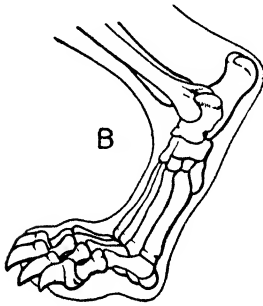
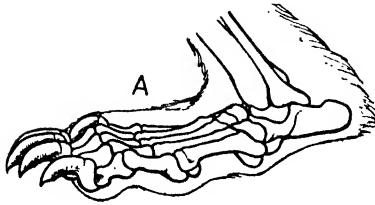

FIG. 203. — Foot postures of Mammals. A, plantigrade; B, digitigrade; C, unguligrade. (From Lull, after Pander and D'Alton.)

limb support the animal (UNGULIGRADE). Thus the typical cursorial forms represent the culmination of Mammalian adaptation to plains and steppes; regions in which long distances must frequently be traversed in quest of food, and safety is to the swift. (Fig. 203.)

Another line of adaptive radiation is presented by the tree dwellers: ARBOREAL forms which make their own the world of foliage high above the ground. Such are, for instance, the Sloths which are really tree climbers that walk and sleep upside down suspended from branches; the tailless Apes that swing among the boughs chiefly by their arms; and the Squirrels that scamper along the branches. Some Squirrels and the so-called Flying Lemurs take long soaring leaps supported by wide folds of skin between the sides of the body and the extended limbs. But the Mammals have not left the air untenanted, for truly VOLANT forms are represented by the Bats in which the fore limbs with greatly elongated fingers form the framework of true wings. (Figs. 204, 207.)

Passing below the surface of the earth, FOSSORIAL Mammals are found such as the Woodchucks,

Gophers, and especially the Moles, which are adapted to a subterranean existence by bodily modifications which facilitate digging.

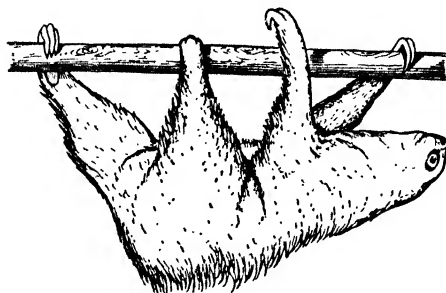

FIG. 204. — A Sloth, *Choloepus*, walking suspended from a branch. (From Allen.)

Furthermore, the gap between terrestrial and aquatic Mammals is bridged by the Muskrats, Beavers, Otters, and Seals which are more or less equally at home on land and in the water. (Fig. 205.)

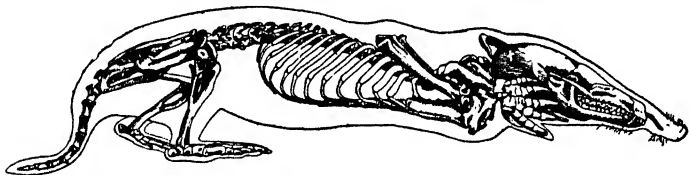

FIG. 205. — Skeleton of a Mole, *Talpa europaea*. (From Pander and D'Alton.)

The truly AQUATIC Mammals, such as the Porpoises and Whales, have completely abandoned the land of their ancestors of the geological past and to-day approach, in adaptations to a marine

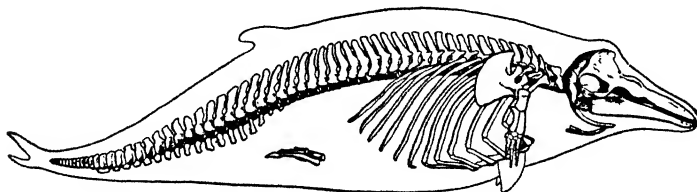

FIG. 206. — Skeleton of a Porpoise. The vestigial pelvic bones are shown imbedded in the flesh. (From Pander and D'Alton.)

life, the general contour of the primitively adapted aquatic Vertebrates, the Fishes. (Fig. 90, 91, 206.)

Thus the various lines of adaptive radiation of the Mammals from a generalized terrestrial type, such as *Gymnura*, have provided



Mammals fitted for all sorts and conditions of the environment — representatives are competing with members of other groups beneath, on, and above the earth and in the water. Somewhat sim-

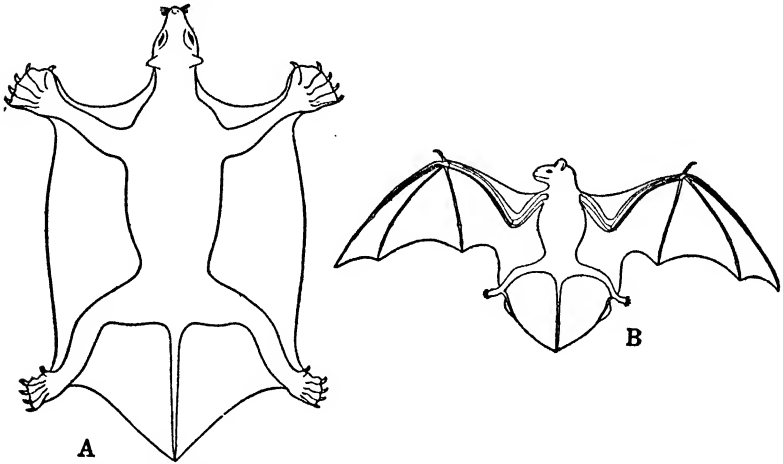

FIG. 207. — A, 'Flying Lemur,' *Galeopithecus volans*; B, Bat, *Vespertilio noctula*. (From Lull.)

ilar adaptive radiations are traceable in other animal groups, especially the Insects, though there seems no doubt that the adaptability of the Mammalian stock — its potential of evolution — is in

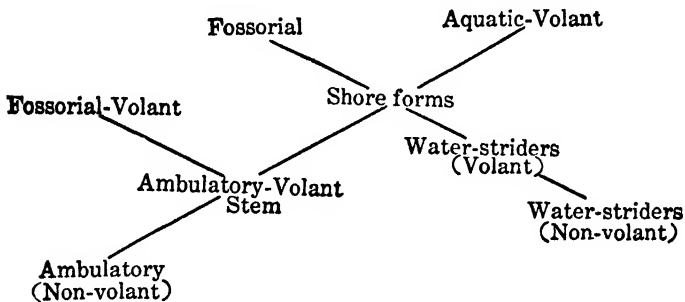

FIG. 208. — Diagram of the adaptive radiation of a group of Insects, the Hemiptera, or Bugs. (From Lindsey.)

no small degree responsible for the dominant position which the Mammals hold in the animal world of to-day. Man is a Mammal. (Figs. 85, 208.)

**ANIMAL COLORATION.** Perhaps the most generally striking characteristic of organisms is their color and color pattern. Among

plants this applies chiefly to the flowers and fruit of the higher forms, though here and there throughout the plant series the typical green color is replaced or rendered inconspicuous by others. But the absence of photosynthetic pigments in animals and their relatively active life have permitted more latitude in body color, and accordingly it is in the animal world that color adaptations are more numerous and varied. Some colors and color patterns are, of course, merely incidental to the chemical composition of the whole or parts of the body. Others, however, irresistibly arouse our interest and seem to demand a less simple explanation because they are apparently of special service to their possessors. A few examples will serve to bring the problem before us and indicate the class of facts involved.

The color and color patterns of many animals are such that they harmonize or fuse with the usual surroundings of the crea-

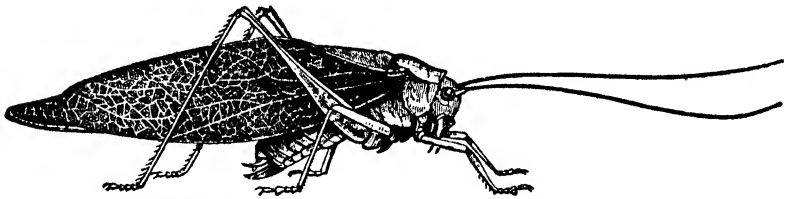

FIG. 209. — The common green Katydid, *Microcentrum*. (From Riley.)

tures and render them practically indistinguishable from their immediate environment. Every frequenter of the open knows innumerable instances. The song of the green Katydid readily guides one to its immediate vicinity, but it is quite another matter to distinguish its leaf-green wings among the foliage of its retreat. Again, one is attracted by the striking colors of an Underwing Moth while in flight, but is at a loss to find the insect when scarlet or orange is obscured by the overlapping, grayish-mottled fore-wings blending with the tree trunk where it has come to rest. (Figs. 209, 210.)

The white of the Foxes, Hares, and Owls of alpine and arctic regions; the green color of foliage-dwelling Toads and Frogs; the tendency toward fawn and gray of desert Insects, Reptiles, Birds, and Mammals; the olive upper surface of the bodies of brook Fishes; the steel gray above and white below of sea Birds that harmonize with sea and sky when viewed from above and below respectively — the number of such cases is legion. Gazelles living

on the lava fields of volcanic regions are dark gray, while those of the great stretches of sand plains are white — the same species exhibiting regional variations in color which blend with the surroundings. Furthermore, the same individual may vary in color with the seasonal changes in its environment, or present different color schemes in different localities. Thus the summer coat colors

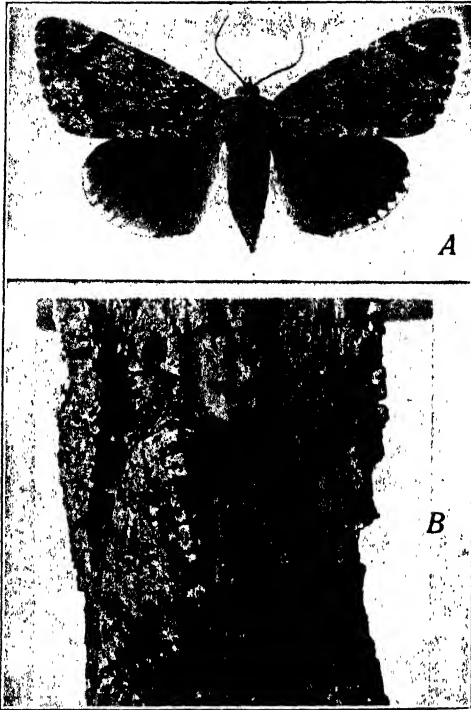

FIG. 210. — Underwing Moth. A, wings expanded, exposing the highly colored hind wings; B, resting on bark. (From Folsom.)

of the Arctic Fox and the Weasel harmonize with the browns of rocks; and the winter coat of white, with snow-clad nature. And the Chameleons are by no means unique in their ability to change their color very rapidly so that self-effacement often results. (Fig. 81.)

But confusion is worse confounded when to harmonizing color is added harmonizing form, striking examples of which are the Leaf Butterflies of the East Indian region, the familiar Walking-

sticks, and the caterpillars ('inch-worms') of Geometrid Moths. (Figs. 211, 212.)

Although the general tendency in nature is for *sympathetic* coloration — indeed, it is frequently possible to infer from the color of an animal its habitat — there are numerous cases in which the colors and color schemes seem to be in striking contrast with the animal's usual background. Sometimes, however, the contrast which is so striking with the bird in the hand, proves to be

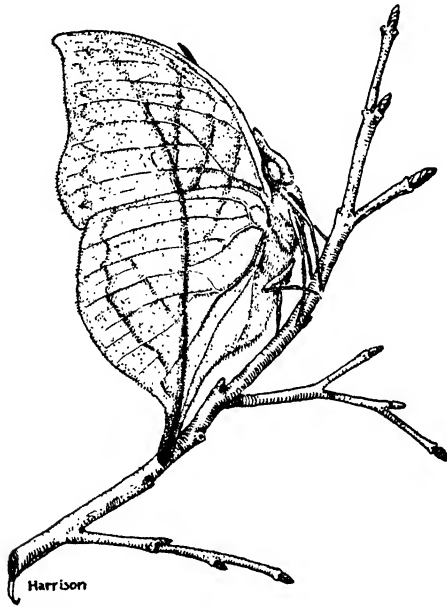

FIG. 211. — Leaf Butterfly, *Kallima*.

*obliterative* with the bird in the bush — a conspicuous color pattern, expressing gradations of light and shadow, and counter shading, fuses with a background of light and shadow afforded by foliage.

But examples of color patterns which by the most liberal stretch of the imagination cannot be interpreted as harmonious with the animal's usual surroundings are not far to seek. Brilliant yellows and reds render, for instance, many Wasps, Bees, Butterflies, and various species of Snakes actually conspicuous. And it is suggestive that very many of these forms are provided with special means of

defense, such as poison glands and formidable jaws, or special secretions which render them unpalatable. Moreover, what is still more interesting, many animals possessing this *protective conspicuousness*, which renders them easily identified and adver-

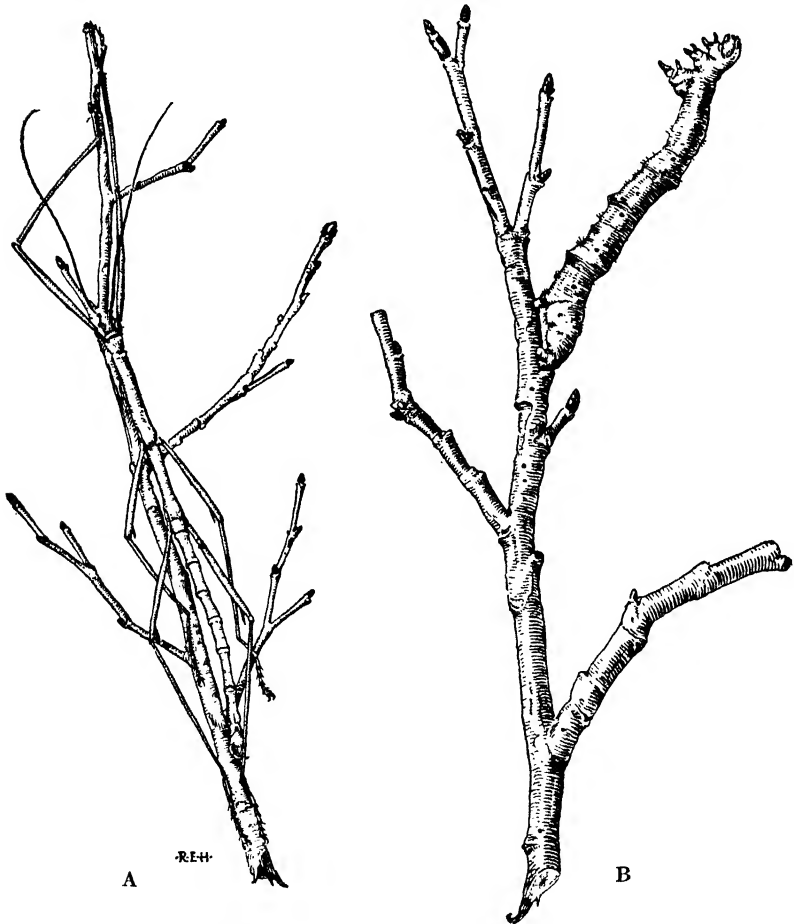

FIG. 212. — A, Walking-stick Insect on a twig; B, larva of a Geometrid Moth resting extended from a twig. (Modified, after Jordan and Kellogg.)

tises that they are to be avoided by their foes, are frequently '*mimicked*' in color pattern and form by defenseless creatures. Thus commonly associating with the various species of Bees hovering about flowers are defenseless Flies which are so bee-like in appearance that they are usually mistaken for Bees, and avoided

accordingly by human, and presumably by other enemies also. (Figs. 213, 218.)

Now, what is the significance of such phenomena of animal coloration and form? This problem has attracted much attention and appears by no means so simple to-day as it did a generation

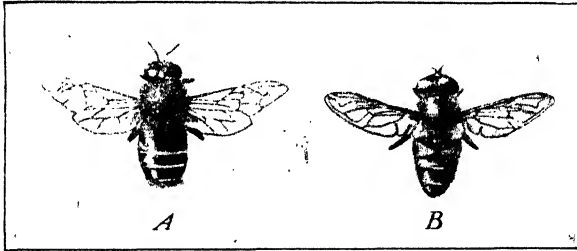

FIG. 213. — 'Protective mimicry.' A, drone Honey Bee; B, a Bee-fly, *Eristalis tenax*. (From Folsom.)

ago. Biologists to-day are not so ready to interpret individual cases as 'protective,' 'aggressive,' 'alluring,' 'confusing,' or 'mimetic.' But nowhere else is the plasticity — adaptability — of organisms better illustrated, and, taken by and large, many such adaptations are of crucial importance in the life and strife of species. Apparently the origin of such adaptive variations must be sought in mutations — the unadaptive mutations being eliminated in the struggle for existence.

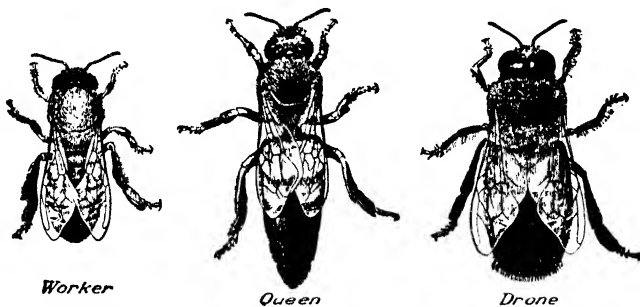

FIG. 214. — The Honey Bee, *Apis mellifica*. (From Bureau of Entomology.)

**THE LEGS OF THE HONEY BEE.** From time immemorial the Honey Bee (*Apis mellifica*) has been the subject of wonder and study, and to-day there is no more interesting and instructive example of adaptation than that exhibited by the Bee in relation to the highly specialized community life of the hive. (Fig. 214.)

An average hive comprises some 65,000 Bees of which one is a QUEEN, several hundred are DRONES, and the rest WORKERS. The queen is the only fertile female and accordingly she is the mother of nearly all the other members of the hive. Throughout her life of a few years she is tended and fed by her numerous offspring. The drones, or males, contribute nothing to the work of the hive but, after the old queen departs at the *swarming*, one of them during the nuptial flight mates with a virgin queen which then is the queen of the hive. Thus queen and drones represent

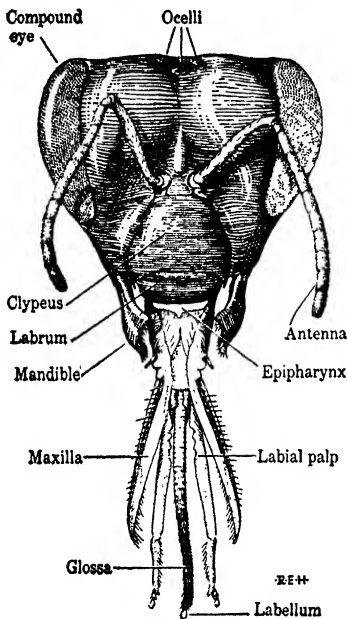

FIG. 215. — Head of a worker Honey Bee.

an adaptation of the colony to communal life — a physiological division of labor in the hive which involves a specialization of a class solely for reproduction, while the daily work and strife of the colony devolves upon the workers. The latter are sexually undeveloped females which do not lay eggs but spend their time carrying water, collecting nectar and pollen, secreting wax, building the comb, preparing food, tending the young, and cleaning, airing, and defending the hive.

The worker is a 'bundle of adaptations' for its varied duties. The primitive insect appendages have become specialized in the worker Bee, so that collectively they constitute a battery of tools adapted with great nicety to the

uses for which they are employed. This applies to all of the appendages of the insect's body, but we shall neglect those of the head and consider only the specializations of the three pairs of legs. These, as in all Insects, arise from the THORAX; the anterior pair from the first segment of the thorax (prothorax); the second, or middle, pair from the second thoracic segment (mesothorax); and the posterior pair from the third, or last, thoracic segment (metathorax). A typical insect leg consists of several parts: the COXA, which forms the junction with the body, followed in order

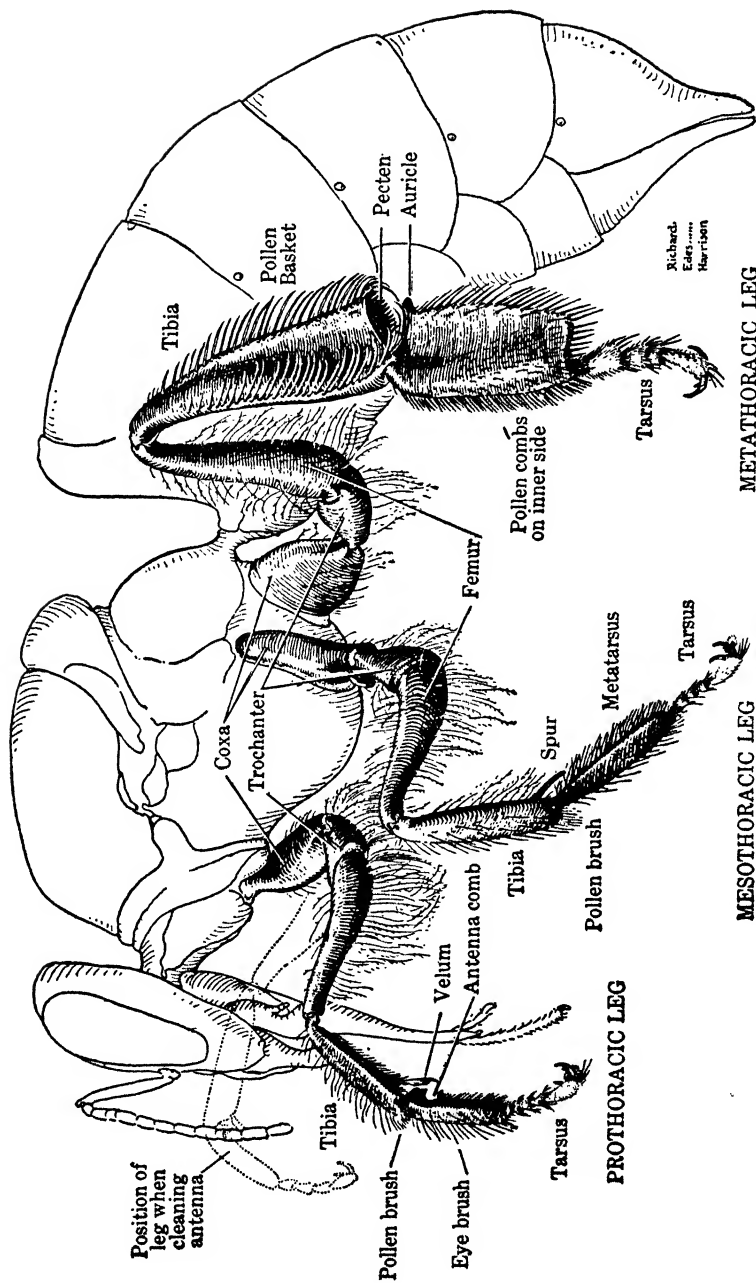

FIG. 216. — Legs of the worker Honey Bee.



by the TROCHANTER, FEMUR, TIBIA, and five-jointed TARSUS, or foot. (Figs. 215, 216.)

The worker Bee's PROTHORACIC LEGS show the following specializations. The femur and tibia are covered with long, branched FEATHERY HAIRS which aid in gathering pollen when the Bee visits flowers: the tibia, near its junction with the tarsus, bears a group of stiff bristles (POLLEN BRUSH) which is used to brush together the pollen grains that have been dislodged by the hairs of

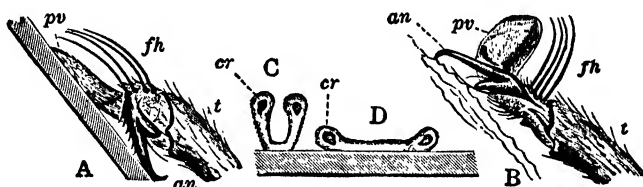

FIG. 217. — Foot of the Honey Bee in the act of climbing, showing the 'automatic' action of the pulvillus. A, position of foot on a slippery surface; B, position of foot in climbing on a rough surface; C, section of a pulvillus just touching a flat surface; D, the same applied to the surface. *an*, claw; *cr*, curved rod; *fh*, tactile hairs; *pv*, pulvillus; *t*, last segment of tarsus. (From Packard, after Cheshire.)

the upper leg-segments. On the opposite side of the leg is a composite structure, the ANTENNA CLEANER, formed by a movable plate-like process (VELUM) of the tibia which fits over a circular notch in the upper end of the tarsus. The notch is provided with a series of bristles which form the teeth of the ANTENNA COMB. The antennae, or 'feelers,' which are important sense organs of the head, are cleaned by being placed in the toothed notch and, after the velum is closed down, drawn between the bristles and the edge of the velum. On the anterior face of the first segment of the tarsus is a series of bristles (EYE BRUSH) which is used to remove pollen and other particles adhering to the hairs on the head about the large compound eyes and interfering with their operation.

The terminal segment of the tarsus of each leg is provided with a pair of notched CLAWS, a sticky pad (PULVILLUS), and a group of TACTILE HAIRS. When the Bee is walking up a rough surface, the points of the claws catch and the pulvillus does not touch, but when the surface is smooth, so that the claws do not grip, they are drawn beneath the foot. This change of position applies the pulvillus, and it clings to the smooth surface. Thus the charac-

ter of the surface automatically determines whether claw or pulvillus shall be used. But there is another adaptation equally remarkable. "The pulvillus is carried folded in the middle, but opens out when applied to a surface; for it has at its upper part an elastic and curved rod, which straightens as the pulvillus is pressed down. The flattened-out pulvillus thus holds strongly while pulled along the surface by the weight of the Bee, but comes up at once if lifted and rolled off from its opposite sides, just as we should pull a wet postage stamp from an envelope. The Bee, then, is held securely till it attempts to lift the leg, when it is freed at once; and, by this exquisite yet simple plan, it can fix and release each foot at least twenty times per second." (Fig. 217.)

The characteristic structures of the middle (MESOTHORACIC) legs of the Bee are a small POLLEN BRUSH and a long spine, or POLLEN SPUR.

The METATHORACIC LEGS exhibit four remarkable adaptations to the needs of the insect, known as the POLLEN COMBS, PECTEN, AURICLE, and POLLEN BASKET.

The pollen combs comprise a series of rows of bristle-like hairs on the inner surface of the first segment of the tarsus: the pecten is a series of spines on the distal end of the tibia which is opposed by a concavity, the auricle, on the proximal end of the tarsal segment; while the pollen basket is formed by a depression on the outer surface of the tibia which is arched over by rows of long curved bristles arising from its edges.

Thus the worker is fully equipped. Flying from flower to flower, the Bee brushes against the anthers laden with pollen, some of which adheres to the hairs on its body and legs. While still in

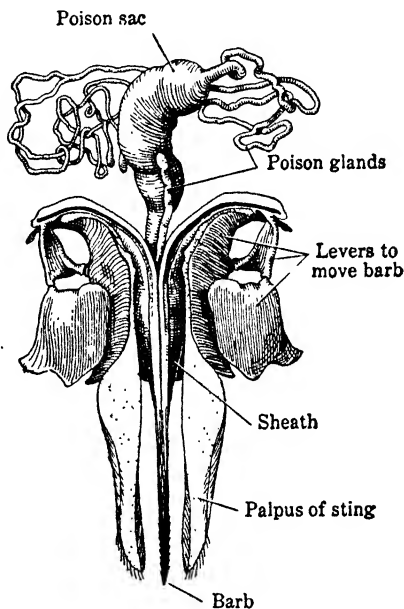

FIG. 218. — Sting of a worker Honey Bee.

the field, the pollen combs are first brought into play to comb the pollen from the hairs, while the pectens scrape the pollen from the combs. Then the auricles are manipulated so that the accumulating mass of pollen is pushed up into the bristle-covered pollen baskets. This process is repeated until the baskets are full and then the insect returns to the hive, where the contents of the

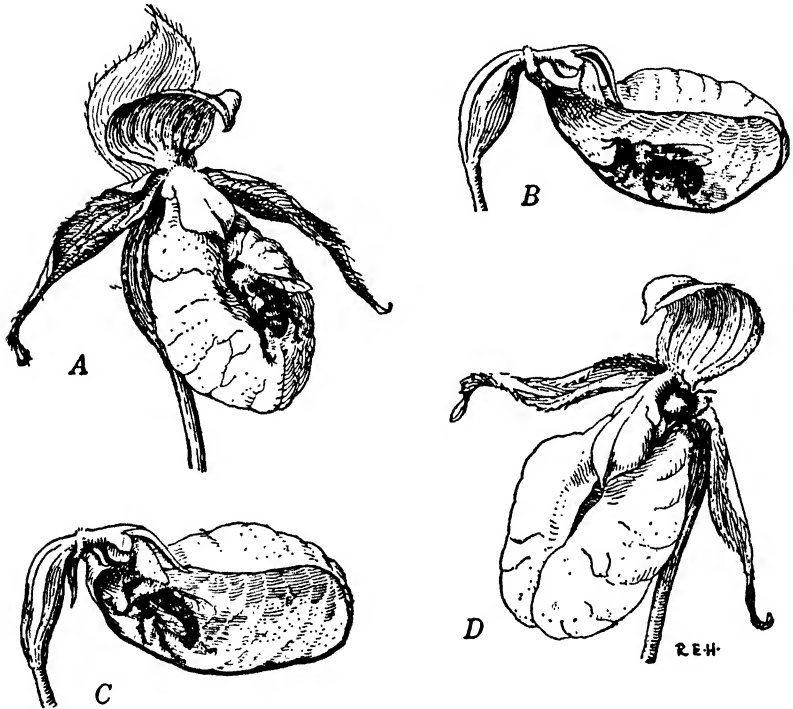

FIG. 219. — Pollination of an Orchid, *Cypripedium*, by a Bumble Bee. A, Bee forcing its way into the flower; B, Bee obtaining nectar in the flower; C, Bee starting to escape brushes pollen upon the stigma of the flower; D, before finally escaping the Bee receives another load of pollen from the anther.

pollen baskets are removed by the aid of the spurs with which the mesothoracic legs are provided. (Figs. 218, 219.)

Moreover, the structural adaptations of the worker Bee are but one aspect of a reciprocal fitness. Many of the flowers which the Bee visits show remarkable adaptations for the reception of the Bee and for dusting it with pollen, because Bees are effective agents in transferring pollen from flower to flower and thus insur-

ing cross-fertilization. And so the Bee which has been given as our final example of adaptation to the physical environment, serves also as an introduction to the consideration of adaptation to the living environment. No better proof could be asked of the futility of attempting to classify the adaptations of organisms—the organism is a unit: a complex of adaptations to any and all of its surroundings, inanimate and animate, otherwise it could not exist.

## B. ADAPTATIONS TO THE LIVING ENVIRONMENT

We now turn more specifically to some striking interrelations of organism with organism, in order to make possible an appreciation of the devious means to which they have recourse—to what

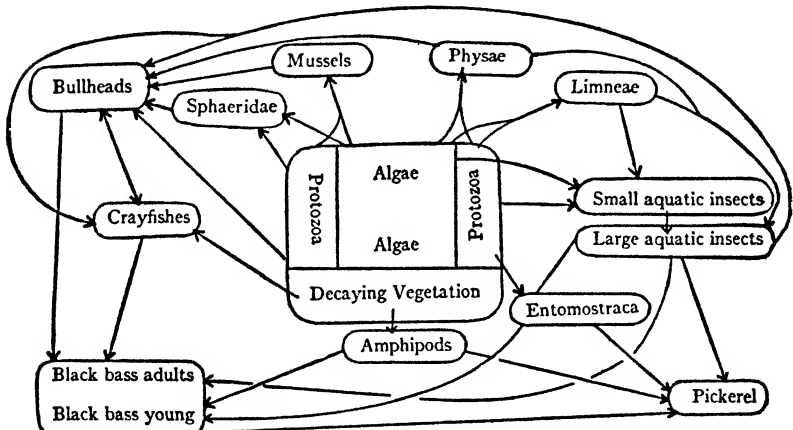

FIG. 220. — Diagram of the web of life and the equilibrium of nature, as illustrated by the food relations in a pond community. Arrows point from the organisms eaten to those doing the eating. The task of ecology is to decipher the patterns of the web of life. (From Shelford.)

extent the strands of the web of life become entangled—in the competition for a livelihood.

The mutual biological interdependence of organisms is, in the final analysis, the result of the primary demands of all creatures—proper food, habitat, reproduction, defense against enemies and the forces of nature. The web of life is an expression of the coöperation, jostling, and strife of individual with individual, and species with species for these primary needs; and the activities which follow from them form the foundations of life in the lowest as well

as the highest. A little patch of meadow soil two feet square has revealed, within about an inch from the surface, over a thousand animals and three thousand plants. There is a *struggle for existence*.

Take a single example. A common food Fish, the Squeteague, captures the Butter-fish or the Squid, which in turn have fed on young Fish, which in their turn have fed on small Crustacea, which themselves have utilized microscopic Algae and Protozoa as food. Thus the food of the Squeteague is actually a complex of all these factors, and such a *nutritional chain* is no stronger than its single links. Circumstances which modify or suppress the food and thereby reduce the abundance of the Algae and Protozoa of the sea are reflected in correlative changes in the abundance of economically important food Fishes. And this same principle is true throughout living nature, though only occasionally is it possible to trace it. "Nature is a vast assemblage of linkages." (Figs. 220, 266.)

### 1. *Communal Associations*

Perhaps the simplest associations of organisms are represented by GREGARIOUS animals, such as Wolves which hunt in packs, and Buffaloes and Horses which herd for protection. Here the association is more or less temporary and there is no division of labor between the members, other than leadership by one animal.

COMMUNAL animals, however, exhibit highly complex associations in which the members merge, as it were, their individuality in that of the community. This is well exhibited, for example, among the Ants, in which all of the various species, about 5,000 in number, are communal, and the Wasps and Bees in which all gradations exist from solitary to hive-dwelling species. In the case of the Bees, and still more in the Ants, the division of labor has developed to the extent that structural differentiations have given rise to classes of individuals specially adapted for the performance of certain functions in the economy of the hive.

But the differentiations of various members of a colony of Ants or Bees are limited to their bodies and are practically fixed and irreversible, while in human society, differentiations are no longer confined to the bodies of individuals. Man's ingenuity has devised what are to all intents and purposes artificial, accessory organs — tools and machines. Accordingly it is in Man that we find the highest expression of communal coöperation, because in-

creased intelligence, in particular, makes flexible the stereotyped life as exhibited in the lower forms — the human individual is adaptable to the various community tasks.

## 2. Symbiosis

Associations are not confined to members of the same species, nor are all an expression of coöperative adaptations. All gradations occur from those which are mutually beneficial to the parties in the pact, to those in which one member secures all the advantage at the expense of the other.

The most intimate associations in which the organisms involved are mutually benefited, if not absolutely necessary for each other's

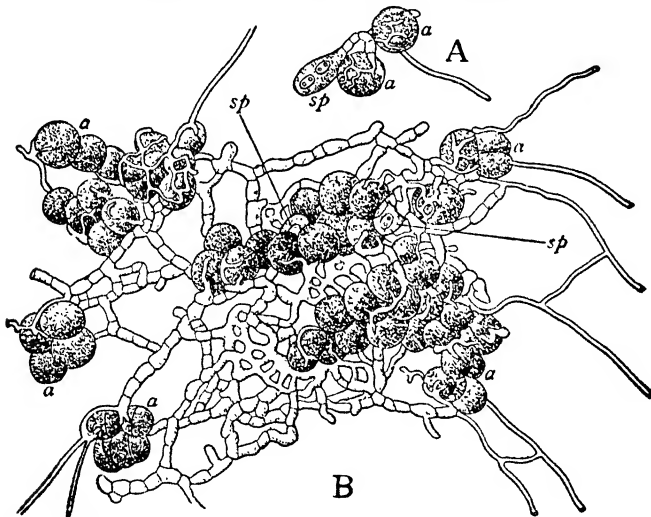

FIG. 221. — The formation of a Lichen, *Physcia parvina*, by the combination of an Alga and a Fungus. A, germination of a Fungus spore (*sp*), whose filaments are surrounding two cells (*a*) of the unicellular Alga, *Cystococcus humicola*. B, later stage in which spores have formed a web of filaments (mycelium), enveloping many algal cells. Magnified about 400 times. (From Bonnier.)

existence, are termed SYMBIOTIC. A familiar case is the common green Hydra (*Chlorohydra viridissima*) that owes its color to the presence of a large number of unicellular green plants which live in its endoderm cells. The products of the photosynthetic activity of the plant cells are at the disposal of the Hydra, and the latter in return affords a favorable abode and the material necessary for the life of the plants.

A far more striking example of symbiosis is afforded by Lichens which represent intimate combinations of various species of colorless plants (Fungi) and simple green plants (Algae). In each case the Fungus supplies attachment, protection, and the raw materials of food, while the Alga performs photosynthesis. Each can live independently under favorable conditions, but in partnership they are superior to hardships with which many other plants cannot cope, and thus some Lichens become the vanguard of vegetation in repopulating rocky, devastated areas. (Fig. 221.)

From the practical standpoint of agriculture the symbiotic nitrogen-fixing Bacteria are of first importance. It will be recalled



FIG. 222. — Rose Aphids visited by Ants.

that these Bacteria form small nodules on the rootlets of higher plants, such as Beans and Clover, and make atmospheric nitrogen available to the latter — return it to the cycle of the elements in living nature. (Fig. 16.)

Still another type of association in which both partners profit is

represented by the relation that occurs between Ants and Plant Lice, or Aphids. The defenseless Aphids are protected, herded, and 'milked' by the Ants to supply their demand for honeydew, a secretion of the Aphids which the Ants greedily devour. (Fig. 222.)

### 3. *Parasitism*

But associations in which one organism, the PARASITE, secures the sole advantage, and in most cases at the expense of the helpless second party, the HOST, are far more numerous — it has been estimated that nearly half the animal kingdom are parasites. And these justly receive considerable notoriety because many human diseases are the result of Man's unwilling partnership in such associations. Indeed, PARASITOLOGY has become an important subdivision of biology, both practical and theoretical. Practical, as a cornerstone of public health; and theoretical, because many of the most remarkable functional and structural adaptations are exhibited by parasites in becoming fitted for this apparently highly successful method of gaining a livelihood, and by the hosts in bearing the burden with the least outlay. Generally speaking, the effect on the parasite consists in a simplification of the various organs of the body devoted to food-getting, locomotion, etc., since their duties are performed by the host; while the organs and methods of reproduction are highly specialized and elaborated, owing to the necessity of producing enough offspring to compensate for the hazards involved in reaching a proper host. For in the majority of cases a parasite is adapted to live in a specific host, and death ensues if this is not attained at the proper time. (Figs. 25, 251, 252, 266.)

Probably the most generally interesting example of parasitism is the cause of the disease known as MALARIA. Man is subject to at least three types of malaria, each the result of infection by a different malarial organism. The malarial parasites are all unicellular animals, Protozoa, with complicated life histories which are adaptations to the specific demands of their parasitic existence. One part of the life history, the asexual, is passed in the red blood corpuscles of Man; while the other, the sexual, occurs in the digestive tract of certain species of Mosquitoes. A single parasite inoculated into the human vascular system by the bite of an infected Mosquito enters a red blood corpuscle and multiplies. The progeny, liberated from the destroyed corpuscle, sim-



ilarly attack other corpuscles and multiply until a very large number of blood corpuscles are destroyed. And poisonous products of the life processes of the parasites provoke the chills and fevers characteristic of the disease. (Fig. 223.)

But the parasites must make their escape before the human host successfully combats the toxic substances, kills the parasites

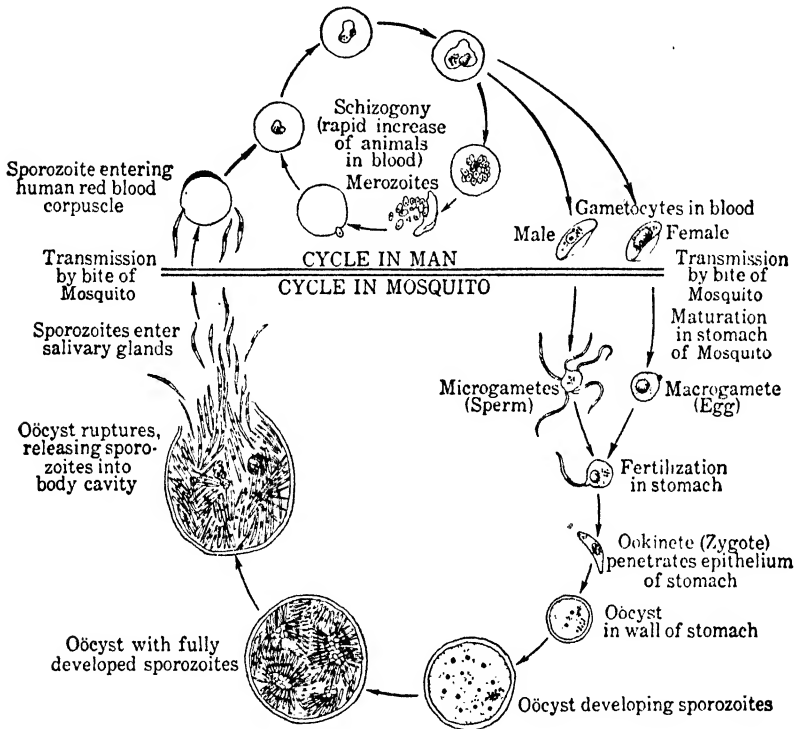

FIG. 223. — Life history of a Malarial Parasite, *Plasmodium malariae*.

by taking quinine, or succumbs to them. The getaway is accomplished, if at all, by a Mosquito biting the host and taking with the blood certain sexual stages of the parasite which can develop in the cold-blooded insect. And now the Mosquito is the host. In its stomach the sexual phase of the life history of the malarial parasite takes place, fertilization occurs, and finally the numerous products of the zygote work their way to the mouth parts of the Mosquito, where they await an opportunity to enter the human blood.

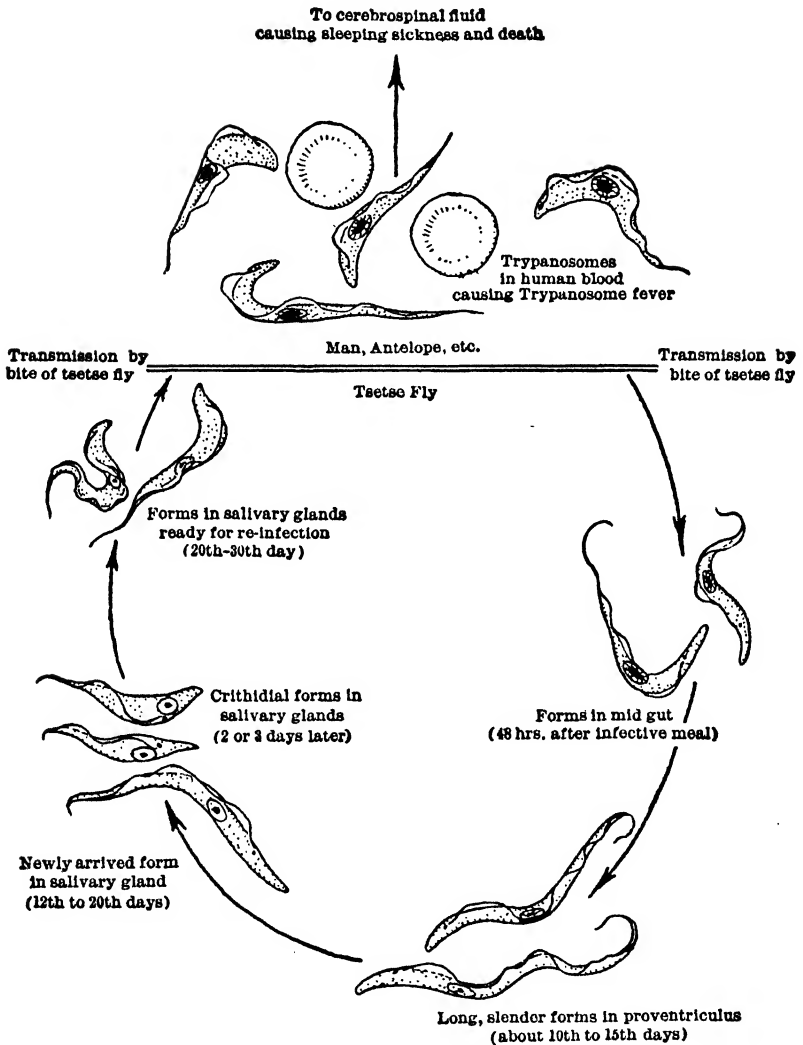

FIG. 224. — Life history of the Trypanosome, *Trypanosoma gambiense*, that produces African Sleeping Sickness in Man. Magnified about 1500 times. (Modified, after Chandler.)

The life history of malarial parasites exhibits a continuous series of adaptations to parasitic life: the nicety of the adjustment being especially well illustrated at the transfer from Man to Mosquito, since all the parasites which enter the stomach of the latter are digested except those sexual forms which are ready to initiate the sexual part of the cycle in the new host. (Figs. 246, 247.)

But the acme of parasitic associations is only attained when the adaptations of parasite and host have become so complete that the latter 'pays the price' without any ill effects. Thus the Antelopes and similar Mammals of certain regions of Africa harbor in their blood various species of Protozoan parasites, known as **TRYPANOSOMES**, without any apparent discomfort. But if the intermediate hosts, which are biting Flies, transfer certain species of Trypanosomes to the blood of imported Horses or Cattle, or of Man, serious diseases result which are usually fatal. Indeed, the opening up of large regions of Africa has been greatly retarded by the ravages of Trypanosomes in new hosts to which they are not adapted. Generally speaking, pathogenic species may be regarded as aberrant forms which are not yet adapted to their hosts or are not in their normal hosts. And these are the parasites which are especially forced upon our attention, though there are few organisms without their specially adapted parasites — the parasites themselves not excepted. (Figs. 224, 245.)

#### 4. *Immunity*

At best, however, the part played by the host cannot be regarded as ideal, and devious types of adaptations against parasites exist which, in so far as they are effective, bring about **IMMUNITY**. Usually among the higher animals, including Man, immunity to the ravages of pathogenic microorganisms seems to depend chiefly upon the activities of the white blood cells and upon specific chemical substances in the blood, termed **ANTIBODIES**.

The white blood cells have been called the policemen of the body because, under the influence of invading organisms, some of them make their way through the walls of the capillaries in the region of the infection and, in amoeboid fashion, engulf and digest the intruders. When acting in this capacity they are referred to as **PHAGOCYTES**. Similar phagocytic cells are found in groups, **PEYER'S PATCHES**, scattered in the intestinal wall. Apparently they are to forestall invasion of the tissues by Bacteria that swarm there.

Among the various classes of antibodies are the ANTITOXINS that neutralize the poisonous products (toxins) of certain Bacteria; the PRECIPITINS that act upon foreign proteins of bacterial or other origin; the LYSINS that actually destroy foreign cells; and the OPSONINS that render Bacteria vulnerable to the attacks of the phagocytes.

Various specific antibodies may be naturally present in the blood — a part of the heritage — so that an individual is immune to certain diseases due to pathogenic organisms. Or the antibodies may be produced in response to the parasites themselves, and the individual acquires immunity only after undergoing the disease. Again, immunity may be artificially acquired by various means, such as VACCINATION, which stimulate the production of antibodies so that the individual is prepared in the event of an infection.

Indeed, the subject of immunity has become a science in itself (IMMUNOLOGY) within the past few years — a science which has as its fundamental basis the investigation of the marvelous power of adaptation of protoplasm as exemplified in coping with disease-producing parasites, and even with those ultramicroscopic agents of disease, the so-called FILTERABLE VIRUSES, such as produce smallpox, measles, rabies, etc. The viruses are so small that they pass through porcelain filters and, in one case at least, consist of a single protein molecule. But they have the power to multiply when in the protoplasm of host cells and so exhibit one fundamental characteristic of life. The viruses appear to be on the border line between the lifeless and the living but to include them with the latter would necessitate an extension of our present conception of life. Their further study is certain to be of immense practical and theoretical importance.

### C. INDIVIDUAL ADAPTABILITY

We may now turn to a survey of the highest expression of adaptation evolved by Nature, which appears as TROPISMS and other elements of BEHAVIOR in the lower organisms, gains definiteness and content as we ascend the animal series, and becomes the basis of INTELLIGENCE and all that the mental life of Man involves. It is the adaptation which renders Man essentially superior to adaptation — enables him to a large extent to control, instead of being controlled by his environment. "It seems that Nature, after elab-

orating mechanisms to meet particular vicissitudes, has lumped all other vicissitudes into one and made a means of meeting them all" — the nervous mechanism.

That organisms respond to environmental changes, we are well aware. Life itself is the result of — in fact, is — a continuous flow of physico-chemical actions, interactions, and reactions with the surroundings. But by the behavior of the organism we refer specifically to the reactions of the organism as a unit, rather than to the internal processes in the economy of its life. And surveyed from a broad viewpoint, there is discernible in the behavior of animals, just as in their structure in general and in their nervous system in particular, from the lowest to the highest, a great though gradual increase in complexity. The behavior of Amoeba

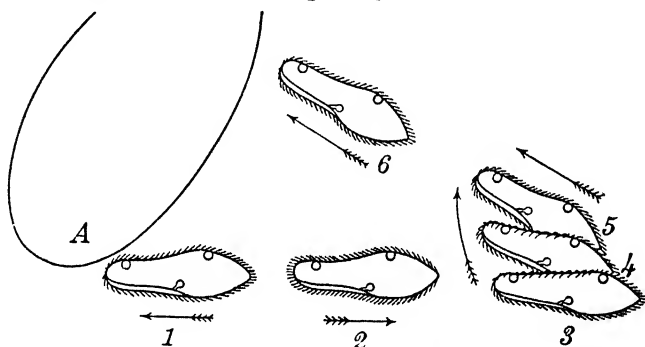

FIG. 225. — Diagram to illustrate the avoiding reaction of Paramecium. A, a solid object or other source of stimulation. 1-6, successive positions taken by the animal. The rotation on its long axis is not indicated. (From Jennings.)

or Paramecium is an expression of the primary attributes of protoplasm — irritability, conductivity, and contractility. So is the behavior of Hydra and Earthworm in which special cells constitute a definite coördinating, or nervous system. And so is the complex behavior of the higher animals, including Man, with their elaborate series of sense organs and highly developed sensorium, or brain.

“Let us now try to form a picture of the behavior of Paramecium in its daily life under natural conditions. An individual is swimming freely in a pool, parallel with the surface and some distance below it. No other stimulus acting, it begins to respond to the changes in distribution of its internal contents due to the fact that it is not in line with gravity. It tries various new positions until its anterior end is directed upward, and continues in that

direction. It thus reaches the surface film. To this it responds by the avoiding reaction (Fig. 225), finding a new position and swimming along near the surface of the water. . . . Swimming forward here, it approaches a region where the sun has been shining strongly into the pool, heating the water. The Paramecium receives some of this heated water in the current passing from the anterior end down the oral groove. (Fig. 226.) Thereupon it pauses, swings its anterior end about in a circle, and finding that the water coming from one of the directions thus tried is not heated, it proceeds forward in that direction. This course leads it perhaps into the region of a fresh plant stem which has lately been crushed and has fallen into the water. The plant juice, oozing out, alters markedly the chemical constitution of the water. The Paramecium soon receives some of this altered water in its ciliary current. Again it pauses, or if the chemical is strong, swims backward a distance. Then it again swings the anterior end around in a circle till it finds a direction from which it receives no more of this chemical; in this direction it swims forward. . . .

"In this way the daily life of the animal continues. It constantly feels its way about, trying in a systematic way all sorts of conditions, and retiring from those that are harmful. Its behavior is in principle much like that of a blind and deaf person, or one that feels his way about in the dark. It is a continual process of proving all things and holding to that which is good." (Jennings.)

The behavior of Paramecium leaves one with the impression that the animal is largely at the mercy of its surroundings —

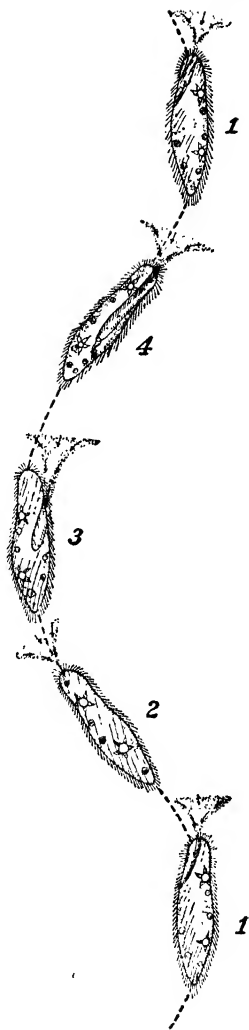

FIG. 226. — Diagram to show the rotation on the long axis, and the spiral path of Paramecium. 1-4, successive positions assumed. The dotted areas with small arrows represent the currents of water drawn from in front. (From Jennings.)

that the environment rather than the organism itself is the dominant factor, and this is true to a considerable degree. But *Paramecium* is not merely an automaton. Its behavior is modifiable and, in the long run, is adapted to the usual changes of its surroundings. It forms immense aggregations where food and other conditions are favorable. That the reactions are adequate for the simple life and methods of reproduction of *Paramecium* is attested by its success — it is one of the most common and widely distributed animals. (Fig. 27.)

In such simple beginnings, then, must be sought the largely automatic responses of animals to the changes in external conditions, known as REFLEXES and INSTINCTS. Both apparently are chiefly the result of inherited nervous structure and therefore may be regarded as inherited behavior. And increase in the complexity of life processes has involved at the same time an increase in the number and complexity of reflexes and instincts. The primitive reflexes and instincts of *Hydra* lead it to seize small organisms within reach of its tentacles and pass them to its mouth; the Earthworm, to swallow decaying leaves as it burrows through the soil; the Crayfish, to grasp its prey with its large claws, tear it into pieces by means of certain appendages about the mouth which are adapted just for the purpose — and so on to the higher Vertebrates where the feeding instincts reach their maximum of complexity. The remarkable behavior of Ants and Bees is essentially a complex of instincts. Moreover, instincts of fear, self-defense, play, care of the young, etc., render a considerable part of the behavior of even the higher organisms more automatic than is perhaps, at first thought, apparent. (Figs. 139, 143.)

But just as the behavior of *Paramecium* and its allies is modifiable, so reflexes and instincts which seem the most fixed show at least a slight degree of adaptability to unusual conditions. Indeed new reflexes, known as **CONDITIONED** reflexes, may be established as the result of experience during the life of the individual. And it is this ever-present power of modifiability, which is in man called 'choice,' that leavens the whole and becomes the dominant factor in the behavior of the highest animals; while reflex action and instinct are relegated to a subsidiary though by no means unimportant rôle. A large part of human education consists in establishing other fixed adaptive responses called **HABITS** which join the earlier reflexes and instincts in relieving the conscious life of innumerable

simple factors of behavior, and leave it more or less free for the higher intellectual processes. The cerebrum, regarded as the organ of the MIND, is superimposed upon the system of automatic, machine-like responses of the reflex centers. It is the executive that reacts to the state of affairs as a whole and coördinates or alters responses when the routine responses are inadequate. The progress of modifiability toward conscious choice-responses to external conditions constitutes a gradual and ill-defined transition from instincts to ASSOCIATIVE MEMORY, or newly conditioned responses, to learning and the highest intellectual processes. (Fig. 143.)

Although it is necessary to emphasize that mind and intelligence, in the biological sense, are expressions for that integration of nervous states and actions which makes possible a nicety of adaptation of behavior to environmental conditions that otherwise would be impossible — that it is our chief means of adaptation; it is a serious mistake to minimize the importance of the vast gulf between Man's nature and that of the most highly developed lower animals. In no respect are these differences more marked than in the various forms of learning that collectively form the means of education. While associative memory, or conditioning, will account for the various non-instinctive actions of Man's animal associates, human racial history and the individual's experience contain much that baffles explanation in such terms. Indeed, in the highest reaches of conscious life we appreciate that it is able to form strange conceptions; that it has not only memory of the past, but also anticipation of the future. We can brood and meditate and understand in part. We are guided by the past, present, and future in making adaptations. "The largest fact in the story of evolution is the growing dominance of the mental aspect of life."

Thus it is clear that, with all the variations in structure and function, organisms all possess irritability in common: they all exhibit adaptive responses which enable them to exist in spite of surrounding changes. "Adaptability appears to be the touchstone with which nature has tested each kind of organism evolved; it has been the yard-stick with which she has measured each animal type; it has been the counterweight against which she had balanced each of her productions . . . the general course of evolution has



been always in the direction of increasing adaptability or increasing perfection of irritability." The individual's heritage affords the cumulative result of the adaptations of the race — including adaptability.

## CHAPTER XXIII

### DESCENT WITH CHANGE

Thoughtful men will find in the lowly stock whence Man has sprung, the best evidence of the splendor of his capacities; and will discern in his long progress through the past, a reasonable ground of faith in his attainment of a nobler future. — *Huxley*.

FROM the time of the Greek natural philosophers there always have been men who have sought a naturalistic explanation of the origin of the diverse forms of animals and plants, and who have suggested that the present ones arose from earlier forms by a long process of descent with change, or EVOLUTION. But with the revival of natural history studies after the Middle Ages, the prevailing ideas in regard to creation led the majority, perhaps almost unconsciously, to assume that there is merely a limited number of kinds of organisms, all of which were created at one time. And this is not so strange when one considers that nearly all of the important facts which we have reviewed in the preceding pages were yet to be discovered, and that the number of known kinds of animals totalled but a thousand or so instead of about a million as to-day.

The pioneer work of the early Renaissance naturalists consisted principally of collecting and describing animals and plants. This involved making a catalog of the different kinds — classifying them in some way — and consequently some basis of CLASSIFICATION was sought. Thus attention was focussed on the kinds, or SPECIES, and for practical, if for no other reasons, the species assumed a prominence which overshadowed the individuals which composed it.

Indeed, to-day biologists are hard put to it to define a species. Of course everyone recognizes not only that there are many kinds of animals and plants, but also that many individuals are essentially the same. Groups may be formed of individuals which differ less among themselves in the sum of their characters than they do from the members of any other group of individuals. And further, the members of a group produce other individuals which

are essentially similar. It is such a group of similar individuals that is regarded by the biologist as a species. But it is difficult to formulate a satisfactory brief definition of a species, unless perhaps it be "a group of individuals that do not differ from one another in excess of the limits of 'individual diversity,' actual or assumed." So with but slight exaggeration it may be said that a species is largely a concept of the human mind: a somewhat arbitrary convenience. The real unit in nature is the individual animal or plant, and an understanding of the differences between individuals should give us the key to the differences between species. In the final analysis, the problem of the origin of species is a problem in genetics. (Figs. 236, 280.)

This seemingly obvious point of view has but relatively recently been clearly grasped by biologists, and the species rather than the individual has loomed large in the discussions of how plants and animals came to be what they are to-day. As a matter of fact, during the eighteenth century the greatest student of plant and animal classification, Linnaeus, emphasized the idea that each species represents a distinct thought of the Creator, and that the object of classification is to arrange species in the order of the Creator's consecutive thoughts. This viewpoint is somewhat whimsically expressed by the old naturalist who, finding a beetle which did not seem to agree exactly with any species in his collection, solved the difficulty by crushing the unorthodox individual under his foot. His credulity surely would have been strained by the estimate of modern entomologists that if all the species of Insects were known they would total upward of three million.

We may consider, then, that the consensus of opinion up to the middle of the last century was overwhelmingly on the side of **SPECIAL CREATION** and **FIXITY OF SPECIES**, and therefore against the idea occasionally advanced by men, as it now appears, ahead of their times, that **DESCENT WITH CHANGE** is the true explanation of the origin of the diverse forms of plants and animals. But, as nearly everyone knows, a complete reversal of opinion has occurred since 1860 — to-day professional scientists and most educated laymen accept **ORGANIC EVOLUTION**. And we have accepted it in the preceding sections of this work; but if this appears to have been prejudging the question, the explanation is that the genetic connection of organisms is the guiding principle of all modern biology. The mere fact that an unbiased presentation of

the data seems to prejudge the question is the most cogent presumptive evidence for evolution. It is true that there are wide differences of opinion among biologists in regard to the *factors* which have brought about the evolutionary change — but there are none in regard to the *fact* of evolution itself. It will be convenient, therefore, first to summarize a few of the *evidences* of evolution, and then to present certain modern views in regard to the *methods* of evolution.

#### A. EVIDENCES OF ORGANIC EVOLUTION

To one who has thoughtfully followed the preceding pages there must immediately occur many facts which are readily and reasonably interpreted from the point of view of descent of one species from another, but which are entirely obscure from that of the special creation of species. For instance, one will recall the cellular structure of all organisms; the method of origin and the fate of the germ layers in animals; the interrelationship of the urinary and reproductive systems in the Vertebrates; the comparative anatomy of the vascular and skeletal systems of Vertebrates; the similarity of the physical basis of inheritance in animals and plants: in a word — the 'unity in diversity' that pervades the world of living things. (Figs. 122, 129, 141, 227.)

In general, such are the types of data which support the evolution theory. Although the evidence, from the nature of the case, must be indirect, it is none the less impressive, chiefly because the facts for evolution are from such diverse sources and all converge toward the same conclusion. The theory of evolution reaches the highest degree of probability, since in every branch of botany and zoölogy all the data are most simply and reasonably explained on the basis of descent with change. It is a cardinal principle of science to accept the simplest conceptions which will embrace all the facts.

Assuming the reader's familiarity with the contents of this volume up to the present point, it is now necessary to summarize some of the most important evidence from various subdivisions of biology. But, as will soon appear, it is impossible to arrange the facts in natural groups because the evidence from one merges into that from another — the evidence interlocks.

### 1. *Classification*

When the serious study of biological classification was well under way, biologists found increasing evidence of the similarity, or affinity, of various SPECIES of animals and plants. Not only is it possible to arrange animals, for example, in an ascending series of increasingly complex forms, but also in many cases it is difficult or impossible to decide just where one species ends and the next begins. That is, the most divergent individuals within a given species frequently approach those of a closely similar species. There are *intergrades*. (Fig. 236.)

Furthermore it is found that species themselves can be naturally arranged in more comprehensive groups to which the name GENUS is applied. For example, the common Gray Squirrel represents the species *carolinensis*, and the Red Squirrel, the species *hudsonicus*. Both are obviously Squirrels, and therefore both species are grouped under the genus *Sciurus*. Accordingly, each animal is given a name composed of two words: the first, generic and the second, specific. The Gray Squirrel is *Sciurus carolinensis* and the Red Squirrel is *Sciurus hudsonicus*. Thus to give a scientific name to an animal or plant is really to classify it, because the first word of the name indicates that it possesses some fundamental characteristics in common with the other species of the genus — in fact, is more like them than it is like any other group of organisms.

But again, the members of the genus *Sciurus* have many characteristics in common with other animals which obviously are not true squirrels. The Chipmunks or Ground Squirrels, for instance, differ not only in certain obvious features, but in the possession of internal cheek pouches, etc. This dissimilarity and similarity is expressed by placing them in a different genus, *Tamias*, but in the same FAMILY, *Sciuridae*. The familiar eastern Chipmunk is *Tamias striatus*.

Moreover, while the Beaver (*Castor americana*) differs still more from the Squirrels than do the Chipmunks, and therefore is placed in a distinct family, the *Castoridae*, it nevertheless agrees with both in many fundamental ways so that it is placed in the ORDER *Rodentia*, which also includes the Squirrels and Chipmunks, as well as many other families and genera. Other orders, such as the *Ungulata* (Horses, Cattle, etc.), the *Carnivora* (Cats, Dogs, Bears, etc.), and the *Primates* (Monkeys, Apes, etc.), while they differ widely from

the Rodents, still agree with them in possessing hair, and milk glands for suckling the young. This basic likeness is expressed by including all under the CLASS *Mammalia*.

The Mammals in turn are readily distinguished from Birds, Reptiles, Amphibians, and Fishes (each of which forms a separate class), but nevertheless are constructed on the same basic plan, comprising a dorsal central nervous system surrounded by skeletal elements forming the skull and vertebral column. Therefore, all are comprehended in the larger group *Vertebrata* which, with certain minor groups, comprises the PHYLUM *Chordata* and stands in contrast with all the Invertebrate phyla which include Hydra, Earthworm, Crayfish, etc. The classification of the Gray Squirrel, *Sciurus carolinensis* (Fig. 108), may be outlined as follows:

KINGDOM — Animalia  
 SUBKINGDOM — Metazoa  
 PHYLUM — Chordata  
 SUBPHYLUM — Vertebrata  
 CLASS — Mammalia  
 ORDER — Rodentia  
 FAMILY — Sciuridae  
 GENUS — *Sciurus*  
 SPECIES — *carolinensis*.

This classification of the Gray Squirrel, although it incidentally serves to illustrate the general method of classification of all organisms, is important because it places concretely before us the fact that organisms show such fundamental similarities with obvious dissimilarities. In short, the mere fact that animals and plants naturally arrange themselves, as it were, in classes, orders, families, genera, species, etc., raises the question of the origin of species. Is special creation implying fixity of species, or is descent with change the more plausible explanation? (See Appendix: Classification.)

The unavoidable answer is descent with change — evolution — because the principle in accordance with which the groups of increasing comprehensiveness are formed is solely the greater or less similarity in the structural features of the organisms. It is much more reasonable to assume that the thread of fundamental similarity which runs through all the Vertebrates, for instance, is the result of inheritance, while the differences of orders, families,

genera, etc., are due to changes brought about under different unknown conditions, than it is to assume that each is the result of a special creative act. Especially so when we realize that in a very large number of cases it is difficult or impossible to decide the limits of a species, owing to variations among the individuals comprising it, and it is necessary to resort to *SUBSPECIES* and *VARIETIES* in classification. Again, among genera, intergrading forms demand *SUBGENERA*; among orders, *SUBORDERS*; among classes, *SUBCLASSES*; and so on. If we admit the origin by descent with change of the subspecies and varieties, there is no logical reason for denying the same origin of species, orders, and higher groups. The difference is one of degree and not of kind. Before the recognition of evolution, classification was a groping after an elusive ideal arrangement which naturalists felt but were unable to express except in artificial form and in transcendental terms. Under the influence of the evolution theory, classification became the natural expression of biological pedigrees. (Figs. 236, 297.)

## 2. Comparative Anatomy

The evidence from taxonomy is, as has just been seen, really evidence from comparative anatomy, since modern classifications are based chiefly on anatomical characters. The various groups — classes, orders, families, genera, species, etc. — are founded not on a single difference, nor on several differences, but on a large number of *similarities*. For instance, the differences exhibited throughout the five classes of the Vertebrates are relatively slight in comparison with the basic resemblances. This similarity in dissimilarity is brought out by the science of comparative anatomy. A few concrete examples, some of which we are already familiar with, will serve to bring the main facts clearly before us.

The fore legs of Frogs and Lizards, the wings of Birds, the fore legs of the Horse, and the arms of Man are built on the same basic plan. The same is true of the hind limbs. Clearly all are *HOMOLOGOUS* structures, such variations as exist being brought about chiefly by the transformation or absence of one part or another. In short, all the chief parts of both the fore limbs and the hind limbs are homologous throughout the series. All are composed of the same fundamental materials disposed in practically the same way — nearly all the bones, muscles, blood vessels, and nerves are homologous. Or compare the digestive systems of the same forms, or

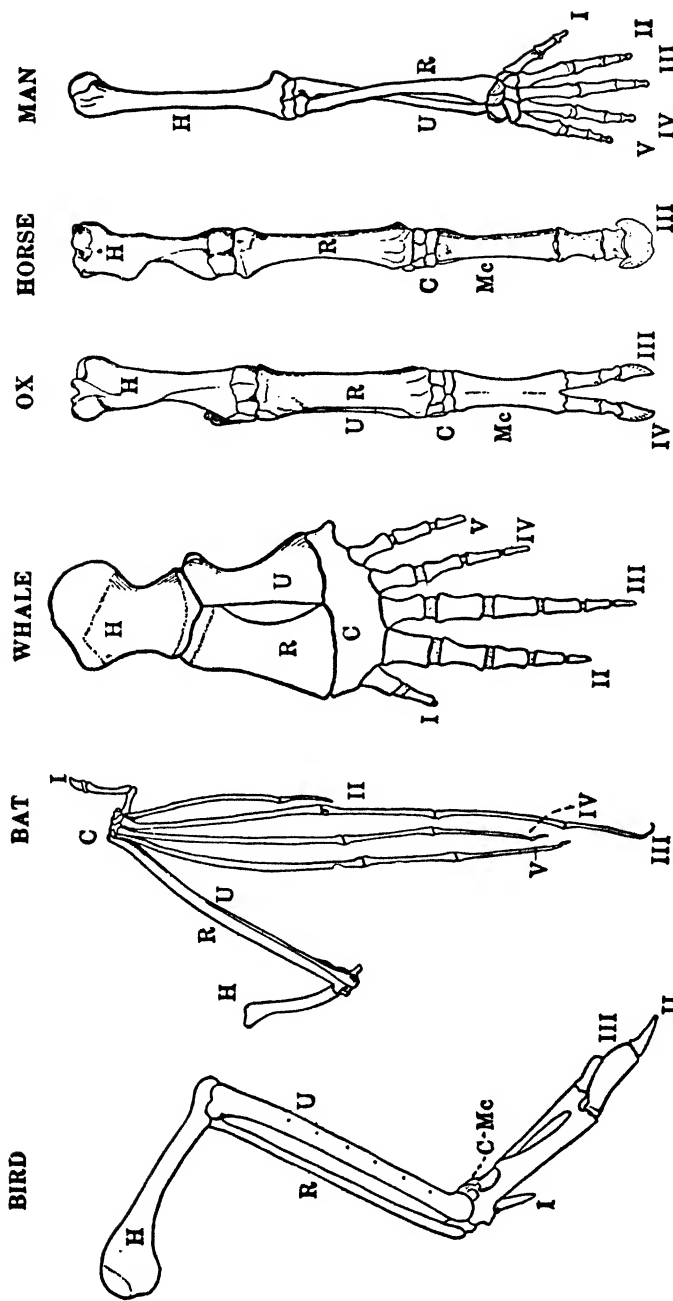

FIG. 227. — Vertebrate fore limbs to show homologous skeletal structures. Bird, left wing; Bat, right wing; Whale, left flipper; Ox, right fore leg; Horse, right fore leg; Man, right arm. C, carpals; H, humerus; Mc, metacarpals; R, radius; U, ulna; I-V, digits. (From Scott.)



the excretory and reproductive systems. One has but to recall that, on an earlier page, it was possible to describe in general terms these systems as they exist throughout the Vertebrate series — in forms as obviously different as Fish and Man. They are all fundamentally the same. (Figs. 102–110, 121, 129, 141, 227, 228.)

Turning to the Invertebrates, we may remind the reader that all the appendages of the Crayfish are built on the same simple

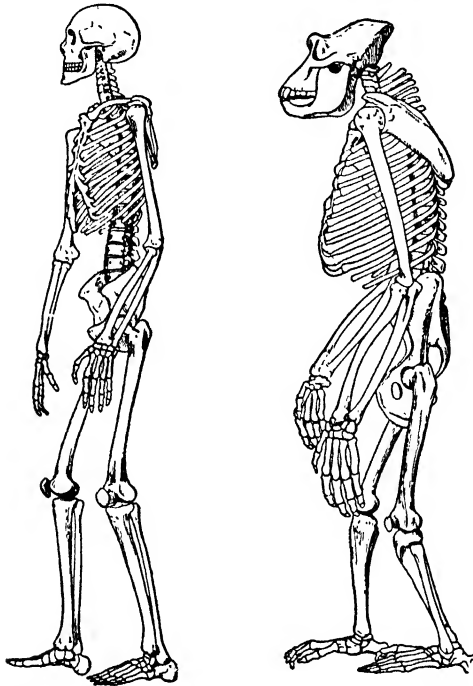

FIG. 228. — Skeletons of Man and of Gorilla. (From Lull.)

plan as exhibited in the swimming legs (swimmerets) of the abdomen. The highly specialized walking legs, great claws, jaws, and feelers (antennae and antennules) are all reducible to modifications of the simple swimmeret type. In short, all are homologous structures, though differing widely in function. This is a most striking example of SERIAL HOMOLOGY, though we have seen the same principle exhibited in the Vertebrates where the fore limbs and the hind limbs of each animal are homologous. Moreover,

the appendages of the Crayfish are not only serially homologous among themselves, but are also homologous with the appendages of all the other members of the class Crustacea — just as the limbs of one Vertebrate are homologous with those of all other Vertebrates. (Figs. 64, 65, 227.)

Another class of facts presented by comparative anatomy is derived from the so-called VESTIGIAL organs. In Man there are nearly a hundred structures which apparently are useless and sometimes are harmful. One thinks at once of the VERMIFORM APPENDIX of the large intestine, apparently a remnant of an organ that serves a useful purpose in certain vegetable-feeding (herbivorous) Mammals. But equally suggestive are the muscles of the ear, which in some individuals are sufficiently developed to move the external ear; or the so-called third eyelid at the inner angle of the eye which corresponds to the lid (NICTITATING

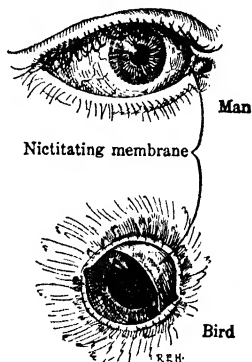

FIG. 229. — The nictitating membrane, or third eyelid.

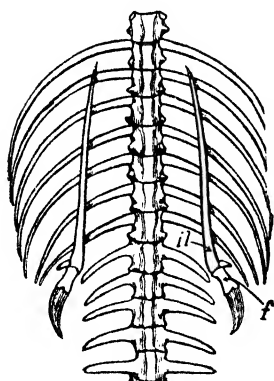

FIG. 230. — Vestigial hind limbs of a Snake, *Python*. *f*, femur or thigh bone; *il*, ilium or hip bone. (From Romanes.)

MEMBRANE) that moves laterally across the eye of Reptiles and Birds; or the terminal vertebrae (COCCYX) of the human spinal column. Other animals likewise possess many such structures. Porpoises have vestiges of hind limbs enclosed within the body, and certain species of Snakes bear tiny useless hind legs. The splint bones of the Horse are remnants of lost toes. (Figs. 109, 206, 229, 230, 234.)

In another class of cases, the organs, or remnants of organs of a lower form are altered or completely made over, as it were, into new organs of the higher form. The milk glands of Mammals are transformed sweat glands of the skin, while the poison glands of Snakes are specialized salivary glands. During the embryonic life of Vertebrates there are gill slits, all of which vanish in higher forms except one pair which remains as passages (EUSTACHIAN TUBES) connect-

ing each middle ear with the pharynx. Gill arches, which function as supports for the gills in the aquatic Vertebrates, persist in highly modified form as skeletal structures associated with the tongue and entrance to the lungs (LARYNX) in terrestrial forms. Finally, in this connection the reader will recall the transformations of the blood vessels in the Vertebrates which occur with the substitution of lungs for gills, and also the variations and interrelationships of the excretory and reproductive systems

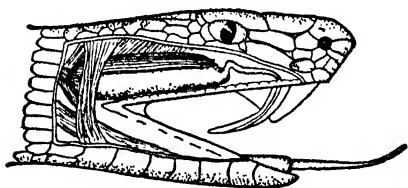

FIG. 231. — Head of a Rattlesnake, with the skin and part of the muscles removed. The long oval mass in the upper jaw which is connected by a duct with the curved tooth, the fang, is the poison gland. (From Smallwood.)

in the ascending series of Vertebrate classes. (Figs. 121, 122, 127, 129, 148, 231.)

One may, of course, conclude from all these facts that the various species of Vertebrates have each been independently created according to the same preconceived plan — and likewise all the great numbers of orders, families, genera, species, etc., of each of the five

classes that these forms represent. Or one may conclude that all have arisen by descent with change from a primitive Vertebrate organism which possessed the fundamental similarities exhibited from Fish to Man. The latter is the conclusion accepted by biologists to-day.

### 3. Paleontology

Huxley once said that if zoölogists and embryologists had not put forward the theory of evolution, it would have been necessary for paleontologists to invent it. What then are the main facts offered by PALEONTOLOGY, the study of the FOSSIL remains of extinct animals and plants?

In the first place it must be made clear that geologists are able to determine, with remarkable accuracy in most cases, the sequence in time, or CHRONOLOGICAL SUCCESSION, of the rock strata composing the Earth's surface. The main outline of this scheme of geological chronology was understood long before the evolution of organisms was a crucial question; so that we may consider the evidence which it affords of the chronological succession of the fossil remains exhibited by the various strata, as impartial testi-

THE GEOLOGICAL TIME-TABLE <sup>1</sup>

## PRESENT TIME.

PSYCHOZOIC ERA: AGE OF MAN OR AGE OF REASON.

The present or 'Recent time,' and the time during which Man attained his highest civilization; estimated to be less than 10,000 years.

## GEOLOGIC TIME.

CENOZOIC OR MODERN ERA: AGE OF MAMMAL AND SEED PLANT DOMINANCE.

*Glacial or Pleistocene epoch.* Last great ice age. Rise of Man.

*Pliocene epoch.* Rise of types transitional to Man.

*Miocene and Oligocene epochs.* Rise of Apes.

*Eocene epoch.* Rise of higher Mammals.

MESOZOIC OR MEDIEVAL ERA: AGE OF REPTILE DOMINANCE.

*Cretaceous period.* Rise of primitive Mammals and Seed Plants.

*Jurassic period.* Rise of Birds and flying Reptiles.

*Triassic period.* Rise of Dinosaurs, and Mammalian stock.

PALEOZOIC OR ANCIENT ERA: AGE OF PRIMITIVE ANIMALS AND PLANTS.

*Permian period.* Rise of Reptiles and Conifer forests. Another great ice age.

*Carboniferous period.* Age of Amphibia. Rise of Insects. Marked coal accumulation.

*Devonian period.* Age of Fishes. First known marine Fishes, and Amphibians.

*Silurian period.* First known land floras.

*Ordovician period.* First fresh-water Fishes.

*Cambrian period.* First shell-bearing marine animals, and dominance of Trilobites.

PROTEROZOIC ERA: AGE OF INVERTEBRATE DOMINANCE.

An early and a late ice age.

ARCHEOZOIC ERA: ORIGIN OF PROTOPLASM AND OF SIMPLEST ORGANISMS.

## COSMIC TIME.

FORMATIVE ERA: ORIGIN OF THE EARTH AS A RESULT OF SOLAR DISRUPTION.

Beginnings of the atmosphere and hydrosphere, and of continental platforms and oceanic basins. No known geological record.

<sup>1</sup> From Schuchert, somewhat modified.

mony to the order of appearance on the Earth of the different types of animals and plants. (Fig. 232.)

The geological time-table (page 359) summarizes the panoramic succession of life as it is seen by the paleontologist. It is of little value to discuss the absolute duration of geologic time, because the estimates vary so greatly, though there are fairly reliable data in regard to the relative length of the various eras. Perhaps the conservative estimate of two billion years — much more than half

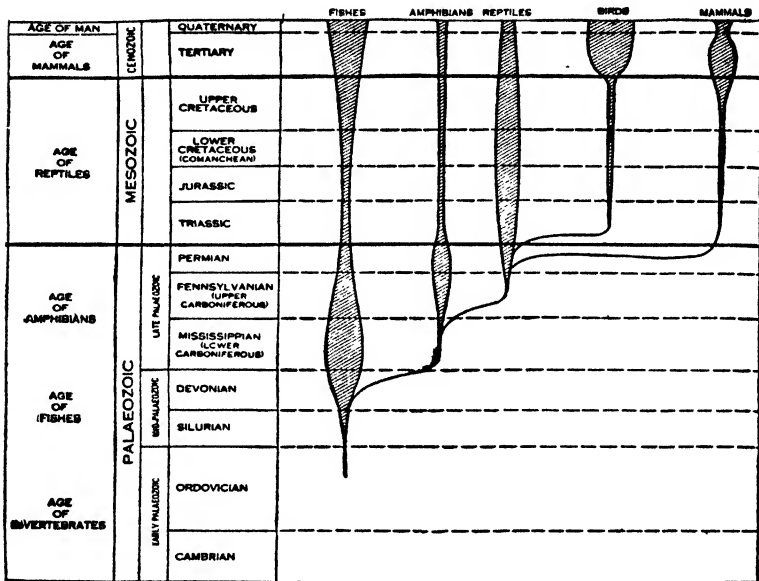

FIG. 232. — Chart showing the origin and degree of development of the chief groups of Vertebrates, correlated with the geological time-table. (From Lindsey, after Osborn.)

of which was before the Cambrian period — will serve to spell the Earth's unfathomable past and to afford some idea of the immensity of time available for evolutionary changes.

Even a casual survey of this history — natural history — of the Earth and its inhabitants cannot but impress one with the fact that, taken all in all, there has been a continuous, though not always a uniform, advance in the complexity of organisms from the most ancient times, and that the older types seem gradually to melt into modern forms as the remoter geological eras merge into the more recent. "Only the shortness of human life allows us

to speak of species as permanent entities." Invertebrates appear in the Proterozoic Era; Fishes, Amphibians, and Reptiles in the Paleozoic; Birds and primitive Mammals in the Mesozoic; higher Mammals and Man in the Cenozoic. Mosses and Ferns arise before Conifers and the latter before the familiar Seed Plants. Just in proportion to the completeness of the geological record is the unequivocal character of its testimony to the truth of the

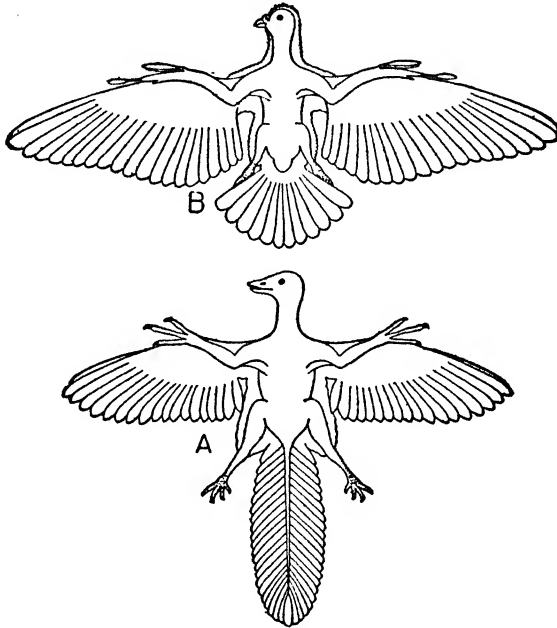

FIG. 233. — Reptilian Bird, *Archaeopteryx* (A), compared with Pigeon, *Columba livia* (B). (From Lull.)

evolution theory. For the sake of concreteness we may select two examples from the wealth of material offered by the paleontologist.

At first glance there seems to be little but contrasts between a typical Reptile and a typical Bird; between a cold-blooded, scaly-skinned Lizard, let us say, and a warm-blooded, feathered Pigeon. And yet the zoölogist is convinced that Birds have evolved from a reptilian stock, because, in spite of superficial dissimilarities, there are fundamental structural resemblances not only between adult Reptiles and Birds, but also between their embryological stages. And further, because the fossil remains of a very primitive Bird, *Archaeopteryx*, have been found which form, in many ways,

a connecting link between the Reptiles and Birds as we know them to-day. (Fig. 233.)

Archaeopteryx was undoubtedly a bird about the size of a Pigeon, but one with jaws supplied with many small teeth; with a long lizard-like tail formed of many vertebrae, each bearing a pair of quill feathers; with a four-fingered reptilian hand; and so on. In brief, just such a creature as the imagination of an evolutionist would picture for a primitive Bird has been actually discovered in the lithographic stone quarries of Bavaria, representing the later Jurassic period.

The ancestry of the modern Horse has been the most impressive fossil pedigree, ever since Professor Marsh collected the famous series of fossil skeletons from the western United States and arranged them in the Yale University Museum. They have been referred to as the "first documentary record of the evolution of a race." Huxley studied this collection and regarded it as conclusive evidence of evolution.

The essential facts of the evolution of the Horse are these. Horse-like animals probably arose from an extinct group, similar to the *Condylarthra*, which had five toes on each foot and a large part of the sole resting on the ground. However, the first unquestionable horse-like forms found in North America are little animals about a foot in height, known as *Eohippus*, from rocks of the EOCENE epoch. The fore foot of *Eohippus* has four complete toes (digits 2, 3, 4, and 5) but no trace of the inner digit, or thumb, while the hind foot has three complete digits (2, 3, and 4) with vestigial remains, or *splints*, of the first and fifth. Later in the Eocene appears *Orohippus* showing a somewhat larger central digit in the fore foot and the disappearance of the splints in the hind foot. Passing up to the OLIGOCENE epoch, *Mesohippus*, an animal about the size of a wolf, occurs with fore and hind feet three-toed, but with the side toes much smaller than the central one, and just a trace of the fifth digit in the fore foot as a splint. Then *Merychippus* appears in the MIOCENE epoch, with still shorter side toes (digits 2 and 4) so that they do not reach the ground, and the weight is borne solely on the hoofed tip of the third digit. This same general reduction of the lateral digits and advance in size and functional importance of the middle digit is carried further during the PLIOCENE epoch in *Pliohippus*, which is usually regarded as the first type of 'one-toed' Horse, and leads finally

# THE EVOLUTION OF THE HORSE.

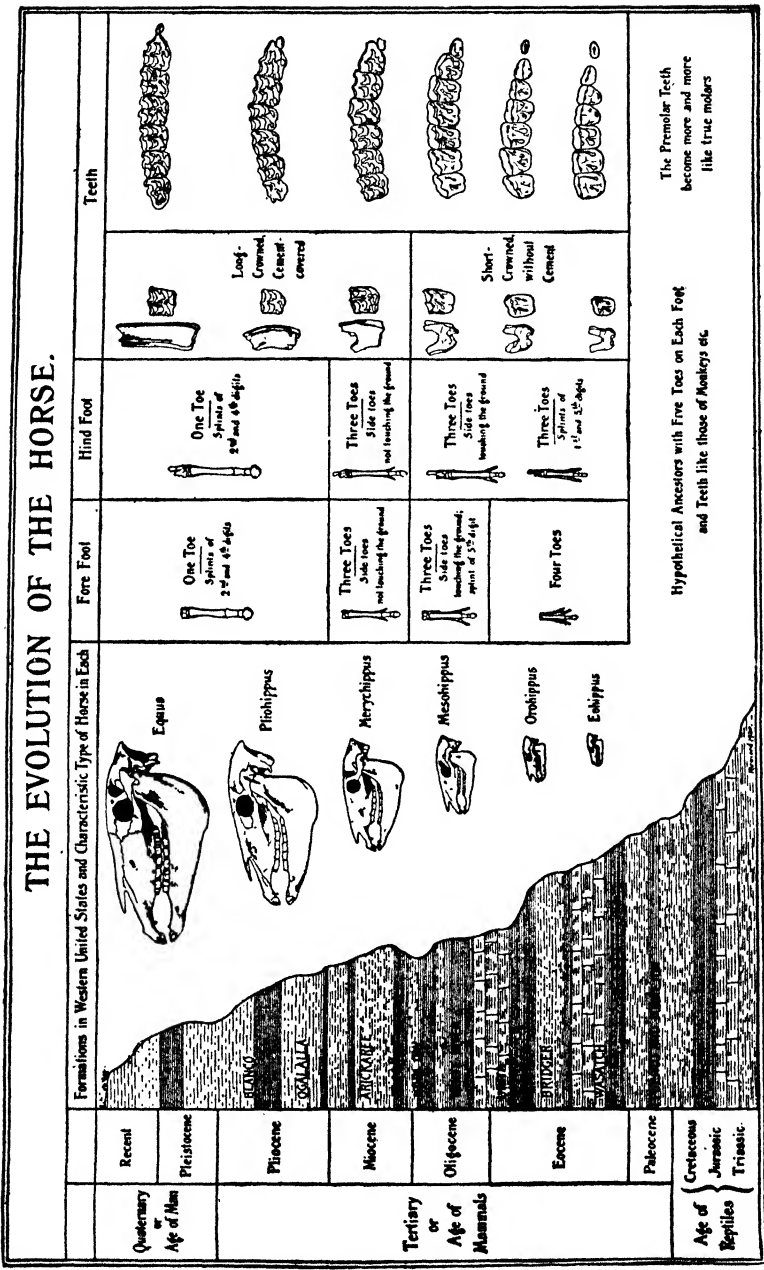

FIG. 234. — Graphic presentation of the evolution of the Horse. (From Matthew.)



to the genus *Equus* which has continued from the PLEISTOCENE epoch to the present. This genus includes the modern Horse, *Equus caballus*, with one functional digit on each foot and vestiges of two more (digits 2 and 4) as the splint bones. (Fig. 234.)

In this outline of what must be interpreted as the fossil ancestors of the Horse of to-day, we have merely selected several representative forms to emphasize changes in foot structure. But the reader will realize that many other equally significant changes were involved in the transformation — during perhaps ten million generations — of an *Eohippus* type into that of *Equus*. This much appears certain to the biologist: “In early Eocene times there lived small five-toed hoofed quadrupeds of generalized type, that the descendants of these were gradually specialized throughout long ages along similar but by and by divergent lines, that they lost toe after toe till only the third remained, that they became taller and swifter, that they gained longer necks, more complex teeth, and larger brains. So from the short-legged splay-footed plodders of the Eocene marshes there were evolved light-footed horses running on tiptoe on the dry plains.”

Truly, the stupendous and ever increasing record of ancient forms of life is not that of a disordered multitude. Newly discovered fossil remains, one after another, fall into the scheme of a common tree of descent — descent with change.

#### 4. Embryology

If evolution is a fact, one would expect to find evidences of the genetic relationships of organisms in their embryological development from egg to adult. Under former headings we have incidentally mentioned embryological data which point toward evolution, so that now attention may be confined to an attempt to make clear a fact of first importance — the history of the individual frequently corresponds in broad outlines to the history of the race as indicated by evidence from comparative anatomy, etc. If we have in mind the earlier discussion of Vertebrate anatomy, just a few examples will suffice to suggest the type of evidence which supports this so-called RECAPITULATION THEORY, or BIOGENETIC LAW. (Page 96.)

Lower Vertebrates, such as the Fishes, have a heart composed of two chief chambers: an auricle which receives blood from the body as a whole and a ventricle which pumps it to the gills on its way to supply all parts of the body. Among the members of the

next higher group, the Amphibia (Frogs, Toads, etc.), the auricle is divided into two parts, while the ventricle remains as before. Thus these forms have a three-chambered heart. Passing to the Reptiles, we find that most of the Lizards, Snakes, and Turtles have the ventricle partially divided into two chambers, while the more specialized Crocodiles and Alligators have a complete partition and therefore a four-chambered heart. This is the con-

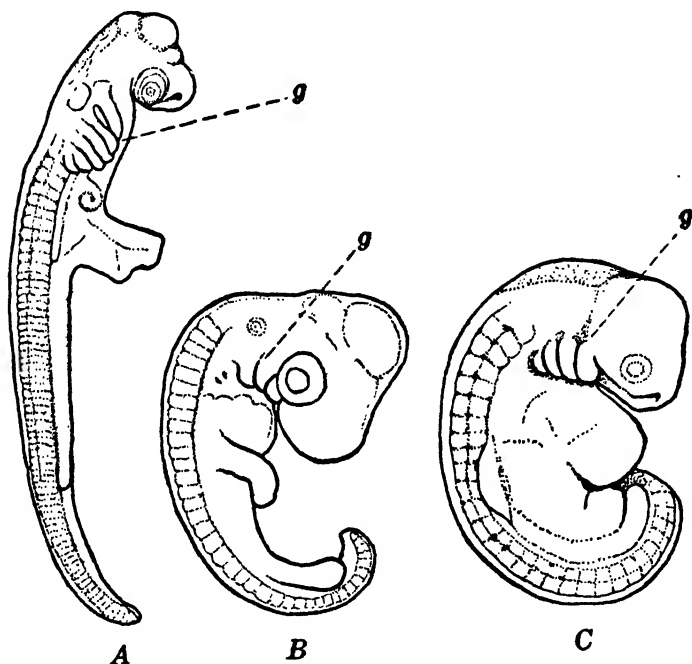

FIG. 235. — Embryos in corresponding stages of development. A, Fish (Shark); B, Bird; C, Mar. *g*, gill slits. (From Scott.)

dition in all adult Birds and Mammals, but the significant fact is that, in the development of the heart of the individual Bird and Mammal, embryonic stages succeed each other which parallel in a general though remarkable way this sequence from a two-chambered to a four-chambered condition as exhibited in the adults of the lower Vertebrates. (Figs. 120-122.)

Or take the development of the brain in the Vertebrate series. Even in the human embryo the fundament of the brain arises by simple transformations of the anterior end of the neural tube,

which at first are nearly indistinguishable from the conditions which exist in the lowest Vertebrates. Then the changes become progressively more complex along lines broadly similar to those occurring from Fish to Mammal, until finally the complex human brain is formed. (Figs. 140, 141.)

The same picture is presented by a study of the development of the excretory system, the reproductive system, the skull, and so on. One cannot avoid the fact that the organs of higher animals during development pass through stages which correspond with the larval or adult condition of similar organs in lower forms. The correspondence is far from exact — to be sure, there are gaps and blurs — but it is not an exaggeration to say that embryological development is parallel to that which anatomical study leads us to expect. A knowledge of the anatomy of an animal actually gives a sound basis of facts from which to predict in broad outlines its embryological development. (Figs. 129, 235.)

What are the bearings of these facts on the evolution theory? It is perfectly logical to conclude that it is an architectural necessity, let us say, for the four-chambered heart to arise from a two- and three-chambered condition — and undoubtedly if this were the only example of 'ontogeny repeating phylogeny' the conclusion would be justified. But when one considers the widespread general correspondence of the developmental stages in higher forms with conditions as they exist in the adults of lower forms, the facts almost overwhelmingly force us to go further and conclude that the similarity has its basis in inheritance, in actual blood relationship between the higher and lower forms, in descent with change — evolution.

### 5. *Physiology*

Fundamental structural similarities throughout a series of organisms implies fundamental physiological similarities — structure and function go hand in hand, each being an expression of the other: function alone gives permanence to structure — and this is strikingly corroborated by the data accumulated which show that species are characterized not only by morphological attributes, but by their specific biochemical constitution as well. But this physiological evidence of the relationships of organisms is less readily presented in brief form, so we may confine attention to the most significant examples.

It will be recalled that chemical control by hormones plays an important part in the coördination of the multicellular animal into a working unit, especially in the case of such functions as digestion, growth, and reproduction. Now it is significant that the hormones seem to be largely if not completely interchangeable from one species of Vertebrate to another. Thus a deficiency in the insulin hormone in Man may be supplied from the pancreas of a Fish or a Sheep. Obviously this strongly suggests that at least certain of the chemical regulators have been common factors from a remote ancestral period.

But chemical differences as significant as anatomical ones have been revealed by the type of crystals formed by the hemoglobin of the blood. When orders, families, genera, or species are clearly separated by anatomical criteria, the crystals are correspondingly markedly differentiated. Thus from crystal form it is evident that the common White Rat is the albino of the Norway Rat (*Mus norvegicus*) and not of the Black Rat (*Mus rattus*); and that Bears are more nearly related to the Seals than they are to Dogs.

Again, there are other important chemical differences, not determinable by ordinary chemical analysis, between the blood even of closely related species, long known by the fact that the TRANSFUSION of the blood of one species into another is usually attended by physiological disturbances and often by death. It has been found by innumerable transfusions and also by so-called PRECIPITIN TESTS of the blood *in vitro*, that is outside the body, that the degree of the reaction is in many cases proportional to the degree of relationship of the species involved, as indicated by their classification on the basis of anatomical structure.

Thus, as one would expect, human blood shows by the precipitin test closer chemical relationships with the blood of the highest Apes than it does with that of the Old World Monkeys; closer relationships with the blood of the latter than it does with that of the New World Monkeys; and closer with the blood of these than with that of the Lemurs; and so on. Or, descending to the Reptiles: paleontology indicates that there is a close relationship between Lizards and Snakes and also between Turtles and Crocodiles, while the reptilian ancestor of the Birds was probably more closely allied with the latter than the former groups. These same relationships are indicated by blood tests.

Thus aside from a few startling exceptions, which further study

perhaps may bring into line, all the data warrant the conclusion that the chemical characteristics of the blood are almost as constant as structural similarities of the blood vessels. Indeed, the inorganic salts present in the various circulating fluids of animals correspond in nature and relative amounts to what we have good reason to believe was the composition of the ocean some hundred million years ago. So in evolutionary terms, a common property has persisted in the bloods of animals throughout the ages which have elapsed during their evolution from a common ancestor: of all the systems, the blood perhaps is the most conservative in retaining its ancestral condition. Blood relationship is a fact.

### 6. *Distribution*

Everyone recognizes that there are wide variations in the fauna and flora of different parts of the Earth. There is a characteristic life on mountain, plain, and seashore, and in the sea — as well as in pond and puddle — and also in arctic, temperate, and tropical regions. But the problem of animal and plant distribution is by no means so simple as this statement might seem to imply, because the study involves the investigation of both the relations of the various organisms to the general environing conditions, and the interrelations of the species with each other. It forms a part of the sciences of plant and animal ECOLOGY. (Figs. 220, 236.)

Confining attention merely to the geographical distribution of animals — which forms the science of ZOÖGEOGRAPHY — let us take a couple of clear-cut examples and see whether or no evolution offers a reasonable explanation of the facts.

A characteristic genus of Mammals, known as the Tapirs, is represented to-day by distinct species in two widely separated regions: Central and South America and southern Asia and adjacent islands. But distribution in the past proves to be the key to the present distribution. Paleontological studies show that in the Pliocene epoch Tapirs were distributed over nearly all of North America, Europe, and northern Asia, and thereafter gradually became extinct so that by the close of the Pleistocene epoch the remnants were distributed as we find them to-day. In brief, the present *discontinuous* distribution represents the remnants of a world-wide Tapir population, and the differences between the existing species are such as one might expect to find among the members of a genus long isolated in different environments by

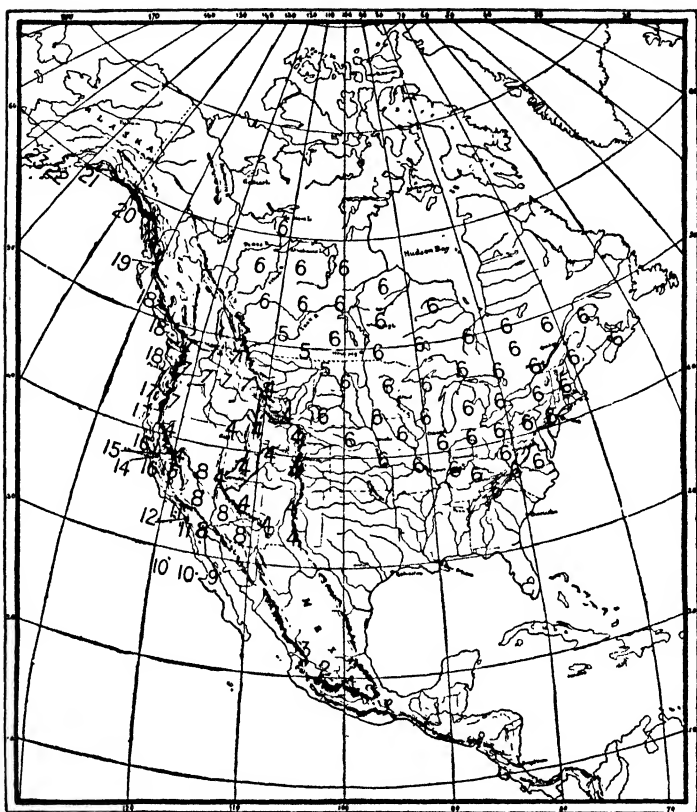

FIG. 236. — Geographical distribution of Song Sparrows. Each different number indicates habitat of a *subspecies*. "We find complete integradation in color and in size. Nowhere can one draw the line. As the climatic conditions under which the birds live change, the birds keep pace. Here we have a species in flower, as it were, a single Song Sparrow stalk with its twenty-nine blossoms, any one of which might make an independent growth as a species if it were separated from the parent stem. Doubtless some day the separation will come, when we shall have several species, each with its groups of races, but at present we have only one species, divided into some twenty-nine subspecies, or species in process of formation." (Chapman.)

geographical barriers. We know, for example, that a litter of European Rabbits was introduced on the small island of Porto Santo during the fifteenth century and by the middle of the last century its descendants had become so distinct from the parent form that they were described as a new species. (Fig. 92.)

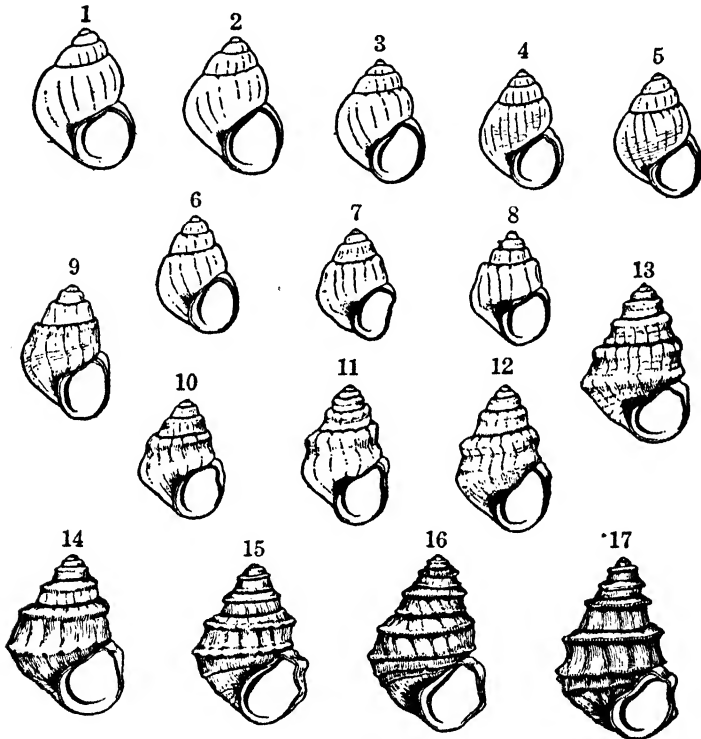

FIG. 237. — Successive forms of a Snail, *Paludina*, from the Tertiary deposits of Slavonia. (From Lull, after Neumayr.)

As a matter of fact the characteristic fauna of islands was what impressed Darwin with the need of some interpretation of their origin other than by special creation. During his famous three years' voyage around the world on the "Beagle," he stopped at the Galapagos Islands, situated about 600 miles off the west coast of South America, and was astonished to find that although the fauna as a whole resembled fairly closely that of the mainland, nevertheless the species for the most part not only were different, but even those of the separate islands were distinct — the islands nearest to

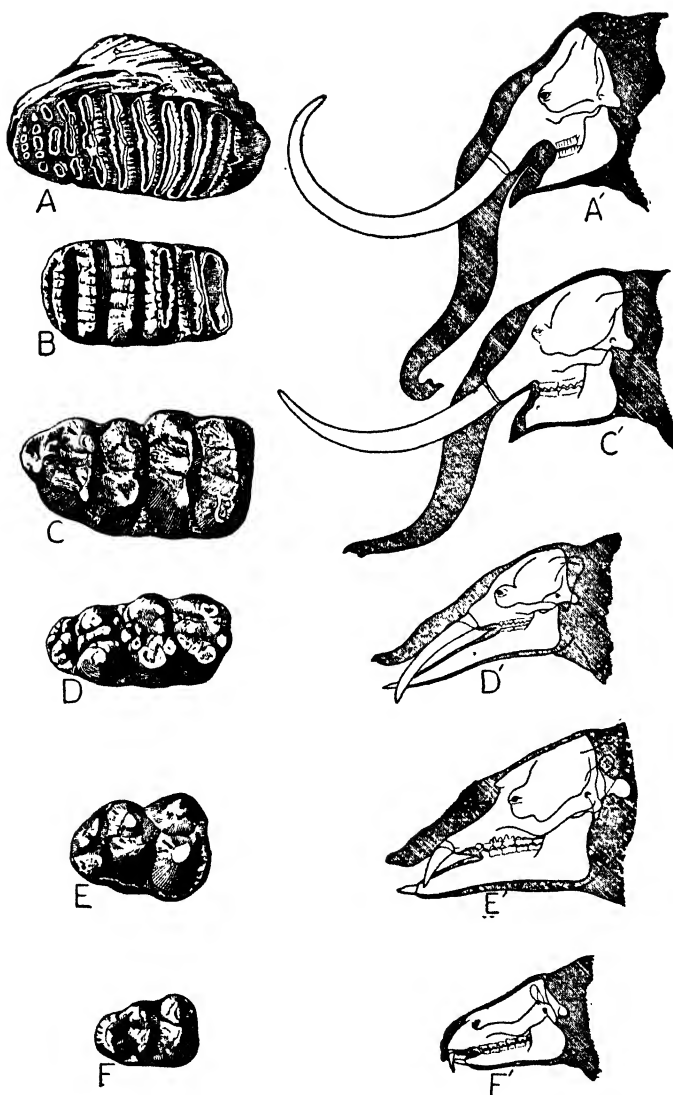

FIG. 238. — Evolution of the head and molar teeth of Elephants. A, A', *Elephas*, Pleistocene; B, *Stegodon*, Pliocene; C, C', *Mastodon*, Pleistocene; D, D', *Trilophodon*, Miocene; E, E', *Palaeomastodon*, Oligocene; F, F', *Moeritherium*, Eocene. (From Lull.)



each other having species most similar. Darwin wrote, "My attention was first thoroughly aroused by comparing together the numerous specimens, shot by myself and several others on board, of Mocking Thrushes, when, to my astonishment, I discovered that all those from Charles Island belonged to one species (*Mimus trifasciatus*); all from Albemarle Island to *M. parvulus*; and all from James and Chatham Islands (between which two other islands are situated as connecting links) belonged to *M. melanotis*."

Darwin's observations of such facts as these have been corroborated in the Galapagos and extended to isolated island faunas and floras all over the world. For instance, half of the species of Insects and four-fifths of the species of Seed Plants that occur on St. Helena are found nowhere else. And further, Darwin's explanation of the phenomena is the most plausible extant. Continental islands secure their life from the mainland before they are cut off, and oceanic islands after their formation by volcanic action alone or aided by coral growth. In either event the organisms inhabiting islands are isolated from the main stock of the species, and they diverge, in proportion to the length of time and the degree of isolation, until they constitute separate races and species. Isolation promotes divergence apparently to a considerable extent by preventing new types from being swamped by interbreeding with the old, and by allowing many mutations to become established that would not survive in a more competitive field. Furthermore, new conditions may afford new problems to be met by mutations, and so favor their persistence. We see evolution as a response of life to its environment. Each species peculiar to each isolated island can reasonably be interpreted as having arisen by descent with change. (Figs. 236-238.)

We have now summarized a few concrete examples of the chief types of evidence that organisms — species — have come to be what they are to-day through a long process of descent with change. This evidence, taken with that presented, so to speak, on and between the lines throughout this work, should place the reader in a position to form a more or less independent judgment of the question. It is only necessary to remind him again that, although the evidence, from the nature of the case, must inevitably be indirect, its force is tremendously increased by its amount. And the reader, with only a very limited amount of the data before him, cannot

appreciate the overwhelming impressiveness of all the concordant evidence for organic evolution.

## B. FACTORS OF ORGANIC EVOLUTION

Taking for granted the fact of evolution, what are the factors which have brought about evolution? That is quite a different question, but one which has often brought confusion to the popular mind. Although biologists are in general agreement on the basic factors involved, there is much debate in regard to their relative importance and method of operation. And the layman has mistaken the questioning of one factor or another for a questioning of the fact.

No purpose will be served by a long historical account of the origin of the present-day point of view. Suffice it to say that the evolution idea is a generalization which has crept from science to science — from astronomy to geology, from geology to biology, thereupon becoming ORGANIC evolution. The idea in one form or another is as old as history, but for all practical purposes the biologist Lamarck, during the early part of the nineteenth century, formulated the first consistently worked out theory of organic evolution. (Fig. 293.)

### 1. *Lamarckism*

The evidence for organic evolution offered by Lamarck was necessarily limited in amount, and in some cases neither happily selected nor convincingly presented, so it was laughed out of court by biologists and laymen alike. His evolution factor was essentially the change of the organism through the use and disuse of parts; the physiological response of the organism to new needs offered by new conditions of life. And these changes, somatic in origin, he believed were transmitted to the progeny. His first statement in 1809, freely translated, is as follows:

“First Law: In every animal which has not exceeded the term of its development, the more frequent and sustained use of any organ gradually strengthens this organ, develops, and enlarges it, and gives it a strength proportioned to the length of time of such use, while the constant lack of use of such an organ imperceptibly weakens it, causing it to become reduced, progressively diminishes its faculties, and ends in its disappearance.

“Second Law: Everything which nature has caused individuals

to acquire or lose by the influence of the circumstances to which their race may be for a long time exposed, and consequently by the influence of the predominant use of such an organ, or by that of the constant lack of use of such part, it preserves by heredity and passes on to the new individuals which descend from it, provided that the changes thus acquired are common to both sexes, or to those which have given origin to these new individuals."

Lamarck's first law is, in general, sound, but the second — the inheritance of acquired characters — is highly questionable to say the least, because, as we have seen, there is no evidence that modifications are heritable. But this weak point was not the one which caused the rejection of the theory by Lamarck's contemporaries. The various antagonistic influences can be summed up by saying: the time was not ripe for evolution.

## 2. Darwinism

Then a generation later appeared Charles Darwin in England. With a better background prepared for him, in part by headway being made by the evolution theory in geology, he did two things in his *Origin of Species* which was published in 1859. He presented an overwhelming mass of *facts* which could be explained most reasonably by assuming the origin of existing species by descent with change from other species. And he offered as an explanation of the origin of species the *theory* of "NATURAL SELECTION, or the preservation of favoured races in the struggle for life." It was the *combination* of the facts and the theory to account for the facts that won the thinking world to organic evolution — a common height from which we view the whole world of living beings. (Fig. 296.)

What, in brief, was the theory? In the first place, without attempting to determine the cause of variations, Darwin showed the great amount of VARIATION in nature. And any and all kinds of heritable variations were, broadly speaking, important — though he somewhat grudgingly admitted the inheritance of acquired characters.

The universality of variations established, Darwin emphasized the fact that the POWER OF REPRODUCTION of organisms far exceeds space for the offspring to live in and food for them to eat. Some recent data will illustrate this point. A microscopic *Paramecium* possesses the power to eat, grow, and reproduce — to

transform the materials of its environment into *Paramecium* protoplasm — at the rate of 3000 generations in five years. And all the descendants (if they actually existed) would equal 2 raised to the 3000th power, or a volume of protoplasm approximately equal to  $10^{1000}$  times the volume of the Earth! The Plant Lice, or Aphids, may produce a dozen generations in a year. The final brood, assuming the average number of young produced by each female to be one hundred and that every individual produced its full complement of young, would consist of ten sextillion individuals — a procession, if it could be marshalled, that “would extend from the Earth out into space far beyond the furthest star that has ever been discerned by the telescope.” The common House Fly under favorable conditions may lay as many as six batches of eggs, of about one hundred and forty eggs each, during its short life of approximately three weeks. Assuming that all the progeny survived and multiplied at the same rate, “the progeny of a single pair, if pressed together into a single mass, would occupy something like a quarter of a million cubic feet, allowing 200,000 flies to a cubic foot.” And the all too familiar Mosquito may have nearly two hundred billion descendants during one summer. Indeed, the common Rat will afford astounding figures. (Figs. 222, 246, 258.)

The number of individual organisms on the Earth is essentially infinite. If it is assumed that the average life span of an individual is a year — a day would probably be nearer the truth — then one must grip the fact that this infinitude of individuals is each year wiped out, and replaced by reproduction. Such an almost explosive expansion of a population under favorable conditions is appalling, though true, and serves to afford an appreciation of the enormous realized and unrealized potentialities of living matter to make more living matter — to reproduce. “The problem of organic evolution is that of the evolution of an organic mass consisting of an infinitude of individuals reproduced during an infinitude of generations.”

Something must — does — suppress the inherent power of each species to overpopulate the Earth, and Darwin emphasized the STRUGGLE FOR EXISTENCE between the individuals of species. Since the struggle is so keen, a variation, however slight, which fits — adapts — an individual better to its surroundings than its neighbors are adapted, will, more often than not, give its possessor an advantage in the struggle, and accordingly the latter will



FIG. 239. — A few varieties of domestic Pigeons. Over one hundred and fifty different breeds have been derived by selection from the wild Blue-rock Pigeon, some of which “differ fully as much from each other in external characters as do the most distinct natural genera.” (Darwin.) 1, Blue-rock Pigeon, *Columba livia*, ancestral form; 2, homing; 3, common mongrel; 4, archangel; 5, tumbler; 6, bald-headed tumbler; 7, barb; 8, pouter; 9, Russian trumpeter; 10, fairy swallow; 11, black-winged swallow; 12, fantail; 13, carrier; 14, 15, bluetts; bird between 14 and 15, a tailed turbit. (From photograph of an exhibit in the United States National Museum.)

tend to survive and to pass on the favorable variation to its progeny. Thus by NATURAL SELECTION is brought about THE SURVIVAL OF THE FITTEST — the survival of those individuals, and therefore species, which are best adapted to the peculiar conditions of their environment and mode of life. And note, this offers an explanation of the fact of *adaptation* itself — perhaps the most striking phenomenon which organisms exhibit.

This is all so simple from one point of view and so confusingly complex from others that it may well be restated in a couple of sentences by Darwin himself: “As many more individuals of each species are born than can possibly survive, and as, consequently, there is frequently recurring struggle for existence, it follows that any being, if it vary however slightly in any manner profitable to itself, under the complex and sometimes varying conditions of life, will have a better chance of surviving, and thus be naturally selected. From the strong principle of inheritance any selected variety will tend to propagate its new and modified form.”

Nothing succeeds like success, and once started Darwin's theory gradually swept nearly all opposition away. Indeed, some of its advocates in their enthusiasm extended Darwin's theory to a point not justified by his own conservative statements. Then, as was to be expected, the reaction came. One objection after another was raised as the problem was studied from nearly every standpoint by biologists the world over. But it is unnecessary to obscure the main issue by entering into these controversies. What is the status of the theory of natural selection to-day? The answer must be sought in the light of genetics. (Figs. 180, 239.)

### 3. *Genetics and Evolution*

Evolution is not a closed book — an event which has been completed in the past — but a process which is actively going on now. It may well be an accelerating process that is gaining momentum. Perhaps it is even to-day but little beyond the beginning of its revelations. “Nothing endures save the flow of energy and the rational order that pervades it.” And there is every reason to believe that the factors involved in present evolution are the same as those which have operated in the past. This UNIFORMITARIAN doctrine has proved productive in explaining the evolution of the Earth, and all the available evidence indicates that this viewpoint will prove — is proving — equally valuable in understand-

ing the origin of the diverse inhabitants of the Earth. We now realize that organic evolution is a bird's-eye view of the results of heredity since the origin of life — the facts of inheritance hold the key to the factors of evolution. Therefore we shall consider the relations of recent discoveries in genetics to the evolution problem — to the origin of the fitness of organisms.

**SELECTION.** The process of selection has long been successfully practiced by man to establish desirable types of domestic animals and plants, and, as we know, Darwin assumed that a somewhat similar but automatic selective process determines the survival of the better adapted wild forms in nature. Darwin clearly recognized that selection in itself can produce nothing — its efficacy depends on the materials afforded by variation. But he did not and, of course, could not make the modern sharp distinction between modifications, recombinations, and mutations. In general he accepted all variations as at the disposal of selection, but emphasized the importance of small, finely-graded fluctuating variations in gradually producing, through many generations, a cumulative effect in the direction of selection — variations that to-day we know are, in part, modifications.

The modern approach to the critical analysis of significant variations was opened by the work of two botanists, deVries and Johannsen. DeVries laid stress on the importance of discontinuous variations which he called **MUTATIONS** — a class of variations that we have already discussed; while Johannsen made clear that in a

homozygous germ complex, or **PURE LINE**, selection is ineffective, as will appear beyond.

Some of the problems of selection will be clear from an example. Take, say, a quart of beans and sort them into groups according to the weight of each bean. Then put each group into a separate cylinder and arrange the cylinders in a series according to the

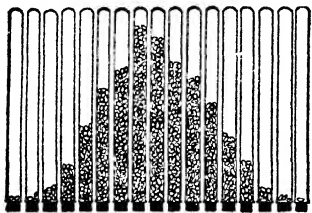

FIG. 240. — Diagram to illustrate a quart (population) of beans assorted according to weight.

weight of the enclosed beans. Now if we imagine a line connecting the tops of the bean piles in the cylinders, it takes the form of a *normal curve of probability, or variability curve*. A similar figure

would be obtained by the statistical treatment of nearly all fluctuating characters among the members of any large group of organisms, or of the size of the grains in a handful of sand, or the deviations of shots from the bull's-eye in a shooting match. Therefore the variations with respect to a given character very closely approximate the expectation from the mathematical theory of probability, or chance, and the reasonable conclusion is that such finely-graded fluctuating variations are a resultant of a large number of factors, each of which contributes its slight and variable quota to the expression in a given individual. (Figs. 240, 241.)

The question is, what results are obtained by breeding from individuals which exhibit such a fluctuating variation to, let us

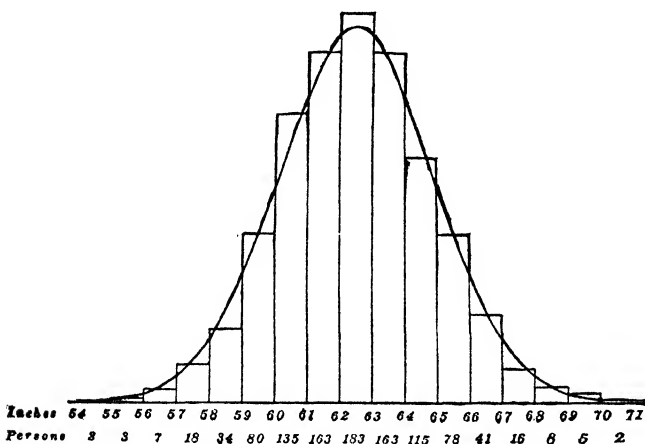

FIG. 241. — Normal variability curve plotted from measurements of the height of 1052 women (population). The height of each rectangle is proportional to the number of individuals of each given height. (From Kellcott, after Pearson.)

say, a greater degree than that of the mean of a mixed POPULATION? One will perhaps expect, and rightly, that the offspring usually will exhibit the character to a less degree than the parents but to a greater degree than the population. The top (mode) of the curve will have moved, so to speak, slightly in the direction of selection. Now, by continuing generation after generation to select as parents the extreme individuals, is it possible, with due allowance for some regression, to take one step after another indefinitely, or until the character in question is expressed to a degree which did not exist previously? The experience of practical breeders



gives a partial answer, since the continual selection of the best animals for mating and the best plants for seed has been a profitable procedure. But it has long been known that after a certain amount of selection has been practiced it may cease to be effective, and thenceforth serves chiefly to keep the character at the higher level attained. (Fig. 242.)

The crux of the matter is in regard to exactly what the variations are. Both modifications and recombinations are usually included, and this mixture of non-heritable and heritable variations

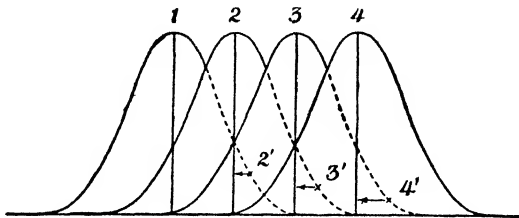

FIG. 242. — Schematic representation of the effect of selection from the viewpoint of Galton's 'law of filial regression.' 1, Mode before selection; 2, 3, 4, new (successive) modes, the results of selections of individuals at 2', 3', 4'. The mode has been shifted in the direction of selection (toward the right). But there has been each time an amount of regression indicated by the length of the arrows.

is what makes confusion. If we rule out recombinations by inbreeding or by self-fertilization of homozygous individuals, soon we establish **PURE LINES**. Then the variations are all modifications and selection is ineffectual with characters which are not inherited.

The importance of this point was discovered by Johannsen in careful experiments on the inheritance of characters in single pure lines of a brown variety of the common garden Bean. For example, by keeping the progeny of each individual bean separate from that of all the rest, he was able to isolate a number of pure lines which differed in regard to the average weight of the beans. Thus selection resolved the bean population with which he began into its constituent 'weight types,' or lines, each of which exhibited a characteristic variability curve of its own with a mode departing more or less from that of the population. But when Johannsen selected *within* a pure line (ruled out recombinations) nothing at all resulted; he was unable to shift the mode because he was dealing with non-heritable characters. In other words, selection sorts out preëxisting pure lines (lines with homogeneous germinal constitu-

tion) from a population and then stops — though if selection is stopped the isolated lines usually merge soon again into the original population. A mutation must occur in the pure line for selection to be effective — but by the mutation the single pure line becomes two. (Fig. 243.)

Thus the pure line concept has served to clarify our ideas in regard to selection by focussing attention on the actual nature of the variations being dealt with — to make a sharp discrimination between modifications, which are a result of environmental influences recurrent in each generation, and variations that are heritable because they are the result of changes in the germ plasm.

However, it will be recognized at once that, in general, the animal breeder, as well as Nature, deals with hybrid stock, heterozygous in regard to many characters, rather than pure lines. Even pure lines do not stay pure — mutations occur. Here selection has ample material at its disposal so it

can and does isolate new combinations and accumulate mutations in the direction of selection. If it is carried on sufficiently long, the extent of the change may be very great: a more or less steady change in the direction of selection when mutations are available.

Although selection is not 'creative,' it is effective: the appre-

Pure Line

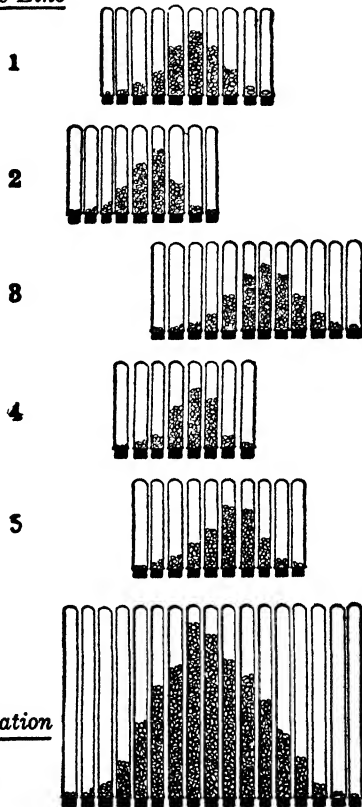

FIG. 243. — Diagram to illustrate a population of beans and its five component pure lines. The beans are assorted according to weight. Tubes containing beans of the same weight are placed in the same vertical row. See Fig. 240. (From Walter, after Johannsen.)

ciation of its limitations has but accentuated its possibilities. NATURAL SELECTION may automatically act as a 'sieve' and sort out the new combinations and mutations presented — retain the fit and discard the unfit — and so afford a natural explanation of adaptation. (Figs. 179, 239.)

METHOD OF EVOLUTION. A synoptic view of some of the essential facts, presented from a different angle, may serve to clarify our view of evolution as fundamentally a complex problem in genetics.

In the first place, we have seen that though variations are the rule and not the exception, some are of importance for evolution and some are not. All the evidence indicates that the effective variations are germinal and not somatic. Changes arising in the soma — modifications — are unable to attain representation in the germ so that they are 'born again,' although modifications renewed by the soma in each generation may enable a race to survive until appropriate recombinations or mutations appear. Evolution must be brought about by changes in the germinal complex — by the evolution of the germ plasm itself. Accordingly selection must operate to eliminate the unfit germ plasm (genotype) rather than the unfit soma (phenotype), though as a matter of fact the fitness of an individual is determined largely by its somatic characters. Dominant genes are directly within the reach of natural selection, whereas recessive genes may slip by because they are frequently concealed by dominants. The latter is a much more select, and selected, group: recessives may be the "skeleton in the nuclear cupboard of the race." We know that inbreeding, *e.g.*, cousin-marriages in man, often reveals recessives because relatives are likely to carry the same recessives and so afford more chance for them to meet and become expressed in the offspring. This presents a complication of the mental picture of the operations of selection which did not exist before our modern concept of phenotype and genotype. Since individuals frequently belie their genotypic condition — what they can pass on to their progeny — natural selection has, so to speak, a more devious though not less sure path. (Fig. 182.)

Secondly, how does the germ plasm change? It will be recalled that germinal alterations result from the usual processes of recombination and crossing-over, as well as from the more radical mutations — chromosomal aberrations and intrinsic gene changes.

These afford a wealth of opportunities for alterations in the germ plasm and so for the appearance of new characters in organisms. Indeed the significance of fertilization, which, of course, is at the basis of hybridization, can hardly be overemphasized at this point. It provides new combinations not only of established germinal factors but also of such mutations as occur, and so affords opportunity for relatively rapid germinal change. (Figs. 167, 189, 196.)

True it is that mutations seem to be infrequent in comparison with non-inheritable changes of somatic origin, nevertheless it must be borne in mind not only that somatic changes are more readily apparent, but also that the majority of the mutations which occur lead to a decrease in vitality or even to death. This is to be expected, for a random change in a highly complicated mechanism such as a living organism, which has long survived in a severely competitive environment, is far more apt to upset than to improve the nicety of its internal and external adaptation; natural selection is conservative unless a changing environment is presenting new conditions to be met.

Relatively little information is available in regard to the basic factors that induce mutations, but we have seen that recent experimental work indicates that environmental factors, such as irradiation, etc., acting directly on the genetic complex are not without influence — mutations have been produced. Indeed it seems probable that both external and internal environmental conditions, particularly the new cellular environment of the genes following hybridization, are potential inducers of genetic change and so of new variations at the disposal of natural selection. However, when all is said, we are far from any appreciation of the physico-chemical changes in the germinal material itself that are responsible for the new characters. Characters may emerge that, at least, are not recognizable as the computable or additive result of newly associated genes — the expressions of the genes may change, new properties may emerge — “emergent evolution.” But witness the properties of water that emerge from a certain association of hydrogen and oxygen!

One may well inquire whether geneticists in their extensive experiments during the past two decades have succeeded in ‘creating’ a new species. And the answer is largely determined by one’s concept of a species — a problem we have already discussed. It is fair to say that some biologists hold that new species have been

'created,' while others who are more conservative prefer to consider the new forms as 'artificial species.' Probably all would agree that some of the new types would be regarded as true species were their origin not actually known. The question, however, is not so important as it may, at first glance, appear. The essential fact is that we now understand, at least to a considerable extent, the mechanism of inheritance and variation that is at the basis of similarity and dissimilarity of individuals, parents and offspring — the mechanism that surely is crucially involved in the differentiation of groups of similar individuals, or species.

To epitomize — these facts from genetics, taken in connection with the wealth of data from geographical distribution, the succession of types in the geologic past, and so on, give us the modern background for attempting to form an opinion of the method of evolution. The opinion of most biologists is that natural selection in general is a guiding principle underlying the establishment of the adaptive complexes of organisms. Evolution is the result of mutations, germinal variations, largely, though not entirely, independent of environing conditions. Many of these variations give rise to characters which neither increase nor decrease the adaptation of the organism, and consequently are neutral from the standpoint of its survival. With regard to such characters natural selection is essentially inoperative. Other germinal changes occur, some of which produce adaptive and others unadaptive characters, and here natural selection is effective. It may eliminate the unadaptive and leave the adaptive variations and so make possible the survival value of the latter in the struggle for existence. The germ plasm never ceases to experiment, or natural selection to discover. Variability affording opportunity for adaptability is expressed in evolvability — perhaps the most profoundly significant characteristic of life.

So, it will be noted, this is essentially a clarified view of Darwin's idea of natural selection that has been made possible by recent intensive studies of the intrinsic nature and the origin of variations. Natural selection still affords the most satisfactory explanation of that coördinated adaptation which pervades every form of life: it shows how nature can be self-regulating in establishing adaptations. But it is probable — indeed, positive — that there are more factors involved than are dreamt of in our biology.

In the words of Thomson: "The process of evolution from in-

visible animalcules has a magnificence that cannot be exaggerated. It has been a process in which the time required has been, as it were, of no consideration, in which for many millions of years there has been neither rest nor haste, in which broad foundations have been laid so that a splendid superstructure has been secured, in which, in spite of the disappearance of many masterpieces, there has been a conservation of great gains. It has its outcome in personalities who have discerned its magnificent sweep, who are seeking to understand its factors, who are learning some of its lessons, who cannot cease trying to interpret it. It looks as if Nature were Nature for a purpose" — but this thought carries us beyond the accepted sphere of science into the great fields of philosophy and theology.

## CHAPTER XXIV

### BIOLOGY AND HUMAN WELFARE

Man is part of a web of life which he continues to fashion, and the success of his weaving depends upon his understanding. — *Thomson.*

Now that we have made a general survey of the foundations of biology, it is important to consider some of the outstanding contributions of biology to human welfare — contributions made, for the most part, within a century, but already so interwoven with our everyday life that they have become indispensable.

Strange as it may at first glance appear, usefulness is not the basic standard of value adopted by most scientific men: the discovery of truth is their aim, lead where it will. Although their controlling motive is increase of knowledge and enlargement of our outlook on nature, it is nevertheless a fact that the practical application of their discoveries is responsible for most of the conditions which constitute the environment of modern life. "Science brings back new seeds from the regions it explores, and these seem to be nothing but trivial curiosities to the people who look for profit from research, yet from these seeds come the mighty trees under which civilized man has his tent, while from the fruit he gains comfort and riches." Indeed, the supreme test of the intellectual life of a community is the importance which it attaches to research and creative intellectual effort. Unless research is held in high esteem, with adequate facilities for its maintenance and adequate rewards for those who devote themselves to it, the development of applied science will be retarded.

One of the most surprising illustrations of the way in which seemingly useless biological research often reveals itself almost overnight as of the greatest utility to business, is afforded by the present interest of the oil industry in certain Protozoa known as FORAMINIFERA: not living Foraminifera but fossil forms from the geological past. A short time ago oil companies were wasting large sums in sinking drills from which no oil came: frequently such a drilling cost as high as sixty thousand dollars, eventually to be paid chiefly by the motor-car owner. Then it was noted that

Foraminifera were brought to the surface with the drilling, and the problem was to determine whether the species found in material, from relatively near the surface in drills that proved to be oil-bearing, could be distinguished from those from dry drills. Accordingly the companies turned to the United States National Museum

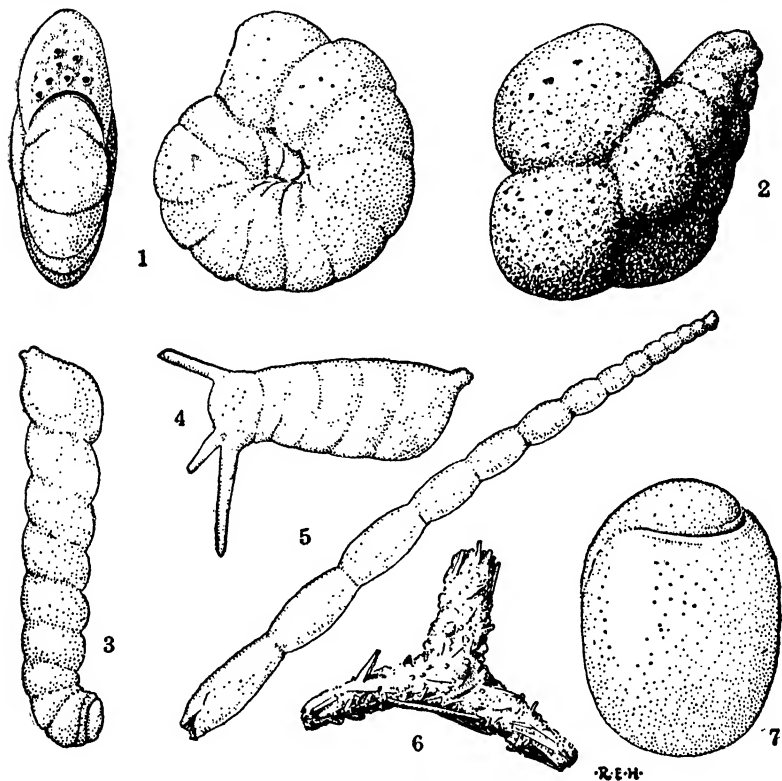

FIG. 244. — Shells of several species of Foraminifera, considerably magnified. 1, *Cyclammina pauciloculata*, two views; 2, *Globotextularia anceps*; 3, *Marginulina ensis*; 4, *Vagulina spinigera*; 5, *Nodosaria filiformis*; 6, *Rhabdammina abyssorum*; 7, *Chilostomella grandis*.

which has made a practice of gathering and preserving samples of microscopic life from all parts of the world: material which the layman would undoubtedly regard as refuse and throw away. Thanks to a lifetime spent in studying Foraminifera, one expert was able to make the necessary determination, and his knowledge when applied in the oil fields resulted in saving the industry many millions of dollars. Whereas the small governmental appropriations



for this biologist's work had been considered by many an economic waste, to-day it is reported that the annual income tax on the salary his services command from the oil industry repays many-fold to the Government the annual grants that formerly were made to him. (Figs. 20, 244.)

Hence it is far from true that so-called pure science and applied science are distinct and independent activities. There is only one kind of science — science aspiring for truth and knowledge, and there could be no application of science unless that knowledge previously existed. Great innovations are chiefly facile applications of truths which their authors have pursued for their own sake, and in our most theoretical moods we are frequently nearest to the most practical applications.

Indeed, some of the great biological generalizations with which we have become familiar on previous pages have in everyday affairs a profound practical significance which is easily overlooked. For example, the cellular structure of all living things — implying the existence of a fundamental similarity in organization throughout the living world. Again, the basically similar life-stuff, protoplasm — demonstrating that all living nature is united by a common bond not only of cellular organization but also of protoplasmic basis to which all life phenomena are referable. Still again, the transformation by protoplasm of non-living material into living material — proving that living matter is ordinary matter peculiarly organized. And finally, organic evolution. All nature is one.

These and other great biological truths have a far-reaching import to everyone, because collectively they unmistakably lead to the grand conclusion that human life must be interpreted in terms of all life. Man must conform to the general order of living nature of which he is an integral but dominant part. Remove one of the essentials of life and he perishes like the beasts. But he differs in capacity to understand and to take advantage of circumstances. Human welfare, therefore, demands that Man must 'control' nature by consciously adapting himself to it. Indeed, the chief purpose of education is the adaptation of the individual and the promotion of adaptability — adjustment to the basic internal and external conditions of life without a loss of plasticity. Thus biology affords the natural foundation of the science and art of right living which human welfare demands.

## A. MEDICINE

Health — the adaptation supreme — is a priceless possession whether it be estimated from the standpoint of the well-being of the individual or in terms of national wealth. Accordingly, medicine, in the broadest sense of the word, is without doubt the most important aspect of applied biology. Human anatomy and physiology, on which the foundations of medicine rest, are merely special parts of the general sciences of anatomy and physiology of all organisms. In fact the interpretation of human anatomy is impossible except in the light of the comparative anatomy of Vertebrates, while human physiology owes its present state of development to the fundamental principles derived from experimentation on the lower animals. And hope for further advance is chiefly dependent upon similar investigations on animals which have been rendered insensible to pain by anesthetics. To mention one example: experimental surgery practiced on animals has demonstrated the possibility of innumerable operations which no conscientious surgeon would have ventured to perform for the first time on Man. In the words of Darwin who gave up the sport of hunting on account of his great sympathy with the suffering of animals: "Physiology can make no progress if experiments on living animals are suppressed, and I have an intimate conviction that to retard the progress of physiology is to commit a crime against humanity."

1. *Microorganisms and Disease*

No one will gainsay that discoveries in preventive and curative medicine rank amongst the most important contributions of scientific research to civilization, and nearly all have as their foundation studies by generations of biologists. Though Pasteur's first investigations were in chemistry, his subsequent work, which pointed out the way of preventing and eradicating diseases due to microorganisms, followed naturally from his discovery that the souring of wine and milk is the result of the activities of organisms from the air which induce chemical changes. Injure the skin of a grape, and organisms from the atmosphere enter and fermentation begins. Exclude air or sterilize it, and fermentation is prevented. Lister immediately saw the importance of this for surgery, and modern aseptic surgery — one of the greatest blessings of mankind — was born. (Figs. 152, 278.)

Proceeding on the theory that since fermentation is the result of the activities of microorganisms, certain diseases of plants and animals are likewise caused by the invasion of the body by similar germs, Pasteur's early success in preventive medicine came from the study of cholera in French Fowls and anthrax in Sheep and Cattle. The treatment he employed reduced the death rate of the animals from about ten per cent to less than one per cent, and saved the French nation in twenty years not less than the amount of the war indemnity of 1871. Then Pasteur devised the treatment for

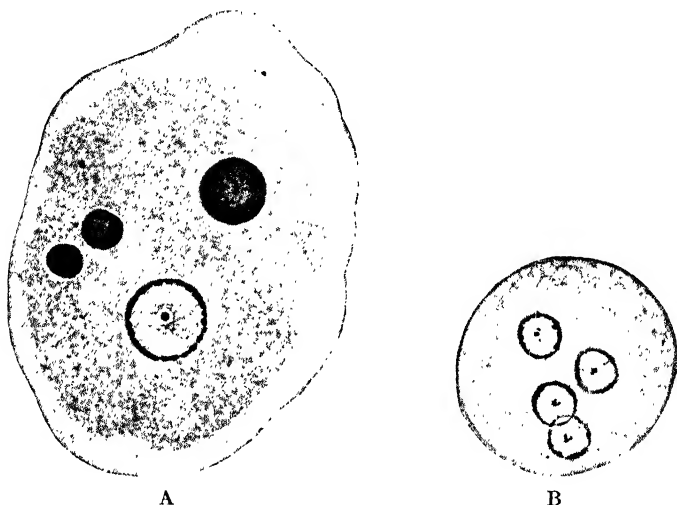

FIG. 245. — *Endamoeba histolytica*, a parasitic Amoeba of the human intestine, which gives rise to amoebic dysentery. A, active Amoeba showing nucleus and three ingested human red blood corpuscles; B, encysted Amoeba with four nuclei, preparatory to division into four individuals. (Redrawn, after Dobell.)

rabies. The human fatalities from this disease, usually arising by infection from the bite of a 'mad' Dog, fell almost at once from nearly one hundred per cent to less than one per cent.

During the past half-century a host of investigators, following the lead of Pasteur, have secured undreamed-of results in discovering preventive measures and curative treatments for a long series of diseases of Man, domestic animals, and plants. One thinks immediately of diphtheria, tuberculosis, bubonic plague, typhus fever, malaria, yellow fever, syphilis, amoebic dysentery, and African sleeping sickness — all the results of the infection of Man

by microscopic organisms. It is hard to realize that so recently as 1884, Koch, probably the greatest successor of Pasteur, proved that tuberculosis is caused by a specific type of Bacteria, and thereby revolutionized the treatment of this disease which has been estimated to cause about one-seventh of all the deaths in the world each year.

Only second in importance to the prevention of diseases of Man that are due to microorganisms, is the suppression of diseases of

## COMMON EPIDEMIC DISEASES

Note Recent Years When Microbic Causes Were Established

Anthrax ( <i>Splenic Fever</i> ) 1876 Asiatic Cholera 1883 Bubonic Plague 1894 Diphtheria 1884 <small>(Antitoxin discovered 1890)</small> Dysentery 1898 Glanders 1882 Gonorrhoea 1879 Infantile Paralysis 1909 Influenza 1892 Leprosy 1892 Malaria 1880 <small>(Transmission by Mosquitoes established 1897)</small>	Malta Fever 1887 Meningitis 1887 Pneumonia 1884 Relapsing Fever 1873 Syphilis 1905 Tetanus ( <i>Lockjaw</i> ) 1889 Tuberculosis 1884 Typhoid Fever 1884 <small>(Immunizing Vaccine established 1896)</small> Yellow Fever <small>(Transmission by Mosquitoes established 1900)</small>
-----------------------------------------------------------------------------------------------------------------------------------------------------------------------------------------------------------------------------------------------------------------------------------------------------------------------------------------------------------	----------------------------------------------------------------------------------------------------------------------------------------------------------------------------------------------------------------------------------------------------------------------------------------------------------------------

*Several fevers are transmitted by lice or other insects -  
 bubonic plague by rats, and sleeping sickness by the tsetse fly. This knowledge has shown how to prevent the spread of these diseases.*

Council on Medical Education and Hospitals  
 AMERICAN MEDICAL ASSOCIATION

domestic animals. For example, the Chief of the Bureau of Animal Industry estimates that the Bacteria which produce infectious abortion in Cattle are responsible for an animal loss of approximately fifty million dollars each year in the United States. And the study of this disease is proving of increasing significance from the recognition that undulant fever in Man is caused by a member of the same group of Bacteria — an excellent instance of how knowledge leads to further knowledge.

Indeed, the way interlocking data from several biological fields are frequently necessary to determine the causative agent of a

disease can, perhaps, be best illustrated by a brief outline of the development of our knowledge of malaria, yellow fever, and syphilis.

**MALARIA.** From ancient times malaria, as the name indicates, was supposed to be due to foul air, especially from swampy regions, but the first step toward the correct explanation was made in 1880 when Laveran found certain microscopic parasites always present in the blood of malarial patients. Nearly two decades later Ross demonstrated similar parasites in the body of a Mosquito, and

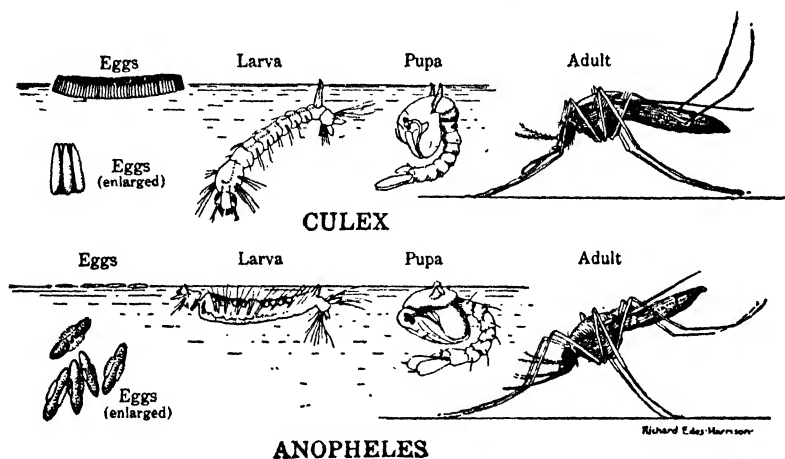

FIG. 246. — Mosquito life histories. Mosquitoes of the genus *Anopheles*, which transmit malarial parasites, differ from the common *Culex* in every stage. When at rest the adult *Culex* holds its body parallel to the surface, whereas *Anopheles* holds it nearly perpendicular.

then a long series of studies by various investigators, among whom Grassi stands foremost, showed that when a mosquito of the genus *Anopheles* bites a malarial patient, it secures with the blood some of the parasites such as Laveran had discovered, and thereupon the mosquito becomes the host of the Malarial organism. Within the mosquito, the parasite undergoes a complicated series of changes, including rapid reproduction. This finally results in myriads of parasites located in the salivary glands of the insect, ready to be injected into the blood of the next individual bitten and to begin the other phase of its life history in Man. (Fig. 223.)

So stated, it appears simple enough, but years of study by specialists on Insects (ENTOMOLOGISTS), by specialists on Protozoa

(PROTOZOÖLOGISTS), and by physicians highly trained in general medical zoölogy are behind the scenes in making clear the way to eradicate a disease which, it is estimated, each year costs the United States not less than one hundred million dollars and the British Empire three times that amount. In India alone it is respon-

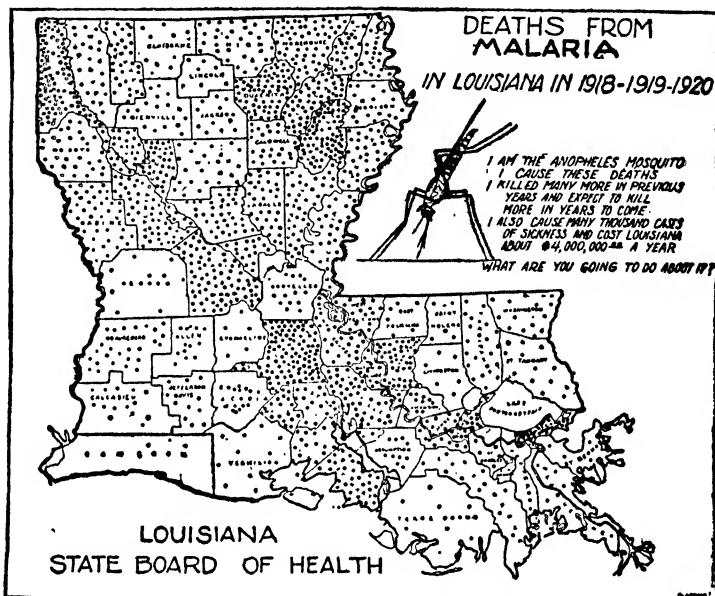

FIG. 247. — Map used in anti-malaria campaign in Louisiana. Each dot represents a death from malaria.

sible for a death list of more than a million people annually. (Figs. 246, 247.)

**YELLOW FEVER.** Proof that malaria is due to a Protozoön which can only be transmitted to Man by members of a certain genus of Mosquitoes, was largely the work of English, French, and Italian biologists; but the demonstration that another kind of mosquito, *Aedes*, is responsible for the transmission of the agent which causes yellow fever is due to Reed, Lazear, and other members of the United States Yellow Fever Commission working in Cuba in 1900. This was followed by the investigations of many biologists, with the result that to-day one may be vaccinated with a weakened virus of yellow fever and probably be rendered immune for several years.

Most inspiring is the long story of heroism and hard work which has made it possible to cope with yellow fever; made possible the building of the Panama Canal, since the earlier attempt by France was unsuccessful largely on account of its ravages. We even have to be reminded that half a million cases occurred in the United States during the past century: the epidemic of 1793 took a total of one-tenth of the population of Philadelphia, and that of 1878 killed more than thirteen thousand in the Mississippi Valley alone.

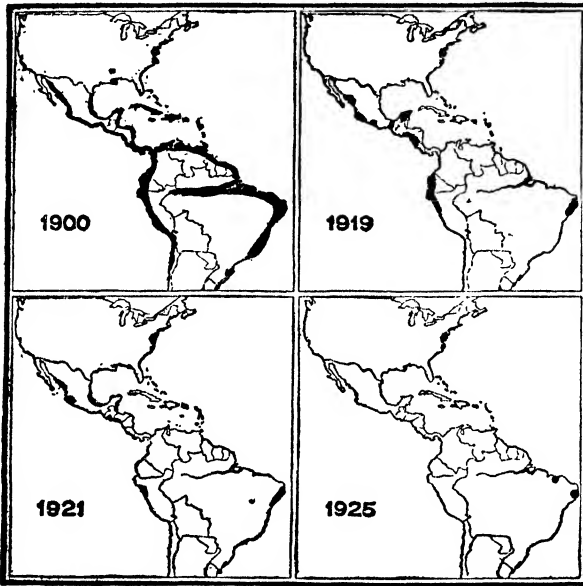

FIG. 248. — Results of a quarter century of yellow fever control. (From the Rockefeller Foundation.)

However, while this and more is true, the recent discovery of new sources of infection in the interior of South America and Africa has made the problem much more complex and the complete control of the fever less certain than it appeared to be a decade ago. (Fig. 248.)

**SYPHILIS.** The brilliant investigations, chiefly of the protozoölogist Schaudinn in 1905, revealed the unicellular parasite, *Treponema pallidum*, that is the cause of syphilis — one of the greatest scourges of mankind since it became widespread during the sixteenth century. The ravages of the parasite produce many symptoms — frequently a type of paralysis, or paresis, with a

gradual loss of the mental faculties and death. The discovery of the cause has made possible intensive studies of therapeutic measures to combat it, and the test of upward of a thousand chemical substances has resulted in the discovery of certain organic arsenic compounds of considerable specific value if employed in the early stages. This knowledge, supported by the enlightened attitude that is gradually being taken toward the disease, offers a brighter outlook for the future. While syphilis, of course, is not inherited, much of it in the world today is due to the infection of infants before or at the time of birth. (Fig. 249.)



FIG. 249. — *Treponema pallidum* (the spiral bodies) in liver of child with congenital syphilis. Highly magnified.

## 2. Parasitic Worms

Thus far we have been considering causative agents of disease which are popularly called microbes, and we must now turn from this "world of the infinitely little" to somewhat larger organisms which form a most important part of medical zoölogy. This field may be illustrated by various kinds of parasitic worms. (Fig. 250.)

**TREMATODES.** There are many parasitic Flatworms, related to the free-living Planaria, that comprise the group TREMATODA. Parasitic species exhibit, for the most part, complicated life histories which have taxed the patience and ingenuity of biologists to unravel. Among the numerous species, the Liver Fluke is perhaps of most interest. (Figs. 43, 156, 161, 251.)



The adult **LIVER FLUKE** is a worm about an inch long which lives in the bile ducts of the liver of Sheep, Cattle, Pigs, etc., and occasionally in Man. It is hermaphroditic, each individual possessing both male and female reproductive organs, and in its isolated position is almost continually producing fertilized eggs. In fact, one Fluke may liberate over five hundred thousand eggs

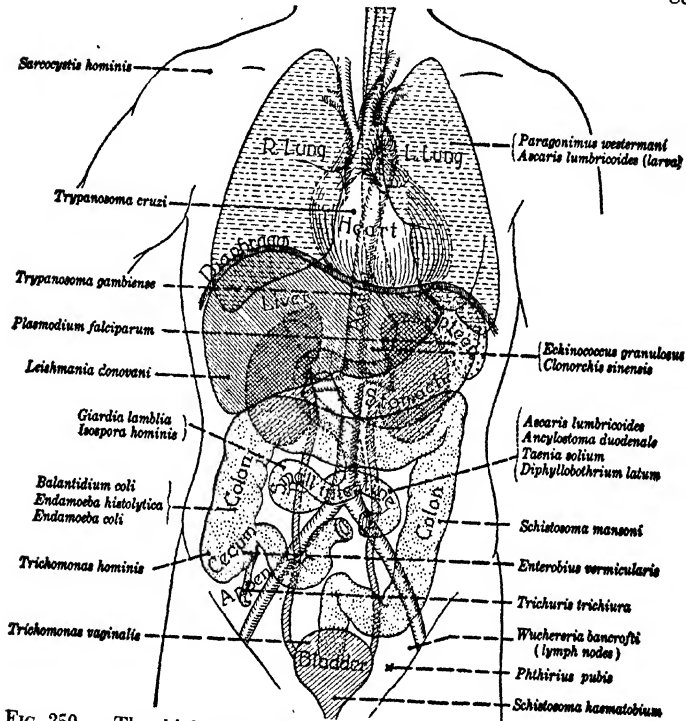

FIG. 250. — The chief points of localization of some of the parasites in the organs of the human body. At the left are Protozoa; at the right, Worms. (After Hegner.)

which pass down the bile ducts of the host (sheep) into the intestine and finally leave the body with the feces. An egg that happens to reach moisture develops into a ciliated larva, or **MIRACIDIUM**, which escapes from the egg-shell and swims about. For further development to occur the larva must encounter within a few hours a certain species of fresh-water Snail, otherwise death results. But once it has bored into a snail's body, the parasite receives

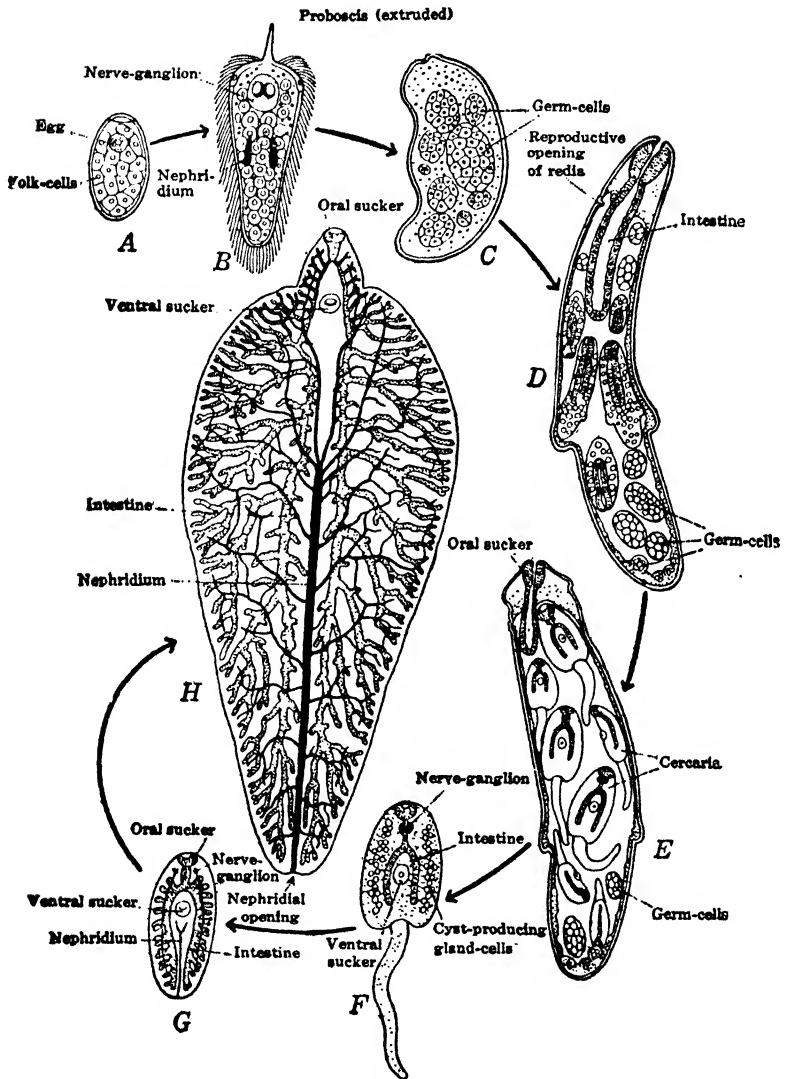

FIG. 251. — Life history of the Liver Fluke, *Fasciola hepatica*. A, 'egg'; B, miracidium; C, sporocyst; D, E, rediae; F, cercaria; G, encysted stage; H, adult (nervous and reproductive systems omitted). (From Hegner, after Kerr.)

a new lease of life involving a series of changes. After about two weeks it has become a sac-like creature, or **SPOROCYST**, which in turn proceeds to develop within itself a brood of another larval stage, the **REDIA**. Each redia liberated from a ruptured sporocyst usually gives rise to one or more generations of redia, and the final generation of these produces a third kind of larva, known as a **CERCARIA**.

All these stages have been arising in the snail's body, but now the swarm of cercariae emerges from the snail, and each swims about in the water and finally encysts on a blade of grass. Here again the life of the parasite hangs in the balance, for death follows unless the grass with the cyst is eaten by a sheep, and the cyst reaches the animal's intestine. This location successfully attained, the cercaria escapes from the cyst, and makes its way to the bile ducts where it soon develops into a mature Liver Fluke, the cause of liver-rot in sheep. The life history is completed.

The large number of eggs produced by a single Fluke increases the chances of a ciliated larva meeting the proper kind of snail, while the various generations within the snail multiplies many-fold the number of cercariae from a single egg, and just to that extent increases the opportunities for at least one to reach another sheep. This life history, while remarkable, is by no means unique, and is presented as a type which is broadly representative of a large group of parasitic Flatworms. No wonder that years of study are required by specialists in different branches of zoölogy to discover the various stages of the different species and determine their relationships.

**CESTODES.** The group of Flatworms known as the **CESTODA** comprises the numerous species of **TAPEWORMS** which infest the lower animals and Man. The best known species are *Taenia solium* and *Taenia saginata*, both living as adults in the human digestive tract, while the larvae of the former infest Pigs, and those of the latter, Cattle.

*Taenia* is a long ribbon-like worm comprising a small knob-like head, or **SCOLEX**, which is an organ for attachment to the lining of the human digestive tract, and a large number of similar segments, or **PROGLOTTIDES**. These are formed by growth just behind the scolex so that the oldest and largest proglottides are at the posterior end of the animal. (Fig. 252.)

The adult Tapeworm is hermaphroditic and each of the older proglottides contains both male and female reproductive organs, while the terminal 'ripe' ones are almost completely filled with eggs which have already developed into embryos. One by one the ripe proglottides become detached from the worm and pass from the host with the feces. For development to proceed further an embryo must be swallowed by a pig, whereupon it bores through the walls of the animal's intestine, passes to the voluntary muscles and there encysts. In this position it develops into the BLADDER-

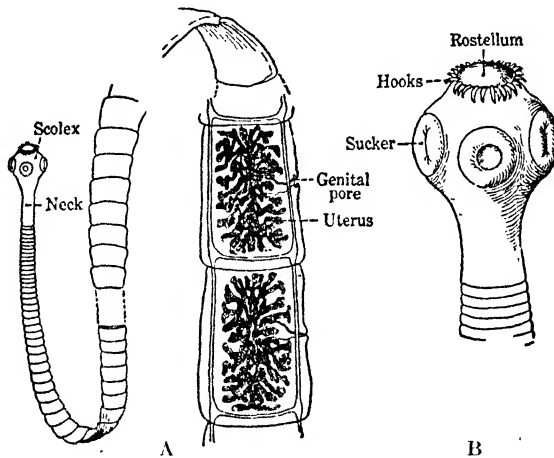

FIG. 252. — Tapeworm, *Taenia solium*. A, Anterior and posterior parts of a specimen about 3 feet long comprising some 900 proglottides. Uteri filled with eggs are shown in the last two proglottides. B, Scolex more highly magnified. (From Hegner.)

WORM, or CYSTICERCUS, stage. To complete the life history, infected meat, insufficiently cooked, must be eaten by Man. If this transfer is successfully accomplished, upon attaining the human digestive tract the parasite gradually assumes the adult form, the scolex becomes attached, and a series of proglottides begins to develop. (Fig. 253.)

Since Tapeworms which live as adults in Man and the higher animals secure their food by absorbing that of their host, they seriously interfere with nutrition, but larval stages are still more dangerous. Thus, the larvae of a tapeworm (*Echinococcus*), which lives as an adult in the intestine of the dog and other carnivores, form in the brain, liver, etc., of man, pig, and sheep large

vesicles, or **HYDATIDS**, usually with fatal results. Such larvae in the brains of sheep were a stumbling-block for the early exponents of

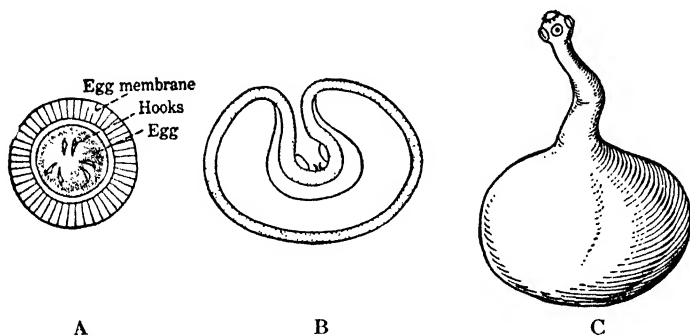

FIG. 253. — Stages in the development of a Tapeworm. A, egg with embryo; B, bladder worm (cysticercus) before head (scolex) is protruded; C, same after protrusion. (From Hegner.)

biogenesis, since, with the life history unknown, they could not account for the larvae except on the theory of spontaneous generation.

**NEMATODES.** Passing now to the **NEMATODA**, or **ROUNDWORMS**, we come to a group which, from the standpoint of medical zoölogy, is of as much importance as the Flatworms. Free-living forms are found literally everywhere in water, soil, and air, and blown about by the wind. Most of these are harmless, but some are of great economic interest because of their destructive action on the roots and other parts of plants. Among the species parasitic in Man and the higher animals, *Trichinella* and the Hookworm will serve as examples. (Fig. 44.)

**TRICHINELLA** is the cause of a serious disease in Man, Pigs, and Rats known as **TRICHINOSIS**. Man becomes parasitized by eating infected pork, insufficiently cooked, and pigs contract the disease by eating offal or infected rats. The larvae from the meat quickly mature in the human intestine, and each female worm produces nearly ten thousand larvae which bore through the intestinal wall, migrate throughout the voluntary muscles, and encyst there to await a possible getaway from the body at death. Since thousands of resistant cysts may occur in a single gram of muscle, the riddling of the tissues is not only very serious, but incurable. (Figs. 250, 254.)

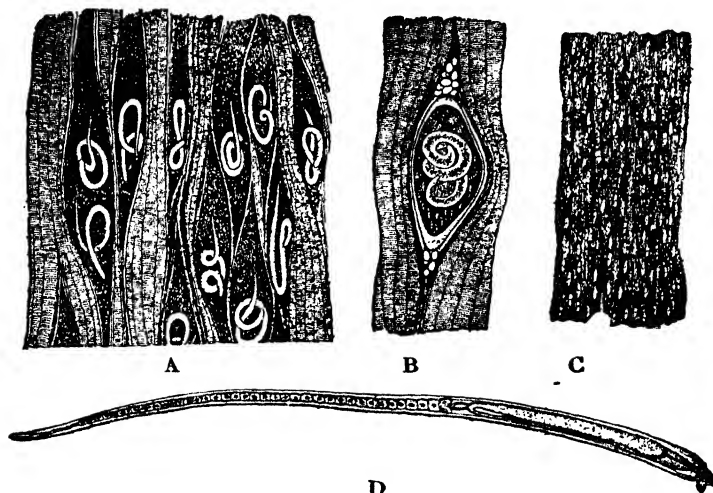

FIG. 254. — *Trichinella spiralis*. A, larvae free among muscle fibers; B, a single larva encysted among fibers; C, piece of pork containing many encysted worms, natural size; D, adult worm, highly magnified. (From Leuckart.)

The widespread distribution of the several species of Hookworms and their insidious effects make them also of great practical importance. Biological studies have demonstrated the process by which the tiny worms, just visible to the naked eye as whitish threads, are hatched in a warm moist soil, make their way through the skin of the human foot, enter the circulatory system, are carried to the lungs, and finally work to the intestine.

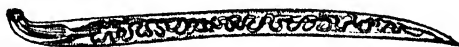

FIG. 255. — The American Hookworm, *Necator americanus*, highly magnified.

Here, as adults, they become attached, feed upon the blood of their host and liberate eggs. These pass out with the host's feces to become the source of infection for others. The spread of knowledge of the essential facts and of vermifuges to expel the parasites has been an important contribution of the International Health Board which has carried on a campaign in over fifty countries. It has been estimated that not less than two million persons are afflicted with the disease, but the recently acquired facts in regard to the parasite should result eventually in its almost complete eradication. (Fig. 255.)

### 3. *Health and Wealth*

It has been aptly said that health and wealth are essentially synonymous, and this is amply shown by the fact that medical progress is reputed to have added at least twenty years to the average life span of Man during the past century — mainly years of the highest efficiency from the age of thirty-five to fifty-five years. It is conservative to say that the increase in longevity has effected a saving of more money than has ever been expended in support of every kind of scientific investigation, and this without taking into account the economic value of the lives or the immensely greater factor of human happiness which follows from healthful and unbroken family life.

The same can also be said for the leading rôle which medical zoölogy has played in rendering vast regions of the tropics almost as safe for human habitation as the temperate regions of the Earth — regions which must offer an outlet for the rapidly increasing human population. Statistics make clear that the population of the world has more than doubled during the last century; what it will do during the next century experts in vital statistics are actively computing. But this much is certain: it is merely a matter of time before regions now untenanted by civilized Man must be encroached upon more and more, not only for food and other materials but also for a place of abode; and the first step necessary to make this possible is the survey of the innumerable biological competitors in the form of parasites, etc., which Man must encounter in adjusting himself to this environment.

Again, knowledge is power — the best investment from the standpoint of health and wealth is in support of research. It is easy to forget that combined studies on the life history of Bacteria, Fleas, Rats, and the rest have made impossible to-day such epidemics as have many times in the past swept over the world. During the Christian era more people have succumbed to the Plague than constitute the total population of the Earth to-day. It is easy to forget that the biological forces of disease are costing the United States nearly four billion dollars annually — a loss largely preventable by an efficient dissemination of knowledge and an efficient application of biological principles already well established. Civilizations in the past have succumbed to the on-

slaughters of pestilences, and the hope of our immensely more complex community life depends upon the development of knowledge of these living agents of disease.

## B. BIOLOGY AND AGRICULTURE

True it is that Man cannot live by bread alone, but it is equally true that the fundamental urge of all living things to secure food and to multiply is, in the final analysis, at the basis of human endeavor. Modern agriculture represents the body of knowledge accumulated by mankind during its slow progress toward civilization, involving increasingly exacting food demands as community life became more and more complex. Agriculture is, of course, dependent upon many fundamental biological sciences — indeed, agriculture is one aspect of applied biology — but merely a few examples must suffice to bring the most significant points before us.

### 1. *Plant and Animal Food*

As we know, all animals, including Man, are absolutely dependent for their food upon the photosynthetic activities of plants. Green plants must manufacture enough food for themselves, and to spare for the rest of the living world as well. Animals must have ready-made food which, after they have used it, is useless both for animals and for green plants. Here, it will be recalled, the Bacteria and other colorless plants come in and make possible the completion of the biological cycle of the elements in nature: put the materials in a condition in which they are again available to green plants. (Figs. 15, 16, 17.)

This intimate food interrelationship of all living organisms, which has been demonstrated by interlocking data accumulated by thousands of biochemical studies, is not only of profound theoretical interest, but also of incalculable practical importance in all problems of soil fertility, including soil composition and maintenance, crop rotation, etc. To coax greater productivity from the soil — “civilization rests upon the soil” — is a problem of no mean importance. One of its most crucial factors is the demand for the economical production of food for plants themselves; in particular, for an adequate supply of nitrogen in a form readily available for the use of cultivated plants.

A natural source of nitrogenous plant food is, of course, the



nitrogen of the atmosphere, trapped by Nitrogen-fixing Bacteria; but the artificial conversion of this gaseous element into solid forms suitable for fertilizers has taxed to the utmost the ingenuity of chemists. Finally after years of intensive laboratory study and experimentation, they have succeeded in developing industrial processes for accomplishing this result, which have created an enormous industry of world-wide extent and supplied agriculture with a cheaper source of this indispensable nitrogenous food for plants.

Soil investigations involving the coöperation of chemist and biologist lay the foundations for studies on seed planting, germination, and growth, which in turn lead to others on transplanting, grafting, and pruning, and on pollination, hybridizing, and developing new varieties of plants. Nearly every cultivated plant that is important for food or other purposes has been improved. The great body of practical information which the human race has accumulated from centuries of toil has been multiplied a hundred fold within merely the past generation, through the intensive work of investigators at Agricultural Experiment Stations, Colleges, and Universities throughout the world. (Page 283.)

But this indispensable work is only a small part of all that must be accomplished. Man's conquest of the plant kingdom has hardly begun, because the number of species already brought into his service is insignificant in comparison with the wealth of available kinds. Relatively few of about two hundred thousand known species of higher plants are cultivated, and most of these in merely an incidental way. There is every reason to believe that many plants not as yet employed possess intrinsic value at least equal to those under cultivation — "some neglected weed in the hands of a skilled botanist may one day revolutionize agriculture." Furthermore, the botanist must develop varieties of important plants which not only afford the largest yield, but also are most resistant to unfavorable climatic conditions and to disease; the forester must develop timberland both for the materials it supplies and the indirect effect it has on soil erosion and on water conservation for agricultural and other purposes; the entomologist and plant pathologist must devise means for holding in check destructive insects, as well as bacterial and related microscopic parasites of plants. All these and others must coöperate. For what does it profit us if we are robbed of our crops? (Fig. 268.)

## 2. *Insects Injurious to Animals*

The former Chief of the United States Bureau of Entomology informs us that Insects alone in this country continually nullify the labor of a million men, in spite of the annual expenditure of between two and three hundred million dollars in fighting insects, and if human beings are to continue to exist they must first win the war. This can only be accomplished by the labors of an army of patient and skilled investigators, and will occupy very many years, possibly all time to come. This is not only because the insect complex is enormous — there are possibly three million species of which only about six hundred thousand have been described — but also because insects achieved an important place on this globe many millions of years before Man came into existence, and to-day are probably the most perfectly adapted of all creatures to live under all sorts of environmental conditions. If this statement appears extreme, the following examples will serve to make clear some of the cardinal facts which are necessary for an appreciation of the stupendous problems involved.

Among this teeming insect population, probably the Botflies, Fleas, and Lice stand preëminent as parasites of Man and beast. Botflies of various kinds infest domesticated animals but rarely human beings. The most common HORSE BOTFLY attaches its eggs to the Horse's hair where the eggs can be licked off and swallowed. Then the larvae spend nearly a year attached to the lining of the stomach, and if present in considerable numbers cause irritation and serious digestive disturbances. When full grown the larvae pass out with the feces, pupate in the ground and emerge as adult botflies.

Again, the common OX BOTFLY deposits its eggs chiefly on the legs of Cattle, but when the larvae emerge, they penetrate the hide, and then wander through the tissues until the following spring. Finally they come to rest just under the hide of their host, which they puncture to get air. When the larvae are ready to assume the pupal state they burrow out, drop to the ground and there complete their life history. It is estimated that the monetary loss from the Ox Botfly alone in the United States is about one hundred million dollars annually, (Fig. 256.)

Fleas and Lice of various species are common parasites of the higher animals throughout most of the world. The JIGGER FLEA

of warmer climates is frequently a serious human pest because the female flea burrows into the skin when ready to deposit eggs. The Cat Flea, Dog Flea, and House Flea we usually consider merely a nuisance, but they are potential carriers of disease-producing

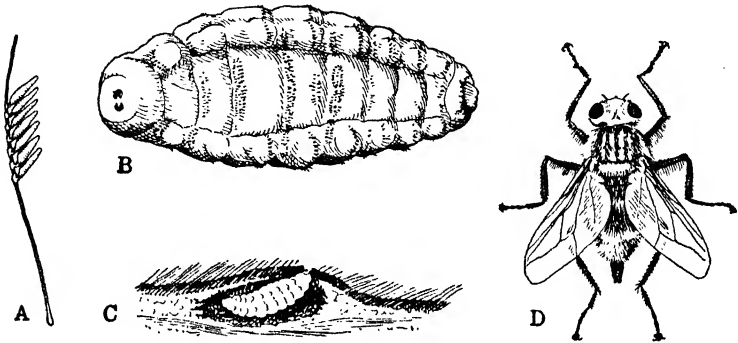

FIG. 256. — Ox Botfly, *Hypoderma lineata*. A, eggs attached to hair; B, larva; C, larva just beneath air-hole in skin of Ox; D, adult.

microorganisms. One might think that a life devoted to the study of fleas and lice could be more profitably spent, until we recall that expert knowledge of these animals was essential to discover that Trench fever in the World War was transmitted by lice; was es-

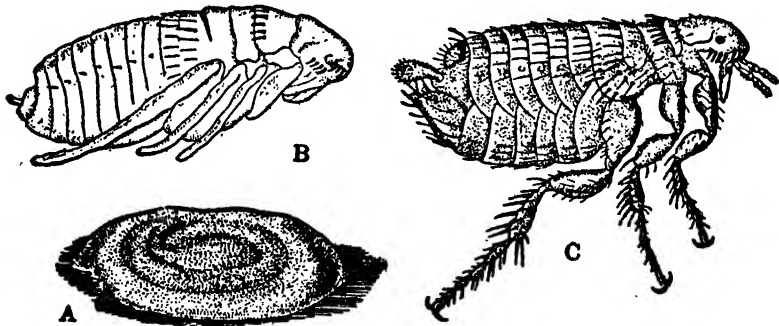

FIG. 257. — Dog Flea, *Ctenocephalus canis*. A, larva in cocoon; B, pupa; C, adult. (From Howard.)

sential to make clear that Bubonic plague, or 'Black Death,' is carried by fleas. (Fig. 257.)

It was long known that rats die in great numbers during a plague epidemic, and accordingly biologists set out to determine whether

there is any relation between the disease of the Rat and of Man, and found that Man is infected with the plague bacillus, *Bacillus pestis*, by being bitten by a Flea from an infected rat. Extermination of rats and fleas means the practical eradication of the disease, but in California the Ground Squirrels have become infected with the bacillus so the problem has become somewhat greater. Bubonic plague is doomed, though it has already taken an incalculable toll of human lives: even during the first four years of the present century it destroyed about two million people in India. Still more recently San Francisco has been fighting an outbreak of the

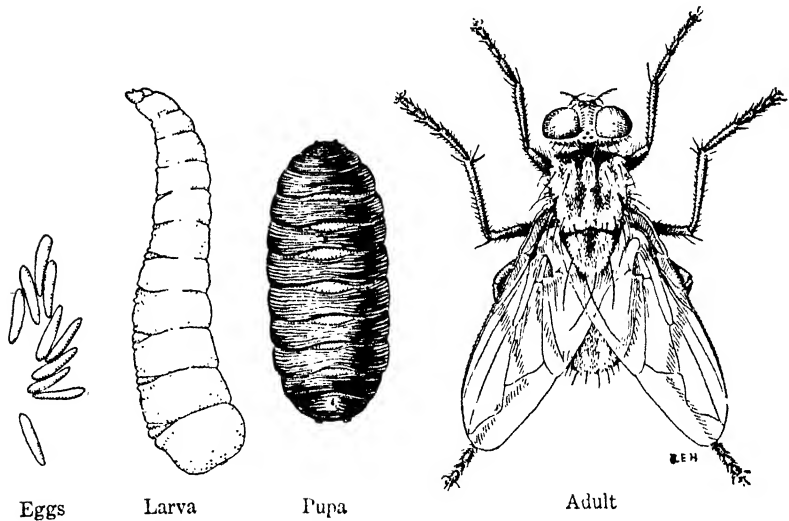

FIG. 258. — Life history of the House Fly, *Musca domestica*.

plague that not long ago would have been a national calamity; but it was immediately stamped out with the loss of comparatively few lives.

In brief, numerous parasitic Insects not only actually develop at the expense of animal tissue, but others act as the transmitting agents of Bacteria, Protozoa, etc., which are the actual parasites, as we have already seen in the case of malaria, yellow fever, and African sleeping sickness. And last, but not least, we know that HOUSE FLIES, which we tolerate as uninvited guests at our tables, have been shown to carry the germs of typhoid fever, tuberculosis, dysentery, and several other scourges. (Figs. 224, 248, 258.)

### 3. *Insects Injurious to Plants*

It has been stated, and truly, that it costs the American farmer more to feed his Insect foes than to educate his children: in fact, more than is expended for all the educational institutions in the United States, nearly twice as much as for our military and naval forces, and more than twice the loss by fire. And we all pay the bill. Every kind of plant supports many species of insects, although usually certain ones are especially destructive. Thus Oak trees are attacked by no less than a thousand kinds of insect pests; Apple trees by about four hundred, and Clover and Corn by some two hundred insect enemies. A few random examples obviously must suffice for our view of the field.

The ARMY-WORM is the larva of a brown Moth which sometimes becomes so numerous in regions east of the Rocky Mountains that the caterpillars have to migrate in search of food. Immense armies crawl along totally destroying the crops over large areas. Fortunately, the pest has its own insect enemies, the chief being certain Tachina Flies which lay their eggs on the caterpillars, and the larvae of the flies burrow into their bodies and finally destroy them. (Fig. 266.)

Of equal interest is the CABBAGE BUTTERFLY which was accidentally introduced from Europe into Canada in 1868, and has

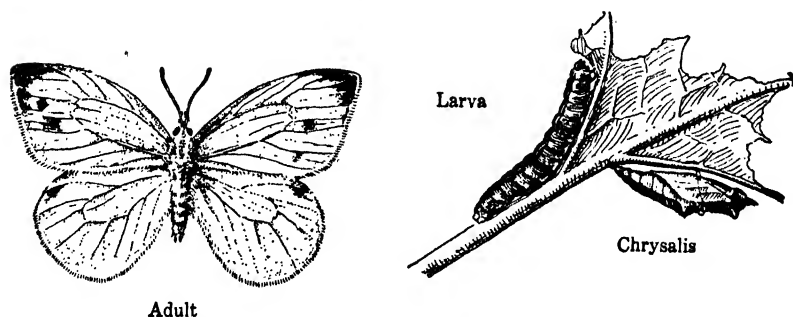

FIG. 259. — Life history of the Cabbage Butterfly, *Pieris rapae*.

gradually made the whole of the United States its field, even ousting a related native species. Many of the caterpillars of the Cabbage Butterfly are destroyed by parasites; one being a Brachonid Fly which was imported from its old home in Europe by entomologists for this special purpose. (Fig. 259.)

The POTATO BEETLE first began to attract attention about eighty years ago when it transferred its activities from certain weeds in the Colorado region to the recently introduced Potato plant, and since that time it has spread all over the United States and has emigrated to Europe to become one of the serious insect pests. Large masses of yellow eggs are deposited by the beetles on the under surface of Potato leaves which serve as food for the caterpillars until they are full grown and ready to pupate in the ground. Two broods of adults are usually produced annually to carry on the depredation.

Among the most destructive parasites of Wheat, Rye, and Barley, nearly the world over, is the HESSIAN FLY which was introduced into America toward the end of the eighteenth century. The life history is especially adapted to the growth of wheat, and two or three broods of the insect develop in one year. Fortunately, it has numerous parasites of its own that hold it somewhat in check.

The EUROPEAN CORN BORER has long been distributed over a large part of the Old World but only recently has reached America. Starting in New England, it is rapidly moving westward and bids fair before long to infest the entire corn-raising area of the continent. The destructive stage, of course, is the caterpillar which, throughout most of the insect's range, spends the winter in the stem of its food plant and gives rise to the adult moth early the following summer. Unfortunately, however, in New England there are two generations annually, one of which winters in the larval state.

The JAPANESE BEETLE was accidentally introduced into New Jersey from Japan about twenty years ago and since has spread rapidly through many of the eastern States, defoliating trees and shrubs and destroying lawns and golf greens. The larva spends the winter underground and the adult emerges the following summer.

It seems safe to say that the destruction wrought by the COTTON BOLL WEEVIL exceeds even its notoriety. During the first thirty-five years after its invasion of the United States from Mexico, it had to its account a wastage of upward of three billion dollars, not to mention other immense financial losses due to depreciated land values, etc. Probably each person in the United States pays annually ten dollars more for cotton fabrics than he would if this weevil did not exist. The injury to the Cotton plant is caused

both by the adults and larvae: the former by feeding and boring holes for their eggs, and the latter by injuring the developing

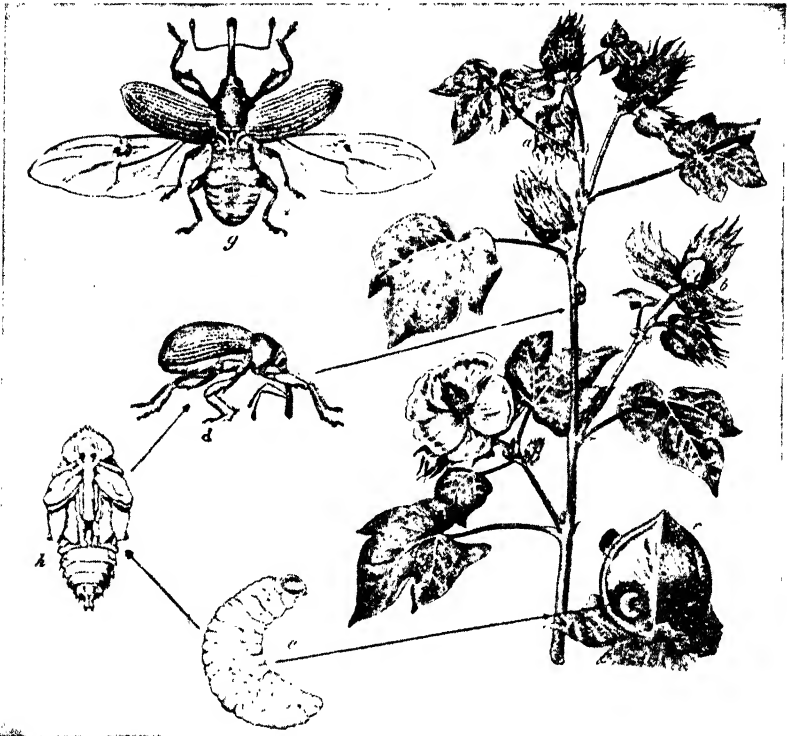

FIG. 260. — Life history of the Cotton Boll Weevil, *Anthonomus grandis*. On the right, a Cotton plant attacked by the Weevil, showing *a*, a dry infested 'square'; *b*, a 'flared square' with punctures; *c*, a cotton boll sectioned to show attacking Weevil and larva in its cell; *g*, adult female with wings spread as in flight; *d*, adult viewed from the side; *h*, pupa, ventral view; *e*, larva. (From Metcalf and Flint, after U. S. Department of Agriculture.)

flowers so that they either fail to bloom, or produce seeds with few cotton fibers. (Fig. 260.)

While SCALE-INSECTS are so small and obscure that they are only a name to all except specialists, they constitute economically one of the most important groups of the insect world. Scale-insects infest almost all kinds of trees and shrubs; in some cases doing merely temporary damage and in others actually killing the hosts. Among the myriads of species, the SAN JOSÉ SCALE is probably the most important, and since being brought to California from China

has spread all over the United States. The adult female insect lies permanently attached by its beak to the bark, underneath a tiny waxy scale which it secretes. Here eyes, legs, and antennae are lost and the sac-like creature sucks the plant sap and reproduces. It is estimated that the progeny of a single individual during one season would number thirty million if all were to survive. (Fig. 264.)

About forty years ago the vineyards of France, and later those of California, appeared to be doomed to destruction by the attacks of a species of minute plant lice, or APHIDS. The French government offered a large reward for an effective remedy, and many entomologists and botanists devoted all their time to the study of the problem. Eventually it was discovered that certain American wild Grapes were naturally immune to the pest. Accordingly by grafting the cultivated grape upon the resistant wild stock a combination was effected which saved the vineyards of both countries. (Figs. 222, 265.)

The MEDITERRANEAN FRUIT FLY appeared a few years ago in certain Florida orchards but the invasion apparently has been repulsed by the vigilance of the United States Bureau of Entomology and Plant Quarantine. It is the larvae of the fly that are the mischief-makers, because when they develop from eggs deposited in the fruit they soon render it unfit for human food. When we realize that the annual fruit and vegetable crop of Florida amounts to well over a hundred million dollars, it is no wonder that this fly is one of our most notorious foreign emigrants. But we maintain a defense on the Rio Grande against the Mexican Fruit Fly, and others throughout the country against our many native species of Fruit Flies, though the latter are held in check to a considerable extent by their own insect enemies. (Fig. 261.)



FIG. 261. — Mediterranean Fruit Fly, *Ceratitis capitata*. (From U. S. Department of Agriculture.)

Another great problem is the preservation of forest and shade trees from native and also imported pests. The enormity of the



loss attributed to this army of silent tree-killers is staggering. They destroy two-thirds as much of the nation's wealth each year as do forest fires — timber equal to one-fifth of the wood produced annually in the United States. At the present time these destructive insects recognize neither limits nor boundaries, for their march has received relatively little resistance. And resistance is not easy when we recall that some insects may travel hundreds of miles on the wings of the wind — aviators have trapped them more than two miles aloft.

The MOUNTAIN PINE BARK BEETLE, after invading the forests of the Northwest, now is threatening those of the Yellowstone

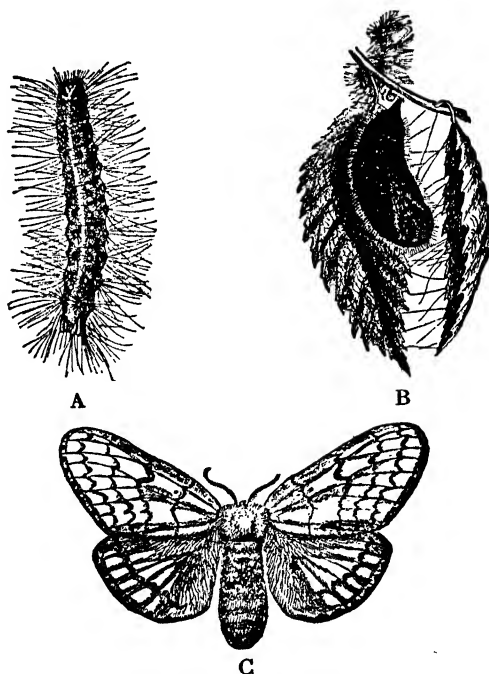

FIG. 262. — Gypsy Moth, *Porthetria dispar*. A, larva; B, pupa; C, adult female. (From Howard.)

National Park. The GYPSY MOTH, accidentally introduced near Boston, has spread throughout a large part of southern New England and is besieging the New York State line. Entomologists have made intensive studies of its European enemies, left behind when it came to America, and the introduction of some of these

into New England gives hope that it may eventually be conquered. In one year alone nearly three million enemies, representing eight species, were liberated. The BROWN-TAIL MOTH is another importation from Europe whose activities thus far have been confined to New England as the result, in part, of control measures. These three examples may stand as representative of the legions of destructive forest insects. (Fig. 262.)

Finally we should be reminded, if necessary, that our households are not immune to insect marauders that take an immense ag-

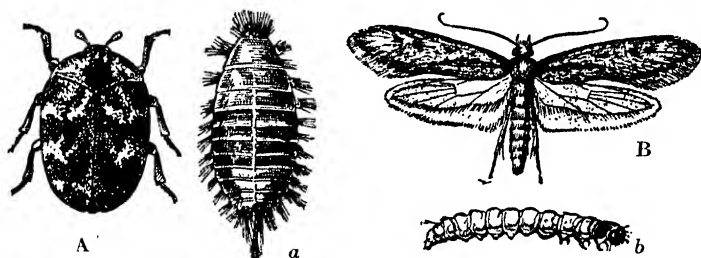

FIG. 263. -- A, Carpet Beetle, *Anthrenus scrophulariae*; a, larva of Carpet Beetle; B, Clothes Moth, *Tinea pellionella*; b, larva of Clothes Moth. (From Riley.)

gregate toll each year. CARPET BEETLES, popularly called Buffalo Moths, and CLOTHES MOTHS are all too familiar examples. (Fig. 263.)

#### 4. Beneficial Insects

Although we have mentioned incidentally the part played by certain insects in suppressing other noxious kinds, it would be unfair to the insect world not to emphasize the existence of members which are serviceable to Man: those thousands which prey upon our enemies or supply us with materials. It has been well said that "if insects would quit fighting among themselves, they would overwhelm all Vertebrate animals"; though sometimes long biological investigations are necessary to keep them fighting when we have upset the natural conditions; e.g., moved them to a new environment away from their natural enemies. Thus Acacia plants brought from Australia introduced the COTTONY CUSHION SCALE which soon spread to the great California orange and lemon groves, and entailed enormous losses. The fruit growers finally sent, at their own expense, an expert entomologist to study in Australia the native enemies of the Scale-insect. As a result some Ladybird

Beetles were eventually discovered which offered hope of meeting the needs, and these were sent to California and reared until they could be colonized in the infected groves. Here they multiplied and ever since have held the Scale in check. (Figs. 264–266.)

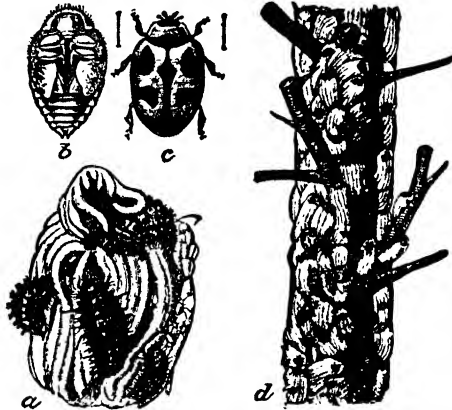

FIG. 264. — Australian Ladybird Beetle, *Rodolia cardinalis*, and Fluted Scale-insect; *Icerya purchasi*. a, larvae of beetle feeding on scale; b, pupa of beetle; c, adult beetle; d, Orange twig showing scales and beetles. (From Marlatt.)

Furthermore we must not forget that such insects as the SILK-WORM MOTH and the HONEY BEE are really domesticated animals: each is at the basis of an enormous world industry. One of Pasteur's most important studies was on the PEBRINE disease of

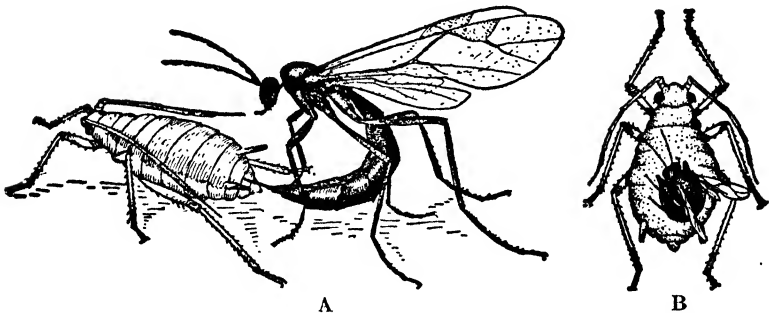

FIG. 265. — A, An Ichneumon Fly inserting egg in an Aphid. B, emergence of the parasite that has developed from the egg. (From Webster.)

Silkworms, and not only saved the silk industry of France, but also paved the way for the study of infectious diseases in higher animals

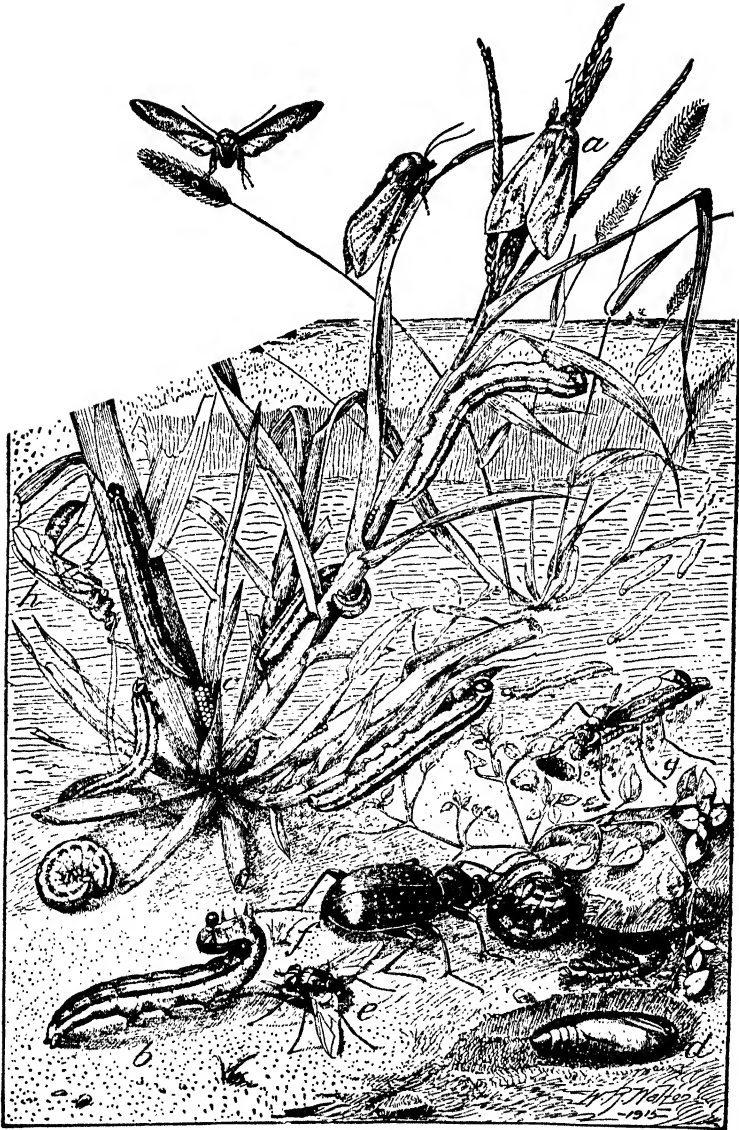

FIG. 266. — Army-worm Moth, *Cirphis unipuncta*, and its ecological relationships with other Insects. *a*, adult Moth; *b*, full-grown larva; *c*, eggs; *d*, pupa in soil; *e*, parasitic Fly, *Winthemia*, laying eggs on an Army-worm; *f*, Ground Beetle, *Calosoma*, preying upon an Army-worm, and, at right, *Calosoma* larva emerging from burrow; *g*, a Digger Wasp, *Spheg*, carrying an Army-worm to its burrow; *h*, a wasp-like parasite of the Army-worm. (From U. S. Department of Agriculture.)

and Man. The cause of pebrine proved to be a Protozoan parasite, *Nosema bombycis*. (Figs. 214, 267.)

The dependence of many plants upon insects for pollination is well illustrated by the difficulties in establishing the SMYRNA FIG in California. The fruit would not mature, and studies by botanists and entomologists showed that in the plant's native land pollination was effected by a certain tiny insect. Importation and es-

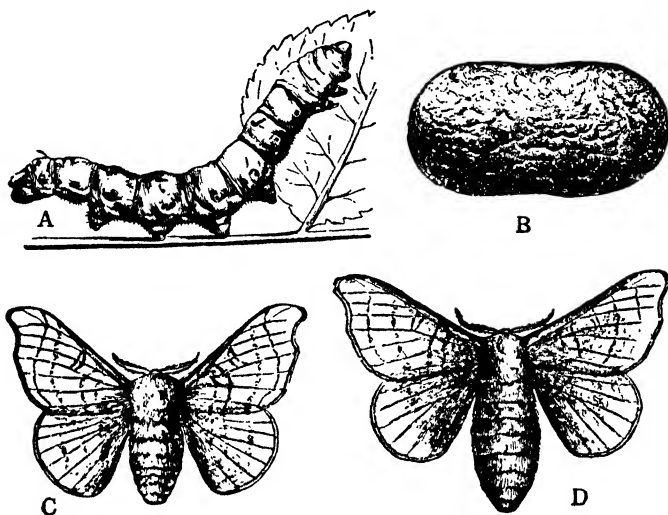

FIG. 267. — Silkworm Moth, *Bombyx mori*. A, caterpillar; B, cocoon; C, male moth; D, female moth. (From Shipley and MacBride.)

tablishment of the insect carrier in California created there the immense fig-growing industry. (Fig. 219.)

As a matter of fact an amazing number of plants that we most highly prize would be unable to reproduce were it not for pollination by insects: for instance, there would be no pears, apples, peaches, plums, oranges, or strawberries. So it is perhaps not unreasonable that an entomologist has asked whether insect depredations may not be regarded as a twenty per cent commission we pay for the invaluable services that "friendly insects" render. It may, but it is economical, if not generous, to reduce the tax to the lowest limit!

Insects touch human affairs in other vital but less direct ways. It will be recalled that Darwin emphasized the importance of Earthworms in aërating and plowing the soil; but various insects

probably contribute at least as greatly to this indispensable work. Ground burrowing insects are still more widely distributed than Earthworms and in most regions they are more numerous and more active. Moreover, not only do they carry decaying leaves beneath the soil, but also rich nitrogenous plant food such as manure and the dead bodies of animals. (Fig. 266.)

Finally, it is not an exaggeration to wonder how land plants could have arisen without the direct or indirect services of insects. Indeed geological history indicates that land plants did not flourish and Seed Plants did not exist before insects became a well-established part of the Earth's fauna.

Enough, perhaps, has been said to indicate the struggle for knowledge which Man must maintain in order to cope with the biological forces that would rob him, are robbing him, of what he considers his heritage. But it is only fair to add that biologists who have given the most thought to the problem are by no means certain that the struggle will eventually be successfully terminated; it is possible that insects and allied enemies will gain the upper hand in the warfare for food when the human population has increased beyond a certain limit. This seems incredible, though it is a conservative statement by men who are specialists and not pessimists. In any event, it is clear that the most urgent need today is more knowledge of the life habits of insects and other destructive organisms. Generous Federal and State appropriations must be made so that through research effective methods of control may be developed. Experience has shown that the research dollar is not only invested in a gilt-edge security, but one at the same time producing a national dividend almost beyond computation. (Figs. 270, 271.)

### C. CONSERVATION OF NATURAL RESOURCES

We are slowly awakening to the fact that we have been very shortsighted. Conservation of natural resources has, until recently, given very little concern, although it is one of the greatest problems which biologists of the present generation face, and it must be solved now or it will be too late. What happened in America is being repeated in many other parts of the world. Our forefathers came to a land of fertile soil covered with primeval forests, abounding with large and small Birds and Mammals, and

with waters richly supplied with Fish. These they necessarily and rightly drew upon for their livelihood. It was their wealth — Nature's generous bonus.

But the apparently inexhaustible supply has already become alarmingly reduced and conservation must be the watchword, as was recognized nearly a half century ago by Theodore Roosevelt who considered it "the weightiest problem now before the nation, as nobody can deny the fact that the natural resources of the United States are in danger of exhaustion, if the old wasteful methods of exploiting them are permitted longer to continue." Yet in spite of this, the conditions are still such that a prominent legislator is more than justified in stating that "it is time that the national conscience be awakened to the necessity of preserving what is left of the outdoor heritage of our fathers, and of restoring some of that which has been destroyed and defiled."

Only about one-eighth of the virgin forest of the United States remains to-day. It seems incredible for a civilized nation — but is only too true. Approximately one-half of this is held by the Government but the rest is being destroyed far more rapidly than unaided nature can restore it. And there is nowhere in the world a sufficient supply of the kinds of timber we use to take their place. We have continuously treated our forests, except those under public control, not as a farm on which to produce crops, but as a mine whose useful product is to be gathered once for all. The axe has held almost unregulated sway, but with ideas of conservation becoming increasingly widespread it appears that hope for a better future for our forests is well founded.

It seems hardly necessary to state that forests are of inestimable value in many ways entirely aside from the lumber they supply. We are, perhaps, prone to forget that under nature's stabilizers of forests, shrubbery, and grass the blowing and washing away of the soil progresses but slowly, while with their removal by Man this erosion is increased tremendously. Witness the great dust storms during recent years in the Southwest. The devastating floods that swept down the Mississippi in 1927, the Yangtze in 1931, and the Ohio River in 1937 are in no small part attributable to deforestation. China's affliction is the product of millenniums, ours of little more than a century. Scientific forestry is crucial for our future. (Fig. 268.)

Many of the larger animals have been exterminated and some of

the smaller ones are fast approaching the same fate. The Bison is extinct in the United States except for the few hundreds preserved in reservations; the Elk is restricted in numbers and range; the Elephant Seal remains only in one small colony; the Bowhead Whale and Right Whale are threatened with extermination; and the Beaver has disappeared from most of its former haunts. The demand for furs is estimated to be responsible for the destruction



FIG. 268. — Soil erosion due to removal of all the trees.  
(From U. S. Forest Service.)

of thirty million Mammals throughout the world each year, and this number is nearly doubled if all the wild Mammals destroyed for commercial purposes are included. While there is life there is hope, but unless immediate steps are taken to reduce the slaughter, the fur-bearing animals of the world at large are doomed.

Birds are now faring somewhat better owing to the heroic efforts started a generation ago by the Audubon Societies, so that a partial restoration of our former bird population seems probable. Of what use are the Birds? Even if usefulness were the only question in-



volved, the answer would still be clear. Experts tell us that without the services of insect-eating and seed-eating Birds, successful agriculture would soon be impossible, and the destruction of the greater part of our vegetation would also result. One caterpillar during its lifetime of less than two months can consume three-quarters of a pound of leaves, or nearly ninety thousand times its original weight. Birds are "the winged wardens of our farms." Their help is needed in the struggle.

In truth, it is dangerous for Man to upset the intricate balance of the economy of nature by the reckless destruction of plant or animal without taking thought for the morrow — without intensive study of the far-reaching consequences which may follow from the breaking of one link in the chain of the interrelationships of organisms. The destruction even of certain Protozoa and other microscopic life may seal the fate of Fish valuable for food. (Figs. 24, 220, 266.)

#### D. CONSTRUCTIVE BIOLOGY

The great living heritage which we have received will be permanently impaired for posterity, even though useless waste is stopped, unless the highly complex problem of conservation is attacked constructively in the light of modern biological knowledge. Merely to hold Nature's bonus unimpaired, crucial as that is, will not adequately meet the requirements of increasing populations with the attendant demands of complex civilized life. Few seem to realize that the whole of our business life takes root in nature. All of our progress and prosperity is predicated on the abundance of our natural resources and the manner in which we develop them for Man's use. Methods of raising crops and domestic animals which were sufficient for primitive communities are entirely inadequate to satisfy modern conditions.

Indeed, the state of civilization of a people is closely related to its success in developing plants and animals for particular needs. One hears of new 'creations,' but often fails to recall that Man can merely direct the laws of inheritance, and this he can do only by intensive investigations of the principles underlying heredity. Certainly the most important recent contribution of biology is the discovery of the general method of transmission of characters from generation to generation, common to all living things, which has established the new biological science, genetics. To-day, as we

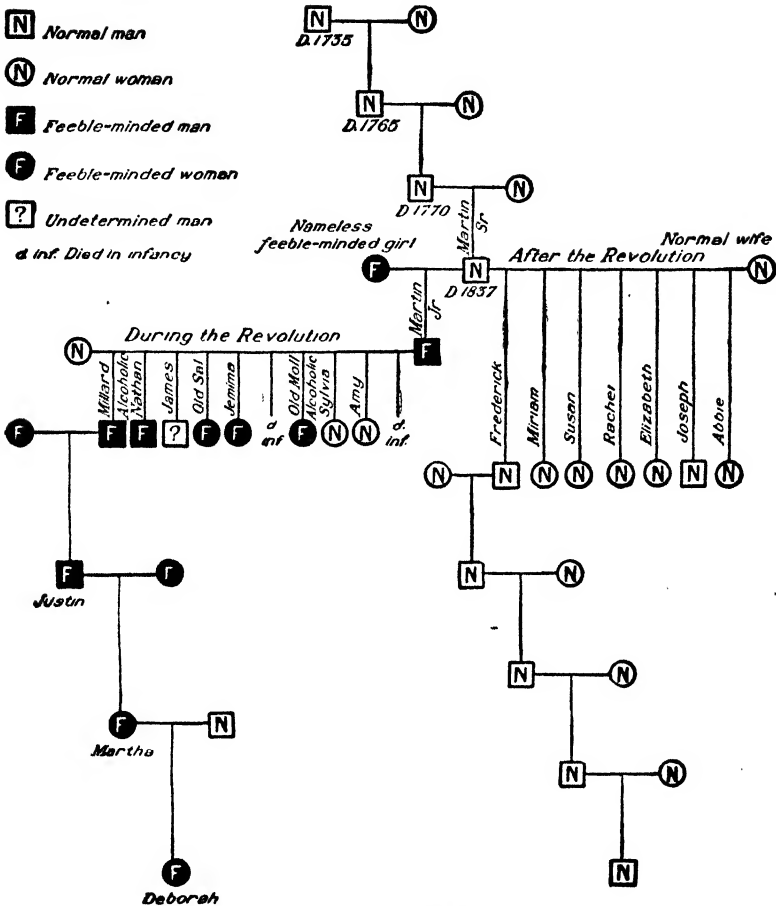

FIG. 269. — The Kallikak family.

Of the 480 descendants, in five generations, of this branch, 143 are known to have been feeble-minded, 36 illegitimate, 33 sexually immoral — mostly prostitutes, 24 alcoholic, 3 epileptic, and 3 criminal. 82 died in infancy.

Of the 496 descendants, in five generations, of this branch, none were feeble-minded, and all but 2 were normal mentally. 2 were alcoholic and 15 died in infancy. Thus nearly all were good citizens. Among them were educators, physicians, lawyers, judges, traders, landowners — men and women prominent in every phase of social life. (After Goddard.)

have seen, biologists the world over are developing and applying these principles in plant and animal breeding. What was impossible a few years ago is now being accomplished almost as a mere matter of routine work in many biological laboratories.

Important as the application of these principles is in the mastery of agricultural problems, a far more profound power remains to be realized when, as nations, mankind becomes awake to the fact that these same basic principles apply equally to human inheritance. If it be true that the human race has not improved in bodily and mental characteristics since the time of the ancient Greeks, the responsibility rests with Man himself. He has studied and applied selective breeding of animals and plants. He has in general kept the best for his purposes that nature offered and eliminated the rest. He has depended chiefly on the stock and only secondarily on the environment for permanent improvement. But it has been otherwise with himself. Much of the worst human stock has continued to survive and multiply, and disproportionately so as civilization has advanced. Reliance has been placed almost solely on the improvement of the conditions of life and not on breeding from the best. We may fairly say that humanity is what it is today in spite of the continual violation of many of the biological principles which would improve the race. (Figs. 179, 269.)

This, of course, is merely a statement of fact: not a reproach. Man could not have done otherwise until it had been demonstrated by biological investigation that he is a part of, and not apart from the rest of living nature — the most profoundly important fact that biology has contributed to human welfare. With this fully grasped, new import is given to the study of general biological principles and no plant or animal is too insignificant to throw light on life problems. And this has been the chief source of the stupendous potential for biological control which has within less than a century come to mankind. Potential for control, we say, because years of research by generations of investigators is still necessary before we shall be prepared to solve the problems we now face and which the saturation point of human population will immensely augment. (Figs. 188, 194, 270, 271.)

The natural method of securing a healthy — adapted — race is, of course, the gradual process of adjustment throughout the ages by response to environmental stimuli. But mankind has the power,

which we believe is denied to the lower animate beings, of conscious response — of choice. Human volition and action can retard or accelerate nature's response. Human volition may not only decide, within limits, the response to surrounding conditions, but also not infrequently may directly change the conditions so as to render unnecessary individual or racial adaptation to them. Thoughts such as these make plain the enormous complexity of the situation and reveal the possibility of danger lurking where it may be least

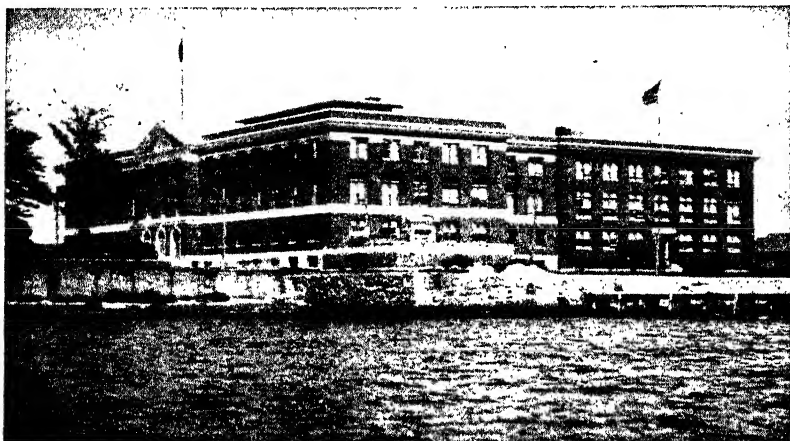

FIG. 270. — The Marine Biological Laboratory, Woods Hole, Massachusetts. One of the laboratories where biologists spend the summer in research covering many branches of the science.

expected — danger lest in acting as we think humane from the point of view of particular individuals, we may be rendering a disservice to the race.

The complex problems of eugenics, the science of being well-born, are problems in genetics so intricately interwoven with those of all the other sciences of human life and relationships, in particular sociology and psychology, that propaganda in eugenics not fundamentally grounded in basic interlocking data from these sciences is not only premature, but fraught with insidious possibilities. Eugenics seeks improvement through nature, euthenics seeks improvement through nurture. Each is a partial view and before significant progress can be made the proper balance between these two aspects of one problem must be grasped. Organism and environment are one and inseparable. ( Fig. 198.)

The crying need of the present is for more and still more knowledge which is secured in the laboratory rather than on the lecture platform. When we realize that if the infants Darwin and Lincoln, who were both born on the same day, had been exchanged by their parents, almost certainly neither would have produced epoch-making contributions to science or civilization, it gives us pause. The Danes have a proverb that it does no harm to be born in a duckyard if you are laid in a Swan's egg — thus emphasizing hered-

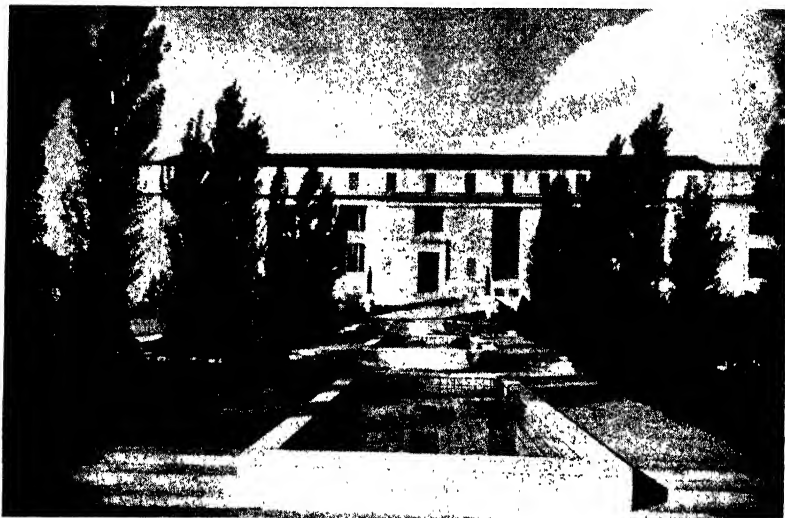

FIG. 271. — The National Academy of Sciences and the National Research Council of the United States, Washington, D. C. The focus of American scientific research.

ity, though heredity implies not a repetition in kind, but in possibilities. We cannot hope to be born equal, but we may ask to be born with an equal opportunity to develop what is in us. At least we can say at present, without fear of contradiction, that Man owes it to himself not to be less mindful of his own stock than he is of that of his domestic animals.

From every standpoint the mere pittance Man casts to biological research returns to him many-fold in health and wealth, in comfort and power, and most of all in a broader and more appreciative outlook on a congenial world. "Man becomes more intelligible, and therefore more controllable, when he recognizes his affiliations and the ancestral strands that linger in his fabric. It

is encouraging to know that we have behind us not a descent, but an ascent, and that there is some appreciable momentum in the right direction." Far from depriving life of its mystery, biology affords a sublime picture of the interrelatedness of living things and still more inextricably interweaves human life with that of all Nature.

## CHAPTER XXV

### THE HUMAN BACKGROUND

The process of evolution has its outcome in personalities who have discerned its magnificent sweep. — *Thomson.*

As the culmination of our survey of the continuity of life, it is important to consider briefly what is known in regard to human origins — to bring Man more specifically into relationship with the evolutionary process and to appreciate his affiliations as evidenced by the ancestral strands that persist in his fabric.

Although the general recognition of Man's place in nature has but recently been attained, more than two thousand years ago Aristotle placed him at the summit of animal creation, emphasizing his God-like nature, but withal regarding him as only the highest point of the Scale of Nature. Linnaeus, the founder of our modern method of classification, during the middle of the eighteenth century placed Man in the order PRIMATES of the class Mammalia, a position he has since held. (Figs. 288, 296.)

#### A. THE PREHUMAN LINEAGE

The order Primates to-day comprises three suborders: the LEMUROIDEA, or Lemurs; the TARSIOIDEA, or Tarsiers; and the ANTHROPOIDEA, or Monkeys, Apes, and Man. Most of the characters which distinguish them from the other groups of Mammals represent adaptations to a tree-dwelling life: adaptations for climbing, for subsisting on a simple and plentiful food supply, and for taking advantage of changing environmental conditions by a bigger and better brain. (Figs. 93, 272.)

The Anthropoidea, in which our interest centers, are widely distributed throughout the tropical regions of both hemispheres, and although those of the eastern and western hemispheres doubtless were derived from the same original stock, they have followed somewhat different though, in general, parallel evolutionary paths since their origin more than fifty million years ago, early in the Age of Mammals.

The Old World branch of the Anthropoidea is of especial im-

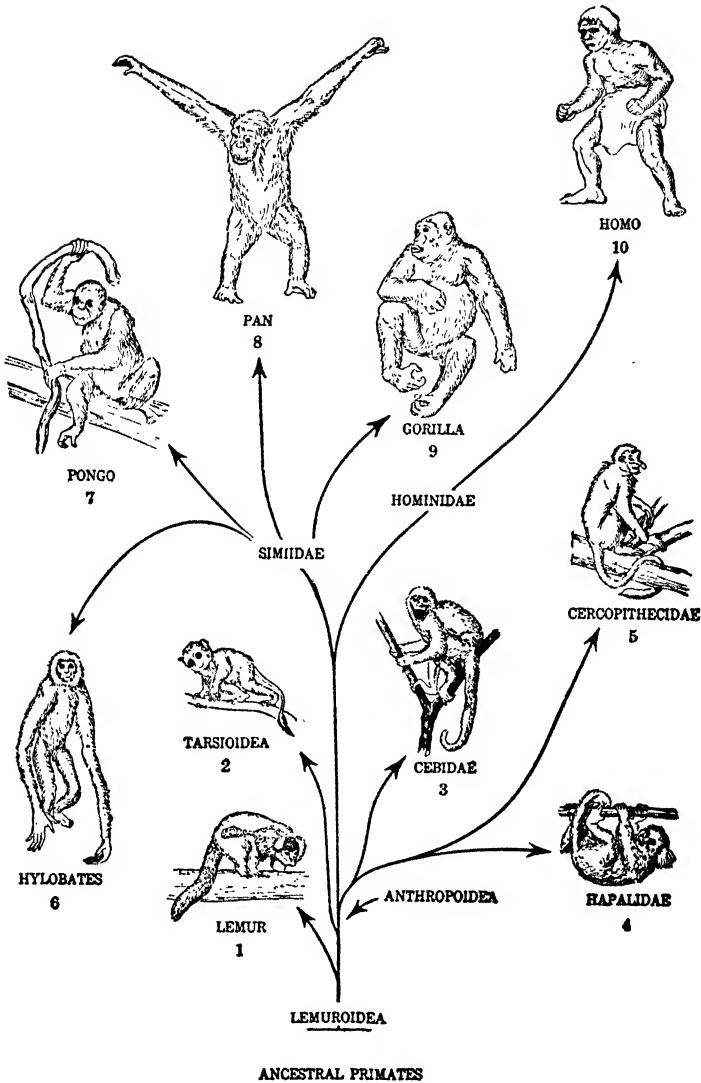

FIG. 272. — General relationships of the Primates. 1, Lemur; 2, Tarsius; 3, New World Monkey; 4, Marmoset; 5, Old World Monkey; 6, Gibbon; 7, Orang-utan; 8, Chimpanzee; 9, Gorilla; 10, Neanderthal Man. See p. 480. (Modified, after Hegner.)



portance because it is dignified by the inclusion of Man. It comprises two families higher in rank than the tailed Monkeys, or Macaques and Baboons. These are the SIMIIDAE, or man-like (anthropoid) Apes — the Gibbons, Orang-utans, Chimpanzees, and Gorillas; and the HOMINIDAE, or Man. However, all specialists are



FIG. 273. — Chimpanzee, *Pan troglodytes*. Note large ears, long lips, ridge above eyes, long arms, nails on fingers and toes, and hand resting on back of fingers. Height  $4\frac{1}{2}$  feet; weight of male, 160 pounds. (From Hegner, drawn by R. Bruce Horsfall.)

not agreed that this separation of anthropoid apes from Man is justified, for, as one states it: "between the Gorilla and Man, barring for the moment the mental and spiritual distinctions, there is hardly more difference than there is between the horse and the ass, and the degree of consanguinity is much the same." (Page 480).

At all events, the inevitable inference is that these various forms have evolved from a common stock, though it should be emphasized

that no living species represents the direct human ancestor. The chimpanzee-gorilla group is regarded as the nearest to Man, but these apes have evolved along different lines since the divergence of the human lineage in the geologic past. Apparently the common ancestor was a rather large animal with a mode of life more similar to the present-day Gibbons than to either the Chimpanzees or the Gorillas, although anatomically the Gibbons to-day differ more



FIG. 274. — Gorilla, *Gorilla gorilla*. Note large head, small ears, short lips, large canine teeth, ridges above eyes, and absence of a chin. The gorilla walks on the backs of its fingers. Height about 5½ feet, weight 500 pounds. (From Hegner, drawn by R. Bruce Horsfall.)

markedly from Man than do any of the other anthropoid apes. Gibbons are relatively small active animals with such very long arms that the knuckles reach the ground even when the body is erect. But they are strictly arboreal forms whose amazing adaptations for progression through the foliage of trees has been suggested as of prime importance in the development of their mentality; and so possibly it was with the prehuman ancestors. (Figs. 93, 273, 274.)

Receding still further into the past, there were antecedent to the common ancestor of the anthropoid apes and Man more and more

primitive forms — Tarsioids and Lemuroids — and so back, and still further back to an insectivorous stem from which the Primates originally emerged. It is perhaps somewhat in deference to Man that the Primates are usually placed as the culminating order of Mammals and so of the Vertebrate series, because in spite of their larger brain — and the use they make of it — the Primates retain many primitive characters that elsewhere are found only in the lowly order INSECTIVORA. (Figs. 201, 202.)

No useful purpose will be served at the present time by delving further into the geologic past for still earlier antecedent forms, because behind the Insectivores the actual record becomes increasingly obscure. However, it seems certain that the latter were evolved from still more primitive Mammals during the Mesozoic Age — the Age of Reptiles; the earliest Mammals arising from the reptilian stock.

Returning to Man as a Primate and his relationships with the anthropoid apes, we are on more firm ground. This relationship



FIG. 275. — Feet of Anthropoid Apes and Man. (From Schultz, after several authors.)

is supported by many independent but interlocking lines of evidence, such as the similarities in structure of the brain and viscera, of the musculature and the skeleton in general and of the hands and feet in particular. The differences are almost entirely in proportions, the structures are almost identical. Indeed, even the ridges on the palms and soles, and the chemical properties of the blood indicate affinity. And not the least important evidence is the structure of the premolar and molar teeth, because those of Man are very unlike those of any other animals except the great apes. Therefore the teeth, especially since they withstand well the ravages of geologic time, afford excellent clues in the search for the fossil an-

thropoids at the root of the human family tree. (Figs. 228, 275.)

Numerous fossil remains have been found that give evidence in regard to the origin of the anthropoids. Back in the Eocene epoch are various Tarsioids and a monkey which bridge the gap to higher Primates, and in the Oligocene epoch are several monkeys and anthropoid apes that, apparently, are near to the main line of ascent. And then late in the Miocene epoch, perhaps ten million years ago, appears *Ramapithecus* with teeth that foreshadow those of Man. Indeed, the number and arrangement of the teeth, the bicuspid pattern of the premolars, as well as various characters of the incisors, canine, and the milk dentition, are prophetic of the human dentition to-day, particularly in certain primitive races. It appears that the differences shown by the human teeth are to a considerable extent the results of an omnivorous diet, and of changes in the proportions of the jaws, following the great expansion of the cranium in providing for the enlarging brain. (Page 359.)

So it seems reasonably clear that the prehuman ancestor arose through or near the *Ramapithecus* stem, from animals adapted to live in the vast forests of the Old World. But as geologic time progressed, climatic changes of course occurred, the forests became restricted, and we may assume that the Primates that had not already made a retreat were impelled to renounce, in part, the arboreal for a terrestrial habitat. Thus the precursor of Man reached the ground: an environment that was provocative of many adaptations, in particular the erect body with hind limbs supporting the entire weight. This necessitated considerable mechanical readjustment, including the alternating curvature of the vertebral column for the nicer balance of the larger cranium. Moreover, the development of the brain, furthered by the emancipation of the hands from their part in locomotion and by changes in the vocal organs leading to speech, eventually paved the way to the emergence of culture from the biosocial foundations of preman—to invention, communication, and social habituation. In the course of the ages Man arrived. (Figs. 105, 109.)

## B. FOSSIL MAN

The evolution of Man, unlike that of other organisms, presents two clear-cut aspects: the physical and the mental. His physical evolution was exceedingly slow, but his cultural development, once started, proceeded with increasing momentum. Both can be

traced with some assurance from the actual fossil remains of prehistoric man and the relics of his handiwork.

When one realizes how slight are the chances for the remains of prehistoric man to become fossilized and, if preserved, to be unearthed to-day, it seems remarkable that the record is no more fragmentary than it actually is, especially when the short time that interest has centered in the problem is considered. Some of the important fossil forms are of the greatest significance, though experts are by no means unanimous in regard to the interpretation

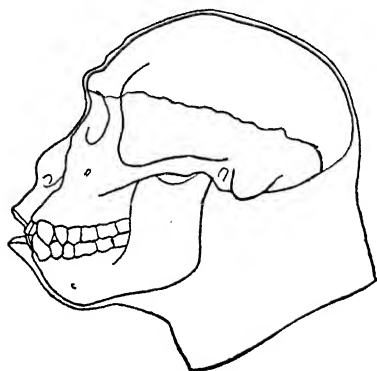

FIG. 276. — Skull and face of the Java Man, *Pithecanthropus erectus*. Portion below irregular line restored. (From Lull, adapted from McGregor.)

of details. At present it is premature to attempt to reach a decision in regard to the specific Early Pleistocene ancestor of modern man, but there is reasonable assurance that the problem will eventually be solved. At all events the emergence of man is essentially a Pleistocene story. Some representative 'fossil men' may be reviewed. (Page 359.)

### 1. *The Java Man*

In deposits of the Middle Pleistocene of Java there have been discovered during the past century various skeletal fragments which possess many of the attributes of 'missing links.' The bones found probably represent several species. The first discovered and the most famous consist of a skull-cap, femur, and three teeth. With these fragments as a guide, experts have attempted to restore the chief features of this so-called JAVA MAN, *Pithecanthropus erectus*. (Fig. 276.)

The face of *Pithecanthropus* shows immense beetling brows. The skull viewed from above is essentially human although the brain itself has deficiencies in the parietal and prefrontal regions, the latter in particular being the seat of the higher mental faculties. The motor and auditory speech centers are significantly developed so it seems probable that *Pithecanthropus* had at least the rudiments of articulate speech which differentiated him from the apes. The volume of the brain, estimated at about 940 cc., is small compared with that of modern man, though barely within the range of

the human brain variation. It far exceeds that of a very large male gorilla. The skull was supported by powerful muscles and ligaments as in the great apes, and not nicely poised as in man, thus indicating a stooping posture. The straight femur probably belongs to a more erect and advanced type of Pleistocene man.

From several standpoints, Pithecanthropus affords an interesting link with the past, but one that is based on somewhat confused evidence. Indeed the importance of this Java man is hardly commensurate with the fame which he has acquired, and he is now overshadowed by the more recent discoveries in regard to Peking man, who actually preceded him.

### 2. *The Peking Man*

At various times during the past thirty-five years fragments of fossil man have been found near Peiping, China, in deposits of Early Pleistocene age, perhaps a million years old. From the fragments discovered — skulls, jaws, teeth,

etc. — it appears that the PEKING MAN, *Sinanthropus pekinensis*, had very thick cranial walls but surprisingly large cranial capacity. The brain was loftier but narrower than in the Java man, and the mastoid region of the temporal bone is suggestive of that in the adult anthropoid apes and the human infant. The teeth are somewhat primitive although essentially human. The Peking man obviously represents a very primitive type in the general line of advance, which probably is fairly closely, but not directly related to the Java man. Moreover, there is some evidence of the dawn of culture with this early man. Abundance of carbonized material indicates the use of fire, and pieces of crudely chipped stones suggest the use of tools. (Fig. 277.)

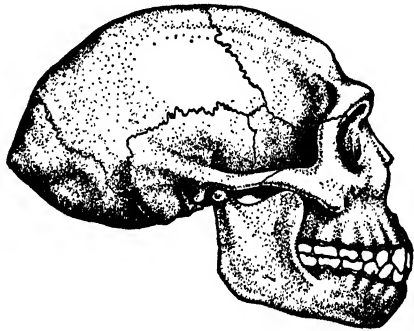

FIG. 277. — Peking Man, *Sinanthropus*. The face and jaws are mainly restored. (From Romer, after Weinert.)

### 3. *The Piltdown Man*

Significant discoveries were made near Piltdown Common in Sussex, England, from 1911 to 1913, that included parts of two crania and a lower jaw, nasal bones, and several teeth. The enor-

mously thick cranial walls of this PILTDOWN MAN, *Eoanthropus dawsoni*, resemble those of the Peking man, but the forehead and vault of the skull approach nearer to that of modern man. However, the jaw and canine tooth are more ape-like than in the man of Peking, and probably do not belong to the same skeleton. Although geologically about contemporaneous, it is difficult from the scanty data to bring the relatively large-brained Piltdown man into relationship with the Java and Peking men. It has been suggested that the human line comes from the Piltdown rather than

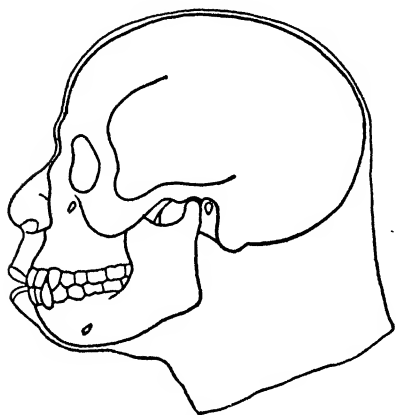

FIG. 278. — Skull and face of Piltdown Man, *Eoanthropus dawsoni*. (From Lull, adapted from McGregor.)

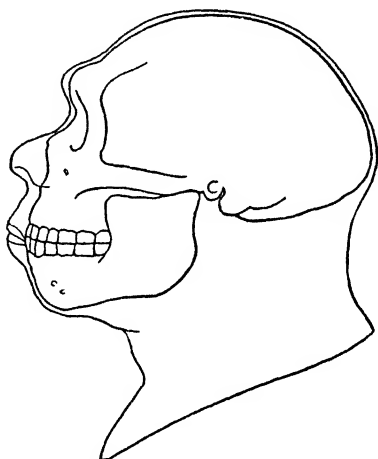

FIG. 279. — Skull and face of Heidelberg Man, *Homo heidelbergensis*, based upon McGregor's restoration of the skull, the lower jaw only being known. (From Lull.)

the Peking line, but their relative significance from the standpoint of the direct human lineage remains to be determined. (Fig. 278.)

#### 4. The Heidelberg Man

A species of early Man is represented merely by a lower jaw found during 1907 in a sand deposit of Early Pleistocene age near Heidelberg, Germany. The quite massive jaw is of a primitive type, but the teeth are essentially human both in relative size and general appearance. Accordingly, the HEIDELBERG MAN is included in the same genus with modern man, as *Homo heidelbergensis*. However, the relationships of Heidelberg man are obscure, though

possibly he is an ancestor of the men of Neanderthal, his successors. (Fig. 279.)

### 5. Neanderthal Man

The remains of NEANDERTHAL MAN, *Homo neanderthalensis*, appear in the caverns or rock shelters of Europe several hundred thousand years after the Heidelberg man. The history of man during the vast interim has not yet been revealed, but we must suppose that he persisted precariously through the intermittent periods of glaciation during the great ice ages. Indeed, the Neanderthal race may have diverged early in the Pleistocene, but it flourished in the last interglacial and the early part of the last glacial epoch. It appears to have sprung from an earlier stock of which the Java and Peking men were members. (Fig. 272.)

Neanderthal man is known to us from many skeletons, one of the earliest in point of discovery being found in the Neander Valley, near Düsseldorf, Germany, in 1857, and one of the most recent in the Cave of Robbers near Jerusalem. The men of Neanderthal averaged about five feet, four inches in

height and were stocky and powerful. They probably walked with a shuffling, slouching gait since curved thigh bones and imperfect curvatures of the spine show that the limbs were habitually bent at hip and knee. A large head with heavy jaws was supported by powerful neck muscles. (Fig. 280.)

The skull is notable for its size but the cranium is low and the forehead retreats from a continuous brow-ridge that is distinctive of the race. The large brain is relatively simple compared with

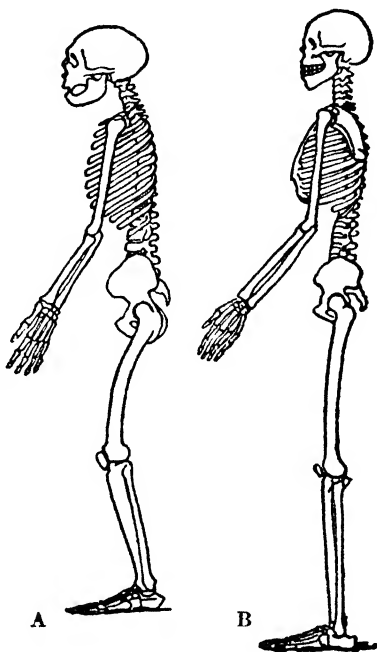

FIG. 280. — Skeleton of Neanderthal Man (A), *Homo neanderthalensis*, compared with that of a living native Australian (B), *Homo sapiens*; the latter the lowest existing race. (After Woodward.)



that of modern man, especially in the regions devoted to the higher mental activities. However, that these cave men were not without ability is attested by the well-wrought stone hunting implements found associated with their remains. But bestiality outweighs human features, according to modern

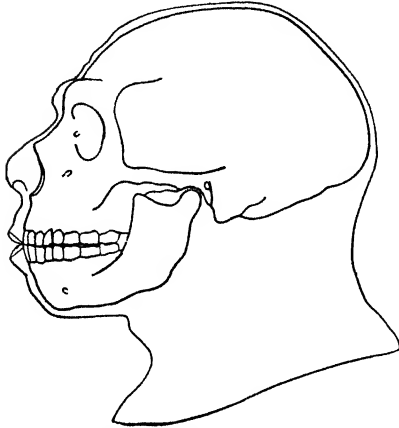

FIG. 281. — Skull and face of Neanderthal Man, *Homo neanderthalensis*. (From Lull, adapted from McGregor and Boule.)

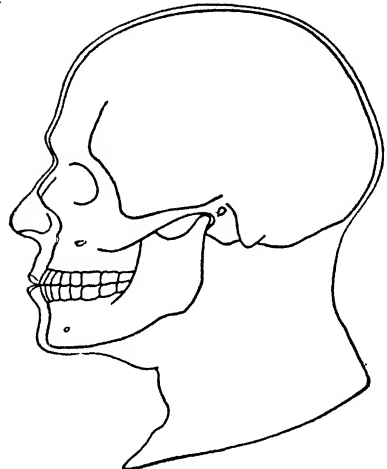

FIG. 282. — Skull and face of Crô-Magnon Man, *Homo sapiens*. (From Lull, adapted in part from McGregor.)

standards, though it seems that some higher human traits lurked in their make-up because in certain instances there is evidence of reverential burial, with all that it implies. (Figs. 281, 283.)

#### 6. Crô-Magnon Man

Sometime in the last glacial epoch the supremacy of Neanderthal man was challenged by a superior race — the first that is recognized as of the same species, *Homo sapiens*, to which modern man is assigned. This invading race of CRÔ-MAGNON MEN seems to be of different immediate stock from the Neanderthal men of Europe and, in large part at least, to be responsible for their extinction. Apparently Crô-Magnon man came from an Asiatic source about fifty thousand years before the dawn of history, after an antecedent evolution of many more thousands of years from a Neanderthaloid stem. If this is true, modern man may be, so to speak, Neanderthal man's progressive nephew, though not his direct descendant.

Although numerous remains of the Crô-Magnon race have been discovered, those from a rock-shelter of Crô-Magnon in western France represent the type. The men were of large stature, averaging at least six feet in height, while the women were much smaller. The posture was entirely erect with the characteristically alternating curves of the human spine, and straight limbs. The cranium

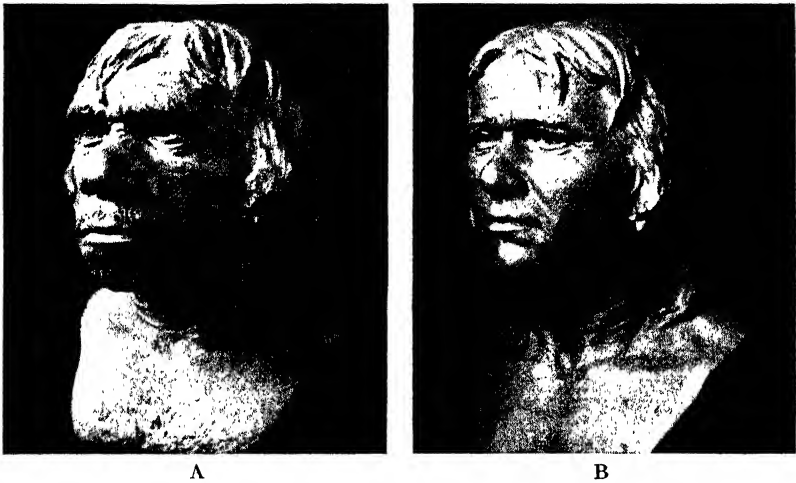

FIG. 283. — A, Neanderthal Man; B, Crô-Magnon Man. Original models by Professor J. H. McGregor, in the American Museum of Natural History.

was of very large capacity with high, vertical forehead and no brow-ridges. The face was broad in comparison with the cranium, and the somewhat prominent chin, narrow and pointed. (Figs. 282, 283.)

The Crô-Magnons were a splendid race physically, and the remarkable Paleolithic art that still survives in certain caverns of France and Spain attests their mental equipment. Thus from both aspects they meet the standard of the species *Homo sapiens*, and differ in no great degree from their successors, the so-called Mesolithic and Neolithic races which, in turn, closely approach the present-day races of man.

### C. CULTURAL DEVELOPMENT

It seems evident that man's position above the beasts is based chiefly upon the fact that he alone possesses a genuine culture. Man domesticated himself and so originated a culture involving the basic tripod of invention, communication, and social ha-

bituation. Man created culture, and culture created Man. But, of course, the biological basis constitutes the foundations upon which the cultural superstructure rests — Man cannot get away from Nature. Various culture patterns are impressed upon the individual as habits of thought and action and this social conditioning demands a complex organism with the ability to make environmental adaptations.

Animals in general exhibit various BIOSOCIAL reactions, such as the group life of Bees and Ants or the simple family life of the anthropoid Apes, that are inherited from generation to generation and are the outcome of evolution. But upon the hereditary biosocial endowment of actions and reactions, Man has superimposed processes of a cultural order that are acquired in each generation by the continuity of so-called group conditioning; *i.e.*, habits of body and mind are impressed upon the young by the elders. Although these cultural processes are an addition to, and are dependent upon the hereditary biosocial endowment, they are something more than merely an elaboration of it. They are essentially untrammelled by the limitations of the slow process of organic evolution that is dependent upon germinal variations and natural selection. Thus the cultural aspect of human nature can and does forge ahead in so far as the physical and mental heritage is adequate to meet the emergency.

### 1. *Paleolithic Culture*

Most of the specimens of prehistoric man have been found in Europe and this holds true also for the evidences of his culture, so our attention may be confined to this region where the chronology has been worked out most thoroughly.

The first artifacts appear in the Pliocene epoch or very early in the Pleistocene epoch of periodic glaciation, and consist of small chips of flint known as EOLITHS, or 'dawn stones,' that obviously have been crudely shaped by man. This culture is evidence of the exceedingly slow dawning of human mental life because it persisted with little improvement for not less than several hundred thousand years. It apparently represents the cultural scale of the Peking and Piltdown men and possibly also of Heidelberg man. However, as time passes we find that the artifacts increase in variety of form and nicety of manufacture, and the so-called PALEOLITHIC culture emerges. There are cleavers, axes, scrapers, drills, etc., some of

them apparently shaped for convenience in grasping, and eventually we reach the work of Neanderthal man — the first Paleolithic culture that can be assigned to a definite race of OLD STONE AGE MEN.

The relics of Neanderthal man, unlike those of his precursors, are found typically in rock shelters and caverns. The chief source has been in western France, although a similar culture is wide-

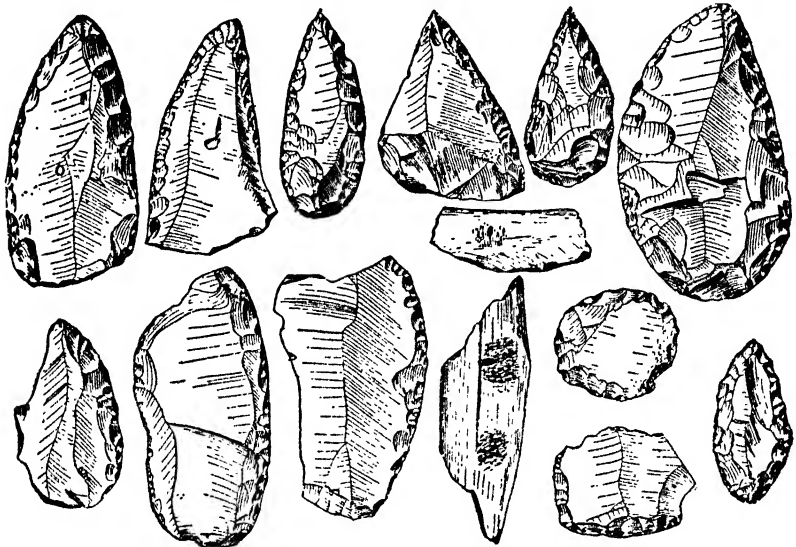

FIG. 284. — Mousterian implements. Flint scrapers and points, and two bone compressors from a rock shelter of La Ferrassie (Dordogne), France. Middle Paleolithic Period. (From MacCurdy, after Capitan and Peyrony.)

spread in other suitable regions of Europe, and in Palestine and Mongolia. The most famous cavern, at Le Moustier in France, is believed to have served as a human abode for more than fifty thousand years, and accordingly the culture of the Neanderthals is known as MOUSTERIAN. (Fig. 284.)

The stone implements of the Neanderthals show technical improvements in the methods of chipping as well as a greater variety of form. In addition to the point and the scraper there are saws, hammers, drills, and skinning implements. Also tools of bone were used for dressing hides, but there is no evidence of implements for sewing so it is assumed that clothing, such as it was, consisted of single skins. The use of fire was known and burial of the dead was practiced, but even the simplest pictorial art was not developed.

Apparently chipping flint tools and hunting demanded all the energy and ability of the Neanderthals until they were superseded by the Crô-Magnons.

A wave of migration from Asia brought the Crô-Magnons to western Europe where they met and to some extent mingled with the Neanderthals, but to the eventual extinction of the latter. Clearly it was the survival of the fit for the Crô-Magnon was essentially like modern man both physically and mentally, and "the

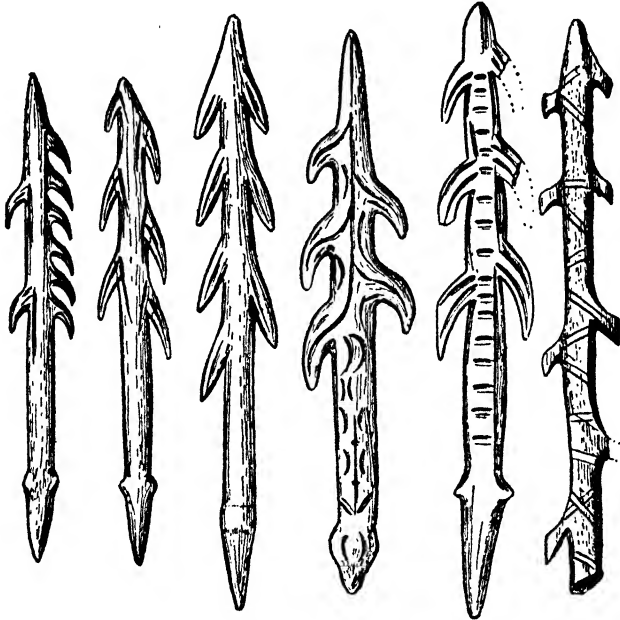

FIG. 285. — Harpoons of reindeer horn from France and Switzerland. Late Paleolithic Period. (From MacCurdy, after Breuil.)

characters of their crania reflect their moral and spiritual potentialities." It was a race of hunters and warriors, of sculptors and painters that lived at the close of the long glacial epoch, some fifty thousand years ago.

The marked line of cleavage between the Neanderthal and Crô-Magnon cultures is attested by a newly developed kit of tools. No longer are the implements confined to such as can be fashioned merely by chipping, but include, for example, the harpoon of reindeer horn, the flat bone point with cleft base, the needle of bone or ivory, the dart thrower, and the flint scratchers, knives, and gravers.

The latter were used both for cutting bone, horn, and ivory and also for engraving and sculpturing. Indeed the Crô-Magnon artist not only modeled in clay, but also was skillful with colors, first simple, later blended, as is still attested by the drawings and frescoes on the walls and ceilings of his caverns. However, the art that depicted the Woolly Rhinoceros and the Mammoth was to fade as the diminishing ice sheets forced these animals north to eventual extinction. The cause of this flowering of artistic ability

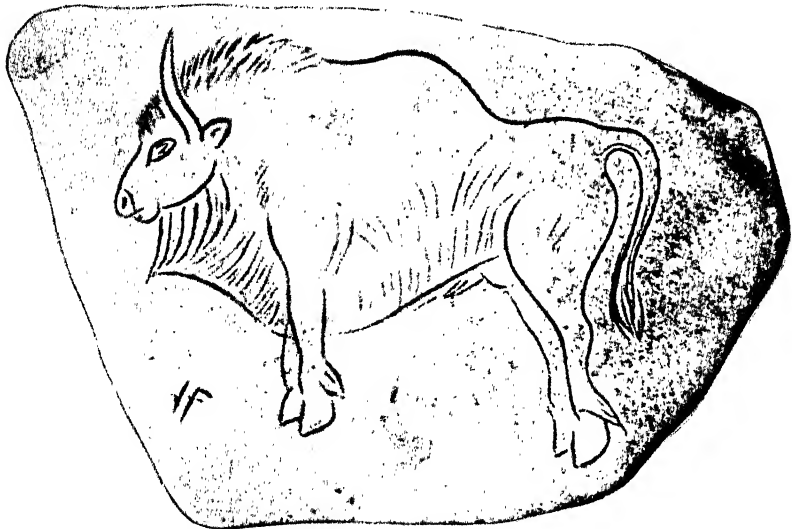

FIG. 286. — Bison incised on limestone. Rock shelter of Laugerie-Basse (Dordogne), France. Late Paleolithic Period. (From MacCurdy.)

and its passing remains an enigma. It was not exhibited by the immediate successors of Paleolithic man. (Figs. 285, 286.)

## 2. Mesolithic Culture

The so-called MESOLITHIC culture succeeded the Paleolithic and represents, as it were, the Dark Ages of the prehistoric era. Characteristic of the period are the huge shell heaps — refuse piles that throw considerable light on the food habits and implements of the people. These are found in Europe, Asia, and America. Usually they were situated near water as is evidenced by the great abundance of oyster and mussel shells, and of the bones of the duck, goose, gull, and swan. Mammals are represented by bones

of the stag, boar, wolf, bear, beaver, etc. It is significant that remains of domesticated animals are not present, except possibly of the dog — the earliest companion of man. Among the implements are arrow points, axes, adzes, and blade-like flints, while remnants of pottery show that at least crudely fashioned bowls and jars were employed.

Other interesting accessions of the period are the curious painted pebbles that are found in stream beds. The pebbles bear symbols of various kinds, some of them crudely resembling modern letters. Indeed it has been seriously suggested that these symbols represent a mode of writing and that some of them have had their influence on our own alphabet.

### 3. *Neolithic Culture*

The culture of the NEOLITHIC, or NEW STONE AGE, is essentially that of modern men who have deserted cavern life and taken to the open. The animal life is also modern since no 'prehistoric' animals persisted and none have since become naturally extinct. The human population appears to have been increasing in numbers, and the division of labor between individuals and communities to have become more significant. Thus the Mesolithic hunter and fisherman gave place to the Neolithic husbandman who, to some extent at least, controlled his food supply and so made possible the development of community life. From a mere food gatherer, Man became a food producer.

Almost surely the relatively rapid transformation of the primitive civilization was the outcome of the cultivation of plants — such as wheat, barley, rye, flax, grape, apple, and pear; the domestication of animals — for example the dog, ox, sheep, and goat; and the development of the art of making pottery and textiles. Moreover pottery and textiles afforded an outlet for artistic ability and this is also evidenced, for instance, in the beautifully chipped flint poignards and knives. The shaping and finishing of stone tools and weapons by a process of polishing appears for the first time in the Neolithic period which accordingly is frequently referred to as the age of polished stone implements. (Fig. 287.)

Transportation on water by means of dugouts began in Neolithic times, and the custom was developed of erecting habitations on piles in rivers, lakes, and swamps. Such PILE VILLAGES, serving both sanitation and safety, were widely distributed in Europe

during the later Neolithic and survived into the following age. The best known representatives are the Swiss Lake Dwellings.

Transportation by dugout apparently antedates the invention of the wheel, but Neolithic man employed at least crude wheels made from sections of logs, and the significance of this advance can hardly be overestimated. The wheel is so inextricably woven into the fabric of modern civilization that one is inconceivable

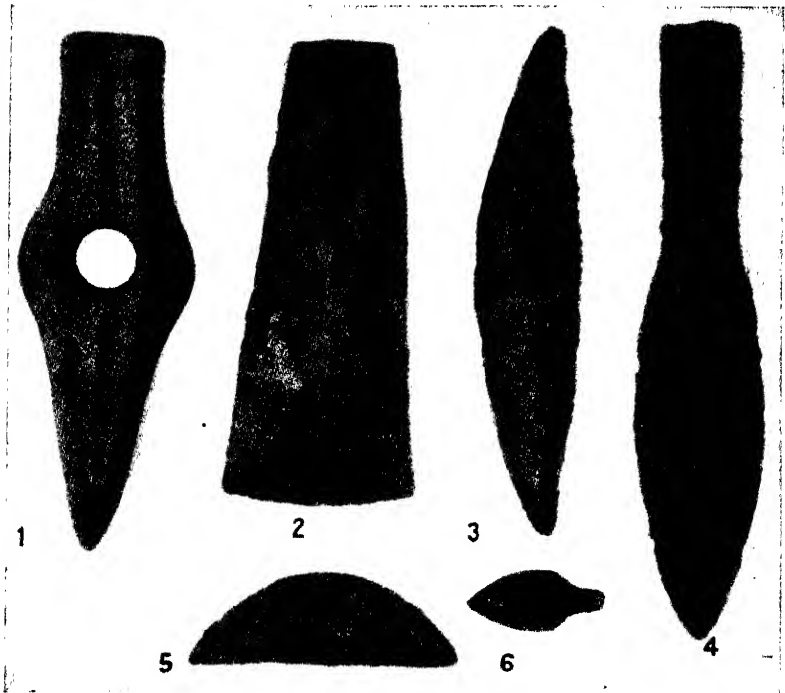

FIG. 287. — Implements typical of the Neolithic Period. 1, ax-hammer; 2, ax; 3, saw; 4, dagger; 5, knife; 6, arrow point. (From American Museum of Natural History.)

without the other. "Take away fire and the wheel and the world would suddenly revert to sub-Neolithic level."

Although burial of the dead extends further into the past, it reaches ceremonial significance with Neolithic man. Numerous so-called MEGALITHIC monuments still remain — some of them memorials to the dead, and others of unknown symbolic import. Probably the most celebrated is the Stonehenge on Salisbury Plain in England. And finally, to his other accomplishments, Neolithic



man developed some surgical skill as evidenced, in particular, by skulls showing trepanation. So culture moved on apace to the Age of Metals.

#### 4. *Age of Metals*

The gradual transition from the Stone Age — Paleolithic, Mesolithic, and Neolithic — to the AGE OF METALS effected perhaps the most important step in the history of human culture. It meant a release from the restrictions inherent in the very nature of stone and the opening up of the almost infinite possibilities of metals in the fabrication of newer and better instruments and utensils. Invention was stimulated.

This turning point in culture came with the development of the art of extracting metals from their ores and of melting and casting them. Copper was the first employed, probably because it was available in its native condition, and led to a transition period, the so-called AGE OF COPPER. This later gave place to the great BRONZE AGE, with the discovery of the many advantages of this alloy of copper and tin. The Bronze Age extended approximately from 3000 to 1500 B.C. and shows gradual progression in the variety and nicety of fabrication of tools, utensils, ornaments, etc., as well as concomitant progress in many other aspects of human culture. It eventually led to the IRON AGE which bridges the transition between prehistoric and historic times.

So Man has travelled far since culture emerged from the mere biosocial pattern. He has gained an increment in each generation and passed it on by so-called 'social heredity' until the cumulative result is monumental. Witness the high order of endeavor and social integration that has led Man not only to modern science and art, but has created within him the aspirations and ideals that make him unique in the world of life. It spells modern civilization that, ideally at least, ministers to the health, wealth, and happiness of mankind.

It is important to note that cultural evolution has given to humanity greatly increased powers, although the hereditary physical basis apparently has remained essentially the same since the origin of *Homo sapiens*. Increased cultural complexity has depended upon the intelligent use of structures and capacities already present and not upon the evolution of new ones. Indeed, the rela-

tively static character of Man's nature may possibly constitute a crucial handicap to indefinite human progress. One may be a confirmed optimist and still admit that the increasing momentum of the stupendous cultural advance during the past century is today taxing the adjustment capacity — the adaptability — of the human biological heritage. Surely, Man must study himself more intensively.

And so we may appropriately reiterate what was stated on an early page: the most pregnant thought from the study of biology in general and Man's past in particular is the unity of nature — the oneness of life — based on the ever-increasing background of knowledge which “robs life of none of its mystery but rather serves to link it securely with the larger mystery of the universe and the Infinite back of it all.” But Man, though one with all living beings, has the unique and all-important power consciously to study the ways, to direct the forces of nature, and to adapt himself to them. The knowledge of Man's physical development through the ages in no wise minimizes the other aspects of his nature on whose origin biology is silent, and which constitute the enormous gap that separates him from the beasts. When the grandeur of this view of life to which biology leads is appreciated to the full, no reassurance is necessary of Man's commanding position — his opportunities and his responsibilities.

## CHAPTER XXVI

### DEVELOPMENT OF BIOLOGY

History must convey the sense not only of succession but also of evolution. — *New York Times*.

THE story of Man's slow emergence from a condition in which he was completely at the mercy of his environment, to his relatively masterful position as exhibited in our present civilization, is the inspiring history of science — the intellectual development of the race. Indeed, as we have seen, knowledge spells power — power to direct and become adapted to the forces of nature, and this knowledge Man has acquired after much labor and safely treasured with great pains as a result of scientific study. Truly "the succession of men during the course of many centuries should be considered as one and the same man who exists always and learns continuously"; but we, for the most part, forget the past whose heirs we are — "the present is vocal and urging, the past silent and patient." Let us for the moment turn to the works of some of the outstanding contributors to biological history.

Some knowledge of hunting, agriculture, and husbandry was one of the early acquirements of prehistoric Man, and at the dawn of history, nearly 5000 years ago, systems of medicine apparently found a place in Egyptian and Babylonian civilizations. So, on the practical side, biology has a very ancient beginning. But biology as the science of life in which emphasis is placed on the study of vital phenomena for their own sake really begins with the Greeks.

#### A. GREEK AND ROMAN SCIENCE

Science reaching Greece from the South and East fell upon fertile soil, and in the hands of the Hellenic natural philosophers was transformed into coherent systems through the realization that nature works by fixed laws — a conception foreign to the Oriental mind but the corner-stone of all future scientific investigation. It is not an exaggeration to say that to all intents and purposes the Greeks laid the foundations of the chief subdivisions of natural science and, specifically, created biology.

**ARISTOTLE** (384–322 B.C.), the most famous pupil of Plato and dissenter from his School, represents the highwater mark of the Greek students of nature and is justly called the Father of Natural History. Although Aristotle's contributions to biology are numerous, perhaps of most significance is the fact that he took a broad survey of the existing data and welded them into a science. He did this by relying, to a considerable extent, on the direct study of organisms and by insisting that the only true path of advance lies in accurate observation and description. The observational method and its very modern development, the laboratory method of biolog-

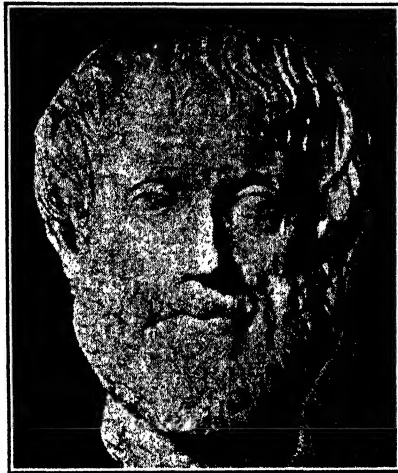

FIG. 288. — Aristotle.

ical study, find their first great exponent in Aristotle. But mere observation without interpretation is not science. Aristotle's generalizations based on the facts accumulated and his elaboration of broad philosophical conceptions of organisms give to his biological works their lasting significance. (Fig. 288.)

While Aristotle's biological investigations were devoted chiefly to animals, his pupil and co-worker, **THEOPHRASTUS** (370–286 B.C.), made profound studies on plants. Theophrastus not only laid the foundations but also gave suggestions of much of the superstructure of botany; an achievement which entitles him to rank as the first great student of plant science. (Fig. 289.)

Before leaving the Greeks we must mention **HIPPOCRATES**

(460–370 B.C.), the Father of Medicine. Lecturing a generation before Aristotle, at the height of the Age of Pericles, Hippocrates crystallized the knowledge of medicine into a science and gave to physicians a high moral inspiration.

The history of medicine and of biology as a so-called pure science are so closely interwoven that consideration of the one involves that of the other. Indeed the physicians form the chief bond of continuity in biological history between Greece and Rome. The chief interest of the Romans lay largely in practical affairs so it would seem that the advantages to be gained from medicine should

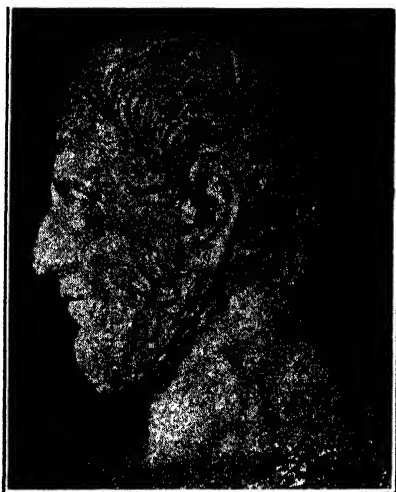

FIG. 289. — Theophrastus of Eresus.

have led them to make important contributions. As it happened, however, two Greek physicians were destined to have the most influence: Dioscorides, an army surgeon under Nero, and Galen, physician to the Emperor Marcus Aurelius.

**DIOSCORIDES** wrote the first important treatise on applied botany. This was really a work on the identification of plants for medicinal purposes but, gaining authority with age and being variously transformed, it became the standard 'botany' for fifteen centuries.

**GALEN** (131–201) was the most famous physician of the Roman Empire and his voluminous works represent both a depository for the anatomical and physiological knowledge of his predecessors,

improved and worked over into a system, and also a large amount of original investigation. Galen was at once a practical anatomist and also an experimental physiologist, inasmuch as he described from dissections and insisted on the importance of vivisection and experiment. Galen gave to medicine its standard 'anatomy' and 'physiology' for fifteen centuries.

Any consideration of the biological science of Rome would be incomplete without a reference to the vast compilation of mingled fact and fancy made by PLINY the Elder (23-79.) It was aside from the path of biological advance, but long the recognized *Natural History*, passing through some eighty editions after the invention of printing.

#### B. MEDIEVAL AND RENAISSANCE SCIENCE

For all practical purposes we may consider that biology at the decline of the Roman Empire was represented by the works of Aristotle, Theophrastus, Dioscorides, Galen, and Pliny. Even these exerted little influence during the Middle Ages. Dioscorides, Galen, and Pliny were in the hands of the scholars, but in so far as science reached the people in general it was chiefly by collections of quotations from corrupt texts of these authors interspersed with anecdotes and fables. From diverse sources gradually developed the oft-quoted *PHYSIOLOGUS*, found in many forms and languages, which is at once a collection of natural history stories, and a treatise on symbolism and the medicinal use of animals. Here, for instance, the mythical centaur and phoenix take their place with the Frog and Lion in affording illustrations of theological texts and in pointing out more or less far-fetched morals. Allusions from the *Physiologus* are readily found in Dante, Cervantes, and Shakespeare, while its illustrations are immortalized in the gargoyles of medieval cathedrals.

Indeed, science was submerged to such an extent that the scientific Renaissance owes its origin largely to the revival of classical learning: in particular to the translation of Aristotle and Theophrastus, and renewed study of Dioscorides and Galen. Their works were so superior to the current science that, in accord with the spirit of the times, to question their authority became almost sacrilegious. The first studies were merely commentaries on the writings of these authors, but as time went on more and more new observations were interspersed with the old. In short, the climax

of the scientific Renaissance involved a turning away from the authority of Aristotle and the past, and an adoption of the Aristotelian method of observation and induction.

Botany was the first to give visible signs of the awakening, probably because of the dependence of medicine on plant products. "All physicians professed to be botanists and every botanist was thought fit to practice medicine." In the HERBALS published in Germany during the sixteenth century we can trace the growth of



FIG. 290. — Andreas Vesalius.

plant description and classification from mere annotations on the text of Dioscorides to well-illustrated manuals of the plants of western Europe.

Meanwhile zoölogy began to emerge as a distinct science, but the less obvious immediate utility of the subject, combined with the greater difficulty of collecting and preserving animals, and therefore the necessity of more dependence on travellers' tales, contributed to retard its advance. One group of naturalists, the ENCYCLOPAEDISTS, so-called from their endeavor to gather all the available information about living things, attempted the impossible. However, this gleaning from the ancients and adding such material as could be gathered led to the publication of huge volumes of fact and fiction, which in the case of the best — Gesner's *History*

*of Animals* — served to popularize zoölogy and afforded the necessary survey which must precede constructive work.

Although GESNER (1516-1565) of Switzerland was without doubt the most learned naturalist of the period and probably the best zoölogist who had appeared since Aristotle, the direct path to progress was blazed by men whose plans were less ambitious. Contemporaries of Gesner, who confined their treatises to special groups of organisms which they themselves investigated, really



FIG. 291. — William Harvey.

instituted the biological MONOGRAPH which has proved to be an effective method of scientific publication.

While the HERBALISTS, ENCYCLOPAEDISTS, and MONOGRAPHERS at work in natural history were making earnest endeavors to develop the powers of independent judgment, long suppressed during the Middle Ages, the emancipator of biology from the traditions of the past appeared in the Belgian anatomist, VESALIUS (1514-1564). Not content with the anatomy of the time, which consisted almost solely in interpreting the works of Galen by reference to crude dissections made by barbers' assistants, Vesalius attempted to place human anatomy on the firm basis of exact observation. The publication of his great work *On the Structure of the Human Body* made the year 1543 the dividing line between ancient and modern anatomy, and thenceforth anatomical as well as biological



investigation in general broke away from the yoke of authority, and men began to trust and use their own powers of observation. (Fig. 290.)

The work of Vesalius was on anatomy, and physiology was treated somewhat incidentally. The complementary work on the functional side came in 1628 with the publication of the epoch-making monograph *On the Motion of the Heart and Blood in Animals* by HARVEY (1578–1657) of London. No rational conception of the economy of the animal organism was possible under the influence of Galenic physiology, and it remained for Harvey to demonstrate by a series of experiments, logically planned and ingeniously executed, that the blood flows in a circle from heart back to heart again, and thus to supply the background for a proper understanding of the physiology of the organism as a whole. With the work of Vesalius and Harvey, biologists had again laid hold of the great scientific tools — observation, experiment, and induction — which since then have not slipped from their grasp. (Figs. 121, 291.)

### C. THE MICROSCOPISTS

During this revival period, when collections and accurate descriptions of plants and animals were being made and the study of anatomy and physiology was going rapidly forward, optical inventions occurred which were destined to make possible modern biology. First came the development of the SIMPLE MICROSCOPE, through an adaptation of the principles of spectacles, during the sixteenth century; then the combination of lenses to form the COMPOUND MICROSCOPE first effectively employed by Galileo in 1610; and by the middle of the century simple and compound microscopes were being made by opticians in the leading centers of Europe. Significant of the times is the clear appreciation of the importance of studying nature with instruments, which increase the powers of the senses in general and of vision in particular, expressed by HOOKE (1635–1703) of London in a remarkable book, the *Micrographia*, published in 1665. Using his improved compound microscope, Hooke clearly observed and figured for the first time the “little boxes or cells” of organic structure, and his use of the word cell is responsible for its application to the protoplasmic units of modern biology. (Fig. 10.)

Microscopical work was a mere incident among the varied inter-

ests of Hooke, while LEEUWENHOEK (1632-1723) of Holland spent a long life studying nearly everything which he could bring within the scope of his simple lenses. With an unexplored field before him, all of his observations were discoveries. Bacteria, Protozoa, Hydra, and many other organisms were first revealed by his lenses. But Leeuwenhoek's discovery of the sperm of animals created the most astonishment. His imagination, however, outstripped his observations for he thought he saw evidence of the organism preformed within the sperm and so regarded it as the complete germ which had only to be hatched by the female. (Figs. 14, 26, 292.)



FIG. 292. — Antony van Leeuwenhoek.

The patience and ingenuity of Leeuwenhoek was equalled, if not exceeded, in the studies on insect anatomy made by SWAMMERDAM (1637-1680) of Holland. Inspired largely by the desire to refute the current notion that Insects and similar lower animals are without complicated internal organs, Swammerdam spent his life in studies on their structure and life histories. Revealing, as he did, by the most delicate technique in dissection, the finest details observable with his lenses, Swammerdam not only set a standard for minute anatomy which was unsurpassed for a century, but also dissipated for all time the conception of simplicity of structure in the lower animals. He thus, quite naturally, added one more argument to those of the Italian REDI (1626-1698) and others

against spontaneous generation — an erroneous theory that survived until the work of Pasteur (1822–1895) in the nineteenth century. (Figs. 152, 294.)

Malpighi of Bologna and Grew of London, contemporaries of Hooke, Leeuwenhoek, and Swammerdam, may be considered as the pioneer histologists. GREW (1641–1712) devoted all his attention to plant structure, while MALPIGHI (1628–1694), in addition to botanical studies which paralleled Grew's, made elaborate investigations on animals. The versatility as well as the genius of



FIG. 293. — Marcello Malpighi.

Malpighi is shown by his studies on the anatomy of plants, the function of leaves, the development of the plant embryo, the embryology of the chick, the anatomy of the Silkworm, and the structure of glands. Skilled in anatomy but with prime interest in physiology, his lasting contribution lies in his dependence upon the microscope for the solution of problems where structure and function, so to speak, merge. This is well illustrated by his ocular demonstration of the capillary circulation in the lungs, which is not only his greatest discovery but also the first of prime importance ever made with a microscope, since it completed Harvey's work on the circulation of the blood by revealing what his experiments predicted. (Fig. 293.)

#### D. DEVELOPMENT OF THE SUBDIVISIONS OF BIOLOGY

The microscopists taken collectively created an epoch in the history of biology, so important is the lens for the advancement of the science. Broadly speaking, we find that its development along many lines during the eighteenth and particularly the nineteenth century went hand in hand with improvements in the compound microscope itself and in microscopical technique. Again, the microscopists in general and Malpighi in particular opened up so



FIG. 294. — Louis Pasteur.

many new paths of advance that from this period on it is not possible, even in the most general survey, to discuss the development of biology as a whole. The composite picture must be formed by emphasizing and piecing together various lines of work, such as classification, comparative anatomy of animals, embryology, physiology of plants and animals, genetics, and evolution.

##### 1. *Classification*

Classification has as its object the bringing together of organisms which are alike and the separating of those which are unlike; a problem of no mean proportions when a conservative estimate today shows nearly a million known species of animals and about a quarter of a million plants — leaving out of account the myriads of forms represented only by fossil remains.

Naturally the earliest classifications were utilitarian or more or less physiological — fowl of the air, beasts of the field; edible, poisonous, etc. But as knowledge increased emphasis was shifted to the anatomical criterion of specific differences, and thenceforth classification became an important aspect of natural history — a central thread both practical and theoretical. Practical, in that it involved the arranging of living forms so that a working catalog was made which required nice anatomical discrimination, and therefore the amassing of a large body of facts concerning animals and plants. Theoretical, because in this process zoölogists and



FIG. 295. — John Ray.

botanists were impressed, almost unconsciously at first, with the 'affinities' of various types of animals and plants, and so were led to problems of their origin. (Fig. 297.)

From Aristotle, who emphasized the grouping of organisms on the basis of structural similarities, we must pass over some seventeen centuries, in which the only work of interest was done by the herbalists and encyclopaedists, to the time of RAY (1628–1705) of England and LINNAEUS (1707–1778) of Sweden. Previous to Ray the term species was used somewhat indefinitely, and his chief contribution was to make the word more concrete by applying it solely to groups of similar individuals which seem to exhibit constant characters from generation to generation. This paved the way for the great taxonomist, Linnaeus. (Figs. 295, 296.)

First and foremost a botanist, Linnaeus published a practical classification of the Seed Plants which afforded a great impetus to plant study, particularly because he insisted on brief descriptions and the scheme of giving each species a name of two words, generic and specific, thereby establishing the system of BINOMIAL NOMENCLATURE. Linnaeus' success with botanical taxonomy led him to extend the principles to animals and even to the so-called mineral kingdom: the latter showing at a glance his lack of appreciation of any genetic relationship between species. Although Linnaeus believed that species, genera, and even higher groups represented

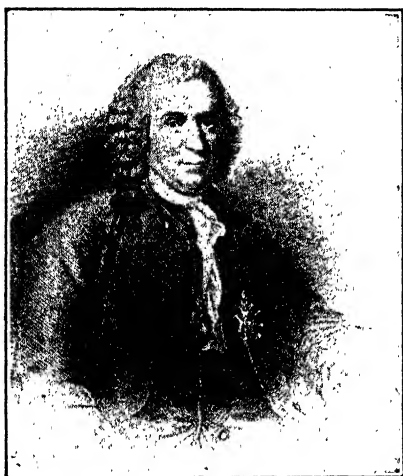

FIG. 296. — Carolus Linnaeus.

distinct acts of creation, nevertheless his greatest works, the *Species Plantarum* and *Systema Naturae*, are of outstanding importance in biological history and by common consent the base line of priority in botanical and zoölogical nomenclature. (Page 352.)

## 2. Comparative Anatomy

Owing to the less marked structural differentiation of plants in comparison with animals, plant anatomy lends itself less readily to descriptive analysis, so that an epoch in the study of comparative anatomy is not so well defined in botany as in the sister science, zoölogy.

Comparative anatomy as a really important aspect of zoölogical work, in fact as a science in itself, was the result of the life-work of

CUVIER (1769–1832) of Paris. It is true that some of his predecessors had reached a broad viewpoint in anatomical study but Cuvier's claim to fame rests on the remarkable breadth of his investigations — his survey of the comparative anatomy of the whole series of animal forms. And not content merely with the living, he made himself the first real master of the anatomy of fossil Vertebrates, as his contemporary LAMARCK was of fossil Invertebrates. (Figs. 232, 297, 309.)

Cuvier's grasp of anatomy was due to his emphasizing, as Aristotle had done before him, the functional unity of the organism:



FIG. 297. — Georges Cuvier.

that the interdependence of organs results from the interdependence of function: that structure and function are two aspects of the living machine which go hand in hand. Cuvier's famous principle of correlation — "Give me a tooth," said he, "and I will construct the whole animal" — is really an outcome of this viewpoint. Every change of function involves a change in structure and, therefore, given extensive knowledge of function and of the interdependence of function and structure, it is possible to infer from the form of one organ that of most of the other organs of an animal. But Cuvier undoubtedly allowed himself to exaggerate his guiding principle until it exceeded the bounds of fact.

Among Cuvier's immediate successors, OWEN (1804–1892) of London perhaps demands special mention. He spent a long life

dissecting with untiring patience and skill a remarkable series of animal types, as well as reconstructing extinct forms from fossil remains. Aside from the facts accumulated, probably his greatest contribution was making concrete the distinction between homologous and analogous structures. This has been of the first importance in working out the pedigrees of plants as well as of animals; though Owen himself took an enigmatical position in regard to organic evolution - not unlike that of the great teacher and investigator of zoölogy in America, AGASSIZ (1807-1873), but quite

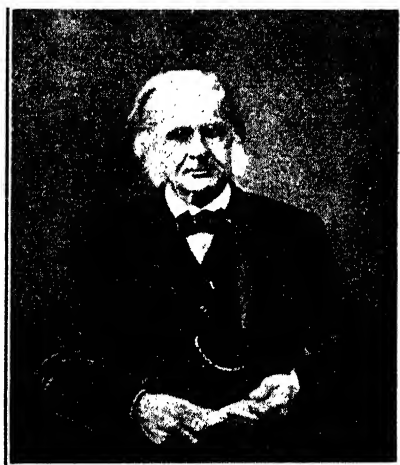

FIG. 298. — Thomas Henry Huxley.

different from that of HUXLEY (1825-1895), his famous English contemporary comparative anatomist. (Figs. 227, 298, 299.)

### 3. *Physiology*

The functions of organisms were discussed by Aristotle with his usual insight, though, as might be expected since physiology is more dependent than anatomy upon progress in other branches of science, with less happy results. Similarly Galen was hampered in his attempt to make physiology a distinct department of learning, based on a thorough study of anatomy, and the corner-stone of medicine; though fate foisted upon uncritical generations through fifteen centuries his system of human physiology.

Neither Vesalius nor Harvey made an attempt to explain the workings of the body by appeal to so-called physical and chemical



laws; and for good reason. Chemistry had not yet thrown off the shackles of alchemy and taken its legitimate place among the elect sciences, while during Harvey's lifetime, under the influence of Galileo, the new physics was born. But by the end of the seventeenth century both physics and chemistry had forced their way into physiology and split it into two schools. The physical school was founded by BORELLI (1608-1679) of Italy, who, employing incisive physical methods, attacked a series of problems with brilliant results; while the chemical school developed from the



FIG. 299. — Louis Agassiz.

influence of FRANCISCUS SYLVIVS (1614-1672) of Holland as a teacher rather than as an investigator.

This awakening brought a host of workers into the field and the harvest of the century was garnered and enriched by HALLER (1708-1777) of Geneva. In a comprehensive treatise which at once indicated the breadth of view and critical judgment of its author, Haller established physiology as a distinct and important branch of biological science. It was no longer a mere adjunct of medicine. Perhaps the most significant advance in Haller's century consisted in setting the physiology of nutrition and of respiration — both of which awaited the work of the chemists — well upon the way toward their modern form. (Fig. 300.)

REAUMUR (1683-1757) of Paris and SPALLANZANI (1729-1799) of Pavia may be singled out for their exact studies of gastric digestion,

which showed 'solution' of the food to be the main factor in digestion; although it was not clear how these changes differ from ordinary chemical ones. It was left for nineteenth-century investigators to establish the fact that food in passing along the digestive tract runs the gauntlet of a series of complex chemical substances, each of which has its part to play in putting the various constituents of the food into such a form that they can pass to the various cells of the body where they are actually used. (Fig. 113.)



FIG. 300. — Albrecht von Haller.

On the side of respiration, a closer approach was made toward a true understanding of the process. In France LAVOISIER (1743–1794) demonstrated that the chemical changes taking place in respiration involve essentially a process of combustion, and it chiefly remained for later work to show that this takes place in the tissues rather than in the lungs. (Fig. 118.)

Most of the firm foundation on which the physiology of animals rests to-day has been built up by the work on Vertebrates. But since the middle of the nineteenth century, when the versatile MÜLLER (1801–1858) of Germany emphasized the value of studying the physiology of higher and lower animals alike, there has been an ever-increasing tendency to focus evidence, in so far as possible, from all forms of life on general problems of function. This has culminated in the science of GENERAL PHYSIOLOGY.

The less obvious structural and functional differentiation of plants retarded progress in plant physiology as it did in plant anatomy. Probably of most historical, and certainly of most general interest is the development of our knowledge of the nutrition of green plants. Aristotle's notion that the plant's food is prepared for it in the ground was still prevalent during the seventeenth century when Malpighi, from his studies on plant histology, gave the first hint of supreme importance — the crude 'sap' enters by the roots and is carried to the leaves where, by the action



FIG. 301. — Stephen Hales.

of sunlight, evaporation, and some sort of a 'fermentation,' it is elaborated and distributed as food to the plant as a whole.

It is HALES (1667-1761) of England, however, to whom the botanist looks as the Harvey of plant physiology, because in his *Vegetable Staticks* (1727) he laid the foundations of the physiology of plants by making 'plants speak for themselves' through his incisive experiments. For the first time it became clear that green plants derive a considerable part of their food from the atmosphere, and also that the leaves play an active rôle in the movements of fluids up the stem and in eliminating superfluous water by evaporation. Still the picture was incomplete, and so remained until the biologist had recourse to further data from the chemist. (Fig. 301.)

In 1779, PRIESTLEY (1733–1804) of England, the discoverer of oxygen, showed that this gas under certain conditions is liberated by plants. This fact was seized upon by a native of Holland, INGENHOUSZ (1730–1799), who demonstrated that carbon dioxide from the air is reduced to its component elements in the leaf during exposure to sunlight. The plant retains the carbon and returns the oxygen — this process of carbon-getting being quite distinct from that of respiration in which carbon dioxide is eliminated. It remained then for DE SAUSSURE (1767–1845) in Geneva to show that, in addition to the fixation of carbon, the elements of water are also employed, while from the soil various salts, including combinations of nitrogen, are obtained. But it was nearly the middle of the last century before the influence and work of LIEBIG (1803–1873) at Giessen led to a clear realization of the fundamental part played by the chlorophyll of the green leaf in making certain chemical elements available to animals. The establishment of the cosmical function of green plants — the link they supply in the circulation of the elements in nature — is an epoch in biological progress. (Figs. 15, 16.)

Enough perhaps has been said to indicate the trend of physiology away from the maze of Galenic “spirits” in which science lost itself, toward the modern viewpoint of science which assumes as its *working hypothesis* that life phenomena are an expression of a complex interaction of physico-chemical laws which do not differ fundamentally from the so-called laws operating in the inorganic world, and that the economy of the organism is in accord with the law of the *conservation of energy* — probably the most far-reaching generalization attained by science during the past century.

However, it is important to emphasize that VITALISM — the conception that life phenomena are, in part at least, the resultant of manifestations of matter and energy which transcend and differ intrinsically in kind from those displayed in the inorganic world: a denial, as it were, in the organism of the full sufficiency of known fundamental laws of matter and energy — has arisen many times in the development of biological thought. This has been either as a reaction against premature conclusions of the rapidly growing science, or from an overwhelming appreciation of the staggering complexity of life phenomena. (Page 24.)

Vitalism attained perhaps its most concrete formulation as a doctrine during the early part of the eighteenth century, in opposi-

tion to the obviously inadequate explanations which chemistry and physics could offer for the phenomena of irritability of living matter then prominently engaging the attention of biologists. The vitalists of that period abandoned almost completely all attempts to explain life processes on a physico-chemical basis, and assumed that an all-controlling, unknown, mystical, hyper-mechanical force was responsible for all living processes. It is apparent that such an assumption in such a form is a negation of the scientific method, and at once removes the problem from the realm of scientific investigation.

Of course, no biologist at the present time subscribes to vitalism in this form; some uphold vitalism — if it must still be called vitalism — in its considerably limited modern form; while all will undoubtedly admit that we are at the present time utterly unable to give an adequate explanation of the fundamental life processes in terms of physics and chemistry. Whether we shall ever be able to do so is unprofitable to speculate about, though certainly the twentieth century finds few scientists who really expect a scientific explanation of life ever to be attained or who expect that protoplasm will ever be synthesized. However that may be, this much is positive: during the past fifty years some biologists have now and then thought they were on the verge of artificially creating life in the test tube, only to leave the problem, like the alchemists of old, with more respect for the complexities of protoplasmic organization and the enormous gap which separates even the simplest forms of life from the inorganic world.

#### 4. *Histology*

Studies on the physiology of plants and animals naturally involved the progressive analysis of the physical basis of the phenomena under consideration, but the Aristotelian classification of the materials of the body as unorganized substance, homogeneous parts or tissues, and heterogeneous parts or organs, practically represented the level of analysis until the beginning of the eighteenth century. In fact it was not until the revival of interest in embryology early in the last century that the cell became a particular object of study, and attention began gradually to shift from more or less superficial details to cell organization. This culminated in the classic investigations of two German biologists, the botanist SCHLEIDEN (1804–1881) and the zoölogist SCHWANN (1810–1882),

published in 1838 and 1839. Together these studies clearly showed that all organisms are composed of units, or cells, which are at once structural entities and the centers of physiological activities. And further that the development of animals and plants consists in the multiplication of an initial cell to form the multitude of different kinds which constitute the body of the adult. (Figs. 7, 32, 302, 303.)

Unquestionably the cell concept represents one of the greatest generalizations in biology, and it only needed for its consummation



FIG. 302. — Matthias Jacob Schleiden.

the full realization that the viscid, jelly-like material which zoölogists interpreted as the true living matter of animals, and the quite similar material which botanists considered the true living part of plants are practically identical. This viewpoint was crystallized in the early sixties by SCHULTZE (1825–1874) of Germany in the formulation of the protoplasm concept, and thenceforth not only morphological elements — cells — but also the material of which they are composed — protoplasm — were recognized as fundamentally the same in all living beings. Indeed, the realization of a common physical basis of life in both plants and animals — a common denominator to which all vital phenomena are

reducible — gave content to the term biology and created the science of life in its modern form. (Fig. 9.)

### 5. *Embryology*

The cell theory resulted, as we have seen, from combined studies on the adult structure and on the development of plants and animals, and accordingly implies that the science of embryology has a history of its own. As a matter of fact, Aristotle discussed the wonder of the beating heart in the hen's egg after three days' incubation, but there the subject practically rested until FABRICIUS



FIG. 303. — Theodor Schwann.

(1537–1619) at Padua, early in the seventeenth century, published a treatise which illustrated the obvious sequence of events within the hen's egg to the time of hatching. This beginning was built upon by a pupil of Fabricius, the celebrated Harvey, who added many details of interest, though little progress in embryology was possible without the microscope.

The microscope was first turned on embryological problems by the versatile MALPIGHI in two treatises published in 1672, and at one step animal development was placed upon a plane so advanced that for over a century it was unappreciated. One conclu-

sion of Malpighi, however, was seized upon by contemporary biologists. Apparently, unbeknown to him, some of the eggs which he studied were slightly incubated, so that he thought traces of the future organism were preformed in the egg. This error contributed to the formulation of the preformation theory, which gradually became the dominant question in embryology. (Page 274.)

As a matter of fact the time was not ripe for theories of development. The preformationists were wrong, but so were Aristotle, Harvey, and later supporters of epigenesis who went to the opposite extreme and denied all egg organization and therefore tried to get



FIG. 304. — Karl Ernst von Baer.

something out of nothing. It remained, as we know, for the present generation of embryologists to work out many of the details of the origin and organization of the germ cells, and to reach a level of analysis deep enough to suggest how "the whole future organism is potentially and materially implicit in the fertilized egg cell" and thus that "the preformationist doctrine had a well-concealed kernel of truth within its thick husk of error."

The next great advance came in the accurate and comprehensive studies of the Russian, VON BAER (1792-1876), published in the thirties of the last century. Taking his material from all the chief groups of higher animals, von Baer founded **COMPARATIVE EMBRYOLOGY**. Among his achievements may be mentioned: the clear



discrimination of the chief developmental stages, such as cleavage of the egg, germ layer formation, tissue and organ differentiation; the insistence on the importance of the facts of development for classification; and the discovery of the egg of Mammals. His observations on the origin and development of the germ layers, which afforded the key to many general problems of the origin of the body form, and his emphasis on the resemblance of certain embryonic stages of higher and lower animals, were made by his successors, under the influence of the evolution theory, the point of departure for the development of the GERM LAYER THEORY and the RECAPITULATION THEORY. (Figs. 176, 235, 304.)

From every point of view von Baer created an epoch in embryology just when the cell theory began to exert its influence on biological research, and thenceforth it became the problem of the embryologist to interpret development in terms of the cell. It is unnecessary to follow historically the establishment of the fact that the egg and the sperm are really single nucleated cells; that fertilization consists in the fusion of egg and sperm and the orderly arrangement of their chief nuclear contents, or chromosomes; that the new generation *is* the fertilized egg, since every cell of the body as well as every chromosome, in every cell is a lineal descendant by division from the zygote, and so from the gametes which united at fertilization to form it. Such, however, are the chief results of cytological study since von Baer. But embryologists have not been content to employ merely the descriptive method, and the dominant note of the most modern research is physiological — the experimental study of the significance of fertilization, the dynamics of cell division, the basis of differentiation, the influence of environmental stimuli, and so on. (Figs. 162, 164, 178.)

### 6. Genetics

The study of inheritance could be little more than a groping in the dark until embryology, under the influence of the cell theory, afforded a body of facts which clearly indicated that typically the fertilized egg is the sole bridge of continuity between successive generations. Indeed, the present science of genetics has a history largely confined to this century.

Although clearly intimated by a number of workers, the conception of the continuity of the germ plasm was first forced upon the attention of biologists and given greater precision by WEISMANN

(1834–1914) of Germany in a series of essays culminating in 1892 in his volume entitled *The Germ Plasm*. He identified the chromatin material which constitutes the chromosomes of the cell nucleus as the specific bearer of hereditary characters, and emphasized a sharp distinction between germ cells and somatic cells. (Figs. 181, 305.)

While this viewpoint had been gradually gaining content and precision, the science of genetics had been advancing not only by exact studies on the structure and physiology of the germ cells, but also by statistical studies of the results of heredity — the various

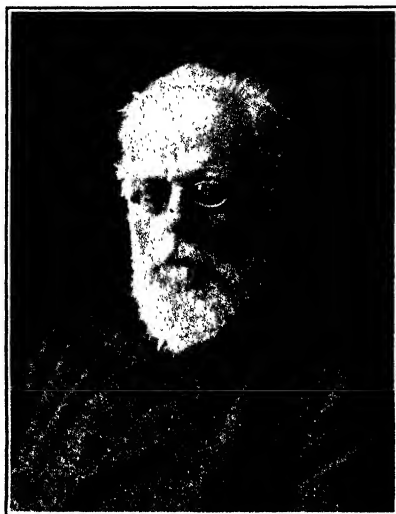

FIG. 305. — August Weismann.

characters of animals and plants as exhibited in parents and offspring. The studies of this type which first attracted the attention of biologists were made by GALTON (1822–1911) of England. In the eighties and nineties of the last century, he amassed a great volume of data in regard to, for example, the stature of children with reference to that of their parents, and derived his well-known 'laws' of inheritance.

But the work which eventually created the modern science of genetics was that of MENDEL (1822–1884) of Brünn, Austria. Mendel combined in a masterly manner the experimental breeding of pedigree strains of plants and the statistical treatment of the data

thus secured in regard to the inheritance of certain characters, such as the form and color of the seeds in Peas. His work was published in 1865 in an obscure natural history periodical, and he abandoned teaching and research to become the Abbot of his monastery. Thus terminated prematurely the scientific work of one of the epoch-makers of biology, and the now famous Mendelian laws of inheritance were unknown to science until 1900, when other biologists,



FIG. 306. — Gregor Johann Mendel.

coming to similar results, unearthed his forty-year-old paper. (Figs. 183, 306.)

We have already seen that the fundamental principle of the segregation of the genes during the development of the gametes, which Mendel's work indicated, has been extended to other plants and to animals, and that instead of being, as at first thought, a principle of rather limited application, appears to be the key to all inheritance. And the present results are extremely convincing because cytological studies on the architecture of the chromosome complex of the germ cells keep pace with, and afford a picture of the physical basis of inheritance — the mechanism by which the segregation and independent assortment of characters by the Mendelian formula takes place. Such is the deeply hidden kernel of truth in the old preformation theories. (Fig. 167.)

*7. Organic Evolution*

A question which has interested and perplexed thinking men of all times is how things came to be as they are to-day. The historian of human affairs attempts to trace the sequence and relationship of events from the remote past to the present. Similarly, the geologist endeavors to formulate the history of the Earth; and the biologist, the history of plants and animals on the Earth. All rec-



FIG. 307. — Comte de Buffon.

ognize that the present is the child of the past and the parent of the future, and that past, present, and future, though causally related, are never the same. It was the Greek natural philosophers who introduced this idea of history into science and attempted to give a naturalistic explanation of the Earth and its inhabitants, and thus started the uniformitarian trend of thought which culminated in the establishment of organic evolution during the past century. (Page 349.)

Aristotle apparently held the general idea of the evolution of life from a primordial mass of living matter to the higher forms, and placed Man at the head of animal creation. "To him belongs the God-like nature. He is preëminent by thought and volition. But although all are dwarf-like and incomplete in comparison with Man, he is only the highest point of one continuous ascent." And evolution is still going on — the highest has not yet been

attained. In looking for the effective cause of adaptation Aristotle rejected the hypothesis of EMPEDOCLES (495–435 B.C.), which embodied in crude form the idea of the survival of the fittest, and substituted secondary natural laws to account for the apparent design in nature. This was a sound induction by Aristotle from his necessarily limited knowledge of nature, but had he accepted the idea to account for adaptations, perhaps it would not be an exaggeration to regard him as “the literal prophet of Darwinism.”

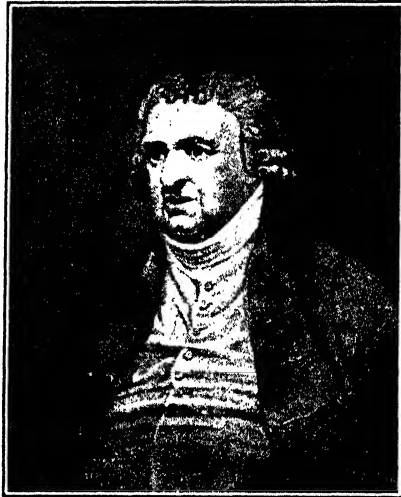

FIG. 308. — Erasmus Darwin.

The thread of continuity in evolutionary thought is not broken from Aristotle to the present, but from the strictly biological viewpoint two Frenchmen, Buffon and Lamarck, and two Englishmen, Erasmus Darwin and his grandson, Charles Darwin, stand preëminent.

BUFFON (1707–1788) was a peculiarly happy combination of entertainer and scientist who found expression in each new volume of his great *Natural History*. And it was largely, so to speak, between the lines of this work that Buffon's evolutionary ideas were displayed; apparently beyond the reach of the censor and dilettante. It is not strange, therefore, that it is often difficult to decide just how much weight is to be placed on some of his statements; though certainly it is not exaggerating to ascribe to him not only the recognition of the factors of geographical isolation, struggle for existence,

artificial and natural selection in the origin of species, but also the propounding of a theory of the origin of variations — that the *direct* action of the environment brings about modifications in the structure of animals and plants and these are transmitted to the offspring. (Fig. 307.)

When Buffon's influence had passed its height, ERASMUS DARWIN (1731–1802) expressed consistent views on the evolution of organisms, in several volumes of prose and poetry, which lead

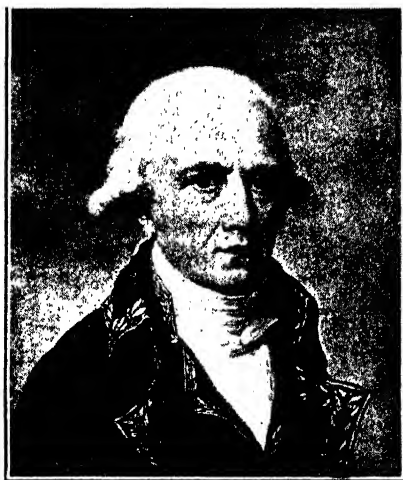

FIG. 309. — Jean-Baptiste Lamarck.

biologists to-day to recognize him as the anticipator of the Lamarckian doctrine that somatic variations arise through the reaction of the organism to environmental conditions. "All animals undergo transformations which are in part by their own exertions, in response to pleasures, and pain, and many of these acquired forms or propensities are transmitted to their posterity." (Fig. 308.)

LAMARCK (1744–1829) developed with great care the first complete and logical theory of organic evolution and is the one outstanding figure in biological uniformitarian thought between Aristotle and Charles Darwin. "For nature," he writes, "time is nothing. For all the evolution of the Earth and of living beings, nature needs but three elements, space, time, and matter." In regard to the factors of evolution, Lamarck put emphasis on the *indirect* action of the environment in the case of animals, and the

*direct* action in the case of plants. The former are induced to react and so adapt themselves, as it were; while the latter, without a nervous system, are molded directly by their surroundings. And, so Lamarck believed, such changes, somatic in origin — acquired characters — are transmitted to the next generation and bring about the evolution of organisms. (Fig. 309.)

Through the relative weakness of Lamarck's successors the French school of evolutionists dwindled to practical extinction;

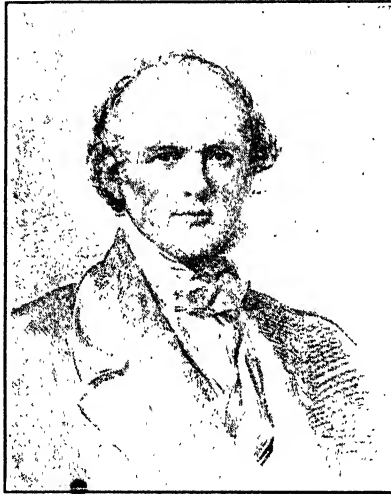

FIG. 310. — Charles Lyell.

while in Germany, GOETHE (1749–1832), the greatest poet of evolution, and TREVIRANUS (1776–1837) “brilliantly carried the argument without carrying conviction,” for the man and the moment must agree. Then in England the uniformitarian ideas elaborated by LYELL (1797–1875) in his *Principles of Geology* established evolution in geology and the way was paved for CHARLES DARWIN (1809–1882) to do the same for the organic world. (Figs. 310, 312; pages 373–377.)

True, “the idea of development saturated the intellectual atmosphere — nevertheless the elaborate and toilsome labor of thinking it through for the endless realm of nature was to be done” and Darwin did it in his *Origin of Species* which appeared in 1859. By his brilliant, scholarly, open-minded, and cautious marshalling of the facts pointing toward the universality of variations and the

mutability of species; and by the theory of natural selection on the basis of slight adaptive variations resulting in the survival of the fittest in the struggle for existence — which, strange to say, Darwin and WALLACE (1822–1913) reached simultaneously and independently — Darwin “made the old idea current intellectual coin.” (Figs. 236, 239, 311, 312.)

To-day, as we know, no representative biologist questions the fact of evolution — “evolution knows only one heresy, the denial

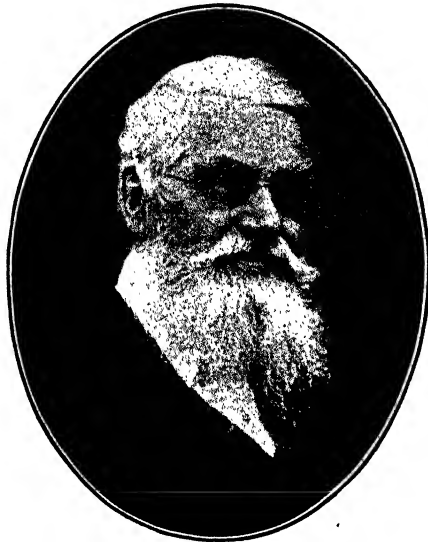

FIG. 311. — Alfred Russel Wallace.

of continuity” — though in regard to the factors involved, there is much difference of opinion. It is possible that we shall have reason to depart widely from Darwin’s interpretation of the effective principles at work in the origin of species, but withal this will have little influence on his position in the history of biology. The great value which he placed upon facts was exceeded only by his demonstration that this “value is due to their power of guiding the mind to a further discovery of principles.” The *Origin of Species* brought biology into line with the other inductive sciences, recast practically all of its problems, and instituted new ones. Darwin beautifully and conservatively expressed this new outlook on nature in the historically important concluding paragraph of his epoch-making work:



“It is interesting to contemplate a tangled bank, clothed with many plants of many kinds, with birds singing on the bushes, with various insects flitting about, and with worms crawling through the damp earth, and to reflect that these elaborately constructed forms, so different from each other, and dependent upon each other in so complex a manner, have all been produced by laws acting around us. These laws, taken in the largest sense, being Growth with Reproduction; Inheritance which is almost implied by reproduction; Variability from the indirect and direct action of the



FIG. 312. — Charles Darwin.

conditions of life, and from use and disuse: a Ratio of Increase so high as to lead to a Struggle for Life, and as a consequence to Natural Selection, entailing Divergence of Character and the Extinction of less-improved forms. Thus, from the war of nature, from famine and death, the most exalted object which we are capable of conceiving, namely, the production of the higher animals, directly follows. There is a grandeur in this view of life, with its several powers, having been originally breathed by the Creator into a few forms or into one; and that, whilst this planet has gone cycling on according to the fixed law of gravity, from so simple a beginning endless forms most beautiful and most wonderful have been, and are being evolved.”

## APPENDIX

### I. A BRIEF CLASSIFICATION OF ANIMALS

The figures indicate the approximate number of known species.

- Phylum 1. PROTOZOA. (20,000 species.)  
Class I. SARCODINA: Amoeba, Foraminifera, Heliozoa, Radiolaria. (Figs. 6, 8, 11, 13, 19-21, 244, 245.)  
Class II. MASTIGOPHORA: Flagellates. Monads, Trypanosomes, Euglena, Volvox. (Figs. 18, 22-24, 224.)  
Class III. SPOROZOA: Plasmodium, Monocystis. (Figs. 25, 223.)  
Class IV. INFUSORIA: Ciliates. Paramecium, Vorticella, Stentor. (Figs. 18, 26-28, 135, 226.)
- Phylum 2. PORIFERA: Sponges. (3000 species.) Leucosolenia, Grantia, Euspongia. (Figs. 35, 36.)
- Phylum 3. COELENTERATA. (10,000 species.)  
Class I. HYDROZOA: Hydra, Obelia, Gonionemus. (Figs. 37, 38, 57, 58, 155, 158.)  
Class II. SCYPHOZOA: Jellyfish. Aurelia. (Figs. 39, 40.)  
Class III. ANTHOZOA: Sea Anemones, Corals. (Figs. 41, 42.)
- Phylum 4. CTENOPHORA: Sea Walnuts. (100 species.)
- Phylum 5. PLATYHELMINTHES: Flatworms. (7000 species.)  
Class I. TURBELLARIA: Planaria. (Figs. 43, 156, 161.)  
Class II. TREMATODA: Liver Flukes. (Fig. 251.)  
Class III. CESTODA: Tapeworms. (Figs. 252, 253.)  
Class IV. NEMERTINEA. (Figs. 157, 159.)
- Phylum 6. NEMATHELMINTHES: Roundworms. (3000 species.)  
Class I. NEMATODA: Ascaris, Trichinella, Hookworm. (Figs. 44, 254, 255.)  
Class II. NEMATOMORPHA: Gordius.  
Class III. ACANTHOCEPHALA: Echinorhynchus.
- Phylum 7. ANNELIDA: Segmented Worms. (7000 species.)  
Class I. ARCHIANNELIDA: Polygordius.  
Class II. POLYCHAETA: Sandworms, Tubeworms. (Figs. 45, 166.)  
Class III. OLIGOCHAETA: Earthworms, Nails. (Figs. 60, 160, 173.)  
Class IV. GEPHYREA: Sipunculus.  
Class V. HIRUDINEA: Leeches. (Fig. 45.)
- Phylum 8. ROTIFERA: Rotifers. (1800 species.)
- Phylum 9. BRYOZOA: Bryozoans. (3000 species.)
- Phylum 10. BRACHIPODA: Brachiopods. (130 species.)

## Phylum 11. ECHINODERMATA. (5000 species.)

Class I. ASTEROIDEA: Starfish. (Fig. 46.)

Class II. OPHIUROIDEA: Brittle Stars.

Class III. ECHINOIDEA: Sea Urchins. (Figs. 47, 172.)

Class IV. HOLOTHUROIDEA: Sea Cucumbers. (Fig. 47.)

Class V. CRINOIDEA: Feather Stars, Sea Lilies. (Fig. 47.)

## Phylum 12. MOLLUSCA. (80,000 species.)

Class I. AMPHINEURA: Chiton. (Fig. 48.)

Class II. SCAPHOPODA: Dentalium. (Fig. 177.)

Class III. GASTROPODA: Snails, Slugs. (Fig. 48.)

Class IV. PELECYPODA: Oysters, Clams, Scallops, Shipworm. (Fig. 49.)

Class V. CEPHALOPODA: Squid, Octopus, Nautilus. (Fig. 50.)

## Phylum 13. ARTHROPODA. (700,000 species.)

Class I. CRUSTACEA.

Subclass 1. *Entomostraca*. Daphnia, Cyclops, Barnacles. (Fig. 51.)Subclass 2. *Malacostraca*. Crayfish, Lobsters, Crabs, Pill-bugs. (Figs. 51, 63-65.)

Class II. ONYCHOPHORA: Peripatus. (Fig. 56.)

Class III. MYRIAPODA: Centipedes, Millipedes. (Fig. 52.)

Class IV. INSECTA. (Fig. 54B.)

Commonly accepted orders are:

- |                                                                 |                                                                 |
|-----------------------------------------------------------------|-----------------------------------------------------------------|
| 1. <i>Thysanura</i> : Silverfish, etc.                          | 13. <i>Anoplura</i> : Sucking Lice.                             |
| 2. <i>Collembola</i> : Springtails.                             | 14. <i>Hemiptera</i> : Bugs.                                    |
| 3. <i>Orthoptera</i> : Grasshoppers,<br>Crickets, Roaches, etc. | 15. <i>Homoptera</i> : Plant-lice, etc.                         |
| 4. <i>Isoptera</i> : Termites.                                  | 16. <i>Dermaptera</i> : Earwigs.                                |
| 5. <i>Neuroptera</i> : Ant-lions, Lace-<br>wings, etc.          | 17. <i>Coleoptera</i> : Beetles.                                |
| 6. <i>Ephemeroptera</i> : Mayflies.                             | 18. <i>Strepsiptera</i> : Stylopids.                            |
| 7. <i>Odonata</i> : Dragonflies.                                | 19. <i>Mecoptera</i> : Scorpion-flies, etc.                     |
| 8. <i>Plecoptera</i> : Stoneflies.                              | 20. <i>Trichoptera</i> : Caddice-flies.                         |
| 9. <i>Psocoptera</i> : Book-lice, etc.                          | 21. <i>Lepidoptera</i> : Moths and But-<br>terflies.            |
| 10. <i>Mallophaga</i> : Bird-lice.                              | 22. <i>Diptera</i> : Flies, Mosquitoes.                         |
| 11. <i>Embioptera</i> : Embiids.                                | 23. <i>Siphonaptera</i> : Fleas.                                |
| 12. <i>Thysanoptera</i> : Thrips.                               | 24. <i>Hymenoptera</i> : Bees, Wasps,<br>Ants, Ichneumons, etc. |

Class V. ARACHNOIDEA: Scorpions, Spiders, Mites. (Fig. 55.)

## Phylum 14. CHORDATA. (70,000 species.)

Subphylum A. ~~ENTEROPNEUSTA~~: Dolichoglossus.Subphylum B. ~~TUNICATA~~: Tunicates, Sea-squirts. Styela.Subphylum C. ~~CEPHALOCHORDA~~: Lancelets. Amphioxus (Branchiostoma). (Figs. 67, 278.)

## Subphylum D. VERTEBRATA.

~~Class I. CYCLOSTOMATA: Hagfish, Lamprey. (Figs. 68, 168.)~~

~~Class H. ELASMOBRANCHII: Sharks and Rays. Dogfish. (Figs. 69, 70, 120.)~~

Class III. PISCES. (30,000 species.)

Subclass 1. *Teleostomi*. Mackerel, Trout, Cod, Perch, Goldfish, Guppy. (Figs. 71-74, 106.)

Subclass 2. *Dipnoi*. Lungfishes. (Fig. 75.)

Class IV. AMPHIBIA. (2000 species.)

Order 1. *Apoda*: Coecilians.

Order 2. *Caudata*: Necturus, Salamander, Cryptobranchus, Amblystoma. (Figs. 76, 77.)

Order 3. *Salientia*: Frogs, Toads. (Figs. 78, 98, 103, 107, 174, 175.)

Class V. REPTILIA. (5000 species.)

Order 1. *Testudinata*: Turtles, Tortoises. (Fig. 80.)

Order 2. *Rhynchocephalia*: Sphenodon.

Order 3. *Crocodylia*: Crocodiles, Alligators.

Order 4. *Squamata*: Chameleons, Lizards, Snakes. (Figs. 81-83, 230, 231.)

Class VI. AVES: Birds. (15,000 species.)

Subclass 1. *Archaeornithes*: Archaeopteryx (extinct). (Fig. 233.)

Subclass 2. *Neornithes*.

Division A. *Ratitae*: Apteryx, Ostrich. (Fig. 84.)

Division B. *Carinatae*: All familiar Birds. (Figs. 85, 86, 239.)

Class VII. MAMMALIA. (10,000 species.)

Subclass 1. *Prototheria*: Monotremes. Duck-bill, Echidna. (Fig. 87.)

Subclass 2. *Metatheria*: Marsupials. Opossums, Kangaroos. (Fig. 88.)

Subclass 3. *Eutheria*: Placentals. All familiar Mammals. (Fig. 202.)

Order 1. *Insectivora*: Moles, Shrews, Hedgehogs, Gymnura. (Figs. 201, 205, 207.)

Order 2. *Edentata*: Sloths, Anteaters, and Armadillos. (Figs. 89, 204.)

Order 3. *Chiroptera*: Bats. (Figs. 207, 227.)

Order 4. *Rodentia*: Rats, Mice, Rabbits, Squirrels, Beavers, Porcupines, Guinea-pig. (Figs. 108, 187.)

Order 5. *Carnivora*: Cats, Dogs, Bears, Seals, Walruses. (Fig. 104.)

Order 6. *Cetacea*: Whales, Porpoises, Dolphins. (Figs. 90, 206.)

Order 7. *Ungulata*: Horses, Tapirs, Rhinoceroses, Camels, Oxen, Antelopes, Giraffes, Pigs, Hippopotami, Elephants. (Figs. 90, 92, 234, 238.)

Order 8. *Sirenia*: Manatee. (Fig. 91.)

Order 9. *Primates*: (Fig. 272.)

Suborder 1. Lemuroidea: Lemurs. (Fig. 93.)

Suborder 2. Tarsioidea: Tarsiers. (Fig. 272.)

Suborder 3. Anthropeidea: Monkeys, Apes, Man. (Fig. 272.)

Series 1. Platyrrhini: New World Species.

Family 1. Hapalidae: Marmosets.

Family 2. Cebidae: Capuchins, Howler Monkeys, Spider Monkeys, etc. (Fig. 93.)

Series 2. Catarrhini: Old World Species.

Family 3. Cercopithecidae: Tailed Monkeys. Macaques, Baboons, etc. (Fig. 93.)

Family 4. Simiidae: Man-like or Anthropoid Apes. Gibbons, Orang-utans, Chimpanzees, Gorillas. (Figs. 93, 228, 273, 274.)

Family 5. Hominidae: Man.

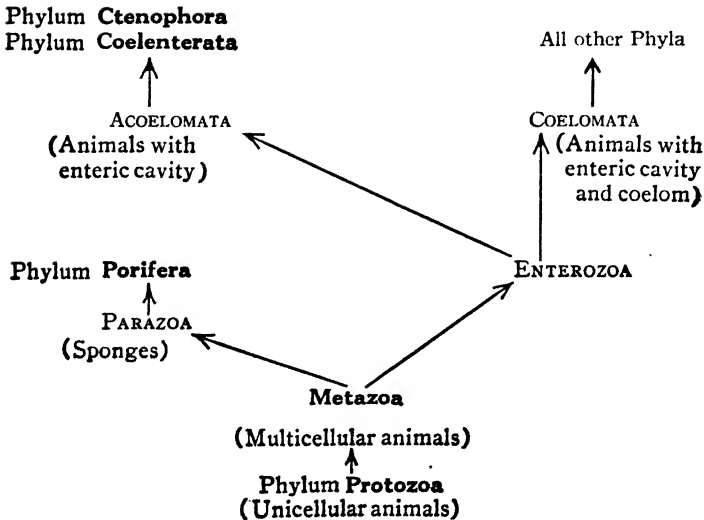

FIG. 313. — Diagram of the relationships of the animal phyla.

## II. BIBLIOGRAPHY

Some easily available works in English which are suitable for reference and collateral reading.

BAITSELL, G. A. *Manual of Animal Biology*. Macmillan, 1932. Detailed descriptions of the structure and life processes of a number of representative animals, together with directions for their study in the laboratory. Written especially to accompany WOODRUFF'S *Animal Biology*.

### CHAPTER I. — THE SCOPE OF BIOLOGY

*Biological Abstracts of the World's Literature in Biology*. Issued monthly. Vol. 1, 1926. Philadelphia.

CATTELL, J. McK. (editor). *American Men of Science*. A Biographical Dictionary. 6th edition. Science Press, 1938.

DAMPIER-WHETHAM, W. C. D. *A History of Science*. Cambridge University Press, 1930.

GREGORY, R. A., *Discovery, or the Spirit and Service of Science*. Macmillan, 1916.

HALDANE, J. S. *The Philosophical Basis of Biology*. Doubleday, Doran, 1931.

HENDERSON, I. F., and HENDERSON, W. D. *A Dictionary of Scientific Terms: Pronunciation, Derivation, and Definition of Terms in Biology, Botany, Zoölogy, Anatomy, Cytology, Embryology, Physiology*. 2d edition. Van Nostrand, 1929.

HUXLEY, T. H. "Educational Value of the Natural History Sciences." 1854. *Collected Essays*, Vol. *Science and Education*. Appleton.

HUXLEY, T. H. "On Our Knowledge of the Causes of the Phenomena of Organic Nature." 1863. *Collected Essays*, Vol. *Darwiniana*.

HUXLEY, T. H. "On the Study of Biology." 1876. *Collected Essays*, Vol. *Science and Education*.

JAEGER, E. C. *A Dictionary of Greek and Latin Combining Forms Used in Zoölogical Names*. Thomas, 1930.

MELANDER, A. L. *Source Book of Biological Terms*. College of the City of New York, 1937.

THOMSON, J. A. *An Introduction to Science*. Holt, 1911.

WELLS, H. G., HUXLEY, J. S., and WELLS, G. P. *The Science of Life*. Doubleday, Doran, 1931.

WESTAWAY, F. W. *Scientific Method*. 3d edition. Blackie & Son, 1923.

WHITEHEAD, A. N. *Science and the Modern World*. Macmillan, 1925.

## CHAPTER II. — CELLULAR ORGANIZATION OF LIFE

- COWDRY, E. V. (editor). *General Cytology*. University of Chicago Press, 1924.
- COWDRY, E. V. (editor). *Special Cytology*. 2d edition. Hoeber, 1932.
- GRAY, J. *Text Book of Experimental Cytology*. Macmillan, 1931.
- SHARP, L. W. *Introduction to Cytology*. 3d edition. McGraw-Hill, 1934.
- THOMPSON, D'ARCY W. *On Growth and Form*. Cambridge University Press, 1917.
- WILSON, E. B. *The Cell in Development and Heredity*. 3d edition. Macmillan, 1925.

## CHAPTER III. — THE PHYSICAL BASIS OF LIFE

- BALDWIN, E. *An Introduction to Comparative Biochemistry*. Macmillan, 1937.
- BARNES, T. C. *Textbook of General Physiology*. Blakiston, 1937.
- BAYLISS, W. M. *Principles of General Physiology*. 4th edition. Longmans, Green, 1924.
- BAYLISS, W. M. *The Nature of Enzyme Action*. Longmans, Green, 1925.
- HEILBRUNN, L. V. *Colloidal Chemistry of Protoplasm*. Borntraeger, 1928.
- HEILBRUNN, L. V. *General Physiology*. Saunders, 1937.
- HUXLEY, T. H. "On the Physical Basis of Life." 1868. *Collected Essays*, Vol. *Method and Results*. Appleton.
- LOEB, JACQUES. *The Dynamics of Living Matter*. Columbia University Press, 1906.
- PARSONS, T. R. *The Materials of Life*. Norton, 1930.
- PHILIP, J. C. *Physical Chemistry: Its Bearing on Biology and Medicine*. Longmans, Green, 1925.
- SEIFRIZ, W. *Protoplasm*. McGraw-Hill, 1936.
- SHERMAN, H. C. *Chemistry of Food and Nutrition*. 5th edition. Macmillan, 1937.
- SHERMAN, H. C., and SMITH, S. L. *The Vitamins*. American Chemical Society, 1931.
- WILSON, E. B. *The Physical Basis of Life*. Yale University Press, 1923.

## CHAPTER IV. — METABOLISM OF ORGANISMS

- GREAVES, J. E., and GREAVES, E. O. *Elementary Bacteriology*. 3d edition. Saunders, 1936.
- HOLMES, E. *The Metabolism of Living Tissues*. Cambridge University Press, 1937.
- HUXLEY, T. H. "On the Border Territory between the Animal and Vegetable Kingdoms." 1876. *Collected Essays*, Vol. *Discourses Biological and Geological*. Appleton.
- JORDAN, E. O. *Bacteriology*. 11th edition. Saunders, 1937.

- LUTMAN, B. F. *Microbiology*. McGraw-Hill, 1930.
- MARSHALL, C. E. *Microbiology*. 3d edition. Blakiston's, 1926.
- PLUNKETT, C. R. *Outlines of Modern Biology*. Holt, 1930.
- WAKSMAN, S. A., *Principles of Soil Microbiology*. Williams & Wilkins, 1927.
- WAKSMAN, S. A., and STARKEY, R. L. *The Soil and the Microbe*. Wiley, 1931.
- WOODRUFF, L. L. "The Origin and Sequence of the Protozoan Fauna of Hay Infusions." *Journal of Experimental Zoölogy*, Vol. 12, 1912.
- WOODRUFF, L. L. *Foundations of Biology*. 5th edition. Macmillan, 1936.

## CHAPTER V. — UNICELLULAR ANIMALS

- CALKINS, G. N. *Biology of the Protozoa*. 2d edition. Lea and Febiger, 1933.
- HEGNER, R. W., and TALIAFERRO, W. H. *Human Protozoölogy*. Macmillan, 1924.
- JENNINGS, H. S. *Genetics of the Protozoa*. Nijhoff, 1929.
- KUDO, R. R. *Handbook of Protozoölogy*. Thomas, 1931.
- MINCHIN, E. A. *Introduction to the Study of the Protozoa*. Arnold, 1912.
- SHIPLEY, A. E. *Hunting under the Microscope*. Macmillan, 1928.
- WENRICH, D. H. "Eight Well-defined Species of Paramecium." *Trans. Amer. Microscopical Society*, Vol. 47, 1928.
- WENYON, C. M. *Protozoölogy*. William Wood, 1926.
- WOODRUFF, L. L. "The Protozoa and the Problem of Adaptation," in *Organic Adaptation to Environment*. Yale University Press, 1924.

## CHAPTER VI. — THE MULTICELLULAR ANIMAL

- BREMER, J. L. *Histology*. 5th edition. Blakiston, 1936.
- DAHLGREN, ULRIC, and KEPNER, W. A. *Principles of Animal Histology*. Macmillan, 1908.
- GAGE, S. H. *The Microscope*. 16th edition. Comstock, 1936.
- GUYER, M. F. *Animal Micrology. Practical Exercises in Zoölogical Micro-technique*. 4th edition. University of Chicago Press, 1936.
- KELLCOTT, W. E. *General Embryology*. Holt, 1913.
- KINGSBURY, B. F., and JOHANNSEN, O. A. *Histological Technique*. Wiley, 1936.
- McCLUNG, C. E. (editor). *Microscopical Technique*. 2d edition. Hoeber, 1937.

## CHAPTERS VII-XVI. — INVERTEBRATES AND VERTEBRATES

- ADAMS, L. A. *An Introduction to the Vertebrates*. Wiley, 1936.
- BAITSELL, G. A. *Human Biology*. Edwards, 1938.
- BEDDARD, F. E. *Earthworms and Their Allies*. Cambridge University Press, 1901.



- BORRADAILE, L. A., and POTTS, F. A. *The Invertebrata*. 2d edition. Macmillan, 1935.
- CARLSON, A. J., and JOHNSON, V. *The Machinery of the Body*. University of Chicago Press, 1937.
- CRANDALL, L. A. *An Introduction to Human Physiology*. Saunders, 1934.
- DREW, G. A. *Invertebrate Zoölogy*. 5th edition. Saunders, 1936.
- FOLSOM, J. W., and WARDLE, R. A. *Entomology*. 4th edition. Blakiston, 1934.
- HARMER, S. F., and SHIPLEY, A. E. (editors). *The Cambridge Natural History*. Ten volumes. Macmillan, 1895.
- HEGNER, R. W. *College Zoölogy*. 4th edition. Macmillan, 1936.
- HEGNER, R. W. *Invertebrate Zoölogy*. Macmillan, 1933.
- HEGNER, R. W. *Parade of the Animal Kingdom*. Macmillan, 1935.
- HERRICK, C. J. *Introduction to Neurology*. 5th edition. Saunders, 1931.
- HOLMES, S. J. *Biology of the Frog*. 4th edition. Macmillan, 1927.
- HOSKINS, R. G. *The Tides of Life*. Norton, 1933.
- HOWELL, W. H. *Textbook of Physiology*. 13th edition. Saunders, 1936.
- HUXLEY, T. H. *The Crayfish*. Appleton, 1880.
- HYMAN, L. H. *A Laboratory Manual for Comparative Vertebrate Anatomy*. University of Chicago Press, 1922.
- HYMAN, L. H. "Hydras of North America." *Trans. Amer. Micr. Society*, Vol. 50, 1931.
- JOHNSON, M. E., and SNOOK, H. J. *Seashore Animals of the Pacific Coast*. Macmillan, 1926.
- KEITH, ARTHUR. *The Engines of the Human Body*. 2d edition. Lippincott, 1926.
- KINGSLEY, J. S. *Comparative Anatomy of Vertebrates*. 3d edition. Blakiston, 1927.
- KINGSLEY, J. S. *The Vertebrate Skeleton*. Blakiston, 1925.
- LANKESTER, E. R. (editor). *Treatise on Zoölogy*. Eight volumes. Macmillan.
- MARTIN, H. N. *The Human Body*. 12th edition. Holt, 1934.
- MITCHELL, P. H. *Text Book of General Physiology*. 2d edition. McGraw-Hill, 1932.
- MORGAN, A. H. *Field Book of Ponds and Streams*. Putnam, 1930.
- NEAL, H. V., and RAND, H. W. *Comparative Anatomy*. Blakiston, 1936.
- NEEDHAM, J. G. *Guide to the Study of Fresh-water Biology*. 2d edition. Thomas, 1930.
- NEEDHAM, J. G. *Culture Methods for Invertebrate Animals*. Comstock, 1937.
- NEWMAN, H. H. *Vertebrate Zoölogy*. 2d edition. Macmillan, 1929.
- NOBLE, C. K. *The Biology of the Amphibia*. McGraw-Hill, 1931.

- PARKER, T. J., and HASWELL, W. A. *Textbook of Zoölogy*. 4th edition. Macmillan, 1927.
- PRATT, H. S. *A Manual of the Common Invertebrate Animals, Exclusive of Insects*. 2d edition. Blakiston, 1935.
- PRATT, H. S. *A Manual of Land and Fresh Water Vertebrate Animals of the United States, Exclusive of Birds*. 2d edition. Blakiston, 1935.
- ROGERS, C. G. *Comparative Physiology*. McGraw-Hill, 1927.
- WALTER, H. E. *Biology of the Vertebrates. A Comparative Study of Man and His Animal Allies*. Macmillan, 1928.
- WALTER, H. E. *The Human Skeleton*. Macmillan, 1918.
- WARD, H. B., and WHIPPLE, G. C. *Fresh-water Biology*. Wiley, 1918.
- WILLIAMS, J. F., *Atlas of Human Anatomy*. Barnes & Noble, 1935.

## CHAPTER XVII. — ORIGIN OF LIFE

- HUXLEY, T. H. "Biogenesis and Abiogenesis." 1870. Collected Essays, Vol. *Discourses Biological and Geological*. Appleton.
- MOORE, B. *The Origin and Nature of Life*. Holt, 1912.
- NEWMAN, H. H. (editor). *The Nature of the World and Man*. University of Chicago Press, 1926.
- OSBORN, H. F. *The Origin and Evolution of Life upon the Earth*. Scribner, 1917.
- SCHÄFER, E. A. "Life: Its Nature, Origin and Maintenance." *Science*, Vol. 36, 1912.
- TROLAND, L. T. "The Chemical Origin and Regulation of Life." *The Monist*, Vol. 24, 1914.
- VERWORN, M. *General Physiology*. 2d edition. Macmillan, 1899.
- WOODRUFF, L. L. "The Origin of Life," in *Evolution of Earth and Man*. Yale University Press, 1930.

## CHAPTERS XVIII-XX. — CONTINUITY OF LIFE, FERTILIZATION, AND DEVELOPMENT

- CHILD, C. M. *Senescence and Rejuvenescence*. University of Chicago Press, 1915.
- DAVENPORT, C. B. *How We Came by Our Bodies*. Holt, 1936.
- DODDS, G. S. *Essentials of Human Embryology*. Wiley, 1936.
- DRIESCH, HANS. *Science and Philosophy of the Organism*. Gifford Lectures, 1907-08. Black.
- GEDDES, P., and THOMSON, J. A. *Sex*. Holt, 1914.
- HEGNER, R. W. *The Germ-cell Cycle in Animals*. Macmillan, 1914.
- JENNINGS, H. S. *Life and Death, Heredity and Evolution in Unicellular Organisms*. Gorham, 1920.
- KELLCOTT, W. E. *Chordate Development*. Holt, 1913.

- LILLIE, F. R. *Problems of Fertilization*. University of Chicago Press, 1919.
- MORGAN, T. H. *Experimental Embryology*. Columbia University Press, 1927.
- NEEDHAM, JOSEPH. *Chemical Embryology*. Cambridge University Press, 1931.
- RICHARDS, A. *Outline of Comparative Embryology*. Wiley, 1937.
- SHUMWAY, W. *Vertebrate Embryology*. 3d edition. Wiley, 1935.
- WEISMANN, AUGUST. *The Germ Plasm*. Scribner, 1892.
- WIEMAN, H. L. *An Introduction to Vertebrate Embryology*. McGraw-Hill, 1930.
- WILSON, E. B. *The Cell in Development and Heredity*. 3d edition. Macmillan, 1925.
- WOODRUFF, L. L. "The Physiological Significance of Conjugation and Endomixis in the Infusoria." *American Naturalist*, Vol. 69, 1925.

#### CHAPTER XXI. — INHERITANCE

- ALLEN, EDGAR (editor). *Sex and Internal Secretions*. Williams & Wilkins, 1932.
- BAUR, E., FISCHER, E., and LENZ, F. *Human Heredity*. Macmillan, 1931.
- CASTLE, W. E. *Genetics and Eugenics*. 4th edition. Harvard University Press, 1930.
- CONKLIN, E. G. *Heredity and Environment in the Development of Men*. 7th edition. Princeton University Press, 1927.
- GALTON, FRANCIS. *Natural Inheritance*. 1889.
- GATES, R. R. *Heredity in Man*. Constable, 1929.
- GOLDSCHMIDT, R. *Physiological Genetics*. McGraw-Hill, 1938.
- GUYER, M. F. *Being Well-born*. 2d edition. Bobbs-Merrill, 1927.
- JENNINGS, H. S. *Genetics*. Norton, 1935.
- JENNINGS, H. S. *Genetics of the Protozoa*. Nijhoff, 1929.
- JENNINGS, H. S. *The Biological Basis of Human Nature*. Norton, 1930.
- MORGAN, T. H. *The Theory of the Gene*. 2d edition. Yale University Press, 1929.
- RUSSELL, E. S. *The Interpretation of Development and Heredity*. Oxford University Press, 1930.
- SINNOTT, E. W., and DUNN, L. C. *Principles of Genetics*. 2d edition. McGraw-Hill, 1932.
- SNYDER, L. H. *The Principles of Heredity*. Heath, 1935.
- STOCKARD, C. R. *The Physical Basis of Personality*. Norton, 1931.
- WALTER, H. E. *Genetics*. 4th edition. Macmillan, 1938.
- WINTERS, L. M. *Animal Breeding*. 2d edition. Wiley, 1930.

## CHAPTER XXII. — ORGANIC ADAPTATION

- ALLEE, W. C. *Animal Aggregations*. University of Chicago Press, 1931.
- ALVERDES, F. *Social Life in the Animal World*. Harcourt, Brace, 1927.
- CHAPMAN, R. N. *Animal Ecology with Especial Reference to Insects*. McGraw-Hill, 1931.
- CHILD, C. M. *Physiological Foundations of Behavior*. Holt, 1924.
- CRILE, G. W. *Man — An Adaptive Mechanism*. Macmillan, 1916.
- DARWIN, CHARLES. *The Fertilization of Orchids. The Various Contrivances by Which Orchids Are Fertilized by Insects*. London, 1862.
- ELTON, C. *Animal Ecology*. Macmillan, 1927.
- HALDANE, J. S. *Organism and Environment*. Yale University Press, 1917.
- HENDERSON, L. J. *The Fitness of the Environment*. Macmillan, 1913.
- HINGSTON, R. W. G. *Instinct and Intelligence*. Macmillan, 1929.
- HOLMES, S. J. *The Evolution of Animal Intelligence*. Holt, 1911.
- JENNINGS, H. S. *Behavior of the Lower Organisms*. Columbia University Press, 1906.
- LLOYD, R. E. *What Is Adaptation?* Longmans, Green, 1914.
- LOEB, JACQUES. *Forced Movements, Tropisms, and Animal Conduct*. Lippincott, 1918.
- PEARSE, A. S. *Environment and Life*. Thomas, 1930.
- PUNNETT, R. C. *Mimicry in Butterflies*. Cambridge University Press, 1915.
- ROOSEVELT, THEODORE. "Revealing and Concealing Coloration in the Birds and Mammals." *Bull. Amer. Museum Nat. Hist.*, Vol. 30, 1911.
- SHELFORD, V. E. *Laboratory and Field Ecology*. Williams & Wilkins, 1929.
- SNODGRASS, R. E. *The Anatomy and Physiology of the Honey Bee*. McGraw-Hill, 1925.
- Symposium on Adaptation*. Papers by M. M. Metcalf, B. E. Livingston, G. H. Parker, A. P. Mathews, and L. J. Henderson. *American Naturalist*, Vol. 47, 1913.
- TALIAFERRO, W. H. *The Immunology of Parasitic Infections*. Century, 1930.
- THAYER, G. H. *Concealing Coloration in the Animal Kingdom*. Macmillan, 1909.
- THOMPSON, J. A. *The System of Animate Nature*. Holt, 1920.
- THOMPSON, J. A. *Biology for Everyman*. Dutton, 1935.
- WASHBURN, M. F. *The Animal Mind. A Textbook of Comparative Psychology*. 4th edition. Macmillan, 1937.
- WOODRUFF, L. L. "The Protozoa and the Problem of Adaptation," in *Organic Adaptation to Environment*. Yale University Press, 1924.

WOODWORTH, R. S. *Psychology*. 3d edition. Holt, 1934.

ZINSSER, HANS. *Resistance to Infectious Diseases*. 4th edition. Macmillan, 1931.

### CHAPTER XXIII. — DESCENT WITH CHANGE

BAITSELL, G. A. (editor). *Evolution of Earth and Man*. Yale University Press, 1929.

BERGSON, HENRI. *Creative Evolution*. English translation, 1911.

BERRY, E. W. *Paleontology*. McGraw-Hill, 1929.

CONKLIN, E. G. *Direction of Human Evolution*. Scribner, 1921.

*Creation by Evolution*. A consensus of present-day knowledge as set forth by twenty-five scientists. Macmillan, 1928.

DARWIN, CHARLES. *Voyage of the Beagle*. (A Naturalist's Voyage.) London, 1839.

DARWIN, CHARLES. *The Origin of Species*. London, 1859. 6th edition, 1880.

DARWIN, CHARLES. *The Descent of Man*. London, 1871.

DARWIN, CHARLES. *Variation in Animals and Plants under Domestication*. London, 1868.

DOBZHANSKY, T. *Genetics and the Origin of Species*. Columbia University Press, 1937.

FISHER, R. A. *The Genetical Theory of Natural Selection*. Oxford University Press, 1930.

JENNINGS, H. S. "Diverse Doctrines of Evolution, and Their Relation to the Practice of Science and of Life." *Science*, Vol. 65, 1927.

LINDSEY, A. W. *Problems of Evolution*. Macmillan, 1931.

LULL, R. S. *Organic Evolution*. 2d edition. Macmillan, 1929.

MORGAN, T. H. *The Scientific Basis of Evolution*. 2d edition. Norton, 1935.

NUTTALL, G. H. F. *Blood Immunity and Blood Relationships*. Cambridge University Press, 1904.

OSBORN, H. F. *The Origin and Evolution of Life*. Scribner, 1917.

PARKER, G. H. *What Evolution Is*. Harvard University Press, 1925.

REICHERT, E. T., and BROWN, A. P. *The Differentiation and Specificity of Corresponding Proteins and Other Vital Substances in Relation to Biological Classification and Organic Evolution*. Carnegie Institution, 1909.

SCHENK, E. T., and McMASTERS, J. H. *Procedure in Taxonomy*. Stanford University Press, 1936.

SCHUCHERT, CHARLES. "The Earth's Changing Surface and Climate," in *The Evolution of Earth and Man*. Yale University Press, 1929.

SCOTT, W. D. *The Theory of Evolution*. Macmillan, 1911.

SHULL, A. F. *Evolution*. McGraw-Hill, 1936.

THOMSON, J. A. *Concerning Evolution*. Yale University Press, 1925.

- DEVRIES, HUGO. *Species and Varieties. Their Origin by Mutation.* 3d edition. Open Court, 1912.
- WALLACE, A. R. *Darwinism.* 3d edition. Macmillan, 1905.
- WALLACE, A. R. *The Geographical Distribution of Animals.* London, 1876.
- WARD, HENSHAW. *Evolution for John Doe.* Bobbs-Merrill, 1925.
- WELLS, H. G. "The Evidence Furnished by Biochemistry and Immunology on Biologic Evolution." *Archives of Pathology*, Vol. 9, 1930.

CHAPTER XXIV.—BIOLOGY AND HUMAN WELFARE<sup>1</sup>

- BOWER, F. O. *Plants and Man.* Macmillan, 1925.
- CHANDLER, A. C. *Human Parasitology.* 5th edition. Wiley, 1936.
- COWDRY, E. V. (editor). *Human Biology and Racial Welfare.* Hoeber, 1930.
- DARWIN, LEONARD. *What Is Eugenics?* Galton, 1930.
- DOANE, R. W. *Common Pests.* Thomas, 1931.
- FERNALD, H. T. *Applied Entomology.* 3d edition. McGraw-Hill, 1935.
- GODDARD, H. H. *The Kallikak Family. A Study in the Heredity of Feeble-mindedness.* Macmillan, 1912.
- HEGNER, R. W., and TALIAFERRO, W. H. *Human Protozoology.* Macmillan, 1924.
- HENDERSON, J. *The Practical Value of Birds.* Macmillan, 1927.
- HOLMES, S. J. *Human Genetics and Its Social Import.* McGraw-Hill, 1936.
- HOWARD, L. O. *The Insect Menace.* Century, 1931.
- KEEN, W. W. *Animal Experimentation and Medical Progress.* Houghton Mifflin, 1914.
- KIRKPATRICK, T. B., and HEUTTNER, A. F. *Fundamentals of Health.* Ginn, 1931.
- KOFOID, C. A. "The Human Values of Biology." *University of Texas Bulletin*, 1925.
- DEKRUIF, PAUL. *Microbe Hunters.* Harcourt, Brace, 1925.
- DEKRUIF, PAUL. *Hunger Fighters.* Harcourt, Brace, 1928.
- MARVIN, F. S. (editor). *Science and Civilization.* Oxford University Press, 1923.
- NEWSHOLME, A. *Evolution of Preventive Medicine.* Williams & Wilkins, 1927.
- PACK, C., and GILL, T. *Forests and Mankind.* Macmillan, 1930.
- PARKINS, A. E. (editor). *Our National Resources and Their Conservation.* Wiley, 1937.
- POPENOE, P. *Practical Applications of Heredity.* Williams & Wilkins, 1930.
- RILEY, W. A., and JOHANNSEN, O. A. *Medical Entomology.* McGraw-Hill, 1932.
- SMITH, THEOBALD. *Parasitism and Disease.* Princeton University Press, 1934.
- SWEETMAN, H. L. *The Biological Control of Insects.* Comstock, 1936.

<sup>1</sup> Also see Bibliography for Chapter XXI.

- VEDDER, E. B. *Medicine: Its Contribution to Civilization*. Williams & Wilkins, 1929.
- WALKER, C. C. *The Biology of Civilization*. Macmillan, 1930.
- WARDLE, R. A. *Principles of Applied Zoölogy*. Longmans, Green, 1929.
- WRIEDT, C. *Heredity in Live Stock*. Macmillan, 1930.

#### CHAPTER XXV.—THE HUMAN BACKGROUND.

- ALVERDES, F. *Social Life in the Animal World*. Harcourt, Brace, 1927.
- BAITSELL, G. A. (editor). *The Evolution of Earth and Man*. Yale University Press, 1929.
- COLE, F. C. *The Long Road*. Reynal & Hitchcock, 1933.
- DARWIN, C. *The Expression of the Emotions in Man and Animals*. London, 1872.
- GREGORY, W. K. *Man's Place among the Anthropoids*. Oxford University Press, 1934.
- JENNINGS, H. S. *The Biological Basis of Human Behavior*. Norton, 1930.
- DELAGUNA, G. A. *Speech*. Yale University Press, 1927.
- LULL, R. S. *Ancient Man*. Doubleday, Doran, 1929.
- LUQUET, G.-H. *The Art and Religion of Fossil Man*. Yale University Press, 1930.
- MACCURDY, G. G. *Human Origins*. Appleton, 1924.
- MACCURDY, G. G. *The Coming of Man*. University Society, 1932.
- MACCURDY, G. G. (editor). *Early Man*. Lippincott, 1937.
- OSBORN, H. F. *Men of the Old Stone Age*. Scribner, 1915.
- OSBORN, H. F. *Man Rises to Parnassus*. Princeton University Press, 1928.
- PEAKE, H., and FLEURE, H. J. *The Corridors of Time*. Vols. 1-3. Yale University Press, 1927.
- ROMER, A. S. *Man and the Vertebrates*. University of Chicago Press, 1933.
- SCHUCHERT, C., and DUNBAR, C. O. *Textbook of Geology*. 3rd edition. Wiley, 1933.
- SMITH, G. E. *The Evolution of Man*. Oxford University Press, 1924.
- SOLLAS, W. J. *Ancient Hunters*. 3d edition. Macmillan, 1924.
- TILNEY, F. *The Brain from Ape to Man*. Hoeber, 1929.
- WARDEN, C. J. *The Evolution of Human Behavior*. Macmillan, 1932.
- WARDEN, C. J. *The Emergence of Human Culture*. Macmillan, 1936.
- YERKES, R. M., and YERKES, A. W. *The Great Apes*. Yale University Press, 1929.

#### CHAPTER XXVI.—DEVELOPMENT OF BIOLOGY

- CLAY, R. S., and COURT, T. H. *The History of the Microscope*. Griffin, 1932.
- COLE, F. C. *The History of Protozoölogy*. University of London Press, 1926.

- DANA, E. S. and others. *A Century of Science in America*. Yale University Press, 1918.
- DARWIN, CHARLES. *Life and Letters, Including a Biographical Chapter*. Edited by Francis Darwin. Appleton, 1887.
- FOSTER, MICHAEL. *History of Physiology during the 16th, 17th and 18th Centuries*. Cambridge University Press, 1901.
- GARRISON, F. H. *History of Medicine*. 3d edition. Saunders, 1921.
- HUXLEY, T. H. "The Progress of Science, 1837-1887." *Collected Essays*. Vol. *Methods and Results*. Appleton.
- HUXLEY, T. H. *Life and Letters*. Edited by Leonard Huxley. Appleton, 1901.
- JUDD, J. W. *The Coming of Evolution. The Story of a Great Revolution in Science*. Cambridge University Press, 1910.
- LOCY, W. A. *Biology and Its Makers*. 3d edition. Holt, 1915.
- LOCY, W. A. *The Growth of Biology*. Holt, 1925.
- NATIONAL ACADEMY. *History of the National Academy of Sciences of the United States of America*, 1913.
- NORDENSKIÖLD, E. *History of Biology*. Knopf, 1928.
- OSBORN, H. F. *From the Greeks to Darwin. An Outline of the Development of the Evolution Idea*. Revised edition. Scribner, 1929.
- SEWARD, A. C. (editor). *Darwin and Modern Science*. Cambridge University Press, 1909.
- SINGER, C. *Short History of Medicine*. Oxford University Press, 1928.
- SINGER, C. *The Story of Living Things*. Harper, 1931.
- WOODRUFF, L. L. (editor). *The Development of the Sciences*. Yale University Press, 1923.
- YOUNG, R. T. *Biology in America*. Gorham, 1922.



### III. GLOSSARY

- ABIOTENESIS.** The abandoned idea that living matter may arise at the present time from the non-living without the influence of the former. *See* Biogenesis.
- ABSORPTION.** The passage of nutritive and other fluids into living cells.
- ACOELOMATE.** Not possessing a coelom, or body cavity; *e.g.*, Hydra. *See* Enterocoela.
- ACQUIRED CHARACTER.** A modification of body structure or function which arises during individual life.
- ADAPTATION.** The reciprocal fitness of organism and environment; a structure or reaction fitted for a special environment; the process by which an organism becomes fitted to its surroundings.
- ADRENAL GLANDS.** Ductless glands situated near the kidneys. Secretion supplies the hormones adrenaline and cortin.
- AEROBE.** An organism requiring free oxygen. *See* Anaerobe.
- AFFERENT ROOT.** Dorsal, or posterior, root of certain cranial and all spinal nerves through which sensory nerve impulses enter the brain and spinal cord. *See* Efferent Root.
- ALBINO.** An individual lacking normal pigment, *e.g.*, a white rat. Albinism in the Rat and Man is a typical Mendelian recessive character.
- ALGAE.** A heterogeneous group of lower plants in which the body is unicellular or consists of a thallus; *e.g.*, Protococcus, Spirogyra, Seaweeds.
- ALLANTOIS.** An embryonic membrane of higher Vertebrates, chiefly respiratory in function.
- ALLELOMORPHS.** Alleles. Genes similarly situated on homologous chromosomes. Homologous genes. *See* Homologous Chromosomes.
- ALTERNATION OF GENERATIONS.** Typically the alternate succession of sexual and asexual generations in the life history; *e.g.*, Obelia.
- ALTERNATIVE INHERITANCE.** *See* Dominant Character.
- AMINO ACIDS.** Components of proteins. Organic acids in which one hydrogen atom is replaced by the amino group ( $\text{NH}_2$ ).
- AMNION.** A delicate membrane enclosing the developing embryos of Reptiles, Birds, and Mammals.
- AMOEBOID.** Usually applied to the flowing movements of a cell, as in Amoeba and white blood corpuscles.
- AMPHIMIXIS.** The mingling of the germ plasma of two gametes in the zygote.
- ANABOLISM.** The constructive phase of metabolism. *See* Katabolism.
- ANAEROBE.** An organism not requiring free oxygen; *e.g.*, certain Bacteria and parasitic Worms. *See* Aerobe.

- ANALOGY.** Structural resemblance, usually superficial, due to similarity of functions; *e.g.*, wing of Butterfly and Bird. *See* Homology.
- ANAPHASE.** Period in mitosis during which the daughter chromosomes move toward the respective centrosomes. *See* Telophase.
- ANATOMY.** The structure of organisms, especially as revealed by dissection. *See* Morphology.
- ANTENNAE.** A pair of appendages of the Arthropod head, sensory in function.
- ANUS.** Terminal orifice of the alimentary canal.
- AORTA.** A great trunk artery carrying blood away from the heart. *See* Dorsal Aorta.
- AORTIC ARCHES.** Arteries arising from the ventral aorta and supplying the gills in aquatic Vertebrates. Undergo many modifications in the ascending series of air-breathing Vertebrates.
- APHIDS.** Small sucking Insects; *e.g.*, the green Plant Lice of garden shrubs.
- APOYLES.** Pores leading from the flagellated chambers to the gastral cavity of Sponges.
- ARTERY.** A blood vessel carrying blood away from the heart.
- ARTHROPODA.** Phylum of Invertebrates. Includes the Crustaceans, Insects, Spiders, etc.
- ASSOCIATIVE MEMORY.** Representative cerebral activity of the higher animals and Man, exclusive of reason which presumably is confined to the latter.
- ASTER.** Radiations surrounding the centrosome during cell division.
- AUTONOMIC SYSTEM.** System of outlying ganglia and nerves which communicates with the central nervous system *via* the roots of the spinal and cranial nerves. Regulates nearly all the involuntary functions of the body. Sympathetic system.
- AUTOTROPHIC.** Power to synthesize food from inorganic substances. Green plants (holophytic) secure the necessary energy from light, and certain Bacteria by the oxidation of inorganic substances. *See* Holozoic.
- AXON.** A nerve fiber conducting impulses away from the nerve cell body. Dendrites conduct toward the cell body. *See* Neuron.
- BILE DUCT.** Tube which conveys the secretions (bile) of the liver to the small intestine. Usually unites with the pancreatic duct to form a common duct which enters the intestine.
- BINARY FISSION.** The division of a cell, especially a unicellular organism, into two daughter cells; *e.g.*, in Paramecium.
- BINOMIAL NOMENCLATURE.** The accepted scientific method of designating organisms by two Latin or Latinized words, the first indicating the genus and the other, the species; *e.g.*, the Dog, *Canis familiaris*; Man, *Homo sapiens*.

- BIOCOENOSIS.** An association of diverse organisms forming a natural ecological unit in which there is more or less interdependence.
- BIOGENESIS.** The established doctrine that all life arises from preëxisting living matter. *See* Abiogenesis.
- BIOGENETIC LAW.** *See* Recapitulation Theory.
- BIOLOGY.** Study of matter in the living state, and its manifestations.
- BIPARENTAL.** Involving two progenitors, male and female.
- BIRAMOUS.** Comprising two branching parts; *e.g.*, abdominal appendages (swimmerets) of the Crayfish.
- BLASTOCOEL.** The cavity within the blastula. Segmentation cavity.
- BLASTOPORE.** The opening to the exterior from the enteric pouch of a gastrula.
- BLASTOSTYLE.** Central axis of an individual (gonangium) of a Hydroid colony that buds medusae, *e.g.*, in Obelia.
- BLASTULA.** The stage following cleavage when the cells are arranged in a single layer to form a hollow sphere.
- BLENDING INHERITANCE.** Apparent fusion of parental characters in the offspring so that a more or less intermediate condition arises; *e.g.*, skin color of mulattoes.
- BLOOD CORPUSCLES.** Detached cells present in the fluid plasma of the blood. Two principal kinds, red and white.
- BUCCAL CAVITY.** Mouth cavity.
- CALCIFEROUS GLANDS.** Glands opening into the esophagus of the Earthworm which secrete calcium carbonate, probably to neutralize acidity of food.
- CALORIE.** The unit of heat energy, and therefore largely of fuel value. Heat required to raise 1000 grams of water through 1° C. Large calorie.
- CARBOHYDRATES.** Compounds of carbon with hydrogen and oxygen, the hydrogen and oxygen typically in the same proportion as in water (H<sub>2</sub>O).
- CARDINAL VEINS.** Pair of large veins returning blood from posterior part of body, *e.g.*, in Dogfish.
- CASTRATION.** Removal of the gonads, especially of the male.
- CATALYSIS.** The inducing or accelerating of a chemical reaction by a substance (*e.g.*, an enzyme) which itself remains unchanged.
- CELL.** A structural and physiological unit mass of protoplasm, differentiated into cytoplasm and nucleus.
- CELLULOSE.** A carbohydrate which characteristically forms the walls of plant cells.
- CENTRAL CAPSULE.** Perforated partition that separates the endoplasm from the ectoplasm in the Radiolaria.
- CENTROSOME.** A body, enclosing a minute granule, or centriole, situated in the center of the aster and active during cell division.

- CHELIPED.** The first thoracic appendages of the Crayfish and its allies. The 'pincer.'
- CHEMOTROPISM.** A simple orienting response, either positive or negative, to chemical stimuli; *e.g.*, of Paramecium or sperm. Chemotaxis.
- CHLORAGOGEN CELLS.** Outer layer of intestine of Earthworm. Probably excretory in function.
- CHLOROPHYLL.** The characteristic green coloring matter of plants, through which photosynthesis takes place. Comprises two pigments.
- CHLOROPLASTS.** The special cytoplasmic bodies containing chlorophyll.
- CHOLESTEROL.** A complex monohydric alcohol of the lipid series. Closely related to vitamin D, certain hormones, and cancer-producing substances. *See* Lipids.
- CHORDATE.** An animal whose primary axial skeleton consists temporarily or permanently of a notochord. All Vertebrates are Chordates, but the lowest Chordates are not Vertebrates. *See* Appendix I.
- CHORION.** External embryonic membrane of Mammals.
- CHROMATIN.** A deeply staining substance characteristic of the nucleus, forming chromosomes, etc. *See* Germ Plasm.
- CHROMOSOME.** One of the deeply staining bodies into which the chromatin of the nucleus becomes visibly resolved during mitosis. A linkage group of genes. *See* Germ Plasm.
- CILIA.** Delicate protoplasmic projections from a cell, which lash in unison and propel the cell in the water (*e.g.*, Paramecium), or move particles over the cell surface (*e.g.*, cells lining various tubes in multicellular forms).
- CLASS.** In classification, a main subdivision of a phylum. *See* Order.
- CLEAVAGE.** Cell divisions which transform the egg into the blastula stage during development.
- CLOACA.** A cavity at the posterior end of the Vertebrate body, into which the intestine, urinary, and reproductive ducts open. Not present in most Mammals.
- COCHLEA.** The portion of the ear, in communication with the sacculus, which is the essential organ of hearing in the higher Vertebrates.
- COELOM.** The body cavity, enclosed by tissue of mesodermal origin.
- COELOMATE.** Possessing a coelom, or body cavity; as in all the chief groups of animals above the Coelenterates.
- COELOMIC EPITHELIUM.** *See* Peritoneum.
- COENOSARC.** Tissue of the tubular branches of a Hydroid; *e.g.*, Obelia.
- COLLAR CELLS.** Cells with cytoplasmic flange, or collar, surrounding the base of the flagellum. Represented by certain Protozoa, and in the gastral epithelium of Sponges.
- COLLOID.** A state of matter in which a substance is finely divided into particles larger than one molecule and suspended in another substance, semi-fluid or fluid.

- COLONY.** An aggregation or intimate association of several or many individuals to form a superior unit.
- COMPOUND EYE.** One composed of numerous facets, or separate visual elements. Supposed to afford mosaic vision; *e.g.*, in Crayfish and Locust.
- CONJUGATION.** Union (usually temporary) of two cells, resulting in fertilization; *e.g.*, in Paramecium. *See* Endomixis.
- CONSERVATION OF ENERGY.** The 'law' that the total energy of the universe is constant, none being created or destroyed but merely transformed from one form to another.
- CONTRACTILE VACUOLE.** A reservoir in unicellular organisms (*e.g.*, Paramecium) in which water and waste products of metabolism collect and are periodically expelled to the exterior.
- COWPER'S GLAND.** Small ovoid body associated with the prostate gland and urethra in the male of Mammals.
- CRANIAL NERVES.** Nerves which arise from the brain.
- CRANIUM.** The protective case enclosing the brain.
- CREATININE.** A nitrogenous waste product. Present in small quantity in human urine.
- CRETIN.** A defective individual, due to a deficiency of thyroid secretion.
- CROSSING-OVER.** The rearranging of linked characters as a result of the exchange of homologous genes during synapsis of chromosomes.
- CRURA CEREBRI.** Thickenings of ventral surface of mid-brain.
- CRUSTACEA.** A group of Arthropoda, including Crayfish, Crabs, etc.
- CUTANEOUS.** Pertaining to the skin.
- CUTICLE.** The outermost lifeless layer of the skin. *See* Epidermis.
- CYST.** A resistant envelope formed about an organism (*e.g.*, many Protozoa) during unfavorable conditions or reproduction.
- CYTOLOGY.** The science of cell structure and function.
- CYTOPLASM.** Protoplasm of a cell exclusive of nucleus. Cytosome.
- DARWINISM.** Charles Darwin's theory of Natural Selection. Erroneously used as synonymous with organic evolution.
- DECAY.** Chemical decomposition involving putrefaction or fermentation. *See* Putrefaction.
- DENDRITE.** *See* Axon.
- DENITRIFYING BACTERIA.** Types of Bacteria which break down compounds of nitrogen and set free the nitrogen to the atmosphere.
- DERMAL.** Pertaining to the skin. The dermis is the inner layer of the Vertebrate skin. *See* Epidermis.
- DIFFERENTIATION.** A transformation from relative homogeneity to heterogeneity, involving the production of specific substances or parts from a general substance or part. Specialization.

- DIFFUSION.** Intermingling of two substances due to migration of their molecules. Pressure exerted by molecules in diffusion through a semi-permeable membrane is osmotic pressure. *See* Osmosis.
- DIGESTION.** Chemical simplification of food so that it can be absorbed and utilized.
- DIHYBRID.** Progeny of parents differing in two given characters.
- DIPLOBLASTIC.** Composed of only two primary layers: ectoderm and endoderm, *e.g.*, Hydra. *See* Triploblastic.
- DIPLOID.** Having two complete sets of homologous chromosomes. Maximum number of chromosomes in the life history of a given species. *See* Haploid.
- DIVISION OF LABOR.** Allocation of special functions to special parts which cooperate toward the unity of the whole.
- DOMINANT CHARACTER.** One of a pair of alternative characters, represented by homologous genes, which appears in the phenotype to the exclusion of the other (recessive) character when both are present in the genotype.
- DORSAL AORTA.** Chief artery distributing pure blood to the body. Ventral aorta carries blood from heart to gill arteries in Fishes.
- DUCTLESS GLAND.** An organ whose function is to elaborate and secrete a hormone directly into the blood. An endocrine gland.
- ECOLOGY.** The study of the relations of the organism to environing conditions, organic and inorganic.
- ECTODERM.** The primary tissue comprising the surface layer of cells in the gastrula. *See* Germ Layer.
- ECTOPLASM.** Modified surface layer of cytoplasm of a cell. *See* Endoplasm.
- EFFERENT ROOT.** Ventral, or anterior, root of certain cranial and all spinal nerves through which motor nerve impulses leave the brain and spinal cord. *See* Afferent Root.
- EMBRYOLOGY.** Study of the early developmental stages, or embryos, of individual organisms.
- ENCYSTMENT.** The formation of a resistant covering, or cyst wall, about an organism; *e.g.*, Euglena.
- ENDOCRINE GLAND.** *See* Ductless Gland.
- ENDODERM.** The primary tissue comprising the inner layer of cells in the gastrula, and in subsequent stages forming the lining of the essential parts of the digestive tract and its derivatives. *See* Germ Layer.
- ENDOMIXIS.** A nuclear reorganization process in Protozoa, *e.g.*, Paramecium, which does not involve the cooperation of two cells (as in conjugation) or synkaryon formation.

- ENDOPLASM.** The inner cytoplasm surrounding the nucleus; *e.g.*, in Amoeba, Paramecium. *See* Ectoplasm.
- ENDOPODITE.** The inner of the two distal parts of the typical biramous Crustacean appendage. *See* Protopodite and Exopodite.
- ENDOSKELETON.** An internal living skeleton affording support and protection, as well as levers for the attachment of muscles. Characteristic of Vertebrates.
- ENERGY.** *See* Potential Energy.
- ENTERIC CAVITY.** The digestive cavity of the gastrula stage, and of simple Metazoa, *e.g.*, Hydra.
- ENTERON.** Enteric pouch forming the wall of the enteric cavity.
- ENTEROZOA.** Animals with an enteron, and with or without a coelom. All animals above the Sponges. *See* Parazoa.
- ENZYMES.** Special chemical substances (apparently proteins) of organisms, which bring about by catalytic action many of the chemical processes of the body; *e.g.*, digestion. *See* Catalysis.
- EPIDERMIS.** The outer cellular layer of the skin.
- EPIGENESIS.** Development from absolute or relative simplicity to complexity. *See* Preformation.
- EPITHELIUM.** A layer of cells covering an external or internal surface, including the essential secreting cells of glands.
- EQUATORIAL PLATE.** The equator of the spindle with its group of chromosomes during the metaphase of mitosis.
- ESOPHAGUS.** Tubular passage from pharynx to stomach.
- EUGENICS.** The system of improving the human race by breeding the best. "The science of being well born." *See* Euthenics.
- EUSTACHIAN TUBE.** Passage connecting the Vertebrate middle ear with the pharynx. Remnant of the most anterior gill slit, represented in present-day Sharks by the 'blow-hole,' or spiracle.
- EUTHENICS.** The system of improving the human race by good environment. *See* Eugenics.
- EUTHERIA.** The highest of the three subclasses of Mammals, including all the familiar forms. Placentals. *See* Appendix I.
- EVOLUTION, ORGANIC.** Present-day organisms are the result of descent with change from those of the past.
- EXCRETION.** The elimination of waste products of metabolism. A waste product. *See* Secretion.
- EXOPODITE.** The outer of the two distal parts of the typical biramous Crustacean appendage. *See* Protopodite and Endopodite.
- EXOSKELETON.** A non-living external skeleton chiefly for protection. The characteristic skeleton of Invertebrates; *e.g.*, Crayfish.
- EXTERNAL RECEPTORS.** Sense organs upon the surface of the body. *See* Internal Receptors.

- FAMILY.** In classification, a main subdivision of an order. *See* Genus.
- FATS.** One of the chief groups of foodstuffs. Compound (esters) of glycerol with a fatty acid; *e.g.*, mutton tallow is chiefly the fat stearin ( $C_{57}H_{110}O_6$ ) = glycerin plus stearic acid. More oxidizable than carbohydrates. *See* Lipids.
- FERMENTATION.** The transformation of carbohydrates by the activity of ferments, or enzymes, derived from living organisms. *See* Putrefaction.
- FERTILIZATION.** The union of male and female gametes, especially their nuclei, by which the chromatin complex of each is arranged to form the composite nucleus (syngaryon) of the zygote.
- FETUS.** An embryo of a Vertebrate, in egg or uterus.
- FLAGELLUM.** A whip-like prolongation of the cytoplasm, the movements of which usually effect the locomotion of the cell; *e.g.*, Euglena.
- FLUCTUATIONS.** Relatively slight variations, usually forming a finely graded series, always found in organisms; may be either modifications or recombinations, but usually the former.
- FUNGI.** Colorless plants; *e.g.*, Bacteria, Yeast, Mushrooms.
- GALL BLADDER.** Receptacle near the liver for the temporary storage of bile.
- GAMETE.** A cell which unites with another at fertilization to form a zygote. Egg or sperm.
- GAMETIC NUCLEI.** Nuclei of gametes that unite to form the syngaryon, or nucleus of the zygote.
- GANGLION.** A group of nerve cells, chiefly the cell bodies, with supporting cells.
- GASTRIC VACUOLE.** A droplet of fluid enclosing ingested food, in which digestion occurs; *e.g.*, in Amoeba and Paramecium. Food vacuole.
- GASTROLITHS.** Calcareous bodies found at certain times in the lateral walls of the stomach of the Crayfish. Probably represent the storage of material for the exoskeleton.
- GASTRULA.** A stage in animal development in which the embryo consists of a two-layered sac, ectoderm and endoderm, enclosing the enteric cavity which opens to the exterior by the blastopore.
- GEMMULE.** An asexual reproductive body liberated by certain Sponges.
- GENE.** Independently inheritable factor or element in the chromosomes which influences the development of one or more characters in the organism. Presumably a protein molecule.
- GENETICS.** The science of heredity.
- GENOTYPE.** The fundamental hereditary constitution of an organism or group of organisms. The gene complex of an organism. *See* Phenotype.
- GENUS.** In classification, a main subdivision of a family. *See* Species.



- GERMINAL CONTINUITY.** The concept of an unbroken stream of germ plasm from the beginning of life, from which each generation is derived.
- GERM LAYER.** A primary tissue (ectoderm, endoderm, or mesoderm) in the embryo, from which the tissues and organs of the adult animal develop.
- GERM LAYER THEORY.** The doctrine that the germ layers are fundamentally similar throughout the Metazoa and that homologous structures in various animals are derived during development from the same germ layer.
- GERM PLASM.** The physical basis of inheritance. The chromatin (genes) which forms the specific bond of continuity between parent and offspring. Contrasted with soma or somatoplasm. Germ.
- GILL SLITS.** Paired lateral openings leading from the anterior end of the alimentary canal to the exterior for the exit of the respiratory current of water. Permanent or embryonic characters of Vertebrates. Branchial clefts.
- GLAND.** One cell or a group of many epithelial cells which elaborate materials and secrete the product for the use of the organism.
- GLOCHIDIUM.** A bivalved larva of certain fresh-water Mussels, that lives temporarily as a parasite on a Fish.
- GLOTTIS.** The opening from the pharynx into the tube (trachea) leading to the lungs.
- GLYCOGEN.** So-called animal starch. Sugar is stored as glycogen in liver and muscle cells.
- GOLGI BODIES.** Formed elements in the cytoplasm; apparently active chemically.
- GONAD.** Ovary or testis.
- GONOTHECA.** Transparent sheath, or exoskeleton, of the reproductive individuals (gonangia) of a Hydroid colony; *e.g.*, Obelia.
- GRAY CRESCENT.** Localized organizing substance in Frog's egg.
- GUSTATORY.** Relating to the sense of taste.
- HAPLOID.** The reduced (one-half) number of chromosomes. A complete single set of chromosomes. *See* Diploid.
- HEMOGLOBIN.** Complex chemical compound, in the red blood corpuscles of Vertebrates, which enters into a loose combination with oxygen, becoming oxyhemoglobin. Respiratory pigment.
- HEPATIC PORTAL SYSTEM.** Non-oxygenated but food-laden blood from digestive tract passes to the liver by the *hepatic portal vein*. Oxygenated blood reaches liver by the hepatic artery. Both leave by hepatic vein. Thus there is a double blood supply to liver in all Vertebrates.
- HEREDITY.** The transmission of characters from parent to offspring by the germ cells.

- HERMAPHRODITE.** An organism bearing both male and female reproductive organs; *e.g.*, Earthworm.
- HETEROZYGOUS.** Hybrid. Formed by gametes dissimilar in regard to a given character, or characters, and producing gametes dissimilar in regard to the character, or characters, in question. *See* Homozygous.
- HISTOLOGY.** The science which treats of animal and plant tissues. Microscopic anatomy.
- HOLOZOIC.** Type of nutrition involving the ingestion of solid food. Characteristic of animals. *See* Autotrophic and Saprophytic.
- HOMOLOGOUS CHROMOSOMES.** The members of a pair of chromosomes, of a diploid group, one paternal and the other maternal in origin, which bear homologous genes. *See* Synaptic Mates.
- HOMOLOGOUS GENES.** Genes similarly situated on homologous chromosomes, and contributing to the same or different expressions of a character. Allelomorphs. Alleles.
- HOMOLOGY.** Fundamental structural similarity, regardless of function, due to descent from a common form; *e.g.*, wing of Bird and fore leg of Dog.
- HOMOTHERMAL.** Animals provided with a mechanism which maintains the body at a practically constant temperature, usually higher than that of the environment; *e.g.*, the 'warm-blooded' animals, or Birds and Mammals.
- HOMOZYGOUS.** Pure. Formed by gametes the same in regard to a given character, or characters, and producing gametes all the same in regard to the character, or characters, in question. *See* Heterozygous.
- HORMONE.** An internal secretion usually from a ductless gland. Secreted directly into the blood which distributes it throughout the body where it selectively influences tissues and organs.
- HOST.** An organism in or on which a parasite subsists.
- HYALOPLASM.** The clear ground-substance of protoplasm.
- HYBRID.** The progeny of parents which differ in regard to one or more characters. A heterozygote.
- HYDRANTH.** A feeding polyp of a Hydroid colony; *e.g.*, Obelia.
- HYDROIDS.** A group of animals (Coelenterates) exhibiting alternation of generations; *e.g.*, Obelia.
- HYDROLYSIS.** Decomposition of a chemical compound by reaction with water; *e.g.*, in digestion.
- HYDROSTATIC ORGAN.** Organ for regulating the specific gravity of an animal in relation to that of water; *e.g.*, the air-bladder of certain Fishes.
- HYDROTHERCA.** Vase-like expansion of the exoskeleton, or perisarc, about a hydranth; *e.g.*, of Obelia.

- IMMUNITY.** Resistance of the body to infection by disease-producing organisms. Exemption from disease.
- INDEPENDENT ASSORTMENT.** Members of different pairs of genes, located in different pairs of chromosomes, are distributed independently.
- INFUNDIBULUM.** A funnel-like outgrowth from the ventral wall of the diencephalon. *See* Pituitary Gland.
- INTERCELLULAR DIGESTION.** Digestion by the secretion of enzymes into a digestive cavity; *e.g.*, in Earthworm and Man. *See* Intracellular Digestion.
- INTERNAL RECEPTORS.** Sense organs within the body. *See* External Receptors.
- INTERNAL SECRETION.** *See* Hormone and Ductless Gland.
- INTESTINE.** Portion of the alimentary canal. In higher forms, portion from pyloric end of stomach to cloaca or anus. Usually divided into small and large intestine.
- INTRACELLULAR DIGESTION.** Digestion of food within the cell itself; *e.g.*, in Paramecium and to some extent in the endoderm cells of Hydra. *See* Intercellular Digestion.
- INVAGINATION.** Sinking or growing in of a portion of the surface of a hollow body; *e.g.*, during transformation of blastula into gastrula.
- INVERTEBRATE.** Animal without a notochord or a vertebral column.
- IRRITABILITY.** The power of responding to stimuli, exhibited by all protoplasm.
- KARYOLYMPH.** The more fluid material of the nucleus in contrast with the linin and chromatin.
- KATABOLISM.** The destructive phase of metabolism. *See* Anabolism.
- KINETIC ENERGY.** Energy possessed by virtue of motion; *e.g.*, union of C with O<sub>2</sub> transforms chemical potential energy into kinetic energy, *i.e.*, heat, etc. *See* Potential Energy.
- LACTEALS.** Lymphatic vessels of the small intestine.
- LAMARCKISM.** Essentially the doctrine of the inheritance of modifications, or acquired characters, as a factor in evolution.
- LARVA.** An immature stage in the life history of certain animals, usually active and differing widely in appearance from the adult; *e.g.*, caterpillar of Butterfly, tadpole of Frog.
- LININ.** Non-stainable portion of the nuclear reticulum, probably closely related chemically to chromatin.
- LINKAGE.** The inheritance together of characters represented by genes in the same chromosome. Independent assortment does not occur.
- LIPIDS.** Fatty substances including the true fats and such compounds as cholesterol (C<sub>27</sub>H<sub>46</sub>OH) and the lecithins containing also phosphorus and nitrogen. *See* Fats.

- LYMPH.** Essentially excess tissue fluid passing through vessels on its way back to the blood vascular system. *See* Tissue Fluid.
- MACRONUCLEUS.** The large 'somatic' nucleus in Infusoria with dimorphic nuclei; *e.g.*, in Paramecium. *See* Micronucleus.
- MADREPORIC PLATE.** A small perforated plate on the aboral surface of certain Echinoderms (*e.g.*, the Starfish) that allows the passage of water to the water-vascular system.
- MALTOSE.** A double sugar derived from starch by hydrolysis during digestion.
- MANDIBLES.** Jaws.
- MANTLE.** Layer of tissue that secretes the shell in Molluscs.
- MATURATION.** Final stages in the formation of the germ cells, involving chromosome reduction (meiosis).
- MAXILLIPEDS.** The three anterior pairs of appendages of the thorax of the Crayfish.
- MECHANISM.** The doctrine that the phenomena of life are interpretable in terms of the laws of matter and energy which hold in the realm of the non-living. *See* Vitalism.
- MEDUSA.** Sexual, gonad-bearing generation of hydra-like animals, the Hydrozoa, and also the Scyphozoa.
- MEIOSIS.** *See* Reduction.
- MENDEL'S LAWS.** *See* Segregation and Independent Assortment.
- MESENTERY.** Fold of the peritoneal lining of the body cavity, suspending the alimentary canal. Also, radial partitions in the enteric cavity; *e.g.*, of Metridium.
- MESODERM.** A primary tissue, or germ layer, of animals, which develops between the ectoderm and endoderm. *See* Germ Layer.
- MESOGLOEA.** The non-cellular layer between the two primary tissue layers of Coelenterates.
- MESORCHIIUM.** Mesentery-like membrane supporting the testes.
- METABOLISM.** The sum of the physico-chemical processes in organisms, involving the building up, maintenance, and breaking down of the living matter and its constituents. *See* Anabolism and Katabolism.
- METAMORPHOSIS.** A more or less abrupt transition from one developmental stage to another; *e.g.*, transformation of larva into adult during the life history of a Butterfly or Frog.
- METAPHASE.** Climax of mitosis involving the separation of the halves of the longitudinally split chromosomes arranged in the equatorial plate. *See* Anaphase.
- METAPHYTA.** Multicellular plants.
- METAPLASM.** Lifeless inclusions in cytoplasm; *e.g.*, yolk granules, etc.

- METAZOA.** Multicellular animals with cells differentiated to form tissues. Invertebrates and Vertebrates. *See* Protozoa.
- MICRONUCLEUS.** The small 'germinal' nucleus in Infusoria with dimorphic nuclei; *e.g.*, *Paramecium caudatum* has one, *P. aurelia* and *P. calkinsi* have two, and *P. woodruffi* and *P. polycaryum* have several micronuclei. *See* Macronucleus.
- MITOCHONDRIA.** Bodies in the cytoplasm which apparently contribute to specific chemical processes.
- MITOSIS.** The typical process of cell division.
- MODIFICATIONS.** *See* Acquired Characters.
- MONOHYBRID.** The progeny of parents differing in regard to one given character.
- MORPHOGENESIS.** The embryological development of the form and structure of an organism.
- MORPHOLOGY.** The science of the form of animals and plants.
- MOSAIC INHERITANCE.** Inheritance of a character in part from each parent but without blending.
- MOULT.** To cast off the outside covering, such as the exoskeleton of Arthropods. Ecdysis.
- MUTATION.** A heritable variation due to a change in the constitution of the chromosome (gene) complex, independent of the usual processes of segregation and crossing-over. Chromosomal aberrations and intrinsic gene changes.
- MYONEMES.** Contractile fibrils of certain Protozoa; *e.g.*, Vorticella.
- MYOTOMES.** Muscle segments in body wall of lower Vertebrates and embryos of higher forms.
- NATURAL SELECTION.** The processes occurring in nature which result in the "survival of the fittest" individuals and the elimination of those less adapted to the conditions imposed by their environment and mode of life. Essence of the Darwinian theory of evolution.
- NEMATOCYST.** A nettle-cell or stinging-cell of Coelenterates; *e.g.*, Hydra.
- NEPHRIDIOSTOME.** Funnel-like opening of a nephridium into the coelom.
- NEPHRIDIUM.** A tubular excretory organ; *e.g.*, in Earthworm.
- NERVE.** Essentially a group or cable of parallel nerve fibers bound together. *See* Axon.
- NEURAL TUBE.** A tube derived from the ectoderm and forming the brain and spinal cord in Vertebrates.
- NEURENTERIC CANAL.** Temporary passage between cavity of enteron and neural tube in Vertebrate embryos; *e.g.*, Frog.
- NEURON.** A nerve cell, comprising cell body and cytoplasmic processes. *See* Axon.

- NITRIFYING BACTERIA.** Nitrite Bacteria which, in the process of their nutrition, change ammonia ( $\text{NH}_3$ ) into compounds with the  $\text{NO}_2$  radical (nitrites), and Nitrate Bacteria which change nitrites into compounds with the  $\text{NO}_3$  radical (nitrates).
- NITROGEN-FIXING BACTERIA.** Types of Bacteria which take free atmospheric nitrogen and combine it with oxygen so that nitrates available for green plants are formed. Found in the soil and in tubercles on root-lets of various leguminous plants such as Beans, Clover, Alfalfa.
- NON-DISJUNCTION.** Failure of homologous chromosomes to separate after synapsis. Therefore they are not independently segregated during maturation — both pass to the same gamete.
- NOTOCHORD.** An axial cord of cells characteristic of the Chordates, and about which the vertebral column is formed in Vertebrates.
- NUCLEOLUS.** A spherical, achromatic body in the nucleus. Plasmosome. Karyosome is chromatic.
- NUCLEUS.** A specialized protoplasmic body in all typical cells. Most characteristic element is chromatin. *See* Cytoplasm.
- OCELLUS.** Sense organ responsive to light, especially the simple eyes of Insects. *See* Compound Eye.
- OLFACTORY.** Relating to the sense of smell.
- ONTOGENY.** The developmental history of the individual. *See* Phylogeny.
- OÖCYST.** Encysted zygote; *e.g.*, of Malarial Parasite.
- OÖCYTE.** The ovarian egg before maturation.
- OÖGENESIS.** The development of the mature egg from a primordial germ cell.
- OPTIC LOBES.** Thickenings of the dorsal surface of the mid-brain.
- ORDER.** In classification, a main subdivision of a class. *See* Family.
- ORGAN.** A complex of tissues for the performance of a certain function; *e.g.*, the heart.
- OSMOSIS.** Diffusion of dissolved substances through a semi-permeable membrane. Osmotic pressure may be considered as a result of the inhibited power of diffusion of a dissolved substance — inhibited because the membrane is *semi*-permeable, *i.e.*, permitting water but not the substance in solution to pass through. The physical phenomena of diffusion and osmosis are complicated in living cells by the fact that their limiting membranes undergo changes in permeability. *See* Diffusion.
- OSTEOLOGY.** The study of the Vertebrate skeleton.
- OSTIUM.** In Sponges, the opening from the gastral cavity to the exterior.
- OVIPAROUS.** Egg-laying. *See* Viviparous.
- OVUM.** Egg. Female gamete.
- OXIDATION.** The combination of any substance or its constituent parts with oxygen. Combustion.

- PALEONTOLOGY.** The science of extinct animals and plants represented by fossil remains.
- PARAPODIUM.** Locomotor and respiratory organ of marine worms; *e.g.*, Nereis.
- PARASITE.** An organism which secures its livelihood directly at the expense of another living organism, on or in whose body it lives.
- PARAZOA.** Animals without an enteron or coelom. Sponges.
- PARTHENOGENESIS.** Development of an egg without fertilization.
- PATHOGENIC.** Disease-producing, especially in regard to the relation of a parasite to its host.
- PENTADACTYL.** Having five fingers or toes; typical Vertebrate limb.
- PERICARDIUM.** Peritoneum lining the pericardial cavity containing the heart.
- PERIOSTEUM.** Connective tissue sheath covering bone and contributing to its growth.
- PERISTALSIS.** Rhythmical contractions of the wall of the alimentary canal which force the food along.
- PERITONEUM.** Membrane lining coelom of Vertebrates. Mesodermal in origin.
- PHARYNX.** Region of alimentary canal between buccal cavity, or mouth, and esophagus. Throat.
- PHENOTYPE.** The somatic, or expressed, characters of an organism or group of organisms irrespective of those potential in their germ cells. *See* Genotype.
- PHOTOSYNTHESIS.** Process by which complex compounds are built up from simple elements through the energy of sunlight absorbed by chlorophyll.
- PHYLOGENY.** The ancestral history of the race. *See* Ontogeny.
- PHYLUM.** In classification, a main subdivision of the animal kingdom. *See* Class.
- PHYSIOLOGY.** The study of the functions of animals and plants. The mechanical and chemical engineering of organisms.
- PINEAL BODY.** An outgrowth from the upper wall of the diencephalon. The vestige of an additional eye possessed by the ancestors of existing Vertebrates. Possibly functions as an endocrine gland in Mammals. Brow-spot of Frog.
- PITUITARY GLAND.** A glandular body under the brain, formed of tissue from the nervous system and from the alimentary canal. Secretes several hormones.
- PLACENTA.** A Mammalian organ adapted for the interchange of all nutritive, respiratory, and excretory materials between the embryo (fetus) and mother. It also serves as an organ of attachment. In the higher Mammals it is composed of both fetal and maternal tissues. *See* Umbilical Cord.

- PLASMA.** Liquid portion of the blood, lymph, and tissue fluid.
- PLASMA-MEMBRANE.** Living cell membrane, as distinguished from the cell wall which may also be present.
- PLASTID.** A specialized cytoplasmic body. *See* Chloroplast.
- PLEXUS.** The intermingling of fibers from one nerve with those of another to form a network; *e.g.*, sciatic plexus.
- POLLEN.** The microspores of Seed Plants.
- POLLINATION.** The transference of pollen to the stigma of the pistil in Seed Plants. Eventuates in fertilization.
- POLOCYTES.** Tiny abortive cells arising by division from the egg during maturation. Polar bodies.
- POLYMORPHISM.** Occurrence of several types of individuals during the life history, or composing a colony; *e.g.*, in some Hydroids.
- POLYP.** Hydra, or a Hydra-like individual of Hydroids, Corals, and other Coelenterates.
- POPULATION.** Entire group of individuals from which samples are taken for genetical study. Usually comprises several pure lines.
- POTENTIAL ENERGY.** Energy possessed by virtue of stresses, *i.e.*, two forces in equilibrium. Criterion is work done against any restoring force; *e.g.*, kinetic energy of sunlight through agency of chlorophyll separates CO<sub>2</sub> into C and O<sub>2</sub> and thereupon is represented by an equal amount of chemical potential energy. Restoring force is here chemical affinity. Similarly a raised weight possesses gravitational potential energy in amount equal to kinetic energy expended in raising it. *See* Kinetic Energy and Conservation of Energy.
- PREFORMATION.** The abandoned doctrine that development is essentially an unfolding of an individual ready-formed in the germ. *See* Epigenesis.
- PRONEPHROS.** Primitive kidney of Vertebrates.
- PROPHASE.** Preparatory changes during mitosis leading to the disposition of the chromosomes in the center of the cell (equatorial plate) ready for division. *See* Metaphase.
- PROPOYLES.** Pores leading into the flagellated chambers of Sponges.
- PROSTATE GLAND.** An accessory male genital gland in Mammals.
- PROSTOMIUM.** A lobe which projects from the first segment of the body of the Earthworm and forms an upper lip.
- PROTEIN.** A class of complex chemical molecules, containing nitrogen, which form the chief characteristic constituent of protoplasm.
- PROTOPHYTA.** Unicellular plants.
- PROTOPLASM.** The physical basis of life. Matter in the living state.
- PROTOPODITE.** The basal portion of the typical Crustacean appendage from which arise the endopodite and exopodite.
- PROTOZOA.** Unicellular animals, or colonies of animal cells not differentiated to form tissues; *e.g.*, Amoeba, Volvox.



- PROTOZOÖLOGY.** The science of unicellular animals, or Protozoa.
- PSEUDOPODIUM.** Temporary protoplasmic projections for locomotion, feeding, etc., as in Amoeba.
- PUPATE.** Assumption of a quiescent stage (pupa), in the life history of Insects with a 'complete' metamorphosis, during which the larva is reorganized as an adult; *e.g.*, chrysalis of a Butterfly and in cocoon of a Moth.
- PURE LINE.** A group of individuals bearing identical genes, derived from a common homozygous ancestor.
- PUTREFACTION.** The simplification of nitrogenous compounds, such as proteins, chiefly through the action of enzymes of living organisms. *See* Fermentation and Decay.
- PYLORIC VALVE.** Muscular constriction between stomach and small intestine.
- PYRENOID.** Portion of chloroplast specialized for starch formation.
- RECAPITULATION THEORY.** Doctrine that individual embryonic development (ontogeny) repeats in abbreviated and modified form the development of the race (phylogeny). So-called biogenetic law.
- RECESSIVE CHARACTER.** *See* Dominant Character.
- RECOMBINATION.** Heritable variation due to the typical reassortment of the chromosomes during maturation and fertilization. Includes crossing-over of genes.
- REDUCTION.** The process in maturation, during spermatogenesis and oögenesis, which separates synaptic mates and reduces the chromosome number one-half. Meiosis. The mechanism of segregation.
- REFLEX.** A relatively simple and essentially automatic response resulting from the transmission of a sensory impulse to a nerve center and its immediate reflection as a motor impulse independent of volition. A conditioned reflex is one established by training.
- REGENERATION.** The replacement of parts which have been lost through mutilations or otherwise.
- RENAL PORTAL SYSTEM.** Blood ('impure') passes from posterior part of the body to kidneys by the *renal portal vein*; oxygenated blood to kidneys by the renal artery. Thus in animals with the renal portal system there is a double blood supply to the kidneys. Present in Fishes, Amphibians, and Reptiles; vestigial in Birds; absent in Mammals.
- REPRODUCTION.** The power of living matter to reproduce itself. Protoplasmic growth resulting in cell division.
- RESPIRATION.** Essentially the securing of energy from food by oxidation, involving the exchange of carbon dioxide for oxygen by protoplasm.

- RESPONSE.** Any change in the activity of protoplasm, and therefore of an organism as a whole, as the result of a stimulus. *See* Irritability.
- RESTING CELL.** One which is not undergoing mitosis.
- RETINA.** Actual percipient part of the eye by virtue of a sensory layer which is stimulated by light rays.
- REVERSION.** The appearance of an ancestral character in an individual after it has been 'latent' for one or many generations. Atavism.
- ROTIFERA.** Microscopic, aquatic, multicellular animals. Wheel animalcules.
- RUSTS.** Fungi which are destructive parasites of the higher plants; *e.g.*, the Wheat Rust.
- SACculus.** The anterior sac of the labyrinth of the ear, a derivative of which becomes the cochlea in higher Vertebrates.
- SAPROPHYTIC.** Type of nutrition involving the absorption of complex products of organic decomposition; *e.g.*, in many groups of Bacteria and other Fungi, as well as various species of lower animals. Saprophytic. *See* Holozoic and Autotrophic.
- SEBACEOUS GLANDS.** Glands which elaborate a fatty substance (sebum) and secrete it into the hair follicles. Oil glands.
- SECONDARY SEXUAL CHARACTERS.** Differences between the sexes, other than those of the gonads and related organs.
- SECRETION.** A substance elaborated by glandular epithelium; or the process involved. *See* Gland and Excretion.
- SEGREGATION.** The distribution of homologous chromosomes, and therefore of homologous genes (allelomorphs), to separate cells during the formation of the gametes. The chief factor of Mendelian inheritance. *See* Reduction.
- SEMICIRCULAR CANALS.** Portion of the Vertebrate ear devoted to the maintenance of equilibrium.
- SEMINAL RECEPTACLES.** Sacs within the body cavity of certain animals (*e.g.*, Earthworm), which receive sperm from another individual and retain them until fertilization is to occur.
- SEPTA.** The partitions which divide the coelom of the Earthworm into a series of chambers, or segments.
- SERIAL HOMOLGY.** Homology of a structure of an organism with another of the same organism; *e.g.*, appendages of the Crayfish, fore and hind limbs of Vertebrates.
- SESSILE.** Attached, sedentary; *e.g.*, Sponges.
- SETAE.** Bristle-like structures which protrude from the body wall and aid in locomotion; *e.g.*, in Earthworm and Nereis.
- SEX-LINKED CHARACTERS.** Characters represented by genes in the X chromosome.

- SOMA.** Body tissue (somatoplasm) in contrast with germinal tissue (germ plasm).
- SPECIAL CREATION.** Doctrine that each species was specially created. Implies fixity of species. *See* Evolution.
- SPECIES.** In classification, the main subdivision of a genus. A group of individuals which do not differ from one another in excess of the limits of 'individual diversity,' actual or assumed.
- SPERM.** Male gamete. Spermatozoön.
- SPERMATID.** Male germ cells after the final maturation division but before assuming the typical form of the ripe sperm.
- SPERMATOCYTES.** Cells arising from the spermatogonia. Primary spermatocyte arises by growth from the last generation of spermatogonia. Primary divides to form two secondary spermatocytes.
- SPERMATOGENESIS.** The development of the sperm from a primordial germ cell.
- SPINDLE.** The fiber-like apparatus between the centrosomes during mitosis.
- SPIRACLES.** Openings on the body surface leading into the tracheal system of Insects.
- SPLEEN.** A vascular ductless organ of most Vertebrates, usually situated near the stomach, that acts chiefly as a stabilizer of the supply of red blood corpuscles.
- SPONGIN.** A horny substance, chemically allied to silk, forming the fibers of the skeleton of certain Sponges; *e.g.*, the Bath Sponge.
- SPONTANEOUS GENERATION.** *See* Abiogenesis.
- SPORE.** A cell which gives rise without fertilization to a new individual. Also the resistant phase assumed by certain unicellular organisms; *e.g.*, Bacteria, Sporozoa.
- SPORULATION.** Occurrence of several simultaneous divisions by which a unicellular organism is resolved into many smaller cells. Formation of spores.
- STATOCYSTS.** Organs of equilibrium; *e.g.*, in medusae.
- STIMULUS.** Any condition which calls forth a response from living matter. *See* Irritability.
- SYMBIOSIS.** The association of two species in a practically obligatory and mutually advantageous partnership; *e.g.*, Lichens, Hydra (green).
- SYMPATHETIC NERVOUS SYSTEM.** *See* Autonomic System.
- SYNAPSE.** The contact of one nerve cell with another, which makes possible the conduction of a nervous impulse from cell to cell.
- SYNAPSIS.** The pairing of homologous chromosomes during maturation of the germ cells.
- SYNAPTIC MATES.** Homologous chromosomes of maternal and paternal origin that pair during synapsis.

- SYNKARYON.** The composite nucleus formed by the union of the nuclei of two gametes. Male and female gametic nuclei united in the zygote. *See* Zygote.
- TAPIR.** A large herbivorous Mammal, having short stout limbs and flexible proboscis with the nostrils near the end. New World species are brownish-black, those of the Old World are black and white.
- TAXONOMY.** The science of classification.
- TELOPHASE.** Final phase of mitosis during which the two daughter nuclei are formed and cytoplasmic division is completed. *See* Prophase.
- TETRAD.** Group of four chromosomes formed by a precocious division of synaptic mates in the primary spermatocyte and primary oöcyte.
- THORAX.** Portion of the trunk in Mammals, containing esophagus, lungs, and heart. The middle portion of the body in the Arthropoda; *e.g.*, in all Insects. In the Crayfish the head and thorax are fused to form the cephalothorax.
- THYMUS.** A glandular structure in the pharyngeal region of Vertebrates. Regresses during early life in Man. Function obscure.
- THYROID GLAND.** An endocrine or ductless gland in the pharyngeal region of Vertebrates.
- TISSUE.** An aggregation of similar cells for the performance of a certain function. *See* Organ.
- TISSUE FLUID.** Essentially plasma and white blood cells that have passed through the capillary walls to supply the milieu of the tissue cells. Interstitial fluid. *See* Lymph.
- TRACHEAL SYSTEM.** Series of tubes that convey air throughout the tissues of certain Arthropods; *e.g.*, Insects.
- TRICHOCYSTS.** Minute bodies, arranged in the outer part of the ectoplasm of certain Infusoria (*e.g.*, Paramecium), each of which upon proper stimulation is transformed into a thread-like process protruding from the cell surface. Apparently defensive structures.
- TRIHYBRID.** The progeny of parents differing in regard to three given characters.
- TRILOBITES.** Crustacea dominant during the early Paleozoic era. Extinct.
- TRIPLOBLASTIC.** Composed of three primary germ layers: ectoderm, endoderm, and mesoderm, as in all animals above the Coelenterates.
- TROPHOZOITE.** Growing and feeding form developed from a Sporozoite; *e.g.*, in Monocystis and Malarial Parasite.
- TROPISM.** Element of behavior of the lower organisms. Orientation with respect to an external stimulus; *e.g.*, chemotrópism, phototropism, etc.
- TUBE FEET.** Locomotor organs of Echinoderms; *e.g.*, Starfish and Sea Urchin.

- TURGOR.** Pressure within a cell, largely due to the absorption of water, which distends or holds rigid the cell wall.
- TYPHLOSOLE.** A median dorsal invagination along the entire length of the intestine of the Earthworm which increases the area of the digestive and absorptive surface.
- UMBILICAL CORD.** A Mammalian structure, commonly known as the navel cord, by which the embryo is attached to the placenta. The blood vessels from the embryo to the placenta pass through it. *See* Placenta.
- UNGUICULATE.** Provided with claws.
- UNIFORMITARIAN DOCTRINE.** An interpretation of the present condition of the Earth on the assumption of similarity of factors at work during past ages and to-day.
- UNIPARENTAL.** Derived from a single progenitor; *e.g.*, in asexual reproduction. *See* Biparental.
- UREA.** Nitrogenous waste product of animal metabolism. Formed as such in the liver, removed from the blood by the kidneys and eliminated from the body chiefly in urine.  $\text{CO}(\text{NH}_2)_2$ . A major part of the nitrogen is excreted in this form in human urine. *See* Creatinine and Uric Acid.
- URETER.** A tube carrying urine from kidney to the cloaca or to the urinary bladder.
- URIC ACID.** A nitrogenous waste product. Present in small quantity in the urine of Man.
- UROGENITAL.** Relating to the urinary and reproductive systems.
- UROSTYLE.** Terminal rod-like bone of the vertebral column of the Frog.
- UTERUS.** Lower portion of the oviduct (or oviducts) modified for the retention of the eggs, temporarily or during development.
- UTERUS MASCULINUS.** Remnant of the pronephric ducts in some male Mammals.
- UTRICULUS.** The posterior sac of the labyrinth of the ear into which the semicircular canals open.
- VAGINA.** Passage leading from the uterus to the exterior.
- VASOMOTOR NERVES.** Nerves which regulate the caliber of small arteries by bringing about relaxation or contraction of the muscular layer of their walls.
- VERMIFORM APPENDIX.** Blind outpocketing of the large intestine near its origin from the small intestine. Vestigial end of the caecum. Found only in Apes and Man.
- VERTEBRA.** One of the series of elements forming the backbone, or vertebral column.
- VERTEBRATE.** An animal with a backbone, or vertebral column. *See* Chordate.

**VITALISM.** The doctrine which attributes at least some of the phenomena of life to an interplay of matter and energy which transcends the so-called laws operable in the inorganic world. *See* Mechanism.

**VITAMINS.** Indispensable accessory food substances whose importance has but recently been realized. Chemical composition of most of them is unknown.

**VIVIPAROUS.** Producing young that have developed to a relatively advanced stage in the uterus; *e.g.*, most Mammals. *See* Oviparous.

**WORKING HYPOTHESIS.** A basic assumption to guide the study of a subject, and to be proved or disproved by facts accumulated.

**X CHROMOSOME.** The so-called sex chromosome.

**Y CHROMOSOME.** The synaptic mate of the X chromosome when present.

**YEAST.** A group of unicellular colorless plants (Fungi) which are chiefly responsible for alcoholic fermentation.

**YOLK.** Food material stored within the cytoplasm of an egg. *See* Metaplasm.

**YOLK SAC.** When a great quantity of yolk is present in an egg, the endoderm gradually grows over it to form the yolk sac which is usually of enormous size in comparison with the embryo proper.

**ZOÖGEOGRAPHY.** The science of the geographical distribution of animals.

**ZYGOTE.** The composite cell formed by the union of male and female gametes. Fertilized egg. *See* Synkaryon.



## INDEX

(Figures in italics designate pages on which illustrations occur)

- Abdomen, 90, 93, 106, 133, 134, *149*  
 Abdominal pore, 190  
 Abiogenesis, 218-221  
 Abortion, infectious, 391  
 Absorption, 153, 154, 157, 158  
 Academy of Sciences, National, *424*  
 Acoelomate, 101, 480  
 Acquired character, 285, 286, 374;  
   *See: Modifications*  
 Actinophrys, *49*  
 Adam's apple, 162  
 Adaptability, 343-348  
 Adaptation, 18, 26, 28, 56, 316-337,  
   375-377, 384, 388, 405, 431, 445  
 Adaptive radiation, 320-324  
 Adrenal gland, *190*, 198  
 Adrenaline, 198  
 Aedes, 393  
 Aerobe, 318  
 Afferent nerve, 208  
 African sleeping sickness, 341, 342,  
   390, 407  
 Agassiz, *459*, *460*  
 Age, old, 25, 256-259  
 Ages, geological, *360*, *363*  
 Agriculture, 6, 342, 403-417, *422*  
 Air bladder, *146*  
 Albino, *291*, *296*, 367  
 Albumin, 21, 253  
 Alcohol, 286, 318, *421*  
 Algae, *335-337*  
 Alimentary canal, 65, 150-160, 168,  
   180, 267-270  
 Allantois, 271, *272*  
 Allelomorphs, 292, 293, 302, *308*  
 Allen's theory, 225, 226  
 Alligator, 120, 121, 365  
 Allogromia, *48*  
 Alternation of generations, 72, *234*  
 Alternative characters, 288  
 Alveolus, *163*, *164*  
 Amblystoma, *118*  
 Ambulacral groove, 84  
 Amino acid, 22, 33, 36, 151, 156  
 Ammonia, 41, 181  
 Amnion, *193*, 271, *272*  
 Amoeba, 10, 12, 15, 27, 28, 35-37,  
   261, 344, *390*, *477*  
 Amoeboid movement, 27, 28, *238*,  
   342  
 Amphibia, 111, 117-119, *147*, *173*,  
   359, 365; *See: Frog*  
 Amphineura, 86  
 Amphioxus, *110*, 111, 145, *478*  
 Amylase, 155, 156  
 Anabolism, 25; *See: Metabolism*  
 Anaerobe, 318  
 Analogy, 107, 216, 459  
 Anaphase, 240-242  
 Anatomy, 3, 4, 354-388, 451-454,  
   457-459  
 Andalusian fowl, 298, *299*  
 Animal, 35-37, 43, 46-56, 67-131;  
   body, 98-109, 132-149; coloration,  
   324-329; number, 47, 66, 67, 349  
 Animal biology, 3  
 Annelida, 81, 82, 457, 480; *See:*  
   *Earthworm*  
 Anopheles, *392*, *393*; *See: Mosquito*  
 Ant, 93, 336-339, 346  
 Anteater, *127*, *321*  
 Antelope, 321, *341*, 342  
 Antenna, 93, *104-106*, *330*, *331*, 356;  
   cleaner, 331, 332; comb, 331, 332  
 Antennule, *105*, *106*, 356  
 Anterior chamber of eye, *150*  
 Anther, *334*  
 Anthozoa, 75-77  
 Anthrax, 390, *391*  
 Anthropoidea, 426-431  
 Antibody, 342, 343  
 Antitoxin, 343  
 Antlers, 192  
 Anus, 80, 132, 159  
 Aorta, 174, *176*, *185*  
 Aortic arches, *173*, *175*; loop, *101*, *102*  
 Ape, 130, 131, 322, 356, 359, 367,  
   426-431  
 Aphid, 338, 339, 375, 411, *414*  
 Apophyle, 70



- Appendages of crayfish, 96, 105, 106, 356  
 Appendicular skeleton, 142, 143  
 Apple, 408  
 Applied science, 386, 388  
 Aptera, 92, 94  
 Apteryx, 124  
 Aqueous humor, 215  
 Arachnoidea, 95  
 Arcella, 48  
 Archaeopteryx, 123, 361, 362  
 Aristotle, 2, 23, 188, 218, 251, 446, 449, 451, 456, 462, 464, 466, 471, 472  
 Armadillo, 128, 129  
 Army worm moth, 408, 415  
 Arterial system, 171-177  
 Artery, 105, 170-179  
 Arthropoda, 90-97, 104-109, 130, 215, 478  
 Artificial parthenogenesis, 260, 261  
 Artificial selection, 378-384, 473-476;  
   *See: Selection*  
 Artiodactyl, 130  
 Ascaris, 80, 396  
 Ascon, 69, 70  
 Asexual reproduction, 57; *See: Bud-  
   ding, Regeneration, Reproduction,  
   and Schizogony*  
 Associative memory, 347  
 Aster, 240, 241  
 Asteroidea, 86  
 Astronomy, 2  
 Atlas, 142  
 Atmosphere, 320  
 Auditory nerve, 212, 213  
 Audubon Societies, 419  
 Aurelia, 73-75  
 Autonomic system, 201, 205, 208, 209  
 Autotrophic, 33, 42  
 Aves, 123-126  
 Avoiding reaction, 344  
 Axon, 200  
  
 Baboon, 131  
 Babylonian science, 446  
 Bacillus, 38, 39; *See: Bacteria*  
 Backbone, 111; *See: Skeleton*  
 Bacon, 452  
 Bacteria, 38-45, 158, 220-223, 318, 319, 342, 343, 391, 402-404, 407, 453; denitrifying, 45; nitrite, 45; nitrogen-fixing, 42, 338  
 Badger, 321  
 von Baer, 1, 467, 468  
 Balanced aquarium, 45; *See: Web of life*  
 Balantidium, 396  
 Barley, 409  
 Barnacle, 91  
 Bat, 128, 129, 321, 324, 355  
 Bath sponge, 69, 70  
 "Beagle," voyage of, 372  
 Bean, inheritance, 380, 381  
 Bear, 129, 321, 352, 367  
 Beaver, 129, 323, 352  
 Bee, 93, 94, 327-336, 346, 414  
 Bee-fly, 329  
 Behavior, 253, 314, 343-348  
 Belief, 228  
 Beri-beri, 159  
 Bibliography, 481-491  
 Bilateral symmetry, 78, 104, 132  
 Bile, 154; duct, 133, 146, 148, 154, 155, 398  
 Binary fission, 50, 56, 188, 229, 230, 255  
 Binomial nomenclature, 353, 457  
 Biochemistry, 5, 366, 403  
 Biocoenosis, *frontispiece*, 494  
 Biogenesis, 218-228, 454  
 Biogenetic law, 364-366, 468  
 Biological sciences, 3, 4  
 Biology, 1-6, 466  
 Biophysics, 5  
 Biosocial reactions, 437, 444  
 Biparental, 274  
 Biramous, 106, 107  
 Bird, 111, 123-126, 204, 251, 253, 319, 325, 355, 361, 362, 365, 369, 372, 376, 419, 420, 479  
 Birth, 191, 192, 194  
 Bison, 419, 441  
 Bivalve, 87-89  
 Bladderworm, 399, 400  
 de Blainville, 23  
 Blastocoel, 60, 264, 266, 268  
 Blastoderm, 253, 272  
 Blastopore, 60, 264, 266, 268  
 Blastostyle, 72  
 Blastula, 60, 98, 263, 264, 266, 268  
 Blending inheritance, 287, 297-301  
 Blind spot, 215  
 Blood, 11, 15, 64, 165, 166, 169-179, 182, 192, 367, 430, 452, 454; corpuscles, 11, 28, 64; pressure, 176, 177;

- rate, 176; relationship, 367, 368; reservoir, 178; transfusion, 367; vessels, 157; volume, 178; *See: Artery and Vein*
- Blue crab, 91
- Boa-constrictor, 123
- Bodo, 51
- Body, invertebrate, 98-109; vertebrate, 132-149
- Boll weevil, 409, 410
- Bone, 15, 62, 63, 113, 124, 138, 139, 213, 215; *See: Skeleton*
- Bony fishes, 115, 116
- Borelli, 460
- Botany, 3, 4, 404, 447, 450, 454, 456, 457, 462, 463
- Botfly, 405
- Bougainvillea, 72
- Box tortoise, 121
- Brachiopod, 82, 83, 477
- Brachonid fly, 408
- Brain, 104, 105, 108, 110, 143, 200-217, 268, 269, 319, 344, 365, 366
- Branchial artery, 170-173
- Branchiostoma, 110; *See: Amphioxus*
- Bright's disease, 182
- Brittle star, 86
- Bronchial tubes, 163
- Bronze age, 444
- Browne, 218
- Brown-tail moth, 413
- Bryozoa, 82, 83, 477
- Bubonic plague, 390, 391, 406, 407
- Buccal cavity, 151, 152
- Bud, 41, 68, 71, 72, 77, 99, 230
- Buffalo, 336
- Buffalo-moth, 413
- Buffon, 220, 471, 472
- Bufo, 118, 119
- Bumble bee, 94, 219
- Buttercup, 7
- Butterfish, 336
- Butterfly, 94, 96, 327, 408
- Cabbage butterfly, 94, 408
- Caddice-fly, 94
- Calciferous gland, 102
- Calorie, 159
- Cambrian period, 359, 360
- Camel, 130, 321
- Camera, 216, 217
- Candle, 24
- Cane sugar, 156
- Capillaries, 101, 163, 170-179, 186, 198, 342, 454
- Caprella, 91
- Carapace, 121
- Carbohydrate, 22, 23, 32, 33, 36, 39, 151, 156, 157, 159, 197
- Carbon, 21-23; cycle, 40; dioxide, 165, 166, 181
- Cardiac muscle, 138
- Carinatae, 124, 126
- Carnivora, 129, 352
- Carpal, 142, 144, 355
- Carpet beetle, 413
- Carrier, 307, 308
- Cartilage, 62, 63, 138, 139
- Cascin, 21, 156
- Castration, 192
- Cat, 129, 142, 204, 352
- Catalysis, 23, 33
- Caterpillar, 408, 416, 420
- Caudata, 117, 118
- Cell, 3, 7-12, 14, 18, 19, 28, 30, 31, 39, 254, 351, 388, 452, 465, 466, 468; cycle, 230, 231, 238; division, 12, 13, 26, 31, 41, 50, 56, 60, 230, 262; theory, 464, 466
- Cellulose, 22
- Cenozoic era, 359, 361
- Centaur, 449
- Centipede, 91, 92
- Central capsule, 49
- Central disk, 84
- Central nervous system, 201; *See: Nervous system*
- Central spindle, 240, 241
- Centrosome, 19, 240, 241, 254
- Centrum, 133, 139, 140
- Cephalization, 206
- Cephalopoda, 89, 90
- Cephalothorax, 90
- Cercaria, 397, 398
- Cercomonas, 51
- Cerebellum, 146-149, 202-204
- Cerebral, cortex, 207, 217; ganglion, 102; hemispheres, 202-205; *See: Brain*
- Cerebrum, 203
- Cestode, 78, 398, 399
- Cetacea, 129
- Chalaza, 253
- Chameleon, 122, 123, 326
- Chapman, 369
- Cheliped, 105

- Chemical coördination, 196-198  
 Chemical physiology, 5, 366, 403  
 Chemistry, 2, 5, 15, 20-23, 196-198, 403, 404, 460, 464  
 Chemotropism, 253, 343  
 Chess, 5  
 Chills and fever, 340  
 Chimpanzee, 427, 428, 431  
 Chipmunk, 352  
 Chiroptera, 129  
 Chiton, 86, 87  
 Chloragogen cells, 103  
 Chlorohydra, 337  
 Chlorophyll, 8, 34, 36, 325, 463  
 Chloroplast, 32, 33  
 Choice, 346, 347, 423  
 Cholera, 390, 391  
 Chordate, 111, 145, 478-480; *See:*  
   Vertebrate  
 Chorion, 272  
 Choroid, 215  
 Chromatin, 19, 20, 240-243; *See:*  
   Nucleus  
 Chromatophore, 50  
 Chromosome, 240-250, 275, 279, 280, 304-314, 468, 469; aberrations, 310, 311; combinations, 248-250; cycle, 248-250; human, 306-311; map, 309  
 Chronological succession, 358-361  
 Chrysalis, 408  
 Chyle, 158  
 Chyme, 153  
 Cicada, 94  
 Cilia, 11, 28, 55, 62  
 Ciliate, *See:* Infusoria  
 Circulating tissue, 64; *See:* Blood and Lymph  
 Circulation, 65, 82, 108, 168-179, 196, 451, 452, 454  
 Cirripede, 91  
 Clam, 88  
 Class, 353  
 Classification, 46, 47, 349, 352-354, 455, 457, 477  
 Clavicle, 140, 144  
 Cleavage, 58-60, 468  
 Cloaca, 133, 147, 159, 190, 194  
 Clostridium, 318  
 Clothes moth, 413  
 Clover, 408  
 Clypeus, 330  
 Cobra, 123  
 Coccus, 38, 39  
 Coccyx, 149, 357  
 Cochlea, 212, 213  
 Cocoon, 406  
 Coelenterate, 71-78, 98-100, 477  
 Coelom, 81, 101-103, 112, 132, 133, 145, 183, 185, 189, 194, 266, 267, 269, 480  
 Coelomate, 101, 169, 189, 480  
 Coelomic fluid, 169  
 Genosarc, 72  
 Cold blooded, 112, 117  
 Cold sense spots, 211  
 Coleoptera, 94  
 Collar cell, 68, 69  
 Colloid, 16, 227, 317  
 Colon, 158  
 Colony, 51, 58, 71, 72, 230, 232, 234, 330, 336  
 Coloration of animals, 324-329  
 Color-blindness, 307, 308, 383  
 Colorless plants, 37; *See:* Bacteria  
 Colpidium, 44  
 Colpoda, 44  
 Comb-jellies, 78  
 Combustion, 166, 167  
 Communal associations, 93, 336, 337  
 Comparative anatomy, 107, 354-358, 389, 457-459  
 Complementary genes, 300  
 Compound eye, 215, 330  
 Conditioned reflex, 208, 346, 437, 438  
 Condylarthra, 362  
 Conifer, 359, 361  
 Conjugation, 55, 230, 255-260; *See:*  
   Fertilization  
 Conjunctiva, 215-217  
 Connective tissue, 62-64, 134, 139  
 Consciousness, 347  
 Conservation, of energy, 463; of resources, 417-420  
 Constructive biology, 420-425  
 Continuity of life, 229-250  
 Contractile vacuole, 10, 27, 35, 37, 50, 55, 56, 180  
 Contractility, 63, 344  
 Conus arteriosus, 170, 171, 173  
 Coördination, 196-217  
 Cootie, 94  
 Copper, age of, 444  
 Copperhead, 123  
 Copulation, 189, 190  
 Coracoid, 140

- Coral, 77  
 Corn, 283, 313, 408, 409  
 Corn borer, 409  
 Cornea, 215, 216  
 Corpus luteum, 192, 193  
 Cortex of brain, 203  
 Cosmic time, 359  
 Cosmozoa theory, 223, 224, 227  
 Cotton boll weevil, 409, 410  
 Cousin-marriage, 383  
 Cowper's gland, 148, 194  
 Coxa, 330, 331  
 Crab, 90, 91, 96  
 Cranial nerve, 205, 206, 211  
 Cranium, *See*: Skull  
 Crayfish, 90, 96, 104-109, 132, 145, 161, 189, 210, 212, 235, 335, 346, 356, 357  
 Creatinine, 181  
 Cretin, 197  
 Crinoidea, 85, 86  
 Crithidia, 341  
 Crocodile, 120, 121, 365, 367  
 Crô-Magnon man, 436-438, 440, 441  
 Crop, 102  
 Crossing-over, 282, 308, 309  
 Crura cerebri, 203, 205  
 Crustacea, 90, 91, 104-109; *See*: Crayfish  
 Crystal, 26, 367  
 Ctenophora, 78, 477  
 Culex, 392  
 Cultural development, 431, 437-445  
 Cumulative genes, 299-301  
 Cursorial, 321  
 Curve of probability, 378, 379  
 Cutaneous senses, 210, 211  
 Cuticle, 102, 103, 135  
 Cuttle-fish, 86  
 Cuvier, 458  
 Cyanea, 73  
 Cyanogen, 224, 225  
 Cycle of elements, 39-45, 403  
 Cyclosis, 28  
 Cyclostome, 112, 113, 184, 479  
 Cyst, 50, 52, 223, 230, 319, 390  
 Cystic duct, 155  
 Cysticercus, 399, 400  
 Cyto-genetic map, 309  
 Cytology, 3, 301  
 Cytoplasm, 10, 18, 19, 240-242; *See*: Protoplasm  
 Cytoplasmic organization, 276-279  
 Dante, 449  
 Daphnia, 91  
 Darwin, Charles, 82, 281, 290, 372, 376, 378, 384, 389, 416, 472-476  
 Darwin, Erasmus, 229, 472, 473  
 Darwinism, 374-377, 384, 472-476  
 Datura, 310  
 Death, 14, 20, 258  
 Decay, 40, 41, 221; *See*: Fermentation and Putrefaction  
 Dedifferentiation, 235  
 Dendrite, 200  
 Denitrifying bacteria, 41, 42  
 Dentalium, 276  
 Dermal branchia, 84  
 Dermis, 134, 135  
 Descent with change, 349; *See*: Evolution  
 Development, 57-61, 231, 263-280, 364-366; *See*: Embryology  
 Devil-fish, 86  
 Diabetes, 182, 197  
 Diaphragm, 134, 148, 149, 152, 163, 164  
 Dickens, 150  
 Didinium, 54  
 Diencephalon, 202, 203, 214  
 Differentiation, 56, 57, 235, 274, 276-279, 460  
 Diffugia, 48  
 Diffusion, 157, 181, 497  
 Digestion, 36, 61, 69, 108, 150-160, 338, 460, 461  
 Digestive tract, 168; *See*: Alimentary canal and Enteric cavity  
 Digit, 322, 355, 361-364  
 Digitigrade, 321, 322  
 Dihybrid, 292-294, 303  
 Dinoflagellata, 51  
 Dinosaur, 120, 123, 359  
 Dioscorides, 448-450  
 Diphtheria, 390, 391  
 Diploid, 245, 248, 249, 303  
 Dipnoi, 116  
 Diptera, 94  
 Disease, 38; inheritance of, 286; microorganisms and, 389-402  
 Distribution of animals, 368-373  
 Division of labor, 232, 234; *See*: Physiological division of labor  
 Dog, 129, 321, 352, 367, 399, 442  
 Dogfish, 114, 171  
 Dog flea, 406

- Dolphin, 129, 321  
 Dominant character, 290-295, 383  
 Donnan, 218  
 Dorsal aorta, 171-173; *See*: Aorta  
 Dorsal nerve root, 201, 207, 208  
 Dragonfly, 94  
 Drone, 330  
 Drosophila, 305, 306, 309, 311  
 Duckbill, 127  
 Duct, *See*: Gland  
 Ductless gland, 160, 196; *See*: Hormone  
 Dust, 220, 222, 418  
 Dysentery, 391, 407  
  
 Ear, 105, 210, 212, 213, 357, 358  
 Earth, 221, 222, 227, 359, 360  
 Earthworm, 52, 81, 82, 100-103, 145, 161, 183, 189, 201, 209, 231, 235, 237, 344, 346, 416, 477; embryology, 263-267; excretion, 183; feeding instinct, 346; nerve cells, 201; regeneration and grafting, 237  
 Earwig, 94  
 Echidna, 127  
 Echinococcus, 396, 399  
 Echinoderm, 83-86; *See*: Sea urchin  
 Ecology, 4, 335, 368, 415, 420; *See*: Web of life  
 Ectoderm, 8, 60, 99, 100, 134, 200, 214, 215, 231, 238, 272; *See*: Germ layers  
 Ectoplasm, 10, 19, 27, 35, 252  
 Education, 5, 347, 388, 437, 444  
 Eel, 115, 218  
 Efferent nerve, 208; *See*: Nerve  
 Egg, 11, 57, 59, 191, 230, 231, 239, 247, 251, 252, 253, 340, 466-468; bird, 253; frog, 190, 239, 268; human, 191, 239, 252, 273; membrane, 252, 253; organization, 254, 275-280; rabbit, 273; sea urchin, 264, 279; shell, 252, 253  
 Egypt, 218, 446  
 Ejaculatory duct, 494  
 Elasmobranch, 113, 114  
 Elements, cycle of, 39-45  
 Elephant, 129, 370, 371  
 Elf, 118  
 Elk, 419  
 Embryo, 272, 365; human, 193, 273, 365  
 Embryology, 4, 57-61, 231, 263-280, 364-366, 454, 466, 468  
 Embryonic membrane, 128, 191-193, 271-273  
 Emergent evolution, 384  
 Emerson, 111  
 Empedocles, 472  
 Encyclopaedist, 460, 461  
 Endamoeba, 48, 390, 396  
 Endocrinology, 160, 172, 196-198, 319, 367  
 Endoderm, 8, 60, 99, 100, 231, 238, 272, 337  
 Endomixis, 55, 258, 259  
 Endoplasm, 19, 27, 35, 252  
 Endopodite, 106, 107  
 Endoskeleton, 138, 145; *See*: Skeleton  
 Energy, 14, 16, 24, 25, 27, 32, 33, 34, 37, 42, 159, 168, 197, 318; conservation of, 463; kinetic, 25, 32, 33, 36, 45; potential, 25, 32, 33, 36, 45, 498  
 Enteric cavity, 8, 60, 61, 71, 73, 99, 100, 264, 266, 268, 480  
 Enteric pouch, 264  
 Enteron, 76, 99, 264, 269; *See*: Enteric cavity  
 Enterozoa, 480  
 Entomology, 350, 392, 416; *See*: Insects  
 Entomostraca, 90  
 Environment, 27, 285, 286, 301, 312-316, 372, 383, 473, *See*: Adaptation  
 Enzyme, 23, 33, 41, 61, 151-159, 226, 318  
 Eoanthropus, 433, 434  
 Eocene epoch, 359-362, 430  
 Eohippus, 362-364  
 Eolith, 438  
 Ephyra, 75  
 Epidemic diseases, 391  
 Epidermis, 8, 103, 134, 135, 274, 280  
 Epigenesis, 274-280, 467  
 Epiglottis, 148, 162, 421  
 Epipharynx, 330  
 Epipodite, 106  
 Epithelium, 11, 28, 61-64, 70, 134, 151, 201, 208, 211, 216  
 Equatorial plate, 241  
 Equilibration, sense of, 210, 212  
 Equilibrium of nature, 335; *See*: Web of life

- Equipotential system, 278  
 Equus, 363, 364; *See*: Horse  
 Erepzin, 155  
 Erosion of soil, 419  
 Esophagus, 103, 146-149, 151-153  
 Ethics, 5  
 Eugenics, 314, 422-424  
 Euglena, 50, 477  
 Euplotes, 54  
 Euspongia, 69, 70  
 Eustachian tube, 213, 357  
 Euthenics, 314, 423  
 Eutheria, 128-131, 479  
 Evolution, 4, 131, 321, 348-385, 388, 459, 471-476  
 Exconjugant, 256, 257  
 Excretion, 25, 37, 39, 61, 134, 154, 180-187  
 Excretory system, 65, 164, 180-187  
 Exopodite, 106, 107  
 Exoskeleton, 96, 104, 105, 138, 145  
 Experimental method, 2, 219, 274, 452, 468  
 Eye, 79, 81, 82, 90, 93, 104, 105, 210, 213-217, 330, 357; brush, 332; color, 287  
 Eyelid, 215, 357  
  
 Fabricius, 466  
 Fallopian tube, 193, 194; *See*: Oviduct  
 Family, 352, 353  
 Fang, 358  
 Fat, 22, 23, 36, 39, 151, 155, 156, 157, 159  
 Fat body, 190  
 Fatty acid, 22, 151, 156, 181  
 Feather, 97, 111, 123, 124, 134, 138  
 Feather star, 85, 86  
 Feces, 159, 180  
 Feeble-minded, 421  
 Female, 57; *See*: Egg and Sex  
 Femur, *See*: Vertebrate and Bee  
 Fermentation, 40, 41, 221, 389, 390  
 Fern, 361  
 Fertilization, 55, 57, 230, 231, 243, 249-262, 305, 340, 383, 468; significance, 255-262  
 Fibula, 142, 144  
 Fiddler crab, 91  
 Fig, 416  
 Filaria, 80  
 Filial regression, 380  
 Filterable virus, 343  
  
 Fin, 110, 112, 133, 142, 143, 146, 270  
 Fire, 433, 439, 443  
 Fish, 111, 112-117, 146, 161, 173, 184, 194, 204, 212, 336, 359, 418, 420  
 Fission, 230, 233; *See*: Binary fission  
 Fixity of species, 350; *See*: Evolution  
 Flagellate, 477; *See*: Euglena, Mastigophora  
 Flagellum, 28, 39, 51, 58, 59, 68, 69  
 Flatfish, 115  
 Flatworm, 78, 79, 233, 235, 396-400, 477  
 Flea, 93, 94, 402, 405, 406  
 Flight, 124  
 Flipper, 355  
 Flounder, 115  
 Flower, 334  
 Fluctuations, 379  
 Fluke, 78, 396-398  
 Fly, 219, 407-409, 411, 415  
 Flying dragon, 122  
 Flying-fish, 115, 116  
 Flying lemur, 322, 324  
 Flying squirrel, 321  
 Follicle, cells, 239; hair, 134  
 Food, 14, 26, 31-33, 36, 159, 221, 317, 318, 335, 336, 403-407; *See*: Metabolism and Nutrition  
 Foodstuffs, 23, 32-36  
 Foot, 140, 431; *See*: Limb  
 Foraminifera, 48, 49, 386, 387, 477  
 Fore-brain, 201, 202, 215, 268, 269  
 Forest conservation, 404, 412, 418  
 Formaldehyde, 32  
 Fossil man, 431-437  
 Fossils, 83, 358-364, 431-437, 459  
 Fossorial, 321, 322  
 Four-o'clock, 297, 298  
 Fox, 321, 325, 326  
 Free-martin, 306  
 Fresh-water sponge, 69, 70  
 Frog, 7, 111, 117-119, 181, 184, 325; circulation, 147, 173, 365; embryology, 267-271; intestine, 147, 155; metamorphosis, 267-271; muscular system, 136; nervous system, 204, 205; pancreas and liver, 155; respiratory mechanism, 165; skeleton, 141; urogenital system, 190, 239  
 Fructose, 22  
 Fruit fly, 305, 306, 309, 311, 411

- Fuel value, 159  
 Fungus, 337, 338
- Galapagos Islands, 372  
 Galen, 448, 452, 463  
 Galileo, 452, 462  
 Gall bladder, 146, 147, 152, 154, 155, 182  
 Galton, 288, 380, 469  
 Game cock, 282  
 Gamete, 52, 57, 188, 230, 231, 238, 243, 251-262, 291-305  
 Gametocyte, 52, 340  
 Ganglion, 101, 108, 199-216  
 Garpike, 115  
 Gastral cavity, 68-70  
 Gastric, glands, 153, 156; juice, 153, 156; mill, 105; vacuole, 10, 35, 36, 55  
 Gastropoda, 87  
 Gastrula, 60, 75, 87, 98, 263-268  
 Gazelle, 325  
 Geddes, 316  
 Gene, 243, 249, 250, 282, 290-315, 352, 353, 383, 384; mutation, 311  
 Genetics, 4, 281-305, 350, 377-384, 420-425, 468-470  
 Genital duct, *See: Excretory and Reproductive systems*  
 Genotype, 291-305, 382  
 Genus, 47, 352, 353, 457  
 Geographical distribution, 368-373, 384  
 Geological succession, 358-364, 370-371, 474  
 Geometrid moth, 327, 328  
 Germ, cells, 58, 59, 65, 188, 231, 232, 238-250, 284, 297, 397, 467, 469; origin, 238-250; layers, 265, 268, 272, 351; plasm, 232, 234, 236, 283, 284, 469  
 Germinal continuity, *See: Germ plasm*  
 Gesner, 450, 451  
 Giardia, 396  
 Gibbon, 321, 427-429  
 Gide, 67  
 Gill, 88, 90, 113, 114, 117, 119, 145, 146, 161, 162, 170-172, 180, 181, 270, 364, 365; arch, 268, 358; pouch, 161, 162; slit, 110, 111, 114, 115, 132, 133, 145, 146, 151, 161, 162, 357, 364, 365  
 Giraffe, 130, 285  
 Girdle, limb, 142-144; *See: Skeleton*  
 Gizzard, 102  
 Glacial epoch, 359, 435, 436, 440, 441  
 Gland, 63, 108, 126, 134, 148-153, 154, 159, 180, 181, 193, 328, 333, 357, 358  
 Glanders, 391  
 Gliadin, 21  
 Globigerina, 49  
 Glochidium, 89  
 Glomerulus, 182, 186  
 Glossa, 330  
 Glossary, 492  
 Glottis, 147, 162, 165  
 Glucose, 22, 32, 182, 183  
 Gluten, 22  
 Glycerol, 23, 151, 156  
 Glycogen, 157, 198  
 Goby, 113  
 Goethe, 474  
 Goiter, 197  
 Goldfish, 113  
 Golgi bodies, 19  
 Gonad, 74, 171, 188-195, 229; *See: Ovary and Testis*  
 Gonangium, 72, 73  
 Gonionemus, 477; *See: Medusa*  
 Gonorrhea, 391  
 Gonothea, 72  
 Gopher, 323  
 Gorilla, 356, 427-429, 431  
 Gout, 182  
 Grafting, 118, 237  
 Grantia, 68  
 Grape, 389, 411; sugar, 182, 183  
 Grasshopper, 93, 97  
 Grassi, 392  
 Gray crescent, 268  
 Gray matter, 203, 207  
 Greeks, 2, 349, 422, 446-449, 471; *See: Aristotle*  
 Green gland, 105  
 Green plant, 30-35, 463  
 Gregarious, 336  
 Grew, 454  
 Gristle, 139  
 Group conditioning, 438  
 Growth, 10, 25, 26, 28, 57; *See: Anabolism*  
 Guinea-pig, 129, 291, 294, 296  
 Guinea worm, 80  
 Gullet, 55, 56

- Gum, 135  
 Guppy, 113  
 Gustatory cell, 211  
 Gymnodinium, 51  
 Gymnura, 128, 129, 320, 321, 323, 479  
 Gypsy moth, 412
- Habit, 347  
 Habituation, social, 437, 438  
 Hagfish, 113  
 Hair, 15, 97, 111, 126, 134, 181  
 Hairworm, 80  
 Hales, 462  
 Halibut, 115  
 Haller, 460, 461  
 Hand, 130, 143, 177, 430, 431  
 Haploid, 245, 248, 249, 303  
 Hare, 325  
 Harpoon, 440  
 Harvest mite, 95  
 Harvey, 168, 451, 452, 454, 466, 467  
 Hay infusion, 43-45, 220, 317  
 Head, 132, 206, 330, 371  
 Health, 339, 389-403  
 Heart, 105, 133, 146-149, 158, 163, 169-179, 364, 365, 452  
 Heat, animal, *See*: Temperature  
 Heat sense spots, 211  
 Hedgehog, 128, 129, 321  
 Heidelberg man, 434, 438  
 Heliozoa, 49  
 Hematochrome, 32  
 Hemiptera, 94, 324  
 Hemoglobin, 166, 367; *See*: Blood  
 Hemophilia, 307, 308  
 Hen, 190, 251, 253, 274  
 Henderson, 316  
 Hepatic, artery, 170, 173; duct, 155; portal, 172, 173; vein, 172, 173; *See*: Liver  
 Herbal, 450, 451  
 Herbivorous, 129, 357  
 Heredity, 3, 281-315, 377-384, 420-425, 468-470; *See*: Inheritance  
 Hermaphrodite, 188, 189, 396, 399  
 Hertwig, 14, 57  
 Hessian fly, 409  
 Heteroploidy, 310  
 Heterozygous, 291-299, 382; *See*: Hybrid  
 Hexuronic acid, 23, 159  
 Hibernation, 117  
 Hind-brain, *See*: Brain
- Hippocrates, 448  
 Hippopotamus, 130  
 Hirudinea, 81, 82  
 Histology, 3, 4, 462, 464-466  
 History of biology, 2, 3, 218-221, 446-476  
 Hive, 330, 334  
 Holothuroidea, 86  
 Holozoic, 44  
 Hominidae, 428, 480  
*Homo sapiens*, 436; *See*: Man  
 Homologous chromosomes, 302-305, 308; *See*: Synapsis  
 Homologous genes, 302, 308  
 Homology, 107, 354-356, 459  
 Homothermal, 123, 126, 178, 319; *See*: Temperature  
 Homozygous, 291-299  
 Honey bee, 260, 327-336, 414  
 Hoof, 134, 362-364  
 Hooke, 452  
 Hookworm, 80, 401  
 Hormone, 160, 169, 192, 193, 196-198, 306, 367  
 Horn, 134  
 Horned-toad, 122  
 Horse, 321, 352, 355, 361-364  
 Horse botfly, 94, 405  
 Host, 52, 339, 340, 342; *See*: Parasite  
 House fly, 93, 375, 407  
 Human, body composition, 21; hand, 143, 431; heredity, 283, 285-288, 299-301, 306-315; origin, 426-445; posture, 143, 431, 435, 436; skeleton, 356; welfare, 386-425; *See*: Man  
 Humerus, 141, 142, 144, 355  
 Hummingbird, 126  
 Huxley, 5, 227, 228, 251, 263, 349, 358, 361, 459  
 Hyaloplasm, 18, 19  
 Hybrid, 290, 314, 382-384  
 Hydatid, 400  
 Hydra, 8, 71, 73, 98-100, 150, 188, 189, 199, 209, 210, 231, 233, 235, 337, 344, 477  
 Hydranth, 73  
 Hydrolysis, 151  
 Hydrozoa, 71-73, 234  
 Hymenoptera, 94, 478; *See*: Bee  
 Hyoid, 142
- Ice age, 359; *See*: Pleistocene epoch  
 Ichneumon fly, 414



- Ideal vertebrate, 132, 133  
 Iguana, 122  
 Iliac artery, 171  
 Ilium, 141, 142, 357  
 Imbecility, 197, 198, 421  
 Immunity, 286, 342, 343  
 Inbreeding, 289, 297, 383  
 Inch-worm, 327, 328  
 Incomplete dominance, 299  
 Incomplete metamorphosis, 97  
 Incubation, 253  
 Incus, 213  
 Independent assortment, 292-297,  
     300, 315  
 Individual, 27, 29, 73, 232, 350, 375  
 Infantile paralysis, 391  
 Influenza, 391  
 Infundibulum, 202, 203  
 Infusoria, 44, 47, 53-56, 477; *See:*  
     Paramecium  
 Ingenhousz, 463  
 Inhalation, 164  
 Inhalent siphon, 88  
 Inheritance, 281-315, 377-384, 420-  
     425, 468-470; *See:* Genetics  
 Inner ear, 212, 213  
 Insanity, 217  
 Insect, 91-94, 161, 162, 324-335,  
     340, 372, 392, 404-413, 453, 478;  
     beneficial, 413-417; injurious, 405-  
     413, 417, 420  
 Insectivora, 128, 129, 427, 430, 479  
 Instinct, 346  
 Insulin, 197, 367  
 Integumentary system, 65  
 Intelligence, 343, 347  
 Internal secretion, 159; *See:* Hor-  
     mone  
 Intersex, 306  
 Interstitial growth, 25  
 Intestinal juice, 155  
 Intestine, 64, 105, 146-149, 171, 441  
 Invention, 444  
 Invertebrates, 66-109, 188, 214; *See:*  
     Hydra, Earthworm, and Crayfish  
 Involuntary muscle, 139  
 Iodine, 197  
 Iris, 215, 217  
 Iron age, 444  
 Irritability, 26, 27, 64, 344, 347; *See:*  
     Nervous system  
 Ischium, 142  
 Islands, 372  
 Japanese beetle, 409  
 Java man, 432, 433  
 Jaws, 112, 141, 151; *See:* Skull  
 Jellyfish, 72-75  
 Jennings, 346  
 Jerboa, 321  
 Jigger flea, 405  
 Jimson weed, 310  
 Johannsen, 380  
 Jugular vein, 171  
 Julius, 92  
 Jurassic period, 359-361  
  
 Kallikak family, 421  
 Kallima, 326, 327  
 Kangaroo, 127, 321  
 Karyolymph, 20  
 Katabolism, 25, 182; *See:* Metabolism  
 Katydid, 325  
 Kidney, 146-149, 168, 172, 180, 182-  
     187, 192, 194; evolution, 183-187  
 Kinetic energy, 14, 25, 502; *See:*  
     Energy  
 King crab, 95  
 Kingsnake, 123  
 Kircher, 218  
 Kissing bug, 94  
 Kiwi, 124  
 Knee cap, 142, 144  
 Koala, 127  
 Koch, 391  
  
 Labellum, 330  
 Labial palp, 330  
 Labium, 93  
 Labrum, 93, 330  
 Labyrinth, 212, 213  
 Lacewing fly, 94  
 Lacrymaria, 54  
 Lactase, 156  
 Lacteal, 157, 158  
 Ladybird beetle, 414  
 Lagenia, 212  
 Lamarck, 3, 46, 286, 373-375, 458,  
     472-474  
 Lamprey, 113, 252  
 Lamp-shell, 83  
 Laplace, 98  
 Larva, 397, 398, 407, 415  
 Larynx, 149, 162, 358  
 Lateral, line, 210; plate, 269  
 Laveran, 392  
 Lavoisier, 461

- Leaf**, 7, 8  
**Leaf butterfly**, 326, 327  
**Leech**, 81, 82  
**Leeuwenhoek**, 453  
**Leg**, of insects, 93, 330, 334; *See*:  
   **Limb**  
**Leishmania**, 396  
**Lemur**, 130, 131, 322, 324, 426, 427,  
   480  
**Lens**, 214-216  
**Lepidoptera**, 94; *See*: **Butterfly** and  
   **Moth**  
**Lepisma**, 92  
**Leprosy**, 391  
**Leucosolenia**, 68  
**Lice**, 405  
**Lichen**, 337, 338  
**Liebig**, 463  
**Life**, 1, 130, 229, 402; characteristics,  
   1, 18-28; continuity, 229-250; defi-  
   nition, 23, 29; origin, 218-228  
**Ligament**, 139  
**Limb**, 112, 117, 118, 134, 142-144;  
   structure, 321, 322, 354-357; *See*:  
   **Leg**  
**Limpet**, 87  
**Limulus**, 95  
**Lincoln**, 424  
**Linnaeus**, 233, 236  
**Lingula**, 83  
**Linin**, 19, 20  
**Linkage**, 307-309  
**Linnaeus**, 350, 426, 456, 457  
**Lionotus**, 54  
**Lipase**, 155, 156  
**Lister**, 389  
**Lithobius**, 92  
**Liver**, 110, 146-149, 152, 154, 155,  
   171, 172, 180, 182, 197  
**Liver fluke**, 121-123, 234, 396-398,  
   477  
**Lizard**, 111, 120-122, 365, 367  
**Lobster**, 90, 106  
**Lockjaw**, 318  
**Locomotion**, *See*: **Movement**  
**Locust**, 93, 97  
**Louse**, 94  
**Lumbricus**, *See*: **Earthworm**  
**Lung**, 116, 133, 145, 147-149, 151,  
   152, 162-166, 168, 180, 181, 192,  
   358, 454, 461  
**Lung-fish**, 113, 116, 479  
**Lyell**, 474  
**Lymph**, 64, 169, 176, 177; vessels,  
   157, 158, 177  
**Lysin**, 342  
**Macaque**, 428  
**Mackerel**, 113, 114  
**Macrogamete**, 340  
**Macronucleus**, 44, 54-56, 257-259  
**Madreporite**, 84  
**Maggot**, 219  
**Maintenance**, 25  
**Malacostraca**, 90  
**Malaria**, 53, 339, 340, 390-393, 396,  
   407  
**Male**, 57; *See*: **Gamete** and **Sex**  
**Malleus**, 213  
**Malpighi**, 454, 462, 466, 467  
**Malta fever**, 391  
**Maltose**, 151, 156  
**Mammal**, 111, 126-131, 148, 173,  
   193, 252, 319, 353, 359-361, 365,  
   419, 426-431; adaptation, 320-324  
**Mammary gland**, 193, 357  
**Mammoth**, 441  
**Man**, 130, 135, 143, 149, 163, 175, 177,  
   355, 365; embryo, 193, 273, 365;  
   fossil, 431-437; inheritance, 250,  
   307-313, 421-423; muscles, 137;  
   skeleton, 144; urogenital system,  
   186, 193, 194; *See*: **Human**, **Mam-**  
   **mal**, and **Vertebrate**  
**Manatee**, 129  
**Mandible**, 93, 105, 106, 142, 330;  
   *See*: **Jaws**  
**Mantis**, 94  
**Mantle**, 87, 88  
**Manubrium**, 73, 75  
**Marmoset**, 427  
**Marsh**, 361  
**Marsupial**, 127, 128, 479  
**Mastigophora**, 44, 47, 50-52, 477  
**Mastodon**, 371  
**Mathews**, 196  
**Matrix**, 62, 63, 139  
**Maturation**, 243, 244-247, 249, 255,  
   304, 340  
**Maxilla**, 93, 142, 144, 330  
**Maxilliped**, 105, 106  
**Mayfly**, 94  
**Measles**, 343  
**Mechanism of inheritance**, 301-312  
**Medicine**, 6, 389-403, 448, 450  
**Medieval science**, 449, 450

- Mediterranean fruit fly, 411  
 Medulla, 147-149, 165, 202-205  
 Medullary plate, 269  
 Medusa, 71-74, 234  
 Megalithic monuments, 443  
 Meiosis, 244  
 Membrane bone, 141  
 Membranous labyrinth, 212, 213  
 Memory, 347  
 Mendel, 288, 297, 469, 470; *See: Inheritance and Genetics*  
 Mendel's laws, 297  
 Meningitis, 391  
 Mental life, 217, 347, 431, 437, 444  
 Merozoite, 340  
 Merychippus, 362, 363  
 Mesenteric filament, 76  
 Mesentery, 133, 134, 147, 148, 153  
 Mesoblast, 265, 266  
 Mesoderm, 60, 61, 100-103, 134, 231, 238, 264-269, 272; bands, 265, 266  
 Mesogloea, 99, 100  
 Mesohippus, 362, 363  
 Mesolithic culture, 441, 442  
 Mesonephric system, 133, 184-186, 190, 194  
 Mesozoic era, 359-361, 430  
 Metabolism, 18, 23-26, 159, 180-183, 316-318; *See: Anabolism and Katabolism*  
 Metacarpal, 142, 144, 355  
 Metals, age of, 444  
 Metamorphosis, of frog, 267-271; of insects, 96, 97, 406-410, 412, 413, 415, 416  
 Metanephric system, 96, 117-120, 184-187  
 Metaphase, 240, 241  
 Metaplast, 19; *See: Yolk*  
 Metatarsal, 142, 144  
 Metatheria, 479  
 Metazoa, 66, 258, 260, 480  
 Metridium, 75, 76  
 Microbe, 38, 396; *See: Bacteria*  
 Microcosm, 43-45, 317; *See: Web of life*  
 Microgamete, 340; *See: Sperm*  
 Micronucleus, 44, 54-56, 257, 259  
 Microorganisms and disease, 38, 39, 389-396  
 Microscope, 15, 452-454, 466  
 Mid-brain, 201, 202, 268, 269  
 Middle Ages, 349, 449  
 Middle ear, 213, 358  
 Milk, 128, 153, 156; souring, 389  
 Millipede, 91, 92  
 Mimicry, 328, 329  
 Mind, 217, 347  
 Miocene epoch, 359, 362, 363, 430  
 Miracidium, 396, 397  
 Mite, 95, 219  
 Mitochondria, 19  
 Mitosis, 13, 239-243, 254, 304  
 Mitral valve; *See: Heart*  
 Mixed nerve, 208  
 Moccasin, 123  
 Modifications, 285, 286, 288, 289, 313-315, 374, 380-384, 473, 474  
 Modifying genes, 300  
 Mold, 40  
 Mole, 323  
 Mollusc, 86-90, 210, 216, 276, 478  
 Monad, 44  
 Monkey, 130, 131, 367, 426-431, 480  
 Monocystis, 52  
 Monograph, 451  
 Monohybrid, 289-292  
 Monosiga, 51  
 Monotreme, 127, 190, 479  
 Moore's theory, 225  
 Morgan, 311  
 Morphology, 3, 4; *See: Anatomy*  
 Mosaic inheritance, 287, 298-301  
 Mosquito, 53, 339, 340, 375, 392, 393  
 Moss, 361  
 Moss-animal, 83  
 Moth, 412-416  
 Motorium, 199  
 Motor nerve, 201, 206, 207  
 Moul, 96  
 Mouse, 129, 218  
 Mousterian culture, 439  
 Mouth, 132, 149, 152, 156, 162  
 Movement, 27, 28; *See: Tropism*  
 Mucus, 151  
 Mud-puppy, 118  
 Mud turtle, 121  
 Mulatto, 299, 300  
 Müller, 461  
 Multicellular organism, 7, 57-66; *See: Metazoa*  
 Multiple genes, 299, 300  
 Muscle, 27, 62-64, 102, 103, 133, 135-138, 165, 201, 215; cells, 11, 28, 138  
 Muskrat, 323

- Mussel**, 89  
**Mutation**, 285, 287, 308-312, 315, 329, 372, 381-384  
**Mycelium**, 337  
**Myoneme**, 44  
**Myosin**, 21  
**Myotome**, 110  
**Myriapoda**, 91, 92  
**Myxedema**, 197  
  
**Nail**, 15, 134  
**Nares**; *See*: Nostril  
**National Academy of Sciences**, 424  
**Natural history**, 2, 3, 349  
**Natural selection**, 285, 374-377, 381-385, 438, 473-476; *See*: Selection  
**Nature and nurture**, 312-315, 444; *See*: Environment  
**Nautilus**, 86  
**Neanderthal man**, 427, 435, 436, 439, 440  
**Nectar**, 334  
**Necturus**, 118  
**Needham**, 220  
**Negro**, 299, 300  
**Nemathelminthes**, 79, 80, 477  
**Nematocyst**, 71, 76  
**Nematode**, 400, 401, 477; *See*: Nematelminthes  
**Neolithic culture**, 442-445  
**Nephridiopore**, 102, 103, 183  
**Nephridium**, 102, 103, 183, 186, 194, 397  
**Nephrostome**, 102, 103, 183  
**Nereis**, 81, 82, 247  
**Nerve**, 11, 64, 108, 134, 135, 200-216, 319; cell, 62, 64, 199-217; cord, 101-105, 108, 145; fiber, 200, 211, 216; impulse, 206; net, 199, 208  
**Nervous system**, 65, 108, 168, 199-217, 269, 344; *See*: Nerve  
**Neural arch**, 139, 140; groove, 201, 268, 269; spine, 139, 149; tube, 145, 201, 202  
**Neurenteric canal**, 268  
**Neurology**, 198  
**Neuromotor system**, 55, 199  
**Neuromuscular mechanism**, 199  
**Neuron**, 11, 62, 64, 199-217  
**Neuroptera**, 94  
**New stone age**, 442  
**Newt**, 117, 118  
**Nictitating membrane**, 357  
  
**Nitella**, 28  
**Nitrate**, 33, 40, 41  
**Nitrite**, 41, 42  
**Nitrogen**, 22, 41, 42, 159, 226, 403, 404, 417  
**Nitrogen-fixing bacteria**, 41, 42, 404  
**Nitrogenous waste**, 181-185  
**Non-disjunction**, 310, 311  
**Nosema**, 416  
**Nostril**, 132, 147-149, 162, 165, 211  
**Notochord**, 110-112, 133, 135, 138, 139, 145, 268, 269  
**Noyes**, 180  
**Nucleolus**, 19, 20, 247  
**Nucleus**, 10-12, 18, 19, 20, 27, 35, 41, 200, 239, 241, 247, 280, 390, 469  
**Nurture**, 312-315, 423, 424  
**Nutrition**, 30-45, 460; *See*: Metabolism  
**Nutritional chain**, 336; *See*: Web of life  
  
**Oak**, 408  
**Obelia**, 72, 73, 234  
**Obliterative coloration**, 327  
**Ocellus**, 93, 330  
**Octopus**, 89  
**Oil**, 386, 388  
**Old stone age**, 438-442  
**Olfactory, cells**, 211; lobes, 147, 148, 202-205; nerves, 146; pouches, 211; pit, 270  
**Oligocene epoch**, 359, 362, 363, 430  
**Oligochaeta**, 81, 477  
**Ontogeny**, 366; *See*: Embryology  
**Oöcyst**, 340  
**Oöcyte**, 245-247  
**Oögenesis**, 245-248, 305  
**Oögonium**, 239, 243-245, 275  
**Oökinete**, 340  
**Operculum**, 114, 115, 270, 271  
**Opossum**, 127  
**Opsonin**, 343  
**Optic, cup**, 214; capsule, 142; lobe, 146, 147, 203, 204; nerve, 146, 148, 205, 214-216; vesicle, 214, 215  
**Oral arm**, 74  
**Orang-utan**, 427, 428, 431  
**Orchid**, 334  
**Order**, 352, 353  
**Order of nature**, 227, 388  
**Organ**, 3, 65, 104; systems, 65, 104

- Organ-forming substance, 277-279  
 Organic adaptation, 316-337  
 Organic evolution, *See*: Evolution  
 Organism, 14, 18, 29  
 Organization, 18-20  
 Origin, of life, 218-228; of germ cells, 238-250; of species, 349-385, 471-476  
 Ornithology, 124  
 Ornithorhynchus, 127  
 Orohippus, 362, 363  
 Orthoptera, 94  
 Osborn's theory, 226, 227  
 Osculum, 70  
 Osmosis, 16, 157, 505  
 Osteology, 139; *See*: Skeleton  
 Ostium, 68, 70, 76  
 Ostrich, 124  
 Otter, 323  
 Outer ear, 213  
 Ovary, 99, 101, 102, 188-195, 238, 239  
 Oviduct, 102, 184, 189-195  
 Oviparous, 123  
 Owen, 458, 459  
 Owl, 325  
 Ox, 355  
 Ox botfly, 405, 406  
 Oxidation, 23, 24, 42, 165, 166, 197  
 Oxygen, 165, 166, 463  
 Oxyhemoglobin, 166  
 Oyster, 88, 89, 236, 306  
  
 Pain sense spots, 211  
 Paleolithic, art, 437, 440, 441; culture, 438-441; man, 433-441  
 Paleontology, 4, 358-364, 368  
 Paleozoic era, 359-361  
 Panama Canal, 394  
 Pancreas, 133, 146-148, 152, 154, 155, 171, 196, 197  
 Pancreatic juice, 155  
 Paralysis, 394  
 Paramecium, 53-56, 199, 229, 230, 235, 255-260, 477; behavior, 344-346; conjugation, 55, 230, 255-260; endomixis, 55, 258, 259; heredity, 284; irritability, 344-346; reproduction, 56, 256, 375; species, 54; structure and life history, 53-55  
 Parasite, 51, 53, 79, 220, 234, 339-343, 396-401, 407  
 Parazoa, 480  
 Parrot, 126  
  
 Parthenogenesis, 234, 255, 260, 261; artificial, 260, 261  
 Pasteur, 221, 389, 390, 414, 454, 455  
 Patella, 142, 144  
 Pathology, 4  
 Pea, inheritance, 288-297  
 Peach, 416  
 Pear, 416  
 Pearl, 89, 90  
 Pebrine, 414  
 Pecten, 331, 333, 334  
 Pectoral girdle, 142-144  
 Pedicellaria, 84  
 Pedigreed race of Paramecium, 258  
 Peking man, 433, 438  
 Pelecypoda, 87, 88  
 Pellagra, 159  
 Pelvic girdle, 142-144, 323  
 Penguin, 126  
 Penis, 148, 194  
 Pentadactyl limb, 140-144, 321  
 Pepsin, 153, 156  
 Peptone, 156  
 Peranema, 51  
 Perch, 113, 146  
 Pericardial cavity, 133  
 Pericardium, 133, 148  
 Periosteum, 135  
 Peripatus, 97, 478  
 Perisarc, 72  
 Peristalsis, 153, 156  
 Peristome, 55  
 Peritoneum, 64, 134  
 Perspiration, 178, 181, 183, 198  
 Petromyzon, 113  
 Peyer's patches, 342  
 Pflüger's theory, 224, 225  
 Phacus, 51  
 Phagocyte, 342  
 Phalanges, 142-144, 355  
 Pharynx, 102, 110, 132, 133, 151, 152, 358  
 Phenotype, 291-296, 382  
 Philosophy, 5, 385, 447  
 Phosphorescence, 51  
 Photosynthesis, 32, 33, 50, 317, 337, 338, 403, 463  
 Phylogeny, 366, 480  
 Phylum, 47, 353, 477-480  
 Physalia, 73  
 Physical basis of life, 14-29, 465; *See*: Protoplasm  
 Physics, 1, 2, 5, 460, 464

- Physiological division of labor, 10, 58, 65, 232-234, 330, 336
- Physiologus, 449
- Physiology, 3, 4, 366-368, 389, 449, 454, 459-464
- Pig, 130, 398, 400, 401
- Pigeon, 362, 376
- Pigment, 11
- Pile village, 442
- Pill-bug, 90
- Piltown man, 433, 434, 438
- Pine bark beetle, 412
- Pineal body, 202-204
- Pinna, 213
- Pisces, *See*: Fishes
- Pithecanthropus, 432, 433
- Pituitary gland, 193, 198
- Placenta, 128, 192, 193, 272, 273
- Placental, 128-131, 321, 479
- Plague, 402, 406, 407
- Planaria, 78, 79, 396; *See*: Flatworm
- Plant, 30-35, 37-45, 404, 408-412, 417, 462, 463
- Plantigrade, 321, 322
- Plasma, 64, 166, 169
- Plasma-membrane, 19
- Plasmodium, 53, 340, 396, 477
- Plastid, 19, 30, 32; *See*: Chloroplast
- Plastron, 121
- Plato, 447
- Platyhelminthes, 78, 79, 477, 480
- Pleistocene epoch, 359, 363, 364, 368, 432
- Pleura, 163
- Plexus, 205, 206
- Pliny, 449
- Pliocene epoch, 359, 362, 363, 368
- Pliohippus, 362, 363
- Ploidy, 310
- Plum, 416
- Plumatella, 83
- Pneumonia, 391
- Podura, 92
- Point change, 311
- Poison gland, 357
- Polar lobe, 376
- Pollen, 333, 334
- Pollen basket, 331, 333, 334; brush, 331-333; comb, 331, 333
- Pollination, 334, 416
- Polocyte, 243, 245-247, 252, 304
- Polychaeta, 81, 477
- Polymorphism, 73, 234
- Polyp, 71-78, 98, 99
- Pond community, 335
- Population, 378-381
- Porcupine, 129
- Porifera, 67-71, 477, 480
- Pork, infected, 400, 401
- Porpoise, 129, 323, 357
- Portal vein, 157, 158, 172, 173
- Porto Santo rabbit, 372
- Portuguese man-of-war, 73
- Position effect, 311
- Potato beetle, 94, 409
- Potential energy, 14, 22, 507; *See*: Energy
- Pottery, 442
- Precipitin, 343, 367
- Preformation, 274, 280, 453, 467, 470
- Pregnancy, 191-193, 273
- Prehistoric man, 431-437
- Prehuman lineage, 426-431
- Pressure, 320; receptors, 210
- Preventive medicine, 389
- Priestley, 463
- Primary, germ layers, 61; tissues, 61, 104
- Primate, 128, 130, 131, 352, 426-431, 480
- Primordial germ cells, 238, 305; *See*: Germ cells
- Probability, theory, 227
- Proglottid, 398, 399
- Pronephros, 133, 184, 185, 270
- Prophase, 240, 241
- Prorodon, 54
- Prosopyle, 70
- Prostate gland, 148, 194
- Prostomium, 82
- Protective mimicry, 328
- Protein, 21-23, 33, 39, 151, 155-159, 225
- Proteose, 156
- Proterozoic era, 359-361
- Prothorax, 330, 331
- Protococcus, 30-35
- Protophyta, 35
- Protoplasm, 3, 10, 14-29, 388, 464, 465; appearance, 17; composition, 20-23; concept, 15; organization, 18-20, 254, 275-280; structure, 17
- Protopodite, 106, 107
- Prototheria, 479
- Protozoa, 35-56, 209, 223, 229, 232, 244-246, 248, 255-261, 284, 318,

- 319, 335, 336, 341, 342, 386, 387, 390-394, 396, 407, 416, 420, 453, 477, 479; *See*: Amoeba and Paramecium
- Protozoölogy, 46, 393; *See*: Protozoa
- Pseudopodium, 10, 35, 48
- Psychology, 4, 5, 423
- Psychozoic era, 359
- Pterodactyl, 120
- Ptyalin, 152, 156
- Pubis, 140, 142
- Public health, 6, 339, 389-403
- Pulmonary circulation, 173-176
- Pulvillus, 332, 333
- Pupa, 97, 392, 406, 407, 410, 412
- Pupil, 215, 217
- Pure line, 380-382
- Pure science, 386, 388
- Purity of gametes, 302; *See*: Segregation
- Purpose in Nature, 385
- Putrefaction, 21; *See*: Decay
- Pyloric, caeca, 84; sac, 84; valve, 153
- Pylorus, 155
- Pyramids, 49
- Python, 123, 357
- Quahaug, 88
- Queen bee, 329, 330
- Quinine, 396
- Rabbit, 129, 372
- Rabies, 343, 390
- Radial, canal, 72, 74; symmetry, 71, 78, 99
- Radio, 210
- Radiolaria, 49
- Radius, 142, 144, 355
- Radula, 87
- Ramapithecus, 430, 431
- Rana, *See*: Frog
- Rat, 129, 367, 401, 402, 407
- Ratitae, 124
- Rattlesnake, 123, 358
- Ray, 113, 114
- Ray, John, 456
- Reason, 347
- Reaumur, 460
- Recapitulation theory, 96, 364-366, 468
- Receptaculum chyli, 158
- Receptor, *See*: Sense organ
- Receptor-effector system, 199
- Recessive character, 290-297, 383
- Recombination, 287, 288, 314, 315, 380-384
- Rectum, 152, 268
- Redi, 219, 220, 453
- Redia, 397, 398
- Reduction of chromosomes, 244, 245, 247, 305; *See*: Maturation
- Reed, 393
- Reef, 77
- Reflex action, 201, 207, 208, 346, 347
- Regeneration, 67, 118, 233, 235-237
- Rejuvenation, 256-260
- Relapsing fever, 391
- Renaissance science, 349, 449-451
- Renal, artery, 171, 185, 186; portal system, 171-173; vein, 171, 185, 186
- Rennin, 153, 156
- Reorganization, 229
- Repair, 10; *See*: Regeneration
- Reproduction, 12, 26, 57, 65, 184, 188-195, 229-258, 262; power of, 375
- Reproductive organs, 184; *See*: Reproduction
- Reptile, 111, 120-123, 204, 359, 360, 367, 430
- Research, 383, 386, 387, 394, 402-404, 417, 423-425
- Resorption, 271
- Respiration, 33, 34, 37, 134, 145, 161-167, 181, 461, 463
- Respiratory center, 165, 205; interchange, 165, 166; mechanism, 164, 165
- Resting cell, 240
- Retina, 213-216
- Reversion, 287
- Rhagon, 69, 70
- Rhinoceros, 130
- Rib, 133, 142, 144, 164
- Rickets, 160
- Roan cattle, 298
- Rodentia, 129, 352, 353
- Rods and cones, 216, 217
- Roman science, 448, 449
- Roosevelt, 418
- Ross, 392
- Rotifer, 82, 83, 260, 477
- Roundworm, 79, 80, 260, 400, 401
- Rye, 409

- Sacculus**, 212, 213  
**Salamander**, 117, 118, 235  
**Salientia**, 117-119  
**Saliva**, 151, 156  
**Salivary gland**, 151, 152  
**Sandworm**, 81, 82, 247, 477  
**San José scale**, 410, 411  
**Saprophyte**, 43, 44  
**Sarcocystis**, 396  
**Sarcodina**, 47-49; *See*: **Amoeba de Saussure**, 463  
**Scale-insect**, 410-414  
**Scale of nature**, 426  
**Scales**, 134, 138  
**Scallop**, 86, 87  
**Scapula**, 142, 144  
**Schaudinn**, 394  
**Schistosoma**, 396  
**Schizogony**, 340  
**Schleiden**, 464, 465  
**Schultze**, 465  
**Schwann**, 254, 464-466  
**Sciatic plexus**, 205  
**Science**, scope, 1, 24, 385, 386, 388  
**Scientific method**, 2, 228, 464  
**Sciurus**, 148, 353  
**Sclerotic coat**, 216  
**Scolex**, 398-400  
**Scorpion**, 95  
**Scorpion-fly**, 94  
**Scrotum**, 148  
**Scurvy**, 23, 159  
**Scyphistoma**, 75  
**Scyphozoa**, 73-75  
**Sea anemone**, 75, 76  
**Sea cucumber**, 85, 86  
**Seahorse**, 115  
**Seal**, 129, 321, 323, 367, 419  
**Sea lily**, 85, 86  
**Sea pen**, 77  
**Sea urchin**, 85, 86, 277, 279, 478  
**Sea walnut**, 78  
**Sebaceous gland**, 134, 181  
**Secondary sexual characters**, 192, 262; *See*: **Sex**  
**Secretin**, 160  
**Secretion**, 61, 63, 134, 159, 180  
**Seed plants**, 221, 359, 361, 372, 417, 457  
**Segment**, 81, 103, 107, 108  
**Segmentation**, 81, 82, 90, 96, 97, 101-108, 112, 185, 206  
**Segmented worm**, 81, 82, 97; *See*: **Earthworm**  
**Segregation**, 244, 246, 290-297, 300, 302, 315, 510  
**Selection**, 282, 376-384, 473, 475, 476; *See*: **Natural selection**  
**Self-digestion**, 156  
**Semicircular canal**, 212, 213  
**Seminal receptacle**, 103; **vesicle**, 103, 194  
**Seminiferous tubule**, 194  
**Senile degeneration**, 256-259  
**Sense organ**, 65, 74, 143, 199, 201, 207, 209-217, 344  
**Sensory nerve**, 201, 206, 207  
**Septum**, 101, 102  
**Serial homology**, 356, 357; *See*: **Homology**  
**Setae**, 81, 102, 103  
**Sex**, 188, 189, 192, 254, 255, 261, 262, 284, 306-310; **determination**, 304-307; **differentiation**, 306; **linked**, 307, 308; **reversal**, 306; *See*: **Fertilization and Reproduction**  
**Shakespeare**, 449  
**Shark**, 113, 114, 171, 365  
**Sheep**, 130, 283, 396-398  
**Shell**, 86-88  
**Shell-fish**, 86  
**Shell-heaps**, 441  
**Shipworm**, 88  
**Shorthorn cattle**, 298  
**Shoulder blade**, 144  
**Silkworm**, 414, 416, 454  
**Silver-fish**, 92, 94  
**Simiidae**, 427-429  
**Simple eye**, 330  
**Simplex group**, 245, 248, 249, 261, 306  
**Sinanthropus**, 433  
**Sinus venosus**, 170, 171, 173  
**Siphon**, 88, 89  
**Sirenia**, 129, 130  
**Skate**, 114  
**Skeleton**, 63, 77, 138-144, 322, 323, 355-357, 435  
**Skin**, 7, 134, 135, 161, 180, 181, 201, 319  
**Skull**, 112, 141-149, 432-437  
**Sleeping sickness**, 341, 391, 407  
**Sloth**, 129, 321-323  
**Slug**, 87  
**Small intestine**, 152-154  
**Smallpox**, 343



- Smell, sense of, 210, 211  
 Smyrna fig, 416  
 Snail, 86, 87, 235, 370, 396-398  
 Snake, 120-123, 327, 357, 358, 365, 367  
 Snapping turtle, 121  
 Social habituation, 431, 437  
 Social heredity, 314, 444  
 Sociology, 4, 5, 286  
 Soil, 82, 403, 416-419  
 Solar energy, 32-34, 45, 224, 226  
 Soma, 58, 59, 231, 232, 236, 243, 284, 383, 469; *See*: Germ plasm  
 Somatic, cells, 243; mesoderm, 265, 266; mutations, 312  
 Song sparrow, distribution, 369  
 Spallanzani, 220, 460  
 Span of life, 375, 402  
 Special creation, 222, 350, 351  
 Species, 46, 47, 349-354, 369, 376, 456, 457; number, 47, 477-479; origin, 349-385, 471-476  
 Spencer, 23, 132  
 Sperm, 11, 57, 59, 191, 230, 231, 247, 251, 252, 340, 453, 468; *See*: Gamete  
 Spermatid, 194  
 Spermatid, 245  
 Spermatocyte, 244, 245  
 Spermatogenesis, 244-248, 305  
 Spermatogonium, 239, 243-245, 304, 306  
 Spicule, 68, 69  
 Spider, 95, 478  
 Spinal, cord, 110-112, 133, 135, 145, 146-149, 200-216; nerve, 205-207  
 Spiny anteater, 127  
 Spiracle, 93, 271  
 Spirillum, 38, 39  
 Spirostomum, 54  
 Splanchnic mesoderm, 265; 266  
 Spleen, 146-148, 178  
 Splint bone, 357, 362-364  
 Spondylomorum, 58  
 Sponge, 67-71, 477, 480  
 Spongilla, 69, 70  
 Spontaneous generation, 218-221, 399, 454  
 Spore, 39, 52, 53, 223, 230, 319, 337  
 Sporocyst, 397, 398  
 Sporozoa, 47, 52, 53, 229, 230, 340, 477  
 Sporulation, 230; *See*: Sporozoa  
 Springtail, 92, 94  
 Spur, 331, 333, 334  
 Squamata, 120, 121  
 Squeteague, 336  
 Squid, 89, 90, 215, 336  
 Squirrel, 129, 148, 321, 322, 352-354, 407  
 Stable fly, 94  
 Stag, 192  
 Stapes, 213  
 Starch, 22, 33, 155  
 Starfish, 17, 83, 84, 236, 478  
 Statoblast, 83  
 Statocyst, 72  
 Stature, human, 379  
 Stentor, 54  
 Sterilization, 220  
 Sternum, 139, 142, 144, 149  
 Stick-insect, 327, 328  
 Stigma, 50, 51, 59  
 Stimulus, 27, 64, 165, 209, 217; *See*: Sense organs  
 Sting of bee, 333  
 Stomach, 105, 146-149, 152-156  
 Stone age, 438-444  
 Stonefly, 94  
 Stonehenge, 443  
 Stork, 126  
 Strawberry, 416  
 Stream of life, 229  
 Strobila, 75  
 Struggle for existence, 329, 336, 375, 376, 472-476; *See*: Web of life  
 Sturgeon, 115  
 Styela, 275, 279, 478  
 Stylonychia, 54  
 Subclass, 354  
 Subcutaneous tissue, 134  
 Subesophageal ganglion, 102, 105-108  
 Subgenital pit, 74  
 Subspecies, 354, 369  
 Sucrase, 156  
 Sugar, 22, 32, 33, 156, 182, 183, 197, 318  
 Sun animalcule, 49  
 Sunlight, 32, 33, 45  
 Supporting tissue, 62, 63, 65, 139; *See*: Cartilage, Skeleton, etc.  
 Suprascapula, 141  
 Surgery, 221, 389, 444  
 Survival of the fittest, 377, 475, 476; *See*: Web of life, Evolution  
 Swammerdam, 453

- Swan, 424  
 Swarming of bees, 330  
 Sweat gland, 181, 357  
 Sweetbread, 154  
 Swiss lake dwellings, 443  
 Sycon, 69, 70  
 Sylvius, 460  
 Symbiosis, 337, 338  
 Symmetry, 71, 99, 104, 132  
 Sympathetic coloration, 327  
 Synapse, 200, 207  
 Synopsis, 244, 245, 249, 302-304, 308  
 Synkaryon, 254-262  
 Syphilis, 286, 390, 394, 395
- Tachina fly, 408  
 Tactile organ, 143, 210  
 Tadpole, 111, 117, 270, 271  
 Taenia, *See*: Tapeworm  
 Tail, 112, 133  
 Tapeworm, 78, 396, 398, 399, 400, 477  
 Tapir, 130, 368  
 Tarsius, 426, 427  
 Tarsus, 142, 144; of bee, 331-333  
 Taste, 210, 211  
 Taxonomy, 4, 455-459; *See*: Classification
- Teat, 128  
 Telencephalon, 202, 203  
 Teleost, 115, 116  
 Telophase, 240-242  
 Telson, 105  
 Temperature, 318, 319; body, 181, 223; on inheritance, 303; sense, 178  
 Tendon, 139  
 Tennyson, 281  
 Tentacle, 71-74, 76, 82, 87  
 Termite, 94  
 Testis, 99, 147, 148, 188-195, 238, 239  
 Testudinata, 120, 121  
 Tetanus, 318, 391  
 Tetrad, 244, 245  
 Textiles, 442  
 Thalassicolla, 49  
 Theophrastus, 2, 447, 448  
 Thomson, 7, 161, 316, 384, 386, 426  
 Thoracic duct, 157, 158, 177  
 Thorax, 93, 106, 134, 163, 330, 331  
 Thrips, 94  
 Throat, 151; *See*: Pharynx  
 Thrush, 372  
 Thumb, 143, 431  
 Thymus gland, 148, 152, 160
- Thyroid gland, 152, 160, 197  
 Thyroxine, 197, 198  
 Tibia, 142, 144, 331-333  
 Tick, 95  
 Times, New York, 446  
 Tissue, 3, 61-65, 100, 104  
 Tissue fluid, 176-178  
 Toad, 118, 119, 325, 365  
 Toe, 142, 361-364, 431  
 Tongue, 151, 211, 358  
 Tonsil, 152  
 Tool, 143, 330, 336, 433, 436, 438-444  
 Tooth, 129, 134, 135, 142, 144, 358, 363, 371, 430  
 Torpedo, 114  
 Tortoise, 120, 121; shell, 121  
 Totipotent, 278  
 Touch sense, 143, 210  
 Toxin, 343  
 Trachea, 90, 147-149, 161-164  
 Trachelomonas, 51  
 Tradescantia, 28  
 Training, 313; *See*: Education  
 Transfusion, blood, 367  
 Translocation, 310  
 Transverse process, 139, 140  
 Tree, 412, 418  
 Tree frog, 119  
 Trematode, 78, 396-398  
 Trench fever, 406  
 Treponema, 394, 395  
 Treviranus, 474  
 Trial and error, 345  
 Triangle of life, 314  
 Triassic period, 359, 360, 363  
 Triatoma, 94  
 Trichinella, 80, 400, 401  
 Trichocyst, 55  
 Trichomonas, 51, 396  
 Trichurus, 396  
 Tricuspid valve, 174  
 Trigeminal ganglion, 205  
 Trihybrid, 294-296  
 Trilobite, 359  
 Triploblastic, 78  
 Triturus, 118  
 Trochanter, 331, 332  
 Trochelmithes, 83  
 Troland's theory, 226  
 Trophozoite, 52  
 Tropism, 253, 343  
 Trypanosome, 51, 341, 342, 396  
 Trypsin, 155

- Tsetse fly, 341, 342  
 Tube feet, 84  
 Tuberculosis, 390, 391, 407  
 Tubeworm, 81  
 Tunicate, 145, 478  
 Turbellaria, 78  
 Turtle, 120, 121, 367  
 Tympanic membrane, 213  
 Tyndall, 222  
 Typhlosole, 102  
 Typhoid, 390, 391, 407  
  
 Ulna, 142, 144, 355  
 Umbilical cord, 192, 193, 272  
 Underwing moth, 326  
 Undulant fever, 391  
 Unguiculate, 129  
 Ungulata, 129, 130, 352  
 Unguligrade, 321, 322  
 Unicellular, 7, 28, 30-56; *See: Protozoa and Bacteria*  
 Uniformitarian doctrine, 377, 471  
 Uniparental, 57; *See: Asexual*  
 United States National Museum, 387  
 Unity of life, 6, 131, 351, 388, 424, 425, 445  
 Urea, 37, 41, 181, 182, 192  
 Ureter, 147, 149, 182, 185, 186, 190, 194  
 Urethra, 148, 149, 182, 194  
 Uric acid, 37, 181, 182  
 Urinary bladder, 133, 146-149, 182, 185, 194  
 Urine, 183, 186, 197  
 Urogenital system, 159, 184, 193-195, 351, 358  
 Urostyle, 141, 147  
 Uterus, 184, 190-194, 252, 273, 399  
 Uterus masculinus, 148  
 Utriculus, 212, 213  
  
 Vaccination, 343  
 Vacuole, cell, 19; contractile, 10, 27, 35, 55; gastric, 10, 35, 55  
 Vagina, 194  
 Valve, 87, 88, 170, 173, 174, 176  
 Van Helmont, 218  
 Variability curve, 378, 379  
 Variation, 250, 261, 281-315, 374-385, 473-476  
 Varieties, 354  
 Vascular system, 169-179, 185, 186, 192; *See: Circulation*  
  
 Vas deferens, 194  
 Vasomotor, center, 205; nerve, 177  
 Vegetal pole, 267, 268  
 Vein, 148, 158, 170-179, 185, 186  
 Velum, 331, 332  
 Venous system, 170  
 Ventral, ganglion, 201; nerve root, 201, 207, 208  
 Ventricle, 170-173  
 Vermiform appendix, 149, 152, 357  
 Vertebra, 138, 139, 142, 144, 146-149, 357  
 Vertebral canal, 139, 141, 145, 149, 353  
 Vertebral column, 111; *See: Skeleton*  
 Vertebral plate, 269  
 Vertebrate, 66, 111-131, 252, 253; body plan, 132-149, 185, 189, 353; characters, 112, 145; *See: Mammal and Man*  
 Vesalius, 450, 452, 459  
 Vestigial organs, 323, 357, 358, 362-364  
 Villus, 157, 208  
 Virginia opossum, 127, 128  
 Virus, 343, 393  
 Vitalism, 24, 227, 347, 385, 463, 464  
 Vitamin, 23, 159, 160  
 Vitreous, chamber, 214-216; humor, 215  
 Viviparous, 123  
 Vivisection, 449  
 Vocal cords, 162  
 Voice, 162  
 Volant, 322  
 Voluntary muscle, 137, 138  
 Volvox, 58, 59, 67, 230-232, 477  
 Vomer, 141  
 Vorticella, 44  
  
 Walking-stick insect, 327, 328  
 Wallaby, 128  
 Wallace, 475  
 Wasp, 327, 336, 415  
 Water, 21, 383  
 Water-flea, 80, 91  
 Water-vascular system, 84  
 Wealth, 389  
 Weasel, 326  
 Web of life, 43, 91, 335, 336, 386, 388, 394, 415, 420

- Weevil, 409, 410  
Weismann, 232, 286, 468, 469  
Whale, 90, 128, 129, 323, 355, 419  
Wheat, 283, 310, 409  
Wheel, 443  
Wheel-animalcule, 83  
White matter, 203, 207  
White rat, 367  
Wing, 107, 355  
Wolf, 321, 336  
Woodchuck, 322  
Woodcock, 126  
Wood-lice, 90  
Woods Hole Marine Biological Laboratory, 423  
Working hypothesis, 4, 463  
Worms, *See*: Earthworm, Flatworm, etc.
- X chromosome, 304-311, 383  
X-rays, 312  
Y chromosome, 304-311  
Yale University Museum, 361  
Yangtze, 418  
Yeast, 40, 41, 230, 317, 318  
Yellow fever, 391-395, 407  
Yolk, 251-253, 267, 268; plug, 268, 269; sac, 272  
Youth, 25  
Zona pellucida, 273  
Zoögeography, 368-373  
Zoölogy, 3, 4  
Zygomatic arch, 142  
Zygote, 52, 57, 59, 188, 190, 230, 231, 238, 243, 245-247, 290-305, 340, 468



