

Birla Central Library

PILANI (Jaipur State)

Engg. College Branch ✓

Class No :- 697

Book No :- F11H

Accession No :- 34291

ARCHITECTURAL AND BUILDING SERIES

Edited by ANTHONY M. CHITTY, M.A., F.R.I.B.A., A.M.T.P.I.

HEATING AND VENTILATING

OTHER BOOKS IN ARCHITECTURAL AND BUILDING SERIES

AN INTRODUCTION TO THE DESIGN OF TIMBER STRUCTURES.

By Phillip O. Reece, A.M.Inst.C.E., M.I.Struct.E., A.M.Inst.M.,
and Cy.E.

AN INTRODUCTION TO THE SCIENCE OF ARTIFICIAL LIGHTING.

By R. O. Ackerley, M.I.E.E., F.I.E.S.

AN INTRODUCTION TO STANDARDS IN BUILDING.

By D. Dex Harrison, A.R.I.B.A., A.M.T.P.I.

BUILDING SUPERVISION.

By W. R. M. Pippard.

COSTING FOR BUILDERS.

By W. Townsend, F.A.S.A., F.R.S.A., and L. Townsend, F.C.C.S.,
F.R.S.A.

FLOOR FINISHES.

By Penelope Whiting, A.R.I.B.A.

PAINTING AND DECORATING CRAFT PRACTICE.

By James Lawrance, F.I.I.B.D.

THE PRACTICAL APPLICATION OF ACOUSTIC PRINCIPLES.

By J. Cullum.

WOOD ADHESIVES.

By Edward H. Pinto.

Editor A. M. Chitty, M.A., F.R.I.B.A., A.M.T.P.I.

HEATING & VENTILATING

by

OSCAR FABER

O.B.E., D.C.L. (HON). D.Sc., M.INST.C.E.,
M.I.MECH.E., A.M.I.E.E.; P.PRES.INST,STRUCT.E.,
P.PRES.I.H.V.E., F.C.G.I.



LONDON
E. & F. N. SPON LTD
57 Haymarket, S.W.1

First Published 1948

MADE AND PRINTED IN GREAT BRITAIN BY
CHARLES BIRCHALL AND SONS LTD.,
LONDON AND LIVERPOOL

FOREWORD

THIS small book is intended to be an introduction to the subject of the heating and ventilation of buildings. In the space available it cannot be more than this, and it is hoped that it will serve the purpose of giving a general indication of the principles and methods of calculation which are commonly adopted in the design of installations for various types of buildings. For more detailed and technical information, larger volumes must of course be referred to.

It is perhaps permissible to mention *Heating and Air-Conditioning of Buildings* by Mr. J. R. Kell and this author, which possibly fills a want in this direction, but there are of course many others.

The author desires to acknowledge his great indebtedness to Mr. J. R. Kell and Mr. J. R. Harrison for the assistance which he has received from them in the preparation of the work and the correction of proofs.

CONTENTS

CHAPTER	PAGE
I. GENERAL CONSIDERATIONS	9
II. FUELS AND SOURCES OF HEAT	28
III. HEAT EMISSION APPLIANCES	45
IV. HEAT PRODUCING APPLIANCES FOR CENTRAL SYSTEMS	67
V. PIPING	90
VI. HEAT LOSSES FROM BUILDINGS	109
VII. EXAMPLE OF DESIGN OF A HEATING SYSTEM	111
VIII. EXAMPLE OF DESIGN OF A VENTILATION SYSTEM	120
IX. FURTHER NOTES ON VENTILATION	134
INDEX	

ILLUSTRATIONS

	PAGE
Fig 1 Chart of Comfort Zone	13
„ 2 Methods of Heat Transfer	17
„ 3 Emission of Heat by Human Beings	24-5
„ 4 Conversion and Dissipation of Energy	28
„ 5 Gas-Fire	48
„ 6 Electric-Fire	50
„ 7 Heating a North Light Factory	55
„ 8 Types of Radiator	57
„ 9 Convection Currents in a Heated Room	58
„ 10 Types of Convector	60
„ 11 Embedded Heating Panel	61
„ 12 Types of Unit Heater	64
„ 13 Cast Iron Sectional Boiler	67
„ 14 Gas-fired Boiler	68
„ 15 (Domestic Cast Iron) Boiler	69
„ 16 Lancashire Boiler	70
„ 17 Economic Boiler	71
„ 18 Gravity-feed Boiler	72
„ 19 Draught Stabilisers	77
„ 20 Types of Mechanical Stoker	79
„ 21 Electrical Load Curve	83
„ 22 Diagram of Thermal-Storage System	86
„ 23 Domestic System Immersion Heater	87
„ 24 Two-Pipe Upfeed System	97
„ 25 Two-Pipe Drop System	97
„ 26 One-Pipe Ring Main System	98
„ 27 One-Pipe Drop System	98
„ 28 Two-Pipe Balanced System	99
„ 29 Indirect Hot Water Supply System	100
„ 30 Direct Hot Water Supply System	102
„ 31 Combined Heating and H.W.S. System	102
„ 32 Expansion of Pipes	105
„ 33 Heating of Small Hall	111
„ 34 Oil-Coated Air-Filter	124
„ 35 Fabric Air-Filters	126
„ 36 Electrostatic Air-Filter	127
„ 37 Types of Fan	128
„ 38 Types of Air-Heater	131
„ 39 Heating and Ventilation of Small Hall	133

TABLES

			PAGE
Table	1	Thermometric Scales	11
	„	2 Specific Heats of Some Common Materials	20
	„	3 Relation between Heat-Emission and Activity of Human Being	22
	„	4 Heat and Energy Equivalents	29
	„	5 Cost of Producing One Therm by Various Methods..	43
	„	6 Coal Consumed to Produce One Therm by Various Methods	44
	„	7 Radiator Data	59
	„	7A Typical Details of Unit Heaters	65
	„	8 Typical Details of Cast-Iron Sectional Boilers for Hot Water Heating	67
	„	9 Typical Details of Cast-Iron Gas-Fired Hot Water Boilers	68
	„	10 Typical Details of Cast-Iron Boilers for Domestic Hot Water Supply	69
	„	11 Gravity Feed Boilers	74
	„	12 Flow of Water in Pipes	92
	„	13 Transmission Coefficients of Constructional Materials	109
	„	14 Cubic Capacity of buildings related to occupancy ..	135
	„	15 Some Useful Constants and Equivalents	138

Chapter I

GENERAL CONSIDERATIONS

(1) CONTROL OF CLIMATE

HUMAN beings can only work and live with comfort and efficiency within a restricted set of physical conditions. When these conditions cannot be provided, health suffers, and in extreme cases the race may die.

It has been shown* that all the early civilisations, both north and south of the Equator, were limited to lands situated around the 70° Isotherm. In this book the 70° Isotherm is traced in relation to the incidence of civilisation and it will be found to pass through Egypt, Sumeria, Assyria, India, Guatemala, Honduras.

The Greeks and Romans were apparently the first to leave the regions along the 70° annual Isotherm and pass to one in which a means of controlling cold had been discovered which was superior to the open fire or brazier, namely the hypocaust system of heating. In this, the floors and later the walls of buildings were warmed by the passage of hot air through flues. This was about 750 B.C.

Civilisation in England cannot be said to have flourished much before about the year 1340, when the first fireplace with an external chimney-shaft was invented.

This book shows most clearly that before the human race had acquired the art of controlling its climate it could only exist near the 70° Isotherm, but that after it had acquired this art it was able to spread to colder climates such as our own.

These general considerations show that the control of climate is not merely a matter of comfort or, as one might say, a luxury, but, with certain definite limits, is a necessity for the existence of the human race.

In excessively hot climates it is necessary to reduce temperature and humidity and in excessively cold climates it is necessary to increase them. There is a definite range of temperatures and humidities within which efficiency and comfort can obtain.

**Climate and the Energy of Nations*—S. F. Markham, Oxford University Press.

It is the duty of the air conditioning engineer to produce those conditions and, in collaboration with the architect, to produce them at the lowest cost having regard to cleanliness, convenience, appearance and preferably as part of the scheme of design and decoration of the buildings.

(2) TEMPERATURE AND HUMIDITY

In the control of climate we are principally concerned with temperature and humidity, and though, no doubt, everyone has a rough idea about them both, it may be desirable to say fairly accurately what we mean by them.

Temperature is a measure of the hotness or coldness of things and is connected with the energy of the vibration of the molecules of which matter is composed, higher temperatures being accompanied by great energy and velocities of the molecules and low temperatures with their relative quiescence.

At standard atmospheric pressure two of the well-known properties of water are convenient points on an arbitrary temperature scale, namely, the boiling-point and the freezing-point of water.

In the *Fahrenheit* scale, almost universal in England outside scientific laboratories, the boiling-point of water at normal atmospheric pressure is arbitrarily marked as 212° while the freezing point is arbitrarily marked as 32° .

If therefore a mercury thermometer is made by filling a glass bulb, connected to a thin capillary tube, with mercury, and we mark the point on this tube at which the mercury stands when we insert the bulb into boiling water, as 212° , and mark the point at which the mercury stands if we insert the bulb into water just as it is freezing, and divide up the distance between the two marks into 180 equal parts, we shall have made a thermometer indicating the temperature between these two limits on the Fahrenheit scale, and we can extend the scale by equal divisions above and below the two limits previously referred to.

On the *Centigrade* scale, which is invariably used in scientific laboratories and generally used on the Continent, the boiling-point is marked at 100 and the freezing point at 0, so that 100° Centigrade is equal to 212° Fahrenheit, and 0° Centigrade is equal to 32° Fahrenheit.

GENERAL CONSIDERATIONS

To convert a Fahrenheit temperature into Centigrade we therefore deduct 32 and multiply the remainder by $\frac{5}{9}$, and to convert a Centigrade temperature into Fahrenheit we multiply it by $\frac{9}{5}$ and add 32.

TABLE I
THERMOMETRIC SCALES

<i>Fahrenheit</i>		<i>Centigrade</i>	
212°	Boiling point of water at standard pressure	100°	
210°	98.9°	
200°	93.3°	
190°	87.8°	
180°	82.2°	
170°	76.7°	
160°	71.1°	
150°	65.6°	
140°	60.0°	
130°	54.4°	
120°	48.9°	
110°	43.3°	
100°	37.8°	
98.4°	Normal blood temperature	36.9°	
90°	32.2°	
80°	26.7°	
70°	Normal room temperature, sedentary occupation	[21.0°	
65°			18.3°
60°			15.6°
55°	Normal room temperature, physical exertion	12.8°	
50°	10.0°	
45°	7.2°	
40°	4.4°	
32°	Freezing point of water	0°	
30°	-1.1°	

The temperature at which most human beings are most comfortable is generally between 60° and 70° F., but it naturally depends on many other factors, such as humidity, clothing, air movement, and whether the individual is doing manual work or resting. Few people can exist with any degree of efficiency at temperatures much below 30° F. or temperatures much above 90° F., though the other factors just referred to have a great influence on these limits.

Humidity is the amount of water vapour contained in the air. At any given temperature space will take up a definite amount of water vapour, and when it has done so, to the maximum compatible with that temperature, it is said to be saturated. Saturated air at a high temperature contains vastly more water

vapour than saturated air at a lower temperature. Thus, a cubic foot of air at 100° F. contains 20 grains of water when saturated, while at 32° it only contains 2 grains.*

The ordinary atmosphere in which we live is seldom completely saturated and usually contains only a part of the water which it would contain if it were saturated. If at any given temperature it only contains half as much water as it would contain if it were saturated, then it is said to have a relative humidity of 50%.† In other words, the *relative humidity* is the ratio between the pressure of water vapour at a given temperature and the pressure of water-vapour when saturated at the same temperature.

From these considerations it is immediately clear that air will increase in relative humidity when the temperature is dropped and *vice versa*, if both the quantity of water in it and also the pressure remains constant while the change occurs.

Humidity has a very great effect on human comfort and health. Excessive humidity makes it very difficult for human beings to get rid of the heat produced by the combustion of organic compounds in the tissues. This heat is normally largely dissipated by evaporation from the surface of the skin, and occurs easily when the humidity is 50% and lower, but occurs with increasing difficulty as the humidity reaches the 100% mark.

Every human being produces some 450 British Thermal Units of heat every hour, and unless this heat is dissipated the temperature rises. As is well known, if the body temperature rises from the normal temperature of 98·4° to something more than 106°, death is almost certain to ensue.

Any humidity in excess of 80% or 90% produces an extremely stuffy feeling and leads to headaches, a disinclination to work, and a general loss of tone.

Too low a humidity, on the other hand, causes excessive evaporation from various portions of the body and tends to produce affections of the throat, a feeling of cold, and the kind of climate in which one can only keep fit while working hard and not while resting.

The most comfortable humidities are usually between 40% and 60%, the higher one associated with more sedentary

*7,000 grains = 1 lb.

†Strictly it is the vapour pressure which determines the relative humidity, but at normal temperatures the difference is slight.

GENERAL CONSIDERATIONS

conditions and the lower one when sport or manual labour are in question.

But temperature and humidity are to some extent inter-related as far as comfort is concerned, high temperatures being bearable with a low humidity more so than when the humidity

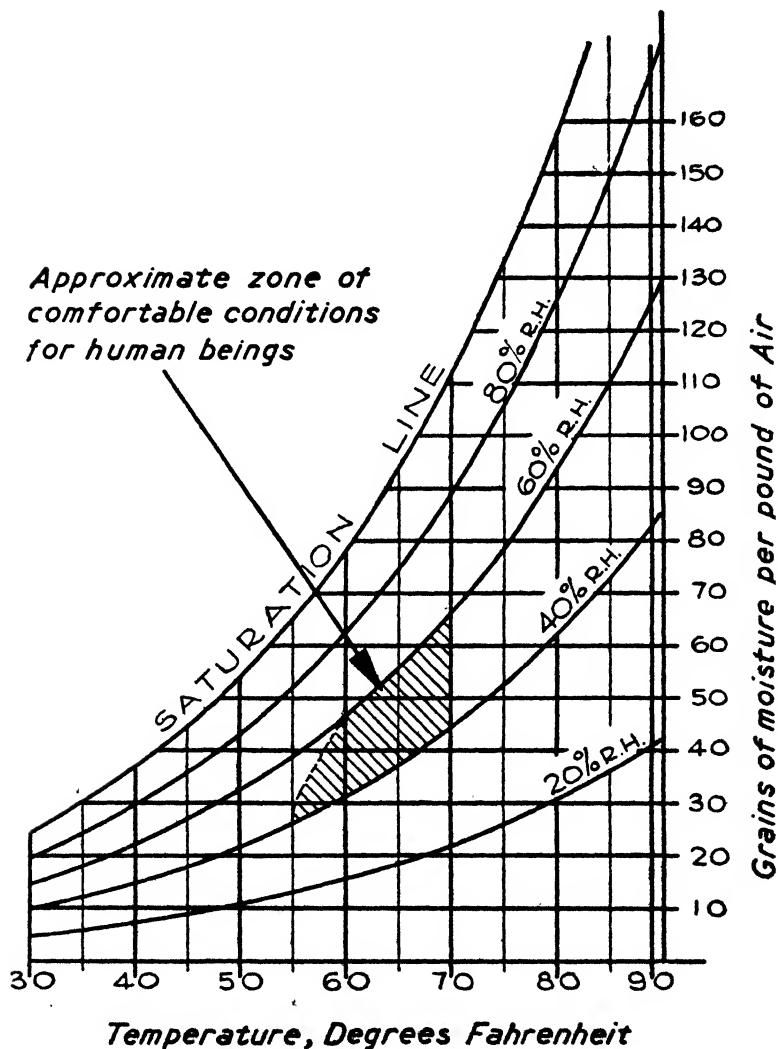

FIG. 1 CHART SHOWING THE AMOUNT OF WATER VAPOUR CONTAINED IN AIR WHEN SATURATED, AND AT VARIOUS RELATIVE HUMIDITIES, TOGETHER WITH THE APPROXIMATE ZONE OF COMFORTABLE CONDITIONS FOR HUMAN BEINGS

is high, as is well known to people who live in the tropics. High temperature at Nairobi for example, with its low humidity is pleasant whereas the same temperature at Mombasa, where the humidity is high, is very unpleasant.

Heating and ventilating engineers have prepared curves of temperature and humidity in which a certain area on the curve is known as the comfort zone.

As a very rough preliminary guide, however, it may be said that the object in most heating and ventilating installations in England is to produce a temperature of somewhere between 60° and 70° and a relative humidity of somewhere between 40% and 60%.

When a temperature of about 65° F. is achieved, the relative humidity is not critical, and considerable variations can occur without sensible discomfort, but probably the optimum values lie between 40% and 60%.

In very hot climates it is obvious that comfort conditions can only be obtained by reducing the temperature, and as has already been stated, if the temperature is reduced without varying the quantity of water contained in the air, then the relative humidity rises and oppressive conditions are set up.

It therefore becomes necessary in such cases not only to reduce the temperature but also to reduce the amount of moisture in the air (de-humidification).

(3) AIR-CONDITIONING

In this book we shall use the term "air-conditioning" as implying the process or installation in which there is complete control of temperature and humidity in an upward as well as in a downward direction, i.e., when the cold air in winter can be warmed and humidified at will and when the hot air in summer can be cooled and de-humidified at will, so that there is perfect control of climate at all periods of the year.

"A ventilation system" will be used as meaning a system by which air can be warmed and humidified and delivered to the various portions of the building as required, but without the apparatus for cooling and de-humidifying.

"A heating system" will be used to denote a system in which the air temperature can be raised without altering the amount of moisture contained in the air and without necessarily causing air movements or air changes.

(4) AIR CHANGES

It will of course, be known by every reader of this book that human beings in the process of breathing inhale air, which is a mixture of nitrogen and oxygen, and that the oxygen burns organic products in the body so as to produce heat and that the air, when expelled, contains carbon dioxide and moisture.

It is therefore obvious that unless the air in a room is changed, the contents of oxygen will gradually decrease and the contents of carbon dioxide and moisture gradually increase. When this is allowed to proceed beyond a certain limit, conditions of great discomfort are set up.

Various other substances are also liberated from the operation of the human body, which, unless the air is changed, produce feelings of stuffiness, smells and oppressive conditions generally.

If it were merely a question of supplying the necessary oxygen to a body to support combustion it could be shown that the supply of about 100 cu. ft. of air per hour to each individual would suffice. But in practice this is by no means sufficient, and the conditions so produced would be intolerable (in a well ventilated building).

The London County Council has stipulated that in a theatre, cinema, etc., not less than 1,000 cu. ft. of fresh air shall be delivered for each person per hour, and this may be looked upon as a minimum for good ventilation, but there will be a great many conditions in which it will be quite inadequate.

Another way of expressing the change of air in a room is to say how frequently the total air content of the room is changed and replaced by new. Thus, we sometimes speak of a building being designed for two air changes per hour, by which we mean that the rate of air inlet and extract is such as to produce twice the content of the building per hour at a uniform rate.

The number of air changes necessary depends not only on ensuring that each occupant will receive about 1,000 cu. ft. of air per hour—which clearly depends on the density of occupation—but also on the amount of heat produced in the room, which has to be got rid of to maintain conditions of comfort.

In a certain sized room, for example, we may have so many occupants, each producing, say, 450 B.T.U. per hour. In addition to this there may be lighting, whether by gas or electricity, machinery and apparatus, also producing definite and usually calculable quantities of heat.

HEATING AND VENTILATING

One of the requirements of good ventilation is that sufficient air is introduced to ensure that all this heat will be removed at such a rate as will keep the temperature rise within certain specific limits. Cases occur where this requires as much as twenty changes per hour.

We therefore see that the number of air changes required depends on density of occupation, the amount of heat liberated from other sources, such as light and apparatus, and on the temperature rise above normal which can be permitted in the circumstances of any special case. Where there are fumes to get rid of, more air changes may be needed to deal with these.

It must not be assumed that, when there is no ventilation plant provided, a heating system may then be designed without taking any air change into account, for there will surely be an accidental air change, even if none be provided for, owing to the porosity of the walls, cracks at doors and windows and the necessary openings which must be maintained if human life is to continue.

The air changes which can obtain by natural means, apart from ventilation, are very variable and usually largely dependent on wind and the difference in temperature between the inside and the outside of the room, the air changes, for example, usually being much greater in winter than in summer.

It is frequently the practice when designing a heating system to which no ventilation system is attached, to allow for one or two air changes per hour as something likely to approximate to the changes produced naturally.

(5) HEAT TRANSFER

There are three ways in which heat can be transferred from one body to another, namely

- (a) Radiation.
- (b) Convection.
- (c) Conduction.

Radiation of heat is of exactly the same nature as radiation of light, except that the wave-length of the vibration is much longer. A luminous body radiates light in all directions and the light received per sq. ft. varies inversely with the square of the distance. And this also applies in the case of heat radiation, when a small surface only is considered as the radiating source.

GENERAL CONSIDERATIONS

Pure radiation can exist only in a vacuum, since whenever it occurs in air it is always combined with some degree of convection.

Convection is the transmission of heat by particles of air or other fluid coming in contact with a hot surface and then passing on and delivering this heat up to some other body, at a lower temperature, after such movement. A common example of this occurs when, a kettle being put on a fire, the bottom surface is heated: cold water particles in contact therewith are heated and rise to the top, are replaced by other water particles and thus set up a circulation which continues so long as the fire is maintained under the kettle.

In an ordinary heating system heat is generally produced in a boiler, the water being heated by contact with the hot

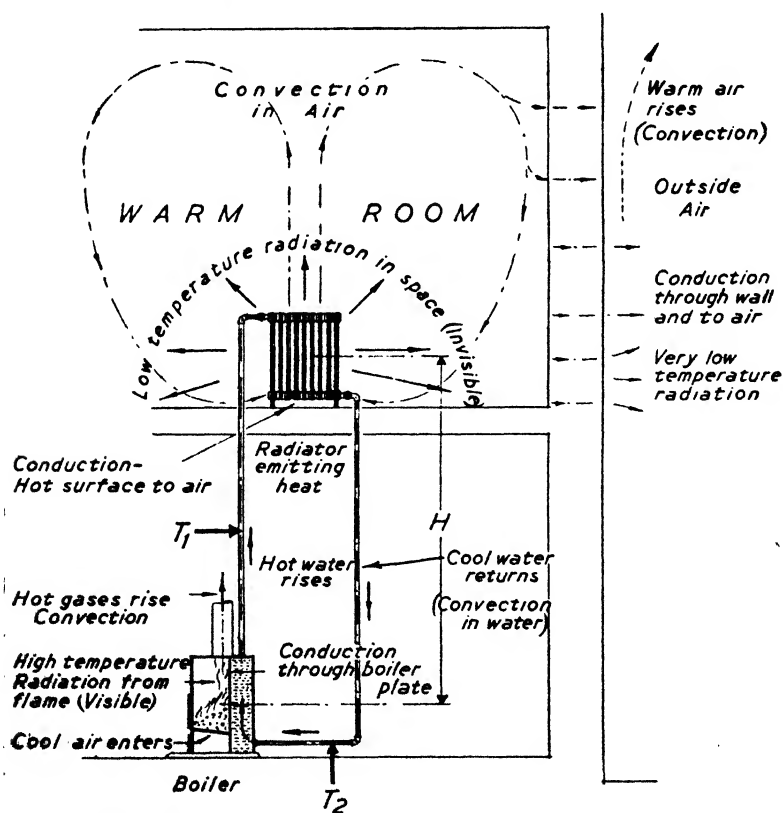

FIG. 2 HEAT TRANSFER BY RADIATION, CONDUCTION AND CONVECTION

metal, and circulated through pipes which deliver up this heat to the radiators which in turn deliver the heat up to the air.

The delivery of heat from the boiler to the radiator is correctly described as convection, whereas the delivery of heat from the radiator to the air is partly convection and partly radiation, and the ratio between the two can vary considerably, but usually is more a case of convection than of radiation. The so-called radiator is therefore slightly a misnomer and would be more correctly described as a convector.

When, however, the heating element is fixed on to the ceiling of a room—as, for example, when the panel system is employed—there is usually less chance of convection occurring, for the warm air is prevented from rising since it is already in the highest part of a ceiling and so no air current is set up. In such cases most of the heat is transmitted to the room by radiation.

Heat can also be transferred by *conduction*, as, for example, when the inside surface of a brick wall is raised to one temperature and heat travels through the wall to a lower temperature outside.

Different materials have different coefficients of conduction (conductivities), i.e. different rates of transferring heat.

Metals and all very dense and heavy materials are good conductors as a rule, while light and porous materials are usually bad conductors. When their conductivities are very low indeed they are known as insulators.

For the purposes of house building it is obvious that we should choose materials for our walls which are as little conducting as possible because in that way we shall require less heat in the winter and the buildings will remain cooler in the summer.

(6) HEAT UNITS

The British standard unit of heat, known as the *British Thermal Unit*, usually contracted into the three letters B.T.U., is the amount of heat required to raise 1 lb of water through 1° F. Thus, to raise 1,000 lb of water through 10° would require 10,000 British Thermal Units.

Similarly, to raise 10 lb of water through 1,000° would also require 10,000 B.T.U., but it must not be supposed that the latter process would be an easy one, as the water would have to be kept from boiling and would be at a very high pressure.

GENERAL CONSIDERATIONS

It is, indeed, part of the definition that the water shall remain in the same state over the period of heating and shall not change either from ice to water or from water to steam, since in both these transformations there is a gain or loss of what is known as *latent heat*, i.e. absorption or giving out of heat without any corresponding increase or loss of temperature.

Thus, when 1 lb of water at 212° is converted into 1 lb of steam at 212° , approximately 970 B.T.U. are absorbed without any change of temperature, and if 1 lb of steam at 212° is condensed to form 1 lb of water at 212° , approximately 970 B.T.U. will be given up.

This means that in converting 1 lb of water into 1 lb of water vapour we require 970 times as much heat as we do to raise 1 lb of water through 1° .

In passing, we may mention that the latent heat of water freezing is approximately 144 B.T.U. per lb.

From what has been said about the latent heat of evaporation it will now be readily understood how very powerful the cooling effect of a wet skin evaporating moisture into the atmosphere can be, and what a severe difference it will make to the well-being of a person when an already fully saturated atmosphere prevents evaporation and so prevents this cooling.

People occasionally feel that it will help them to have some rough idea, in terms of everyday things, by which they can more easily visualise the magnitude of a British Thermal Unit.

If a kettle of water contains $2\frac{1}{2}$ lb (2 pints) then to raise it from 62° F. to boiling point (212° F.) will require $2\frac{1}{2} \times 150 = 375$ B.T.U. So that in round figures it takes 375 B.T.U. to raise an ordinary kettle of water to boiling-point.

The *therm* is the ordinary commercial unit of heat and is equal to 100,000 B.T.U.

(7) SPECIFIC HEAT

Although it requires 1 B.T.U. to raise 1 lb of water through 1° F. it requires less to raise any other known substance through the same range of temperature, and the ratio of the two is known as the specific heat of the other substance.

The specific heat of a substance may therefore be defined as the amount of heat required to raise 1 lb of it through 1° F.

It is curious that so common a substance as water should

HEATING AND VENTILATING

have the unique property of having the greatest specific heat of any known substance.

The following table gives a list of the specific heats of a few of the materials likely to be encountered in the course of building and heating installations.

TABLE 2
SPECIFIC HEATS OF SOME COMMON MATERIALS

Water	1.0
Copper, zinc, brass		0.09
Iron, steel	0.12
Aluminium	0.24
Bricks, tiles	0.20
Plaster	0.20
Building stones, concrete	0.21
Glass	0.20
Timber (average)	0.50
Cork-board	0.43
Ice	0.50
Air (at constant pressure)		0.24

(These figures are average values at temperatures of normal use.)

If s is the specific heat of a substance, and w its weight, and t the range of temperature in an operation involving temperature change, then it is clear that the amount of heat given out or absorbed will be

$$H = w \times s \times t$$

(8) OUTSIDE TEMPERATURE

The principal object of a heating system is, of course, to produce comfort conditions, notwithstanding the external conditions, and obviously therefore the installation has to be more powerful and the amount of fuel consumed annually will be greater in proportion as the external conditions are severe or otherwise.

This is largely determined by the position of the building in question and the local climate. Thus there are obviously places in Africa where no heating is ever required. In Lisbon the heating season is short and the climate mild, and even in England places round the west and south coasts require less heating than places in the north and east.

Assuming an internal temperature of about 65° F. to be wanted, it is usual to calculate the installation on the assumption that the outside temperature may drop to about 30° in the case

GENERAL CONSIDERATIONS

of English west and south coast districts, 25° in the midlands, and 20° in the north.

(9) DEGREE DAYS

Some attempt has been made to put the above on to a scientific basis as a result of a study of meteorological records. A map of England has been prepared in which the degree days are shown, with different hatchings or colours, over the whole area of the British Isles.

The degree days are determined in the following manner. The average temperature over the whole 24 hours is recorded for each day and the number of degrees of every day which has a temperature below a fixed standard, such as 60° , is calculated for each day in the year. Thus if the standard is taken as 60° , any day in which the average over the 24 hours was 50° would count as 10 degree days. If the outside temperature were 30° it would count as 30 degree days.

If the sum of all these degree days for the whole year is added up it comes to a total which is relatively low for the warmer parts of England and relatively high for the colder parts, and the amount of fuel required for heating a building of given size is approximately proportional to the number of degree days of the district in which it is situated.

In England, the standard temperature from which the degree days are measured is usually taken as 60° F., while in America 65° F. is more common.

From a study of such a map we see that round the coast of Cornwall and Devonshire the degree days are between 3,000 and 3,500. Round the coast of Wales and South of England up as far as about Ipswich the degree days are between 3,500 and 4,000. The Home Counties, Midlands, and East Coast from Ipswich up to about Newcastle, 3,500. A strip running up the centre, 3,500 to 5,000; a central strip from Derbyshire to the Firth of Forth, 5,000 to 5,500; including the northern part of Scotland and certain isolated mountainous areas including Dartmoor, Braemar, 6,000 to 6,500.

A map of this kind is useful when computing annual fuel consumption and has some influence on the capacity of the heating installation, though the latter does not vary directly with the number of degree days.

GENERAL CONSIDERATIONS

It is of interest to note that an expenditure at the rate of 2,544 B.T.U. per hour corresponds to 1 horse power (33,000 ft.-lb per minute), so that an office worker expending about 500 B.T.U. is giving the heat equivalent of energy at the rate of about one-fifth horse power, while walking upstairs involves an expenditure of energy at the rate of about $1\frac{3}{4}$ horse power.

All this energy has to be dissipated. Part of it is dissipated in the form of sensible heat by radiation and convection, i.e. transferring the heat from the body to increase the temperature of the surrounding air.

Another part is dissipated, without any increase in the temperature of the surroundings, by evaporation of moisture both from the lungs and from the skin, and the proportion of one to the other varies greatly at different temperatures and also for different rates of exertion.

Fig. 3(a) shows the total heat, the sensible heat, and the latent heat for a person doing fairly heavy manual work at temperatures between 30° and 100° in an atmosphere with a relative humidity of about 45-60%. It will be seen that the total heat, which is of course the sum of the other two, varies little between 30° and 80°, but after that begins to drop rapidly, due, no doubt, partly to the fact that a person under such hot climatic conditions cannot maintain the same degree of labour for long and partly to the fact that his body will suffer and he will become a less efficient machine.

While the total heat varies comparatively little, therefore, over this wide range, the sensible heat, i.e. the heat given to the surrounding air, etc., falls off very rapidly indeed, at a temperature of 30° being 1,160, while at 90° it has dropped to about 220.

The falling off at higher temperatures is of course very easy to understand, since the air temperature is approximating more and more to the skin temperature as the surrounding air gets hotter.

Similarly, the amount of latent heat, i.e. the heat dissipated by evaporation, is only about 150 at 30°, when the skin is hard and dry, and up to about 1,000 at 90°, when the skin is soft and moist.

These figures of sensible heat are to be used in calculations relating to the temperature which will be produced in a room containing many persons so occupied, while the latent heat curve gives an indication of the moisture which will be liberated—which of course affects the relative humidity.

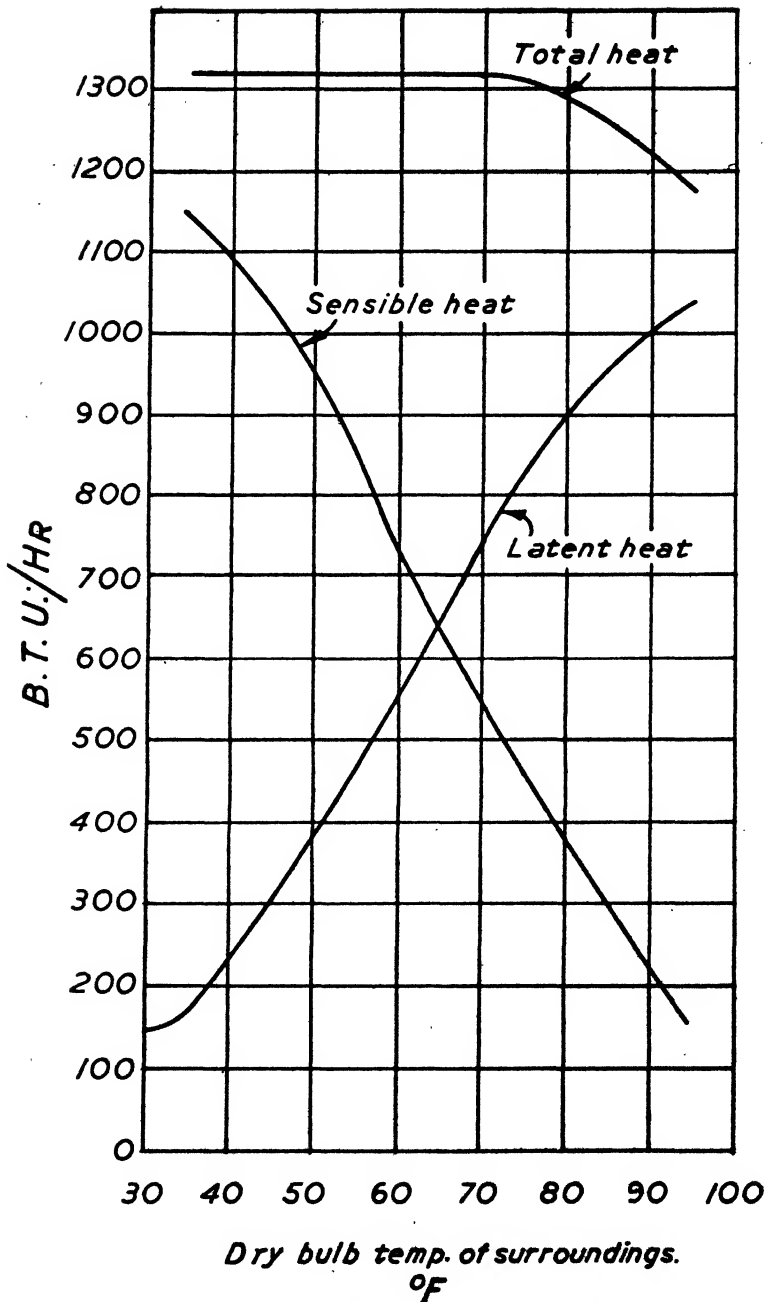

FIG. 3A CURVES OF SENSIBLE, LATENT AND TOTAL HEAT EMISSION BY PERSON WALKING BRISKLY OR DOING FAIRLY HEAVY MANUAL WORK. N.B.—R.H. TAKEN AT 45-60 PER CENT.

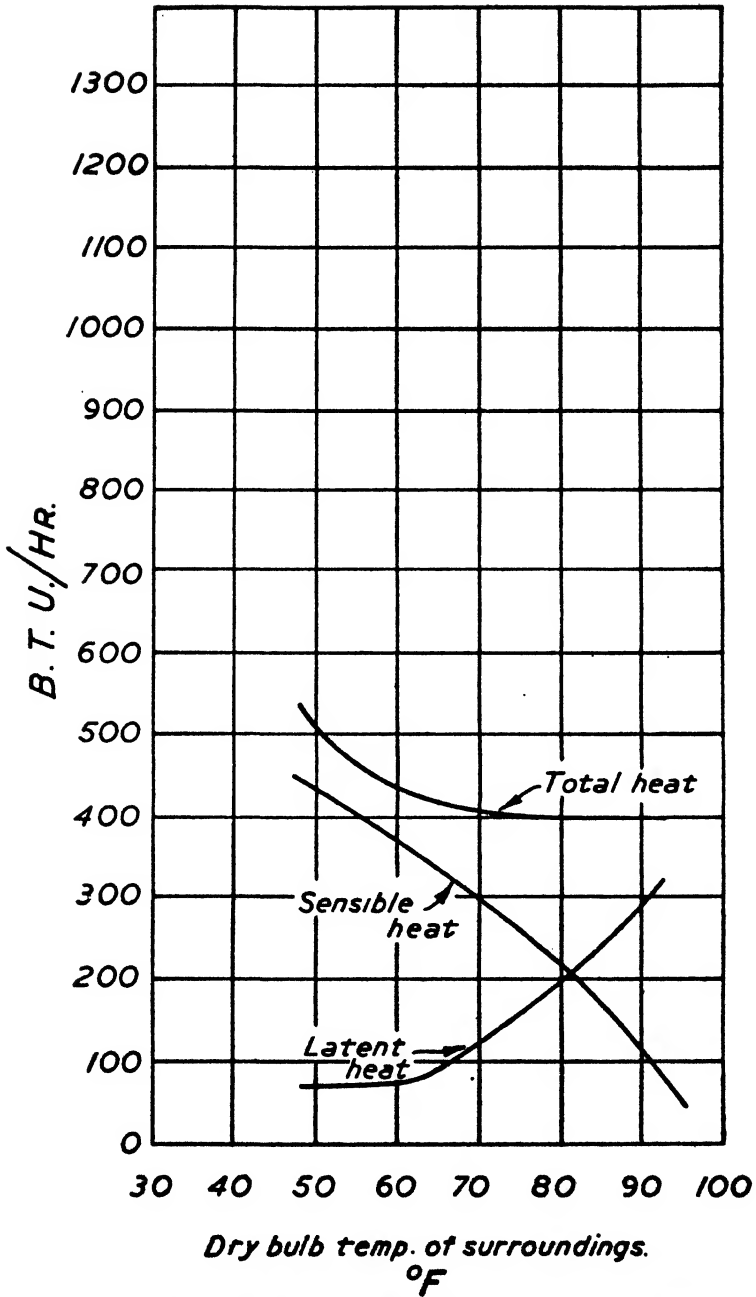

FIG. 3B CURVES OF SENSIBLE, LATENT AND TOTAL HEAT EMISSION BY A PERSON PERFORMING LIGHT SEDENTARY TASKS. *N.B.*—R.H. TAKEN AT 45-60 PER CENT.

HEATING AND VENTILATING

Coming now to Fig. 3(b), similar curves are shown for a person performing light sedentary tasks, such as clerical work, seated. Here it will be seen that the total heat falls rapidly down to a temperature of about 70°, after which it remains constant up to about 95°, while the sensible heat and the latent heat fall and rise respectively with the increase in temperature as shown on the diagram.

It will now be appreciated how important low humidity is in hot climates, and also how important is the question of air movement, since the total heat produced must be dissipated in one way or another. If the air is saturated and there is little air movement the amount of dissipation by evaporation given by these curves cannot be achieved and the only way in which heat can then be dissipated is by an increased radiation and sensible heat. This can only take place by raising the temperature of the person, which of course results in his becoming feverish and ill, and, if carried to extreme, in complete breakdown and death.

It will be seen from these curves, therefore, that the conditions for comfort at very high temperatures are low humidity and plenty of air movement and everything which induces evaporation and the removal of heat in the latent form.

At low temperatures, on the other hand, very little heat is given out as latent heat and a much lower humidity and air speed are desirable and sufficient to produce comfort conditions.

We see, therefore, that the ventilating engineer is greatly concerned with temperature and humidity and air movement, and that he cannot carry out his function properly without understanding something of the physiological requirements of the human beings for whom he is attempting to produce comfort conditions.

The curves given are of great assistance in calculating the conditions which are produced in a room, since both the heat given out as sensible and the moisture produced by evaporation can be estimated therefrom.

If the conditions involve human beings at a different rate of exertion from those for which the two curves are drawn, these figures can be obtained near enough for most practical purposes by applying the factor to one or other of the diagrams.

We are, as a rule, more concerned with the figure in Fig. 3(b), which relates to persons seated or doing light sedentary work; but there are, of course, exceptions.

GENERAL CONSIDERATIONS

An example showing how these figures can be applied in a practical example will be given later.

It will also now be seen that the amount of the heat produced in an assembly hall by all the occupants contained in it may be so great as to require a large number of air changes to prevent the temperature of the room rising unduly. On the other hand, the heat may be non-existent when the room is empty.

Consequently, for rooms of this character it is essential that the heating apparatus or the method of supplying heat shall be of such a nature that it can be varied almost instantaneously to conform to the number of persons entering or leaving the hall, as the room has to be reasonably warm when the first persons enter and yet suffer no appreciable increase in temperature when the room fills.

The only way this can be done is by supplying heat in a form which can be instantaneously varied and will not be subject to a long *time-lag*.

If, for example, a hall is heated by a panel heating system, i.e. a system in which the ceiling, walls or floor contain embedded pipes with hot-water circulation, so that the whole body of the carcase is warmed, then if the temperature is suitable when the first persons enter, it will rapidly become unbearable when the hall fills, because it may take an hour or two before the heating surfaces cool down sufficiently to compensate for the increased heat expended by the occupants.

The same applies to a lesser extent with radiator systems, where even if the valves controlling the mains are shut off, it may take an appreciable time before the radiators and the water contained in them drop sufficiently in temperature. Probably the best method to employ in such cases is to supply the heat in the form of warm air, the temperature of which can be varied almost instantaneously with the least possible time lag.

We are thus introduced to the importance in certain types of buildings of having a system with a small time lag and of heating by means of air.

Chapter II

FUELS AND SOURCES OF HEAT

(1) COMBUSTION OF FUELS

IT is difficult to discuss fuels fully apart from appliances for burning them, but in a rapid survey, such as this, it is necessary to skirt round the problems first before attacking them as systematically as one might have desired.

(2) HEAT ENERGY

Heat is a form of energy and is always produced by converting other forms of energy into heat energy. Frequently this transformation is a somewhat complicated one. Thus, coal was produced originally by the heat energy of the sun producing certain chemical effects on organic materials, such as foliage, peat, wood, etc., so that the heat energy of the sun was

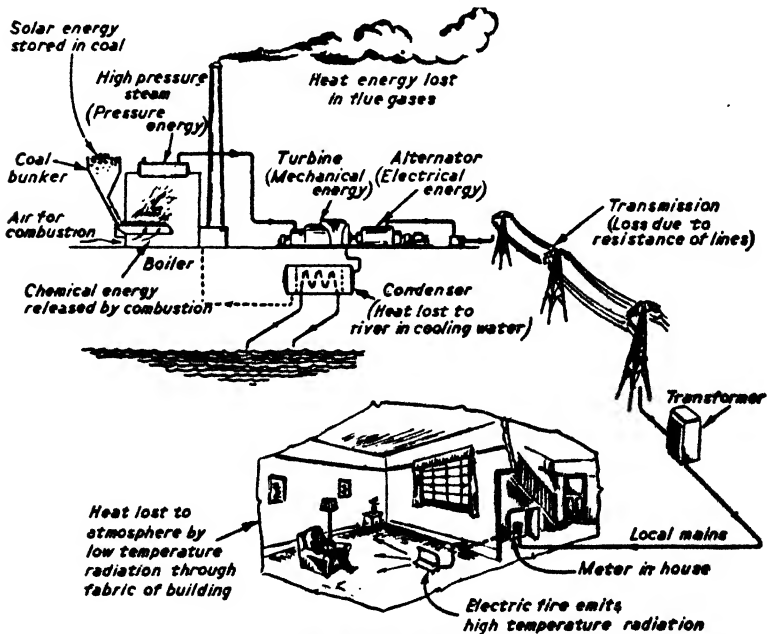

FIG. 4 CONVERSION AND DISSIPATION OF ENERGY IN GENERATING AND USING ELECTRICITY

converted into chemical energy in the coal. This chemical energy lies latent in the coal and can be converted back into heat by the process of combustion whereby the carbon combines with the oxygen of the air to form carbon monoxide (CO) and carbon dioxide (CO₂), while the hydrogen combines with the oxygen of the air to form water and the hydrocarbons combine with oxygen from the air to form both CO₂ and water vapour. All these chemical processes are attended by the emission of great heat.

The same applies to the combustion of natural oils, which are almost entirely hydrocarbons and in which the combustion produces CO₂ and water vapour and leaves no residue corresponding to the ash which represents the mineral remainder of incombustible material which remains when coal is burnt.

In the case of electricity, the changes of energy are even more complicated. When electricity is produced in an ordinary coal-burning generating station the chemical energy of the coal is first converted into heat energy in a boiler producing steam under pressure which in turn through the medium of a steam engine (reciprocating or turbine) converts the energy into mechanical energy producing rotation of electric generators which convert this mechanical energy into electrical energy. When we use this electrical energy for producing light or heat in our building we convert the electrical energy back into heat again.

When electricity is produced from water power the potential and velocity energy of the water is converted into mechanical energy in the water turbines, driving generators which convert this mechanical energy into electrical energy.

(3) EQUIVALENTS OF ENERGY

All forms of energy are mutually convertible one into the other. Thus 778 ft. lbs of mechanical energy will produce 1 B.T.U., i.e., if the heat produced by a 1 lb weight falling through 778 ft. against a resistance is collected and measured it will be found that it can raise the temperature of 1 lb of water by 1° F.

TABLE 4
HEAT AND ENERGY EQUIVALENTS

1 Therm	=	100,000 B.T.U.
1 Kilowatt-hour	=	3,415 "
1 Horsepower-hour	=	2,544 "
1 Calorie (kg)	=	3.97 "
1 Horsepower	=	0.746 kilowatts
	=	33,000 ft. lbs./min.

One horse-power (1 H.P.) converted into heat will produce 2,544 B.T.U. per hour.

A human being at rest emits about 440 B.T.U. of heat per hour and therefore is developing nearly one-sixth H.P. in merely making good the radiant and other heat losses from his body at normal temperatures.

The unit of electrical power is the *watt*, which is the power dissipated in a circuit maintained at a potential difference of 1 *volt*, when a current of 1 *ampere* is flowing.

1,000 watts are known as a *kilowatt* and 746 *watts* are equivalent to 1 H.P., so that approximately $\frac{3}{4}$ kW. is equivalent to 1 H.P. of mechanical energy.

A *unit of electricity* is 1 kW. maintained for one hour, and is equivalent to 3,415 B.T.U. of heat energy per hour.

(4) CALORIFIC VALUE

Various fuels having stored chemical energy which being converted into heat by combustion, will produce varying amounts of heat, depending on the amount and the composition of the combustible material they contain. The total number of B.T.U. which can be obtained by the combustion of any material is known as its *calorific value*.

In practice there are two calorific values, i.e., the gross and the nett.

The *gross calorific value* represents the total quantity of heat which can be obtained, but part of this is given off in the form of water vapour which, when the temperature of the flue gases is high, is not conveniently recoverable. In fact it can only be recovered if arrangements are made for the water vapour to be condensed inside the apparatus and the latent heat of the water vapour recovered. This is very rarely practicable and it is more usual therefore to deal with the *nett calorific value* which represents heat recoverable from 1 lb of fuel by combustion when the water vapour is allowed to escape, taking its latent heat with it.

(5) COAL

Coal is the principal source of heat in England, America, and most other civilised countries in the present era, and the prosperity of England in the 19th Century was very largely determined by the presence of very large and accessible coal

supplies, and it still forms the chief source of our industrial well-being.

Coal varies very greatly in composition. Thus anthracite is a coal rich in pure carbon, while the various bituminous coals contain a high percentage of hydrocarbon. Anthracite on analysis shows very little hydrogen, and the amount of hydrogen increases progressively as the bituminous contents increase, coal with very little hydrogen producing correspondingly little water vapour in its combustion and therefore the difference between the gross calorific value and the nett calorific value is much less with anthracite than it is with bituminous coals.

Anthracite has a gross calorific value of approximately 14,800 B.T.U. per lb. and a nett calorific value of about 14,650 B.T.U.

Welsh steam coal is but slightly inferior.

Good bituminous coal is about 13,500 B.T.U. gross and about 13,000 nett, while a very poor coal may be as little as 10,000 B.T.U. gross and 9,250 B.T.U. nett.

At the present moment, when our coal production is attended with difficulties much greater than was the case some twenty years ago, large industrial users of coal are being forced to use coal of poor quality containing a great deal of dust, ash and slack which would have been rejected by these industrial users some years ago, and the use of this bad coal has raised increased difficulties in its combustion in boilers and necessitated mechanical stokers of special design, and thus an increased draught has had to be provided for its proper combustion.

The ash content may be as little as 2% to 3% on a good anthracite, 4% on a good Welsh steam coal, 5% to 8% on a good bituminous coal, and as high as 15% to 20% in the case of slack.

Anthracite is more difficult to ignite as it has to be raised to a fairly high temperature before it will support combustion, whereas bituminous coals at a much lower temperature give off gases such as methane which are readily ignited.

Hence, bituminous coals are usually preferred for fires in open grates, while anthracite and Welsh steam coal are mostly confined to use in anthracite stoves and boilers.

Bituminous coal can, however, be burnt in boilers, but produces much more smoke than anthracite.

Anthracite and Welsh steam coal are more expensive than the bituminous coals, even when the additional calorific value

HEATING AND VENTILATING

has been allowed for, but their absence of smoke and their low ash content make them specially suitable when the price consideration is not prohibitive, and an anthracite stove is such an efficient heat producing appliance, as compared with an open grate, for example, that it will be more economical even if the coal cost £1 per ton more.

It will be appreciated that in these difficult transition days when the cost of fuels is varying so rapidly from year to year, it is a little difficult to give accurate figures of comparison, but it may perhaps be mentioned that anthracite at 80/- per ton and with a nett calorific value of 14,500 B.T.U. is equivalent to 3d. per therm, whereas bituminous coal at 60 /- per ton with say 12,000 B.T.U. per lb nett calorific value is equivalent to 2·7d. per therm.

From these figures it will be easy for the reader to calculate the cost per therm with other prices and calorific value, and the figures obtained will need to be so corrected in the light of the circumstances of any given case.

It will of course be appreciated that this represents the cost of the heat produced in the fire, or, when a boiler is used, in the boiler, but only part of this heat can be rendered useful and this depends on the efficiency of the combustion and of the appliance.

Thus, if the anthracite previously referred to was burnt in a boiler with 75% efficiency, the cost of the heat rises from 3d. to 4d. per therm, while if the bituminous coal previously referred to is burnt in an open fireplace with an efficiency of say 20%, then the cost of the heat liberated to the room will rise from 2·7d. to 13·5d. per therm.

This aspect of the matter will be considered later under heat producing appliances.

(6) COKE

Coke is of two kinds, gasworks coke and metallurgical coke.

Gasworks coke is produced when a bituminous coal is heated at the gasworks in closed retorts and when the volatile gases pass out and are collected in the gasholders, after purification, for distribution as gas, the remainder containing the non-volatile portion of the coal together with the ash.

At the gasworks the raw coke is broken down into varying sizes for domestic consumption. Such coke often has a calorific

FUELS AND SOURCES OF HEAT

value of about 12,000 B.T.U. per lb, giving a cost per therm (assuming 100% efficiency of apparatus and combustion) of 2·7d. if the coke costs 60/- a ton.

When consumed in a boiler with a 50% efficiency this would give 5·4d. per therm of useful heat in the boiler.

Metallurgical coke is a coke specially prepared for certain metallurgical operations and generally has a high calorific value, lower ash content, and commands a higher price, and is seldom used in ordinary domestic or heating installations, though it is sometimes available for this purpose, and if the difference in cost is low, is generally a better fuel than gasworks coke.

Gasworks coke usually has an ash content of about 5% to 8%. A lower quality, known as breeze, has a lower calorific value, generally about 10,000 B.T.U. nett, and an ash content as high as 15% to 20%, whereas the metallurgical coke (also known as furnace coke or oven coke) may have a calorific value as high as 13,500 B.T.U. nett, and an ash content as low as 4%.

Coke shares with anthracite the qualities of being difficult to ignite, but it burns readily with a smokeless flame when once ignited and is an excellent fuel in anthracite stoves, boilers, and can even be used in an open grate after the fire has been thoroughly set going with ordinary bituminous coal or gas.

It will be appreciated from what has been said that the gasworks have to maintain a balance between their gas sales and their coke sales, and the price of coke is thus generally determined at a figure which enables the gasworks to sell whatever they produce at the best price they can get, and in quantities which are determined by their gas production.

Coke has the good quality that it usually contains very little dust, so that the gases passing through the firebed in a boiler will pass with less resistance and therefore a lower draught than is the case when coals containing dust are used.

(7) MANUFACTURED FUELS OTHER THAN COAL AND COKE

There are several other manufactured fuels besides coal and coke available for combustion both in the open grate and in boilers.

These include the semi-cokes and various materials such as Coalite, Phurnacite, and others. Some of these are converted into special shapes, such as briquettes, ovoids, etc., which makes them particularly clean and convenient to use.

Coalite is obtained from low temperature carbonisation of coal.

Most of these materials have a nett calorific value between 13,000 and 14,000 B.T.U. per lb, an ash content varying from 5% to 10%, and are worth nearly as much as anthracite.

(8) GAS

As has been explained, gas is obtained by the distillation in retorts of bituminous coal.

Gas generally contains about 50% of hydrogen, 20% methane, 15% carbon monoxide, and the balance is mostly of inert gases having little or no calorific value.

Its density is approximately one-half that of air, and it was originally used in fishtail burners for gas lighting when its chief value was the luminosity of its flame.

With the invention of the Welsbach mantle and burner, which only require heat, the luminosity of the flame became of no importance and practically all gas to-day has a flame of poor luminosity. It is practically always used in some type of Bunsen burner in which some air is admitted with the gas prior to the flame, so that the flame is a non-luminous one.

Most gas has a calorific value of approximately 500 B.T.U. per cu. ft. and therefore goes about 200 cu. ft. to a therm or 5 therms to 1,000 cu. ft.

Gas is measured by volume in the ordinary gas meter and therefore it is of direct interest to the consumer that its calorific value should be maintained. Under the Gas Regulation Act, 1920, gas undertakings have to supply gas at a declared calorific value, which the Board of Trade check from time to time, and its value at the gasworks can be maintained by adding a gas obtained by the cracking of oil at high temperature. In some districts, however, gas is supplied at a much lower calorific value.

In many industrial processes a special kind of gas, known as producer gas, is manufactured by a producer gas plant at the works. Not only the bituminous volatile portions of the gas are used, but the residual coke is combined with water to form carbon monoxide and hydrogen, so that there is no residue from the solid fuel used except the ash.

Such producer gas has a much lower calorific value, generally round about 150 B.T.U. per cu. ft., so that its use in ordinary domestic appliances is difficult, as it becomes necessary to

burn $3\frac{1}{2}$ times as much gas to get the equivalent heat, but for power purposes it has the great advantage of costing less per therm. Such gas goes about 700 cu. ft. to the therm.

When gas is referred to in the remainder of this book we shall always be referring to ordinary town gas from gasworks, unless otherwise specially mentioned.

There is a good deal of sulphur in most bituminous coals and most of this passes out in the process of distillation in the gas. The gasworks have to remove this as part of their process, and they now do this much more efficiently than they did originally.

Gas containing any sulphur, if burnt in a room under conditions when the products of combustion are not entirely removed, has a deleterious effect on the health of the individual and on plants, fabrics, leather upholstery, the binding of books, etc.

For these reasons gas in which the products of combustion were not entirely removed had its disadvantages when used in habitable spaces. This objection is by no means as formidable as it used to be owing to the improved technique in the gasworks.

The matter is of some importance in connection with the so-called flueless gas heater, in which gas is consumed in a heating appliance and the products of combustion are discharged into the room. This has the great advantage that the efficiency of the appliance is nearly 100%, but it still has the disadvantage, much smaller now than it used to be, that any residual sulphur is discharged into the room.

It is a matter of some controversy as to whether such appliances are desirable or otherwise, and perhaps it is a reasonable view that in places where there is a good air change, as for example, in shops, where the door is likely to be frequently opened, such appliances are permissible, while they are probably inadmissible in the best applications in large offices, where the air change is likely to be small.

The price of gas varies considerably in different districts and when gas used to cost about 8d. in London there were some districts in the North where it cost as little as 4d. per therm or less.

If a flueless heater is used, gas is used most economically and is therefore usually a cheap fuel. When the flueless heater is not admissible, then the cost of gas heating has to be increased owing to the inefficiency of the combustion and the appliance.

It must be remembered that the declared calorific value on which the gas is sold is the gross, and that as gas contains a relatively high percentage of hydrogen and methane (which contains hydrogen), it produces a relatively high percentage of water vapour in its products of combustion and that therefore its nett calorific value is lower than the gross or declared calorific value. This factor ought always to be taken into account in estimating the quantity of gas required to produce a given quantity of heat from a gas fire or a gas boiler. In very rough figures it may be assumed that the nett calorific value is approximately 90% of the gross calorific value. That of course depends on the characteristics of the particular gas in question.

One of the great advantages of gas is its cleanliness and convenience. There is no labour in the building in the way of unloading coal, stoking, as in the case of boilers, carrying it about, as in the case of anthracite and other stoves, open grates, etc. There is no ash to remove, less dust settles on horizontal surfaces, it is easily adaptable to thermostatic control and it can be used for heating domestic hot water with automatic shutting on and off.

It therefore has a high convenience value and in any fair adjudication as between it and the solid fuels the labour saved by the use of gas ought to be given its fair value in the circumstances of any given case, rather than just to compare the cost per therm without such comparison.

We may fairly look upon gas as a refined fuel which, for the reasons mentioned, should be worth more per therm than the solid fuels in their unrefined and less convenient forms.

(9) OIL

Before the war many modern heating installations were fired with oil. These included, for example, such buildings as the Bank of England and the Head Offices of Lloyd's Bank, Martins Bank, Glyn Mills Bank, South Africa House, India House, etc.

During the war it was obviously nationally undesirable to bring oil into the country for such applications when it could only be done at the risk of ships and human lives, and creosote-pitch, a home produced fuel, replaced it in a large number of cases. With the more recent shortage of coal, however, there has been a Government sponsored programme of conversion from

FUELS AND SOURCES OF HEAT

coal to oil, with the result that oil firing has again become widely adopted for heating and industrial steam raising.

Oil has the great advantage of flowing out of the earth spontaneously when suitable wells have been sunk for the purpose in the appropriate places, and its transport by long pipe-lines and tankers is convenient and cheap; as also is its delivery to buildings where proper provision has been made by way of tanks with pipes having outlets in the streets to which the oil tanker wagons can conveniently be connected.

It shares with gas all the advantages of running on thermostatic control with practically no labour and no handling. It burns with a smokeless flame (except when something goes wrong with the burner, when the smoke can be so dense as to make it the standard material for naval smoke screens).

The calorific value of oil is approximately 19,300 B.T.U. down to 18,900 B.T.U. gross, depending on the source, while the nett calorific values vary from about 18,200 B.T.U. down to about 17,800 B.T.U.

The cost before the war was about 80/- per ton and at that figure its cost was about 2·4d. per therm, assuming 100% efficiency of combustion and appliance. It therefore compared very favourably with all other fuels when its convenience was taken into account and was a good deal lower than the cost of gas.

On the other hand its use in boilers requires the installation of tanks and blowers and oil firing apparatus, whereas gas is delivered as it is required and can be burnt without these accessories.

The cost of oil is now about 180/- per ton but the cost of other fuels has risen also and is still rising so that comparisons are at the moment not capable of generalisation.

(10) ELECTRICITY

Electricity is not perhaps strictly a fuel, but it is certainly a method of producing heat, and of all the various fuels and heat-producing forms of energy it is unquestionably that which combines the highest appliance efficiency with the greatest degree of cleanliness, convenience and ease with which it can be automatically regulated. This can be done with an entire absence of labour, being turned on or off at will, whereby considerable economy in its use can be effected.

For intermittent heating it is supreme, though gas approaches it closely. Thus, for the purpose of dressing and undressing, an electric fire can be turned on for a quarter of an hour only, whereas a hot water radiator would have produced little effect unless it had been on some two or three hours previously. Here then, its economy of use is obvious.

Unfortunately these great advantages are bought at a cost which, for some other purposes, such as basic heating, i.e., the maintenance of a continuous warmth throughout a house or building, often renders it somewhat expensive.

This relatively high cost is due principally to the fact that when the energy of coal is converted into electricity at the generating stations a large percentage of this energy is lost in the form of low temperature heat which goes to waste into the river or the cooling towers from the condensers into which the steam from the turbines is discharged.

In the best generating stations only about 25% of the energy contained in the coal is converted into electricity. In other words, roughly some 4 tons of coal have to be burnt to produce the equivalent heat of 1 ton of coal in a building, and in stations less efficient than the latest large power stations attached to the grid, conditions are even worse in this respect.

Having regard to these factors and to the necessary charges for capital amortization and interest on the relatively high costs of generation stations, transmission lines, sub-stations, cables, as well as management costs, it is not surprising to find that electricity is often charged at prices varying between 1d. and 2d. per unit for peak load use and figures of the order of $\frac{1}{2}$ d. for off peak load use.

Perhaps these terms need explaining.

Electricity cannot be stored and it therefore has to be produced at the same rate as it is consumed. The demand, naturally, varies considerably at different times of the day. Thus there is usually very little demand between midnight and seven o'clock in the morning and then the demand increases to a high value between 8 and 10 o'clock, when people turn on their electric cookers, lights and fires, and when the industrial load comes on. The loading usually reduces between ten and twelve o'clock, when there is frequently another peak between twelve and two o'clock associated with the mid-day meal.

There is frequently a third peak in the evening between

FUELS AND SOURCES OF HEAT

seven and ten o'clock, associated again with cooking and the heating and lighting of rooms when people are resting.

The magnitude and times of these peaks varies a good deal in different districts according as to whether the load is mainly domestic or mainly industrial.

Any additional demand when the peak load is on, not only involves additional expenditure in fuel, but also involves the installation of more plant in the way of boilers, engines, transmission lines, etc., to which the electricity consumed has to bear its proper contribution.

If, however, electricity can be taken at periods between the peak loads, then additional electricity can be supplied from the generating station without requiring additional plant, and it is recognised by all the companies that such electricity, under suitable arrangements and safeguards, be supplied at lower rates which are known as the *off peak rates*, in which no contribution towards the plant need be calculated in the assessment of the cost.

This cheaper electricity, for which the demand is discontinued at peak load periods, is known as *off-peak load supply*.

Some buildings can be suitably heated electrically by the installation of thermal storage vessels containing water. This is heated by immersion heaters or in some other way during the non-peak load periods and the supply is cut off during peak loads.

There is usually sufficient storage provided so that a radiator system can be heated by water circulating from these storage cylinders as required throughout the day, notwithstanding the fact that the heating of the water is intermittent and takes place when it suits the supply companies best to do so, i.e., usually through the night with a topping up period in the daytime off-peak period.

The heating of Earls Court Exhibition is perhaps the largest installation of this kind in this country and will be referred to later.

In this case the charge for electricity was less than $\frac{1}{4}$ d. per unit, but this was quite exceptional and was a pre-war rate. To-day it is doubtful whether a charge of much less than $\frac{3}{8}$ d. would be made in any thermal storage installation.

Many areas of electricity supply are, however, served by companies willing to supply at a rate of $\frac{1}{2}$ d. per unit, without restriction to off-peak periods, when electricity is taken for

heating domestically. To this, however, has to be added a quarterly standing charge, depending usually on the floor area, and a wartime increment based on the price of coal. The latter however is never likely to be reduced.

When these are taken into account the electricity seldom costs less than about $\frac{3}{4}$ d. per unit, or about double the price sometimes obtainable with thermal storage.

Most industrial consumers have to pay more than this and commercial buildings and factories using peak load electricity are usually charged rates varying from 1d. to 2d. per unit, depending on their load factor and the circumstances of the supply.

To convert these into values which are in any way comparable to the costs per therm referred to in connection with the above mentioned fuels it should be noted that electricity at 1d. per unit is equivalent to 29·2d. per therm and of course at other rates *pro rata*, so that with thermal storage at $\frac{3}{8}$ d. per unit it would cost about 11d. per therm, while domestic heating at $\frac{3}{4}$ d. per unit, all in, would be 22d. per therm.

It has already been mentioned that these figures are not directly comparable with the costs per therm of the heat contained in the various fuels because the electricity in the building can be converted into heat with practically no loss, i.e., at 100% efficiency, whereas practically all the other fuels, except gas in flueless heaters, have to be multiplied by their appropriate appliance efficiencies before figures can be obtained which are in any way comparable.

Furthermore, for any fair comparison, allowance has to be made for the economy associated with electricity when it is used for intermittent use only and for the saving in labour and its general convenience. This should certainly be given a high convenience value but it depends on the circumstances of each particular case.

Electricity also, except in the case of thermal storage installations, requires no space for boilers, fuel storage, fireplaces, chimney shafts, etc. and so enables a higher proportion of the available cubic content of the building to be used for productive purposes. In the case of cheap buildings on open sites, such as schools and factories, the latter may not be a very important consideration but it is certainly one which ought to be properly evaluated and considered in any fair comparison.

FUELS AND SOURCES OF HEAT

In many congested sites where values are high, or where extensions cannot be made, it may prove to be a very important consideration.

Nevertheless, it remains true that for general basic and continuous heating of most buildings, electricity is to-day usually the most expensive method, and its use for these purposes would generally require a good deal of justification. For intermittent heating in bedrooms and any other places likely to be required in short duration, a good case can much more easily be found for its adoption.

(11) DISTRICT HEATING

Though in a work of this character it will be impossible to go into the merits or otherwise of district heating, it is perhaps worthy of note that investigations are in process of being made into the economics of district heating, i.e., the distribution of heat through the streets in mains by which the various buildings giving thereon would receive their heat by pipe connections. Where such stations are combined with electrical generating stations higher overall efficiency can be obtained and coal is saved.

It is already clear that such installations are more likely to be economic where the buildings served by the mains are in areas of high density of occupation and where all the buildings take their heat in this way. This can no doubt most conveniently be arranged in the new areas such as those areas requiring to be rebuilt as the result of the "blitz" and in which commercial buildings of many storeys will be erected. Especially is this the case where the municipality owns the land and can compel the incoming tenant to take the heat as part of his lease arrangements thus assuring a considerable load.

Such systems have already been extremely successful abroad and are only mentioned here by way of showing that some of the heat losses at present associated with our generating stations may perhaps be reduced in the future if only in some stations.

(12) STORAGE

In considering the relative advantages of various fuels consideration must be given to the space occupied by the heat producing apparatus and the fuel storage. Thus, it is obvious that whenever coal, coke or patent fuels are used there must be boiler houses and fuel storage spaces provided.

HEATING AND VENTILATING

In connection with this it is perhaps of interest to note that the cubic feet required for fuel storage per ton vary as follows:

Oil	40 cu. ft.
Anthracite	45 ,,
Bituminous coal	50 ,,
Coke	90 ,,

while the potential heating value in B.T.U. per cubic foot of fuel vary as follows:

Oil	1,000,000 B.T.U.
Anthracite	700,000 ,,
Bituminous coal	563,000 ,,
Coke	300,000 ,,

It will be seen from this that oil requires the least storage and coke the maximum storage of any of the solid and liquid fuels.

From the consumer's point of view, gas used direct, as in fires, and peak load electric heating used for electric fires, etc. have the great advantage of requiring neither storage nor boiler rooms or their equivalent in the building, but as we have shown, these advantages have to be paid for by a somewhat enhanced cost.

Gas differs from electricity in that it is stored at the gasworks in the gas-holder tanks so that gas companies are not very interested in questions of peak load or at what time the gas is taken, as their holders will carry more than a day's supply thus smoothing out the load to a uniform production over the twenty-four hours.

If this were so with electricity, its price could be considerably reduced as many more units could be supplied for a given capacity of station, but as we have seen, this is not the case.

(13) COST OF PRODUCING HEAT

Table 5 gives the cost of producing one therm by various methods and with assumed coal costs and combustion efficiencies, and Table 6 gives the amount of coal consumed in so doing.

FUELS AND SOURCES OF HEAT

TABLE 5
DOMESTIC HEATING AND H.W.S. COST OF PRODUCING
ONE THERM BY VARIOUS METHODS

System	Cost coal		Total cost at consumer's premises	B.T.U.	Cost per therm in fuel	Effic. of use	Cost per therm useful heat
	Bulk del. per ton	Distrb. small consumer per ton					
DOMESTIC HEATING							
Open coal fire ..	30/-	30/-	per ton 60/-	12,500	2.57d.	25%	10.28d.
Coke boiler and radiators ..	30/-	30/-	60/-	„	2.57d.	50%	5.14d.
Anthracite stove	—	—	80/-	14,000	3.05d.	70%	4.35d.
			per therm				
Gas fire ..	30/-	—	8d.	100,000	8d.	50%	16.0d.
Gas boiler and radiators	30/-	—	8d.	„	8d.	70%	11.5d.
			per unit				
Electric fire ..	30/-	—	½d. 1d.	3,415 „	14.6d. 29.2d.	100% 100%	14.6d. 29.2d.
			per therm				
District heating (combined heat & electric station)	30/-	—	about 5d.	—	—	100%	about 5d.
District heating (straight heating station) ..	30/-	—	about 6d.	—	—	100%	about 6d.
HEATING AND H.W.S. COMBINED							
Combined boiler and stove ..	30/-	30/-	per ton 60/-	12,500	2.57d.	70%	3.7d.
DOMESTIC H.W.S.							
Coke boiler ..			60/-	12,500	2.57d.	50%	5.14d.
			per therm				
Gas boiler ..			8d.	100,000	8d.	70%	11.5d.
Gas instantaneous heater ..			8d.	100,000	8d.	60%	13.3d.
			per unit				
Electric heater			½d. 1d.	3,415 „	14.6d. 29.2d.	100% 100%	14.6d. 29.2d.
			per therm				
District heating (combined station)			about 5d.	—	—	100%	about 5d.
District heating (straight heating station) ..			about 6d.	—	—	100%	about 6d.

HEATING AND VENTILATING

TABLE 6

DOMESTIC HEATING AND H.W.S.-COAL CONSUMED TO PRODUCE ONE THERM BY VARIOUS METHODS

System	C.V. B.T.U. per lb.	Effic. at Works	Coal to produce 1 therm	Effic. of use	Lb. of coal per useful therm
DOMESTIC HEATING					
Open coal fire	12,500	—	8	25%	32
Coke boiler	12,500	76%*	10.5	50%	21
Anthracite stove	14,000	100%	7.15	70%	10.2
Gas fire	12,500	76%*	10.5	50%	21
Gas boiler	12,500	76%*	10.5	70%	15
Electric fire	11,500	20%	43	100%	43
District heating (combined station)	11,500	108%	8	100%	8
District heating (heating only)	11,500	61%	14.2	100%	14.2
HEATING AND H.W.S. COMBINED					
Combined boiler and stove—					
Using coal	12,500	100%	8	70%	11.1
Using coke	12,500	76%*	10.5	70%	15
DOMESTIC H.W.S.					
Coke boiler	12,500	76%*	10.5	50%	21
Gas boiler	12,500	76%*	10.5	70%	15
Gas instantaneous heater	12,500	76%*	10.5	60%	17.5
Electric heater	11,500	20%	43	100%	43
District heating (combined station)	11,500	108%	8	100%	8
District heating (heating only)	11,500	61%	14.2	100%	14.2

* Overall gas-works efficiency including all products.

Chapter III

HEAT EMISSION APPLIANCES

THESE are divided into two main heads, those associated with a central system and those where local heating in the various rooms of the building occur.

Thus, the former includes, for example, hot water radiator systems whether supplied with heat produced from electricity or any of the other fuels, while the latter includes the open fireplace, the various types of stoves, gas fires, electric fires, etc.

We propose to say a few words about the latter category first.

LOCAL APPLIANCES

(1) OPEN FIREPLACE

The Englishman, being a very conservative person, is very attached to his open fireplace, and it is no part of the duty of the author to argue with him on this matter. It is perhaps fair to mention a few of the considerations which arise in connection with its use.

The open coal fire unfortunately has a very low thermal efficiency. The Egerton Committee gives this as varying from 15% to 25%. If we take the middle figure of 20% it means we are burning five times as much fuel as we need, which means that the coal consumption is roughly the same as if we were using electricity where a somewhat similar efficiency of production and distribution applies.

Actually it is even rather worse than this because an open fireplace, as normally constructed, is only free from smoking out the room when the chimney shaft is a good deal bigger than is theoretically necessary, and a great deal of air is discharged up the chimney, which has to be replaced with cold air which finds its way into the room through the porous walls, through cracks in doors and windows.

If this replacement of the air did not occur the fire would go out.

HEATING AND VENTILATING

The heating of all this additional air from the outside temperature at which it enters to the temperature of discharge from the fireplace, represents a large amount of additional heat which the fire has to provide, so that compared with the electric heating of a room it may be said that the low appliance efficiency of the fireplace roughly balances the low generation efficiency and transmission of the electricity, but the fireplace has to produce more heat to compensate the heat wasted in excess ventilation.

It may be argued that this excess ventilation will ensure a freshness of atmosphere and an adequate air change and so avoid stuffiness. This is no doubt true. On the other hand we are all familiar with the state of affairs when the door or window is on the side of the room remote from the fireplace and when a person sitting in front of the fire has his face scorched by the fire while his back is subjected to cold draughts, a feature which is usually only enhanced when it is attempted to compensate by putting more coal on the fire and enlarging the source of irritation.

The draught can of course be eliminated to a large extent if the windows are really close fitting and if the air comes in from an opening under a door giving on to a corridor or lobby which is itself heated by radiators or otherwise, so that the incoming air is already warmed. In such cases the fire is really mostly for supplying a centre of attraction, a focus for the social gathering, and a source of radiant heat over and above the basic warming of the room in question.

With an appliance efficiency as low as 20% the amount of coal required to produce a useful therm is 40 lb, roughly speaking, the same as when electricity is used in the room, and from a coal conservation point of view both these are the highest of any of the appliances normally used for heating even in England.

The open coal fire can be considerably improved in design and the Coal Utilisation Research Association are engaged in such improvement. This, however, is a sort of half-way house between an open coal fire and a closed stove.

(2) STOVES

On the Continent, where they are perhaps more economical and where they certainly have severer winters and where the

HEAT EMISSION APPLIANCES

cost of fuel is frequently much higher, or used to be so, the open fireplace is practically unknown, and most rooms, where there is no central heating, are heated by stoves of various types, some of them very elaborate and large, so as to give a considerable heating effect with a low temperature of surface which seems to produce more comfortable conditions than a small surface heated to a high temperature.

In this country many excellent stoves have been in use for a considerable number of years and they all have much higher efficiencies than the open coal fire. Thus the anthracite stove usually has an efficiency of about 70% whereby the coal required to produce a useful therm in the room comes down to about 10 lb, a very important factor for those who have the coal conservation of our country at heart.

In other words, if all the coal at present used in open fires were used in stoves of this type we could do most of our domestic heating with one-quarter the present coal consumption.

There are many other useful types of stoves of which it is perhaps permissible to mention the *Cosy Stove* which can be opened and used as an open fire.

We are all familiar with the slow combustion coke stove, usually of circular design, made of cast iron top and bottom and lined with firebrick. The use of this is usually confined to foremen's huts and temporary huts for military and other purposes, though this type of stove did reach its highest peak of achievement when it for many years heated St. Albans Abbey, for which, however, it was eminently unsuitable. Unfortunately it still heats many other cathedrals and churches, though no one could suggest that it is well adapted for this purpose.

Many War Office establishments and large industrial works are heated by the *Tangye* coke-burning stove which is also excellent for its purpose.

Hitherto, however, it may be said that the anthracite and *Cosy* stoves are perhaps better known than any others for purely domestic application, though there are several new ones on the market and there is no reason why these should not be just as good.

For those who are not wedded to the open fireplace, stoves of this type are certainly much more economical in fuel and require less frequent bringing of coal to the fire, less frequent making-up of the fire, and produce less dirt and dust. They are

HEATING AND VENTILATING

also greatly superior from the point of view of reducing smoke pollution and they can be left on all night so as to save re-laying the fire in the morning.

(3) GAS FIRE

Gas can be used for direct heating in buildings either in gas fires or as gas radiant panels. Everyone is familiar with the ordinary gas fire in which the gas is burnt in Bunsen burners which heat fireclay radiants. The latter become incandescent and send out radiant heat into the room.

The design of appliances of this kind has improved very much in the last twenty years and in some of these improved patterns the burner is of the luminous, not the Bunsen type. These are silent in operation.

The efficiency of a good gas-fire may be as high as 50%, though many of the old ones are considerably lower.

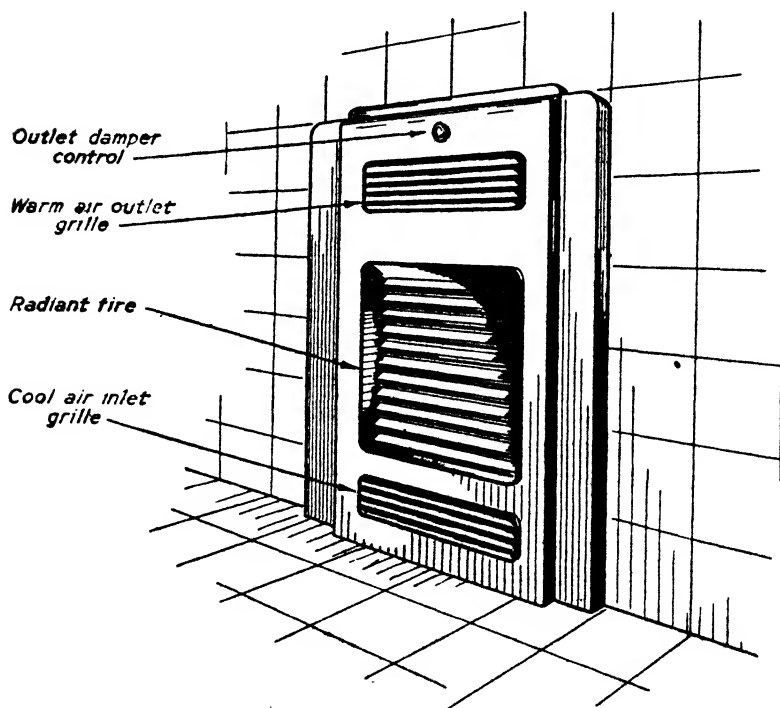

FIG. 5 GAS FIRE WITH SECONDARY CONVECTOR EFFECT

HEAT EMISSION APPLIANCES

A very recent type in which the flue gases are circulated round a metallic casing which contains the gas-fire in the middle is said to have an efficiency as high as 60%. This is due to the heat recovered from the flue gases and given out as radiation and convection from the surround, and no doubt other developments in this direction will follow now that the end of the war permits improvements in appliances to be considered.

With an efficiency of 50% the gas-fire consumes about 21 lbs. of coal to give a useful therm and so consumes only one-half as much coal per therm as compared with the open coal fire or electric heating, but on the other hand, approximately twice as much as the closed stoves previously referred to.

Gas radiant panels sometimes consist of porous fireclay through which the gas passes, under considerable pressure, and is burnt on the surface, so emitting a radiant heat at about cherry-red temperature. These are very useful for schools, churches, halls, etc., where large volumes of air are available and a good air change can be arranged for, as of course the flue gases are discharged into the room. Hence the appliance efficiency is very high, nearly 100%, but the disadvantage of the discharge of flue gases into the room would be quite considerable if the use of the hall, etc., were unduly prolonged, or if the air change provided for were inadequate.

There are other gas panel radiators somewhat similar to the ones just described, but provided with a metallic face, heated to a much lower temperature, round about 500° F., which have much the same properties as those already described. These radiant panels, whether of the luminous or non-luminous type, are usually mounted 12 ft. to 15 ft. above the ground and are usually set at an angle pointing towards the assembly. They obviously have the great advantage, as compared with the gas-fire, that people a considerable distance from the wall can immediately get the full and direct effect of the radiation.

Another type of gas heating apparatus is that where gas flames are allowed to burn in a metallic casing, somewhat resembling a radiator in shape, and perhaps being connected to a flue. In the latter case they may have an efficiency of about 50% and are free from any objection on the score of fumes, or they may discharge their products of combustion into the room, in which case the efficiency is nearer 100%, but what has already been said about flueless heaters will apply.

(4) ELECTRIC FIRE

The electric fire is usually either in the form of a panel containing fireclay elements with coiled resistance wires wound on them whereby a cherry-red heat is produced, or it consists of electric resistance wires wound on a rod, usually about one foot long, and placed in the centre of a parabolic reflector, usually chromium plated.

There are many other types, being variants of the two above mentioned.

They all have an appliance efficiency of 100% and would be the ideal solution to all heating problems if only electricity were cheaper.

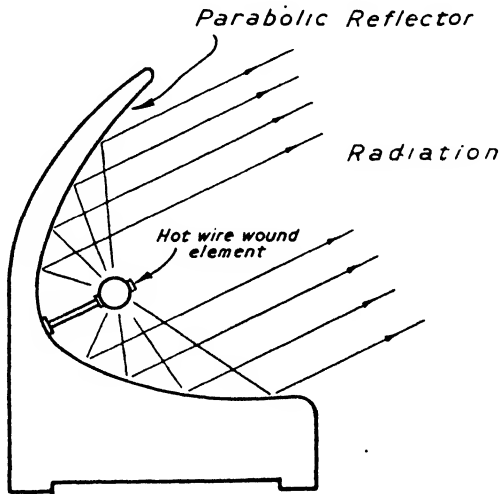

FIG. 6 REFLECTION TYPE ELECTRIC FIRE

Those of the reflector type have the property of concentrating the radiation into a small beam which is very advantageous if it is only one or two persons who require local heat, but it is not such a happy solution of the problem where a whole roomful of people requires to be heated.

In other words, their heat is very localised.

(5) ELECTRIC PANELS

This type can also be used in the same way as the gas radiant heater above referred to, by mounting at a height of 12 ft. to

HEAT EMISSION APPLIANCES

20 ft. above the floor and being directed in a diagonal downward direction on to the assembled company.

There are various types of electric panels also specially designed to be used in this latter manner, some working at a very high temperature, such as a red heat, and others of a non-luminous type at a much lower temperature.

(6) ELECTRIC WALLPAPER

A recent development in electric heating is the manufacture of wallpaper containing resistance wires, such as the *Dulrae*. This paper is pasted up on the ceiling and connected to a source of electricity with a voltage of 230 volts or thereabouts. The resistance wires warm the ceiling up to a temperature sufficient to keep the room comfortable.

The physiological effect of this type of heating is exactly similar to that of hot water panel heating, which will be referred to later.

Most of the heat is emitted as radiant heat, since no doubt it warms the air in contact with the ceiling, which air usually cannot get away and remains as a blanket of air trapped under the ceiling. Thus, little convection can occur. This system has of course the advantage that no appliance is visible.

(7) ELECTRIC HEATING TUBES

Another system of heating by electricity is with the use of tubular electric heaters, usually fixed on the walls at about 6 in. above the floor. These are usually kept at a moderate temperature only and arranged to consume about 60 watts per foot run. They have the advantage of being safer than the ordinary electric fire, as the latter will of course set alight any readily inflammable material, such as dresses, with which they may come into contact, while the tubular heaters are at too low a temperature for this to occur.

They are frequently used in small garages and glasshouses for keeping out frost but have also been used in offices and other places where radiant heat is not required.

Owing to the low temperature at which they work they have a long life and are fairly sturdy in construction.

CENTRAL HEATING APPLIANCES

(8) CIRCULATION OF HOT WATER

All the appliances previously referred to can be used without any heat-producing unit in the building, outside the appliance itself, and the only connections required are, in the case of electricity, to appropriate mains, in the case of gas appliances, to a gas pipe, and in the case of stoves and fireplaces, the only necessity is that they be built into a suitable flue.

Central heating is normally understood to mean a system whereby a boiler burning either coal, coke, oil, or gas, produces heat in some central or convenient position, frequently in the basement, and is connected to heat emission apparatus such as radiators, convectors, panels, etc., by a system of pipes in such a way that when the whole system is filled with water this water is heated in the boiler and circulates through the pipes to the radiators and other heat-emitting appliances, where it gives up a large proportion of its heat and returns to the boiler at a lower temperature, so setting up a closed system and a continuous circulation. Use is usually made of the lower density of hot water in the mains which rises from the boiler to the radiators, etc., as compared with the greater density of the cooler water which returns from the radiators, etc., to the boiler to set up a *natural circulation*. When this is done it is necessary that the radiators shall be above the boilers for otherwise no natural circulation will occur.

Such a natural circulation works quite well on small installations and even on quite considerable ones, provided the pipe sizing is calculated accordingly, but on big installations it is usually better to install circulating pumps for the following reasons:

- (a) The size of pipes can be much reduced.
- (b) The circulation is more rapid and more positive and is independent of the temperature of the water, and
- (c) The system is not so sluggish in starting up.

It stands to reason with natural circulation that when the boiler is cold there will be no circulation at all and that until the boiler has been heated up to a temperature approximating to 180° F. there will be little sentient effect on the radiators.

HEAT EMISSION APPLIANCES

With an accelerated system, i.e., a system embodying circulating pumps, the water begins to be circulated as soon as the boiler is lighted and the pump started up, and heat is therefore transmitted throughout the building much more quickly.

A system of this kind is known as a central heating system, and any kind of fuel may be consumed in the boilers and any kind of emission apparatus used in the rooms to be heated.

Water is however not the only medium used for transmitting heat from the central heating apparatus to the building. Steam, for example, is frequently used.

The relative advantages of water and steam may perhaps be roughly summarised as follows:

Steam has the advantage that—

- (a) Owing to its higher temperature a smaller emission surface in the radiators, etc. is required to give the same heating effect.
- (b) The time lag on the apparatus as a whole is less owing to the absence of a large volume of water which, in the water system, requires to be heated up before the designed emission can be achieved.
- (c) It is usually cheaper, especially in cold climates.

As against this, however, water has the following advantages:

- (a) It is much more easily regulated to the requirements set by external temperature conditions. With hot water, the temperature in the radiators, etc. can vary anywhere from 100° to 200° as required, but with steam the temperature in the radiators, etc. is usually either 212° or some higher temperature. It is theoretically possible to regulate the temperature in a steam radiator by the adjustment of the valve, but in practice the setting has to be so fine as to be almost impossible to achieve.

This objection to steam does not apply in the case of the vacuum system which works at or below atmospheric pressure and uses a pump to return the condensate.

- (b) The steam systems are frequently noisy, whereas water systems are not.

HEATING AND VENTILATING

- (c) With steam systems careful arrangement of the pipes is necessary to carry the condensation back to the boiler, whereas in a water system, provided provision is made for air venting, the running of the pipes is usually simpler.

Another objection to steam is that the high temperature of the radiator surface seems to produce an unpleasant stuffy effect, thought to be due to the roasting of the organic matter in the dust which settles on it and which is carried by the convection currents into circulation throughout the room.

Steam is generally used in very cold countries, but hot water is usually more suitable to conditions in England and other countries of more equable climate.

Air also can be used as a circulating medium, and the Roman system whereby warm air conducted heat from the fire through channels in the floors and walls is well known. This air did not communicate with the air inside the rooms and therefore is not to be confused with the plenum system of ventilation in which air is heated in a central position and then blown as hot air into the rooms.

Liverpool Cathedral has recently been heated by circulation of air in ducts in the floors, but with this exception it is not usually a convenient method, and is little used for ordinary industrial applications.

It is obvious that owing to the low specific heat of air an enormous volume of air has to be circulated to give a specific quantity of heat as compared with the volume of steam or water.

(9) PIPING

Central heating systems were first used in connection with greenhouses and the original heating engineers were greenhouse specialists to begin with.

The heating systems were not dissimilar to those which are still used for many greenhouses.

Such systems consisted of a cast iron coke boiler connected to two or three cast iron pipes running round the walls of the greenhouse, generally about 4 in. diameter, and returning to the boiler.

The heating was frequently sold at so much per square foot of radiation, i.e. so much per square foot of pipe surface.

HEAT EMISSION APPLIANCES

Cast-iron pipes are still one of the cheapest forms of heat emission appliances and we find them also used in underground trenches covered with gratings in many old churches and even in cathedrals, as in Canterbury.

Such systems have the advantage of cheapness, but they have many disadvantages, notably the fact that dust falls on to the pipes from the boots of people walking on the grating, and, settling there, is carried up when the pipes are heated, and mingles with the general atmosphere to produce an unpleasant stuffy smell. It is also very unhealthy.

Cast-iron pipes in trenches are difficult to clean and are consequently seldom, if ever cleaned, so that in due course the pipes become covered with a very thick layer of dust by which their emission is greatly reduced.

Cast-iron pipes have the advantage of being fairly resistant to corrosion, and with certain waters would have a longer life than mild steel pipes. This applies more to hot water supply systems than to heating systems, but the joints are difficult to make and maintain and they are not suitable for considerable pressures.

In modern work we should generally prefer mild steel piping for a heating installation owing to its greater strength and reduced brittleness and its neater finish and smaller thickness.

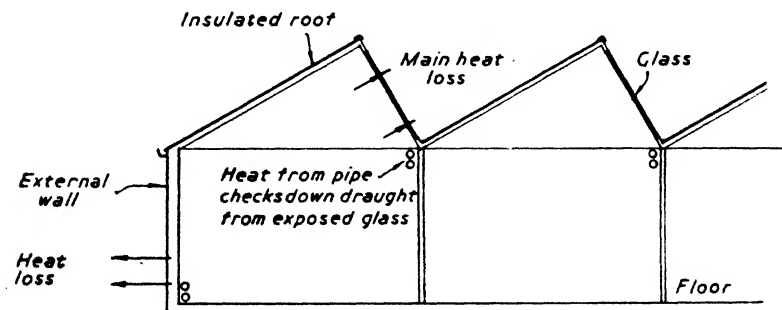

FIG. 7 HEATING A NORTH-LIGHT FACTORY BY EXPOSED PIPES

In single storey north-light factories, down-draughts from the north-lights are often counteracted by lines of piping, generally about 4 in. diameter, running at the level of the ties of the trusses under the north-lights, and with this arrangement no obstruction of the floor underneath occurs and the height of the pipes which act as radiation surface will frequently enable the boiler to

be above ground and still maintain a natural circulation, which of course, as we shall see later, requires the centre of gravity of the emission surface to be at an elevation above the centre of gravity of the heating surface in the boiler.

The use of piping as useful heating surface is also common in schools and offices and the pipes usually act both as radiation surface and as a means of conveying the hot water or steam.

They may also be combined with radiators so that part of the radiation or convection comes from the radiators and part from the pipes which connect them, the pipes in such case being of course not lagged but used as useful heating surface.

Mild steel pipes can be jointed either by screwing or by welding.

It is of great importance where welding is used to ensure that the inside of the weld is not left with jagged projections. These greatly obstruct the flow. The welding of pipes of this kind has now reached a high degree of efficiency in the hands of capable operators and both electrical and gas welding apparatus is used.

Even when the water is very corrosive, so that copper pipes have to be used for the hot water supply system, it is still usually quite satisfactory to use mild steel pipes for the heating circuit, assuming that the heating circuit is a closed system kept separate from the hot water supply, as it should be, since in this case the water is continually circulating and the corrosive properties of the water are quickly neutralised and after that have no deleterious effect on the piping.

(10) RADIATORS

Everyone is now familiar with the ordinary radiator which usually consists of cast-iron and may be two, three, four or even six columns wide and of varying heights, some suitable for putting under low window-sills and others high for standing against walls.

The early designs of radiators had very large sections, which we generally found to give a clumsy appearance in living room or office, and a later design, known as the Classic, Pall Mall or Royal, have much smaller waterways and generally give a much neater appearance.

Radiators usually give about 80% of their emission in the form of convection and about 20% as radiation, but a good deal depends on their situation and arrangement.

HEAT EMISSION APPLIANCES

Radiators are usually fitted with a valve by which they can be shut off, and a regulating valve whereby the whole system can be adjusted. They also have a small air-cock at the top whereby air can be allowed to escape.

The ordinary radiator gives about 150 to 180 B.T.U. per hour per sq. ft. of surface when the difference in temperature between the water and the air is 100° , as for example, when the room temperature is 65° F. and the mean temperature of the water 165° F., but it varies considerably with different types of radiators.

The emission varies approximately as the difference in temperature between the mean water and air temperatures raised to the power of 1.3, so that with a 70° temperature

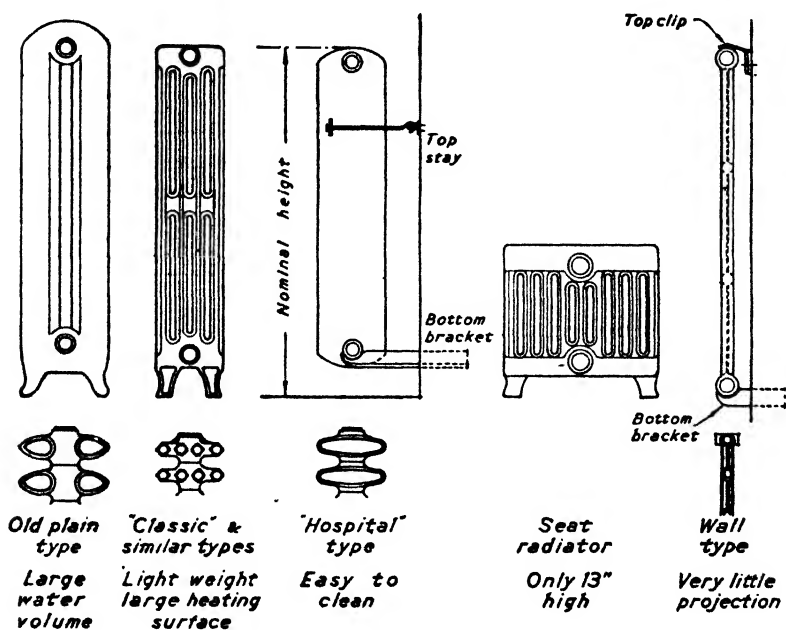

*"Classic" and similar types are of varying widths depending on number of columns (2, 3, 4, 5, or 6 - 4 column shown).
 "Hospital" type are in widths from 3" to 7 1/4".
 Both groups are in varying heights from 18" to 36" and may be with or without feet*

FIG. 8 SOME TYPES OF CAST IRON RADIATORS

HEATING AND VENTILATING

difference it might be 116 B.T.U., 100° F. temperature difference 185 B.T.U. and 120° F. temperature difference 234 B.T.U. per hour.

There are specially shaped radiators suitable for hospitals, so that cleaning can be more easily performed, and for these details of radiators the reader should consult the maker's catalogues which give this information in greater detail.

It has been the practice on the Continent for the last twenty years or so to use radiators made of thin pressed steel. These are much lighter than the cast-iron variety, and some people consider them neater. Steel radiators have a smoother surface and are therefore perhaps easier to keep clean, though this advantage tends to disappear when they are suitably painted.

The emission of radiators is considerably reduced when they are painted with aluminium or other metallic paint. When painted with ordinary paint the colour seems to have little effect.

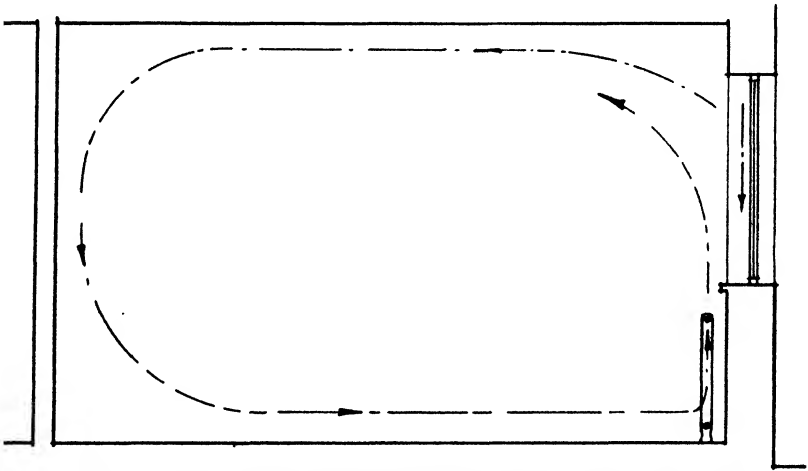

FIG. 9 CONVECTION CURRENTS IN ROOM HEATED BY RADIATOR

Radiators are generally stood under windows, and this is usually the best arrangement, as the uprising current of air counters the down-draught from the window. This will be seen from Fig. 9.

This position also avoids, as far as possible, the unpleasant dark markings on the walls which generally occur when radiators are stood against walls instead of under windows. These markings

HEAT EMISSION APPLIANCES

are due, of course, to the upward air currents induced by the radiator which carry up with them the dust from the floor and brush it against the wall surface.

TABLE 7
RADIATOR DATA

Radiator Type	Height	Heating Surface in Square Feet		Length per Section
		Per Section	Per Ft. Length	
2 Column Classic or equivalent	in.			in.
	30	$1\frac{1}{2}$	8	2
	24	1	6	2
	18	$\frac{3}{4}$	$4\frac{1}{2}$	2
4 Column Classic or equivalent	36	$3\frac{1}{5}$	17	$2\frac{1}{4}$
	30	$2\frac{3}{5}$	14	$2\frac{1}{4}$
	24	2	12	2
	18	$1\frac{2}{5}$	$8\frac{2}{5}$	2
6 Column Classic or equivalent	36	5	$26\frac{3}{5}$	$2\frac{1}{4}$
	30	$4\frac{1}{10}$	$21\frac{4}{5}$	$2\frac{1}{4}$
	24	3	18	2
	18	$2\frac{1}{10}$	$12\frac{3}{5}$	2

This unpleasant effect can be mitigated by the use of a shelf over the radiator, but it is an essential feature of such a shelf, if it is to be effective, that it should have side pieces carried down a foot or so at the sides, otherwise the hot air escapes out at the two sides at the top and only concentrates the black marks at the sides instead of having them uniformly distributed along the length of the radiator surface.

Some people build an opening in the wall immediately behind the radiator, and this is usually provided with a grating on the outside to prevent access of birds, etc. and preferably a baffle plate on the inside with adjustable louvres so that the opening can be closed or opened at will.

The object of this arrangement is of course to permit the access of fresh air and to ensure its being warmed by passing over the radiator surface.

On the whole this arrangement must be looked upon as a rough makeshift and many people have discontinued its use.

The louvred baffles in high winds frequently make a rattling noise, and openings of this kind generally end their days by

HEATING AND VENTILATING

getting filled up with brown paper and dirt, since, when a strong wind blows on to the wall in question, the incoming draught may become quite objectionable.

It is generally best to depend for ventilation on the opening of windows or better still, a separate ventilation system where properly cleaned and tempered air can be introduced.

(II) CONVECTORS

Convectors are a special form of radiator where the emitting or convecting surface is put into a recess separated by a plate from the room and provided with a slotted opening at the bottom and at the top so that a current of air is sent up into the recess from the bottom opening, past the convector, and out at the top as a current of warm air. Some people consider them neater than the ordinary radiator and they do not protrude into the room.

The makers' catalogues will give the various types and their rated emission.

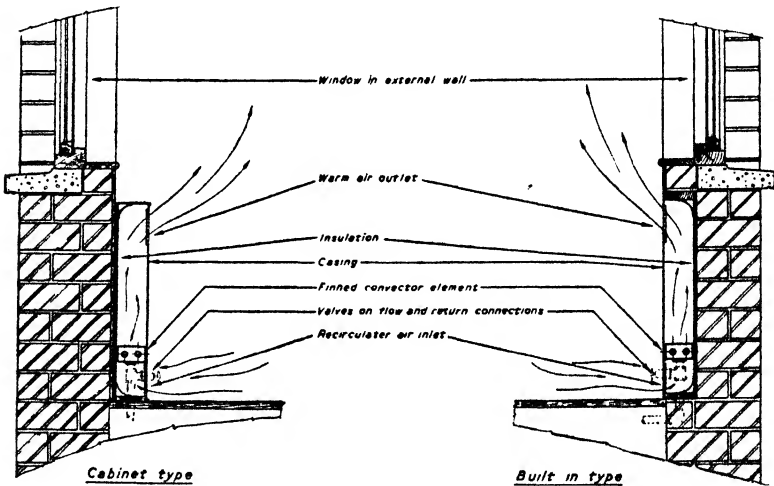

FIG. 10 TYPES OF CONVECTOR

Convectors are of two types; the cabinet type which stands out a little like a radiator but resembles a neat closed box apart from the gratings, and the wall type fitted into a recess with a front plate.

The former are more easily cleaned than the latter, by lifting the top they can be cleaned with a special brush.

HEAT EMISSION APPLIANCES

(12) PANELS

Panels are of various types. One type consists of a metal plate usually let in flush with the wall or ceiling and warmed by having waterways cast or welded on to the back.

The cast-iron variety is made by the radiator firms, but there are others made of steel, with back pipes welded on, which are made by heating engineers.

When fixed in walls and floors the emission is about 250 B.T.U. per sq. ft., when fixed in ceilings where no convection can occur, about 180 B.T.U. per sq. ft.

Panels of this type have the advantage over convectors of having no spaces at the back for collecting dirt, but some care has to be taken as to the finishing of the edges to the wall finish, as it must be remembered that the panel plates will expand and contract with variation of temperature, and a black marking results if a gap is left.

Metal panels, together with the previously-mentioned appliances, such as pipes, radiators and convectors, can work at any convenient temperature. With an ordinary low pressure hot water system the temperature is generally confined to about 180° F. With low pressure steam the temperature is usually about 212° F.

It is usually undesirable to go to higher temperatures since not only will some of the constructions not readily withstand

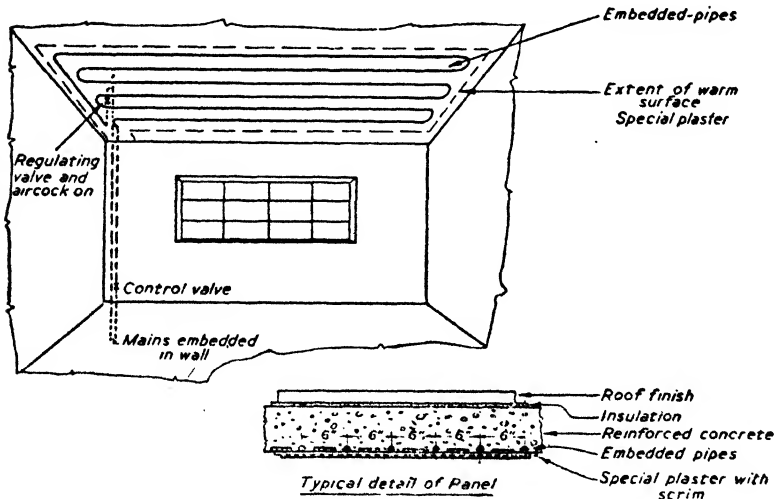

FIG. 11 EMBEDDED CEILING PANEL

the higher pressures which this involves, but high temperature emission surfaces frequently produce a stuffy feeling for reasons already discussed (*see p. 54*).

(13) EMBEDDED PANEL HEATING

Another type of panel which has been very extensively used in the last twenty-five years, and known as panel heating, consists of embedding behind the surface of the floor, wall or ceiling, pipes carrying warm water, these being subsequently covered by plaster and normal finish, such as paint.

The action in this type of heating is that the heat from the pipes is conducted by the concrete and plaster to the whole surface of the panel and a low temperature emission results.

This type of heating was used throughout in such important buildings as the Head Offices of the Bank of England, Lloyd's Bank, Martins Bank, etc. and presents an absolutely unbroken surface to the finish of the floor, wall or ceiling, which is generally architecturally desirable, and there is no risk of cracks or black markings of any kind when the work is really skilfully designed and executed and all precautions observed.

With this system it is generally desirable to limit the temperature of the water in the pipes to 120° F. or 130° F., in which case the temperature of the exposed surface of the wall, ceiling or floor is generally about 100° F. immediately opposite the pipe and about 90° F. halfway between two pipes. Higher temperatures are undesirable as there would then be risk of cracking.

In the author's practice he has generally laid the pipes at 6 in. centres, the pipes being usually $\frac{1}{2}$ in. or $\frac{3}{4}$ in. bore, and they are usually arranged in the form of a coil returned on itself at the two ends.

The panels in the case of ceiling panels are usually arranged near the outside walls where the windows and the chief radiation surface occurs. Such panels will generally extend some 4 to 8 ft. into the room, depending on the height of the room and the amount of exposed surface.

The panel pipes in the best work are, in the author's opinion, preferably made of thin copper and there should be no joints in the pipes except at the points where they are connected to the rising mains.

HEAT EMISSION APPLIANCES

In the case of steel pipes, these are usually welded at the end of each loop.

In the early development of this system, panel pipes were frequently applied to a ceiling and took the form of Compo, i.e., tin lead alloy, which after suspension from the ceiling, was then covered with plastering. This has in many cases proved quite unsatisfactory as the resultant expansion caused the plastering to become detached from the suspended floor. In the author's experience the panel pipes are preferably incorporated at the time when the floor itself is cast and not laid in the plastering. In this way the stresses set up by the expansion are taken in the strong concrete of the floor and not in the relative weak rendering which forms the plastering under the floor, and when arranged in this way it produces no tendency for the plastering or rendering to become detached from the floor itself.

When arranged in the manner previously indicated the total emission is usually about 90 B.T.U. per sq. ft. of ceiling surface, of which frequently about 70 B.T.U. is radiation downwards into the room below and the remaining 20 B.T.U. is conducted upwards into the floor above, but the exact ratio depends on floor level, floor construction, and various other factors.

(14) UNIT HEATERS

A system of heating large open spaces, usually but by no means invariably confined to factories, is by the use of unit heaters. These consist essentially of a radiator, like that of a motor car, generally consisting of piping with its outer surface enormously increased by the provision of finned elements, in combination with a fan which blows the air in the room past the finned surfaces which it therefore leaves at a greatly enhanced temperature.

Unit heaters may be heated by connection to steam pipes or water pipes conveying steam or water from a central boiler system. Steam is much more frequently used as the unit heaters can be smaller.

They can, however, also be heated locally by gas or electricity and are not then, properly speaking, parts of a central heating system.

Fig. 12 shows various arrangements of unit heaters in buildings of different types. They are generally arranged in one of the following ways.

HEATING AND VENTILATING

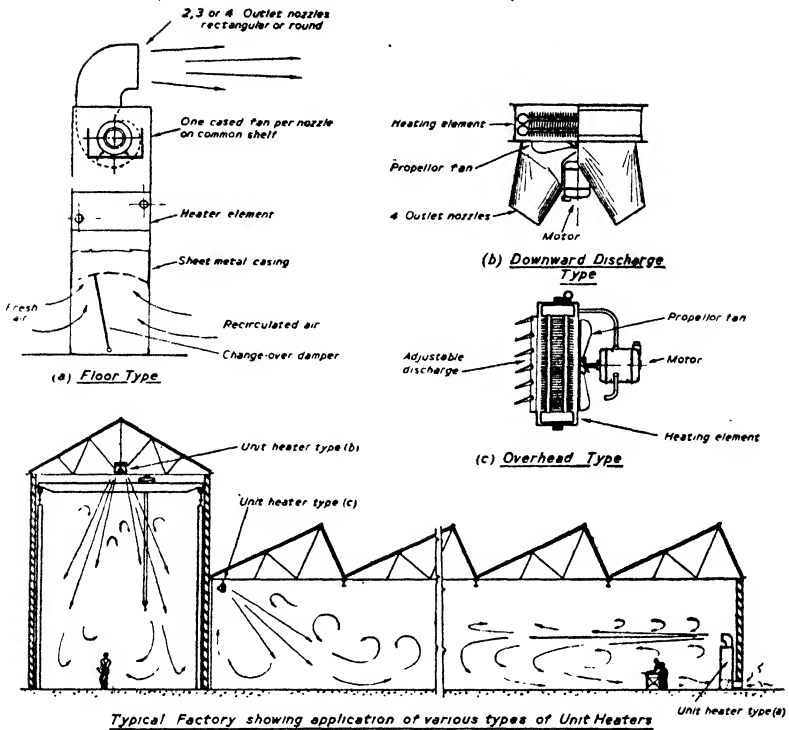

FIG. 12 TYPES OF UNIT HEATER

They can be placed standing on the floor, along the outside walls, spaced about 40 or 50 ft. apart and blowing out warm air into the room at a height of about 8 to 9 ft. above the ground, the air being generally directed horizontally and frequently producing a current of warm air which can be felt 50 ft. or so from the unit heater.

With this arrangement the unit heater is generally so arranged that it can either take air from the outside or from inside the factory, with a damper arranged to change over from one to the other.

When taking air from the factory it heats up the air content of the factory more quickly and with greater economy, but does not of course in itself produce an air change.

When connected with the outside air the unit heater has more heat to supply as the outside air is presumably colder, but it is then more effective in producing air changes.

HEAT EMISSION APPLIANCES

It is quite common for the unit heater to be arranged for re-circulation and to warm up the factory before the personnel arrive and then to be changed over to accept outside air. In extremely cold weather, when there is difficulty in maintaining temperature, it may be thrown back to re-circulation.

Another very common arrangement is to hang unit heaters from roof trusses. They may then either be arranged to give a downward vertical blow, as in Fig. 12(b), in which case the fan is mounted with a vertical spindle and placed below the heating coil or on the other hand they can be arranged as in Fig. 12(c), when the fan is arranged with a horizontal spindle and blows the air horizontally, but it is usually then provided with louvres which can deflect the air into a diagonal direction, usually adjustable.

TABLE 7A
TYPICAL DETAILS OF UNIT HEATERS

	Size Overall	Approx. Weight of Unit	Heating Medium	*Approx. Duty B.T.U./hr.	Approx. Cost, Installed Complete
Floor Type	60" × 32" × 10' high overall	11 cwts.	Steam or High Pressure	250,000 Min. 400,000 Max.	£140
	87" × 32" × 10' high overall	15 cwts.	Hot Water	400,000 Min. 700,000 Max.	£185
Downward Discharge Type	18" × 18" × 20" high	80 lbs	30 p.s.i.* Steam	40,000	£27
	38" × 38" × 33" high	340 lbs	30 p.s.i. Steam	300,000	£58 (fixed at about 30' above floor).
Sideways Discharge, Overhead Units	12" × 12" face × 14" deep over motor	80 lbs	30 p.s.i. Steam	30,000	£28
			L.P. Hot Water	20,000	£26
	24" × 24" face × 20" deep over motor	240 lbs	30 p.s.i. Steam	190,000	£44
L.P. Hot Water			120,000	£41	

* p.s.i. = pounds per sq. in. pressure.

HEATING AND VENTILATING

These two types of unit heater are seldom connected to the outside air but give re-circulated air only, though the last type can be placed near the wall and arranged to give outside air if required.

Table 7A gives the approximate size, weight and capacity in B.T.U. of various types of unit heater commercially used, with a very rough idea of approximate prices at the present day, which, however, must be looked upon guardedly as the prices vary and change so rapidly.

(15) GAS UNIT HEATERS

These generally consist of a gas burner usually arranged in the form of a ring with a fan with vertical spindle placed under the burner so as to blow the products of combustion in a vertical direction downwards. They are economical in places where the price of gas is low and of course the total heat of the gas is delivered to the building.

They are usually arranged with a by-pass so that as soon as the unit heater is started, the fan and gas are turned on simultaneously, and the gas is ignited from the pilot light.

They are usually provided with a safety device whereby, if the pilot light should be extinguished, the gas is automatically cut off.

Unit heaters of this type obviously discharge the carbonic acid and other products of combustion into the factory or space to be heated and are therefore usually only used where the space is large or a reasonable amount of air change is provided for.

This would be an objection if the gas contained much sulphur but in normal town gas supplies great care is now taken to reduce this to a very low figure.

Another type of gas unit heater has a heater battery through which the hot gases are passed internally, while air is blown over the outside. The products of combustion in this type can be removed by a flue connecting with the open.

Chapter IV

HEAT PRODUCING APPLIANCES FOR CENTRAL SYSTEMS (BOILERS ETC.)

(1) CAST-IRON SECTIONAL BOILERS

THE boiler in most general use for ordinary central heating is the cast iron sectional boiler, illustrated in Fig. 13.

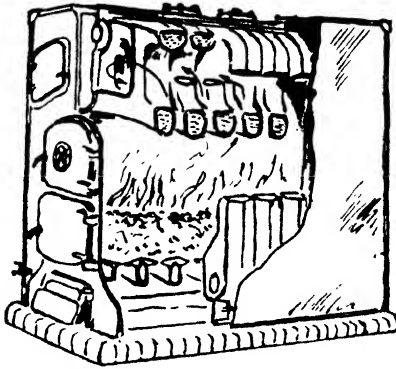

FIG. 13 CAST IRON SECTIONAL BOILER

TABLE 8
TYPICAL DETAILS OF CAST IRON SECTIONAL
BOILERS FOR HOT WATER HEATING

Approx. Size Overall Width & Depth & Height	Approx. Weight without water Cwts.	Approx. Duty B.T.U./hr.	Approx. Cost installed
	Cwts.		
15" × 12" × 36"	3½	35,000	£17
19" × 20" × 42"	6	90,000	£35
26" × 40" × 40"	15	160,000	£55
36" × 40" × 50"	25	300,000	£80
45" × 50" × 60"	40	450,000	£115
54" × 63" × 68"	68	800,000	£185
65" × 70" × 76"	97	1,500,000	£340
65" × 100" × 76"	133	2,000,000	£480

HEATING AND VENTILATING

Table 8 gives an approximate idea of sizes and ratings in B.T.U. This type of boiler has the advantage that it is relatively cheap and with reasonable maintenance may be expected to last a long time. It is well adapted to burn coke and anthracite and several other fuels of this type.

Cast-iron sectional boilers are principally used with low pressure hot water circulating systems where the height of the building, and consequently the pressure, in the boiler is not excessive. The limit is usually placed at about 100 ft.

When used for steam systems the pressure is usually limited to about 10-15 lbs per sq. inch.

Sectional boilers can also be used to burn gas, but in that case a special type is desirable as shown in Fig. 14.

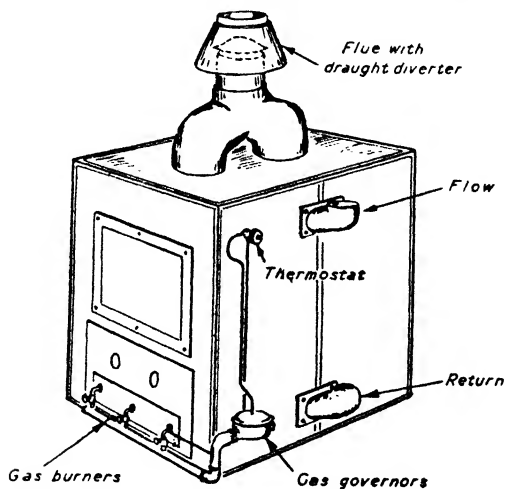

FIG. 14 GAS BOILER

TABLE 9
TYPICAL DETAILS OF CAST IRON GAS-FIRED
HOT WATER BOILERS

Approx. Size Overall Width & Depth & Height	Approx. Weight without water Cwts.	Approx. Duty B.T.U./hr.	Approx. Cost installed
14" × 18" × 24"	Cwts. 2½	20,000	£25
16" × 19" × 40"	4	50,000	£40
26" × 19" × 40"	6½	120,000	£60
24" × 30" × 42"	12½	250,000	£100
50" × 60" × 60"	59	900,000	£350

HEAT PRODUCING APPLIANCES FOR CENTRAL SYSTEMS

Gas has of course the great advantage of not requiring hand stoking, but gas is frequently a more expensive fuel, so it is a case of balancing cost and convenience.

Cast-iron sectional boilers using solid fuel are usually arranged to be stoked by hand, though certain types of mechanical stokers can be applied to them.

Fig. 15 shows the cast iron domestic hot water boiler, and Table 10 gives some idea of its sizes and ratings.

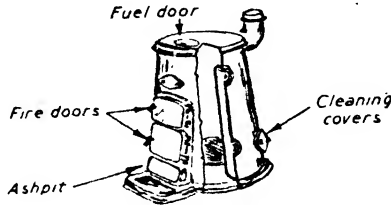

FIG. 15 CAST IRON DOMESTIC BOILER

TABLE 10
TYPICAL DETAILS OF CAST IRON BOILERS FOR
DOMESTIC HOT WATER SUPPLY

Approx. Size Overall Width & Depth & Height	Approx. Weight without water Cwts.	Approx. Duty B.T.U./hr.	Approx. Cost installed
15" × 15" × 24"	Cwts. 1½	20,000	£8
24" × 33" × 33"	4¼	70,000	£16
25" dia. × 42"	6	100,000	£22
20" × 33" × 34" (Sectional)	10	160,000	£45
27" × 45" × 45" (Sectional)	17½	300,000	£100

(2) LANCASHIRE BOILERS

For large installations such as institutions, laundries, hospitals, factories, the Lancashire boiler is frequently adopted. These are usually 30 ft. long and 8 or 9 ft. in diameter, and rated at 8,000,000 and 9,000,000 B.T.U. per hour respectively.

They contain two large flues with a grate in each and are provided with boiler settings so arranged that the gases come

HEATING AND VENTILATING

back outside the outer shell through a central flue underneath the shell and then return to the back through side flues. Fig. 16 shows this arrangement.

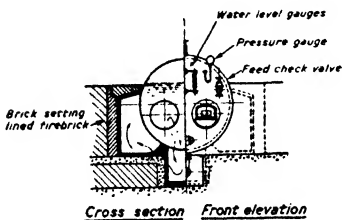
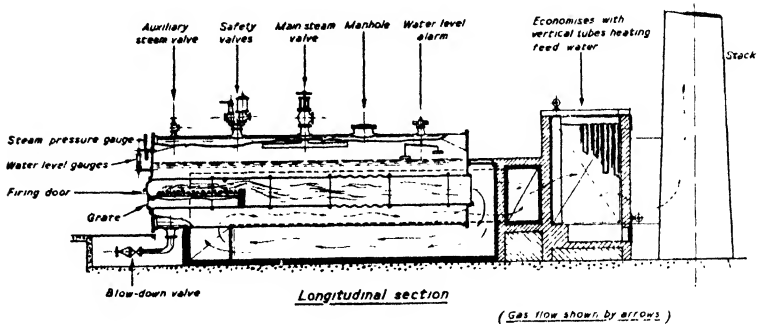

FIG. 16 TYPICAL ARRANGEMENT OF LANCASHIRE BOILER WITH ECONOMISER.

Lancashire boilers can be used for pressures up to 200 lbs per square inch, and the mountings usually include gauge glass, safety valve of the dead weight type (not adapted for hanging the fireman's coat on!), sludge cocks, main stop valve and isolating valve, pressure gauge, and feed-check valve.

The Lancashire boiler has a large steam capacity above the water level and contains also a great deal of water which enables it to take large and sudden variations in load more easily than boilers of certain other types. It is well adapted to mechanical stoking with cheap fuel, though it can of course be used for hand-firing.

(3) ECONOMIC BOILERS

These are a development of the Lancashire boiler and are usually approximately 14 ft. long by 8 ft. diameter or thereabouts.

HEAT PRODUCING APPLIANCES FOR CENTRAL SYSTEMS

They usually have a rating of approximately 7 to 15 million B.T.U. per hour and are chiefly distinguished from the Lancashire boiler in that they have no brick settings, but are entirely self-contained inside the outer shell.

The flue gases are brought back to the front of the boiler by a large number of tubes, of usually about 3 in. in diameter, and in some types taken back again to the back of the boiler by other similar tubes in the lower portion of the boiler. By this arrangement the flue gases get a long travel in a large area of piping and are better adapted to giving up their heat before escaping into the flue or chimney shaft.

Boilers of this type were used in the Bank of England and are well adapted for use in buildings where space is limited in view of their smaller size for a given capacity. They can be used with solid fuel and mechanical stokers or hand-fired, but are equally well adapted to burn oil, gas or any other heating medium.

In the Bank of England they were originally designed for oil firing and subsequently turned over to creosote pitch.

Other types of Economic boiler have a single "pass" of fire tubes, with the smoke outlet at the front, as in Fig. 17.

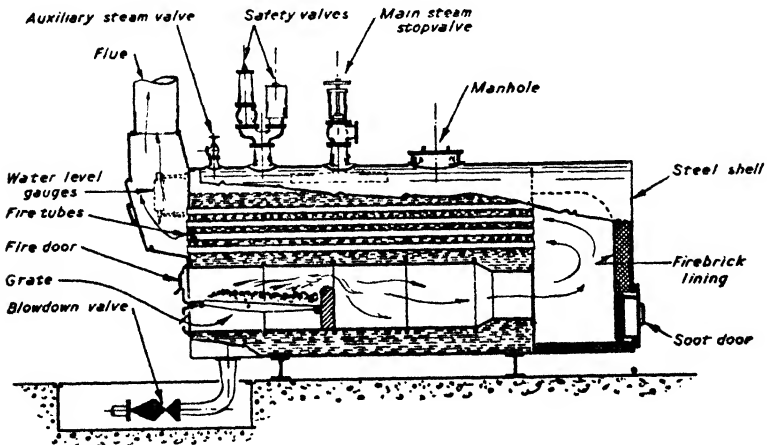

FIG. 17 SINGLE PASS ECONOMIC BOILER

This is the more usual type.

Economic boilers can also be used with brick settings which bring the outer casing into play as a heating surface.

HEATING AND VENTILATING

(4) GRAVITY FEED MAGAZINE TYPE BOILERS

This type of boiler has been the subject of considerable development in the last twenty-five years and was evolved principally with the object of reducing the labour required in connection with stoking. A section of a successful type is shown in Fig. 18 together with a table giving approximate sizes and ratings in B.T.U.s. per hour.

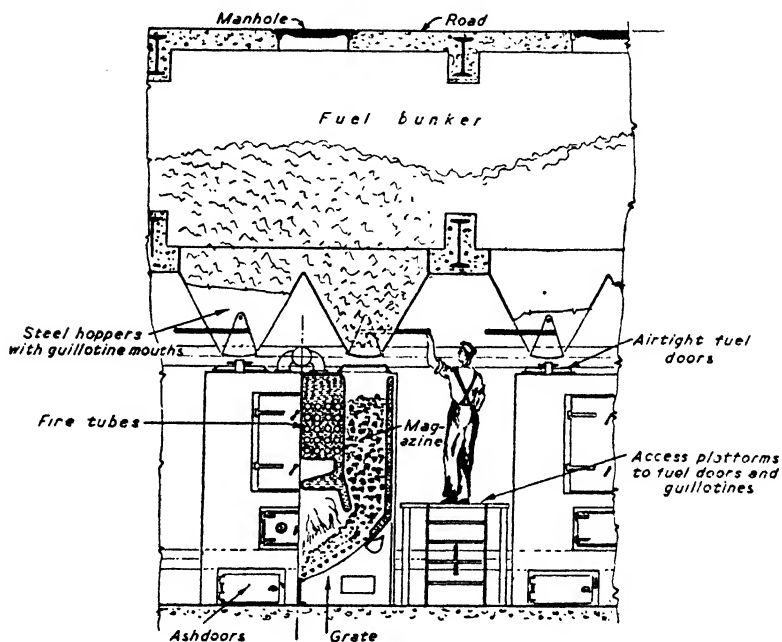

FIG. 18 SECTION OF BOILER HOUSE SHOWING GRAVITY FEED BOILERS AND OVERHEAD BUNKERS

The underlying principle of the boiler is that the solid fuel is fed into two magazines disposed on either side of the grate and as the solid fuel burns away on the grate fresh fuel falls down on to it by gravity, so that the position of the fuel bed remains constant until the magazine is empty. In the case of small sizes the magazine is on one side only.

Magazine boilers of this type, unprovided with additional hoppers overhead, will generally run for approximately 12 to 18 hours at fairly full duty and longer when on low duty and if the system is on thermostatic control do not need more than

perhaps one hour every 12 hours of an attendant's time. The attention consists in refilling the boiler and removing clinkers.

These boilers work best on coke but they will also run quite well on anthracite if some slight adjustment is made to prevent the anthracite piling up too high on the grate for it has a lower angle of repose and so stands at a flatter angle.

The gravity magazine type of boiler is sometimes, and very usefully so, fitted with overhead bunkers which will take an additional supply of solid fuel. Such hoppers can be designed to take several week's supply. Where such hoppers are provided, the filling of the magazine boiler resolves itself into a very simple process of sliding back or unhinging an opening in the top and operating a valve at the bottom of the overhead hopper so that the solid fuel flows direct into the magazine boiler.

Boilers of this type do not work well with coals liable to caking and selection of fuel to suit the boiler is very desirable. Hence, coke and anthracite should be used. A fuel that clinkers readily will necessitate more frequent attention, which it is of course the object of the boiler to avoid.

Given a suitable fuel the boiler is extremely efficient and produces very little clinker. This is generally achieved by providing a very large grate area for a given rating so that the fire can be maintained at a dull red heat instead of the white heat often seen in some types of boilers where clinkering occurs much more rapidly.

In the author's experience a grate area of $2\frac{1}{2}$ square feet for every 100,000 B.T.U. of rating gives a first approximation of the desired result in this respect.

These boilers have been made in both cast-iron and in mild steel, but the mild steel ones are greatly to be preferred.

In the early days when these boilers were a little experimental a great deal of trouble was experienced owing to the fuel in the magazines lighting back and burning towards the top. One essential for preventing this is that the magazines shall be really airtight, particularly at the openings at the top, and that they shall be water-jacketed, for if the latter condition is satisfied so much heat is immediately abstracted that any tendency to maintain a fire receives great discouragement.

Boilers of this type have been in very successful use in connection with the heating of St. Albans Abbey, the large block of

HEATING AND VENTILATING

flats at Dolphin Square, the Queen's Hotel at Leeds, and various Town Halls. This gives some indication of the kind of buildings where they are specially useful.

As they have fairly large flat surfaces they are not suitable for the highest pressures. For these, the Economic and Lancashire Boilers can be used.

Table 11 gives approximate details of these boilers.

TABLE 11
GRAVITY FEED BOILERS

Approx. Size overall width. length. height.	Approx. Weight	Duty B.T.U. per hour	Approx. Cost
34" × 40" × 54"	Tons .75	105,000	£140
60" × 64" × 73"	2.00	200,000	£300
63" × 92" × 73"	3.25	400,000	£415
62" × 99" × 82"	5.25	700,000	£570
71" × 115" × 88"	6.5	1,000,000	£640
84" × 126" × 97"	8.5	1,500,000	£770
104" × 141" × 103"	9.75	2,000,000	£950

(5) WATER TUBE BOILERS

There is a large range of water tube boilers which are most efficient for specific purposes, but their description in detail is perhaps outside the range of this work as they are not frequently used in connection with buildings and are more suitable for District Heating, Generating Stations and so forth. One of these, the *Lamont* Boiler, is of special construction and is frequently used in connection with high pressure hot water heating systems. It has particular advantages in large installations and where large horizontal distances have to be traversed.

It has been used successfully in the author's experience for a large War Office Depot involving the supply of heat to many large buildings situated at a considerable distance apart and combines the advantages of hot water in allowing the temperature to be varied to suit the climate with the advantages of steam in reducing the sizes of pipes and radiating surfaces necessary for a given heat output. It is however rather more complicated and seldom, if ever, used for the heating of ordinary buildings.

(6) NATURAL AND MECHANICAL DRAUGHT

Draught is said to be *natural* when the flue gases from the boiler are merely connected to a vertical flue, usually of brick-work, without the intervention of any fan or other mechanical device. In this case a draught is produced by the tendency of hot air to rise relative to cold. In other words, by the fact that a column of hot air, being of low specific gravity, weighs less than a column of the same height of cold air external to the chimney, and the difference between the two weights forces the hot air up so that it may be displaced by the cold air entering the boiler.

It will therefore be clear that, in order to procure an adequate natural draught, consideration must be given to the three following matters :

- (a) The height of the stack.
- (b) The temperature of the stack.
- (c) The size of the stack.

A common rule is that the flue area shall be three-quarters of the grate area in square feet divided by the square root of the height of the chimney in feet.

Another convenient formula is that the flue area in square feet shall be the rating of the boiler in B.T.U. per hour divided by 80,000 times the square root of the height of the chimney.

From either of these formulae it is easy to see when the size and height of the chimney will satisfy the reasonable requirements of any boiler or range of boilers.

It is objectionable to have too small a flue for this will prevent an adequate draught in the boiler and reduce its capacity to give the desired output. It may even cause explosions on account of the insufficiency of oxygen provided to secure combustion of the gases distilled from the coal. An excessive size of flue also has its disadvantages. When carried to extreme lengths this may keep the chimney too cold to maintain the temperature required to give the draught required, a condition which sometimes occurs when many boilers are connected to one large flue and only one of the many boilers happens to be in use, as when the hot water supply boiler alone is connected to the flue in the summer and the heating boilers are not in use. To overcome this difficulty there is much to be said for keeping the hot water supply boiler upon a separate flue, when practicable, so that it

shall be independent of the large heating boilers. This is particularly important in very hot weather. The difference in temperature on which the draught depends then tends to be reduced, on account of the outside air being relatively hot and perhaps the air entering the hot water supply boiler from the boiler house in the basement being drawn from a relatively cool source.

In the case of a sudden spell of very hot weather following rapidly after a long spell of cold weather the author has known an actual down-draught to occur in the flue and this condition applies particularly before the flue has been heated up by the fire.

Mechanical draught is often used, especially in larger installations with the object of :

- (a) giving complete control independent of weather, boiler-output, etc.
- (b) as a method of controlling the output of the boiler.
- (c) for increasing the output of the boiler; and
- (d) as a means of reducing the height and the size of the chimney.

Mechanical draught can take the form either of *induced draught*, in which case a cased fan sucks the gases from the boiler and delivers them to a shaft, or of *forced draught* where a cased fan delivers air under some small pressure under the grate of the boiler.

Mechanical draught is very frequently applied to the large installations which justify the use of Lancashire, Economic or Water Tube Boilers.

Mechanical stokers of solid fuel are generally designed to run in conjunction with a moderate degree of forced draught.

Where induced draught is used on large installations it is frequently necessary to arrange for water cooling of the bearings to protect them against the high temperatures of the flue gases involved.

Where forced or induced draught is used on a considerable scale there may be some tendency to lift grits from the fire and deliver them up the chimney, whence they are deposited on the surrounding land or buildings, and which when carried to excess may constitute a nuisance.

This can be overcome by the installation of so-called grit-arrestors. These provide means by which the flue gases are passed

into a settling chamber where their velocity is constantly reduced thus allowing a large percentage of the grit to settle before the gases are taken to the stack. These have been successfully employed on many large installations.

As mechanical draught is seldom requisite for heating installations in normal buildings and is reserved generally for much larger installations, it is perhaps unnecessary in this work to elaborate on it further.

(7) DRAUGHT STABILISERS

It is a common experience that a boiler set to give a required output may be very sensitive to fluctuations in flue temperature, wind intensity, and wind direction. Thus while the domestic boiler may be set for the night, in the hope that it will burn slowly and be alight in the morning, a change of wind direction or intensity may on the one hand have the effect of causing it to burn away much more rapidly than was desired causing the water to boil and burning out of the fuel in the boiler. On the other hand the boiler can go out from lack of sufficient draught during the night. Both these phenomena are sources of great inconvenience.

They can to a large extent be overcome by providing immediately above the boiler an opening to the flue. This is

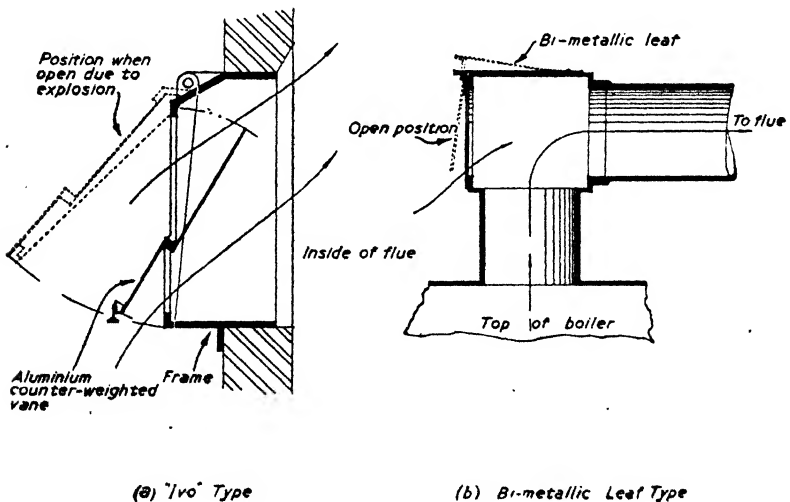

FIG. 19 DRAUGHT STABILISERS

covered by a hinged damper plate so arranged that when the draught in the flue is excessive it opens a by-pass and allows cold air into the flue thus detracting from the suction of the boiler.

There are several types of these stabilisers and one of these is shown in Fig. 19(a).

Draught stabilisers can also be constructed on a principle whereby they depend on flue gas temperature for their action. In this case they may be constructed of two metals with different rates of expansion, so contrived that as the temperature of the flue gases goes up, the by-pass is opened, allowing the cold air to enter the flue. This sounds perhaps unduly complicated but the resulting device is extremely simple in its construction. It is shown in Fig. 19(b).

(8) MECHANICAL STOKERS

There are available on the market a very large number of mechanical stokers whereby solid fuel can be fed into the boiler without the necessity of hand stoking.

The advantages of mechanical stoking include :

- (a) A saving in labour whereby one or more stokers can attend to a large range of boilers which would otherwise require one or two stokers per shift for each of them.
- (b) Whereas hand stoking involves the opening of the fire door and the admission of a large volume of excess air, thus resulting in loss of efficiency, the mechanical stoker works continuously and admits only the air needed for proper combustion.
- (c) Hand stoking is intermittent and seldom keeps the fire at all times in its most efficient condition. The fire is generally allowed to get fairly low and then 2 in. or 3 in. of solid fuel are thrown on to it which at first cools the fire and allows the volatiles from the newly added coal to be distilled and in some cases to be partly lost in the flue with a formation of heavy smoke. Mechanical stoking can maintain the fire bed at a uniform thickness and give a steady supply of fuel at the optimum rate and under the best conditions.
- (d) The installation of mechanical stokers in suitable circumstances tends to save on the amount of fuel consumed.

All large boiler installations where water tube boilers or

HEAT PRODUCING APPLIANCES FOR CENTRAL SYSTEMS

Lancashire boilers are used are fitted with mechanical stokers, but even in comparatively small boilers there is frequently a good case to be made out for their installation.

It will be unnecessary in this work to describe the mechanical stokers which are used with very large boilers, such as the Chain-Grate type.

There are many useful mechanical stokers now in common use for small boilers of heating installations in ordinary buildings. One of these consists of a small hopper supplying coal to a horizontal tube fitted with a worm screw which, by rotating, delivers the coal along the tube into the boiler centrally under the fire whence it gradually rises and spreads over the grate.

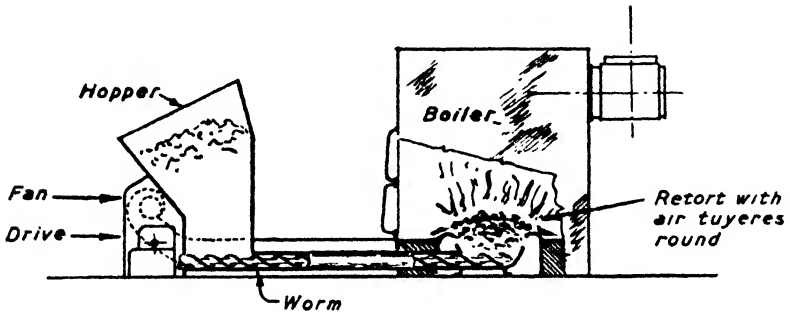

FIG. 20A UNDERFEED STOKER

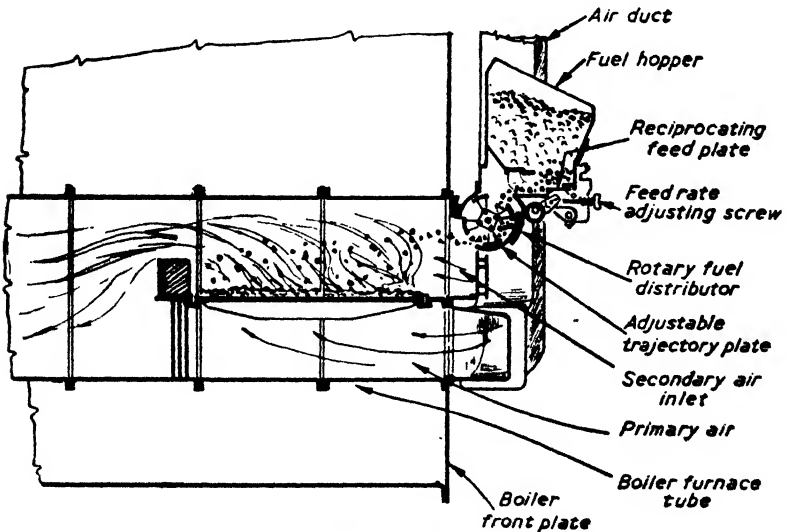

FIG. 20B SPRINKLER STOKER

HEATING AND VENTILATING

Another kind is known as the sprinkler type by which solid fuel is sprinkled over the top surface of the fire.

Fig. 20 shows both these types.

Stokers of the sprinkler type have proved particularly useful in dealing with inferior fuel containing a large percentage of fines. These are difficult to burn in conjunction with some types of mechanical stokers as they tend to clog and prevent the air from passing through the fire.

(9) OIL FIRING

All the boilers mentioned previously can be effectively adapted to burn fuel oil.

Fuel oil is usually the heavy residue of natural petroleum after many of the volatiles have been extracted for petrol and paraffin. It may be too viscous to deliver to the oil burner without pre-heating and frequently the storage tanks as well as the pipes leading the oil to the oil firing plant are provided with arrangements for heating the oil to make it sufficiently fluid.

The oil has to be atomised before injection into the boiler and this is usually done in conjunction with compressed air. The compressed air may be either high pressure or low pressure. The high pressure is usually reserved for places where the noise associated with it does not matter. The low pressure system can be almost noiseless.

The mixture of compressed air and oil is usually given a rotary motion which assists in the atomisation and intimate mixture of air and oil.

When oil firing is to be adapted to a boiler not primarily intended for it, it is necessary to insert firebrick into the combustion chamber so that the flame impinges on the firebrick and not on the metallic portions of the boiler.

(10) GAS FIRING

Gas suitable for firing boilers can be of two kinds:

- (a) Town gas.
- (b) Producer or power gas.

The former is of course more generally available for ordinary buildings and has the advantage of being readily available where there is a gas main in the street, of being more highly purified so as to exclude the great bulk of the sulphur and other

HEAT PRODUCING APPLIANCES FOR CENTRAL SYSTEMS

impurities found in the coal, and having generally a higher calorific value than the other type of gas. The calorific value usually is 475 to 500 B.T.U., per cubic foot, though it varies considerably in different localities. On the other hand, town gas is usually more expensive than producer or power gas. There are however exceptions to this and in some industrial districts and towns the town gas is supplied at a very low rate. In some cases this low rate is obtained by the gas undertaking being able to receive, at very favourable terms, gas obtained as a by-product from coke ovens used for producing primarily the coke necessary for iron and steel production. Thus in such places as Sheffield the present price of gas in large quantities from the City supplies is about 6d. per therm. In other places, on the other hand, gas costs 9d. to 1/- per therm and then is not so economical as coal or other forms of heat.

Gas firing has many conveniences which sometimes make it worth while even when the cost per therm makes it at first sight appear uneconomic.

It is always readily available and lends itself well to self-regulation by thermostatic control. There is no carting, carrying or handling of fuel or stoking, and the boiler can frequently therefore be put into a much smaller space than where fuel storage and space for stoking has to be provided for. There is no ash to be removed. It is therefore a cleaner system. In small dwellings, where space is not readily available, a self-regulating gas boiler can often be introduced into a small space where the provision of a boiler for solid fuel would be difficult or impracticable.

Where gas is to be used as a fuel it is usual to install a boiler specially designed and made for the purpose. Such boilers usually contain finned surfaces or fire tubes and are more efficient than ordinary boilers adapted to take gas.

In the combustion of any fuel the burning of the carbon produces carbon-dioxide which is not liable to condensation, whereas hydrogen which may exist in the form of methane and other organic hydro-carbons, combines with oxygen to produce water and hence the greater the percentage of hydrogen in a fuel the greater is the liability to produce condensation. Gas frequently contains as much as 50% of hydrogen by volume, whereas bituminous coals seldom contain more than 5% of

hydrogen. Welsh steam coal, anthracite and coke contain a very much lower percentage.

It will therefore be easily understood that the danger of condensation with gas is far greater than with solid fuel, especially with coke, anthracite, etc.

It is therefore normally necessary to make special provision for condensation in the flues when gas is to be used. Condensation almost invariably occurs when a gas heated boiler is first lighted and the products of combustion enter a cold flue or stack. These should be arranged to drain. Whether condensation will occur during normal working will then depend almost entirely on the temperature in the flues and stack. If the latter is relatively high there may be no danger of this, but this of course usually involves a lower efficiency than is normally sought after.

Great care must be taken in the design of a flue for gas boilers to prevent down draughts as the flue gas temperatures are usually low owing to the high efficiency of the gas boiler, and therefore bafflers or draught diverters are often fitted before the flue gases enter the chimney.

Gas can of course also be used for heating buildings, in the form of gas fires and gas heated radiators or unit heaters. The products of combustion in all these can either be discharged into the room or extracted by flues, but this aspect of gas heating has already been described in the previous chapter.

The efficiency of gas boilers sometimes rises to 85 % whereas that of boilers for solid fuel seldom exceeds 75 % and is frequently much lower.

(II) THERMAL STORAGE

Heat supplied electrically can be of two kinds :

- (a) the kind where it is consumed as it is received,
and
- (b) where it is produced and stored at times most suitable to the electricity supply authority and consumed at such times as required by the building owner.

The latter system is known as electrical thermal storage.

Where electricity is to be consumed without thermal storage it naturally has to bear its proper share of interest and depreciation of generating station, plant, cables, sub-station, etc., and will therefore frequently be found to be rather expensive. This

HEAT PRODUCING APPLIANCES FOR CENTRAL SYSTEMS

has already been shown in Table 5, page 43, where it is seen that even at $\frac{1}{2}$ d. per unit the cost is 14·6d. per therm as compared with lower costs with other forms of heating.

There are many cases where this cost is partly off-set by its greater convenience, cleanliness and economy in use by reason of its being turned on and off according to need without long periods of heating prior and subsequent to the time when the heat is actually required. Nevertheless, when all is said and done on this score it still remains an usually expensive method of heating for the day-in, day-out, heating load on a big building such as an office building or a block of flats.

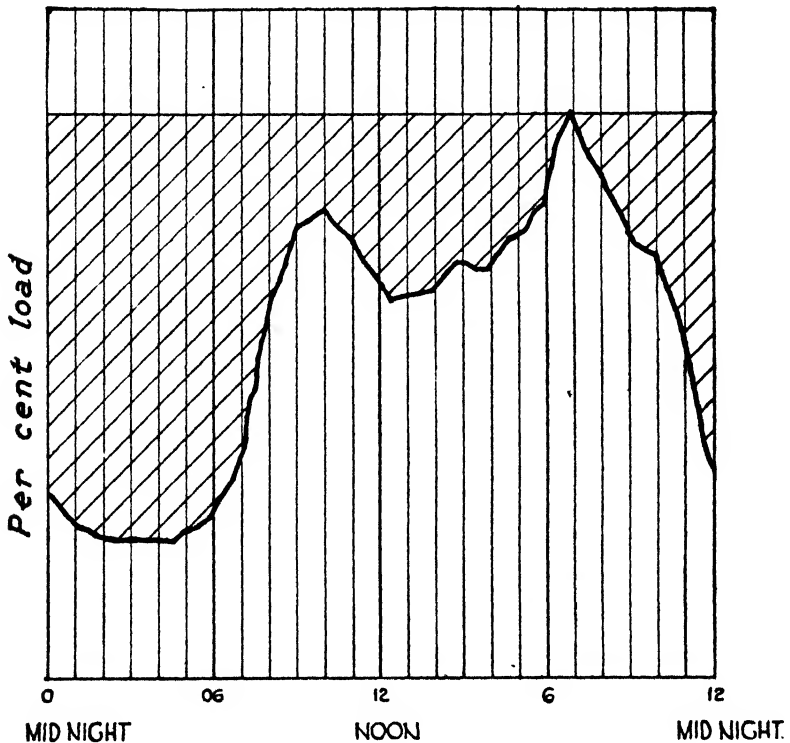

FIG. 21 TYPICAL DAILY ELECTRICAL LOAD CURVE FOR A GENERATING STATION. THE SHADED AREA REPRESENTS THE PERMISSIBLE "OFF PEAK" LOAD WHICH CAN BE TAKEN WITHOUT INCREASE OF GENERATING PLANT

The theory behind the thermal storage system is that the electrical load of an electricity supply system varies considerably

HEATING AND VENTILATING

at different times during the day, usually leading to a peak load between eight and ten a.m. and another peak load in the evening, though the exact time and distribution of the load varies greatly according as to whether the district served is mainly domestic or mainly industrial. There is however usually very little electrical load on the system between midnight and seven a.m. If therefore this period can be used for delivering electricity to thermal storage systems, this can be done without either increasing the plant in the generating station or the cables or the sub-stations and hence it becomes economically justifiable to supply electricity for this purpose at a lower cost. In this case no charge is made for interest and depreciation on these items.

The electricity authorities in some cases have therefore been willing to supply electricity for thermal storage at a rate only slightly exceeding that of the coal cost. This is frequently less than half the total cost of the electricity. In one exceptional instance a job for which the author was acting was offered thermal storage electricity at the very low rate of 0·1d. per unit. This worked out at about 3d. per therm and having regard to its many other advantages was most acceptable, and in fact accepted. Such rates are unfortunately things of the past and it is doubtful whether rates of 3d. per therm are likely to be common in the future, even for thermal storage, which will cost 9d. or so a therm, a figure for which alternative fuels may be more economical.

Each case, nevertheless, must be treated on its merits and the absence of flues, stacks, boiler settings, labour, etc., must be fully taken into account in arriving at a decision.

Large thermal storage systems can be arranged to be switched on or off from the generating station. This not only gives the latter the necessary control (so that they can sometimes supply at times when they could not ordinarily undertake to do so) but also reduces the attention necessary on the part of the building owner or occupier.

Where thermal storage is adopted the system usually comprises:

- (a) One or more electrode boilers connected to one or more storage cylinders from which hot water is circulated to an ordinary hot water system of radiators, panel heating, etc.

HEAT PRODUCING APPLIANCES FOR CENTRAL SYSTEMS

Electricity is supplied to the electrode boiler either in the form of low tension immersion heaters (suitable for relatively small plants) or of high tension electrodes which heat the water by the current passing through the water which itself acts as an electrolyte. In the latter case the electrodes are supplied by three-phase current.

- (b) The hot water is delivered from the electrode boiler to the top of the storage cylinders and the water from the bottom of the cylinders returns to the electrode boiler. It thus sets up a primary circulation, a pump usually being supplied to ensure this circulation, which enables the storage cylinders and the electrode boilers to be at the same level.

The storage cylinder therefore contains hot water above and cool water below and owing to the indifferent conductivity of water a sharp line of demarcation between the two is maintained provided suitable arrangements are made, such as the proper use of sparge pipes etc., to prevent mixing.

- (c) Water for the secondary circulating system which heats the building is taken from the top of the cylinder to a mixing valve which delivers a small portion of this hot water to the secondary system which serves the building. The remainder is taken from the cool return from the same system and the balance of the cool return goes back to the bottom of the storage cylinder.

The temperature of the water from the top of the cylinder may be as high as 280° F. to 300° F., depending on the height of the building and the pressure head available to prevent the production of steam. As the water required for a low pressure radiator system seldom exceeds 180° F., and for a panel heating system 120° F., it will be seen that only a small fraction of this water will be required to be mixed with the return from the secondary.

The effect during the night of the primary circulation of the water delivered to the electrode boilers is to lower the level which separates the hot and cold water in the cylinder until the storage cylinder is almost full of the high temperature water when the electric supply is automatically cut off. The circulation in the secondary system during the day has the effect of the gradual raising of this line of demarcation until, at the end of the day,

HEATING AND VENTILATING

the level separating the hot and the cold water may have risen to near the top of the cylinder. Thus the capacity of the cylinder has to be so arranged that the differences in the heat content between the two cases represents the quantity of heat sufficient to heat the building for the longest period between re-chargings. The electricity authorities are frequently able to give a boost in the day time at a time to suit themselves so as to reduce the storage cylinder capacity as much as possible.

At the Earl's Court Exhibition, where the thermal storage system is probably one of the largest in this country, the three electrode boilers have a total capacity of 14,000 kilowatts and deliver to seven cylinders placed horizontally with a total capacity of 170,000 gallons. Fig. 22 shows a diagram of a thermal storage system. From this the foregoing description is perhaps more easily understood.

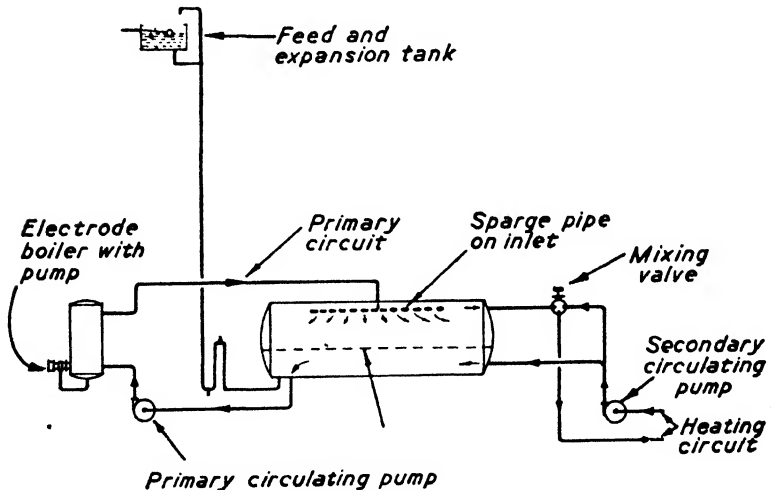

FIG. 22 DIAGRAM OF THERMAL STORAGE SYSTEM

It will readily be appreciated that a large volume of water such as that involved (in the case of Earl's Court 170,000 gallons) varies greatly in its volume as between hot and cold and consequently an expansion tank near the top of the building has to be provided large enough to take the difference with a suitable margin, something of the order of 10% of the volume in the system.

There is a limit to the amount of thermal storage which

electricity authorities can supply at the reduced rate calculated on the basis previously explained. It will be seen that the electrical loads involved are great and if universally adopted will more than absorb the difference between the peak load and night load capacity of the distribution system. Consequently, when this point has been reached, the generating plant, cables, etc., have to be increased and the costs involved reasonably debited to the load which necessitates their increase. At this point thermal storage ceases to be economic. It is however only fair to say that this point has not, so far as the author knows, been reached with any supply authority.

Where the difference in cost between the thermal storage and ordinary electricity supply is small there is of course no point in incurring the considerable additional extra capital cost of the thermal storage system as compared with direct electric heating. The latter has already been referred to.

(12) IMMERSION HEATERS

Electricity can with great convenience be used for supplying hot water, either for heating or for hot water supply, by connecting one or more immersion heaters to a tank or cylinder to which

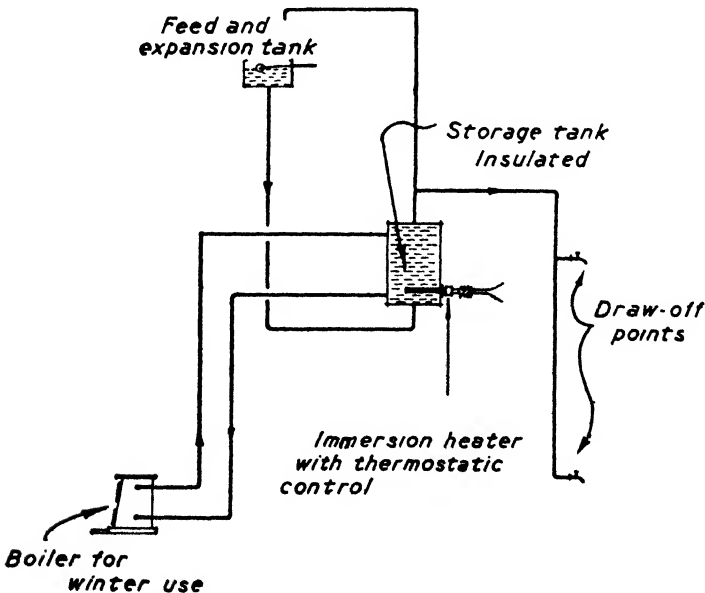

FIG. 23 DIAGRAM OF DOMESTIC H.W.S. SYSTEM WITH IMMERSION HEATERS

the water system is connected. Thus it is a very common and desirable arrangement in small houses to have a hot water supply heated from a small boiler using solid fuel during the winter but to have an immersion heater in the hot water tank or cylinder, which is used in the summer when the demand for hot water is less.

In an ordinary small house the capacity of such an immersion heater is usually 2 or 3 kilowatts and if, as is frequently the case, electricity for this purpose is supplied at a rate of $\frac{1}{2}$ d. to $\frac{3}{4}$ d. a unit then the cost of a 2 kW. immersion heater would vary between 1d. to $1\frac{1}{2}$ d. per hour, and the cost per therm would vary between 14·6d. and 21·9d. per therm. Such immersion heaters are fitted with thermostatic control so that as soon as the water in the tank or cylinder reaches the pre-determined temperature (usually about 150°) the electricity is cut off. Owing to the somewhat considerable cost per therm it is clearly necessary that the hot water tank or cylinder heated in this way should be efficiently lagged.

It is usually desirable to cover the tank or cylinder with 2 in. cork or magnesia finished with white enamelled canvas, or other lagging of equal efficiency, or alternatively, with a box containing granulated cork. Cork slabs containing natural or bituminous adhesive are not generally suitable for lagging hot water as the adhesive smells and becomes soft at these high temperatures. Mattresses containing glass silk are sometimes used and have the advantage of making less mess if they have to be applied after the house is in occupation.

(13) BOILER EFFICIENCY

In the design of an economic heating system reference has to be made to the efficiency of the boiler since obviously an inefficient boiler requires more fuel for a given output of useful heat. There must of course be some losses due to radiation and to hot flue gases carrying heat to the chimney and to the outside air. The latter is naturally enhanced if, in addition to the air taken in to support combustion, excess air is taken in. The latter is accepted at a low temperature like 70° and it may be rejected at a high temperature like 500° , so that it is clearly abstracting additional heat. It therefore becomes useful, and is one of the routine tests, in a large boiler installation, to form a measure of the excess air. The most convenient way of achieving this is to

fit a CO_2 indicator or recorder. When there is no excess air it can be shown that the CO_2 content will be dependent on the analysis of the fuel but will usually be about 18%. With excess air this will drop and the same fuel which has given 18% CO_2 content will, with 100% excess air, show a drop to 8.3% CO_2 content.

It is also clear that the amount of heat abstracted by the flue gases will also vary with the temperature of these gases as they leave the boiler; the lower the flue gas temperature the smaller being the loss and therefore the higher the efficiency. Any boiler which is forced has the flames extending a long way into the boiler and even emerging into the flue. This is clearly extremely wasteful.

There is no space in this short work to go fully into the question of boiler efficiencies but it may be said in general that for an efficient boiler using coal or coke the CO_2 should in general not be less than 10% and the flue gas temperatures not higher than the temperature of the water or steam in the boiler, plus 100° , and that the higher the CO_2 content and the lower the flue gas temperatures the higher will be the efficiency of the boiler. When oil or gas are used the CO_2 content is lower as these fuels contain less carbon and more hydrogen or hydro-carbons.

Efficiencies, in practice, range from 70% to 85% on test, using solid fuel, and 80% to 90% on test, using oil or gas firing, but efficiencies over the year are often considerably lower.

Chapter V

PIPING

IN a heating installation, such as that having radiators and a boiler of ordinary type, it is obvious that the radiators have to be connected to the boilers by a system of piping and that these pipes have to be so proportioned as to be able to deliver the requisite amount of heat to the radiators to enable them to fulfil their function.

If the pipes are too small, or the circulation too sluggish, the temperature in the pipe taking the hot water from the boiler (usually called the *flow*) may be far greater than the temperature in the pipe bringing the water back to the boiler (usually called the *return*). This has disadvantages. If several radiators are connected in series, those nearest the flow will be at a much higher temperature than those nearest the return and some will be overheated if they are placed in different rooms.

The circulation of the water in the system can be either (a) *gravity* (sometimes known as *natural*) or (b) *pump circulation* (sometimes known as *forced* or *accelerated circulation*).

(1) GRAVITY CIRCULATION

The principle underlying gravity circulation is that hot water is lighter than water which is cooler. Thus, in a closed system, with the boiler near the bottom and the radiators near the top, the temperature of the water rising from the boiler to the radiators will be high and consequently its weight less than the weight of the corresponding column of water on the return. The latter is at a lower temperature and therefore tends to fall relative to the rising water in the flow.

It will therefore be seen that the circulation depends on :

- (a) the difference in temperature between the flow and the return, and
- (b) the difference in level between the boiler and the radiator, or if there are many radiators, between the boiler and the centre of gravity of the radiator system, and

(c) the size of the pipes.

It is obvious that, with a small pipe, a higher velocity has to be maintained to circulate the same volume of water. It is not less obvious that the friction in a pipe varies rapidly with the velocity and indeed approximately with the square of the velocity. Hence, a 2 in. pipe, which has of course four times the area of a 1 in. pipe, will, for a given quantity of circulating water, only have a quarter of the velocity, and, as the friction varies with the square of the velocity, will only have approximately one sixteenth of the frictional resistance.

In actual practice there are finer points to be taken into account but this is sufficiently accurate for a first approach.

To take a simple example let us consider Fig. 2, page 17, in which H represents the difference in level between the centre of gravity of the boiler and the centre of gravity of the radiator system. T_1 is the temperature of the flow and T_2 is the temperature of the return. From what has been said it is clear that the forces promoting circulation, usually termed the *circulating pressure* and denoted by the letters CP , is proportional to $H (T_1 - T_2)$.

Elaborate tables are, in practice, used for the calculation of this but as an approximation sufficient for many purposes it may be said that when $(T_1 - T_2)$ is 40° F., then the circulating pressure will be 1.6 in. head of water for every 10 feet of H . It varies *pro rata* so that if $(T_1 - T_2)$ is 20° it will be half as much, and if H instead of being 10 ft. is 100 ft. it will be ten times as much.

This circulating pressure will be absorbed in overcoming the friction in the pipes. The problem of pipe sizing includes the problem of so adjusting the sizes so that when the velocity is reached at which the circulating pressure is exactly absorbed in the friction head of the pipes a sufficient flow of water will be maintained to give the temperature drop between $T_1 - T_2$ which was assumed in calculating the circulating pressure. For this purpose we must have access to tables showing the friction in pipes of various sizes at different velocities. Such a table is given with great accuracy in "*Heating and Air Conditioning of Buildings*" (see *Foreword*) and there is unfortunately no space to delve into this matter in great detail here. Nevertheless, Table 12 gives some approximate figures which may be sufficient for approximate calculations in simple cases.

HEATING AND VENTILATING

TABLE 12 FLOW OF WATER IN PIPES

Resistance Inches w.g. per foot	Nominal Bore of Pipe							
	½"	¾"	1"	1¼"	1½"	2"	2½"	3"
				Lbs of Water		per Hour		
.001	—	—	130	240	390	860	1,580	2,580
.002	—	90	190	355	570	1,250	2,900	3,680
.003	—	110	240	440	720	1,570	2,870	4,670
.004	40	130	280	520	840	1,830	3,330	5,400
.005	49	150	320	580	950	2,070	3,750	6,200
.006	54	165	350	650	1,030	2,270	4,100	6,800
.008	63	190	420	750	1,230	2,670	4,830	8,000
.01	71	215	470	850	1,380	3,000	5,500	9,000
.02	105	315	670	1,240	2,000	4,300	8,000	13,000
.04	150	450	990	1,800	2,900	6,300	11,600	18,700
.06	190	570	1,230	2,200	3,600	7,800	14,200	23,300
.08	220	670	1,430	2,600	4,200	9,100	16,700	27,200
.10	250	740	1,630	2,900	4,700	10,300	18,800	30,700
.12	275	830	1,760	3,200	5,200	11,300	20,700	34,000
	Equivalent foot-run of pipe for local resistances							
Gate valve	0.5	1	1.5	2	2.5	3.5	5	6
Long radius bend	1	2	3	4	5	7	10	12

Top, middle and bottom lines in each column correspond to velocities of 0.2, 0.5 and 1.0 feet per second respectively.

The following example illustrates the principle by which is determined the necessary pipe sizes in a simple case.

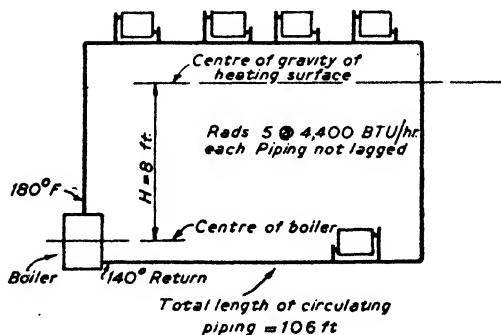

GRAVITY CIRCULATION

PIPING

Given system as diagram, to size the main circulating pipe:

CP=circulating pressure.

CH=circulating head.

C.P. = 1.6 in. w.g. per 10 ft. circulating head.

In above CH = 8'.

$$\therefore \text{C.P.} = 1.6 \times \frac{8}{10} = 1.28 \text{ w.g.}$$

Total heat emission Radiators 22,000 B.T.U. /hr.

*Piping 11,600 " "

33,600 " "

Temp. drop = 180° — 140° = 40°

$$\therefore \text{amount of water to be circulated} = \frac{33,600}{40} = 840 \text{ lbs. /hr}$$

Total run of pipe 106 ft.

Resistance of 3 Bends equiv. to 3 × 4* = . . . 12 ft.

Resistance of Boiler equiv. to 10 ft.

Total travel equiv. to 128 ft. of pipe

$$\therefore \text{Pressure drop permissible} = \frac{1.28}{128} = .01 \text{ in. /ft.}$$

From Table 12, 840 lbs/hr. at .01 in./ft. requires 1¼ in. pipe.

Bends and angles in piping systems are usually allowed for by considering them as equivalent to so many feet of piping, the approximate figures being given in Table 12 previously referred to. These bends should be gradual and not sharp right angle bends.

It will be appreciated that where the system is a high one, i.e. where H is great, relatively small pipes may be permissible. If, on the other hand, the system is long horizontally and short vertically, then the circulation will tend to be very sluggish and large pipe sizes will be a necessity if it is to work at all efficiently.

Gravity circulation usually works sufficiently well for small houses with the boiler on the ground floor, provided some at least of the radiators are on the first floor, but if the boiler is on the ground floor and the radiators are also on the ground floor, the circulation would be very sluggish indeed.

*These figures are based on an assumed pipe size. If the size finally calculated is different, the calculation must be repeated using the calculated pipe size to arrive at the piping heat loss and resistance.

Circulation can be improved however by taking the flow right up into the roof space and dropping it to the radiators. Thus the heat loss of the roof piping has the effect of increasing the effective H and promoting circulation.

Ideal cases for gravity circulation are those where the height H is high and the horizontal runs small.

(2) PUMP CIRCULATION

Where these conditions are not fulfilled, it becomes necessary to introduce *accelerator pumps* or *accelerators* so as to promote the necessary circulation. It is frequently economical and desirable to have pump circulation even in large systems where the gravity circulation can be made to work because:

- (a) Smaller pipe sizes can be used with some economy in first cost, and
- (b) the system responds much more quickly when required.

Thus in a gravity circulation system it may well take half an hour after the fire is lit before the water in the boiler reaches the desired temperature and a further half hour before the circulation has become established and the radiators have reached their required temperature. With pump circulation on the other hand, the radiators begin to feel the benefit very soon after the boiler temperature becomes appreciable and long before the maximum boiler temperature has been reached.

With a well-designed pump circulation system it frequently happens that the pumps are required for the first two or three hours but that the system can afterwards give a sufficient flow, thus acting as a natural circulation.

In designing a pump circulating system a higher circulating pressure is generally used in the calculations and the pipes sized accordingly, and the difference between the circulating pressure provided by the head and temperature difference is made up in the pressure for which the pump is designed. The latter usually varies between 5 ft. and 20 ft. head.

The circulating pumps can be put either in the flow or the return side of the boiler. Both have their advantages. When they are on the return side an additional pressure is put on the boiler. This may be an important consideration if the boiler is being used somewhere near the limit of its permissible head. On the other hand this is normally a most convenient

PIPING

place for the circulating pump to be put as it can rest on the floor and so be level with the point in the boiler where the return is to be taken. This avoids looping the flow down to the pump from the top of the boiler and then up again. The latter is usually not a good arrangement as it tends to collect air and steam. Thus it must be avoided where possible. The circulating pumps are usually arranged in duplicate on an important system and it is frequently a good thing to design each of the two pumps to take two-thirds of the duty. They can then be started up in parallel and get a quick initial flow with the result that after an hour or so one pump can be switched off. In the event of a breakdown of one pump the remaining pump will then usually be sufficient to maintain the circulation sufficiently to prevent considerable discomfort. The system is of course rather more precarious where only a single pump is put in since, in the event of its breakdown, the system will either work not at all, or only with an inadequate flow, dependent on how far it will work as a gravity system (for which it was not designed).

It is very desirable in the latter case to have a valve by-pass to the pumps and of course a valve on each side of each pump so as to give complete control.

Some simple calculations of pipe sizing are given in the *Ideal Manual* and the matter is dealt with even more fully in Chapter IX of *Heating and Air-Conditioning of Buildings*. (see Foreword).

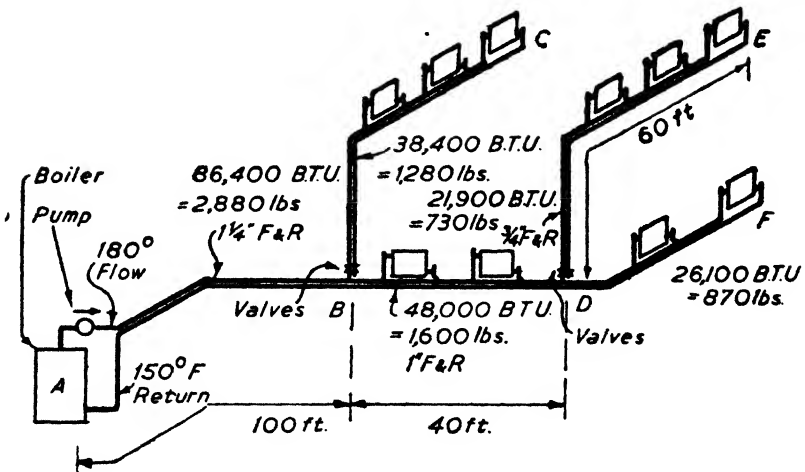

ACCELERATED CIRCULATION

HEATING AND VENTILATING

Given system as diagram, to size the main piping and the pump :

The heat emission, including mains losses from each section, is marked on the drawing and "added back" to the boiler as shown. These values divided by $(180-150) = 30^\circ$, give the lbs. of water passed per hour.

The circuit A.B.D.E. is the longest and is known as the "index" circulation.

$$\begin{array}{rcl}
 \text{Total run of index circ.} & 2 \times 200 & = 400 \text{ ft.} \\
 \text{Bends } 9 \times 3 \text{ (average)} & & = 27 \text{ ft.} \\
 \text{Valves } 2 \times 2 & & = 4 \text{ ft.} \\
 \text{Index Travel} & & = \underline{431 \text{ ft.}}
 \end{array}$$

Assuming a pressure drop of 0.1 in. per ft., from Table 12, mark on the diagram the pipe sizes required for the index circulation.

$$\text{The pump must pass } \frac{2,880 \text{ lbs/hr.}}{10 \text{ lbs./gall.} \times 60 \text{ mins.}} = \frac{4.8}{\text{g.p.m.}}$$

The net head of the pump is:—

$$\begin{array}{rcl}
 \text{Piping } 431 \times 0.1 & & = 43.1 \text{ in.} \\
 \text{Pump connections and boiler resistance} & & \\
 \text{allow} & & = \underline{12} \\
 \text{Head} & & = 55.1 \text{ in.}
 \end{array}$$

The calculated pump capacity assumes perfect distribution of the water and exact estimation of heat emission. To cover inaccuracies it is usual to allow a margin.

The actual pump specification would

$$\begin{array}{rcl}
 \text{probably be} & \dots & \dots & \dots & 6 \text{ g.p.m.} \\
 & & & & 5 \text{ ft. head}
 \end{array}$$

Branches B.C. and D.F. would in the present example be sized at 0.1 in./ft. For larger systems with widely differing travels for the different circulations, it is usual to calculate the pressure drop up to points B. and D. and size the branches to absorb the remaining pressure.

(3) PIPING SYSTEMS

There are various alternative systems of pipes where many radiators have to be served. These are illustrated in the accompanying diagrams 24 to 28 and are known respectively as the two-pipe up-feed system, the two-pipe drop system, the one-pipe ring main system, the one-pipe drop system, and the two-pipe balanced system.

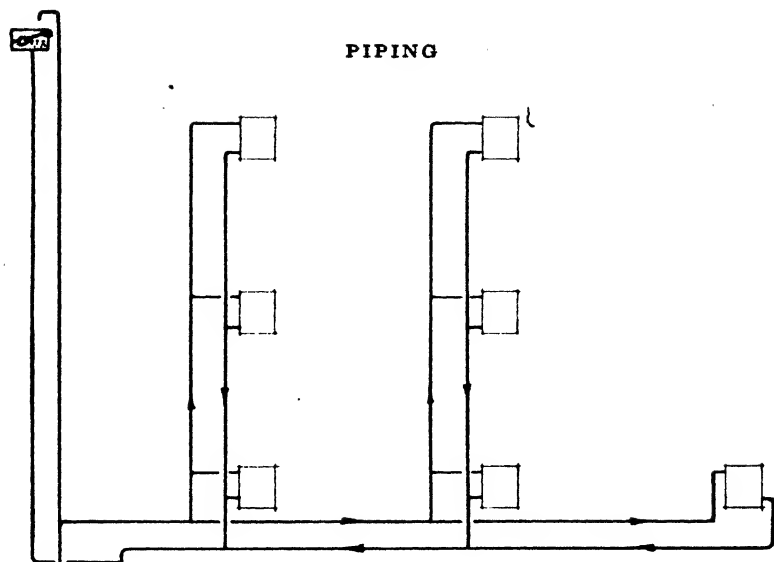

PIPING

(Circulation may be by gravity or pump)

Boiler

FIG. 24 TWO-PIPE UP-FEED SYSTEM

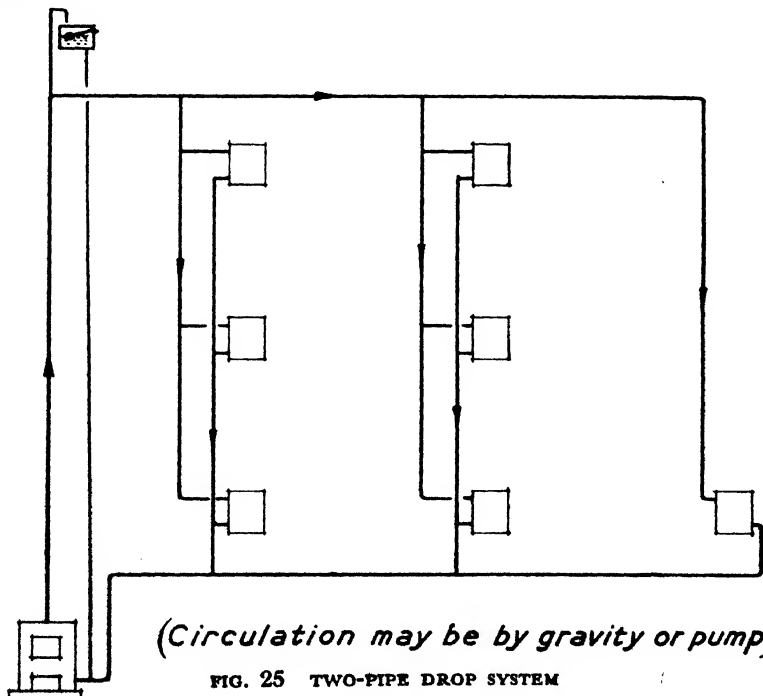

(Circulation may be by gravity or pump)

FIG. 25 TWO-PIPE DROP SYSTEM

HEATING AND VENTILATING

The determination of the best system is a matter for experts and depends very much on the type of building to be served. There is perhaps no need to deal with it in this short work.

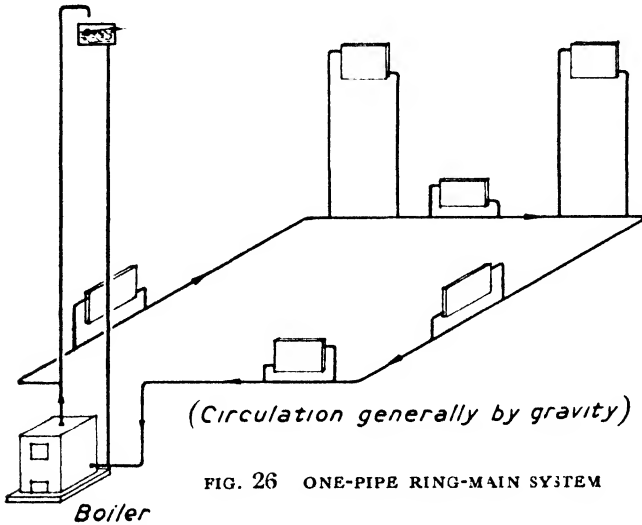

FIG. 26 ONE-PIPE RING-MAIN SYSTEM

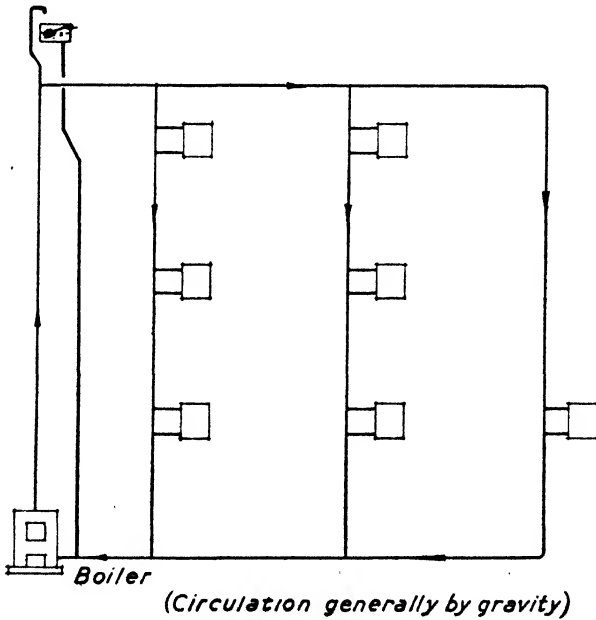

FIG. 27 ONE-PIPE DROP SYSTEM

PIPING

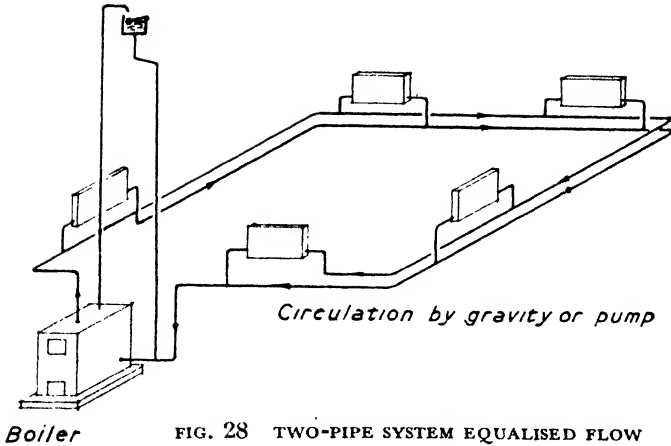

FIG. 28 TWO-PIPE SYSTEM EQUALISED FLOW

(4) EXPANSION TANK AND COLD FEED

From what has been said it will be appreciated that hot water occupies a larger volume than the same quantity of cold water and hence provision must be made to allow for the expansion of the water as the system gets hot. This is done by fitting an expansion tank some distance above the highest radiator. To ensure that the system will always be full of water, in spite of evaporation in the expansion tank and possible small leakages, it is of course necessary that the heating system should be connected with a cold water supply. This is usually controlled by a ball-cock in the expansion tank and the connections are usually made as shown on the accompanying diagrams 24 to 28.

(5) MATERIALS FOR PIPES

The materials used in pipes are usually determined by questions of economy, durability, and the properties of the waters available.

In heating systems the same water is used over and over again and consequently the properties of the water are not so important as in a hot water supply system where fresh water is constantly introduced.

In a hot water system excessively hard water will tend to cause furring, generally in the boiler, but also in the pipes and radiators, and on the other hand excessively soft water will,

HEATING AND VENTILATING

in a hot water supply system, cause excessive corrosion of the iron or steel used in the boilers and pipes respectively.

For these reasons it generally happens:

- (a) that steel and cast iron are quite suitable for a heating system whatever is used, whereas
- (b) far greater care has to be exercised with a hot water supply system, and
- (c) except on very small systems where capital cost has to be kept to a minimum at the expense of everything else, it is inadvisable to combine the two systems.

(6) HOT WATER SUPPLY PIPING

With a hot water supply the character of the water has to be carefully considered owing to the effects previously referred to.

A very hard water will produce furring and a very soft water may produce very heavy corrosion.

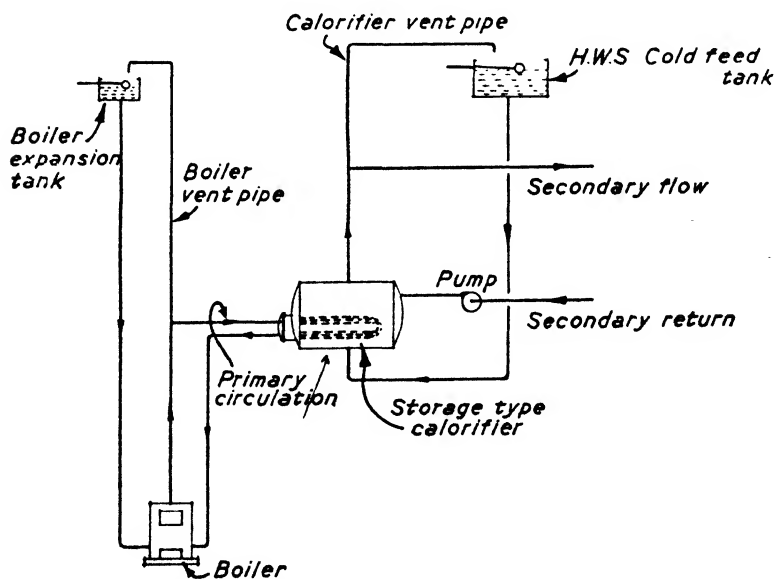

FIG. 29 INDIRECT HOT WATER SUPPLY SYSTEM

Where either of these are likely to occur it is best that the system should be an indirect one as illustrated in Fig. 29 in which the boiler serves a calorifier in a primary circulation and the calorifier in turn serves the hot water supply system.

PIPING

When this arrangement is made it is clear that no corrosion or furring need be feared in the boiler and the primary circuit. Furthermore, furring where hard water has to be used is likely to be limited to the coils in the calorifier and the calorifier should be so arranged that these coils can be periodically removed for the purposes of de-scaling.

Where corrosive water is used the calorifier coils and the pipes from the calorifier throughout the rest of the system should preferably be made of copper or some material not liable to corrosion from the particular water in question.

The Metropolitan Water Board supply water with a hardness of approximately 7 parts per 100,000 permanent and 15 parts per 100,000 temporary. This may be looked upon as non-corrosive and not particularly conducive to furring when used reasonably. Well water from artesian wells in London is softer and contains certain salts such as sodium chloride, which make it somewhat corrosive in iron pipes when used for a hot water supply system. In most of the more important buildings with which the author has been concerned, in which artesian well water is used, it has been found that electrolytic copper piping has been the ideal solution. The difference in cost between copper and steel pipes is not as great as would at first sight be imagined because the copper pipes, with some of the best types of compression or capillary joints, can be used with very thin sections and the labour involved in bending such pipes is considerably less than the labour used with iron or steel pipes.

British Standard Specifications give the necessary thicknesses of pipes of both metals to be used for various heads and should be referred to in specifying requirements.

When steel is used a light weight piping is usually specified for cheap jobs and heavy weight for more permanent ones. It is quite suitable for Metropolitan Water Board, or similar water, when galvanised.

With copper piping it is important that electrolytic copper should be used and the B.S. No. 61 gives two tables of dimensions, covering tubes for pressures up to 175 p.s.i. and up to 300 p.s.i. respectively. For most purposes in buildings it will be found that the light gauge piping of B.S.659 suffices for all practical requirements.

Figs. 30 and 31 show two arrangements of hot water supply systems, the former being a simple system comprising boiler,

HEATING AND VENTILATING

cylinder, and pipes to taps, whereas the latter shows an indirect system comprising boiler, calorifier, and piping with a small radiator system served off the primary.

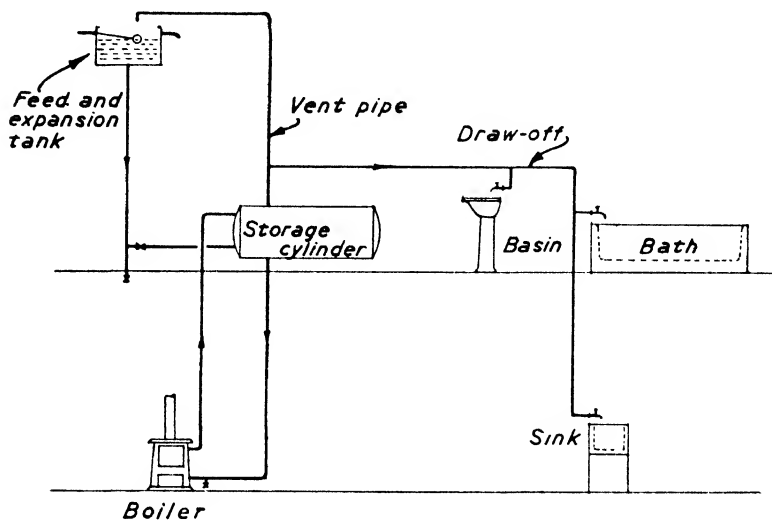

FIG. 30 TYPICAL DIRECT H.W.S. SYSTEM FOR A SMALL HOUSE

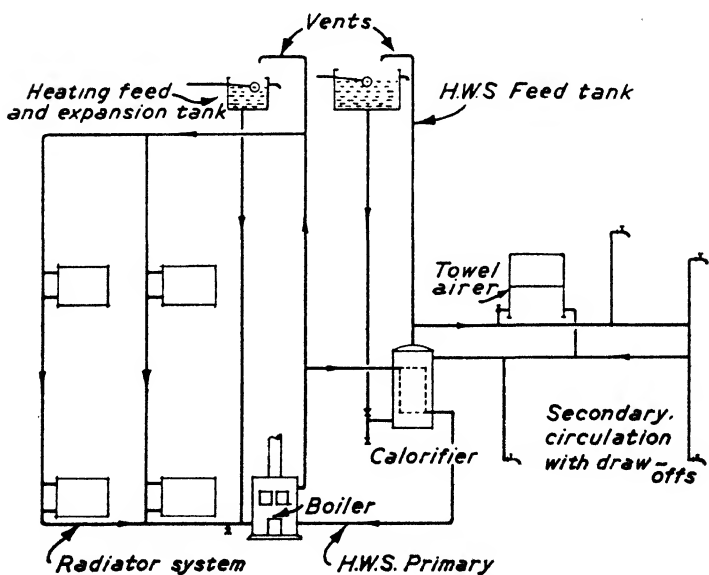

FIG. 31 COMBINED CENTRAL HEATING AND INDIRECT H.W.S. FOR A LARGER HOUSE

PIPING

At one time it was customary to supply a hot water tank in the roof of a building, but it is far better not to do this but to use a cylinder as close to the boiler as possible. The piping from the cylinder can be a simple delivery system to the taps, or alternatively, a circulating system with a flow from the cylinder and a return to it; thus a continuous circulation is maintained. This is of course more expensive in first cost but on the other hand has the advantage that hot water is supplied at once when the tap is turned on, whereas, in the case of a simple system, if the tap is far removed from the boiler it may be necessary to run off a considerable quantity of cold water before the hot water is obtained. This is uneconomical both in water and in heat because the whole heat content of the hot water thus brought into the pipe is subsequently lost by radiation.

The circulating system of a hot water supply should always be lagged so as to reduce the heat lost from it. This may otherwise be considerable over the twenty-four hours.

Where a circulating system is installed the return should preferably not go to the bottom of the cylinder but to some point about one-third of the way down, so as to avoid mixing the relatively high temperature return water with the cold feed water at the bottom of the cylinder and so pushing this up to the top and providing a draw-off which will be a mixture of hot and cold. This also avoids the drawing of cold water up the return.

Where the return is brought in as advocated, a definite layer of cold water will lie at the bottom until replaced by hot from the boiler and there is stratification and a sharp line of demarcation between the hot and the cold. This occurs in the thermal storage cylinders previously referred to.

Since the hot water supply is in use summer and winter it is usual to arrange for it to circulate by gravity to avoid running the pump the whole year round but circulating pumps may be necessary in more extensive systems.

The storage cylinders should of course be proportioned to the needs of the building and considerable experience is necessary in determining requirements.

For a small domestic house, such as that required under Ministry of Health schemes, a 30 gallon cylinder is usually provided. In hotels and blocks of flats it is usual to allow 20-30 gallons per occupant of hot water at 150° F. per 24 hours and

HEATING AND VENTILATING

about 10 gallons consumed in any one hour. The daily consumption may however rise to 50 gallons per head in an Infectious Diseases Hospital and drop to as low as 4 gallons per head in some factories, 5 gallons in blocks of offices, while the peak consumption per hour may be 10 gallons per head for Infectious Hospitals, 5 gallons for Mental Hospitals and 2 gallons for offices and types of factories where there is no process work.

(7) EXPANSION OF PIPING

The temperature differences experienced in pipes are sufficient to cause considerable expansion and contraction as between hot and cold.

Taking the coefficient of expansion of steel as .0000055 per degree Fahr., and the difference in temperature between hot and cold as 100° F., it is of course easy to calculate that there will be an expansion of $\frac{3}{8}$ in. per 100 ft. of pipe. With steam the temperature difference might be twice this amount and even three times this amount with high pressure hot water.

Long lengths of mains are for this reason usually slung by a type of sling which supports a horizontal roller at the bottom on which the pipe rests. This gives it complete freedom to move. The expansion can then be taken up either by introducing a sliding type joint or a horse-shoe type.

The former consists of a machined pipe sliding inside another one, with a packed joint to make it watertight, and has the advantage over the horse-shoe type, especially for large pipe sizes, of taking up very little room. A sliding type joint for a 9 in. pipe, for example, need not be more than about 18 in. diameter and about 2 ft. long overall.

On the other hand with the sliding type leakage has to be provided against.

When one is not limited by space, as for example, in an outdoor system, a horse-shoe, or loop type, is trouble free. The divergence of the loop from the straight line of the pipe and also the distance from one flange of the loop to the other needs to be about twelve times the diameter. Thus, that with a 9 in. pipe, would be about 9 ft., and so on *pro rata*.

In a relatively small building, and especially if the pipes change direction by means of right angle bends, etc. every 20 or 30 ft., this generally gives sufficient provision.

On a large heating system where steam or hot water is carried

PIPING

from a central boiler house to many buildings, as occurred, for example, in the large ordnance factories, War Office depots, etc., overhead steel mains from 14 in. diameter downwards were used, these mains being sometimes several miles in length.

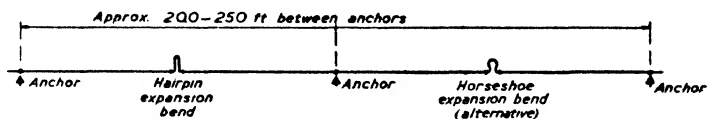

(a) Plan showing Expansion Arrangements on a Long Straight Steam Main

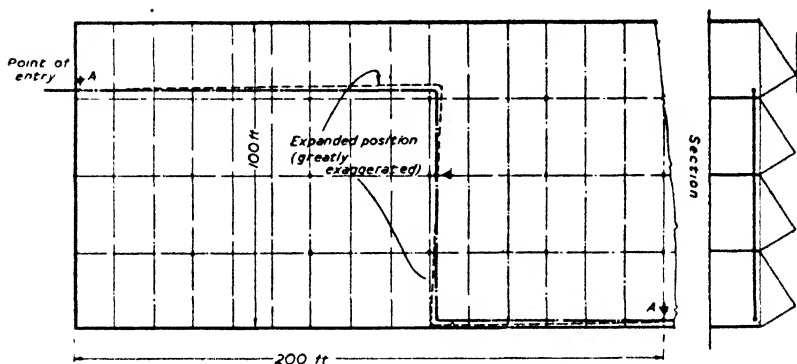

Plan

A indicates Anchor-Point to steelwork at high level

(b) Steam main inside a factory making use of changes of direction to allow for expansion

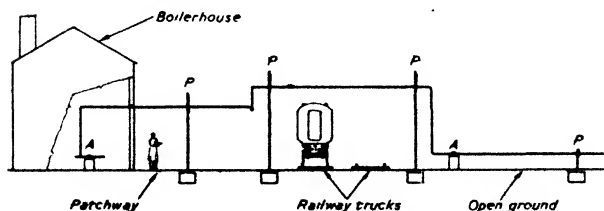

A = Anchor point or block

P = Post with pipe freely supported

(c) Typical Arrangement of Large Steam Main in a Factory

FIG. 32 EXPANSION OF PIPES

HEATING AND VENTILATING

The joints were welded and the pipes suspended from steel or reinforced concrete poles by hangers giving flexibility in the manner already described. The total amount of expansion to be taken up in such cases sometimes amounted to as much as 8 in. It is not satisfactory in a case of that kind to leave the whole main floating without any knowledge of where the fixed points will be because it is difficult to tell how much movement the connections may then be called upon to bear.

What was done, and what it is best to do, is to fix a pipe of that kind by definite anchor blocks at intervals, the anchor blocks consisting of massive concrete blocks heavy enough to prevent movement, and then provide a satisfactory system of expansion joints by which the movement from the next anchor block can be taken up.

In ordinary building work, and especially in domestic properties, pipes are frequently laid in the floors and rest on floor joists. Changes of length caused by heating and cooling then sometimes cause an intolerable nuisance in the shape of the pronounced creaking which occurs whenever the hot water is turned on and when the pipe is subsequently allowed to cool. This is a matter that should be carefully guarded against. It can be eliminated by wrapping the pipe with felt, wired on at the point of support. Unless this is done it is sometimes possible, as in a guest's bedroom, to hear a commentary on everything that happens elsewhere in the house. This can be disturbing.

(8) VENTS AND DRAINAGE

Pipe systems must be laid out so as to prevent air-lock on the one hand and to permit of complete emptying of the water on the other.

All high points must either have vent pipes rising to expansion tanks, be provided with automatic air vents, or be vented by some apparatus such as a radiator containing an air cock.

All horizontal pipes ought to be laid to a slight slope, falling in such a direction as to enable the system to be drained by a draining cock at the bottom, and should generally rise in the direction of flow.

(9) PIPE INSULATION

Pipes used for heating should be insulated where they run

PIPING

in ducts or cellars not requiring heat, and left uninsulated where they run in corridors where heat is required.

Hot water supply pipes, on the other hand, should always be insulated, though this is frequently not done in domestic work. It is particularly important where a circulating hot water supply system is installed for otherwise the heat loss over a year is very considerable. It causes overheating in summer if it is not done.

There are various types of insulation, some of which are applied in the form of a wet paste moulded round the pipe, reinforced with wire netting and usually covered with canvas. This is finished with enamel paint.

The material used for such plastic covering is usually magnesia and the thickness usually varies from 1 in. for small pipes up to 1½ in. for larger ones.

By insulating a pipe in this manner heat loss can be reduced to 15-20% of its unlagged loss, but this is only true of large pipes. In small pipes some of the advantages of lagging the pipe are lost, in that it gives a greater radiating surface than that of the unlagged pipe. In a 1 in. pipe, for example, it is difficult by means of lagging to reduce the heat loss to more than about 30-35% of its original value.

Plastic insulation is generally used in original installations where a little mess is no great objection, but any insulation required after the building is in being is more conveniently of the dry sectional type. This may consist of glass silk, asbestos, or magnesia. It is usually supplied in the form of hollow cylinders slit along the axis, the two halves then being put together round the pipe and secured by clips or metal bands.

Cork is a good insulator for pipes but is not usually used for temperatures exceeding 100° F. as it tends to smell at the higher temperatures if a bitumen binder has been used.

First-rate insulation of pipes is particularly important in connection with refrigeration and the low temperature pipes used in connection with air conditioning. For such pipes cork is usually the best.

(10) PAINTING

On a large building it is extremely useful, as well as decorative, to have the pipes coloured to indicate the circuits which they serve, so that these may be recognised anywhere all over the

HEATING AND VENTILATING

building at a glance. Thus in the Bank of England the following colours were adopted for the piping wherever they occurred:

Heating mains	Red
Cold water supply	Black
Hot water supply	Green
Steam	Orange
Condensate	Blue
Refrigerating media	Grey

There is now a British Standard Specification for the painting of all pipes, which may be referred to in this connection.

The B.S. painting specification appears to have the disadvantage that the same colour is used for hot water heating and hot water supply which it is very important should be readily distinguished.

Chapter VI

HEAT LOSSES FROM BUILDINGS

IN designing a heating system the first calculation usually made is that of the amount of heat required to balance the heat loss from the building to the outside in cold atmosphere, so that if the inside is kept, for example, at 65° and the outside is at 30°, the number of B.T.U. required to maintain this difference of temperature is to be calculated.

This depends chiefly on the transmission losses in the various materials from which the outside of buildings is made and is usually in B.T.U. per sq. ft. per degree difference of temperature per hour, and denoted by the letter U.

For glass and flat sheets of thin asbestos or iron this is generally taken as 1, and for other materials commonly used, may be taken at the following figures:

TABLE 13
WALLS

4½ in. brickwork59
9 " "39
13½ " "29
18 " "23
22½ " "20
(When plastered these figures may be reduced by about 10 per cent.)						
11 in. cavity walls27
4 " concrete75
6 " "61
8 " "52
10 " "45
12 " "40
Corrugated iron	1.5
" asbestos	1.4

WALLS WITH SOME DEGREE OF INSULATION

Brick with 1 in. cork and plaster :

4½ in. brick19
22½ " "12
Concrete with 1 in. cork and plastered :						
4 in. concrete21
12 " "17
Corrugated iron or asbestos lined with ¾ in.						
wood41
Lined with plaster board53
Lined with ¾ in. fibre board31

HEATING AND VENTILATING

DOORS AND WINDOWS

Wooden doors5
Glazing	1.0
Double glazing5

FLOORS.

Wooden floor on joists with plaster ceiling	.27
6 in. concrete floor with screed48
” ” ” ” wood floor finish	.33

ROOFS

	No Insulation	Insulated with 2" cork
Reinforced concrete with asphalt outside and plaster inside :		
3 in. concrete63	.13
6 ” ”5	.12
12 ” ”35	.11
Corrugated iron	1.5	
” asbestos	1.4	
R.P.M. of similar material9	
Tiles or slates unlined	1.5	
” ” ” with boarded lining felt or paper56	
Tiles or slates unlined, but plaster ceiling56	
Tiles or slates with board lining and felted with plaster ceiling32	

FLOORS RESTING ON THE GROUND

6 in. concrete with granolithic finish	.5
” ” ” wood blocks or boards on fillets35

Chapter VII

EXAMPLE OF DESIGN OF A HEATING SYSTEM

(I) FABRIC LOSS

As a simple example, let us consider an assembly hall 100 ft. long, 40 ft. wide, 15 ft. high, walls of 11 in. cavity brickwork, plastered, floor of 6 in. of concrete with wood block flooring, roof of tiles, boarded and felted with

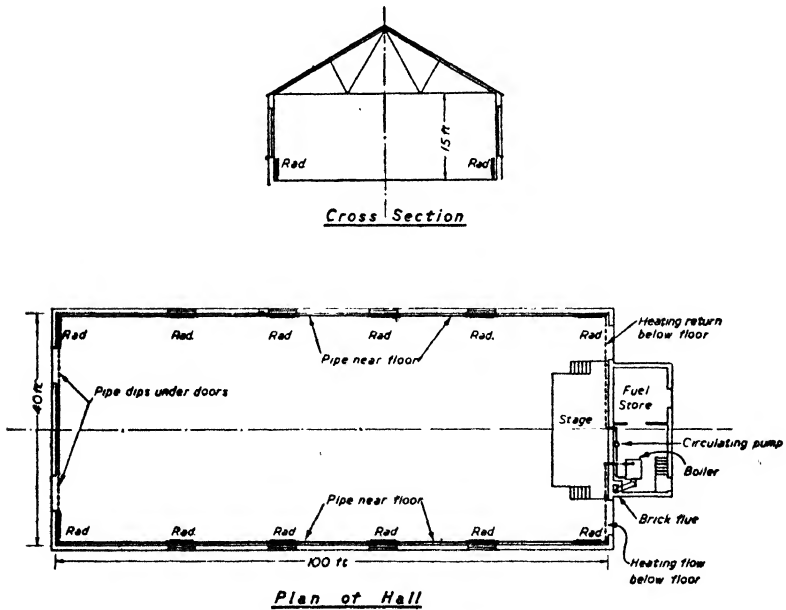

FIG. 33 ASSEMBLY HALL SHOWING HEATING PLANT

a flat plastered ceiling. Four windows on each side 10 ft. \times 5 ft. Two doors at each end 8 ft. \times 6 ft.

HEATING AND VENTILATING

The calculation would then proceed as follows :

<i>Item</i>	<i>Area.</i>	<i>Coefficient.</i>	<i>Heat Loss per °F.</i>
Glass	$8 \times 50 = 400$ sq. ft. ..	1	400
Doors	$4 \times 48 = 192$ sq. ft. ..	.5	96
Walls	$280 \times 15 = 4,200$ sq. ft.		
	Less doors and windows		
	592 sq. ft.		
	3,608 sq. ft.	.27	1,000
Roof	$100 \times 40 = 4,000$ sq. ft.	.32	1,280
			2,776

If it is required to maintain 65° with an outside temperature of 30° the difference of temperature is 35° and the heat loss per hour :

$2,776 \times 35 \dots \dots \dots 97,000$ B.T.U.

To this should be added a floor loss. The area is 4,000 sq. ft. The coefficient .35. Heat loss per °F. 1,400 B.T.U.

It is usual to assume that the temperature below the floor will be maintained at a standard temperature of about 50° , so that when it is 65° outside the temperature difference will be 15° and the heat loss $1,400 \times 15 \dots \dots \dots 21,000$ B.T.U.

118,000 B.T.U.

(2) AIRCHANGE

To the above it is necessary to add some allowance for air change.

Even when a building is kept with all windows and doors shut there may be a considerable amount of air transmission because walls, ceilings and roofs are to some extent porous and neither doors nor windows fit perfectly, but provide cracks at the edges.

The amount of infiltration depends on the difference in temperature and on the wind and exposure. .

As far as temperature is concerned, the greatest infiltration

EXAMPLE OF DESIGN OF A HEATING SYSTEM

occurs at the critical period, namely in the coldest weather, as a kind of flue effect is then set up.

The amount of air change which it is desirable to allow for is really based on experience, and for a building of this type would probably be taken at about 2.

The air volume is clearly

$$4,000 \times 15 = 60,000 \text{ cu. ft.}$$

Hence with two air changes 120,000 cu. ft. of air has to be changed per hour.

The specific heat of air is .019 per cu. ft. at these temperatures. Hence the amount of heat required to allow for this air change is

$$120,000 \times .019 \times 35^\circ \text{ F.} = 80,000 \text{ B.T.U.}$$

Adding this to our previous figure we get a total heat loss of
 $118,000 + 80,000 = 198,000 \text{ B.T.U. per hour.}$

(3) ELECTRIC HEATING SCHEME

If this building was to be heated electrically the number of kW. of radiators or radiant panels required would be (remembering that 1 kW. is equivalent to 3,415 B.T.U.)

$$\frac{198,000}{3,415} = 58 \text{ kW.}$$

It was stated in Chapter III, paragraph (7) that tubular electric heaters are normally designed to consume 60 watts per foot run. Hence the number of feet run required would be

$$\frac{58,000}{60} = 967$$

This could be provided with a 4-tier bank of such tubes all round the walls which gives 800 ft. and the remainder in the ends. This would be a reasonable solution to the problem.

Alternatively, any system of well-designed and arranged electric radiant panels giving 58 kW. would serve equally well.

The consumption of electricity is, of course, 58 units per hour. If electricity costs $\frac{1}{4}$ d. per unit the running cost is then $\frac{2}{5}$ d. per hour. If electricity costs 1d. it is, of course, $\frac{4}{10}$ d. per hour.

(4) HOT WATER RADIATOR SCHEME

If the building is to be heated by using coal or coke as a fuel, then let us assume that a small boiler house is attached to the building and a system of mains run along the outside walls and connected to radiators under the windows. We may assume, in

a provisional way, from past experience, that this pipe would need to be 2 in. diameter, and that the exposed length would be approximately 250 ft. This gives a radiating surface of $250 \times .62$ sq. ft. per foot = 155 sq. ft.

If this pipe is kept at 180° mean temperature and the room is at 65° the difference of temperature between the pipe and the room will be $180^\circ - 65^\circ = 115^\circ$.

The emission of such a pipe per degree difference of temperature would be 2.2 B.T.U. per sq. ft.

Hence the emission of the pipe would be

$$155 \text{ sq. ft.} \times 115^\circ \times 2.2 = 39,000 \text{ B.T.U.}$$

This clearly leaves $198,000 - 39,000 = 159,000$ B.T.U. to be provided by the radiators. For radiators we may take the total emission per sq. ft. per degree difference in normal temperature conditions as being approximately 1.5 B.T.U. per sq. ft. Hence the emission per sq. ft. in our case is 115° difference of temperature, which would be 172 B.T.U. per sq. ft. Hence the number of sq. ft. of radiator surface would be

$$\frac{159,000}{172} = 926 \text{ sq. ft.}$$

If we have one radiator under each window and two radiators on each end wall either side of the doors, making twelve in all, the surface required for each radiator would be

$$\frac{926}{12} = 77 \text{ sq. ft.}$$

It will be seen from Table 7 that a four-column Classic or equivalent 36 in. high gives an area of $3\frac{1}{5}$ sq. ft. per section. Hence, clearly 24 sections are required and as each section is $2\frac{1}{4}$ in. long the length of the radiator will be 54 in.

Actually it would be better to make the radiators 28 sections long and make them 63 in. long, because if the hall is for intermittent use it is important that it should be possible to get it up to temperature quickly, and this can only be done by having excess heating capacity in the heating up period.

(5) SIZE OF BOILER

Assuming a hot-water radiator scheme as in (4) above, we must now determine the size of the boiler required. For this purpose we have to remember that there are certain losses such as radiation from the boiler and from the pipes in the

EXAMPLE OF DESIGN OF A HEATING SYSTEM

boiler house, etc. The estimation of these losses depends on circumstances.

In our case, the mains which are not used as heating surfaces will be very small and we take these losses as 10%, though in some jobs they may rise to as much as 20% or 25%.

The boiler required should therefore have a rating of at least $198,000 + 10\% = 218,000$, but it must be remembered also that manufacturers rate their boilers under more or less test conditions and to enable the boiler to be run without forcing and with average stoking with a reasonable margin in hand it is good practice to allow another 10% in arriving at the maker's rated figure.

There is yet another consideration to be borne in mind.

An assembly hall of this kind would probably be used intermittently, and if a boiler is to be supplied which is only just sufficient to maintain the temperature conditions when achieved, it will take a long time to heat the hall up from cold. Some additional capacity is therefore very desirable and as a result of experience it has been found good practice to add 25% to cover this.

Taking the two figures together we may therefore add 35% to the 218,000 previously arrived at, which gives us a figure of 294,000 B.T.U.

Referring to Table 8 it will be seen that a cast iron sectional boiler 36 in. wide, 40 in. deep and 50 in. high gives the desired duty. Maker's catalogues should also be consulted as there are of course several types of boiler suitable for this duty and all are of about the same size.

(6) STACK

It was stated in Chapter IV, paragraph (6) that one rule for the flue area in sq. ft. is

$$\frac{\text{Rating of the boiler in B.T.U.}}{80,000 \times \sqrt{\text{the height of chimney.}}}$$

If we take the height of the chimney as being 25 ft. then the square root is 5 and the area of the stack required is

$$\frac{\text{Boiler rating}}{80,000 \times \sqrt{h}} = \frac{300,000}{80,000 \times 5} = .75 \text{ sq. ft.}$$

A 13 in. \times 9 in. flue gives .81 sq. ft. and would be suitable.

(7) PIPE SIZING

We must now consider the pipe sizing where we provisionally assumed a 2 in. pipe, and consider whether gravity or pump circulation should be adopted.

It was mentioned in Chapter V, paragraph 1, that the circulating pressure with a 20° drop will be one-half of 1.6 in. per 10 ft., i.e. .08 in. per foot.

If we work with a gravity circulation we then have to determine H, the difference in height between the centre of the radiators and the centre of the boiler.

This of course depends on the depth of the boiler below ground, but it would probably usually be inconvenient to make the boiler house more than 5 ft. below ground level, and as the centre of the boiler may then be about 3 ft. below floor level, the centre of the radiators may be about 3 ft. above floor level, giving a total height from centre of radiator to centre of boiler of 6 ft.

Hence the circulating pressure with gravity flow would be

$$CP = .08 \times 6 \text{ ft.} = 0.48 \text{ in.}$$

The length of pipe is about 280 ft., but allowing for the drops at the doors we must allow for 24 bends as follows.

Horizontal bend in each corner of the building ..	4
4 bends at each door to take the pipe down and up again	16
2 horizontal bends into the boiler house	2
2 vertical bends down into the boiler	2
	—
	24
	=

Referring to Table 12 it will be seen that the equivalent ft. run of pipe for long radius bends in the case of a 2 in. pipe is 7 ft., hence the equivalent length of the bends is

$$24 \times 7 = 168 \text{ ft.}$$

Adding this to the 280 ft. of straight pipe in the building clearly gives a total length of 448 ft. equivalent of straight pipe.

Hence the resistance of the pipe in inches per foot would need to be for correct gravity circulation

$$\frac{0.48}{448} = .0011 \text{ per foot.}$$

EXAMPLE OF DESIGN OF A HEATING SYSTEM

Referring back again to Table 12 it will be seen that this will only circulate somewhere about 900 lbs per hour. This would not suffice, as will be seen from the following.

The amount of water required to be circulated to give a 20° drop is the B.T.U. to be transmitted divided by the temperature drop, which is

$$\frac{218,000}{20} = 10,900 \text{ lbs per hour.}$$

As against 900 lbs. which the pipe would carry by gravity.

It is clear from this that gravity circulation would not be satisfactory unless pipes much larger than 2 in. were used, and these would be ugly and probably rejected on aesthetic grounds.

This conclusion is entirely consistent with what was stated in the text when considering the relative merits of natural and pump circulation, as it was pointed out then that pump circulation is needed where the length of horizontal run is great and the vertical height is small, of which this is an outstanding example.

Of course a very large pipe would be quite satisfactory both from a circulating pressure and a heat emission point of view, but many architects would object to their assembly hall being treated on the same principle as a greenhouse.

Let us assume that it has been decided to work on a radiator scheme with pipes 2 in. diameter as previously stated and then it is clear that the disparity between the 900 lbs per hour which the 2 in. pipe will circulate under these conditions and the 10,900 lbs required can best be bridged by the introduction of a circulating pump which also has the advantages previously referred to in the text, namely, of giving a much more rapid circulation from cold.

Referring again to Table 12 it will be seen by looking down the 2 in. pipe column that the resistance in inches per foot run corresponding to 10,900 lbs per hour is about .11 whence the total resistance on the 448 ft. of equivalent length of pipe will be

$$.11 \times 448 = 49.2 \text{ in.}$$

10,900 lbs is of course 1,090 gallons, and it would be usual to specify under these circumstances a circulating pump of 20 gallons per minute (1,200 gallons per hour) against a circulating pressure of 60 in. water gauge.

The margin between 49.2 in. and 60 in. is desirable to allow for additional resistance of pump connections and the boiler resistance.

(8) RUNNING COST OF THE COKE SCHEME

The heating load was 218,000 B.T.U. per hour, and if we assume a coke having a calorific value of 12,500 B.T.U. per lb. the number of pounds required per hour at 100% efficiency will be

$$\frac{218,000}{12,500} = 17.4 \text{ lbs}$$

This must however be increased to allow for the inefficiency of the boiler. If the boiler efficiency is taken at 65%, then the consumption per hour must be increased to

$$\frac{17.4}{.65} = 27 \text{ lbs per hour.}$$

If the coke costs £3 per ton, the cost per lb is

$$\frac{720}{2240} = 0.325 \text{d. per lb}$$

Whence the running cost per hour would be $27 \times 0.325 = 8.8 \text{d.}$, say 9d.

The corresponding electric cost at $\frac{1}{2}$ d. per hour was $2/5 \text{d.}$ It is however only fair to say that with coke something ought to be allowed for labour. How much, would depend on circumstances. It may well be that a caretaker is required anyhow, who can do the necessary stoking as well as turn on the lights, open the doors, etc., etc.

If of course it meant engaging an additional person at a cost of say 2/- per hour, then the labour cost would of course make the electric scheme the cheaper of the two and all these matters have to be taken carefully into account on their merits.

The electric installation should also be credited with some advantage owing to greater ease of control and earlier shutting off.

(9) EFFECT OF OCCUPANCY

It is of interest to consider what happens when the hall is now filled with people, since the heat loss of 198,000 B.T.U. was arrived at on the basis of the hall empty with two air changes due to infiltration.

Let us assume now that this hall would take 480 persons (equivalent to $8\frac{1}{2}$ sq. ft. per person) and that these persons are sedentary, in which case from paragraph (10) of Chapter I we may take about 400 B.T.U. per person total emission, but

EXAMPLE OF DESIGN OF A HEATING SYSTEM

reference to Fig. 3(a), shows that only 330 of this would be sensible heat. Hence the total emission by personnel with 480 people would be 160,000 B.T.U. per hour.

It will be seen that this is comparable to the total heat losses of the building (198,000) even in very cold weather, and therefore would soon produce conditions of discomfort. This shows how important it would be to be able to shut off the heat immediately the hall was filled and not have a system with a very long time lag.

Assume, however, that this cannot be done immediately and the radiators continue to emit the 198,000 B.T.U. in addition to the 160,000 previously referred to. We therefore get a total heat emission of 358,000. Deducting from this the radiation losses of 118,000 leaves 240,000 B.T.U. to be expended in air change. As the two air changes absorb 80,000 B.T.U. it will be seen that approximately six air changes will now be needed, but if the heating can be cut off very quickly as the people enter, far less will suffice.

It is therefore usually desirable with a radiator system to get the building well warmed up and then start cutting off radiators about half an hour before the hall will be filled.

As has been said earlier, no hall of this kind to hold 480 persons can be considered to be really well equipped unless it has mechanical ventilation as well as heating, since to introduce air from the outside at a temperature of 30° when the inside temperature is 65° or more, cannot be done without the creation of most objectionable draughts and the ventilation of the building with tempered air is the only satisfactory method.

Chapter VIII

EXAMPLE OF DESIGN OF A VENTILATION SYSTEM

PERHAPS the best way of getting a grasp of the problem of ventilation will be to follow up the design of the small assembly hall, referred to in the last chapter, having a dense occupancy of 480 persons rated at $8\frac{1}{2}$ sq. ft. This will give an idea of the calculations and the principles involved.

(1) AIRCHANGE

We have already shown that the cubic contents of the hall are
 $100 \text{ ft.} \times 40 \text{ ft.} \times 15 \text{ ft.} = 60,000 \text{ cu. ft.}$

and that the sensible heat emission at about 65° for sedentary persons is 330 B.T.U. each, which for 480 persons comes to 160,000 B.T.U.

As the hall will be used at night we must per hr.
 also allow for the heat produced by the electric light, which we may take as 3 kW., the heat equivalent of $3 \times 3,415 \text{ B.T.U./hr.} \dots \dots \dots 10,000 \text{ ,,}$

170,000 ,,

If we are to limit the temperature between the inlet air and the extract air to 15° so as to prevent objectionable draughts, then clearly every cubic foot of air that we introduce will only carry $15 \times .019 = .285 \text{ B.T.U.}$, and hence the number of cu. ft. of air will be

$$\frac{170,000}{0.285} = 600,000 \text{ cu. ft. per hour.}$$

As the capacity of the hall is 60,000 cu. ft. it will be seen that this corresponds to ten air changes per hour.

It is perhaps of interest to note that the L.C.C. statutory requirements for theatres require 1,000 cu. ft. per hour per person, which corresponds to 480,000 cu. ft. per hour, or eight air changes.

(2) SUMMER CONDITIONS

Let us now consider for a moment what happens in hot summer weather when no mechanical ventilation is provided.

We have shown that even with ten air changes per hour the temperature rise will be 15° , and this makes no allowance for additional heat which may be received by direct sunlight acting on the roof and walls. This clearly means that when the outside air temperature is 80° F. the inside temperature would be at least 95° F., which is an intolerable temperature, especially when it is at high humidity, since as can be seen from Fig. 3, page 25 and Table 3, page 22, 480 persons would also be giving up a considerable quantity of moisture in the form of latent heat.

The complete solution to this is of course reduction of temperature and humidity by a complete air conditioning plant, this includes refrigeration.

This plant is, unfortunately, both somewhat costly to install and to run. Hence it always becomes a question as to whether it is economically possible for the particular purpose under consideration.

In America, most modern theatres are provided with such a system, including refrigeration. This also applies as well, to the better class hotels, stores and offices. Extremes of temperature are of course greater there than in this country. One does not pretend that there are as many days when refrigeration is required here, as in the United States. Nevertheless, a very large number of buildings in this country have, in fact, been provided with complete air conditioning, including refrigeration plant. Such buildings include the whole of the Bank of England and part of Lloyd's Bank, Martins Bank, South Africa House basement cinema, Church House, Princes House, some of the best large cinemas, and of course the new House of Commons.

Where, however, no such refrigeration plant is provided the occupants must just put up with an inside temperature that is considerably higher than the outside temperature. It is occasionally argued that passing the air through a water spray or washer is beneficial because it reduces the temperature. This however is a very doubtful expedient, though washers of this type have their definite uses. But it gives very little relief from summer conditions to pass air through a washer, because it increases in humidity, and, as explained in the first chapter this leads to oppressive conditions.

In hot, sultry weather, when the outside humidity is very high, the evaporation is negligible and therefore the system has very little cooling effect. The function of the washer is to humidify the air in the winter when its temperature is going to be raised and when without it the air may become so dry as to produce parched throats and other discomforts.

We have shown that the internal temperature may be expected to reach 15° above external temperatures even with mechanical ventilation to the extent of ten air changes per hour. What then will be the conditions in the hall if no such mechanical ventilation is provided? In this case one is of course entirely dependent on the accidental air change which can be obtained by opening the windows. It is impossible to give any figures as to what air change can be obtained by the opening of windows because it is accidental and depends on wind, exposure, orientation and difference of temperature between the inside and the outside. It also depends a great deal on the height of the building, since a tall building will set up an appreciable flue effect, outside air entering near the bottom and escaping near the top on the same principle as produces a draught in a chimney.

All that can be said with certainty is that the conditions will be far worse than where simple mechanical ventilation is provided, and the occupants of the building can be fairly certain of having a really hot and stuffy time.

(3) WINTER CONDITIONS

Under winter conditions we now have to visualise and provide plant for the introduction of 600,000 cu. ft. of air per hour and as we do not want the inlet air to differ from the extract air by more than 15° F. we clearly have to raise the air temperature of inlet from say 30° outside to say 50° inside. In a good system it would be wise to allow for a greater rise than this, since when the hall is only partially filled, 50° would be too low a temperature to bring the air in, since a reduced occupancy would not raise it to 65° F. and it is usual to design the plant to raise the temperature to 65° though with full occupancy the heater would be partially closed down.

This is one of the many cases where compromise is sometimes effected between what is most desirable and what the client can afford. It is true that when the hall is only partially filled the air volume can be correspondingly reduced.

EXAMPLE OF DESIGN OF A VENTILATION SYSTEM

It is also permissible in many cases to recirculate at any rate a large proportion of the air, and fuel is of course saved by so doing.

In the present example we will assume that of the 600,000 cu. ft. per hour required with full occupation, 300,000 will be taken as fresh air from outside and 300,000 as recirculated air taken from the hall. Thus, the heat required to heat the fresh air from 30° to 65° is, for the reasons already given,

$$300,000 \times .019 \times 35 = 200,000 \text{ B.T.U. per hour.}$$

It will be seen that this is almost exactly the same as the heat shown to be required in the last chapter for heating the building by radiators. In the author's view, where economy is urgent it would be satisfactory to provide a boiler to give this, and having a suitable margin to serve the radiator system for raising temperature and for keeping it tempered, and then to switch the boiler power over to the ventilating system when the hall begins to fill.

In other words, the 200,000 B.T.U. are not to be looked upon as additional to those required for heating, but the same boiler can provide for both the heating when the hall is empty and the ventilation when the hall is full.

It is perhaps of interest to work out reasonable sizes, etc. for the different components of the ventilation system for our hall.

(4) FRESH AIR INTAKE

The position of this requires careful selection in order to make sure that dust from the street, petrol fumes, smells from kitchens, etc. and smoke from adjacent boiler stacks are not drawn in to the building by the fans. A compromise has to be effected and it will generally be found that a point at least 10 ft. above the pavement level and not level with a chimney will be satisfactory.

The intake, which is usually arranged vertically, is generally provided with louvres to keep out rain and snow, and a wire mesh is fitted behind the louvres to prevent ingress of paper and birds.

The size of the intake must be proportioned to the volume of air passing through it at a speed of about 60,000 ft. per hour through the free area of the louvres, and hence in our case the area required is

$$\frac{600,000}{60,000} = 10 \text{ sq. ft.}$$

As the louvres, etc. take up some area a nominal opening of 4 ft. \times 3 ft. will probably be required if the louvres are of thin metal, but more if they are of wood. In the latter case probably a 5 ft. \times 4 ft. opening would be required.

It will be noted that in the above calculation we have designed the inlet for the full quantity which the fan is capable of moving, although we agreed only to use 300,000 cu. ft. per hour, i.e. one-half of this quantity in the winter time. The reason for this is that in the summer time there is no loss of economy by taking all the air from the outside and indeed there is a definite gain in doing so as the outside temperature is, as we have seen, frequently lower at a time when it is desired to cool the hall.

(5) FILTER

The question of air filtration to remove dirt is a difficult one and depends on circumstances.

Filters are of many types. There is, for example, the *oil filter* which consists of metal plates, generally of zig-zag shape, which causes the air to deflect on to plates covered with sticky oil to which the dirt particles adhere.

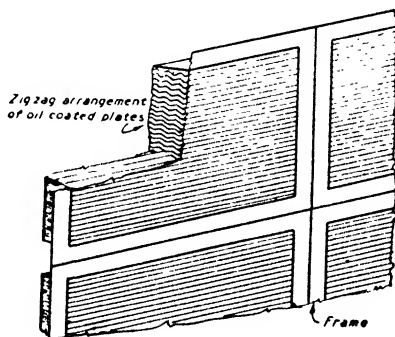

FIG. 34 OIL COATED FILTER

This type of filter can be arranged in units which are removed for cleaning and are boiled in caustic soda, washed and then re-dipped in sticky oil. This is a troublesome and somewhat expensive process. Alternatively, they may be of the *self-cleaning* type, in which case oil is pumped from the bottom to the top and allowed to run down the plates, the latter type never needing more attention than cleaning out the oil perhaps once a year so as to remove the collected dirt.

EXAMPLE OF DESIGN OF A VENTILATION SYSTEM

Filters of this type are specially useful for removing relatively large dirt particles, such as dust from the street, but they are not particularly efficient in catching that almost impalpable dirt, such as flocculent smoke, and it is the latter which causes most of the dirt marks round fresh air intakes making an otherwise beautiful building unsightly.

The *washer* which consists of a series of sprays of finely atomised water injected into the air stream and collected on eliminator plates also serves to clean the air to some extent. The water is usually continuously recirculated by a small pump and gradually becomes highly acid. If the eliminator plates are made of steel, they will, whether galvanised or not, frequently corrode through in a few years and require replacement. In the author's experience even copper plates have only lasted five to ten years, and the best practice is undoubtedly to use glass, though this requires some modification to the design of the washer.

The principal function, however, of the washer is to humidify the air in winter.

Perhaps the most satisfactory type of filter for finally removing the residue of the dirt is either the fabric filter, as installed at the Bank of England, Queen's Hotel, Leeds, etc. or the *electrostatic filter*. The *fabric filter* consists of light zig-zag frames across which a special cottonwool fabric is stretched, this cottonwool being lightly packed between two layers of scrim and perhaps $\frac{3}{16}$ in. thickness.

Another type is the *Throw away* made of cardboard, fibre, or glass silk, which, as its name implies is thrown away when it is charged with dirt.

Air has to be passed through the filter at a low velocity, approximately 50 ft. per minute, equivalent to 3,000 ft. per hour, so that to pass 600,000 cu. ft. per hour would clearly require an area of 200 sq. ft. This does not of course occupy a wall surface of anything like this extent owing to its zig-zag form, but it would probably require an area of about 40 sq. ft. in the ventilation plant chamber.

The *electrostatic filter* is the most modern type and is extremely efficient. It consists of an arrangement under which the air is ionised by passing an arrangement of wires charged with high tension electricity and it then passes between parallel metallic plates to which the ionised particles are attracted by a static difference of high potential. In this way all the dirt is

HEATING AND VENTILATING

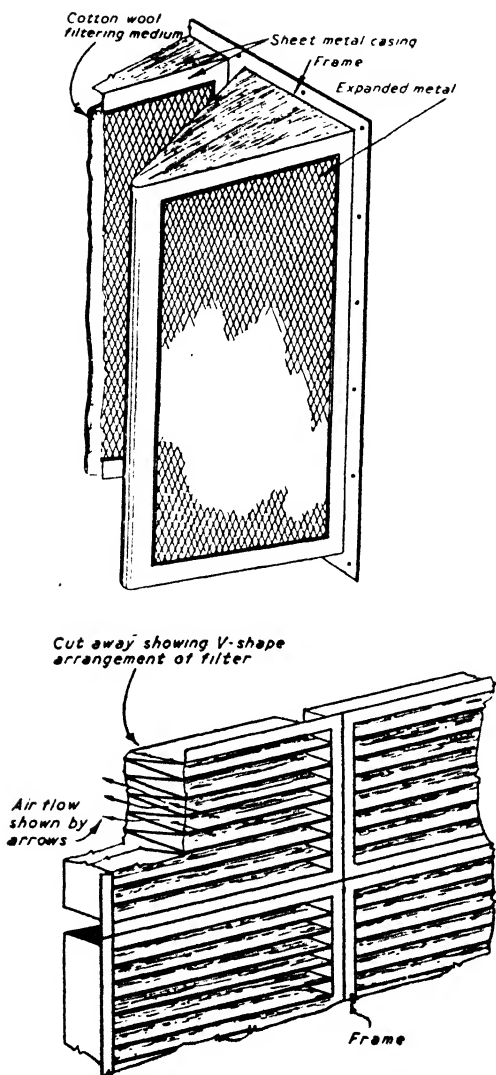

FIG. 35 FABRIC FILTER

collected on to these plates by electrostatic attraction and can be removed by washing at intervals. The worst feature of the electrostatic filter for ordinary everyday use is its very high initial cost.

EXAMPLE OF DESIGN OF A VENTILATION SYSTEM

Its use is therefore limited to special jobs or jobs of considerable magnitude. It would be quite out of scale to suggest it for the present example, where the cost would be at least £1,000.

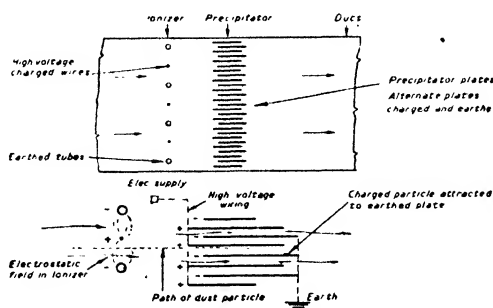

FIG. 36 ELECTROSTATIC AIR FILTER

For the latter the author would consider the fabric filter to offer a reasonable solution to a difficult problem. The various units are taken out one at a time for renewing the cottonwool fabric after the latter has become thoroughly impregnated with dirt. It is surprising how much dirt it can hold.

A very careful selection of the fabric being necessary, one is, to some extent, between the devil and the deep sea. Too open a fabric allows all the dirt to get through, too close a fabric quickly clogs and lets no air through. It requires a good deal of research to discover the desirable material.

In the present case 200 sq. ft. of cottonwool fabric will be provided in screens occupying a surface of about 40 sq. ft.

(6) FANS

Fans are of two principal types, i.e., cased fans and propeller fans. The latter are by far the cheaper, but are only useful for blowing air against a negligible resistance. Thus an extract fan provided in a window or wall for blowing the air out may be a propeller fan, but to deliver air into a duct system where there is a resistance of more than 0.2 in. of water gauge would normally not be the place for a propeller fan, and a cased fan would be used.

A variation of the propeller fan is the Axial Flow type which can be used against some resistance due to ducts.

The Bank of England has two double inlet cased fans each driven by a motor of approximately 100 H.P.

HEATING AND VENTILATING

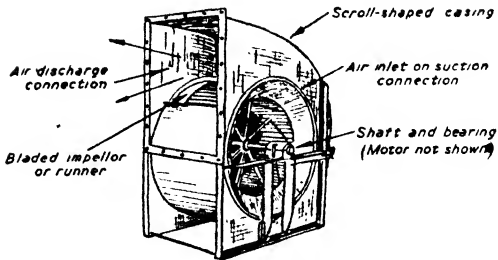

FIG. 37A CENTRIFUGAL OR CASED FAN

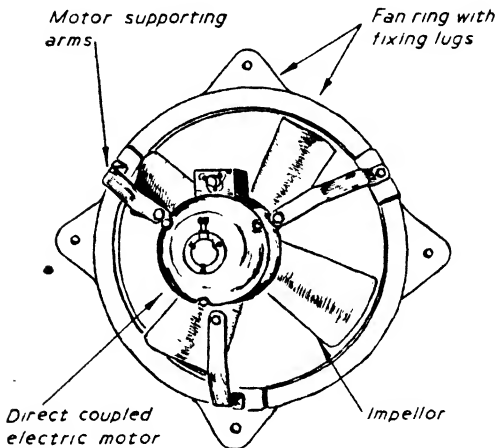

FIG. 37B PROPELLER FAN

In the present instance a cased fan would certainly be required to deal with 600,000 cu. ft. of air per hour, and if the duct-work is reasonably designed it would probably work against a resistance of about 1 in. water gauge, including the resistance of the air heater and filter.

Given these particulars the size may well be left to the maker, as well as the H.P. required to drive it.

For reasonable silence the outlet from the fan should be limited to a speed not exceeding 80,000 ft. per hour.

(7) INLET GRATINGS AND DUCTS

Inlet gratings have to be proportioned so as to give a speed which will not be noisy or create draughts. What exactly

EXAMPLE OF DESIGN OF A VENTILATION SYSTEM

constitutes a draught is too complicated to go into here though air speeds in excess of 1 ft. a sec. at head level may be looked upon as carrying some risk of giving offence. Suffice it to say that air speeds which are quite innocuous at one temperature and humidity will be felt to be draughts at other temperatures and humidities. No two people easily agree as to their ventilation requirements. This is one of the circumstances that make the function of the ventilating engineer so delightful, since, as he has really very little hope of pleasing everybody, he might just as well please himself.

It is good practice to limit the speed of the air at the inlet to 20,000 ft. /hr. or about $5\frac{1}{2}$ ft. a sec. through the free area of the grating.

Experience shows that it is dangerous, except in factory work, to have the air stream low or pointing downwards, and the best position as a rule is to keep it some 10 ft. or more up and direct the air as horizontally as possible. After all, God's winds blow horizontally and not vertically, and these are the conditions that man was presumably designed for.

In our present case it would be a reasonable and satisfactory solution of the problem from a ventilation point of view, to provide a duct over the windows along one wall of the hall with louvred openings so as to blow a horizontal air current under the ceiling. If this duct were made to carry the whole volume it would probably be too large to be very easily treated architecturally, and this difficulty can be overcome by providing a much larger duct in the roof. This feeds the duct below the ceiling at frequent intervals and preferably between the actual outlets.

It is clear that the total area of inlet gratings will have to be

$$\frac{600,000}{20,000} = 30 \text{ sq. ft. of free area.}$$

If it is architecturally convenient to have a long slot in the side of the duct practically the whole length of one wall and about 4 in. deep, this from a ventilation point of view is satisfactory, but if it was necessary to divide this up so that its effective length was only one-half the total length then the depth required would have to be about 8 in.

No doubt for architectural symmetry this duct, which could be treated in a variety of ways, would be balanced by something to resemble it on the other wall.

HEATING AND VENTILATING

The air issuing horizontally from this long grating, or series of gratings, should be made to traverse the hall along the ceiling. This is conveniently done by extracting it through the ceiling as near the other wall as possible, it might even be done by providing a similar horizontal duct on the other wall, with a similar grating to serve as an extract. In this way the air would be under complete control and hardly affected by the opening or closing of windows or doors. The extract duct should of course be taken to an extract fan designed to blow 600,000 cu. ft. of air out into atmosphere, but arranged with a damper so that the air can be diverted in whole or in part to recirculation. This fan would of course have to be somewhat similar to the inlet fan previously described, as its resistance and capacity are similar.

The ducts in the ceiling for serving the delivery ducts in the coves could be sized at 75,000 ft. per hour for the large one and branches from the big duct to the duct in the cove to about 50,000 ft. per hour. The large duct would be tapered.

Assuming that the ventilation plant is at one end of the building the duct would have to carry the whole volume, and its sectional area would require to be

$$\frac{600,000}{75,000} = 8 \text{ sq. ft.}$$

This is equivalent to a duct 3 ft. 3 in. in diameter.

(8) HEATER

It has already been explained that the heater should be of a size capable of delivering 200,000 B.T.U. per hour into the air stream. Heaters usually consist of coils of piping which may or may not be provided with fins so as to increase the radiating surface. The emission from such piping depends very much on the velocity, but if the velocity is taken at 30,000 ft. per hour over the face area of the coil, then in our case the face area of the heater has to be

$$\frac{600,000}{30,000} = 20 \text{ sq. ft.}$$

The velocity between the heater tubes is generally at about 75,000 ft. per hour, which means that the clear space between two pipes is to be taken at about two-thirds the pipe diameter. Succeeding rows of pipes are usually staggered so as to force the air to impinge on them as much as possible.

EXAMPLE OF DESIGN OF A VENTILATION SYSTEM

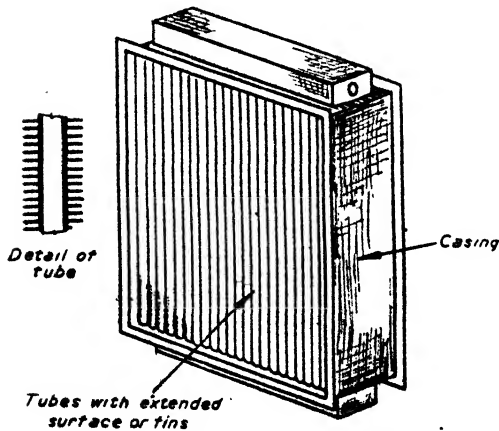
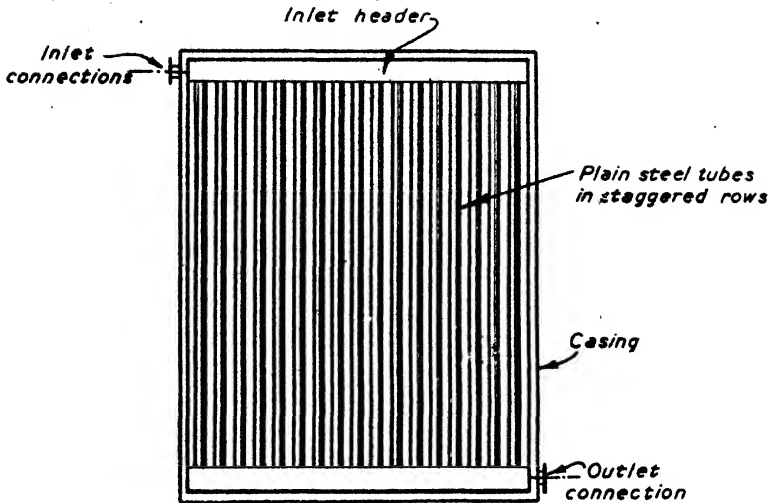

FIG. 38 TYPES OF AIR HEATER :

(A) PLAIN TUBE TYPE, (B) FINNED TUBE TYPE

(9) CONTROLS

Having put in a system like this it is important to see that it is used intelligently and that its use is made as simple as possible.

In the author's experience many a good system has been completely spoilt by handing it over to an unintelligent operator,

FURTHER NOTES ON VENTILATION

who probably never had explained to him the theory on which it was based and the manner in which it should be operated. Alternatively it may be handed over to a gardener or some person whose intelligence is not sufficient to enable him to understand it however much information is given.

For this reason it should be thermostatically controlled.

The normal operation is somewhat as follows :

- (a) In warm summer weather the dampers are set to give no recirculation, and this arrangement continues until the weather cools down to a point when this produces air too cold for comfort.
- (b) The dampers can then be re-set so as to give partial recirculation down to half fresh air and half recirculation, still no heat being required.
- (c) With a further reduction of outside temperature the boiler has to be in operation and heats the hall through the radiators until half an hour before the function is timed to begin.
- (d) It is then switched over from radiators to ventilation system working on full recirculation.

When the hall begins to fill, the temperature will tend to rise and this can be countered by admitting part fresh air in lieu of recirculated air until a balance is struck. At the same time the temperature of the water in the heater is thermostatically controlled from the hall temperature and left on thermostatic control.

- (e) When the function is over the ventilation system is switched off and the boiler reconnected to the radiator system so as to keep the building tempered until again required with high occupancy.

By such operation not only is the first cost kept to a minimum, but what will become increasingly important in the future, the greatest conservation of fuel consistent with good results will be maintained.

Fig. 39 shows the hall, which we have been considering, with its heating and ventilating system.

EXAMPLE OF DESIGN OF A VENTILATION SYSTEM

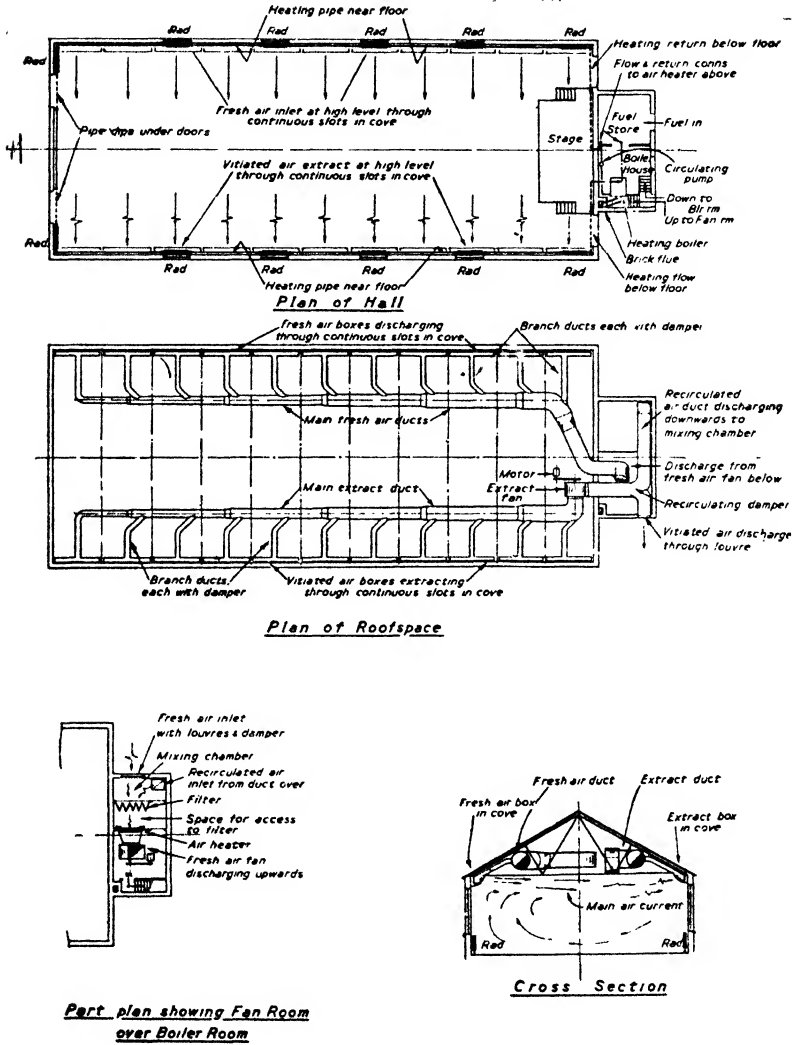

FIG. 39 ASSEMBLY HALL SHOWING HEATING AND VENTILATING PLANT

Chapter IX

FURTHER NOTES ON VENTILATION

(1) CUBIC CAPACITY PER PERSON

FROM the example just concluded, and what will have been gathered throughout the book, it can be seen that ventilation is particularly necessary where people are crowded together as in legislative chambers, cinemas, theatres, restaurants, or foyers. The need for ventilation increases where, under the foregoing conditions, the ceiling height is low and when the period of the session of dense occupation may be a long one. Thus, if one considers a restaurant seating persons at the rate of 8 sq. ft. per person, if the ceiling height is only 10 ft., that person will clearly have 80 cu. ft. of air. If for proper ventilation he requires 1,000 cu. ft. of air per hour, he will have used up his air allowance in approximately five minutes, and after that time, will be dependent on the ventilation system.

At the other end of the scale consider, for example, people seated in a cathedral, where, allowing for gangways, chancel, and other unoccupied spaces, persons are not likely to sit more than one to every 10 sq. ft., and where the height may be of the order of 100 ft., the initial air capacity per person will be about 1,000 cu. ft. and no feeling of stuffiness will arise for at least one hour, and, in practice, probably for longer, as the warm air will rise to the upper portions of the cathedral.

We see, therefore, that in addition to the density of occupation of the floor, another very important factor is the height of the occupied space, and the two taken in conjunction can be expressed as the initial capacity per person in cubic feet.

The following table shows some calculations made to illustrate this point in a few buildings of different types taken from the author's experience.

FURTHER NOTES ON VENTILATION

TABLE 14

Building	Cubic Contents of occupied space cu. ft.	Maximum capacity of persons	Capacity per person	1,000 cu. ft. divided by capacity per person	Air changes provided intentionally
Watford Public Hall ..	420,000	1,850	230	4.4	5.6
Hall from Example in Chapters VII and VIII	60,000	480	125	8	10
House of Commons ..	174,000	937	185	5.4	5 to 10 Varies with occupancy
Earls Court Main Hall ..	11,000,000	23,000	480	2.1	2.1
Harringay Skating Rink	3,800,000	11,200	340	3.0	2.7 winter 5.4 summer
All Saints Church, Shillington ..	142,300	300	470	2.1	none
St. Peters Church, St. Albans ..	202,200	700	290	3.5	Natural ventilation, flue in tower : about 1
St. Albans Abbey ..	1,720,000	1,700	1,000	1	none
Canterbury Cathedral ..	2,731,000	2,700	1,000	1	none
Basement Restaurant ..	137,000	1,000	137	7.3	18

The first column gives the cubic contents of the occupied space in cubic feet. The second gives the maximum capacity of persons, the third (which is the first divided by the second) is the capacity per person, the fourth is 1,000 cu. ft. divided by the last figure, and the last column is a record of the air changes provided intentionally for purposes of comparison.

It will be seen that St. Albans Abbey and Canterbury Cathedral provide a capacity per person of approximately 1,000 cu. ft., and it must be remembered that the maximum

HEATING AND VENTILATING

occupancy there stated is one which would not frequently be attained, and when attained, would seldom last more than 1 to 1½ hours. No ventilation is necessary under these conditions.

St. Peter's Church, St. Albans, on the other hand, is much more densely occupied and only has a capacity per person of 290 cu. ft. Some ventilation was found most necessary and this has been provided by constructing a large flue in the tower.

A good example of a mechanically ventilated building is perhaps that of Watford Public Hall which seats about 1,850 persons and has a cubic content of 420,000 cu. ft., giving a capacity per person of about 230 cu. ft.

1,000 cu. ft. divided by this capacity gives a figure of 4·4 and the air changes provided by the mechanical ventilation system are 5·6.

In the new House of Commons the capacity per person with full occupation is 185 cu. ft., while 1,000 divided by the capacity gives a figure of 5·4, and the air changes provided will vary from 5 to 10 according to occupancy.

Reviewing the results of this table, and bearing in mind one's other experience, it may be said generally that the capacity per person is a very important factor in a building, and mechanical ventilation is not likely to be required where the building is high, but it is a necessity when it is low.

The dividing line between the two is one which cannot be stated with too much rigidity, but probably lies round about the figure of 500 cu. ft., above which ventilation is unnecessary, and below which it becomes increasingly a necessity, depending on the length of occupation.

It is also interesting to see from the table that the air changes required in a mechanically ventilated system approximate closely to the figure arrived at in the preceding column, by dividing 1,000 cu. ft. by the capacity per person. This is however, only true when the heat liberated in the occupied spaces is almost limited to that provided by the persons in it. Thus, it does not apply to kitchens, factories containing heat-producing units such as furnaces, offices with a great deal of mechanical equipment absorbing considerable power, and so on.

Nevertheless, we see that a very quick way of determining the number of air changes required as a first approximation,

FURTHER NOTES ON VENTILATION

excluding the cases last enumerated, is to take the figure of 1,000 cu. ft. and divide by the cubic capacity of the assembly hall per person, and remember that where this comes to 1 or less, mechanical ventilation is probably not necessary.

(2) AIR SPEEDS

Subject to the provisos which can be gathered from the foregoing and from the previous portions of the book, it may be said generally that for a successful ventilation system the air speeds at the level of where persons are sitting should not exceed 1 to 2 ft. per second, depending on temperature, humidity, etc., the higher figure only being permissible with a high temperature and high humidity and the lower figure with a lower temperature and a lower humidity.

To secure this result and also to prevent hissing and other noises it is usually necessary to limit the air speed at inlet gratings to about 5 ft. per second. Air speed in ducts is usually limited to 10 to 20 ft. per second, the higher figure being appropriate to ducts of 3 ft. diameter and upwards and the smaller one to smaller ducts.

Air speeds in ventilation plants are usually limited to 8-10 ft. per second.

(3) AIR VOLUMES AND TEMPERATURES

Where there are no great heat gains from electric light, power, cooking apparatus, warm surfaces due to radiation from the sun, etc., an allowance of 1,000 cu. ft. of air per person is usually fairly satisfactory, and it is seldom satisfactory to introduce air into a crowded hall at a temperature lower than 15° below hall temperature.

(4) AIR CHANGES

From what has already been said it will be seen that the number of air changes required varies enormously for different purposes. A crowded hall with a relatively low ceiling may require as many as 10 air changes whereas with a very high ceiling like Earl's Court and Harringay Arena, as few as 2 to 4 changes.

Places like kitchens and furnace rooms in factories may require far more owing to the heat provided by sources of

HEATING AND VENTILATING

heat other than the occupants, (60 changes per hour being not uncommon).

Where the air change exceeds 10 per hour it is difficult to make it entirely free from draughts such as would be noticed in a long session by persons seated and critical, while 20 air changes or more may be necessary in kitchens, factories, etc., where a draught would be looked upon with gratitude, rather than otherwise, by occupants.

TABLE 15
SOME USEFUL CONSTANTS AND EQUIVALENTS

1 lb. (avoirdupois) =	7,000 grains = 0.4536 kg.
1 ton (British) =	2,240 lbs = 1,016 kg.
1 ton (U.S. or "short" ton)	=	2,000 lbs = 907 kg.
1 gallon (Imperial) ..	=	Volume of 10 lbs of water at 62° F. = 1.2 U.S. gallons = 4.55 litres.
1 B.T.U. =	Heat to raise 1 lb of water by 1° F. = 778 ft. lbs = 0.252 K.-Calories.
1 horsepower =	33,000 ft. lbs per minute. = 2,544 B.T.U. per hour. = 0.746 kw.
1 kilowatt-hour =	1,000 watts maintained for 1 hour. = 3,415 B.T.U.
1 lb per sq. inch (p.s.i.) ..	=	2.32 ft. water column. = 0.88 in. mercury column. = 816 ft. air column at 62° F.
1 standard atmosphere ..	=	14.7 p.s.i. = 29.92 in. mercury. = 1,013.2 millibars.
1 cubic foot of water ..	=	62.4 lbs = 6.24 gallons.
Latent heat of water at atmospheric pressure ..	=	(Evaporation) 970.6 B.T.U. per lb (Melting) 144 " " "

FURTHER NOTES ON VENTILATION

TABLE 15 (continued)

	Specific Gravity (water at 1.00)	Specific Heat (water at 1.00)	Coefficient of Linear Expansion $10^{-6} \times \dots$	Conductivity B.T.U./deg. F./sq. ft./ hour/inch thickness
Mild Steel	7.8	0.12	6.5	325
Concrete	2.4	0.20	5.5	7.0
Limestone	2.2	0.20	3.5	10.6
Brickwork	1.8	0.20	1.2	5.0
Asbestos Cement ..	1.5	0.20	5.5	1.9
Soft Wood	0.6	0.50	2.2 mean	0.87
Fibre Board	0.28	—	—	0.38
Cork Board	0.14	0.43	—	0.30
Water at 60° F. ..	1.00	1.00	36	4.0
Air (at normal pressure and 60° F.) ..	0.0012	(0.24 per lb) (0.019 per cu. ft.)	630	0.18

INDEX

† Denotes that a table accompanies the text.

<p>AIR changes 15, 112, 120, 137</p> <p> conditioning 14, 121</p> <p> ducts 130</p> <p> ducts in floor 54</p> <p> filters 124</p> <p> heaters 137</p> <p> inlets 129</p> <p> intakes 123</p> <p> intakes for radiators 59</p> <p> speeds 129, 137</p> <p> washers 125</p> <p> volume per person 134†</p> <p>BOILERS, domestic 69†</p> <p> Economic 70</p> <p> electrode 84</p> <p> gas 68†</p> <p> La Mont 74</p> <p> Lancashire 69</p> <p> magazine 72†</p> <p> sectional 67†</p> <p> water-tube 74</p> <p>Boiler efficiency 88</p> <p> sizing 114</p> <p>British Thermal Unit 18</p> <p>CALORIFIC value 30</p> <p>Calorifier 100</p> <p>Centigrade temperature scale 10</p> <p>Central heating 52</p> <p>Chimneys 75, 115</p> <p>Circulating head, pressure 91</p> <p>Circulation of hot water 52, 90</p>	<p>Coal, characteristics, costs, etc</p> <p> , to produce one therm 30-32</p> <p> Coke 32</p> <p>Combustion of fuels 28</p> <p>Comfort zone 13</p> <p>Condensation in gas boilers 81</p> <p>Conduction 18</p> <p>Conductivity coefficients 139†</p> <p>Convection 17</p> <p> from radiators 59</p> <p>Convect or effect in gas fires 48</p> <p>Convectors 60</p> <p>Conversion of energy 28</p> <p>Corrosion of piping 56</p> <p>DATA—miscellaneous 138†</p> <p>Degree-day 21</p> <p>District heating 41</p> <p>Draught, mechanical 76</p> <p> , natural 75</p> <p> stabilizer 77</p> <p>ELECTRIC fire 50</p> <p> heating 113</p> <p> panels 50</p> <p> tubes 51, 113</p> <p> wall paper 51</p> <p>Electrical units 30</p> <p> peak loads 38</p> <p>Electricity 37</p> <p> , cost of 84, 38</p> <p>Embedded panels 62</p> <p> , emission from 63</p>
---	---

Energy equivalents	29†	Inlet ducts	128
Expansion, coefficients of	139†	gratings	128
of piping	104	Insulation of H.W.S. cylinders of piping	88 106
FABRIC losses	111	LATENT heat	19
Fahrenheit temperature scale	10†	MARGIN, boiler power	115
Fans	127	Mechanical stokers	78
, propellor	128	Metal heating panels	61
Floor-duct heating	54	Moisture in air	12
Fuels, manufactured	33	Natural ventilation	136
Fuel storage	41†	North-light factory heating	55
GAS boilers	68†	Occupants, heat gain from	118
, cost of	35, 81	, air required for	137
fire	48	Oil firing	80
firing	80	fuel	36
unit heaters	66	storage	41
Gravity circulation	90	Open fires	45
HEAT, cost of	42	Outside temperature	20
energy	28	PANELS, electric	50
, emission by human beings	22†, 12	, embedded	62
emission appliances	45	, metal	61
losses from buildings	109†	, radiant, gas	49
transfer	16	Peak load, electrical	83
transmission coefficients	109†	Pipe-sizing	93
, sensible, latent, total	23	, example of	116
units	18	Piping as heating surface	56
Heating systems	14	, copper	101
, time lag of	27	, corrosion of	56
Hot water heating	53	, expansion of	104
supply piping	100	, flow of water in	92†
storage	103	generally	54, 90
Horsepower	30	, insulation of	106
Humidity	11	materials	99
, relative	12	, painting of	107
IMMERSION heaters	137	systems	96
Infiltration	16, 112	, venting and draining of	106
		, welding of	56

INDEX		143
Pump circulation	94	TEMPERATURE 10
Pump head and capacity	96	rise with ventilation 16
Psychrometric chart	13	Therm 19
		Thermal storage 39, 82
RADIANT panels	49	Thermometric scales 104
Radiation	16	Thermostatic controls 131
Radiator, convection from	58	Time lag of heating systems 27
fresh air intake	59	
, painting of	58	
shelf	59	
, sizing	114	UNIT heaters 63†
, steel	58	, gas 66
, types of	56	
Refrigeration	121	
Relative Humidity	12	VACUUM steam heating 53
Running cost of heating systems	118	Ventilation, example of design 120
		systems 14
		with fire-place 106
SPECIFIC gravity	139†	Venting of piping 106
heat	19†, 139†	
Steam heating	53	
Stoves	46	
Summer conditions	121	WINTER conditions 122

Birla Central Library

PIHANI (Jaipur State)

Class No :- 791.4

Book No :- M324F

Accession No :- ~~19202~~

