

BIRLA CENTRAL LIBRARY

PILANI (RAJASTHAN)

Call. No. 621.319

R192F

Accession No. 33172

FAULT LOCALIZING AND TESTING ON ELECTRIC MAINS

BY

F. CHARLES RAPHAEL
M.I.E.E., F.I.E.S., M.Cons.E.

AND

CHARLES A. GROVER
M.I.E.E.



LONDON
SIR ISAAC PITMAN & SONS, LTD.

SIR ISAAC PITMAN & SONS, LTD.
PITMAN HOUSE, PARKER STREET, KINGSWAY, LONDON, W.C.2
THE PITMAN PRESS, BATH
PITMAN HOUSE, LITTLE COLLINS STREET, MELBOURNE
ENGINEERS BUILDING, RIVER VALLEY ROAD, SINGAPORE
27 BECKETTS BUILDINGS, PRESIDENT STREET, JOHANNESBURG

ASSOCIATED COMPANIES

PITMAN PUBLISHING CORPORATION
2 WEST 45TH STREET, NEW YORK
205 WEST MONROE STREET, CHICAGO

SIR ISAAC PITMAN & SONS (CANADA), LTD.
(INCORPORATING THE COMMERCIAL TEXT BOOK COMPANY)
PITMAN HOUSE, 381-383 CHURCH STREET, TORONTO



**THIS BOOK IS PRODUCED IN
COMPLETE CONFORMITY WITH THE
AUTHORIZED ECONOMY STANDARDS**

MADE IN GREAT BRITAIN AT THE PITMAN PRESS, BATH
D7—(T.5759)

PREFACE

THE third edition of Raphael's *Localization of Faults in Electric Light and Power Mains, with Chapters on Insulation Testing*, published in 1916, has been out of print for a number of years. References to the subject have since appeared from time to time in various publications, and in the technical press, but it became evident that there was still a definite demand for a complete practical textbook on the subject. The preparation of the present volume was therefore undertaken by us, and, after unavoidable delays from one cause and another, has now been completed.

With the intensive development of electricity distribution which began around 1918-1920, changes in the technique of testing and localizing faults in underground cables were devised to cope with the problems which higher transmission voltages involved; the older and proven methods had their limitations when applied to cables used at working pressures of 11 kV and over. Nevertheless, these older methods are still the ones most frequently employed, more especially for fault localizing in low-tension mains, and the general principles of fault localizing remain unaltered. To this fundamental matter has been added information in respect of more recently developed methods, gained as a result of a not inconsiderable practical experience.

Difficulties often arise in localizing the position of complete and partial burn-outs, now more frequent than formerly; the application of various methods to these is discussed, and an endeavour has been made throughout the book to classify the types of faults which occur in underground electricity supply mains and the appropriate methods of localizing them.

It is hoped that the chapters dealing with the use of rectifying valves for high voltage tests, and the breaking down and localizing of stubborn and intermittent faults in H.T. cables will be found useful, while, on the other end of the scale, hints are given to show how straightforward faults on low and medium tension cables can frequently be accurately located with the minimum of instrumental equipment.

One of the comparatively recent innovations in cable testing at manufacturers' works has been "spark testing" as a substitute for immersion in water in the case of un-sheathed cables, a test which is now advocated by British Standard Specification. By the courtesy of Mr. J. H. Savage it has been possible to describe in some detail the application of this at the works of Messrs. W. T. Henley's Telegraph Co., Ltd., and we are also indebted to him for permission to include descriptions of his developments of the induction and capacitance methods of fault localization.

We have also to acknowledge encouragement, assistance, and suggestions from many other quarters too numerous to specify individually in this preface.

F. C. R.

C. A. G.

December, 1944.

CONTENTS

	PAGE
PREFACE	v
ILLUSTRATIONS	viii

CHAPTER I

INTRODUCTION	1
Causes of faults—Routine factory tests—Immersion tests—Stability and time type tests—Tests after laying—Low and medium pressures—High voltage—Super tension cable faults	

CHAPTER II

MEASUREMENTS OF INSULATION, CAPACITANCE, AND RESISTANCE	23
Galvanometers—Measurement of insulation-resistance—Direct deflection method—Direct deflection method with portable galvanometer—The "Megger"—Temperature correction—Measurement of capacitance—Ballistic measurement—Simple A.C. method—Conductor resistance tests—Potentialmeter method—Kelvin double bridge—Wheatstone bridge	

CHAPTER III

HIGH VOLTAGE TESTS	59
High voltage A.C. tests—High voltage D.C. tests—Principles of rectifying valves—Insulation resistance at high voltage—Discharging after test—Two-valve rectification—Graetz connection—Polarity of testing	

CHAPTER IV

TESTING LIVE NETWORKS	100
Fault resistance—Three-wire low-tension networks—Middle wire earthing ammeter—Test by earthing the outers—Low and medium tension D.C. two-wire networks—Insulation of feeders—Low and medium tension A.C. networks—Three-phase networks—Single-phase three-wire and two-wire A.C. networks—Self-contained A.C. installations and leakage indicators—Earth leakage tripping devices—H.T. overhead lines	

CHAPTER V

	PAGE
LOCALIZING FAULTS AND METHODS OF BREAKING DOWN	139
L.T. systems—Breaking down incipient faults—Mains records	
—H.T. systems—Breaking down intermittent faults with high-pressure D.C.	

CHAPTER VI

LOOP TESTS FOR LOCALIZING FAULTS IN LOW AND MEDIUM PRESSURE CABLES	157
---	-----

The Murray loop test—The slide wire bridge—Making up the loop—Equivalent loop length—Connecting leads—The resistance box bridge—Concentric, twin, and multicore cables—False zero—Contact resistance—Temperature effects—High resistance faults—Examples of Murray loop localization tests—The Varley loop test—Modification of Murray loop test, when resistance of looped return is not known

CHAPTER VII

LOOP TESTS FOR LOCALIZING FAULTS IN H.T. CABLES	200
--	-----

Low resistance faults—High resistance faults—Examples of tests

CHAPTER VIII

LOOP TESTS (CONTD.)	216
--------------------------------------	-----

Loop test where only a small return of unknown resistance is available—Loop test where only a small return of known resistance is available—Direct indicating loop test—Localization without disconnection of consumers—Tests on live mains—Tramway and trolley bus feeders—Loop tests on lead sheath—The “Resultant Fault”—Accuracy obtainable—Loop tests on branched cables

CHAPTER IX

FALL OF POTENTIAL METHODS	245
--	-----

General principles—Application to various types of fault—Overlap test—Potentiometer methods

CHAPTER X

	PAGE
DISCONTINUITIES AND SHORT CIRCUITS	265

Multicore cables—Breaks with insulation intact—A.C. bridge tests—Breaks with shorts—Shorts combined with partial discontinuity—Werren's method—Twin and concentric cables—Triple concentric cables—Long cables

CHAPTER XI

INDUCTION METHODS	305
-----------------------------	-----

Simple search coil method and its uncertainty—Amplifier unit—Double search coil—Other modifications—Microphonic faults—Sectionalizing faults on overhead systems

CHAPTER XII

SPARK TESTING METHODS, ETC.	322
-------------------------------------	-----

Savage spark tester—Simple run-off test—Allscott tester for trailing cables—Broken conductor faults

APPENDIX	333
--------------------	-----

Conductor tables—Table of equivalent lengths—Standard Dielectric thicknesses—Specimen feeder record—Kirchoff's laws—Proof of formulae in Chapter IV—Proof of Werren's method—Spark-testing of rubber cables (B.S. 7)

INDEX	355
-----------------	-----

ILLUSTRATIONS

FIG.	PAGE
1. Diagram to illustrate the "Cut and Try" Method	4
✓ 2. Typical Faults on Three-core Cable	5
3. Showing Conditions for Feed-back unless Switch D is off	6
4. A Time-stability Test, showing Unsatisfactory Ionization Characteristics over a 60° C. Heating Cycle	15
5. Typical Time-breakdown Curve	16
6. Diagram to show Principle of Moving Coil Galvanometer	23
7. Sullivan Moving-coil Galvanometer (Cover Removed)	26
8. Suspension of Sullivan Galvanometer Coil	27
9. Coil of "Taut Suspension" Tinsley Galvanometer	28
10. Semi-transparent Scale with Lantern and Lens	29
11. Onwood Suspended Coil Portable Galvanometer: One-third Full Size	29
12. Suspension of Onwood Galvanometer	29
13. Onwood Self-contained Portable Reflecting Galvanometer	30
14. Movement of "Unipivot" Galvanometer	31
15. Coil of "Unipivot" Galvanometer showing Position of Pivot	32
16. Connection for Direct Deflection Method	34
17. Rymer Jones Key	35
18. Principle of the "Megger"	40
19. Low Resistance Measurement with Potentiometer	48
20. Diagram of Kelvin Double Bridge	50
21. Diagram of Wheatstone Bridge	52
22. Five-dial Plug Wheatstone Bridge	54
23. P.O. Pattern Wheatstone Bridge	55
24. Diagram of P.O. Pattern Wheatstone Bridge	56
25. Diagram of Four-dial Bridge	56
26. Everett-Edgcumbe E.H.T. Voltmeter	64
27. Diagram of Everett-Edgcumbe E.H.T. Voltmeter	65
28. Osram E.H.T. Valve	67
29. Philips Type K 220 Valve	68
30. Philips Metalix E.H.T. Rectifying Valve	68

FIG.		PAGE
31.	Philips Type G 125 Rectifying Valve	71
32.	Connection for H.T. D.C. Test with Rectifying Valve	72
33.	Diagram of Wave Rectification and Cable Charge	74
34.	Theoretical Diagram	75
35.	Variation of Percentage Loss of Charge	79
36.	Effect of Low Insulation on Charging Voltage ✓	81
37.	Two-valve Rectification	92
38.	Alternative Connections for Two-valve Rectification	93
39.	Callender-Smith Connection	96
39A.	Callender-Smith Two-valve Test Set	97
40.	The Graetz Connection	98
41.	Earthing Ammeter with Limiting Resistance	103
42.	Limiting Resistance with Automatic Cut-in Switch ✓	103
43.	Numerical Example with Permanent Limiting Resistance	106
44.	Numerical Example when Limiting Resistance (not shown) is Short-circuited	108
45.	Earthed Middle-wire Ammeter Method of Measuring the Insulation Resistance of a Three-wire Network	109
46.	Test of Insulation Resistance by Earthing the Outers ✓	113
47.	Direct Reading Insulation Tester for Unearthed Medium Pressure D.C. Networks	116
48.	Diagram of Test Set for Two-wire Installation	119
49.	Insulation Test of Feeders	120
50.	Typical Chart from Evershed Self-protecting A.C. Indicator . . . ✓	124
51.	Leakage Indicator for Private Three-phase Installations ✓	127
52.	Earth Leakage and Delayed Action Overload Protection for L.T. A.C. Feeders	130
53.	Alternative Method of Earth Leakage and Overload Protection for L.T. Feeders, without separate Time-lag for Overload Trip . . ✓	132
54.	Electrostatic Voltmeters as Leakage Indicator ✓	135
55.	Earth Leakage Tripping Device for H.T.	136
56.	Back-to-back Transformer Connection for Breaking Down Faults . . ~	144
57.	Use of Star Winding as Auto-transformer ✓	145
58.	Improvized Water Resistance ✓	147

FIG.	PAGE
59. Water Resistance for D.C. Control in H.T. D.C. Testing	151
60. Murray Loop Test	158
61. Diagram of Slide Wire Bridge	161
62. Raphael Direct-reading Fault Localizer	162
63. Drawing and Diagram of Direct-reading Fault Localizer	163
64. B.I. Low Tension Localization Set, Connected Up	165
65. Cable Loop of Different Sizes	170
66. Equivalent Lengths of Fig. 65 in Terms of 37/16 S.W.G.	170
67A. Diagram for Loop Test	172
67B. Loop Test with Four-dial Bridge	172
67C. Loop Test with P.O. Bridge	173
68. Resistance Ratio of Conductors in a Concentric Cable	176
69. Three-core Cable with Two Cores Short-circuited	177
70. Neutralizing a False Zero	179
71. Eliminating Contact Error of Cable Connection	180
72. P.O. Bridge with Independent Galvanometer Key	181
73. Slide Wire Loop Test with Special Leads	182
74. Loop Test with Positions of Battery and Galvanometer Reversed	186
75. Method of Annulling Earth Currents as Applied to Fig. 74	187
76. Varley Loop Method	192
77. Murray Test adapted to Looped Return of Unknown Resistances	197
78. Loop Method, Utilizing Comparison by Weights	202
79. H.T. Loop Test with Rectifying Valve	206
80A. Gambrell H.T. Slide Wire	208
80B. Diagram of Connections of Gambrell H.T. Slide Wire	209
81. Checking Slide Wire Reading with Dial Bridge	210
82. Loop Test with Pilot Wire Return	217
83. Calibration of Pilot Wire in Slide Wire Divisions	217
84. Loop Test with Two Pilot Wire Returns	221
85. Direct Indicating Loop Test	222
86. Alternative Direct Indicating Loop Test	222
87. Equipotential Points on Wheatstone Bridge	224
88. Example of Test without Disconnection of Consumers	224
89. Direct Indicating Loop Test on a Live Network	225
90. Extemporized Fuse	226
91. Test on Tramway Feeders	227

FIG.	PAGE
92. Direct Indication of Position of Fault in Tramway Feeder	229
93. More Accurate Method, allowing for Resistance of Side Feeds	230
94. Loop Test on Lead Sheath	234
95. Effect of General Low Insulation on Fault Test	235
96. Accuracy of Loop Test	238
97. Principle of Fall of Potential Method	245
98A.) } Four-way Plug Switch	249
98B.) }	
99. Fall of Potential Method, showing Ammeter in Main Circuit	251
99A. An Application of the Fall of Potential Method	252
100. An Alternative Fall of Potential Method	253
101. Faults that can be Localized by Method 5	255
102. Connection for Faults shown in Fig. 101	255
103. Overlap Test with Ammeter and Voltmeter	256
104. Cores Burnt Through, but in Electrical Contact	258
105. Potentiometer Method: Connection for First Reading	260
106A. Potentiometer Method with Earth Fault on One Core of a Three-core Cable	262
106B. Potentiometer Method with Fault Between Two Cores of a Three-core Cable	262
107. Fault in a Street-lighting Cable or Distributor	263
108. Burnt-out, but Partial Contact	266
109. Connections for Capacitance Test as for Insulation Test	268
110. Connections for Simplified Capacitance Test	268
111. Simple A.C. Localization Test for Break	272
112. Simple A.C. Localization Test from One End	272
113. A.C. Bridge Test	273
114. A.C. Bridge Test on Three-core Cable	274
115. Short Circuit between Two Cores	277
116. All Cores Shorted; Two Broken	277
117. Fall of Potential Test for Short with One Core only Unbroken	279
118. Bridge Method with only One Core Unbroken	281
119. All Cores Shorted, Two Broken, and One Core Earthed but not Broken	282
120. All Cores Shorted and Earthed, and One Core Broken	283

FIG.		PAGE
121.	Overlap Method	283
122.	Overlap Test with Slide Wire	284
123.	Overlap Test with Two Cores	285
124.	Blavier Test	286
125.	Shorts Combined with Partial Discontinuity and Earth Faults	289
126.	Werren's Method	290
127.	Faults on Twin Cables	292
128.	A.C. Bridge Test	294
129.	Simple Search Coil Method	305
129A.	Effect on Branch	308
130.	J. H. Savage's Amplifier Unit	310
131.	Method of Mounting Two Search Coils	312
132.	Iron-cored Search Coil	314
133.	Double-frequency Rectification	316
134.	Another Form of Search Coil	317
135.	Compass Method on D.C. Cables	318
136.	Test Based on Microphonic Property of Fault	320
137.	Sectionalizing Fault Indicator for Overhead Lines	321
138.	Group of Spark Testing Sets in Factory	323
139.	Electrode Compartment Open	325
140.	Appleyard's Modification of Winding-off Method	326
141.	Break Locator for Single Non-screened Cable	329
142.	Break Locator for Multicore Non-screened Cable	330
143.	Break Locator for Twin Cables	330
144.	Kirchoff's First Law	342
145.	Kirchoff's Second Law	342
146.	Testing Live 3-wire Networks	343
147.	Testing Live 2-wire Networks	346
148.)	Werren's Method	350
149.)		

FAULT LOCALIZING AND TESTING ON ELECTRIC MAINS

CHAPTER I

INTRODUCTION

THE localization of faults in cables owes its original development to the telegraph industry. Without a means of ascertaining the position of a cable fault from tests at the ends, submarine cable telegraphy could never have become a commercial proposition. One of the authors of this book was among those engaged in working out the necessary adaptation and modification of these methods of measurement for the requirements of the cable manufacturing industry and the distribution engineer during the growth of the lighting and power side of electrical engineering. The great advances which have been made since then in methods of distribution and protection, and the manufacture of cables and accessories themselves, have certainly resulted in a very great reduction in the number of faults per mile per annum in distribution systems. But the mileage of cables in operation is now so great that it is incumbent upon every engineer engaged in electricity supply and distribution to have the necessary knowledge at his disposal for rapid and accurate fault localization. This necessity has become more important during recent years owing to the higher transmission voltages in use, which in their turn have resulted in modifications of some of those methods of test which had hitherto been considered sufficient for all purposes.

The localization of a dead earth in a cable with an

accuracy as great as that of an ordinary resistance measurement is extremely easy. It need not involve the use of very delicate instruments, nor the exercise of a high degree of manipulative ability. Faults of higher resistance demand a little more skill for their localization, and in the case of serious burn-outs, which may have caused fusion of the conductor and an actual break in the circuit, the difficulty of accurate localization by means of ordinary low pressure testing methods can be very great, and various methods have been evolved to enable useful results to be obtained. The introduction of extra high tension testing apparatus involving the use of rectifying valves has enormously increased the ease with which high resistance faults can be localized.

While the effects of a fault in low tension networks usually leave unmistakable evidence of their presence, at any rate a permanent "low" test, those occurring in cables working at high voltage can be of merely transient duration. Frequently the only tangible evidence of their existence is the tripping of a circuit breaker accompanied by the operation of a relay; and to establish a regular routine of breaking down the fault to a permanent low resistance value by repeated closing of the circuit breaker would involve considerable risk, because, with these higher voltages and the enormous power behind them, the energy liberated at a fault might have a disastrous effect over a widespread area.

As unfortunately many mains engineers find themselves only in possession of antiquated, primitive, and often only home-made apparatus for fault localization, the authors will endeavour to show that given initiative and resource, satisfactory results can often be obtained with comparatively simple appliances, but let it be clearly stated that these examples are not in the least intended to imply that there is no necessity for the mains department

of an electricity authority to be adequately equipped with fault locating instruments. Quite the contrary; every such department should have accurate, reliable, and up-to-date instruments, capable of dealing with any emergency that might interfere with the continuity of supply to the consumer. Nevertheless, although one may be possessed of a suitable instrumental equipment it does not necessarily follow that accurate location tests will result automatically. Not only is personal initiative and resource necessary, but it is essential to possess a detailed knowledge of the system on which a fault may be found. As speed is as important as accuracy, the operator must have his methods more or less cut-and-dried in advance, so that his localization tests follow a routine as closely as possible, and that no time need be wasted in making experiments or in measuring route lengths, resistances, or other constants that could have been equally well determined at any time previously to the emergency.

There are some classes of faults which present great difficulties to accurate testing with apparatus ordinarily available, especially where, as frequently happens, fault currents or earth currents are present. Often the known inaccuracy of previous test results in similar cases incline one towards the use of the "cut and try" method as being the most expeditious way of getting at the fault. Such an instance is when all three cores of a fairly long H.T. feeder are burnt through, leaving a fault resistance of a few hundred ohms between cores and a similar resistance between cores and earth.

A few preliminary tests will soon enable the distribution engineer to tell whether his available localizing instruments are likely or not to give an approximately true result. If he has decided that they cannot, he may very profitably proceed at once to open joints at first half-way

along the length of the cable, note on which half the fault lies, and continue to bisect and test until the fault is isolated to a single section between joints. Supposing, for example, a spur feeder two miles long develops a fault such as that just described, and assume that the length between joints is 220 yards, so that there are 15 joints in the 16 cable lengths (see Fig. 1).

The first joint opened would be that between cable

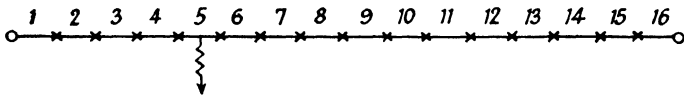

FIG. 1. DIAGRAM TO ILLUSTRATE THE "CUT AND TRY" METHOD

sections 8 and 9. On testing the insulation, the fault would be found, say, between section 8 and section 1. The joint between sections 4 and 5 would next be opened and the fault found to be between sections 4 and 8. The third joint opened would be between sections 6 and 7, bringing the fault between sections 4 and 6; while the next step of opening the joint between sections 4 and 5 definitely locates the fault to section 5. The same principle, applied in cutting the faulty cable section, will in three cuts isolate the fault to $27\frac{1}{2}$ yards of cable should the fault be in the cable itself and not in a joint.

It may be said that this crude method is so obvious that it need not have been described even in an "introductory" chapter, but it is remarkable how much time is frequently wasted hunting out various "probable" positions for a fault when there is no real weight of probability at all.

It must be emphasized, however, that such a primitive method as this is not recommended unless it is definitely realized that a fault localization test will be useless. Let it be left at this: there are rare occasions when the "cut

and try" method may be the quickest and cheapest way out of a difficulty, but then it should be applied systematically.

Underground cable faults may be any of the following—

(1) *L.T. Single Core Cables.* (a) Severed conductor. Insulation intact. (b) Contact with earth. Conductor continuous. (c) Severed conductor and contact with earth.

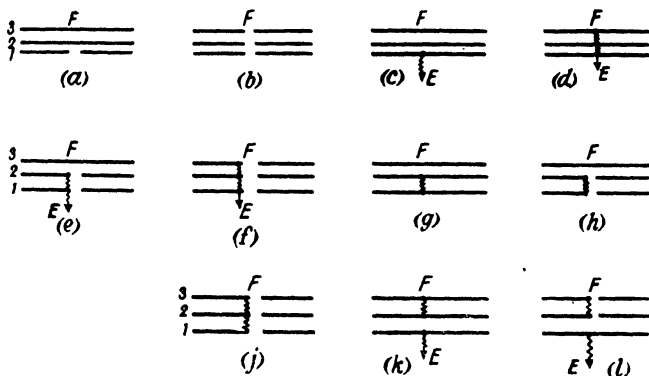

FIG. 2. TYPICAL FAULTS ON THREE-CORE CABLE

(2) *L.T. and E.H.T. Multicore Cables* (as in diagram below shown for three-core cables). Other combinations of severed conductors, contacts between phases and earth contacts are possible, in addition to those given in the above diagram, but the list given is sufficiently comprehensive for our purpose.

(3) *Concentric Cables.* The faults that can arise in two-conductor concentric cables are shown in Fig. 2 (a to h), but with the upper conductor in each diagram omitted. For triple-concentric Fig. 2 can, of course, be taken to apply.

Faults in overhead lines can be any of the variations in Fig. 2, but the most usual are simple breaks in the conductors as (a) or (b), and earths on one or more conductors as (c), (e), or (f).

Once the existence of a fault has been established, the first thing to do is to ascertain its characteristics, so that the person whose duty it is to locate it may decide upon the procedure and method to be adopted. Without this knowledge an operator runs a great risk of obtaining

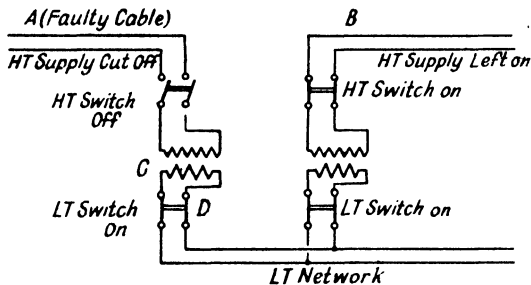

FIG. 3. SHOWING CONDITIONS FOR FEED-BACK UNLESS SWITCH D IS OFF

misleading results, which cause unnecessary expense and delay.

Elaborate apparatus is not needed for this preliminary examination ; a low reading megger (see page 40), an ordinary electric bell with a few primary cells, or a test lamp, are all that are actually necessary.

The very first step is to clear the faulty cable from all sources of supply and apparatus, and in the case of an E.H.T. feeder to verify as well, before the cable is handled, that no feed-back or stepping up from an adjacent L.T. system is possible. The danger of this feed-back is illustrated in its simplest forms in Fig. 3. If A is a faulty cable, it is not sufficient merely to cut off the supply from it. The L.T. network would be left energized by the cable B, and unless the L.T. side of transformer C is first disconnected from the network, it will step up and make its H.T. side live, so that it would be dangerous to handle the cable terminals of A on the H.T. switch for testing.

Needless to say, in modern switchboards, isolating links are interposed between the cable and the H.T. switch; the removal of these after switching the H.T. switches off at both ends of the faulty cable will usually obviate the necessity of disconnection on the L.T. side.

The method of disconnecting H.T. cables, and for that matter also L.T. cables, for testing and localizing purposes when a fault appears, should be made according to a definite and strict routine; otherwise, in the hurry following the development of a major breakdown, proper precautions for safety may be neglected.

If the fault is in an L.T. cable, to which branches or services are connected, these should be disconnected, or false results may be obtained. See also Chapter VIII, page 223.

First with the distant end of the cable isolated, and in the case of a multi-core cable cores free from one another, ascertain the insulation resistance to earth and between cores, those not under test at the moment remaining free. The next step is to test for continuity with the battery and bell (or a conduit continuity tester may be employed for the purpose). The conductors are connected together at the distant end, and a test is made to see whether they all ring through, that is to say in a three-core cable between conductors 1 and 2, 1 and 3, and 2 and 3 consecutively. Next the cores at the far end, still connected together, should be earthed and a similar bell test taken between each conductor and earth. The reason for this second bell test is clear. Failure to ring between all three cores of a three-core cable on the first test, might indicate that either two of the cores are burnt through or all three. If, however, the third core is still continuous, it will ring through on the bell test with earth. If there is no telephonic communication between the ends, and one is tempted to save time by connecting the far ends together and earthing them at the same time, instead of making

the preliminary test between cores before the earth connection is made, there is a risk of arriving at a false conclusion. For instance, if the conditions are as in (e), Fig. 2, and the test is made from the left-hand end, with the right-hand ends bunched, there will be no ring between either 1 and 3 or 2 and 3 before the distant ends are earthed, but if the earthing connection is made before trying to ring between conductors a ring might be obtained through the earth fault, and one might wrongly conclude that the conditions are as in (g), Fig. 2, with all conductors continuous, which are very different and much easier conditions for the localization test.

A useful instrument for the mains man, which is often substituted for the bell in testing through, is the ordinary type of Post Office "lineman's detector." It is a cheap but robust moving-magnet galvanometer, capable of withstanding quite strong currents, and if used in conjunction with a small primary battery, it will not only serve for the continuity tests above described, but can also give some idea as to whether the resistances of the faults themselves are low or not. That is to say it will give a rough range of insulation resistance measurements below the usual minimum 10 000-ohm reading of the megger. One has to be careful, however, not to draw a wrong inference as to the continuity of a conductor; it may be both burnt through and earthed. The first test of all with the cores open will, however, be a guide, for if a low resistance fault is indicated, then one would naturally observe things more closely when testing for continuity. When there is any doubt, a resistance test can, of course, be taken between two conductors; if one is burnt through, measurement of the resistance, when connected together at the far end, is bound to be higher than normal, however bad the fault.

One more caution may be given: before accepting any

insulation or continuity test as final, make sure that it is not vitiated by a meter left in circuit in the case of an L.T. cable, or a potential transformer in the case of an H.T. feeder. Even old hands in the art of fault localizing are sometimes caught in this way by a meter shunt or a transformer left in circuit. Again, before accepting the failure of the bell to ring as an indication of a conductor being burnt through, it is advisable to satisfy oneself that the earthing is effective.

The position of a fault, and the cable on which it occurs, at once determines the urgency with which it must be located. If it is on an L.T. distributor shutting down several consumers, the need of restoring supply in the shortest possible time is the first essential, and if an alternative source is not available, no effort can be spared in securing a rapid and accurate test. The question of expense must often fade into the background. Local knowledge of the system possessed by those responsible for its operation dictates the best course to be pursued in a case like this, so that no suggestions as to the precise routine to be followed can be made, except that the first step should be the immediate summoning of a jointer and the necessary labourers to do excavation work and the immediate dispatch of all necessary tools and equipment to the scene of activity. Where an alternative source of supply is available, and no interruption occurs apart from the brief interval of changing over to this alternative source, a good deal of expense can be avoided by first carefully deciding the type of fault on the lines of the suggestions already made, then proceeding to obtain an accurate localization test, and finally arranging a programme to carry out repair work. No suggestion is implied that this sequence of events may proceed in a leisurely fashion, because the cutting out and repair of a mains fault is necessarily an urgent matter, but a gang of

labourers and a jointer are expensive spectators to the preliminary operations, and where the summoning of them to site can be deferred until the fault is definitely located, the cost of the repair bill will be less.

CAUSES OF FAULTS

In modern paper-insulated lead-covered cable systems under normal peace conditions the number of cable faults in a well designed transmission or distribution system are comparatively few. Faults which mostly occur are due to external influences such as corrosive soils, electrolysis, subsidences, bad handling during laying operations, and external damage caused during excavation work in the street carried out for other purposes. As a sequence to "enemy action," however, there may be an aftermath of faults for a considerable period after the more obvious damage has been made good. It is only on some of the older systems of mains that deterioration of the cable itself or its protection may be a serious problem. For instance, vulcanized bitumen mains have mostly outlived their useful life after twenty years or so.

Joints, distribution boxes, and service connections are responsible for most faults in paper-insulated cable systems, as they are more susceptible to moisture, and needless to say, once the moisture has gained ingress, the conditions are there for development of a fault.

A prevalent source of joint failure is defective plumbing; often caused by metal of incorrect consistency. It is not generally appreciated that even a microscopic hole in a wiped joint or cable sheath can, in the course of time, admit very considerable quantities of water. During the process of making the joint the cable is heated, and when it cools after being sealed, a partial vacuum is established, capable of sucking in water through any small hole, or through a porous wiped joint. A similar effect may even

occur after a cable has been on full load for some time, the expanded air finding an egress through any hole, and a partial vacuum being created when the cable cools down again. Faults due to this cause have been known to occur, even many years after the cable has been laid, owing to the gradual accumulation of moisture sucked in through badly plumbed joints, etc. A burn out in a junction box or service box is frequently due to a similar effect. War emergency conditions have necessitated the use of plumbing metal containing a lower proportion of tin than was previously customary. Particular care should be taken to ensure that wiped joints made with this metal are not porous.

When removing a fault from an impregnated paper cable, tests for the presence of moisture should be carefully carried out, and the cable cut back until all traces have disappeared. The test is very simple: if a piece of the paper insulation taken from the suspected cable is immersed in cable-oil or paraffin wax heated to about 250° F. the presence of moisture will at once cause frothing or crackling. In taking off the paper for this test, however, one should be careful not to touch it with one's fingers; doing so may give a misleading result. Paper adjacent to the conductor as well as the wormings and paper adjacent to the lead should be equally treated in this manner, as one can never be sure up which channel the moisture has travelled into the cable. It is unwise to test a mass of paper in several layers simultaneously, as occluded air between the layers will cause bubbling which might be mistaken for moisture.

ROUTINE FACTORY TESTS

The probability of a fault inherent in the cable itself due to manufacturing defects is reduced to very low odds by the normal routine tests which are carried out before

the cable leaves the works. To conform with the British Standard Specification No. 480 as revised in 1942, paper insulated lead covered cables for nominal or "declared" voltages up to 660 must withstand 3 500 volts pressure for 15 minutes between conductors and 2 000 volts between each conductor and the lead sheath.* The pressure must be alternating of approximately sine wave form, and may be of any frequency between 25 and 100 cycles per second, the voltage mentioned being the root mean square value. It must be applied gradually and then maintained at full value for the whole period of 15 minutes. The test has to be made after at least 24 hours' immersion in water. The corresponding tests for high voltage cables are tabulated on pages 20 and 21. Minimum dielectric thicknesses according to the size and type of cable and the voltage at which it is to be used are tabulated in convenient form in the Appendix, the values given conforming with British Standard Specification 480, 1933. This Specification also includes conductor resistances (see also Appendix at end of this book), but does not specify insulation resistance, which must nevertheless be tested at the makers' works. Cables for 33 000 volt working pressure and upwards are subjected in addition to tests at the works for dielectric losses and power factor by wattmeter or bridge methods. The Schering bridge is most commonly used for this purpose.† A detailed description of these special dielectric tests does not appear in the present volume, as they have

* 460-volt cables made to the 1933 edition of B.S.S. 480 were tested at 2 500 volts; 250-volt V.I.R. cables must withstand a pressure of 1 500 volts A.C. at works, in accordance with B.S.S. 7, and 660-volt V.I.R. cables an A.C. voltage of 3 500 at works, in both cases after immersion in water for at least twelve hours. By agreement between the manufacturers and the purchaser, "spark testing" (see page 322) may replace testing under water for V.I.R. cables up to .0025 sq. in. conductor section. "War emergency" quality V.I.R. and P.V.C. (polyvinyl chloride) need not be tested for insulation under water, but should be subjected to the spark test.

† See *Alternating Current Bridge Methods*, by B. Hague (Pitman).

no direct application in the procedure of fault localization. Factory methods for measuring insulation resistance, capacitance and conductor resistance are, however, described in detail later.

IMMERSION TESTS

It is a general routine, subject to the exceptions explained in Chapter XII and in the footnote on page 12, to test under water all cables for working pressures up to 22 000 volts. The period of immersion prior to the test is 24 hours, and the temperature of the water 60° F. The testing tanks at works are usually provided with steam heating to maintain them at this temperature during the winter, but in practice a rigid adherence to the 60° is not considered necessary, since a few degrees more or less will not make any appreciable difference to the dielectric strength, and temperature coefficients can be applied to correct the conductor resistance and insulation measurements.

The purpose of immersion in water is to reveal any defects either in the lead sheathing or in the dielectric of unsheathed cables.

At higher working pressures than 22 000 volts, however, it is found that immersion in water for 24 hours is no longer useful for this purpose, as the thickness of the dielectric prevents the water from penetrating sufficiently to ensure a breakdown of insulation in 24 hours or even longer. In some works, therefore, the test is made more severe by subjecting the water to hydraulic pressure. Mr. E. A. Beavis,* however, carried out a series of experiments in this connection and found that sheath defects in high voltage cables could remain undetected by the standard electric tests after long periods of immersion under considerable hydrostatic pressures, and he came

* *Journal of the Institution of Electrical Engineers*, April, 1930, Vol. 68, page 434.

to the conclusion that, except for low-voltage cables, such defects could not be detected with certainty by the usual 24 hours in water. The risk of manufacturing defects in lead sheaths, however, is small, and practically non-existent when the continuous type of lead-press is used.

STABILITY AND TIME TYPE TESTS

Type tests for stability and time-breakdown are also made, but need only be considered in a general way here. The stability test* is applied to verify if the impregnation is perfect, and it consists of subjecting a sample of cable to several cycles of alternate heating and cooling over the range of the usual operating temperatures, and measuring dielectric losses at various voltages at the upper and lower extremes of temperature after each cycle. The power factor increment over a temperature cycle known as the "ionization characteristic" is a measure of the electric stability of the cable. If there is any tendency for the dielectric losses to increase with successive heating cycles it may be taken that the cable is in an unstable condition and will ultimately fail in service. The heating causes expansion of the lead sheathing, which may loosen the dielectric, allowing electrical discharge to occur in the minute voids formed between the layers of the dielectric; consequently, unless the cable is so designed that these layers remain in close contact under any temperature conditions that will occur in operation, the cable will eventually break down. Great attention is given in this feature in the design of modern super-tension cables, and this test is usually applied to cables for working pressures of 33 000 volts and over.

The conventional method of expressing the result is to plot the power factor against the number of heating

* For further information see *High Voltage Cables*, by P. Dunsheath, and *Alternating Current Bridge Methods*, by B. Hague (Pitman).

cycles at the various voltages, as shown in Fig. 4. In the lower curves, a slight increase of power factor occurs during the first few heating cycles, after which the curve remains perfectly flat. At a higher temperature or volt-

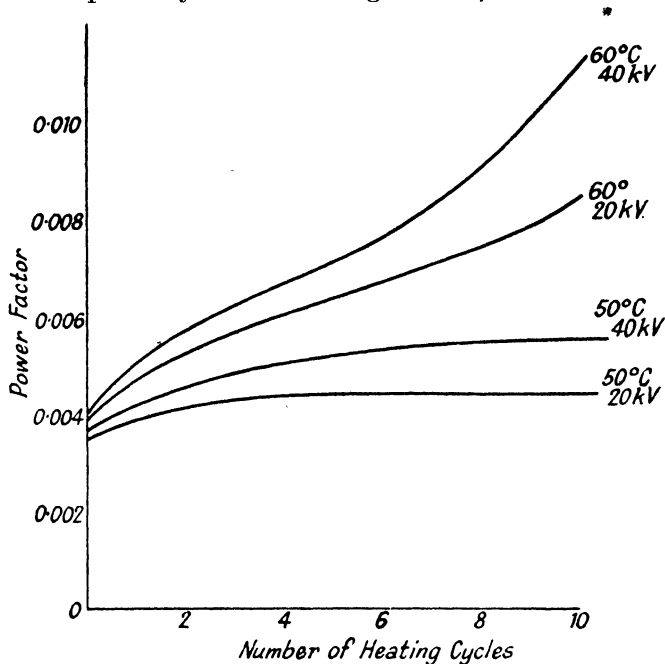

FIG. 4. A TIME-STABILITY TEST, SHOWING UNSATISFACTORY IONIZATION CHARACTERISTICS OVER A 60° C. HEATING CYCLE:

age, however, the curves show that there is a very marked tendency for the "ionization characteristic" to increase with each successive heat cycle, indicating that the cable is electrically unstable and will ultimately break down if the tests are continued. Stability tests were first introduced by Straberen (Holland).*

A characteristic time-breakdown curve of cables for

* *Elektrotechnische Zeitschrift*, Vol. 45, pages 12-159, 1924.

33 000 volts and over is also determined by taking a large number of breakdown tests on samples about five yds. long. The voltage is increased at a given rate to various values which are then sustained until breakdown occurs. Fig. 5* shows a typical form of curve. For the first half-hour the curve tends to flatten and the asymptotic value is

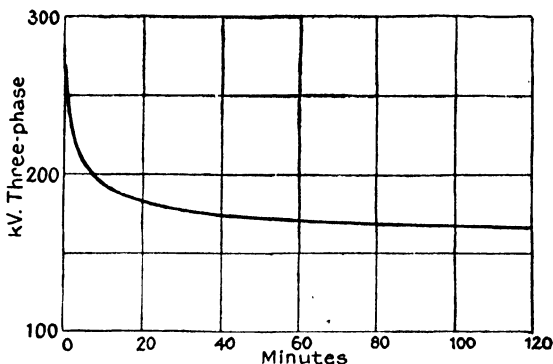

FIG. 5. TYPICAL TIME-BREAKDOWN CURVE

the maximum voltage which the cable would stand indefinitely. This value must necessarily always be well in excess of the working voltage, but in the case of the super-tension cables there is no conventional factor of safety. As a general rule, however, the ratio between the above asymptotic pressure values and the working pressure decreases as the working pressure increases.

TESTS AFTER LAYING

The *Electricity Commissioners' Regulations* issued in 1937 under the *Electricity Supply Acts, 1882 to 1933*, specify tests to be carried out on cables after laying.

Low and Medium Pressures. In respect of cables and apparatus for use on low pressure (up to 250 volts) and

* Fig. 5 reproduced from Dunsheath's *High Voltage Cables*.

medium pressure (up to 650 volts) para. 1 (b) of the *Electricity Supply Regulations, 1937*, provides that, in addition to the tests at works prescribed in the British Standard Specification, every cable, after being placed in position and before being connected to the system, must withstand an insulation test for one minute at 500 volts between conductors and also between conductors and earth. This test has to be repeated whenever the cable is disconnected from the system for alteration or repair, and the test in all cases applies to overhead lines as well as underground cables. For cables, the British Standard Specification requires a test at 1 150 volts between conductors and sheath and 2 000 volts between conductors after laying and jointing, and this should be adhered to; but for the test after alteration or repair distribution engineers are usually content with an ordinary "Megger" test. It may be noted, however, that 1 000-volt meggers are obtainable, and should be considered as an almost indispensable piece of equipment for mains departments.

High Voltage. The definition of "high voltage" is a voltage normally exceeding 650.

Regulation 6 (a) refers to tests on high voltage electric lines and apparatus, and prescribes that they shall not be connected to a system for the purpose of the supply of energy unless their insulation has withstood "either (i) the tests prescribed in that behalf in the appropriate specification of the British Standards Institution then current: or (ii) in cases where no such tests have been prescribed, the continuous application between conductors and also between conductors and earth during that period of not less than 15 minutes of alternating current either at a testing voltage equal to at least one and one-quarter times the normal working voltage to which the electric lines, circuits, or apparatus will be subject under conditions of supply, or at a testing voltage equal to the

aforesaid working voltage with the addition of 10 000 volts, whichever be the less.

“Provided that for the purposes of such alternative tests—

“(i) The testing voltage between the outer conductor and earth in cases where the outer conductor of an electric line having concentric conductors is to be connected with earth shall be 1 000 volts;

“(ii) The aforesaid working voltage between any phase of an alternating current system and earth in cases where the neutral conductor of the said system is not to be connected with earth shall be deemed to be the voltage between phases;

“(iii) The duration of the test may be reduced to one minute in the case of apparatus for use at high voltage subject to the testing voltage being increased so as to equal not less than one and one-half times the aforesaid

TABLE I
TESTING PRESSURES FOR CABLES AT MANUFACTURERS' WORKS
(B.S. Specification No. 480)

Nominal Working Pressure	Between Conductors (kV)	Between Conductors and Earth	
		Centre-point Earthed (kV)	Earthed Outer of Concentric (kV)
460 v.*	2.5†	2.5	2.5
660 v.	3.5†	2.0	2.5
1 500 v.‡	—	5.0	—
3 300 v.	10.0†	5.8	2.5
6 690 v.	16.0†	9.2	2.5
11 kV	24.0†	14.0	2.5
22 kV	44.0	25.5	—

* Cables made to the 1933 edition of B.S.S. 480, now superseded.

† And between conductors and earth, if centre-point is not earthed.

‡ Single-core, primarily for D.C. railway electrification.

working voltage, or the aforesaid working voltage with the addition of 20 000, whichever be the less.

“(iv) Direct current may be used instead of alternating current, subject to the testing voltage being increased so as to exceed by at least 50 per cent the corresponding testing voltage prescribed for alternating current.”

In the tables which follow, it is seen that the British Standard Specification for paper-lead cables also include a test after laying and jointing. The Commissioners' Regulations “whenever reasonably practicable” require a similar test or the alternative as specified in Reg. 6 (a) quoted above after “lines and apparatus” have been “placed in position and before being connected to the system”; but if the tests under Reg. 6 (a) have been carried out at works they will be satisfied with the simple test of 1 000 volts between conductors and also between conductors and earth (for one minute) after laying. This latter test, as in the case of low and medium pressure lines, has also to be carried out after disconnection for alteration and repair. It is thus seen that these minimum requirements are less onerous than those of the British Standard Specification and, for the sake of security, the voltage values required by the British Standard should always be followed if possible.

Owing to the capacitance of the cables, a large leading current is taken when testing with A.C., and portable apparatus for testing at the higher voltages would be too unwieldy. Table III gives the D.C. voltages which may be employed for the test.

The Electricity Supply Regulations require that the results of every pressure test shall be recorded by the undertakers.

The figures in the columns headed “Overhead Lines and Other Apparatus” in Tables II and III are calculated in accordance with the Commissioners' Regulation 6 (a)

for cases in which no British Standard Specification prescribing tests applies.

Table IV gives the test voltage after laying required by the Regulations for 33 kV to 132 kV, to which there is at present no British Standard Specification applicable, and also the slightly higher values which represented current practice by the cable manufacturers and supply undertakings before the issue of the 1934 and 1937 Regulations. These higher values are still commonly employed.

TABLE II
TESTING PRESSURES FOR CABLES AFTER LAYING AND JOINTING
(When Test is made with A.C.)

Nominal Working Pressure	Cables (B.S. Specification No. 480) Test 15 minutes			Overhead Lines and Other Apparatus (Electricity Commissioners' Regulations)§	
	Between Conductors (kV)	Between Conductors and Earth		15 min. (kV)	1 min. (kV)
		Between Centre-point Earthed (kV)	Earthed Outer of Concentric (kV)		
480 v.*	1†	1.0	1	—	0.5
660 v.	2†	3.0	—	0.825	1.0
1 500 v.‡	—	3.0	—	—	—
3 300 v.	6†	3.5	1	4.2	5.0
6 600 v.	12†	7.0	1	8.3	9.9
11 kV	20	11.5	1	13.75	16.5
* 22 kV	40	23.0	—	27.5	33.0

* Cables made to the 1933 edition of B.S.S. 480, now superseded.

† And between conductors and earth if centre-point is not earthed.

‡ Single-core, primarily for D.C. railway electrification.

§ If centre-point of a three-phase system is permanently earthed, these figures may be multiplied by 0.577.

|| For short service lines, a 500-volt test is sufficient if the cable has been tested at works.

TABLE III
TESTING PRESSURES FOR CABLES AFTER LAYING AND JOINTING
(When Test is made with D.C.)

Nominal Working Pressure	Cables (B.S. Specification No. 480) Test 15 minutes			Overhead Lines and Other Apparatus (Electricity Commissioners' Regulations)§	
	Between Conductors (kV)	Between Conductors and Earth		15 min. (kV)	1 min. (kV)
		Between Centre-point Earthed (kV)	Earthed Outer of Concentric (kV)		
	480 v.*	1.5†	1.5	1	—
660 v.	—	3.0	—	1.3	1.5
1 500 v.‡	—	4.5	—	—	—
3 300 v.	9.0†	5.0	1	6.2	7.5
6 600 v.	18.0†	10.5	1	12.4	14.9
11 kV	30.0	17.5	1	20.6	24.75
22 kV	60.0	35.0	—	41.25	49.5

* Cables made to the 1933 edition of B.S. 480, now superseded.

† And between conductors and earth if centre-point is not earthed.

‡ Single-core, primarily for D.C. railway electrification.

§ If centre-point of a three-phase system is permanently earthed, these figures may be multiplied by 0.577.

|| For short service lines, a 500-volt test is sufficient if the cable has been tested at works.

TABLE IV
D.C. TEST PRESSURES ON SUPER-TENSION CABLES
(Pressures applied between phases, and between phases and earth for 15 minutes)

Working Pressure (kV)	Minimum under Regulations (kV)	Current Practice (kV)
33	62	66
66	114	132
132	213	260

SUPER TENSION CABLE FAULTS

Faults in 33 and 66 kV cables having the ordinary "mass impregnated" dielectric are rather in a class by themselves. Considerable difficulty is often experienced in their detection, as the higher inherent dielectric stresses at which such cables operate may cause the generation of gas during the development of a fault and advanced deterioration over several yards of cable. Chapter VII deals with the localization of faults of this nature.

CHAPTER II

MEASUREMENTS OF INSULATION, CAPACITANCE, AND RESISTANCE

GALVANOMETERS

THE moving-magnet type of galvanometer, which has done good service for test room purposes in the past, has now been entirely superseded by the moving coil pattern on the d'Arsonval principle, which, while sufficiently sensitive to measure insulation resistances of comparatively short lengths of cable, has the advantage of being unaffected by stray magnetic fields, is practically "dead beat" in its swing, and far more robust in construction.

N. and S. in Fig. 6 are the poles of a powerful permanent magnet with a soft iron centre piece C. A fine wire coil, as indicated, is suspended from a very thin phosphor bronze strip A (about 0.002 in. \times 0.0005 in. in a highly sensitive instrument), while a similar strip in a spiral form is attached to a terminal at B. The two ends of the coil are connected to these strips, which in turn are connected to the terminals of the instrument.

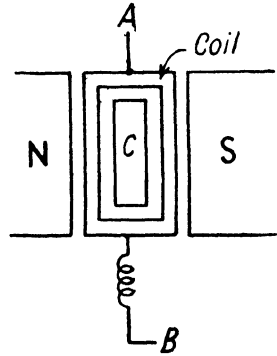

FIG. 6. DIAGRAM TO SHOW PRINCIPLE OF MOVING COIL GALVANOMETER

Current passing through the coil tends to turn it on an axis coincident with the suspension from A. When an external circuit exists, the eddy currents produced in the coil winding as it moves provide sufficient damping to render the movement dead beat. The coil is sometimes

wound on a metallic former, the eddy currents in which make the instrument entirely self-damping.

The determining factors in selecting a suitable galvanometer are resistance, periodic time, and sensitiveness. Resistance and sensitiveness are connected, for greater sensitiveness is produced not only by using as thin a suspension as possible, but also by increasing the number of turns on the coil. Periodic time is the time measured in seconds for the coil to make one complete oscillation, for instance from zero to the extreme right, to the extreme left, and back to zero; or, if the coil is perfectly self-damping, the time required to come to rest after deflection.

For insulation resistance and ballistic measurements (tests of capacitance, etc.) a resistance of 1 000 to 1 500 ohms and 8 to 10 sec. periodic time are convenient values, while for Wheatstone bridge work (for instance for conductor resistance measurements and fault localization) a much lower resistance and periodic time are desirable, say 100 ohms resistance and 5 sec. periodic time for testing room instruments, and a still lower resistance and periodic time for portable galvanometers. For bridge work it is also essential that the self-damping should not be so great as to make the instrument too sluggish in returning to zero. This is also one of the reasons for not selecting an instrument of too high resistance, for the more turns there are on the coil the heavier it is, and the consequent larger moment of inertia makes it swing more slowly. Another reason for the lower resistance for bridge work is that the instrument has to be as sensitive as possible to small differences of potentials, while for purely insulation measurements the accuracy of the test depends on the sensitiveness of the instrument to small currents.

In highly sensitive galvanometers a concave mirror approximately 1 cm. in diameter is attached to the coil. The beam from a small electric lamp filament is

sharply focused on to the mirror by means of a suitable lantern, the lens of which is provided with a hair line. The mirror reflects this back upon a semi-transparent scale in the form of a round spot of light with a firm line vertically across it. The scale is usually marked from left to right 100—0—550, and 1 mm. is a convenient space for a scale division.

To get sharp definition of the hair line, the distance between the galvanometer and the scale has to be adjusted. The scale-zero, lamp, and galvanometer mirror should be mounted in the same straight line to secure accurate scale proportionality; and the scale itself must be set at right angles to this line, otherwise errors might arise owing to the scale readings not being proportional to the current. This applies to measurements of insulation, capacitance, etc., but not to bridge work in which accurate proportionality of the reading to the current is not essential.

The usual measurement of sensitiveness is the "figure of merit." This is the current producing the smallest conveniently readable deflection, say one division of the scale. To measure the figure of merit of a galvanometer, a resistance r is connected in series, and the deflection d is observed when a known voltage V is applied. If g is the resistance of the galvanometer, the figure of merit is

$$\frac{V}{(r + g)d}$$

For instruments intended for insulation measurements in the cable works test room a figure of merit of about 1×10^{-9} ampere per scale division is usual, and for bridge work 2×10^{-8} ampere. Both figures apply to a distance between the galvanometer mirror and the scale of one metre, and to galvanometers of the resistances and periodic times already suggested for the two purposes. It

may be mentioned, in passing, that reflecting moving coil galvanometers are obtainable, for special purposes, so sensitive that millions of megohms can be measured with an accuracy of 1 per cent, but this necessitates a

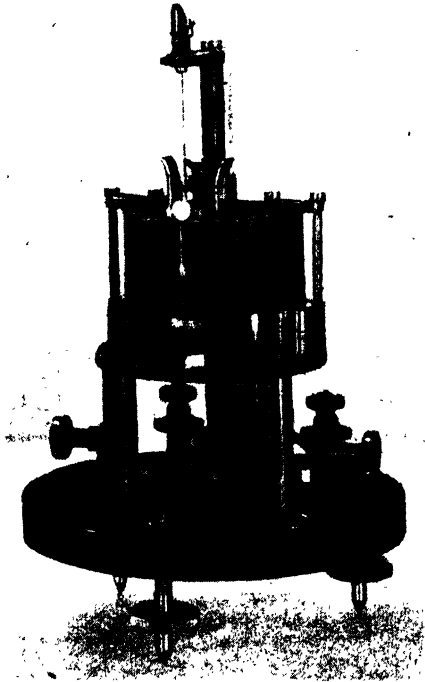

FIG. 7. SULLIVAN MOVING-COIL GALVANOMETER (COVER REMOVED)

high periodic time that renders them unsuitable for cable test room routine work.

Makers usually state the figure of merit of the galvanometers they supply, but it must not be taken as an absolutely accurate figure from which results of cable

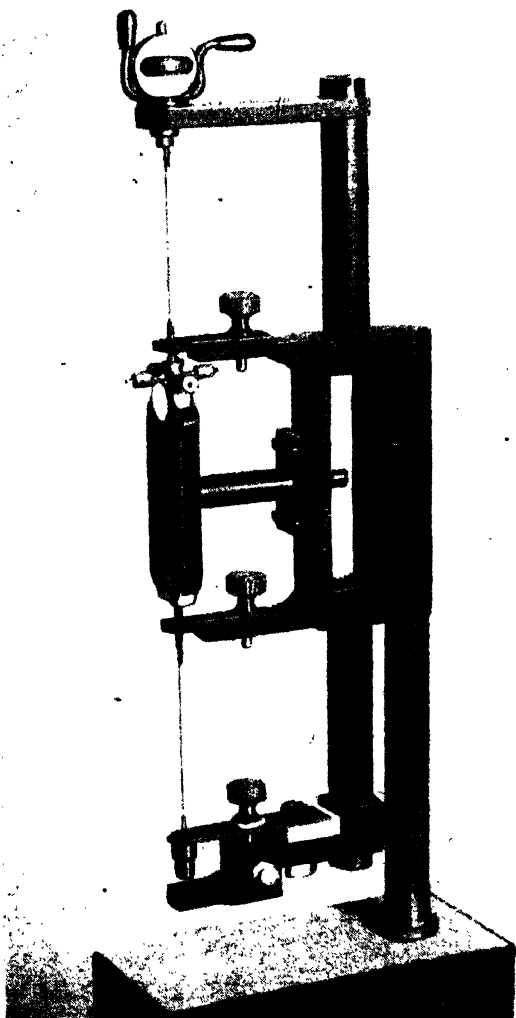

FIG. 8. SUSPENSION OF SULLIVAN GALVANOMETER COIL

tests can be calculated without calibrating the instrument, as would be the case with an ordinary commercial measuring instrument with a constant. The simple method of taking a daily calibration for insulation measurements is described on page 36.

Portable types of moving coil instruments are provided with pointers, and spirit levels and levelling screws for setting up are an advantage; some types, however, can be fairly easily set up without levelling screws.

Fig. 7 shows a highly sensitive pattern of moving coil reflecting galvanometer without its protecting cover, and Fig. 8 (on a larger scale) the removable frame containing the moving coil. Fig. 9 is the suspension unit used in a more compact model. In both instances it is a comparatively easy matter to remove the coil system and replace a broken suspension.



FIG. 9. COIL OF
"TAUT SUSPENSION"
TINSLEY GALVANO-
METER

Fig. 10 illustrates a semi-transparent scale fitted with a lantern and lens. To obtain a sharply defined spot of light, a low voltage lamp (4 to 12 volts) is employed behind the lens. The observer reads from the side of the scale away from the galvanometer.

Fig. 11 is a portable galvanometer made by Gambrell Brothers, Ltd. The method of coil suspension, devised by Onwood, makes it remarkably robust for a suspended coil instrument, and is shown in the diagram, Fig. 12 (which may be regarded as a sectional elevation). The coil *a* is circular, and the suspension strip *c* has its top end fixed at the point *h* in the centre of the iron core *j*, between the magnet poles, and the lower end to a cross pin *g* fixed in the tube *b*, which is fixed vertically at the bottom end of

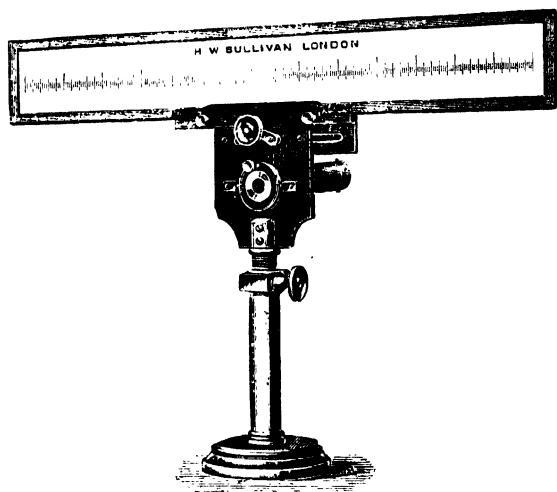

FIG. 10. SEMI-TRANSPARENT SCALE WITH LANTERN AND LENS

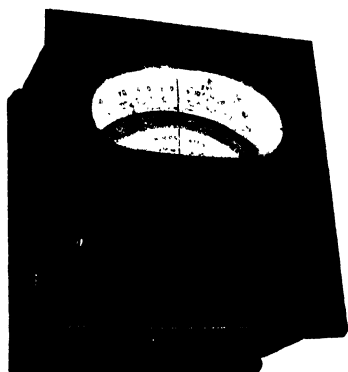

FIG. 11. ONWOOD SUSPENDED COIL PORTABLE GALVANOMETER ONE-THIRD FULL SIZE

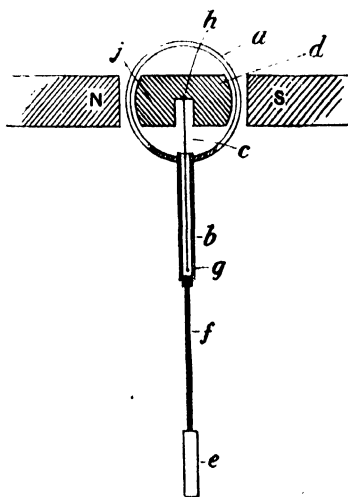

FIG. 12. SUSPENSION OF ONWOOD GALVANOMETER

the coil. A balance weight e at the end of a rod f keeps the coil hanging vertically. The pointer is attached at the point where the tube and rod are joined and is approximately Z-shaped, so that the reading on the horizontal scale corresponds with the angular movement of the coil. With a galvanometer having a resistance of 100 ohms,

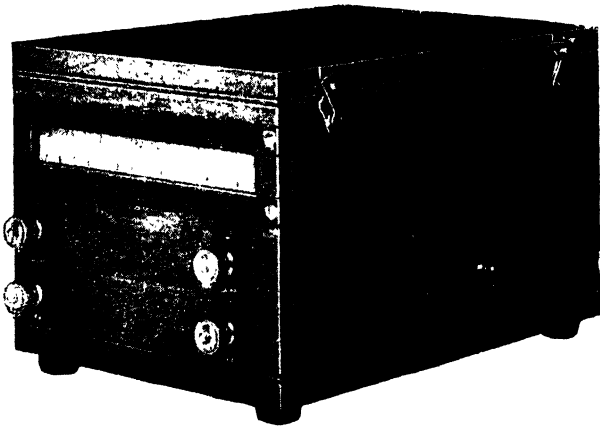

FIG. 13. ONWOOD SELF-CONTAINED PORTABLE REFLECTING GALVANOMETER

the figure of merit is from 4 to 7×10^{-7} ampere per scale division, and with an instrument of 10 ohms resistance from 1.5 to 2×10^{-6} . For fault localization with a slide-wire bridge by the loop method (see Chapter VI), the instrument of lower resistance will usually be the more suitable. The reason for this is that the accuracy of the test depends more on the potential difference required to give unit deflection than on the current required for unit deflection. Multiplying the above figures of merit by the resistance, to give what may be called the volt figures of merit, we get 7×10^{-5} for the 100-ohm galvanometer, and 2×10^{-5} for the 10-ohm instrument.

A more sensitive form of this instrument, and equally portable, is a self-contained mirror galvanometer, lamp, and semi-transparent scale shown in Fig. 13. It measures 10 in. \times 7 in. \times 6 $\frac{1}{8}$ in. high, weighs only about 5 $\frac{1}{2}$ lb., and is as robust as the needle pattern shown in Fig. 13. The figure of merit with a 10-ohm coil is 5×10^{-7} ampere

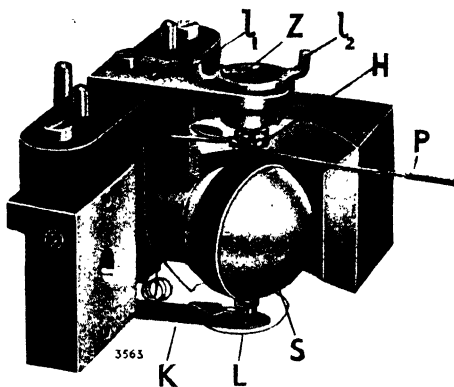

FIG. 14. MOVEMENT OF "UNIPIVOT" GALVANOMETER

(i.e. 5×10^{-6} volts) per mm. deflection on the scale, and the corresponding values with 100-ohm and 500-ohm coils are 1.7×10^{-7} and 9×10^{-8} ampere per mm. scale division respectively. The periodic time of these instruments is about 3 sec. The "2-volt" terminals on the right of the illustration are for the supply to the lamp, but there is space in the box to take two small dry cells for this purpose, the use of which is usually more convenient, and the outside terminals can be replaced by a switch.

Fig. 14 illustrates the movement of the Cambridge "Unipivot" galvanometer; the method of pivoting the coil is seen diagrammatically in Fig. 15, the pivot entering the core between the pole-pieces, which is spherical. The figure of merit of the 50-ohm portable instrument is

3×10^{-6} amp. per scale division, and of the 100-ohm instrument 6×10^{-7} . In Fig. 14, S is the spherical core, L the ligament conveying current to the coil, H the controlling spring, Z the zero adjusting device actuated through two lugs l_1 and l_2 , which engage with a fitting in the cover of the instrument, K the lifting device for

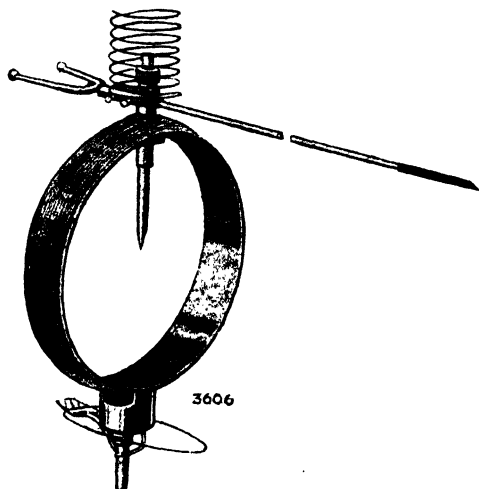

FIG. 15. COIL OF "UNIPIVOT" GALVANOMETER SHOWING POSITION OF PIVOT

lifting the movement off the pivot when the instrument is not in use, and P the pointer.

Those who have frequent occasion to use portable moving coil galvanometers are recommended to keep a supply of suspension strip available. It is a fairly simple matter to re-suspend a galvanometer coil with the assistance of a small soldering iron, and the necessary degree of patience.

Nevertheless it is a nuisance to have to repair a suspension, and every precaution should be taken not to jolt the

instrument, and also to avoid passing too heavy currents through it. Portable galvanometers are provided with a means of taking the weight off the suspension or lifting the coil off its pivot when the instrument is moved about, as K for example, Fig. 14, and the suspension of reflecting galvanometers should also be lowered during transit. Besides the risk of damaging the suspension or burning out the coil if the instrument is given a shock from too heavy a current, there is the minor nuisance that the zero will be shifted and, in the case of reflecting galvanometers, when this is restored, the "constant" will probably be altered and have to be remeasured. In bridge measurements, however, it is difficult to avoid entirely occasional violent movements of the coil and spot, or pointer, so that before the final observation is reached the zero should be checked; but with these measurements it is easier to work to a false zero, if there is any tendency for it to vary, than to make repeated zero adjustments.

THE MEASUREMENT OF INSULATION RESISTANCE

The Direct Deflection Method. In the works test room the direct deflection method is the one most usually employed for measuring the insulation resistance of cables; the connections are shown diagrammatically in Fig. 16. The battery B is usually made up of about 350 Leclanché cells or 250 secondary cells, giving an E.M.F. of approximately 500 volts. A plug switch (not shown in the diagram) is employed on one pole of the battery, enabling a 15-volt tapping to be taken off for capacitance measurements. K_1 is a reversing key by means of which current may be sent in either direction through the insulation of the cable. Fig. 17 shows the type of key developed by Rymer Jones for this purpose, this being the most popular form in test rooms. The galvanometer G is a sensitive moving coil pattern of the reflecting type such as has

been already described. S is a universal shunt having multiplying values up to ten thousand. Formerly shunts proportional to the resistance of the galvanometer were always supplied with the instrument, but the so-called universal shunt is now almost invariably employed, this being independent of the resistance of the galvanometer itself, and therefore interchangeable almost for any ordinary galvanometer. Its principle is briefly that the

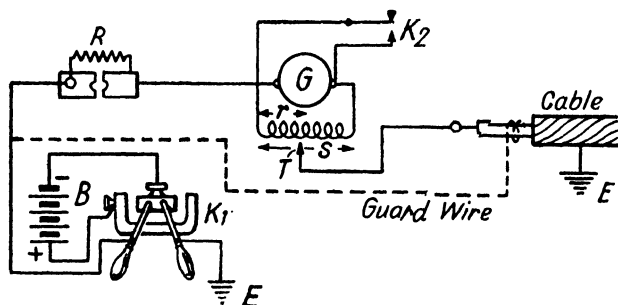

FIG. 16. CONNECTION FOR DIRECT DEFLECTION METHOD

galvanometer is permanently shunted by a resistance S , which is large compared with the resistance G of the galvanometer itself, and the position of the tapping T to which the circuit is connected is altered according to the multiplying power required. In any position of the tapping, the multiplying power of the shunt (i.e. the number by which the actual reading of the galvanometer has to be multiplied to give the value of the deflection if the instrument were unshunted) is $(S + G)/r$. It is thus inversely proportional to r , no matter what is the resistance of the galvanometer itself. The positions of the sliding contact on the shunt box are simply marked with the multiplying powers, not with the actual resistance. K_2 is a short-circuit key across the galvanometer. It is a single-contact key, and a catch is provided to hold it down

in the short-circuiting position. Its object is to prevent the rush of current charging or discharging the cable from passing through the galvanometer at the moment the main key is switched on or off during an insulation test.

In the central position of the main key (the actual position shown in the diagram) the conductor of the cable is connected to earth through the galvanometer. On

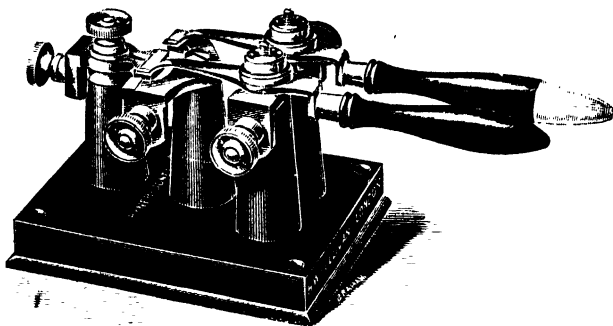

FIG. 17. RYMER JONES KEY

switching the left-hand arm of the key over, the small current to be measured is sent from the positive pole of the battery to the conductor of the cable, through the galvanometer and the insulation of the cable, to earth and back to the battery. If the right-hand arm of the key is used, instead of the left-hand arm, the current is sent in the reverse direction. Before switching-on, the galvanometer must be short-circuited by K_2 to prevent the initial rush of current charging the cable from passing through the galvanometer; it is released as soon as the main key is over, and the reading is taken with the appropriate shunt. On completing the test, K_2 is depressed and held permanently down while the key K_1 is switched off, and this prevents the discharge current of the cable from passing through the galvanometer. The correct

manipulation of K_2 is important, both at the commencement and completion of the test, to prevent damage to the suspension of the instrument. It may be noted that some short-circuiting keys are made with the reverse connections to those shown in the diagram, so that the galvanometer is short-circuited in the normal position of the key, and the key has to be depressed to open the circuit. In many cable testing rooms this arrangement is preferred as it renders the galvanometer less liable to damage through inadvertence.

R is a resistance of about 10 000 ohms in series with the galvanometer to prevent excess current passing in the event of the cable being faulty. Its resistance is negligible compared with the hundreds or thousands of megohms which represent the insulation resistance of the cable in series with it, but a short-circuiting plug is used to short-circuit it when taking the "constant" of the galvanometer before commencing the test on the cable itself.

A known high resistance, usually one megohm, is first connected in place of the cable, and a reading is taken, the shunt being given a value to make it as large as possible. If S_1 is the reading of the shunt and d_1 the deflection, and one megohm is used as the resistance, the "constant" is $S_1 d_1$, that is to say, the deflection of $S_1 d_1$ would be obtained through a resistance of one megohm; as the resistance of the shunted galvanometer will be small in proportion to a megohm, it can be neglected.

The cable is then connected up in place of the known resistance, and a deflection d_2 obtained with a suitable value of the shunt S_2 . Once again the resistance of the galvanometer and shunt can be neglected in comparison with the high insulation resistance of the cable, so that all it is necessary to do to obtain the value of the insulation resistance in megohms is to divide the "constant" by $S_2 d_2$.

The keys and galvanometer terminals are insulated by ebonite pillars, and if these are kept dry there is no need to compensate for any leakage across them. On the other hand, unless both ends of the cable under test are well trimmed and perfectly dry, and also the lead connecting the cable to the galvanometer shunt terminal free from leakage, a false result might be obtained by leakage to earth through the galvanometer. To overcome this, a device known as "Price's Guard Wire" is employed. It is simply a wire wound round the bare insulation of the cable at a point between the conductor and the sheath, and connected as shown in the dotted line in Fig. 16, and it shunts the unwanted leakage current past the galvanometer.

In factory test rooms this principle is extended to the connecting lead, which is made concentric, the outer conductor being insulated and taking the place of the dotted line shown. In this way the leakage of the lead is annulled. On the other hand, if a concentric lead is not used, it is advisable first to take a deflection with the lead hanging free, and to subtract this from the deflection obtained when the lead is connected to the cable.

The use of a short circuit key has already been mentioned, and in practice after switching on the cable one should not be too quick in opening this key. Following on the initial charging current of the cable the current takes some time to settle down during the initial stage of "electrification." This phenomenon, also known as "dielectric absorption," is considered to be due to a viscous recovery of the molecules of the dielectric to their normal formation after displacement caused by the initial charging. Its effect is to cause the current passing through the dielectric to fall exponentially with time. The conventional value of the insulation resistance is calculated after one minute's electrification, and it is usual

to open the short circuiting key, say, about a quarter of a minute after switching on the current, and observe the gradual drop in the galvanometer deflection, which should be perfectly even if the insulation of the cable is good. The value is then observed after one minute from switching on, and again after two and sometimes after three minutes as a record. The insulation is defective not only if steady electrification does not occur, but also if no electrification occurs at all. A sound dielectric will always show a steady absorption of charge.

Tests of connected up cables after laying will not always show this electrification, as the insulation resistance of the end terminals will be less than that of the cable itself, so that the variation of the cable charging current with time is negligible compared with the leakage current over the insulation of the end terminals.

Insulation resistances are customarily expressed per thousand yards of cable, so that if K is the "constant," L the length of the cable in yards, and $S_2 d_2$ the shunt reading and deflection after one minute respectively, the insulation resistance per thousand yards is

$$\frac{K}{S_2 d_2} \times \frac{1000}{L}$$

Direct Deflection Method with Portable Galvanometer.

The direct deflection method is equally applicable to insulation measurements on mains in the ground after laying, but as a rule it is inconvenient to have to carry about and set up a laboratory pattern reflecting galvanometer. A portable pattern has therefore to be employed, at the sacrifice of sensitiveness. An instrument such as described on pages 28 to 32 is quite suitable, and one with a high resistance (say 700 ohms) should be chosen if available, as this will be more sensitive to small currents than the lower resistance instruments, which are preferable

for bridge work. For the battery, two or three 120 v. wireless H.T. batteries connected in series will serve, and for the "known" resistance a wire-wound resistance of one megohm of good make. Portable galvanometers can be obtained with shunts either self-contained or as separate units, but failing one of these, if the resistance of the galvanometer is known the variable arm of a Wheatstone Bridge (see pages 54 and 55) can be employed. The multiplying power N of a simple shunt is

$$N = \frac{G + S}{S}, \text{ or } S = \frac{G}{N - 1}$$

Therefore for a one-tenth shunt, one-ninth of the resistance of the galvanometer is connected across it; for a one-hundredth shunt, one ninety-ninth of the galvanometer resistance, and so on. If, say, the resistance of the galvanometer is 100 ohms, 11.1 ohms would be used to form a one-tenth shunt.

On the other hand, if great accuracy is not required, a portable pointer-type galvanometer with pivoted coil on the moving coil principle can be relied upon, or even a portable suspended coil will have a fairly constant figure of merit when still equipped with the original suspension fitted by the makers. For a rough test, therefore, the battery voltage may be taken at its nominal value or checked by a high resistance voltmeter at the electricity works. Then a simple circuit is made: battery—galvanometer—cable—earth—battery, and the reading I as a decimal of an ampere is calculated, when, by Ohm's Law, the total resistance in the circuit will be $R = V/I$. Supposing the figure of merit of the galvanometer is 0.25×10^{-6} ampere, the battery 200 volts, and the deflection 10 scale divisions, R would be $200/(2.5 \times 10^{-6})$, i.e. 80 megohms. A reading of one scale division only would represent 800 megohms. As the resistance of the galvanometer

and battery would certainly not total more than a few hundred ohms, they could be neglected, and the above value could be taken as the insulation resistance of the cable.

Various patterns of combination testing sets make use of the direct deflection method in more or less a manner

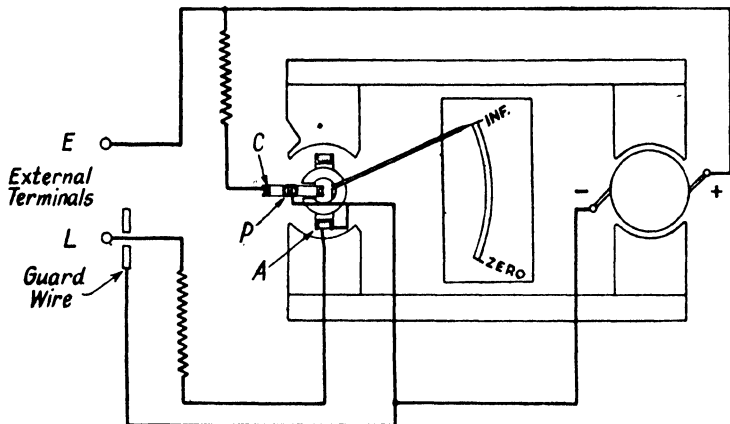

FIG. 18. PRINCIPLE OF THE "MEGGER"

to that explained in the above paragraphs, but most people nowadays employ a "Megger" or some similar testing set in which a direct reading of the insulation resistance can be obtained merely by turning a handle.

"The Megger." Fig. 18 shows the principle of Evershed and Vignoles "Megger" in diagrammatic form. The instrument, which is self-contained, consists of a D.C. magneto generator and a direct-reading ohmmeter contained in the same case, the permanent magnets in some patterns being common to the generator and ohmmeter. The generator armature is turned by a handle external to the case.

The popular pattern generates 500 volts when the handle is turned at 100 revs. per minute, but sets are also

made with 1 000 and 2 500-volt generator pressure. The ohmmeter portion consists of two coils at an angle to one another, and free to rotate as a whole between the poles of the permanent magnet system. In the diagram, the air gap between the coils and the pole pieces is exaggerated in order to show the coils more clearly. The current coil A is connected in series with a resistance between one of the generator terminals and the external line terminal. The pressure coil P is connected directly across the generator terminals through a suitable resistance. Both these resistances are contained within the set. The high resistance to be measured is connected between the external terminals E and L. If the insulation resistance to be measured is "infinity" no current will pass through the current coil, and the pressure coil alone will control the movement of the suspended coil system. It will set itself in the position shown in the diagram. When, however, there is a resistance across the terminals a current will flow through the current coil, and the corresponding torque will draw the pressure coil away from the infinity position into a field of gradually increasing strength, until balance is obtained between the forces acting on the two coils. The makers can thus adjust the internal resistance to suitable values and calibrate the scale to read directly in thousands of ohms and megohms.

It will be noticed that the pressure coil extends from the centre to one side of the cylindrical magnet keeper, and not right across, as does the current coil. In order to protect it from the influence of external fields a compensating coil C, shown in the diagram, is added outside the pressure coil, and connected in series with it, the coils being wound so as to form an astatic combination so far as external fields are concerned. Very thin phosphor-bronze ligaments generally similar to those for galvanometer suspensions act as leading-in wires to the coils.

The guard wire principle is adopted to avoid error due to any leakage which may occur across the line terminal. This is simply a guard ring surrounding the terminal of the generator, and short-circuiting any surface leakage currents so that they do not pass through the current coil of the movement. For high range instruments, the guard ring is also connected to an external terminal, so that a guard wire may be taken to the cable end performing the same function as the guard wire shown dotted in Fig. 16.

“Meggers” are made in various ranges, the lowest range being scaled to read from 0 to 10 megohms, and the highest range from 8 to 20 000 megohms. The standard set familiar for ordinary tests of house wiring reads from 0 to 100 megohms, with the lowest scale reading of 10 000 ohms. For cable testing, however, the higher range instruments are useful. Those reading up to 2 000 and 5 000 megohms, for instance, are provided with 1 000 v. generators, and the one reading up to 10 000 megohms has a 2 500 v. generator. There is also a 5 000-volt pattern. For testing the insulation of ordinary 400 to 500 v. circuits, one with a 1 000 v. generator and reading up to 200 megohms is useful, and there is a cheaper and lighter 500 v. set known as the “Meg.” as well as a “Wee-Megger” which is still smaller and has no compensating coil.

For tests in which the capacitance of the cable or cable system is comparatively small, say less than 0.5 microfarad, a slight variation in speed when turning the handle of the generator does not matter, but variations of speed and consequently of E.M.F. will cause an unsteadiness when the capacitance is high. For such purposes, therefore, a “constant pressure” set should be used. This embodies a constant pressure clutch, which prevents the generator from revolving at a higher speed than that proper for its rated voltage.

It may be mentioned here that unsteady readings may

also occur through a different cause, even when testing with a constant speed megger. If the brushes of the generator are dirty, unsteadiness may be noticed when the machine has to deliver the large current required for charging a comparatively long cable, but it will disappear on cleaning the brushes. It is essential that this matter be not neglected, for an incipient fault can equally cause an unsteady megger reading, and a false conclusion might be arrived at if the brushes are dirty.

A necessary precaution after taking a "Megger" test is to earth the cable for several minutes. A cable with a high dielectric resistance can retain its charge for a long time, being in effect an insulated condenser, and anyone touching such a cable which has not been discharged may receive a nasty shock. With long lengths of cable, momentary earthing is not sufficient, for dielectric absorption (see pages 37 and 87) gives rise to the reappearance of a considerable charge after a few minutes.

After testing one core of a multi-core cable, the other cores which have remained free or insulated during the test should also be earthed when the test is concluded. This precaution is really necessary for safety considerations.

Temperature Correction. Dielectric resistances of all classes of cable are considerably affected by temperature. Between 32° and 150° F. the resistance variation conforms closely to a "compound interest" law, decreasing as the temperature increases. With impregnated paper, the drop of the insulation resistance is in the order of 6 per cent per 1° F. increase of temperature.

For practical purposes it is sufficient to know the dielectric resistance at two different temperatures, from which the temperature coefficient ρ can be calculated, and thence the resistance at any other temperatures.

The coefficient ρ is the ratio of decrease of resistance

per 1° F., that is to say, if $R\theta_1$, $R\theta_2$, $R\theta_3$, etc., are the resistances at 1° intervals

$$\rho = \frac{R\theta_1}{R\theta_2} = \frac{R\theta_2}{R\theta_3} = \frac{R\theta_3}{R\theta_4}, \text{ and so on.}$$

If R_1 and R_2 are the dielectric resistances at θ and $(\theta + n)^\circ$ respectively,

$$\rho^n = \frac{R_1}{R_2} \text{ or } \log \rho = \frac{1}{n} \log \frac{R_1}{R_2}$$

If the resistance is required at a temperature $(\theta + x)^\circ$, calling this R_x we have

$$\rho^x = \frac{R_1}{R_x}$$

whence

$$\left(\frac{R_1}{R_x}\right)^{\frac{1}{x}} = \left(\frac{R_1}{R_2}\right)^{\frac{1}{n}}$$

or

$$R_x = R_1 \left(\frac{R_2}{R_1}\right)^{\frac{x}{n}}$$

Knowing R_2 and R_1 , a series of tables giving the multiplying coefficients $\left(\frac{R_2}{R_1}\right)^{\frac{x}{n}}$ for various values of x can be calculated.

Knowledge of the temperature coefficient is very useful, for, when the insulation resistance of a feeder is measured immediately after being taken off load, a low reading due to high temperature may be mistaken for fault conditions.

Here is an example which will illustrate this. A five mile 11 000 volt feeder, whose normal dielectric resistance was 100 megohms at about 60° F. was laid on posts above ground fully exposed throughout most of its length to the sun. On a hot summer day the insulation resistance was found to be only two megohms at about 3 p.m. The cable was suspected of being faulty, but when the test was

repeated at midnight the insulation resistance was found to be normal. It was known that the temperature coefficient per degree F. was about 7 per cent, and, calculating back, the cable would have been about two megohms at an average temperature of about 85° F. Thus it is seen that dielectric resistances must generally be considered with reference to a temperature basis to become comparable. The factory tests are usually referred to 15° C. or 60° F. for that reason.

MEASUREMENT OF CAPACITANCE

Ballistic Measurement. The routine measurement of capacitance at the factory is effected by the "ballistic method," where great accuracy is not sought, otherwise various A.C. bridge methods are used. The errors in the ballistic method are mainly due to dielectric absorption (see page 37) and the inseparable effect of leakage current through the dielectric.

The connections can be the same as those for measuring insulation resistance (Fig. 16, page 34). A standard condenser, usually $\frac{1}{3}$ rd microfarad, is connected in place of the cable. With the galvanometer key K_2 closed, 15 volts is switched on by K_1 for about 10 seconds, which allows the condenser to charge fully. The key K_2 is then opened and K_1 is switched off, thus closing the galvanometer circuit across the condenser so that it discharges through the galvanometer. If S_1 and d_1 are the shunt multiplying power and deflection respectively, the unshunted deflection obtained from one microfarad would be $S_1 d_1$ divided by the capacitance of the standard condenser. This is known, in test room parlance, as the "Capacity Constant." Thus if the standard condenser is $\frac{1}{3}$ rd m.f., the "capacity constant" is three times $S_1 d_1$.

The cable is then connected as shown in Fig. 16 in place of the condenser. If the shunt and deflection are

respectively S_2 and d_2 , we have the capacitance of the cable by dividing $S_2 d_2$ by the "capacity constant" as the discharging currents of the condensers are proportional to their capacitances.

Since the capacitance of a cable is proportional to its length, the capacitance per thousand yards will be obtained by multiplying by 1 000 and dividing by its length in yards.

The voltage should be kept as low as is consistent with obtaining a sufficiently large deflection, to minimize leakage errors. Within fairly wide limits the capacitance is independent of the voltage, and 15 volts is a usual value for ballistic capacitance tests. Before taking the reading for the constant with the standard condenser, the latter should be short-circuited for a moment to dissipate any absorbed charge. It is also advisable that the galvanometer should have a periodic time of several seconds, so that all the discharge has passed before the coil has reached the end of its swing. The highly sensitive reflecting galvanometer generally employed for insulation measurements is generally suitable for capacitance measurements by this method. The capacitance could also be calculated by observing the galvanometer swing on charge instead of discharge, but the latter is usually preferred, as there is less chance of a low insulation resistance impairing the accuracy of the result.

It is to be remembered that the short circuit key of the galvanometer must be closed before charging the cable if the capacity measurement is to be taken on the discharge swing; and also that the discharge current will be in the opposite direction to the ordinary charge current when taking insulation tests. Therefore, if a simple charge and discharge key is used instead of a Rymer Jones reversing key, it is necessary to have a reversing key in the circuit as well, to reverse the galvanometer if a scale

with an end zero is employed, or else, of course, the connections to the galvanometer can be reversed if a series of capacitance tests is taken in sequence. An alternative method of connection, useful when a series of capacitance tests has to be taken independently of insulation resistance, is given in Fig. 110 (Chapter X).

Measurements of capacitance are very useful for locating broken conductors, as will be seen in that chapter. A knowledge of cable capacitance is also often of use in connection with some systems of feeder protection. For these reasons it is always advisable to keep records of the capacitance per thousand yards of all cables installed. With lead-sheathed cables it can be taken that the capacitance of the cable itself is the same after laying as before, as capacitance is only very slightly affected by temperature changes within the normal limits of operating temperatures.

Simple A.C. Method. If C is the capacitance of a cable in microfarads and a pure sine wave alternating E.M.F. with an R.M.S. voltage E and a frequency ω is impressed upon it, the R.M.S. value of the current passing through the condenser is

$$I = 2\pi\omega CE \times 10^{-6}$$

From this the capacitance can be calculated from the formula

$$C = \frac{I \times 10^6}{2\pi\omega E}$$

It should be mentioned that this simple method of measurement is only true when the insulation resistance is high; otherwise one of the A.C. bridge methods must be used.* Although not generally employed for factory measurements, the simple A.C. method is of considerable practical

* See *Alternating Current Bridge Methods*, by B. Hague (Pitman).

value in locating a broken wire, for which purpose a sensitive A.C. milliammeter is necessary. In localization tests a variation of the impressed E.M.F. from pure sine wave form does not matter.

On multicore cables, capacitance measurements, like dielectric resistance measurements, are usually made on

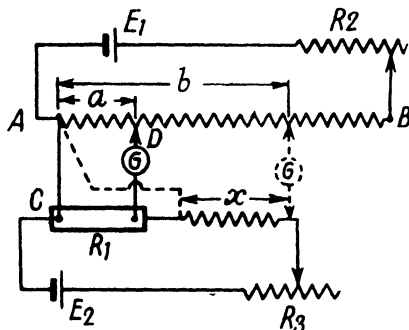

FIG. 19. LOW RESISTANCE MEASUREMENT WITH POTENTIOMETER

each conductor, with the remaining conductors and lead sheath earthed.

CONDUCTOR RESISTANCE TESTS

The methods ordinarily used in the factory for conductor resistance measurement are the potentiometer, the Kelvin double bridge, and the Wheatstone bridge. Each has its application to fault localization, but the Wheatstone bridge is the simplest and most extensively used. The first two are particularly suitable for accurate measurements of low resistances.

The Potentiometer Method. The principle is as follows: In Fig. 19 AB represents a slide wire accurately divided into a large number of equal parts. A battery E_1 passes a current along AB, controlled by a rheostat R_2 . A standard resistance R_1 is connected in series with the

resistance x to be measured and another battery E_2 , the current in this circuit being controlled by the rheostat R_3 . Points A and C, or the similar poles of E_1 and E_2 , are connected together. The other terminal of the standard resistance is connected through a galvanometer G to the sliding contact D. When this sliding contact is adjusted at a so that no current passes, that is when the currents due to E_1 and E_2 are in exact opposition, if I_1 and I_2 are the currents in the slide wire and standard resistance respectively, we have

$$aI_1 = R_1I_2$$

If without disturbing R_2 and R_3 so that I_1 and I_2 remain constant, the point A is connected to one side of x , and the galvanometer to the other side, as shown dotted in the figure, and the slide wire is adjusted to b so that again no current passes through G, then

$$bI_1 = xI_2$$

whence
$$\frac{a}{b} = \frac{R_1}{x}, \text{ and } x = \frac{b}{a} R_1$$

As a and b are always expressed as a ratio, length units of the slide wire need only be known.

During the tests, I_1 and I_2 must remain absolutely steady, for which purpose E_1 and E_2 must be storage batteries, for polarization of primary batteries renders their use impracticable.

The potentiometer method is very satisfactory for the accurate measurement of low resistances, for by arranging the potential connections to the measured resistances inside the main current contacts, errors due to connections are avoided. All connections must, however, be clean and solid, or unsteadiness of currents will occur. The method may conveniently be used for measurements of from 1 to 0.001 ohm, using 1, 0.1, or 0.01 ohm standard

resistances at R_1 . At lower resistances, the standard resistance and the heavy currents necessary for high accuracy present several difficulties.

The Kelvin Double Bridge. The Kelvin double bridge is another method well suited to the accurate measurement of low resistances. It possesses the advantages over the

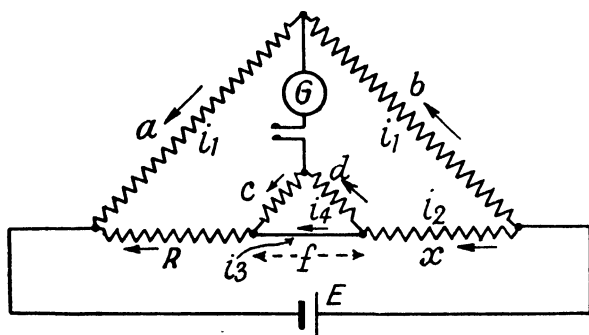

FIG. 20. DIAGRAM OF KELVIN DOUBLE BRIDGE

potentiometer method that only one source of E.M.F. is necessary and a perfectly steady current is not required.

The system of circuits is shown in Fig. 20. a , b , c , and d are variable resistances, R is a standard resistance, capable of withstanding, without heating, currents corresponding to 1 volt drop when its value is one ohm or less, and x is the resistance to be measured. The points where a , b , c , and d connect to R and x are arranged inside the points where the heavy current connections are made to these two latter resistances, so that contact errors are eliminated. f is the resistance between the points where c and d connect to R and x ; i_1 , i_2 , i_3 , and i_4 are currents in the various resistances, as shown.

Now if a , b , c , and d be adjusted so that no current

flows through the galvanometer G, we get, from Kirchoff's laws (see Appendix),

$$i_4 + i_3 - i_2 = 0$$

$$ci_4 + Ri_2 - ai_1 = 0$$

$$di_4 + xi_2 - bi_1 = 0$$

$$fi_3 - di_4 - ci_4 = 0$$

By eliminating i_2 and i_3

$$i_1 a = i_4 \left(\frac{c+d}{f} R + R + c \right)$$

$$i_1 b = i_4 \left(\frac{c+d}{f} x + x + d \right)$$

whence, dividing these two equations,

$$\frac{a}{b} = \frac{R(c+d+f) + cf}{x(c+d+f) + df}$$

and

$$x = R \frac{b}{a} + \frac{cf \left(\frac{b}{a} - \frac{d}{c} \right)}{c+d+f} \quad (1)$$

Now, if we make $a/b = c/d$, equation (1) becomes

$$x = \frac{b}{a} R$$

With a suitable Kelvin double bridge, resistances as low as 0.0001 ohm can be measured to four-figure accuracy.

There is no advantage, however, in using this method for measuring resistances above 10 ohms because connection errors can be reduced to a negligible value and a Wheatstone bridge used.

THE WHEATSTONE BRIDGE

r , q , x , and y are wires or resistances connected as shown in Fig. 21, G being a galvanometer, and B a battery or continuous-current generator. This arrangement of resistance is known as a Wheatstone bridge.

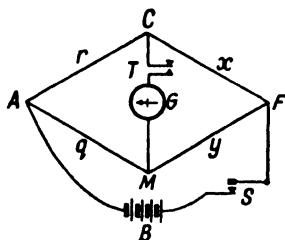

FIG. 21. DIAGRAM OF WHEATSTONE BRIDGE

If no current flows through the galvanometer, the following equation holds—

$$\frac{r}{q} = \frac{x}{y} \quad (2)$$

r , q , x , and y being the ohmic resistances of the wires. This is true whatever be the resistances of the galvanometer and battery, and the wires leading to them.

In this condition the bridge is said to be “balanced,” or “in equilibrium.”

If the ratio r/q be known, and y is a resistance that can be adjusted to any known value, the resistance of x can be measured by adjusting y until no current passes through the galvanometer, when

$$x = \frac{r}{q} y \quad (3)$$

r and q are known as the ratio arms, and in some standard forms of bridges can be set to 10, 100, or 1 000 ohms, so that r/q can be any decimal multiplier from 0.01 to 100; y , the adjustable resistance, can be varied from 1 to 999 ohms, or in some sets from 1 to 999.9 ohms.

In an alternative and cheaper form of bridge, y is a known resistance of fixed value, and r and q a plain wire stretched over a scale between the two points C and M , A being a sliding contact-maker. The position of this contact-maker is then adjusted until no current passes

through the galvanometer, and then x is calculated from equation (3), r/q being now the variable.

This form is extremely useful in its application to fault localization, when, it will be seen later, it is possible to dispense altogether with the known resistance y . In practice, keys are put in the battery and galvanometer circuits as shown in Fig. 21. In ordinary circumstances, the battery key S is first depressed, to allow the current to reach a steady value before closing the galvanometer circuit by depressing its key T.

The proof of equations (2) and (3) is very simple: Let i_1 be the current flowing through the circuit ACF, and let i_2 be the current flowing through the circuit AMF, when no current is passing through the galvanometer. And let the potential at the point A be V_1 , at the point F, V_2 ; and at the points c and M, v . (If no current flows through the galvanometer, C and M have the same potential.) Taking the piece of circuit AC, which has a resistance, r , by Ohm's law,

$$i_1 = \frac{V_1 - v}{r} \quad \therefore i_1 r = V_1 - v$$

similarly,

$$i = \frac{v - V_2}{x} \text{ and } \therefore i_1 x = v - V_2$$

$$i_2 = \frac{V_1 - v}{q} \quad \therefore i_2 q = V_1 - v$$

$$i_2 = \frac{v - V_2}{y} \quad \therefore i_2 y = v - V_2$$

Combining these equations,

$$i_1 r = i_2 q. \quad . \quad . \quad . \quad (4)$$

and

$$i_1 x = i_2 y. \quad . \quad . \quad . \quad (5)$$

Dividing (4) by (5) we get

$$\frac{r}{x} = \frac{q}{y}$$

or

$$\frac{r}{q} = \frac{x}{y}$$

When a secondary battery is used as the source of current, care should be taken that none of the resistances in

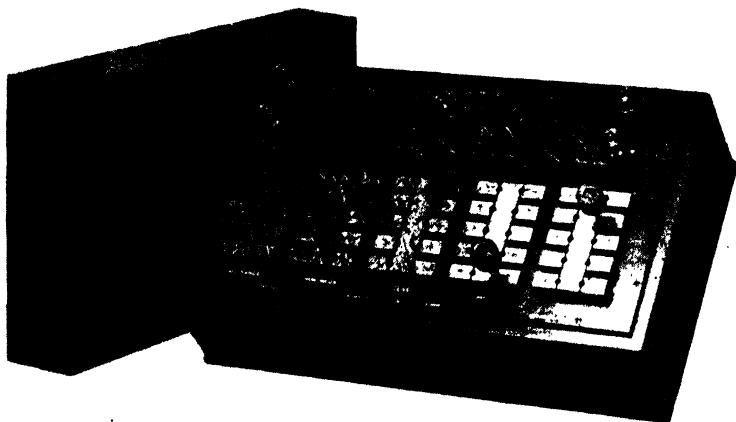

FIG. 22. FIVE-DIAL PLUG WHEATSTONE BRIDGE

any of the arms of the bridge are sufficiently low to cause currents injurious to the coils of the bridge to pass. As a rule the resistance coils in Wheatstone bridge sets will not carry more than about 20 milliamperes safely, so that, should there be any possibility of currents in excess of this passing through them during adjustments for a measurement, a suitable limiting resistance should be placed in series with the battery, sufficient only to limit the current to a safe value; if it is too high, the accuracy of observation will be impaired.

Fig. 22 illustrates a useful five-dial bridge, so-called because in earlier patterns the five groups of adjustable resistances were arranged in dial form. Fig. 23 is a former pattern of Wheatstone bridge still largely used by the Post Office on account of its portability; it includes the keys for controlling the battery and galvanometer; Fig. 24 shows the connections of this bridge, x being the resistance to be measured. (It should be noted that in some makes the positions of the battery and galvanometer keys are reversed.) The plugs normally short-circuit the various resistances, the values of which are indicated. q , r , and y correspond to the resistances similarly designated in Fig. 21. The variable arm y can be adjusted in units from 1 to 10 000 ohms. No resistance is connected across the blocks marked "INF"; removal of this plug breaks the circuit. The r and q arms are of 10, 100, and 1 000 ohms each, and in use one plug only on each side is removed to obtain the ratio required.



FIG. 23. P.O. PATTERN WHEATSTONE BRIDGE

Fig. 25 shows the arrangement of resistances for the "dial" pattern illustrated in Fig. 22, but represents the four-dial pattern. It will be seen that this is more rapidly manipulated than the Post Office type, as fewer plugs have to be removed, and the result is read directly from the y arm, which is arranged in decades usually of units,

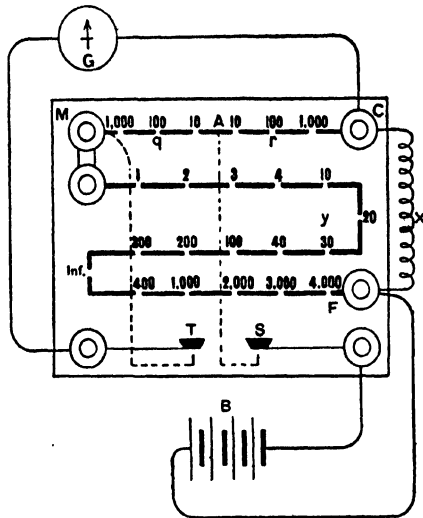

FIG. 24. DIAGRAM OF P.O. PATTERN WHEATSTONE BRIDGE

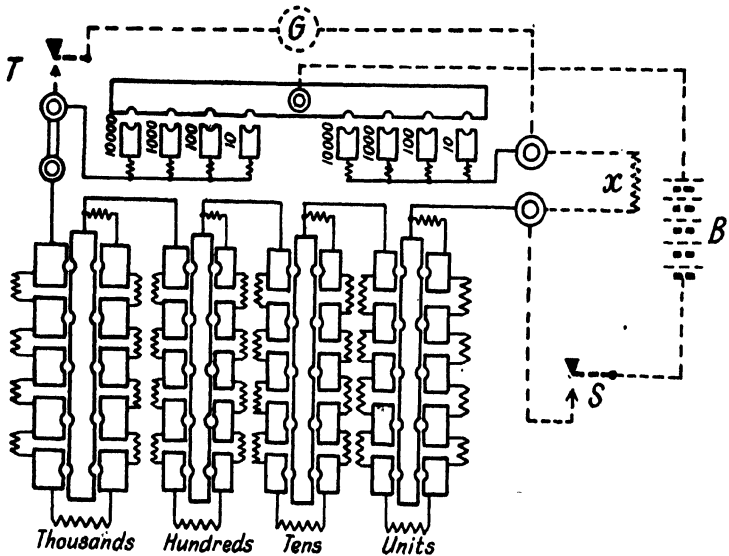

FIG. 25. DIAGRAM OF FOUR-DIAL BRIDGE

tens, hundreds, and thousands of ohms. The r and q arms are usually 10, 100, 1 000, and 10 000 ohms each, with a link to disconnect them from the variable arm if required for other purposes.

To measure a resistance between 10 and 100 ohms with the Post Office pattern bridge, one would make q and r 1 000 and 10 respectively, so that y would have to be somewhere between 1 000 and 10 000 to balance the bridge and thus could be adjusted accurately to four figures. To measure resistances less than 10 ohms the same value of q/r , viz. 1 000/10 should be used, so as to have as high a resistance as possible in the arm y . Similarly for resistances between 100 and 1 000 ohms one would use the ratio 1 000 : 100, and for resistances between 1 000 and 10 000 the even ratio 1 000 : 1 000. Again, by making $q = 10$ and $r = 1 000$, one can measure resistances up to 1 000 000 ohms (1 megohm).

The lowest resistance which can be measured to two significant figures on this type of bridge is 0.1 ohm. Where four resistances are provided on the r and q arms the extreme limits of measurement are 10 megohms and 0.01 ohm, the latter figure being to two significant figures. The five-dial pattern illustrated in Fig. 22 gives a larger range.

Bridges such as those illustrated made by reputable makers are usually calibrated in standard or International ohms, and possess a negligible temperature coefficient.

Theoretically it is best to employ a galvanometer having a fairly high resistance to get the best results from bridges having the usual values of coil resistances, but (as has already been explained) galvanometers of lower resistance are more suitable for fault localization by the "loop" method, and these will answer quite well for the usual run of conductor resistance measurements also. Even the portable galvanometers which have been described are

sufficiently sensitive to enable observations to be made to three or four significant figures with any of the bridges similar to those illustrated. A highly sensitive reflecting moving-coil galvanometer will usually require shunting for use with a Wheatstone bridge.

When the sensitivity of the galvanometer is sufficiently high, the accuracy of measurement can be extended to a further significant figure by the use of "proportional deflections." For example, suppose when the variable arm of the bridge is adjusted to y ohms, the galvanometer deflection is d in the "more" direction, and when adjusted by one more unit to $(y + 1)$ ohms the galvanometer deflects d_1 in the opposite ("less") direction, the correct value of the resistance x is

$$x = \frac{r}{q} \left(y + \frac{d}{d + d_1} \right)$$

When not incorporated in the bridge as in the Post Office pattern, keys for controlling the battery and galvanometer are necessary. Two press keys mounted side by side on a common insulating base are the best for rapid manipulation.

The contacts of the keys should be periodically cleaned, and it is also essential that damp or dirt should not be allowed to accumulate round the plugs of a bridge, or errors will arise.

The battery circuit should be closed before the galvanometer circuit, for if the sequence of operation is reversed, unless the resistance to be measured is absolutely non-inductive and has no capacitance, a kick of the galvanometer movement occurs when the battery key is closed, which makes balance difficult to obtain.

CHAPTER III

HIGH VOLTAGE TESTS

High Voltage A.C. Tests. In Chapter I reference was made to alternating pressure tests applied to cables at the factory and after installation, and tables were given of the recognized test voltages for cables for various working pressures.

Every cable factory is equipped with an efficient plant capable of dealing with the widely-varying voltage and loading which routine testing involves. Voltage control is effected either by field control of the alternator supplying current to the transformers or by induction regulators. Whichever system of control is adopted, it must be such that the voltage increases are smooth and do not alter the wave form or frequency. Great attention is given to these features as well as to the wave form itself, which must conform as closely as possible to a pure sine wave, as frequently the same plant is used when measuring dielectric losses and applying the other special tests to cables.

If a pressure having a high amplitude factor (that is the ratio of the maximum voltage during the cycle to the R.M.S. value) is applied to a cable, injurious effects may result, detrimental to the life of the cable. In a pure sine wave voltage, this ratio is, of course, only $\sqrt{2}$. For the same reason attention should also be given to the form of voltage wave available when A.C. tests are imposed on cables after laying.

It is customary to express all A.C. pressure tests in R.M.S. values, and 50 cycles per second is the usual frequency adopted in Great Britain. In the U.S.A. 60 cycles is the standard testing frequency.

Although low and medium voltage V.I.R. cables used

for wiring lighting and power installations in houses and factories are subjected in the factory to the tests prescribed by the British Standard Specification No. 7 (see footnote* on page 12), it is not advisable to apply the full test pressure after installation because of the difficulties encountered in isolating connected apparatus ; a megger test will suffice.

A.C. testing pressures should never be suddenly switched on at their full value ; if this is done, dangerously high transient voltages may arise, depending upon the characteristics of the transformers and the capacitance of the cables under test.

Factory pressure testing plants are arranged for making either single-phase or three-phase tests, the latter being applied when the belt thickness of the dielectric of three-core cables is reduced to the values marked E for earthed neutral operating in Table F of the Appendix. If V is the pressure applied between phases or conductors during a three-phase test, the pressure between phases and earth or lead sheath will be $V/\sqrt{3}$. In cables for working pressures of 3 000 volts and over between conductors, this is the standard test voltage as specified in the third column of Table I (Chapter I, page 18), so that one test fully stresses the cable if the lead sheath is earthed, and there is no need to make a separate single-phase test between conductors and earth.

Where the thicknesses of dielectric between conductors and conductors and lead sheath are uniform, however, as in a cable designed for unearthed neutral working, single phase tests are usually applied to each conductor in turn, with the remaining conductors earthed. Time can be saved by connecting any two conductors of a three-core cable to the transformer and earthing the remaining one, repeating this test by changing over conductors. In this way two tests stress all parts of the dielectric ; three tests are necessary if the cores are tested singly.

Table V on this page gives a summary of the various combinations of connections for the A.C. pressure testing usually employed for all ordinary types of power cables. Each test is usually of fifteen minutes' duration, and a study of the table will show that all parts of the dielectric in any type are stressed for at least this period, except for the 6-core split conductor cable.

The cores are designated by numbers in sequence rather than by the colour scheme, as there is considerable

TABLE V
METHODS OF CONNECTING CABLES FOR HIGH-PRESSURE TESTS

Type of Cable	Conductors Energized	Conductors Earthed	Number of Tests	Single-phase (1) or Three-phase (3)
Single.	Conductor	—	1	1
Concentric	Outer	Inner	1	1
Concentric*	Inner	Outer	2	1
	Outer	Inner		
Twin	1	2	2	1
	2	1		
3-core.	1	2 and 3	3	1
	2	1 and 3		
	3	1 and 2		
3-core†	1 and 2	3	2	1
	1 and 3	2		
3-core.	1, 2, and 3	—	1	3
4-core.	1 and 3	2 and 4	3	1
	2 and 4	1 and 3		
	1 and 2	4 and 3		
5-core.	1, 2, and 4	3 and 5	3	1
	2, 3, and 5	1 and 4		
	4, 2, and 5	1 and 3		
6-core‡	1, 3, and 2a	1a, 3a, and 2	2	1
	1a, 3a, and 2	1, 3, and 2a		

* Applied to H.T. concentric where outer is insulated only for earthed neutral working.

† Two tests can be considered adequate for practical purposes, as the conditions of working render faults between cores exceedingly improbable.

‡ Split-conductor cable.

non-uniformity in the latter, the colours according to the British Standard having not yet been universally adopted.

Except for three-phase tests it is not possible to stress all parts only once for the fifteen-minute period; the various combinations of connections make it unavoidable that some parts will be stressed twice or in the case of five-core cables thrice.

To avoid overloading the testing transformers (and also excessive pressures), the capacitances of cables under test should be known so that one may verify that conditions are safe. On page 47 the formula for the charging current is given. Under factory conditions, loading difficulties do not arise, as only a few drum-lengths need be tested in a batch, suited to the kVA. capacity of the transformers. In applying an A.C. test to a laid feeder, however, the cable length is not controllable, and the transformer must therefore be suited to the capacitance of the cable. Suppose, for example, that it were desired to apply 20 000 v. R.M.S. to a 0.15 sq. in. 11 000 v. three-core feeder $2\frac{1}{2}$ miles long. The capacitance of one conductor against the remaining two earthed is approximately 0.25 microfarad per 1 000 yd. or 0.44 microfarad per mile. The charging current per conductor of the feeder at 20 000 volts and 50 cycles would then be

$$\begin{aligned} I &= 3.14 \times 2 \times 50 \times 0.44 \times 2.5 \times 20\,000 \times 10^{-6} \text{ amp.} \\ &= 6.91 \text{ amp.,} \end{aligned}$$

and the transformer necessary to provide this current would have to be capable of an output of 138 kVA. at 20 000 volts. If the feeder had a working pressure of 33 000 volts, a much larger transformer would be necessary, something of the order of 1 000 kVA. for applying a test of twice the working pressure.

The large transformer sizes necessary to apply A.C. tests to long high tension feeders, has consequently led

to the general practice of applying D.C. tests (see pages 21 and 67). These are not, however, applied in the factory as a matter of routine.

When making A.C. tests, the voltage applied to the cable should always be measured by a high tension voltmeter connected directly to the cable end. The cable is almost a pure non-inductive load so that the charging current leads by almost 90° . The effect of this on the magnetizing current of the transformer is to increase the normal transformation ratio to such an extent that when the charging kVA. of the cable under test approximates the kVA. rating of the transformer, this increase can be as much as 25 per cent. Thus it will be seen that, if the pressure applied to the cable is calculated from a measurement of the primary pressure multiplied by the normal transformation ratio there is a considerable risk of applying an excessive voltage to the cable.

A cable can be seriously damaged by the application of an excessive testing pressure, and the effect may not be apparent until the cable has been in service for some time, unless dielectric loss tests are made. In extreme cases this injury takes the form of a partial burning of the insulating papers in fine irregular tracks like branches of a tree; its occurrence is usually associated with the presence of air between the layers of the dielectric. Excessive pressure may also cause partial disintegration or movement of the insulating oil which will likewise shorten the life of the cable.

There are risks of injury if normal A.C. testing pressures are applied for too long a time or repeated frequently. On the other hand, there is no evidence in existence that D.C. testing pressures, within the limits of accepted practice, produce any of these undesirable effects.

Fig. 26 illustrates an electrostatic high tension voltmeter suited to factory or outdoor use. Fig. 27 shows its principle, which is very simple, the working parts being

few. A and B are mathematically formed electrodes supported on insulators giving a uniform electrostatic field between them. One is connected to the transformer H.T.

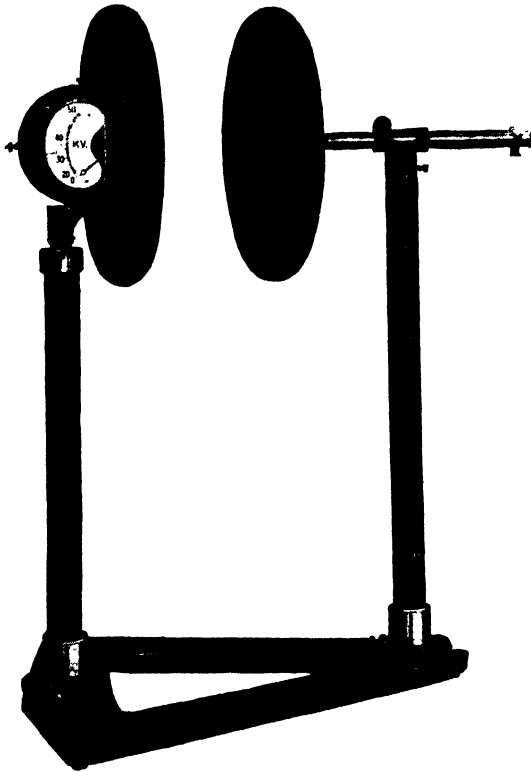

FIG. 26. EVERETT-EDGCUMBE E.H.T. VOLTMETER

terminal and the other to earth ; it is immaterial which. In the centre of A a movable disc C is suspended by means of suspension springs from E and F, secured to the arm J. D is an air dash-pot. An arm K works on a cranked pin pivoted at G. C being electrically connected to A, the

effect of the field between the two main electrodes is to attract C towards B, turning the cranked pin about G to which the pointer shown dotted is attached.

The position of electrode B is adjustable, and its supporting arm is marked at three or four positions, which vary the gap d , giving a corresponding number of ranges for the instrument. The usual ranges are 0 — 40 000 v. in three ranges; 0 — 60 000 v. in three ranges; 0 — 120 000 v., and 0 — 200 000 v. in four ranges. When used for outdoor testing, the instrument must be shielded from the wind, as it affects the movement.

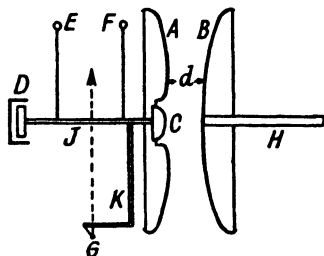

FIG. 27. DIAGRAM OF
EVERITT-EDGCUMBE E.H.T.
VOLTMETER

Before making high pressure tests to installed cables, the operator should carefully verify that power transformers, potential transformers, switchgear, and all other apparatus is disconnected. With some types of switchgear, however, it is not possible to isolate all parts entirely because current transformers are sometimes accommodated in the cable sealing chambers, and bus bars in compound filled chambers may be solidly connected to the cable. One would never consider breaking open the sealing end of a cable to isolate the latter for a pressure test. Apparatus thus inseparably connected to the cable must therefore be tested with it.

Switchgear manufacturers usually make such parts suitable for withstanding pressure tests for the period of 15 minutes prescribed for cables, although normally the standard tests for switchgear are of one minute duration only.

When disconnecting the windings to clear for test

cables terminated at a transformer in a sealing chamber integral with the transformer, ample clearances under oil should be allowed to prevent a flash-over to the windings. A good working rule is 1 in. for every 10 000 volts. All low tension transformer windings, instrument wires, and meters appertaining to apparatus, parts of which may be inseparably connected to the cable under test, should be earthed during the test whether the latter is A.C. or D.C., to prevent them acquiring a high voltage charge, which might produce a small fault not immediately apparent.

In the factory, pressure tests are usually carried out in an enclosure which is locked against access to all unauthorized persons while tests are in progress. As an additional safeguard, a gate contact on the door to the enclosure is sometimes provided, operating a no-volt release, which trips the switch in the testing room if the door is opened before the test operator has switched off. When testing installed cables, further precautions have to be taken. All persons ordinarily having access to the apparatus to be tested should be notified in writing when the test will take place, and acknowledgments of receipt of the warning should be obtained from each. Keys of substations housing apparatus made alive during tests should be withdrawn from all persons not warned, and kept in possession of the person responsible for the test until its completion. He should also be in possession of a written certificate that all apparatus is dead and earthed before touching any part. In a complex system, the risk of a feed back from an L.T. system such as was described in the introductory chapter may exist, so that it is essential that the person responsible for making the cable or apparatus dead should be thoroughly conversant with the system.

When there is possibility of access by unauthorized

persons which is not preventable by the means already described, for instance during constructional work in sub-stations, effective barricades should be placed around danger areas and conspicuous "DANGER" notices fixed thereto. The posting of look-out men is also desirable.

On completion of a D.C. test, the cable and connected

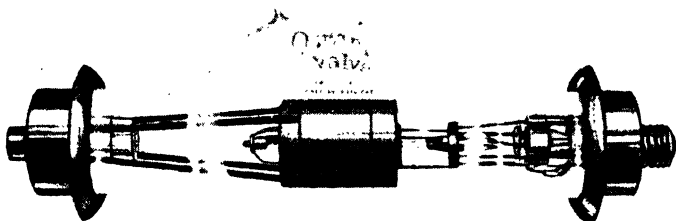

FIG. 28. OSRAM E.H.T. VALVE

apparatus should be effectively earthed for a sufficient period to avoid the reappearance of a dangerous charge through the effects of absorption.

HIGH VOLTAGE D.C. TESTS

The Principles of Rectifying Valves. As the rectifying valve is the most essential part of a D.C. testing equipment, its characteristics will first be briefly considered. Several types of valves are available rated at various filament and anode voltages and currents. Figs. 28, 29, and 30 show examples. Their principal characteristics are given in Table VI.* From what will be said later, it will be seen that these valves can be used for testing pressures of half the "reverse potentials."

* It should be noted that some of these valves may no longer be obtainable under war and post-war conditions and that it may be necessary to use alternatives with slightly different characteristics.

The Kenotron is the American name for the thermionic valve.

The basic principle of the hot cathode valve, which is the type in question, is that the highly-evacuated space within the bulb possesses a unidirectional conductivity.

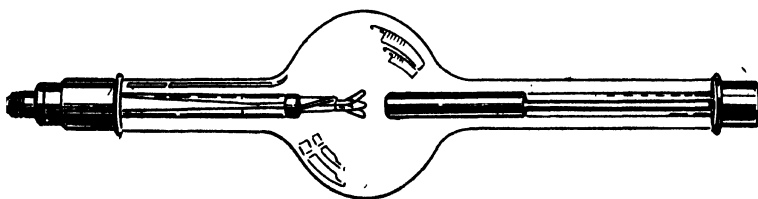

FIG. 29. PHILIPS TYPE K 220 VALVE

In this high vacuum a stream of electrons flows from the hot cathode to the cold anode when an E.M.F. is applied. If this is alternating, current can only pass when the



FIG. 30. PHILIPS METALIX E.H.T. RECTIFYING VALVE

heated filament is negative. The magnitude of this current depends upon the temperature of the filament and it has a finite maximum for a given filament temperature. If currents in excess of this maximum are forced through the valve by increasing the impressed E.M.F., heating of the anode occurs causing it to give off occluded gases which tend to destroy the vacuum.

When passing currents of 10 milliamperes or more, careful observation of the anode should be made. If it tends to become red hot, the filament current must be increased if permissible, but not beyond the maximum value given by the makers, or the valve will be ruined.

TABLE VI
RECTIFYING VALVE CHARACTERISTICS

Maker and Type of Valve	Filament		Maximum Anode Emission	Reverse Potential
	Max. V	Max. I		
	Volts	Amperes	Milliamps	
Philips "Metalix"				
M.125	17	8.5	1 200	125 kV
M.160				160 kV
M.200				200 kV
Philips "K" series				
K.125	14	8.2	550	125 kV
K.160	14	8.2	400	160 kV
K.220	14	8.5	400	220 kV
G.E. Co. series				
No. 1	17	10.0	200	80 kV

When breaking down a fault (see pages 150 and 205) special attention must be given to this matter.

Sometimes it may be observed that a bluish fluorescence or flickering occurs in the valve. This is usually a symptom of loss of vacuum with which a tendency towards a low rectification factor is often associated, and, although in these circumstances a valve may operate satisfactorily on small emission current, its useful life for larger currents can be considered at an end.

No definite figures can be given for the life of valves. So much depends upon the make and usage. With careful use, any of the makes given in the table will give years of good service under the ordinary requirements of outside testing conditions. To ensure long life, the filaments should not be operated at their maximum voltages or currents unless heavy anode currents are demanded. Also the filaments should not be kept burning unnecessarily as they disintegrate with time in much the same way as in an ordinary incandescent electric lamp.

Some makers recommend that the filament current be

checked by an ammeter, others by a voltmeter. Those who advocate the latter consider that the gradual reduction of the filament volume, with continued use caused by emission, leads to overrunning if a constant current is worked to, although experience indicates that either instrument can be safely used in practice with a good make of valve. Indeed, for normal cable tests extreme exactitude in setting the filament current is hardly necessary, provided one avoids excessively high or low filament currents.

Nevertheless, it must be remembered that the emission of the filament of the highly evacuated valve is purely thermionic and, therefore, attention must be given to the filament current setting.

In the latest development of rectifying valves, the passage of current between the anode and cathode is initiated by "collision ionization" in a low pressure inert gas medium. This is called the gas-filled valve, and its filament is of the oxide-coated dull emitter type, having a very low watt consumption. The emission is very nearly independent of the filament heating current. Once the gas has been ionized, any current within the capacity of the valve can be passed, even when the filament heating current falls considerably.

The Philips valve shown in Fig. 31 is an example of this type of valve. The filaments may be heated from a two or four-volt battery, and the maximum current is about four amps. Filament current controlling rheostats are not necessary. The voltage drop across the electrodes is of the order of 50 volts only, and anode cooling devices are not required as the energy dissipation is only about 50 watts.

A further improvement introduced into the construction of the gas-filled valve is a series of annular condensers surrounding the glass tube, which produce a uniform potential gradient along the glass tube and thus minimize

the risk of puncture. The ordinary valve is subject to failure through puncture of the glass when operated at a high stress on a fluctuating load.

The annular projections on the body of the valve in Fig. 31 are the condensers referred to. This type of valve is manufactured for reverse tensions of 125 and 160 kV, and will pass currents up to one ampere.

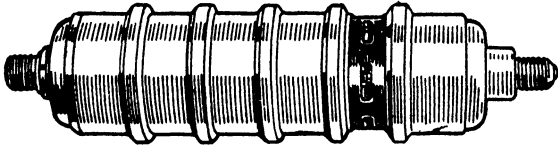

FIG. 31. PHILIPS TYPE G 125 RECTIFYING VALVE

It has been shown on page 62 that heavy charging currents are required for A.C. tests on a long length of cable. With D.C. we are not concerned with charging currents except during the period of building up the voltage on the cable, control of which is simple. The only current to be catered for in a D.C. test is that which leaks through the dielectric of the cable with the possible addition of a small corona loss and slight leakage on the apparatus itself. A cable, say, three miles long and having a dielectric resistance of, say, 500 megohms per mile, when tested at 30 000 v. D.C. would pass a leakage current of approximately 0.2 milliampere, or the energy required for the test is of the order of six watts. Since ordinarily the energy to be provided for is only a few watts as compared with hundreds of kVA possibly when considering an A.C. test, the apparatus required for D.C. cable tests can be comparatively light and easily transportable. For cable testing, a transformer capacity of 2 kVA meets all practical requirements, but long lengths of overhead lines may require a transformer up to 10 kVA when tested during wet weather, or if located near the sea.

The simplest arrangement for applying a D.C. test is shown in Fig. 32. The filament F of a hot cathode rectifying valve V is incandesced by the secondary winding S_1 of a filament transformer T_1 , the primary Pr_1 of which is controlled by a rheostat R_1 . An H.T. step-up transformer

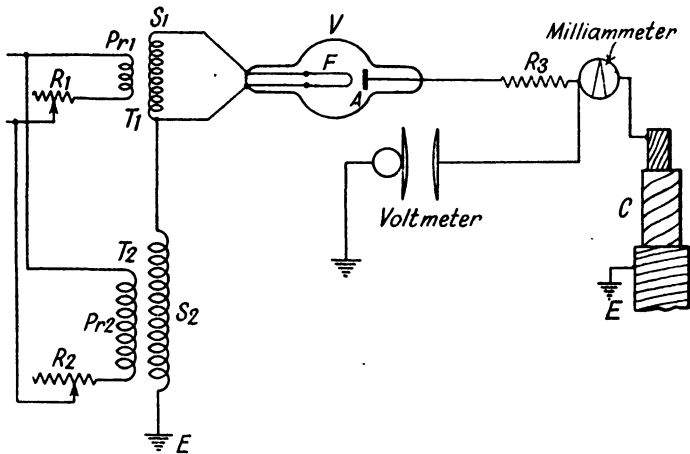

FIG. 32. CONNECTION FOR H.T. D.C. TEST WITH RECTIFYING VALVE

T_2 has one side of its H.T. winding S_2 connected to the filament F and the other to earth E . The secondary voltage is controlled by the rheostat R_2 in the primary winding Pr_2 . C represents the cable connected to the anode A of the valve through a resistance R_3 of the order of four or five ohms per volt, whose function is to smooth out voltage ripples, to limit the current during the charging period, and to protect the valve against short circuits.

A milliammeter records the current leaking through the dielectric. If it is not convenient to connect this to the high voltage side as shown, it may be connected between the low voltage end of S_2 and earth, but in this case it records the leakage currents to earth through the

secondary windings of T_1 and T_2 in addition to the leakage through the cable dielectric.

In Fig. 32 the secondary winding of T_1 will be at the high-tension potential of T_2 , and it must therefore be insulated to withstand the high voltage. Filament transformers are specially made for such conditions. With connections as shown, a negative charge will be imparted to the cable. If the source of current for heating the valve filament cannot be suitably insulated, the earth point in the H.T. circuit can be transferred to the valve filament, in which case the high tension terminal of T_2 shown earthed would be connected to the cable via R_3 instead, and the cable will be given a positive instead of a negative charge. This arrangement is not desirable, however, as owing to electro-osmotic action tending to bring any moisture present in the dielectric to the negative pole, the test with a negatively-charged cable is the more severe and is the one conventionally adopted. A storage battery mounted on an insulated stand can be used instead of the filament transformer T_1 , but it should be of sufficient capacity to give, say, two hours' steady supply to the filament.

When T_2 is excited, the valve will pass a succession of negative parts of the waves of the alternating E.M.F. Each half wave imparts a charge to the cable depending upon its capacitance, which, provided that the leakage when no current is passing is not too great, causes the potential of the cable to build up gradually until it is practically equal to the peak value of the source of supply.

Referring to Fig. 33, the alternating E.M.F. is shown with the negative half cycles (that is those which the valve passes) in full lines and the positive half cycles dotted. At zero time, or at the commencement of the first negative half cycle after switching on, the cable begins to charge. The resistance R_3 , Fig. 32, and the capacitance of the cable will usually prevent the acquisition by the

cable of the full potential of the first half wave. Suppose it assumes a potential of v_1 when the peak of this half wave is reached; no further current can pass into the cable, but it begins to lose its charge at a rate depending upon the insulation resistance, until the voltage of the succeeding negative half wave is the same as that to which the cable charge has fallen, that is at the point a , Fig. 33,

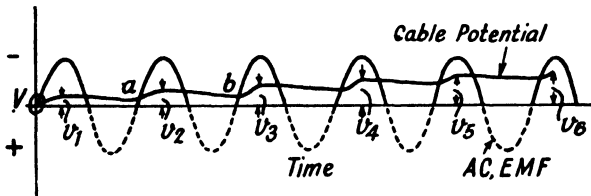

FIG. 33. DIAGRAM OF WAVE RECTIFICATION AND CABLE CHARGE

when a further charge is imparted between this and the instant of peak voltage of the second half-wave, increasing the cable potential to v_2 . Again, after the peak voltage is reached, the charge tends to leak away until the cable potential and that of the ascending part of the third negative half wave are coincident as at b , when a still further charge is imparted to the cable, and so on until steady conditions obtain, when the cable voltage will very closely approximate the A.C. peak voltage, after which the only current taken through the valve is that necessary to make good the leakage loss during the idle periods. It follows from Fig. 33 that during these idle or non-charging periods the voltage between the filament and anode of the valve is very nearly twice the peak value of the A.C. voltage. This is known as the reverse voltage on the valve. Makers usually define the voltage rating of a valve by this term as in Table VI on page 69.

An approximate mathematical investigation follows

from which the number of cycles, and consequently the time necessary to charge the cable fully under given conditions, can be approximately determined. For simplicity, the cable constants are not considered as distributed; at 50 cycles per sec. the attenuation of power cables of moderate length is negligible.

In Fig. 34 let R_3 be the high protective resistance,

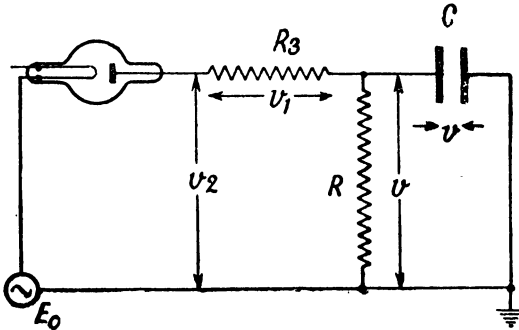

FIG. 34. THEORETICAL DIAGRAM: C REPRESENTS CABLE CAPACITANCE, R CABLE LEAKAGE RESISTANCE, R_3 PROTECTIVE RESISTANCE

E_0 the peak value of the source of alternating current assumed to be a pure sine wave, C the capacitance of the cable, and R its leakage resistance. v_2 and v_1 and v are the instantaneous voltages in the various parts of the circuit as indicated.

The current passing through R_3 is

$$\frac{v_1}{R_3} = \frac{v_2 - v}{R_3}$$

The currents passing through C and R are $C \frac{dv}{dt}$ and $\frac{v}{R}$ respectively.

As the current through R_3 is the sum of the currents through C and R we have

$$\frac{v_2 - v}{R_3} = C \frac{dv}{dt} + \frac{v}{R}$$

but v_2 is the impressed voltage which during the charging half cycles can be expressed by

$$v_2 = E_0 \sin \omega t,$$

where ω is 2π times the frequency.

$$\text{Hence } \frac{dv}{dt} + \frac{1}{C} \left(\frac{1}{R_3} + \frac{1}{R} \right) v = \frac{E_0}{CR_3} \sin \omega t \quad . \quad (6)$$

The solution of this equation is

$$v = \frac{E_0}{CR_3} \left[\frac{\frac{1}{BC} \sin \omega t - \omega \cos \omega t}{\left(\frac{1}{B^2 C^2} + \omega^2 \right)} \right] + A e^{\frac{-t}{BC}} \quad . \quad (7)$$

where

$$\frac{1}{B} = \frac{1}{R_3} + \frac{1}{R}$$

A is a constant, and e is the base of Napierian logarithms.

When $t = 0$, $v = 0$, whence

$$A = \frac{E_0 \omega}{CR_3 \left(\frac{1}{B^2 C^2} + \omega^2 \right)} \quad . \quad . \quad (8)$$

If T is the periodic time of the A.C. voltage, then when $t = \frac{T}{4}$, the value of v at the end of the first quarter cycle is obtained by substituting this value for t in (7) and (8); that is

$$v = \frac{E_0 (1 + BC\omega e^{\frac{-T}{BC}})}{(1 + B^2 C^2 \omega^2)} \cdot \frac{B}{R_3} \quad . \quad . \quad (9)$$

Equation (9) gives the value of v at the end of the first quarter cycle. If R is large compared with R_3 , equation (9) becomes

$$v = \frac{E_0 (1 + R_3 C \omega e^{\frac{-T}{BC}})}{(1 + R_3^2 C^2 \omega^2)} \quad . \quad . \quad (10)$$

During the remainder of this cycle, that is over a time $\frac{3}{4}T$ seconds, the potential of the charge falls at the end of the cycle to

$$v_T = ve^{\frac{-3T}{4RC}} \quad . \quad . \quad . \quad (11)$$

The cable will not charge during the whole of the first quarter of the second cycle, but only from the time when the impressed voltage is v_T until the peak value of E_0 is reached, that is for a time period equal to

$$\frac{T}{4} - \frac{T}{2\pi} \sin^{-1} \frac{v_T}{E_0}$$

while the time during which loss of charge occurs will also be successively greater with each ensuing half cycle, approaching T as the cable becomes fully charged. Therefore, when v_1 approaches E_0 , the charging time interval becomes very short, for the above expression shows that each successive cycle imparts a lower charge than its predecessor to the cable. As an approximation, let it be said that the average charging period per cycle from the moment of switching on to the acquisition of full charge by the cable is $\frac{T}{8}$. Let the assumption also be made that

during every such period the voltage increment of the cable charge is accordingly half that given by equation (9). On these assumptions, the number of periods n necessary to build up the charge in the cable to a voltage approximating the peak value of E_0 is

$$n = \frac{2R_s(1 + B^2C^2\omega^2)e^{\frac{3T}{4RC}}}{B(1 + BC\omega e^{\frac{-T}{4RC}})}$$

The time in seconds required to charge the cable is

obtained by dividing this expression by the frequency, whence assuming this to be 50 cycles,

$$\text{Charging time} = \frac{2R_3(1 + B^2C^2\omega^2)e^{\frac{3T}{4RC}}}{50B(1 + BC\omega e^{\frac{-T}{4BC}})} \quad (12)$$

There is a critical value for $e^{\frac{-3T}{4RC}}$ because, if it is very small, the charging period of the impressed voltage wave as the slope decreases towards the peak is insufficient to make good the loss during the non-charging period after a certain voltage is imparted to the cable. The result is that the latter, although unidirectional, will be rippled. In the extreme, when practically the whole of the imparted charge is lost during the non-charging periods, no potential can be built up in the cable. This is the fault condition.

It is desirable that the ripples in the cable charge do not exceed 5 per cent, or from equation (11)

$$\frac{v_T}{v} = \frac{95}{100} = e^{\frac{-3T}{4RC}}$$

Assuming that the frequency is 50, $T = 0.02$, whence,

$$\log \frac{100}{95} = \frac{3}{4} \times 0.02 \times \frac{1}{RC} \times 0.434$$

or $RC = 0.292$.

Fig. 35 shows the relation between the product RC and the percentage variation in the cable charge voltage. If R is expressed in megohms and C in microfarads the product is the same as if they were expressed in ohms and farads respectively.

When overhead lines are tested under adverse weather conditions, one cannot avoid the application of a pressure having ripples exceeding the above value. Under these conditions it is advisable to disconnect any cable in the

line and test it separately. Further mention is made of this matter following Example III.

Example I. Consider, say, 10 miles of 33 000 v. cable having a capacitance of 0.5 microfarad per mile and a dielectric resistance of 500 megohms per mile. R_3 should be about 0.5 megohm in this case. The constants will be as

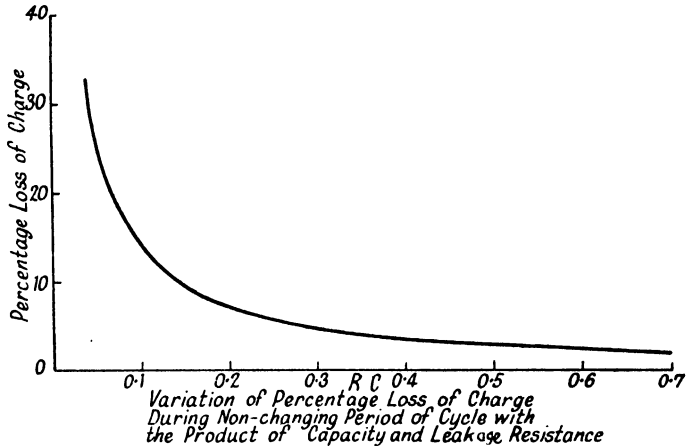

FIG. 35

follows, assuming the frequency of supply to be 50 cycles per second.

$$R_3 = 5 \times 10^5 \text{ ohms}$$

$$R = 5 \times 10^7 \text{ ohms}$$

$$T = 0.02 \text{ second}$$

$$\omega = 314$$

$$C = 0.5 \times 10^{-5} \text{ farads}$$

$$CR = 2.5 \times 10^2$$

$$B = 5 \times 10^5 \text{ (very nearly)}$$

From formula (12) the charging time for a given steady value of E_0 is about 31.4 seconds. (Note the indices with the above constants are very small, so that the exponential

factors are practically unity.) This does not mean that the cable can be fully charged in this time to the desired pressure, which for this particular cable would be 66 000 volts, because if the full necessary A.C. pressure were applied the initial charging current would be so large that damage to the apparatus would be probable. In practice, therefore, the H.T. transformer excitation is increased gradually to keep the cable-charging current within reasonable limits. More will be said on this matter later.

Example II. Let us now take the case of two miles of 11 000 volt cable for which R and C are of the order of 10^8 ohms and 10^{-6} microfarads respectively. Writing down the constants as before,

$$\begin{aligned} R_3 &= 10^5 \text{ ohms} \\ R &= 10^5 \text{ ohms} \\ T &= 0.02 \text{ second} \\ \omega &= 314 \\ C &= 10^{-6} \text{ farads} \\ CR &= 10^2 \\ B &= 10^5 \text{ (nearly)} \end{aligned}$$

Again in formula (12) the indices are very small and the exponential factors are unity. N is therefore 61 cycles, whence the time for the cable charge to become steady is 1.22 seconds.

Example III. Taking a couple of miles or so of overhead line during bad weather conditions when the insulation may fall as low as 10^5 ohms, let the constants in this case be

$$\begin{aligned} R_3 &= 10^5 \text{ ohms} \\ R &= 10^5 \text{ ohms} \\ T &= 0.02 \text{ second} \\ \omega &= 314 \\ C &= 10^{-8} \text{ farads} \\ CR &= 10^{-3} \\ B &= 0.5 \times 10^5 \end{aligned}$$

The indices for the numerator and denominator exponentials are now large, so that these factors are important. From formula (11) the ratio of the line potential at the beginning of the second charging period to that at the end of the first is

$$e^{-15} = 3.05 \times 10^{-7}$$

that is the whole of the charge is virtually lost during the non-charging period.

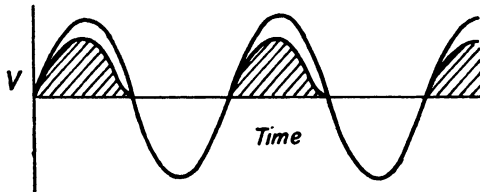

FIG. 36. EFFECT OF LOW INSULATION ON CHARGING VOLTAGE

The voltage recorded by a voltmeter attached to C in Fig. 34 would be the average due to a series of sharp peaks as shown in Fig. 36 shaded, which would be very much lower than the peak voltages and therefore no guide as to the maximum potentials impressed upon C. In actual practice there is a probability that the circuit under test would be sufficiently inductive to make the discharges during the non-charging periods oscillatory, so that a series of damped oscillations would be imposed instead of a unidirectional voltage. Under these conditions a D.C. test would be considered impracticable.

In Example III, CR is very much below the desired value of 0.28, although for tests on overhead lines which have no cables connected thereto a larger ripple than that given by this value for CR can be permitted.

The initial current i necessary to charge the cable, apart from the leakage current through the dielectric, is

$$i = -C \frac{dv}{dt}$$

This will be at a maximum at the moment of switching on, decreasing until the maximum value of the first charging cycle is reached, attaining a slightly lower initial value at the commencement of the next charging cycle, and so on. The exact form of the time-current curve during the whole charging period is too complex to calculate, and is in fact of no practical interest. What is more important is that it should be kept within a reasonable limit. The following is a guide to the value of the initial current for given impressed voltage increments.

The average value of i during the charging period of the first cycle is

$$\bar{I} = \frac{4C}{T} \int_0^T \frac{dv}{dt} dt = \frac{4C}{T} \left[\frac{v}{0} \right]$$

from (7)

$$v = \frac{E_0 B}{R_3(1 + B^2 C^2 \omega^2)} \left\{ \sin \omega t - BC\omega \cos \omega t + BC\omega e^{\frac{-t}{BC}} \right\}$$

That is

$$\bar{I} = \frac{4CBE_0}{TR_3(1 + B^2 C^2 \omega^2)} \left[\frac{1}{4} \sin \omega t - BC\omega \cos \omega t + BCe^{\frac{-t}{BC}} \right]$$

whence

$$\bar{I} = \frac{4BCE_0(1 + BC\omega e^{\frac{-T}{BC}})}{TR_3(1 + B^2 C^2 \omega^2)} \quad \dots \quad (13)$$

From equations (12) and (13), calling the charging time τ ,

$$I = \frac{8CE_0 e^{\frac{3T}{4BC}}}{\tau} \quad \dots \quad (14)$$

Applying formulae (13) and (14) to Example I, the mean initial charging current is $1.28 \times 10^{-3} E_0$ milliamperes.

A reasonable maximum charging current during the charging period is five milliamps, to obtain which E_0 should be

$$\frac{5}{1.28 \times 10^{-3} \times \sqrt{2}} = 2\,760 \text{ R.M.S. volts.}$$

As the leakage component is very small, being only 1.3 milliamperes at 66 000 volts D.C. on the cable, its influence on the charging current during the charging period can be ignored; there will be a very small ripple in the final steady voltage, hence the R.M.S. value of the impressed voltage will be very nearly $\frac{66\,000}{\sqrt{2}}$ or 46 600 volts when the cable is fully charged.

We may say that each voltage increment of 2 760 volts will produce an initial charging current of five milliamperes; therefore, to avoid exceeding this current, $\frac{46\,000}{2\,760}$ voltage increments will be needed to obtain 66 000 volts D.C. on the cable, that is, say, 17 stages. We have previously calculated that 31.2 seconds elapse before the cable voltage equals the peak value of the impressed voltage wave, therefore the time necessary to charge the cable fully is of the order of $31.2 \times 17 = 528$ seconds, say nine minutes, which is approximately the time taken in actual practice with such a cable.

In Example II, the initial charging current is similarly found to be of the order of $6.55 \times 10^{-3} E_0$ milliamperes. This also gives a leakage component, which can be ignored during the charging period, viz. 0.3 milliamperes, when a steady voltage of 30 000 volts D.C. is maintained on the cable. Confining the maximum charging current to five milliamperes as in Example I, the voltage increment corresponding to this current is approximately

$$E_0 = \frac{5}{6.55 \times 10^{-3} \times \sqrt{2}} = 540 \text{ R.M.S. volts}$$

Again assuming that the cable charge approaches the peak voltage of the impressed voltage, the number of increments necessary to reach the full testing pressure of 30 000 volts D.C. on the cable is $\frac{30\ 000}{540 \times \sqrt{2}} = 39$.

As τ was found to be about 1.22 seconds, about 48 seconds would be required to charge the cable under the conditions prescribed.

Conditions are quite different in Example III. If formula (13) is applied \bar{I} is found to be of the order of $E_0 \times 10^{-3}$ milliamperes. The leakage current through the dielectric, which is not taken into account in formula (13), is the quotient of the average value of the impressed voltage v_2 over a half cycle and R , that is $0.636 E_0 \times 10^{-2}$ milliamperes which is over six times greater than the capacity current. If it was possible to attain a steady charge on the line of 10 000 volts (average in this case) the leakage current would be 100 milliamperes and the energy passed by the valve of the order of 1 kilowatt. It has previously been stated, however, that a D.C. test with the above line constants would not be practicable, as the entire charges imparted during the negative half cycles of the transformer would be lost during the positive half cycles, as indicated by the shaded areas in Fig. 36.

The calculations applied to Examples I and II are only intended to be indicative of what may be expected in practice. They show that, for a moderate capacitance and high insulation, the cable can be charged in a minute or so, but a higher voltage and a larger capacitance may require several minutes to accomplish full charge. The actual time taken to charge a cable fully is dependent upon the rate at which the primary voltage of the high tension transformer is increased; if this is done continuously so as to keep the charging current during the charging period steady at, say, three to five milliamperes the calculated

times of charging would be somewhat reduced, but dielectric absorption, which the calculations do not take into account, has a retarding effect, being more noticeable as the cable capacitance increases. Dielectric absorption also makes it necessary to reduce the high tension transformer excitation gradually for a few minutes after the desired testing pressure is reached, to counteract the tendency of the pressure to creep upwards. It is well known that with the application of a steady potential to a cable, the dielectric resistance increases with time; in the valve test this means that the leakage current decreases with time, and so the cable charge continues to approach the peak value of the transformer voltage. The longer the time spent in charging up the cable, the less will be the tendency for the voltage to "creep" when the desired pressure is reached. It follows from these statements that one cannot expect to produce rapid changes in the cable voltage. Several minutes may be necessary to make the small final adjustments to obtain the desired pressure on long lengths of cable.

It is bad practice to attempt to charge a long cable too quickly, as the effects of the distributed capacitance and resistance, which the mathematical analysis has not taken into account, may give rise to undesirable transient voltages.

It will be appreciated that the relationship between the transformer secondary voltage and the voltage which the cable attains is dependent upon the leakage. The theoretical maximum of the cable voltage with a true sine wave and a single valve is $\sqrt{2}$ times the R.M.S. value of the transformer voltage. When leakage is heavy, this figure may become unity. It is thus never advisable to calculate the cable voltage from the product of the primary transformer voltage and the transformer ratio. An electrostatic voltmeter, preferably of the type shown in

Fig. 26, should be connected to the cable so as to record the voltage directly. It is obvious that no wound type of instrument can be used because the resistance of the windings would constitute a virtual short circuit.

Provided leakage is negligible and that the insulation of a cable is of the order of 100 megohms or more, the current settles down after steady conditions are reached to a value commensurate with the insulation resistance of the cable measured in the ordinary way; by a megger, for example. It may be said that the quotient of leakage current into the testing pressure gives a value for the insulation resistance of the same order as that obtained by low-voltage methods, and, as in the latter methods, electrification or dielectric absorption makes itself evident in the high-voltage D.C. test.

INSULATION RESISTANCE AT HIGH VOLTAGE

At D.C. pressure testing voltages, this may be deduced by the loss of charge method, provided that precautions are taken to prevent end leakage and loss over the testing apparatus, which is best done by a well-insulated isolating switch between the cable end and the apparatus, arranged so that the voltmeter is left connected to the cable end.

If V represents the testing pressure at the moment of isolating the cable, its potential is also V . Let V_1 be the potential after a time T has elapsed, and v the potential at any instant t . The rate of loss of charge is equal to the current flowing through the dielectric, or

$$-\frac{dq}{dt} = -C \frac{dv}{dt} = \frac{v}{R}$$

where q is the quantity of the cable charge, and R the dielectric resistance; whence,

$$\frac{dv}{dt} = -\frac{v}{CR}$$

The solution of this is

$$v = Ae^{\frac{-t}{CR}} + B$$

A and B being constants.

When $t = \infty$, $v = 0$; and when $t = 0$, $v = V$.

$$\therefore v = Ve^{\frac{-t}{RC}}$$

whence
$$t = CR \log_e \frac{V}{v} \quad (15)$$

Therefore if the charge falls from V to V_1 in a time T secs.

$$R = \frac{T}{2.303 C \log \frac{V}{V_1}} \quad (16)$$

The value of R will be found to vary with time, again because of the effect of dielectric absorption. This method gives a better result than the quotient of the leakage current and voltage, because the former includes leakage on the apparatus and the instrumental reading is usually very small. It is seldom applied, however, as the results have little practical value.

DISCHARGING AFTER TEST

When the A.C. voltage is switched off, the cable becomes an insulated condenser, whether or not the valve filament remains incandesced. The time of discharging by dissipation through the dielectric is infinite from equation (15). With the constants given in Example I, page 79, the time required for the voltage to fall 50 per cent is

$$\begin{aligned} t &= 5 \times 10^{-6} \times 5 \times 10^7 \times 2.3 \log 2. \\ &= 173 \text{ secs.} \end{aligned}$$

or nearly three minutes, while in 19 minutes it would fall by 99 per cent or to 300 volts. But absorption would tend to retard the rate of loss of charge, so that one can hardly afford the time for a cable to discharge itself after a test.

In practice, therefore, after allowing the charge to fall for two minutes or so, the cable is earthed through a high resistance, afterwards being solidly earthed and kept so during the change-over of connections. On completion of the test, the cable should be left effectively earthed for several hours, for absorption will cause the reappearance of a charge sufficient to impart a dangerous shock if earthing is only maintained for a few minutes.

A cable should not be directly earthed immediately after switching off on completion of a test. It possesses sufficient inductance to give rise to undesirable oscillatory voltages if this is done. A 0.2 sq. in. 33 000 volt cable would have an inductance of about 0.5 millihenry, a capacitance of about 0.5 microfarad per mile. The discharge of a condenser is oscillatory if the discharging resistance is less than $\sqrt{\frac{4L}{C}}$ where L is the inductance of the discharging circuit; so, regarding the resistance and capacitance as non-distributed, if this cable is discharged through a resistance R less than 63 ohms an oscillatory disturbance results, the frequency being

$$\frac{1}{2\pi} \sqrt{\frac{1}{LC} - \frac{R^2}{4L^2}}$$

Allowing for earth resistance, if R is represented by 1 ohm say, on directly earthing the cable the frequency of the oscillatory discharge will be of the order of 10 000 cycles per second for a mile length of cable.

The expression for determining the value of an oscillatory discharge current is

$$i = \frac{V}{\beta L} e^{-\frac{Rt}{2L}} \sin \beta t \quad (17)$$

where

$$\beta \text{ is } \sqrt{\frac{1}{LC} - \frac{R^2}{4L^2}}$$

If in the case just considered R is 63 ohms, the discharge is instantaneous and the current is theoretically infinity; actually it would momentarily be very large. This expression for i consists of two parts: the exponential factor which decides the time taken to discharge the cable and the oscillatory factor $\sin \beta t$ which determines the frequency. As e^{-5} is numerically 0.00673 it can be said that

when $\frac{Rt}{2L} = 5$ the charge is, to all practical purposes, fully dissipated.

In the following table values of the short circuiting resistance R are assumed for a mile of 33 000-volt cable with inductance and capacitance as stated previously, from which the time of discharge T (column 4), the frequency of discharge (column 6), and the value of the instantaneous current at the crest of the first oscillation (column 7) are calculated from formula (17). Column (5) is the value of the exponential factor in formula (17), when $\beta t = \frac{\pi}{2}$, that is, when the first wave crest is reached.

The cable is considered to be charged at 66 000 volts.

(1)	(2)	(3)	(4)	(5)	(6)	(7)
R	β	$\frac{V}{\beta L}$	T sec.	$e^{-\frac{Rt}{2L}}$	Frequency	Max. Current Amps.
1	6.32×10^4	2 090	5×10^{-2}	0.975	1.006×10^4	2 035
10	6.24×10^4	2 120	5×10^{-4}	0.777	0.993×10^4	1 640
20	6.00×10^4	2 200	2.5×10^{-4}	0.592	0.955×10^4	1 300
30	5.57×10^4	2 370	1.67×10^{-4}	0.429	0.887×10^4	1 017
40	4.90×10^4	2 700	1.25×10^{-4}	0.277	0.780×10^4	748
50	3.86×10^4	3 420	1.00×10^{-4}	0.1315	0.616×10^4	450
60	2.00×10^4	6 600	0.83×10^{-4}	0.0091	0.319×10^4	60

The product of the time of discharge and the frequency is a measure of the number of oscillations which occur in effecting the virtual discharge of the cable (theoretically they are numerically infinite).

The maximum currents are heavy, but they are, of course, of an immeasurably small time duration. The attenuation, however, is large when R is more than 10 ohms.

These figures are intended to convey some idea of what happens when a charged cable is discharged by directly connecting it to earth. They also illustrate the nature of disturbances occurring when a discharge occurs through a fault during the process of breaking down, should the resistance of the fault fall below the critical value necessary for oscillatory conditions. In this circumstance, if there is no resistance between the valve and the cable, the second half cycle of the discharging transient will dissipate the remainder of the cable charge through the valve and the transformer secondary winding, the combined impedance of which will be high enough to make the current unidirectional and relatively small. The inclusion of the resistance between the valve and filament will still further reduce this current. This argument holds whatever the polarity of the cable charge, since the second half cycle of the first wave of the transient current must be in the direction in which the valve is conductive.

The resistance used for discharging the cable on completion of a test should never be so low as to approach the critical value for oscillatory conditions. It should be of similar value to that placed between the valve and the cable (R_3); in fact discharging is often effected by earthing R_3 (Fig. 34) on the side which is connected to the valve.

A yard or so of $\frac{1}{2}$ in. diameter rubber tubing filled with clean tap water, provided with rubber corks at each end, through which a short piece of heavy gauge copper wire can be threaded to form electrodes, makes a good discharging resistance for pressures up to 66 000 volts. Solid resistances of carbon or carborundum compounds such as "Silit" are very serviceable, being obtainable in

units about 6 in. long of 50 000 ohms each. At pressures above 100 000 volts they become troublesome through surface leakage and the heavier currents encountered are liable to shatter them.

A yard or so of moistened cotton tape is also an effective discharging resistance for pressures up to 66 000 volts.

Mr. J. Urmston has devised a discharging resistance consisting of a large number of washers of carbon-bearing paper about 1 in. in diameter built up on an insulating stem. A length of 18 in. will give a resistance of approximately a megohm and is quite suitable for discharging up to 150 000 volts.

The problem of discharging 132 000 volts cable after testing with D.C. at twice the working pressure is a very difficult one, by no means easily solved. Water jets have been tried where cables have terminated with outdoor porcelain insulators, but there are objections to this practice. Salt water spray mists have also been suggested. Although the energy *rate* required to charge, say, 10 miles of 132 000 volt cable having a capacitance of, say, five microfarads, to 260 000 volts D.C. may be small, the energy of the final charge is very large, being

$$5 \times 260\,000 \times 10^{-6} = 1.3 \text{ coulomb}$$

If this energy was discharged by dead short circuiting the cable end, the instantaneous current at the crest of the first wave of the transient would be of the order of 10^4 amperes. If discharged through a resistance of one megohm, the discharge current would be aperiodic and its initial value would be about 0.25 ampere. When the short circuiting resistance is above the critical value for oscillatory conditions, the current-time relations are, assuming the circuit practically non-inductive,

$$i = \frac{V}{R} e^{-\frac{t}{RC}}$$

From this equation it will be seen that the charge in the above cable would fall 99 per cent in about 23 seconds whilst the average current would be 0.056 ampere during this period. It will therefore be appreciated that the construction of a resistance of one megohm to carry this current is no easy matter.

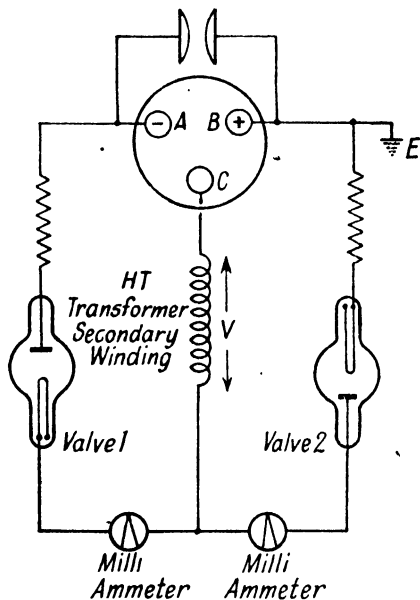

FIG. 37. TWO-VALVE RECTIFICATION

TWO-VALVE RECTIFICATION

Single valve tests with the connections shown in Fig. 32 can be applied to stress all parts of a cable according to the table on page 61. If, however, the desired testing pressure exceeds the voltage available from one valve then the two-valve scheme can be resorted to. The advantage of this system is that the reverse peak pressure applied to the valves does not exceed the testing pressure, thereby

lightening the duty of the valves, when equal pressures on all parts of the cable are desired.

Fig. 37 shows an arrangement for rectifying both halves of the transformer wave so that the voltage applied between the cable cores A and B and between core A and the lead sheath is $2\sqrt{2}$ times the R.M.S. voltage of the H.T.

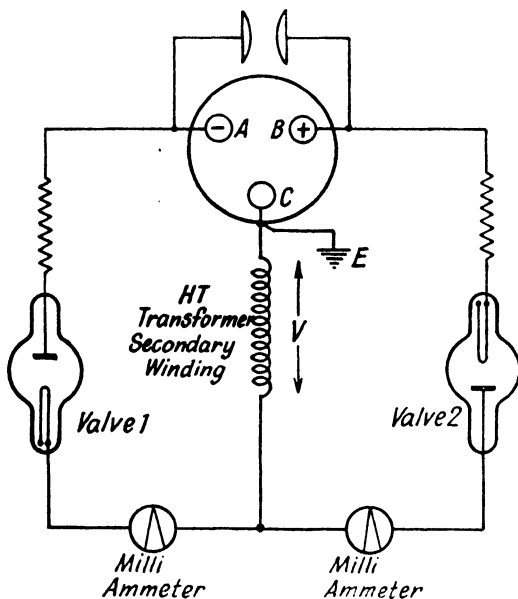

FIG. 38. ALTERNATIVE CONNECTIONS FOR TWO-VALVE RECTIFICATION

transformer secondary voltage V (provided the insulation resistance of the cable is high). The cable core C will be at half this pressure, or $\sqrt{2}V$.

Fig. 38 is similar, except that the earth point in the system is transferred to one side of the H.T. transformer secondary. In this arrangement, the core A is at a negative potential and the core B is positive. The potential

difference between them is the algebraic sum, $2\sqrt{2}V$ while the pressures of A and B to earth are $-\sqrt{2}V$ and $\sqrt{2}V$ respectively. Recourse to this system of connections is made when it is desired to apply a greater pressure between cores than between cores and earth, as for cables designed for earthed neutral working. With these connections the valves are subjected to full reverse potentials.

Apart from the need of applying a lesser pressure between cores and earth, the use of the scheme of Fig. 38 is decided by the voltage required and the available apparatus.

Using the scheme of Fig. 37, all parts of the insulation could be stressed in three tests as follows—

Test	Core Connected to Valve 1	Core Connected to Transformer Terminal T	Core Connected to Earth
(1)	A	B	C
(2)	B	C	A
(3)	C	A	B

Using the system of Fig. 38, all parts of the insulation between cores would be stressed as follows—

Cores Connected to Valve 1	Core Connected to Valve 2
A and C A and B	B C

If a single valve would not give the desired 60 per cent of the core to core test, then the scheme of Fig. 37 must be used to test cores to earth, which must be done in two tests, first A and B say connected to valve 1 with C connected to T and then B and C and A respectively similarly

connected. If another cable or a condenser is available, this can be connected to T and the three cable cores bunched in one test.

Valves capable of withstanding 200 000 volts on reverse are manufactured, which, connected as Figs. 37 and 40, would give D.C. output voltages of the same value. The H.T. transformer must therefore be large to secure the necessary insulation, and the left-hand filament transformer (Fig. 38) would need to be insulated for 100 000 volts D.C. at least, so that the equipment as a whole for 200 000 volts would be bulky. Half this pressure is the usual maximum at which these connections, sometimes known as the "Delon," are used.

Mr. Stretton-Smith has devised a system for higher pressures known as the Callender-Smith connection, the principle of which is the separation of the D.C. from the A.C. stresses.

Fig. 39 shows the arrangement. It is similar to Fig. 38, but with the transformers T_1 and T_2 interposed between the source of supply and the primary windings of the H.T. transformer and the filament transformer of the valve operating at the highest voltage. These transformers (T_1 and T_2) have a ratio of 1 to 1 with the windings insulated to withstand the appropriate D.C. pressures. The windings of the H.T. and filament transformers need not then be heavily insulated from each other or their respective cases, but they are insulated from earth by insulating supports. The latter two transformers may be each auto-connected if desired; their cases are usually connected to their secondary windings to secure stability.

Fig. 39A is a complete two-valve set manufactured by Messrs. Cuthbert Andrews suitable for D.C. pressures up to 200 000 volts. The component parts are comparatively light and easily transportable. The set is easily capable of charging 10 miles of 66 000 volt cable at double

working pressure. The limited output of the H.T. transformer restricts the suitability of the equipment for testing long lengths of overhead lines except under absolutely ideal conditions.

Two systems shown in Fig. 38 can be connected in series and pressures up to 400 000 volts D.C. obtained. Heavily

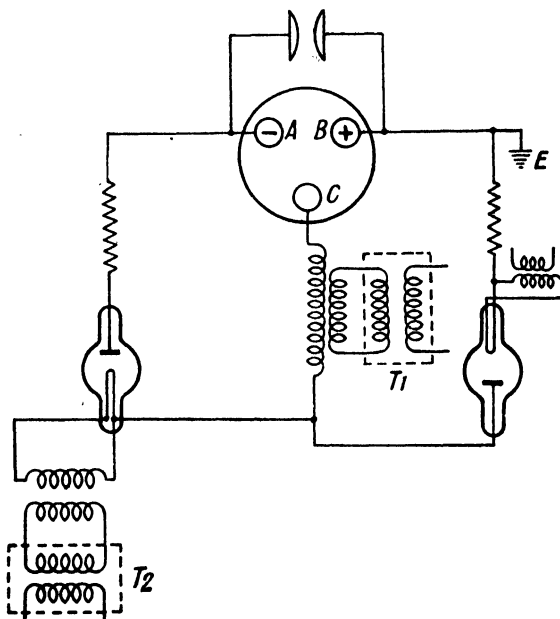

FIG. 39. CALLENDER-SMITH CONNECTION

insulated transformers would be necessary for the higher voltage side of the series. Again two systems as Fig. 39 can be connected in series to obtain this pressure, using suitable 1 to 1 transformers for separating the D.C. and A.C. stresses in the higher voltage equipment of the series. The equipment as a whole would be much lighter than two sets as Fig. 38. High tension condensers can be used

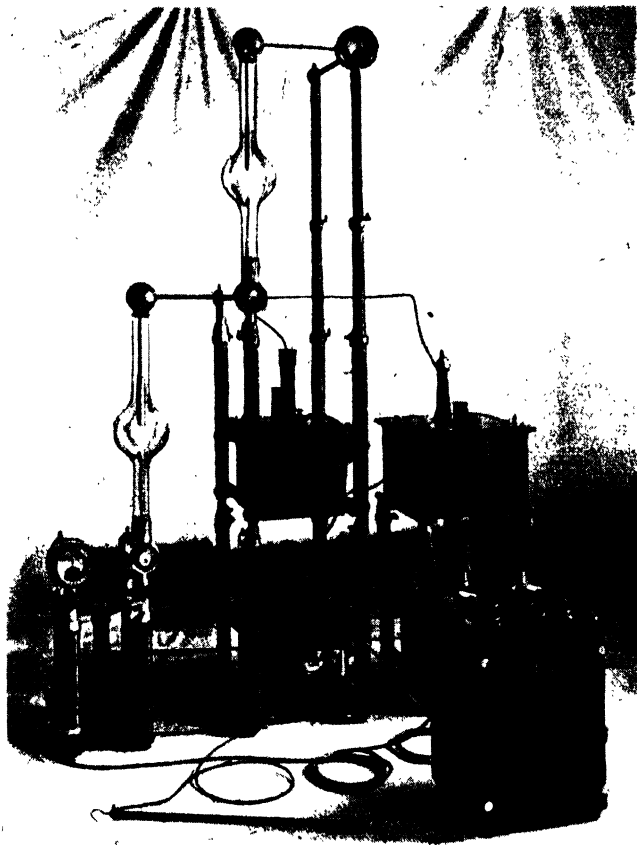

FIG. 39A. CALLENDER-SMITH TWO-VALVE TEST SET

in one system in place of the cable cores indicated in the diagrams.

THE GRAETZ CONNECTION

Another system of connection appropriate to the need of heavy currents for fault burning and localizing is shown in Fig. 40, known as the Graetz connection. Both half

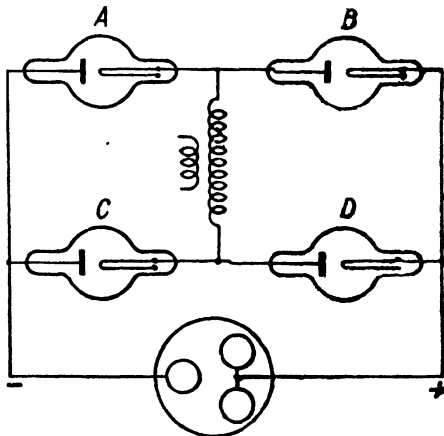

FIG. 40. THE GRAETZ CONNECTION

waves of each transformer secondary terminal are rectified, giving the best possible efficiency obtainable in valve rectification. The valves B and D can be incandesced from a common transformer, and similarly the valves A and C.

If the H.T. transformer has the centre point of the secondary winding brought to a terminal and earthed, or two identical transformers with their secondaries connected in series have the point of connection together earthed, one side of Fig. 40 can be used to obtain heavy currents when only two valves are available. Neither this nor the complete Graetz connection is recommended as a

means of forcing up a testing pressure when leakage is excessive, for although the idle periods are reduced, the effect of doubling the frequency of input charges into the circuit under test has the effect of making the charging voltage very much rippled.

POLARITY OF TESTING PRESSURE

It has already been mentioned that, since the effect of a negative charge is to concentrate moisture at a point, it is customary to connect the anode of the valve to the cable core under test, so that moisture, if present, is actuated towards an incipient fault. Increasing leakage current during the progress of a test indicates this condition, whence the application of the pressure would be continued in an endeavour to develop the fault.

CHAPTER IV

TESTING LIVE NETWORKS

At the present day it can be regarded as impracticable to shut down a distributing network for the purpose of testing its insulation resistance. Consequently it is useful to investigate various methods by which some indication of the amount of leakage from a live network can be ascertained. Under most conditions, for instance with a solidly and permanently earthed star-connected three-phase system or one with a multiple-earthed neutral, leakage to earth simply appears on the station or substation instruments as an increase in load, and cannot be separately measured or registered. In some circumstances, however, it is possible to interpose measuring instruments or a leakage trip in the earthing connection.

On D.C. two-wire networks, on the other hand, if neither pole is earthed, actual measurements of insulation resistance can be made without interrupting the supply. On three-wire D.C. networks, a leakage test is also possible, either as a permanent record or by making periodical measurements.

Fault Resistance. This term is now generally accepted as indicating what was formerly, and incorrectly, termed the insulation resistance of one main. It is the insulation the main in question would have if it were not connected to the other (or others) by means of the lamps, etc. Thus, if in a three-wire network the fault-resistance of the mains were f_+ , f_0 , and f_- , it is these three resistances in parallel that constitute the insulation resistance of the network. If we denote this insulation by F ,

$$\frac{1}{F} = \frac{1}{f_+} + \frac{1}{f_0} + \frac{1}{f_-} \quad . \quad . \quad . \quad (18)$$

(i.e. the conductance between the whole network and earth is equal to the sum of the fault conductances between each main and earth).

On measuring the resistance between any point of one of the mains of a connected-up network and earth, the insulation-resistance F of the network is obtained, and this same result will be obtained from any other point or from another main of the same network. This distinction between the terms "insulation-resistance" and "fault-resistance" may at first appear pedantic; but, when studying insulation-testing and fault-localizing, especially on live mains, the use of the two terms will obviate much confusion.

Before describing the methods which may be adopted for testing, it is advisable to obtain an idea of the magnitude of the insulation resistance or leakage current we have to measure. It will not do to base this on the indulgent figures for maximum permissible leakage handed down through successive editions of the Board of Trade Regulations under the Electric Lighting Acts during the last thirty or forty years, and still maintained in the present-day Electricity Commissioners Regulations. These permit a leakage of $1/1\ 000$ th of the maximum supply current on the network; and on a consumer's premises $1/10\ 000$ th of the maximum current supplied to him. Taking a three-wire D.C. network at 500 volts between outers for the purpose of quick approximate calculations, each kilowatt output means two amperes through the mains, neglecting the out-of-balance current. A maximum output of 5 000 kW will correspond therefore to 10 000 amperes, and $1/1\ 000$ th of this gives 10 amperes as the permissible leakage current. The mains engineer should set about localizing faults before such a leakage was reached.

Passing to the consumer's installation, even if we take so

small a one as 2 kW this means eight amperes at 250 volts. 1/10 000th (this time) of eight amperes is 0.0008 ampere. For this leakage to occur, at 250 volts, the insulation resistance would have to be down to one-third of a megohm. This is too low even for the minimum on an installation of this size, and a long way too low to assume as an average.

Nevertheless, to obtain a rough estimate of a fair leakage on the whole connected-up network when fault conditions do not prevail, it will still be best to start from the consumer's end. Let us take one megohm for each connected kW as an average; this is probably underestimated, but we must remember that a few bad installations will bring down the average considerably. On a network with a maximum demand of 5 000 kW this average gives the insulation resistance of the connected up network as 200 ohms, which would mean, at 250 volts potential above earth, a leakage current of $1\frac{1}{4}$ amperes if we assume all the leakage to be on one pole only. Actually, however, the leakage will be divided over the two outers and the neutral, so that these figures of leakage current under normal conditions would be less in actual practice. We may take it, therefore, that any leakage in the order of even five amperes occurring continuously on a fairly large network will certainly indicate a definite fault either on a consumer's installation or on the network itself, or that, if we are measuring insulation resistance and not leakage current, we should expect a value of at least 200 ohms on a connected 5 000 kW network.

THREE-WIRE D.C. LOW TENSION NETWORKS

We will now get down to ways and means of measurement, considering the three-wire D.C. network first, so as to have one of the simplest cases in practice.

The Middle Wire Earthing Ammeter. On D.C. three-wire

networks, the Regulations of the Electricity Commissioners require that an ammeter shall be permanently connected between the neutral and earth, and that a continuous record shall be kept of the current passing through it. If this current at any time exceeds $1/1\,000$ th part of the maximum supply current "steps shall be immediately taken to improve the insulation of the

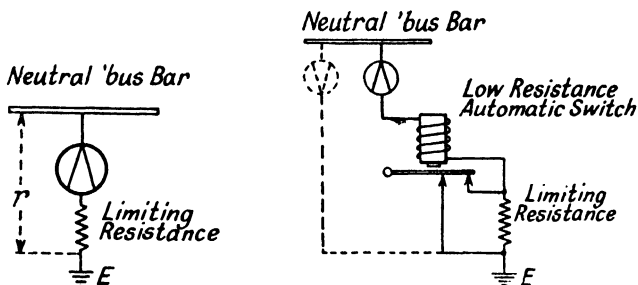

FIG. 41. EARTHING
AMMETER WITH
LIMITING RESISTANCE

FIG. 42. LIMITING RESISTANCE
WITH AUTOMATIC CUT-IN
SWITCH

system." At one time it was customary to include a limiting resistance in series with the ammeter as shown in Fig. 41, but this is no longer permitted as a permanent connection. It is necessary to connect it so that it is normally short-circuited by the contacts of an automatic switch or circuit-breaker as seen in Fig. 42. When the current exceeds a pre-determined value, the short-circuit is automatically taken off the limiting resistance, and in some cases the automatic switch is made to actuate an audible signal when it comes into action.

The limiting resistance also protects the recording ammeter to a certain extent from having to carry excess current when a dead-earth occurs on an outer. In practice, however, it may happen that the automatic switch does not act quite quickly enough to prevent a violent throw

of the pen of the recorder across the paper and against the stop, and consequently breaking or bending the pen. To guard against this, Messrs. Everett Edgcumbe & Co. employ a special quick-acting relay which short-circuits the instrument. It has sufficient time-lag to allow a sharp "kick" to be recorded, but acts more rapidly than the switch can in breaking a heavy current.

It will be noted that in Fig. 42 the dotted lines show a voltmeter connected between the neutral bus bar and earth. This is an elaboration which is quite desirable. Under normal conditions the reading of this voltmeter will be zero, but it will give a permanent indication of the rise of voltage that has occurred if the limiting resistance has been cut in, and will then be of more value than the reading of the ammeter. Needless to say, both the voltmeter and ammeter, which should be central zero instruments, will give a *plus* reading for a fault on the negative wire and a *minus* reading for a fault on the positive wire. The voltmeter is also useful to determine whether the earth is only a momentary one on a consumer's premises, in which case it will return to zero again and the automatic switch can be re-set.

Although the use of the limiting resistance and automatic switch is not obligatory, it is desirable to use it in order to limit the leakage current passing out in the event of a dead earth occurring on one of the outers without tripping the main circuit breaker. It also limits the excessive out-of-balance current which the balancer might have to deal with. On the other hand, it must not be forgotten that the cutting-in of the limiting resistance is definitely an emergency condition. A dead fault on one of the outers will have brought it down to earth potential while the potential of the neutral will rise from 0 to 200, 230, or 240, whichever the supply pressure may be, and the potential of the other outer to double that value. This

may in itself produce new faults on the other outer, and may even be a source of danger on a consumer's premises if maintained.

Under the conditions shown in Fig. 41 the current passing through the ammeter will be—

$$I = \frac{V}{r} \left(\frac{\frac{1}{f_-} - \frac{1}{f_+}}{\frac{1}{F} + \frac{1}{r}} \right) \quad . \quad . \quad . \quad (19)$$

where f_+ and f_- are the fault resistances of the positive and negative outers respectively; F is the insulation resistance of the whole network, including the middle wire; r is the value of the limiting resistance *plus* that of the ammeter shunt (or the ammeter itself if an ammeter with no external shunt is used); and V is the voltage between the neutral bus bar and the outers. Under the conditions in Fig. 42 the same value for I applies, but then r is simply the resistance of the ammeter shunt or ammeter, as the case may be, *plus* the resistance of the coil of the automatic switch under normal conditions when the limiting resistance is short circuited; and, when the limiting resistance is cut in on a fault occurring, its value must, of course, be added to the previous value of r .

In examining this formula it is seen that the fault resistance of the neutral only occurs as part of the value F ; consequently a fault on the neutral will increase $1/F$ and thus diminish I . This important fact is frequently overlooked, namely that a fault on the middle wire will actually decrease the value of the leakage current shown through the ammeter.

Another thing is fairly obvious from the equation, namely, that no matter how low they are, if f_+ is equal to f_- no current at all will be recorded on the earthed middle wire ammeter. In practice this will not prevent the

indication of a fault on one of the outers as it is extremely unlikely that faults of equal resistance will develop on the two outers simultaneously. But on the other hand it will often happen that a fault does affect both poles, so that the reading of the ammeter will not be a true indication of the leakage current from the network.

Fig. 43 is a numerical example of what might be normal

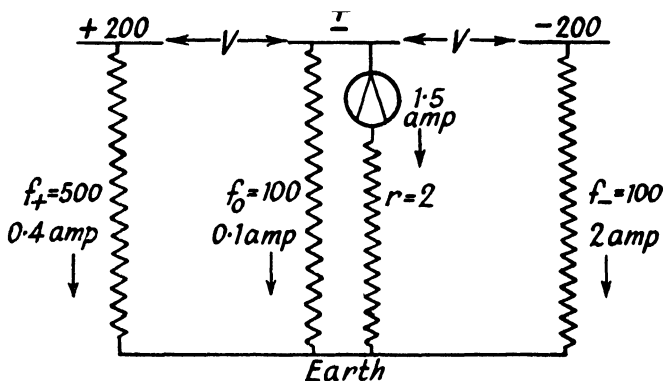

FIG. 43. NUMERICAL EXAMPLE WITH PERMANENT LIMITING RESISTANCE

conditions under the old practice of employing a permanently connected limiting resistance of two ohms. The fault resistance of the positive main is taken as 500 ohms and the fault resistance of the positive and negative as 100 ohms each. Assuming that a limiting resistance is in use as in Fig. 41, making the total resistance between the bus bar and earth through the ammeter two ohms, the instrument will show about 1.5 amperes by formula (19), that is to say, almost, but not quite, the algebraical sum of the leakage currents between the outers and earth. The remaining 0.1 ampere will simply be passing from the neutral bus bar through the fault resistance of the neutral to earth.

Now if f_- drops to 1 ohm, the current shown on the ammeter will increase to about 66 amperes, and similarly a fault of one ohm on the positive side would make the ammeter current slightly less than 66 amperes in the other direction, but if f_0 drops to one ohm the ammeter current will drop to 0.53 ampere if the fault resistance of the outers continues at the values shown in the diagram. It will be seen also by applying the formula that it is not necessary to have a dead earth on an outer to obtain a fairly large reading on the ammeter. Suppose, for instance, f_- falls to 10 ohms, f_0 and f_+ remaining at the original values of 100 and 500 respectively, I will be 16 amperes. So far, so good. But the illustration also shows the effect of the limiting resistance in increasing the voltage of the outers on a fault occurring. We may apply the same values. An absolute dead earth on one of the outers only will, of course, immediately push up the other outer to 400 volts above earth. In the first example taken of f_+ dropping to one ohm and 66 amperes passing through the earthing ammeter and the two-ohm limiting resistance, the voltage of the neutral bus bar will rise to 132 volts negative to earth and the negative bus bar 332 volts negative to earth.

As a real security against voltage rise, therefore, the arrangement must be, as now required by the Regulations, that normally the neutral bar is kept at earth potential through the coil of the automatic switch, which should have as low a resistance as possible, and the limiting resistance be only sufficiently high to save the mains in the event of a dead earth. Five ohms has been laid down as the *maximum* value, and although it must normally be short-circuited as in Fig. 42 it is unnecessarily high under most conditions. It is unfortunate that the limiting resistance has to be inserted automatically just at the moment that the only way to prevent an undue rise of

voltage would be to lower the resistance between the neutral bus bar and earth, but it cannot be helped.

It will be useful to investigate the difference caused in the reading of the earthed ammeter by having it normally connected to earth with the limiting resistance short-circuited as in Fig. 42. We will take the same values as in Fig. 43, but with r merely the resistance of

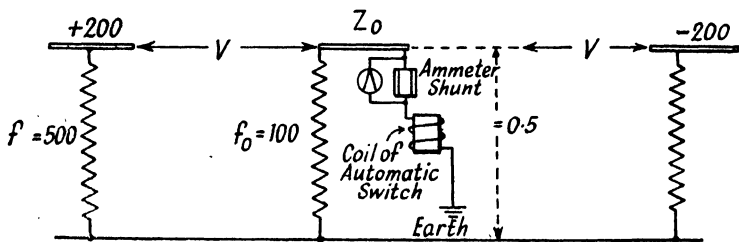

FIG. 44. NUMERICAL EXAMPLE WHEN LIMITING RESISTANCE (NOT SHOWN) IS SHORT-CIRCUITED

the permanent ammeter shunt plus the resistance of the coil of the circuit breaker, giving a total resistance of only, say, half an ohm, for r . Fig. 44 shows this, but with the limiting resistance omitted, to simplify the diagram.

The current through the ammeter will be given from formula 19 on page 105, and will still be between 1.5 and 1.6 amperes—in fact it cannot exceed 1.6 amperes with these values for f_+ and f_- .

But now assume, as before, that f_- has dropped to one ohm. The current through the earthed ammeter would rise to 132 amperes, as against 66 amperes when the limiting resistance of two ohms was in circuit.

On the other hand, if f_0 drops to one ohm, f_+ and f_- remaining at 500 and 100 ohms respectively, the current through the earthed ammeter will only drop from about 1.6 to 1.06 amperes as against 0.53 when the resistance of the earthed ammeter circuit was two ohms.

It is seen, therefore, that the short-circuiting of the limiting resistance, besides reducing the voltage rise on one of the outers when a fault occurs on the other, has the additional advantage that faults on the outers give larger readings and that consequently the existence of a slight or incipient fault can be detected earlier.

The earthing ammeter can be applied in such a way that

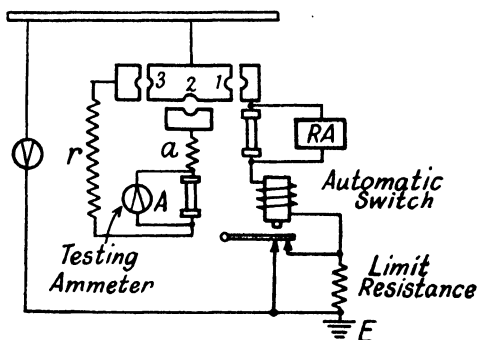

FIG. 45. EARTHED MIDDLE-WIRE AMMETER METHOD OF MEASURING THE INSULATION RESISTANCE OF A THREE-WIRE NETWORK

a measurement of the actual insulation resistance of the network can be calculated from its readings, but this, as will be seen, necessitates a momentary increase in the earthing resistance during the test. It is therefore not applicable to a public supply network, but may prove useful in the case of a large self-contained D.C. three-wire installation run from its own generating plant, or in other circumstances in which the Electricity Commissioners' Regulations do not apply. The connections are shown in Fig. 45, and the additional equipment is a plug switch and two resistances a and r connected as shown, in addition to the limiting resistance that is normally short-circuited by the automatic switch, and an ammeter A , for the purposes of the test independent of the earthed

recording ammeter RA. r is given a value somewhat greater than the normal insulation resistance of the network, but not more than twice as great. a is a resistance slightly less than r and exactly calculated, so that when its resistance is added to that of the shunted testing ammeter, the resistance between the bus bar and earth is exactly r . The bottom ends of r and of the ammeter shunt are connected directly to earth (not shown on the diagram).

Normally plug 1 only is inserted, and the recording instrument becomes simply an earthed ammeter as in Fig. 42.

The daily insulation test of the network is taken as follows—

Plug in at 2, remove the plug from 1, and obtain a reading d_1 on the testing ammeter.

Then insert a plug in 3, and obtain a reading d_2 . The insulation of the network can then be calculated from the simple formula—

$$F = \frac{d_1 - d_2}{2d_2 - d_1} r \quad . \quad . \quad . \quad (20)$$

It should be noted that d_1 and d_2 are not necessarily amperes; they may be any readings proportional to the current.

As soon as the readings have been taken, plug 1 is replaced and plugs 2 and 3 removed.

A central zero voltmeter is shown in Fig. 45, connected between the neutral bus bar and earth for the reasons already stated; it is also useful in interpreting the indications given by the ammeter readings.

The following example will show the application of this method: On a 2×200 volt network, a resistance of 400 ohms is selected for r , and a central zero milliammeter reading to 300 milliamperes is used as a testing instrument.

With the plug in 2, a reading $d_1 = 95$ m.a. is obtained. When the second plug 3 is inserted in addition, the reading drops to 65 m.a. The insulation resistance of the network will then be, according to formula (20),

$$F = \frac{95 - 65}{130 - 95} \times 400 = 343 \text{ ohms}$$

As the readings are positive, they show that the fault resistance of the negative is lower than that of the positive. It will also be noticed that, when plug 2 is inserted and plug 1 removed to enable the first reading d_1 to be obtained, the voltmeter will show a positive voltage on the neutral bus bar.

If on subsequent tests, the milliammeter readings are still positive, but of higher value, with less difference between d_1 and d_2 , it will show that the fault resistance of the negative bus bar continued to decrease, this being indicated also by an increase in the positive voltmeter reading. When there is a dead earth on the negative, the ammeter will show 500 milliamperes both for d_1 and d_2 , and the neutral bus bar will show practically the full 200 volts pressure.

Lower positive ammeter readings, on the other hand, and ultimately a reversal to *minus* readings, will indicate the development of a fault on the positive side, while the voltmeter needle will gradually travel through zero to the negative side.

If there is a bad fault on the neutral, both readings d_1 and d_2 will be zero, and the voltmeter will remain at zero when plug 1 is employed.

Such a condition might also occur if the fault resistances of the two outers happened to be exactly the same, which is, however, unlikely. This may easily be tested out by connecting a resistance of a few ohms between one of the outer bus bars and earth. Then if the voltmeter remains

at zero when plug 1 is removed it shows that there is an earth on the neutral in the network; but, if there is a definite voltage indicated, it shows that the cause of the zero ammeter reading was merely that the fault resistance of the two outers was practically equal. The actual insulation resistance can then be measured with this artificial fault on. Assuming that the result is F' , and that the artificial fault has a resistance of f' ,

$$\frac{1}{F} = \frac{1}{F'} - \frac{1}{f'}$$

and

$$F = \frac{F'f'}{f' - F'} \quad (21)$$

Test by Earthing the Outers. This leads us to another method of testing insulation of a live three-wire network, but is only applicable if it is admissible to remove the neutral wire earth connection entirely during the course of the test. A central zero ammeter of known resistance r is inserted in turn between each bus bar and earth, and the reading a_+ , a_0 , and a_- taken, see Fig. 46. Then the insulation resistance of the network is given by the formula

$$F = \frac{V}{a_- - a_0} - r, \text{ or } \frac{2V}{a_+ - a_-} - r \quad (22)*$$

V is the voltage between outer and neutral.

With an ordinary shunted ammeter, r is, of course, negligible, and it is advisable to bring it up to two ohms or more by including a limiting resistance in series, r being then the value of this resistance plus the resistance of the shunt. It should be noted that the expressions in the denominators are algebraical differences, that is to say, if the readings are on opposite sides of the zero, they have to be added instead of subtracted.

Instead of using an ammeter for this test, a voltmeter

* A mathematical proof of this formula is given in the Appendix.

may be substituted, as shown dotted in the diagram. Then the formula for the insulation resistance of the whole network is

$$F = r \left(\frac{V}{V_+ - V_0} - 1 \right) \text{ or } r \left(\frac{2V}{V_+ - V_-} - 1 \right). \quad (23)$$

where V_+ , V_0 , and V_- are the three voltmeter readings, r is the resistance of the voltmeter, and V , as before, the voltage between the outers and the neutral. But it is no

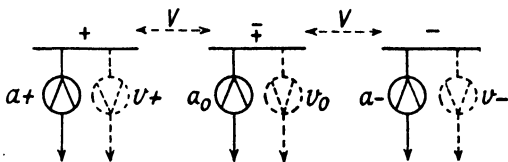

FIG. 46. TEST OF INSULATION RESISTANCE BY EARTHING THE OUTERS

good using a high resistance voltmeter for the test on a network with a low insulation resistance, for then $V_+ - V_0$ will be very little smaller than V (or $V_+ - V_-$ very little smaller than $2V$), and the test will be useless, as a fractional error in either reading will upset the result. It is again to be noted that the denominator of the fraction is the algebraical difference, so that if the readings are on opposite sides of the scale, as is usual, they must be added, and not subtracted.

This test with an ammeter of low resistance was once popular as an effective way of clearing a fault on a consumer's installation from the network. If the fault was on one of the outers, 400 volts would be applied to it as soon as the other outer was earthed through the ammeter, and the consumer's fuse would blow. Similarly, if the fault was on the consumer's neutral, 200 volts would be applied to it on earthing each of the outers through the ammeter, and in all probability this would

also be sufficient to blow the consumer's fuse. This drastic treatment is, however, a dangerous practice which the authors certainly do not wish to encourage, and they believe, or at any rate hope, it has been abandoned, as it must be wherever the Electricity Commissioners' Regulations apply.

It may again be emphasized that removal of the normal earth connection on the neutral is absolutely essential before this test is applied in the manner described. Alternatively, however, in order to prevent too high a potential rise on the mains while the test is applied, one can leave a resistance f' between the neutral bus bar and earth, obtain a result F' from the test, and then correct it by means of the formula (21) on page 112 in order to get the true insulation resistance of the network.

LOW AND MEDIUM TENSION D.C. TWO-WIRE NETWORKS

The preceding test is the most suitable for a two-wire low-pressure network. Then, if V is the bus bar voltage and the positive and negative sides are successively earthed through an ammeter or voltmeter r , the insulation resistance is given by the formula—

$$F = \frac{V}{a_+ - a_-} - r, \text{ if an ammeter is used.}$$

$$\text{or } F = \left(\frac{V}{V_{+,-} - V_-} - 1 \right) r, \text{ if a voltmeter is used.}$$

On a two-wire network, the fault resistance of each main may also be calculated from the test—

If an ammeter is used,

$$\text{and } \left. \begin{aligned} f_+ &= \frac{V - r(a_+ - a_-)}{-a_-} \\ f_- &= \frac{V - r(a_+ - a_-)}{a_+} \end{aligned} \right\} \dots \dots \dots (24)$$

If a voltmeter is used,

$$\left. \begin{aligned} f_+ &= \frac{r[V - (V_+ - V_-)]}{-V_-} \\ \text{and} \quad f_- &= \frac{r[V - (V_+ - V_-)]}{V_+} \end{aligned} \right\} \quad (25)$$

The differences $(a_+ - a_-)$ and $(V_+ - V_-)$ are algebraical differences, so that, as they will be obtained on opposite sides of zero if a central zero instrument is used, the actual readings must be added.

It will be noted that there is a simple relationship between the fault resistances and the pair of readings—

$$\frac{f_+}{f_-} = \frac{a_+}{a_-} \text{ or } \frac{V_+}{V_-}$$

If there is a fault on either main, it will be shown by an increased reading between the *opposite* main and earth.

The actual leakage from main to main in a two-wire network may be obtained from the values of f_+ and f_- in equations (24) or (25) by Ohm's law

$$\text{Leakage current} = \frac{V}{f_+ + f_-} \quad (26)$$

The ideal way to use this method on an unearthed two-wire network, is to have a recording voltmeter connected between one of the mains and earth, and to test once daily with an ammeter or voltmeter, as above described. Then, if only a slight variation in the insulation resistance, and consequently in the readings of the recording voltmeter, has occurred, it can at once be seen, by examining the recording voltmeter curve, whether this has been due to a sudden alteration in the conditions, i.e. by the development of a fault, or by a gradual decrease in the insulation resistance. If the resistance of the recording voltmeter is

high compared with the insulation resistance of the network, it is not necessary to disconnect it for the ammeter test.

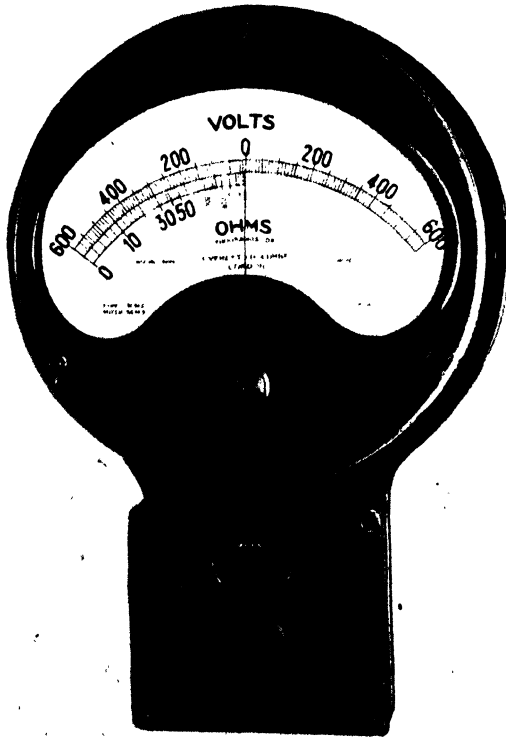

FIG. 47. DIRECT READING INSULATION TESTER FOR UNEARTHED MEDIUM PRESSURE D.C. NETWORKS

After the "earth ammeter" test probably the "earth lamp" test is the most common. This is simply a pair of lamps, one of which is connected between each of the outers and earth. This is employed as a permanent

connection on a very large number of small two-wire networks. It is, of course, useless on a three-wire network unless the middle wire earth connection is removed. It is practically the test just described, with the difference that lamps are employed instead of voltmeters. The lamp connected to the outer with the higher fault resistance will glow brighter than the other, and, if there is a bad fault, the lamp on the side on which the fault occurs will get dimmer. It is useful to leave the earth lamps on permanently, even if a regular test with an ammeter or voltmeter is made periodically.

Various "circuit testers" and "leakage indicators" based on the earthed ammeter or voltmeter method have been put on the market from time to time. Fig. 47 shows an ingenious instrument of this nature devised by Messrs. Stubbings & Quenza, made by Everett, Edgcumbe & Co., Ltd., and scaled to read directly in thousands of ohms. It is in regular use on those of the 600-volt trolley-bus lines of the London Passenger Transport Board on which the supply is not earthed. It consists of a centre zero D.C. voltmeter which, by means of a self-contained selector switch, can be connected between either the positive or negative mains of the system and earth. The selector switch is normally held in the open position by means of a spring. The total resistance of the instrument is 30 000 ohms, and it is provided with an external knob whereby the pointer may be set by hand to any point on the scale by turning the control spring. It is scaled 600–0–600 in volts and on the left-hand side of the zero voltage mark is a scale of ohms in accordance with the formula—

$$\text{ohms} = R \left(\frac{600}{v} - 1 \right)$$

where R is the resistance of the instrument, and V the corresponding reading on the volt scale.

The instrument is used in the following manner. The pointer is first set to the zero of voltage and is then connected to the positive main so as to give a deflection to the right. While so connected, the pointer is re-set to the zero mark. The instrument is then connected to the negative main when the reading of the pointer on the ohms scale gives the combined insulation resistance of the system.

Another pattern of testing set embodying a milliammeter, introduced by the same firm several years ago for testing two-wire installations in mines, is still largely used, and at the suggestion of one of the authors the makers provide this with a chart from which the actual leakage current from main to main as well as the fault resistance of each main can be read off directly from the two readings of a milliammeter connected in turn between each bus bar and earth; this lead has been followed by other makers. The arrangement of the leakage indicator is as follows—

A resistance, marked "bridging coils" in Fig. 48, is connected across the bus bars. In the "normal" position of the switch the centre point of this is earthed through a milliammeter, which shows a reading if the fault resistance of one main is less than that of the other, just as the middle wire ammeter of a three-wire system. On connecting the switch to the stop marked "+ test," the negative bus bar is earthed through the milliammeter and a reading obtained proportional to the fault resistance of the + side of the system. Similarly, on connecting to the next stop, a reading is obtained proportional to the fault resistance on the negative side. The shunt key is depressed when greater accuracy is required. The reading in the normal position is not the actual leakage current on the system, but this is calculated from readings given from the + test and - test, as well as the two fault resistances (by the formulæ (24) and (26) on pages 114 and 115);

the chart provided with the instrument has these figures ready worked out for every reading. A relay is included in the "normal" circuit, and this closes the circuit of an alarm bell if the fault is serious.

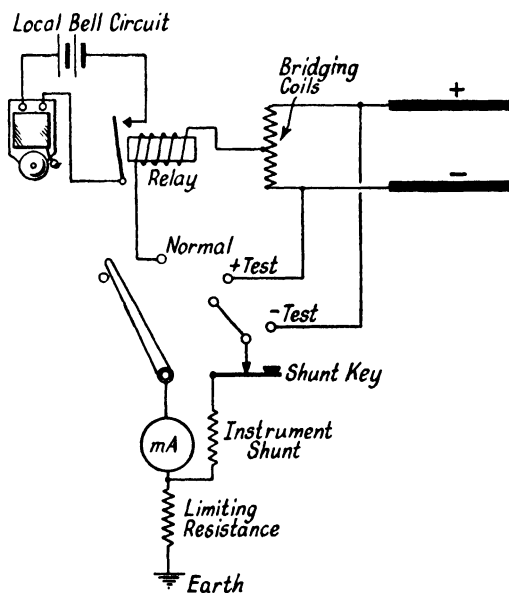

FIG. 48. DIAGRAM OF TEST SET FOR TWO-WIRE INSTALLATION

In the rare instances of two-wire D.C. public supply networks, the Electricity Commissioners Regulations require the supply authority to earth one pole through an ammeter, and to take a continuous record of the readings.

INSULATION OF FEEDERS

A differential method of measuring insulation resistance suggested by the late Dr. Martin Kallmann of Berlin in 1898 may prove of occasional service for testing the insulation of a suspect feeder during working, irrespective of

the remainder of the network. Two small resistances of equal value are connected in series with the feeder cable, one at the incoming end and the other just before the feeding point. If there is no leakage from the feeder, the current through the two resistances will be equal; if, on the other hand, there is leakage, the current flowing out

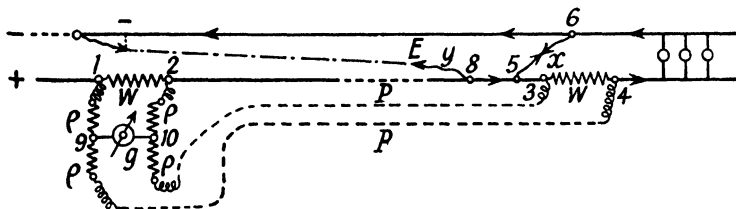

FIG. 49. INSULATION TEST OF FEEDERS

through the feeder at the outgoing end will be greater than that flowing in to the network at the feeding point. The currents can be compared by comparing the fall of potential over each of the resistances, and wires from them are connected for this purpose to a differential galvanometer, or to an ordinary galvanometer connected as shown in Fig. 49. W , W are the two resistances between the points 1, 2 and 3, 4; they may be short lengths of the feeder itself if its sectional area is not too great. The resistances $\rho\rho$ may be very small so long as they are large enough to render negligible the differences in resistance between the pilot or testing wires p , p and the shorter leads to the points 1 and 2. If there is no leakage, the galvanometer will show no deflection, but if there are any number of leakage currents, x , y , etc., the deflection of the galvanometer will be proportional to their sum, $x + y + \dots$. An ammeter calibrated to be used in shunt with a resistance W , and with resistances $\rho\rho$ in series may be employed if the actual leakage in amperes is required; and from this value and the potential of the main

the insulation resistance may be calculated. Dr. Kallmann also suggested a signalling relay by means of which the fault could be automatically indicated. For other applications of Dr. Kallmann's differential method the reader is referred to *The Electrician*, Vol. XLII, pages 286, 303, and 322. It will be noted that, in the principle of the test described, he very nearly anticipated the Merz-Price feeder protective system.

LOW AND MEDIUM TENSION A.C. NETWORKS

All the methods described for D.C. networks are to some degree applicable, but the measurements of leakage current and insulation resistance will not be absolutely accurate owing to the effect of the capacitance of the mains, and the requirements of the Electricity Commissioners Regulations are also different. Unless by their consent, the network must be earthed at one point (i.e. at the generating station or sub-station, as the case may be), but this connection may include a switch or link which may be temporarily opened for testing or locating a fault. It is not allowable to include any impedance in the earthing connection, other than that required *solely* for the operation of switchgear or instruments, and neither a fusible cut-out nor circuit-breaker may be included. The only exemption from this is for the purpose of operating relays for the remote control of switches, for which it is permissible to include the secondary winding of a high frequency transformer, of ohmic resistance not exceeding 2 000 microhms and inductance not exceeding 10 microhenries.

The permanent inclusion of an earthing ammeter is not obligatory, for the regulation that the leakage current shall not exceed one-thousandth of the maximum supply current applies only to D.C. Nevertheless, the Electricity

Commissioners Regulation 4 (ii) requiring connection with earth at one point lays down that "the insulation of the system shall be efficiently maintained at all other parts," the only exception being on multiple earthed neutral (M.E.N.) systems, to which reference is made later in this chapter.

THREE-PHASE NETWORKS

On a star-connected three-phase four-wire supply network to which consumers are connected between phase conductors and neutral, even a momentary disconnection of this earth connection while the network is live might lead to unfortunate results. Not only would any out-of-balance between the leakage currents from the three phases result in two of the phase conductors being above earth potential by the full phase voltage, but the same would occur if there were any out-of-balance between the capacitances or inductances of the phase conductors. It is usual, therefore, to include an ammeter and its current transformer or shunt permanently in the earth connection. This ammeter should normally show a very small reading, but the formula (19) on page 105 will not apply since the current through the ammeter will depend on the leakage current from all the phases, which are, of course, 120° apart. An increase in the normal current will indicate that there is a fault on one phase, and the faulty phase can be located by applying momentarily an earthing resistance to each phase in turn, without disturbing the connection of the ammeter. The faulty phase will be the one that shows an increased reading or the greatest increase in the reading of the ammeter on connecting up the artificial fault.

As the use of a limiting resistance or circuit breaker is not permissible by the regulations, it is necessary to ensure that the permanent earthing ammeter or its current

transformer will stand up to the overload which may occur when a bad earth fault appears on one of the outers. A way of doing this, which also has the advantage of giving an open scale for the lower readings of the ammeter, is to employ a current transformer with a core that will be magnetically saturated by a primary current just above that corresponding to the maximum scale value of the testing instrument. Two makers, Everett, Edgcumbe & Co. and Evershed & Vignoles, make outfits for this purpose. Either an indicating or a recording instrument, or both in series are connected to the secondary of the transformer, and the latter firm also include a reactor in the circuit to make the readings independent of wave form and to damp out the effect of the third harmonics, which are usually present in leakage current from a three-phase network. Fig. 50 is a typical record taken with the Evershed & Vignoles instrument, and gives the current flowing to earth from the neutral bus bar of a large three-phase sub-station on which there is considerable leakage. The variations in current are shown from noon on Sunday to noon on Monday, and it is clear from the period over which the maximum readings have extended that the leakages indicated are on consumers' installations. Investigation will probably have followed promptly, for an out-of-balance leakage of $9\frac{1}{2}$ amperes, taken in conjunction with the wide fluctuations at other times, makes it reasonable to suppose that a considerably greater leakage exists on one of the three phases.

SINGLE-PHASE THREE-WIRE AND TWO-WIRE A.C. NETWORKS

What has been said with regard to three-phase networks largely applies to single-phase three-wire. An ammeter permanently connected between the neutral and earth is the test usually preferred. Some of the leakage current from the outers, it is true, will flow directly from the

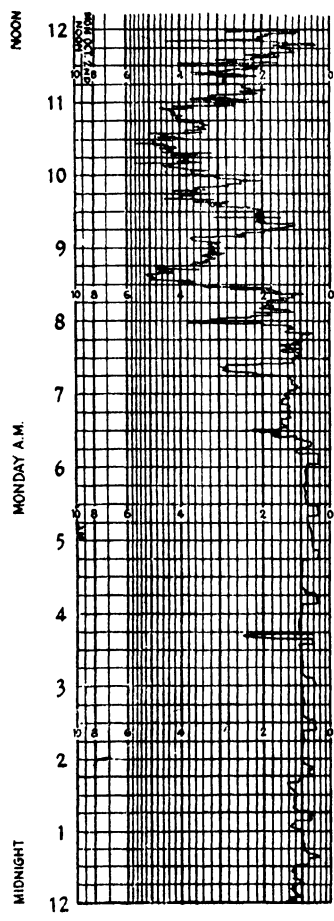
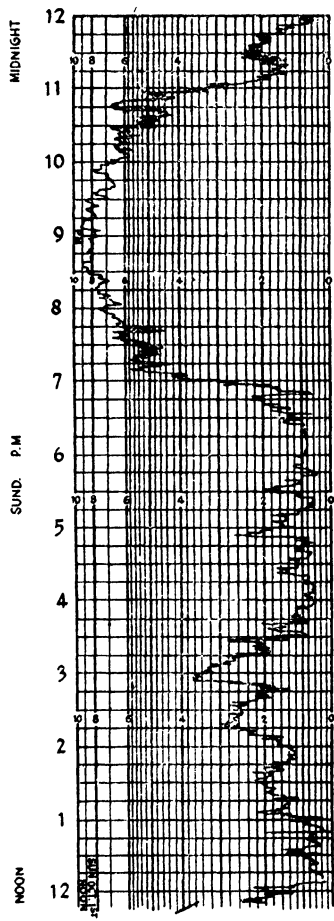

FIG. 50. TYPICAL CHART FROM EVERSHED SELF-PROTECTING A.C. INDICATOR

outer to the neutral through the capacitance of the latter, but the greater part will return through the station or sub-station earthing connection and be fully recorded on the earthing ammeter, which should, of course, be an A.C. instrument.

It is customary, therefore, to rely on the continuous test afforded by this ammeter, and not to attempt to make any actual measurement of insulation resistance. Normally the reading of the ammeter should be very small, and an increase in it indicates a definite fault, which may only be a transient one due to an earth on a consumer's installation. If the increased reading persists, it is necessary to see on which outer the fault is. All that it is necessary to do, however, is to "flash" an artificial earth of a few ohms resistance on one of the outers through an ammeter. If this is the faulty side, the reading of the permanent earthing ammeter will increase; if the reading diminishes, the fault is on the other main.

If a neutral fault is suspected, a simple way of testing for this is similarly to earth one of the outers momentarily through a resistance and an ammeter, and to observe both ammeter readings simultaneously. If the increase in the neutral wire earthing ammeter reading is exactly equal to the current passing through the temporary earth made on the outer, it can be assumed that there is no fault on the neutral. If, on the other hand, the increase in the neutral earthing ammeter is less than that shown through the temporary connection, it is clear that the difference is returning to the neutral bus bar through a fault on the neutral main.

Two-wire A.C. networks must have one pole earthed if the pressure is above 125 volts. On voltages up to 250, however, there is no reason why the earth connection should not be temporarily removed for testing purposes and an ammeter or voltmeter of the moving iron pattern

applied successively between each pole and earth as in the D.C. test described on page 112. If the two readings are the same, the leakage is negligible; if they differ, the fault will be on the pole showing the lower reading. The approximate value of the fault resistance on each main will be given by the formula

$$\left. \begin{aligned} f_1 &= \frac{V - r(a_1 + a_2)}{a_2} \\ f_2 &= \frac{V - r(a_1 + a_2)}{a_1} \end{aligned} \right\} \quad (27)$$

if an ammeter is used; or, more simply, the joint insulation, resistance will be

$$F = \frac{V}{a_1 + a_2} - r \quad (27a)$$

r in the above formulae is the impedance of the ammeter, including any resistance which may be inserted in series with it.

If a voltmeter is used, the formula becomes

$$\begin{aligned} f_1 &= \frac{r[V - (V_1 + V_2)]}{V_2} \\ f_2 &= \frac{r[V - (V_1 + V_2)]}{V_1} \\ F &= \left(\frac{V}{V_1 + V_2} - 1 \right) r \end{aligned}$$

r , in this case, being the impedance of the voltmeter.

SELF-CONTAINED A.C. INSTALLATIONS AND LEAKAGE INDICATORS

An installation supplied by private generating plant is not subject to Electricity Commissioners Regulations. A

two-wire system need not be earthed if the voltage does not exceed 250, although in some instances it may have been preferred to follow the practice under the Commissioners Regulations and earth one pole if the voltage is above 125 volts. Tests may be made as previously described.

Private three-phase medium pressure installations not

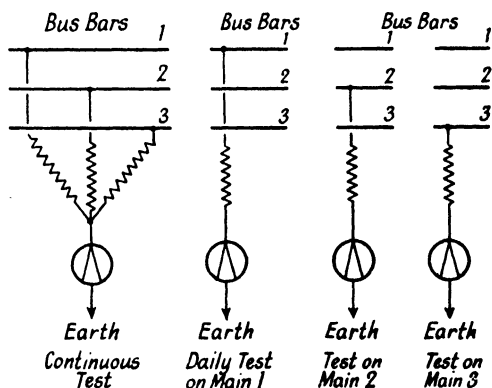

FIG. 51. LEAKAGE INDICATOR FOR PRIVATE THREE-PHASE INSTALLATIONS

connected to the supply mains are preferably permanently earthed, the earth connection being made at the neutral point of the star connection in the generating station, and a low resistance ammeter may be included in the earth connection. In some instances, however, the earth connection is not permanently maintained, and leakage indicators connected as Fig. 51 are used. Testing sets can be obtained in which the change of connections is conveniently carried out by successive depression of keys, and turning a switch. Records of the tests may be taken daily, so that comparisons may be made, and the presence of a fault detected. For the test marked "continuous test" the instrument should remain at zero, and a sudden permanent departure

from this shows that a defect has occurred on the network. When the instrument is connected to main 1, a fault on *either of the other* mains will cause a current to flow through it. Thus if main 2 be faulty, and the other two mains in good condition, then there will be a current (whose magnitude is a rough indication of the extent of the leakage) through the instrument when it is connected to 1 or 3, but none when it is connected to the faulty main 2; while if two mains, say 2 and 3, are both faulty, the largest deflection will be when the instrument is connected to the sound main 1. The diagram assumes a network fed from delta-connected transformers or generators. If star-connected, the three resistances in the left-hand diagram may be omitted, and the instrument connected direct to the centre of the star as an ordinary earth ammeter. In an earthed star-connected system, it is, of course, necessary to remove the normal earth connection when making the three daily tests.

There is just one method, not very frequently employed, however, by means of which an accurate measurement of the insulation resistance of the whole of a live alternating-current network may be measured, namely, by the use of superimposed direct current. If there be a permanent earth connection, this is removed, and a battery or a source of rectified current is connected up in series with a galvanometer, milliammeter or ammeter, and fine fuse, between any convenient point of the network and earth. The point chosen is preferably one which is at low potential, for instance the outer of a concentric system, the middle wire of a three-wire system, or the neutral point of a three-phase four-wire system. The instrument used should be of moving coil type. Then a reading, d_1 , is taken, the instrument being shunted if necessary. The instrument and battery are then disconnected from the network, and a resistance r inserted in circuit with them,

giving a second reading d_2 . The insulation resistance may then be worked out by the formula

$$F = \frac{d_2(r + g)}{d_1} - g$$

when g is the ammeter resistance.

If g is low compared with F it may be neglected, and F is then simply $\frac{d_2}{d_1} r$.

This is, of course, nothing more than the direct deflection method described on page 33, with the difference that an alternating current may be flowing through the galvanometer or ammeter at the same time. For this reason a fine fuse is essential, as during the test the reading of the instrument is not an indication of the total current flowing through it.

If a secondary battery of known voltage is available for the test, the measurement is still further simplified, for then the comparison with the substitutional resistance is unnecessary, and the insulation resistance is simply, by Ohm's law, $\frac{V}{I}$. From this the milliammeter resistance must be deducted if it is comparable with the insulation resistance of the network.

Messrs. Nalder Bros. & Thompson make an insulation tester on this principle, especially for measuring the insulation resistance of alternating current mines-networks.

EARTH LEAKAGE TRIPPING DEVICES ON L.T., A.C. SYSTEMS

It is now the usual practice to provide current-transformer-operated mechanism on all important L.T. feeders, which automatically causes the circuit breaker to open when currents exceeding a predetermined value pass to earth from any of the phase wires or neutral, while the

mechanism remains inoperative under all normal working conditions. To a certain extent the principles described below are comparable with the earth leakage device applied to D.C. systems as described in Fig. 42, page 103.

A typical example of earth leakage protection for an L.T. three-phase four-wire feeder is shown in Fig. 52. Current

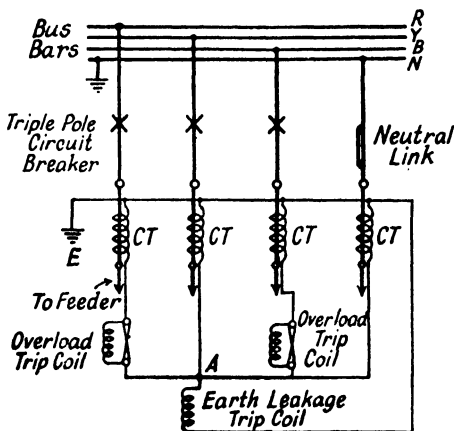

FIG. 52. EARTH LEAKAGE AND DELAYED ACTION OVERLOAD PROTECTION FOR L.T. A.C. FEEDERS

transformers indicated by C.T. are arranged on the outgoing side of the triple-pole circuit-breaker, which is mechanically constructed so that any of the tripping coils will open the switch simultaneously on each phase. Each of the four current transformers has similar characteristics.

The tripping coils, connected to the secondary windings of the current transformers, are usually solenoids, into which iron cores are forcibly drawn when the current exceeds a certain value. The movement of the iron cores is communicated to a toggle mechanism which opens the switch. Two tripping coils are arranged to function on overload only, on the R and B phase as shown in the

diagram, while the third is arranged to operate when excessive currents pass from any phase line to earth. The fuses shown shunting the overload coils delay their action in the inverse time ratio to the current passing; then when a current not greatly in excess of normal maximum passes through any of the phase wires, but not to earth, the fuse will take several seconds to blow, after which the whole of the current induced in the secondary winding of the current transformer will traverse the tripping coil, causing it to operate. On the other hand, a very excessive phase current would give rise to a current which would blow the fuse rapidly, causing a correspondingly quick action of the tripping mechanism.

The action of the earth leakage tripping coil is not similarly delayed, so that the effects of heavy leakage currents are instantaneous. The precision with which the switch opens is governed by the design of the operating mechanism as a whole, because electrical and mechanical inertia require that a brief time interval must elapse between the occurrence of the fault and the opening of the switch. Obviously the ideal aimed at in design is to reduce this interval to the lowest possible limit, particularly for switches operating on a system fed by large power sources, because short circuit or earth currents can reach an enormous value in a very brief time interval.

Let us consider how the current transformers and tripping coils in Fig. 52 will function under varying conditions—

(a) *Balanced load and no earth leakage.* The three currents from the R, Y, and B phase current transformers meet at A, and their vector sum will be zero; no current passes through the neutral, therefore none passes through the earth leakage tripping coil. The current passing through R and B overload trip coils only operates these when it exceeds a predetermined value.

(b) *Balanced load, and earth leakage on one phase line.* The current in the faulty phase line will exceed that of the other two phases, so that A is no longer at zero potential. The neutral current transformer remains inoperative because no neutral current passes; therefore current

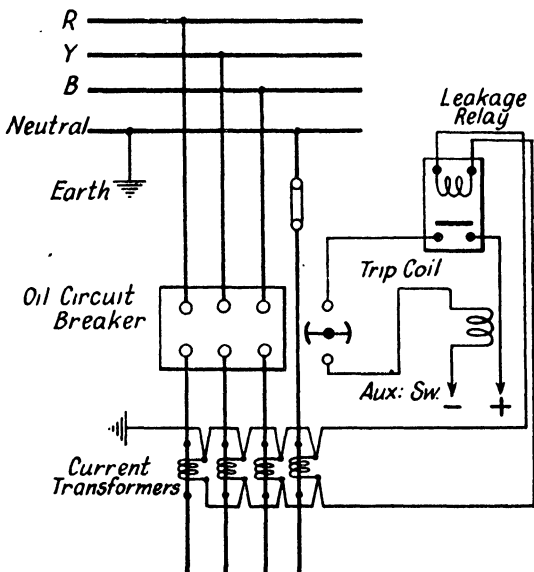

FIG. 53. ALTERNATIVE METHOD OF EARTH LEAKAGE AND OVERLOAD PROTECTION FOR L.T. FEEDERS, WITHOUT SEPARATE TIME-LAG FOR OVERLOAD TRIP

passes through the earth leakage tripping coil from A to earth, tripping the breaker if it exceeds a predetermined value. It is easy to see that a fault on any phase will operate one or the other of the trip coils.

(c) *Unbalanced load, and no earth leakage.* The current in the neutral is the vector sum of the phase currents. For similar current transformers the vector sum of the phase and neutral currents meeting at A is zero; therefore the earth leakage trip remains inoperative.

(d) *Unbalanced load and earth leakage.* The vector sum of the phase and neutral currents meeting at A is a finite quantity; therefore the earth leakage trip operates.

Fig. 53 shows another method of overload and earth leakage feeder protection. A study of this diagram shows that the system remains inoperative similarly to that of Fig. 52 for balanced or unbalanced loads when no phase or neutral earth faults exist, that is to say that the effect of neutral current is compensated; an earth leakage on any phase or the neutral operates the trip coil *via* the relay.

Fig. 53 cannot, however, be arranged with a time lag discriminating between overload and fault currents as Fig. 52.

Faults Between Phases. It is apparent that both systems as Figs. 52 and 53 will operate when faults between phases occur.

EARTH LEAKAGE INDICATION FOR HIGH-PRESSURE SYSTEMS

Incipient Faults and Routine Tests. The testing of a connected-up high-pressure network is not so useful as the testing of a low-pressure network. Usually a fault is not detected until it is a dead earth. The normal insulation resistance of a high pressure cable may be some hundreds of megohms per mile, while that of the switches, cut-outs, and transformer terminals combined is, owing to surface leakage, only a few megohms. Even when it is possible to clear a high pressure feeder from the masking effects of leakage over ends and connected apparatus, the results of insulation tests can be very misleading.

The inaccessibility of live parts and dangers attached to handling apparatus connected to live mains in addition

to the unreliability of insulation resistance tests on H.T. mains has generally ruled these out as a matter of routine. Generally, before a fault develops sufficiently to make an appreciable difference in the measured insulation resistance of the connected-up network, it will arc over and trip the circuit breaker. Concentric systems are exceptions, however. A well-insulated concentric system has its outer conductor at a comparatively low potential, and faults between it and the lead sheathing may in some circumstances endure some time before a catastrophe occurs. It is rarely feasible, as it was in the early days of electric lighting, to disconnect high-tension feeders occasionally for testing purposes. Reliance is now placed very largely on automatic feeder protective gear for cutting off faulty high-tension feeders before the trouble extends.

The explosive effects of a fault on a high pressure cable frequently result in a large hole being blown in the cable or joint at the seat of the fault, while the rapid operation of the protecting switch does not allow the current to pass for sufficient time to carbonize enough dielectric to give a low insulation resistance. Indeed, in dry soil, a fault of this description may sustain the working pressure for weeks without disturbance. Such faults are known to occur which have tripped the circuit breaker at irregular but fairly long intervals for months, whilst the feeder shows a normal insulation resistance when tested with a megger immediately after tripping. They cause great annoyance, for there is often no direct evidence where they exist. Cable, switchgear, and transformers are in consequence placed under suspicion.

The only way of finding faults of this type is to disconnect, and then to apply a high voltage D.C. test, as described in Chapter III. The leakage current recorded is a good guide to the condition of the cable, for the order

of the insulation resistance can be obtained from Ohm's law. If this resistance is found to be below normal, making due allowance for end-leakage, it is only a question of continuing the pressure test long enough, when complete breakdown will finally occur. The procedure of breaking down is fully explained in Chapter V (pages 141 to 155).

Three-phase feeders entirely insulated from earth can, however, be checked for insulation resistance by connecting an electrostatic voltmeter to each phase while working. A low voltage on one phase would indicate a leakage, provided no undue out-of-balance of current in the phases existed; or in practice only two phases need be checked, for if the voltage on one was low, that on the others would be high.

Some makers combine two or three electrostatic voltmeters conveniently in one case as leakage indicators. and a pattern of electrostatic instrument is also made as a leakage indicator, in which the needle is at the centre of the scale for normal insulation. A pair of these combined as a three-phase leakage indicator is shown diagrammatically in Fig. 54. In this case each phase is connected to a pair of fixed quadrants, and the moving vanes (which are earthed) will remain in a central position under normal conditions. As connected, an earth on line 1 or 3 would make the pointer of M or N respectively deflect inwards, and an earth line 2 would send *both* pointers outwards.

Neon tubes attached to a highly insulated contactor, so that contact to each phase can be made, are another arrangement which indicates whether one phase on an unearthed neutral system is faulty. An alternative

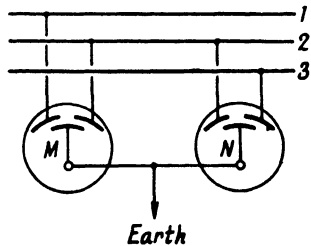

FIG. 54. ELECTROSTATIC VOLTMETERS AS LEAKAGE INDICATOR

arrangement provides for permanent illumination of the neon tubes through a condenser connected to the high pressure bus bars. Both schemes also serve as "live" or "dead" indicators.

EARTH LEAKAGE TRIPPING DEVICES

An example of overload and earth leakage protection to operate on H.T. feeder switches is shown in Fig. 55.

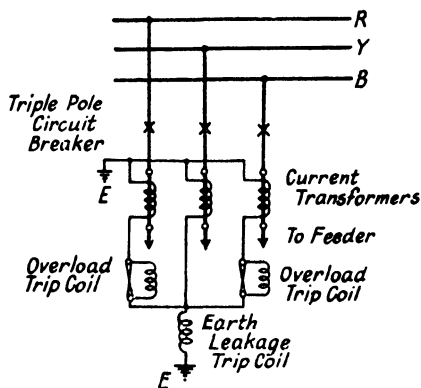

FIG. 55. EARTH LEAKAGE TRIPPING DEVICE FOR H.T.

It is similar to that described for L.T. in Fig. 52, but the earth leakage tripping coil is not automatically compensated for out-of-balance currents as in the case of L.T. feeder protection. This is here of less importance because the usual transformer arrangements at either end of an H.T. feeder assist in balancing out the phase currents, but the earth leakage tripping mechanism must be set to remain inoperative below a certain minimum current. Therein lies the distinction between this simple form of earth leakage protection and the more sensitive and discriminative systems of automatic feeder and network protection.

As in the case of L.T. feeders, the arrangement shown in Fig. 55 can be modified so that a relay and battery operate a single switch tripping coil, similarly to Fig. 53.

Glover's Test Sheath Cable. Messrs. W. T. Glover & Co., Ltd., manufacture a cable with a "test sheath" concentric with the lead covering and insulated from it by only a small thickness of dielectric.* The normal insulation of this is about 50 megohms per mile, and if this insulation is tested regularly, a fault will be detected before moisture has penetrated far into the cable. The idea, which is an excellent one, was anticipated to some extent by a suggestion made by M. Paul Charpentier many years ago,† but not put into actual practice at the time.

FAULT INDICATION ON E.H.T. OVERHEAD LINES

Two alternative methods of indicating not only the presence of faults on the 132 kV overhead grid, but also their approximate position, have been developed by Mr. C. W. Marshall and Mr. W. T. J. Atkins of the Central Electricity Board.‡ The neutral points of all the higher-voltage transformer windings are solidly earthed at the sub-stations. By means of a current transformer the value of the current passing to earth can be measured, but, in the event of a fault, the time during which the excess current passes is limited by the circuit-breaker, which is normally set to open at from 0.15 to 0.2 second from the initiation of the fault. An instrument made by Messrs. Nalder Bros. & Thompson for the purpose comprises three essential parts, a detector, a timing device, and an integrator. The timing device is automatically released

* *Journal of the Institution of Electrical Engineers*, Vol. LIII, 15th December, 1914, pages 63, 84, 85, and 92.

† See *The Localization of Faults*, by F. C. Raphael, Second Edition (1903).

‡ *Electrical Review*, Vol. 128, pages 252 and 253, 17th January, 1941.

take all reasonable precautions to avoid any accidental interruptions of supply, and also to avoid danger to the public or to any employee or authorized person when engaged on any operation as aforesaid."

Needless to say, the ease with which a mains fault can be isolated, and the minimizing of inconvenience to consumers, depends upon the foresight used in planning the system.

On a suitably fused system much information as to the approximate locality of a fault can be gleaned from a study of the fuses which have blown and their respective current carrying capacities, or the deductions which can be drawn from blowing a few trial light fuses within the wider limits of the affected area may be equally helpful. The intermittent type of fault can generally only be narrowed down within a confined area by a continued study of the blowing of trial fuses. This kind of fault will sometimes persist on a consumer's installation, without his being aware of its existence, so that a knowledge of the time of blowing fuses is very helpful, as the occurrence at regular times generally directs suspicion to a consumer.

Assuming the extreme case in which feeder ammeters, feeding-point voltmeters, and information from consumers give insufficient assistance to enable the engineer to determine the faulty section of main at once, the network should be divided up into two or more parts at the disconnecting and feeder boxes in such a way that each part is fed by an independent feeder. By observing the current passing through the feeder ammeters, or by other methods, it can be seen which part contains the fault, and this method of dividing up may be continued until all the feeders have been employed in this way. Then sections can be transferred, a few at a time, from the faulty part to the others, and finally sections may be isolated and tested one at a time until the faulty one is found.

On a properly districted and fused network, if a fault persists and refuses to clear itself, the obvious assumption is that it is on the feeder. It is true that, if the feeders were connected through fuses to the bus bars at the feeder pillars, the faulty feeder would be cut out by the current fed back to the feeder fault from the network, but, before this happened, other sound feeders might be disconnected by their fuses, owing to the additional current they would be carrying, just at the particular time they were most wanted. If the districting and fusing is successfully carried out, the fuses connecting the distributors to the bus bars at the feeder pillars will be the first to blow when the feeder develops a fault, owing to the current coming back from the network after the feeder fuse or circuit-breaker on the station switchboard has acted, and the faulty feeder will be isolated automatically without trouble.

The next step after tracing the fault to a confined area is to track it down to a particular distributor. (If it is on a feeder the completion of the initial search will have determined the particular feeder.) This is not always an easy matter, and often the only way of getting positive results is to isolate distributors one at a time at each end, by withdrawing fuses, or distribution box links, noting when the fault disappears on the station or sub-station indicator. These operations usually have to be carried out at such times as to give the least inconvenience to consumers.

In the foregoing remarks it has been assumed that the fault has not been so serious as to cause an extensive shut down. A major fault of this description would, in the absence of any tangible information from casual observers, be sought by similar processes, but necessarily with the utmost dispatch.

Breaking Down Incipient Faults. In the cable factory the usual pressure testing plant affords every convenience

for breaking down an incipient fault indicated by low insulation test. Precise pressure control is available enabling the current passed when the fault develops to be regulated with nicety so that carbonization at the fault is just sufficient to enable a location test to be made. The comparatively limited kVA capacity of the plant also limits the current, so that conductors are not seriously damaged.

These facilities are not generally available for the development of incipient faults on mains, particularly on D.C. systems; and even on A.C. systems one is obliged to have recourse to such improvised apparatus as can be rigged up from available spare transformers, etc., unless one is fortunate enough to possess special equipment for the purpose. Although a few suggestions are submitted for breaking down faults, there is ample scope for the exercise of ingenuity, and no one universal arrangement can be recommended.

The only general recommendation which can be put forward is that, for dealing with L.T. faults an undertaking should possess a single phase transformer rated at a few kVA with its secondary winding subdivided into two or more sections, which can be easily connected in parallel or in series, capable of giving secondary pressures up to 1 000 volts. A similar transformer suitable for giving pressure up to 10 000 volts would have a wider application as it could be used for the high pressure mains, but there are limitations respecting size and transportability as has already been mentioned in the chapter on pressure testing, although to a certain extent these difficulties can be overcome by having the transformer designed with an open iron circuit. This feature enormously increases the magnetizing current of the transformer, which has the opposite effect to the charging current of the cable, so that the lagging current tends to neutralize the leading current, thereby reducing the kVA input of

the transformer. The uncertainty of the pressure resulting from the combination of the lagging and leading currents leads to a possible approach to resonant conditions in some instances, dependent upon the length of cable under test, and it is not safe to compute the pressure applied to the cable from the primary voltage of this type of transformer; an H.T. voltmeter connected to the cable end is a necessity. A three-phase instrument potential transformer with two of the primary windings used as an auto transformer is a useful method of applying double phase-to-neutral voltage to a short length of L.T. cable for fault reduction (see Fig. 57, page 145).

Intermittent mains faults whose effects do not cause much inconvenience are, as a matter of expediency, often left until they develop fully of their own accord.

On D.C. systems, the application of pressures exceeding the working pressure for breaking down a fault is almost an impossibility unless a rotary converter and transformer as described are available to supply the necessary A.C. or, unless, as can only be done in isolated cases, for a neutral fault, the neutral can temporarily be connected to an outer for the purpose of breaking down.

In the case of impregnated paper-insulated concentric cables, it is doubly important to break the fault down without loss of time. An injury to the lead-covering of the cable will cause a fault to develop between the outer conductor and lead, due to moisture soaking into the insulation. If this fault is discovered soon enough, the moisture will not have had time to reach the insulation between the inner conductors, and, this insulation being still intact, the inner conductor can be used to make up the loop for the localization test (see Chapter VI, page 157). But if one has waited too long, a fault will have developed between the conductors as well, reaching a very low resistance when the fault to earth is broken down, if not before.

If that were to happen, another return wire is required to make up the loop, and, should this not be available, nothing remains but to use one of the methods of localizing without a return wire described in later chapters; or, if the resistance of the short-circuit is small, to localize it as a short-circuit as explained in the same chapter. These methods do not give nearly such accurate results as a

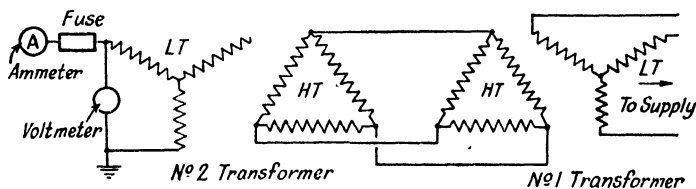

FIG. 56. BACK-TO-BACK TRANSFORMER CONNECTION FOR BREAKING DOWN FAULTS

loop method, and it is always worth while to put oneself to some inconvenience to form a loop.

On polyphase A.C. systems, an earth fault can sometimes be reduced in resistance by using two transformers connected "back to back," as shown in Fig. 56, and earthing one phase of the L.T. side on No. 2 transformer, isolating the neutral, and connecting another phase to the faulty cable core through a fuse. Transformers used for regular service should not be subjected to too much of this treatment as the L.T. winding of star connected transformers is not usually designed for working at the phase pressure to earth. Most transformers nowadays are star wound on the L.T. side.

A liquid resistance, not shown in the diagram, should be inserted between No. 1 transformer and the source of supply so that the pressure applied to the faulty cable can be regulated. When the fuse shown in the diagram has blown, a megger test should be made to ascertain if the resistance of the fault has been lowered. This fuse should

not be too heavy—20 to 30 amperes fusing current is ample.

If after repeated blowing of fairly light fuses the fault does not appear to have had its resistance reduced, the fuse should be progressively stiffened on successive trials until the lightest fuse which will hold in has been determined, and then the pressure should be lowered as soon as the ammeter has recorded the passage of fault current, allowing current to pass at a reduced value for a few moments.

This process will generally bring the fault resistance down to a low value, sufficient for localizing with accuracy, but care must be taken not to continue passing current through the fault

too long or at too heavy a rate, or the conductor may be burnt through, which will add enormously to the difficulty of localizing.

These suggestions for reducing the fault resistance are equally applicable to intermittent and established faults of a few thousand ohms resistance, which cannot always be localized with a great degree of accuracy.

Faults between phases on L.T. cables can be similarly developed with a transformer wound for a higher primary voltage than the supply, or the H.T. winding of a normal supply voltage transformer can be used, connected as in Fig. 57.

Where the primary winding is used the operator must remember that the H.T. windings will be at a dangerous potential.

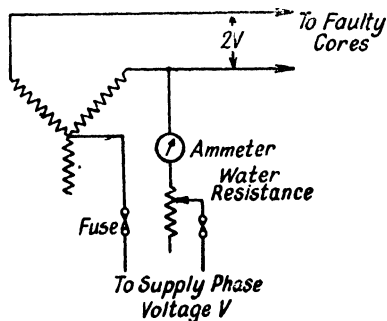

FIG. 57. USE OF STAR WINDING AS AUTO-TRANSFORMER

Most undertakings now have high tension feeders operating at 6 600 or 11 000 volts; whence spare transformers are often available for breaking down a fault by the method just described.

No undertaking, however, enjoys complete immunity from faults on the L.T. network, and, for the time and inconvenience saved, the purchase of a small 230:1 000 volt transformer at the cost of a few pounds is well warranted.

With an L.T. cable, unless it can be completely isolated from all switchgear and connections, the breaking down voltage applied should not exceed 1 000. When it is found necessary to resort to breaking down a distributor fault, the services connected thereto should be first cleared or a crop of burnt-out meter shunt coils will result, and damp or dirty service cut-outs should be dried and cleaned previously to applying pressure, or other faults will be produced.

To control the current, a water resistance is best, and it should be arranged so that some delicacy of adjustment is possible; the simple expedient of lowering one electrode by a piece of rope or its connecting wire into the electrolyte is clumsy and risky. In the absence of a properly constructed piece of apparatus Fig. 58 shows a simple arrangement which does not take many minutes to fix up.

Clean water should first be employed for the electrolyte, and a preliminary trial should be made so that an idea can be formed of the depth of immersion of the electrode and the amount of salt or soda which must be added to the water. A 2 in. french nail driven home at about the point of balance pivots the triangular lead electrode so that it can be very nicely adjusted. An ordinary bucket three-quarters full of water will dissipate the heat developed in this crude resistor.

Before attempting to locate the fault by any of the

methods to be described, its condition should be diagnosed along the lines of the suggestions made in Chapter I to enable the selection of the appropriate test to be made.

Faults on A.C. systems usually take longer to develop naturally than those on D.C. systems, because endosmose effects accelerate development in the latter on the negative mains. A.C. on the other hand tends to disperse

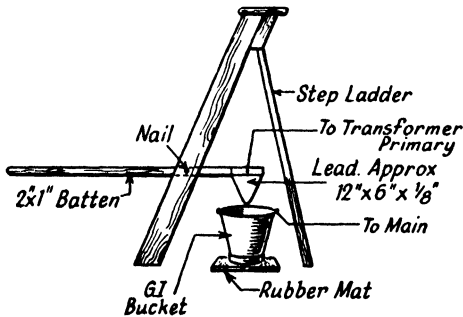

FIG. 58. IMPROVIZED WATER RESISTANCE

moisture, and where its admission into a cable is the primary cause of a fault, it will generally be found to have penetrated further.

MAINS RECORDS

A most necessary adjunct to the successful application of any location test is the possession of accurate mains records. The exact length, sectional area of cable conductors, position of disconnecting boxes, service joints, and connected branches should all be known and accurately charted, or much time and money are wasted in searching for the cable on completion of a localization test. Mention of this is made because quite a number of undertakings, particularly those operating old mains systems, lack this information in detail.

The method of treatment when the sectional area of the copper varies along the cable run and when branches are solidly connected is described under the heading "Making up the Loop" in Chapter VI.

HIGH TENSION CABLE SYSTEMS

The isolation of a fault to a particular feeder is a simple matter compared with the L.T. network problem. With modern systems upon which protective systems are installed, the tripping of certain circuit breakers and the dropping of relays tell one at once on which feeder and phases the fault has occurred. Assuming that the fault is in the cable, its isolation from transformers and switch gear occupies but little time, and again if the fault resistance is low, its condition is readily diagnosed as has been described in Chapter I. Sometimes isolation can only be effected up to the transformer windings where the cable box is integral with the transformer, or up to the incoming switch terminals where the cable sealing box is incorporated in the switchgear, in which cases the cable terminations must remain in circuit during location tests, as it is never worth the expense of breaking open these boxes before testing. To do so, moreover, would introduce a risk of having the accessory in a weakened state after reconstruction.

As some switchgear manufacturers embody current transformers in switchgear cable sealing boxes, some knowledge of their design is desirable; generally their resistance and that of connections is negligible, but, especially when localizing on cables of comparatively large section, they may affect the accuracy of the test result.

Solid branches are rarely made to high tension feeders; at the most their number would be limited so that if isolation of a fault has to proceed somewhat along the

lines of that in an L.T. network, the eliminating process is much simpler. Loop localization tests on branched mains are described in Chapter VI.

As soon as a fault is suspected by the operation of discriminative protective apparatus or the tripping of circuit breakers, before attempting to re-close the switches, a megger test should be made. Serious damage to switch-gear and great risk of injury to personnel may result from closing a breaker on a faulty feeder. Some operating engineers on smaller systems will close repeatedly on a fault in the hope of fully developing it, with little thought of the damage consequent upon their action and the difficulty they add to the task of localizing. On larger systems, however, the immense power source behind a fault dictates special precautions before closing on a suspected feeder. This is only done as a last resource with the lightest possible breaker setting, and with time-lag fuses withdrawn, after all other efforts to isolate the fault have failed.

Some large undertakings will not even go to this extent when a definite fault indication has occurred. Their procedure is to apply a D.C. pressure test, as the discriminative action of protective devices such as the Merz-Hunter or the Beard-Hunter is so delicate that the fault scarcely has time to develop before the switches trip. Faults of this description, as well as those of the intermittent type, can only be reasonably developed by the application of high pressure D.C. The use of A.C. is often precluded by the size of the transformer necessary to charge the cable above its working pressure if its length is considerable, for, as previously stated, one would not run the risk of putting the normal operating transformers in series to obtain the requisite pressures. One hesitates to apply more than 50 per cent A.C. in excess of the working pressure on a high tension cable that has been operating some years.

for fear that irreparable damage may be caused in sound parts of the cable.

BREAKING DOWN INTERMITTENT FAULTS WITH HIGH PRESSURE D.C.

D.C., on the other hand, can safely be applied with impunity up to twice the working A.C. pressure (R.M.S. value) even on reasonably old impregnated paper insulated cables.

The apparatus described in Chapter III is well suited for burning out faults, although a less expensive equipment can be improvised if valves are at hand. For example, the transformer supplying current to be rectified can be a spare instrument potential transformer. If two valves such as the G.E.C. No. 1 type, page 69, are available, one can utilize the two-valve arrangement described on page 92, Fig. 37, to obtain D.C. pressures of 2.8 times the normal phase voltage by connecting two phase terminals of the potential transformer to the rectifying circuit. On a good standard British-manufactured cable this maximum D.C. pressure can be safely applied between cores or between cores and earth provided the cable is designed for unearthed neutral working. If it is designed for earthed neutral working, either one valve used with the phase pressure, or two valves with one H.T. phase and the star point terminal of the potential transformer connected to the rectifying circuit, will give sufficiently high D.C. pressures for breaking down faults. As in any of these arrangements the maximum available pressures can be confined to safe limits according to the design of the cable, it is possible to dispense with a voltmeter connected directly to the cable; in any case, for fault-burning purposes, one would naturally confine operations to the faulty cable disconnected from overhead lines and any other equipment, and it would be reasonably safe to

estimate the maximum pressure applied to the cable during the process by the ratio of the transformer and the rectifying factor, viz. 1·4 or 2·8, according to whether one or two valves were used respectively.

The valve filaments can be incandesced by storage batteries supported on insulated stands. There is little difficulty nowadays in securing these. The only trouble is

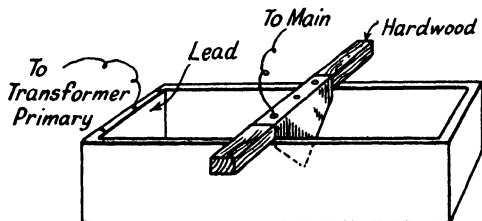

FIG. 59. WATER RESISTANCE FOR D.C. CONTROL IN H.T. D.C. TESTING

that when the fault is particularly obstinate, small batteries are apt to run down before the breaking down process is completed.

Control of the primary voltage of the transformer is best effected by a water resistance, the water being salted only slightly at the commencement of operations so that ample range of D.C. voltage control is possible during the initial charging of the cable. Some hard tap waters require very little salting for small currents. An improvised resistance which works excellently can be made from a hardwood box run inside with hot pitch to make it water-tight, with a triangular lead electrode fixed to a sliding insulated bar and a fixed electrode fastened to one end as shown in Fig. 59. A convenient size for the box is 15 in. long \times 10 in. wide \times 6 in. deep. Sliding the moving adjustable electrode towards the fixed one increases the transformer voltage. An open circuit trial should be made before connecting the cable, to check the suitability of the electrolyte.

A resistance should be placed between the valve and the cable, and a milliammeter scaled up to 100 milliamps is necessary in the H.T. D.C. circuit, suitably insulated if on the high potential side, which, incidentally, is its best position.

Pressure is raised on the cable in the same way as when conducting a normal D.C. test, that is by limiting the charging current to a few milliamperes.

If the fault rapidly develops, no readable voltage will be recorded by the voltmeter, which should be connected across the primary of the H.T. transformer in the absence of an H.T. voltmeter connected to the cable, but a fairly heavy current (comparatively speaking) will be observed on the milliammeter. This current should be gradually increased by the H.T. transformer primary voltage control until 40 to 60 milliamperes is reached, by adding salt or soda to the water resistance. The maximum current should be maintained for only a few minutes, after which the cable should be disconnected and its insulation resistance should be measured by a megger. It is advisable to repeat the megger test after a short interval, as sometimes a fault will seal up after yielding to the application of D.C. If the fault remains at a few thousand ohms after the first applications of the H.T. D.C., it is unwise to try and finish off by connecting the cable directly to the L.T. mains through a light fuse, because the chances are that a fault which was initially obstinate enough to need H.T. treatment will re-seal after a large current is passed through it.

When the fault resistance finally appears to be stable at a low value, it is a good plan to burn a single 60-watt lamp through it as a sort of last finishing-off process, as, in spite of apparent stability, it may still seal up while the localizing apparatus is being connected up; 230 to 240 volts D.C., if available, should be used for this final

burning, because A.C. is misleading; a mile or more of perfectly sound 11 000 volt cable has a capacitance which will pass enough current to light a 60-watt lamp fairly brightly, and this may be mistaken for fault current.

If no L.T. D.C. is available two or more lamps in parallel can be used with A.C. which will enable one to distinguish better between capacitance and fault current, but the current should be kept within such limits as is just necessary to obtain this indication. Nothing is more annoying than to have a fault seal itself after some hours have been spent in breaking it down, and to have to repeat the whole process; unfortunately this does sometimes happen.

Some faults are very obstinate and hours of work are necessary to break them down finally with D.C., but patience usually wins in the end. The time occupied may be as long as 24 hours, but the results are well worth waiting for.

The type of fault in a cable which only makes itself evident occasionally, and on which the circuit breakers can be closed and will hold in after its rare appearances, usually takes some time to break down. It has already been intimated that A.C. over-pressures are practically useless for faults of this kind, whose characteristic behaviour under D.C. is that the cable acquires a charge of anything up to twice the working voltage, and then suddenly discharges through the fault, allowing the voltage to rebuild to a similar value, discharging again and so on, hundreds of times repeatedly, before the voltage at which discharge at the fault occurs is low.

Very often a tendency for the discharge voltage to *increase* will be observed. This can be taken as a fairly good indication that a confined cavity from which gases cannot readily escape has formed at the fault. This may occur in the filling compound of a joint or end sealing chamber. The effect of repeated discharges of the energy

in the cable at the fault, is to build up a lip of carbonized material, in the same way as a lip forms round the crater of a volcano, which ultimately forms a conducting path, bridging the cavity. This process must necessarily be very slow because the time duration of each discharge current is only a few micro-seconds and its magnitude is dependent upon the quantity of electricity held in the cable immediately prior to each discharge.

The effect of gas pressure at the fault is to increase the spark over-voltages, and sometimes this is so marked as to enable the fault to withstand the full normal D.C. pressure test for half an hour or more. By waiting an hour or two the gas will disperse, and then a further trial can be made when the fault may arc over at a lower pressure.

Between each discharge, the initial recharging current recorded by the milliammeter will be high because the transformer will be well excited. This current is sometimes mistaken for current passing through the fault. All the time the transformer primary voltage or the cable voltage continues to rise and the charging current to fall with time between discharges, no arcing at the fault is taking place, indicating that the latter has not fully developed. It is not safe to attempt to localize with H.T. while this condition prevails, because, as the fault arc resistance is low, oscillatory disturbances occur which will burn out the galvanometer in the loop test, which will be described in Chapter VII. Moreover, the succession of transient disturbances makes a balance very difficult or impossible to obtain.

What one observes is a sequence of kicks on the voltmeter and milliammeter pointers, at a frequency depending upon the voltage at which the fault arcs over and the rate of charging. When the cable is long, the transformer voltage should be reduced immediately after a discharge has taken place to reduce the re-charging current and

consequent strain upon the valve, transformer, and cable ; this requires a little skill in manipulation, but is well worth trying.

With a high resistance fault it is recommended first to apply D.C. between each core and earth in turn (with the others free) for a few minutes, to see which core appears to be the easiest to break down. A similar trial can be made with pressure applied between pairs of cores, leaving the remaining one free, and the condition which appears most likely to yield should be retained. In this way there is a greater chance of retaining one core of the cable in a sufficiently sound condition to enable a loop test to be carried out. Every endeavour must be made to do this unless one is fortunate enough to have another sound cable available for completing the return of the loop.

The ultimate result of the repeated discharges will be that the fault will finally break down, allowing 40 to 60 milliamperes to pass steadily through the fault, while no appreciable voltage on the cable can be observed. To pass a current of this order, the resistance between the valve and cable can be removed. Again, when breakdown appears to be complete, this current should be reached only by gradual increase, because from what has been said of the nature of obstinate faults, it will be appreciated that the low resistance path at the fault may be only a few shreds of carbonized material, easily fused. The maximum available H.T. D.C. current should be passed through the fault for five or ten minutes to ensure its permanency. As this current is never more than a fraction of an ampere, there is no risk of burning through the conductor. The "finishing off" process with a lamp previously described is then best omitted, lest the fault re-seals itself in consequence ; recourse is then made to the loop test, using the valve apparatus in place of the battery for localization, as will be described in Chapter VII.

A rough idea of the fault resistance can be formed if the cable end is dead earthed while the current from the valve is passing, and the increase of current observed. If the valve impedance is known (usually given by the manufacturer) to be, say, R , and the fault resistance is F , then if I_1 is the current observed on the milliammeter while burning the fault, and I_2 that when the cable end is dead earthed.

$$F = R \left(\frac{I_2}{I_1} - 1 \right) \text{ approximately.}$$

If the difference between I_2 and I_1 exceeds 10 per cent the burning process should be continued in an endeavour to reduce this difference, because the lower the fault resistance the less likelihood of re-sealing.

Preparations for making the localization test should be completed with the least possible delay on completion of the burning process, as it is no unusual thing for a fault to re-seal in an hour or so after it has been burnt to a low resistance.

Although successful localization tests can be made with quite primitive apparatus on short lengths of cable (all that is absolutely necessary being a galvanometer and some wire), properly constructed and sensitive apparatus is an essential possession for the longer H.T. feeders for quick work and accurate results. An error of 1 per cent, it must be remembered, means 35 yards on a cable one mile long, that is to say a loop of two miles. The undesirability of an error of this magnitude is at once apparent when expensive road surfaces must be dug up to gain access to the cable. Suitable apparatus is described in the chapters on loop tests which follow.

CHAPTER VI

LOOP TESTS FOR LOCALIZING FAULTS IN LOW AND MEDIUM PRESSURE CABLES

WHEN John Murray, a telegraph electrician, while acting as an assistant to Lord Kelvin during the laying of the first Atlantic cable in 1858, hit on a loop method of localizing faults in cables, twenty years before the invention of the incandescent lamp, he little dreamed that his name would be handed down in electrical history, not as a telegraph pioneer, but as the author of the most useful method of determining the position of faults in electric light and power mains, things unknown at that date. The Murray loop method is still by far the best means of localizing the majority of cable faults, and its greatest merit is in its simplicity. It is, to us latter-day electrical engineers, almost an obvious application of the Wheatstone bridge, equally due to a telegraph pioneer.

Referring back to the diagram of the Wheatstone bridge in Chapter II (Fig. 21, page 52), we can re-draw it as Fig. 60, replacing the arms x and y by a length of cable having a fault at F , and connecting one pole of the battery to earth instead of directly to the bridge. This battery connection thus reaches its proper corner of the bridge through the fault, and, when the bridge is balanced by arriving at the proper ratios between r and q (i.e. no current passing through the galvanometer on the depression of the galvanometer key while the battery key is held down), we have the same ratio as before, viz.

$$\frac{r}{q} = \frac{x}{y} \quad \dots \quad (28)$$

If $l = x + y$, the resistance of the loop of cable, and

$s = r + q$, the sum of the resistance of the other two arms, we can write this equation

$$\frac{r}{s} = \frac{x}{l} \text{ or } x = \frac{r}{s} l \quad . \quad . \quad . \quad (29)$$

The resistance between the end of the cable C and the fault is thus the fraction r/s times the resistance of the

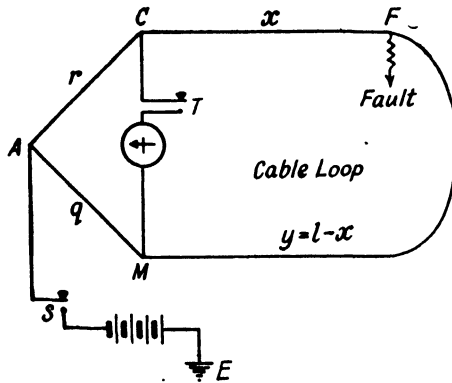

FIG. 60. MURRAY LOOP TEST

cable. This is the original formula for the Murray loop localization test.

But we can go a step further. r/s is the ratio of two resistances, and therefore a simple fraction. If the cable is of the same sectional area throughout, and is connected directly to the terminals C and M, we can consider l as its length in yards instead of its resistance, and then x is the distance in yards of the fault from the end of the cable connected to C. We have merely to multiply the length of the loop of cable by the ratio r/s to find where the fault is.

THE SLIDE WIRE BRIDGE

Still another simple step. If s is not a series of resistance coils, but merely a long wire, say 1 000 mm. long stretched

over a graduated scale, and the point A carrying the battery connection is a sliding contact which we can move along the stretched wire until balance is obtained, we have only to read off on the scale under the stretched wire the distance in mm. of A from the terminal C, multiply it by the length of the cable in yards, and divide by 1 000, and we are given the number of yards we must measure along the cable from the end C to find the fault.

It seems almost too simple. But there is no catch in it, only a few precautions to be taken, which will be dealt with later. All we need assume for the moment is that the cable ends are actually brought to the terminals C and M, and that the fault is a dry fault to earth through the lead sheath of the cable, let us say. The allowances to be made for indirect connection to the terminals and for wet faults will be considered in their proper place, but meantime it will be noted that the resistance of the fault itself does not enter into the calculation, but merely, if it is too large, unduly limits the current available for the test.

If we can secure the conditions of direct connection of the cable to the terminals of the slide wire, as it is called, this wire need not be inordinately long. The length of 1 000 mm. already mentioned, the almost classical metre bridge, will permit of the slider being set to the accuracy of half a mm. or one part in 2 000, and if the cable loop is 2 000 yd. long we shall have localized the fault to within a yard if our battery power is adequate, the fault resistance low, and the galvanometer sufficiently sensitive.

For localization tests on the Murray loop method, keys are required in the battery and galvanometer circuits as for the Wheatstone bridge, and the battery key should first be depressed for sufficient time to enable the current to become steady before operating the galvanometer key. The contact key on the slide wire serves for the battery

key T, and this must always be released before moving the slider. The slide wire can be made of any uniformly-sectioned resistance wire such as platinoid, manganin, nichrome, or any other high resistance alloy. For a test with improvised apparatus, a piece of such wire or even a long stretch of tinned copper binding wire, if nothing else is handy, may be soldered to the two ends of the faulty cable loop, and if the lengths between the cable ends and the point of balance of the adjustable contact A are carefully measured, there is no reason why the test, even with such crude apparatus, should not be accurate if care is taken to eliminate the effect of contact resistances (see page 179). The metal of which the wire is composed and its thickness is not important so long as it is homogeneous, of equal section throughout, and of sufficient thickness to stand the current employed for the test, without perceptible heating. Care must be exercised in this matter, even if resistance alloys with negligible temperature coefficient are used. Such alloys have very marked thermo-electric E.M.F.'s in contact with other metals, which may introduce disturbing factors or even serious errors. This caution is equally necessary when using resistance boxes for the variable arms, because apart from the risk of burning out the coils, thermo-electric E.M.F.'s due to excessive currents can be generated where they are soldered to the connecting blocks or terminals.

But however accurate may be the tests which it is possible to carry out with rough or make-shift apparatus, a carefully constructed and properly designed instrument is always best in the long run, especially when used for emergency work such as fault localization often is. One such instrument is the Raphael direct-reading fault localizer, made by Messrs. Muirhead & Co. It is particularly suitable for quick localization tests on comparatively short cables. To secure lightness and portability the slide

wire is kept down in length, but the direct reading principle, by which the position of the fault is read off directly in yards, can be applied to any slide wire provided with two movable contacts instead of one. To make this principle clear, Fig. 60 is re-drawn as Fig. 61, with two arms CAM representing a straight slide-wire stretched

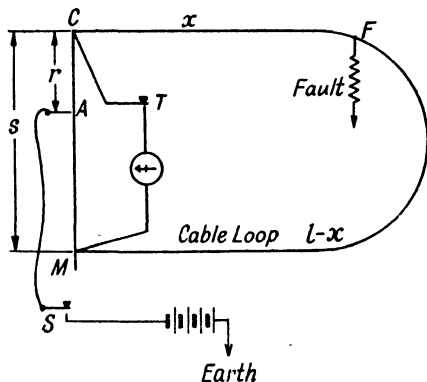

FIG. 61. DIAGRAM OF SLIDE WIRE BRIDGE

over a scale with the zero end at C. A is the sliding contact to make the battery connection. The terminal M, instead of being fixed, can also be moved to any position on the slide wire. If it is clamped down to a reading on the scale corresponding to the length l of the cable loop, the position r of the slider A when the bridge is balanced will indicate directly the exact distance of the fault from the testing point C.

The actual instrument as constructed by Messrs. Muirhead & Co. is shown in Figs. 62 and 63. A wire of hard and high-resistance material is stretched on a board opposite a scale graduated from 0 to 1 000. A cursor, or "sliding jockey," S, slides on a brass rod and carries a contact edge on each side, being so arranged that either one contact edge or the other can be pressed down tightly

on to the wire at any point and clamped in position. This connection marks off the length of the slide wire employed in the test, and in making the test the slider is set so that this reading is the length (or equivalent length—see page 168) of the loop. The ordinary connections having been made, as shown in the diagram, the other contact maker, or “portable jockey,” is adjusted until the bridge is balanced, the key on this jockey being pressed first, and

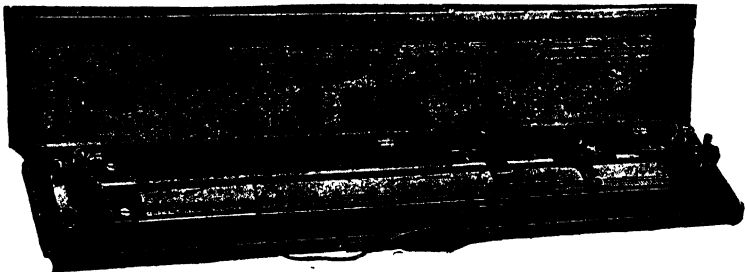
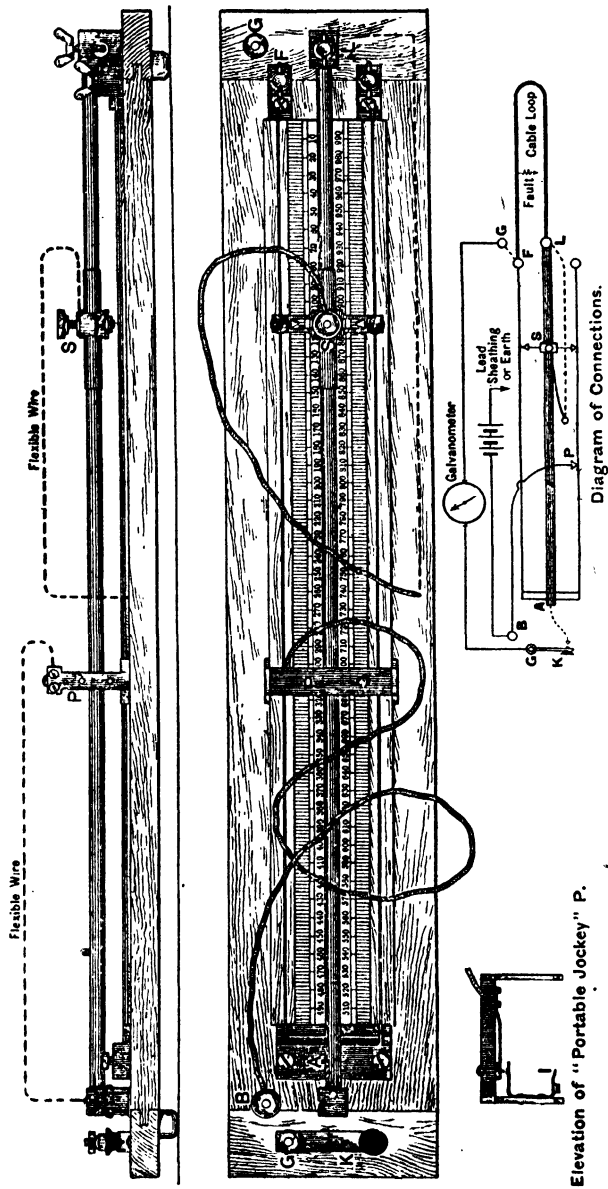

FIG. 62. RAPHAEL DIRECT-READING FAULT LOCALIZER

then the galvanometer key on the left. This slider, it will be noticed, has a contact for the wire at one side only, and it can be turned to either side of the wire, the index I, clearly seen below the narrow ebonite top of the jockey, rendering a mistake impossible. It may be mentioned that, in making the instrument, the index of the “sliding jockey” S is set back slightly with reference to the contact beneath it, to compensate for the slight contact resistance at the surface of the wire. When balance is obtained, the distance of the fault from the terminal F is shown by the index on the “portable jockey” P. If the wire is clean, absolute accuracy to within less than one scale division has been found possible in a localization test on a loop of cable.

To obtain the equivalent of a very long slide wire—without the direct-reading device, however—Mr. Trubie



Elevation of "Portable Jockey" P.

FIG. 63. DRAWING AND DIAGRAM OF DIRECT-READING FAULT LOCALIZER

Moore has employed the following arrangement: A platinum wire one metre in length, of about 1.5 ohms resistance, is stretched on a metre scale, and a contact-maker slides upon this wire. In conjunction with it there are 18 non-inductive resistance coils, each of the same resistance as the stretched wire, and connected to selector switches in such a manner that there are always nine coils and the stretched wire between the terminals, and so that the stretched wire may be made to take up any position in the sequence of the coils. This arrangement, it is seen, allows the equivalent of a longer range of scale than with the ordinary stretched wire bridge.

Fig. 64 is a fault localizing slide wire set manufactured by British Insulated Cables, Ltd. The slide wire is wound in a spiral groove on a drum about 3 in. in diameter, embodied in the centre instrument, and the wire is approximately 80 ft. long. The drum is turned by a handle at the side, and a contact, attached to a leaf spring and connected to the battery, traverses in the direction of the axis of the drum as it is rotated, and can be depressed so as to make contact with the slide wire. The ends of the latter are soldered to brass plates, one at each end of the drum, to which contact is made by two strong metal brushes connected to the cable loop terminals. The galvanometer is normally connected to the cable ends with a contact key which operates in conjunction with the battery key.

Each turn of the drum moves the sliding contact one division indicated on the horizontal scale divided into 100 divisions; and a circular scale at the end of the drum, divided into 100 divisions, indicates fractions of a turn. This enables observations to four significant figures to be made. This bridge is excellently suited to long cable loops, because the accuracy of the scale reading is equivalent to 1 in 10 000.

Exceptional care is necessary to avoid heating the slide wire of this bridge, since its long length permits enough expansion to make the wire ride out of the spiral groove when heating is only comparatively slight. Also the

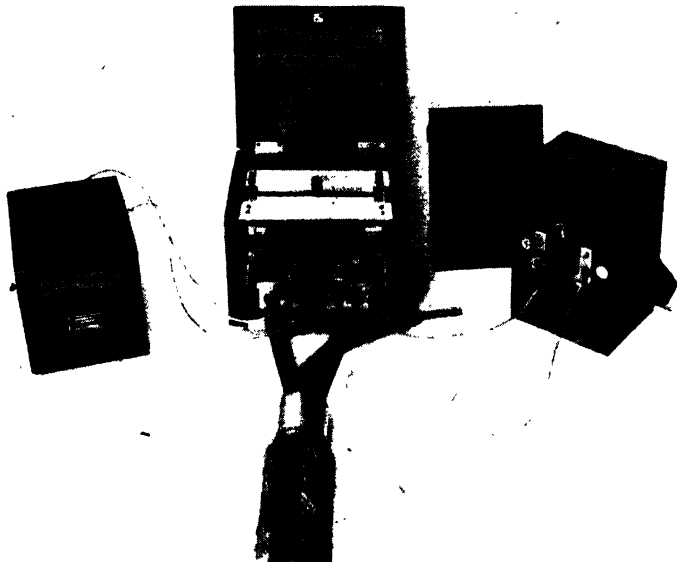

FIG. 64. B.I. LOW-TENSION LOCALIZATION SET, CONNECTED UP

drum should not be revolved when under pressure on the sliding contact; this tends to stretch the wire.

With all slide wire bridges, it is necessary to exercise caution when the fault is of very low resistance and it is found that balance is being obtained on the slide wire near to one end. This means, of course, that the fault is close to that end of the loop, and an examination of Figs. 60 and 61 will show that there will then be a very low resistance between the two battery terminals on one side

of the bridge. Overheating of the slide wire is possible under these conditions, and also heating and sparking at the moving contact A, which can damage the slide wire and contact. Such conditions are quickly noticed, and can be overcome by reducing the battery to a single cell if necessary, or by inserting a resistance, such as a few yards of wire, in one of the battery leads.

On D.C. systems, when the localization test is made on a cable loop entirely disconnected from the rest of the network, as is assumed to be the case for the moment, quite good results can be obtained by using a connection to the live mains instead of a battery. The battery key S (Fig. 60 or 61) is then connected through a 60-watt lamp to one of the outers, and the earthed neutral takes the place of the other pole of the battery. It is essential when testing in this manner that all the apparatus is well insulated from earth to prevent stray leakage from affecting the accuracy of the test and stray shocks upsetting the equanimity of the operator. A 60-watt or 100-watt lamp will allow quite sufficient current to pass if the fault has only a few ohms resistance to earth and the galvanometer is fairly sensitive. If it is found that the current is not sufficient to obtain clear galvanometer deflections on either side of balance of the slider, so that an accurate setting for balance is not obtainable, a few lamps in parallel may be used so as to allow more current to pass, and if it has been found impossible to break down the fault lower than to a few hundred ohms resistance, the battery key can be connected directly to the main through a fuse.

Similarly, if a battery is used, one of higher voltage will be required the higher the resistance of the fault.

MAKING UP THE LOOP

To localize a fault by the loop method, a complete circuit of cable is necessary, from the testing station,

through the faulty section, and back to the testing point. This circuit is called the "loop." The different sections of cable forming the loop need not be of the same sectional area; it is only necessary that there be two independent paths of good insulation resistance from the testing point to the fault. In the case of a fault in a feeder consisting of single core cables, the simplest way to get the loop, if the other feeder of the pair is sound, is to connect the faulty cable with its fellow cable at one end, and to test at the other end. It must not be forgotten, however, that the cable employed to complete the loop must be sound. A common error is to suppose, for instance, that in the case of a burn-out on a concentric cable, which has not only connected the outer to the lead and earth at the fault but has also short-circuited the two conductors, an accurate loop test can be made by short-circuiting the cable at the far end. This would only be possible on a concentric cable if the outer had developed a fault and the insulation of the inner conductor was still intact. In the case of a concentric cable in which an earth fault and a short-circuit have developed simultaneously, therefore, a second cable must be employed to make up the loop, and, failing this, one of the methods for localizing short-circuits described in Chapter X must be employed.

Again on a D.C. single-core cable system, if there is a fault on a distributor which has a clear run between two feeding points and a test in the street must be avoided, a natural loop is formed by two feeders of the same polarity and the length of distributor between them. On the other hand, if street testing is possible with anything approaching accuracy, better results may be obtained by taking the pair of distributors between two feeder pillars or section boxes to make up the loop. One can come to closer quarters still by short-circuiting at a service box, and, on the other hand, if things are jointed up too "solid" to get at

conveniently otherwise, the short-circuit to form the loop may be made at a consumer's main fuse. The chief points to be aimed at, in fact, to get the utmost accuracy are that the loop should be as short as possible, of as large sectional area as possible, and with as few connections as possible. Every connection introduces a possible error due to contact resistance.

If multicore cables are used for distributors or feeders the above considerations generally apply, except that if the insulation of one core remains intact, this core can be used for the return of the loop, thus avoiding the need of making dead another cable for the purpose. Needless to say, the loop test can only be successfully made in any case provided that no severance of conductors forming the loop occurs at the fault. This should be checked by the methods described in Chapter I, or better still a resistance test of the loop should be made, which can be checked by the known length and sectional area of the conductors.

EQUIVALENT LOOP LENGTH

If the loop has to be made up of several lengths of cable of different sectional area, to facilitate calculations, the length of the loop should be reduced to the "equivalent length" of the size of cable in which the fault is, that is to say, to the length of that sized cable which would have the same resistance as the loop. If a and b be the sectional areas of two conductors A and B, the length of B, which would have the same resistance as unit length of A, is b/a . The following example is given to show this process; it is merely selected for the purpose of explanation, as, in practice, it would not often be necessary to adopt so roundabout a way to make up the loop. In the example the sizes of the cable have been assumed to be S.W.G. sizes, such as might be found on an old network, to emphasize the necessity of using accurate sectional areas in the

calculations. It is not sufficient to work with the nominal sectional areas from the usual tables. In the Appendix convenient tables are given both of the present standard sizes and the old gauges. The loop in Fig. 65 is made up of 340 yd. of 19/18 S.W.G. cable, 105 yd. of 37/16 S.W.G. (the faulty section), 84 yd. of 19/16 S.W.G. and 529 yd. of 19/18 S.W.G.

The sectional area of 37/16 cables may be taken as 37×0.003217 sq. in. The sectional area of 19/18 cables may be taken as 19×0.001810 sq. in. Therefore the length of 37/16 cable, which would have the same resistance as 340 yd. of 19/18 cable, is

$$\frac{340 \times 37 \times 0.003217}{19 \times 0.001810} = 1\ 177 \text{ yd.}$$

The piece of 19/16 cable is equivalent to

$$\frac{84 \times 37}{19} = 163 \text{ yd. of 37/16 cable.}$$

The next piece of 19/18 cable is equivalent to

$$\frac{529 \times 37 \times 0.003217}{19 \times 0.00180} = 1\ 831 \text{ yd. of 37/16 cable.}$$

This is shown on the diagrams (Figs. 65 and 66). The length of the loop taken for the calculations of the test is then $1\ 177 + 105 \times 163 + 1\ 831 = 3\ 276$ yd. If the result given by the localization test is that the fault is 1 270 yd. from the end A, the position of the fault will be $1\ 270 - 1\ 177 = 93$ yd. from the point C.

In cases in which it is not known which is the faulty piece of cable, the length is taken as the equivalent length of the cable of largest section. Suppose, for example, there is a fault in the loop just considered (Figs. 65 and 66), and that the position of this fault works out to 1 380 yd. from the end A. Then it is apparent that it is in the section

DE, and at the *equivalent* distance of $1\ 380 - 1\ 177 - 105 = 98$ yd. from D. But as this section is of 19/16 cable, and not of 37/16, the *actual* distance from D will be less, in fact

$$\frac{98 \times 19}{37} = 50 \text{ yd.}$$

In all cases where reference to a "loop" has been, or will be made, "equivalent length" is implied.

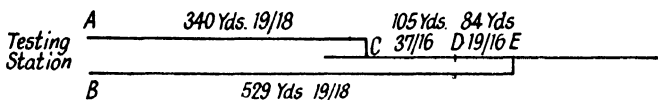

FIG. 65. CABLE LOOP OF DIFFERENT SIZES

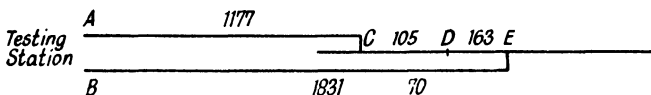

FIG. 66. EQUIVALENT LENGTHS OF FIG. 65 IN TERMS OF 37/16 S.W.G.

It is always a good plan to reverse the connections of the loop on the bridge, and to make a second test as a check on the first. If the positions of the fault indicated by the two tests differ only by a few yards, the mean position should be taken as the correct one. If there is a considerable difference, the connections should be looked to and all contacts tightened. The error introduced by contact resistance and the method of avoiding it will be considered later in this chapter.

Careful note should be made of the connections of cable ends to the bridge to avoid errors in reckoning the fault distance. The position cannot very well be wrongly calculated in a loop of uniform section; but when the return lead is of a different section, a wrong position may

be obtained if one has not been careful to check the point from which distance has to be reckoned.

CONNECTING LEADS

The wires leading from the instrument to the cable should be as short as practicable. Unless they are excluded from the cable arms of the bridge by the method indicated on page 182, they must be considered as part of the loop, and their equivalent lengths must be reckoned in when calculating the equivalent length of the loop. If, for instance, the fault is in a piece of 19/0.064 in. cable, and one uses, say, 1 yd. of 0.064 in. wire to connect up with at each side of the instrument, the equivalent length of the loop is thereby increased 38 yd., 19 yd. at each end. To make an absolutely accurate allowance for the resistance of the leads connecting to the loop the resistance R of the complete loop, including leads, must first be measured, and then the resistance (m and c) of each of the leads. Then the equivalent lengths to be allowed for the leads, in calculating the length of the loop and the position of the fault, are

$$R - m - c \cdot m \text{ and } \frac{l'}{R - m - c} c \text{ respectively}$$

where l' is the equivalent length of the rest of the loop.

The length and size of the wires leading to the battery and galvanometer are immaterial, as their resistances do not affect the result of the test.

The connection between the distant cable ends forming the loop should be as short as possible, and of similar area to the cable conductor; otherwise its equivalent length must be taken into account.

THE RESISTANCE BOX BRIDGE

Something must now be said of the use of a resistance box bridge instead of a slide wire for the arms r and q .

The simple loop test diagram given at the beginning of this chapter is, therefore, repeated below (Fig. 67A), with the methods of connecting up alternatively a "four-dial"

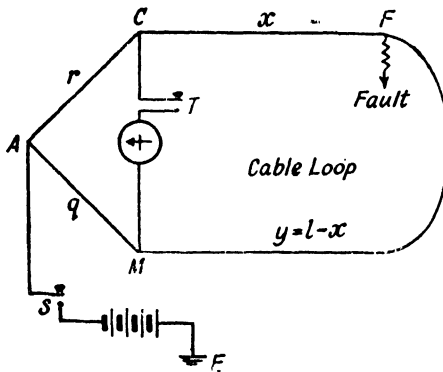

FIG. 67A. DIAGRAM FOR LOOP TEST

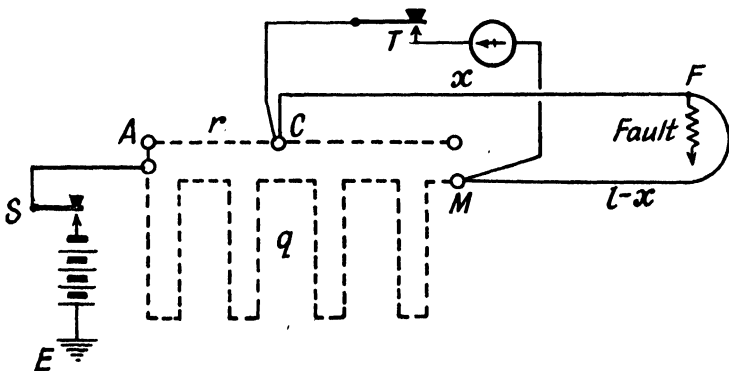

FIG. 67B. LOOP TEST WITH FOUR-DIAL BRIDGE

plug bridge (Fig. 67B) and one of the portable types of bridge used by the Post Office (Fig. 67C), still occasionally the only pattern of bridge available for fault-testing on some undertakings.

The four-dial plug bridge is assumed to be of the pattern shown in Figs. 22 and 25 in Chapter II. The terminal at the right-hand side of the ratio coils must not be used, and one of the two ratio arms serves as the arm r , the four dials constituting the arm q . It will be noticed that different terminals are employed for connecting the battery

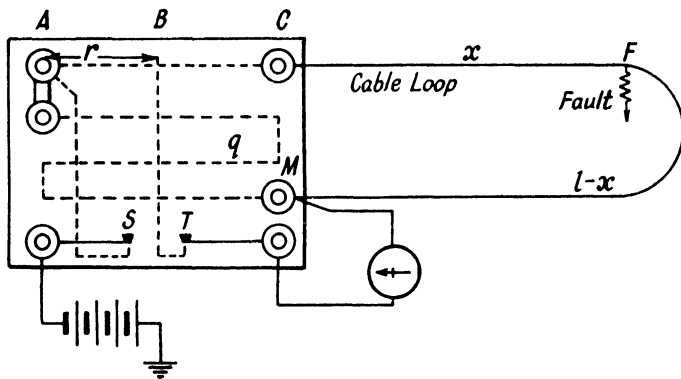

FIG. 67C. LOOP TEST WITH P.O. BRIDGE

and galvanometer from those employed when the apparatus is used as a bridge for plain resistance measurements.

In the P.O. pattern bridge (Fig. 67c) it will also be noticed that the connections differ from those for the ordinary conductor resistance tests, and that the battery and galvanometer keys are not as marked on the instrument; their position is reversed.

In carrying out the test, a start is made with 1 000 ohms in the arm r , which is plugged in with the dial bridge and unplugged with the P.O. bridge. The battery key S is then depressed, and the galvanometer key T is lightly tapped to see in which direction the galvanometer needle turns when *more* resistance is required for the adjustable arm A M. Then the resistance in the arm A M is adjusted till no deflection is obtained on depressing the

galvanometer key T, the battery key S always being depressed first or kept permanently down. If, when all the resistance between A and M is unplugged, the galvanometer still asks for more, the infinity plug should be taken out.* If, then, the direction of the deflection is not reversed there is a mistake in the connections.† If everything is correct and the removal of the infinity plug reverses the direction of the deflection, as it should, this plug is reinserted and $r = 100$ must be tried, and if this fails $r = 10$. If balance can then not be obtained the fault is very near to the end C. Then the connections of the cable loop to the bridge are reversed, r is made 1 000, and A M is adjusted until balance is obtained.

The formula for the distance of the fault from the end connected to C is

$$x = \frac{r}{r + q} l \text{ yards}$$

q being the resistance unplugged between A and M, and l being the length of the loop in yards.

It is to be noted in Fig. 67c that, in the old forms of P.O. bridge, there is no terminal brought out at the point B, the mid-position between the proportional arms. The resistance of the bar between B and C is therefore in the cable loop, since the galvanometer is connected at B (through the key T). It is therefore very essential that the contacts between the plugs and the blocks are exceptionally good as even a small resistance between them may correspond to that of a considerable length of cable loop and so upset the accuracy of the test. The same thing is particularly important in the dial pattern modification

* Some makes of the four- and five-dial bridges have no infinity plug, but the removal of a plug from any one of the "dials" in the arm q effects the same purpose.

† An open-circuit at the fault will also give this effect with correct connections; this should, however, have been ascertained in the preliminary test.

of the P.O. bridge with sliding contacts, and it is essential to see that these should be thoroughly clean.

CONCENTRIC, TWIN, AND MULTICORE CABLES

We will now consider the application of the localization tests to the classes of cable which are commonly used in distributing networks, viz. concentric, twin, three-core, and four-core cables. In concentric cable two cases arise to which reference has already been made. If frequent insulation tests have been carried out, a fault may be discovered in the outer before the insulation between the conductors has given way. More often, however, the earth on the outer is a short-circuit as well. In this latter case the loop must be made up by means of another cable; but if the inner conductor is still well insulated, it may be used to complete the loop, the two conductors being well connected together at the far end.

It is not always accurate to assume that the two conductors of a concentric cable have the same sectional area and the same resistance, and it is well to measure the relative resistances, and record them when the cable is laid, or before. Manufacturers' test certificates should record the true resistance, but it is easy to measure this ratio without actually measuring the resistances. If the two cables be connected together and the junction point is connected to the testing battery, they can be made to form the two arms of a bridge, and the ratio between the slide-wire or resistance box arms at balance gives the ratio between the resistances of the conductors. This is shown in Fig. 68. The lines r and q correspond to the two sides of the resistance-box bridge or slide-wire in Murray's loop method, A being the sliding contact in the latter case. At balance,

$$\frac{\text{Resistance of inner conductor}}{\text{Resistance of outer conductor}} = \frac{r}{q} = Z, \text{ say.}$$

If the cable is laid, and it is inconvenient to run a wire back from the far end for the battery connection, the right-hand terminal of the battery in Fig. 68 may be earthed, and also the junction at the far end of the cable, provided, of course, that the insulation of the cable is still good. This ratio is recorded, and when subsequently a localization test has to be made, the length of the loop

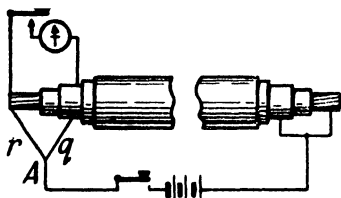

FIG. 68. RESISTANCE RATIO OF CONDUCTORS IN A CONCENTRIC CABLE

is taken not as twice the length of the cable, but as $(1 + Z)$ times the length of the cable in terms of the outer conductor.

The same applies to a triple concentric cable. Two-phase cable, with a twin core and an outer conductor surrounding the two and

concentric with the lead, may be dealt with in the same way.

Faults in twin and three-core cable are also preferably localized by the loop method if one conductor remains good. The length of the loop is taken as twice the length of the cable, provided that it is known that the area of the conductors forming the loop are equal or that their relative resistances have been verified by the method described in Fig. 68.

A case which may occur sometimes with three-core cables is that there is a fault between two conductors while the third conductor is sound, and none of the three have developed earths. Then it is best to connect one of the bad conductors to the sound one at the far end, so as to make up the loop, and to utilize the other bad conductor for the battery connection in place of earth. The connections are then as in Fig. 69. These connections may be used even if the fault between 2 and 3 is an earth as well,

so long as the insulation of conductor 1 is intact. Other cases of short-circuit where a loop test is impracticable are dealt with in later chapters.

“FALSE ZERO”

There are two bugbears to be taken stock of in considering the application of loop methods—(1) “False zero” and (2) contact resistances.

In telegraph work most localization tests are taken to false zero. That is to say, the galvanometer key, not the battery key, of the bridge is first depressed; a certain deflection of the galvanometer needle occurs, chiefly due to earth currents, and the bridge is considered balanced if this deflection is again obtained when both galvanometer and battery keys are down. Now in a loop of a power cable earth currents are not usually troublesome, but there is sometimes an unlooked-for electromotive force, due to a small primary cell being automatically set up at the fault. The electrodes are copper, and either lead, iron, or the zinc of the galvanized iron wires, if the cable is so armoured; moisture at the fault provides the electrolyte. On examining the diagrams it will be seen that this electromotive force is actually in the battery circuit and not in either of the four arms of the bridge. It is simply between the point F and earth. Any deflection obtained on depressing the galvanometer key alone is usually due to leakage to earth from the instruments themselves. This leakage is removed by dusting the instruments, and then applying a little benzine, benzoline, or petrol to the insulating parts with a soft brush or piece of rag. If a leakage current can still be observed in the galvanometer it is due to leakage across the battery key, and being in the battery

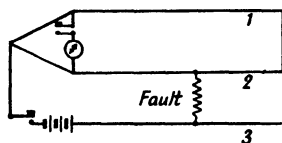

FIG. 69. THREE-CORE CABLE WITH TWO CORES SHORT-CIRCUITED

arm of the bridge it will disappear when the bridge is balanced; therefore it is of no importance.

If the battery leads pass too near to the galvanometer there may be a deflection on depressing the battery key before the galvanometer key is down. This is due to the inductive effect of the current in the battery circuit. The effect is removed by leading the battery wires further from the instrument.

If in spite of the above precautions a "residual" deflection of the galvanometer persists when the battery key is open, adjustments of the bridge or slide wire can be made to the false zero of the residual deflection, for it is obvious that when depression of the battery key makes no difference to the galvanometer deflection, the principles of the Wheatstone bridge described in Chapter II apply. So long as the residual deflection is constant, it causes little trouble, but when it fluctuates or is large enough to send the needle off the scale it is very difficult indeed to obtain an accurate test. If leakages on instruments and keys are eliminated, the occurrence of a false zero when the battery key is open and the galvanometer key depressed can only be due to one of two causes. A long cable previously charged from a D.C. source may take considerable time to lose its charge, and the charge may even build up again to some extent after the cable has been earthed. If, therefore, both the fault and the galvanometer are of high resistance and the cable is long, a false zero is just possible from this cause. Earthing the cable for an hour or so should effectively discharge the cable. A more likely reason for it, however, is the presence of two or more faults in the cable. If each had an E.M.F. in it for the reasons explained on page 177, the result would be that a small current would flow through part of the cable loop, and some would be shunted through the galvanometer. In such circumstances, too much reliance must not be placed

on the accuracy of the test, which will indicate a position between the faults, and not the exact position of one of them, unless this one has a much lower resistance than the others. In all probability, however, if there is more than one fault of comparatively low resistance on the cable, there would be some instability in the balance of the bridge which would sufficiently indicate the condition of affairs.

A steady deflection which is large enough to make balance to a false zero impracticable can be cancelled by the method shown in Fig. 70.

B can be a primary cell or preferably a small two-volt accumulator and S an adjustable high resistance of the potentiometer type. An adjustable 50 000 ohm radio set type of resistance is very suitable and inexpensive. The battery should be connected to the galvanometer and potentiometer in opposition to the residual deflection, whence by adjustment of the potentiometer this deflection is annulled. With skilful manipulation the worrying effects of fluctuating stray currents can be to some extent overcome.

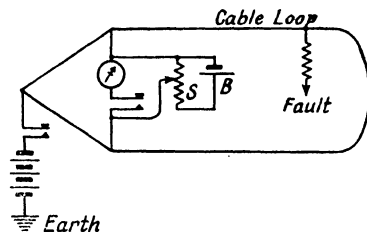

FIG. 70. NEUTRALIZING A FALSE ZERO

CONTACT RESISTANCE

Whenever possible, in forming a loop, the cable tails at the distant end should be connected directly together. Switches, current transformers, fuses, or any other appliance left in the loop circuit will seriously affect the accuracy of the test.*

All connections in the loop circuit and from this to the

* In this connection, however, see there marks on page 223, Chapter VIII.

slide wire or bridge must be perfectly clean, preferably tinned, contacts being made over a reasonable area, to avoid "point" contacts. It is a good practice to clean all contact surfaces, both cable ends and terminals thoroughly with emery cloth and wipe off the dust with a clean rag (not cotton waste), and the cable contacts should be secured by bolting or sweating them together. This is not always a simple matter however; for example, when

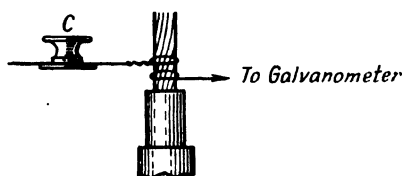

FIG. 71. ELIMINATING CONTACT ERROR OF CABLE CONNECTION

localizing a fault on a section of cable terminated at either end in a link box with spring contacts, the cable connections to which are embedded in hard compound, it is often impracticable to break

away the compound to get at the cable ends because other links in the box may be alive. In such a case the contact surfaces are cleaned with emery cloth as described and the ends of the leads are sweated to pieces of copper, parts of which are a replica of the parts of the links or fuseholders fitting into the springs. These pieces of copper are fitted into the spring contacts and suitable clamping plates are made up and fitted, so that the spring contacts are not distorted or damaged.

Whenever it is possible to connect the cable directly to the bridge it should always be done. Suppose the connection is so made, one end of the cable loop being connected to the terminal C of the slide wire or resistance coils. Usually the resistance of the cable arm of the bridge system is smaller than the resistance of the adjacent slide wire arm. If so, the galvanometer must be connected as in Fig. 71, so that the contact resistance C is not added to the cable arm of the bridge. In such a case when a Post

Office pattern bridge is used for Murray's method, it is well not to use the key on the instrument, but to have an independent galvanometer circuit. It simply means that Fig. 67c would be altered to Fig. 72.

On the other hand, should it happen that the loop is long, and is made up of small-sized cable or wire, and that the instrument employed is a slide wire bridge, the slide wire may have a lower resistance than the cable loop.

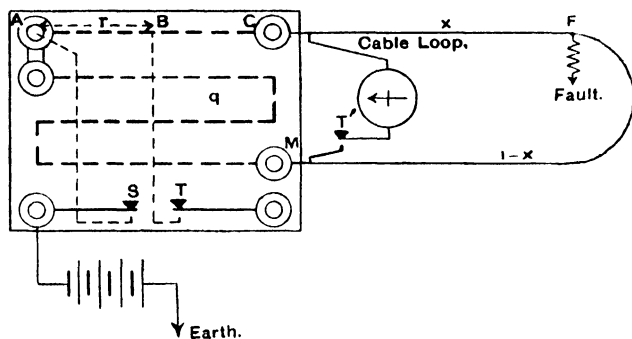

FIG. 72. P.O. BRIDGE WITH INDEPENDENT GALVANOMETER KEY

In that case the galvanometer must be connected directly to the terminals of the slide wire, so that the contact resistance is in the cable arm.

When it is not possible to bring ends of the cable directly on to the terminals of the slide wire or resistance bridge, and leads are necessary, the way to allow for them by considering part of the cable loop and including their equivalent length has already been explained, page 171. If, however, the cable itself is short and of large sectional area, the equivalent length of the leads in terms of the cable section can be so high that the accuracy of the test may be diminished. Take an extreme case in which, say, the loop of cable is 200 yd. of 0.25 sq. in. cable, and it is not possible to get the testing set nearer than within 10 yds.

If $7/029$ in. were used for the leads, this would have a sectional area of about 0.0045 sq. in. The 20 yd. of this cable required for the leads would be equivalent to about $\frac{20 \times 0.25}{0.0045}$ yd. of the 0.25 sq. in. cable, i.e. 1 111 yd. The equivalent length of the loop would therefore be 1 311 yd.

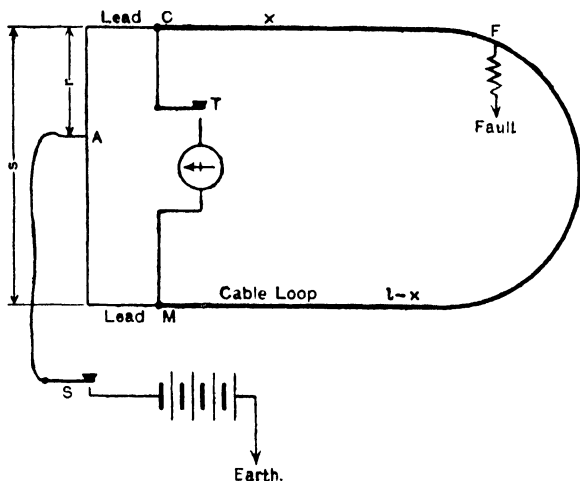

FIG. 73. SLIDE WIRE LOOP TEST WITH SPECIAL LEADS

instead of 200 yd., and we should have to deduct $555\frac{1}{2}$ yd. from the distance x given by the localization test. Moreover, the actual sectional area of the $7/029$ in. would not have been determinable with sufficient accuracy, and there could be an error of a good many yards in our result. One way of getting over this would be to make separate measurements of the resistance of the loop with leads, and of the leads alone, and to calculate the equivalent length of the leads.

A better way, if a slide wire is being used, is to have a pair of leads prepared which are specially devoted to

the purpose of connecting up the cable loop to the slide wires (just as is done in the case of leads used to connect up ammeters to their shunts). The connections of a slide-wire bridge, so arranged, are shown in Fig. 73. These may be made of such a length and section that they are each equivalent in resistance to say 10 divisions of the slide wire. For example, if the slide wire has a resistance of 0.001 ohm per division, the leads would be given an exact resistance of 0.01 ohm. If 7/036 in. cable having a resistance of 3.427 ohms per 1 000 yd. is selected for the leads, these would each have an approximate length of $\frac{0.01 \times 1\,000}{3.427}$ yds., i.e. 8 ft. 9 in. Makers of the slide wire

bridge would have no difficulty in supplying special leads calibrated in this manner as part of the equipment.

By starting the marking of the slide wire scale at 10 instead of 0 and finishing at 980 instead of 1 000, the slide wire length (s) would still be taken as 1 000 in the calculation and the distance r read off from the scale.

If, on the other hand, no special marking were adopted, 20 would have to be added to the length of the whole slide wire to give s , and 10 to the slider reading to give r .

Should this principle be adopted with a direct-reading slide-wire bridge with two sliding contacts (Fig. 62) two sets of figures would have to be marked on the scale to preserve the direct-reading principle, say one in black (representing 20 divisions added to the actual length) for the "sliding jockey" (S in Fig. 63), and the other in red (representing 10 divisions on instead of 20) for the "portable jockey" (P in Fig. 63).

With this arrangement of definite leads taking the place electrically of an extension of a certain number of divisions on to each end of the slide wire, it will, of course, not be possible to obtain balance if the fault is quite near one of the ends of the cable loop. It would then be necessary to

make use of the extended slide-wire principle described on page 162.

It has been said before, but it will bear repetition, that it is the arrangement of the leads and contact resistances that is the chief cause of ill-success in fault localization. Whatever system of leads be adopted, therefore, it should be determined upon, not after the fault occurs, but once for all when the mains are first connected up, as a fault has nearly always to be localized "against time" and the less there is to do and think about the better.

TEMPERATURE EFFECTS

Temperature effects on the cable resistance (which increases with temperature) need not usually be considered in locating faults in L.T. cables because neglect to do so does not introduce serious errors in the comparatively short cable loops usually encountered. On the other hand, if a loop has to include a combination of underground and overhead cables, each of considerable length, it may become necessary to apply a temperature correction in calculating the equivalent lengths. Resistance of a copper conductor increases 0.22 per cent for every degree Fahrenheit increase in temperature.

HIGH RESISTANCE FAULTS

A high fault resistance makes the normal connections of the Murray loop, as hitherto shown, very insensitive. Examination of the fundamental diagram, Fig. 67A, shows that the higher the resistance of the fault the lower is the current available for operating the bridge. The test depends on balancing the difference in the fall of potential along the arms x and y by the difference of the fall of potential in the resistance-box or slide-wire arms r and q . If the bridge current is much reduced by a fault of high resistance, these falls of potential are correspondingly

reduced, the bridge becomes insensitive, the galvanometer will show zero reading over a wide range in the adjustment of the resistances in the arms r and q or of the position of the point A in the slide-wire bridge, and consequently the result of the test will be inaccurate. That is why the best results are obtained if the resistance of the fault has first been broken down to a few ohms only. When this breaking down of the resistance of the fault is not possible, the best way out of the difficulty is to use high battery power. Then, if a sensitive galvanometer is available it is remarkable what a high degree of accuracy can be obtained with this simple test; Example III on page 190 shows how a 20 000 ohm fault on a 0.12 sq. in. cable about 200 yd. long (400 yd. loop length) was accurately located within 1 ft. by using three 120 v. radio batteries in series and a piece of binding wire as a slide wire. For a test of this sort, a sensitive galvanometer of *low* resistance is necessary, that is to say the lowest possible *volt* figure of merit (see Chapter II, page 30) is desirable.

If only an insensitive galvanometer or one of high resistance is available, or if high battery voltage is unobtainable, the connections given in Fig. 74 may be used as an alternative to Fig. 60 for localizing high resistance faults. Bigger galvanometer deflections will then be obtained on either side of the balance position than if the same apparatus is connected as Fig. 60, as the resistance of the fault is in the galvanometer circuit, where it has much less effect on the currents in the various arms of the bridge. On the other hand, earth and polarization currents as they are called due to the E.M.F. in the fault are then almost invariably introduced into the galvanometer circuit directly, and with them the inconvenience and inaccuracy of balancing to false zero, so that the possibility of error in the result is increased.

The annulling method of Fig. 70 can sometimes be

employed to advantage in conjunction with the connections of Fig. 74, but if the currents fluctuate very violently the use of this method is precluded. Indeed, when electric tramways are running in the vicinity of a faulty cable, stray currents picked up have been known to burn out a high resistance galvanometer.

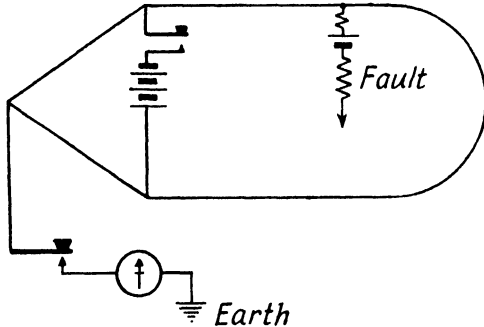

FIG. 74. LOOP TEST WITH POSITIONS OF BATTERY AND GALVANOMETER REVERSED

One must be careful when using a slide wire with these methods of connection to avoid currents sufficient to cause heating, as is very likely to happen when the usual practice of using a storage battery is followed. Suppose a six-volt accumulator is used in conjunction with a slide wire, having a resistance of one ohm, reference to Fig. 70 will show that six amperes will be passed through the latter, sufficient to elevate the temperature of the usual type of slide wire to several hundred degrees. Two possible sources of error previously mentioned will arise, one through thermoelectric potentials set up at the junction of the slide wire with its terminals, and the other due to the variation of resistance per unit length of the wire; its terminals will have a cooling effect, so that the temperature of the wire will not be uniform throughout its length. In spite of the low temperature coefficient of resistance wire, this

difference can cause considerable inaccuracies. Furthermore, if the slide wires are excessively heated they may be permanently ruined for accurate work.

If a resistance box is used instead of a slide wire damage to the coils may similarly be done; care must be taken

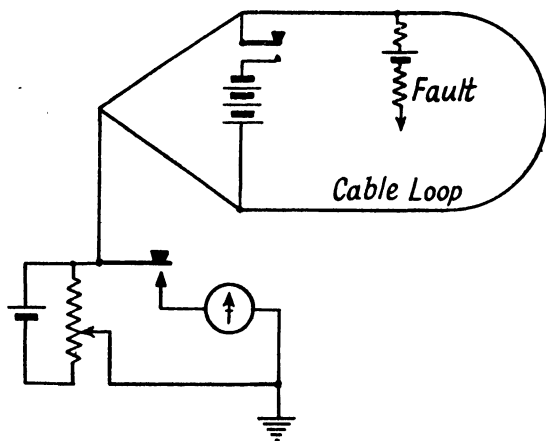

FIG. 75. METHOD OF ANNULING EARTH CURRENTS AS APPLIED TO FIG. 74

while making adjustments to avoid plugging the box at any total resistance lower than $V/0.030$ where V is the accumulator E.M.F., as 30 milliamperes is the maximum current the coils of most boxes can be relied upon to carry without risk of damaging them.

As a general rule, the connections of Figs. 60, 67A, 67B, and 67C are recommended; experience shows that these generally give the best results and freedom from sources of error to which Fig. 74 is not subject.

EXAMPLES OF MURRAY LOOP LOCALIZATION TESTS

Example I. A 0.12 sq. in. concentric cable 116 yd. long, the area of the outer conductor of which was the same as

the inner, developed a low resistance fault in the outer, the inner giving a test of 0.2 megohm when the cable was disconnected from the transformer at one end, and from the back of the distribution board at the other. A short circuit was made at the transformer end by bolting the two tail ends together.

The available instruments were a Post Office pattern bridge, and a moving coil galvanometer whose figure of merit was 10^{-6} amp. The nearest position for the testing instruments to the cable required wire three yd. long to connect the cable ends to the bridge, and 16 S.W.G. V.I.R. only was available. As a 0.12 sq. in. conductor is 37/16 the equivalent length of each lead was $3 \times 37 = 111$ yd., and the equivalent loop length was $2 \times (111 + 116) = 454$ yd. Connections were as Fig. 67c, the outer conductor being connected first to C and the inner to M. A 12-volt motor-car battery was used in series with a four-watt lamp.

$r = 1\,000$ ohms was first unplugged in the arm AB.

It was found that there was too small a current to be able to determine the balancing value of q more accurately than to within 40 ohms or so. Therefore 100 ohms was substituted for 1 000 in the arm AB; and balance was obtained for $q = 241$.

The connections were now reversed, the outer conductor being connected to M, and the inner conductor to C. $r = 100$ was unplugged in the arm AB, and balance was obtained for $q = 43$.

From the first test, the calculated distance of the fault from the bridge end of lead 1 was

$$\frac{100}{241 + 100} \times 454 = \frac{45\,400}{341} = 133 \text{ yd.}$$

and, therefore, $133 - 111$ (111 being the equivalent length of one lead) = 22 yd., is the distance of the fault from the testing station.

From the second test, the calculated distance of the fault from the bridge end of lead 2 was

$$\frac{100}{43 + 100} \times 454 = 317 \text{ yd.}$$

Therefore $454 - 317 = 137$ yd. is the distance of the fault from the other end of the loop, that is to say, from the bridge end of lead 1; and, therefore, the distance of the fault from the testing station was, according to the second test, $137 - 111 = 26$ yd.

The mean of these two results, viz. $\frac{22 + 26}{2} = 24$ yd.

from the testing station, was taken as the correct position of the fault.

Example II. A loop of 205 yd. 0.2 sq. in. cable had a fault of low resistance. No testing apparatus was available except a low resistance galvanometer having a figure of merit of 2×10^{-6} ampere, and an ordinary key. The fault was localized as follows.

About a yard of No. 20 bare resistance wire from an old heating element was straightened out and connected across the ends of the loop, a soldered joint being made. Two wires leading to the galvanometer circuit were also soldered on at the same place, as in Fig. 71. The supply being 230-volt D.C. three-wire, with earthed neutral, one wire from a 60-watt lamp was connected to the negative main and the other wire from the lamp was arranged for sliding along the slide wire. The lamp incandescenced fairly brightly through the fault. These connections constituted the bridge as Fig. 67A, the yard of No. 20 wire forming the two arms C A M, and the bared end of the wire from the lamp being the sliding contact at A. This sliding contact was moved along the bare wire until the position of balance was obtained. This point was then marked, and the length of the wire

between it and the nearer cable end was carefully measured. Its length was $11\frac{5}{8}$ in., the length of the whole wire between the cable ends being 3 ft. $1\frac{1}{4}$ in.

Therefore the distance of the fault from the cable-end nearer to the point of balance was

$$\frac{11\frac{5}{8}}{37\frac{1}{4}} \times 205 \text{ yd.} = \frac{93 \times 205}{298} = 64 \text{ yd.}$$

The source of uncertainty in this arrangement is that the old wire from a heating element is unlikely to have uniform resistance throughout its length.

Example III. A dead earth was reported on the outer conductor of a 0.12 sq. in. concentric lead-covered and armoured cable laid direct in the ground and used at 100 volts D.C., but a subsequent test showed a resistance of 20 000 ohms to earth and it was not possible to reduce this with the plant available. The importance of the building supplied, and the fact that original report of a dead earth was deemed to be correct, made it advisable to locate at once. A sensitive portable reflecting galvanometer as described on page 30 (Fig. 13) was available, but no other test equipment. The cable was about 200 yd. long. Three 120-volt dry batteries were obtained, a well-insulated bell push to serve as galvanometer key, and 100 in. of No. 22 S.W.G. tinned copper wire was used as slide wire. This latter was connected up so as to form the arms r and q in Fig. 60, the point A being the loose end of a lead from the battery, but initially only a few cells of the battery were used, and the concentric cable well short-circuited and earthed at the end-box at the far-end, giving the arrangement shown in Fig. 68, except that the battery connection to the far end of the cable was made by means of the two earth connections. As the fault itself was of high resistance, leakage into the bridge during this preliminary test

could be neglected, and the position of A when the bridge was balanced gave the relative resistances of inner and outer conductors including the switchboard tails in each case. This point was not exactly 50 in. but $50\frac{3}{4}$ in. from the point of the slide wire attached to the tail from the inner core. The route length of the cable *plus* the length of the tail on the outer conductor (which was of the same sectional area as the cable itself) was 203 yd. This made the "equivalent length" of the inner conductor and its tail $203 \times \frac{50\frac{3}{4}}{49\frac{1}{4}} = 209$ yd., and the equivalent length of the whole loop 412 yd.

The earth connection was then removed from the distant end-box, leaving the ends short-circuited there, so that the actual connections were as Fig. 60, and the full 360-volt battery was used for the actual localization test to force sufficient current through the fault. Balance was obtained at 31 in., so the distance of the fault from the switchboard end was 31 per cent of the equivalent length of the whole loop, viz. $127\frac{3}{4}$ yd. Subtracting this from the route *plus* tail length of the outer (203 yd.) gave $75\frac{1}{4}$ yd. back from the end box. This was measured off and the spot found to be in a grass plot, which was then excavated a couple of feet on each side, when it was found that a spike at the end of the support for a practice cricket net here had at one time pierced the armouring and lead covering of the cable but had subsequently been withdrawn.

THE VARLEY LOOP TEST

The Varley loop test was generally used by telegraph engineers in preference to the Murray loop test. It was more suitable for long cables of comparatively high resistance than the Murray loop, and was retained as the standard method in cable testing rooms for a long time, having

the convenience that the bridge connections for the ordinary conductor resistance tests needed no change. It cannot be employed with a slide wire bridge and is not of much use for ordinary mains work where the resistance of the cable loop is very low. As is seen from Fig. 76, the proportional arms a and b of the bridge are used in the ordinary way, but the battery is earthed instead of being con-

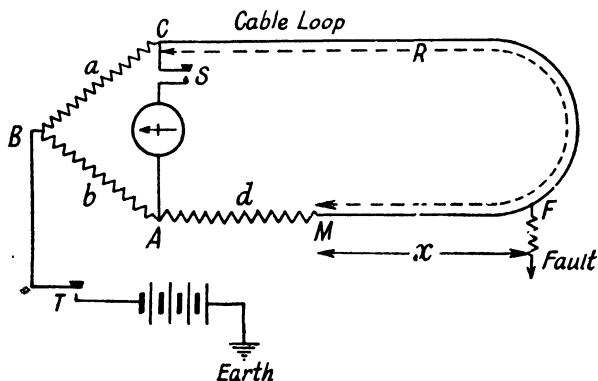

FIG. 76. VARLEY LOOP METHOD

nected to the terminal M. To balance the bridge, the adjustable resistance arm d supplements the resistance of the part of the cable between M and the fault.

For loops of low resistance the value of d would have to be so small that it could not be adjusted accurately with the coils of an ordinary resistance-box bridge. But in cable factory testing rooms the conditions are different. The bridge often has coils from one-tenth of an ohm upwards, as well as a sensitive galvanometer, so that d can be determined to one-hundredth of an ohm by taking proportional deflections. A testing-room electrician prefers slightly longer calculation to disturbing the connections on his instrument table. Some of the portable testing sets

primarily designed for insulation testing and resistance measurements are applicable for fault localization by Varley's method (but usually not by Murray's method without changing the internal connections). As a rule, however, the accuracy obtainable is not very great, when applied to power cables, for the reason stated.

After the cable has been connected up as shown, and one pole of the battery is earthed, d is adjusted until balance is obtained, and the values of a , b , and d are noted.

Then the earthed pole of the battery is disconnected from earth and connected to M instead, the connections being then as for an ordinary resistance test with earth-free battery. The resistance of the loop R is then measured.

From the first test $\frac{a}{b} = \frac{R - x}{x + d}$, where x is the resistance of the part of the loop from M to the fault.

From this $xb + xa = bR - ad$, and

$$x = \frac{bR - ad}{b + a}$$

If $l =$ the length of the loop, its resistance per yard is R/l . Hence the distance of the fault from the point M is x divided by R/l , that is

$$\frac{l(bR - ad)}{R(b + a)}$$

The ends of the cable loop should then be reversed in Fig. 76 and the tests repeated with the battery also reversed, so that its other pole is the one connected to earth. The fault position calculated from this test should not differ materially from the first result, and the mean of the two results is usually accepted. If the difference is considerable the loop connection at the distant end and

the connections to the Wheatstone bridge should be examined and cleaned, and the tests repeated.

It has been assumed that the leads have been included in calculating the equivalent length of the loop. They can be allowed for in the test if preferred; this is especially convenient when the loop is of one size of cable throughout. After measuring the resistance R of the loop and leads together, the leads are disconnected and the resistance of each is measured separately. We will call m the resistance of the lead connected to the end M , and c the resistance of the lead connected to C .

Then $R' = R - m - c$ is calculated, and the formula for the distance of the fault from the M end of the cable is

$$\frac{l}{R'} \left(\frac{bR - ad}{b + a} \right) - m$$

l being now the length of the loop from cable end to cable end, without leads.

Example. One core of a twin 7/18 S.W.G. cable developed a fault, the insulation of the other remaining perfect. The cores at the far end were connected to 7/20 S.W.G. extensions each 5 yd. long, the connection being in a junction box and not conveniently accessible. At the other end the faulty cable ran straight to a switchboard. The instruments available were a Wheatstone bridge and a moving coil portable galvanometer. The cable was disconnected from the rest of the circuit.

The length of the twin 7/18 cable was 1 358 yd.

The length of 7/18 cable which would have the same resistance as the 10 yd. of 7/20 cable, would be

$$\frac{10 \times 0.00180}{0.001018} = 18 \text{ yd. nearly,}$$

0.00180 and 0.001018 being sectional areas of 18 and 20 S.W.G. wire respectively.

The length of the loop was therefore taken as $2\ 716 + 18 = 2\ 734$ yd.

The ends of the 7/20 cable were short-circuited, and the switchboard ends of the 7/18 cable were connected up to the bridge as in the diagram Fig. 76. The wires used to connect the cable ends to the instrument were two pieces of 14 gauge wire of equal length.

Test. 1. Connections as Fig. 76, core No. 1 connected to M; core 2 connected to C.

$$b = 1\ 000 \quad a = 10$$

Balance obtained with $d_1 = 467.4$.

2. Copper resistance of the whole loop (including connecting wires), 5.368 ohms = R.

3. Resistance of the two 14 S.W.G. leads connected in series, 0.042 ohm.

4. Reconnected as Fig. 76, but with ends of cable reversed—viz. core 2 connected to M, core 1 connected to C,

$$b = 1\ 000 \quad a = 10$$

Balance obtained for $d_2 = 64.4$.

(Note the third significant figure was obtained by proportional deflections (see page 58).

Working these results out—

$R' = R$ minus the resistance of the two leads—i.e.
 $5.368 - 0.042 = 5.326$

$$\frac{bR - ad_1}{b + a} = \frac{5\ 368 - 4\ 674}{1\ 010} = \frac{694}{1\ 010} = 0.687$$

$$\begin{array}{r} \text{Subtracting the resistance of one lead } 0.021 \\ \text{we get } \underline{0.666} \end{array}$$

To obtain the distance of the fault from the station we must multiply by l/R , i.e. by $2\ 734/5.326$ (l being the length of the loop).

Hence, the distance of the fault from the end of core 1 is

$$\frac{2\,734}{5.326} \times 0.666 = 342 \text{ yd.}$$

$$\frac{bR - ad_2}{b + a} = \frac{5\,368 - 644}{1\,010} = \frac{4\,724}{1\,010} = 4.677$$

Subtracting the resistance of one lead 0.021
we get 4.656

Therefore the distance of the fault from the station end of core 2 is

$$\frac{l}{R} \times 4.656 = \frac{2\,734}{5.326} \times 4.656 = 2\,390 \text{ yd.}$$

The fault distance from the station end of core 1 calculated from this latter test is the equivalent length of the loop of 7/18 and 7/20 cable *minus* 2 390 yd., i.e. $2\,734 - 2\,390 = 344$ yd.

The cable was therefore examined at 343 yd. from the station, this being the mean between 344 and 342.

MODIFICATION OF MURRAY LOOP TEST, WHEN THE RESISTANCE OF THE LOOPED RETURN IS NOT KNOWN

So far, it has been assumed that the sectional area of the other conductor or conductors making up the loop is known. Occasions arise, however, in which a return path from the far end of the faulty cable is only possible through a conductor or conductors whose accurate sectional area or resistance is not known, or which are of a different material to that of the faulty cable. An instance is that of a tramway or trolley bus feeder when the only return circuits available are the two trolley wires, which are of hard-drawn copper. This material has a different specific resistance from that of the annealed copper of the feeder,

and wear renders the true area uncertain. Consequently, an estimate of "equivalent lengths" based on the relative

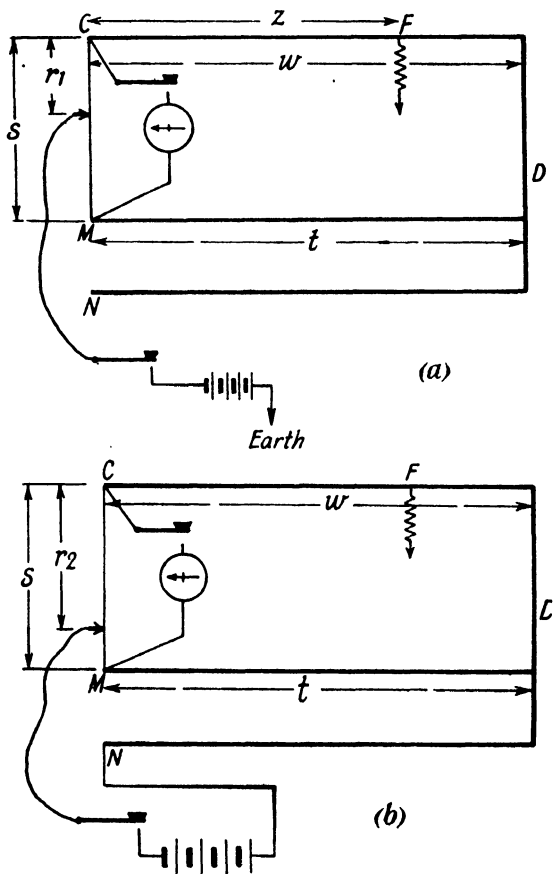

FIG. 77. MURRAY TEST ADAPTED TO LOOPED RETURN OF UNKNOWN RESISTANCES

sectional areas would be incorrect. Under conditions such as these, the following modification of the Murray loop method is of great practical utility; it requires two

alternative return circuits, the far ends of which should be joined up to the far end of the faulty cable before the test is commenced. The diagrams (Figs. 77 (a) and 77 (b)) are drawn on the assumption that a slide wire is used. If a resistance bridge is used, the two arms of the bridge will be substituted for the slide wire similarly to Figs. 67B or 67C.

The connections are first made as in Fig. 77 (a). All three cables are connected solidly together at the far end D, and the slide wire s is connected between the faulty cable CD and one of the sound cables MD. The galvanometer and battery are connected in the usual way, as shown, and balance is obtained with the slide at r_1 .

The right-hand battery connection is then changed from earth to the end N of the second good cable ND as Fig. 77 (b), and balance is again obtained, with the slide at r_2 .

Calling z the resistance CF up to the fault w , the resistance CD of the cable under test, and t the resistance of the return cable MD, when balance is obtained with the connections in Fig. 81 (a)

$$\frac{z}{w + t} = \frac{r_1}{s}$$

or
$$w + t = \frac{zs}{r_1} \quad . \quad . \quad . \quad (30)$$

When balance is obtained with the connections in Fig. 77 (b)

$$\frac{w}{w + t} = \frac{r_2}{s} \quad . \quad . \quad . \quad (31)$$

Substituting (30) in (31)

$$\frac{wr_1}{zs} = \frac{r_2}{s}$$

or
$$z = \frac{wr_1}{r_2}$$

But since $\frac{z}{w} = \frac{x}{l}$

where x and l are the lengths of cable with resistances z and w

$$x = \frac{r_1}{r_2} l$$

This, it is seen, is quite independent of the resistance of the faulty cable, which need not be known, and as r_1 and r_2 occur as a ratio, they can be expressed in slide wire length units if desired. The larger the cable MD the more accurate is the result; so if MD and ND are of different sizes, the larger should be selected for MD. The other cable ND may be quite small if a large one is not available, and may even be a pilot wire, so long as the testing current does not exceed its carrying capacity.

CHAPTER VII

LOOP TESTS FOR LOCALIZING FAULTS IN H.T. CABLES

LOW RESISTANCE FAULTS

WHERE the fault is a burn-out to earth on an H.T. cable which leaves the resistance at not more than a few hundred ohms, all the considerations of the previous chapter apply provided that there is no discontinuity, and that one core of the faulty cable remains of good insulation, or that another return is available for completing the loop. It must be added, however, that, as high tension feeders are much longer as a rule than the cable section to which an L.T. fault is usually isolated, the need for extreme accuracy is even more essential. At working pressures of and above 6 600 volts, feeders are often several miles long without a break, so that the selection of fault localizing apparatus for applying the Murray loop test has an important bearing on the accuracy obtainable.

Thus apparatus embodying a slide wire only one metre long divided into 1 000 parts cannot give a very exact result in locating a fault on loops of several miles, because one cannot expect to observe the slide wire subdivision more closely than to half a division.

The possible error can conveniently be expressed in the following simple formula. If the slide wire is divided into n divisions, and no galvanometer reading is obtained at δ divisions on either side of the true balance position, and if L is the length of the loop of cable in yards the possible error is

$$\lambda = \frac{\delta}{n} L \text{ yd.}$$

The percentage error, as a percentage of the *whole*

length of the loop is $\frac{n}{\delta} 100$; or if expressed as a percentage of the distance of the fault from the testing station $\frac{\delta}{a} 100$, if a is the correct reading at balance. It is more useful, however, to consider the percentage accuracy in terms of the length (or equivalent length) of the whole loop, and if c is the route length of the cable in which the fault has to be localized, the percentage error in terms of route-length is $\frac{\delta}{n} \times \frac{L}{c} \times 100$. With a plain loop made up of the faulty core of the cable, and a sound core as a return, the accuracy would be $\frac{\delta}{n} \times 200$ per cent.

All this is more or less obvious, and the reason for insisting on it is to emphasize that if the fault has been broken down to so low a resistance and the galvanometer is so sensitive that it will respond to the smallest possible movement of the slider from the balance position, there is still a limit to the accuracy obtainable if the slide wire is too short or if the cable under test is only a small proportion of the total equivalent length of the loop. To make up the loop with a cable of considerably smaller sectional area than that of the cable under test can involve the introduction of large errors in the result. With a slide wire one metre long, a possible accuracy of adjustment of half a mm. means one-twentieth per cent. If the cable is a mile long with a fault in one conductor, and another similar conductor is used to make up the loop, the accuracy will be within 1/2 000th of the loop length, or 1/1 000th of the cable length, i.e. within $1\frac{3}{4}$ yd., which is good enough for practical purposes; but when we have to deal with loops of greater equivalent length than a couple of miles, greater accuracy is desirable than can be obtained with a short slide wire.

In the absence of a properly-constructed long slide wire bridge very satisfactory results on long loops can be obtained by arranging a resistance wire 10 to 20 ft. long, suitably supported and connected across the ends of the loop as described in Example 1 in the last chapter. By

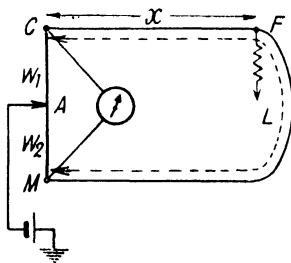

FIG. 78. LOOP METHOD UTILIZING COMPARISON BY WEIGHTS

cutting the wire exactly at the point of balance and just where it leaves the ends of the loop, and accurately weighing the parts in a chemical balance, the ratio of subdivision can be determined to a nicety, but previously to its selection, the uniformity of the diameter of the wire should be carefully checked with a micrometer. Thus, in Fig. 78, if W_1 and W_2 be the weights of the lengths AC and AM respectively,

$$x = \frac{W_1}{W_1 + W_2} L$$

Care should be taken to identify the respective lengths on cutting, or one loses trace of the point from which the distance of the fault is to be measured. It is well to make two or three trials of this method, accepting the mean of the results.

In an actual example of the application of this method, approximately 25 ft. of 20 S.W.G. tinned copper wire was soldered across the ends of a 7 032 yd. loop of a faulty 0.1 sq. in. 6 600 volt cable, and supported in a semi-circle by varnished cambric tape suspensions. A highly sensitive galvanometer was available and the fault resistance was only of the order of 100 ohms. 50 volts D.C. from the station switch-operating battery was used through four 60-watt lamps in parallel. Contact to the

slide wire was made by a penknife blade to which the negative battery lead was connected and, to prevent leakage through the body of the operator, the penknife handle was wrapped with insulating tape.

The point of balance was very "sharp" and the slide wire was cut at this point, and also exactly at the points where it left the cable ends, the galvanometer leads being arranged according to the principle of Fig. 71 (page 180). Three trials were made and the pieces of wire were carefully labelled and taken to a neighbouring chemist's shop and weighed as follows—

Test	W_1	W_2	$\frac{W_1}{W_1 + W_2}$
1	273.5	424.9	0.3916
2	277.8	433.0	0.3909
3	268.4	416.4	0.3919
Mean	—	—	0.3915

The fault position was therefore at $0.3915 \times 7\ 032 = 2\ 753$ yd. from the end of the loop to which the pieces of wire W_1 were connected. According to the mains records a joint existed at 2 751 yd. from this same end, which, on being opened up, proved to be the fault position.

The error was thus (assuming absolute accuracy of the records) 0.03 per cent expressed in terms of the length of the loop and 0.07 per cent in terms of the distance of the fault from the end. It would correspond to a difference of 0.25 grain in the weight of the shorter piece of wire, and is therefore not due to an error in weighing but to the resistance of the wire not being absolutely proportional to its weight—which is, of course, to be expected. Slight differences of temperature along the length of the wire would also contribute a certain amount of inaccuracy, as the wire was of copper, which possesses a fairly high temperature coefficient.

Note was taken of the minimum distance of the pen-knife contact from the point of balance at which a perceptible galvanometer was obtained. This was $\frac{1}{32}$ in., and the length of the shorter piece was 118 in. It represents an accuracy of about 0.03 per cent, showing that the error was not wholly one of observation but merely due to the improvised nature of the slide wire.

The comments made in previous chapters on the need of accurate and adequate mains records are again emphasized, especially with reference to high pressure and super-pressure cables. Several large operating companies make a practice of fully scheduling all data respecting lengths, joint positions, equivalent lengths where the sectional area of the copper varies, and depths, etc., of all important high voltage cables, on the lines of the example shown in the Appendix, page 341. These records are usually made when the feeder is laid so that all fluctuations in the cable length can be accurately accounted for and joint positions accurately charted. They are invaluable in finally determining a fault position. An exact reference position is at once obtained for the joint nearest the estimated fault position whence only a small measurement from this point is necessary.

Errors of several yards can arise in the absence of accurate records when long distances have to be "chained," and the exact cable position is lost sight of in the course of years. Very careful consideration should be given before cutting a high voltage feeder at the calculated fault position on a long loop. It is as well to keep two axioms in mind.

(1) Never cut the cable unless test result is beyond doubt.

(2) Never cut the cable unless there is no other alternative.

These two axioms apply whatever the type of fault, or

method of testing. If after carefully checking the test, calculations, and measurements, the fault position is a considerable distance from a joint, the nearest one should be inspected and opened out in preference to cutting the cable, for the chances of joint failure are greater than those of cable failure in modern high pressure cables. Should the joint be intact, with reasonable care another localization test can be made from the joint whilst open, or, if the testing apparatus is not portable, the faulty conductor can be shorted on to a sound one at the joint, and a fresh localization test made from the other end. Substantial agreement with the former test should warrant opening up and cutting the cable at the mean position indicated.

HIGH RESISTANCE FAULTS IN HIGH-PRESSURE CABLES

Faults of the stubborn type, which can only be broken down with difficulty before a localization can be made, may often only be reduced to a resistance of 10 000 ohms or even higher. Current from 240-volt D.C. mains or a high tension battery is then inadequate for an accurate test on a long cable loop, and only moderately approximate results could be obtained by a skilled operator using sensitive instruments. In such circumstances, if after applying D.C., H.T. voltage as described in Chapter III, one is satisfied that a very low fault resistance is not likely to be obtained within a reasonable time, but 50 or 60 milliamperes can be steadily passed through the fault without any appreciable voltage showing between the cable end and earth, valve apparatus should be used, instead of a battery for supplying current to the bridge. The arrangement is shown in Fig. 79.

As much current as the valve will safely pass may be forced through the fault. Any of the valves described on pages 67 to 71 will give sufficient current for localizing

faults by this method, and there is no need to consider using two or more in parallel. The resistance R can be dispensed with if necessary.

The D.C. voltage can be raised to a value sufficient to arc over the fault, and maintain the requisite current; according to the nature of the fault, 1 000 to 2 000 volts

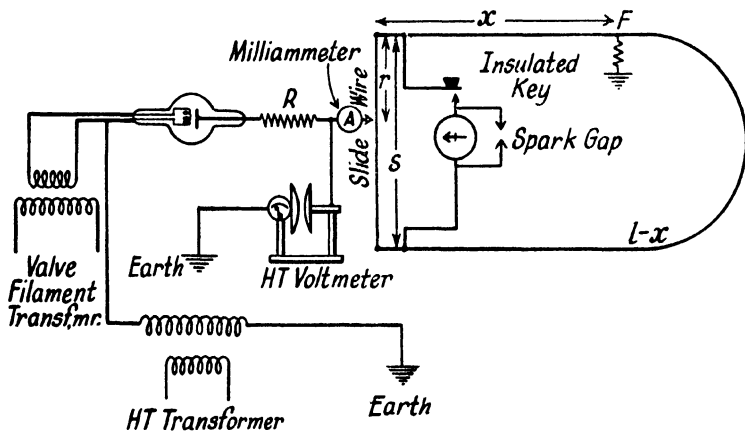

FIG. 79. H.T. LOOP TEST WITH RECTIFYING VALVE

may be necessary to do this. Moreover, when the fault has a marked tendency to seal up each time after the valve current is switched off, it may be that the bridge, slide wire, and galvanometer will be subjected to much higher voltages for short periods. Therefore they should be suitably insulated to withstand pressures up to, say, 10 000 volts, but the galvanometer key should not be closed (or opened, if it is a short-circuit key) whilst the fault resistance is in an unstable condition, or the galvanometer coil will in all probability be burnt out.

A spark gap of one or two thousandths of an inch is usually arranged across the galvanometer terminals to relieve the high frequency transients which pile up against

the galvanometer terminals when a fault has a tendency to seal up during the progress of the localizing test. This gap is shown in Fig. 79; care should be taken to see that it is clear and not shorted by dirt or dust. A mere spark-gap has not proved wholly sufficient, and a proper surge absorber forms part of modern equipment.

Even in circumstances where the capacitance of the loop is relatively low so that the intermittent discharges through an unstable fault are not dangerous to the galvanometer, the series of violent kicks imparted to the needle makes balance very difficult to obtain. Such is the case when this method is applied to an overhead line, which naturally has a very small capacitance compared with a cable loop, and on which the resistances of faulty insulators are inherently high.

One would not attempt to apply a Murray loop test to an overhead line, unless visual examination had failed to detect the fault, because defective insulators are usually apparent. A direct puncture of the porcelain between the conductor and the insulator pin underneath a conductor binder, on the other hand, is difficult to detect, and a loop test as Fig. 79 can be applied with successful results. The nature of such a fault mostly gives it a high resistance and better results are likely if the test is made in wet weather. If the fault is a crack in an insulator, arcing takes place which makes balance rather difficult to obtain.

As poles or towers of overhead lines are placed 200 to 600 ft. apart or more, the same high degree of accuracy as for a cable loop is not required. One can obtain a result within two insulators or so, and a few minutes' inspection will reveal which insulator is faulty.

It must not be forgotten that the secondary winding of the filament transformer may have to withstand a high voltage, so it must be suitably insulated and protected.

Fig. 80A illustrates a slide wire manufactured by Messrs. Gambrell Bros. specially constructed and insulated for localization tests at high voltage. A diagram of its simple connections is given in Fig. 80B. The slide wire bridge is

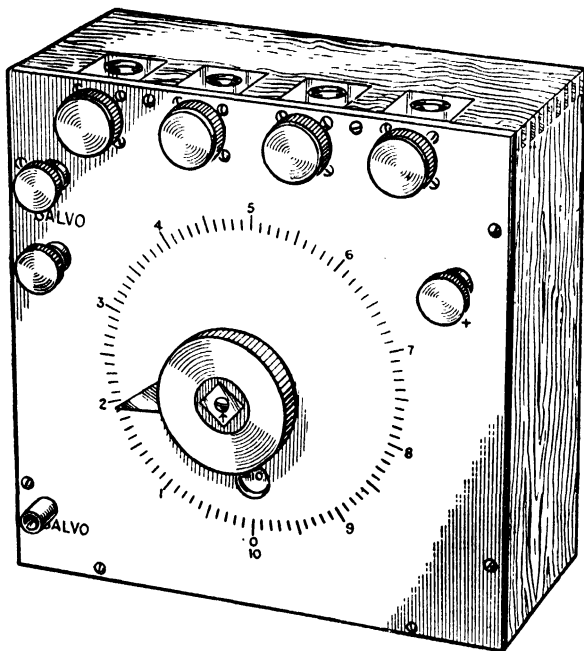

FIG. 80A. GAMBRELL H.T. SLIDE WIRE

placed horizontally on a stand insulated for any pressure that is likely to be imposed upon the instruments, and a long insulating rod fits over the square nut shown, seen in the centre of the control knob in Fig. 80A. Another insulating rod is employed for operating the galvanometer key. The slide wire has a normal resistance of about eight ohms, and consists of five complete turns round a helical V groove in an ebonite disc, the sliding contact being a

small wheel which is in contact with the terminal marked H.T. in Fig. 80B. Within the slide wire box there is a resistance of exactly four times the slide wire resistance so that the slide wire can be "lengthened," when the fault

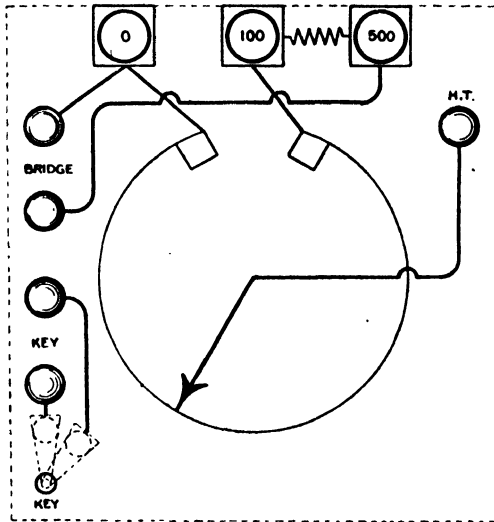

FIG. 80B. DIAGRAM OF CONNECTIONS OF GAMBRELL H.T. SLIDE WIRE

is near the testing end, on the principle suggested by Mr. Trubie Moore (Chapter VI, page 162). One end of the cable loop is connected to the left-hand top terminal, and the other to the middle or right-hand terminal as required. The slide wire scale is divided into 1 000 parts. When balance is obtained, the distance of the fault is the length (or "equivalent length") of the loop multiplied by the reading of the slide wire and divided by 1 000 or 5 000 according to which terminal is used for the return end of the loop.

The galvanometer, not shown in Fig. 80A, is carried on an insulated stand similar to that of the slide wire itself.

If the galvanometer circuit is brought directly to the cable ends as Fig. 71 (page 180) and Fig. 73 (page 182), one of its connections is brought through the two terminals marked "key." If, on the other hand, the cable can be connected directly to the bridge and is not so large that contact errors need be anticipated, the galvanometer is connected to the two outer terminals on the left-hand side, and the two middle terminals are short-circuited.

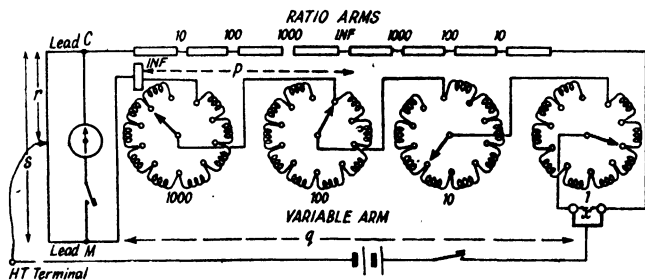

FIG. 81. CHECKING SLIDE WIRE READING WITH DIAL BRIDGE

On loops, 20 000 yd. long or more, one cannot expect the highest attainable accuracy in the fault position by making a direct calculation from the slide wire reading, in spite of the care taken by the manufacturers in the selection of a wire of uniform diameter and fine scale calibration. When balance on the slide wire has been obtained, the ratio of the slide wire subdivision should be checked with an accurate Wheatstone bridge, without moving the sliding contact of the slide wire from the point of balance. This is particularly useful when comparatively long leads from the slide wire to the cable cannot be avoided, and the galvanometer is connected directly to the cable ends as in Fig. 73 (page 182). For this check, the high tension apparatus is disconnected or made dead without disturbing the slide wire slider, the leads are transferred to one of the ratio arms and the variable arm of the Wheatstone bridge, and

a battery connected up in the place of the high tension supply with its other pole to the short-circuited x terminal of the resistance bridge, all as shown in Fig. 81.

This saves the trouble of allowing for the resistance or equivalent length of the leads in the calculation. In Fig. 81 the ratio arms are assumed to be of the plug pattern and the variable arm dial decades of 1 000, 100, 10, and 1 ohm units. The resistances in the ratio arms would be plugged in as shown by the lines between the blocks. If p and q are the resistances of the Wheatstone bridge arms, we have

$$\frac{r}{s} = \frac{p}{p + q}$$

That is, the distance of the fault from C is

$$\frac{p}{p + q} L$$

The galvanometer supplied in conjunction with the Gambrell slide wire has a resistance of about 20 ohms and a figure of merit of 10^{-6} amp.; a nine-volt dry battery will give sufficient current to enable readings of four figures on the decade dials to be taken.

The British Insulated Cables pattern of slide wire bridge (Fig. 64, page 165) can similarly be provided with an extended insulated operating handle and rods for operating the current and galvanometer keys so that it can be safely used for any voltage necessary when applied as in Fig. 79. Notwithstanding the greater subdivision of the slide wire, the Wheatstone bridge check of the ratio of the two parts of the slide wire just described is still advantageous when faults are located on long loops.

A few examples which have been encountered in practice will illustrate conditions likely to be met.

Example I. A five-mile 11 000-volt feeder tripped out

mysteriously at regular intervals during a period of six months. Megger tests after each trip showed an insulation of 100 megohms on all three cores. The station capacity behind the fault was only about 1 000 kVA and the feeder was fed by a 500 kVA transformer. No earth leakage relays were installed, and after the first few trippings the breaker time-lag fuses had been removed. A D.C. voltage of 12 000 applied to one core of the cable showed that fault conditions existed. For half an hour the cable would charge to approximately this pressure and then suddenly discharge at roughly two-minute intervals. For the next hour the charge and discharge intervals remained about the same, but the maximum voltage fell to 5 000 volts.

After an hour's interval D.C. pressures were resumed and in another half-an-hour 50–60 milliamperes could be passed with no appreciable voltage showing on the H.T. voltmeter connected to the cable end. After passing this current for five minutes the insulation test on the cable was six megohms. The H.T. slide wire bridge was connected as Fig. 79 and, for the first five minutes of re-application of pressure, 5 000 volts built up and discharged at fairly rapid intervals, after which the conditions just prior to connecting the bridge prevailed, but the fault still showed a tendency to seal when the current was increased above 30 milliamperes. A quick localization test was made at this current, after which it was increased to 60 milliamperes, when the fault suddenly sealed, and the voltage rose to 12 000 volts. The fault position calculated from the "snap" test came between two joints, but this test was not very sensitive. The bridge was left connected, but the galvanometer was disconnected, and another 40 minutes' application of pressure was necessary to reduce the fault again, periodical discharging taking place at progressively decreasing pressures until finally 80 milliamperes could be

passed, and a megger test showed the insulation to be 10 000 ohms only. A further localization test at 80 milliamperes was made, the conditions now being such that an accurate balance was possible. This gave the fault position 103 yd. nearer the testing station and $2\frac{1}{2}$ yd. from a joint. The fault proved to be in this joint, which was enclosed in a cast-iron box filled with bitumen compound and laid in dry, sandy soil. The lead sleeve of the joint had practically burst asunder from wipe to wipe, and the joint had no doubt been working for some time in this condition, because the discharge current during the breaking-down process was certainly not sufficient to have caused the burst.

Example II. A 0.2 sq. in. 33 000 volt feeder 13 528 yd. long on a large undertaking tripped on the R and Y phases and the needle of the earth leakage ammeter scaled to 1 000 amperes stuck at the maximum scale reading stop. D.C. pressure showed the R core faulty at 45 000 volts, but after several hours' application of pressure up to 66 000 volts the highest current which could be sustained steadily was 10 milliamperes at 25 000 volts, at which a "snap" localization test was made. The result was very uncertain, the probable error being hundreds of yards. During three days, pressures up to 66 000 volts D.C. were applied and the discharge pressure at the fault gradually increased until finally this pressure could be sustained for an hour continuously without any discharge taking place. At this stage the leakage current and loss of charge was as on a perfectly sound cable, notwithstanding that all cores had been tried, several reversals of polarity of current made, and intervals allowed at times for dispersal of gas pressure (see Chapter V, page 154).

Contrary to the usual practice of the undertaking the feeder was energized, but from the "hospital" bus bars on a separate generator; it was run up to 10 per cent excess

pressure for half-an-hour and the cable held up perfectly. Then it was put back into service and it operated without interruption for some weeks, when it again tripped out. As before, the megger showed 100 megohms immediately afterwards, but the fault eventually succumbed to an hour's application of D.C. pressure, the fault initially discharging at 30 000 volts.

A good localization test at 80 milliamperes was made, and the fault proved to be in a damp joint, but it was hundreds of yards from the position given by the previous "snap" test.

This was one of the very few instances when the high pressure loop test has failed on first application.

Example III. Nine miles of 11 000 volt overhead line developed a fault during the acceptance test at 31 000 volts D.C. The conductors were not generally made off in sections but were jointed in the spans so that the line could not be readily sectionalized. A steady current of 20 milliamperes could be passed at 12 000 volts, above which the voltage could not be increased, but transient currents would appear.

Patrolling the line whilst pressure was on failed to reveal the seat of the trouble, so a Murray loop test at 12 000 volts D.C. and 20 milliamperes was made. The sensitivity of observation was only one part in 100, corresponding to 317 route yards of the 9-mile loop. The conductor binders were removed from the insulators on the faulty line at the position indicated by the test and the insulators were minutely examined. Proceeding from pole to pole towards the testing point, at the third pole examined the fault was found. It was a fine crack in the top of the insulator caused by the pin "bottoming" in the porcelain.

Various applications of arc suppression coils enable

faults to be traced to a limited section of an H.T. system. In the case of overhead lines, visual examination then usually suffices for exact localization, while for underground cables a localization test is necessary. Attention may also be directed to a paper by Mr. K. I. Brown, M.B.E., read before the Transmission Section of the Institution of Electrical Engineers in May, 1943, on "Automatic Selective Isolation of Sustained Earth Faults on a Network Protected by Petersen Coils."

CHAPTER VIII

LOOP TESTS (*contd.*)

THE test described on page 197 (Figs. 77 (a) and (b), Chapter VI), utilizing a return circuit of unknown resistance for the loop, requires that the resistance of one of the return conductors should be commensurate with that of the faulty core. If this is not so, the effect of a relatively high resistance return circuit is to give the point of balance close to an end of the slide wire and consequently an insensitive reading. A case in point would be a 7/·036 in. pilot cable running parallel to a 0·1 sq. in. faulty cable. Using the pilot as a return, the equivalent lengths of lead and return would be as $\frac{1}{0\cdot10}$ is to $\frac{1}{0\cdot007}$ that is 10 to 143.

With a slide wire subdivided into 1 000 parts this means that the fault balance position can only be within the first 65 divisions of the slide wire, an obvious loss of sensitivity. An alternative test to meet this case is as follows—

LOOP TEST WHERE ONLY A SMALL RETURN OF UNKNOWN RESISTANCE IS AVAILABLE

This test needs an additional return wire for the galvanometer as shown in Fig. 82, which gives the connections for the test, and lines l_1 and l_2 representing the two cores of a pilot cable, and $a b$ the slide wire.

If the resistance of l_2 is likely to be an appreciable proportion of the slide wire resistance, the length of l_2 in terms of slide wire divisions must be ascertained. This may be done by a simple test as follows. Connect a few feet of resistance wire, say 20 S.W.G. as represented by m and n in Figs. 83 (a) and 83 (b) to the ends of the slide wire. The pilot cable, shown as $2l_2$, is short circuited at the far end.

If s is the length of the slide wire, then, with the connections as Fig. 83 (a) we have, when balance obtains,

$$\frac{r}{s} = \frac{m}{m + n} \quad (32)$$

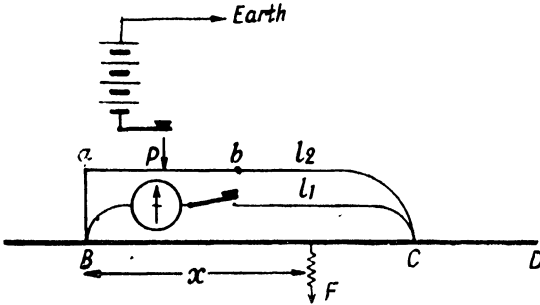

FIG. 82. LOOP TEST WITH PILOT WIRE RETURN

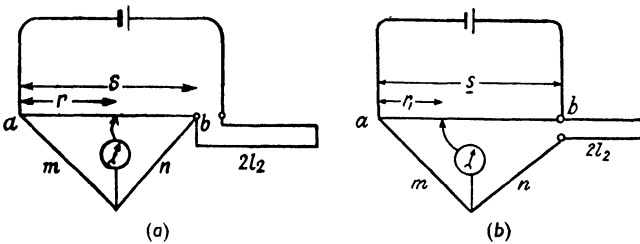

FIG. 83. CALIBRATION OF PILOT WIRE IN SLIDE WIRE DIVISIONS

The connections are then altered to include $2l_2$ in the bridge arm in series with n , the slide wire connections being then as Fig. 83 (b). Then, on rebalancing the bridge by means of the slide wire, if r_1 is the new value of r we get

$$\frac{r_1}{s + 2l_2} = \frac{m}{m + n} \quad (33)$$

m and n must remain unaltered during these tests. From (32) and (33) we obtain

$$l_2 = \frac{s}{2} \left(\frac{r_1}{r} - 1 \right) \quad . \quad . \quad . \quad (34)$$

which is the value of l_2 expressed in terms of slide wire divisions. If in the first test (Fig. 83(a)) m and n are made

exactly equal, then $r = \frac{s}{2}$ and equation (34) becomes

$$l_2 = r_1 - \frac{s}{2} \quad . \quad . \quad . \quad (35)$$

Returning now to Fig. 82, in making the localization test the effective slide wire length is s increased by the value of l_2 obtained from either equation (34) or (35), that is to say, if L is the length of the cable under test from B to C.

$$x = \frac{aP}{s + l_2} L \quad . \quad . \quad . \quad (36)$$

This method may fail when the resistance of the slide wire is less than that of l_2 and the fault is near the centre of the cable, as the point of balance would then be in l_2 itself, no matter from which end the test was made. Such a difficulty may be overcome, however, by calibrating another piece of wire in terms of slide wire divisions by the same method as that just described for calibrating l_2 . This piece of wire would be inserted between B and a (Fig. 82) and should be approximately equal to l_2 slide wire divisions. The fault position would then be given by

$$x = \frac{R + aP}{s + l_2 + R} L \quad . \quad . \quad . \quad (37)$$

where R represents the slide wire divisions to which the added resistance corresponds.

Example. A 0.5 sq. in. concentric feeder, 256 yd. long,

developed a fault on both inner and outer conductors to earth; while both remained continuous, a 12-volt accumulator would not ring a bell between conductors.

The only available return was a street lighting circuit known to be a small twin cable, but no precise data was available. One end of the faulty feeder terminated in a feeder pillar and the other in an underground link disconnecting box. The available instruments were a slide wire subdivided into 1 000 parts and a sensitive galvanometer.

The nearest lamp posts to the feeder pillar and disconnecting box were tapped at the lampholders with 3/029in. S.W.G., V.I.R. Appropriate fuses were withdrawn to isolate the street lighting feeder, the cores of which were assumed to be of equal area.

Test (1). On applying the tests as Fig. 83 no balance could be obtained with the arrangement 83(b) with m equal to n , proving that the resistance of the pilot cable loop was greater than that of the slide wire, so that formula (35) could not be used; m and n were then made roughly two and three feet respectively of 0.036 in. diameter resistance wire, when balance was obtained with both connections 83 (a) and 83 (b), r being 397 and r_1 802 divisions.

The equivalent length of l_2 in slide wire divisions was therefore (from formula 34)

$$\frac{1\ 000}{2} \left(\frac{802}{397} - 1 \right) = 510$$

The effective length of slide wire was therefore

$$1\ 000 + 510 = 1\ 510.$$

Test (2). Applying actual localization test as Fig. 82 from the feeder pillar end, balance was obtained with aP equal to 882 divisions, the loop being made on the outer

conductor. The distance of the fault, using (34), was therefore,

$$x = \frac{882}{1510} \times 256 = 149.5 \text{ yd.}$$

The actual error proved to be approximately $1\frac{1}{2}$ yd.

If the loop return and galvanometer leads in Fig. 82 are known or suspected to be of unequal area, the tests indicated by Fig. 83 can be modified as follows. Firstly make a loop of l_2 and the faulty cable conductor, insulating the battery, slide wire, and galvanometer from earth, and make the two tests as described, obtaining values for r and r_1 . Calling L the length of the faulty conductor in slide wire divisions, we can substitute $l_2 + L$ for $2l_2$ in equation (34) and get

$$l_2 + L = s \left(\frac{r_1}{r} - 1 \right). \quad (39)$$

Secondly repeat tests as Fig. 83(b) without altering m and n , but with l_1 substituted for l_2 , whence, if balance is obtained at r_2 ,

$$l_1 + L = s \left(\frac{r_2}{r} - 1 \right). \quad (40)$$

Thirdly, repeat the tests with the loop formed by l_1 and l_2 for which, if balance obtains at r_3 ,

$$l_1 + l_2 = s \left(\frac{r_3}{r} - 1 \right). \quad (41)$$

From equations (39), (40), and (41)

$$l_2 = \frac{s}{2} \left(\frac{r_1 + r_3 - r_2}{r} - 1 \right). \quad (42)$$

If r_1 and r_2 are equal obviously l_1 equals l_2 .

If a Wheatstone bridge is used instead of a slide wire, the value of the return wire in ohms is readily obtained

and the necessary allowance in calculating the fault distance-is a simple matter.

LOOP TEST WHERE ONLY A SMALL RETURN OF KNOWN RESISTANCE IS AVAILABLE

The connections in Fig. 82 would be used. If the resistance of the slide wire is known, and the length and area of

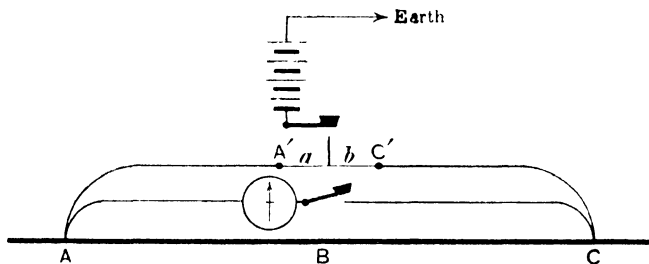

FIG. 84. LOOP TEST WITH TWO PILOT WIRE RETURNS

the return, the conversion of this to slide wire divisions is a simple matter. If the resistance of the slide wire is not known, then a short length of conductor of the same area as the return can be calibrated in terms of slide wire divisions by the method described in Fig. 83, from which the equivalent in slide wire divisions of the return is readily resolved.

Again if the length of faulty cable is comparatively short, a length of say 7/036 in. V.I.R. can be run over the route on the ground to form a return and similarly a finer wire for the galvanometer connection. This may be more expedient than incurring the trouble of disconnecting an available pilot lamp or street lighting cable.

An alternative to the foregoing methods is indicated in Fig. 84, which assumes that a pilot circuit is more expediently tapped in position B. The slide wire is connected between A' and C'. On a short length the error due to

the pilot cable resistance can be more safely ignored, especially if B is approximately in the centre of the faulty cable. If desired, however, the pilot AA', CC' can be calibrated in slide wire divisions as described.

A DIRECT INDICATING LOOP TEST

On short lengths of cable, provided traffic conditions permit (and a signaller or a man with good carrying voice

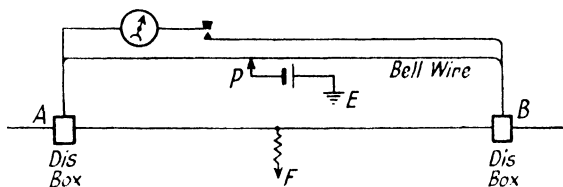

FIG. 85. DIRECT INDICATING LOOP TEST

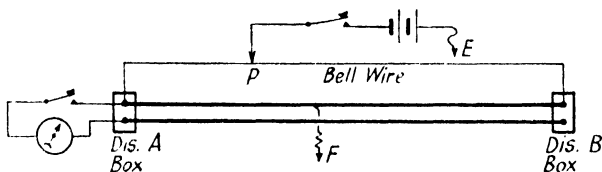

FIG. 86. ALTERNATIVE DIRECT INDICATING LOOP TEST

and dead-beat galvanometer is stationed at A), the exact fault position can be directly indicated if a length of lightly insulated wire, say bell wire, is run over the ground surface along the cable route and used as a slide wire. Another insulated wire must be similarly run and connected to the cable ends as shown in Fig. 85 for the galvanometer.

The galvanometer would be connected at one end of the faulty cable section, outside the slide wire connections, while the battery contact could be made by a pin or penknife piercing the insulation of the bell wire APB. On

moving the point P until no deflection of the galvanometer occurs, this point of balance will be exactly above the fault. Two men are, of course, necessary for carrying out the test.

Fig. 86 is another form of this test in which a loop is made by any available cable or core of sound insulation. Some method of signalling between the two operators is necessary unless the battery and battery key are taken along on a truck with the galvanometer and a trailing cable for the latter extended from the end A. The positions of the battery and galvanometer in this and the foregoing test can be reversed for increased sensitivity, but it may then be necessary to work to a false zero.

LOCALIZATION WITHOUT DISCONNECTION OF CONSUMERS

It has been explained that, to make an accurate localization test on a distributor it is advisable to clear all consumers' connections. This means house to house visits and takes time. Mr. W. Redmayne has pointed out* that, in certain circumstances, the disconnection of consumers' installations can be dispensed with, provided that the neutral is disconnected from earth for the purpose of the test and there is no serious fault on the neutral itself.

Fig. 87 represents a balanced Wheatstone bridge. The points AA_1 , BB_1 will be equipotential points, and connecting them up as shown by the dotted lines would not disturb the balance of the bridge. Fig. 88 shows how this might be expected to work out in practice, assuming that consumers' "loadings" are left connected between the phase wire and the isolated neutral all along the distributor. Actually, these loads are not evenly distributed, but if the test is carried out with a low resistance slide wire the result may not be seriously affected, and an approximately

* *Electrical Power Engineer*, Vol. XXII, page 39, January, 1940.

correct indication of the position of a dead earth or a low-resistance fault can be obtained. It is seen that the loop is made up of two phase wires. Only a comparatively low-voltage test battery can be used ; Mr. Redmayne has found it unsafe to apply more than about 12 volts owing to the risk of overloading such things as clocks, meter shunts, and particularly the transformers of radio sets, the reactance of which will, of course, not limit the D.C. current. Tests made on a

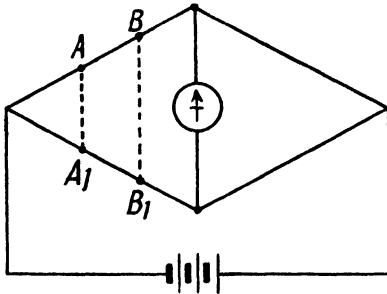

FIG. 87. EQUIPOTENTIAL POINTS ON WHEATSTONE BRIDGE

scale model with a view to indicate the degree of accuracy obtainable showed an error of half a yard with

Tests made on a scale model with a view to indicate the degree of accuracy obtainable showed an error of half a yard with

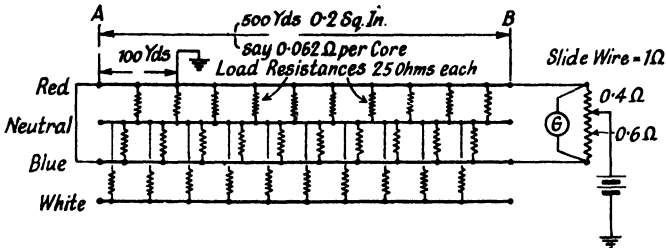

FIG. 88. EXAMPLE OF TEST WITHOUT DISCONNECTION OF CONSUMERS

all loads connected as shown, one yard with loads on the red core only, and two yards with an additional dead earth on the neutral core at fault position. Even with all loads connected as shown and additional loads corresponding to 50 kW at 230 volts at the B end of the red core and the A

end of the blue core the error was only $5\frac{1}{2}$ yd., i.e. about $\frac{1}{2}$ per cent of the total length of the loop.

A theoretical investigation as to the effect of general low insulation and the effect introduced by the existence of more than one fault in a cable is given on page 235 of this chapter.

TESTS ON LIVE MAINS

Cases may arise occasionally in which considerable trouble would be experienced in disconnecting the faulty

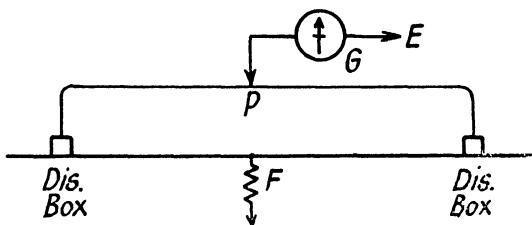

FIG. 89. DIRECT INDICATING LOOP TEST ON A LIVE NETWORK

piece of cable absolutely from the network, while at the same time the insulation resistance of the remainder of the network is known to be high relatively to the resistance of the fault. Then if the station earth be removed, on a D.C. system a live cable may be tested by simply connecting the piece of bell wire and a well-shunted galvanometer as Fig. 89. By making contact to the bell wire as explained on page 222 a point of balance may be found. A fair degree of accuracy is possible if the fault is a dry dead earth so that the galvanometer can be sufficiently shunted to be insensitive to earth currents. A fine fuse should be inserted in the galvanometer circuit to protect it.

Testing similarly on a live A.C. system, a high resistance pair of earphones can be substituted for the galvanometer in Fig. 89, minimum sound indicating the approximate fault

position, but if the connected network is at all extensive, capacitance currents will render the test valueless.

The tests shown in Figs. 82 to 86 may be carried out on live A.C. networks by superimposing the battery current on the A.C. As the alternating current will not directly

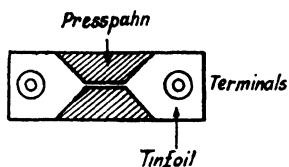

FIG. 90. EXTEMPORIZED FUSE

cause a deflection of the galvanometer needle, one must be doubly careful that it does not damage the instrument; fine fuses should be used as recommended. One simple way of making a fine fuse is to paste a piece of tinfoil on a piece of presspahn, approximately 2 in. \times 1 in. fitted with a pair of terminals as shown in Fig. 90, cutting the tinfoil away with a sharp knife in the form indicated to as narrow a strip as possible.

TRAMWAY AND TROLLEY BUS FEEDERS

The principles governing the localization of faults on mains supplying tramways and trolley buses are naturally identical with those for other cables, but in some instances the conditions under which they have to be utilized may vary slightly. Taking first the case of ordinary tramway feeders, instead of these being run in pairs as electric light feeders, the positive feeders are run parallel to the line and are looped in to bus bars in feeder pillars every half mile, and cables are run from these to the trolley wires. The current from the rails, on the other hand, may be led back by only one negative feeder; and on long routes, upon which additional negative feeders may be run, these are not necessarily led in and out of the feeder pillars all along the route.

Thus in the case of a fault on a positive feeder, it will be the exception rather than the rule that a simple loop

back through a negative feeder can be obtained for localization purposes. But the trolley wires themselves are always available to make up the loop. True, their resistance will not be known accurately, owing to wear having diminished their section, but by employing both wires for

the test, as described in Chapter VI, their resistance does not come into consideration at all. After finding out, by disconnecting the feeder at the feeder pillars, in which half-mile length the fault is, the feeder is left disconnected from the trolley wires at one end, and left joined up to the two trolley wires back towards the fault at the other end. For convenience the diagrams are repeated here (Figs. 91 (a) and 91 (b)). The slide wire is connected between one of the trolley wires and the feeder, the galvanometer and battery connections are made as in Fig. 91 (a), and the reading r_1 is taken when the bridge is

balanced. The earthed terminal of the battery is then disconnected from earth, and connected to the second trolley wire as shown in Fig. 91 (b), and the balance again obtained with the slider at r_2 . The distance of the fault will be

$\frac{r_1}{r_2} l$, where l is the length of the feeder.

The connections to the trolley wires as well as the connections to the feeder itself can be made in the feeder

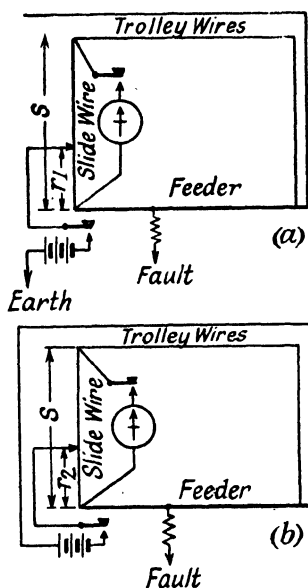

FIG. 91. TEST ON TRAMWAY FEEDERS

pillar. The galvanometer circuit connection at the trolley wire end of the slide wire must be made directly on to the slide wire terminal, not on to the trolley wire terminal; the length of the wire connecting the slide wire to the trolley wire is then immaterial. On the other hand, the wire connecting the feeder terminal to the slide wire does come into consideration. If it is very short and thick, so that its resistance is not greater, say, than two or three divisions of the slide wire, no allowance need be made for it, and then the galvanometer connection must be made on to the feeder terminal, and not on to the slide wire terminal, so as to put the wire between these two terminals in the slide wire arm of the bridge, and not the cable arm. If, however, a few feet of wire are required for connecting the feeder and slide wire terminals, it is best to allow for it in the calculation by the method of equivalent lengths, and to connect the galvanometer wire directly to the slide wire terminal. For instance, if the feeder is of $37/064$ in., and exactly 880 yd. long, and a yard of $7/064$ in. cable is used to connect it to the slide wire, l is taken as $880 + \frac{37}{7} =$ say, 885 yd. The value $\frac{r_1}{r_2} \times 885$ is then calculated, and five yards are subtracted from the result before measuring off the position of the fault.

A method of street testing by using as a slide wire a bare or lightly-insulated cable or wire laid in the street over the faulty cable has already been described in this chapter. Mr. W. Redmayne* has pointed out how a similar method (which he has used successfully in actual practice) may be employed for finding a fault in a tramway feeder. The method is a very neat one, and can be used in the day-time while cars are running, as only one trolley wire has to be

* In a letter to the *Electrical Review* of 13th September, 1912 (Vol. LXXI, page 410).

disconnected. The trolley wire further from the footpath is left live, and the cars can make use of it during the test; the other is made dead as well as the faulty feeder. The connections are shown in Fig. 92. They involve only an ammeter (preferably of the central zero pattern), or a galvanometer connected across the two ends of the faulty feeder by means of a telephone wire or any other wire

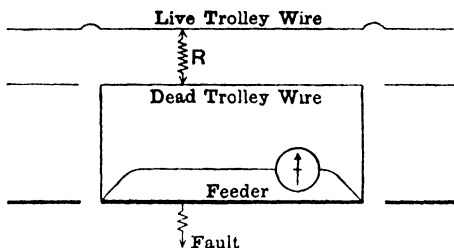

FIG. 92. DIRECT INDICATION OF POSITION OF FAULT IN TRAMWAY FEEDER

connecting the two feeder pillars, and a resistance R (about 20 or 30 ohms, say a 2 kW radiator) carried on a tower wagon and arranged to bridge across from the live to the dead trolley wire. The tower wagon is pushed along until the galvanometer reading is zero, and in that position it will be almost immediately above the fault. As a matter of fact, the actual position of the fault will be slightly nearer the centre of the length of feeder in question than the position indicated, owing to the "slide wire" not being made up of the trolley wire only but the trolley wire plus the two cables from the feeder pillar to it. Assuming, for instance, that this "side feed," "line tap," or "feed wire," as it is variously called, is of slightly less sectional area than the trolley wire, the error will be somewhat less than the length of the side feed if the fault is near the end of the feeder, but will gradually diminish the nearer the fault is to the centre of the section, at which

point the result of the test would be theoretically absolutely accurate, provided the resistances of each connection from the trolley wire to the feeder are identical.

To calculate the position of the fault with greater accuracy, the connections shown in Fig. 93 are to be recommended—that is to say, the galvanometer is connected directly to the trolley wire and the “side feeds” form part

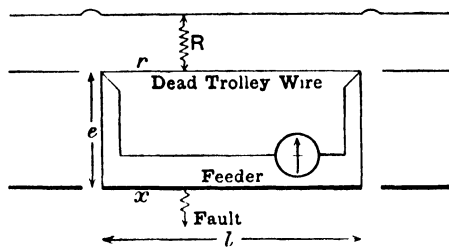

FIG. 93. MORE ACCURATE METHOD, ALLOWING FOR RESISTANCE OF SIDE FEEDS

of the cable loop. Then, if a is the section of the feeder and b the section of each side feed, the equivalent length of each feed wire in terms of a cable of the same section as the feeder is $e = \frac{a}{b} l'$ where l' is the actual length of the cable from the feeder pillar to the trolley wire.

If l is the actual length of the feeder itself, and r the length of the trolley wire measured off at balance, assuming equal lengths of side feeds, the distance of the fault x is not exactly r , but is given by the formula

$$x = r + \frac{2er}{l} - e$$

As before, if balance is obtained exactly in the centre of the feeder section, the fault will be at this central point. But, with these connections, if r is less than half the length of the section, x will be not quite so far; and if the tower

wagon at balance is beyond the centre of the section the fault will be a little further on. The amount to go back or forward, after obtaining balance, in order to find the fault, is the difference between $2er/l$ and e .

Mr. Redmayne suggests that the connections should first be made as Fig. 93, and, if then balance is obtained near one of the ends of the feeder section, the connections should be changed to Fig. 92, and the mean between the two positions taken as the position of the fault. With certain sections of side feeds and feeders this may be a fair approximation, although if the actual sections of the two cables are easily known it is obviously advisable to make the simple calculation above so as to obtain the proper position before opening up the street.

To take an example—

Feeder 880 yd. long and 0.5 sq. in. section.

Connections as Fig. 93.

Side feeds each 57 ft. long (from feeder pillar to trolley wire) and 0.15 sq. in. section.

Balance obtained 280 yd. from the near end of the feeder.

$$e = \frac{a}{b} l' = \frac{0.5 \times 19}{0.15} \text{ yd.} = 63\frac{1}{3} \text{ yd.}$$

$$\frac{2er}{l} = \frac{126\frac{2}{3} \times 280}{880} = \text{about } 40\frac{1}{3} \text{ yd.}$$

The position of the fault will be 23 yd. back from the position of the tower wagon at balance.

On the other hand, if balance is obtained at 462 yd. from the near end of the feeder, that is 22 yd. after the centre of the feeder sections has been passed over.

$$\frac{2er}{l} = \frac{126\frac{2}{3} \times 462}{880} = 66\frac{1}{2} \text{ yd.}$$

and the position of the fault will be about three

yards further than the position of the tower wagon at balance.

An alternative method of the foregoing test is an adaptation of the test described in Fig. 89, page 225. The dead trolley wire only is connected as in Figs. 92 and 93, and this replaces the bell wire in Fig. 85. By arranging a sliding contact to the trolley wire by means of a hook on a long pole connected to an earthed battery, a point of balance is found. The corrections mentioned in the foregoing test will apply similarly. This arrangement is useful where means of access to the second trolley wire involves inconvenience or delays.

A fault on a negative feeder should be localized by the ordinary loop method if a loop can conveniently be made up by means of the positive feeder. The fuses between the positive-feeder terminals and the bus bars in the feeder pillars should be replaced by links, and the fuses on the live side removed. If a pilot wire is a more convenient return wire, a fall of potential method may be used with some sacrifice of accuracy. In fact, the same methods of localization are available as for an ordinary feeder.

Similar methods can be used for trolley bus feeders, or, since in this case the positive and negative feeders will run together, the ordinary loop test can be carried out with accuracy. If care is exercised to avoid shock, a battery can be dispensed with. The two cables would be disconnected between feeder pillars, short-circuited at one end to form a loop, and the connection to the moving contact of the slide wire taken from the live pole in the feeder pillar through a couple of lamps in series.

LOOP TESTS ON LEAD SHEATH

Under favourable conditions it is possible to obtain successful results from a loop test made on the lead sheath, in cases where a complete copper loop is not available, for

example, faults as Fig. 2, *d*, *e*, and *f* (Chapter I, page 5). The useful application of this test will usually be confined to cables laid on the solid system or drawn into fairly dry earthenware ducts, in which systems the shunting effects of contact with earth can be reduced to a minimum by the temporary removal of bonds.

The loop can be formed by the lead sheath of an adjacent cable, which need not necessarily be dead. In this case it has to be assumed that the sheaths are not in contact anywhere except at the looping points. If the two faulty and return cables are known to be similar, the sheath resistances per unit length can be considered equal, otherwise the return sheath should be converted to the equivalent area of the sheath of the faulty cable by the same process as the conversion of conductors to equivalent lengths, by taking the ratios of sectional areas of the sheaths. If the types of the two cables are known, the lead thicknesses can be determined from the British Standard Specification No. 480, but older cables should not be referred to recent editions of these specifications as lead thicknesses may differ. The inner and outer diameters of the lead can be measured in most cases near a joint and the sheath areas thus calculated.

Where a copper conductor is used as a return, this must be converted to an equivalent length of the lead sheath as follows. Taking the conductivity of copper as k times that of lead and bearing in mind that most cables of British manufacture are sheathed with almost pure lead whose specific resistance can be considered substantially uniform, if A_L and A_C are the respective areas of the lead sheath and the copper conductor, the former having been calculated as first described, then the equivalent length of the copper return in terms of the lead sheath is $kL \frac{A_L}{A_C}$, where L is the length of the faulty cable.

The connections for the test are given in Fig. 94, which shows a fault in which all three conductors of a three-core cable are burnt through and in contact with one another and the lead sheath.

The battery, slide wire, and galvanometer must be insulated from earth. Balance would be made in the usual way for a loop test and the results similarly calculated.

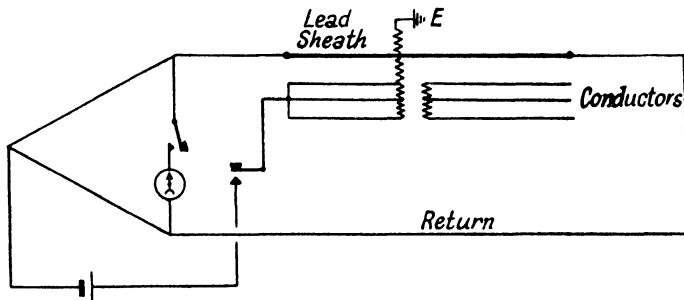

FIG. 94. LOOP TEST ON LEAD SHEATH

In addition to the inaccuracy involved in the determination of equivalent lengths owing to uncertainty as to the exact sectional area and specific resistance of the lead sheaths, the principal disadvantage of this test is the prevalence of earth currents in the sheath which may be injurious to the galvanometer. The galvanometer circuit should therefore be first closed through a resistance or shunted to ascertain the magnitude of any such currents. They may be high enough to vitiate the accuracy of the test, although their effects may be reduced by passing as large a current as possible through the fault, shunting the galvanometer, and working to a false zero.

These factors, and the uncertainty of freedom from contacts with earth at various points along the run, limit the application of the tests to short lengths of cable. In fact, the test can only then be considered accurate if the

sheath of a second cable exactly similar to the faulty one is available to make up the loop, both of which can be reasonably insulated from earth.

THE "RESULTANT FAULT"

Where the normal insulation of the cable is low, the question arises as to how accurately the fault can be localized. It is impossible to give a hard and fast rule, as it depends on circumstances. The resistance of the fault must be so low that the following two conditions are fulfilled—

(1) The resistance of the fault must be low compared with the insulation resistance of the rest of the cable and its connections.

(2) The battery power used for localizing must be high enough to pass adequate current through the fault.

As regards (1), if the normal insulation of a cable and its connected apparatus is low, one can conceive, for the purpose of the following investigation, that some sort of a result might have been obtainable from a loop test applied to the cable when sound. The position obtained would be called the *resultant fault position*. If the cable had an evenly distributed low insulation, this position, or the centre of gravity, so to speak, would be midway along the loop.

In Fig. 95 let CBDHM represent the loop of cable.

D being the position of the fault as indicated by the test; let $CD = x$.

H the estimated position of the resultant fault due to other leakages from the loop; let $CH = y$.

And, let B be the true position of the fault, which we want to estimate. We will call $CB = b$.

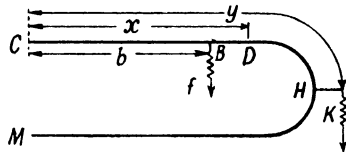

FIG. 95. EFFECT OF GENERAL LOW INSULATION ON FAULT TEST

Also let K be the insulation resistance of the loop before the fault occurred—in fact, the resistance of the resultant fault acting at H .

F is the insulation resistance of the loop at the time of the localization test; and f the resistance of the fault itself.

The resistance F is made up by the two resistances K and f in parallel, so that

$$F = \frac{Kf}{K + f}$$

from which
$$f = \frac{KF}{K - F} \quad (43)$$

Now, clearly, the position D of the fault which we calculated from the test will lie between its true position B and the position H of the resultant fault due to other leakages; and its position with respect to these will depend on the relative values of K and f . (If K were equal to f , D would be halfway between B and H .)

In fact,
$$\frac{BD}{DH} = \frac{f}{K}$$

i.e.
$$\frac{x - b}{y - x} = \frac{f}{K}$$

from which
$$b = x + \frac{f(x - y)}{K}$$

Substituting the value of f , given in equation (43),

$$b = x + \frac{(x - y)F}{K - F} = \frac{xK - yF}{K - F} \text{ or } \frac{x - y \frac{F}{K}}{1 - \frac{F}{K}} \quad (44)$$

To get an idea of the error caused by this resultant fault we can consider a mean case. Suppose the resultant fault was at the middle point of the cable loop ($l/2$ from

the testing point), and the position of the new fault, as given by the localization test, is a quarter way along the cable ($l/4$ from the testing point). Then, if F be $1/10$ th of K , the test is about 10 per cent wrong; if F be $1/100$ th of K , the test is 1 per cent wrong—that is to say, the actual error is $\frac{1}{4}$ per cent of the length of the cable loop.

The difficulty is to fix the position of this previous resultant fault. Sometimes it may be guessed or "estimated," and sometimes it is correct to assume it to be at the middle point. A localization test can be *absolutely* relied on when the fault resistance of the rest of the cable and connections is very great compared with the resistance of the fault, i.e. when K is very great in comparison with F . If a loop is made up of several pieces of different-sized cable, a distinction must be made between the actual middle point of the loop and the centre of the equivalent length. The former would be assumed to be the position of the previous resultant fault in many cases, and then its equivalent distance from the end must be calculated and equation (44) be employed.

Another difficulty is that, if the insulation of the rest of the cable is low so that it is comparable with the resistance of the fault, it is not at all easy to balance the bridge owing to the constant change in the position and value of the resultant fault.

The same also holds good when there are two faults in the cable, in which case the position worked out from the test will lie between the actual positions of the two faults and nearer to the worse one.

The effect of consumers' connections being left on during a localization test has been dealt with in this chapter.

In a long submarine cable the resultant fault position is a very important factor in the calculation of a fault position because the normal resistance of the cable is commensurate with the fault resistance. As the resultant

fault position is a function of time because of the effects of "electrification" the time of application of the battery should be noted. In submarine work it is customary to record all data respecting the resultant fault position observed when the cable is sound.

ACCURACY OBTAINABLE

How low must the resistance of a fault be to be localized to a given degree of accuracy? Or, what is the error in localizing a fault of known resistance with a given battery and apparatus?

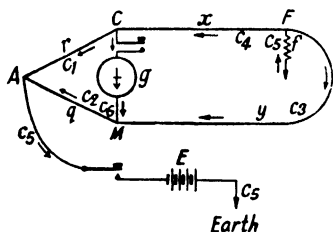

FIG. 96. ACCURACY OF LOOP TEST

To solve this problem we will consider that the test is carried out by Murray's method, using a slide wire bridge, as this is the simplest case. To make use of the formula (50) on page 241 in order to determine the accu-

racy obtainable in localizing a fault, or the maximum resistance of a fault that can be localized to a required degree of accuracy, it is not necessary to read the proof here given. As it is simple, however, it has not been omitted.

Taking the bridge shown in Fig. 96, let the resistance of the cable loop be l , the resistance of CF x , and of MF y ; so that $l = x + y$. Let s be the resistance of the slide wire CAM, and for balance let $CA = r$ and $AM = s - r = q$. We will first suppose that the sliding contact A is not quite at the balance position, but that CF is r_1 instead of r , and that AM is q_1 instead of q . $r_1 + q_1$ is, of course, s as before. Let f be the resistance of the fault + the resistance of the battery, let g be the resistance of the galvanometer, and E the electromotive force of the battery.

Then, if c_1 , c_2 , c_3 , and c_4 be the currents through CA, AM, MF, and FC respectively, c_5 the current through the battery and fault circuit, and c_6 the current through the galvanometer, we have by Kirchoff's laws (see Appendix)

$$\begin{aligned}c_5 - c_4 - c_3 &= 0 \\c_4 - c_6 - c_1 &= 0 \\c_3 + c_6 - c_2 &= 0 \\c_5 f + c_3 y + c_2 q_1 - E &= 0 \\c_1 r_1 - c_2 q_1 - c_6 g &= 0 \\c_3 y - c_4 x - c_6 g &= 0\end{aligned}$$

By eliminating c_1 , c_2 , c_3 , c_4 , and c_5 in the above set of equations, we get the following value for c_6 , the current through the galvanometer—

$$c_6 = \frac{E(r_1 y - q_1 x)}{g\{(r_1 + x)(q_1 + y) + f(r_1 + q_1 + y + x)\} + f(y + x)(r_1 + q_1) + q_1 y(r_1 + x) + r_1 x(q_1 + y)}$$

As balance very nearly obtains, we may substitute in the denominator $\frac{r_1}{q_1} = \frac{x}{y} = \frac{r}{q}$, or $q_1 = r \frac{y}{x}$.

(We cannot substitute this in the numerator, as this includes a difference between two multiples of r_1 and q_1 .)

Making this substitution, and also substituting l for $x + y$ wherever it occurs, we get

$$c_6 = \frac{Ex(r_1 y - q_1 x)}{\{g(r + x) + rl\} \{fl + y(r + x)\}} \quad (45)$$

Now suppose that c_6 is the smallest current that will produce a visible deflection on the galvanometer scale, and that this corresponds to the position of the slider which divides the stretched wire into the two parts r_1 and q_1 , instead of r and q . On calculating the position of the

fault from this reading r_1 , we would employ the usual equation $\frac{r_1}{s} = \frac{x_1}{x + y}$, where x_1 is $x + \lambda$, λ being the error occasioned in the result. From this

$$\begin{aligned} r_1(x + y) &= (x + \lambda)s \\ r_1y &= (s - r_1)x + \lambda s \\ &= q_1x + \lambda s. \end{aligned}$$

Consequently $(r_1y - q_1x) = \lambda s$, and equation (45) becomes

$$c_6 = \frac{Ex\lambda s}{\{g(r + x) + rl\} \{fl + y(r + x)\}}$$

Substituting, in the denominator, $l - x$ for y , and $\frac{xs}{l}$ for r

(since $\frac{r}{s} = \frac{x}{l}$) we get

$$\begin{aligned} c_6 &= \frac{Ex\lambda sl^2}{x(gs + gl + sl) \{fl^2 + x(l - x)(l + s)\}} \\ &= \frac{Ex\lambda sl^2}{(gs + gl + sl)(fl^2 + xl^2 + xls - x^2l - x^2s)} \\ &= \frac{E\lambda}{(gs + gl + sl) \left(\frac{f}{s} + \frac{x}{s} + \frac{x}{l} - \frac{x^2}{ls} - \frac{x^2}{l^2} \right)}. \quad (46) \end{aligned}$$

All the terms in the second bracket of the denominator are probably fractional, with the exception of $\frac{f}{s}$ and f is large in the case we are considering, so that we have, as a close approximation

$$c_6 = \frac{E\lambda}{\frac{f}{s}(gs + gl + sl)}. \quad (47)$$

$$\therefore \lambda = \frac{c_6 f}{E} \left(g + \frac{gl}{s} + l \right). \quad (48)$$

We may put this question in another form. If v is the potential difference that will produce the smallest deflection visible on the galvanometer scale, $c_6 = \frac{v}{g}$. Substituting, we get

$$\lambda = \frac{vf}{E} \left(1 + \frac{l}{s} + \frac{l}{g} \right) . \quad (49)$$

What we really want to know is the possible error in yards, not the possible error in ohms. This will be

$$\lambda \times \frac{\text{length of loop}}{l}$$

Multiplying, therefore, both sides of the equation by $\frac{\text{length of loop}}{l}$ we get—

Possible error in yards

$$= \frac{vf}{E} \left(\frac{1}{l} + \frac{1}{s} + \frac{1}{g} \right) \times \text{length of loop} \quad (50)$$

This is a very simple result.

v is a property of the galvanometer (the potential difference necessary to produce the smallest visible deflection—see page 30, Chapter II).

f is the resistance of the fault,

E is the E.M.F. of the battery,

l is the resistance of the cable loop,

s is the resistance of the slide wire,

and g is the resistance of the galvanometer.

The possible error is proportional to v and f , and inversely proportional to E .

If a resistance box bridge is used for the test instead of a slide wire bridge, it will not be accurate to derive equation (47) from equation (46), if s is of the same order as f .

But, so long as f is larger than s , the formula (50) will be an approximation, as all the terms after f/s within the bracket in equation (46) are fractional. This approximation will cause the result to show a less value for λ than is really the case.

Within these limits it is seen, from equation (50), that the greater s is, the less will be the possible error in yards for any particular value of f . The error is, however, not by any means inversely proportional to the value of s , since the term $1/l$ in the bracket is usually much more important than $1/s$ or $1/g$.

It must not be assumed from equation (50) that there is necessarily any virtue in using a high resistance galvanometer, for in this connection one has to take account of v outside the bracket, as this is also a function of the resistance of the galvanometer, being c_6g . To consider fully the effect of galvanometer resistance, therefore, we must go back to equation (48), where it is seen that g occurs only in the numerator and therefore increases the error. On the other hand, in order to get the highest possible figure of merit for the galvanometer, i.e. a low value for c_6 , a high resistance galvanometer is necessary. Taking all things into consideration, however, a good volt figure of merit, i.e. a low value of v is the thing to go out for in bridge work. The best results are not obtainable with the very high resistance sensitive galvanometers. Given the lowest v we can get, a galvanometer of a comparatively low resistance is best suited to our purpose, since with any commercial instrument $1/g$ can be virtually neglected in comparison with the term $1/l$, the conductance of the cable loop.

There is one other limit to the application of equation (50) which may be mentioned, though it is more or less self-evident. If the length of the slide wire used for the test be, say, 1 000 scale divisions, and if it is only possible

to read the position of the pointer to half a division, it is evident that no greater accuracy than a two-thousandth part of the length of the cable loop is obtainable whatever result may be obtained by calculating from equation (50). Thus, again, if a bridge with two sliding contacts be used, so as to be direct reading, and the movable terminal be fixed at the length of the scale in yards, we know that no greater accuracy is obtainable than that corresponding to the accuracy with which the position of the slider can be read. This matter has already been dealt with in some detail in Chapter VII.

The same applies if a resistance box bridge of the Post Office portable pattern is used instead of a slide wire: suppose, for instance, that balance is obtained when the amount of resistance unplugged in both arms ($r + q$) is about 3 000 ohms. Since q can only be adjusted to within one ohm, there is always a possible error not exceeding half an ohm in the value read for q , and consequently the possible error on either side in the result of the test will be a six-thousandth of the length of the loop.

We will now consider a numerical example, and see how the result of this investigation is applicable in practice. Suppose that the resistance (l) of a loop containing a fault is 0.08 ohm, the resistance (s) of the stretched wire is 0.3 ohm, and the resistance (g) of the galvanometer is 50 ohms. Also suppose that the v of the galvanometer is 3×10^{-5} volt, that an E.M.F. of 100 volts is available for the test, and that the length of the loop is 400 yd. How low must the resistance of the fault be to enable us to localize it with a certainty that our test is not more than four yards out?

$$\begin{aligned} \frac{1}{l} + \frac{1}{s} + \frac{1}{g} &= \frac{1}{0.08} + \frac{1}{0.3} + \frac{1}{50} \\ &= 12.5 + 3.3 + 0.02 = \text{about } 16 \end{aligned}$$

Substituting in equation (50),

$$4 = \frac{3 \times 10^{-5} \times f}{100} \times 16 \times 400$$

$$\therefore f = \frac{10^5}{48} = \text{about } 2\,000 \text{ ohms}$$

LOOP TESTS ON BRANCHED CABLES

In concluding this chapter on Loop Tests mention must be made of errors which frequently occur in practice when localizing faults by the loop method on cables to which branched circuits are jointed. Taking the simple case of a straight run to which only one branch is jointed, if the fault is in the latter and the loop is made at the end of the main and the end of the branch left open, it is obvious that the test result will indicate the fault as being at the T-joint. If, on the other hand, the loop is made at the end of the branch, and the end of the main left open, then the test gives the correct fault position, bearing in mind the necessity of conversion of the length of the main to the equivalent length of cable of the same sectional area as the branch, if the latter cable is smaller.

If after a fault on a network has been narrowed down to as small an area as possible by the removal of disconnecting links, several "solid" branches such as services remain, a number of tests are possible before the correct fault position is localized, should it happen to be on a branch or service. Rather than waste time in making systematic loops on branches, it is expedient to loop on the main and if the fault is given at a T-joint, to loop again at the end of the branch at this point and repeat the test, after opening the first loop of course. Two tests will thus suffice to ascertain the fault position, and if both give the same result then the fault is in the T-joint itself.

The same principles apply in making the fall of potential tests (Chapter IX) on "teed" cables.

CHAPTER IX

FALL OF POTENTIAL METHODS

THE principle of these methods is delightfully simple. A galvanometer is required whose deflections are proportional to the current through it, the instrument being used to measure relative differences of potential. Its resistance

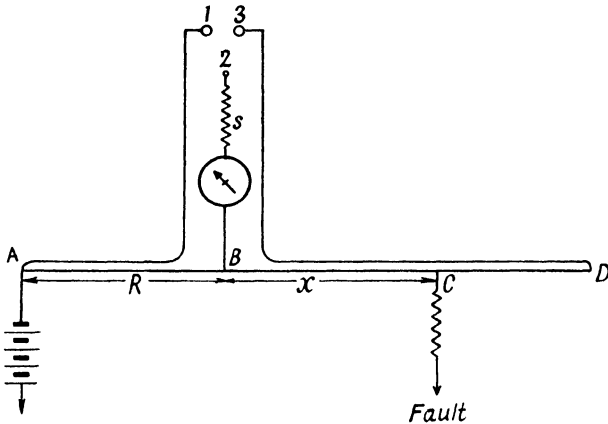

FIG. 97. PRINCIPLE OF FALL OF POTENTIAL METHOD

must be high compared with the resistances of the battery, fault, pilot wires, and cable; if it is not, a resistance must be placed in series with it to fulfil this condition. Connections are made as in Fig. 97.

AB represents a known resistance R ; BD represents the faulty section of cable, C being the position of the fault; x stands for the resistance of BC, and s is the resistance in series with the galvanometer.

On connecting the points 1 and 2 together there will

be a galvanometer reading d_1 proportional to the difference of potential between A and B.

On connecting the points 2 and 3 together there will be a deflection of d_2 proportional to the difference of potential between B and D, i.e. between B and C, as CD is not in the main circuit.

$$\text{Then} \quad x = R \frac{d_2}{d_1} \quad . \quad . \quad . \quad . \quad (51)$$

If there is any doubt as to the true proportionality of the galvanometer (scale readings : current strengths) the value of s , instead of remaining at the same for the two readings, may be adjusted so that d_1 and d_2 are equal. Then, calling the galvanometer resistance g , the voltage drops across AB and BC, v_1 and v_2 respectively, and the instrument constant k , we have

$$kd_1 = \frac{v_1}{g + s_1} \quad \text{and} \quad kd_2 = \frac{v_2}{g + s_2}$$

where s_1 and s_2 are the respective values of the resistance s , whence

$$\frac{d_1 v_2}{d_2 v_1} = \frac{g + s_2}{g + s_1}$$

If s_1 and s_2 have been adjusted so that d_1 equals d_2 then

$$\frac{v_2}{v_1} = \frac{g + s_2}{g + s_1}$$

whence formula (51) becomes

$$x = R \frac{g + s_2}{g + s_1} \quad . \quad . \quad . \quad . \quad (52)$$

If s_1 and s_2 are high compared with g ,

$$x = R \frac{s_2}{s_1} \quad . \quad . \quad . \quad . \quad (53)$$

Method 1. AB is a section of good cable, in series with BD, the faulty section. Pilot wires or spare wires or cables of good insulation are available to connect D and B respectively to the testing station at the end A. There must be a resistance box in series with the galvanometer. This resistance is adjusted until both the deflections d_1 and d_2 are readable on the scale of the instrument, and are conveniently large.

Let b be the distance required, viz. that from B to the point C; and let a be the length of cable between A and B. If AB has the same sectional area as the faulty cable,

$$b = \frac{ad_2}{d_1} \quad (54)$$

If, by adjusting the resistance in series with the galvanometer, the reading d_1 be made numerically equal to a , d_2 will give directly the required length b . In practice, however, this adjustment is not always feasible, nor is it worth the trouble. As already mentioned, however, d_1 and d_2 can be made equal by adjusting s , and the ratio $\frac{g + s_2}{g + s_1}$ is then used (or s_2/s_1 if g is relatively small) in place of d_2/d_1 .

If the cables AB and BC are made up of several pieces of cable of different sectional areas, the "equivalent lengths" of the pieces (as explained in describing the loop tests on pages 168 to 171) must be taken for a and b in equation (54). Thus, in the simple case in which AB has throughout a sectional area S_1 , and BC throughout a sectional area S_2 ,

$$b = \frac{aS'_2 d_2}{S_1 d_1} \quad (55)$$

where a' is the actual length of the piece AB, $\frac{aS'_2}{S_1}$ being its equivalent length—i.e. the length of a cable of

sectional area S_2 , which would have the same resistance as the piece AB.

Method 2. When the good cable and pilot wire from A to B are not obtainable, a resistance coil may be used for R if the resistance per yard of the faulty cable is known accurately. The resistance along the faulty cable up to the fault is then calculated from equations (51) or (53). Or AB may be a piece of cable in the testing station itself, BD being, as before, a length of cable containing the fault. Then the one pilot wire from the far end is all that is required in the way of external circuit. If the fault is in a concentric or multicore cable, one conductor of which is normal, then the latter can be used to connect D to 3 in place of a pilot wire.

It may be necessary to make a correction for difference in temperature between the cable in the station and that outside. In calculating the equivalent length of the piece of cable in the station, 0.22 per cent must be added for every degree Fahrenheit its temperature is above the estimated temperature of the cable in the ground. The length and size of the piece of cable AB in the station should be chosen so that its equivalent length, and therefore its resistance, is about the same as that expected from the station to the fault, so that the deflections d_1 and d_2 do not differ widely.

Thus, if the fault be in a cable of 37/064 in. gauge, running to the station, and it is expected that the fault is about 100 yd. distant, the piece AB may be taken of

7/064 in. cable, and its length $\frac{100 \times 7}{37}$ yd. = 56 ft. 9 in.

Then, if the temperature error is negligible, its equivalent length is 100 yd. If this piece of cable is in the engine room, whose temperature is 15° higher than the estimated temperature underground, $15 \times 0.22 = 3.3$ per cent must be added to obtain its correct equivalent length, which

then becomes 103.3 yd. Suppose the deflections obtained were $d_1 = 241$ and $d_2 = 218$, the distance of the fault from the station would be $a = \frac{218}{241} \times 103.3 = 93$ yd.

The size of the cable AB and the current sent through the circuit ABC . . . must be so chosen that there is no appreciable heating of either of the cables. This is very important, and applies to all methods. The connection

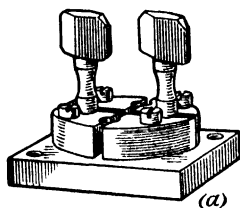

FIG. 98A. FOUR-WAY
PLUG SWITCH

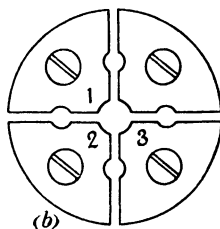

FIG. 98B. FOUR-WAY
PLUG SWITCH

between the two cables at B must be a very good one. A good plan is to sweat both ends together, or to sweat each into a connecting-lug and bolt them up tightly, the lugs being first polished clean with emery cloth.

The difficulty in carrying out these fall of potential tests is that the current through the main circuit ABC must be kept absolutely constant during the test. This would be easy enough if it were an ordinary circuit, but it includes the fault, which frequently has a varying resistance. In carrying out the test, the resistance of the galvanometer circuit is adjusted so that the deflections d_1 and d_2 are of convenient size, as above explained. If necessary the E.M.F. of the generator or battery must also be adjusted, and a resistance inserted between the battery and A. A two-way plug switch is the best to use to make the contacts, 1, 2 and 2, 3, but an ordinary reversing plug switch, Figs. 98A and 98B, may be used, in which case one

segment is left free, and one plug only is utilized. The current in the main circuit ABC should be switched on about five minutes before the final test is made, so that the resistance of the fault has time to assume a steady value; the current must be maintained constant, and must not be switched off until the test is completed. First the connection 2, 1 is made. The deflection is watched until it appears quite steady, neither increasing nor decreasing. Then 2, 1 is disconnected, and the connection 2, 3 is made. The deflection d_2 is read as quickly as possible, and then 2, 3 is disconnected, and 2, 1 made as at first. If it is now found that d_1 has not altered, the readings d_1 and d_2 can be taken as correct. But if d_1 is now considerably different, one must take more readings until they seem reasonably constant. Changing the connections and reading the deflections must be done as quickly as possible, from the first change onwards. The following is an example of the kind of readings one may get—

d_1	d_2
216	186
225	197
230	198
231	198

In this case the readings 230 and 198 may be taken for the calculation of the position of the fault. If the readings are very irregular a number of them must be taken, and d_2/d_1 must be calculated from their averages.

It is always advisable to have an ammeter in the battery circuit, to see that too much current is not allowed to pass and that it is reasonably steady.

This may be replaced by a galvanometer of the moving coil pattern, if one is available in addition to the instrument which is required for observing d_1 and d_2 . It should be connected in the cable circuit between the battery and A, and should be shunted in the same way as the ammeter in the diagram. By choosing a suitable shunt, a fairly

large reading can be obtained. An adjustable resistance of some sort, capable of standing the main current, should also be included in the circuit. This is shown in Fig. 99. The latter resistance is to be continually adjusted so as to keep the deflection of the galvanometer constant, and thus to compensate for the variations in the resistance of

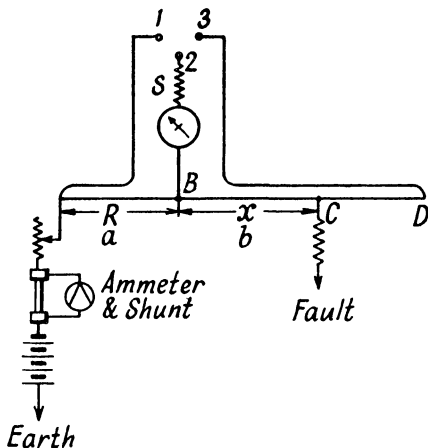

FIG. 99. FALL OF POTENTIAL METHOD, SHOWING AMMETER IN MAIN CIRCUIT

the fault. If this be done it is convenient to have two observers, one watching the galvanometer in the battery circuit and maintaining the current constant, the other observing d_1 and d_2 .

It is advisable that the galvanometer scale should be readable to three significant figures to obtain accurate results. Furthermore, the galvanometer, as has been said, should give deflections strictly proportional to the current strengths. However, one can rarely rely upon this being accurately so in the instruments usually called upon to perform all the duties required by the mains engineer. It is therefore much better that an accurate

milliammeter or millivoltmeter of the moving coil pattern be used for observing the voltages between the points 1, 2, and 3.

On D.C. systems, instead of using a battery, a connection through a suitable resistance to a live main can be made. A 1 kW heater element makes a good resistance.

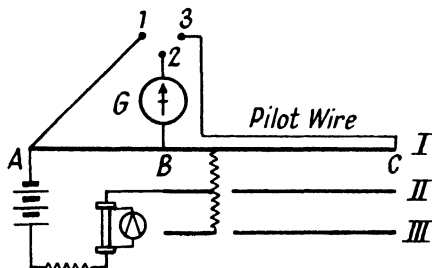

FIG. 99A. AN APPLICATION OF THE FALL OF POTENTIAL METHOD

as on a 230 volts nearly $4\frac{1}{2}$ amperes can be passed, which is a very suitable current for the test, but it is advisable to have an adjustable resistance in series as well.

If the fault resistance is so variable that control of the main current as just described becomes impracticable, it is advisable to try method 3 (page 253), which does not pass the full current through the fault, or method 4, in which the actual currents passing are taken into account.

An adaptation of method 2 is shown in Fig. 99A applicable to a type of fault to which the fall of potential method is particularly suitable in the absence of a low-resistance return of good insulation for the loop test. It is seen that two cores of a three-core cable are burnt through and all three cores are in contact, but a pilot wire is available to the point C.

One side of the battery is connected to one of the faulty cores instead of earth.

no appreciable E.M.F. in the fault itself comparable with the readings V_1 and V_2 , and that the resistance of the fault is small compared with the resistance of the voltmeter. These two conditions may be fulfilled frequently, but not always.

Method 4. This is a variation to methods 1 and 2 when the fault resistance is too variable to obtain reliable average voltage drop readings.

Use the connections of Fig. 99. With 1 and 2 connected take a series of simultaneous current and voltage readings and from the average of each calculate the quotient p of voltage by current. If the instruments record volts and amperes respectively, this quotient is the resistance in ohms, but it is not essential that this is so, provided the instrument constants remain unaltered. Connect 2 and 3 and from another set of simultaneous observations obtain a similar quotient q . Assuming R to be known as before, in ohms or equivalent yards,

$$x = R \frac{q}{p}$$

If an instrument with a series resistance s is used for the potential reading, this resistance must remain the same for the two tests.

Methods 1 to 4 are applicable to earth faults in single core cables when another sound cable or a pilot wire is available for a return conductor, or to faulty multicore cables in which one conductor is sound which can be used for the return as in the case of Fig 2 (c) in Chapter I. The same methods are also applicable to a fault of the type shown in Fig. 2 (g), in which case one of the cores in contact would be used in place of the earth connections in the diagrams 97 or 99.

Provided that a pilot wire or another sound cable was available a fault like Fig. 2 (d) could be found by either

of these methods: one of the cores could be treated as a single core cable and another used in place of earth as just suggested, as this procedure generally has the advantage of eliminating any earth currents.

Method 5. This method has been used to give an approximation to the fault position in a single core cable where

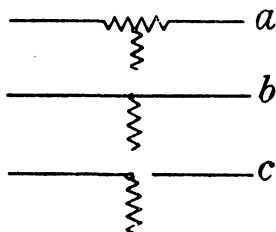

FIG. 101. FAULTS THAT CAN BE LOCALIZED BY METHOD 5

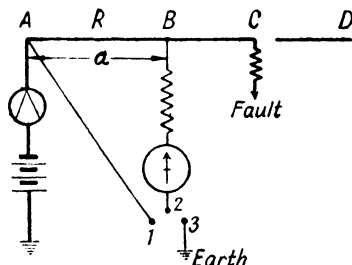

FIG. 102. CONNECTION FOR FAULTS SHOWN IN FIG. 101

the fault is one of the forms shown in Fig. 101, *a*, *b*, or *c*, and no return is available, but it is of little use unless the fault resistance is very low and the cable of small sectional area. The true fault position will always lie nearer to the testing station than the test result, and with a fault of the nature shown in *a* is likely to be hopelessly inaccurate.

The cable is represented by the line BD with the fault at C (Fig. 102). A resistance (or known length of cable) AB is connected in series with it, and a current is sent through it. A voltmeter, millivoltmeter, or galvanometer is connected as shown, first between A and B (by joining 1, 2) and the reading d_1 taken; then between B and earth (by joining 2, 3), and the reading d_2 taken. If R is the resistance of AB, the resistance from B to the fault will be not greater than $R d_2/d_1$.

If AB can be a length of cable of the same section as

the faulty cable, its length is substituted for R in the formula above, and the result will be in length units.

If AB is a length of a of different section area S_1 , and the sectional area of the cable is S_2 , the distance of the fault from B will be not greater than $a \frac{S_2 d_2}{S_1 d_1}$.

The current employed in the main circuit should be fairly large, and the voltmeter, millivoltmeter or galvano-

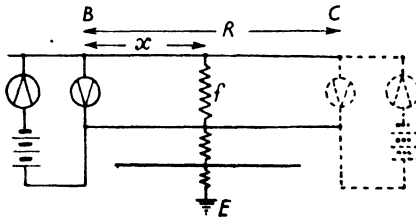

FIG. 103. OVERLAP TEST WITH AMMETER AND VOLTMETER

meter should have a sufficient resistance in series with it, so that the total resistance is very high compared with that of the fault.

In the case of Fig. 101c, the capacitance method, Chapter X, would be applied from the end of the cable free from earth, as being more reliable than the fall of potential method.

Method 6 (the overlap test). When no other cable or pilot is available, a combined short circuit and earth fault in a concentric, twin, or multicore cable (Fig. 2 (d), Chapter I) can be localized by fall of potential, provided that the fault resistance between conductors is low and fairly steady.

Using an accurate voltmeter and ammeter each connected between two cores at B as shown in Fig. 103, the resistance of the two cables from B to the fault, plus the resistance of the short circuit itself can be measured by

the simultaneous readings of the two instruments V_b and A_b , and will be, by Ohm's law, $R_b = V_b/A_b$.

If the instruments are then transferred to the end C, and similar readings taken, $R_c = V_c/A_c$.

If R is the actual resistance of one conductor from B to C, x the resistance from B to the fault, and f the resistance of the fault itself, we get

$$R_b = 2x + f$$

and

$$R_c = 2(R - x) + f$$

Subtracting these two equations, we eliminate f , and get

$$R_b - R_c = 4x - 2R$$

and consequently $x = \frac{2R + R_b - R_c}{4}$

If l is the length of the cable in yards, R/l is the resistance per yard, and therefore the distance of the fault from B is

$$\frac{x}{R} l = \frac{(2R + R_b - R_c)l}{4R} \text{ yd.} \quad (57)$$

We can arrive at the same result by taking the distance from each end as *approximately* $\frac{R_b}{R} l$ and $\frac{R_c}{R} l$ respectively, and taking the mean position.

If R is not known or calculable, we may also get an approximation to the correct position of the fault by working out the distance from B as $\frac{R_b}{R_b + R_c} l$, and the distance from C as $\frac{R_c}{R_b + R_c} l$. The positions indicated by the two calculations will in each case be widely different, but the mean position between the two may not be far out.

The accuracy of the result in all cases depends on the resistance f not varying between the tests taken from the

two ends. To guard against this, the smallest current should be used consistent with useful readings being obtained both on the voltmeter and ammeter. For this reason, if a portable Wheatstone bridge and galvanometer are available, it is better to measure R_b and R_c by this means, provided their values suit the bridge, as smaller currents will be used which will be less liable to change

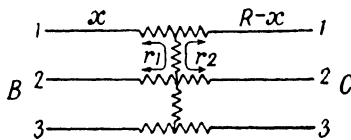

FIG. 104. CORES BURNT THROUGH, BUT IN ELECTRICAL CONTACT

the resistance of the fault.

The test can be repeated by measuring from each end the resistance between cores 1 and 2, 1 and 3, and between 2 and 3. Then the average of the three results can be taken.

In the rare instances in which single cables are employed and all have developed earth faults, each can be localized by measuring the resistances R_b and R_c between each end and earth, and formula (57) becomes

$$\frac{x}{R} l = \frac{R_b + R_c - R}{2R}$$

and can be applied to calculate the position of the earth fault on each cable, or we can take a shot at the mean

position between $\frac{R_b}{R_b + R_c} l$ from the end B, and $\frac{R_c}{R_b + R_c} l$ from the end C.

A special case arises if the fault is of the type shown in Fig. 104, where all cores are burnt through, but each is still connected across at the break by a few ohms resistance. Measurements can again be made as previously, but the first test R_b from the end B will give a resistance

$$R_b = 2x + r_1$$

and the second test from C will give

$$R_c = 2(R - x) + r_2$$

where R is the normal resistance from end to end of one core of the cable.

If we make the not altogether justifiable assumption that $r_1 = r_2$, we get, by subtraction of the two equations,

$$x = \frac{2R + R_b - R_c}{4}, \text{ as before.}$$

Here again, we can make three sets of tests, between cores 1 and 2, 1 and 3, and 2 and 3, take the average of the three results, and hope for the best.

Method 7. Potentiometer methods can give accurate results and are easy to carry out, but, like some of the other fall of potential methods, have the disadvantage that the fault is in series with the galvanometer, so that, if there is moisture in it or earth currents, there is a risk of inaccuracy. They are much favoured in the factory for localizing manufacturing faults in power cables, where care can be taken to break down the fault to the lead sheath in one conductor only. A loop is necessary, so that in a laid cable one would ordinarily prefer a Murray loop test, but the following potentiometer method can be used with advantage when the cable ends are only accessible with difficulty so that with a loop test large corrections would be necessary for the leads and a possibility of connection errors would be introduced. A cable terminating each end on a pole or tower is a case in point.

A small loop ABC (Fig. 105) is formed, for instance, by the faulty core AC and a sound core BC. A single cell storage battery V_2 is connected across the loop through an adjustable resistance R_2 and a similar cell V_1 , across the slide wire S_1S_2 , through an adjustable resistance R_1 . The currents must be such that neither the slide wire, the cable, nor the resistances will heat, as this would introduce inaccuracies. Both V_1 and V_2 should be nearly fully charged so that their voltages remain constant throughout the

test. R_2 must be higher than R_1 , otherwise the drop of potential from A to B will exceed that over the slide wire and balance will be impossible.

The only other apparatus required is a central zero galvanometer and a throw-over or plug switch for convenience in changing connections.

Connections are first made as in Fig. 105 with the points 1 and 3 connected together. A balance position d_1 on the slide wire is found, at which there is no galvanometer deflection when the key is depressed. This distance on the slide wire corresponds to the length of the loop, i.e. $2l$ if l is the length of the cable.

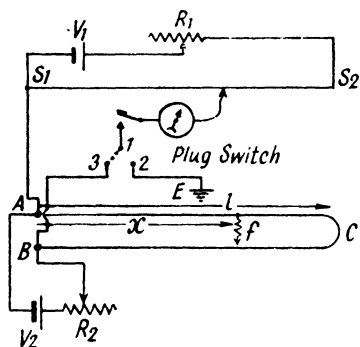

FIG. 105. POTENTIOMETER METHOD: CONNECTION FOR FIRST READING

The plug switch is then changed to connect 1 and 2 and a second balance is obtained at d_2 corresponding to x .

Keeping 1 connected to 2, reversing the battery

V_2 , and changing the connection S_1 to B and 3 to A, a third balance is obtained at d_3 corresponding to $2l - x$.

It is essential that, after the first balance is obtained, R_1 and R_2 are not altered, as everything depends on the current in the cable loop and slide wire remaining absolutely constant during the test.

Plenty of time should be taken over the first reading d_1 to ensure that the current has attained a steady value in case there is any slight rise in temperature in the slide wire and then the tests for d_2 and d_3 should follow one another as quickly as possible.

The ratio $d_1 : d_2 : d_3 \therefore 2l : x : 2l - x$ obtains and

$$x = 2l \frac{d_2}{d_1}, \text{ or } 2l \frac{d_2}{d_1 + d_3}$$

Thus there is a check on the results.

The potential connections at A and B should be made beyond the main current connections as in Fig. 71 (page 180) so frequently referred to. It is seen that the resistance of these leads comes in the galvanometer circuit, so that their length and size is immaterial.

It may be noted that the test can be made direct reading. If on connecting 1 and 3, Fig. 105, the slider is set to read $2l$, and R_1 and R_2 are adjusted until balance is obtained, then on connecting 1 and 2 and leaving R_1 and R_2 unchanged, d_2 will give the direct fault position from A.

With faults of the types indicated by (e) and (g) in Fig. 2 in Chapter I, i.e. an earth on one core only of a three-core cable or a fault between two cores, the connections may be modified as in Figs. 106 A and B respectively. In the case of Fig. 106A, l would be used in the calculations instead of $2l$.

When these methods are used in the factory, a more elaborate potentiometer is usually employed instead of a slide wire, to arrive at greater accuracy, or a similar instrument to that used for the routine conductor resistances. Under factory conditions, as has been said, earth currents are absent, and polarization can be made negligible by breaking down the fault to a steady low resistance; in addition the manufacturing lengths of the cable are comparatively short, and temperature is uniform. In a factory, therefore, the test can be carried out with long leads from the cable to the testing room, and, as instrument readings can be made to at least four significant figures, faults can be localized to within a few inches.

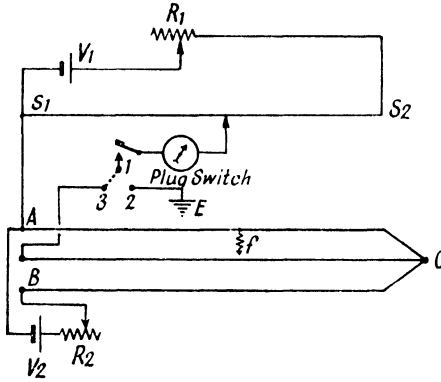

FIG. 106A. POTENTIOMETER METHOD WITH EARTH FAULT ON ONE CORE OF A THREE-CORE CABLE

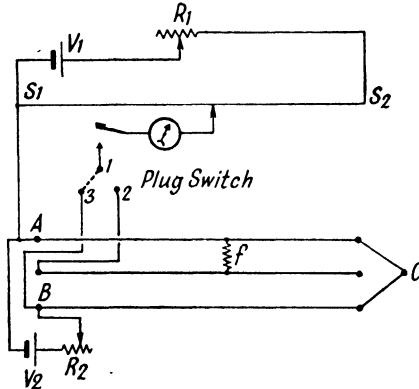

FIG. 106B. POTENTIOMETER METHOD WITH FAULT BETWEEN TWO CORES OF A THREE-CORE CABLE

(Note. This may be an earth fault also)

Method 8. By the following method, the approximate position of a fault in a street lighting cable or a distributor can be very easily determined.

AB in Fig. 107 is a street lighting cable or a distributor with a fault at *f*. If the former, the lamps are removed

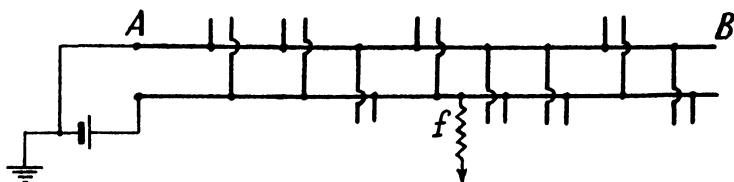

FIG. 107. FAULT IN A STREET-LIGHTING CABLE OR DISTRIBUTOR

from the posts and the individual switches left "on." If the latter, service cut-outs are removed so as to isolate meters.

Connect a battery at one end.

By proceeding from lamp post to lamp post, or service to service, as the case may be, away from the end to which the battery is connected, and measuring the voltage, at the lampholders or at the incoming service terminals, a continuous fall of voltage will be observed up to a certain point, beyond which the voltage remains at a minimum value.

The fault will lie between the first tee to give the minimum voltage and the next beyond it. As a check the battery may be transferred to the other end of the cable and the fault should be found to be between the two points at which zero or minimum voltages were observed.

Having proceeded so far, if a closer localization test is desired, method 3 of this chapter, the induction method (Chapter XI), or a Murray loop test (Chapters VI and VIII), can be applied, the latter based on the equivalent length of the cable between the terminals of the two

services immediately on either side of the fault. In so doing, care must be taken to ensure that all other branch connections remain open-circuited.

Several of the insulation and other testing sets placed on the market are arranged for taking fault localization tests by the fall of potential method, and in some cases the method for which they are connected, or for which the instructions are given, is method 3. It has been explained that, under certain conditions, this is liable to error, so that discrimination must be used before accepting the results as accurate.

CHAPTER X

DISCONTINUITIES AND SHORT CIRCUITS

WHATEVER method it is proposed to apply for localizing the fault, the first step is to make a full diagnosis of the fault condition by resistance tests, as one may otherwise be led easily to false conclusions. Reference to this was made in Chapter I, but it will bear repetition that the best procedure to adopt is to measure the resistance of each possible pair of conductors and of each conductor to earth. By comparing the results with the known or calculated resistance of loops one is able to determine precisely the fault condition.

With high-tension cables known to be protected with discriminative and rapidly-operating switchgear, this step is not quite so important as on an L.T. feeder or distributor protected only by heavy fuses, as in the latter case there is always a risk of a break in a conductor. The ends may be in contact or partial contact at the break, but even a small fraction of an ohm can be the equivalent in resistance of several hundreds of yards of conductor. For instance, in a 0.075 sq. in. cable, if the conductor is burnt through but still in partial contact through a resistance of only one-tenth of an ohm, this resistance would be equivalent in a plain loop test to the interposition of over 300 yd. of cable at the break if no allowance were made for it.

Fig. 108 indicates the condition referred to. A continuity test would indicate continuity from one end to the other, but if a loop localization test were carried out by one of the methods described in previous chapters, in ignorance of there having been a burn-out of this nature, the result given would be entirely wrong. On the other hand,

although one may easily be misled by a simple continuity test, a resistance test before commencing localization will seldom fail to reveal whether there is a break in the conductor.

If a Wheatstone bridge is not available, the resistance of the loop may be determined in terms of a short length of conductor of similar or equivalent size as the faulty cable, by using a slide wire as a bridge.

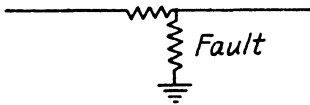

FIG. 108. BURNT-OUT, BUT
PARTIAL CONTACT

MULTICORE CABLES

For the purpose of localization, these faults may be divided into three classes.

Case I. Clean breaks leaving the insulation wholly or partially unimpaired. These occur mostly in small conductor cables, such as pilots and telephone cables, through stretching during laying and subsidences afterwards; in power cables by pulling apart in joints or junction boxes through the expansion and contraction due to load or subsidences; and sometimes in a complete burn-out one core is left with its insulation resistance good.

Case II. Discontinuities combined with earth faults and faults between cores.

Case III. Partial discontinuities but otherwise as Case II.

The localization of Cases II and III is often very difficult and some of the tests must be regarded as giving only approximate results. If one or more of the tests described are selected, however, according to the conditions prevailing, they should be found of some assistance when the position of the fault cannot be ascertained with sufficient approximation by the usual procedure of noting which parts of the circuit have been affected.

Reference should also be made to the induction methods described in Chapter XI, which, in certain circumstances,

With Fig. 109 the connections are as for an insulation resistance test. The galvanometer is first short-circuited by the key K_2 . Then the cable is charged by depressing

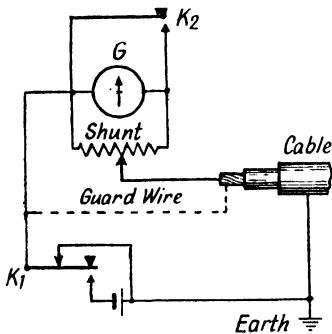

FIG. 109. CONNECTIONS FOR CAPACITANCE TEST AS FOR INSULATION TEST

K_1 for, say, 10 seconds, K_2 is opened and the deflection due to leakage (if any) observed, and K_1 is released to get the discharge reading.

With Fig. 110 it is seen that the cable is charged directly from the battery, and the current is only taken through the galvanometer on discharge. This is the most satisfactory method and it is then unnecessary to make any compensation for low

insulation resistance. It is, however, desirable to take the mean of several readings.

In both cases, if long leads are used from the testing point to the cable, this lead must be disconnected from the cable, and its capacitance swing taken separately and deducted from the swing given by cable and lead together, to give the correct value proportional to the cable capacitance.

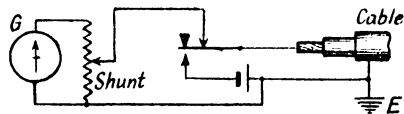

FIG. 110. CONNECTIONS FOR SIMPLIFIED CAPACITANCE TEST

In locating a break in one core of a three-core cable, one may compare the capacitance of the broken core with one of the sound cores, making the test between core and lead sheath in each case, calculating the position of the fault from formula (58); this has the advantage that both tests can be taken from one end, and the actual galvanometer deflections can be taken for C_1 and C_3 .

Alternatively, the tests can be taken from both ends of the broken core, and the formula (59) used, in which case it will be advisable to connect the other two cores to the lead sheath. On setting up the instrument for the second test, after moving from one to the other, however, one cannot assume that the galvanometer "constant" remains unaltered, so it then is necessary to compare each deflection with a condenser deflection and work out the capacitance.

If at one end d_1 is the discharge swing for the broken core or cable, and D_1 the discharge deflection from the condenser or the cable or core used for comparison; and from the other end the corresponding swings are d_2 and D_2 , d_1/D_1 is substituted for C_1 and d_2/D_2 for C_2 in equation (59), and we get the distance from the end 1 as

$$x = \frac{\frac{D_1}{d_1}}{\frac{D_1}{d_1} + \frac{d_2}{D_2}} L$$

For the discharge swings of the galvanometer to be absolutely proportional to the capacitance, a ballistic galvanometer is theoretically necessary; but for short lengths of cable a moderately sensitive reflecting galvanometer, with a sensitivity of say two divisions per microampere and giving discharge swings under the test conditions of 100 divisions or more, can be used.

The battery should be of as low a voltage as practicable to obtain sufficiently large swings for accurate calculations with the shunts available—two volts is often sufficient. Whatever may be the battery voltage selected, it must be the same for both tests C_1 and C_2 if equation (58) is used, but the different shunts may be used for the two deflections in each case, and allowed for in the usual way.

Theoretically again, the use of shunts involves an inaccuracy, for the part of the discharge passing through

the galvanometer will not vary strictly in inverse proportion to the multiplying power of the shunt as is the case with steady currents. In practice, this can be ignored, as in any case localization tests by this method can only be regarded as approximate.

Having selected the battery voltage, the connections should preferably be made as Fig. 109, and a test made as for insulation of the cable. If the leakage shown is inappreciable, it is safe to continue with this connection.

On the other hand, if there is much leakage, the Fig. 110 arrangement will probably give the most accurate result. With the Fig. 109 connection, a correction for leakage can be applied. The cycle of operations would then be: Charge for 10 seconds with the galvanometer short-circuited; open the short-circuit key, noting the deflection; put the key K_1 over to the discharge position and note the swing (the appropriate shunt having previously been determined by trial swings); short-circuit the galvanometer with the key K_2 ; and as soon as the needle or spot has come to rest, repeat the cycle to obtain a second series of readings.

If there is a wide divergence between the results obtained, repeat the whole series of tests and take the average of results. For leakages equivalent to any small deflections of the galvanometer, it will be sufficient to deduct them from the swing observed. If, however, the permanent leakage is relatively large, it may be allowed for as follows: Taking the deflection due to permanent leakage as p , and the discharge deflection as t , the corrected swing d for use in the localization would be*:

$$d = \sqrt{t(t - 2p)} \quad . \quad . \quad . \quad (60)$$

For example, suppose after current had been switched on to the cable for 10 seconds with the same galvanometer

* See Kempe's *Handbook of Electric Testing*, seventh edition, page 93.

shunt as that to be used for the capacitance test, a *steady* deflection of 50 divisions persisted, and on discharge a swing of 280 divisions was obtained, the corrected swing would be

$$d = \sqrt{280(280 - 100)} = 224 \text{ divisions.}$$

It will have been gathered that a reflecting galvanometer and a "universal" shunt are essential instruments, the latter enabling the capacitance swings for C_1 , C_2 , and C_3 (and that with the standard condenser if required) to be regulated as near as possible to equal magnitude.

In outdoor testing with such highly sensitive apparatus as this, notwithstanding that every precaution would be made for the protection of the apparatus against damp, all parts, including the bases of the instruments should be guarded with a Price's guard wire (see page 37) to minimize the effect of leakage. The cause of leakage should always be investigated. If it is found to be due to instrument or cable-end leakage only, this should immediately be remedied by drying round the instrument terminals with petrol, and retrimming the cable ends. On the other hand, if the leakage is due to the fault resistance having a definite value instead of being a clean insulated break, it is hopeless to expect great accuracy; if the fault resistance is below a few megohms, A.C. methods should be resorted to.

In Chapter II a simple A.C. method of measuring capacitance was explained. In applying this to the localization of a break the only instrument necessary is an A.C. milliammeter. Assuming an L.T. A.C. supply with earthed neutral is available at each end of the broken conductor, if I_1 and I_2 are the currents measured from the A and B ends of the conductor of length L , Fig. 111, then $x = \frac{I_1 L}{I_1 + I_2}$, since, assuming the same voltage and frequency is used

for each measurement, the current will be proportional to the capacitance.

If the cable is twin or three-core with one core only broken and the other sound, the test can be made from one end only as Fig. 112. The broken core is first connected to the live pole of the supply and the milliammeter reading

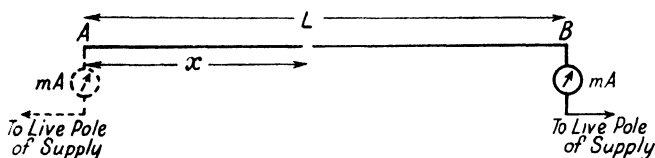

FIG. 111. SIMPLE A.C. LOCALIZATION TEST FOR BREAK

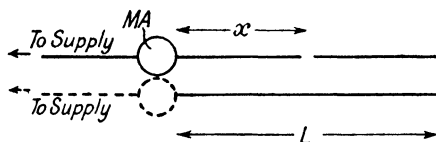

FIG. 112. SIMPLE A.C. LOCALIZATION TEST FROM ONE END

I_1 is taken; it is then disconnected and a similar milliammeter reading I_2 taken on the sound core, when

$$x = \frac{I_1}{I_2} L$$

If all the conductors are discontinuous at the fault, and voltage for the test is only available at one end, one conductor is selected for the test, the others earthed at both ends, and the capacitance C_x calculated by the formula given in Chapter II, page 47. This is compared with the capacitance C of the whole cable as shown from the records, and the distance is

$$x = \frac{C_x}{C} L$$

It is advisable, therefore, to keep records of the capacitance of all cables, either the makers' original test figures or from a test made after laying. The capacitance does not alter appreciably, but the capacitance of cables made by different makers or at different periods is not always the same. For this reason, tables of capacitance are not included in the present volume, as their use might lead to serious inaccuracies in fault localizing calculations.

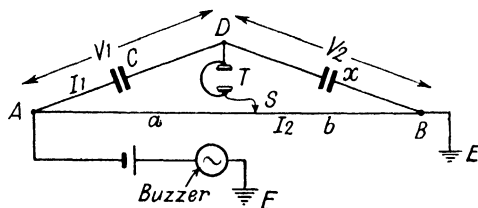

FIG. 113. A.C. BRIDGE TEST

A.C. Bridge Test. Although the apparatus for this test as applied to long power and telephone cables is costly, very simple apparatus suffices for power cables of moderate length. Fig. 113 shows the principle. At the end of this chapter a brief discussion of precision A.C. bridge tests is included.

AB is a plain non-inductive slide wire of 10 ohms resistance or more. C, x, and T represent respectively a known condenser, the capacitance of the cable up to the break, and a pair of fairly high-resistance headphones. The buzzer can be an ordinary electric bell with gong removed, and should be enclosed in a sound-proof box to prevent confusion with the headphone sounds. In practice, D would simply be connected to the conductor of the cable. The sliding contact S can be adjusted until silence or a minimum of sound is heard in the headphones.

Under this condition, let the potentials and currents in the various arms be V_1 , I_1 , V_2 , I_2 , as shown in Fig. 113.

Assume that a pure sine wave is impressed at A having a frequency f .

$$\text{Then,} \quad I_1 = 2\pi f C V_1 = 2\pi f x V_2 \quad . \quad . \quad (61)$$

If the slide wire resistances AS and SB are a and b respectively,

$$V_1 = I_2 a \quad \text{and} \quad V_2 = I_2 b$$

substituting in (61)

$$2\pi f C I_2 a = 2\pi f x I_2 b$$

$$\text{or} \quad x = C \frac{a}{b} \text{ microfarads} \quad . \quad . \quad (62)$$

As a/b is a ratio, a and b can be expressed in slide wire length units.

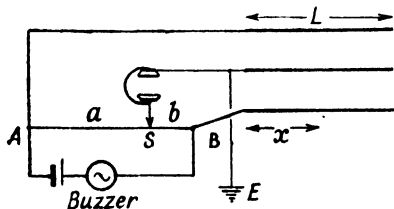

FIG. 114. A.C. BRIDGE TEST ON THREE-CORE CABLE

If the capacitance of the cable per yard is known, x is readily converted to a length.

If a sound core similar to the faulty one exists then the apparatus may be connected as Fig. 114, where the

condenser C is replaced by the capacitance of the good core. The sound core is thus connected to A and the faulty one to B. A three-core cable is shown, but the cable could also be a twin or four-core; if the former, one side of the 'phones would be connected to earth only, and if the latter, the free cores should be earthed. With equal-sized cores, the capacitances will be proportional to the lengths L of the cable, and we therefore have from (62)

$$x = L \frac{a}{b}$$

when S is adjusted to give silence in T. It will be noted that

a/b is the reciprocal of the corresponding ratio for the Wheatstone bridge. This is because a capacitance acts conversely to a resistance; the larger the capacitance the larger the current it passes.

If a break has remained insulated at each side, tests can be made from both ends of the cable, using the connections of Fig. 113. If the slide wire values at balance are ab and a_1b_1 , for tests from the near and distant ends respectively, and C_1 represents the capacitance of a complete core to earth for the cable length L yd., we have, from equation (62),

$$x = C \frac{a}{b} \text{ microfarad}$$

and
$$C_1 - x = C \frac{a_1}{b_1}$$

from which
$$\frac{x}{C_1} = \frac{ab_1}{a_1b + ab_1}$$

but x/C_1 may be expressed as a length ratio, therefore the distance of the fault from the end at which the ab readings were obtained will be

$$\frac{ab_1}{a_1b + ab_1} L \text{ yd.}$$

In this test, therefore, C need not be known, but it should be commensurate with the capacitance of the cable length to secure reasonable accuracy.

The buzzer frequency should be high; current from 50 cycle mains through a bell transformer does not give a very satisfactory note for the purpose.

The method of test from one end only described in Fig. 114 can also be applied to concentric and triple concentric cables if the relative capacitances of the conductors are known so that one may be converted to an equivalent length of the other. For example, if it were known from

the makers' certificates that the respective capacitances of the inner and outer conductors of a concentric cable were 0.34 and 0.47 microfarad per 1 000 yd. respectively and the break to be located is in the outer, then the equivalent length of the inner in terms of the outer would be $34L/47$.

In making any sort of capacitance tests for breaks on distributors, one must bear in mind that service connections add to the capacitance measured and allowance should be made for them as far as available data will permit.

A compact self-contained instrument embodying the principle of Fig. 113 is made by Messrs. Price and Belshaw. It consists of a slide wire arranged in 10 parallel sections, divided by a scale into 1 000 parts with an insulated contactor which can be slid along the slide wire. The standard condenser and buzzer are mounted in the instrument case, the buzzer being designed to be as nearly silent as possible. The telephone receiver is accommodated in the instrument cover.

Terminals and a plug are provided to enable the instrument to be used either as Fig. 113 or Fig. 114. It can, of course, also be used for a simple capacitance test.

CASE II. BREAKS WITH SHORTS

When the conditions are such that methods (i) to (v), described below, can be applied, one of these should be selected. Nos. (i) and (ii), which involve the use of a sound core or another cable as a return circuit, can be depended upon. Nos. (iii), (iv), or (v) should be selected under other conditions whenever possible. Nos. (vi) to (xi) may give approximate indications of the position of the fault when the fault conditions are stable, but otherwise are liable to considerable error.

(i) *Break in One Core only; Short between Two Cores*

only. A fault of the description shown in Fig. 115 can be located with great accuracy by the loop method described on page 176, Chapter VI (Fig. 69). Obviously it is imma-

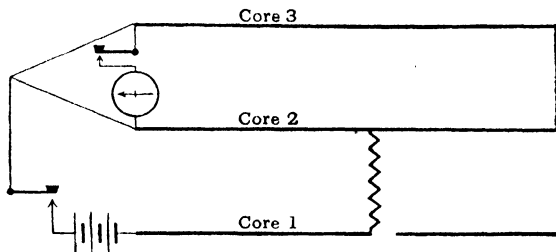

FIG. 115. SHORT CIRCUIT BETWEEN TWO CORES

terial whether an earth fault exists or not in the faulty cores, but should this be so the battery and galvanometer should be insulated from earth.

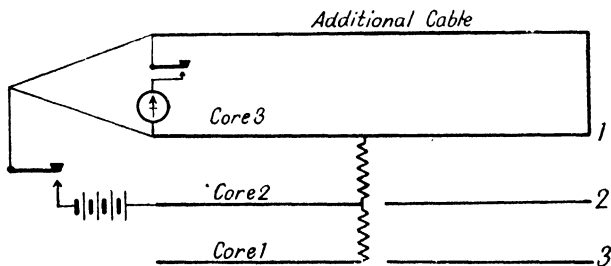

FIG. 116. ALL CORES SHORTED; TWO BROKEN

(ii) *Break in Two Cores and all Cores shorted, but separate return cable available.* If two cores were discontinuous or partially so, a loop could be formed by another cable if available, as shown in Fig. 116, in which case again the condition of the faulty cores with respect to earth is of no account, provided the galvanometer and battery are insulated from earth.

The fall of potential method, Fig. 99A, Chapter IX, can

also be applied to this kind of fault. The return circuit need then only be a pilot wire.

(iii) *Break on Two Cores and all Cores shorted, or shorted and earthed, but no separate return cable available.* If no return of any description is available, the fall of potential (method 5, Chapter IX, Fig. 102) could be used by connecting the lower end of the battery and point 3 of the switch to one of the shorted cores instead of to earth. It is necessary for the resistance of the short circuit to be very low for accurate results and the resistance of the millivoltmeter or galvanometer to be relatively very high. When the fall of potential test is applied in this manner, it must be remembered that the reading d_2 will then represent the potential drop over twice the length of cable from B to the fault, the distance of which is therefore not more than $\frac{Rd_2}{2d_1}$ ohms or $\frac{ld_2}{2d_1}$ yd. according to the terms in which AB is known. If the cores are earthed at the short, care must be taken that the battery and galvanometer are insulated from earth.

(iv) *As (iii), but no earth at fault.* Under the same condition if there is no earth at the fault and no return wire, the following fall of potential method may also be applied. Connections are made as in Fig. 117, the far end of the uninterrupted core being put to earth (only one of the interrupted cores is shown in the diagram). V is a low reading voltmeter, or a galvanometer whose readings are proportional to the current through it. Its resistance must be high compared with that of the cable and fault. The resistance R is given a value, preferably about equal to half the resistance of a single length of core. (If its resistance is about the same as the resistance up to the fault, the test will be most accurate.) The readings V_1 and V_2 are taken with the free terminal of the voltmeter connected, first to position 1 and then to position 2, and the

resistance from the testing end to the short-circuit will then be $\frac{V_1}{V_2} R$. If R be given a resistance of 1 ohm, the number of ohms from the testing end to the fault will be obtained by dividing V_1 by V_2 , or, better still, if, instead of R , a piece of cable of the same size as the faulty one be used,

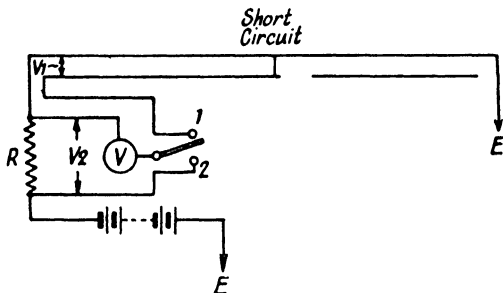

FIG. 117. FALL OF POTENTIAL TEST FOR SHORT WITH ONE CORE ONLY UNBROKEN

whose length is l , the distance to the fault will be $\frac{V_1}{V_2} l$.

This piece of cable need not, of course, necessarily be of the same section as the faulty cable; its equivalent length is then taken for l instead of its actual length.

(v) *Same conditions as (iv).* A more accurate but less simple loop method for this kind of fault is shown diagrammatically in Fig. 118 (a) and (b). To simplify the diagram, only one discontinuous core HK is shown.

When balance obtains with connections as 118 (a)

$$\frac{r}{q} = \frac{x + y + e}{a} \quad . \quad . \quad . \quad (63)$$

where e is the sum of the earth resistance at C and N. Now remove the battery connection from C and connect it to H, as Fig. 118 (b). The resistance a is also removed and B is put directly to earth. Balance again to r_1 and q_1 .

The piece of wire from C to earth must remain the same in each test, which assumes that this connection remains unaltered. We then have

$$\frac{r_1}{q_1} = \frac{x}{y + e}$$

or
$$y + e = \frac{q_1 x}{r_1}$$

Substituting this value of $y + e$ in (63), we get

$$\frac{r}{q} = \frac{x}{a} \left(1 + \frac{q_1}{r_1} \right)$$

whence
$$x = \frac{arr_1}{q(r_1 + q_1)} \text{ ohms} \quad . \quad . \quad . \quad (64)$$

If the resistance per yard ρ of MN is known, the fault distance in yards is

$$\frac{arr_1}{\rho q(r_1 + q_1)} \quad . \quad . \quad . \quad (65)$$

The arms MAB may be those of a Wheatstone bridge or a stretched wire. A piece of cable similar to that faulty may be used for a in Fig. 118 (a), the earth wire being connected directly to B in the second test. If the equivalent length of this piece of cable l is substituted for a/ρ in equation (65),

$$x = l \frac{rr_1}{q(r_1 + q_1)}$$

The lead sheath and armoring of the cable would, of course, be used to advantage for earth connections.

This method is entirely independent of the resistance of the short-circuit itself, which is often very unsteady, and it only depends on the resistance of the two earth connections remaining constant. As earth currents will influence both tests balance should be made to a false

zero. The compensating arrangement described on page 179, Chapter VI, can be used if desired.

(vi) *Break on Two Cores, with short and earth on all three Cores.* No separate return cable available. This test can

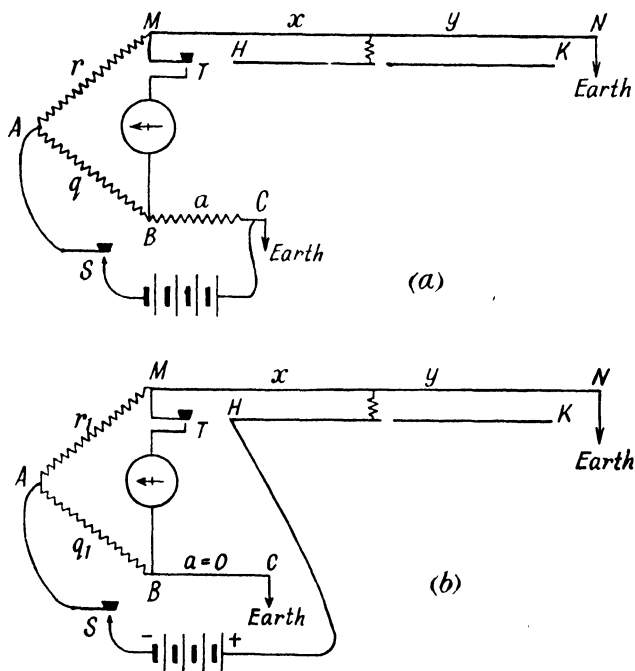

FIG. 118. BRIDGE METHOD WITH ONLY ONE CORE UNBROKEN

be used as an alternative to (iii) if one or more cores are burnt through but one has remained continuous, and the earth is actually a dead earth. The test result will be beyond the fault position, according to the resistance of the fault to earth.

A resistance or known length of spare cable AB (Fig. 119), preferably of the same section as the cable under

test, is connected in series with the uninterrupted core, and a constant current is sent through the fault. The use of an ammeter and adjustable resistance is advisable in the circuit, as indicated in the diagram, so as to keep the current absolutely steady. Readings proportional to the voltage drop over AB, the potential between B and earth, and the potential between the far end C and earth are taken by the voltmeter, millivoltmeter, or a reliable

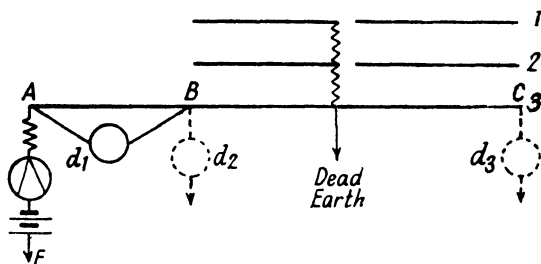

FIG. 119. ALL CORES SHORTED, TWO BROKEN, AND ONE CORE EARTHED BUT NOT BROKEN

galvanometer (the same instrument used in each case) and the resistance of the core from B up to the fault will then be $R \frac{d_2 - d_3}{d_1}$. If AB is a cable of the same section as the core under test, the distance of the fault from B is $l \frac{d_2 - d_3}{d_1}$. If AB is of different section the equivalent length is taken for l .

If the fault condition of the C side of core 3 is a partial discontinuity of low resistance compared with the instrument resistance this test can be applied with the same degree of accuracy.

(vii) *Break on One Core only, but all Cores shorted and earthed. No separate return cable available.* If only one core is discontinuous but the fault otherwise as Fig. 119,

the connections may be made as Fig. 120, as an alternative to the preceding method. It is seen that core 2 is used instead of earth, and the conditions are likely to be more stable. The fault distance now is $R \frac{d_2 - d_3}{2d_1}$ ohms, or $l \frac{d_2 - d_3}{2d_1}$ yd., R being the resistance and l the equivalent length of AB.

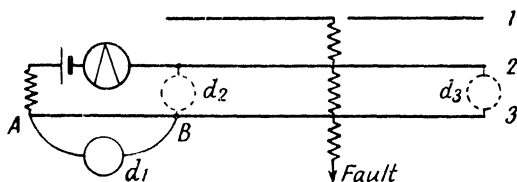

FIG. 120. ALL CORES SHORTED AND EARTHED, AND ONE CORE BROKEN

(viii) *Overlap Method for same conditions as (vi)*. This has the same disadvantage that tests have to be taken from both ends, but it is a bridge test instead of a pure fall of potential method. Measure the resistance from each end to earth on the continuous core with the far end free; if r_1 is the measurement at the end 1, and f is the fault resistance, $r_1 = x + f$. From the other end, $r_2 = f + y$ (see Fig. 121). If l is the length of the cable ($l = x + y$) and ρ is the resistance per yard, the distance of the fault from end

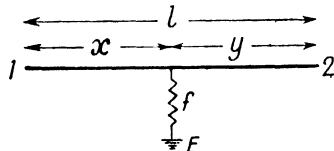

FIG. 121. OVERLAP METHOD

$$\frac{r_1 - r_2 + l\rho}{2\rho}$$

If earth currents are present, balance to a false zero and if desirable correct this by the method on page 179,

Chapter VI. (This test is equally applicable to single core, twin, or concentric cables.)

The overlap method may be modified for the slide-wire bridge. The connections are as Fig. 122. CD may be a piece of wire whose equivalent length is c when compared

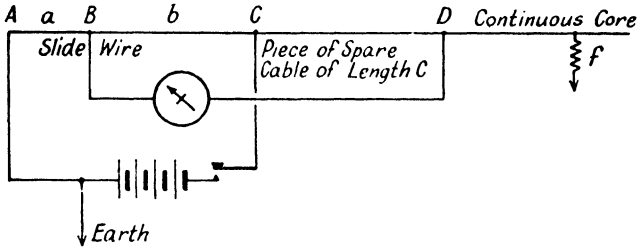

FIG. 122. OVERLAP TEST WITH SLIDE WIRE

with the faulty cable. The same piece of wire should be used for the tests made at each end. Then if a_1 , b_1 , and a_2 , b_2 are the slide wire readings for balance at the ends 1 and 2 respectively, and l the end to end length of the faulty cable, the distance of the fault from end 1 will be

$$\frac{1}{2} \left\{ c \left(\frac{a_1}{b_1} - \frac{a_2}{b_2} \right) + l \right\}$$

(ix) *Overlap Method for same conditions as (vii).* If two cores are continuous as Fig. 123, instead of testing to earth the resistance of the loops formed by cores 1 and 2 from either end can be measured with distant ends free in each case, when the distance of the fault from the test end can be calculated from the formula

$$\frac{r_1 - r_2 + 2l\rho}{4\rho} \text{ yd.} \quad . \quad . \quad . \quad (66)$$

l being the length of the cable and ρ the resistance per yard in ohms as before.

If a slide wire bridge is used the formula corresponding to (66) for an equal area loop is

$$\text{Distance of fault from end 1} = \frac{1}{4} \left\{ c \left(\frac{a_1}{b_1} - \frac{a_2}{b_2} \right) + 2l \right\} \quad (67)$$

where, as before, a_1/b_1 and a_2/b_2 are the slide wire ratios for tests r_1 and r_2 , and l is the length of the cable under test and c is the equivalent length of the cable (C.D. Connections would be as Fig. 122. except that the battery will be connected to the other core instead of to earth. If the loop is made up of unequal size conductors having resistances of ρ_1 and ρ_2 ohms per yard, then

$$r_1 = x(\rho_1 + \rho_2) + f$$

$$r_2 = (l - x)(\rho_1 + \rho_2) + f$$

subtracting and rearranging,

$$\text{Distance in yards} = \frac{r_1 - r_2 + l(\rho_1 + \rho_2)}{2(\rho_1 + \rho_2)} \quad (68)$$

This test can be made on a twin or concentric cable shorted and earthed, but with cores continuous.

It is obvious that neither test (viii) or (ix) can be of use if the fault resistance is high. The resistance of a faulty power cable up to the fault is usually only a fraction of an ohm, so that if the fault resistance is several hundred ohms r_1 and r_2 would be virtually equal, and formula (66) would become $l/2$ whatever the fault position might actually be.

(x) *Blavier's Test for same conditions as (vi).* This is applicable to earth faults on one or more continuous cores or two or more shorted continuous cores. For clarity one earthed core only is shown in Fig. 124.

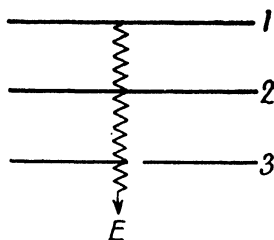

FIG. 123. OVERLAP TEST WITH TWO CORES

or (73) become indeterminate arithmetically, because $R - r_2$ approaches zero. Usually the resistance of a length of a power cable is of the order of an ohm or less, from which it follows that the use is limited to faults of 500 ohms resistance or less. When the fault resistance is comparatively high it is advantageous to insert a resistance r of the same order as the fault resistance between the distant end and earth or at the point E when making the test (2), when equation (72) becomes

$$x = r_2 - \sqrt{(R - r_2 + r)(r_1 - r_2)} \text{ ohms.} \quad (74)$$

In practice, however, the accuracy of the test is very poor unless the fault is of the order of the resistance of the cable itself and fairly stable in value.

If a slide wire is used, Blavier's method is best modified by using the connections shown in Fig. 122 (page 284). A length of cable c of similar section to the faulty core CD forms the third arm of the bridge. If only a different size of cable is available, its equivalent length must be taken for c . If the slide wire readings for balance be $a_1 b_1$ with the distant end open, and $a_2 b_2$ with the distant end earthed, then we can substitute length values in terms of c for r_1 and r_2 , which become $r_1 = a_1 c / b_1$ and $r_2 = a_2 c / b_2$, whence substituting these values in (72), and taking L as the length of the cable in yards instead of its resistance R , the distance of fault from D is

$$c \left\{ \frac{a_2}{b_2} - \sqrt{\left(\frac{a_1}{b_1} - \frac{a_2}{b_2} \right) \left(\frac{L}{c} - \frac{a_2}{b_2} \right)} \right\} \text{ yd.} \quad (75)$$

(xi) *Alternative Blavier's Test for same conditions as (vii).* With the limitations as to fault resistance laid down in the previous test, this test can be applied between shorted cores, r_1 being first measured with the distant ends free and then r_2 with the distant ends connected

together. It follows from (73) that the fault distance from the testing end is

$$\frac{r_2 - \sqrt{(L\rho - r_2)(r_1 - r_2)}}{2\rho} \text{ yd.} \quad (76)$$

if the loop is of equal area. If it is made of unequal area conductors of resistance ρ_1 and ρ_2 ohms per yard, the distance will be

$$\frac{r_2 - \sqrt{\{L(\rho_1 + \rho_2) - r_2\}(r_1 - r_2)}}{\rho_1 + \rho_2} \text{ yd.}$$

If a slide wire bridge is used, the connections will be similar to Fig. 122, except that the battery and A would be connected to one of the shorted cores instead of to earth when using the notation of equation (75).

Distance of fault

$$x = \frac{c}{2} \left(\frac{a_2}{b_2} - \sqrt{\left(\frac{2L}{c} - \frac{a_2}{b_2} \right) \left(\frac{a_1}{b_1} - \frac{a_2}{b_2} \right)} \right) \text{ yd.}$$

for equal area loop.

CASE III. SHORTS COMBINED WITH PARTIAL DISCONTINUITY

The extreme case of this is shown in Fig. 125, that is to say with *all* cores burnt through but still making contact through a resistance of high value compared with the resistance of the cable. If this condition obtains on all conductors, a plain loop test is out of the question even if another cable is available as a return. If, however, it is found from insulation tests of all cores at both ends that, at one side of the fault, one of the conductors has remained reasonably insulated at the burn-out, the case becomes one for a capacitance test as described in the earlier part of this chapter.

If, on the other hand, contact between any two cores

or any core and earth, while of high resistance compared with the resistance of the cable itself, is still low enough to be negligible in series with a high resistance low-reading voltmeter, a millivoltmeter, or galvanometer that may be available, the fall of potential method 5 described in Chapter IX, Fig. 102, can be used. Sufficient current should be passed through the main circuit for the fall of potential readings on the testing instrument to be as high as possible, as there is usually an E.M.F. in the fault itself which will affect the reading. The overlap test carried out as described in Chapter IX, Method (6), can also be applied if the fault resistance between any two conductors is low and fairly steady.

The following test, although rather burdensome to carry out, may be preferred when the resistance of the faults is unstable, or when the resistance per yard of the cable is not accurately known—

*Werren's Method.** All conductors may have a relatively low resistance to earth and between themselves, but it generally happens that one core will have broken down to earth to a greater extent than the others. The two cores having the highest and lowest resistances to earth are then selected to form a loop, such selection being made from actual resistance tests to earth by a bridge. (A megger is not sufficiently sensitive for the comparatively low fault resistances to which the method is limited.)

Murray loop connections are made at either end of the cable as shown in Fig. 126, PQ and RS being slide wires of identical resistance. This is an essential feature of the

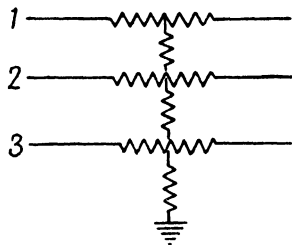

FIG. 125. SHORTS COMBINED WITH PARTIAL DISCONTINUITY AND EARTH FAULTS

* J. Urmston, *Jour. I.E.E.*, Vol. 69, page 1001, 1931.

test. A short-circuiting switch S_1 and S_2 is also connected at each end; connections to these must be thick, clean and short, so as to make a dead short-circuit when the switch is "on."

Tests from the two ends should be made with utmost dispatch, so that two operators are necessary, who should

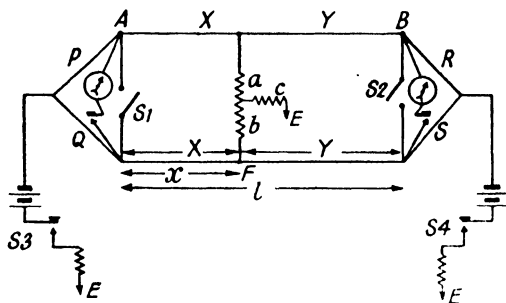

FIG. 126. WERREN'S METHOD

be in telephonic communication. The operator at B first closes the switch S_2 and opens S_4 , thus making a loop, and the observer at A takes a balance with S_1 open and S_3 closed; if there is any tendency to variation, he makes several readings and takes the mean result. He then closes S_1 and opens S_3 , and B then tests by opening S_2 and closing S_4 , and taking the readings (or mean readings) of his slide wire when the bridge is balanced.

If l is the route length of the cable in yards, the fault distance from the end A

$$\frac{(R - S)l}{(R - S) + (P - Q)} \text{ yd.} \quad (77)$$

where R, S, P, and Q are the slide wire divisions at balance.

If the fault resistances a and b of the two conductors are equal, $R - S$ and $P - Q$ will each be zero and the method will fail, hence the need for selecting the cores having the most widely divergent fault resistances.

None of these methods is very serviceable for faults of this class if the fault resistances between cores and between cores and earth are high, and very variable. In these circumstances, definite results can more frequently be obtained with the induction methods described in Chapter XI, particularly if the ground is fairly dry and the route is not congested with other cables and gas and water mains which will mask the results. Accurate localizations have also been obtained with a simple method of exploration, described on page 319, Chapter XI, dependent on the microphonic property often observed in faults of this nature.

TWIN AND CONCENTRIC CABLES

There are four possible sets of conditions for short-circuits combined with discontinuities in these cables. These are shown diagrammatically in Fig. 127.

For case (I)—one core interrupted and no earth—one of the tests, (ii) Fig. 116, should be used if a return cable of good insulation is available. Failing that, test (iii) or (iv) (pages 278 to 279).

For case (II)—one core interrupted and short-circuit combined with earth—the test (ii) (page 277) should be used if there is an additional sound cable available to make up the loop; or method 2, Chapter IX, if there is a pilot wire only back from the far end. Should there be no return wire at all, one must fall back on a method such as (vi) to (x), pages 281 to 287, or use an induction method. If the induction method is used, it is best to send the alternating or interrupted current through the discontinuous core only to earth, leaving the other core free.

Case (III)—both cores burnt through and shorted without earth—is not capable of very accurate localization unless the cores are of small section, and the short-circuit of negligible resistance. It is almost hopeless to try the

induction method, as the inductive effects of the current through the two cores will neutralize one another, but a measurement of the resistance between the two ends, divided by 2, will at any rate give the resistance corresponding to the maximum possible distance of the fault from the end. The fault may be localized by the capacitance method from the right-hand ends shown in the

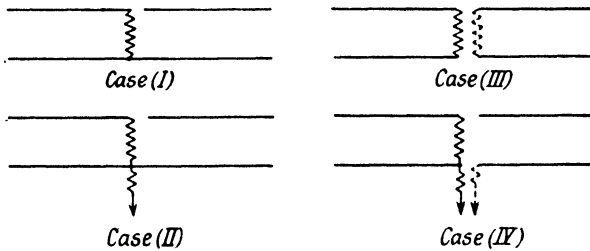

FIG. 127. FAULTS ON TWIN CABLES

diagram, as explained in the earlier part of this chapter, unless there is also a short at this side of the fault, as indicated by the dotted line, in which case the fault can be treated as a pure short-circuit, and the methods (ii), (iii), and (iv) (pages 277 to 279) are applicable.

With case (IV)—both cores burnt through, shorted, and earthed—it is worth while trying the induction method, sending the current through one core and earth only. If no result is obtained, a simple resistance test may be made, as an approximation, as above, taking the resistance between either core and earth or half the resistance between the two cores—whichever is the lowest—as a basis for the calculation. Or, as in case (III), capacitance measurements may be made from the other end if there is no short at that side. If there is an earth fault there and no short, as shown by the dotted line, the capacitance must be measured between the free core and the other core earthed, and compared with a similar test on a piece

of spare cable of the same size connected in the same way, or with the record of a factory or other test on the cable when sound between one core and the other core earthed. If a capacitance test is used in case (II), it is also usual to take it between one core and the other core earthed, as the records of factory tests usually relate to this method of connection unless otherwise stated.

TRIPLE CONCENTRIC CABLES

Discontinuities combined with shorts or earths are not likely to occur on these, but if a case is met with, the method of treatment will be fairly obvious from what has been said with regard to three-core and concentric cables. If any tests are made dependent on loop or resistance methods involving the use of the neutral conductor, it must not be forgotten that this frequently has less cross-section than the two others. A plain discontinuity, such as would arise from the cables drawing apart at a junction box, can, of course, be localized by a capacitance test as described at the commencement of this chapter.

LONG CABLES

The various tests described in this chapter so far, are those which can be applied with reasonable hope of successful results to cables not exceeding a few hundred yards in length. They do not, however, offer much hope of reasonable accuracy when applied to long lengths of cable, because the effects of the distributed cable constants and, in certain cases, the fault resistance itself, make necessary the application of a correction to the observed bridge capacitance and inductance readings.

In what follows, it is assumed that the reader is familiar with the processes of vector calculations and the theory of the propagation of currents through long cables: Reference should be made to Sir J. A. Fleming's work, *The*

Propagation of Electric Currents in Telephone and Telegraph Conductors, for full details of vector calculation methods and propagation theory, and to *A.C. Bridge Methods* by B. Hague for full details of A.C. Bridges.

Fig. 128 (a) and (b) show two forms of A.C. bridges commonly used in which the arms *a* and *b* are non-inductive and non-capacitative resistances either fixed or

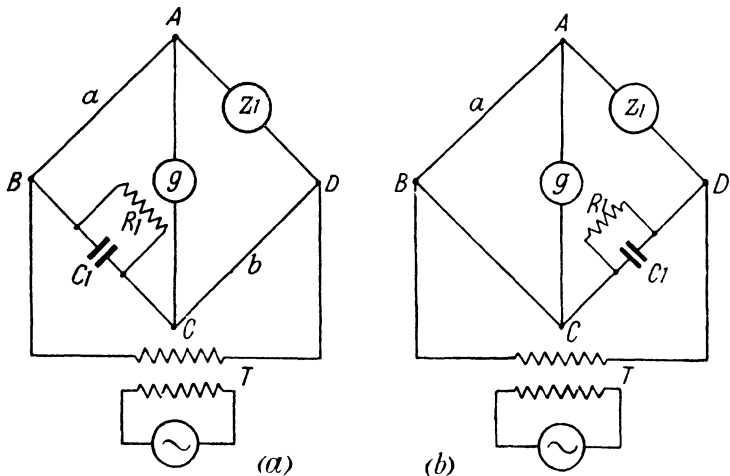

FIG. 128. A.C. BRIDGE TEST

adjustable. R_1 is a similar adjustable resistance and C_1 an adjustable condenser. Usual values for R_1 and C_1 are 10 000 ohms and 1.111 microfarads respectively. The unknown impedance to be measured is z_1 . The source of supply must be a pure sine wave A.C. of usually 800 or 50 cycles per second, coupled to the bridge through a screened 1:1 transformer T. The detector device *g* is either a pair of sensitive earphones or a vibration galvanometer.

The unknown impedance z_1 from the testing end to the fault is a vector of form $A + jB$ ohms, and the vector

ohm values of the BC arm, Fig. 128 (a) and CD arm Fig. 129 (b), are

$$\frac{1}{\frac{1}{R_1} + j\omega C_1}$$

ω being 2π times the frequency.

The following relations occur when the current in g is nil.

$$\text{Fig. 128 (a). } z_1 = ab \left(\frac{1}{R_1} + j\omega C_1 \right) \quad . \quad (78)$$

$$\text{Fig. 128 (b). } z_1 = \frac{a}{b} \left(\frac{1}{\frac{1}{R_1} + j\omega C_1} \right) \quad . \quad (79)$$

Fig. 128 (b) is used for fault lengths mainly capacitive, and Fig. 128 (a) for those mainly inductive.

Let R , L , G , and C be respectively the resistance in ohms, the inductance in henries, the leakance in mhos, and the capacitance in farads per unit length of cable.

A fault involving a high resistance break in the conductor with a high resistance to earth too can be localized by the bridge connection of Fig. 128 (b). The point D of the bridge would be connected to earth and the faulty cable core conductor to A. The impedance up to the fault will be, from equation (79),

$$z_1 = \frac{1}{G_{11} + j\omega C_{11}} = \frac{a}{b} \frac{1}{\frac{1}{R_1} + j\omega C_1}$$

where G_{11} and C_{11} are the *apparent* leakance and capacitance of the cable length l up to the fault. If $a = b$ we have

$$G_{11} + j\omega C_{11} = \frac{1}{R_1} + j\omega C_1$$

that is the observed bridge readings R_1 and C_1 are equal to the *apparent* insulation resistance plus fault resistance and the cable capacitance respectively, up to the fault.

It is incorrect, however, to take $\frac{l}{R_{11}} = Gl$ and $C_{11} = Cl$ unless the cable length is comparatively short.

Similarly, when the fault resistance across the break is either high or low, but the resistance to earth low, then the fault length is mainly inductive and the connections of Fig. 128 (a) can be applied, whence, from equation (78).

$$z_1 = R_{11} + j\omega L_{11} = ab \left(\frac{1}{R_1} + j\omega C_1 \right)$$

and thus the observed bridge resistance R_1 divided into ab is the *apparent* cable core resistance plus the fault resistance and the product abC_1 the *apparent* reactance, up to the fault. Again, however, these apparent values are not the products of the respective cable constants and the fault distance l unless l is comparatively short.

It is not possible always to make the product of ab in Fig. 128 (a) a round figure, whence the adjustment of the bridge arms is usually more tedious than in the case of Fig. 128 (b), when it is usually possible to make $a = b$. An alternative arrangement to Fig. 128 (a) is to use the connections of Fig. 128 (b) with a variable inductometer in the place of C_1 , in which case we should have

$$z_1 = R_{11} + j\omega L_{11} = R_1 + j\omega L_1$$

where R_1 and L_1 are the observed bridge resistances and inductances, a and b having been made equal, which will generally be possible with this connection, so facilitating the determination of the bridge balance. R_{11} and L_{11} are again the *apparent* resistance and inductance of the cable up to the fault.

The connections of Figs. 128 (a) and (b) together with

the alternative arrangement with the inductometer referred to, are the usual bridge arrangements used for fault localization tests. The connections can be varied by using R_1 in series with c_1 when balance cannot be obtained with the connections shown.

The relationship between z_1 and the bridge balance settings are easily calculable from the normal Wheatstone bridge ratios of the vector impedances of the various arms.

Before a fault distance can be ascertained, knowledge of R , L , G , and C is essential. For high accuracy, most important when l is long, the A.C. values at the testing frequency must be known; D.C. values are insufficiently correct. These values must therefore be measured on the sound cable as one may be confronted by faults in which all cable cores are damaged.

The distribution of voltage and current along a long length of cable is not linear but exponential, and in all calculations the "propagation constant" P figures prominently. It is a vector quantity of the form $A + jB$ or A / θ and in this form its value is

$$P = \sqrt{(R + j\omega L)(G + j\omega C)} \quad . \quad . \quad (80)$$

Another important constant is the "initial sending end impedance" z_0 which value is

$$z_0 = \sqrt{\frac{R + j\omega L}{G + j\omega C}} \text{ vector ohms} \quad . \quad . \quad (81)$$

The propagation factor for a given length of cable l is Pl , whilst z_0 is constant for any length of given cable.

When the distant end of a cable l units long is earthed or short circuited, its impedance z_c at the testing end is

$$z_c = z_0 \tanh Pl \text{ vector ohms} \quad . \quad . \quad (82)$$

and when the distant end is free or open-circuited, the impedance at the testing end z_f is

$$z_f = \coth Pl \text{ vector ohms} \quad . \quad . \quad (83)$$

From (82) and (83) we therefore have

$$z_0 = \sqrt{z_c z_f} \text{ and } Pl = \tanh^{-1} \sqrt{\frac{z_c}{z_f}}. \quad (84)$$

It is easy to resolve $\sqrt{\frac{z_c}{z_f}}$ into the form $x + jy$ and, expressing Pl in the form $(\alpha + j\beta)l$, it can be shown that

$$\alpha l = \tanh^{-1} \frac{1}{2} \left\{ \frac{x^2 + y^2 + 1}{x} \pm \sqrt{\left(\frac{x^2 + y^2 + 1}{x} \right)^2 - 4} \right\}$$

$$\beta l = \tan^{-1} \frac{1}{2} \left\{ \frac{x^2 + y^2 - 1}{y} \pm \sqrt{\left(\frac{x^2 + y^2 - 1}{y} \right)^2 + 4} \right\} \quad (85)$$

If z_c and z_f are measured on sound cable, we have from (84)

$$R + j\omega L = \frac{\sqrt{z_c z_f}}{l} \tanh^{-1} \sqrt{\frac{z_c}{z_f}}. \quad (86)$$

$$G + j\omega C = \frac{1}{l\sqrt{z_c z_f}} \tanh^{-1} \sqrt{\frac{z_c}{z_f}}. \quad (87)$$

whence equating real and imaginary quantities in these equations when the right hand sides are reduced to the form $A + jB$, the values of R , L , G , and C are found. In making these measurements, the bridge connections of Figs. 128 (a) and (b) are used. As each of the cable constants, except C , varies with frequency, it is important that the constants are determined at the frequencies of the fault localization tests.

It is recommended that these cable constants are measured as soon as possible after a cable is laid, and filed for future reference. It is only necessary, of course, to do so on important long cables on which the effects of the distributed constants have to be taken into account when making capacitance or inductance fault localization tests. Failing this predetermination, one may, on the

occurrence of a fault, have the luck to find one core intact on which the measurements can be made, but this would be purely fortuitous, and should not be taken for granted. Or a spare drum of similar cable on which tests can be made may be available.

The calculations of the constants are, however, lengthy and tedious, and much valuable time will be lost if this determination is left until a fault actually occurs.

When making the evaluations it is advisable to work to five significant figures, for which, when dealing with small circular angles, tables of seven-figure trigonometrical functions are recommended. β in equation (85) is in terms of radians, and must be converted to degrees to ascertain the inverse tangent. The assignation of the correct sense signs to the linear and angular quantities is also essential.

When the distant end of a long cable is earthed through a resistance r ohms, the impedance measured at the near end is

$$z_1 = z_0 \left\{ \frac{r + z_0 \tanh Pl}{z_0 + r \tanh Pl} \right\} \text{ vector ohms} \quad . \quad (88)$$

Severed conductor faults may be any of the following general classifications—

I. High or low resistance across the break and very low resistance to earth to which equation (82) may apply.

II. High resistance across the break, a high resistance to earth to which equation (83) may apply.

III. Moderate resistance across the break and a finite value of r such that equation (88) applies.

When neither the vertical or horizontal components of $\tanh Pl$ exceed 0.10, Pl is nearly enough for practical purposes equal to $\tanh Pl$, whence it is correct to accept under I, from equation (82).

$$z_0 Pl = z_1, \text{ i.e. } l(R + j\omega L) = z_1$$

If an inductometer is used in place of C_1 in the bridge arrangement of Fig. 132 (b) and $a = b$ we have

$$l = \frac{L_1}{L} = \frac{R_1}{R} \quad . \quad . \quad . \quad (89)$$

The ratios of L_1 and L are usually accepted because R_1 will also include the small fault resistance to earth and make l somewhat erroneous.

Similarly under II when Pl can be accepted as equal to $\tanh Pl$ we have from equation (83)

$$\frac{z_0}{Pl} = z_1, \text{ i.e. } l(G + j\omega C) = z_1$$

and if in Fig. 128 (b), the a and b arms of the bridge are equal, we have

$$l = \frac{R_1}{G} = \frac{C_1}{C} \quad . \quad . \quad . \quad (90)$$

In this case it is usual to accept the value of l derived from the ratio of the capacitances.

When the assumption that $\tanh Pl = Pl$ is no longer acceptable and r is either very high or very low, so that formulae (83) or (82) respectively are applicable, then z_0/z_1 or z_1/z_0 must be reduced to the form $A + jB$ and $\tanh Pl$ components evaluated from equations (85). The effects of the distributed cable constants are then accounted for.

When r has a finite value such that it has to be taken into account as in III above, formula (88) must be applied whether or not the equality $\tanh Pl = Pl$ is acceptable. The A.C. value of r cannot be directly measured, and as $\tanh Pl$ and Pl consist each of two unknown components, neither r or $\tanh Pl$ can be deduced from the two equations derived from (88) by equating real and imaginary quantities.

This difficulty can be overcome in two ways: the first, by substituting a D.C. source of supply at the bridge and measuring r_1 , making an estimate of l from the capacitance C , obtained on balancing the bridge with A.C. and deducting from r_1 the estimated conductor resistance up to the fault, when the value of r is such that z_1 is inductive. When it is capacitive this conductor resistance is generally negligible compared with r and the correction is not necessary. Utilizing this derived value of r , an expression for $\tanh Pl$ is found from (88) in the form $x + jy$, whence Pl in the form $l(\alpha + j\beta)$ is found from equations (85).

It is not correct to take for granted that the A.C. and D.C. values of r will be identical: not that r is inductive or capacitive, but different results may arise from varying current strengths as between the two tests, therefore efforts should be made to make the D.C. test with as nearly as possible the same current strength as that at which the A.C. test is made. Whatever error may occur in the value of r so derived, it will not be reflected in corresponding magnitude in l , as the latter is derived usually from the cable capacitance, and the effects of an error in r upon the latter will be relatively small.

The second method is that recommended by J. Urmston in his paper submitted to the I.E.E. on 25th October, 1930. It consists of the predetermination of a number of values of z_1 for varying assumed cable lengths and fault resistances from which families of curves are prepared, whence the cable length for a given measured value of z_1 can be read off. A large amount of work is involved in the calculations, so the charts must be prepared before the occurrence of a fault. When these are available, a fault position is determined directly after a bridge balance is obtained, no calculations being necessary when the bridge connections are such that it is direct reading.

It is to be noted that for a given cable length l and fault

resistance r there is only one size and slope for the vector value of z_1 .

When the fault resistance to earth is above, say, 200 ohms, the cable impedance is capacitive and the bridge connections in Fig. 128 (b) can be used. If r is 500 ohms or above and l is short, the bridge reading C is a direct reading of the cable capacity Cl . Below a fault resistance of approximately 200 ohms, the cable impedance tends to become inductive, and below about 50 ohms it is wholly so, whatever the type of cable, when the bridge connections Fig. 128 (a), or the alternative with an inductometer in place of C in Fig. 128 (b), are applicable.

It is difficult to lay down any hard and fast rules as to when the values of r and/or $\tanh Pl$ must be taken into account, instead of accepting fault distances based on the apparent capacitances or inductances from equations (89) and (90). Either singly or conjointly, these factors when accounted for will give true fault distances varying up to 50 per cent of those obtained from equations (89) and (90) for very long cables.

The best procedure is to determine from trial calculations the limits within which the effects of these quantities are negligible for a specific cable before fault conditions arise, so that one is enabled to decide quickly which course to adopt when the occasion arises.

As P varies with frequency, it is an advantage to test at low frequency in order to simplify calculations by extending the length range over which $\tanh Pl = Pl$, but, in so doing, sensitivity of the bridge is sacrificed somewhat. Compromising, therefore, it is best to use 800 cycles for short cable lengths, to avail oneself of the higher bridge sensitivity, and 50 cycles for long lengths of cable in order to preserve so far as possible the advantages of the simplified calculations.

When making localization tests, it is important to earth

the distant end of the faulty cores when the fault resistance is such that z_1 is capacitative and to leave free the distant end when z_1 is inductive. The converse processes will tend to make r capacitative or inductive respectively when formula (88) will not apply, unless the true impedance of r is used in place of its ohmic value. This true impedance is practically indeterminate.

Reliable capacity bridges connected in accordance with Fig. 128 (b) are available in which the a and b arms are fixed equal resistances, making the instrument direct reading. They embody a valve oscillator giving 800 cycle supply at which ω is taken as 5 000, or A.C. mains supply at 50 cycles can be used instead. These instruments cannot be used for the determination of the cable constants R , L , G , and C , however, because they are not suitable for measuring z_1 , neither are they suitable for measuring fault length impedances which are inductive.

It is therefore preferable to be in possession of separate units so that the bridge connections can be varied as required and the inclusion of an inductometer is desirable. The valve oscillator for HF is preferably battery-operated, and the frequency should be accurately known for the purposes of calculating the cable constants. The bridge components must be connected together with short, fine, and straight wires to reduce to a minimum stray capacitances and inductances.

Sharp balance points can easily be detected when good earphones are used, but it is essential to select a quiet place for making tests, and one where adjacent machinery and circuits will not induce stray currents in the earphones. The vibration galvanometer eliminates these sources of interference, but it is not so easily transported and requires a fair amount of setting up.

Although the foregoing treatment relates to faults in which the conductors are severed, it is to be noted that

the methods can be applied to faults in which conductors are not initially burnt through: For example, the difficult case when all cores of a cable are faulty at high resistances between one another and to earth with no breaks can be reduced by the process described in Chapter V. If the final resistances are so low as to make the fault length impedance inductive, a complete break is not essential. If, after the breaking-down process the fault length impedance is still capacitive, the conductor can be severed by passing a fairly heavy current through the fault to earth for a few minutes. The only faults which do not yield to A.C. bridge methods are high resistance faults without breaks, which can be localized by the Murray loop method described in previous chapters.

It follows, of course, that faults between cores without paths to earth can also be localized by A.C. bridge methods where another core, whether or not severed, can be used as the earth circuit.

CHAPTER XI

INDUCTION METHODS

WHEN a cable carries an alternating current or an interrupted or periodically reversed direct current, a variable magnetic field is set up in its vicinity. If a coil of wire is placed so that the lines of force of this field cut the coil at right angles, an E.M.F. is developed in the coil, and this

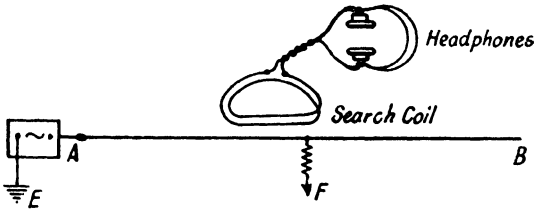

FIG. 129. SIMPLE SEARCH COIL METHOD

can be detected by closing the circuit of the coil through a telephone receiver in which some sort of a note will be produced. This effect is used either to detect a buried cable carrying A.C. under service conditions, or to trace the position of a fault. For the latter purpose a circuit is so arranged that the current flows to earth at the fault and returns to its source.

This method is known as the search coil or induction method, and is shown in its simplest form in Fig. 129.

The cable conductor AB has an earth fault at F. If the end B is insulated and an alternating or pulsating E.M.F. is applied at A, current will flow through the cable from A to F and return to the source through earth. If the cable is neither lead sheathed nor armoured, practically no current will flow from F to B. Whenever, therefore, the "search coil" is placed above the cable between the

supply and the fault, a sound will be heard in the telephone, but if the coil is over the cable on the far side of the fault there will be silence or a distinct diminution in the sound. The position of the fault is thus indicated by the point at which the change in volume of the sound occurs as the coil is carried over the cable route.

It is not possible to make a definite recommendation as to the size or best number of turns of wire in the coil as these factors will vary with the class of cable on which it would be used, the current passing through the cable and its depth in the ground. To obtain the maximum induced current for a given length of wire, probably the best shape for the coil is in the form of a letter "D," the flat side being held nearest to the cable and parallel to it. A coil which will give good average results is one having a diameter of about 18 in., wound with about 2 lb. of No. 36 S.W.G. enamelled or D.C.C. wire.

The testing current applied to the faulty cable should produce a note of such frequency that it is easily distinguishable from hum due to adjacent live cables. Methods of producing testing currents will be described later.

The chief difficulty in obtaining good results by this method in practice is that there is not always a sharp reduction of sound when the coil passes over the fault, particularly on lead covered cables. Armoured cables present a still more difficult problem. The following considerations will explain why with metal sheathed cables no definite cessation of sound will occur. The current traversing the cable conductor up to the fault will, assuming A.C., induce a current of opposite phase in the lead sheath and there will be also a small mutually induced current. The external field will be due to the resultant of these currents and will obviously be much weaker than that produced by the same current traversing a non-metallic sheathed cable. Then again, the current will

return to source only partly through the lead or armour; the remainder will continue on beyond the fault, returning by less direct routes as it is reasonable to assume that a good path to earth will exist more or less uniformly along the whole length of the cable sheath. Immediately before we arrive at the fault with our search coil, the inductive effect will be due to the alternating current passing through the core less that returning through the lead sheathing and armouring which is concentric with it. Immediately beyond the fault the inductive effect will be produced by that part of the current which travels beyond on the sheathing and armouring to return through the earth or other pipes near the cable. The two currents are therefore similar, and no sharp difference in the inductive effect will be noticeable on passing the fault.

With a concentric cable, a similar difficulty arises. If the fault is between conductors and the alternating E.M.F. is applied between them at one end, the outgoing and return currents practically neutralize one another so far as external inductive effect is concerned. On the other hand, if the fault is between outer and sheathing, the effect is just the same as that with a single cable explained in the previous paragraph.

The eccentricity of the cores of multicore cables with respect to the lead sheath, however, and their lay or twist, give better chances of success with this class of cable than with single core or armoured lead sheathed cables.

The presence of armouring, particularly steel tape, or of an iron pipe in a drawn-in system, still further adds to the skill necessary for the successful application of the method, because the relatively high magnetic permeability of the steel or iron almost absorbs the external field. The strength of the magnetic field around a cable also decreases very rapidly with distance, possibly something in the order of the inverse cube of the distance. In fact, without the

aid of amplifying apparatus, which will be described later, the hopes of success are very small with armoured cables, unless they can be exposed so that the search coil can be very closely applied. Even then the difficulty of discerning the very small change of sound at the fault remains.

The simple form of this test as shown in Fig. 129 has

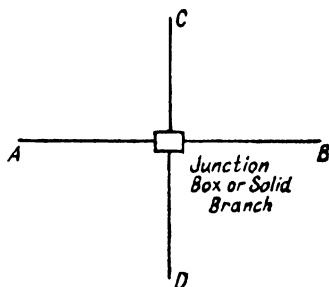

FIG. 129A. EFFECT ON BRANCH

in the past frequently given good results on vulcanized bitumen and rubber cables. Although, theoretically, lead covered cables laid on the solid system should yield good results if the lead bondings are removed, results obtained in practice are apt to be misleading. If the cables are laid on this system in dry soil or the lead has some sort of insulation to earth, it is often preferable to apply the testing current to the lead sheath, using the faulty conductor as the return.

It is interesting to note that gas and water companies make use of the induction method for tracing pipe runs.

Breaking the continuity of the lead sheathing or armour at accessible points assists in tracking the fault down to a short section of cable in difficult cases.

Junction boxes or solid branches on lead covered systems are apt to cause confusion. As an example, consider Fig. 129A. Suppose the observer has been tracing from A towards B; on arrival at the junctions he notices a diminution of sound. If the branch is a solid tee its presence may be unsuspected or forgotten, whence the fault is wrongly supposed to be at this point. On turning the search coil with its plane normal to the cable AB at the junction, the same volume of sound is heard as existed just before the junction point was reached. The observer

would, therefore, move the coil first towards C and then D, noticing that sound persisted in either direction and he would note in which direction it appeared unchanged, thus identifying the correct direction in which to proceed towards the fault.

Thus we are led to the rule that the search coil should be turned through 90° on reaching a point where sound diminishes, and traversed in either direction to see if any branches exist, and the correct direction in which to proceed would be judged by the sounds heard. If the sound ceases, or is reduced in each position of the coil, the fault position is found.

On a distributor one may encounter many points where branches exist, each of which would cause the observer some concern as possible sources of error. He would therefore, if possible, have previously narrowed down the length of distributor to which the search coil was applied by a simple fall of potential test similar to method 8, Chapter IX.

The efficiency of a search coil can be greatly improved if the induced currents are intensified by a valve amplifier. The important feature of this apparatus is the need for efficient screening of the components so that all extraneous sounds are eliminated, which otherwise swamp the detector current.

Mr. J. H. Savage* has designed a very successful amplifier unit in which all parts are efficiently screened, including the connecting leads to the search coil and to the telephone receiver. The valves are also protected from jarring by felt buffers, so that microphonic noises are reduced.

The circuit of the amplifier is shown in Fig. 130. The apparatus, including its L.T. and H.T. batteries, is contained in a screened case which is provided with a carrying

* See *Distribution of Electricity*, Vol. IV, page 761, September, 1931.

strap for portability. The capacitance of the screened case to earth forms the normal earth so that no connecting wire is needed. A volume control is provided, as experience has shown that it is much easier to detect a change from a small sound to practically silence than from a loud sound to one of slightly less volume.

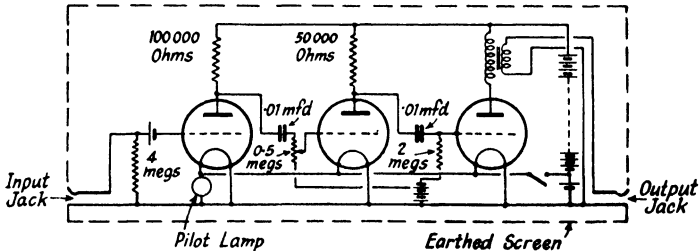

FIG. 130. J. H. SAVAGE'S AMPLIFIER UNIT

Mr. Savage has pointed out that background noises in industrial districts due to adjacent cables, motors, or tramways, may render the use of an amplifier in conjunction with an open search coil of the ordinary pattern impossible, because these noises are also amplified to such an extent that they drown the sound due to the fault current. He therefore recommends the use of a screened coil to reduce as far as possible the effects of these disturbances. He also filed a Patent Application, No. 33019/31, which covers a specially designed search coil.

This invention makes use of the fact that the magnetic field from a multicore cable conductor follows the lay of the cores and is not exactly parallel to the axis of the cables, therefore if a small search coil is held parallel to the faulty cable core in the position which gives greatest sound, then as it is moved along the cable a point of minimum sound is reached, followed by maximum sound, and so on as the angle of the cable core coincides with or

turns away from that of the search coil. Such a search coil will pick up external magnetic fields as well as the field from the cable. If now a second search coil is connected in series so that its direction of winding is reversed (astatic formation) any stray fields present will cut both coils and induce practically equal and opposite currents, which cancel out.

By suitably spacing the coils over the cable so that when one is in the minimum field the other is in the maximum field, the cable field effects are summed by the coils, and a note can be heard largely free from interference, enabling high amplification to be used. With a core to core fault the "go" and "return" currents are in opposite directions, and if the coils are spaced parallel to the two faulty cores the phase of the currents induced in each coil will be such that they add up, and the arrangement will still be practically free from interference.

The coils may conveniently be mounted separately in a common frame so that they can be moved with respect to each other, preferably with some device to keep their axes parallel. Fig. 131 shows a possible arrangement. If the direction of winding of each coil is the same, then the outer end of each is joined together, and the two inner ends are taken to the telephone receiver with or without a valve amplifier. The coils should not be longer than half the length of lay of the core, otherwise they may pick up reverse magnetic fields from the cable with a consequent neutralizing effect and reduction of efficiency.

In order to eliminate electrostatic interference it is advisable to fit static screens to the coils, and these should be so arranged that they do not act like short circuited turns to the search coil. An effective way of doing this is to lap each coil with metallic tape interleaved with insulating tape, one end of each such metallic lapping being

left free and the other connected to the earth potential side of the amplifier.

Consider first the case of a core to core fault.

Alternating or interrupted current is passed along one conductor and returns along the other, via the fault.

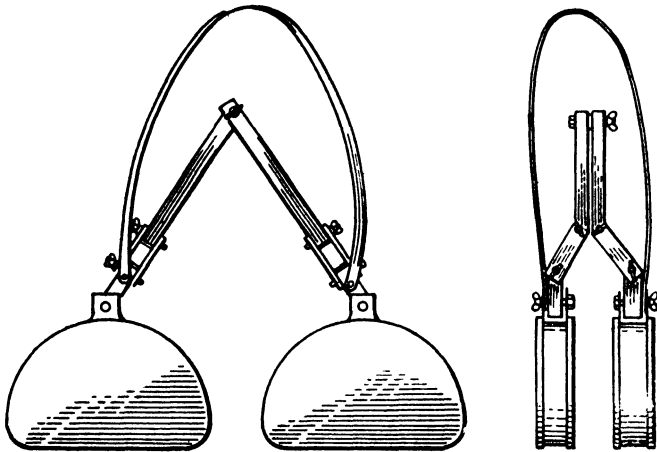

FIG. 131. METHOD OF MOUNTING TWO SEARCH COILS

The two coils are slightly separated and held vertically over the cable, then moved along in the direction of the cable until maximum sound is heard in the detector. The volume of sound can then be further increased by moving one coil with respect to the other and by altering the angle of each in the horizontal plane until they coincide with the angle of lay of the cores of the cable.

The method of connecting the coils in series adds the voltages across each. Any external magnetic field (unless it comes from a cable having conductors with exactly the same length of lay) will cut both coils and produce voltages in opposite directions, which will tend to cancel out. If the interfering cable is not parallel to the one under

test, but runs at a tangent, the effect on the detector can be reduced by decreasing or increasing the number of turns on one coil (by a tapping switch or similar means) so that the opposing voltages are again balanced. Interference can thus be eliminated without appreciable loss of sensitivity.

For core to earth faults the procedure is similar to the above, but in this case the maximum sensitivity is when one coil is directly over the faulty core and the other a half "lay length" away, i.e. in the point of minimum field.

Mention has been made that, with a single search coil on lead sheathed cables, the results are sometimes unreliable owing to part of the fault current flowing along the sheath to earth on the far side of the fault. The double coil method overcomes this trouble to some extent, since the fault current and consequently the magnetic field then follows the direction of the sheath, not the lay of the cores to which the coils had previously been adjusted. As the field from the sheath is uniform its effect on the reverse connected coils is to cancel out.

It is not claimed that this double search coil method is perfect, but it has a considerable advantage over the single coil.

Mr. Redmayne, of the Rotherham Corporation, has also found that a screened amplifier adds enormously to the scope of application of the search coil, but that even this in conjunction with a simple search coil, although screened, cannot always be relied upon to give a definite result. He has demonstrated* that on the supply side of a fault, in a multi-core cable, the field strength will vary from zero to a maximum around the circumference of the cable, whilst beyond the fault it remains practically constant. In the former case, the variation of field is due to the eccentricity of the core with respect to the lead

* *Distribution of Electricity*, Vol. IV, 1931, pages 668, 713.

sheath, the external field at any point being due to the conductor and lead sheath resultant currents. Beyond the fault, little or no conductor current exists, the field then being due to a current uniformly distributed over the lead sheath.

By means of an iron-cored search coil of the form illustrated in Fig. 132, the winding of which is connected to an

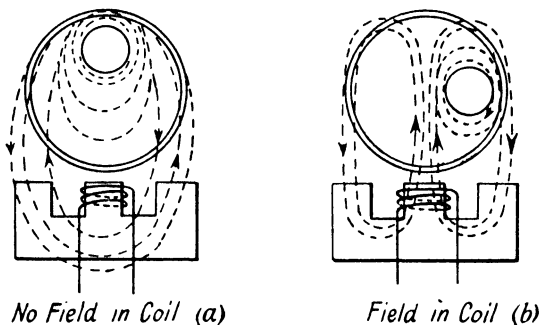

FIG. 132. IRON-CORED SEARCH COIL

amplifier, the observer is able to trace whether the induced field is uniform or variable by moving the search coil circumferentially around the cable.

The coil should be of a width suitable for embracing the cable, and it is, of course, necessary to be able to apply it closely against the cable, for which purpose the latter must be exposed at a number of points, but this is preferable to resorting to the drastic measures of cutting repeatedly, assuming other methods have failed.

Referring to Fig. 132, which represents conditions between the supply point and the fault, one core only being shown for clearness, assume that at a particular instant the lines of field due to the conductor are clockwise; the field due to the sheath current will be anticlockwise. Assuming also the two fields are of similar strengths, in

(a) the flux through the centre limb of the search coil will be relatively small, whilst in (b) this flux will be much greater. Thus as the search coil is moved circumferentially round the cable, with its length normal to the cable axis, the induced E.M.F. in the search coil will vary in strength from approximately zero to a maximum.

It is clear from Fig. 132 that if the flux is due to lead sheath current only, as exists beyond the fault, then the E.M.F. induced in the search coil will be uniform for any similar position of the latter.

Mr. Redmayne has also shown that if a fault is between conductors only in a multicore cable, similar characteristics will be observed if the testing current is passed through the loop formed by the faulty cores. Messrs. H. Tinsley & Co. have manufactured an apparatus based on the above principles.

Wherever D.C. is available it should be used, and an interrupted current of several amperes should, if possible, be passed through the fault, which produces a very distinctive sound. There are several ways of doing this—one is to use an electric bell excited by a local battery, the bell being mounted and the hammer being bent back so that it just dips into a mercury bath. The frame of the bell and the mercury bath can be arranged in series with the D.C. supply to the cable via a bank of lamps or a 2 kW heater, whence a rapidly interrupted current of several amperes is obtained.

Mr. Redmayne has suggested energizing the cable from a 50 cycle A.C. supply through a highly saturated iron-cored choke coil. This would produce a pronounced third harmonic, which would be distinctly audible above the 50-cycle hum in the telephone.

A heavy current Westinghouse metallic rectifier connected for double wave rectification and supplied from 50 cycle A.C. mains, as shown in Fig. 133, will produce a

unidirectional pulsating wave of 100 cycles frequency provided the fault resistance is low. This arrangement, however, could not be used for localizing an insulated break by the induction method because a steady charge free from ripples would result, having no external field.

Sometimes earth faults require a considerable voltage to break down the fault resistance. By connecting the cable to

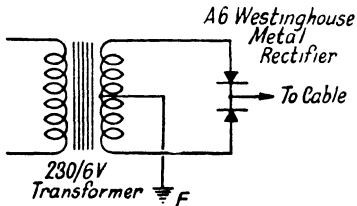

FIG. 133. DOUBLE-FREQUENCY RECTIFICATION

one sparking plug lead of a motor car engine and earthing the car frame, a sequence of high voltage wave trains is passed through the fault, which will produce audible and distinctive signals in the search coil.

If the fault has a very low resistance, an ordinary electric bell or buzzer may be connected in series with the faulty cable and a battery, one pole of the latter being earthed, but following on what has been stated, good results cannot be expected on a lead sheathed or armoured cable.

Mr. Wilson (Central Electricity Board) has devised a piece of apparatus nicknamed a "woodpecker." A buzzer current is connected in series with an oscillating contactor controlled by an electro-magnet and a spring, which makes a sequence of double contacts. The buzzer and contactor are placed in series with the cable and the letter C, in morse, or two dashes, at about two-second intervals, is induced in a specially designed iron-cored search coil. The "woodpecker" note is distinctly audible when superimposed on a 50 cycle A.C. hum. The contactor, buzzer, and energizing battery, which is common to the buzzer and the electro-magnet of the contactor, are contained in a case. The complete apparatus is manufactured by Standard Telephones & Cables, Ltd.

The apparatus as a whole was designed primarily for the detection of "dead" and "live" cables, and gives excellent results, provided the cables are not nested too closely together. The iron-cored search coil, the currents of which are amplified by a valve amplifier, has to be placed within a few inches of the cable under test, and is not therefore suitable for fault location on buried cables, unless they are exposed at a number of points.

Another form of search coil suitable for identification tests, shown in Fig. 134, is easily made up and consists of a laminated "U" shaped iron core with a coil of about 6 oz. of 20 S.W.G. D.C.C. wire wound round the centre. The legs of the iron core would be arranged to straddle the cable at right angles to the axis of the latter.

Whatever type of search coil or generator is employed care should be taken in interpreting observations close to the apparatus generating the fault current, as the magnetic field leakage, even within a radius of many yards, may induce stronger signals in the search coil than those induced by the faulty cable.

Yet another expedient useful for identification tests is the ordinary double telephone receiver. The diaphragm of one of the receivers is removed and the receiver magnet is presented to the cable as a search coil. The other headphone is held against the ear. If the normal connections

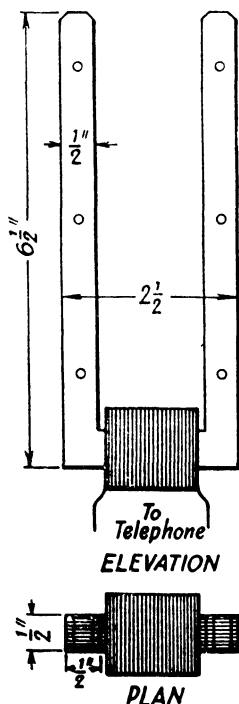

FIG. 134. ANOTHER FORM OF SEARCH COIL.

are retained the arrangement is practically free from interference as the direction of the windings of the coils is reversed. A fairly high resistance set should be selected and the two head-pieces should be an original pair as their impedances will then be automatically matched. This simple arrangement has also a field of usefulness for

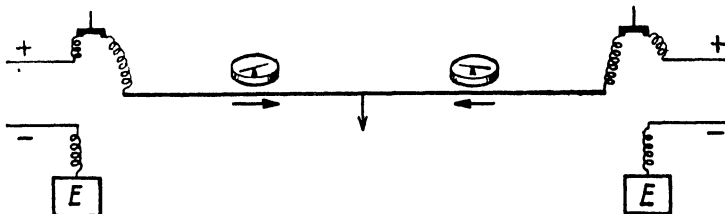

FIG. 135. COMPASS METHOD ON D.C. CABLES

the search coil method of fault localization as applied to internal installations.

Faults on lead covered and armoured cable in D.C. systems can be traced by noting the effect of the sheath or armour currents on a compass as shown in Fig. 135. A current of 30 amperes has been found to give a reliable indication with cables buried 2 ft. 6 in. deep. On small cables, this current should, of course, only be applied for brief intervals. By opening up over the cables at a number of points and laying the compass on the cable, a much smaller current can be used, and the fault could be narrowed down to a short length, after opening a few trial holes. Cables drawn into ducts could be tested at the manholes.

The secret of success with the search coil induction method is practice, which alone inculcates the precise discernment necessary for detecting a slight change in the intensity of sound. There are many factors which tend towards indeterminate or negative results. The effect of armour, lead sheaths, and capacitance have been

mentioned. The effects of adjacent cables in congested routes on A.C. systems, or adjacent tramways will add enormously to the difficulties of detecting the desired telephone sounds or changes in intensity thereof. Noise from traffic can also be troublesome in preventing audibility of the note in the telephone.

A factor which should be watched is the variation in depth of a cable, for instance where a cable route crosses under a road it may be considerably deeper than normal, with a consequent rapid reduction in sound in the telephone which might be misinterpreted as a fault. The same effect will be produced where the cable passes through a length of iron pipe in the course of its run. An obvious precaution is to have the mains records handy for reference when listening so that depth and conditions of laying can be immediately referred to. If a point of silence was found and the records showed that at that spot the cable was laid in an iron pipe, the search should be continued beyond this section of iron pipe.

Under favourable conditions, induction methods can be used successfully on faults which are difficult to locate by other methods; for example, all cores shorted, earthed, and partially discontinuous, as Fig. 125, Chapter X. Mr. W. Redmayne* has pointed out that such faults usually consist of loose connections or carbonized paths, globules of metal, etc., and are consequently "microphonic" in character. By tapping the pavement above them their resistance will vary. He has been quite successful in many instances by making use of this property with the use of a simple telephone induction coil connected as Fig. 136. The secondary is connected directly to the headphones or an amplifier may be interposed. Reception on the telephone will usually be disturbed by other noises and vibration, so it is advisable that the tapping should

* *The Electric Power Engineer*, Vol. XXII, page 41, January, 1940.

be in accordance with a definite sequence or code arranged between the two operators.

It should be noted that tests depending on a simple travelling search coil are likely to fail if the type of fault corresponds to *g* or *h* shown in Fig. 2, Chapter I, for the applied current will flow through the partially short-circuited conductors in reverse directions and the induced

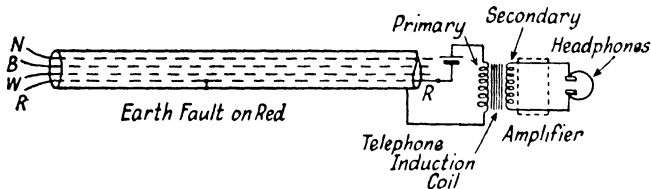

FIG. 136. TEST BASED ON MICROPHONIC PROPERTY OF FAULT

current in the search coil will be neutralized. In such cases the "microphonic" test just mentioned above may be very useful. As an alternative, for faults as *h*, Fig. 2, if the break has a fairly high resistance, a high voltage, high frequency current could be applied between one conductor and earth, depending on the capacity current to produce sufficient field to induce a current in the search coil. For this an amplifier would almost certainly be necessary between the coil and the telephone.

Mr. McCauseland, of the Bournemouth and Poole Electric Supply Co., has designed a simple yet very effective method of sectionizing faults on overhead systems, H.T. or L.T.

A small laminated iron core of about $\frac{1}{2}$ in. \times $\frac{1}{2}$ in. section and $2\frac{1}{2}$ in. square overall is wound with a coil of about 1 oz. of 20 S.W.G. D.C.C. wire, to the ends of which a piece of 5-ampere fuse wire threaded through a bead is connected. (The turns of the coil and size of the fuse wire can be varied to suit the normal load of the faulty

line.) At a number of convenient points in the overhead line, jumper wires at section poles are disconnected, threaded through the iron core of the detectors, and re-connected (Fig. 137). This means shutting down the line temporarily, of course. The fuse wire should not melt with the normal full load current on the line, but as most overhead line faults are intermittent, the sudden increase of current will melt the fuse wire and cause the bead to drop. By patrolling the line and examining the beads through a pair of field glasses, one can readily detect which section of the line has carried an excessive current on the occurrence of a fault. The field of final search for the fault is thus narrowed down.

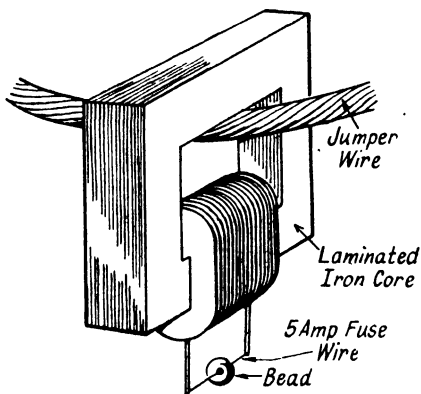

FIG. 137. SECTIONALIZING FAULT INDICATOR FOR OVERHEAD LINES

It is also possible to arrange similar apparatus on the connecting tails of L.T. feeders in a feeder pillar, or at a substation to detect on which an intermittent fault exists. Although in the ordinary way feeders would be individually fused and the blowing of fuses would follow the occurrence of a heavy fault, it is conceivable that a light fault may be neither bad enough nor of sufficient duration to blow the normal fuse. Small current transformers as Fig. 137 are easily constructed to blow, say, a 5-ampere fuse wire at any pre-determined primary load.

CHAPTER XII

SPARK TESTING METHODS, ETC.

Routine Factory Insulation and Fault-finding Tests. Spark testing methods have been much developed and applied during the last decade, both for routine works tests and maintenance purposes. The method embodies the application of a high tension voltage to dry electrodes through which the cable to be tested is passed. The conductor of the cable is earthed, and the presence of a fault in the cable between the electrodes is indicated by a spark. Thus, in the one process, the cable insulation is subjected to a brief high voltage test, and the existence and exact positions of any insulation faults are immediately detected.

Factory routine spark testing is best suited to small non-metal sheathed cables. It is officially recognized in British Standards Specification No. 7 (1939), which, as amended in October, 1943, stipulates 5 and 8 kV respectively as the testing voltages for 250 and 600 volt cables up to 7/064 conductors. The method can, however, be applied to larger sizes of cables; it is a question of suitably-designed electrodes and cable-winding gear. Cables for higher working voltages can be spark tested by using a voltage of a suitably higher value.

Mr. J. H. Savage, M.I.E.E., has developed a spark testing apparatus* for factory routine testing which is now in commercial use to a very considerable extent. The electrical equipment, comprising the high tension transformer, spark detection apparatus, and controls, is assembled in a metal cabinet of 45 × 19 in. base and height to the centre of the electrodes, 32 in. This cabinet is mounted on a framework into which the cable winding

* U.K. Patent No. 451768. U.S.A. Patent 2087783.

gear is built. Fig. 138 shows a group of testing sets in a cable factory.

The electrodes consist of two pairs of rectilinear mail chain, the pairs being arranged at right angles to each other and the members of a pair parallel to each other. They are mounted horizontally, so that, when a cable



FIG. 138. GROUP OF SPARK TESTING SETS IN FACTORY

passes between the chain members, contact is made with the whole periphery of the cable.

While in some of the earlier types of spark testers visual detection of spark was made, for factory purposes this is not sufficiently reliable. In the Savage apparatus, high frequency resonance currents are utilized for spark detection.

Tuned inductance and capacitance in the high tension circuit initiate a high frequency current when a spark through a fault occurs, which in turn "triggers" a gas-filled three-electrode valve detector having a master relay in its anode circuit. This relay operates visual and audible alarms and at the same time stops the winding gear,

so that the operator knows at once that a fault is present within the small cable length encompassed by the electrodes.

The valve detector is without inertia and is therefore instantaneous in its action. The very small inertia of the relay movement does not permit a fault to travel beyond the electrodes before the cable winding gear stops.

The high tension voltage is controlled by a variable auto transformer and potentiometer in the primary side of the step-up transformer. This voltage is recorded by an electrostatic voltmeter scaled 0–12 kV, mounted on the control panel of the cabinet.

The fault current is limited by a condenser to avoid burning the insulation at a fault.

All the live parts are contained within the metal cabinet, which is earthed, and, if access to the high tension electrode compartment is desired, the process of opening its cover automatically cuts off the energy supply, so that shock risks to the operator are eliminated. Earthed guards surrounding the cable on either side of the H.T. electrodes also safeguard the operator.

The energy consumption is about 100 watts at 230 volts.

In Fig. 139 the electrode compartment of the cabinet is shown opened out, exposing the electrodes. The chassis carrying the H.T. transformer, auto-transformer, and valve detector apparatus can be withdrawn as a separate unit for cleaning and maintenance purposes.

The spark testing cabinet is semi-portable inasmuch as it can be removed, if desired, from the framework and used between other winding stands.

The apparatus conforms in all respects to Appendix B of B.S.S. No. 7—1939, which, for reference, is reproduced in the Appendix at the end of this book.

Paragraph (a) of this Appendix to B.S.S. No. 7—1939 approves of the substitution of spark tests for immersion

in water and subsequent insulation resistance measurements and high voltage tests; hence for small non-metal sheathed cables, these routine tests in the factory are now superseded by spark tests. A saving of time is gained and the old and costly process of overhauling for faults is eliminated.

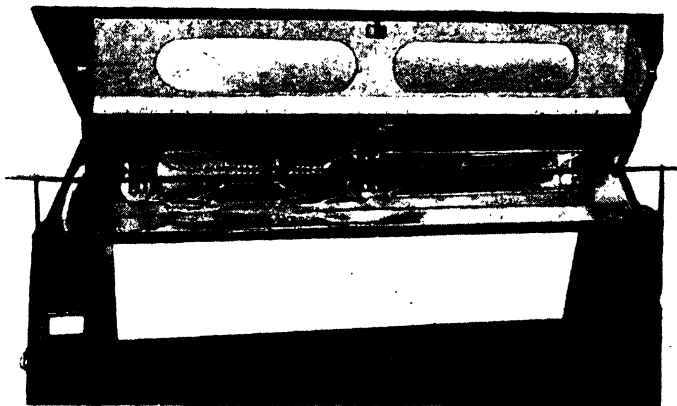

FIG. 139. ELECTRODE COMPARTMENT OPEN

This former method of finding faults consisted of winding over the length of cable between two drums mounted on insulated stands, one drum stand being provided with a collector ring, to which the cable conductor was connected. A swab connected with a 500-volt battery and galvanometer was placed on the cable between the two drum stands. Fig. 140 shows an improved arrangement in which damp swabs make connection with the cable at A and B, the latter acting as a Price's guard. The galvanometer deflection is only slight until the moment that the

fault passes A. It is convenient to let the cable pass over a measuring wheel in advance of B.

When dealing with high resistance faults it is as well to place swab A on the cable on the forward drum from time to time to make sure that the fault has not passed unobserved. It is also advisable to place swab A on the cable on the rear drum after a fault is found to ascertain if

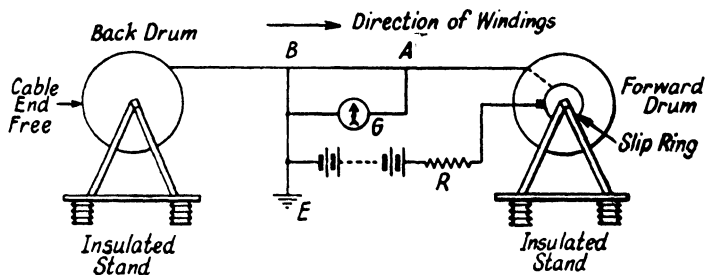

FIG. 140. APPELYARD'S MODIFICATION OF WINDING-OFF METHOD

there are other faults in the part of the cable remaining on the drum.

Before commencing to run a cable over, the insulation of the drum stands should be checked.

Usually it is necessary to immerse cables in water before this method of fault finding as the moisture in the swab would not be sufficient to ensure definite penetration into a dry fault: a crack, for example, could pass undetected if the cable is very dry.

Unarmoured Trailing Cables. The expense, want of flexibility, and difficulty of repairing armoured trailing cables results in an extensive use of unarmoured cables, particularly those of the solid rubber-sheathed type for mining, harbour, and factory purposes, and any incipient defect in a core or in the sheathing may endanger life when

the surface of the cable becomes moist. H.M. Inspector of Mines insists on periodical testing of mining trailing cables.

It is obvious that a "Megger" test on a dry unsheathed cable is useless, but for such periodical tests immersion in water is neither a convenient nor commendable practice. If the sheathing is cracked but the core insulation sound water will be admitted between the cores which will bring about rapid deterioration of the rubber core of the cable as it cannot be effectively dried out. Also, unless the sheathing and insulation is damaged right through to the core, the insulation test on immersion will be quite normal.

The Allscott cable tester was introduced some years ago for the routine spark testing of trailing and flexible cables. It comprises a spark coil capable of giving a peak voltage up to 7 000 volts, one side of the secondary winding being connected to the electrodes through which the cable runs, the other side being earthed. The conductor of the cable under test is also earthed. The electrode consists of four metallic rollers, each having a curved groove with their axes at 90° to each other, so as to touch the whole of the cable perimeter. The secondary winding of the spark coil is shunted by a spark gap which can be set to spark over at a voltage predetermined as suitable for the cable. When a fault passes through the rollers, sparking at the auxiliary gap either ceases or a different note is emitted; this is a more definite indication than visual inspection or listening for sparks at the electrodes.

Energy is supplied from a six-volt accumulator and the secondary voltage of the coil can be regulated between peak values of 6 000 to 7 000 volts. The live parts of the apparatus are protected by a stout earthed wire mesh guard which, when removed, automatically breaks the supply to the coil. Two brushes are also arranged on the guard, which prevent leakage currents over damp cable

surfaces from giving shocks to the operator. An insulated probing rod is provided for the closer localization of faults whose exact position cannot be easily detected visually as the cable passes through the rollers.

A convenient speed for testing for earth faults with this apparatus is 5 to 10 yd. per minute, and no particular skill is necessary for its efficient application.

This method is not suited for core to core faults in multicore cables; these can be burnt out so as to develop earth faults when, if not visually evident, they can be localized with the apparatus.

BROKEN CONDUCTOR FAULTS

For finding the position of cable breaks in unsheathed cables of any class under workshop conditions there are simple methods which will give definite indications. In many cases a visual examination will suffice, and this may usefully be supplemented by connecting a battery and lineman's detector across the ends of the broken conductor, which will reveal if contact is temporarily re-established during examination and handling. This method of detection, however, frequently fails with tough rubber cable and flexible cords.

Messrs. W. T. Henley's Telegraph Works Co., Ltd., have developed a piece of portable apparatus with which after a little practice it is possible to locate the position of a break in a single, twin, or multicore cable, to within $\frac{1}{2}$ in. Although originally designed for dealing with short lengths of flexible cables, it can be adapted for use on long drum lengths or on installed cables which are accessible throughout their run. It is, however, essential that the cables should not be metal sheathed.

The method is somewhat similar to the search coil method for locating insulation faults, but, instead of using a coil to explore the electromagnetic field of the cable,

a metal plate or tube is used for exploring the electrostatic field. A source of alternating or interrupted current (preferably of high audio-frequency) and also a pair of headphones are required. On multicore cables where the broken conductor is covered by layers of wires, a screened amplifier is used in order to increase the sensitivity.

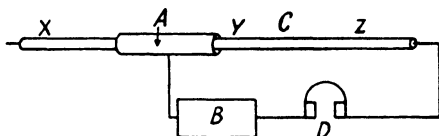

FIG. 141. BREAK LOCATOR FOR SINGLE NON-SCREENED CABLE

The circuit in its simplest form is shown in Fig. 141. A metal tube A is slipped over the cable, and a high-note buzzer B is connected to this tube and also to the cable conductor through the headphones D.

Assuming that the break is at point Y, then when the tube is at point Z there will be a hum in the phones due to capacity current flowing through the condenser formed by the cable conductor and the outer tube. If the tube is moved past the break say to point X the hum will cease. The point where the hum ceases, therefore, is where the conductor is broken.

It will be seen that if this method is used on twin or multicore cables, a capacity current will be carried across the break by the capacitance of each part of the broken conductor to the adjacent conductors, and so prevent a silent point being reached. This can be overcome by connecting all the ends to one side of the buzzer except for one end of the broken conductor which is connected to the phone via the amplifier as shown in Fig. 142. Capacity current flowing from the search electrode A to one end of the broken conductor will flow through the amplifier D, but similar capacity currents in the good conductors

will flow back to the buzzer, not through the amplifier. In the first place there will be a hum in the phones, and when the search electrode passes the break there will be silence.

As this apparatus works on extremely small capacity

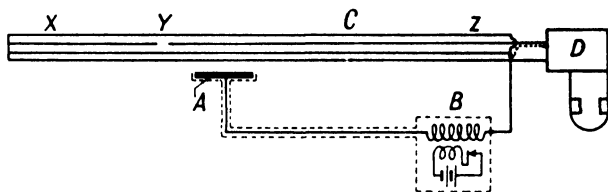

FIG. 142. BREAK LOCATOR FOR MULTICORE NON-SCREENED CABLE

currents it is essential to have an earthed metal screen over the leads, buzzer, amplifier, etc.; the only place which must not be screened is the surface of the search electrode

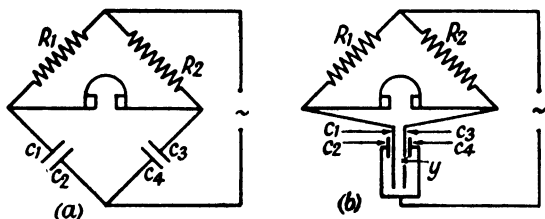

FIG. 143. BREAK LOCATOR FOR TWIN CABLES

facing the cable. These screens are shown by dotted lines in Fig. 142.

The buzzer in Fig. 142 has a secondary winding in order to increase the voltage at the electrode and so improve the sensitivity of the apparatus, and with this arrangement it is advisable to fit a piece of sheet mica over the live part of the electrode to prevent shock through accidental contact.

Another interesting test for locating breaks in twin

flexibles, etc., is shown in Fig. 143 (a) and (b), the apparatus required being a short length of metal tube which can be slipped over the cable, a buzzer, a pair of high resistance phones, and two radio-type high resistances, say 10 000 ohms each.

The basic circuit is shown in (a) and is a conventional A.C. bridge diagram. If the resistances R_1 and R_2 are equal, and the condenser C_1 and C_2 is equal in capacitance to C_3 , C_4 , then the bridge is in balance and no sound will be heard in the phones.

The same circuit is re-drawn in (b), but the condenser plates C_2 and C_4 are now formed by a single short metal tube slipped over the cable, C_1 and C_3 being the two conductors of the cable. With the tube in the position shown the capacitances of each wire to the tube is equal, and the bridge is in balance, therefore no sound is heard in the phones.

If the break in the conductor is at point y then as the tube is moved along the cable (equivalent to lowering the plates C_2 , C_4 in Fig. 143 (b)), the capacitance C_1 , C_2 remains unaltered, but that of C_3 , C_4 drops considerably, as this condenser is virtually disconnected. This throws the bridge badly out of balance and gives a distinct sound in the phones. The break is therefore at the point where sound in the phones commences.

APPENDIX

TABLE A

RESISTANCES PER 1000 YARDS AT 60° F.
BRITISH STANDARD CONDUCTORS

(In accordance with British Standard Specifications No. 7—1939,
and No. 480—1933)

Nominal Area (sq. in.)	Calculated Area (sq. in.)†	Number and Diameter of Wires (in.)†	Ohms per 1000 yd.‡
0.001	0.001018	1/0.036	23.59
0.0015	0.001521	1/0.044	15.79
0.002	0.001943	3/0.029	12.36
0.003	0.002994	3/0.036	8.019
0.003	0.003217	1/0.064	7.463
0.0045	0.004546	7/0.029	5.281
0.007	0.007005	7/0.036	3.427
0.01	0.01046	7/0.044	2.294
0.0145	0.01462	7/0.052	1.643
0.0225	0.02214	7/0.064	1.084
0.03	0.02840	19/0.044	0.8468
0.04	0.03960	19/0.052	0.6063
0.06	0.05999	19/0.064	0.4002
*0.075	0.07592	19/0.072	0.3162
0.10	0.1009	19/0.083	0.2380
*0.12	0.1168	37/0.064	0.2056
0.15	0.1478	37/0.072	0.1625
0.2	0.1964	37/0.083	0.1223
0.25	0.2465	37/0.093	0.09738
0.3	0.3024	37/0.103	0.07939
0.4	0.4064	61/0.093	0.05908
0.5	0.4985	61/0.103	0.04816
0.6	0.6062	91/0.093	0.03961
0.75	0.7435	91/0.103	0.03229
*0.85	0.8459	127/0.093	0.02838
1.0	1.0376	127/0.103	0.02314
1.25	1.2269	127/0.112	0.01957
1.5	1.4900	169/0.107	0.01611

* These sizes are omitted as standards in later editions, but are in use.

† These columns apply to circular conductors, and the figures are sometimes varied when shaped conductors are used.

‡ Applies both to circular and shaped conductors.

TABLE B
S.W.G. ANNEALED COPPER WIRE

S.W.G.	Diameter (in.)	Sectional Area (sq. in.)	Ohms per 1000 yd. at 60° F.
22	0.028	0.000616	39.04
21	0.032	0.000804	29.89
20	0.036	0.001018	23.59
19	0.040	0.001257	19.13
18	0.048	0.001810	13.29
17	0.056	0.002463	9.761
16	0.064	0.003217	7.463
15	0.072	0.004072	5.897
14	0.080	0.005027	4.783
13	0.092	0.006648	3.616
12	0.104	0.008495	2.830
11	0.116	0.01057	2.275
10	0.128	0.01287	1.868
9	0.144	0.01629	1.476

TABLE C

STRANDED COPPER CONDUCTORS IN S.W.G. SIZES

(Note. The Sectional Areas and Resistances are given to three significant figures only, as, in old cables, there are variations in the "lay" of the strand which would affect the fourth figure of decimals.)

S.W.G.	Diameter of Stranded Cable	Effective Sectional Area (sq. in.)	Ohms per 1000 yd. at 60° F.
3/22	0.060	0.00181	13.3
3/20	0.078	0.00299	8.03
3/18	0.103	0.00532	4.52
7/22	0.084	0.00424	5.67
7/21½	0.090	0.00486	4.94
7/20	0.108	0.00700	3.43
7/18	0.144	0.0125	1.93
7/16	0.192	0.0221	1.08
7/15	0.216	0.0280	0.858
7/14	0.240	0.0346	0.695
19/22	0.140	0.0115	2.09
19/20	0.180	0.0190	1.267
19/18	0.240	0.0337	0.712
19/16	0.320	0.0600	0.401
19/15	0.360	0.0750	0.317
19/14	0.400	0.0937	0.256
37/18	0.336	0.0657	0.366
37/16	0.448	0.117	0.206
37/15	0.504	0.150	0.163
37/14	0.560	0.182	0.132
37/12	0.728	0.300	0.0780
61/16	0.576	0.192	0.125
61/14	0.720	0.301	0.0799
61/13	0.828	0.400	0.0605
61/12	0.936	0.500	0.0473
91/13	1.012	0.600	0.0413
91/12	1.144	0.758	0.0315

TABLE
EQUIVALENT

The following table gives the coefficients for converting stan
The coefficients are calculated from standard *resistances*. Coefficients based

Nominal Area	Conductor	Conversion from								Coefficient for
		0-002	0-0045	0-0145	0-0225	0-04	0-06	0-075	0-10	sq.
0-002	3/0-020	1-000	2-340	7-522	11-40	20-38	30-89	39-08	51-92	
0-0045	7/0-029	0-4273	1-000	3-214	4-872	8-707	13-20	16-70	22-19	
0-0145	7/0-052	0-1329	0-3111	1-000	1-516	2-710	4-106	5-195	6-903	
0-0225	7/0-064	0-08771	0-2052	0-6597	1-000	1-788	2-709	3-428	4-554	
0-04	19/0-052	0-04906	0-1148	0-3691	0-5593	1-000	1-515	1-917	2-548	
0-06	19/0-064	0-03238	0-07578	0-2436	0-3692	0-6602	1-000	1-266	1-682	
0-075	19/0-072	0-02558	0-05987	0-1925	0-2917	0-5216	0-7902	1-000	1-329	
0-10	19/0-083	0-01926	0-04507	0-1448	0-2190	0-3926	0-5947	0-7523	1-000	
0-12	37/0-064	0-01663	0-03893	0-1251	0-1897	0-3391	0-5138	0-6501	0-8637	
0-15	37/0-072	0-01315	0-03077	0-09893	0-1499	0-2680	0-4060	0-5139	0-6827	
0-2	37/0-083	0-009894	0-02315	0-07446	0-1128	0-2107	0-3056	0-3867	0-5138	
0-25	37/0-093	0-007879	0-01844	0-05926	0-08982	0-1606	0-2433	0-3080	0-4091	
0-3	37/0-103	0-006424	0-01503	0-04832	0-07324	0-1309	0-1984	0-2511	0-3336	
0-4	61/0-093	0-004780	0-01119	0-03596	0-05450	0-09745	0-1476	0-1869	0-2482	
0-5	61/0-103	0-003897	0-009119	0-02931	0-04444	0-07944	0-1203	0-1523	0-2024	
0-6	91/0-093	0-003205	0-007504	0-02411	0-03654	0-06534	0-09898	0-1253	0-1664	
0-75	91/0-103	0-002612	0-006117	0-01965	0-02979	0-05327	0-08068	0-1021	0-1357	
1-0	127/0-103	0-001872	0-004983	0-01409	0-02135	0-03817	0-05781	0-07317	0-09724	

D

LENGTHS

Standard conductor sizes to an equivalent length of another size.

upon *nominal areas* are insufficiently accurate except for short loops.

Conversion to:

in.

0.12	0.15	0.2	0.25	0.3	0.4	0.5	0.6	0.75	1.0
60.10	76.06	101.1	126.9	155.7	209.2	256.6	312.0	382.8	534.2
25.60	32.50	43.18	54.23	66.52	89.39	109.7	133.3	163.6	228.2
7.990	10.11	13.44	16.87	20.69	27.81	34.11	41.48	50.88	71.00
5.273	6.670	8.866	11.12	13.65	18.33	22.51	27.37	33.57	46.84
2.949	3.732	4.958	6.225	7.636	10.26	12.59	15.31	18.78	26.20
1.947	2.463	3.273	4.110	5.041	6.773	8.309	10.10	12.40	17.30
1.538	1.946	2.586	3.247	3.983	5.352	6.565	7.983	9.794	13.67
1.158	1.465	1.947	2.444	2.998	4.028	4.941	6.008	7.371	10.20
1.000	1.265	1.681	2.111	2.589	3.480	4.269	5.190	6.367	8.885
0.7903	1.000	1.329	1.669	2.047	2.750	3.374	4.102	5.032	7.022
0.5948	0.7525	1.000	1.256	1.540	2.070	2.539	3.087	3.787	5.285
0.4736	0.5993	0.7962	1.000	1.227	1.648	2.022	2.458	3.016	4.205
0.3862	0.4886	0.6492	0.8152	1.000	1.344	1.649	2.004	2.459	3.435
0.2873	0.3636	0.4831	0.6067	0.7440	1.000	1.227	1.492	1.830	2.555
0.2343	0.2964	0.3939	0.4945	0.6066	0.8150	1.000	1.216	1.492	2.08
0.1927	0.2438	0.3240	0.4067	0.4989	0.6704	0.8224	1.000	1.227	1.711
0.1571	0.1987	0.2640	0.3316	0.4067	0.5464	0.6704	0.8151	1.000	1.30
0.1126	0.1424	0.1892	0.2370	0.2914	0.3916	0.4804	0.5842	0.7166	1.00

TABLE E

PAPER-LEAD CABLES: STANDARD DIELECTRIC THICKNESSES FOR
460, 1 000, AND 1 500 VOLTS

(In accordance with British Standard Specification No. 480, 1933.)

(See also Table E.1)

(Note. Cables purchased or laid prior to 1933 will probably have thicker dielectrics.)

For Standard Voltage Tests see tables in Chapter I.

Nominal Area of Conductor	Thickness of Insulation					
	460 Volts				1 000 Volts*	1 500 Volts*
	Condr./ Condr. Multi- core	Condr./ Condr. Con- centric	Condr./ Sheath Multi- core	Condr./ Sheath Single and Con- centric		
sq. in.	in.	in.	in.	in.	in.	in.
0.007	0.07	0.055	0.035	0.055	0.07	—
0.01	0.07	0.055	0.035	0.055	0.07	—
0.0145	0.07	0.055	0.035	0.055	0.07	—
0.0225	0.07	0.055	0.035	0.055	0.07	0.09
0.03	0.07	0.055	0.035	0.055	0.07	0.09
0.04	0.07	0.055	0.035	0.055	0.07	0.09
0.06	0.07	0.055	0.035	0.055	0.07	0.09
0.075	0.07	0.055	0.035	0.055	0.07	0.09
0.1	0.07	0.055	0.035	0.055	0.07	0.09
0.12	0.07	0.055	0.035	0.055	0.07	0.09
0.15	0.07	0.055	0.035	0.055	0.07	0.09
0.2	0.07	0.055	0.035	0.055	0.07	0.09
0.25	0.08	0.060	0.040	0.060	0.08	0.09
0.3	0.08	0.060	0.040	0.060	0.08	0.09
0.4	0.09	0.070	0.045	0.070	0.09	0.10
0.5	0.09	0.080	0.045	0.080	0.09	0.10
0.6	0.09	0.080	0.045	0.080	0.09	0.10
0.75	0.10	0.090	0.050	0.090	0.10	0.11
0.85	0.10	0.090	0.050	0.090	0.10	0.11
1.0	0.10	0.090	0.050	0.090	0.10	0.11
1.25	—	—	—	—	0.11	0.12
1.5	—	—	—	—	0.12	0.13

* Between any one conductor and the next conductor or metallic sheath.

TABLE E.1

PAPER-LEAD CABLES: STANDARD DIELECTRIC THICKNESSES FOR
660 VOLTS (CENTRE-POINT EARTHED)

(In accordance with British Standard Specification No. 480, 1942)

(Note. The 1933 edition of this Specification to which the Table E on the preceding page applies, was revised in 1942, and a 660-volt class established in place of the 460-volt class. Cables of this 660-volt class are all "belted," and the thickness of insulation between conductors and sheath is increased to the values shown in the table below.)

Nominal Area of Con- ductors	Thickness of Insulation		Nominal Area of Con- ductors	Thickness of Insulation	
	Condr./ Condr.	Condr./ Sheath		Condr./ Condr.	Condr./ Sheath
(sq. in.)	(in.)	(in.)	(sq. in.)	(in.)	(in.)
0.007	0.07	0.055	0.30	0.08	0.06
0.0145	0.07	0.055	0.40*	0.09	0.07
0.0225	0.07	0.055	0.50*	0.09	0.07
0.04	0.07	0.055	0.60*	0.09	0.08
0.06	0.07	0.055	0.75*	0.10	0.09
0.10	0.07	0.055	1.00*	0.10	0.09
0.15	0.07	0.055	1.25*	—	0.10
0.20	0.07	0.055	1.50*	—	0.11
0.25	0.08	0.06			

* All areas of conductor above 0.3 sq. in. are marked in the table with an asterisk in the columns headed "Nominal Area of Conductors." Dimensions are provided for cables having these areas of conductor in case they are required for special purposes, although these cables may not be economic for general use.

TABLE F

PAPER-LEAD CABLES: STANDARD DIELECTRIC THICKNESSES FOR
3 000, 6 000, 10 000, AND 20 000 VOLTS

(In accordance with British Standard Specification No. 480, 1933)

In the 1942 edition, these figures apply to 3 300, 6 600, 11 000, and 22 000 volts respectively, if the centre-point is earthed, except that in the three-core screened class for 11 000 volts the thickness of insulation between any conductor and its screen is reduced to 0.13 in.

3 000 VOLTS.	For conductors from 0.0225 to 0.3 sq. in. If centre-point not earthed, D^* = 0.11 in. If centre-point earthed E^\dagger = 0.09 in.; except outer insulation of concentric cables, which may be 0.07 in.
6 000 VOLTS.	For conductors from 0.0225 to 0.3 sq. in. If centre-point not earthed D^* = 0.15 in. If centre-point earthed E^\dagger = 0.12 in.; except outer insulation of concentric cables, which may be 0.08 in.
10 000 VOLTS.	For conductors from 0.0225 to 0.3 sq. in. If centre-point not earthed D^* = 0.21 in. If centre-point earthed E^\dagger = 0.15 in.; except outer insulation of concentric cables, which may be 0.09 in.
	<i>Screened Conductors.</i> Thickness between conductor and its screen—
	Twin 0.21
	Three-core (including S.L. type):
	Centre-point not earthed 0.21
	Centre-point earthed . 0.14
20 000 VOLTS.	Centre-point earthed. For conductors from 0.04 to 0.3 sq. in.—
	Single-core 0.24 sq. in.
	Three-core belted:
	Conductor to conductor . . 0.34 in.
	Conductor to sheath . . . 0.27 in.
	Three-core screened:
	Conductor to screen . . . 0.23 in.

* D is the thickness of the insulation as follows—

- (1) Single-core cables, three-phase centre-point not earthed system: between the conductor and metallic sheath.
- (2) Concentric cables, not earthed: between the conductors and between the outer conductor and metallic sheath.
- (3) Concentric cables, earthed: between the conductors only.
- (4) Twin cables: between the conductors and between any conductor and metallic sheath.
- (5) Three-core cables, centre-point not earthed: between the conductors and between any conductor and metallic sheath.
- (6) Three-core cables, centre-point earthed: between the conductors only.

† E is the thickness of the insulation as follows—

- (1) Single-core cables, three-phase centre-point earthed system: between the conductor and metallic sheath.
- (2) Three-core cables, centre-point earthed: between any conductor and metallic sheath.

ST. CECIL MEN FEEDER RECORD

11 000 Volt Feeder: No. 1 Generating Station to Smithfield Road Sub-station

Laid: 23rd October, 1932

Nominal Area: 0.15 sq. in.

Resistance Cold (R: 0.4392 ohm
after Laying (Y: 0.4389 ohm
B: 0.4384 ohm

Joint Identification Marks: GS SR No. 1
Total Length: 8148 feet

Section No.	Joint No.	Section Length, feet	Area of Conductor	Equip. Length of Section	Actual Joint Distance from G.S. in feet	Equip. Distance of Joint from G.S. in feet	Joint Depth	Section Laid	Joint Position
1	4 2	392	0.15	392	—	392	ft. in.	D	3 ft. 6 in. W. of E. side entrance G.S. and 2 ft. South.
2		600	0.15	600	—	—	3 6	D	
3	2 3	600	0.15	600	992	992	4 2	D	Opposite side gate No. 49 Stewart Road in pavement.
4	3 4	595	0.2	447	1592	1592	4 0	P	28 ft. 6 in. S. lamp-post, opp. No. 21 Stewart Road.
5	4 5	600	0.15	600	2187	2039	3 9	D	3 ft. 6 in. from W. side curb in roadway.
6		603	0.15	603	2787	2639	3 9	D	
7	6/7	600	0.15	600	3380	3242	3 10	D	
8	7/8	600	0.15	600	3990	3842	4 6	D	
					4590	4442	3 6		

D signifies direct laid under concrete slabs.

P signifies drawn into 6-in. iron pipes.

KIRCHOFF'S LAWS

(1) The algebraic sum of all currents meeting at a point is zero.

(2) The algebraic sum of all the products of current strengths and resistances in all parts of a closed network equals the algebraic sum of all E.M.F.'s in the network.

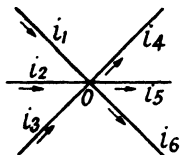

FIG. 144

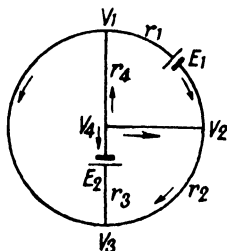

FIG. 145

Proofs. First Law. Let the currents be flowing as in Fig. 144.

The sum of the currents flowing into the point 0 where they meet must be the same as those flowing out, as there can be no accumulation of current at 0

$$\therefore i_1 + i_2 + i_3 = i_4 + i_5 + i_6$$

$$\text{i.e. } i_1 + i_2 + i_3 - i_4 - i_5 - i_6 = 0$$

NOTE. In applying this law, the senses of the currents must be taken into account.

Second Law. Let the network be as Fig. 145, the currents being i_1, i_2 , etc., corresponding to the resistances r_1, r_2 , etc., flowing in the directions shown, clockwise being + and anti-clockwise - *ve.* Let the + convention be from the thick lines to the thin at E_1 and E_2 and conversely negative. V_1, V_2 , etc., represent potentials at the points indicated.

If i, r , and E are the currents, resistance, and E.M.F.

between two points, then the potential difference is the algebraic sum of $i r$, and E .

Taking the closed circuit V_1, V_2, V_3, V_4 ,

$$V_1 - V_2 = - E_1 + i_1 r_1$$

$$V_2 - V_3 = i_2 r_2$$

$$V_3 - V_4 = - E_2 - i_3 r_3$$

$$V_4 - V_1 = i_4 r_4$$

Adding these equations

$$i_1 r_1 + i_2 r_2 - i_3 r_3 + i_4 r_4 = E_1 + E_2$$

PROOF OF THE FORMULE FOR TESTING LIVE D.C. NETWORKS. CHAPTER IV

Let Fig. 146 represent a three-wire network. Let the difference of potential between each pair of mains be V , and let the absolute potential of each main or bus bar be P_1, P_2 , and P_3 respectively, so that $P_1 - P_2 = P_2 - P_3 = V$. Further, let f_1, f_2 , and f_3 be the fault resistances of the three mains, and let the leakage currents flowing through these fault resistances be designated by i_1, i_2 , and i_3 . Then we have, by Kirchoff's laws,

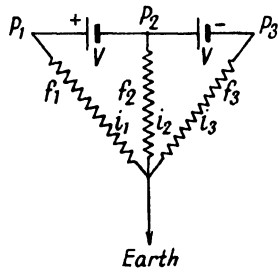

FIG. 146

$$i_1 + i_2 + i_3 = 0 \quad \dots \quad (91)$$

$$i_1 f_1 - i_2 f_2 = V \quad \dots \quad (92)$$

$$i_2 f_2 - i_3 f_3 = V \quad \dots \quad (93)$$

From (92) $i_1 f_1 f_3 = V f_3 + i_2 f_2 f_3$.

From (93) $i_3 f_1 f_3 = - V f_1 + i_2 f_2 f_1$.

Adding and remembering (91)

$$- i_2 f_1 f_3 = V (f_3 - f_1) + i_2 (f_2 f_3 + f_2 f_1).$$

$$\therefore i_2 (f_2 f_3 + f_2 f_1 + f_1 f_3) = V (f_1 - f_3).$$

Dividing by $f_1 f_3$,

$$i_2 f_2 \left(\frac{1}{f_1} + \frac{1}{f_2} + \frac{1}{f_3} \right) = V \left(\frac{1}{f_3} - \frac{1}{f_1} \right)$$

$$\therefore i_2 f_2 = P_2 = \frac{\frac{1}{f_3} - \frac{1}{f_1}}{\frac{1}{f_1} + \frac{1}{f_2} + \frac{1}{f_3}} V \quad (94)$$

$$P_1 = P_2 + V = \frac{\frac{1}{f_3} - \frac{1}{f_1}}{\frac{1}{f_1} + \frac{1}{f_2} + \frac{1}{f_3}} V + V \quad (95)$$

and $P_3 = P_2 - V = \frac{\frac{1}{f_3} - \frac{1}{f_1}}{\frac{1}{f_1} + \frac{1}{f_2} + \frac{1}{f_3}} V - V \quad (96)$

Now, if a voltmeter of resistance g be connected between the + pole and earth, the potential of the + bar becomes

$$P_1' = \frac{\frac{1}{f_3} - \frac{1}{f_1} - \frac{1}{g}}{\frac{1}{f_1} + \frac{1}{f_2} + \frac{1}{f_3} + \frac{1}{g}} V \quad (97)$$

if $F =$ the insulation resistance of the network, so that

$$\frac{1}{F} = \frac{1}{f_1} + \frac{1}{f_2} + \frac{1}{f_3} \quad (98)$$

If the same voltmeter be connected between the middle bus bar and earth, the potential of this bar becomes

$$P_2' = \frac{\frac{1}{f_3} - \frac{1}{f_1}}{\frac{1}{f_1} + \frac{1}{f_2} + \frac{1}{f_3} + \frac{1}{g}} V \quad (98)$$

Subtracting (98) from (97)

$$(P_1' - P_2') = - \frac{V}{g \left(\frac{1}{F} + \frac{1}{g} \right)} + V$$

from which
$$\frac{1}{F} = \frac{P_1' - P_2'}{g \{V - (P_1' - P_2')\}}$$

and
$$F = g \left(\frac{V}{P_1' - P_2'} - 1 \right) \quad . \quad . \quad (99)$$

which is the same as equation (23) in Chapter IV.

If an ammeter be used instead of a voltmeter, we have, instead of equations (97) and (98).

$$d_1 = \frac{V}{g} \left(\frac{\frac{1}{f_3} - \frac{1}{f_1} - \frac{1}{g}}{\frac{1}{F} + \frac{1}{g}} + 1 \right)$$

$$d_2 = \frac{V}{g} \left(\frac{\frac{1}{f_3} - \frac{1}{f_1}}{\frac{1}{F} + \frac{1}{g}} \right) \quad . \quad . \quad (99A)$$

and similarly
$$d_3 = \frac{V}{g} \left(\frac{\frac{1}{f_3} - \frac{1}{f_1} + \frac{1}{g}}{\frac{1}{F} + \frac{1}{g}} \right)$$

From these we get, in the same way as before,

$$F = g \left(\frac{\frac{V}{g}}{d_1 - d_2} - 1 \right) = \frac{V}{d_1 - d_2} - g \quad . \quad (100)$$

which is equation (22).

The case of a two-wire network is simpler. If this be represented by Fig. 147, we have, by Kirchoff's laws,



FIG. 147

$$\begin{aligned}
 i_1 + i_2 &= 0 \\
 \text{and } i_1 f_1 - i_2 f_2 &= V \\
 \text{Eliminating } i_1, -i_2 f_1 - i_2 f_2 &= V \\
 \text{and } i_2 &= -\frac{V}{f_2 + f_1} \\
 \therefore P_2 = i_2 f_2 &= -\frac{V f_2}{f_2 + f_1} = -\frac{V \frac{1}{f_1}}{\frac{1}{F}}
 \end{aligned}$$

and similarly
$$P_1 = \frac{V \frac{1}{f_2}}{\frac{1}{F}}$$

If a voltmeter of resistance g be connected between the + main and earth, the potential of the + bus bar becomes

$$P_1' = V \frac{\frac{1}{f_2}}{\frac{1}{F} + \frac{1}{g}} \quad \dots \quad (101)$$

If the same instrument be connected between the - bus bar and earth,

$$P_2' = -V \frac{\frac{1}{f_1}}{\frac{1}{F} + \frac{1}{g}} \quad \dots \quad (102)$$

On subtracting (102) from (101), and remembering that

$$\frac{1}{F} = \frac{1}{f_1} + \frac{1}{f_2} \text{ we get, as before,}$$

$$F = g \left(\frac{V}{P_1' - P_2'} - 1 \right)$$

From equations (101) and (102) we also get

$$f_1 = \frac{g\{V - (d_1 - d_2)\}}{-d_2}$$

and

$$f_2 = \frac{g\{V - (d_1 - d_2)\}}{d_1}$$

true, of course, for a two-wire network only.

If an ammeter is used instead of a voltmeter, we get, instead of equations (101) and (102),

$$d_1 = \frac{V}{g} \frac{\frac{1}{f_2}}{\frac{1}{F} + \frac{1}{g}}$$

and

$$d_2 = -\frac{V}{g} \frac{\frac{1}{f_1}}{\frac{1}{F} + \frac{1}{g}}$$

Equation (100) can again be got from these, or by substituting $d_1 = \frac{P_2'}{g}$ and $d_2 = \frac{P_2'}{g}$ in equation (99), which we have just proved for a two-wire network.

On examining equation (99), the mistake of using a high-resistance voltmeter for this test, when only a low insulation is to be measured, will be apparent. If g is large compared with F , it is necessary that the value within the

bracket be very small—that is to say that $\frac{V}{P_1' - P_2'}$ will be not very much greater than unity. Hence, a very small error in reading P_1' or P_2' will mean an enormously large error in the result.

Arising out of these investigations of the effect of fault resistances on the potential difference between the conductors of a three-wire network and earth when there is no solid earth connection of the neutral bus bar, the proof of the formula (20), for the test described on page 109, becomes very simple. The current through the earthed middle wire ammeter connected as Fig. 41 or as the current through the ammeter A when the plug is inserted in 2 and 1 and 3 are open in Fig. 45 is

$$d_1 = \frac{V \frac{1}{f_3} - \frac{1}{f_1}}{r \frac{1}{F} + \frac{1}{r}} \quad (103)$$

r being the resistance of the shunted ammeter A plus the resistance a in series with it.

On inserting a second plug in 3 (Fig. 45), thus shunting the ammeter with a similar resistance r , the current will not be exactly halved, but will be

$$d_2 = \frac{V \frac{1}{f_3} - \frac{1}{f_1}}{r \frac{1}{F} + \frac{2}{r}}$$

Whence

$$\frac{d_1}{d_2} = \frac{\frac{1}{F} + \frac{2}{r}}{\frac{1}{F} + \frac{1}{r}}$$

$$\text{From this} \quad \frac{1}{R} (d_1 - d_2) = \frac{d_1}{r} - \frac{2d_2}{r}$$

$$\frac{1}{R} = \frac{d_1 - 2d_2}{r(d_1 - d_2)}$$

and

$$\frac{1}{R} = \frac{r(d_1 - d_2)}{d_1 - 2d_2}$$

It should be noticed that, since the currents d_1 and d_2 are both measured by the same instrument, it does not matter whether it be direct reading, or, if not, what its constant is, since this constant would appear in both the numerators and denominators of the fraction $\frac{(d_1 - d_2)}{2d_2 - d_1}$. Thus we may use an ammeter, voltmeter, or any galvanometer giving proportional readings.

It is also seen that the test fails if $1/f_1$ exactly equals $1/f_3$ or if there is a dead earth on the neutral somewhere on the network. The result of either of these two conditions will be that no reading is obtainable on the ammeter, but the use of a voltmeter between neutral and earth as shown in Fig. 45 and an artificial fault applied to one outer as explained on page 111 will indicate which condition obtains.

PROOF OF WERREN'S METHOD

Referring to Fig. 126, Chapter X, when the switch S_2 is closed and S_4 is open, the bridge system is equivalent to Fig. 148 (a), where a , b , and c correspond to the similar fault component resistances as Fig. 126, the test being made from the end A.

Taking the delta resistance formed by $2Y$, a and b , in Fig. 148 (a), let us consider the equivalent star resistance.

In Fig. 149 (a) represents this delta resistance and (b) the equivalent star resistance.

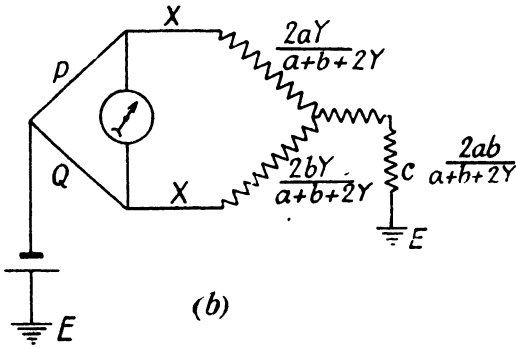
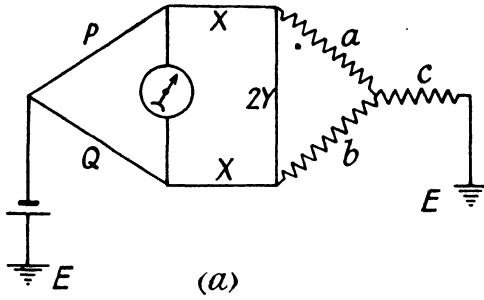

FIG. 148

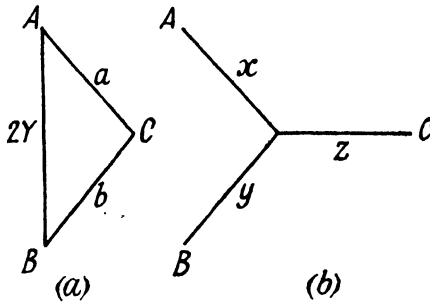

FIG. 149

FIGS. 148 AND 149. WERREN'S METHOD

The resistances between A and B, B and C, C and A, Fig. 149 (a), must be equal to those between the same points respectively in Fig. 149 (b), whence we have

$$\frac{2Y(a+b)}{2Y+a+b} = x+y$$

$$\frac{b(a+2Y)}{2Y+a+b} = y+z$$

$$\frac{a(b+2Y)}{2Y+a+b} = x+z$$

Whence

$$x = \frac{2aY}{a+b+2Y}, \quad y = \frac{2bY}{a+b+2Y}, \quad \text{and} \quad z = \frac{ab}{a+b+2Y}$$

Fig. 148 (a) can, therefore, be redrawn as Fig. 148 (b), in which latter, when balance obtains.

$$\frac{P}{Q} = \frac{aX + bX + 2XY + 2aY}{aX + bX + 2XY + 2bY}$$

As $2XY$ will generally be negligible compared with the other terms.

$$P = \frac{(aX + bX + 2aY)Q}{aX + bX + 2bY}$$

Substituting this value of P in $\frac{P-Q}{P+Q}$ and simplifying.

$$\frac{P-Q}{P+Q} = \frac{Y(a-b)}{(X+Y)(a+b)} \quad . \quad . \quad (104)$$

Similarly, when the test is made from the other end B in Fig. 126, Chapter X.

$$\frac{R-S}{R+S} = \frac{X(a-b)}{(X+Y)(a+b)} \quad . \quad . \quad (105)$$

Dividing (104) by (105)

$$\frac{P - Q}{P + Q} = \frac{Y}{R - S}$$

$$\frac{R - S}{R + S}$$

If the two slide wires have equal resistance

$$\frac{P - Q}{R - S} = \frac{Y}{X}$$

and

$$\frac{P - Q}{R - S} + 1 = \frac{Y}{X} + 1$$

whence

$$\frac{R - S}{(P - Q) + (R - S)} = \frac{X}{X + Y} = l$$

SPARK TESTING OF RUBBER CABLES

(Appendix B of B.S. 7-1939)

(a) OBJECT. Spark testing in accordance with this Specification can be used as an alternative to insulation-resistance and voltage tests, which are generally carried out after immersion in water, on certain cables, flexible cables and flexible cords insulated with vulcanized rubber.

(b) CABLES TO WHICH SPARK TESTING MAY BE APPLIED. All sizes of 250-volt and 660-volt vulcanized rubber-insulated cables and cords up to a maximum conductor area of 0.0225 sq. in.

(c) STAGE OF MANUFACTURE AT WHICH SPARK TESTS MAY BE TAKEN. The test shall be taken at the core stage, except for single braided and compounded cable, in which case the test may be taken at the finished stage as an alternative to the core stage.

(d) TEST-ELECTRODE. The electrode shall make intimate contact with the surface of the core or cable and shall preferably consist of a fine link mesh.

(e) **RUNNING SPEED.** The speed at which the core or cable passes through the electrode shall be such that every point is in the electrode for not less than 0.1 second.

(f) **TEST-VOLTAGE.** The supply to the electrode shall be alternating current at 50 cycles. The conductor of the core or cable shall be earthed and the potential difference between the electrode and the conductor shall be as under --

Cable Working Voltage	Test Voltage R.M.S.
250 volts	6 000 volts*
660 volts	10 000 volts†

(g) **FAULT INDICATOR.** The detector shall be arranged so as to maintain its indication even after the fault has passed out of the electrode.

(h) **SENSITIVITY.** The minimum sensitivity of the spark-testing apparatus shall be such that the detector will operate when an artificial fault device, consisting of a spark-gap in series with a capacitor, is connected between the electrode and earth. The electrode potential shall be 6 000* volts R.M.S. and the capacity of the capacitor shall be 350 micro-microfarads. The spark-gap shall consist of a metal plate moving past a needle point in 0.02 second, and the distance between them during this time shall be 0.2 in.

* Amended to 5 000 volts in 1942.

† Amended to 8 000 volts in 1942.

USE A 'MEGGER' TESTER

REGISTERED TRADE MARK

The word "MEGGER" is the Registered Trade Mark of Evershed & Vignoles Ltd., and applies exclusively to their products—"MEGGER" Testers are used throughout the world for testing electrical insulation.

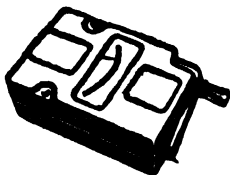

THE WEEMEGGER TESTER

This instrument is suitable for testing house wiring, small motors, etc., operating on voltages not exceeding 250 volts. Testing pressures up to 500 volts. Ranges up to 20 megohms. Weight only 3 lb. Write for List FL 208.

THE MEG INSULATION TESTER

This instrument is suitable for testing power circuits, motors, etc., operating on 500 volts, and for mains having moderate electrostatic capacity. Testing pressures up to 1,000 volts. Ranges up to 2,000 megohms. Write for List FL 454.

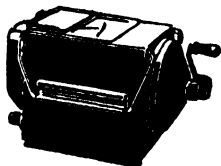

THE MEGGER INSULATION TESTER

This instrument is suitable for testing high-tension equipment, transformers, mains, etc., and apparatus having a high degree of insulation and considerable electrostatic capacity. Testing pressures up to 2,500 volts. Ranges up to 10,000 megohms. Write for List FL 209.

A special 5,000 volt tester is also available, reading up to 20,000 megohms. Write for List FL 191.

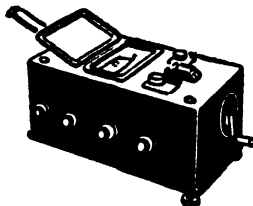

EVERSHED & VIGNOLES LTD.

CHISWICK, LONDON, W.4

REGISTERED 'MEGGER' TRADE MARK

ELECTRICAL TESTING INSTRUMENTS

Insulation Testers, Resistance Testers, Earth Testers, Switchboard and Portable Indicating and Recording Instruments, Apparatus for Remote Indication and Control, etc.

INDEX

- A.C. BRIDGE test, 273, 294
Accuracy obtainable, 200, 210, £35, 238
Allscott cable tester, 327
Ammeter, middle-wire earthing, 102
Amplifier with search coil, 309
Appleyard's modification of winding-off method, 326
Artificial fault, 111, 349
Automatic switch, 104
- BALLISTIC measurement of capacitance, 45, 249
Beavis, E. A., 13
Blavier Test, 285
Branched cables, 244, 308
Breaking-down faults, 135, 141-7, 212
Breaks, factory test for unsheathed cables, 328
 ---, partial, 288
 ---, with insulation intact, 267
 --- with shorts, 276
British Insulated Cables slide wire bridge, 164, 211
B.S. Specifications, 12, 17-21, 324, 333-5, 338-40, 352
Burn-through, 8, 252, 255, 258, 265—*see also* Discontinuities
Buzzer for A.C. bridge, 275
Buzzers for induction methods, 315
- CALLENDER-SMITH connection, 95
Capacitance bridge, 273
 ---, measurement of, 45-8, 267
Capacity current—*see* Charging Current
Causes of faults, 10
Central Electricity Board, 137
Charging current, 19, 37, 47, 62, 71, 77
Classification of faults, 5
Compass induction method, 318
Concentric cables, 5, 61, 134, 167, 175, 218, 275, 291, 338-40 (Tables)
Conductor resistance tests, 48
 --- tables, 333-7
Constant of galvanometer, 33, 36
Consumers, localization without disconnection of, 223
Contact resistance, 160, 179
"Cut and try" method, 3
- D.C. HIGH voltage tests, 19, 21, 63, 67-99, 150, 205
Delayed action tripping device, 130
Dielectric absorption, 37, 87
 --- loss, 12
 --- resistance, 23, 33, 79
 --- thicknesses, 12, 338-40 (Tables)

*Let Henley Cables carry
the current.*

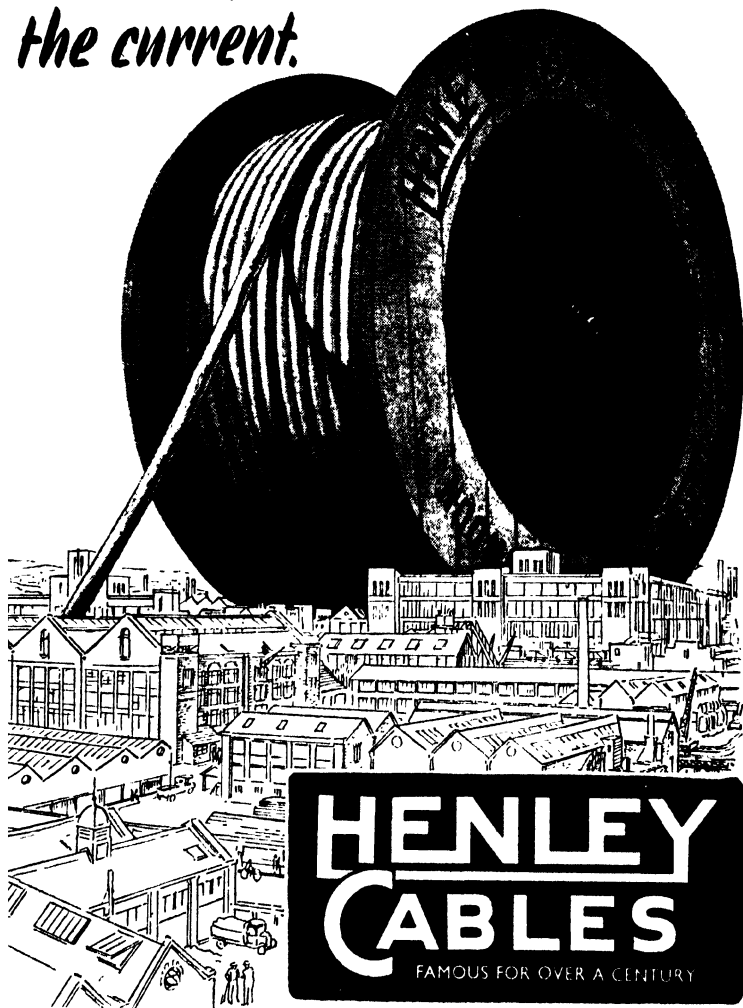

W. T. HENLEY'S TELEGRAPH WORKS CO. LTD., MILTON COURT, WESTCOTT, DORKING, SURREY

- Direct deflection method (insulation measurement), 33
— -indicating loop tests, 222, 225, 228
— reading bridge, 160
- Discharge after test, 43, 67, 85, 87
- Disconnection of consumers, 223
- Discontinuities, 5, 265-304
- Discontinuity, partial, 288
- Drop of potential—*see* Fall of potential
- Dunsheath, P., 14, 16
- Duration of voltage test, 18
- EARTH** currents, 186
— lamp test, 116
— leakage indication for H.T. systems, 113
— ——— for L.T. systems, 100
— ——— tripping devices, 129, 136
- Earthed middle wire insulation test, 109, 348
- Earthing ammeter, 103, 121, 345
— the outers for insulation test, 112, 343
- Electrification (insulation testing), 37
- Electricity Commissioners' Regulations, 16, 101, 121, 139
- Enclosure for H.V. tests, 66
- Equipotential points on Wheatstone bridge, 224
- Equivalent loop length, 168, 336 (Table)
- Everett-Edgumbe E.H.T. voltmeter, 64
— leakage indicators, 117
— quick-acting M.D. ammeter, 138
— recording ammeter, 123
- Evershed "Megger," 40
— recording ammeter, 123
- FACTORY** tests—*see* Manufacturers' works
- Fall of potential methods, 245-64, 278, 282
- False zero, 177
- Fault resistance, definition of, 100
- Feed-back, danger of, 6
- Feeder record, specimen, 341
- Feeders, insulation test on, 119
- Figure of merit, 25, 39, 242
- Filament current and voltage, 69, 70
— transformer, protection of, 207
- Five-dial bridge, 54, 174
- Flexibles, 322, 327, 328
- Four-dial bridge, 55, 172
- Fuse, tinfoil, 226
- Fuses, network, 139
- GALVANOMETERS**, 23 33, 57
- Gambrell's H.T. slide wire, 208
- Glover's test sheath cable, 137
- Graetz connection, 98
- Guard wire, 34, 37, 42

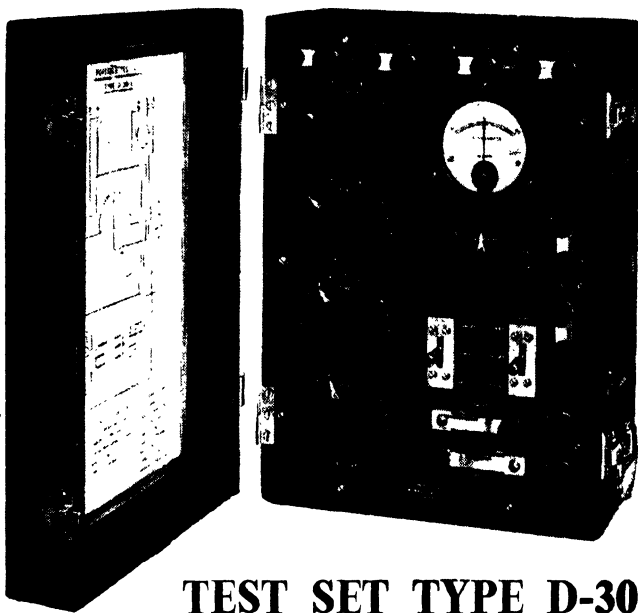

TEST SET TYPE D-30-A

A portable test set for general resistance measurements and for fault location on lines and cables—May be used for A.C. tests with suitable power source and detector—Resistance decades and galvanometer can be used externally.

A descriptive bulletin will be supplied on request.

RANGE 0.001 ohm to 11.11 megohms
DIMENSIONS $12\frac{1}{2}'' \times 9\frac{1}{2}'' \times 6''$
WEIGHT 12-lbs.

MUIRHEAD

MUIRHEAD & COMPANY LIMITED, ELMERS END, BECKENHAM, KENT. PHONE: BECKENHAM 0041-0042
FOR OVER 60 YEARS DESIGNERS AND MAKERS OF PRECISION INSTRUMENTS

- HENLEY's break tester**, 328
 ——— spark testing, 323
High-resistance faults, 155, 184, 205
 ——— tension cable systems, 148, 200
 ——— voltage, definition of, 17
 ——— tests, 19, 59
H.T. cables, table of dielectric thickness, 340
 ——— slide wire, 208
- IMMERSION tests**, 12
Improvised slide wire bridge, 189, 190
Incipient faults, 141, 143
Induction methods, 305
Initial test, 8
Insulation of connected-up network, 102
 ——— of consumers' connections, 101
 ——— measurement, 23, 33
 ——— resistance at high voltage, 86
Intermittent faults, 140, 150
Iron-cored search coil, 313, 315, 317
Isolating links, 7
- JOINT and junction box failures**, 10
Junction boxes, effect on search coil methods, 308
- KALLMANN feeder test**, 119
Kelvin double bridge, 50
Kenotron, 68
Key, Rymer-Jones, 33, 35
 ———, short-circuit, 35
Kirchoff's Laws, 239, 342 (proof)
- LAYING**, tests after, 17, 20, 21, 62
Lead sheath, loop tests on, 232
Leads, connecting, 37, 171, 180, 181, 268
Leakage indicators, 117, 118, 127, 135
Limiting resistance (earthing middle wire), 103
Lineman's detector, 8
Live mains for bridge tests, 166
 ——— ———, localization on, 225
 ——— network testing, 100, 121, 343
Long cables, 293
Loop, making up the, 166
 ——— test, direct-indicating, 222, 228
 ——— ——— for shorts, 277, 279
 ——— tests, 157, 216
 ——— ——— on branched cables, 244
 ——— ——— on H.T. cables, 200
 ——— ——— with return of unknown resistance, 196, 216
 ——— ——— with pilot wire return, 216, 221
Low pressure, definition of, 17

FAULT LOCATION

PORTABLE EQUIPMENT FOR
THE LOCATION OF CABLE
FAULTS BY MURRAY LOOP

*LOW VOLTAGE SETS AND SETS FOR
USE UP TO 50 KILOVOLTS.*

Also, instruments for Location
by means of Capacity and
Inductance Measurements.

*A complete range of instruments
covering all tests on High and Low
Voltage Cables, including that of
Power Factor up to 300 K.V. (Peak.)*

GAMBRELL BROS. & CO. LTD.

307 MERTON ROAD, SOUTHFIELDS

LONDON, S.W.18

- MCCAUSELAND**, 320
Manufacturing lengths, capacitance of, 267
Manufacturers' works, tests at, 18, 59, 142, 322
Marshall & Atkins fault indicating method, 137
Medium pressure, definition of, 17
 "Megger," 17, 40
Microphonic detection, 319
Middle wire earthing ammeter, 102
Mine trailing cables, 326
Mines installations, 118
Moisture, test for, 11
Moore, Trubic, 163
Muirhead direct-reading bridge, 161
Multicore cables, 5, 168, 175, 266-91, 310, 338-40 (Tables)
Murray's loop test, 157
 -----, with return of unknown resistance, 196

NALDER Bros. & Thompson fault indicator, 137
 ----- insulation tester, 129
Neon tubes, 135
Network fuses, 139

OSRAM, E.H.T. valve, 67, 69
Overhead cables, 5
 ----- lines, indication of faults on E.H.T., 137, 320
Overlap tests, 256, 283

PHILIPS valves, 68-71
Pilot wire return, 216, 221, 252, 254
Plug switch, 249
Polarity of testing pressure, 99
Post Office pattern bridge, 55, 173, 188, 243
Potential, fall of—see Fall of Potential
Potentiometer method of resistance measurement, 48
 ----- of fault localization, 259
Power factor, 12
Pressures, testing, 18, 20
Price & Belshaw A.C. bridge, 276
Proportional deflections, 58

RAPHAEL direct-reading bridge, 160
Recording ammeters, 103, 123
Records, 19, 147, 204, 319, 341
Rectification, single-valve, 67-92
 -----, two-valve, 92
Rectifying valves, 67
Redmayne, W., 223, 227, 313, 315, 319
Regulations, Electricity Commissioners, 16, 101, 121, 139
Resistance box bridges, 54, 172
----- discharging cable, 90
----- measurement, 48
----- tables, 333-5

TINSLEY PRECISION INSTRUMENTS

BUILT IN
GALVANO-
METER
BATTERIES

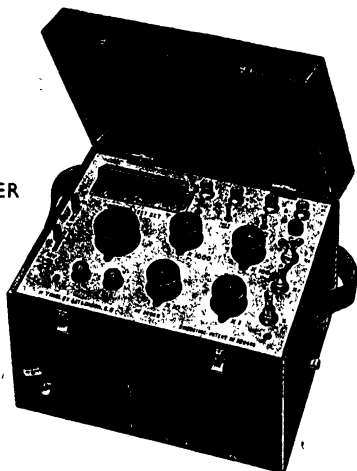

ACCURATE
ROBUST
RELIABLE

PORTABLE TEST SET

FOR LOCALIZATION OF FAULTS INCLUDING
OPEN CIRCUITS BY A CHOICE OF METHODS

**MURRAY LOOP
VARLEY LOOP
CAPACITY TESTS**

ALSO INSULATION & RESISTANCE MEASUREMENTS

Write for full particulars to :

H. TINSLEY & CO. LTD SCIENTIFIC INST. MAKERS
WERNDÉE HALL, SOUTH NORWOOD, S.E.25

- "Resultant" fault, 235
 Reverse voltage on valve, 69, 74
 Routine factory tests, 11
 Rymer-Jones key, 33, 35

SAVAGE'S amplifier unit for search coil, 309
 ——— screened search coil, 310
 ——— spark testing apparatus, 322
 Schering bridge, 12
 Sealing boxes, 148
 ——— up, 153, 212
 Search coil methods, 305
 Sectionalising the network, 140
 Self-contained installations, 126
 Service cables, 223, 244, 276
 Severed conductors *see* Discontinuities
 Short circuits, 176, 252, 276-304
 Shunt, multiplying power of, 34, 39
 ———, universal, 34, 271
 Shunts, accuracy of, 269
 Single-core cables, 5, 254
 Single phase networks, 123
 Slide-wire bridge, 53, 158, 196, 227, 288
 ——— ———, accuracy of, 200, 210
 ———, H.T., 208
 Spark gap, 206
 ——— testing, 12, 322, 352
 Sparking plugs for induction tests, 316
 Stability and time type tests, 14
 Stretched wire bridge (*see* Slide Wire Bridge)
 Stretton-Smith, 95
 Stubbing & Quenza leakage indicator, 117
 Super-tension cables, 21, 22
 Superimposed D.C. insulation test, 128
 ——— ——— localization test, 226
 Suppression coils, 214
 Surge absorber, 207
 S.W.G. tables, 334, 335

TELEPHONE receiver, double, as search coil, 317
 Temperature correction (insulation), 43
 ——— ——— (resistance), 184, 248
 Test sheath cable, 137
 Thermo-electric E.M.F., 160
 Three-core cables, 5, 60, 175, 266-91, 310, 338-40 (Tables)
 Three-phase networks, tests on live, 122
 ——— tests, 60
 Three-wire D.C. networks, insulation of, 102, 343
 Trailing cables, 326
 Tramway and trolley bus lines, 226
 Transformers for breaking-down faults, 142, 149
 ———, back-to-back connection of, 144

- Triple concentric cables, 176, 275, 293
- Tripping devices, earth leakage, 129, 136
- Trolley bus lines, 117, 226
- Twin cables, 61, 175, 291
- Two-wire networks, insulation tests on, 114, 346

- URMSTON, A.C. bridge test, 301
- application of Werren's method, 289, 301

- VALVES, rectifying, 67, 150, 205
- Varley loop test, 191
- Visual examination of overhead lines, 207, 214
- Volt figure of merit, 30, 242
- Voltmeters, high tension, 63, 135

- WATER resistance, 146, 151
- Weighing method for slide wire loop test, 202
- Werren's method, 289, 349
- Wheatstone bridge, 52, 157, 224
- Wilson's "Woodpecker," 316
- Winding-off method, 326
- Wiped joints, 11
- "Woodpecker," the, 316

**BIRLA INSTITUTE OF TECHNOLOGY & SCIENCE
PILANI (Rajasthan)**

Call No.

Acc. No.

DATE OF RETURN

33172

--	--	--	--

