

Birla Central Library

PILANI (Jaipur State)

(Engg College Branch)

Class No :- 620.13

Book No :- D 146L

Accession No :- 31556

LIMES AND CEMENTS
THEIR NATURE, MANUFACTURE AND USE

LIMES & CEMENTS

*THEIR NATURE, MANUFACTURE
AND USE*

AN ELEMENTARY TREATISE

BY
ERNEST A. DANCASTER

B.Sc. (London), A.I.C.

SECOND EDITION, REVISED AND ENLARGED



LONDON
THE TECHNICAL PRESS LTD.
LATE OF AVE MARIA LANE, LUDGATE HILL
GLOUCESTER ROAD, KINGSTON HILL, SURREY

1920

All rights reserved



PREFACE TO FIRST EDITION

THIS brief account of the nature, manufacture and uses of limes and other calcareous cements is an endeavour to present a useful elementary treatise which, while suited to the needs of the beginner, shall contain as full an account of the subject as is possible, in the limited amount of space available; and, as the author believes, contains very little that the reader will have to unlearn as his knowledge increases. It is, of course, impossible in a volume of this size to give a full account of the details necessary to the specialist, but the bibliography included at the beginning of the work indicates the sources of information available for those who desire to know more.

G. R. Burnell's treatise on "Limes, Cements, Mortars, etc," has formed the basis of the present work. Owing, however, to the enormous developments which have taken place since that book was written, it has been found necessary to rewrite it entirely, and also to make extensive additions. Few industries have expanded with such rapidity as the manufacture of Portland cement, and the importance of this material is likely to increase considerably in the future: the manufacture and chemistry of this cement has, therefore, been treated more fully than that of any other. The analysis, and also the physical and mechanical testing of cement have assumed great importance during recent years, and two chapters have therefore been included on this subject.

Notwithstanding the great developments which have been made during recent years in the manufacture of cements, especially Portland cement, we have still much to learn in this direction. A typical modern Portland cement works bears but little resemblance to one of twenty years ago, and the methods of manufacture and machinery of to-day will be obsolete to-morrow.

Our knowledge of the chemistry of the calcareous cements has increased greatly during the last thirty years, but, although many points have been elucidated, much more remains to be done, and neither the constitution of cement clinker, nor the phenomena of the setting and hardening of cement have been settled.

My best thanks are due to the Engineering Standards Committee for their permission to quote from the "British Standard Specification for Portland Cement (1915)," and for the loan of blocks; also to Messrs. Longmans, Green & Co., Messrs. Baird & Tatlock, Messrs. R. Broadbent & Son, Ltd., Messrs. The Associated Portland Cement Manufacturers (1900), Ltd., Mr. Patrick Adie, and others for the loan of blocks.

ERNEST A. DANCASTER.

WIMBLEDON.

PREFACE TO SECOND EDITION

THE first edition of this book having run out of print, the author has taken the opportunity to make a careful revision before the issue of a second edition. Besides making a few minor corrections and additions, the discussion of the constitution (and also of the setting and hardening) of Portland cement has been brought up to date, and the chapter on the chemical analysis of limes and cements has been revised and extended. A separate chapter has now been allotted to the varieties of Portland cement, and, owing to its increased importance and interest, the new Super cement has been dealt with at greater length than was considered necessary in the first edition.

The author is indebted to Mr. W. J. Cooper, Mr. J. F. Goddard and others for several corrections and suggestions.

E. A. D.

WIMBLEDON.



CONTENTS

	PAGE
PREFACE	v
BIBLIOGRAPHY	xi
CHAPTER	
I. PROGRESS OF DISCOVERY IN THE SCIENCE CONNECTED WITH LIMES, ETC.	1
II. CHEMISTRY AND CLASSIFICATION OF LIMES	10
III. THE COMPOSITION AND ORIGIN OF THE ROCKS WHICH FURNISH DIFFERENT KINDS OF LIME	21
IV. THE CALCINATION OF LIMESTONES	29
V. THE ARTIFICIAL HYDRAULIC LIMES, POZZOLANIC, AND SLAG CEMENTS	45
VI. PORTLAND CEMENT	50
VII. VARIETIES OF PORTLAND CEMENT	94
VIII. THE NATURAL CEMENTS	99
IX. THE PLASTER CEMENTS	108
X. THE SLAKING OF LIMES	120
XI. SANDS, POZZOLANAS AND OTHER MATERIALS USED WITH LIME IN THE PREPARATION OF MORTAR	124
XII. MORTARS	136
XIII. CONCRETE	141
XIV. PLASTERING	148
XV. STUCCOS	153
XVI. WATERPROOFING CEMENT	158
XVII. BITUMINOUS AND OLEAGINOUS CEMENTS.	162
XVIII. THE "SALTPETREING" OF LIMES, CEMENTS, AND PLASTERS	168
XIX. THE CHEMICAL ANALYSIS OF LIMES AND CEMENTS.	173
XX. PHYSICAL AND MECHANICAL TESTS	182
INDEX	197

LIST OF ILLUSTRATIONS

FIG.		PAGE
1.	Intermittent Lime Kiln	35
2.	The Aalborg Lime Kiln	39
3.	The Rüdersdorf Kiln	40
4.	Schmatolla's Kiln	41
5.	Wet Edge-Runner	52
6.	Clarke's Mill	54
7.	Section of Broadbent's Improved Blake Stonebreaker	55
8.	Krupp's Ball-Mill	58
9.	Section of Davidsen Tube-Mill	59
10.	Section of Griffin Mill	60
11.	Dietzsch Kiln	64
12.	General Arrangement of Rotary Kiln Plant with Coal Dryer behind Cooler	68
13.	The Selector	75
14.	Transverse Section of the Dumesnil Kiln	112
15.	Apparatus for Estimation of CO ₂	174
16.	Specific Gravity Bottle	183
17.	The Vicat Needle	186
18.	Le Chatelier Gauge	190
19.	Outline of Standard Briquette	191
20.	The Adie Testing Machine	192
21.	Compression Test Machine made by Messrs. The Asso- ciated Portland Cement Manufacturers (1900), Ltd.	194

BIBLIOGRAPHY

- A. H. HEATH, "A Manual of Lime and Cement." London and New York. 1893.
- U. CUMMINGS, "American Cements." Boston. 1898.
- M. PEDROTTI, "Der Gips und seine Verwendung." Leipzig. 1901.
- A. MOYE, "Der Gyps." Leipzig.
- H. LE CHATELIER, "Recherches experimentals sur la Constitution des Mortiers hydrauliques." Paris. 1904.
- G. R. REDGRAVE and C. SPACKMAN, "Calcareous Cements." London. 1905.
- E. CANDLOT, "Ciments et Chaux hydrauliques." Paris. 1906.
- H. SEGER and E. CRAMER, "Apparate und Gerate zur Prüfung von Portlandzement, Beton und Zementwaren. Berlin. 1908.
- F. GATEHOUSE, "A Handbook for Cement Works Chemists." London. 1908.
- A. C. DAVIS, "Portland Cement." London. 1909.
- C. NASKE, "Die Portlandzement Fabrikation." Leipzig. 1909.
- P. C. H. WEST, "The Modern Manufacture of Portland Cement." London. 1910.
- R. K. MEADE, "Portland Cement." London. 1911.
- C. H. DESCH, "Chemistry and Testing of Cement." London. 1911.
- B. BLOUNT, "Lectures on Cement." London. 1912.
- E. LEDUC and G. CHENU, "Chaux, Ciments et Plâtres." Paris. 1912.
- F. QUIETMEYER, "Zur Geschichte der Erfindung des Portlandzements." Berlin. 1912.
- D. B. BUTLER, "Portland Cement. Its Manufacture, Testing, and Use." London and New York. 1913.
- E. C. ECKEL, "Cements, Limes and Plasters." London and New York. 1913.

- W. A. RICHARDS and H. B. NORTH, "Manual of Cement Testing." London. 1913.
- R. FERRET, "Étude Experimentale du Ciment Armé." Paris. 1906.
- C. F. MARSH and W. DUNN, "Reinforced Concrete." London. 1908.
- G. REVERE, "Le Construzione in Cemento Armato." Milan. 1910.
- W. A. BROWN, "The Portland Cement Industry." London, 1916.
- Berichte der deutschen Chemischen Gesellschaft. Berlin.
Beton und Eisen.
Bulletin de la Société Chimique. Paris.
Cement and Engineering News.
Chemiker-Zeitung.
Concrete and Constructional Engineering.
Concrete—Cement Age.
Engineering News.
Ferro-Concrete.
Gazzetta chimica italiana.
Il Cemento.
Les Annales de Chemie et de Physique.
Les Annales des Mines.
Les Comptes-Rendus des seances de l'Academie des Sciences.
The American Journal of Sciences and Arts.
The Chemical News.
The Journal of the American Chemical Society.
The Journal of the Society of Chemical Industry.
The Transactions of the Chemical Society.
The Transactions of the Faraday Society.
Tonindustrie Zeitung.
Transactions of the Concrete Institute.
Zeitschrift für angewandte Chemie.
Zeitschrift für anorganische Chemie.
Zeitschrift für Chemie und Industrie der Kolloide.

LIMES AND CEMENTS.

CHAPTER I

PROGRESS OF DISCOVERY IN THE SCIENCE CONNECTED WITH LIMES, ETC.

THE use of some cementing material to bind together the smallstones or othersubstances employed in the construction of walls, and also for the purpose of giving them a smooth surface adapted to receive polychromic or other decoration, dates from a very high antiquity. It is, however, probable that it was subsequently to the discovery of the art of brick-making, that the ancients arrived at that of burning lime. Indeed, the use of moistened clay, which was found to have a certain ductility, and to harden also in drying, was likely to have preceded that of lime, as a cement ; for the qualities and the mode of obtaining the latter were of a nature to require long study and great experience.

The Assyrians and Babylonians appear to have employed either moistened clay, or the bitumen so plentifully supplied by the springs in their country. Some doubt, however, exists as to whether these people did ever really use mortar. Captain Mignan sometimes talks of bricks which were cemented together with a coarse layer of lime. "At others," he says, that "between the brickwork at irregular distances a layer of white substance is perceptible, varying from $\frac{1}{4}$ in. to 1 in. in thickness, not unlike burnt gypsum

2 DISCOVERY IN SCIENCE CONNECTED WITH LIMES

or the sulphate of lime. From the peculiarly mollified state of the bricks I apprehend this white powder is nothing more than common earth, which has undergone this change by the influence of the air on the clay composing the bricks.”

The walls of ancient Egyptian buildings were constructed of unburnt bricks dried in the sun, and cemented together by means of a layer of moist clay, with or without chopped straw. Massive works, however, such as the pyramids, were constructed of blocks and slabs of stone set in mortar made of a calcareous cement mixed with sand, and the interiors of some of the pyramids were stuccoed. The nature of the mortar used varied considerably. Thus, the mortar of the great pyramids is composed of impure gypsum containing 81·5 per cent. of calcium sulphate and 9·5 per cent. of calcium carbonate.¹ According to Vicat² true lime mortar appears to have been used at Edfu and other places, but according to Choisy³ the Egyptians employed a mortar made from burnt gypsum, and never used lime. It is possible that the mortar at Edfu was really made from very impure gypsum containing a large percentage of calcium carbonate, and that the Egyptians were unacquainted with the preparation and use of lime.

The Greeks, at a very early period of their civilization, used compositions, of which lime was the base, to cover the walls constructed of unburnt bricks. According to Plinius and Vitruvius, the palace of Croesus, the Mausoleum, and the palace of Attalus were protected, or ornamented, in this manner. According to Strabo, the walls of Tyre were built of stone set with gypsum, a very common material apparently in Asia Minor, and the centre of the old Assyrian civilization. The Greeks were aware that a superior mortar,

¹ W. Wallace, *Chem. News*, 1865, 11, 185.

² L. J. Vicat, *Mortiers et Ciments calcaires*. Paris, 1828.

³ A. Choisy, *L'art de bâtir chez les Egyptiens*. Paris, 1904.

which was capable of resisting the action of fresh or salt water, could be prepared by adding certain finely ground volcanic earths (pozzolana) to the lime and sand.

In Italy, the first people who employed mortar in their buildings were the Etruscans. Gori, in his *Museum Etruscum*, mentions that in the tombs found near their ancient cities, such as Iguvium, Clusium and Volterra, the constructions were made with mortar. Near Volterra also, in 1739, a cistern, entirely built and lined with that material, was discovered. A branch of this nation, known under the name of Tyrrhenians, was considered by the Greeks to have invented, or at least considerably improved, the art of masonry. The most ancient authors, such as Homer, Hesiod, Herodotus, and Thucydides, speak of them under that name, and call their walls by the word "tyrsis," instead of "teichos," the term used by the more modern authors. The word "tyrsis" is supposed to have had the same signification in the Etruscan language; and the towers erected for the purpose of fortification were also called "tyrseis" by the Greeks.

The Romans, as is well known, derived all their knowledge of the arts either from the Etruscans or the Greeks. They added little to the general stock of knowledge as to the use of limes, but Vitruvius is the first author upon the subject whose works have descended to us. The text of this remarkable man's work shows that the ancients, although they adopted a different scientific phraseology from that in fashion in the eighteenth century, knew as much of the laws regulating this branch of chemistry as the moderns of that time. For all practical purposes Vitruvius¹ is as safe a guide as most of the authors who treated the subject subsequently; at least until we arrive at the researches of M. Vicat. Plinius and St. Augustin

¹ Vitruvius, *De Architecturâ*, Book II., Chap. V.

4 DISCOVERY IN SCIENCE CONNECTED WITH LIMES

treat about limes and cements. The Romans perfected the use of lime mortar; like the Greeks, they were in the habit of adding pozzolanic materials to their mortar, and, when the natural volcanic materials were not available, made use of powdered tiles or pottery. The quality of the mortar employed in building gradually deteriorated from Roman times onwards, until the art of lime burning was almost lost. The quality then began to improve, so that by the end of the fourteenth century it was the custom to prepare mortar from well-burnt lime and clean sand. Recent researches have shown that these mediæval mortars contained a greater proportion of lime than is now considered permissible, and there does not appear to have been any systematic method in their preparation. When obtainable, preference was given to an aggregate consisting largely of gravelly sand with clean ferruginous clay; the latter constituent in some cases represents as much as 19·5 per cent. of the aggregate. The nature of the aggregate, however, varied considerably.¹

In 1796, James Parker introduced the first of the natural cements (see p. 99). Portland cement (see p. 50), the most important of all the hydraulic cements, was first made in 1824 by Joseph Aspdin, a bricklayer of Leeds.

On the revival of literature, after the Middle Ages, the authors who treated upon the art of building did little more than follow in the traces of Vitruvius. There was a difference of opinion as to the quality of sand which it was most advisable to use: some new limes, some pozzolanas, trass, and ashes, were employed to give to certain other limes the faculty of setting under water; but until about the middle of the eighteenth century no advance was made towards ascertaining the principles which regulate this branch of chemistry.

¹ W. J. Dibdin, *Trans. Faraday Soc.*, 1919, 14, 31.

It is, indeed, worthy of remark, that the more useful arts appear to be carefully studied until the practical results they are capable of producing are ascertained ; then the rules drawn from such results are received implicitly for a long period, and any attempt to ascertain the laws which regulate them is regarded as useless. We, the human race, appear to attain empirical knowledge quickly ; scientific knowledge arrives at a much later period. So it was with limes, and also with the casting and puddling of iron—a subject of equal, if not greater, interest.

The first serious attempt made to ascertain the causes which gave some limes the power of setting under water, and which modified their rates of hardening, was made by the father of civil engineering in England, John Smeaton, in 1756. Being at that time engaged in the construction of the Eddystone Lighthouse, he found it necessary to have a cement capable of hardening at once in the water ; he therefore began a series of experiments, which are detailed in his account of the building of that work.¹ The results he arrived at were very remarkable, not only for their practical utility, but also as an illustration of the ease with which a very acute observer may stop short on this side of the attainment of a great truth. Smeaton found that the commonly received opinion that the hardest stones gave the best limes, was only true as far as regarded each quality considered by itself. That is to say, that of limes not fit to be used as “ water cements,” those made of the hardest stones were the best for certain uses in the air ; but that whether obtained from the hardest marble, or the softest chalk, such limes were equally useless when employed under water. He found that all the limes which could set under water were obtained from the calcination of such limestones as contained a large portion of clay in their composition.

¹ J. Smeaton, *Narrative of the Building, etc., of the Eddystone Lighthouse*, Book III., Chap. IV.

6 DISCOVERY IN SCIENCE CONNECTED WITH LIMES

His experiments led him to use, for the important work of the lighthouse, a cement compounded of blue lias lime from Watchet, and of pozzolana brought from Civita Vecchia, near Rome. But Smeaton, after giving a table showing that all the water limes were obtained from limestones containing clay in chemical combination, in proportions varying from $\frac{3}{14}$ to $\frac{1}{17}$, goes on to say, "that it remains a curious question, which I must leave to the learned naturalist and chemist, why an intermediate mixture of clay in the composition of limestone of any kind, either hard or soft, should render it capable of setting in water in a manner no pure lime, I have yet seen, from any kind of stone whatsoever, has been capable of doing. It is easy to add clay in any proportion to a pure lime, but it produces no such effect; it is easy to add brick dust, either finely or coarsely powdered, to such lime in any proportion also; but this seems unattended with any other effect than what arises from other bodies become porous and spongy, and therefore absorbent of water as already hinted, and excepting what may reasonably be attributed to the iron particles that red brick-dust may contain. In short, I have as yet found no treatment of pure calcareous lime that rendered it more fit to set in water than it is by nature, except what is to be derived from the admixture of trass, puzzolana and some ferruginous substance of a similar nature."

Smeaton was not alone in attributing the properties of hydraulic limes to the presence of ferruginous substances, as Belidor¹ recommended the addition of carefully cleaned and ground scales from a blacksmith's forge, in order to increase the hydraulic properties of lime.

Although Smeaton's experiments proved that the hydraulic limes owed their power of setting under water to the presence of clayey matter in the limestones from

¹ Belidor, *Architecture hydraulique*, Book I., Vol. II., Chap. IX.

which they were prepared, his results were ignored by most of the chemists of his day, because of the superior chemical authority of Bergman. This celebrated Swedish chemist had previously found manganese in a sample of hydraulic lime, and, therefore, attributed the hydraulic properties of these limes to the presence of salts of this metal.¹ This view was generally accepted by chemists, even Guyton de Morveau² supporting it in spite of the fact that with one exception he failed to find any manganese in the French hydraulic limes which he examined, whilst they all contained clay. De Saussure³ similarly examined the Swiss hydraulic limes and found that they contained clay but no manganese, yet he also, on the authority of Bergman and Guyton de Morveau, declared that the presence of manganese was the principal cause of the hydraulic properties of lime, though he added that clay could, to a certain extent, replace the manganese, but was greatly inferior. In 1813, Collet-Descotils⁴ published the analyses of the limestone of Senonches, and of the lime obtained from it. Both the stone and the lime contain a considerable amount of silica, and Collet-Descotils showed that whilst the silica in the lime was soluble in acids, that in the unburnt limestone was not, thus indicating that the silica had apparently combined with the lime during the calcination. He therefore concluded that the hydraulic properties of the lime were due to the compounds thus produced. Five years later Vicat⁵ published his first memoir on the hydraulic limes, in which he proved conclusively that these owed their power of setting under water entirely to the presence of a suitable quantity of clay in the limestone from which

¹ T. O. Bergman, *Opuscula phys. chem.*, 1779 to 1788, 2, 229.

² L. B. Guyton de Morveau, *Académie de Dijon*, 1785.

³ T. de Saussure, *Voyage dans les Alpes*, 3, 192.

⁴ Collet-Descotils, *Ann. des Mines*, 1813, 34, 308.

⁵ L. J. Vicat, *Recherches expérimentales sur les Chaux de Constructions, les Bétons et mortiers Ordinaires*. Paris, 1818.

they were prepared, and considered that the hardening of the lime was due to the silica of the clay. Since clay consists of silicates of aluminium, this view agrees with those of De Saussure and Collet-Descotils. Vicat¹ also succeeded in preparing artificial hydraulic limes by burning previously prepared mixtures of lime and clay, and, later on, by burning mixtures of chalk and clay (see p. 46).

Berthier² repeated the experiments of Vicat and confirmed their accuracy, and practically the same results were obtained by Dumas, Treussart, Gay Lussac, John, Pasley, Ansted, and most of the other chemists and engineers who investigated this subject. Fremy³ did not agree with Vicat's conclusions as to the rôle played by the calcium silicate, because he found that this substance did not set in contact with water, and he therefore considered calcium aluminate to be the essential agent in the process. This view did not agree with the fact that the best French hydraulic limes only contain 2 per cent. or less of alumina. Later on, however, Fremy found that although calcium silicate did not set in contact with pure water, it would set in the presence of free lime, and he therefore concluded that the calcium silicate reacted with the lime in the manner of a pozzolana. Winkler⁴ suggested that basic silicates are formed during calcination, and that in contact with water these are hydrolyzed into lime and hydrated lower silicates, and this opinion has since been confirmed. Fuchs⁵ has shown that whilst the crystalline forms of silica are inactive

¹ L. J. Vicat, *Résumé des connaissances positives actuelles sur les qualités, les choix et les convenances réciproques des matériaux propres à la fabrication des Mortiers et Ciments Calcaires, etc.* Paris, 1828.

² P. Berthier, *Ann des Mines*, 1822 (1), 8, 483.

³ E. Fremy, *Compt. rend.*, 1865, 60, 993; 1868, 67, 1205.

⁴ A. Winkler, *J. prakt. Chem.*, 1856, 67, 444.

⁵ J. N. Fuchs, *Dingl. polyt. Jour.*, 1883, 49, 271.

the amorphous and hydrated forms behave as pozzolanas, and combine with lime to form hydraulic cements.

The study of the constitution of the hydraulic limes, especially of Portland cement, and of the processes of setting and hardening of these cements, has become of great importance during recent years, following on the pioneer work of Landrin, Le Chatelier, Michaelis and others. These questions are attracting the attention of an ever widening circle of investigators of the greatest ability, and already great advances have been made in our knowledge of these subjects. This recent work is, however, of most importance in the study of Portland cement, and is dealt with on page 81.

CHAPTER II

CHEMISTRY AND CLASSIFICATION OF LIMES

COMMON lime, CaO , is the monoxide of calcium, and, when pure, contains 71.43 per cent. of calcium and 28.57 per cent. of oxygen. Lime does not occur in the free state in nature, the metal calcium always being found combined with acids in the form of salts, such as the carbonate, CaCO_3 , and the sulphate, CaSO_4 . It may be prepared in various ways, but is always obtained commercially by the calcination of the carbonate, by which means the carbon dioxide, CO_2 , is expelled (see p. 29). The reaction takes place according to the equation—



The lime thus obtained is known as *quick lime* or *caustic lime*. As usually obtained, pure quick lime is a white, amorphous substance, but it can also be prepared in the crystalline form. It is strongly basic and combines with acids to form salts. The specific gravity of the amorphous variety is 3.15, and that of the crystalline form is 3.251. The melting point of lime is exceedingly high, above 3000°C ., so that it may be heated to full white heat without fusion, but it facilitates the melting of refractory acid substances such as silica and alumina, combining with them to form salts. Amorphous quick lime readily absorbs water, with which it combines to form the hydroxide, $\text{Ca}(\text{OH})_2$, thus—

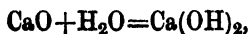

and on this account it is frequently employed as a dehydrating agent. This absorption of water by quick lime is known as *slaking*, and the resulting calcium hydroxide is called *slaked lime*. In the case of a pure lime the combination is effected with the evolution of a considerable amount of heat, and if a little more than the correct amount of water (18 parts by weight of water to 56 parts by weight of quick lime) is used, the lime crumbles to a perfectly dry powder, the excess of water being driven off as steam. In the presence of moisture lime also absorbs carbon dioxide, with which it combines to form the carbonate, so that on exposure to the atmosphere it not only gradually becomes slaked by absorption of the moisture present in the latter, but a portion is converted into the carbonate. Such air-slaked lime has approximately the composition $\text{CaCO}_3 \cdot \text{Ca}(\text{OH})_2$.

Calcium hydroxide is usually obtained in the form of a white amorphous powder, which is much less caustic than quick lime. The specific gravity of the pure amorphous substance is 2.073, and that of the crystalline form is 2.236. It is one of the most stable hydroxides known, and can be kept at 100° C. without decomposition taking place, but when it is heated to between 530° and 540° C. water is liberated and quick lime remains behind.

Quick lime is sparingly soluble in water, and the solubility decreases with increase of temperature. The solution, which is known as *lime water*, is strongly alkaline in reaction, turning red litmus blue. It readily absorbs carbon dioxide with the formation of calcium carbonate, which is precipitated from solution. According to Dalton, water will dissolve $\frac{1}{772}$ of its weight of quick lime at 15.5° C., $\frac{1}{972}$ of its weight at 50° C., and $\frac{1}{1270}$ of its weight at 100° C. The solubility is said to vary according to the state of aggregation, and, therefore, according to the method of preparation, of the lime. Thus, Lamy¹ has investigated the

¹ A. Lamy, *Ann. Chim. Phys.*, 1878 (v.), 14, 145.

12 CHEMISTRY AND CLASSIFICATION OF LIMES

solubility of lime prepared, (a) by heating calcium nitrate, $\text{Ca}(\text{NO}_3)_2$, (b) by heating calcium carbonate, CaCO_3 , and (c) by heating calcium hydroxide, $\text{Ca}(\text{OH})_2$. The number of grammes of lime dissolved per litre of solution in each case is given below.

Temperature. Degs. C.	Grammes of lime per litre of solution.		
	From $\text{Ca}(\text{NO}_3)_2$.	From CaCO_3 .	From $\text{Ca}(\text{OH})_2$.
0	1.362	1.381	1.430
10	1.311	1.342	1.384
15	1.277	1.299	1.348
30	1.142	1.162	1.195
45	0.996	1.005	1.033
60	0.844	0.868	0.885
100	0.562	0.576	0.584

Dalton states that water will dissolve $\frac{1}{384}$ of its weight of slaked lime at 15.5°C ., $\frac{1}{729}$ of its weight at 50°C ., and $\frac{1}{952}$ of its weight at 100°C . The solubility of the hydroxide as found by Maben¹ is given in the table below.

Temperature. Degs. C.	Parts of water required to dissolve 1 part CaO .	Temperature. Degs. C.	Parts of water required to dissolve 1 part CaO .
0	759	55	1104
5	764	60	1136
10	770	65	1208
15	779	70	1235
20	791	75	1313
25	831	80	1362
30	862	85	1388
35	909	90	1579
40	932	95	1650
45	985	99	1650
50	1019		

¹ T. Maben, *Pharm. Journ.*, 1883 (iii.), 14, 505.

According to Lamy¹ the solubility varies according to the method of preparation of the hydroxide. It would, however, be more correct to say the rate of solubility of both the oxide and the hydroxide varies according to the state of aggregation, and, therefore, according to the method of preparation.

If calcium hydroxide be mixed with a small quantity of water it forms a paste, which, on exposure to the air, dries and shrinks to a porous mass of no great hardness. The paste absorbs carbon dioxide from the atmosphere, thus gradually forming a harder crust of calcium carbonate, but this action is superficial in character and does not affect the interior of the mass. When preserved from atmospheric action the hydroxide, whether in the state of dry powder or paste, remains unaltered, even after many years (see p. 121). The *setting* of pure slaked lime depends upon this property of drying to a cake of moderate hardness, and the *hardening* of the material is due to the subsequent absorption of carbon dioxide from the atmosphere. The process of induration is slow and may never be completed, as the external layer of calcium carbonate which is first formed protects the interior from further action. Such a lime is purely an *air lime*, as it cannot set unless exposed to the atmosphere. The limes used for building purposes, however, are made from limestones containing more or less impurities, and the behaviour of the resultant lime depends upon these, especially upon the amount of clayey matter present.

Clay consists of more or less complex silicates of aluminium; during the calcination of a clayey limestone these silicates are decomposed and the silica and alumina combine with the lime to form calcium silicates and aluminates, and perhaps alumino-silicates, whilst the iron oxide also combines with the lime, forming calcium ferrites.

¹ A. Lamy, *Compt. rend.*, 1878, 86, 333.

When a lime containing these constituents is slaked, we not only have the hydration of the calcium oxide to consider, but also that of the calcium silicates and aluminates. The presence of these constituents considerably moderates the violence of the combination of the lime and water, and, if present in sufficient quantity, may cause the lime to become hydrated without perceptible heat and with but little change in volume. The hydrated aluminates and silicates of calcium possess the property of setting and hardening under water (see p. 81), so that if a lime contains these ingredients in sufficient amount it becomes a *water* or *hydraulic* lime. An ideal hydraulic lime clinker should contain just sufficient free lime to completely disintegrate by the force of its own slaking, and should not contain any free silica or alumina. According to Le Chatelier,¹ lime clinker containing four equivalents of lime for one of silica would satisfy these conditions if it could be obtained, but in practice it is found necessary to modify this ideal composition; because, if a limestone of the composition calculated to give these proportions be burnt, it is found that some of the silica remains uncombined leaving an excess of free lime. Moreover, Le Chatelier takes no account of the action of the alumina.

For the purposes of classification we may observe the phenomena which attend the slaking and setting of various samples of lime. A fresh sample is placed in a small basket and immersed in pure water for the space of five or six seconds. The basket is then withdrawn, the excess of water allowed to drain off; and the lime emptied into a stone or iron mortar, or a porcelain dish. The following observations may then be made.

1. The lime hisses, crackles, swells, gives off a large quantity of very hot vapour, and falls into powder instantly; or,

¹ H. Le Chatelier, *Trans. Amer. Inst. Min. Eng.*, 22, 16.

2. The lime remains inert for a period of variable duration, but which does not exceed five or six minutes; after which the phenomena above described declare themselves energetically; or,

3. The lime, again, remains inert for five or six minutes, or the period of its inactivity may extend to a quarter of an hour. It then begins to give off vapour and to crack, without decrepitating to any great extent. The steam formed is less abundant, and the evolution of heat is less than in the two former cases; or,

4. The phenomena only commence about an hour after the immersion of the lime, and sometimes even after a lapse of time still more considerable. The lime cracks, without decrepitation, it gives off little steam or heat; or,

5. The phenomena commence at epochs which are very variable, and in fact hardly perceptible; the heat given off is only distinguishable by the touch; the lime does not fall readily into powder, and at times it does not do so at all.

Before the effervescence has entirely disappeared, the slaking of the lime should be completed. As soon as the cracking and falling to pieces begin, water should be poured into the vessel, not upon the lime, but by the side, so that it may flow freely to the bottom, from whence it would be absorbed by the portions of the lime in a sufficiently advanced state of chemical action to require it. The mass should be frequently stirred, and sufficient water should be added, taking care not to flood the lime, but merely to bring it to the consistence of a thick paste.

Thus prepared, the lime should be left to itself until all the inert particles have had time to complete their action. The end of this is announced by the cooling of the mass, and it may last from two to three hours, or sometimes even more.

The lime should then be beaten up again, and water added, if necessary, until a paste be obtained as firm as

possible, but at the same time preserving a certain degree of ductility. Its consistence should be equal to that of clay ready to be worked into pottery. A vessel should then be taken and well filled with this paste; it should be marked and immersed in water, taking note of the day and hour of the immersion.

Careful observations made upon the limes thus treated show that they may be divided into the five following classes, characterized by the phenomena before described: namely, 1, the rich or fat limes; 2, the poor or lean limes; 3, the moderately hydraulic limes; 4, the hydraulic limes; and, 5, the eminently hydraulic limes.

Smeaton used the term *water lime* instead of *hydraulic*; this practice was followed by most of the earlier English engineers, and is still used to some extent. The two terms are synonymous, but the modern English custom is to use the term *hydraulic*, and this has long been the usage throughout the Continent.

1. The *rich* or *fat* limes are the purest limes obtained, and are prepared from the purest forms of calcium carbonate, *e.g.* white marble, white chalk, pure limestones, oyster shells and so forth. They slake rapidly with a considerable evolution of heat, and yield a large amount of powder, sometimes augmenting in volume to more than twice their original bulk. If employed without any admixture of foreign substances, their consistency even after many years' immersion is the same as on the first day. When quite pure they are completely soluble in a sufficient quantity of water, so that if exposed to pure water, frequently renewed, the whole of the lime will be dissolved.

2. The *poor* or *lean* limes slake slowly with little evolution of heat, and yield a comparatively small volume of powder, the increase in volume being very small, if any. They do not harden under water any more than the rich limes, and therefore must be distinguished from the

hydraulic limes, which also slake slowly and with little increase in volume, but which set under water. When repeatedly treated with fresh quantities of pure water a residue of insoluble matter is always left behind. Poor limes either contain insufficient clay to be hydraulic, or they may be "overburnt" or "underburnt."

3. The moderately hydraulic limes set under water after from fifteen to twenty days' immersion, and continue to harden for some time afterwards; but the progress of their hardening diminishes after the sixth or eighth month; after a year their consistence is equal to that of dry soap. They dissolve, but with difficulty, in frequently renewed pure water. The change of bulk they undergo in slaking is the same as that of the poor limes, but never equal to that of the richer varieties.

4. The hydraulic limes set after from six to eight days' immersion, and continue to harden; the progress of this solidification may extend to twelve months, although the greater part of it is completed by the end of the first six. At this last epoch the lime is already of the consistence of the softer building stones, and the water in which it is immersed is no longer able to dissolve it, even when renewed. Its change in bulk whilst slaking is about the same as that of the poor limes.

5. The eminently hydraulic limes set within the third or fourth day of their immersion, or even sooner. After a month they are already quite hard, and capable of resisting the solvent action of running water. At the end of six months they are capable of being worked like the harder natural limestones, and present a fracture closely resembling that of the latter. Their change in bulk is invariably as small as that of the poor limes.

It must be remembered that this classification is only approximate. The different classes of lime are not sharply differentiated, but gradually merge into each other, so that

there are limes of all degrees of richness between the typically rich and typically poor varieties, and limes of all degrees of hydraulicity between common lime and eminently hydraulic lime. It must, therefore, frequently happen that a particular sample of lime cannot be satisfactorily placed in any of the above divisions.

It is to be observed that all the qualities of lime, except absolutely pure lime, whether rich, poor, or hydraulic, in any degree, assume indifferently every kind of colour. They may be either white, grey, yellow, buff, or red, without any corresponding change in their quality, as far at least as our present knowledge of the art of lime-burning will allow us to assert with any degree of certainty. We shall have occasion to revert to this question of the colour of limes when we treat of their calcination in a subsequent chapter.

Some of the French eminently hydraulic limes are of an exceptional type. The silica in the limestones from which they are made exists in such a finely divided and soluble form that it combines with the lime on burning, although the amount of alumina present seldom exceeds two per cent., and is generally less than this. One of the best limes of this class is the famous *chaux de Theil*, which is made from a limestone found at Ardrèche, on the Rhone. This lime contains about 65 to 75 per cent. of calcium oxide, 20 per cent. of silica, 2 per cent. of alumina, and small quantities of magnesia, ferric oxide and other impurities. It has been largely used by French engineers, especially for marine work, such as the harbours of Port Said and Suez.

In France, hydraulic limes are slaked and then sieved at the lime works. The hard lumps (*grapiers*) which are left on the sieves consist partly of unchanged limestone, and partly of calcium silicates, and therefore, when ground possess more or less value as a cementing material, according to the proportions in which the two kinds of material exist in the original lumps, the unchanged stone being of

course useless. These lumps are collected and finely ground, the resultant cement being known as *ciment grapier* in France and as *grappier cement* in England and America. One of the best known of these cements is that called *La Farge cement*, which is largely used in the United States as a "non-staining cement."

As a result of calcining some lumps of chalk in a common fireplace, Captain (afterwards General) Scott found that the lime thus obtained would not slake in the usual manner in water, although it was shown to have been properly burned. It was afterwards found that the peculiar properties of the lime thus obtained were due to the presence of small amounts of calcium sulphate, which were produced by the action of the sulphur in the fuel. He subsequently prepared this material under the name of "*selenitic cement*" by calcining lumps of feebly hydraulic lime in an oven with a perforated floor, beneath which were pots containing sulphur. The heat of the furnace ignited the sulphur, and the sulphur dioxide, SO_2 , thus formed, combined with a portion of the hot lime, forming calcium sulphite, CaSO_3 , which soon became oxidized to calcium sulphate, CaSO_4 . The lumps were then ground so that the sulphate became evenly distributed throughout the mass. Later on, General Scott obtained the same result by adding either powdered plaster of Paris (see p. 111) or gypsum (see p. 108) to the ground lime and also by adding sulphuric acid or soluble sulphates to the water used when mixing the lime in order to prepare mortar. He finally prepared the cement by adding 5 per cent. of ground plaster of Paris to calcined lime, and finely grinding the mixture. The feebly hydraulic limes are the best to use for the preparation of this cement, although eminently hydraulic limes are improved by the same treatment. Pure limes are not affected by sulphates, and therefore cannot be employed. According to Schott ¹

¹ F. Schott, *Dingl. Polyt. Journ.*, 1873, 159, 30.

the slow hydration of the cement prepared by this process is due to the deposition of the calcium sulphate in solution upon the particles of lime, thus retarding the access of water to the latter.

Selenitic cement has a warm buff colour, sets rapidly and soon becomes hard. It is an improvement on ordinary hydraulic lime, but its use has not become general, partly because it is unsuitable for work which is exposed to the weather or to the action of salt water, but especially because of the superior qualities of Portland cement (see p. 50). It is also known as *Scott's cement*.

In addition to its use in mortars, concrete, plaster and stucco for building purposes, lime is used in the manufacture of "sand-lime" bricks, for softening water, and for many agricultural purposes; it is also used in the manufacture of bleaching powder, in the preparation of lyes, in the defecation of sugar, in the purification of coal gas, for the production of limelight, and in medicine.

CHAPTER III

THE COMPOSITION AND ORIGIN OF THE ROCKS WHICH FURNISH DIFFERENT KINDS OF LIME

THE limes are obtained by the calcination of naturally occurring forms of calcium carbonate, CaCO_3 , of which there are many varieties, such as marble, limestone and chalk. The white variety of *marble* consists of almost pure calcium carbonate, but it is too expensive to use for the preparation of lime, except when the latter is required to be very pure, and the lime obtained from it is too rich to use for building purposes, unless mixed with burnt clayey matter (see p. 45). The different kinds of *limestone* and *chalk* are, therefore, used as raw materials from which to prepare lime. Oyster shells are also employed in some countries where they are sufficiently common, *e.g.* the waste shells from the oyster canning industry at Baltimore and other places. The lime obtained from these shells is, however, too rich to use for building purposes unless, like that from white marble, it be mixed with burnt clayey matter. In India an impure form of calcium carbonate known as *kunkur* or *kankar* is found in the form of concretionary masses, from the size of a bean to blocks weighing hundreds of pounds, imbedded in the alluvial soil of the plains and is used as a source of lime (see p. 151).

The limestones are fragmental sedimentary rocks, *i.e.* they have been formed by the deposition of fragmentary

22 ROCKS WHICH FURNISH DIFFERENT KINDS OF LIME

materials which have previously existed in another form. By far the larger number are of organic origin, having been produced by the accumulation at the sea-bottom of the calcareous remains of foraminifera and other organisms, and they frequently contain fossils. In many cases, however, a part of the calcium carbonate may have been chemically deposited from solution, and some forms of limestone, such as *tufa* or *calc-sinter* and *travertine*, are not of organic origin at all, but have been deposited by calcareous springs. In some cases, also, all trace of the organic origin of the rock has been subsequently destroyed, as in the case of *marble*, which has become more or less crystalline as a result of the action of heat and pressure. The limestones vary considerably in colour, texture and composition. They consist essentially of calcium carbonate, but usually contain more or less magnesium carbonate, oxides of iron, silica, alumina and other impurities, and they are also found with a mechanical admixture of clay, sand, and other substances. Rocks containing less than 50 per cent. of calcium carbonate are not usually regarded as limestones, but as calcareous varieties of clay, sandstone, shale or other rock.

Special names are given to those varieties of limestone which contain considerable amounts of non-calcareous matter of a distinct character. Thus, we have siliceous, argillaceous, magnesian, sandy, ferruginous, bituminous, fetid and other limestones. Other varieties such as oolitic, sacchroid, granular and compact limestones, receive their names on account of their characteristic forms and textures ; whilst others are named according to the geological system or formation in which they occur, as Carboniferous and Lias limestones. Those limestones in which the *débris* of crinoids, corals or shells form the most conspicuous ingredient are known respectively as crinoidal, coral and shelly limestones. Chalk is a less massive variety of limestone formed

of the calcareous remains of foraminifera and other microscopic organisms.

This nomenclature is important; for every description of limestone yields a lime of different quality, distinct in colour and weight, in its avidity for water, and especially in the degree of hardness it is capable of assuming when made into mortar. But the physical and mechanical nature of a stone are far from being certain guides as to the quality of the lime it can yield. A chemical analysis of a hand sample also frequently gives different results from those obtained in practice. Experience alone should be the final guide of the engineer or of the builder.

Limestones occur in nearly all the geological formations. They are comparatively scarce in the deposits of the primary or Palæozoic period until we come to the Carboniferous and Permian systems, when they become common; mountain limestone being found in the first, and magnesian limestone in the second. The calcareous rocks of the Palæozoic period furnish the greater number of stones which are worked under the name of "marbles." The limestones become much more plentiful in the formations of Secondary or Mesozoic period, especially in those of the Jurassic and Cretaceous systems, of which they constitute the greater part, at any rate in the British Islands. They are also common in the Tertiary or Cainozoic period; partly in the form of massive rocks, such as the nummulitic limestone, which attains a thickness of several thousand feet, and partly as limestone gravels, marls, etc. So far as this country is concerned the Cainozoic rocks are chiefly represented by clays and sands, but some of the clays contain septaria nodules consisting of argillaceous limestone (see p. 99). Many of the limestones of the Mesozoic and Cainozoic periods contain the mixtures of clay and other siliceous matter which render them the most adapted to furnish hydraulic limes and cements.

24 ROCKS WHICH FURNISH DIFFERENT KINDS OF LIME

Some of the limestones found in the Silurian and Devonian systems, such as the Wenlock, Woolhope and Petherwin limestones, yield fairly good limes.

Carboniferous, or *mountain limestone* is very widely distributed. It constitutes a large portion of the ranges of hills in the north and west of England and is also found in Wales, Scotland, Ireland and the Isle of Man. Generally speaking, this stone produces a lime which is suitable for air-mortar, but sometimes it contains sufficient silica and alumina to produce a hydraulic lime. Many of the beds are highly fossiliferous, and these are less suitable for the manufacture of lime (see p. 27).

Geologically, the limestones of the Permian formations are known as *magnesian limestone*, whether they contain much or little—or indeed no—magnesium carbonate, because the typical stones of these formations do contain this substance. From the point of view of the lime or cement manufacturer, however, the name should be confined to those stones which contain at least 20 per cent. of magnesium carbonate. These limestones are widely distributed, and, in this country, are common in the Midland and Yorkshire districts. When magnesian limestone contains 5 per cent. or more of magnesium carbonate it is known as *dolomitic limestone*, and when it contains 23 per cent., or more, it is called *dolomite* or *magnesian limestone*; typical dolomite, $\text{CaCO}_3 \cdot \text{MgCO}_3$, contains 45.66 per cent. of magnesium carbonate. Limestones which contain much magnesium carbonate are not suitable for the manufacture of lime, except for special purposes, such as for the basic lining of some furnaces. During calcination the magnesium carbonate is converted into magnesia, MgO , in the same manner as calcium carbonate is converted into lime,



The magnesia thus obtained slakes and hardens in water,

but as it absorbs water much more slowly than does lime, the material obtained from a limestone containing much magnesium carbonate does not slake evenly, and is liable to disruption after setting. Magnesian limestones containing a small percentage of magnesium carbonate and a sufficient amount of silica and alumina may be used for the manufacture of hydraulic lime, but unless they are burned at a high temperature the lime will be devoid of hydraulic properties. Magnesia is used in the manufacture of *magnesia bricks* for furnace linings.

The Lias formations of the Jurassic system contain thin beds of limestone separated by seams of clay. Such beds occur in many localities spreading over an area extending from the south coast of Dorset to Lincolnshire, and, in small patches, in other parts of the country. Owing to the presence of ferrous oxide the colour of the stone is generally blue when freshly fractured, hence it is called *blue lias limestone*, and the lime produced from it is known as *blue lias lime*. The composition of the stone is very variable, every bed containing a different proportion of silica and alumina, so that the quality of the lime produced will also be variable. Even at the base of the series the differences that occur are as great as between about 8 per cent. of aluminium silicate and 90 per cent. of calcium carbonate, and 64 per cent. of the former ingredient to 34 per cent. of the latter. The first of these stones would yield a moderately hydraulic lime, whilst the latter would yield an energetic cement, if burnt and ground. The high reputation of these limes has been established chiefly upon the results obtained from the middle beds of the series, which usually contain from 16 to 20 per cent. of aluminium silicate. The best descriptions of blue lias lime are obtained from Warwickshire, Leicestershire, Dorsetshire and the neighbourhood of Bath, Rugby, etc. The lias limes of South Wales are known as *Aberthaw lime*. The lime from Watchet, which was used by Smeaton

in the construction of his lighthouse on the Eddystone rock is a well-known lime of this class. Most blue lias limes can be slaked in the usual manner, but require several days for this purpose; some, however, approach Portland cement in composition and require to be ground because there is no, or at any rate insufficient, free lime to bring about the disintegration of the clinker. In any case it is safer to grind the clinker and expose the ground material to the air for two or three weeks before using.

The *oolitic limestones* of the Jurassic system are sometimes found in thick beds from which valuable building stones are obtained, but these beds do not produce a good cementing material when burnt. There are, however, also beds of oolitic limestone intercalated between the marls of the Kimmeridge and Oxford clays, and these are capable, when burnt, of furnishing good hydraulic limes. The beds are very variable in composition, so that it is necessary to test the stone before use. Nodules of argillaceous limestone belonging to these formations are also found in various parts of the country, and are used in the manufacture of natural cements (see p. 100).

The Cretaceous system is so named because its formations met with in England (and France) consist to a large extent of chalk (*creta*, chalk). The chalk formations occur in many localities, extending from the Isle of Wight across the southern and eastern counties of England. The North and South Downs and the Yorkshire Wolds are composed of this material. The lowest chalk formation is the *chalk marl*. This is very impure and contains variable amounts of clay, silica, oxide of iron, etc. The lime produced from chalk marl is sometimes known as *clunch lime*. It is of uncertain quality and is liable to shrink in setting owing to an excess of clayey matter. Chalk marl is used in the manufacture of Portland cement. The *lower* or *grey chalk* occurs between the chalk marl and the upper or white

chalk. It is less pure than the latter and may contain from 5 to 15 per cent. of silica, alumina and iron oxide. Owing to the presence of these impurities it is liable to be overburnt unless due care be exercised during calcination. The lime produced from the grey chalk is often called *stone lime* or *flare lime*, the latter name being derived from the manner of burning (see p. 35). In the south of England, and especially in the London district, it is also named after the district from which it is obtained, as Dorking lime, Halling lime, Grey stone Medway, etc. These limes slake with much less vigour than those obtained from the white chalk, and the increase in volume is not so great.

The *upper* or *white chalk* is abundant in the southern and eastern counties of England. It is one of the purest of the common forms of calcium carbonate, but usually contains from 1 to 6 per cent. of clay, sand, magnesia, oxide of iron and other impurities. The lime produced from this stone is a "fat" or "rich" lime, and for building purposes it is only suitable for the preparation of air-mortar. The chalk is used in the manufacture of Portland cement.

An important practical observation is to be made respecting the results of the calcination of the different limestones. It is, that those, in which the silica is insufficient to convert the caustic lime into calcium silicate, are liable to swell in setting, and therefore, are likely to dislocate the masonry executed with them. Those in which the alumina is in excess are liable to shrink and crack, and to crumble away on exposure to the weather. The limes obtained from the Oxford clay generally swell, those from the chalk marl contract.

Another observation is, that many limestones which are highly fossiliferous are liable to produce limes of uncertain quality which slake unevenly, or which retain their avidity for water to a later period, and in either case they swell and disintegrate the mass around them. The

28 ROCKS WHICH FURNISH DIFFERENT KINDS OF LIME

properties of lime obtained from fossiliferous limestone are due to the presence of calcium phosphate, of which the fossils are largely composed.

Pure limestones, or chalks, containing not more than 6 per cent. of silica, alumina and other impurities, yield rich limes; whilst those containing from 15 to 30 per cent. of impurities other than clayey matter, yield poor limes.

Clayey limestones containing from 4 to 7 per cent. of combined silica yield moderately hydraulic limes, those containing from 8 to 10 per cent. of combined silica yield hydraulic limes, and those containing from 11 to 25 per cent. of combined silica yield eminently hydraulic limes. It must not be forgotten that some limestones contain free silica in a soluble form (see p. 18).

The mode of analysis recommended by Berthier to ascertain whether a stone be, or be not, fit to be burnt for the purpose of obtaining a hydraulic lime, is as follows:—

“The stone should be powdered, and passed through a silk sieve; ten grammes of this dust are to be put into a capsule, and by degrees diluted muriatic [hydrochloric] acid is to be poured upon it, stirring it up continually with a glass or wooden rod; when the effervescence ceases, no more acid is to be added. The dissolution is then to be evaporated by a gentle heat until it is reduced to the state of a paste; it is then to be mixed with half a litre of water, and filtered; the clay will remain upon the filter. This substance is to be dried and weighed; the desiccation being made as perfect as possible. Lime water is then to be added to the remaining solution as long as any precipitation takes place from it. This precipitate must be collected as quickly as possible upon a filter; it is then desiccated and weighed. It is magnesia, often combined with iron and manganese.” For all practical purposes the above mode of analysis is sufficiently accurate, and is sufficient to indicate all the details necessary to be known.

CHAPTER IV

THE CALCINATION OF LIMESTONES

THE calcination of limestones is a comparatively simple process, as it is only necessary to observe certain simple and easily obtainable conditions. The raw material must be heated to a temperature of not less than 812° C., nor more than 1100° C., in order to expel the carbon dioxide (see p. 10), and the water with which the stone is mechanically mixed. In practice the temperature is maintained at about 1000° C. The temperature must be steadily maintained until all the gas has been driven off, and the products of decomposition must be removed, as otherwise the decomposed carbonate may recombine with the carbon dioxide, thus forming an imperfectly burnt lime; indeed calcium carbonate can be fused without decomposition in an atmosphere of carbon dioxide, yielding a crystalline, marble-like mass. The removal of the gas is effected by means of the natural draught of the kiln. In this country the carbon dioxide produced during lime-burning is usually wasted, although it is a valuable by-product, and is utilised in condensing plants in Germany and the United States.

In general, the time necessary for the complete expulsion of the gas is proportional to the size, density, and dryness of the stone. The interior parts of large pieces of limestone can only receive the heat through an envelope of feebly

conducting power ; and, moreover, the carbon dioxide has a certain pressure to overcome, in this case, before it can escape.

In practice, whenever the nature of the limestone is such as to render its being broken into small fragments too expensive an operation, the lime-burners place the largest blocks in the centre, and in the positions where they are exposed to the greatest heat. Generally speaking, the temperature to be produced in a kiln is also, from the size of the stones, much greater than is necessary for the decomposition. It is, in fact, a question of economy, whether the saving of the fuel compensates for the expense of breaking the stones into very small pieces.

The action of the water may be explained as follows. There is no chemical action involved in the process, but at the temperature of the kiln, the water is converted into steam, and this not only drives a portion of the carbon dioxide that has already been liberated out of the kiln, but dilutes the remaining portion, reducing its partial pressure, and thus facilitating the decomposition of the remaining stone. The introduction of a current of air, or other gas of comparatively low density, at a high temperature would act in the same manner, but the desired result is most conveniently obtained by means of water vapour. The action of water vapour is so well known to the lime-burners that they are in the habit of watering the stone, if they are prevented from using it fresh from the quarry, and in some works it is the practice to inject water or steam into the kilns.

When clayey limestones are calcined, the expulsion of the carbon dioxide is facilitated by the affinity of the silica and alumina for the lime, and also by the atmosphere of steam produced by the water liberated from the hydrated aluminium silicates. So far as this part of the process is concerned, such limestones are, therefore, burnt more

readily than the purer carbonates. On continuing the calcination, however, the "nascent" silica and alumina combine with a part of the lime to form calcium silicates and aluminates, and the ferric oxide also combines with it to form calcium ferrites. These hydraulic limestones, therefore, require to be calcined at a higher temperature than the common limestones, in order to bring about this combination of the silica and alumina with the lime, and they also require greater care and attention during the process because they are more liable to fuse, especially when they contain a comparatively large proportion of iron oxide and alkalis.

General Treussart, in his observations upon the burning of lime, says, "that all the limestones upon which he operated, when of a blue colour, became of an ochreous yellow if burnt in a slight degree. Upon augmenting the degree of heat, the colour passed successively to a deep yellow, to an ash-grey, and at last to a slate-coloured blue, when the heat was very intense." The mode in which he accounts for this blue colour is, by supposing that the iron has been reconverted into the state of a protoxide. Similar facts occur in brick burning, when the clay employed contains much oxide of iron, and is of a very dark colour. In both cases, however, the colour obtained depends upon the nature of the atmosphere inside the kiln, rather than upon the temperature of calcination. General Treussart appears inclined to differ from Vicat upon the question as to whether the colour of a lime may be taken as an approximate indication of its quality. According to the former, the best hydraulic limes, when properly burnt, are of a light straw colour. It is much to be desired that some such easy mode of at once distinguishing the degree of calcination were ascertained, for the qualities of the lime are very seriously affected by the heat it has been exposed to.

The importance of so determining the proper point at

which to stop the calcination becomes more evident when we consider that some of the hydraulic limes, if over-burnt, lose all their useful properties, and are, to use the workman's phrase, killed: if under-burnt, they are often poor, without any hydraulic powers. The purer limestones, or those which yield rich limes, present other phenomena. For instance, if white chalk be burnt in such a manner as to drive off all the carbon dioxide it contains, it yields a lime whose hydrate never solidifies under water, as we have already seen. If the calcination be stopped at a point below that necessary for the expulsion of the gas, the lime produced does not change in bulk by slaking, and it will be found to set under water almost as rapidly as the moderately hydraulic limes. If over-burnt, the resulting chalk-lime requires a much longer time in order to slake. This loss of reactivity appears to be due to the shrinkage, and consequent reduction of surface, of the overheated lime. A lump of fused pure lime hydrates so slowly that no appreciable rise in temperature is observable, but if the lump is finely powdered (*i.e.* if the surface is increased) before mixing with the water, a very vigorous reaction takes place after a few moments.

No invariable rule can be laid down as to the description of fuel to be employed. In our own country, so far as non-gaseous fuel is concerned, the choice is practically limited to two sorts, coal or coke; and the only reason we can have to decide our preference must be based upon motives of economy. In some countries, Germany, Holland, the French Flanders, etc., peat is used very successfully when the kilns are constructed for the use of this combustible. In new countries, where wood abounds, it is largely used for lime-burning; but the kilns are, in such cases, made with hearths upon which the wood is burnt separately from the limestone; for wood is not well adapted to what are called running kilns. The

same objection also applies to the use of fresh coal; it often cakes, and runs; thus not only impeding the calcination, but also giving rise to great impurities in the lime. If any use of the produce of the distillation of the coal can be made, there is then an evident advantage in the employment of coke, for the gases which the latter gives off during combustion, arrive at once at their highest degree of temperature; whilst, with those from the coal in its natural state, the combustion is continued far beyond the surfaces of contact, and the temperature only arrives at its maximum at the end of this combustion. The quantity of smoke that escapes from the mouth of a kiln where coal is burnt, may be taken as an indication and a proof of the fuel wasted. But, as was said before, the determining motive in the choice of combustible must be found in local considerations of economy.

The nature of the fuel employed may, however, have a serious influence upon the quality of the lime produced. If the fuel contain much sulphur the latter will be oxidised into the gas sulphur dioxide, SO_2 , which will then combine with a portion of the lime with the formation of calcium sulphite CaSO_3 , which is finally oxidised to calcium sulphate, CaSO_4 . As calcium sulphate sets much more rapidly than calcium carbonate, and with a different crystallization, lime containing this material does not assume the same degree of hardness which a more homogeneous material would do. Moreover, calcium sulphate decomposes when exposed to the open air or to fresh or salt water, so that if present in any considerable quantity it will cause the disintegration of any masonry into the execution of which it enters.

Gaseous fuel is used in some modern types of lime kiln, producer-gas being employed for the purpose.

Limestone is sometimes burnt in stacks in the open air, the stone and fuel being arranged in alternate layers,

similar to the mode of burning bricks in clamps. The same care is required as with the latter, in well coating the sides with clay, so as to retain the heat as much as possible; and the heaps require the same attention to secure an equality of draught, so that the whole mass may be burnt alike. This method can, however, only be employed in the coal districts of any country, for the waste of fuel by the radiation of heat is enormous.

At the present time lime-burning is almost invariably carried out in kilns. The forms of kiln employed are very numerous, but they may be classified under two heads. *Intermittent kilns*, in which the calcined charge is withdrawn when it is cold and the kiln restarted with a fresh charge, and *continuous or draw kilns*, in which the raw material is fed in at the top and the lime is removed at the bottom, so that the process is continuous. Continuous kilns are sub-divided into two classes, *stationary or vertical kilns*, which may be of the mixed feed (*running*) or of the separate feed type, and *rotary kilns*, in which the calcination is carried out in a rotating iron cylinder. Kilns in the form of rectangular prisms are used in some parts of the continent for the purpose of burning at the same time both lime and bricks or tiles. The limestone occupies the lower half; the upper part is filled with the bricks or the tiles placed on edge.

The simplest form of intermittent kiln is built of the limestone itself, as shown in Fig. 1, but kilns of this type are often constructed of brick or stone work, the inside being generally lined with fire-bricks set in fire clay for a thickness of from 14 to 18 inches. The thickness of the external wall should be sufficiently great to retain the greatest quantity of heat. These kilns are usually either cylindrical with a truncated conical chimney, or they consist of two truncated cones placed base to base. The height of the kiln should be twice the largest diameter,

the mouth of the chimney should be one-third the largest diameter, and the opening for the fire should be about one-quarter of the same dimension. Roughly constructed cylindrical intermittent kilns without a conical chimney are sometimes used where large quantities of lime are required within a short space of time; they are easily built and cheap, but are not of long duration.

When kilns of the intermittent type are employed the fuel may be mixed with the raw material, or the two

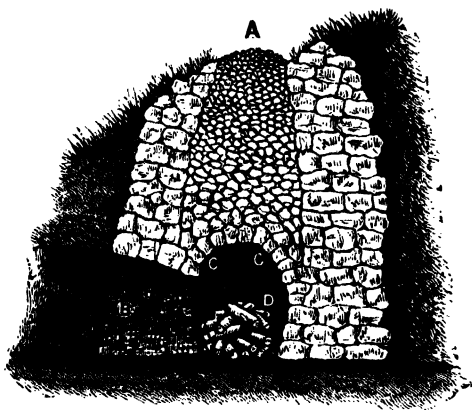

FIG. 1.—Intermittent Kiln.

may be kept separate, the latter being by far the most usual practice. Those kilns in which the limestone is kept separate from the fuel are known as *flare kilns*, and the lime obtained from them is called *flare-lime*. The charge of limestone or chalk rests upon one or more roughly built arches, constructed of the larger pieces of the raw material. A small fire is lighted below these arches, and quite at the back; this is gradually increased towards the mouth as the draught increases. The opening is then regulated to secure the proper degree

of combustion, and fresh fuel is added to maintain it to that point. The air, which enters by the fire door, carries the flame to all the parts of the arch, and gradually brings the whole mass of the limestone into a state of incandescence. It is to be observed, that some stones are exposed to the inconvenience of cracking and of bursting with a loud explosion, by the application of heat. It is dangerous to use them in the construction of the arches; care must therefore be taken only to employ such as are exempt from this inconvenience.

When the upper part of the kiln is of a smaller dimension than the lower, it often happens that the current of heated air, being impeded in its escape, returns, and drives the flame through the fire door. It is advisable, therefore, for this and for several other reasons connected with the draught of the kilns, to make the upper part in such a manner as to allow of the openings being enlarged or contracted, as the case may require. In some places the lime-burners, in filling the charge, introduce pieces of wood, placed vertically, in order to facilitate the circulation of the air and heat. These pieces are burnt at an early stage of the process, and they leave spaces which act as chimneys. It admits, however, of question, whether the circulation, being so much more active in these parts, does not produce an unequal calcination.

The length of time necessary for the perfect calcination can only be ascertained by experience. It depends not only upon the nature of the stone, and the quality of the fuel, but also upon the draught of the kiln, the state of the atmosphere, and the direction of the wind. Before the operation is completed in the lower portion, a gradual subsidence of the mass takes place; the stones which form the arches crack, the interstices diminish, and at length the charge sinks about one-sixth or one-fifth of

its height. A very simple and effectual way of ascertaining whether the calcination is complete, is to drive a bar into the body of the charge. If it meets with a considerable resistance, or strikes against the firm hard materials, it is a proof that the burning is not finished. But if, on the contrary, it penetrates easily, and only meets with a resistance similar to that which it would encounter in passing through a mass of gravel, the calcination may be regarded as complete. Another method of ascertaining whether this is really effected, consists in drawing a sample of the lime, upon which a direct essay is made; but this is liable to error, according to the position the piece may have occupied in the kiln. The combustion is continued on an average for three days and three nights; but of course the duration must vary according to the circumstances of each particular case. They usually require about 60 cubic feet of oak timber; 117 cubic feet of fir; about the same quantity of peat of the best quality; or 9 cubic feet of coal; to produce about 35 cubic feet of lime.

Vertical continuous kilns are much taller than those just described, the height being usually from three to five times that of the diameter. When the raw material and fuel are mixed in alternate layers these kilns are known as *running kilns*. They are somewhat more difficult to manage with certainty than are the intermittent kilns, but when established under favourable conditions they are more economical as they do not consume on an average more than 7 cubic feet of coal to produce 35 cubic feet of lime. A mere change in the direction of the wind, a falling in of the inner parts of the kiln, an irregularity in the size of the pieces of limestone, are any of them causes sufficient to retard or accelerate the draught (by producing irregular movements in the descent of the materials), and thus give rise to either excessive or defective calcination. At times,

a kiln will act perfectly for several weeks, then all of a sudden it will get out of order without any apparent reason. A mere change in the nature of the combustible will often produce so great a difference in the action as to defy all the calculations of the lime-burner. In fact, the use of running kilns is essentially a matter of practice.

The most favourable conditions to ensure a successful result from this mode of burning seem to be, that the thickness of the charge of limestone does not exceed from 1 foot to 14 inches; that the charge does not pass the top of the kiln; and that the fuel is well and equally distributed throughout the mass. The man charged with the direction of the operation must carefully watch the upper part of the furnace and open fresh currents of air in the places where the gases in combustion do not pass. These may be ascertained by observing whether the stones are blackened by the smoke escaping through the top, for that evidently can only take place in the direction of the escape of the gases. Wherever, therefore, the stones remain unblackened, the kilnsman must pass a bar through them to open a new chimney.

The lime, whose calcination is complete, must be withdrawn with precaution, because a precipitate fall of the upper mass might derange the coal between the joints, and thus some of the layers might have an excess of coal, whilst others would be entirely without any. The upper parts of the charge must be well arranged after each withdrawal from the lower, the large unburnt pieces being thrown towards the centre, and proper currents of air formed through them. Generally speaking, the lime is extracted every morning and evening; on Sundays and holidays, precautions must be taken to render the action of the fire less rapid. It is usual to light the fire in this description of kiln as soon as the third course of limestone and combustible is filled in, in order to avoid the serious

inconvenience of being obliged to empty the kiln, should the mass not get well into combustion.

Special forms of running kiln are also used. The *Aalborg lime kiln*, which is a modification of the Portland cement kiln of the same name, is shown in section in Fig. 2. The raw material is fed in through the charging door, *A*,

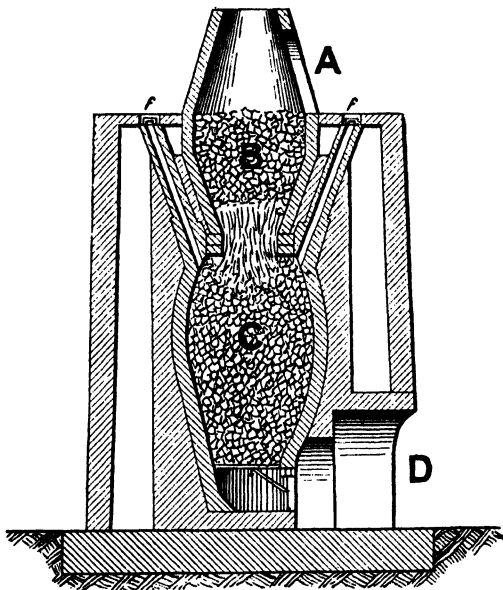

FIG. 2.— The Aalborg Lime Kiln.

and, as it descends through the *preheating zone*, *B*, is heated and partly decarbonated by the hot gases arising from the lower part of the kiln. It then enters the constricted *burning zone*, where it becomes mixed with the fuel charged in through the shoots, *f, f*, which are closed by iron covers when not in use, and the decomposition of the stone is completed. Continuing its descent the burnt material reaches

the *cooling zone*, *C*, which not only serves to cool the lime, but heats the air supply required for the combustion of the fuel, thus adding to the efficiency of the kiln. The cooled

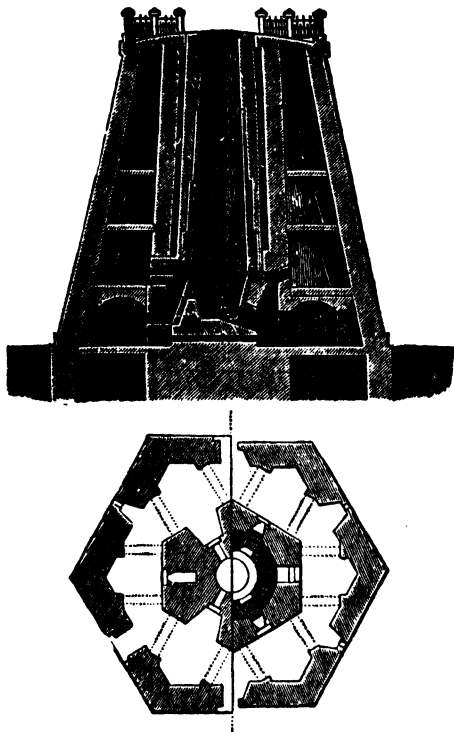

FIG. 3.—Rüdersdorf Kiln.

lime clinker is withdrawn at *D*. Another kiln of a somewhat similar type is the *Dietzsch kiln* described on p. 65.

Vertical kilns with separate feed are used to a considerable extent, especially on the Continent and in America. They are provided with separate fireplaces to carry the fuel;

so that, as in the case of the flare kilns, the lime produced is uncontaminated with the ash of the fuel. The *Rüdersdorf kiln*, shown in Fig. 3, is a well-known kiln of this class. It is polygonal in form and consists of a central shaft about

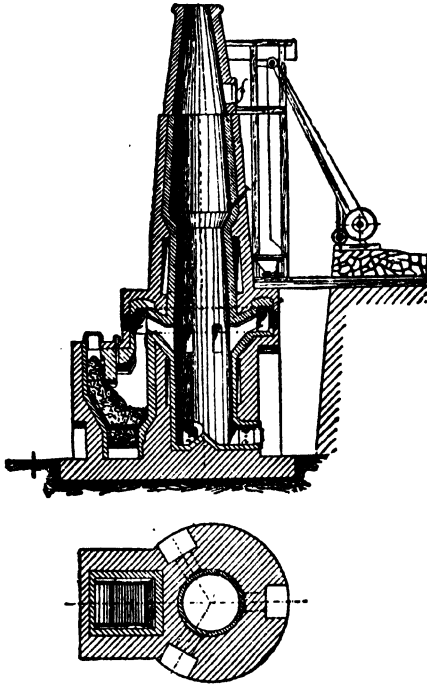

FIG. 4.—Schmatolla's Kiln.

40 feet high, connected to the fire chambers by means of arched openings. This central shaft is about 10 feet in diameter at the widest part, just above the fire chambers, and tapers off above and below. It has a diameter of about 7 feet at the top, where the limestone is charged into the

kiln. There are many modifications of the kiln, such as the well-known *Rumford's kiln*, and in the most recent modifications the fireplaces are replaced by generators for producer gas as in *Schmatolla's kiln*, which is shown in Fig. 4. In this kiln the gas passes from the producers at the side of the kiln through ports into the kiln shaft, where it is burnt with a supply of air which has passed through the hot lime in the lower part of the kiln and thus become heated. An American kiln of the separate feed type is the *Keystone lime kiln*. This consists of a steel cylinder lined with fire bricks and resting on a heavy steel base. Beneath the cylinder is the *cooling-cone*, which consists of an inverted truncated cone. The furnaces are carried on steel platforms which are extended beyond the firing doors, in order to give sufficient room for working. The cylinder is charged with limestone and the hot gases from the furnace are directed on to the stone through two large openings, lined with fire-brick, in the walls. The burnt lime falls into the cooling-cone, from which it is withdrawn by means of draw-gates at the bottom. The heated air around the cooling-cone passes into the ash-pit under the grates, and sometimes a steam jet is placed in the hot-air passage in order to provide forced draught.

The *Hoffman ring kiln* was originally introduced for burning bricks, but it is also used for burning lime and Portland cement (see p. 64). It may be regarded as intermediate between the intermittent and continuous classes of kiln, because although it is continuous as a whole, each of the chambers into which it is divided acts as an intermittent kiln. The burning chamber consists of an endless tunnel divided into compartments of approximately equal size by means of dampers, which are usually made of paper. Each chamber is provided with an opening in the outside wall, for the purpose of loading and unloading, and with one or more flues, furnished with dampers, which

connect it to the main flue leading to the chimney. There are also a number of openings in the arched roof which serve for the introduction of the fuel; usually small coal, or a mixture of breeze and coal. The lumps of raw material are carefully packed in the chambers, continuous flues being left in order that the hot gases may pass through the mass, and, as each chamber is charged, the opening in the outside wall is bricked up and plastered over with clay paste. The working of this kiln is as follows. At any moment after the kiln has been started there is a series of chambers which form the hottest part of the kiln, and in which the limestone is being calcined, the paper screens having been burnt through. The first of these chambers is supplied with fuel, through the shoots in the roof, in order to complete the calcination of the stone, and the flues from the last chamber of the series are left open whilst all the others are closed by the dampers. A current of air for the combustion of the fuel is drawn through the preceding chambers in which the limestone has already been burnt, thus utilising the heat given out by the cooling clinker to raise the temperature of the air supply. The temperature of the chambers increases until another screen is burnt through, when the next chamber becomes included in the series. The dampers of this compartment are then opened and those of the preceding one are closed. Fuel is now added to what was the second chamber of the original series, but which is now the first of the new series, and the clinker of the preceding chamber is allowed to cool. As the heat thus passes from chamber to chamber those first burned become sufficiently cool to open. They are one by one unloaded and recharged, and the cycle of operations repeated. This kiln is very economical in fuel, but expensive in labour. It is largely used on the Continent, but has not proved so successful in England, where labour is more costly. It is not used in America.

Rotary kilns, similar to those used in the manufacture of Portland cement (see p. 66), but worked at a lower temperature, are sometimes employed for burning lime. Their use is increasing, but is not as yet very extended, at any rate so far as Europe is concerned. In America many of the modern lime manufacturers employ this type of kiln, the size of which often approaches that of the rotary kilns used for Portland cement. Thus, at their lime plant at Buffalo, N.Y., the Kelly Island Lime and Transport Co. employ a rotary kiln 150 feet long and 8 feet in diameter.

Rotary kilns cannot be employed where the lime is required to be in large lumps, but as the demand for "hydrated lime" (see p. 122) increases, this disadvantage will become less, and in the near future the rotary kiln will probably be regarded as the standard pattern for large plants, the other types of kiln being relegated to small and old-fashioned works.

CHAPTER V

THE ARTIFICIAL HYDRAULIC LIMES, POZZOLANIC, AND SLAG CEMENTS

ALTHOUGH the limestones which furnish hydraulic limes naturally are very plentifully distributed, circumstances may occur to render their employment too expensive. In such cases their want is supplied, at least upon the Continent, by the use of natural or artificial pozzolanic materials (see p. 124), which are mixed with the rich limes, or by the use of artificial hydraulic limes. Vicat, the inventor of the system employed near Paris of making the latter, naturally recommends their use. General Treussart, apparently for no other reason than because Vicat had so recommended the artificial hydraulics, gives the preference to the mixture of the trass, etc., with the rich limes. Experience has settled this question, however, in favour of Vicat's opinion; and unless the trass and pozzolanas are found in the most extraordinarily favourable conditions of economy, they are never used in the present day by engineers who have at all studied this branch of their profession.

Indeed, it must be evident that the chemical action produced upon the lime by the mechanical mixture of pozzolanas can never be so perfect in its results as that which is called into activity during the process of calcination. Even if we leave out of account the effect of the heat in producing a more perfect chemical combination between

the materials, there is always a danger attending the use of the subsequent mechanical mixtures. Either from carelessness, want of skill, or even in spite of the best intentions, it often happens that the combination is not perfect, and that the limes and pozzolanas are so mingled that there is excess of lime in one place, of pozzolanas in another. Very serious failures have occurred from the use of these mixed materials in sea works, and the experience of the best Continental engineers has led them to prefer the use of the artificial hydraulic limes wherever natural ones are not to be met with.

There are two methods of preparing the artificial hydraulic limes. The first, which is the more perfect, but at the same time the more expensive, consists in mixing the slaked rich lime with a certain proportion of clay, and burning this compound. The lime in this case goes through a double calcination.

The second method consists in mixing, instead of the slaked lime, soft calcareous matters with the clays, such as chalk, or the tuffas of some of the other formations, and in reducing the whole to a paste by grinding them together in a mill. Being in both cases masters of the proportions of the different ingredients, it is easy to communicate the hydraulic properties in any degree of energy the works they are intended for may require.

Generally speaking, twenty parts of dry clay are mixed with eighty parts of very pure rich lime, or with one hundred and forty parts of calcium carbonate; but if the lime or the carbonate already contains any clay, a smaller proportion would be necessary. It is impossible to say beforehand what the precise proportions should be, because the limestones and the clays of every locality differ in their nature. Of the latter, the finest and softest to the touch are the most preferable.

At Meudon, near Paris, some extensive lime works

were erected under the directions of Vicat, by MM. Brian and St. Leger, for the manufacture of artificial hydraulic limes from the chalk and clays of that country. The chalk was divided into pieces of the size of a fist previously to being ground. The materials, which were introduced in the proportion of four of the chalk to one of the clay, were crushed and mixed together in a large vertical mill, worked by means of two horses. The liquid mixture was run off into a series of five troughs placed at successive differences of level, and deposited in them the matter it held in suspension. A double set of these troughs was necessary in order that one might be worked whilst the liquid was depositing in the other, and it was found that the shallower the troughs were in proportion to their surface, the more rapidly did the deposition take place.

As soon as the deposited matter became of sufficient consistence to support manipulation, it was made into small prisms with a mould. The prisms were then placed on a drying platform, and allowed to dry until they arrived at the state of freshly quarried limestone. They were then put into a kiln, and burnt by any of the methods already mentioned (see p. 34). A somewhat similar process is followed in the manufacture of Portland cement (see p. 51).

General Treussart's experiments upon the artificial hydraulic limes led him to believe that their quality would be much improved if they were prepared with water in which soda or potash was mixed, and this opinion has been confirmed by subsequent researches. Thus, Kuhlmann has shown that it is possible to obtain a hydraulic lime of a superior quality by calcining an intimate mixture of finely powdered rich lime and sodium or potassium silicate, in the proportion of 10 to 12 parts of silicate to 100 parts of lime.

Artificial hydraulic limes prepared by mixing slaked lime with natural or artificial burnt siliceous matter are known

as *pozzolanic* cements, because the most important of the naturally occurring siliceous substances used in their manufacture are the volcanic products known as pozzolana, trass, and santorin earth. They are not burnt at any stage of the process of manufacture, the materials being simply mixed together and finely ground. The ancient Roman cements belonged to this class, but the modern, so-called Roman cement is of quite a different character (see p. 99).

By far the most extensively employed of the artificial siliceous materials used in the manufacture of such cements is blast-furnace slag; and *slag cements* are therefore the most important members of this class. The slags used in the manufacture of these cements are obtained from iron smelting operations, and consist of fusible silicates, aluminates, and perhaps aluminosilicates, formed by the combination of the limestone and other fluxing materials with the gangue of the ore. As the composition of such slags varies considerably they cannot all be used for the manufacture of slag cement, only those of a certain type being suitable for the purpose. These slags may also be used in the manufacture of true Portland cement (see p. 50).

Slag cements may be prepared by mixing the granulated and finely ground slag with slaked lime, as in the older methods of manufacture, or by grinding the granulated slag without any additional lime, as in the more modern methods. In the older method the granulation is usually carried out by allowing the molten slag to flow from the blast-furnace into a stream of running water. By this means it is broken up into fine, porous particles known as *slag sand*, rendered hydraulic, and partially freed from sulphur, which escapes as sulphuretted hydrogen, H_2S . The granulated slag is then dried in some form of drier, mixed with slaked lime, in proportions depending upon the composition of the slag, and the mixture finely ground. The

lime used may be either common or hydraulic lime, but in either case it must be carefully slaked and then sieved, and all the material which fails to pass the sieve should be rejected.

The modern method of manufacture is to granulate the slag by allowing it to fall upon rapidly rotating iron drums, from which it is thrown off in the form of fine globules, which are cooled in the air, the slag being at the same time sprayed with a solution of alum, magnesium sulphate, or other salt. The granulated slag is then finely ground in ball- and tube-mills (see pp. 57, 60), a little lime and gypsum being added in order to retard the setting time.

A German cement of this class which is composed of 70 per cent. of Portland cement and 30 per cent. of granulated highly basic slag, is known as *eisen-Portland-zement* or *iron Portland cement*. The Portland cement used for the purpose is made by mixing slag with the correct proportion of limestone, grinding, and burning to the clinkering temperature.

Slag cements are usually pale bluish grey in colour, but they may have a brownish tint, owing to the presence of manganese derived from the slag. They differ chemically from Portland cement in containing much less lime and much more alumina. The specific gravity of these cements is low, never exceeding 2.8, and the tensile strength is less than that of Portland cement. Slag cements are slow setting, but the setting time may be shortened by suitable treatment, such as the addition of caustic soda, potash, or sodium carbonate, either during or after manufacture. They attain their maximum hardness more rapidly than does Portland cement, sometimes during the first month. They stand the accelerated tests for Portland cement very well. These cements are well adapted for use under water, but are not suited to work which is exposed to the atmosphere.

CHAPTER VI

PORTLAND CEMENT

IN 1824 Joseph Aspdin, a Leeds bricklayer, patented a process for making an artificial cement to which he gave the somewhat misleading name of "*Portland*" cement. This cement was prepared by lightly calcining a mixture of limestone and clay, and grinding the product; it was therefore a very different material from that known by the same name to-day. At the present time Portland cement is by far the most important of the hydraulic cements, its superiority, both as regards strength and durability, having led to its general adoption, to the increasing exclusion of the natural cements (see p. 99). Portland cement may be defined as the material obtained by heating an intimate mixture of calcareous and argillaceous materials to incipient fusion and finely grinding the resulting clinker. The choice of raw materials is very wide: limestone, chalk, cement rock, marls, clay, shale, slate, blast-furnace slag, alkali waste, and other substances being employed. Whatever may be the materials used, the proportions must be so adjusted that the mixture contains about 75 per cent. of calcium carbonate and 25 per cent. of aluminium silicate and free silica, and the mixture must be uniform and in a fine state of division. The finished product only varies in composition within very narrow limits.

The mixing of the raw materials is brought about by

one of three methods, known as the *wet*, *semi-wet*, and *dry* processes. The method chosen depends partly upon the nature of the raw materials used, and partly upon the age and locality of the works.

The *wet* process is the original process and is now almost obsolete, but is still used in some old works where soft, wet raw materials, such as chalk and river mud, are employed. The materials are mixed in the proper proportions with sufficient water to bring the total amount up to about 80 per cent., and reduced to an impalpable mud, known as *slip* or *slurry*. The process is carried out in a *wash-mill* consisting of a circular or octagonal basin about 15 feet in diameter, in which a central vertical shaft is rotated at the rate of about 24 revolutions per minute by means of bevel wheels. Iron or steel harrow frames carrying steel tines are suspended from the radial arms, and these, as they rotate, break up and mix the materials. After having been churned to the correct consistency, the slurry is run off through sieves or gratings into troughs which convey it to large reservoirs called "*backs*," where it is allowed to settle. The water is removed by drawing off the supernatant fluid through a perforated *peg-board*, but also partly by soaking away and by evaporation, and the slurry is dug out of the backs, dried, and burnt. The drying may be carried out on *drying-floors*, heated by means of the waste gases from the coke ovens used for coking the coal before burning the slurry, but at the present time it is more usual to effect this by means of the waste heat from the kilns. On the Continent the slurry is left in the backs until it is stiff enough to be pugged, when it is made into bricks and dried in *tunnel driers*, which consist of tunnels about 100 to 120 feet in length, through which the trucks conveying the material are slowly conveyed in the opposite direction to a current of hot air.

The *semi-wet* or *semi-dry* process, which is also known as

the *Goreham* process, is similar to that employed in the manufacture of hydraulic lime at Meudon (see p. 46). The raw materials are mixed with sufficient water to form a paste containing about 40 per cent. of water. This paste is known as *thick slurry*, but is sufficiently wet to be capable of flowing through pipes and of being pumped like a liquid. The mixing and grinding are usually carried out in wash-

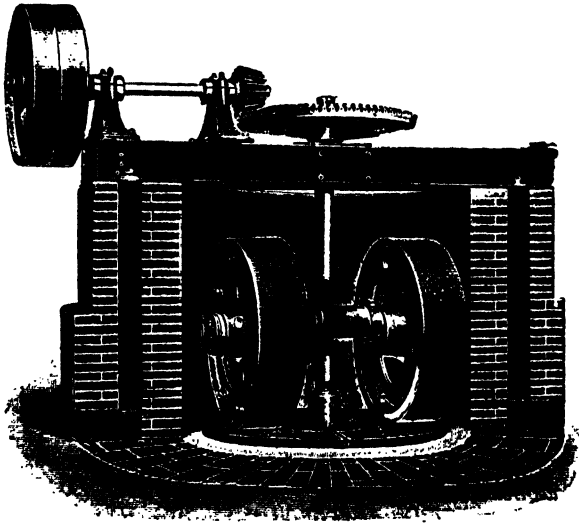

FIG. 5.—Wet Edge-Runner.

mills similar to those employed in the old wet process, but when the materials are of a hard nature they are generally ground in mills of some other type, such as the *wet ball-mill*, which is very similar to the ordinary ball mill described on p. 57, and the *wet edge-runner*, see Fig. 5. In the latter mill the slurry is ground between the two heavy runners, which rotate about the vertical shaft, and the floor of the pit, and is finally discharged through coarse grids. As it

is necessary in this process that the slurry should be extremely finely ground it must be further reduced after it comes from the wash-mills or other grinders. This reduction may be carried out in mills of the ordinary flour-mill type, or in *tube-mills* (see p. 59), or the slurry may be passed through a series of wash-mills, each of which reduces it to a finer state of division than the previous one, or some sifting device, such as *Clarke's mill*, may be employed. This mill, which is shown in section in Fig. 6, is a wash-mill, in which brushes are attached to a rotating iron plate. The slurry is passed into the mill through a perforated iron plate and is thrown by the centrifugal action of the brushes against the periphery of the tank, where the finer portion passes through sieves, whilst the coarser particles are swept away by the revolving brushes and are discharged through an outlet near the bottom of the tank, back to the grinding mills.

The finished slurry is usually run into large tanks known as *mixers*, where it is kept stirred by means of mechanical stirrers, or, as in at least one modern system, by means of compressed air. The slurry is tested at this stage, and, if the proportions are found not to be correct, a suitable quantity of a slurry made entirely of clay or chalk is added. It is finally pumped from the mixers to the kiln, or to the drying floors, if it is to be formed into briquettes. On the Continent the latter are usually dried in tunnel driers (see p. 51). In America this process is known as the *wet* process, the old wet process being unknown.

The *dry* process is chiefly used where the raw materials are of a hard nature, though it is also applicable to soft materials. It is necessary to crush and dry the materials before submitting them to the fine grinders, and, except in the case of very wet, soft substances, the crushing is carried out before the drying. The type of crusher employed depends principally upon the nature of the materials to be

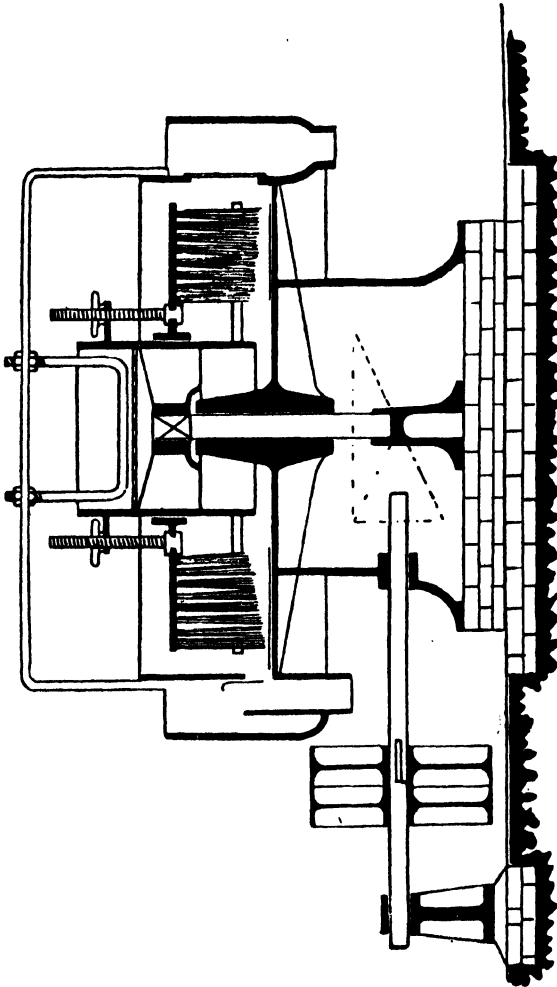

FIG. 6.—Clarke's Mill.

crushed. If these are hard and fairly dry they are usually broken up in stone breakers of the *swing-jaw* type, or in *gyratory* crushers; the former method being generally employed in this country and the latter in America. Soft, wet materials, however, are crushed in *rotary* crushers.

The swing-jaw crusher, of which *Blake's stonebreaker* may be considered as the type, consists of a fixed jaw, against which a hinged jaw is caused to swing to and fro by means of an eccentric shaft, or by some other method. Fig. 7 shows

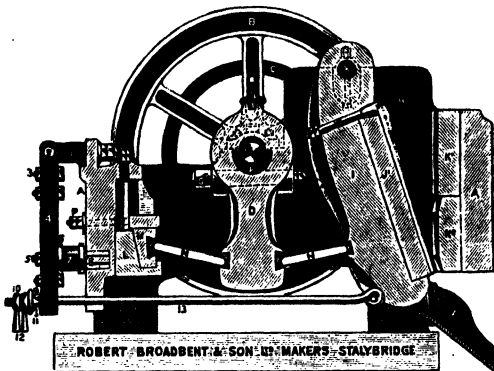

FIG. 7.—Section of Broadbent's Improved Blake Stonebreaker.

a section of *Broadbent's Improved Blake Stonebreaker*. The swing jaw, *I*, is provided with a chilled iron or manganese steel face, *J*, whilst the facing of the fast jaw is in two sections, *K*¹, *K*². The swing jaw is caused to swing backwards and forwards, through a very small arc, by means of the pitman, *D*, which is alternately raised and lowered by the rotating eccentric shaft, *E*, the return of the swing jaw being effected by means of the drawback motion 1-13. The size of the crushed material is regulated by raising or lowering the wedge, *L*. In a modern form of crusher, known as the *Wheeling Forced*

Feed Crusher, a rolling motion is imparted to the swing jaw, thus increasing the crushing power and output. Gyratory crushers, such as *Hadfield's Gyratory Crusher*, consist essentially of an inverted conical shell in which a crushing cone is caused to gyrate. *Crackers* of the coffee mill type are occasionally employed for reducing the size of the material after it has been crushed by the more powerful machines mentioned above, and they may also be used for the initial crushing of moderately soft materials, but their use is not general in the manufacture of Portland cement. Soft materials are usually crushed in mills with *toothed* or *hedgehog* rolls.

At one time the crushed material was dried in vertical kiln-like structures, but at present *rotary driers* are almost universally employed. The simplest form of rotary drier consists of an inclined iron tube about 30 to 40 feet long with channel bars extending along its entire length. The tube is capable of being rotated about an axis slightly inclined to the horizontal. The wet material is fed in at the upper end of the tube, and, as it descends, is dried by the hot gases which pass in at the lower end from a furnace, or from the kilns, where *rotaries* (see p. 66) are employed. Special forms of drier are sometimes used. The *Ruggles-Coles drier* consists of two concentric cylinders capable of revolving about their slightly inclined common axis. The wet material is charged into the annular space between the cylinders, and, as it descends, is dried by hot gases which are drawn through the inner cylinder, then back through the annular space between the cylinders, and, finally, through a flue leading to the exhaust fan. Instead of channel irons, scoops are attached to the inner surface of the outer cylinder and the outer surface of the inner cylinder. In hot, dry countries, such as California, the materials may conveniently be dried without artificial aid.

The crushed and dried material was formerly ground

by means of French Burr millstones, or stones with rock-emery faces, but this method is now obsolete, and the modern practice is to use the *ball-mill* followed by the *tube-mill*, or, in some works, to employ a single grinder such as the *Griffin mill*.

The *ball-mill* is not suited for producing fine flour, but is one of the best mills for preliminary grinding. Ball-mills vary considerably in constructional details, but consist essentially of a drum containing a number of forged steel balls and capable of rotation about a horizontal axis. The *Krupp ball-mill* is shown in Fig. 8. This mill consists of a circular drum, the inner circumference of which is built up of perforated steel grinding plates which are so arranged as to form steps. The drum is charged with forged steel balls. The material is fed in through a hopper at the side of the drum, and, after being crushed by the balls, which fall from step to step as the drum rotates, passes through the holes in the grinding plates on to the coarse sieve, which retains the larger particles and allows the finer portion to pass through to the fine sieve, where the same process is repeated. The finest portion, which succeeds in passing both sieves, falls into the iron casing and is removed, whilst the remainder is returned to the interior of the drum and reground. In an improved form of ball-mill known as the *Kominor mill* the grinding plates are not perforated. The coarse particles retained by the sieves are returned through shoots into the drum, which they must retrace before they again enter the ports leading to the sieves, thus receiving a much more thorough grinding between each sifting. The *Molitor ball-mill* is not provided with fine sieves, the ground material being discharged through gratings placed between the steps. Sometimes *edge-runners* are used instead of ball-mills for dry grinding. These somewhat resemble the wet edge-runner shown in Fig. 5, but vary considerably in design. In some forms the runners

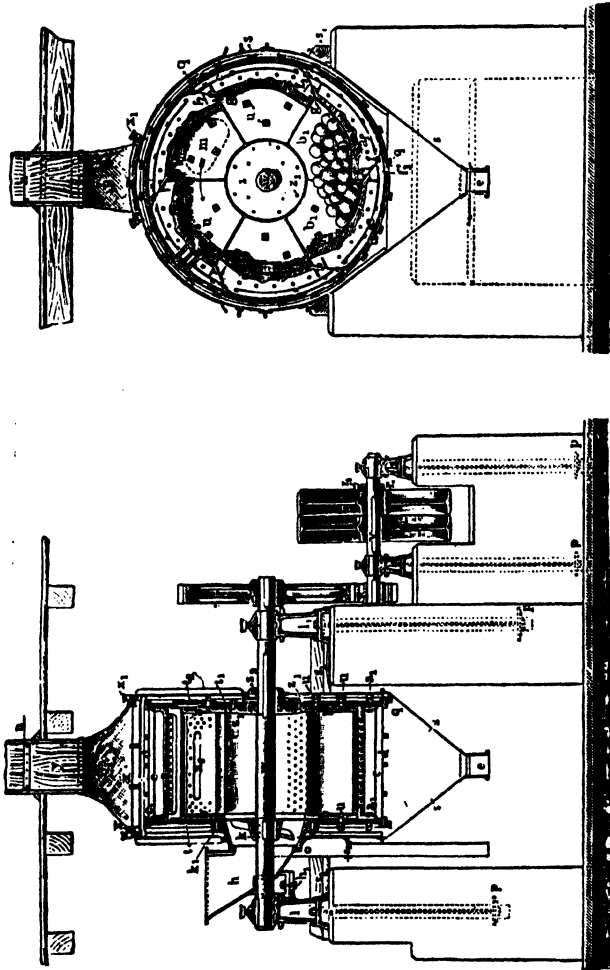

FIG. 8.—Krupp's Ball-Mill.

are driven whilst the pan remains stationary, and in others the exact opposite is the case. Like ball-mills, edge-runners must be followed by a finishing mill, or they may be used in conjunction with fine sieves or air separators (see p. 74). Short tube-mills or *pre-grit mills* are also employed for the preliminary grinding. These resemble the tube-mill described below, but are shorter and are charged with steel balls. Mills of the type of the *Jeffrey pulveriser* are also used for the preliminary grinding. In this mill a spider carrying four hammers is caused to rotate in a circular grinding chamber, and the material is ground between the

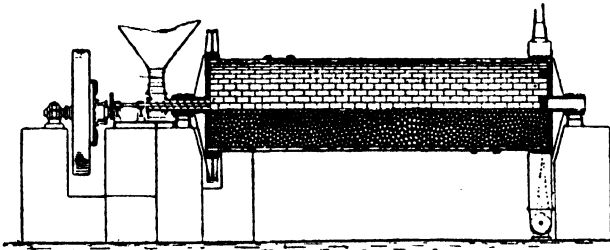

FIG. 9.—Section of Davidsen Tube-Mill.

hammers and the breaking plate. Soft materials may be ground in *bar disintegrators*, which consist of two or more revolving cages arranged one within the other in concentric circles. Each cage is rotated in the opposite direction to the one within, and the material is crushed between the bars of the revolving cages as it passes outwards from the centre of the mill.

Tube-mills are used for finely grinding the "grit" from the ball-mills, or other preliminary grinders. As in the case of the ball-mill, there is a considerable variety of tube-mills which differ in details, especially in the method of discharge. The *Davidsen tube-mill*, which is shown in Fig. 9, consists of a steel tube capable of being rotated about a

horizontal axis by means of a spur wheel attached to the inlet end. The cylinder is lined with chilled iron plates

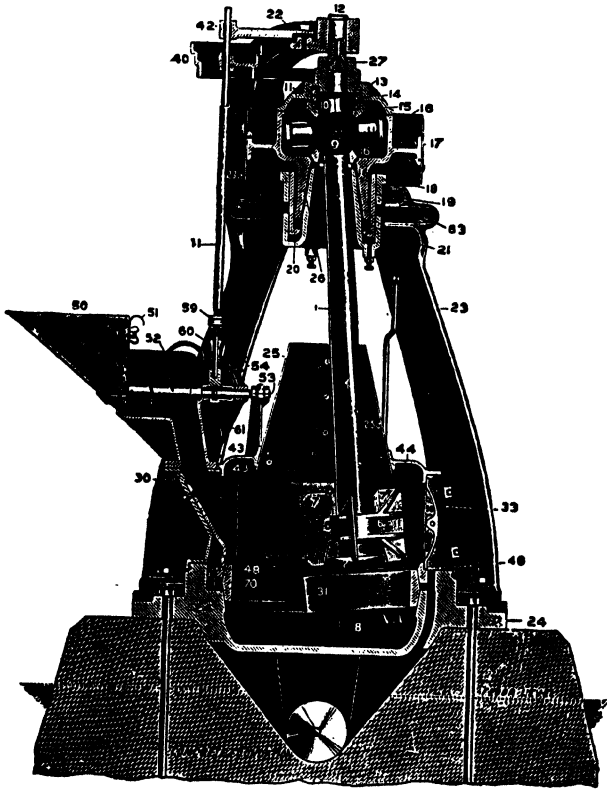

FIG. 10.—Section of Griffin Mill.

or quartzite blocks, and is about half filled with flint pebbles of various sizes, the largest being placed near the inlet and the smallest near the outlet. The material is fed into the

mill through the hollow trunnion at the inlet end, and, as it passes through the rotating tube, is ground by the crushing and rubbing action of the flints, until on reaching the further end it is discharged through grids arranged around the circumference of the tube, into an annular casing from which it is conveyed to the storage bins. *Compound mills* in which the ball-mill is combined with the tube-mill are also employed.

Centrifugal roller mills provided with sieves, in which the grinding is usually completed in one operation, are sometimes used for grinding the raw materials. A typical mill of this class, known as the *Griffin mill*, is shown in Fig. 10. In this mill a roller, 31, to the under side of which shoes or ploughs are attached, is secured to the lower end of the shaft, 1, which is suspended from the centre of the horizontal driving pulley, 17, by means of the universal joint, 9. The roller swings and rotates within the grinding ring which is held in the base pan, 24. Attached to the latter is a sieve frame, 44, carrying a cylindrical sieve surrounded by a sheet-iron casing, and above this is the conical shield, 25, through which the shaft passes. The raw material is fed into the hopper, 51, and is conveyed by means of the worm, 49, into the base pan, where it is ground between the roller and the grinding ring, the shoes attached to the former stirring it up and forcing it between the roller and the die. The fine particles are winnowed by the fans, 7, and passing through the sieve, fall through a number of openings arranged around the base pan into the receptacle below, from which the ground material is removed by means of a worm conveyor. A larger and more powerful form of this mill is known as the *Giant Griffin mill*. Other centrifugal roller mills are the *Neuss mill*, the *Bradley three-roll mill*, the *Roulette mill*, and the *Fuller-Lehigh mill*. In the *Roulette* and *Fuller-Lehigh* mills the rollers are replaced by balls which are driven by propelling lugs.

A somewhat similar class of mill, in which the grinding

pressure is obtained by means of powerful springs, is also used. The *Kent mill* is the type of this class of grinder. In this mill there are three rollers arranged inside a grinding ring which is caused to rotate by means of the friction of the topmost roll. A modern improved form of this mill is known as the *Maxecon mill*; it operates on exactly the same principle as the older Kent mill, but is more powerful and has been considerably improved in structural details. The *Sturtevant ring-roll mill* is somewhat similar in principle to the Kent mill, but the grinding ring is connected to the driving shaft instead of being driven by friction against one of the rolls. As these three mills are not provided with sieves they can only be used for preliminary grinding unless a separate sifting apparatus is provided.

The ground material from the finishing mills is known as *raw meal*, *raw flour*, or *compo*. It is tested for fineness, and the content of calcium carbonate determined, any necessary alterations being made. When rotary kilns are used, the compo is conveyed direct to the small bins from which the kilns are supplied, but in other cases it is stored in large *mixing silos*, where it is kept constantly stirred. When required the raw flour from the silos is mixed with water and made into briquettes which are dried by means of the waste heat from the kilns, or, especially on the Continent, in tunnel driers (see p. 51). Sometimes a little lime is added to the raw flour in order to increase its binding power, and sometimes the raw flour and fuel are mixed together and made into briquettes. In some works a combination of the wet and dry processes is employed, a wet slurry being made from the soft material and a dry flour from the hard. The two materials are then pugged in the correct proportions and made into briquettes.

The raw materials must now be heated to the point of incipient fusion (*i.e.* to about 1400° C.). The water is first driven off, then, as the temperature rises, the carbonates

are decomposed, carbon dioxide being evolved, and finally, at the clinkering temperature, combination takes place between the free lime and the silica, alumina, and iron oxide of the clayey portion. The kilns in which this operation is carried out are of several types, but they may be classified under two general heads, *stationary* or *vertical kilns* and *rotary kilns*, and the former class may be subdivided into *intermittent* and *continuous kilns*, according to whether the burnt product is removed before adding a fresh charge or whether the fuel and raw material are gradually fed into the kiln as the burnt clinker is withdrawn. The rotary kiln is always a continuous kiln. The intermittent kiln in all its forms is obsolete and is only of historical interest, though it is still used in some old and small works; stationary continuous kilns are much used, especially on the Continent; but the rotary kiln is the most popular at the present time, especially in America, where it is almost universally employed.

The simplest form of intermittent kiln is that known as the *dome* or *bottle kiln*, which is similar to the common lime kiln, but usually has a tapering chimney in order to increase the draught. Although capable of producing excellent clinker this kiln is extravagant as regards fuel. Several modifications have been introduced, some of which are still in use in old works. In the *Johnson kiln* the slurry is dried ready for the next charge in a long, slightly inclined, arched drying chamber which connects the calcining portion of the kiln to the somewhat lofty chimney. The floor of this chamber is of the same width as the kiln and is of sufficient length to hold enough slurry to fill the kiln. The *Batchelor kiln* has two or three arched drying chambers, placed one above the other, with flues beneath the lower tier. The hot gases from the kiln pass through the drying chambers and flues and are finally discharged through a chimney at the rear.

The *Hoffman ring kiln* described on p. 42 is also used for burning Portland cement clinker. It may be regarded as intermediate between the intermittent and continuous classes of stationary kiln, because each of the chambers in which it is divided acts as an intermittent kiln although the kiln considered as a whole is continuous.

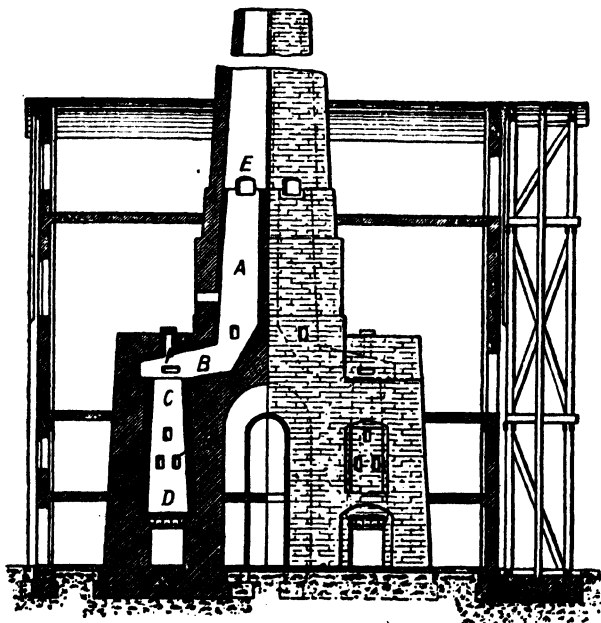

FIG. 11.—Dietzsch Kiln.

As most of the continuous stationary kilns resemble a tall chimney they are known as *shaft kilns*, and because they are sometimes divided into zones or stages they are also called *stage kilns* (*Etageofen*). They are more common on the Continent, where the dry process is largely employed,

than in this country. A modern form of the *Dietzsch kiln* shown in Fig. 11, which represents two kilns placed back to back as in the usual arrangement, may be taken as a type of this class of kiln. It consists of four zones or sections surmounted by a chimney. The dry slurry, in the form of half-bricks, is introduced through the loading eye, *E*, into the *preheating zone*, *A*, where it is gradually heated to redness by the hot gases as they pass from the lower part of the kiln on their way to the chimney. The fuel is introduced through the doors, *F*, into the *mixing zone*, *B*, where it is mixed with the hot cement material, and the hot mixture is raked into the *burning or clinkering zone*, *C*, where it is heated to the requisite temperature. The hot clinker passes down from this zone into the *cooling zone*, *D*, any masses which adhere to the walls being pushed down by means of iron tools thrust through the openings, *G*. The clinker in *D* is cooled by the air entering at the grate, *H*, and is withdrawn at regular intervals, a further supply of raw material and fuel being added through *E* and *F*. The usual fuel employed in this kiln is small coal, and the amount used is about 17 to 20 per cent. of the weight of the clinker produced. The output of the double kiln is from 20 to 30 tons per day. In the *Aalborg kiln* the heating zone is placed directly above the clinkering zone, and the latter is considerably constricted. Firing holes provided with iron covers are placed at intervals around the kiln. The coal consumption of this kiln is from 12 to 15 per cent. of the weight of burnt clinker, and the output is from 12 to 14 tons per day. The "*R*" kiln is somewhat similar to the *Aalborg kiln*, but is characterized by possessing two preheating chambers, with a passage between; the fuel is introduced into the clinkering chamber through holes in the floor of this passage. The *Schneider kiln* consists of a plain cylindrical shaft connected to a chimney by means of a conical hood, or a number of kilns may be connected

to the same chimney by means of flues. The lining of the clinkering zone is protected by a thin layer of finely crushed raw material which is placed between the charge and the lining by means of a special *filling ring*. Sometimes this kiln is worked with forced draught, in which case the raw material is mixed with coke breeze and the mixture made into briquettes. Other well-known shaft kilns are the *Hauenschild*, the *Hotop*, and the *Stein Ribbed* kilns. The last-mentioned kiln consists of a cylinder built up of cast-iron rings, supported on short masonry columns, and surmounted at the top by a conical iron hood, which supports the chimney.

The *rotary kiln* is the most modern form of cement kiln, and also the most popular, especially in America, where it is rapidly becoming universal. The kiln consists essentially of a steel cylinder lined with fire-brick, which is capable of being slowly rotated about an axis slightly inclined to the horizontal. This type of kiln is very economical in labour, but not in fuel, as from 30 to 40 tons of dry coal are required per 100 tons of burnt clinker. It has the great advantage that the calcination of the clinker can be controlled by the burner to a greater extent than in any other type of kiln.

The first practical kiln of this type was patented in 1885 by Ransome, who is usually regarded as the inventor of the rotary kiln, though Crampton patented a kiln of this type as far back as 1877. Ransome's kiln consisted of a slightly inclined iron cylinder 25 feet long and 5 feet in diameter, supported on rollers, and rotated by means of worm gearing. It was lined with fire-bricks, every fourth row being set edgewise so as to form longitudinal ridges. The dried and ground raw materials entered the cylinder at the upper end, and, as they slowly descended, they were raised to the clinkering temperature, and finally discharged at the lower end. The fuel employed was producer gas, which entered the cylinder at the lower end, where it was

burnt. Ransome claimed that this method of calcination would abolish the necessity for crushing the clinker before grinding, but it was found that at the temperature to which it had to be raised the material caked together and the clinker obtained was always in the form of small, but exceedingly hard, lumps. After many trials this kiln was abandoned by English cement manufacturers, the various improvements effected by Stokes sharing the same fate. Some years later, however, the idea was again taken up, this time in America, and through the efforts of Hurry and Seaman, Giron, Newberry, and others, it soon proved a success. The length of the cylinder was considerably increased and finely ground coal dust was substituted for the producer gas or oil which were used for fuel in the earlier kilns.

The cylinders of modern rotary kilns are usually from 6 to 9 feet in diameter, and from 100 to 150 feet in length, but they are sometimes made much larger than this. They are generally constructed of steel plates, riveted to butt straps, and lined with suitable material, usually bricks. Ordinary building bricks may be used for the comparatively cool upper end, and common fire-bricks for the central portion, but the hot lower end of the cylinder must be lined with special fire-bricks which should contain about 41 per cent. of silica and 49 per cent. of alumina. A layer of asbestos has sometimes been placed behind the fire-bricks, but the plan is of doubtful value. In many works a concrete lining is used, the concrete being made with about two parts of hard burnt clinker, and one to one and a half parts of cement. The clinker must be at least small enough to pass through a sieve with a half-inch mesh. The cylinders may have parallel sides or they may be made tapering at the upper end, or one portion may be made larger than the other as shown in Fig. 12. Although the last-mentioned form was originally adopted in order to utilize two short cylinders of different diameters which

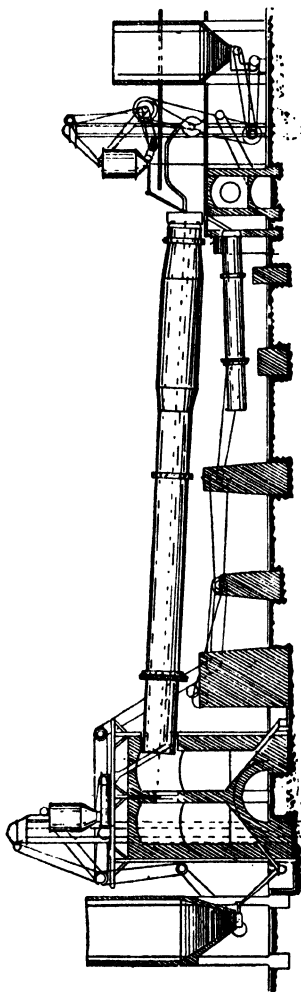

FIG. 12.—General Arrangement of Rotary Kiln Plant with Coal Dryer behind Cooler.

would otherwise have had to be scrapped, it has been proved to give a larger output than the parallel-sided form and to decrease the tendency of the clinker to adhere to the lining of the cylinder, so that it has become the most popular form. The cylinder is carried on two or more pairs of roller bearings placed at a convenient distance apart, and is rotated by means of a split toothed wheel which is actuated by a worm-wheel driven by means of suitable reduction gearing. It is customary to employ some form of speed-changing device, usually a three-speed gear, to regulate the rate of rotation, in order to have the feed, etc., under proper control. The rate of rotation usually varies between 20 and 60 revolutions per hour, and depends upon the slope of the kiln, the nature of the raw materials, and the thermal conditions inside the kiln.

The upper end of the cylinder terminates in a flue leading to a chimney, or, if the kilns are worked in batteries, one large chimney may be connected to several kilns by means of flues provided with dampers; and, as the kiln gases are heavily laden with dust, it is necessary to pass them through some form of *dust chamber* in which the dust is deposited before they reach the chimney. This dust chamber usually consists of two chambers separated by means of a wall in which there are openings. The gases are caused to pass downwards in the first chamber, and, through the openings in the wall, into the second chamber, from which they pass to the flue leading to the chimney. The accumulated dust is removed either periodically or continuously. The apparatus for the introduction of the raw materials into the kiln is placed above the dust chamber (see Fig. 12). When the semi-wet process is employed the slurry is pumped from the mixers into a tank connected to the kilns by means of a *feed-shoot*, but when the dry process is used, the flour may be delivered from the storage bins into the kiln by means of a worm conveyor, or fed by means of a worm into

a trough containing knives or arms attached to a rotary shaft. As the material travels along this trough, water is added by means of a perforated pipe placed over the trough, and the granular paste thus formed falls in small lumps into a shoot leading into the kiln.

At the lower end of the cylinder is the *kiln hood*, which is often mounted on wheels, so that it can be run back when required. The hood is generally made of steel plate and is lined with fire-brick. It is provided with a door, two or three sighting holes, and the burner. In modern practice it is almost universal to use finely ground bituminous coal dust for the fuel, but natural gas, producer gas, and petroleum are also used to some extent. The coal must be thoroughly dried, and ground so finely that it only leaves a residue of about 15 per cent. on a sieve containing 180 meshes per linear inch. This finely divided coal is very explosive, so that it must be handled with great care; it cannot be stored, but must be used as soon as it has been ground. When an initial crushing is required before drying, this is usually carried out in hedgehog rolls, but sometimes swing-jaw crushers (see p. 55) or crackers of the coffee-mill type (see p. 56) are used for this purpose. The crushed material is then dried, generally in a rotary drier similar to that described on p. 56, heated by means of the hot air from the clinker coolers, or by a separate furnace. The dry coal is next ground, usually in a Griffin mill (see p. 61) or in ball and tube-mills (see pp. 57, 60), after which it is conveyed to hoppers placed over the lower end of the kiln. It is blown into the cylinder by means of a fan, by compressed air, or by some other means, and immediately bursts into flame.

As the raw material gradually descends the cylinder it first becomes dehydrated; when about half-way down the limestone is decomposed and carbon dioxide is evolved; then, as the material passes further down, reactions take

place between the lime and the silica, alumina, etc., and the mass becomes heated to the clinkering temperature, and is finally discharged in the form of little balls varying in size from that of a pea to that of a walnut, into the cooler. In this country and on the Continent the most usual form of cooler is an inclined rotating cylinder about 30 to 50 feet in length and 4 to 5 feet in diameter, supported and rotated in a similar manner to the kiln. The interior of this cylinder is provided with a number of channel irons, so that as it rotates, the clinker is continually lifted up by these irons and caused to fall, thus being fully exposed to a current of air which passes through the cylinder on its way to the kiln. The cooler therefore serves the double purpose of cooling the clinker and heating the air supply of the kiln. In America it is more usual to employ vertical coolers. The earlier forms consist of a vertical tower, the interior of which is provided with conical baffles. The hot clinker is discharged from the kiln into a pit from which it is raised by means of an elevator to the top of the cooler. As it descends the latter it is spread over the conical surfaces, and thus exposed to a current of cold air supplied through branches from a central blast-pipe. Sometimes the clinker is partially cooled by sprinkling it with water as it descends into the boot of the elevator. When this type of cooler is used the whole of the heat given up by the clinker is lost, but in the later forms of vertical cooler a portion of this heat is utilized. In the *Mosser cooler* there are two cylinders, one within the other. The cold air enters the central blast pipe, and, passing through holes arranged in rings at intervals of 5 feet along the pipe, enters the inner cylinder, where it cools the clinker. The heated air then passes through holes in the wall of this cylinder, into the outer one, from which it is conveyed to the coal feed. *Shaking coolers* are also used in some works. In these, the hot clinker

from the kiln falls into an enclosed inclined tray, the bottom of which is formed by a series of steps. The vibration imparted to the clinker by the shaking motion of the tray gradually carries it to the lower end, where it is discharged. Cold air is drawn in at both ends of the tray, and, after cooling the clinker, is discharged into a hot-air chamber, and thence to the kiln.

The clinker may be ground as soon as it is cool, or it may be stored for a time and ground as required. The latter course may be adopted because clinker can be stored more satisfactorily than ground cement, but the clinker from the rotary kilns is often stored for a few weeks in order to allow it to soften. The effect of this treatment depends, however, upon the degree of burning and the composition of the clinker; low-limed clinkers readily fall to powder, and those which are higher in alumina crumble more readily than those which are more siliceous.

Properly burnt clinker is a dark brown or greenish-black, hard, but somewhat porous material. When underburnt, however, it is comparatively soft and generally has a greenish-grey colour, but it may be yellow or pink, or even of a reddish or purple tint. It is known as *half-burnt*, *slack*, or *pink*. Overburnt clinker is hard and non-porous, it is usually of a bluish-black colour, with a metallic appearance. The clinker from vertical kilns is commonly in large lumps, and always contains some underburnt and overburnt material. Before it is ground it is necessary to pick out all the underburnt and overburnt pieces; particularly the former, because, owing to the free lime which they may contain, these are actually harmful to the cement. This underburnt material is usually thrown aside and reburnt. The clinker from rotary kilns is in the form of small rounded lumps, which are much harder, and usually much darker in colour, than that from vertical kilns; like the latter, it usually contains some underburnt

and overburnt material, but these should only be present in small quantities.

The clinker from vertical kilns is first crushed in machines of the swing-jaw type (see p. 55) or between toothed crushing rolls, and is then ground to a fine powder. At one time French burr millstones were always used for this purpose, but at the present time these are only used in some old works, and the grinding is carried out in mills of various types. The ball-mill (see p. 57) followed by the tube-mill (see p. 59) is the most usual arrangement, but any of the mills described on pp. 57 to 62 may be employed. In many old works the millstones and edge-runners are retained as coarse grinders, preliminary to the finishing mills. A *sieveless ball-mill* in combination with a *Selector* sifting machine (see p. 74) has recently been introduced in Germany for grinding Portland cement clinker, and also for grinding the raw materials. It is claimed for this arrangement that the output is about 20 per cent. higher than that of other machines, for cement of the same degree of fineness, and that a superfine cement, known as *Selector cement*, may be prepared by it at the same cost as ordinary Portland cement prepared by other means. Of course cement of the same degree of fineness can be prepared in mills other than the sieveless ball-mill, and there is no difference between the cement thus produced and selector cement. The clinker from rotary kilns does not usually require any preliminary grinding because of its small size, but on account of its extreme hardness it is more difficult to grind than the clinker from vertical kilns. The same types of mill are employed for grinding the clinker in either case.

Even when vertical kilns are used it is sometimes necessary to treat the clinker in order to regulate the setting time; when rotaries are used, however, such treatment is imperative, because the ground cement sets almost

instantaneously if the clinker is ground as it comes from the coolers, and used without any further treatment. The most usual method of regulating the setting time is to add a little gypsum or plaster of Paris to the clinker before or during the grinding, but sometimes the same result is obtained by moistening the clinker with water, or a combination of the two methods may be employed. Where tube-mills are used as finishing mills, *Bamber's* method of regulating the setting time may be employed with advantage. In this method, steam under a suitable pressure is passed into the tube-mill, through the hollow trunnion at the feed end; the setting time of the finished cement depends upon the pressure of the steam admitted.

Most of the modern grinding machines used in the cement industry are provided with suitable sieves, but when edge-runners are employed for grinding the clinker, the ground cement is conveyed from the mills to an elevator which raises it to the sieves by which the coarser particles are retained, and returned for further reduction, whilst the fine flour passes on and is conveyed to the warehouse, where it is deposited in bins or silos. The sieves used for this purpose are of various kinds and shapes; revolving ones of circular, hexagonal or octagonal cross-section are frequently employed, as are also flat, shaking sieves. *Air separators* are much more efficient than sieves for this purpose, and their use is rapidly increasing. These are all modifications of the original *Mumford* and *Moodie* or *Askham air separator*, which was introduced about the year 1884. In all cases the fine and coarse particles are separated by means of a current of air. One of the most modern and also one of the best of these separators is the *Selector*, which is shown in section in Fig. 13. In this separator the rotating spreader extends almost to the outer casing, and beneath it a number of rotating sheet

steel rings are arranged with spaces between. The material is fed on to the spreader and is driven outwards, by centri-

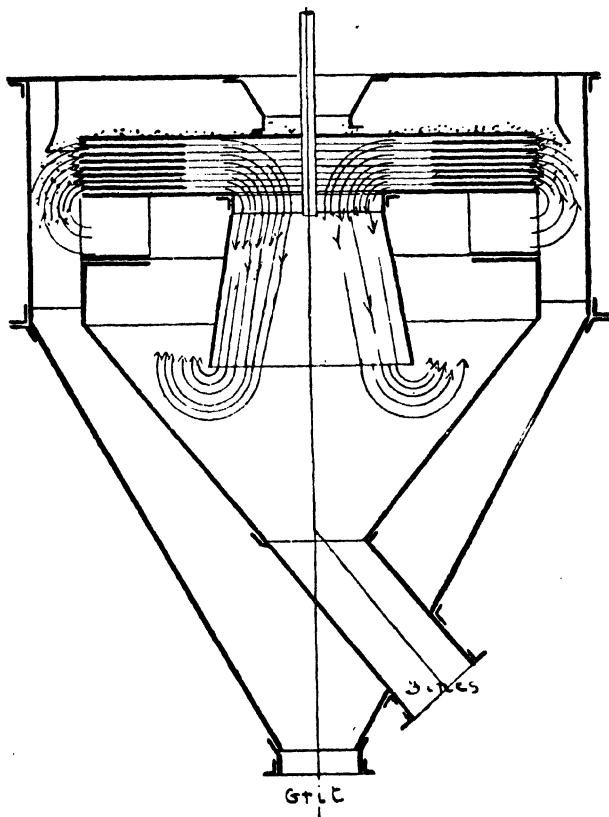

FIG. 13.—The Selector.

fugal force, into the space between the inner and outer casings, whilst a current of air, produced by means of

rotating fans placed beneath the steel rings, is caused to pass through the floating material in the direction shown by the arrows. The fine flour is borne by this air current through the spaces between the rotating rings and delivered into the inner casing, whilst the coarser particles are again driven outwards, by centrifugal force, and escape by way of the outer casing.

The finished cement is conveyed by means of elevators and conveyors to the storage bins or silos, where it may be kept for several weeks before packing. In this country it is usual to store the cement in flat-bottomed bins, the floors of which are level with the loading platform, the cement being dug out of these bins and packed by hand. In some Continental works silos with hopper-shaped bottoms are used, from which the cement is discharged through a spout into sacks or casks placed beneath. In most American works the silos have slightly sloping floors and automatically discharge their contents into a common tunnel, where the cement is conveyed to the packing room by means of a screw conveyor. Both on the Continent and in America the packing is often effected by means of automatic machines, but in this country it is usually carried out by hand.

Owing to the large amount of dust generated at most of the stages of the process of cement manufacture, especially where the older methods of grinding are employed, it is necessary that this should be collected. *Expansion chambers*, such as those described on p. 69, are the only means available for separating the dust from gases at a high temperature, as in the case of the air from the driers, kilns, and coolers. These chambers may also be used for collecting the dust from the crushing and grinding mills, but in this case *filters* and *collectors depending upon centrifugal force* are also employed, the last-mentioned are, however, usually less satisfactory than the filters. In the

Belt dust collector, the dust-laden air is drawn through a number of cylindrical sleeves made of textile material, and the dust is left adhering to the interior of the latter. The sleeves are automatically cleaned from adhering dust, which falls into the hopper bottom of the box containing them, and is removed by means of a screw conveyor.

Commercial Portland cement should be of a cold bluish-grey colour; a brownish, "foxy" appearance indicating an excess of clay, the use of an unsuitable clay or an underburnt cement. The specific gravity should not be less than 3.10. The cement should be very finely ground, as only the finest particles are of value as a cementing material.¹ Formerly, Portland cement was much too coarsely ground, but in modern practice it is not unusual to produce cement of such a degree of fineness that less than 10 per cent. is retained on a sieve containing 180 meshes to the linear inch, and the tendency is to increase the fineness of grinding. The setting time varies considerably, according to the treatment the cement has received during manufacture (see p. 73). In this country cements are graded according to their setting time into "quick" setting, "medium" setting, and "slow" setting cements. Portland cement is much stronger than any other hydraulic calcareous cement. The tensile strength of the neat cement, after seven days, is generally between 500 and 700 lbs. to the square inch, and the crushing strength is usually about ten times as great. Both the tensile and crushing strength increase during a period extending over a year or more; they are greater with neat cement than with mixtures of cement and sand, the decrease in strength being proportional to the amount of sand used.

Although Portland cement may be made from a variety of raw materials, the composition of the finished product is

¹ D. B. Butler, *Proc. Inst. Civ. Eng.*, 1898, 133, 343

practically constant. The essential constituents are lime, silica, and alumina; less important components are oxides of iron, magnesia, and the alkalis, whilst sulphur is usually present in small amounts. Carbon dioxide and water are not found in any notable quantities except in old or improperly burned samples.

According to the British Standard Specification for Portland cement (1915) the proportion of lime to silica and alumina (calculated on the chemical equivalents) must not be greater than the ratio $\frac{\text{CaO}}{\text{SiO}_2 + \text{Al}_2\text{O}_3} = \underline{2.85}$, or less than the ratio $\frac{\text{CaO}}{\text{SiO}_2 + \text{Al}_2\text{O}_3} = \underline{2.0}$, whilst according to the German "Normen" this ratio (based on actual weights) must not be less than 1.7, no higher limit being specified. It is often said that there should be no free lime present, or the cement will "blow" and disintegrate after setting, owing to the slaking of the lime, but it is very improbable that ordinary free lime is ever found in modern Portland cement.

Magnesia is nearly always present in small amounts. It combines with silica and alumina to form silicates and aluminates similar to the corresponding calcium compounds, but which hydrate much more slowly, so that a cement consisting of a mixture of calcium and magnesium silicates and aluminates is likely to suffer disruption after setting. According to Messrs. Newberry the silicates and aluminates of magnesium possess no hydraulic properties, and magnesia is incapable of replacing lime in cement mixtures. The British Standard Specification (1915) does not permit more than 3 per cent. of magnesia in Portland cement, whilst the German "Normen" allows as much as 4 per cent.

The presence of *oxides of iron* is the principal cause of the colour of commercial Portland cement, the pure material

being almost snow white in colour. At the clinkering temperature these oxides combine with the lime to form *ferrites* which, according to Le Chatelier, slake and decompose in the presence of water, but do not set. If any sulphides are present these react with the iron compounds to form ferrous sulphide, which is afterwards oxidized to ferrous oxide, and finally to ferric oxide.

The only *alkalies* usually found in Portland cement are *soda* and *potash*. These are mainly derived from the clays and clay shales; they are generally present to the extent of about 0·5 to 1·0 per cent., in the form of silicates. As some of these silicates are soluble in water, they may play an important part as carriers of silicic acid during the setting of the cement.

The *sulphur* in Portland cement is derived in part from the calcium sulphate and iron pyrites (iron sulphide, FeS_2) present in the clay and clay shales, in part from the fuel, and in part to the gypsum or plaster of Paris which is usually added after calcination in order to retard the setting time. The presence of sulphur in the raw materials or fuel is always objectionable, owing to its tendency to become reduced to sulphide during the calcination. The sulphide then decomposes the ferrites with the formation of iron sulphide, and ultimately of iron oxides. Small amounts of calcium sulphate added after calcination are not only harmless, but are necessary to regulate the setting time. Larger quantities are, however, injurious because they lead to the formation of the highly expansive calcium sulpho-aluminate, and also because calcium sulphate is a much softer substance than Portland cement, and, owing to its greater solubility in water, is liable to be washed out of the mortar. The British Standard Specification (1915) allow a maximum of 2·75 per cent. of sulphur trioxide (sulphuric anhydride, SO_3), and the German "Normen" fixes the limit at 2·5 per cent.

The following are typical analyses of Portland cement :—

	No. 1.	No. 2.	No. 3.
Lime	61·07	62·12	62·80
Silica	21·74	22·82	23·49
Alumina	8·01	7·01	6·34
Ferric oxide	4·35	3·49	2·85
Magnesia	1·04	1·16	1·07
Alkalies, etc.	0·83	0·54	0·68
Sulphur trioxide	0·94	1·04	0·90
Loss on ignition	0·81	1·03	0·98
Insoluble residue	1·08	0·83	0·94
	99·87	100·04	100·05

The properties of Portland cement do not, however, depend so much upon the proportions of the constituents mentioned above as upon their state of combination, and a great deal of work has been done on the constitution of cement clinker and the processes of setting and hardening. These investigations, which include those of other hydraulic calcareous cements, have been carried out along four different lines. (1) By the analysis of the cements and the study of their chemical and physical properties. (2) By the synthesis of the probable or possible constituents of the cements, and the comparison of the properties of the products thus obtained with those of cements. (3) By the microscopic examination of cement clinker and of hardened cement. (4) By the investigation of the reactions which occur during the formation and cooling of cement clinker, especially by observing the changes in the electric conductivity. Conclusions which have been arrived at as a result of investigations on several different lines are, of course, the most trustworthy, but no generally acceptable complete theory has yet been put forward, and much more research work remains to be done before these questions are finally settled.

1. But little regarding the constitution of cements can be learnt from their analysis, or from the study of their

chemical properties, although, of course, the composition which gives the best results can be ascertained by these methods. This was naturally the earliest method of investigation, but, although it produced good results as far as the early study of the hydraulic limes was concerned (see p. 7) it is practically abandoned at the present time for other methods.

2. In the synthetic method the supposed constituents are built up from pure lime, silica, alumina, etc., mixed in definite proportions, and the behaviour of the compounds thus obtained is then investigated. Fremy was one of the first chemists to employ this method of studying the constitution of the hydraulic limes and cements (see p. 8). Some years afterwards Landrin studied the calcium silicates, but the most striking advance in our knowledge of the chemistry of Portland cement was made by Le Chatelier.¹ According to this investigator, tricalcium silicate, $3\text{CaO}.\text{SiO}_2$, is the constituent to which the hardening of Portland cement is due, whilst the initial setting of the cement is principally due to tricalcium aluminate, $3\text{CaO}.\text{Al}_2\text{O}_3$, but also to dicalcium aluminate, $2\text{CaO}.\text{Al}_2\text{O}_3$, and monocalcium aluminate, $\text{CaO}.\text{Al}_2\text{O}_3$, as all three compounds set in water. Tricalcium silicate cannot be formed by the direct combination of lime and silica, but is produced in the cement clinker by the fusion of lime and a silicate. Dicalcium silicate, $2\text{CaO}.\text{SiO}_2$, forms twinned crystals, which, owing to the unequal contraction of the opposite faces, separate on cooling and thus cause the spontaneous disintegration of cement clinker. Monocalcium silicate is unacted upon by water, and can therefore have no effect upon the hardening of the cement. Later on S. B. and W. B. Newberry² found

¹ H. Le Chatelier, *Compt. rend.*, 1882, **94**, 867, 1883, **96**, 1056. *Annales des Mines*, 1887 (8), **11**, 345. *Recherches Experimentales sur la Constitution des Mortiers Hydrauliques*, 1904.

² S. B. and W. B. Newberry, *Jour. Soc. Chem. Ind.*, 1897, **16**, 887.

that when powdered tricalcium aluminate was mixed with water it cracked after setting and completely disintegrated when immersed in water. They also claimed to have prepared tricalcium silicate by the direct union of lime with silica. According to these investigators, the most important constituents of Portland cement clinker are tricalcium silicate and dicalcium aluminate. In 1906 Day, Shepperd, and Wright¹ attempted to show that tricalcium silicate cannot be prepared from lime and silica alone, and that the material prepared by Messrs. Newberry consisted of an intimate intergrowth of crystals of lime and of calcium orthosilicate. More recent work, however, has fully demonstrated the existence of tricalcium silicate, and its presence in Portland cement. Although the synthetic method was used in these investigations the microscope played an important part in the study of properties of the products obtained. Richardson also has studied the optical and other properties of the silicates and aluminates of calcium, and has shown that tricalcium silicate is moderately hydraulic, dicalcium silicate is much less so, and monocalcium silicate has little or no hydraulic properties. Monocalcium aluminate was not considered to be sufficiently basic to enable it to exist in the free state in such a basic material as Portland cement.

3. Two methods of investigation by the microscope are employed. In the first a chip of clinker of suitable size is ground down to a sufficient thinness, polished on both sides, and mounted on a microscope slide, after which the specimen is examined by transmitted light by means of a petrological microscope, and the various constituents identified. Owing to the difficulty of preparing such thin specimens it is more convenient to adopt

¹ A. L. Day, E. S. Shepherd and F. E. Wright, *Amer. J. Sci.*, 1906 (4), 22, 265.

the second method, which is similar to that used by metallographists. In this method one side only of a small piece of clinker is ground, polished, and etched with a suitable medium. The surface is then examined under the microscope by means of reflected light. When the surface is etched with a one per cent. alcoholic solution of hydrochloric acid, and examined under the microscope, a number of crystalline grains are observed imbedded in an inter-crystalline matrix. The structure of the clinker from rotary kilns is essentially the same as that from vertical kilns, except that it is usually much finer. This method has the advantage that it can be used to examine the hardened cement, which is much too soft to prepare such thin specimens as are required for the first method of examination.

At least four different kinds of crystals were observed by Le Chatelier and also by Törnebohm,¹ who proposed the names "alite," "belite," "celite," and "felite," by which these constituents are generally known. *Alite* is in the form of nearly colourless crystals belonging to the rhombic system. It appears to be the principal constituent of Portland cement clinker, and the greater the proportion of lime in the clinker the greater the quantity of alite found in the clinker. It forms the crystalline grains observed in etched clinker. Pure alite has been prepared and found to contain lime, silica, alumina, ferrous oxide, and magnesia. According to Le Chatelier some of the grappiers (see p. 18) consist almost entirely of alite. *Belite* is not so light coloured as alite, and generally shows fine striæ. It is not always present in cement clinker, but is generally found in samples which are poor in lime. *Celite* appears to be the only other essential constituent besides alite of Portland cement clinker. It is evidently the more fusible portion of the clinker, because it forms a matrix between the grains of alite, so that it must have been in a state of fusion at the

¹ Törnebohm, *Ueber die Petrographie des Portlandzements*, 1897.

clinkering temperature. Celite is of a deep brownish orange colour ; it contains more iron than does alite, and an increase in the proportion of ferric oxide in the clinker results in a corresponding increase in the amount of celite. *Felite* is not often found in cement clinker, but is a constituent of blast furnace slag ; the calcination of the clinker at a high temperature favours the production of this constituent.¹ Richardson² considered that cement clinker should be regarded as an alloy ; in the case of pure cement the alite was thought to be a solid solution of tricalcium silicate in tricalcium aluminate, and the celite a solid solution of dicalcium silicate in dicalcium aluminate, whilst commercial Portland cement was regarded as a complex alloy which also contained compounds of iron oxide and lime corresponding to the aluminates. The magnesia, alkalies, and sulphur trioxide were regarded as non-essential constituents. The solid solution theory found great favour with other investigators and was almost universally held for a time. It has, however, had to be abandoned, and Richardson has since admitted the error of his former conclusions, which were due to the insufficiency of the older petrographic methods.³ Keiserman⁴ has investigated the specific absorption capacity of the chief constituents of cement for a large number of dyes, and finds that *patent-blue* is the best dye for the detection of alumina, alcoholic *anthropurpurin* for free lime, a solution of *methylene blue* in acetic acid for combined silica, and a neutral solution of the same dye for free amorphous silica. Employing his staining process, he has made a microscopic examination of cement, from the results of which he concludes that it is a conglomerate of dicalcium silicate and tricalcium aluminate, the presence

¹ H. Kappen, *Tonind. Zeit.*, 1905, **29**, 370.

² C. Richardson, *ibid.*, 1903, **27**, 942. *Cement*, 1903, **4**, 276.

³ A. A. Klein, *Trans. Faraday Soc.*, 1919, **14**, 14.

⁴ S. Keiserman, *Koll. Chem. Beihefte*, 1910 **1**, 423. *Cement and Eng. News*, 1911, **23**, 6 and 56.

of alumino-silicates being considered improbable. The proportions in which the constituents exist in the clinker correspond to the formula $4(2\text{CaO}.\text{SiO}_2) + 3\text{CaO}.\text{Al}_2\text{O}_3$.

4. The most usual method of investigating the reactions which take place during the formation and cooling of cement clinker is by means of the changes in the electrical conductivity of the mixture. Here again, however, recourse may be had to the microscope and the heat-microscope, and also to the preparation of pure synthetic materials. Ditter and Jesser¹ have made a thermal and microscopical study of the change which takes place during the sintering process in the manufacture of Portland cement, and have found that the conductivity gradually increases until a temperature of 1375°C . is attained. At this point, and also at 1500° , the process is endothermic, but between 1425° and 1430°C . the reaction is strongly exothermic. The sintering of the particles can be observed by means of the heat-microscope at about 1375° , and between 1425° and 1450° there is a sudden separation of crystals of alite, with a little celite. Jänecke² has investigated the quaternary system, $\text{CaO}-\text{SiO}_2-\text{Al}_2\text{O}_3-\text{Fe}_2\text{O}_3$, and concludes that ferric oxide only occurs in combination with lime, and does not form solid solutions, and that a single ternary compound is formed, the composition of which is $8\text{CaO}.2\text{SiO}_2.\text{Al}_2\text{O}_3$. He regards this compound as being identical with alite, and considers that its existence explains why the presence of alumina is necessary in Portland cement. Finally, he concludes that belite probably has the composition $2\text{CaO}.\text{SiO}_2$, celite the composition $3\text{CaO}.\text{Fe}_2\text{O}_3$, and felite the composition CaO . A year later Jänecke and Schumann³ found that the compound $8\text{CaO}.2\text{SiO}_2.\text{Al}_2\text{O}_3$ forms the principal component of Portland cement clinker, in which

¹ E. Ditter and L. Jesser, *Zentr. Chem. anal. Hydraul. Zements*, 1910, **1**, 71. *Chem. Zentr.*, 1911, **1**, 1329.

² E. Jänecke, *Zeitsch. anorg. Chem.*, 1911, **73**, 200.

³ E. Jänecke and K. H. Schumann, *ibid.*, 1912, **74**, 428.

it is readily detected. According to Rankin and Wright,¹ however, Jänecke's supposed compound is really a mixture of calcium silicates and aluminates, containing, at ordinary temperatures, tricalcium silicate, dicalcium silicate, and tricalcium aluminate.

Rankin,² working with pure oxides, has shown that Portland cement clinker is produced by the formation of the following compounds. Water and carbon dioxide are driven off, the oxides then combine to form dicalcium silicate and pentacalcium trialuminate, $5\text{CaO}\cdot 3\text{Al}_2\text{O}_3$, which, as the temperature increases, combine with more lime with the formation of tricalcium silicate and tricalcium aluminate. He regards the finished clinker as consisting essentially of a mixture of the compounds $3\text{CaO}\cdot\text{SiO}_2$, $2\text{CaO}\cdot\text{SiO}_2$ and $3\text{CaO}\cdot\text{Al}_2\text{O}_3$, together with some $5\text{CaO}\cdot 3\text{Al}_2\text{O}_3$, and, possibly, a small amount of free lime.³ Investigations carried out by the Bureau of Standards, Pittsburg, support this view. According to Klein⁴ the constituents of properly burnt Portland cement are dicalcium silicate, tricalcium silicate and tricalcium aluminate; free lime is also usually present in small quantities. Neumann⁵ has also shown that the existence of a ternary compound in Portland cement is extremely unlikely. Accepting Rankin's view, given above, he regards tricalcium silicate as the essential constituent of the cement, and considers that the tricalcium aluminate acts chiefly as a flux which reduces the temperature at which the former constituent is produced. According to Campbell⁶

¹ G. A. Rankin and F. E. Wright, *Zeitsch. anorg. Chem.*, 1912, 75, 63.

² G. A. Rankin, *J. Franklin Inst.*, 1916, 181. *Trans. Faraday Soc.*, 1919, 14, 23.

³ G. A. Rankin and F. E. Wright, *Amer. J. Sci.*, 1915, [iv.], 39, 1.

⁴ A. A. Klein, *loc. cit.*, p. 84.

⁵ B. Neumann, *Stahl u. Eisen*, 1918, 38, 953.

⁶ E. D. Campbell, *J. Ind. Eng. Chem.*, 1917, 9, 943.

the tricalcium aluminate is to be regarded as a solid solution of lime in pentacalcium trialuminate. The clinker should contain a ternary eutectic, there being two such eutectics within the range of its usual composition, and the presence of this eutectic structure has been shown by Desch and others.¹ The results of these recent investigations are well established, but Jänecke² still insists that *élite* consists of the definite ternary compound $8\text{CaO}\cdot\text{Al}_2\text{O}_3\cdot 2\text{SiO}_2$, and considers that other investigators have not succeeded in obtaining this compound simply because they have not heated the mixture to a sufficiently high temperature.

As shown above, the work of the last few years has done much to clear away our doubts and errors regarding the constitution of Portland cement, but there still remains a great deal to learn about this interesting and important subject. According to Messrs. W. and D. Asch, there is not one Portland cement, but a number of closely allied cements consisting of the calcium salts of highly complex alumino-silicic acids, which form a number of isomerides and polymerides. These are sometimes given elaborate constitutional formulæ based on those used in organic chemistry, but unlike the latter, the formulæ given for the alumino-silicic acids and their salts are purely speculative, and, although they look imposing, they are of little or no value. Indeed, the very existence of these compounds is extremely doubtful, let alone their exact constitution.

The chemistry of the setting and hardening of cement is of equal interest with that of the constitution of the clinker, and the remarks made above as to our knowledge of the constitution of these cements also apply to our knowledge of the phenomena of setting and hardening. Le Chatelier³

¹ C. H. Desch, *Trans. Faraday Soc.*, 1919, 14, 1.

² E. Jänecke, *Zeitsch. anorg. Chem.*, 1914, 89, 355.

³ H. Le Chatelier, *opus cit.*, p. 81.

has extended his theory of the setting of plaster of Paris (see p. 116) to Portland cement, and supposes that the initial setting is mainly due to the formation of a supersaturated solution of tricalcium aluminate which immediately deposits crystals of the hydrated salt, according to the equation

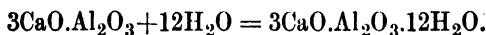

The solution is now able to dissolve a further quantity of the anhydrous tricalcium aluminate and at once deposits more of the hydrated salt, the two processes of solution and deposition going on simultaneously at adjacent points. The subsequent hardening is due to the decomposition of the tricalcium silicate, which in contact with water yields a hydrated monocalcium silicate, $(\text{CaO}.\text{SiO}_2)_2.5\text{H}_2\text{O}$, and calcium hydroxide. The first salt crystallizes out in minute needles and the second in hexagonal plates. Richardson¹ has since suggested a modification of this theory; he considers that the setting of Portland cement is due to the production of a peculiarly active form of hydrated lime which is produced by the action of water upon the calcium silicates and aluminates. According to Rebuffat,² the hardening of the hydraulic calcareous cements is mainly due to the hydration of the calcium orthosilicate, $2\text{CaO}.\text{SiO}_2$, and incidentally also to the hydration of the calcium aluminate, whilst Rohland³ attributes the hardening of these cements to the formation of solid solutions or absorption compounds. As far back as 1893, Michaelis⁴ suggested that the hardening of calcareous hydraulic cements—including Portland cement—was mainly due to the formation of colloidal (glue-like) calcium hydro-silicates. This theory was disregarded by

¹ C. Richardson, *Eng. News*, 1905, **53**, 84.

² O. Rebuffat, *Gazzetta*, 1898, **28**, ii., 209.

³ P. Rohland, *Zeit. Elektrochem.*, 1904, **10**, 893; 1905, **11**, 129 and 338. *Zeit. chem. Ind. Kolloide*, 1911, **9**, 21.

⁴ W. Michaelis, *Chem. Zeit.*, 1893, **17**, 982. *Cement and Eng. News*, 1907, **19**, 140; 1909, **21**, 298 and 338.

most chemists for some years, but is generally accepted at the present time, because it is strongly supported by a considerable amount of experimental evidence. Michaelis has also shown that the strength of the hardened colloid is increased by the crystallization of calcium hydro-aluminate and hydro-ferrite, and, when sufficient gypsum is present, of calcium sulpho-aluminate. Ambronne¹ has shown that when a little powdered cement is mixed with water under suitable conditions the formation of a gelatinous coating around the cement grains can be observed under the microscope, and both Rohland² and Stern³ have shown that the colloidal constituents in hardened cement can be dyed by immersion in a dilute solution of eosin or some other dye. Keiserman, using his staining method (see p. 84), concluded that the hardening of the cement is due to the dicalcium silicate, and commences by the formation of fine, needle-shaped crystals, which are imbedded in, and cemented by, the surrounding colloidal mass. The tricalcium aluminate accelerates the process of hydration but does not contribute towards the hardening process. Other workers have also used staining methods, and have confirmed much of Keiserman's work. Wetzel,⁴ however, has pointed out the dependence of the observations on the size of the cement particles, and Desch⁵ has found that the results obtained depend to a large extent on the concentration of the substances concerned. According to Blumenthal,⁶ calcium metasilicate and calcium aluminate are first produced in a crystalline condition, gelatinous silicates being formed later on; the hydration taking

¹ Ambronne, *Tonind. Zeit.*, 1909, **33**, 270.

² P. Rohland, *Zeitsch. anorg. Chem.*, 1907, **56**, 46.

³ E. Stern, *ibid.*, 1909, **63**, 160.

⁴ Wetzel, *Zentr. hydraul. Zemente*, 1911, **2**, 34.

⁵ C. H. Desch, *loc. cit.*, p. 87.

⁶ F. Blumenthal, *Dissert.*, Jena, 1912. *Tonind. Zeit.*, 1912, **36**, 1044. *Silikat Zeitsch.*, 1914, **2**, 43.

place by the following successive stages : (1) fine needles, (2) small hexagonal plates, (3) large hexagonal crystals, and (4) a gelatinous mass. This colloidal substance strengthens the mass by binding the crystals together and filling up the pores. Colony¹ considers the hardening of the paste to be due to the desiccation of a secondary amorphous substance formed by the reaction of the gelatinous material and the remaining constituents of the cement.

As in the case of the constitution of Portland cement clinker, much of the most important of the recent work on the hydration of Portland cement has been carried out at the Geophysical Laboratory, Washington, and the Bureau of Standards, Pittsburg; the hydration of the constituents of the cement being investigated separately, as well as that of the complete cement. Recourse was had to staining methods in these investigations. According to Rankin² the setting and hardening of Portland cement involve the production of an amorphous hydrated material which subsequently partially crystallises. The initial setting of the cement is probably due to the hydration of the tricalcium aluminate, whilst the hardness and cohesive strength are in the early stages due to the cementing action of the amorphous material produced by the aluminate, and of tricalcium silicate. The gradual increase in strength is due to the further hydration of these two compounds, together with the hydration of the dicalcium silicate. Tricalcium silicate is regarded as the essential constituent of Portland cement because it is the only one of the three compounds that take part in the setting and hardening of the cement which, when mixed with water, sets and hardens within a reasonable time to a mass

¹ R. J. Colony, *School Mines Quart.*, 1914, 36, 1.

² G. H. Rankin, *J. Ind. Eng. Chem.*, 1915, 7, 466. J. Franklin *Inst.*, 1916, 747. *Trans. Faraday Soc.*, 1919, 14, 23.

comparable to Portland cement in strength and hardness. Klein's¹ conclusions are in general much the same as those given above.

Although the colloidal theory appears to be well established, it has recently been strongly and somewhat petulantly attacked by Le Chatelier,² who maintains that his explanation of the setting and hardening of cement has not yet been weakened. The phenomena of setting and hardening are not yet completely explained, there are many reasons for accepting the views of both Le Chatelier and Michaelis as affording correct though only partial explanations. The process may be described as follows. On adding water to the cement the alite is partially decomposed, the calcium aluminates being attacked first, and the supersaturated solution thus obtained deposits tricalcium aluminate, partly in the form of crystals and partly in the form of a colloid. The calcium silicate is much more slowly attacked, and, owing to its insolubility, separates from solution as a colloid which forms a gelatinous coating around each cement grain. The hardening of the mass is brought about by the further hydration of the silicates, and, perhaps, of the aluminates. This view is supported by the fact that when hardened cement is polished and etched it is found to consist of a number of grains of unaltered cement clinker imbedded in a matrix, the colloidal nature of which is shown by its power of absorbing dyes, and that when such cement is reground and mixed with water it is still capable of setting and hardening, though to a lesser extent than the original cement.

According to Rohland,³ the part played by gypsum or plaster of Paris in the setting of Portland cement is that of a catalyst. Other salts may be used instead of calcium

¹ A. A. Klein, *loc. cit.*, p. 84.

² H. Le Chatelier, *Trans. Faraday Soc.*, 1919, 14, 8.

³ P. Rohland, *Zeitsch. angew. Chem.*, 1903, 16, 622; 1906, 19.

sulphate in order to modify the setting time, and those salts which accelerate the hydration of pure lime also accelerate the setting of cement, whilst those which retard the hydration of the one also retard the setting of the other. Also when two salts which have an accelerating effect, such as sodium carbonate and aluminium chloride, are used together, their combined effect is greater than the sum of their individual effects when used separately; on the other hand, when two salts which have a retarding effect, such as potassium dichromate and borax, are allowed to act together the retardation obtained is less than the sum of their individual effects. According to Bamber¹ the retarding effect of gypsum passes off when the cement to which it has been added is stored, but the retarding effect obtained by passing steam into the tube-mill during grinding is much more permanent.

Sea-water has sometimes been found to have a deleterious action on Portland cement. This was at one time attributed to the dissolving out of some of the lime from the cement and the precipitation of salts of magnesium; later on it was considered to be due to the formation of sulpho-aluminates. This view has much to commend it, because calcium sulpho-aluminate, $3\text{CaO} \cdot \text{Al}_2\text{O}_3 \cdot 3\text{CaSO}_4$, is known to be highly expansive, but, according to Rebuffat,² when cement is immersed in sea-water, sulpho-aluminates are formed to a very slight extent, and their existence is only transitory. On the other hand, Poirson,³ who has since investigated the action on powdered cement of solutions of the salts found in sea-water, finds that calcium sulpho-aluminate is the only stable compound formed.

At one time the adulteration of Portland cement was somewhat extensively practised; the choice of adulterants

¹ H. K. G. Bamber, *Trans. Concrete Inst.*, 1909, 1, 106 and 132.

² O. Rebuffat, *Gazzetta*, 1901, 31, i., 55.

³ L. Poirson, *Zentr. hydraul. Zemente*, 1910, 1, 151.

being naturally limited to those very cheap substances which resembled Portland cement in colour and general appearance. The most usual materials used for this purpose were *Kentish rag* (a siliceous limestone) and *blast furnace slag*, but other limestones, sandstones, and such substances as old fire-bricks were also used. These materials were, of course, added after the calcination of the clinker, and the only expense attached to their use was for grinding. Such adulteration is rare at the present time, at least so far as British and German cements are concerned, and the most usual fraud is the substitution of cheap Belgian natural cements and slag cements for Portland cement.

CHAPTER VII

VARIETIES OF PORTLAND CEMENT

THERE are several varieties of Portland cement which have been introduced for special purposes ; among which may be mentioned "white Portland cement," the "iron-ore cements," "sand cement," and "Super cement." The *eisen-Portland-zement* mentioned on page 49 may also be regarded as a variety of Portland cement, as it is a mixture of this material and granulated slag.

As already stated on p. 78, ordinary commercial Portland cement owes its colour to the presence of iron, the cements made in the laboratory from pure materials being almost snow-white in colour. A white cement, which is evidently made from much purer raw materials than those generally used, is sold under the name of *White Portland cement*. This cement meets the requirements of the British Standards Specification (1910). It is used for many purposes, such as for plaster and stucco, for repairing or joining marble pillars and blocks, making imitation marble, the manufacture of tiles, mosaic, etc., and as a substitute for plaster of Paris for making casts, reproducing statuary, and so forth, but it is too expensive to be used extensively for ordinary building purposes. The cement can be successfully coloured by means of such pigments as Venetian red, ultramarine blue, and yellow ochre.

The *iron-ore cements* are Portland cements in the manufacture of which a part or the whole of the clay is replaced

by iron ores, the finished cement thus containing a large percentage of ferric oxide. There must always be some alumina present, as all attempts to prepare Portland cement in which the whole of this substance is replaced with ferric oxide have ended in failure. The first cement of this class was introduced in 1901 by Messrs. Krupp, under the name of *Sidero cement*. The following analysis of an iron-ore cement is due to Michaelis.¹

Silica	23·26	per cent.
Alumina	1·67	„
Ferric oxide	8·20	„
Lime	64·84	„
Magnesia	0·66	„
Sulphur trioxide	1·08	„
	<hr/>	
	99·71	„

The specific gravity of these cements varies from about 3·25 to 3·44, and they are very slow setting. They are intended for use in marine work, it being claimed that they are not acted upon by sea-water, or by soda, lime, magnesia, and sulphate of iron. This claim has, however, been disputed.²

Sand cement is only Portland cement diluted with sand. It is prepared by mixing together equal weights of Portland cement and sand, and finely grinding the mixture. If the tensile strength of this cement be tested it will be found that the neat cement is almost as strong as neat Portland cement, but the tensile strength of a mortar made with 3 parts of standard sand to 1 of “sand cement” is much less than that of a similar mortar made with standard sand and Portland cement.

A variety of Portland cement was introduced by Mr. J. F. Goddard in 1915 under the name of *Super cement*. This cement is manufactured from Portland cement

¹ W. Michaelis, *Cement and Eng. News* 1907, 19, 140.

² *The Cement Age*, 1912, 14, 194.

clinker by grinding in with it treated gypsum instead of the ordinary gypsum used for regulating the setting time. Super cement was originally intended to be a waterproof Portland cement, that is to say, an ordinary Portland cement to which material was added in order to render it waterproof (see p. 158), thus obviating the disadvantage of having to entrust the mixing of the waterproofing compound to possibly careless or ignorant workmen. It was soon found, however, that the cement prepared in this manner not only produced a waterproof mortar, but the latter was also much stronger than ordinary Portland cement mortar, thus differing from the usual waterproofing materials, which tend to weaken the cement with which they are used. The increase in strength is specially marked in the case of cement and sand mortar, and the difference increases with time. This cement requires more water to produce a paste of "normal" consistency (see p. 186) than does ordinary Portland cement, and the mortar is both denser and harder. It is too soon to say definitely in what manner this addition of the treated gypsum acts upon the cement, but it certainly is neither a mere water repellent nor a pore filler. The main effect appears to be to bring about a more complete hydration of the cement particles.

A number of tests with this cement have been carried out by the author, and also by others, and it has been found that the same clinker invariably yields a stronger cement when ground with the treated gypsum than it does when ground in the ordinary way.

The following tensile and crushing results were obtained by Messrs. David Kirkaldy & Son. Both the Portland cement and the Super cement were made from the same clinker, but the former was ground with ordinary gypsum and the latter with the treated material.

TENSILE STRENGTH.

SAMPLE OF ORDINARY CEMENT.

Neat Cement.

3 parts Standard Sand. 1 part Cement.

Gauged with 23 per cent. water.

Gauged with 9 per cent. water.

Age 7 days.	Age 28 days.	Age 90 days.	Age 6 mths.
lbs.	lbs.	lbs.	lbs.
646	787	755	862
672	899	895	865
614	837	790	879
682	778	843	908
684	915	745	846
Mean 660	843	806	872

Age 7 days.	Age 28 days.	Age 90 days.	Age 6 mths.
lbs.	lbs.	lbs.	lbs.
342	397	474	487
374	413	487	500
406	436	421	461
382	450	459	502
350	429	427	476
Mean 371	425	453	485

SAMPLE OF SUPER CEMENT.

lbs.	lbs.	lbs.	lbs.
760	871	895	903
702	907	908	887
780	916	875	926
703	822	920	862
786	809	895	893
Mean 746	865	899	894

lbs.	lbs.	lbs.	lbs.
404	482	503	498
410	464	486	509
412	498	510	487
386	481	530	539
430	428	475	520
Mean 408	471	501	511

CRUSHING STRENGTH.

ORDINARY CEMENT.

1 and 3. Per sq. inch.
lbs.

Age 7 days—			
3320	}	3260
3370			
3080			
Age 28 days—			
4820	}	4470
4210			
4390			
Age 90 days—			
5230	}	5080
5030			
4990			
Age 6 months—			
6700	}	6580
6630			
6410			

SUPER CEMENT.

1 and 3. Per sq. inch.
lbs.

3970	}	4030
4000			
4130			
5330	}	5400
5620			
5260			
6260	}	6320
6540			
6150			
7670	}	7560
7610			
7390			

The tensile tests given below were carried out by the author—

TENSILE STRENGTH.

SAMPLE OF ORDINARY PORTLAND CEMENT.

Neat Cement. 3 parts Standard Sand. 1 part Cement.
Gauged with 25 per cent. water. Gauged with 10 per cent. water.

Age 7 days.	Age 28 days.	Age 90 days.
lbs.	lbs.	lbs.
605	670	718
599	662	696
593	657	696
573	656	682
Mean 592.5	661	698

Age 7 days.	Age 28 days.	Age 90 days.
lbs.	lbs.	lbs.
291	326	361
259	324	350
255	322	349
248	285	313
Mean 263	314	343

SAMPLE OF SUPER CEMENT.

lbs.	lbs.	lbs.
723	794	838
708	782	824
692	770	803
687	759	790
Mean 702.5	776	814

lbs.	lbs.	lbs.
413	436	472
395	429	458
393	422	450
389	418	449
Mean 397.5	426	457

This cement may truly be described as a waterproof cement. It is found that a slab 1 inch thick, made of a mortar composed of 1 part by weight of Super cement to 1 part of washed Thames sand, will keep back water under a pressure of over 300 lbs. per square inch. The cement is also petrol proof, a similar slab having been found to keep back petrol under a pressure of 50 lbs. per square inch for 67 days. At the end of this period the test was stopped and the slab broken, when it was found that no penetration had taken place. Advantage has already been taken of this property, a number of storage tanks for petrol having been built with Super cement reinforced concrete at various aerodromes.

CHAPTER VIII

THE NATURAL CEMENTS

THE cements obtained by calcining certain naturally occurring argillaceous limestones and finely grinding the product are known as *natural cements*; a preliminary mixing and grinding is sometimes necessary before burning. Such cements are, of course, really extreme types of eminently hydraulic limes which contain so little free lime that the clinker does not disintegrate when in contact with water; like all other hydraulic calcareous cements, they consist essentially of silicates and aluminates, and perhaps aluminosilicates, of calcium.

The first cement of this class was discovered by James Parker, of London, who in the year 1796 took out a patent (No. 2121) for the manufacture of a cement from the septaria nodules found in the London clay formation off the Island of Sheppey, and at other places along the Kentish coast. His process consisted in calcining the stone, previously broken into small fragments, to the point of incipient fusion, and then grinding the clinker to powder. The cement thus obtained was at first known as *Parker's cement*, but some years afterwards the inventor called it *Roman cement*, by which name it is still known.

Subsequently Mr. Frost discovered that the septaria of Harwich, on the coast of Essex, produced a cement of the same nature, and it became the custom to employ a mixture

of the Harwich and Sheppey septaria. Mr. Atkinson introduced another made from the nodules of the argillaceous limestones of the secondary formations of Yorkshire.

Similar nodules are also found on the Hampshire coast, in the Isle of Wight, in the bay of Weymouth, and in many other places in the marl beds intercalated between the limestones of the Jurassic system, and in the clays of the Cainozoic period. The nodules consist of a dark-coloured argillaceous limestone traversed by veins filled with calcareous spar. The colour is sometimes blue, especially when the nodules are obtained from the Lias; sometimes brown, or a deep red, in the Cainozoic formations, owing to the presence of ferric oxide in very considerable quantities.

The composition of the stones from which the cement is made differs very much; but the characteristic type may be said to consist of from 60 to 70 per cent. of calcium carbonate, 18 to 20 per cent. of silica, 6 to 10 per cent. of alumina, and small quantities of magnesia and oxide of iron. The following analyses were made by Berthier.

The stones experimented upon were—column 1, the Sheppey stone; column 2, the septaria of the coast near Boulogne; column 3, a stone from Matala in Sweden; column 4, a stone from the neighbourhood of Argenteuil, near Paris.

Calcium Carbonate	0·690	0·639	0·661	0·651
Magnesia	0·002	0·019
Oxide of iron	0·037	0·075	0·022	0·060
„ manganese	0·012	0·070
Silica	0·180	0·150	0·295	0·140
Alumina	0·066	0·048		0·060
Water	0·013	0·066		0·060
	1·000	0·978	0·978	1·060
Waste or error	0·022	0·022	0·060 deduct.
Total	1·000	1·000	1·000	1·000

Before being burnt, the stone is of a fine close grain, of a peculiar pasty appearance; the surfaces of fracture are rather greasy to the touch, and somewhat warmer than the surface of the stone. Examined with the microscope it exhibits many sparkling points, which may be either crystals of calcium carbonate or of some of the other constituents. It sticks easily to the tongue; it does not strike fire; its dust, when scraped with the point of a knife, is a greyish white for the most part, especially when derived from the blue lias formation. During calcination the cement stone loses about one-third of its weight, and the colour becomes of a brown tinge, differing from the stones from which the cement is obtained. When burnt it becomes soft to the touch, and leaves upon the fingers a very fine dust; and it sticks very decidedly to the tongue.

The cement stones are first calcined at a temperature below the point of vitrification in conical running kilns, and, in England at least, the fuel used is coal or coke. The mode of burning requires a considerable degree of attention, for experience has demonstrated that Parker was mistaken in supposing that a commencement of vitrification was necessary. On the contrary, the practice of manufacturers at the present day is rather to under-burn the cement, with the object of economizing the expense of grinding. The clinker thus obtained is then crushed, finely ground, and packed in casks. The cement clinker may be kept unchanged for a considerable time and absorbs water with so much difficulty that General Pasley was almost justified in stating that it could not do so, but after it has been ground it deteriorates rapidly in contact with moist air and should, therefore, be used as soon as possible after grinding.

There does not appear to be any definite rule in the London trade respecting the size of the casks, or the nature of the means by which the cement is transported. This is of little importance so long as it is intended to use it in the

immediate neighbourhood of the source of supply. When, however, the cement has to be transported to a great distance, it should never be packed in barrels of more than 6 cwt. each, and the greatest precautions should be adopted to prevent the contact of the atmosphere in any manner whatever.

The following analyses of Roman cement are due to Knauss.¹

	From Harwich septaria.	From Sheppey septaria.
Insoluble matter	10·5	7·8
Silica (soluble)	17·4	19·4
Alumina	4·6	7·3
Ferric oxide	12·4	9·2
Lime	46·1	48·2
Magnesia	3·7	2·7
Alkalies	1·0	1·0
Carbon dioxide and water	4·3	4·4
Total	100·0	100·0

Roman cement is reddish-brown in colour and the specific gravity is about 2·5 to 3·0. It sets very rapidly, the time of setting varying with the temperature and amount of water used, and, if exposed to the atmosphere, with the temperature and state of humidity of the latter. If gauged with pure water at 15° C. a good neat Roman cement takes about ten minutes to set in air and from fifteen minutes to one hour to set under water. The setting time is longer in sea-water than in fresh, especially if the cement be also gauged therewith, and it may be increased by the use of plaster of Paris and other substances. Mixtures of Roman cement and sand set more slowly than the neat cement.

When mixed with sand in proportions varying from $\frac{1}{2}$ to 1, $1\frac{1}{2}$, and 2, to 1 of cement, the time of setting becomes from about 1 hour to about 1 h. 20 min. in the air; under water the time becomes proportionally longer. It may even, under sea-water, and if the mixture be also made therewith, extend, for the mixtures with large proportions of sand, to 24 hours. The strength of the best cement is much greater than that of mixtures of cement and sand in any proportions whatever. Both the tensile and crushing strengths are very low as compared with those of Portland cement.

Roman cement is a good hydraulic cement, and, on account of its property of setting rapidly, it is very useful for the protection of slow-setting Portland cement, concrete, etc., from the action of waves in marine work. For most purposes, however, it has been almost entirely superseded by Portland cement, because of the superior strength and hardness, and more constant composition and quality, of the latter. *Medina cement* is a variety of Roman cement which is made from a stone found in the Isle of Wight.

Similar materials to the cement stones of the Island of Sheppey are found on the Continent. In the year 1802 Le Sage prepared a cement which he called *plaster cement*, from the nodules found at Boulogne-sur-mer. Similar cements were prepared by Lacordaire at Pouilly in 1829, by Gariel at Vassy in 1831, and at other places. These French natural cements are all prepared in much the same manner as Roman cement, which, except for their lower specific gravity, they closely resemble. They are usually ground under edge-runners (see p. 57), and passed through wire sieves containing eighteen meshes per linear centimetre. Vassy cement is very dark in colour, on account of the large quantity of iron which it contains, and is very quick setting when freshly burned.

In most European countries natural cements are made from argillaceous limestones of very variable composition. The stone is usually burnt without any preliminary treatment and the resultant cement, consequently, varies both in composition and quality. The most important centre of this industry is at Tournai, in Belgium. These cements somewhat resemble Portland cement both chemically and in physical properties, and are therefore known as *natural Portland cements*. The name is somewhat misleading, because the natural cements not only vary considerably in composition, but are of lower specific gravity (about 2·1 to 3·1), set more rapidly, and are less strong. True Portland cement is made from the same rock, but in this case the composition is carefully adjusted by adding the required amount of non-clayey limestone, and the mixture is more thoroughly calcined. Unfortunately, the natural Portland cements are sometimes sold as genuine Portland cement. Cinders are often added, thus slightly increasing the strength of the material and considerably enhancing its resemblance to Portland cement so far as the colour is concerned.

The French *chaux de Teil* mentioned on p. 18 and the more eminently hydraulic *blue lias limes* of England mentioned on p. 25 may be regarded as belonging to the class of natural cements, rather than to the limes proper.

In some parts of France, especially in the ancient Lorraine, limestone beds are worked which yield a species of lime intermediate between the Roman cements and the eminently hydraulic limes. The best of these occur at Flavigny, and Richard Menil, near Nancy, where they are principally used for making floors of one piece, and of a smooth uniform surface. The stone is of a darkish brown colour; it is of a great tenacity, and very compact; its specific gravity is 2·62. The lime it produces is of a yellowish grey, and it sets very rapidly in water. Mixed

with the clean gravel of the Moselle, in the proportions of $4\frac{1}{2}$ to 1 of cement, the volume of the mixture diminishes one-fourth; it is then spread upon the form prepared to receive it, and well beaten.

Natural cements were of great importance in America before the introduction of the manufacture of Portland cement in that country, but their manufacture has fallen off considerably during recent years owing to the superior qualities of the latter cement. They are made from *cement rock*, a clayey magnesian limestone containing from about 13 to 35 per cent. of clayey matter, and usually containing a comparatively high percentage of magnesium carbonate. Cummings¹ divides the American natural cements into two classes, according to whether they contain a preponderance of bisilicates or trisilicates. The cements of the first class contain a larger proportion of lime, and are calcined at a higher temperature than those of the second class, which, excepting the high percentage of magnesia, resemble Roman cement. The cements of the first class are known in America as *natural Portland cements*, but, as they contain from 10 to 15 per cent. less of lime than does Portland cement, and vary somewhat in composition, the name is inappropriate. When non-clayey limestone is added to the cement rock so as to produce a clinker of the correct composition the cement obtained is a true Portland cement.

One of the best-known cements of the second class is *Rosendale cement*, which is made from the argillaceous magnesium limestone of the Appalachian range. The stone is loosened by blasting and is conveyed in trucks to the running kilns in which it is calcined. These kilns are cylindrical in form, with a conical contraction at the bottom. A portion of the charge is withdrawn

¹ U. Cummings, *American Cements*, 1898.

every twelve hours, and fresh layers of raw material and small coal are added as the charge descends through the kiln. The burnt stone is carefully examined and any underburnt lumps are picked out and returned to the kiln. The properly calcined material is broken up into pieces about the size of a hazel nut, in rotary mills of the coffee-mill type, known as *crackers*, ground (usually between millstones) and packed in paper-lined casks.

Rosendale cement contains a large amount of magnesia, whilst the silica and alumina are comparatively low. Thus, samples of this cement contain from about 15 to 18 per cent. of magnesia, about 18 to 25 per cent. of silica, and about 2 to 4 per cent. of alumina. According to Gillmore¹ the average tensile strength of the neat cement is 104 lbs. per square inch after seven days, and the average crushing strength after the same period is 546 lbs. per square inch. *Louisville cement* is similar to Rosendale cement, but contains less magnesia. It is made from cement rock obtained at Louisville, in Kentucky.

There are many brands of these American natural cements, the manufacture of which follows much the same course as that of Rosendale cement, with the exception of the temperature of calcination. Until recently the final grinding was carried out between millstones, and the degree of fineness of the finished product was only such that about 90 to 95 per cent. passed through a sieve containing 50 meshes per linear inch, but the advantage of finer grinding is now recognized. At some works the old-fashioned burr stones have been replaced by *rock-emery mills*, in which the skirts of the stone are formed of lumps of rock-emery cemented with metal run in whilst molten, whilst at others, mills of the types described on pp. 57 to 62 are employed.

The use of natural cements requires a great degree

¹ Q. A. Gillmore, *Practical Treatise on Limes, Hydraulic Cements, and Mortars*, 1874.

of skill and attention on the part of the workman. If the cement be not brought to a proper consistence—if too much or too little water be used—if it be not immediately employed as soon as made—it solidifies unequally, cracks, and adheres badly to the materials. The care requisite for its successful application constitutes, in fact, the great objection to the use of cement. It is always dangerous to be obliged to rely on the skill or integrity of workmen, who either do not understand the necessity of taking pains with their work, or who, from being paid by the piece, have an interest in slurring it over.

A small quantity of water only is necessary to work up cements to their greatest point of resistance, which General Treussart found to be the most successfully attained when the water was employed in the proportion of one-third of the cement in volume. It is necessary to beat up the cement very frequently; indeed, the more it is turned over before the setting commences, the harder it becomes. No more should be prepared than can be immediately employed, for without this precaution it will set before it can be used.

CHAPTER IX

THE PLASTER CEMENTS

THE plaster cements, of which plaster of Paris is the most important, are prepared from gypsum, or hydrated calcium sulphate, $\text{CaSO}_4 \cdot 2\text{H}_2\text{O}$, by driving off all or part of the water of hydration, and they, therefore, consist essentially of more or less dehydrated calcium sulphate.

Gypsum occurs in great abundance and in many varieties, differing in form, texture, and colour. *Alabaster* is a pure, white variety used for indoor statuary; *satin spar* is a fibrous form with a beautiful satin-like appearance; and *selenite* is a nearly transparent kind occurring in crystals. On account of their comparative rarity none of these varieties are employed for making plaster cements. The variety most used for this purpose is a massive form known as *massive* or *rock gypsum*, or sometimes as *plaster stone*, which is found in beds, frequently interstratified with layers of limestone and shale. *Gypsum earth* or *gypsite*, an impure, earthy variety, consisting of small grains of gypsum together with a large quantity of clay and sand, is also used, and *gypsum sands* are employed in Arizona, New Mexico, and some other western states of America. An anhydrous calcium sulphate, called *anhydrite*, also occurs, but it is not used for the preparation of the plaster cements.

Gypsum is found in England, at Alston, in Cumberland; at Shotover Hill, in Oxfordshire; and a variety of the

fibrous gypsum occurs in Derbyshire and in Cheshire. In the neighbourhood of Paris the plaster stone is met with at Montmartre, Belleville, Charonne, Ménilmontant, le Mont Valérien, Triel, Meulan, and Vaux. It is worked in the departments of the Soane and Loire, of the Rhône, of the Marne, the Seine and Oise, and of the Landes; in the Alps and the Lower Pyrénées; it is also found near Marseilles, Grenoble, Mont Blanc, and Mont Cenis; in Tuscany, Savoy, Spain, and Switzerland. An anhydrous variety is worked at Bergamo and Milan, which comes from the neighbourhood of Vulpino. In Germany there are also beds of it which are largely worked for the purpose of dressing the meadows; and in Canada large quantities are extracted for the same purpose, and also for the preparation of plaster. It is widely distributed throughout the United States, especially west of the Mississippi.

Geologically, gypsum occurs either in contemporary strata of great thickness (as near Paris) in the Cainozoic formations; or in the iridescent marls (*les marnes irisées*) of La Meuse, or the Aveyron; or in masses of a subsequent date in the different mesozoic rocks. These last masses are constantly in contact with the igneous rocks, and they are very frequently associated with limestones, dolomites, shales, rock-salt, bitumen, and sulphur in a distinct form. In America there are large deposits of gypsum in the formations of the Silurian, Devonian, and Carboniferous systems of the Palaeozoic period.

Pure gypsum is colourless, and, when in the crystalline form, translucent; owing to the presence of impurities, however, it is usually obtained as an opaque, fine-grained mass, which may vary in colour from white to reddish-grey or brown. It is usually very soft, so that it can be scratched by the finger nail, but the hardness varies, and sometimes the stone is as hard as the softer kinds of limestone. The hardest gypsum is said to produce the hardest

plaster. The specific gravity varies from 2.30 to 2.33, being usually about 2.31. It is slightly soluble in water; starting at 0° C. the solubility gradually increases until the temperature reaches 35° C., when one part of the salt dissolves in 432 parts of water; above this point the solubility again decreases. The solubility is greater in many saline solutions than in water, because of the formation of more soluble double salts which takes place in these solutions. When pure gypsum is treated with acids there is no effervescence, but samples containing limestone effervesce more or less vigorously, according to the amount of carbonate present. When heated to about 100° to 120° C., three-quarters of the water of crystallization is expelled, and the hemihydrate, plaster of Paris, $(\text{CaSO}_4)_2 \cdot \text{H}_2\text{O}$, is obtained; on raising the temperature to about 200° to 250° C., the remaining water is driven off and the so-called "soluble anhydrite" is obtained. At this stage the plaster is said to be *dead-burnt*. If the heating be continued still further, the anhydrous residue loses its power of combining with water and resembles natural anhydrite. The anhydrous sulphate remains undecomposed even when heated to redness, but it gives off sulphur trioxide at white heat. The specific gravity of plaster of Paris is 2.7, and that of the anhydrous sulphate is about 2.9 to 3.0, varying according to the degree of calcination. Both plaster of Paris and the "soluble anhydrite" are usually said to be more soluble than gypsum, but it is more correct to say that the rates of solubility are greater, for they both combine with water to form the fully hydrated sulphate, and, therefore, the ultimate solubility is the same in each case.

Rock gypsum is quarried either in open workings or in underground mines, according to the thickness of the bed, its depth below the surface, and the amount of dip. The greater number of the quarries round Paris are underground,

and at Montmartre, nearly the whole hill is thus dug out. The stone is broken up into small blocks, about the size necessary for rubble masonry, before it is carried to the kilns. Gypsite always occurs in deposits at or near the surface, and, after the removal of the soil, with which it is covered, it is loosened by means of harrows or ploughs, collected by means of wheeled scrapers, and stored in drying sheds.

Plaster of Paris is prepared from fairly pure samples of gypsum by converting it into the partially dehydrated compound $2(\text{CaSO}_4)\cdot\text{H}_2\text{O}$. *Cement plasters* are impure varieties of plaster of Paris, which are prepared from impure raw materials, or by adding a "retarder" during or after manufacture. They set much more slowly than true plaster of Paris.

The method of manufacture is the same in either case, the raw material being calcined and ground. The grinding may be carried out before burning, or afterwards, the latter method being the usual one, except in America.

The burning of the plaster stone at Paris, and throughout the Continent, is often managed in a very slovenly way. The kilns consist simply of three sides of a square enclosed by brick walls, covered with a rough tiled roof, in which spaces are left to allow the escape of the steam. Under this sort of shed (for that is a more correct name than that of a kiln) the plaster is arranged by constructing, firstly, a series of vaults of the largest stones, filling in the haunches as the arches are carried up. Upon these the remaining stones are piled, paying attention only to the fact that the larger ones should be near the fireplace formed by the vaults. These are subsequently filled with faggots, or other firewood, which is then lighted. The flames rise through the spaces left in the stones; they ascend gradually through the mass, and distribute the heat, as equally as may be, in their passage. This system of calcination, as might naturally

be expected, leads to a great waste of raw material, owing to the very slovenly way in which it is executed. As much as one-fifth is wasted in many of the kilns. Sometimes coal is used for fuel. In this case it is burnt in arched spaces beneath the floor, and the hot gases pass into the kiln through holes in the tops of the arches.

The *Dumesnil kiln*, shown in Fig. 14, is a great improvement on that described above, because the heat is much

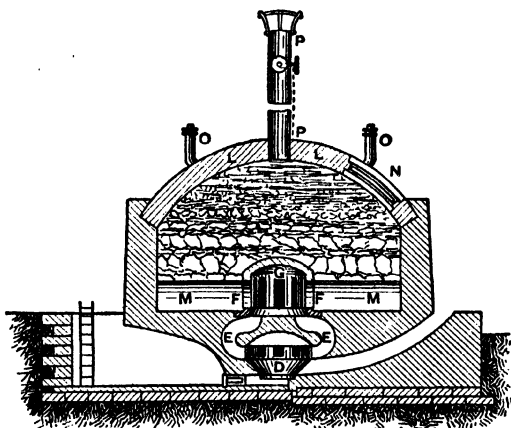

FIG. 14.—Transverse Section of the Dumesnil Kiln.

more under control, and is evenly distributed throughout the whole mass of plaster stone. This kiln is circular in plan, and has an arched roof, *L, L*, in which are four small flues, *O, O*, and one large central one, *P*, all of which can be closed by means of dampers. At the bottom of the kiln there is a central furnace, *D*, the flames from which pass through the flues, *E, E*, into the fire chamber, *G*, and hence through twelve openings, *F, F*, into an equal number of radiating arched flues, *M, M*, built of the larger pieces of plaster stone. There is a door at the side of the kiln for

the purpose of loading and unloading, and an opening, *N*, in the roof, which serves for filling the top of the kiln. In working this kiln the charge is dehydrated by means of a moderate fire, then about six or seven cubic yards of unburnt stone are added at the top, and all the openings are closed, when the second lot of stone is dehydrated by the heat still remaining in the former charge. Although this kiln is expensive to build, it is economical in working.

Sometimes gypsum is dehydrated by means of superheated steam. A jet of steam at a temperature of about 200° C. is blown alternately into each of two chambers charged with raw material; the water of hydration is rapidly absorbed by the steam, leaving the plaster ready for grinding. The waste gases from coke ovens are also used to dehydrate the plaster stone. Some of the London manufacturers adopt a continuous method of preparing the plaster. The gypsum is burnt in a kiln so arranged that the fuel is never in immediate contact with the stone; but the chimney from the fireplace passes round and round the kiln, and communicates its heat during the whole of its passage, rendering the interior, in fact, an oven.

The best quality of plaster is sometimes prepared on a small scale by a process known as *boiling*. The raw stone is ground to a fine powder and then spread in a layer about two or three inches in depth, upon a metal plate or shallow dish placed over a fire, care being taken to avoid too high a temperature. The water vapour given off from the lower layer appears to raise the remainder of the material and keep it in suspension with a peculiar motion to which the process owes its name of "boiling," and small craters are soon formed from which the steam escapes. The mass is stirred from time to time until no more water is given off, when the plaster is ready for use.

A somewhat similar method is used on a large scale in the United States, where it is the practice to prepare plaster

by *boiling in kettles*. This method is superior to the old-fashioned European processes, but it is slow and expensive, and is therefore being gradually abandoned in favour of calcination in rotary kilns. The gypsum is first ground and then charged into cylindrical iron kettles. The powdered material must be kept constantly stirred by mechanical means until the calcination is complete. As the temperature rises to about 105° to 110° C. the contents appear to boil violently until all the mechanically held water is driven off through a stack passing through the sheet-iron cover, after which they settle down. On heating to 134° C., however, the "boiling" recommences, as the combined water of hydration begins to be driven off. When all this water of hydration has been expelled, the hot, finished material is run into a fireproof pit, left until it has slightly cooled, then passed through a revolving wire screen, in order to separate all large particles and coarse foreign matter, and is finally conveyed to the storage bins.

Rotary kilns for calcining plaster stone have been in use for a number of years both in Europe and America. The process is a continuous one. *Perin's barrel oven* consists of a rotary steel cylinder supported upon hollow trunnions, through which the heated gases from a furnace pass into and out of the cylinder. The material is charged through a hopper placed over the kiln. The *Mannheim calciner* is provided with a *Forewarmer*, which is placed above the rotating cylindrical calciner. The crushed raw material is passed into the former, along which it is carried by means of a worm conveyor, until it falls into the rotating cylinder, where it is calcined. The hot gases required for the calcination of the stone first pass through the rotating cylinder, then through the forewarmer, where they partially heat the stone, and finally through a dust chamber to the chimney. The heat is so well utilized in this kiln that the temperature of the gases passing to the chimney is only

about 80° C. The *Cummer rotary calciner* is much used in the United States. The rotating cylinder is surrounded by a brick chamber, into which the hot gases are drawn by means of a fan, and cooled to the required temperature by introducing a sufficient amount of cold air; they are then drawn into the calcining cylinder, where they partially dehydrate the stone. The hot material is conveyed by means of an elevator to the *calcining bins*, where the heat which it still retains completes the calcination. When cold, the plaster is ground, passed through sieves, and placed in sacks ready for market.

When the plaster stone is ground before calcination it is first crushed in a swing-jaw, or other coarse crusher (see p. 55), then passed through crushers of the coffee-mill type, and finally ground between French burr millstones, or other fine grinding machines (see pp. 57 to 62), until about 55 to 56 per cent. will pass through a sieve containing 100 meshes to the linear inch. The preliminary crushing is unnecessary when gypsum earth is used as the raw material, and the grinding is then carried out in two stages. When the grinding is carried out after the calcination, it is usually done between millstones, but edge-runners (see p. 57) or rollers are sometimes employed.

The ground plaster should be kept from contact with air as it readily absorbs moisture and deteriorates; unfortunately, however, but little attention is usually paid to this detail, and the plaster is generally placed in sacks instead of air-tight cases. It is sometimes the practice in France to preserve the plaster in heaps by slightly wetting the surface so that the crust thus formed protects the remainder of the heap. This plan is at once simple and effective.

Plaster is used for making casts, for plastering (see p. 148), and other building purposes, for cementing small objects, and as a top dressing for certain crops.

When plaster of Paris is mixed with water a species of confused crystallization takes place, with considerable evolution of heat and an increase in volume. It is this property of expansion which causes the plaster to fill any mould in which it is cast, and therefore makes it valuable for preparing casts. The first scientific explanation of the phenomena which accompany the calcination and hardening of plaster was given in 1765 by La Voisier,¹ who showed that the stone became partially dehydrated during calcination, and that when the burnt plaster was mixed with water it combined with a portion of the latter to reform the fully hydrated compound. With characteristic modesty La Voisier considered that his explanation was sufficient and that there remained nothing further to discover about this phenomenon. Marignac,² however, treated plaster of Paris with a large excess of water and then filtered. The filtrate was found to be five times as concentrated as a saturated solution of gypsum at the same temperature. This supersaturated solution soon became turbid and deposited crystals of the dihydrate. Le Chatelier³ has since shown that plaster of Paris is a definite hydrate of the composition $(\text{CaSO}_4)_2 \cdot \text{H}_2\text{O}$, and also that the dehydration takes place in stages, two distinct periods of rest being observed during the process, thus indicating an absorption of heat and pointing to the existence of two intermediate hydrates. He has also shown that when plaster is gauged with water it forms locally supersaturated solutions from which crystals of the fully hydrated salt are soon deposited. The solution then becomes able to dissolve more of the plaster and again deposits crystals, the process going on in this manner until the whole of the plaster has been hydrated and crystallized. The two

¹ A. L. La Voisier, *Compt. rend.*, 1765. *Œuvres Complètes*, 3, 122.

² C. Marignac, *Arch. sci. phys. nat.*, Geneva, 1873, 48, 120.

³ H. Le Chatelier, *opus cit.*, p. 81.

contrary actions occur simultaneously at adjacent points. The rate of hydration and setting depend upon the degree of concentration at which solution is maintained. Cloez¹ has shown that the heat evolved during the setting of plaster of Paris appears at two different stages, and Davis² has observed that the crystals of the dihydrate which separate at first are a rhombic modification of gypsum, but these subsequently pass into the stable form. According to Rohland³ the size of the particles of plaster have a considerable influence upon the rate of hydration, and the setting and hardening is a colloidal process, but this view is not supported by evidence and is not generally accepted.

Plasters made from impure gypsum are usually sufficiently slow setting, but pure plaster of Paris sets with extreme rapidity, and, in order to moderate this action, it is a common practice to add various substances known as *retarders* to the cold calcined plaster. The materials most usually employed for this purpose are glue, sawdust, blood and other substances of animal or vegetable origin. There are also many patent retarders which consist essentially of the same or similar substances. It is usual to add from 2 to 15 lbs. of the retarder per ton of plaster, the mixing being carried out in a mixing machine such as the *Broughton mixer*. Sometimes *accelerators* are added in order to hasten the setting of an impure plaster. These are crystalline salts, one of the most efficient accelerators being sodium chloride (common salt).

Plaster may be hardened by the addition of various substances. A solution of glue or of gum arabic may be employed, as in the preparation of "stucco" (see p. 153),

¹ C. Cloez, *Bull. Soc. Chim.*, 1903, [iii.], 29, 171.

² W. A. Davis, *J. Soc. Chem. Ind.*, 1907, 26, 727.

³ P. Rohland, *Zeitsch. angew. Chem.*, 1905, 18, 327. *Kolloid Zeitsch.*, 1913, 13, 61.

or the plaster may be mixed with a little freshly slaked lime and the casting dipped in a strong solution of magnesium sulphate. Another method is to use a solution of sodium silicate (water glass), but the most usual plan is to use a solution of alum, as in the preparation of the "hard finish" plasters (see p. 119). The casting may be placed in the alum bath for some weeks and then slowly dried, or the plaster may be soaked in the solution, dried again and calcined. Still another method consists in mixing the plaster with a little finely ground mallow root and kneading the mixture in water, or gauging the plaster with a decoction of mallow root.

Flooring plasters give a hard and durable surface which is very suitable for floors, etc., on which account they are used to a large extent in Germany, where they are known as *Estrichgips*. They are prepared by coarsely crushing a relatively pure plaster stone and calcining it in a vertical kiln at a temperature of about 400° to 500° C., for not more than four hours. If the heating be continued for a longer period than this, the plaster becomes entirely deprived of its setting power. The fuel employed is generally coal, and is burnt on a grate at the side of the kiln, the hot gases passing through the mass of the gypsum. The calcined stone is then very finely ground. The flooring plasters set with extreme slowness, but finally acquire great hardness. They consist essentially of anhydrous calcium sulphate, CaSO_4 . According to van't Hoff and Just,¹ when gypsum is completely dehydrated the ability to combine with water is at first only retarded, but gradually becomes lost, either by prolonged exposure to a high temperature or by submitting it to more intense heat. Hence the necessity for keeping the temperature between 350° and 500° C., and for discontinuing the calcination after four hours.

¹ J. H. van't Hoff and G. Just, *Sitzungsber. Kgl. pr. Akad. Wiss. Berlin*, 1903, p. 249. *Chem. Centr.* 1903, 1 (15), 900.

The group of plaster cements known as *hard finish plasters* resemble the flooring plasters in consisting essentially of anhydrous calcium sulphate, but they are calcined at a higher temperature (sometimes at a red heat) and are usually treated with various chemicals, such as alum, during the process of manufacture. The calcination is carried out in two stages, the plaster stone being first calcined, then dipped in a solution of alum, borax, or other salt, and again calcined at a high temperature, after which it is finely ground. *Keene's cement* is now the general name for a number of different plasters of this class, prepared by various manufacturers, the original patent having expired. It is usually prepared by first calcining the plaster stone so as to form plaster of Paris; dipping this in a solution of alum or aluminium sulphate, drying, and recalcining at a much higher temperature. Sometimes, however, the first calcination is carried out at a high temperature, and sometimes other salts are used instead of alum; indeed, in some cases, the plaster is prepared without dipping in any solution, when it is, of course, really a "flooring plaster." *Mack's cement* is prepared by adding calcined sodium sulphate or potassium sulphate to completely dehydrated gypsum. *Martin's cement* is similar to Keene's, but the solution of alum is replaced by one of potassium carbonate. *Parian cement* may also be prepared in the same manner as Keene's cement, by employing a solution of borax in place of alum, or it may be manufactured by burning an intimate mixture of powdered gypsum and dry borax and grinding the product to a fine powder. All these plasters set rapidly, and are hard and durable, but they are all liable to one objection, namely, the expense.

CHAPTER X

THE SLAKING OF LIMES

THE subject of the slaking of lime is of great importance, not only in connection with the ordinary preparation of mortar for structural work, but also in the manufacture of *hydrated lime*, and *sand-lime bricks*.

The object to be attained in ordinary slaking is to reduce the quicklime into a pasty hydrate, as unctuous as possible, and one which has absorbed the greatest possible quantity of water without having taken up too much, and thereby lost a proper consistence. As we have already seen that every separate variety of limestone produces a lime of a different chemical composition, it would in all probability be found that it would be dangerous to decide, before making experiments upon each of them, the mode of slaking which would be the most advantageous. Three methods may be employed, (a) immersion or maceration, (b) sprinkling with small quantities of water, and, (c) allowing the lime to slake spontaneously by absorption of the moisture in the atmosphere. The method chosen in any particular case depends to a large extent upon the kind of lime employed.

All the rich limes, as we have already seen, are capable of being slaked by immersion; they keep in a plastic state under water, and they even gain by being allowed to remain therein, for all the core becomes thus slaked. Plinius states that the Romans were so convinced of the truth of

this, that the ancient laws forbade the use of lime unless it had been slaked for three years ; and that it was owing to this regulation that their works were not disfigured by cracks or crevices. Alberti mentions, in the eleventh chapter of the second book, that he discovered once, in an old trough, some lime which had been left there five hundred years, as he was led to believe, by many indications around it ; and that this lime was as soft and as fit to be used as at first.

In the preparation of ordinary mortar for building purposes, it is the custom to add considerably more water than is required to merely slake the lime, the result being that a paste is obtained. Although this method ensures a thorough slaking of the lime, there is some danger of using too much water, the excess of which might somewhat impair the quality of the mortar. Fat lime is frequently slaked by total immersion in water for some days, whilst hydraulic limes which, like the blue lias limes, do not slake readily, are first wetted with water and then covered over with sand or sacks, in order to retain the heat. Moderately hydraulic limes require at least two days to slake, and more hydraulic limes should be allowed from seven to fourteen days. Such limes should always be sifted after slaking in order to remove any imperfectly slaked lumps, and it is advantageous to grind the lumps of clinker before adding the water, so as to bring every particle into contact with the latter. If the lime is not perfectly slaked before being made into mortar the unslaked particles will ultimately absorb water and expand, so that the masonry in which it is employed may be ruptured.

If just sufficient water be added to a lump of hydraulic lime, only the calcium oxide will be hydrated, but the expansion due to the slaking of this portion of the material will cause the whole lump to ultimately crumble to a

fine white powder, consisting mostly of calcium silicate calcium aluminate, and calcium hydroxide; the same result is obtained when the lime is exposed for a sufficient length of time to the atmosphere. It is still usual in this country to sell hydraulic lime in lumps, just as they come from the kilns. A much better plan, which was first proposed by Vicat, is, however, employed in France, where the slaking is carried out at the limeworks. The lime is spread out in layers, sprinkled with just sufficient water to bring about complete slaking of the free lime, shovelled into heaps, and kept for about ten days, the slaking becoming completed by the steam thus generated. The slaked material is then sieved in order to remove all lumps (*grapiers*), after which the lime is ready for market. As described on p. 18, the lumps which fail to pass the sieves are ground and sold as a cement, but a portion of this ground material is added to the lime in order to increase its hydraulic properties.

The practice of slaking hydraulic limes at the limeworks has often been condemned, especially in this country, on the grounds that the slaked material gradually absorbs carbon dioxide from the atmosphere and thus loses some of its concretionary power. This argument, however, is due to a confusion between the processes of setting of air and hydraulic limes. The setting and hardening of hydraulic lime is due to the action of water on the calcium silicates and aluminates present, and the slaking of the calcium oxide only serves to disintegrate the lumps (see p. 14).

During comparatively recent years ready-slaked lime has been somewhat extensively sold under the name of "*hydrated lime*," "*new process lime*," and other fancy titles. The methods employed in preparing this lime vary considerably in detail, but the general procedure is much the same in each case. The lumps of quicklime are ground

to a fairly fine powder, which is then thoroughly slaked with water, and finally passed through fine sieves or air separators (see p. 74), thus being brought to a uniform, fine powder of slaked lime. The greatest differences in the methods of preparing hydrated limes are to be found in the methods of slaking. In some cases the lime is simply sprinkled with water, but in the more recent methods comparatively elaborate processes designed to ensure complete saturation with water are employed. The *Kritzer hydrator* consists of six cylinders, each of which is provided with a screw conveyor. The cylinders are connected to a 40-foot stack, which is water-jacketed to a height of 30 feet, so that the water becomes heated to about 43° C. by the hot gases. The powdered lime is fed into the cylinder where it is conveyed along in the opposite direction to the gases, and is discharged in a fully hydrated condition. The hydrated lime is then passed through air separators. It is claimed for this process, that the plasticity of the lime particles is not interfered with, and that there is no risk of crystallization on account of excessive heat. Other well-known hydrators are the *Schaffer*, the *Lauman*, and the *Clyde*.

Although lime has no action upon sand at ordinary temperatures, at moderately high temperatures there is a reaction, and this fact is made use of in the manufacture of *sand-lime bricks*. The sand is mixed with about 5 to 10 per cent. of lime and the mixture moulded into bricks, which are then exposed to superheated steam at a temperature of about 150° C. The lime reacts with a portion of the sand, forming calcium silicates, which cement the sand grains together. These sand-lime bricks are quite strong enough for ordinary building purposes, and are used in localities where clay suitable for brick-making is not available, and sand is abundant.

CHAPTER XI

SANDS, POZZOLANAS AND OTHER MATERIALS USED WITH LIME IN THE PREPARATION OF MORTAR

SEVERAL kinds of material are used to mix with lime in the preparation of mortar. They are, 1, the sands, properly so called, whether fluvial or pit-sand ; 2, the clays, either in their natural or their burnt state ; 3, the pozzolanas, trass, or other volcanic productions ; and, 4, the produce of artificial calcination, such as cinders, slag of furnaces, or scorixæ.

1. Sands are derived originally from the decomposition of the older rocks, either by the action of running water, or by other means. They are technically distinguished from dust, by the fact that they sink at once to the bottom of water, without leaving any sensible quantity in suspension. The decomposition of the rocks often gives rise to a kind of agglutinating substance, which accompanies the sand, and binds it together. But this only takes place in the positions where the sand is found "in situ" ; washed by the rains and the running waters, it soon parts with such heterogeneous particles, and it arrives in a comparatively pure state into the bed of the principal rivers. This purity is lost as the rivers approach their embouchures ; for, in the first place, the diminished velocity of the current causes the heavier particles to subside before arriving there ; the waters then only carry down the light earthy particles,

and the decaying vegetable matter which may fall into them, thus giving rise to the formation of clay deposits. The constituent parts of the sand represent faithfully the rocks from whence they are derived; thus the granitic rocks produce a sand, the principal ingredients of which are quartz, feldspar, and mica; the volcanic rocks are represented by sands in which lava, obsidian, etc., appear; the flat, soft-grained sands arise from the disintegration of the schistose rocks; the calcareous rocks, as might naturally be expected from their soft nature, are those which are the least represented in the series.

Immense deposits of sand are found among the rocks and soils of the Earth's crust, in places where rivers have long ceased to flow. Sand extracted therefrom is known under the name of "pit-sand," to distinguish it from that borne down by the rivers, called "river-sand," and from the "virgin-sand," which remains in the places where formed, without in any way suffering the action of water. *Pit-sand* has been deposited by the action of water at some more or less remote period, and the grains are usually somewhat rounded and waterworn, though sharper and more angular than those of *river-sand*; they are sometimes mixed with clayey matter.

In many places near the sea-coast there are large tracts covered with *blown-sand*, which forms constantly shifting hillocks and ridges. This sand naturally consists of very small, round grains, because the wind has most effect upon the smallest grains, and all the angles soon become rubbed down by the action of the shifting grains upon each other.

Sea-sand varies considerably in size of grain, etc.; the grains are often very round and smooth, and the sand is contaminated with salts from the sea-water.

The most important sands for the preparation of mortar are the river and pit-sands. Those which are mixed with loamy, clayey, or organic matter must be thoroughly washed

in clean water, as these impurities are injurious to the mortar, especially to cement mortar. The grains should be angular, the surface of rough texture, and they should vary between $\frac{1}{4}$ and $\frac{1}{8}$ of an inch in diameter. "Blown-sand" is not suitable, because, although clean, the grains are too small and too rounded. Sea-sand, when not too water-worn, may be used, but should be thoroughly washed in clean fresh water in order to get rid of all the salts with which it is contaminated.

Generally speaking, siliceous sands are the best, and calcareous or argillaceous sands are unsuitable for making mortar, but there are exceptions to this rule. There exists certain species of sand in very large masses in some parts of France, where it forms even entire hills, which is derived from the decay of trap, basalt, and other igneous rocks, and have slight pozzolanic properties. These are known under the name of "arènes," and were largely used in conjunction with rich limes for river and water works, but are of little importance at the present time. Some of the decomposed greywacke rocks also yield an argillaceous sand, composed of quartz, schiste, feldspar, and particles of mica agglutinated by a species of clay, which is very valuable, whether used in its natural state, or calcined to make artificial pozzolanas, like the arènes. The granitic rocks of Devonshire, some parts of Brittany and of the extreme north-west of Spain, all of which are characterized by a remarkable excess of feldspar, yield a sand of great value for building purposes, especially when the mortars composed of it are not immediately exposed to the effects of running water. In all probability, the potash present in the decomposed and decomposing feldspar may influence the setting of the limes mixed with the sands thus obtained.

Crushed sandstone, quartzite, or quartz furnish very suitable sands for mortars.

2. The clays are rarely used in their natural state in

combination with lime, unless it be to give a certain degree of consistence to mud walls or pisé work. When burnt, they act somewhat in the manner of pozzolanas; and for all cases in which the mortars thus made are not exposed to the action of sea-water, they appear to answer very well. The Romans were perfectly aware of the practical value of this process; for many of their works, which have survived to the present day, especially the aqueducts, were executed with a mortar containing pounded bricks or tiles.

M. Raffineau de Lille made a very important essay of the artificial cements obtained from pounded bricks in some works he executed, in fresh water, near Calais. There it answered as well as the ancient Romans had found it to have done. He called the attention of Vicat to the question, and that eminent engineer, after a laborious series of experiments, arrived at the conviction that the action of the burnt clay was in every respect analogous to that of the natural pozzolanas. Berthier had previously shown that the latter materials consisted principally of aluminium silicate mixed with a very small proportion of lime and iron; and, as Vicat found the clays to differ in their composition only in the fact of their being aluminium hydro-silicates with nearly the same foreign ingredients, he thought that all that was necessary to render the clays as useful for hydraulic purposes as the pozzolanas, would be to drive off the water of combination. His experiments led him also to believe that a low degree of heat produced the best results, provided that it were managed in such a way as to allow the free access of the air to all parts of the matter in incandescence.

General Treussart applied similar artificial pozzolanas on a large scale at Strasbourg. Other essays were made at Algiers, the Fort Boyard in the Ile de Ré, at Brest, and at Cherbourg. At Strasbourg no accident has occurred; but in all the cases where the cements thus prepared were

exposed to the action of sea-water, they appeared to set very satisfactorily at first—the favourable appearances lasted even for three or four years, but at the expiration of that time all these cements fell to powder.

Vicat studied the causes of these failures, and was led by them to the conclusion that the calcium hydroxide had been attacked by the magnesium chloride present in the sea-water, and had ultimately been converted into a double carbonate of calcium and magnesium, similar to dolomite (see p. 24). This would be accompanied by a mode of crystallization different from that of the ordinary calcium carbonate, and, therefore, lead to the disintegration of the whole mass. In view of the more recent work on the effect of sea-water on Portland cement (see p. 92), it seems likely that one of the causes of the failure of these cements was the formation of the highly expansive calcium sulpho-aluminate, $3\text{CaO} \cdot \text{Al}_2\text{O}_3 \cdot 3\text{CaSO}_4$.

These artificial pozzolanic materials are rarely used at the present time, owing to the superior results obtained with Portland and other cements.

3. *Pozzolanas* are volcanic lavas, which, owing to the action of superheated steam and other gases, have become pulverulent, and have gained hydraulic properties. They derive their name from the town of Pozzuoli, near Naples, where, according to Vitruvius, the material was first found. They are also found in several other parts of Italy, in south-eastern and central France, and in the Azores and other places. Typical pozzolana consists principally of silica and alumina, with smaller amounts of lime, magnesia, oxides of iron and alkalis.

The silica is in such a condition that it readily combines with lime in the presence of water, forming calcium silicates. The following table, giving the analyses of two pozzolanas, is due to Gallo.¹

¹ G. Gallo, *Gazzetta*, 1908, 38, ii., 156.

	Pozzolana.	
	From Pratolungo.	From Vesuvius.
Silica	46·24	48·45
Alumina	19·26	17·81
Ferric oxide	11·18	3·49
Ferrous oxide	—	3·35
Lime	9·82	12·09
Magnesia	2·84	3·02
Sodium oxide	2·66	5·46
Potassium oxide	2·77	5·01
Water and volatile matter ..	6·10	0·60
Total	100·87	99·28

Pozzolana varies very much in appearance ; sometimes it is in a state of powder, at others in coarse grains ; often in the form of pumice, scoriæ, or of tuffa or small rubble-stone. It is mainly amorphous, but contains crystals of mica and other minerals. The colour may be white, grey, brown, black, yellow, or violet-red.

The pozzolana is generally obtained in small open cuts or pits, but some of the Italian workings are of great depth, those of the Trentaremi being about 600 feet deep. It is screened and ground, and, sometimes, slightly roasted. Owing to the careless manner in which the Italians mine and prepare the pozzolana, they have brought their material somewhat into dispute, and that from the Azores is generally preferred. A reddish coloured pozzolana found in these islands is known as *tetin*. Another variety known as *tosca* is found in Teneriffe, in the Canary Islands ; it is chiefly used in Spain.

A somewhat similar material to pozzolana is found on the west bank of the Rhine, in the Eifel district, between Bonn and Andernach. This material, which is called *trass*, is a pale yellow or grey coloured, metamorphosed, volcanic

ash. The following table, giving the analysis of trass, is due to Berthier and Feichtinger.¹

	Berthier.		Feichtinger.	
Silica	57.0	53.08	59.3	
Alumina	16.0	18.28	12.2	
Ferric oxide	5.0	0.48	8.5	
Ferrous oxide	—	3.33	—	
Lime	2.6	1.25	6.2	
Magnesia	1.0	1.31	1.9	
Sodium oxide	1.0	3.44	3.3	
Potassium oxide	7.0	4.17	3.5	
Water and volatile matter ..	9.6	12.65	3.5	
Total	99.2	97.99	98.4	

Trass is usually more compact than the true pozzolanas, but some varieties are light and porous, resembling pumice. It is used to some extent in Holland in hydraulic engineering work.

Santorin earth is a light grey coloured volcanic ash found in the Island of Santorin or Thera, in the Grecian Archipelago. It is very similar to pozzolana and trass, but contains a larger percentage of silica; it also contains pumice, quartz, and feldspar.

Sandstones and limestones which have been altered by contact with the rocks of eruption also frequently take the character of pozzolanas, and may be classed, therefore, as pseudo-volcanic products of a similar category. But the conditions under which they were exposed to the heat of the volcanic rocks, and under which they gradually cooled, have necessarily modified their chemical and physical nature. In the neighbourhood of Catania, on the east coast of Sicily, there are beds of a small red gravel, which have been produced by the action of molten lava on clay.

¹ Feichtinger, *Chem. Technologie*, 1885, p. 82.

This material is used to a large extent for local building purposes, and acts admirably as a pozzolanic material.

Essays have also been made with the basaltic and trap rocks in the same manner as with the pozzolanas, and the result has been found to be the same. The difficulty of breaking or pounding them, however, is a very serious objection to their economical employment. According to Vicat, basalt should be burnt so as to produce a vitrification before it is employed for this purpose.

At the present time these naturally occurring pozzolanic materials are rarely used in England for making hydraulic mortars, and they are only used to a limited extent on the Continent, because of the superior results obtained with the natural and slag cements, and especially with Portland cement.

4. *Slags* are fusible substances produced during metallurgical operations by the combination of the flux with the siliceous and earthy impurities of the ore. They are generally vitreous compounds which closely resemble the volcanic lavas. Somewhat similar substances obtained from glass furnaces are also known as "slags." *Scoriæ* are the lighter, more porous, and less perfectly vitrified substances, which arise principally from the puddling and refining of iron; the term is also applied to the less compact portions of the slag. *Cinders* are the earthy residues from the combustion of woods, peat, coal, or other combustibles.

The slags and scoriæ differ very considerably in their chemical nature, partly from the composition of the ores from which they are obtained, partly from the different action of the furnaces from whence they are produced. They principally consist of silica, with smaller amounts of lime, alumina, magnesia, and oxides of iron, and, sometimes, manganese. The scoriæ, however, contain considerable quantities of iron.

When ground into powder, the scoriæ and slags make

very good mortars if mixed with moderately or perfectly hydraulic limes. With the former it is not advisable to use them in positions where the mortars would be exposed to the action of running water ; with the latter they may be used to replace sand, sometimes with advantage. When slags are simply crushed and ground they only act as sand, but certain varieties of slag become hydraulic when granulated, and are used in the manufacture of slag cements (see p. 48).

When properly mixed, coal cinders appear to render the rich limes moderately hydraulic. Great care requires to be exercised in their manipulation to proportion the quantity of water used, for they absorb it with such avidity that, unless there be a large quantity present, they abstract it from the calcium hydrate, and render the crystallization of the latter imperfect. Workmen characterize this action by saying that the lime becomes short ; in fact, its coherent powers are much diminished. If, however, the necessary precautions be taken, coal cinders may be usefully employed for works out of the water.

Wood cinders are often objectionable in consequence of the excess of alkali they contain : if this be removed by washing they may occasionally be useful in the absence of other materials capable of communicating hydraulic properties. So far as the author is aware, peat ashes have never been tried in any scientific manner ; but there does not appear to be any reason why they should not be as useful as those of wood.

The clinkers which fall through the fire-bars of lime-kilns owe their hydraulic properties to the combination of the lime with the aluminium silicate of the cinders. In Belgium they are very largely and very successfully used for canal and river works under the name of "*cendrée de Tournai*."

Vicat classes the different materials named and described above still further, according to the energy of their

action upon the limes with which they are mixed. He calls "very energetic" any substance which, after being mingled with lime slaked in the usual manner, and brought to the consistence of a stiff paste, produces a mortar capable of setting from the first to the third day; of acquiring after the lapse of twelve months a degree of hardness equal to that of a good brick; and of giving a dry powder if sawn with a tooth-saw after that time.

"Simply energetic," any substance which will determine the setting from the fourth to the eighth day; and which is capable of acquiring after twelve months the consistence of a soft stone, and of giving a damp powder under the tooth-saw.

"Slightly energetic," when the setting only takes place between the tenth and the twentieth day; the consistency of hard soap would be acquired after twelve months, and the mortar would then clog the tooth-saw.

"Inert," when the materials, if mixed with rich limes, exert no influence upon their action under water. In all these cases the mortars are to be immersed immediately. It is, moreover, to be observed that the degree of hardness attained is the only invariable characteristic, for the time of setting varies very considerably.

Having established these differences, Vicat ranges the common sands amongst the materials he classifies as "inert." The arênes and greywacke rocks yield materials which are but slightly energetic. The pozzolanas, whether natural or artificial, are classed occasionally as being simply energetic or very energetic, as the case may be. Experience, however, shows that the artificial pozzolanas should only be ranged in the first class.

These different actions appear to be owing to the affinity of the several materials for the lime. Vicat found, in fact, that, if treated by acids and by lime water, they were distinguished from one another as follows:—The inert

materials resisted the action of acids, except when calcareous sand was operated upon, and were totally without influence, even upon boiling lime water. The slightly energetic materials yielded in a trifling degree to the acids, and took up a small proportion of the lime from the lime water. The energetic, and very energetic, materials were powerfully affected by the acids, and took up a very notable portion of the lime in solution.

The same author gives, as the result of forty years' experience, the following tables of the materials it is advisable to mix together to obtain the best results in the respective cases mentioned. He supposes that the architect or engineer has under hand the four descriptions of lime, and the different substances to be mixed with them; and that in the first case he desires to obtain a mortar capable of attaining a great degree of hardness under water, under ground, or in places where there is a constant humidity; in the second case, where it is desired to obtain a mortar able to set rapidly in the open air, to resist rain, and the changes of the weather. He recommends, then, to mix with

CASE THE FIRST.

Rich limes.	Moderately hydraulic.	Hydraulic.	Eminently hydraulic.
The very energetic pozzolanas, either natural or artificial.	The simply energetic pozzolanas. The very energetic ditto, mixed with half sand or other inert matter. The energetic arènes, or grey-wacke rocks.	The slightly energetic pozzolanas. The energetic ditto, with half sand or inert matters. The slightly energetic arènes, etc.	The inert matters such as sand, etc. Slag, scorïæ, etc.

CASE THE SECOND.

Rich limes.	Moderately hydraulic.	Hydraulic.	Eminently hydraulic.
No ingredient can attain the object.	No ingredient can perfectly attain the object.	Any description of sand; pounded quartz. Dust of pounded limestone and other inert matters.	Any description of sand; pounded quartz. Dust of pounded limestone and other inert matters.

General Treussart does not agree with Vicat in supposing that the chalk, or rather the rich limes, cannot be rendered capable of setting by the mixture of pozzolanas. Gauthey, in his work upon the construction of bridges, however, seems rather to lean to Vicat's opinion; which is confirmed, it must be added, by the experience of the engineers of Toulon and Marseilles.

CHAPTER XII

MORTARS

MORTARS are divided into *common* or *lime mortar*, which is made with lime; *trass mortar* or *pozzolanitic mortar*, in which trass or some other pozzolanitic material is mixed with the lime; and *cement mortar*, which is made with Portland, natural or slag cement.

The making of common and trass mortars comprehends the slaking of the lime and the mixture of the ingredients worked up with it. As we have already seen, both the former process and the nature of the latter differ, according to the nature of the lime to be dealt with. It is, however, a universal rule, in contradiction to the slovenly practice of London builders, that all limes except the eminently hydraulic ones should be reduced to a paste before being mixed with the other ingredients. The degree of consistence of this paste should vary with the nature of the extraneous materials. It should be stiff whenever it is intended to form a gauge for substances whose particles are hard and palpable, and which are capable of preserving sensible distances from one another. It should be more liquid when the substances to be mixed with it are pulverulent, of impalpable and fine grains, presenting an homogeneous appearance, and in which it is impossible to distinguish the separate elements, such as the pozzolanas, etc.

Sand is mixed with the lime in order to reduce the shrinkage and to prevent the cracking which would take place if a paste made of lime and water alone were allowed to dry; the sand also renders the mass more porous, thus facilitating the absorption of the carbon dioxide upon which the ultimate hardening depends, and increases the resistance of the mortar to crushing. It also lessens the cost because sand is cheaper than lime.

The quantities of sand to be used vary, as might be expected, according to the nature of the limes, and also of the sand itself. Rich limes can be mixed with from 2 to $2\frac{1}{2}$ times the bulk of the lime before it is slaked, whilst hydraulic limes should be mixed with smaller proportions. Thus, blue lias lime should not be mixed with more than twice its bulk of sand, and equal proportions of lime and sand should be used on important work. It must be remembered that although fat lime will stand more sand, the strength of the mortar is less.

If it be required to mix common lime and pozzolanas, the best proportions, according to General Treussart, are 1 of lime in powder to $2\frac{1}{2}$ of pozzolana; 1 of lime to 2 of trass; or 1 of lime to 1 of sand, and 1 of pozzolana or trass.

The best hydraulic limes, as we have seen, lose much of their qualities if long exposed to the air; it is therefore advisable to work them only for the time absolutely necessary to ensure, firstly, their perfect reduction to the state of hydrates; and, secondly, the intimate mixture of the lime and sand. The rich limes, however, as we have before said, inasmuch as they absorb carbon dioxide with difficulty, gain by being exposed for a longer period to the contact of the atmosphere. As far as such a proceeding is consistent with economy, it is advisable, then, to protract the operation of their manipulation as much as possible; it is even advisable to work up large quantities of such

mortar beforehand, rendering it fit for use by a second manipulation.

Some of Vicat's experiments show that all limes lose two-fifths of their strength if mixed with too much water. It is then better to wet the materials to be used, and to employ a stiff mortar, than to follow the course usually adopted by masons and bricklayers of using very soft fluid mortar. The system of grouting is more than questionable in its results; the lime suspended in it is nearly destroyed, the extra quantity of water is but an addition to the difficulties of setting opposed to the mortar already in place.

There are conditions of the atmospheric state which affect the goodness of the mortars. For instance, those made in summer are always worse than those made in winter. This fact is probably accounted for by the too rapid desiccation of the mortar; and Vicat even asserts that they lose four-fifths of their strength if allowed to dry very rapidly. He recommends, in consequence, that the masonry be watered during the summer months, in all constructions of importance, to guard against this danger. Probably the hydrates are not in a favourable condition to absorb carbon dioxide if they be allowed to dry rapidly; the presence of the water being necessary for the combination of the lime and the gas.

The freedom of the water from carbon dioxide in solution is also a necessary condition of the successful use of the hydraulic limes. Their success depends, to a certain extent, upon the slow, gradual manner in which they take up that gas from the atmosphere, and crystallize about the nuclei offered to their action. Some engineers prescribe that the water should be deprived of such impurities by boiling, and although the precaution be rather exaggerated, it is certainly of a useful tendency.

As the lime reduced into a paste does but fill up the

voids of the materials it is mixed with, there is necessarily a very considerable diminution of bulk upon the quantities of the respective substances taken separately. The exact amount of this diminution varies, of course, with the limes or sand employed; but as a general rule it may be taken at about three-fourths of their collective volumes. To state this in a convenient formula: if a = the bulk of the lime, b = the bulk of the sand; then $(a + b) \times 0.75$ = the bulk of the mortar they will produce.

The position in which a mortar of any description is to be used also modifies the proportions of sand which it is desirable to mix with it. Underground, in the water, and in damp positions, less sand should be employed than in the open air, where it is exposed to the changes of the atmosphere.

It is often a matter of importance to know the powers of resistance of lime mortars; but, as they differ within a very large range, it is not easy to state them very precisely. The best experiments, however, show that we may safely calculate, for all practical purposes, upon a tensile strength of 14 lbs. per square inch, a crushing strength of 42 lbs. per square inch, and a resistance of $5\frac{1}{2}$ lbs. per square inch against a shearing force. It would not be safe to expose new works to greater efforts than those which could be included within the above limits.

Small quantities of mortar are mixed by hand, but when large amounts are required it is usual to employ some form of mechanical mixer. If the dimensions of the construction should be such as to justify the expense, it should be made a necessary condition that mechanical means be employed, for even with the greatest possible care the mixture by hand is never perfectly effected. In France, whenever great care is required in the fabrication of the mortars, the lime is worked up into a paste in a mill, consisting of two vertical stones working in a trough. The lime, after

going through this operation, is then mingled with the sand in a pugmill, or by hand, upon a floor.

Cement mortar may consist of a mixture of sand and water with natural, slag, or Portland cement, the last mentioned being by far the most frequently employed at the present time. It is much stronger than common mortar, but as it does not spread so freely it is usual to add more or less lime to the mixture, or sometimes loam is added instead of lime. Both these substances are detrimental to the strength of the mortar, though this fact is not generally recognized by builders. The proportion of sand to cement should not exceed 4 to 1, and in most cases should not be greater than 3 to 1. Cement mortar is mixed either by hand or in some form of mixing machine; unlike lime mortar, the materials should be thoroughly mixed in the dry state, and then the water should be added by sprinkling on through a rose.

Cement mortar is employed in masonry which is exposed to the action of running water or of waves, and, more recently, in many large works on dry land, where great strength is required; it is also used as a surface coating to cover masonry or concrete walls, and for other purposes.

CHAPTER XIII

CONCRETE

CONCRETE or *béton* consists of a conglomerate of pebbles or broken stones termed the *aggregate*, embedded in a matrix of mortar. The latter may be either lime mortar, as in the case of the ancient and mediæval concrete, or cement mortar, as in most modern work.

The use of lime *béton*, or concrete, is very ancient, for it is known to have been employed by the Romans; and Smeaton expressly states that he derived the idea of using it, as a backing for river works, from an inspection of the ruins of Corfe Castle, in Dorsetshire. In the Middle Ages it was very commonly used, as may be proved by an inspection of the ruins of feudal fortifications. General Pasley was, therefore, mistaken in awarding the merit of the introduction of this system to Sir Robert Smirke. At the present time concrete is extensively used for the purpose of distributing the weight of a large, heavy construction over the greatest surface possible; and for the backing of coursed masonry, in cases where walls are required of great thickness. Cement concrete is also much used for making blocks of artificial stone, and for the production of monolithic work. The use of concrete made with Portland cement has extended enormously during recent years, especially since the introduction of ferro-concrete.

The *aggregate* may consist of gravel, or broken stone,

or of such materials as broken bricks, slag, clinker, coke and ashes. Any compact crystalline stone may be used for this purpose, but it should be broken into rough angular fragments, as rounded pebbles do not bond so well with the mortar. Granite and the more siliceous igneous rocks are particularly suited for aggregates, and so are some varieties of sandstone. The shales and slates are not so suitable, as they do not form such a strong concrete, and are liable to decompose. On account of their decomposition by heat, limestones may cause the collapse of any structure in which they are employed, should the latter be exposed to fire, and there is a similar objection to flints on account of their tendency to "fly" when heated. Where a very light concrete is required and strength is not essential it is usual to employ a porous material such as pumice or coke for the aggregate. Owing to the presence of oxidizable sulphur compounds, however, coke is liable to expand and rupture the concrete, and ashes are even worse than coke, as they usually contain more sulphur. Slags and clinker are also liable to expansion owing to the presence of these sulphur compounds. Such materials as broken bricks and burnt clay do not form such strong aggregates as most of the natural stones, when used they should be as hard as possible, and are best when partially vitrified. Broken tiles and pottery are not suitable, because they bridge over each other, leaving large voids.

The material forming the aggregate should be of various sizes, as the mass will then be stronger and more compact than if all the pieces were uniform in size. The careful grading of the aggregate is of importance, as it is quite possible to nearly double the strength of the concrete by proper attention to this matter. Some gravels, however, do not require grading as they contain particles of the right sizes and in the correct proportions. For most purposes the largest particles of the aggregate should pass through

a hole one inch in diameter, but where large masses of concrete are employed, the aggregate may contain much larger pieces, and large stones or "plums" are embedded at intervals in the mass. The smallest particles should not be able to pass through a hole one quarter of an inch in diameter; all smaller material should be removed, preferably by washing, and the aggregate should be well wetted before use. The proportion of *voids* or spaces between the particles of the aggregate should not exceed 45 per cent.

The remarks already made concerning the sands used for mortar apply to those used in concrete. The most usual sands employed are siliceous pit and river-sands, but sea-sand and artificial sands obtained from crushed stone or slag are also employed, and, sometimes, pozzolanas. The sands should be clean and the particles should be well graded, varying in size from about $\frac{1}{24}$ to $\frac{1}{8}$ of an inch in diameter. They should have a rough surface and be angular.

For waterwork required to set rapidly, an excellent lime concrete may be made by a mixture of hydraulic limes, pozzolanas, and sand. The proportions found to yield the best results are given by Treussart, as follows:—

- | | | |
|----|--|----------|
| 30 | parts of hydraulic lime, very energetic, | measured |
| | in bulk, and before being slaked. | |
| 30 | „ of trass of Andernach. | |
| 30 | „ of sand. | |
| 20 | „ of gravel. | |
| 40 | „ of broken stone (a hard limestone). | |

The above proportions diminished one-fifth in volume after manipulation: the mortar was made first, and the stones and gravel then added. When Italian pozzolana is used, the proportions, for the same descriptor of work, become (measured in bulk, as before)—

- 33 parts of energetic hydraulic lime, measured before
slaking.
45 „ of pozzolana.
22 „ of sand.
60 „ of broken stone and gravel.

The first of these concretes should be employed immediately it is made: the second requires to be exposed about twelve hours before it is put in place.

In positions where sufficient time can be allowed for a concrete or *béton* to set (if made simply of lime, sand, and gravel), the expense of the pozzolana should be avoided. A very excellent concrete for either sea or river works is made by a mixture of mortar made of three parts of fine sand to one of hydraulic lime unslaked, with equal quantities of gravel or broken stone: the proportions of the last may often be augmented to $1\frac{1}{2}$ to 1 of the mortar without inconvenience. No water should be mixed with the mortar and gravel during their manipulation; the mortar itself, if possible, should be prepared in a pug-mill, and mixed with the gravel by being frequently turned over on a platform. Every precaution should be taken to prevent the different ingredients from being mingled with clay or other foreign matter.

The concrete thus made should be spread in layers from 10 inches to 1 foot in thickness, and well rammed, until the mortar begins to flush up at the top. A course once commenced should never be allowed to be interrupted until completed throughout the whole of its length. When the work is executed in water, other precautions require to be taken, not only for the purpose of compressing the concrete, but also to prevent the lime from being washed away. These must, of course, vary with the circumstances of each particular case (see p. 146); but we must always remember that works of this kind, executed under water, are far inferior to those executed in the open air.

The proportions employed in Portland cement concrete depend partly upon the class of work to be executed, and partly upon the quality of the cement used and the nature of the sand and aggregates. For foundations, and most other purposes, the proportions may be as follows:—

Cement	1 part by volume.
Sand	2 parts by volume.
Aggregate	from 4 to 6 parts by volume.

Much poorer concrete is sometimes used where it is only required to add weight, and strength is of no great importance; on the other hand, for certain purposes the concrete should be somewhat better. Thus, for a watertight reservoir wall the proportions may be—

Cement	1 part by volume.
Sand	from $1\frac{1}{2}$ to 2 parts by volume.
Aggregate	„ $2\frac{1}{2}$ to 4 „ „

In this case Portland cement could be advantageously replaced by Super cement (see p. 95).

The amount of water used depends upon the nature of the materials employed, the consistency desired, and the temperature at the time of mixing. For ordinary work, the amount of water used is generally between 20 and 30 per cent., but much drier mixtures are used when the concrete is required to set rapidly, and, on the other hand, very wet mixtures are sometimes employed. When the mixture is of a creamy consistency and the particles of aggregate are very small, it is known as *grout*. The water used should be clean, and not too hard; whenever possible clean rain-water should be employed. Where the concrete is required to possess the maximum resistance, care should be taken that only just sufficient water is used to form a plastic mass, but the concrete should be kept as wet as possible whilst hardening.

In order to prepare the concrete the materials must be mixed in the dry state before adding the water; the sand and cement should be well mixed before adding the aggregate, and the whole is then turned over three or four times, after which the water is added and the mixing continued. The operation must be carried out rapidly after adding the water, as the mixing must be completed before the cement has begun to set. Small amounts of concrete are commonly mixed by hand, but larger quantities are usually mixed by means of mechanical mixers.

Whenever possible, concrete should not be allowed to set under water. Where this cannot be avoided special precautions must be taken to prevent the cement from floating away. This may be done to some extent by means of a canvas, wooden or iron tube, or "tremie," the upper end of which projects out of the water, whilst the lower end almost rests on the surface of the submerged ground. Another method is to use a skip or discharging box, which is filled with concrete, lowered through the water, and, when it reaches the bottom, opened and the contents discharged. In some cases, especially when it has to be protected from running water, the concrete is filled into sacks, the mouths of the latter are sewn up, and the bags are placed in position under the water.

During comparatively recent years a method of using concrete in combination with metal (usually steel) has been greatly developed. The combination is known as *reinforced concrete*, *ferro-concrete* or *armoured concrete*.

The tensile strength of steel is about 300 times as great as that of concrete and the resistance to compression is about 30 times as great, so that a steel structure will be much stronger than a concrete one of the same dimensions. As steel is about 50 times as expensive as concrete (by volume), the cost of such a structure would be prohibitive, but a combination of the two can be so arranged that it

will be cheaper than either of the materials alone, considering the tensional and compressional stresses to be resisted. Not only this, but the concrete is an efficient protection to the steel against corrosion, and expansion or contraction due to large temperature changes. At ordinary temperatures the co-efficients of expansion of concrete and steel are almost identical, so that there is no risk of disruption through the unequal expansions of the concrete and the enclosed metal.

The cement employed in ferro-concrete must be of the best quality, and the aggregate and sand must be carefully selected. The aggregate should be of a hard and undecomposable nature; slags, coke, cinders, or any materials containing oxidizable sulphur compounds must never be used. The sand must be clean and sharp, and free from clayey matter. The steel employed is usually a mild steel, and must be free from scabs, flaws, and rust. The metal may be in the form of rods or bars, perforated iron plates (*expanded metal*), wire netting and so forth. The various "systems" of reinforced concrete differ in the shape and arrangements of the metal used, and in the methods of attachment. The most usual arrangement is the insertion of rods in those places where the tensile resistance of the concrete most requires to be supplemented. The bars are often bent at the ends in order to increase the resistance to shearing forces, or small bars, loops, or other "shearing members" may be attached to them for the same purpose.

Reinforced concrete is used in the construction of houses, sheds, bridges, boats, etc., and for paving and building blocks, railway sleepers, telegraph poles, gate posts, tiles, drain pipes and many other purposes.

CHAPTER XIV

PLASTERING

THE modes of "rendering" the insides of dwellings vary in different countries with the materials most commonly found. Wherever calcium sulphate occurs in large quantities, it is the material exclusively employed; when this becomes too dear, a combination of lime with sundry other materials is substituted for it; or cement, either natural or artificial, is used.

In England, where plaster is both bad and expensive, its use is confined to the more costly descriptions of decoration. In France, however, it is largely used for the construction of walls, both internal and external, as well as for rendering them afterwards. The plaster is eminently useful in such positions if proper precautions are taken to cover the surfaces exposed to the weather, and if they are painted as soon as dry. But it is utterly incapable of resisting the action of water.

The coarser kinds of plaster are used for the ordinary works, such as the rendering of walls and partitions; the finer qualities are reserved for the ceilings, cornices, and other decorative works. A difference is to be observed in the quantity of water to be mixed, according to the position and nature of the work to be executed. Thus, for walls, the plaster must be gauged stiff for the first coats, and more fluid for the second coat. For cornices worked out

in the solid, the core is made of stiffly gauged plaster, which is floated with finer material, and lastly finished off with plaster, about the consistence of cream, laid on by hand. Practice only can ascertain the precise degree of stiffness to be given, especially as every burning yields a different quality.

When walls are to be rendered in plaster, they require to be first jointed, and then wetted with a broom. The surface is then covered with a coat of thinly gauged stuff laid on with a broom, or at least worked with the trowel in such a manner as to leave sufficient hold for the next coat. This is gauged stiff, and is laid on with the trowel; it is floated with a rule, but the face is finished with a hand trowel. Owing to this, and to the fact that the plaster sets too rapidly to allow of great pains being taken with the floating, the surfaces are never so even, nor are the angles so square and true, as with the common system adopted in England. But this mathematical nicety is not really of importance in ordinary works, whilst the rapidity with which the plaster dries constitutes a real and very important recommendation in its favour.

The partitions in Paris are generally made solid, so as to prevent sound from passing through them. They are executed with quarters of oak or of fir, according to the nature of the building. Upon the quarters, laths are nailed every 4 inches apart, and the interior is filled in with plaster rubble. This is made even and flush with the laths, and the whole is then rendered like an ordinary wall.

The ceilings are sometimes executed with close laths, but the usual plan is to nail them about 3 to 3½ inches from centre to centre. A sort of flat centering is put under them, and what are called "augets" are then formed between in plaster, which finish about flush with the under side of the laths, and return up the joists to nearly their

total height, forming a sort of channel, which the workmen often finish by drawing a bottle along the sides. The minimum thickness in this case should be about 1 inch; the ceiling itself is added underneath; the floors are either of wood, or of tiles upon a bed of plaster formed above the joists. The better description of such floors and ceilings are often made, however, with laths spaced 4 inches from centre to centre; the space between ceiling and floor is then filled up with light plaster rubble, and the upper and under surfaces are rendered to receive the ceiling and the tiles. Ceilings executed in either of these two last-named manners cost $1\frac{1}{2}$ time those executed either with laths or flat "augets."

In countries like our own, and in Belgium and the French Flanders, where the price of plaster is very high, it is replaced by the use of a mixture of lime and sand, to which cows' or calves' hair is added. This mixture is then applied upon close lathing for ceilings and partitions, and in the usual manner upon walls.

The lime generally used for this purpose is the chalk lime, which is slaked with a great deal of water, and run from an upper basin in the state of a cream into a lower one, where the excess of water is allowed to evaporate. A grating should be placed at the entry of the passage between the two basins to keep back the core, or any unslaked particles the upper one might contain. The lime run in this manner is made into a mortar with a very fine sand, and the hair is then added. For the first coats coarse hair will be most desirable; for the finishing coats it should be finer.

In well-finished works two coats are given, which are distinguished by the names of the "rendering" and the "floating." A third coat is then added called the setting coat, which is made of the pure lime as it is run from the basin. Ceilings are afterwards covered with a very light

coat of plaster, gauged thin, and laid on with a trowel. Such plastering is very cheap; and if proper attention be paid to its execution so as to avoid blisters from the use of unslaked lime; to fill the cracks which frequently take place in the thicker coats, from the unequal contraction of the lime in setting; and to allow a proper interval for the whole plastering to dry before the painting, or subsequent decoration to be added, is applied; the lime and hair may be safely admitted as a substitute for the natural plaster. The greater rapidity with which the latter dries, the much superior manner in which it takes colour, and the degree of hardness it attains, will, however, secure it the preference, unless very weighty considerations of economy opposes its employment.

The various "hard finish" plasters (see p. 119) are also used, and, especially for outside work, cement mortar.

The kind of rendering that is so much used in India under the name of *chunam*, appears to merit a passing notice on the present occasion. There are some principles brought into play in the setting of this form of lime that are indirectly connected with the action of the oleaginous cements, so that it may be as well to dwell upon them.

There are several kinds of this *chunam*, according to the locality where it is employed, and to the uses to which it is proposed to be applied. In the interior of the country it is said to be prepared most usually from *kunkar* nodules (see p. 21). These nodules consist mainly of calcium carbonate mixed with a little clay in impalpable powder. This, when burned, is mixed with coarse or fine siliceous sand, and tempered thoroughly with water, to which most generally (but not always) a coarse syrup or molasses from the native sugar is added in small quantity. The only real use of the molasses appears to be to retard the too rapid drying of the fresh laid *chunam* in the torrid climate of India. On the sea-coast shells are burned,

and mixed with sand, which is treated in the same manner. The practice is to boil with the syrup, called locally *jaggree*, some description of fruits, but these do not appear to have much influence on the setting of the lime ; and immediately upon application, is added a portion of short tow, if it be desired to employ the *chunam* as a stucco. The kind that is habitually used as a material for rendering walls is obtained by the calcination of the purest limestone, or shells. That is beaten up with *jaggree*, mixed with water ; and this kind of *chunam* becomes very hard, so as to bear, in fact, a polish. In the patient hands of the Hindoo labourers the use of this material, no doubt, produces excellent results ; but as the whole process of manufacture employed in the preparation of *chunam* is, in fact, founded upon the retardation of the setting and the careful manipulation of the material in place, there can be little reason to regard this application as anything more than a local one, that is to be accounted for by the want of limestone in mass over great areas, and by the low price of labour, in India

CHAPTER XV

STUCCOS

STUCCO is the name given to a specially hard plaster which can be polished, and is usually coloured so as to imitate various kinds of marble. There are three kinds of stuccos, those made from lime, those made from plaster, and those made from cement ; of these, the lime and plaster stuccos are the most important. Stucco is generally made of lime mixed with powdered chalk, plaster, and other materials, in such a manner as to obtain in a short time a solid surface, which may be coloured, painted, and polished. It is employed in architecture to cover columns, pilasters, walls and plinths ; to form mouldings, bas-reliefs, and other analogous objects of decoration.

Stucco is also sometimes used to protect exterior surfaces exposed to the air or to humidity ; but in this case such materials only should be used as are capable of resisting the action of water. As the materials for making stuccos do not exist everywhere in the same manner, their composition must differ in every locality. The principal object is to obtain a material which is capable of acquiring a great degree of hardness, and which is able to receive a polish. To obtain these results, one of the most important conditions is, that the different ingredients be reduced to the greatest possible degree of fineness, and that they possess the power of rapidly solidifying.

The Italians usually execute their stuccos in three coats ;

the first is a very coarse one, and forms merely what we would call the "rendering." The materials of the second are much finer, and they contain a larger proportion of lime; the surface being thus brought up to a very even, close grain. The last coat of stucco is made of rich lime which has been slaked, and run through a very fine sieve, and is usually allowed to stand from four to five months before being used, in order that every particle of it may be reduced to a hydrate. If the lime cannot be kept for so great a length of time, the slaking may be perfected by beating it up very frequently. When great perfection is required, it is usual to mingle pounded white Carrara marble, or even gypsum or alabaster; but the latter are only used in situations which are entirely protected from the action of the atmosphere. The powdered marble and the lime in the form of a very damp paste are mixed, in equal quantities, until the whole is perfectly homogeneous. Vitruvius even recommends that the trituration with a trowel be continued, so long as any portion of the mixture adheres to the iron, before it be applied. This preparation is then laid very carefully upon the even surface of the second coat of plaster, and well worked with the trowel until the face becomes perfectly polished. It forms a very good imitation of marble of a uniform colour.

The different colours are obtained by mixing with the lime such metallic oxides as the case may require; thus, to obtain blues, two measures of marble powder, one of lime, and a half measure of the oxide, or the carbonate of copper, are mixed together.

To obtain greens, a quantity of green enamel is used with a larger proportion of marble powder, and the mixture is worked up with lime water. Pearl greys are made by mingling ashes with the marble. Browns, by mingling ashes and cement in proportions varying with the tones desired to be obtained. Blacks are made by using

forge ashes containing numerous particles of iron. Calced ochres are used to make the reds, as is also minium, or the red oxide of lead; the yellow oxide of lead, massicot or litharge, serves to give that colour. The mixtures thus obtained are subsequently laid on in patches; and the excellence of the work consists in the taste with which they are employed to imitate the effects of the natural marbles, so as to give either the blending or the distinct opposition of colours to be met with therein.

When plaster is used instead of lime, it is gauged with lukewarm water in which size, fish glue, or gum arabic has been dissolved, in order to fill up the pores, to give it more consistence, and to render it susceptible of receiving a better polish. This kind of stucco is the one more especially employed when it is required to produce details of great delicacy and perfection. If it be required to produce divers tints with this material, the colours should be dissolved in the size water before it is used for gauging the plaster.

The polishing should never be commenced until the whole of the stucco is perfectly dry. To hasten the desiccation a linen may be applied frequently to the face to absorb the moisture which may have worked through; but no friction should be allowed until the whole is perfectly dry. The surface is then rubbed with a very fine-grained grit stone, washing and cleaning it with a sponge in the same manner as a real marble; it is then rubbed with a linen containing moistened tripoli powder and chalk; and the whole is finished by a rubber of felt imbibed with oil and very fine tripoli powder, which is quite at the end changed for a rubber containing nothing but oil. The thickness of the coat of stucco varies from between $\frac{1}{8}$ to $\frac{1}{8}$ of an inch, for internal works.

Scagliola is made by a process of a similar nature to the one thus executed, with perhaps some slight differences in the manner of setting up and drying the coat of plastering

which forms its base. There are a greater number of small pieces, splinters, "scagliole" of marble in the best descriptions of this work, and it is from them that the process derives its name.

MM. Darcet and Thénard applied to the interior of the dome of the Panthéon in Paris an encaustic, for the purpose of rendering the stone fit to receive the paintings executed by M. Gros, which answered remarkably well for the plaster under similar circumstances. The surfaces to be covered were firstly dried by large braziers for the purpose of driving out the moisture in the stone, and removing all the air contained in the parts exposed to the heat, so that the stone might be rendered more absorbent, and that the encaustic might penetrate further into it. A mixture of 1 part of yellow wax, and 3 parts of oil, in which $\frac{1}{10}$ of the whole weight of litharge had been mixed before melting, was then applied at a temperature of 100° C. It was laid on with a brush, in frequent coats, until in fact the stone was so thoroughly impregnated with it that it could absorb no more.

Should the above mixture be too expensive, another, consisting of 1 part of oil, containing $\frac{1}{10}$ of its weight of litharge, and of 2 or 3 parts of rosin, may be substituted. This mixture should be allowed to cool, and be remelted before it is applied; the walls being previously well dried, and the encaustic laid on in five or six coats. Plastering which has been thus treated becomes sufficiently hard to resist the nail in a very short time; and it is effectually protected against any changes of the atmosphere. The action of these oleaginous substances is merely to fill the pores of the plaster, and thus to prevent the action of the moisture. They do not appear to enter into any chemical combination.

In India the material known as *chunam* is sometimes used as a stucco (see p. 151). Some kinds of *chunam*

are quite suitable for this purpose, as they become hard and capable of being polished.

Cement stuccos are employed to form the foundations on which the more elegant preparations are applied, whenever any danger is to be feared from humidity, but their colour prevents their extended use for internal decorative purposes. The white Portland cement, mentioned on p. 94, is, however, free from this objection, and produces an excellent ornamental stucco. Cement plaster is also called "cement stucco" when used for coating the surfaces of walls, pillars, etc.

For temporary buildings of an ornamental character, such as those required for exhibitions, etc., it is usual to employ a plaster which is toughened and bound together by means of tow, or sometimes by asbestos, slag wool, or coke breeze. This material is known as *staff* or *fibrous plaster*. It is fixed upon a backing of very coarse, open canvas called "scrim." The moulds are usually made of gelatin on a plaster core.

CHAPTER XVI

WATERPROOFING CEMENT

It is often of great importance that cement structures should be waterproof. This result can usually be obtained in new structures by employing a sufficient thickness of well-mixed concrete in which the aggregate is carefully graded and the voids completely filled with mortar prepared with cement and well-graded fine sand. It is a common practice, however, to employ some special means of rendering the cement waterproof, and this is always necessary when a structure already in existence has to be dealt with.

The desired effect may be obtained by coating the surface with some impermeable substance, such as asphalt, tar, or paint; by applying washes to the surface, by which means the pores of the cement become filled with an insoluble precipitate; and by mixing the waterproofing materials in with the mortar.

The use of asphalt is dealt with in Chap. XVI. Coal tar, applied hot, makes an efficient waterproof coating where the appearance is not of great importance. Special casein paints followed by treatment with formaldehyde are much used, and also coatings in which Portland cement forms the base. Paraffin wax is sometimes employed for this purpose, the wax either being applied hot by means of a brush, or in solution in light petroleum. There are many processes which depend upon the formation of insoluble precipitates by means of washings applied to

the surface. One of the oldest of these is *Sylvester's process*, in which alternate washes of soap and alum solution are employed. Solutions of sodium silicate (water glass), of sodium oxalate, and of various zinc salts are also used with more or less success.

Waterproofing by mixing the materials in with the cement may be carried out by adding soft soap, potash, alum or other substances to the latter, in which case the insoluble precipitates are produced right through the mass. Moyer¹ has shown that a waterproof material is obtained when mineral oil is mixed with the cement mortar, but that animal or vegetable oils are not suitable for this purpose, as they are liable to decompose, with the production of free fatty acids.

A great many compounds of very different degrees of efficiency have been introduced for the purpose of waterproofing cement mortar and concrete.² These compounds are usually sold under fancy names, such as "Ceresit," "Driwall," "Impervite," "Densin," "Cementkote," and so forth; they mostly consist of soaps, oils, fats, solutions of various salts, etc., and are essentially the same materials as those described above. So far as the author is aware all the compounds hitherto introduced fail when exposed to water under a high pressure, and many of them fail even when the water is under a very low pressure; most of them also have a more or less harmful effect upon the cement, the reduction in strength often being very considerable. A large number of these compounds consist essentially of calcium carbonate, alum, calcium soap, and, sometimes, oil, fat, or wax. The compounds of this class are sold either in the form of a powder, which is to be mixed with the dry cement before adding the water, or in the form of a paste, which is mixed with the water before gauging the cement.

¹ A. Moyer, *Concrete and Constr. Eng.*, 1910, 5, 166.

² W. L. Gadd, *ibid.*, 1908, 3, 154.

One of the best compounds of this type that has come under the author's notice is known as "Medusa." This compound is a white, extremely water-repellant powder; when mixed with proper care it proves satisfactory for the purpose for which it is intended. Compounds of another class consist of mineral oils. Another class consists of solutions of sodium silicate, or of silicofluorides of sodium or other metals. The silicofluorides of zinc, magnesium, and aluminium are sold under the name of "fluates." A somewhat similar class consists of various solutions of acids and salts, one of these is a solution of oxalic acid, and another consists of a mixture of alum and zinc sulphate in insufficient water for complete solution. All these solutions are brushed into the surface of the concrete or mortar, where they fill the pores with insoluble compounds. They are also used for the protection of stone, plaster, and brickwork. Solutions of paraffin wax in light petroleum, and solutions containing bituminous substances are also sold under various names. A waterproofing compound of a different type is sold under the name of "Ironite." This consists essentially of a mixture of rather finely powdered iron and a soluble salt which in the presence of water brings about the rapid rusting of the iron. The material is made into a paste with water, and by means of a stiff brush is well rubbed into the surface to be waterproofed, two or three coats being usually necessary. The author has found this compound to be efficient when properly applied. The hardened paste possesses a considerable degree of strength, so that broken briquettes which have been joined together with this material frequently show a tensile strength of over 400 lbs. per square inch. A special variety of "Ironite" is also sold for use in making hard floors. It consists entirely of iron powder, which is rather more coarse than that of the ordinary variety, and it is mixed with the cement before adding the water.

Notwithstanding the certain amount of success which some of these waterproofing compounds have met with, it is obvious that the use of either water repellants or pore-fillers is undesirable, because they have a more or less harmful effect upon the cement. Water-repellants also decrease the strength of the cement because they hinder its proper hydration. The problem of rendering cement waterproof should, therefore, be attacked in another manner. The hydration of Portland cement is never complete, at any rate in ordinary practice, and, if the amount of hydration can be increased sufficiently, a denser and more waterproof mortar will be obtained. This appears to be the case with the recently introduced "Super cement" (see p. 95), which not only produces a mortar or concrete which, without any further treatment, is really waterproof even under very high pressures, but is also able to withstand petrol, etc. The mortar or concrete made with this cement is much stronger than that obtained with ordinary Portland cement, and, when the material becomes more widely known, it will probably not only be used universally wherever waterproof cement work is required, but also in ordinary work where a cement of high quality is desired, especially in reinforced concrete.

CHAPTER XVII

BITUMINOUS AND OLEAGINOUS CEMENTS

THE bituminous cements are used chiefly for the purpose of street paving, but they are also employed for covering the extrados of arches, in order to prevent the percolation of water, for making watertight roofs, and for other constructional work. For covering arches, these cements are, moreover, very much to be recommended. In all new masonry, with whatever care executed, there are always movements which fissure the coatings executed in limes, natural or Portland cements. These again are subject to unequal shrinkage and contractions, which produce crevices; and from these united causes it is very rare to find that such coatings are impermeable. The bituminous cements are more elastic; it often happens in their case that small crevices solder themselves, so to speak; and if any serious repairs are required to be done, it is much easier to execute them than it is when the works are executed with limes.

The best bituminous cements are obtained from the natural asphalt, which is met with in large quantities on the shores of the Dead Sea; in Albania; in Trinidad; at Lobsann and Bekelbronn, in the département of the "Bas Rhin"; in the department of the Puy de Dôme; near Seyssel, in the department of the "Ain"; at Gaugeac, in that of the Landes. There are hills of bitumen over a hundred feet in height in the Caucasus, and part of the Island of Cheleken, in the Caspian Sea, is composed of

this material. Large deposits also occur in Canada, the United States, Cuba, Bermudas, and Venezuela.

There are two sorts used in commerce, the pure and the impure. The first does not contain extraneous matter in any great degree; the second contains a variable proportion of calcium carbonate, and is, therefore, better adapted to such works as are exposed to the effects of the sun. The purer asphalt melts in such positions, but it is better adapted for subterranean works.

The terms *asphalt* and *bitumen* are used rather indiscriminately, thus incurring more or less confusion. The term *asphalt* should be confined to that portion of the material which is of solid or nearly solid consistency at ordinary temperatures, and which is soluble in carbon disulphide; it consists mainly of the two hydrocarbons *petrolene* and *asphaltene*, which may be separated by means of various solvents. The term *bitumen* should include not only the asphalt, but also the other liquid and solid hydrocarbons present in the crude material. For convenience, however, it is sometimes necessary to apply the term *asphalt* to the whole bituminous material, as when we speak of Trinidad or Bermudas asphalt.

The best bitumen is free from water. Its specific gravity is 1.00 to 1.68 at the ordinary temperature; it is solid, but highly ductile, for it draws easily into threads; its fracture is black, slightly brilliant. Put into warm water, it should float upon the surface, and in that operation it should not deposit any sand. It dissolves completely in oil of petroleum and turpentine; and the solution, which should be of a bistre or dark-brown colour, after being filtered, should not be found to have contained more than 7 per cent. of earthy matters. It is also soluble in naphtha and benzene, but not in alcohol or water. In commerce, much fraud takes place by adulteration with coal tar and pitch; but these materials,

though very valuable by themselves, destroy the superior qualities of the mineral asphalts. It is also highly important to secure the purity of the asphalt from sulphur, or the sulphates of iron. Even so small a proportion as 0.5 per cent. would materially diminish its value.

Asphalt *mastic*, used for paving, or as a damp course, is prepared by crushing and grinding bituminous limestone to a state of powder. This is mixed in a cauldron with a quantity of mineral pitch or bitumen, in proportions which vary according to the richness of the original stone. Blocks of asphalt mastic contain, as a rule, about 15 per cent. of bituminous mineral pitch.

When the asphalt is to be used, the solid bituminous block is broken into small pieces which are thrown into a quantity of mineral pitch, in a state of ebullition; for if it were put into the caldron alone, it would calcine without melting. The mixture is applied by means of large spatulas, or trowels.

The thickness advisable to use for coating arches is $\frac{3}{4}$ of an inch, in two layers, and the same thickness should be employed for vertical walls built against earth. The quantity thus used to cover a yard square is about 70 lbs.

For street paving, it is absolutely necessary to employ a bed of cement concrete under the asphalt. The upper surface of this concrete bed is rendered smooth, and must be perfectly dry before the asphalt is applied. The thickness of the asphalt paving should not be less than $\frac{3}{4}$ of an inch.

Coal tar, coal tar pitch and vegetable pitch are not so desirable as the natural bitumens for building purposes, but they may in many cases become very valuable substitutes for them. They are not so supple, the stone powder to be mingled with them requires to be prepared with great care; and it would appear that they are not

so durable as the natural productions of a corresponding class. But they make very good coatings for vaults, or for walls exposed to the dampness of the earth; and many situations occur in which their use must be more economical than that of the materials they are to replace.

The mode of using them is to mix powdered calcareous stone, in variable proportions, with the pitch or tar in a state of ebullition. Care must be taken that the stone be thoroughly dry; for if it were wet, it would render the cement porous, from the effect of the vapour trying to escape. The burning, or degree of heat, must also be so regulated that the stone be not converted into quicklime, which takes place with comparative facility owing to its highly comminuted state. The proportions of powder are from 6 to 7 of the pitch in volume, but these require to be ascertained by direct experiment in each case. All the other details of the use of these cements are precisely the same as in the case of the natural asphalts, excepting that it is advisable to use them in greater thicknesses.

The cements used for mosaic works are sometimes of the bituminous character. As applied on the continent, they are of three sorts. The first, which serves to set the large tesserae in forming floors, is composed of pitch mixed with a black earth; the second, which serves to set stones of moderate dimensions, is made of the calcareous stone of Tivoli, and of oil; it is properly an oleaginous cement; the third, which is used for the more delicate mosaics of pieces of glass, is made of lime, pounded bricks, gum andragan, and the white of eggs. The French plumbers unite the glazed pottery tubes they employ for the distribution of water, with a hot cement made of resin, wax, and lime; or with a cold cement composed of quicklime, cheese, milk, and the white of eggs. The list of these mixtures is, as we observed before, interminable;

but their use is not of sufficient importance to require a detailed notice.

The oleaginous cements were formerly very much used in London under the name of *mastic*, for the purpose of the ornamental decorations of the Quadrant, and of King William Street in the City. They produce a very fine, close-grained, even surface, and if painted in the beginning, and repainted every three or four years, they retain their beauty for a very long period. Their use has, however, become obsolete, partly owing to the expense, and the difficulty of manipulation, but chiefly owing to the extended employment of the natural and artificial hydraulic cements, especially Portland cement.

Two of the best of these mastics were *Hamelin's mastic*, in England, and the *mastic de Dhil*, in France. Their composition was kept secret, but many more or less successful substitutes have been introduced, some of which are described below.

A litharge mastic which was introduced by Thénard is made by mixing 93 parts of pulverized burnt clay with 7 parts of litharge ground to a very fine powder. It is mixed up for use with a sufficient quantity of very pure linseed oil, to reduce it to the consistence of plaster in a similar state, and is applied like plaster, after the surface has been previously wetted with a sponge filled with oil.

At La Rochelle, the officers of the engineers used, in 1826, a mastic which very closely resembled the *mastic de Dhil*. It was composed of—

14 parts by volume of siliceous sand,

14 parts of pulverized calcareous stone.

$\frac{1}{4}$ by weight of litharge (of the united weights of the sand and stone).

$\frac{1}{7}$ of the total weight of linseed oil.

These powders were previously well dried in an oven; the mastic thus produced was mixed with oil in the usual

manner, and the surfaces upon which it was applied were previously soaked with oil.

In Paris, the military engineers have sometimes used a mastic of a nearly similar composition, which is made of 6 parts in weight of natural or artificial hydraulic cement, 1 of white lead, 1 of litharge, 3 of linseed oil, and $\frac{1}{2}$ of a richer oil, perhaps an animal oil. It has been found that in some positions the white lead might be advantageously replaced by a similar quantity of pozzolana.

Vauban recommended a kind of mastic which appears to have answered very well for the lining of cisterns and such works. He took 5 or 6 parts in volume of rich lime, which had been mixed in linseed oil, and to these he added 2 parts of good cement passed through a very fine sieve. The mixture was beaten up for about half a day; it was laid aside for a night, and beaten up again during half an hour on the next day. It was then laid on the work to be covered in coats of from $\frac{1}{8}$ to $\frac{1}{6}$ of an inch at a time, the joints being first well raked out and cleaned. After three or four days, a second, and subsequently a third and a fourth coat were added, the lower one being well scored to form a key to the last one to be applied. This is the simplest, and experience has shown it to be one of the best methods of making mastic; but we may repeat that such compositions are but elaborate modes of supplying the places of materials which exist already in a more convenient form.

CHAPTER XVIII

THE "SALTPETREING" OF LIMES, CEMENTS, AND PLASTERS

It often happens in damp situations that walls in new works are covered with a white substance of a fleecy appearance, and of a slightly acid flavour, which works its way through any ordinary coat of paint; and, as it absorbs the humidity of the atmosphere in efflorescing, it renders the walls damp on the surface, and carries off the paint in large patches. This process is called "*saltpetreing*" by workmen, but saltpetre or potassium nitrate is far from being the only substance found in the efflorescence; sodium nitrate, the chlorides and sulphates of the alkali and alkaline earth metals, and other soluble salts are also present.

It has been suggested that the presence of the nitrogen is entirely due to the decomposition of the animal matters contained in the building materials. M. Longchamp proposed another theory by which he sought the explanation of the phenomenon of the production of the nitrogen, by supposing that the carbonates of lime and of magnesia, taken in a proper degree of comminution, and properly wetted, could absorb air, condense it, and, in the course of time, transform it into nitric acid; or rather bring it to that state, after condensation, which would cause it to enter into combination with the lime and magnesia, giving rise to the formation of calcium and magnesium nitrates,

and so much the more readily enable it to combine with the potassium, especially if it were present in the form of a carbonate.

Under all circumstances, the presence of powerful bases, such as the lime and magnesia, or potash, appears to be necessary, and they require to be in a highly comminuted state. Lime in the form of chalk, or a highly porous limestone, is favourable to the action of the nitrogen. Marbles, and the densest class of limestones, nitrify with great difficulty, hardly at all; and the limes made from them are said to enjoy a corresponding immunity from this inconvenience. The plaster cements, which consist essentially of calcium sulphate, also produce this efflorescence.

Whichever theory we adopt to account for the presence of the nitrogen, there appear to be certain conditions which facilitate the production of the saltpetre. Firstly a degree of humidity, about equal to that of garden earth, is very favourable to it. At 32° F. the nitrification does not take place; between 60° and 70° it is the most abundant. In Sweden, light is considered rather to retard it, and an exposition towards the north is always sought for; but that does not appear so much to be owing to the absence of strong sunshine, as to the evaporating effects of the north winds, which are eagerly desired in the artificial nitre factories. Light, in fact, appears to be without influence on its action. The most favourable conditions for the formation of the nitre, indeed, are united in cellars, and other underground constructions; and it was from them that the French chemists, during the war, extracted the saltpetre necessary for their gunpowder manufactures; especially from the demolition of cellars executed with plaster instead of mortar. The richest of these materials contain sometimes as much as from 5 to 7 per cent. of saltpetre.

The nitrification takes place very freely when sea-water and sea-sand have been used, so much as to render them totally unfit for works requiring any perfection of execution. The efflorescence upon works executed with sea-water is, however, very distinctly and decidedly sodium nitrate; and, as it occurs in much greater abundance wherever such water is used, we may safely assume that some portion at least of the nitre is furnished by it.

The practical bearings of this interesting chemical question, upon the professions of the engineer and architect, are as follows:—

Firstly. Sea-water, or sea-sand, should never be used in making up mortar, or plaster, which is likely to require painting, or any sort of decoration, such as papering, stuccoing, etc. The water employed should be clean, fresh, soft water, such as rain water; and the sand, whether pit or river-sand, should also be quite clean. For outside works, the use of sea-sand which has been well washed in fresh water, and exposed for at least six months, may be admitted, but it is still likely to cause a nitrification; and as the conditions of temperature internally are more favourable to that action than externally, it is most likely to manifest itself in that direction. There is always a danger attending the use of sea-sand; if it can be replaced, it should therefore be so, even at an increased expense.

For such works as sea walls, lock chambers, quay walls, etc., it is not of so much importance that the nitrification be avoided, provided always that the stones used be of such a nature as to resist the destructive tendency of the process. Many of the oolites, such as the Portland stone, the Caen, and the Bath stone are not able to resist this destructive action. They should, then, neither be used in conjunction with mortar made with either sea-sand or sea-water; nor should they, in any case, be exposed to the latter. The purer crystalline limestones, and the

granites, resist this cause of chemical decomposition much better, and should be employed in such positions in preference. It is, however, to be observed that there are some kinds of oolite, such as the Ranville stone, near Caen, the Roach beds of the Portland, which are as little affected by the sea-water as the stones just mentioned.

Secondly. When it is absolutely necessary to use such materials as we know to be exposed to the inconvenience of nitrification, it is advisable to take early precautions with the view of preventing the action of the atmosphere upon the chemical ingredients. We see that in whatever manner the bases absorb the nitrogen, whether from the decomposition of the animal matter, or from the condensation of the gases, that the absorption could not take place unless the atmosphere were in contact with the internal structure. If, then, we protect the interior in some manner by a coat of paint, or an encaustic, for instance, we shall probably stop the action of the nitrification. It is thus, doubtlessly, that we may account for the fact that if Roman cement be painted as soon as it is dry, it does not assume the action in question; but if it be left for any length of time unpainted, it becomes useless to attempt to execute such work. The atmosphere has entered the pores of the cement; the nitrates will cause any coat of paint to fall off.

Such a precaution can, however, only be successful when the body of the work is not of a nature to furnish its own nitrogen, if such an expression be allowable; or when it is in such positions, and of such dimensions, as not to derive it from any other quarter. If, for instance, a wall be built of bricks made from the alluvial mud of the embouchures of rivers, no precautions can prevent the saltpetre from forming. Engineers or architects, then, who have any decorative works to execute in places where such materials only are used, must detach them from the

walls. If the wall be thin and the coat of encaustic penetrate very deeply into the plastering, it may happen that the saltpetreing may take place entirely on the outside; but this is a mere chance, that is to say, it is an action we can neither explain nor control; one, therefore, no prudent man would calculate upon. In very thick walls we often find that the saltpetreing does not take place on both sides, only on the weather (or exposed) side. But if the process once begin with such thick walls it never leaves off, at least within any reasonable time.

London workmen have a practice whenever they use Portland stone in elevation, of covering it with a wash made of pounded stone-dust and sand, which is rubbed off upon cleaning down the work. This very simple precaution serves temporarily to protect the stone against the formation of the saltpetre. But it is not effectual to stop the process of the saltpetreing, otherwise than temporarily, although it diminishes its force afterwards. The process is resumed, but in a weaker degree, as soon as the coating is removed.

These precautions are unfortunately very doubtful in their results; at any moment we are liable to see the materials which contain soda and potash take up the action of saltpetreing. Many noble frescos have perished in this manner; many of the finest buildings have been ruined by the decomposition it induces in the stones of which they are built.

CHAPTER XIX

THE CHEMICAL ANALYSIS OF LIMES AND CEMENTS

THE methods of analysis given in this chapter are sufficiently accurate for most ordinary technical purposes, but larger text-books should be consulted for the more elaborate methods used when more information or specially accurate results are required. It is assumed that the reader has some experience of chemical analysis, and, therefore, detailed explanations of the methods of carrying out such operations as filtering, igniting filters and precipitates, etc., are omitted. These explanations would occupy more space than can be spared, and the necessary information can be obtained from any good text-book on quantitative chemical analysis. The methods of analysis described below should be practised on samples of known composition until the manipulations become quite familiar, and the results obtained are concordant and correct.

THE ANALYSIS OF LIMES

The sample must be kept in an airtight vessel. The portion to be analysed is crushed and finely ground, as rapidly as possible, and then placed in a dry weighing bottle. Hydraulic limes are usually submitted to a more complete analysis than air limes, indeed the latter are often only tested for the amount of caustic lime present, but when a complete analysis is required it is carried out in the same manner as in the case of the hydraulic limes.

(1) *Loss on Ignition.*—Carefully weigh out about 0.5 gramme of the powdered lime into a weighed platinum crucible, ignite at bright red heat (not above 800° C.) for at least twenty minutes, cool in the desiccator, and weigh. The ignition should then be repeated and the crucible and contents again weighed in order to be certain that the weight had become constant.

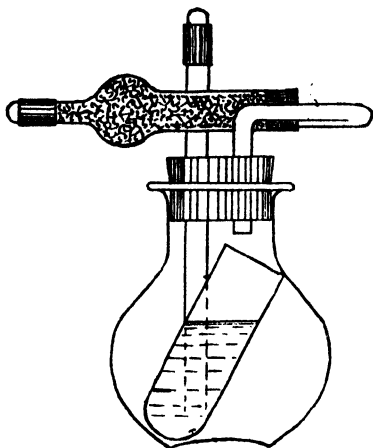

FIG. 15.—Apparatus for Estimation of CO_2 .

$$\frac{\text{Loss in weight} \times 100}{\text{Weight of sample}} = \text{per cent. loss on ignition.}$$

The loss on ignition is due to water and carbon dioxide.

For most purposes it is unnecessary to separate these two components, but when this is desired the percentage of carbon dioxide can be approximately determined by means of the apparatus shown in Fig. 15. This consists of a small, wide-necked flask, the mouth of which is closed with a rubber stopper through which pass a calcium chloride tube and a piece of straight glass tubing reaching nearly to

the bottom of the flask. A little glass wool is placed in the bulb of the calcium chloride tube, the bulb is then filled with dehydrated copper sulphate pumice, and the straight part of the tube is similarly charged with granular calcium chloride. A second pad of glass wool is then inserted, and the tube is closed with a rubber cork through which passes a short length of glass tubing. The outer ends of the tubes are fitted with short pieces of rubber tubing which are closed with stoppers made of glass rod. Within the flask is a small test-tube of such a length that it stands obliquely in the flask without touching the stopper.

In order to carry out the determination, weigh out about a gramme of the sample, place in the flask, add sufficient water to cover the sample, and charge the test-tube with about 10 c.c. of concentrated HCl. Weigh the apparatus and contents without the glass stoppers. Place the stopper in the straight glass tube and carefully tilt the flask so that the acid is caused to flow slowly on to the sample. The carbonate is decomposed with gradual evolution of carbon dioxide. When all the acid has been added and the effervescence has ceased, warm the flask for a few minutes to a temperature not exceeding 75° C., allow to cool somewhat, remove the cap from the tube, and slowly aspirate a current of air through the apparatus, in order to displace all CO₂. Place both caps on the tubes and leave the apparatus to cool. When quite cold, remove the caps and weigh.

$$\frac{\text{Loss in weight} \times 100}{\text{Weight of sample}} = \text{percentage of carbon dioxide.}$$

The results obtained by this means are usually too high. A better method, which is suitable for more accurate determinations, is that of Fresenius.¹

The difference between the weight of CO₂ and that of the total loss on ignition gives the amount of water present.

¹ C. M. Fresenius, *Quantitative Chemical Analysis*, 1900, 1, 340.

(2) *Silica and Insoluble Matter*.—Weigh out about 0·5 gramme of the sample into a 6-inch evaporating dish, or carefully brush the ignited residue from (1) into the dish. Cautiously add about 15 c.c. of distilled water, stir well, in order to prevent the formation of lumps, and add 25 c.c. of concentrated HCl. Carefully heat the dish and its contents on the water-bath, or on the cooler part of a hot iron plate, until the contents have evaporated to dryness, then cover the dish with a clock glass and bake for an hour on the hottest part of the hot plate. Remove the dish, allow to cool, add 25 c.c. of concentrated HCl, and gently warm, rinse the under side of clock glass with hot distilled water, collecting the rinsings in the evaporating dish. As some of the silica may pass into solution after the first baking it is advisable to again evaporate to dryness and bake for an hour as before. Remove the dish, allow to cool, then treat with HCl, and gently warm until the residue is free from iron, as shown by the colour. Filter through a quantitative filter paper, wash thoroughly and collect the filtrate and washings in a large beaker for further examination. Dry the filter and contents in the steam oven, ignite in a weighed crucible, cool in desiccator and weigh.

$$\frac{(\text{Weight} - \text{filter ash}) \times 100}{\text{Weight of sample}} = \text{percentage of silica and insoluble matter.}$$

It is not usually necessary to separate the soluble and insoluble silica, but when this is required the separation may be carried out in the following manner.

Weigh out another 0·5 gramme of the sample into a platinum dish, add water and concentrated HCl, and treat as before, but, when filtering, take care to retain as much as possible of the insoluble matter in the dish and wash by decantation. Invert the filter funnel over the dish and wash into the dish any insoluble matter which has fallen on to the filter. Add a strong solution of sodium

carbonate, boil for at least 20 minutes, filter rapidly, and wash with boiling water until the washings are free from alkali. Dry the filter and contents, ignite in a weighed crucible, cool in desiccator, and weigh.

$$\frac{(\text{Weight} - \text{filter ash}) \times 100}{\text{Weight of sample}} = \text{percentage of insoluble matter.}$$

The percentage of soluble silica is found by subtracting this amount from that previously obtained.

(3) *Alumina and Ferric Oxide.*—Heat the filtrate and washings from (2) until nearly boiling, then add a few drops of bromine water and continue heating, but do not boil. Now add ammonium hydrate solution, little by little, until there is a slight excess, and boil until the odour of ammonia has almost disappeared. Filter, wash thoroughly, collecting the filtrate and washings in a large beaker, dry filter and contents, ignite, cool and weigh.

$$\frac{(\text{Weight} - \text{filter ash}) \times 100}{\text{Weight of sample}} = \text{percentage of alumina and ferric oxide.}$$

It is not usually necessary to separate the alumina and ferric oxide, but when this is required it is best done by estimating the iron in a fresh sample by means of standard dichromate solution.¹

(4) *Lime.*—Cover the beaker containing the filtrate and washings from (3) with a clock glass, heat nearly to boiling, add a little dilute NH_4OH , and boil. Whilst boiling add an excess of a boiling solution of ammonium oxalate, allow to boil for a few minutes, remove beaker to a warm place and leave for two or more hours in order to allow the precipitated calcium oxalate to settle. Whenever possible, it is best to allow the beaker and its contents to stand over night, in order to ensure the complete precipitation of the calcium oxalate. Filter and wash, saving the filtrate and washings for the next determination. Dry

¹ C. M. Fresenius, *Quantitative Chemical Analysis*, 1900, 1, 220.

the filter and precipitate, strongly ignite in a weighed platinum crucible, cool and weigh as caustic lime, CaO.

$$\frac{(\text{Weight} - \text{filter ash}) \times 100}{\text{Weight of sample}} = \text{percentage of lime.}$$

The calcium oxide in an air lime may be rapidly determined as follows. Weigh out about 0.5 gramme of sample into an Erlenmeyer flask containing about 250 c.c. of distilled water which has been recently boiled in order to expel all the dissolved air. Boil for about 5 minutes, then close the mouth of the flask by means of a cork fitted with a soda-lime tube, and stand aside to cool. When cold, add a few drops of phenol phthalein solution and gradually add $\frac{N}{10}$ HCl from a burette until the pink colour just disappears. This change of colour takes place as soon as all the free lime has been neutralized and before the calcium carbonate has been attacked. Allow the flask to stand for some time in order to see if the pink colouration returns, and, if it does so, continue the titration until it just disappears again.

$$\frac{\text{No. of c.c. } \frac{N}{10} \text{HCl used} \times 0.0028 \times 100}{\text{Weight of sample}} = \text{percentage of calcium oxide.}$$

(5) *Magnesia*.—Evaporate the filtrate and washings from (4) until the ammonium salts begin to crystallize out, then add 30 c.c. of concentrated HNO₃, and gently warm until all the ammoniacal salts are driven off. Allow to cool and add a little water acidulated with a few drops of HCl. Warm and then add a slight excess of NH₄OH (should a slight precipitate of magnesium hydrate separate out it must be dissolved by adding a few drops of ammonium chloride) and a few drops of a solution of ammonium oxalate, and boil. Allow the solution, which should not exceed about 100 c.c., to cool, filter off any precipitate which may be formed, disregarding the precipitate, wash

and add an excess of a solution of sodium phosphate to the filtrate and washings, stir well or shake, and stand aside overnight. Filter, wash precipitate with dilute NH_4OH , dry, ignite, cool and weigh as $\text{Mg}_2\text{P}_2\text{O}_7$.

$$\frac{(\text{Weight} - \text{filter ash}) \times 0.3619 \times 100}{\text{Weight of sample}} = \text{percentage of magnesia.}$$

(6) *Sulphur trioxide, SO_3* .—Weigh out about 0.5 or 1.0 gramme of the sample into a 6-inch evaporating dish, add about 10 c.c. of water, stir well, and then add 25 c.c. of concentrated HCl . Evaporate to dryness on the water-bath or hot plate. Bake the dish and contents on the hottest part of the plate for half an hour, then cool and digest with 10 c.c. of concentrated HCl and 25 c.c. of distilled water. Filter off the silica and insoluble matter and wash thoroughly, adding the washings to the filtrate. Boil, and, whilst boiling, add, drop by drop, an excess of boiling barium chloride solution. Continue boiling for 5 minutes, and then leave in a warm place for a few hours. Filter, wash, dry, ignite, and weigh as BaSO_4 .

$$\frac{(\text{Weight} - \text{filter ash}) \times 0.34291 \times 100}{\text{Weight of sample}} = \text{percentage of } \text{SO}_3.$$

When the soluble silica is determined, the first (acid) filtrate and washings from that process may be used to determine the sulphur trioxide instead of taking a fresh quantity of cement.

(7) *Sulphur as Sulphide*. — The determination of sulphur in the form of sulphide is not usually required, but in some cases it is necessary. In order to carry out the determination weigh out about 0.5 or 1.0 gramme of the sample into an evaporating dish, add a little water, stir well and then add 25 c.c. of concentrated HNO_3 . Gently evaporate to dryness and continue the process exactly as described under (5), weighing as BaSO_4 . The

object of using HNO_3 is to oxidize the sulphides into sulphates so that all the sulphur is converted into barium sulphate, whereas, when HCl is used to dissolve the cement, the sulphides are decomposed and their sulphur driven off in the form of sulphuretted hydrogen, only the sulphates being determined.

From the total weight of BaSO_4 thus obtained, deduct the equivalent found in the determination of sulphur trioxide.

$$\frac{\text{The remainder} \times 0.137 \times 100}{\text{Weight of sample}} = \text{percentage of sulphur as sulphide.}$$

The sulphur as sulphide may be calculated to calcium sulphide, CaS , thus :

$$\frac{\text{The remainder} \times 0.30895 \times 100}{\text{Weight of sample}} = \text{percentage of CaS.}$$

(8) *The Alkalies.*—For most purposes the alkalies are estimated by difference, but they may be determined directly.¹

ANALYSIS OF PORTLAND, NATURAL, AND SLAG CEMENTS

These cements are analysed in the manner described above for hydraulic lime, but as they are already in the form of a fine powder they do not need any grinding, the portion selected for analysis being at once placed in a dry weighing bottle. The slag cements may be distinguished from Portland cement by Seger and Cramer's method.²

The adulteration of Portland cement with limestone may be detected by the high loss on ignition, due to the liberation of carbon dioxide from the limestone ; and the adulteration with siliceous materials, by the determination of the insoluble residue, which should not be above 2 per cent. The presence of these substances may also be detected by means of the microscope, the appearance of the ground adulterants being quite different from that of ground clinker.

¹ W. Crookes, *Select Methods in Chemical Analysis*, 1905, p. 23.

² H. Seger and E. Cramer, *Chem. Zeit.*, 1903, 27, 879.

THE ANALYSIS OF THE PLASTER CEMENTS

Like the hydraulic calcareous cements, these do not need any preliminary grinding, but a portion of the sample selected for analysis is placed in a dry weighing bottle.

(9) *Water*.—Weigh out about 0.5 gramme of the cement into a weighed platinum crucible. Ignite at about 400° C. for 20 to 30 minutes, cool in desiccator, and weigh.

$$\frac{\text{Loss in weight} \times 100}{\text{Weight of sample}} = \text{percentage of water.}$$

The temperature of ignition must be kept comparatively low in order to avoid possible loss of sulphur trioxide, or reduction of the sulphate to sulphide.

(10) *Silica and Insoluble Matter*.—Weigh out about 1 gramme of the plaster into a 6-inch evaporating dish. Add a little distilled water, stir well and add 10 c.c. of concentrated HCl. Proceed as in (2), saving the filtrate and washings for the next determination.

$$\frac{(\text{Weight} - \text{filter ash}) \times 100}{\text{Weight of sample}} = \text{percentage of silica and insoluble matter.}$$

(11) *Alumina and Ferric Oxide, Lime, and Magnesia*.—Make up the volume of the filtrate and washings from (9) to 500 c.c. and divide into two equal parts. Use one portion for the estimation of alumina and ferric oxide, lime and magnesia, employing the methods described in (3), (4), and (5). When making the necessary calculations remember that the weight of sample originally taken has been halved.

(12) *Sulphur Trioxide, SO₃*.—Transfer the other half of the filtrate and washings from (9) into a 400 c.c. beaker and boil. Whilst boiling, add, drop by drop, an excess of a boiling solution of barium chloride. Continue boiling for 5 minutes, stand aside in a warm place for a few hours, filter, wash, ignite in a weighed crucible, cool in desiccator, and weigh.

$$\frac{(\text{Weight} - \text{filter ash}) \times 0.34291 \times 100 \times 2}{\text{Weight of sample}} = \text{percentage of sulphur trioxide.}$$

CHAPTER XX

PHYSICAL AND MECHANICAL TESTS

PORTLAND cement is by far the most important of the calcareous cements, and is the only one that is systematically submitted to physical and mechanical tests. The chief tests are—

Specific gravity ; fineness ; setting time ; constancy of volume and soundness ; tensile strength ; crushing strength.

The most important of these tests are those for the crushing strength, fineness, and constancy of volume and soundness, but it must be remembered that unless the tests are carried out in a proper manner under specified conditions they will be worse than useless, as the results obtained will be quite misleading. Some users of Portland cement are in the habit of entrusting the testing to inexperienced men, or even lads. Such a practice cannot be too strongly condemned. There is a tendency, when carrying out these tests, to disregard the importance of the temperature, and the quantity of water used in gauging the cement. Unfortunately, many users of cement regard these points as being of purely academical interest and quite beneath the notice of practical men. This is a great mistake ; the tests should be carried out at the specified temperature, because the difference of a few degrees either way will seriously affect the results obtained. Similarly, if too much or too little water be used the results obtained will no longer be reliable. The consistency of the cement paste should, therefore, be just "normal" (see p. 186). It is important to notice that it is not the amount of water used that is kept constant, but the consistency of the paste.

Specific Gravity.—Although, so far as this country is concerned, this test is almost universally carried out, its utility is more than doubtful, and a knowledge of the specific gravity is no guide whatever to the quality of

Portland cement.¹ This fact is recognized in France and Germany, but the British Standard Specification (1915) demands that the specific gravity of Portland cement, when presented by the manufacturer, shall be not less than 3.10. The determination of the specific gravity may be carried out in an ordinary specific gravity bottle, but it is more conveniently made in the Blount's *volumemeter*,² or in Leipper's modification of Le Chatelier's flask.

The British Standard Specification (1915) approves the flask shown in Fig. 16. In order to determine the

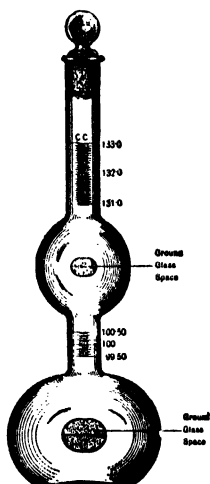

FIG. 16.—Specific gravity bottle.

specific gravity of cement by means of this flask, insert approximately 100 c.c. of *dry* petroleum, turpentine, or other suitable liquid, place the flask and contents in a bath of water which is maintained at a temperature of 15° to 18° C., and allow it to remain therein until the level of the liquid in the

¹ P. B. Butler, *Proc. Inst. Civ. Eng.*, 1906, 166, 342.

² W. H. Stanger and B. Blount, *Jour. Soc. Chem. Ind.*, 1894, 13, 455.

flask is constant. Read this level, and make a note of the reading on the lower ground glass space. Now add exactly 100 grammes of the cement, insert the stopper, and get rid of any entangled air by gently tapping the bottle on a soft pad, so as to cause the air-bubbles to rise to the surface. Replace the flask in the water bath (which must be maintained at the original temperature), and, when the level of the liquid is constant, again take the reading, making a note of it on the upper ground glass space.

The volume of liquid displaced by the cement is given by the difference between the two readings, and the specific gravity of the cement is calculated from the equation—

$$\frac{100}{\text{Volume displaced}} = \text{specific gravity.}$$

The turpentine or petroleum must be quite free from water; a convenient method of ensuring this being to add a little freshly dried cement to the liquid some time before transferring it to the flask.

Fineness.—The degree of fineness of the cement is of great importance, the strength of a sand and cement mortar depending to a large extent upon the size of the particles of the cement.¹ It is tested by means of circular sieves of brass wire cloth, which must be woven, and not twilled. According to the British Standard Specification (1915), the residue on a sieve containing 32,400 meshes per square inch must not exceed 14 per cent., when 100 grammes of the sample is continuously sifted for a period of 15 minutes, and that on a sieve containing 5776 meshes per square inch must not exceed 1 per cent. under the same conditions. According to the German “Normen” the residue must not exceed 5 per cent. on a sieve containing 900 meshes per square centimeter, the width of the mesh being 0.222 mm.

¹ D. B. Butler, *Proc. Inst. Civ. Eng.*, 1898, 133, 343.

Owing to irregularities in the weaving of the cloth, the diameter of the holes in a sieve vary, sometimes to a considerable extent, and great care should be exercised in selecting a suitable cloth.¹ It would be an advantage if some other means could be employed to test the fineness of cement. The use of plates containing a number of holes of a specified diameter has been proposed; and *flourometers*, by means of which the fine and coarse particles are separated by a current of air, are sometimes used, but have not so far met with general approval.

Setting Time.—The setting time of a cement is not usually of great importance, except in the case of quick or medium setting cements. It is divided into two periods known respectively as the *initial set* and the *final set* or *set hard*. The time of the *initial set* is the period between the addition of the water to the cement and the moment when the mixture loses its semi-fluid condition. The *final set* is the period between the addition of the water and the moment when the cement is sufficiently hard to withstand a specified pressure. The initial set is sharply defined in quick-setting cements, but is very vague and ill-defined in those which are slow setting. The setting time is greatly influenced by the amount of water used for gauging, by the temperature of the water, and by the temperature and state of humidity of the atmosphere of the room in which the test is carried out. Hence, the paste should be made of a specified consistency with water at a temperature of 15° to 18° C. The room should also be at this temperature and the atmosphere should be saturated with moisture. Both the setting times are determined by means of the *Vicat Needle* shown in Fig. 17, the needle, *A*, of which is 1 mm. square and is loaded to 300 grammes. The paste is contained in a split ring 8 cms. in diameter and 4 cms.

¹ W. L. Gadd, *Trans. Conc. Inst.*, 1913.

high, which rests on a glass plate. In England, the consistency is usually regarded as correct when the mixture is plastic after being filled into the ring, but in the Continental method—which is frequently adopted in this country—the consistency is determined by means of a plunger, *B*, 1 cm. in diameter, weighted to 300 grammes, and is considered *normal* when the plunger penetrates to within 6 mm. of the bottom of the pat. The initial set is considered to have taken place when the 1 mm. needle will no longer penetrate to the bottom of the mould, and the *final set* when the same needle fails to make any impression upon the surface of the cement. The needle must be kept clean throughout the test, because, otherwise, the cement which collects on its sides and point will affect the result. It is also important to see that the end of the needle rests

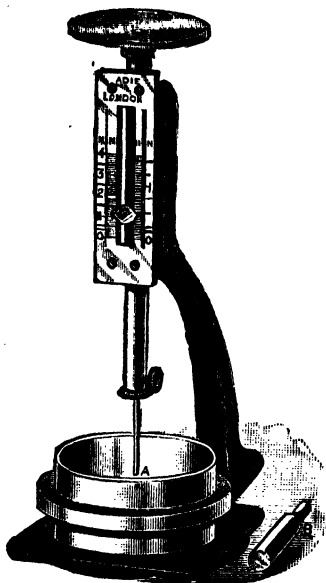

FIG. 17.—The Vicat Needle.

squarely on the surface of the pat. The upper surface of the latter is frequently covered with a film which yields to the needle and thus prevents the exact point of "no impression" from being distinguished. When this happens it is advisable to turn the pat upside down in order to obtain the final setting time. Various automatic machines for the determination of the setting time of cement have been

introduced, but few of them have proved satisfactory in use. In Tetmajor's apparatus the needle is depressed at regular intervals by means of flowing water, and the distance through which the needle moves at each stroke is recorded on a rotating drum by means of a pen. Perin's instrument is somewhat similar, but the needle is driven by means of clockwork. In Marten's apparatus there are three needles placed side by side. These needles are held up by means of magnets, and are caused to descend at intervals by means of a cam which cuts out the sustaining magnets. Woodcock's apparatus is actuated by means of clockwork, and consists of two Vicat needles which are gently lowered on to two semicircular pats of cement of standard thickness held in moulds resting on a turntable, which moves one space onwards every 10 minutes, so as to bring a fresh portion of the pat under the needle. The whole is enclosed in a case in which the temperature can be kept under control. Once started, the apparatus needs no further attention, the time of setting (in minutes) being ascertained by counting the number of impressions and multiplying by 10. This apparatus has been in constant use since 1908 at the laboratory of Mr. F. Woodland Toms, Official Analyst at Jersey, and has proved quite satisfactory, giving results that are claimed to be more trustworthy than those obtained by hand; indeed there can be little doubt that the instrument would be largely used if it were more widely known. Other automatic machines are Goodman's "*Cement tester*" and Nicol's "*Spissograph*."

There is a certain amount of indefiniteness about the needle method of testing the setting time of cement, since the time depends upon the weight and dimensions of the needle employed. In order to avoid this, Gary¹ has introduced a thermometric method, in which the evolution of heat during the process of setting is ascertained by means

¹ Gary, *Concrete and Constructional Eng.*, 1907, 1, 350 and 431.

of a thermometer embedded in the cement, which is held in a rubber ring, placed in a glass vessel and packed round with sawdust, in order to prevent loss of heat. This is certainly a more scientific method of ascertaining the setting time than that usually adopted, since it indicates a real point of chemical change, but so far it has not proved a complete success, because the results obtained vary when different quantities of the same cement are used. In the British Standard Specification (1915), Portland cement is divided into three classes, according to the setting time, *i.e.*—

Quick Setting.—When the initial setting time is not less than 2 minutes, and the final setting time is not less than 10 minutes or more than 30 minutes.

Medium Setting.—When the initial setting time is not less than 10 minutes, and the final setting time is not less than 30 minutes or more than 3 hours.

Slow Setting.—When the initial setting time is not less than 30 minutes, and the final setting time is not less than 3 hours or more than 7 hours.

In addition to these three grades, specially slow cements, of which the minimum time of setting has been specified, may also be supplied.

The cement must be spread out for a depth of three inches, and kept at a temperature of 15° to 18° C. for 24 hours, before commencing the test, and the setting time is to be determined by means of the Vicat needle. In order to determine the final setting time, the needle, A, is replaced by a special needle provided with an attachment, the annular under surface of which comes in contact with the surface of the cement when the needle has penetrated 0.5 mm. The cement is considered as finally set when the needle makes an impression on the cement pat, but the attachment does not.

According to the German "Normen" the initial setting

of normal Portland cement must not take place in less than one hour after gauging, but for special purposes a quicker setting cement may be prepared, which, however, must be marked as such. The final setting time is not specified.

Constancy of Volume and Soundness.—The test for constancy of volume and soundness are the most important of the mechanical tests. At one time unsoundness was attributed to the presence of ordinary free lime, due to overliming or underburning. It was supposed that the lime slaked and expanded after the setting of the cement, thus causing the latter to “blow.” This view has had to be abandoned, because, apart from the improbability of the existence of ordinary free lime in Portland cement, such lime would undergo immediate hydration on the addition of water, and therefore could not be the cause of any subsequent expansion. Crystalline quicklime, however, hydrates very much more slowly, and blowing may be due to the presence of a crystalline form of lime in excess of that which the alite (see p. 83) is capable of holding in combination or solid solution. It may also be due to the presence of an excess of magnesia, or of sulphates; the expansion in the latter case is considered by Candlot¹ to be due to the formation of calcium sulpho-aluminate. Many methods have been used for testing the soundness of cements, an *accelerated* test being generally used at the present time.

In the *Faija* test a freshly gauged pat is placed on a glass plate and kept at a temperature of 40·5° to 43° C. in a moist atmosphere until it has set; it is then immersed in water at a temperature of 46° to 49° C. for the remainder of 24 hours. If the pat does not then show any cracks or blisters on the surface next the glass, the cement is considered to be sound; otherwise the sample is spread out in a thin layer in a cool dry place for a day or two and the

¹ E. Candlot, *Bull. Soc. d'Encouragement*, 1890 [4], 5, 682.

test repeated. If the pat in the second test does not show any cracks or blisters the cement is considered sound when properly aerated.

The *Le Chatelier test* is almost universally employed at the present time. The apparatus, which is sometimes called a *gauge* and sometimes a *caliper*, is shown in Fig. 18. It consists of a split brass ring 30 mm. in diameter and 30 mm. deep, to which are soldered two pointers 150 mm. in length (one on each side of the split). The ring is placed on a glass

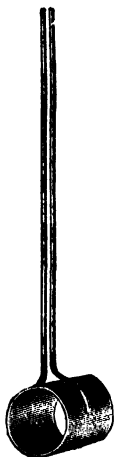

FIG. 18.—Le Chatelier gauge.

plate, filled with the cement paste, covered over with a second glass plate, and the whole is then placed in water at 15° to 18° C. for 24 hours. The distance between the ends of the pointers is then measured, and the apparatus is placed in cold water which is gradually raised to the boiling point and kept boiling for 6 hours. The apparatus is then allowed to cool, and the distance between the ends of the pointers is again measured, the increase in the distance being termed the expansion.

According to the British Standard Specification (1915) the soundness of Portland cement must be determined by means of the Le Chatelier method, and the expansion must not exceed 10 mm. when the sample has been aerated for 24 hours, in the manner described on p. 188, before beginning the test. If the expansion is greater than this limit, the test must be repeated, with the difference that the sample is previously aerated for 7 days. In this case the expansion must not exceed 5 mm.

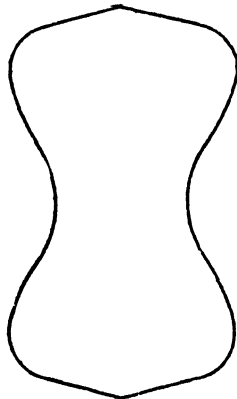

FIG. 19.—Shape of standard briquette.

Tensile Strength.—Although a knowledge of the tensile strength is of comparatively little importance, this test is almost universally employed in this country. The cement is mixed with sufficient water to form a plastic mixture when in the mould. It is then moulded in brass or gun-metal moulds, which should be wiped with an oily cloth before filling. The shape of the briquettes so produced has varied somewhat at different periods; that shown in Fig. 19 is the one recommended by the British Standard Specification (1915). The briquettes are kept in a damp atmosphere at

a temperature of 15° to 18° C. for 24 hours after gauging, and are placed in clean water at the same temperature until required; the water must be changed every 7 days

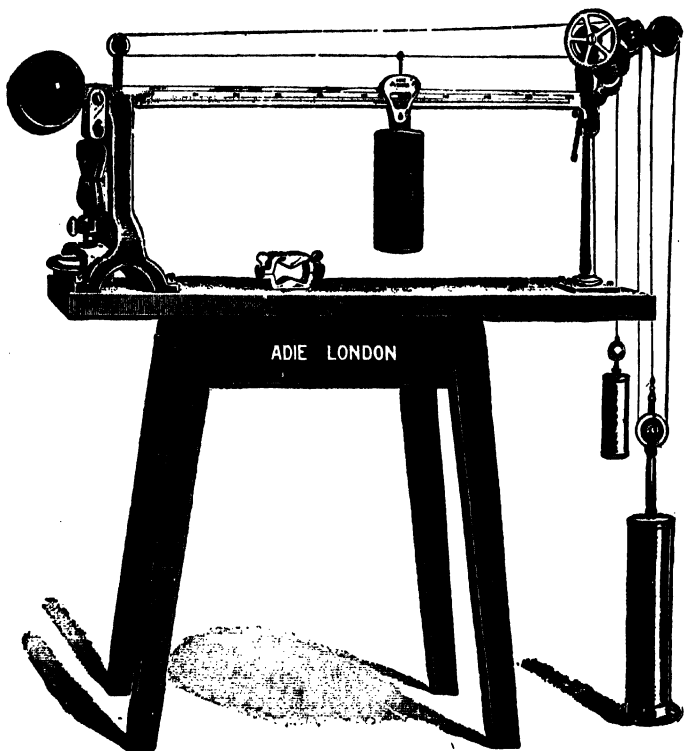

FIG. 20.—The Adie testing machine.

if the briquettes are to be kept for more than a week. The briquettes are broken immediately after being taken out of the water, care being taken in centring the briquettes in the testing machine, in order to avoid cross-strains.

The machines for this purpose are of various designs, one of the oldest and best being the *Adie testing machine* shown in Fig. 20. Similar tests are also carried out with a mixture of 1 part by weight of cement and 3 parts by weight of dry standard sand. According to the British Standard Specification (1915), the cement is to be aerated for 24 hours in the same manner as in the test for the setting time (see p. 188), before commencing the test. The neat cement briquettes are to be prepared without mechanical ramming or hammering in any form, and are to be tested at 7 and 28 days. The average breaking stress of 6 briquettes must not be less than 450 lbs. per square inch at 7 days. At 28 days the average breaking stress of 6 briquettes must not be less than the number of pounds per square inch arrived at from the formula—

$$\text{Breaking stress at 7 days} + \frac{40,000 \text{ lbs.}}{\text{breaking stress at 7 days}}$$

The breaking stress of 6 of the cement and sand briquettes must be not less than 200 lbs. per square inch at 7 days, and at 28 days the average breaking stress of 6 briquettes must be not less than the number of pounds arrived at from the formula—

$$\text{Breaking stress at 7 days} + \frac{10,000 \text{ lbs.}}{\text{breaking stress at 7 days}}$$

The tensile strength of both neat cement and of a mixture of cement and sand is omitted from the German "Normen."

Crushing Strength.—The compression test is of much greater importance than the tensile test, although it is not so frequently employed in this country. In order to carry out this test, cubes of specified dimensions are prepared and kept in the same manner as are the briquettes described above. They are then tested for resistance to compression. The machines used for crushing the cubes

differ from each other almost as much as do those employed for the tensile test, but as the crushing stress of Portland cement is about ten times as great as the tensile strain,

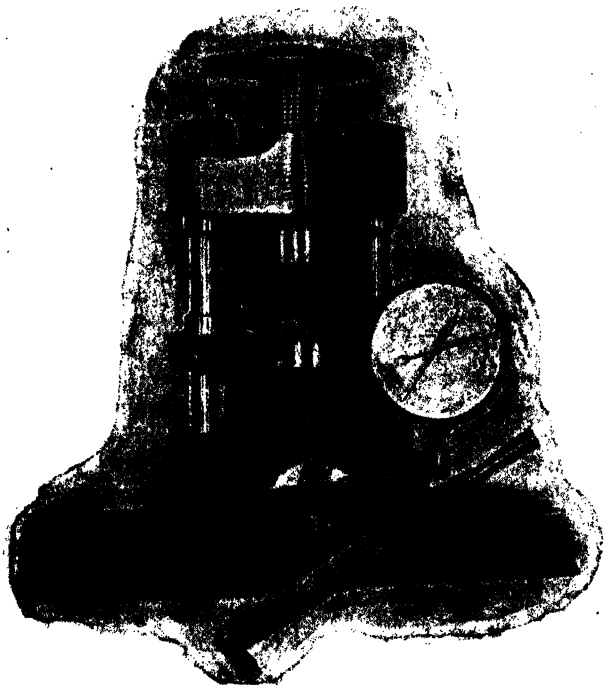

FIG. 21.—Hydraulic press made by Messrs. The Associated Portland Cement Manufacturers (1900), Limited.

the machines used for crushing have to be much more powerful than those used for tensile tests. The *Amsler-Laffon hydraulic press* is a very popular form of crushing machine; the machine shown in Fig. 21 is manufactured

by the Associated Portland Cement Manufacturers (1900), Limited. It is very convenient and satisfactory.

The compression test has so far been omitted from the British Standard Specification for Portland cement; according to the German "Normen" a mixture of 1 part by weight of Portland cement to 3 parts by weight of standard sand must have a compressive strength of at least 120 kilogrammes per square centimetre after 7 days (1 day in moist air and 6 days in water), and a compressive strength of at least 250 kilogrammes per square centimetre after a further 21 days in air at a temperature of 15° to 20° C. By the same standard Portland cement intended for use under water must show a compression stress of at least 200 kilogrammes per square centimetre after 28 days (1 day in air and 27 days in water).

INDEX

A

- Aalborg cement kiln, 65
— lime kiln, 39
Aberthaw lime, 25
Accelerated tests for soundness of cement, 189
Accelerators for plaster of Paris, 117
Adie testing machine, 193
Adulteration of bitumen, 163
— of Portland cement, 92, 180
Aggregate, 141
— employed in ferro-concrete, 147
—, grading of, 142
—, nature of in mediæval mortars, 4
—, proportion of voids in, 143
Air separators, 59, 74
Air-slaked lime, composition of, 11
Alabaster, 108
Albania, occurrence of asphalt in, 162
Alberti on the permanence of slaked lime, 121
Algiers, use of artificial pozzolanas at, 127
Alite in Portland cement clinker, 83
Alkalies, estimation of, in lime, 180
— in Portland cement, 79
Alkali waste, use of, in manufacture of Portland cement, 50
Alum, use of, for hardening plaster of Paris, 118
—, —, for rendering cement waterproof, 159
—, —, for the preparation of hard finish plasters, 119
Alumina, action of, in the calcination of clayey limestones, 31
—, determination of, in lime, 177
—, —, in plaster cements, 181
Aluminates of calcium in Portland cement clinker, 81
Aluminium silicates in clay, 8, 13
— in limestones, 8, 13
— silicofluoride, use of, for rendering cement waterproof, 160
— sulphate, use of, in the preparation of hard finish plasters, 119
Alumino-silicates of calcium in hydraulic limes, 13
— in natural cements, 99
— in Portland cement clinker, 85, 87
Ambronne on the hardening and setting of Portland cement, 89
American natural cements, 105
Amsler-Lafion hydraulic press, 194

- Analyses of Portland cement, 80**
 — of pozzolanas, 128
 — of Roman cement, 102
 — of trass, 130
Analysis of limes and cements, 173
 — of iron ore cement, 95
 — of natural cements, 180
 — of plaster cements, 181
 — of Portland cement, 180
 — of slag cement, 180
Analytic method of investigation of the constitution of Portland cement clinker, 80
Anhydrite, 108
Appalachian range, the magnesian limestones of, 105
Apparatus for the determination of CO₂, 174
Arènes, 126
Argillaceous limestones of the Jurassic system, 26
Armoured concrete, 146, 147
Artificial hydraulic limes, General Treussart on, 45
 — —, methods of preparation, 45, 46
 — —, use of pozzolanic materials in preparation of, 45
 — —, Vicat's method of preparation, 45
 — pozzolanic materials, 126
Asch, Messrs. W. & D., on the constitution of Portland cement clinker, 87
Ashes, use of, for aggregate, 142
Askham air separator, 74
Aspdin, invention of Portland cement, 50
Asphalt, 163
 —, for rendering cement water-proof, 158
 —, mastic, 164
 —, occurrence of, 162, 163
 — paving, 164
Asphaltene, 163
Associated Portland Cement Manufacturers (1900), Ltd., hydraulic machine for testing the crushing strength of cement, 195
Assyrians, cement used by the, 1
Atkinson, discovery of septaria in Yorkshire by, 100
Atmosphere, influence of, upon mortar, 138
Augustin, St., on mortar, 3
Automatic machines for the determination of the setting time of cements, 186, 187
Azores, pozzolana found in the, 128, 129
- B**
- Babylonians, cement used by the, 1**
Backs, use of, for drying slurry, 51
Ball-mill, 57, 70
 —, molitor, 57
 —, sieveless, 73
 —, wet, 52
Bamber on retarding action of gypsum upon Portland cement, 92
Bamber's method of regulating the setting time of cement, 74
Bar disintegrator, 59
Bas Rhin, department of, occurrence of asphalt in, 162
Basaltic rocks, use of, as pozzolanic materials, 131
Batchelor kiln, 63
Bath stone, not able to resist action of saltpetreing, 170
Bearings for, cylinders of rotary kilns, 69
Bekelbrom, occurrence of asphalt at, 162
Belgian natural cements, 104
 — —, substitution of, for Portland cement, 93, 104
Belgium, use of cendrée de Tournai in, 132

- Belidor on increasing the hydraulic properties of lime, 6
 Belite in P. C. clinker, 83
 Bergman on hydraulic limes, 7
 Bermudas, occurrence of asphalt in, 163
 Berthier, analyses of septaria by, 100
 —, analysis of trass by, 130
 —, method of examination of limestones, 28
 — on composition of pozzolanas, 127
 — on hydraulic limes, 8
 Beth dust collector, 77
 Béton, 141
 Bins, calcining, 115
 Bitumen, 163
 — associated with gypsum, 109
 —, use of, by Assyrians and Babylonians, 1
 Bituminous cements, 162
 Blake's stone breaker, 55
 Blast-furnace slag, adulteration of Portland cement by, 93
 — used in manufacture of Portland cement, 50
 — used in manufacture of slag cement, 48
 Bleaching powder, 20
 Blood, retarding action of, upon the setting of plaster of Paris, 117
 Blount's volumeter, 183
 Blowing of cement, causes of, 189
 Blown sand, 125, 126
 Blue lias lime, 25, 104
 —, slaking of, 26, 121
 — limestone, 25
 Blumenthal on the setting and hardening of Portland cement, 89
 Boiling plaster, 113
 — in kettles, 114
 Borax, use of, in preparation of hard finish plasters, 119
 —, —, in preparation of Parian cement, 119
- Bottle kiln, 63
 Bottle, specific gravity, form approved in the British Standard Specification for cement (1915), 183
 Bradley three-roll mill, 61
 Brest, use of artificial pozzolanic materials in marine works at, 127
 Bricks, sand-lime, 120, 123
 —, broken, use of, for aggregate, 142
 —, magnesia, used for furnace linings, 25
 —, slurry made into, 51
 Briquettes for the determination of the tensile strength of cement, 191
 —, raw materials moulded into, 62
 British Standard Specification for Portland cement (1915), 79, 94, 183, 184, 188, 190, 191, 192, 193, 195
 Broadbent's improved Blake's stonebreaker, 55
 Broken bricks, use of, for aggregate in concrete, 142
 — stone, use of, for aggregate, 141
 — tiles and pottery, use of, for aggregate, 142
 Broughton mixer, 117
 Burnt clay, pozzolanic action of, 127
 —, use of, for aggregate, 142
 Butler on effect of fineness of grinding upon Portland cement, 184
 — on specific gravity of Portland cement, 182
- C**
- Caen stone, unable to resist action of saltpetreing, 170
 Cainozoic period, occurrence of gypsum in formations of, 109

- Cainozoic period, occurrence of limestone in formations of, 23
- Calcination of clayey limestones, 30
- of American natural cements, 105
 - of flooring plasters, temperature of, 118
 - of hard finish plasters, temperature of, 119
 - of limestones, length of time required, 36
 - —, method of ascertaining completion of, 37
 - —, temperature of, 29
 - of plaster of Paris, temperature of, 110
 - of Portland Cement, temperature of, 62
 - of Roman cement, temperature of, 101
- Calciner, Cummer rotary, 115
- , Mannheim, 108, 114
- Calcium aluminate in limes, 13
- — in natural cements, 99
 - — in Portland cement, 81, 82, 84, 85, 86, 87, 88, 89, 90, 91
 - aluminosilicate in limes, 13, 14
 - — in natural cements, 99
 - — in Portland cement, 85, 87
 - carbonate, fusion of, in atmosphere of CO_2 , 29
 - , varieties of, 21
 - ferrite in limes, 13
 - — in Portland cement, 79
 - hydroxide, 11
 - —, solubility of, in water, 12
 - , mode of occurrence in nature, 10
 - orthosilicate in Portland cement clinker, 82, 88
 - oxide, 10
 - —, determination of, in limes, 177
- Calcium oxide, determination of, in plaster cements, 181
- —, solubility in water, 11, 12
 - phosphate in limes from fossiliferous limestones, 28
 - silicate in limes, 8, 13
 - — in natural cements, 99
 - — in Portland cement, 81, 82, 84, 85, 86, 87, 88, 89, 90, 91
 - soap, 159
 - sulphate, anhydrous, 108, 118, 119
 - —, effect of, upon Portland cement, 91
 - —, hemihydrate, 110, 116
 - —, hydrated, 108, 116
 - — in Portland cement, 79
 - —, varieties of, 108
 - sulpho-aluminate, a cause of expansion of cement, 189
 - —, formed by action of sea-water upon Portland cement, 92
 - —, the cause of the failure of cement exposed to sea-water, 128
- Calc-sinter, deposition of, by calcareous springs, 22
- Caliper, Le Chatelier's, 190
- Calves' hair used with lime in plastering, 150
- Campbell on constitution of Portland cement, 86
- Canada, occurrence of asphalt in, 163
- Candlot on the expansion of cement, 189
- Carbon dioxide, absorption of, by moist lime, 11
- , determination of, in limes, 174
 - , from lime kilns, utilization of, in Germany and U.S. of America, 29
 - in Portland cement, 78

- Carbon dioxide, removal of, from lime kilns, 29
- Carboniferous limestone, 22, 24
— system, occurrence of gypsum in formations of, 109
— —, occurrence of limestone in formations of, 23
- Casein paints for rendering cement waterproof, 158
- Caspian Sea, occurrence of asphalt in, 162
- Catania, beds of pozzolanic material found near, 130
- Caucasus, occurrence of asphalt in, 162
- Caustic lime, properties of, 10
- Ceilings, plastering, 149, 150
- Celite in Portland cement clinker, 83
- Cement, blowing of, 189
—, concrete, 141
—, expansion of, 182
—, General Scott's selenitic, 19, 20
—, grappier, 19
—, iron Portland, 49
—, Keene's, 119
—, La Farge, 19
—, Louisville, 106
—, Mack's, 119
—, Martin's, 119
—, Medina, 103
—, Mortar, 136, 140
—, —, employment of, 140
—, —, use of, for plastering, 151
—, Parian, 119
—, Parker's, 4, 99
—, plaster, 103, 111
—, Portland, *see* Portland cement
—, rock, 105
—, Roman, 4, 99, 102, 103
—, Rosendale, 105, 106
—, sand, 94, 95
—, Scott's, 20
—, selenitic, 19
—, sidero, 95
- Cement stones, 100, 101
— stucco, 147, 153, 157
—, Super, 94, 95, 145, 161
— tester, Goodman's, 187
—, unsoundness of, 189
—, Vassy, 103
—, waterproofing, 158
—, white Portland, 94, 157
- Cementing materials, antiquity of, 1
- Cements, bituminous, 162
—, —, use of, in mosaic work, 165
—, efflorescence of, 168
—, iron ore, 94, 95
—, natural, 99
—, —, American, 105, 106
—, —, Belgian, 104
—, —, French, 103, 104
—, —, use of, 106, 107
—, oleaginous, 162, 166, 167
—, plaster, 108, 111
—, pozzolanic, 48
—, slag, 48, 49
— slag, analysis of (Seger & Cramer's method), 180
— —, use of, as a substitute for Portland cement, 93
— —, use of, for making cement mortar, 136, 140
- "Cementkote," 159
- Cendrée de Tournai, 132
- "Ceresit," 159
- Chalk, 21, 22, 23
—, lower or grey, 26
— lime, 27
— marl, 26
—, occurrence of, 26
—, upper or white, 27
—, use of, for production of lime, 21
—, use of, as raw material in manufacture of Portland cement, 27, 50
- Chambers, expansion, 70
- Chaux de Theil, 18, 104
- Cheleken, occurrence of asphalt in island of, 162

- Cherbourg, use of artificial pozzolanic materials in marine construction at, 127**
Chunam, 151, 152
 —, use of in India as a stucco, 156
Ciment grapier, 19
Cinders use of in preparation of, mortar, 132
Clarke's mill, 53
Classification of materials used with lime in making mortar, 133
Clay, 13, 124, 127
 —, burnt, acts as a pozzolanic material, 127
 —, —, use of, for aggregate, 142
 —, cause of hydraulic properties of lime, 6
 —, composition of, 13
 —, use of, by ancient Egyptians, 2
 —, use of, by Assyrians and Babylonians, 1
 — used as a raw material in manufacture of Portland cement, 50
 — used in making mortar, 124, 126
 — used in mud walls and Pisé work, 127
Clayey limestones, calcination of, 13, 20
Clinker, hydraulic lime, ideal composition of, 14
 —, Portland cement, 72, 73
 —, —, treatment of, to regulate the setting time, 73, 74
Clinkers from lime kilns, hydraulic properties of, 132
Clinkers, use of, for aggregate, 142
Cloez on the setting of plaster of Paris, 117
Clunch lime, 26
Clyde hydrator, 123
Coal tar, use of, as a substitute for natural bitumen, 164
Coal tar, use of, for water-proofing cement mortar, 158
Coal for rotary kilns, treatment of, 70
Coal, use of, for calcination of limestone, 32, 33, 37, 43
 —, —, in cement kilns, 65, 67, 70
 —, —, in plaster kilns, 112
Coke, liability to cause expansion when used in concrete, 142
Coke, use of, for calcination of limestone, 32, 33
 —, —, in cement kilns, 66
Collectors, dust, 76
Collet Descotils on hydraulic limes, 7
Colloidal theory of setting and hardening of hydraulic cements, 88, 89, 90, 91
Colony on the setting and hardening of Portland cement, 90
Common lime, 10
 — mortar, 136
Compo, 62
Compound mills, 61
Compounds sold for water-proofing cement, 159
Concrete, 141
 —, armoured, 146, 147
 —, cement, 141
 —, ferro, 146, 147
 —, lime, 143, 144
 —, reinforced, 146, 147
 — under water, 146
Consistency of cement mortar, methods of determination, 182, 185, 186
Constancy of volume, tests for, 182, 189, 190
Constitution of Portland cement clinker, 80
Continuous kilns, cement, 63, 64
 —, lime, 34, 37, 42
 —, plaster, 111
Conveyors, 76
Coolers, various types, 71

Corfe Castle, use of lime concrete or béton at, 141
 Cow's hair used with lime in plastering, 150
 Crackers, 56, 70, 106
 Cretaceous system, 23, 26
 —, occurrence of limestone in formations of, 23, 26, 27
 Crusher, Hadfield's gyratory, 56
 Crushers, types of, 55, 56
 —, use of, for crushing coal, 70
 —, —, for crushing clinker, 73
 Crushers, use of, for crushing plaster stone, 115
 Crushing strength of cement, test for, 182, 193
 — of lime mortar, 139
 — of natural cements, 103, 106,
 — of super cement, 97
 Crystalline calcium oxide, hydration of, 189
 Cuba, occurrence of asphalt in, 163
 Cummer rotary calciner, 115
 Cylinders for rotary kilns, length of, 67
 —, lining of, 67
 —, rotation of, 69

D

Dalton on the solubility of quicklime in water, 11
 — on the solubility of slaked lime in water, 12
 Dancaster on tensile strength of Super cement, 98
 Darcey and Thénard's encaustic for stone, 156
 Davidsen tube mill, 59
 Davis on the setting of plaster of Paris, 117
 Day, Sheppard and Wright on tricalcium silicate, 82
 Dead burnt plaster, 110
 Dead Sea, occurrence of asphalt in, 162

Dehydration of gypsum, 108, 110, 116
 "Densin," 159
 De Saussure on hydraulic limes, 7
 Desch on the constitution of Portland cement, 87
 — on the setting and hardening of Portland cement, 89
 Devonian system, occurrence of gypsum in formations of, 10
 —, occurrence of limestones in formations of, 24
 Dibdin on the composition of mediæval mortars, 4
 Dicalcium aluminate in Portland cement clinker, 81, 84
 — silicate in Portland cement clinker, 81, 82, 84, 85, 86, 89
 Dietzsch kiln, 40, 65
 Disintegrator, bar, 59
 Ditter and Jesser on the constitution of Portland cement clinker, 85
 Dolomite, 24
 Dolomites associated with gypsum, 109
 Dolomitic limestone, 24
 Dome kiln, 63
 Dorking lime, 27
 Driers, for drying coal, 70
 —, rotary, 56
 —, Ruggles-Coles, 56
 —, tunnel, 51, 62
 Drying floors, 51
 Dry method of mixing raw meal, 51
 Dry process, 53
 Dumesnil kiln, 112
 Dust chamber for rotary kilns, 69
 Dust, collection of, in cement works, 76
 — collector, Beth, 77

E

Edge-runners, 57, 59, 115
 —, wet 52

Efflorescence of limes, cements and plasters, 168, 170
 —, precautions against, 171, 172
 Egyptians, use of mortar by the, 2
 Eisen-Portland zement, 49
 Electrical methods of investigating the constitution of Portland cement and clinker, 80, 85
 Elevators in cement works, 76
 Eminently hydraulic limes, 17, 18, 104, 134, 135, 136
 Encaustic for stone, 156
 Estrichgips, 118
 Etageofen, 64
 Etruscans, use of mortar by the, 3
 Expanded metal for reinforced concrete, 147
 Expansion chambers, 76
 — of cement, 189

F

Faija test for soundness of cement, 189
 Fat lime, properties of, 16
 —, slaking of, 120
 Feed shoot for rotary kilns, 69
 Feichtinger, analysis of trass by, 130
 Feldspar, found in Santorin earth, 130
 —, in certain sands, 126
 Felite in Portland cement clinker, 83, 84
 Ferric oxide, determination of, in limes, 177
 —, —, in plaster cements, 181
 — in Portland cement, 79, 80
 Ferrites, formation of, in lime at clinkering temperature, 13, 31
 —, —, in Portland cement at clinkering temperature, 79

Ferro-concrete, 141, 146, 147
 Ferrous oxide in blue lias limestone, 25
 — — in Portland cement clinker, 79
 Fibrous plaster, 157
 Filling ring for Schneider kiln, 66
 Filters, dust, 76
 Final set of cement mortar, 185, 186
 Fineness of grinding, test for, 182, 184
 Flare kilns, 35
 — lime, 27, 35
 Flasks for the determination of specific gravity, 183
 Flint pebbles, use of, in tube mills, 60
 Floating, 150
 Flooring plasters, 118, 119
 Flour, raw, 62
 Fluates, 160
 Fluorometers, 185
 Foraminifera, remains of, in chalk, 23
 —, —, in limestone, 22
 Forewarmer for the Mannheim calciner, 114
 Fossiliferous limestones, 24, 27
 —, lime from, 27
 —, calcium phosphate in, 28
 France, method of making lime mortar in, 139
 —, occurrence of asphalt in, 162
 —, pozzolanas found in, 128
 Fremy on the constitution of hydraulic limes and cements, 8, 81
 French burr millstones, 57, 73, 115
 — method of slaking limes, 122
 — natural cements, 103, 104
 Fresenius, method of estimating CO₂ in lime, 175

Frost, discovery of septaria at Harwich by, 99
 Fuchs on hydraulic limes, 8
 Fuel, amount required in cement kilns, 65, 66
 —, amount required in intermittent lime kilns, 37
 —, effect of, upon quality of lime produced, 33
 — used in rotary kilns, 70
 Fuels, effect of sulphur in, 33
 — employed for the calcination of limestone, 32
 —, gaseous, used in lime kilns, 33
 Fuller-Lehigh mill, 61

G

Gadd on cement waterproofing compounds, 159
 — on selection of wire cloth for sieves, 185
 Gallo, analyses of Italian pozzolanas by, 128
 Gariel's Vassy cement, 103
 Gary's thermometric method of determining the setting time of cement, 187
 Gauge, Le Chatelier's, for testing soundness of cement, 189, 190
 Gauthey on the use of pozzolanas with rich limes, 135
 German "Normen" for Portland cement, 78, 79, 184, 188, 193, 194, 195
 Giant griffin mill, 61
 Gillmore on tensile and crushing strength of Rosendale cement, 106
 Giron, improvements of the rotary kiln, 67
 Glue, hardening effect upon plaster of Paris, 117
 —, retarding action of, upon the setting of plaster of Paris, 117

Goddard, invention of super cement, 95
 Goodman's cement tester, 187
 Goreham process, 52
 Grading of the aggregate in making concrete, 142
 Granite, use of, for aggregate, 142
 Grapiers, 18, 83, 122
 Grappier cement, 19
 Gravel, use of, for aggregate, 142
 Greeks, use of cement by the, 2
 Grey or lower chalk, 26, 27
 Grey stone Medway lime, 27
 Greywacke, sand formed by decomposition of, 126
 Griffin mill, 61, 70
 Grinding machines used in cement industry, 74
 — plaster stone, 115
 Grout, 145
 Grouting, questionable value of, 138
 Guiton de Morveau on hydraulic lime, 7
 Gum arabic, hardening effect of, upon plaster of Paris, 117
 Gypsite, 108
 Gypsum, 108
 —, action of on Portland cement, 91
 —, association with dolomite, 109
 —, boiling of, 113
 —, boiling in kettles, 114
 —, calcination of, 111, 116
 —, dehydration of, 108, 110, 116
 —, dehydration by means of steam, 113
 — earth, 108
 —, occurrence of, in various geological systems, 108, 109
 —, use of, by ancient Egyptians, 2
 —, —, by Assyrians and Babylonians, 1
 Gyrary crushers, 55, 56

H

- Hadfield's gyratory crusher, 56
 Half-burnt, 72
 Halling lime, 27
 Hard finish plasters, 119
 —, use of, for plastering, 151
 Hauenschild kiln, 66
 Heat microscope, use of, in the investigation of the constitution of Portland cement clinker, 85
 Hedgehog rolls, 56
 Hoffmann ring kiln, 42, 64
 Holland, use of trass in, 130
 Hood for rotary kilns, 70
 Hotop kiln, 66
 Hurry and Seaman's improvements in rotary kilns, 67
 Hydrated calcium aluminate, properties of setting and hardening under water, 14, 88, 90, 91
 — calcium silicate, properties of setting and hardening under water, 14, 81, 82, 88, 89, 90, 91
 — lime, 120, 122
 Hydrating lime, methods of, 120
 Hydrator, Kritzer, 123
 Hydraulic limes, 14, 16, 17
 — —, artificial, 45
 — —, Smeaton's experiments on, 5
 — —, Vicat's method of slaking, 122
 — limestones, contain clay, 5, 7, 28
 — —, liability to fuse during calcination, 31

I

- "Impervite," 159
 Impurities in sand injurious to mortar, 126
 Initial set of cement mortar, 185

- Insoluble matter, determination of, in limes, 176
 — —, in plaster cements, 181
 Intermittent cement kilns, 63
 — lime kilns, 34
 Investigation of the constitution of Portland cement clinker, 80
 — of the processes of setting and hardening of cement, 80, 87
 Iridescent marls, 109
 "Ironite," 160
 Iron ore cements, 94, 95
 Iron, oxides of, in limes, 13
 — —, in Portland cement, 78
 — Portland cement, 49

J

- Jaggree, use of, in India, 152
 Jänecke on the constitution of Portland cement clinker, 85, 87
 — and Schumann on Portland cement clinker, 85
 Jeffrey pulveriser, 59
 Jersey, use of Woodcock's apparatus in official analyst's laboratory at, 187
 Johnson kiln, 63
 Jurassic system, occurrence of limestones in, 23, 25, 26

K

- Kankar, occurrence and use of, in India, 21
 Kappen on the presence of felite in Portland cement clinker, 84
 Keene's cement, 119
 Keisermann on the constitution of Portland cement clinker, 84
 — on the setting and hardening of cement, 89

Kentish rag, use of, for the adulteration of Portland cement, 93
 Kent mill, 60
 Kettles, boiling plaster in, 114
 Keystone lime kiln, 42
 Kiln hood for rotary kilns, 70
 Kilns, cement, 63
 —, lime, 34
 —, plaster, 111
 Kirkaldy, tests of Super cement, 96
 Klein, on the constitution of Portland cement, 84, 86
 — on the setting and hardening of Portland cement, 91
 Knauss, analyses of Roman cement, 102
 Kominor mill, 57
 Kritzer hydrator, 123
 Krupp ball-mill, 57
 Kuhlmann's experiments with sodium or potassium silicate and lime, 47
 Kunkur, 151

L

Lacordaire's Pouilly cement, 103
 La Farge cement, 19
 Lamy on the solubility of quick lime in water, 11
 — on the solubility of slaked lime in water, 13
 Landes, occurrence of asphalt in department of the, 162
 Landrin on calcium silicates, 81
 — on hydraulic cements, 9
 La Rochelle, mastic used at, 166
 La Voisier on calcination and setting of plaster of Paris, 116
 Lauman hydrator, 123
 Lean limes, properties of, 16
 Le Chatelier, caliper for determination of expansion of cement, 189
 — on hydraulic cements, 9

Le Chatelier on the composition and setting of plaster of Paris, 116
 — on the constitution of Portland cement clinker, 81
 — on the different kinds of crystals in cement clinker, 83
 — on the formation of ferrites in Portland cement clinker, 79
 — on the ideal composition of hydraulic cement clinker, 14
 — on the presence of alite in gapiers, 83
 — on the setting and hardening of Portland cement, 87, 88, 91
 — test for constancy of volume and soundness of cement, 189
 Le Sage's plaster cement, 103
 Lias formations of Jurassic system, 25
 — limestone, 22
 Lime, analyses of, 173
 —, antiquity of, 1
 —, béton, 141
 —, blue lias, 25, 104, 121
 —, —, slaking of, 121
 —, clunch, 26
 —, colour of, not an indication of its quality, 31
 —, common, 10
 —, composition of, 25
 —, concrete, 141
 —, —, proportions of ingredients, 143, 144
 —, determination of, in limes, 177
 —, — of in plaster cements, 181
 —, Dorking, 27
 —, flare, 27
 —, free, in Portland cement, 78
 — from upper or white chalk, 27
 Lime, grey stone Medway, 27
 —, General Treussart's observations upon the burning of, 31

- Lime, Halling, 27
 —, hydrated, 120, 122
 —, mortar, 136, 139
 —, proportion of in mediæval mortars, 4
 —, proportion of, to SiO_2 and Al_2O_3 in Portland cement, 78
 —, slaking of, 26
 —, stone, 27
 —, stucco, 153
 — used for plastering, 150
 — — for rendering, 148
 — — in manufacture of slag cements, 49
 —, uses of, 20
 —, water, 11
 —, withdrawal of, from kilns after calcination, 38
 Limes, behaviour of, when treated with water, 14, 15, 16
 —, classification of, 14, 16, 17
 —, colour of, 18
 —, containing silicates, slaking of, 14
 —, deficient in silica, behaviour of, 27
 —, eminently hydraulic, 17, 18, 104, 134, 135, 136
 —, efflorescence of, 168
 —, fat or rich, 16, 121, 137
 —, French eminently hydraulic, 18
 —, from chalk marl, 27
 —, from fossiliferous limestone, 27
 —, hydration of, 120
 —, hydraulic, artificial, 45
 —, —, effect of overburning, 32
 —, —, French method of slaking, 18, 122
 —, —, properties of, 17
 —, —, method of treatment in preparation of mortars, 137
 —, —, slaking of, 14, 18, 121
 —, hydraulic, Smeaton's experiments on, 5
 Limes, lean or poor, 16, 121
 —, methods of hydrating, 120
 —, moderately hydraulic, 17
 —, saltpetreing of, 168
 —, slaking of, 120, 121
 —, used for building purposes, 13
 —, with an excess of alumina, behaviour of, 27
 Limestone, arrangement of, in kilns, 30
 —, blue lias, 25
 —, burning in stacks, 33
 —, calcination of, 29
 —, carboniferous, 24
 —, change of colour during calcination, 31
 —, composition of, 22
 —, dolomitic, 24
 —, fossils in, 24, 28
 —, gravels, 23
 —, magnesian, 24
 —, marls, 23
 —, mountain, 24
 —, nummulitic, 23
 —, occurrence of, in different geological formations, 23
 —, oolitic, 26
 —, Petherwin, 24
 —, pure, effect of overburning, 32
 —, use of, for aggregate, 142
 —, —, for the production of lime, 21
 —, —, in the manufacture of Portland cement, 50
 —, varieties of, 22, 24, 25, 26
 —, Wenlock, 24
 —, Woolhope, 24
 Limestones altered by contact with eruptive rocks, 124
 —, clayey, calcination of, 30
 —, composition of those yielding different varieties of lime, 28
 —, containing magnesium carbonate, 24

Limestones, hydraulic, distribution of, 45
 —, —, liability to fuse during calcination, 31
 —, method of analysis recommended by Berthier, 28
 —, origin of, 22
 Linings of cylinders of rotary kilns, 67
 — of lime kilns, 34
 Litharge mastic, Thénard's, 166
 Lobsann, occurrence of asphalt at, 162
 Loss on ignition, determination of, 174
 Louisville cement, 106
 Lower or grey chalk, 26, 27

M

Maben on the solubility of calcium hydroxide in water, 12
 Machines for testing the crushing strength of cement, 193, 194
 — for testing the tensile strength of cement, 192
 —, automatic, for the determination of the setting time of cement, 186, 187
 Mack's cement, 119
 Magnesia, 24
 — bricks, use of, for furnace linings, 25
 —, determination of, in lime, 178
 —, —, in plaster cements, 181
 —, expansion of cement caused by excess of, 189
 — in Portland cement, 78
 —, use of, 24
 Magnesian limestone, 24, 25
 Magnesium carbonate in limestones, 24
 Magnesium silicofluoride, use of, for rendering cement water-proof, 160
 Mallow root, hardening effect of upon plaster, 118
 Manganese, formerly supposed to be the cause of the hydraulic properties of lime, 7
 Mannheim calciner, 114
 Marble, composition and use of, for the production of lime, 21
 Marbles found in rocks of Palæozoic period, 23
 Marignac on hydration of plaster of Paris, 116
 Marl, chalk, 26
 Marls used in manufacture of Portland cement, 50
 Marten's apparatus for the determination of the setting time of cement, 187
 Martin's cement, 119
 Massive gypsum, 108
 Mastic, asphalt, 164
 —, de Dhil, 166
 —, Hamelin's, 166
 —, oleaginous, 166
 —, recommended by Vauban, 167
 —, used at Paris by military engineers, 167
 Maxecon mill, 62
 Meal, raw, 62
 Mechanical mixers, use of, for mixing concrete, 146
 — —, for mixing mortar, 139, 140
 Mediæval mortars, 4
 Medina cement, 103
 Medium setting cement, 188
 "Medusa," 160
 Mesozoic period, occurrence of gypsum in formations of, 109
 —, — of limestones in formations of, 23
 Meudon, method of making artificial hydraulic lime at, 46
 Michaelis, analysis of iron ore cement, by, 95
 — on hydraulic cements, 9, 88, 89

- Microscope, heat, use of, in the investigation of the constitution of Portland cement clinker, 85**
 —, use of, for the detection of adulterants in Portland cement, 180
 —, —, in the investigation of the constitution of Portland cement clinker, 82
 —, —, in the investigation of the phenomena of setting and hardening of cements, 89
Microscopic organisms, remains of, in chalk, 23
 —, —, in limestones, 22
Mignan, Captain, on the use of bricks and mortar by the Assyrians and Babylonians, 1
Mills, types used in cement industry, 57, 70, 73, 103, 106, 115
 —, types used for grinding coal for rotary kilns, 70
Millstones, French burr, 57, 73, 106, 115
 —, rock, emery, 57, 106
Mineral oil, use of, for rendering cement mortar waterproof, 159, 160
Mixers, 53
Mixing raw materials in manufacture of Portland cement, 50
 — silos, 62
Moderately hydraulic limes, 17, 121
Monocalcium aluminate in Portland cement clinker, 81, 82
 — silicate in Portland cement clinker, 81, 82
Mortar, cement, 136, 140
 —, consistency of, 136
 —, deterioration in quality after Roman period, 4
 —, formula for obtaining the bulk of, 139
 —, improvement in the quality of, after the eleventh century, 4
Mortar, lime, 136
 —, —, strength of, 139
 —, —, preparation of, 121, 136, 139
 —, pozzolanic, 136
 —, trass, 136
 —, use of, by Assyrians and Babylonians, 1
 —, —, by ancient Egyptians, 2
 —, —, by Etruscans, 3
 —, —, by Greeks, 2
 —, —, by Romans, 3
Morveau, Guiton de, on hydraulic limes, 7
Mosaic work, bitumen cements used for, 165
Mosser cooler, 71
Mountain limestone, 24
Moyer on use of oil for rendering cement waterproof, 159
Mumford and Moodie's air separator, 74
- N
- Natural cements, 99**
 —, American, 105
 —, analysis of, 180
 —, Belgian, 104
 —, composition of, 99, 102, 106
 —, French, 103
 —, introduction of, by Parker, 4, 99
 —, superseded by Portland cement, 103, 105
 —, use of, in making cement mortar, 136, 140
Natural gas, use of, as fuel in rotary cement kilns, 70
Natural Portland cements, 104, 105
Needle, Vicat, 185
Neumann on the constitution of Portland cement, 86
Neuss mill, 61

Newberry, development of the rotary kiln, 67
 —, Messrs., on the constitution of Portland cement clinker, 81, 82
 "New process" lime, 122
 Nicol's "Spissograph," 187
 Nitrification, conditions favourable to, 168
 Nitrogen, origin of, in some efflorescences on limes, etc., 168, 169
 Nodules of argillaceous limestone, use of in manufacture of natural cements, 28, 99, 100, 103
 "Normen," the German, 78, 79, 184, 186, 193, 195
 Normal consistency, determination of, 186
 Nummulitic limestone, 23

O

Oils used for rendering cement waterproof, 159
 Oleaginous cements, 162, 166
 Oolites, not able to resist salt-petreing action, 170
 Oolitic limestones, 22, 26
 Oxide of calcium, determination of, in limes, 177
 —, —, in plaster cements, 181
 —, —, preparation and properties of, 10
 —, —, solubility of, in water, 11, 12
 Oxide of iron, determination of, in limes, 177
 —, —, in plaster cements, 181
 —, —, in Portland cement, 78
 Oxide of magnesium, 24
 —, —, in Portland cement, 78
 Oyster shells, use of, for the production of lime, 21

P

Paints, casein, for rendering cement waterproof, 158
 —, ordinary for, rendering cement waterproof, 158
 Palaeozoic period, occurrence of gypsum in formations of, 109
 —, —, of limestones in formations of, 23
 —, —, of marbles in formations of, 23
 Paraffin wax, use of, for rendering cement waterproof, 158
 Parian cement, 119
 Paris, mastic used at, by military engineers, 167
 Parker, J., introduction of first natural cement by, 4, 99
 Parker's cement, 4, 99
 Pasley, General, on the keeping quality of natural cement clinker, 101
 —, —, on the origin of concrete, 141
 Paving, street, with asphalt, 164
 Peat, use of, as fuel for the calcination of limestones, 32
 Pebbles, flint, use of, in tube-mills, 60
 Peg-board, 51
 Pentacalcium trialuminate, 86
 Perin's automatic apparatus for the determination of setting time, 187
 — barrel oven, 114
 Permian system, occurrence of limestones in formations of, 23, 34
 Petrol proof tests with Super cement, 98
 Petrolene, 163
 Petroleum, use of, as fuel in rotary cement kilns, 70
 Pink, 72
 Pitch, use of, as a substitute for natural bitumen, 164
 Pit sand, 125

- Plaster cements, 108**
 —, analysis of, 181
Plaster, efflorescence of, 168
 — of Paris, 108, 111
 — —, effect of on setting of
 Portland cement, 91
 — —, hardening of, 117
 — —, method of manufac-
 ture, 111
 — —, setting of, 116, 117
 —, saltpetreing of, 168
 — stone, 108
 — —, calcination of, 111
 — —, storing of, 115
 — —, uses of, 115
 — stone, grinding of, 115
 —, stucco, 155
Plastering, methods employed
 in Belgium, 150
 —, — in England, 150
 —, — in France, 149
 —, use of chunam for, 151
 —, use of hard-finish plasters
 for, 151
 —, use of lime for, 148, 150
 —, use of plaster of Paris for,
 148
Plasters, flooring, 118
 —, hard finish, 119
 —, —, use of, for plastering,
 151
Plinius on mortars, 2, 3
 — on Roman practice of
 slaking limes, 120
**Poirson on calcium sulpho-
 aluminate, 92**
Polishing stucco, 155
Poor lime, 16
Portland cement, 50
 —, action of gypsum or plaster
 of Paris upon, 74, 91
 —, action of sea-water upon,
 92
 —, adulteration of, 92
 —, analyses of, 80
 —, analysis of, 180
 —, Belgian natural cements
 substituted for, 92
**Portland cement, British Stan-
 dard Specification (1915), for,**
 78, 79, 94, 183, 184, 188, 190,
 191, 192, 193, 195
 —, colour of, 77, 78
 —, concrete, 141, 145
 —, constitution of, 80
 —, —, according to Asch &
 Asch, 87
 —, —, — Campbell, 86
 —, —, — Day, Shepherd
 and Wright 82
 —, —, — Desch, 87
 —, —, — Ditter & Jesser,
 85
 —, —, — Jänecke, 87
 —, —, — Jänecke and
 Schumann, 85
 —, —, — Kappen, 84
 —, —, — Keisermann, 84
 —, —, — Klein, 84, 86
 —, —, — Le Chatelier, 81
 —, —, — Neumann, 86
 —, —, — Newberry and
 Newberry, 81
 —, —, — Rankin, 85
 —, —, — Rankin and
 Wright, 86
 —, —, — Richardson, 84
 —, —, — Törnebohm, 83
 —, detection of adulterants
 in, 180
 —, deleterious action of sea-
 water upon, 92
 —, fineness of grinding, tests
 for, 184, 185
 —, free lime in, 78
 —, German "Normen," 78,
 79, 184, 186, 193, 195
 —, invention of, by J. Aspdin,
 4, 50
 —, magnesia, proportion of, in,
 78
 —, mechanical testing of, 182
 —, methods of investigating
 the constitution of, 80
 —, physical properties, 77
 —, —, testing of, 182

- Portland cement, oxides of iron in, 78
 —, slag cements substituted for, 93
 —, setting and hardening of, 87
 —, setting time, methods of testing, 185
 —, soundness, methods of testing, 188
 —, storing of, 76
 —, sulphur in, 79
 —, tensile strength, method of testing, 191
 —, uses of, 136, 140, 141, 145
 —, varieties of, 94
 Portland stone, not able to resist action of saltpetreing, 170
 Potash, influence of, on artificial hydraulic limes, 47
 — in sands containing feldspars, influence of, on the setting of limes, 126
 Potassium carbonate, use of, in preparation of Martin's cement, 119
 Potassium chloride in efflorescence of limes, mortars, etc., 168
 — nitrate in efflorescence of limes, mortars, etc., 168
 — silicate, influence of, upon artificial hydraulic limes, 47
 — —, in Portland cement, 79
 — sulphate, use of in preparation of Mack's cement, 119
 Pozzolanas, 128
 —, analyses of, by Gallo, 129
 —, artificial, 126, 127, 128
 —, Berthier on the composition of, 127
 —, composition of, 128, 129
 — in concrete, 143, 144
 —, use of, by the ancient Greeks, 3
 —, —, by the Romans, 4
 —, —, in the manufacture of artificial hydraulic limes, 45, 46
 Pozzolanas, use of, in the manufacture of pozzolanic cements, 48
 —, —, with lime in the preparation of mortar, 124, 137
 Pozzolanitic cements, 48
 — materials, use of, in the manufacture of artificial hydraulic limes, 45, 48
 — mortar, 136
 Pozzuoli, town of, 128
 Pre-grit mills, 59
 Producer gas, use of, as fuel in lime kilns, 33
 —, —, as fuel in rotary cement kilns, 66, 67, 70
 Proportions of sand mixed with lime when making mortar, 137
 Pulverizer, Jeffrey, 59
 Pumice found in Santorin earth, 130
 —, use of, as aggregate for concrete, 142
 Pyramids of Egypt, use of mortar in, 2
- Q
- Quarrying of gypsum, 111
 — of rock gypsum, 110
 Quartz, crushed, use of, in preparation of mortar, 123
 — found in Santorin earth, 130
 Quartzite blocks, use of, for lining tube mills, 60
 Quartzite, crushed, use of, in preparation of mortar, 126
 Quick lime, 10
 —, absorption of carbon dioxide by, 11
 —, absorption of water by, 11
 —, crystalline, 10
 —, —, hydration of, 189
 —, properties of, 10
 —, solubility of, in water, 11
 12
 Quick-setting cement, 77, 188

R

Raffineau de Lille on artificial cements, 127
 Rankin on the constitution of Portland cement, 86
 — on the setting and hardening of Portland cement, 90
 — and Wright on the constitution of Portland cement, 86
 — on the constitution of Jänecke's compound, 86
 Ransome's rotary kiln, 66
 Raw flour, 62
 — materials used in the manufacture of Portland cement, 50
 — meal, 62
 Rebuffat on the formation of sulpho-aluminates, 92
 — on the setting and hardening of hydraulic cements, 88
 Reinforced concrete, 146, 170
 Rendering, methods of, 146, 170
 Retarders for plaster of Paris, 111, 117
 Richardson on the constitution of Portland cement clinker, 84
 Richardson on the properties of the silicates and aluminates of calcium, 82
 — on the setting and hardening of Portland cement, 84
 Rich limes, 18, 121, 137
 Ring kiln, Hoffmann, 42, 64
 River-sand, 125
 "R" kiln, 65
 Rock emery millstones, 57, 106
 — gypsum, 108, 110
 Rohland on the part played by gypsum or plaster of Paris on the setting of Portland cement, 91
 — on the setting of plaster of Paris, 117
 — on the setting and hardening of Portland cement, 88, 89
 Rollers for grinding plaster stone, 115

Roman cement, 48, 99
 —, introduction of, by Parker, 4, 99
 —, physical properties of, 102
 —, setting time of mixtures of, with sand, 102
 — tensile and crushing strength, 103
 Romans, slaking of lime by the, 120
 —, use of lime concrete or béton by the, 141
 —, use of mortar by the, 3
 —, use of pounded bricks or tiles in mortar by the, 4, 127
 Rosendale cement, 105, 106
 Rotary cement kilns, 63
 — driers, 56
 — kilns for the calcination of plaster of Paris, 114
 — lime kilns, 44
 Roulette mill, 61
 Rüdersdorf lime kiln, 41
 Ruggles-Coles drier, 56
 Rumford's lime kiln, 42
 Running lime kilns, 37
 —, conditions most favourable to the working of, 38
 —, special forms of, 39

S

Saltpetreing of limes, cements, and plasters, 168
 —, Longchamp's theory of, 168
 —, precautions against, 171, 172
 Salt, common, accelerating action of, upon the setting of plaster of Paris, 117
 Salts present in sea-sand, 126
 — in sea-water, 170
 —, soluble, occurring in efflorescence on limes, etc., 168
 — used for rendering cement waterproof, 159

- Sand, blown, 125, 126**
 —, cement, 94, 95
 —, impurities in, injurious to mortar, 126
Sand-lime bricks, 20, 120, 123
Sand mixed with lime in preparation of mortar, 137
 —, occurrence of, 124, 125
 — pit, 125
 —, proportion of, used in preparation of mortar, 137
 —, river, 125
 —, sea, 125, 126, 170
 —, size and shape of grains of, 126
 —, virgin, 125
Sands, argillaceous, 126
 —, calcareous, 126
 —, felspathic, 126
 —, siliceous, 126
 — used for concrete, 140
 — used for reinforced concrete, 147
Sandstone, crushed, use of, in the preparation of mortar, 126
Sandstones, altered by contact with eruptive rocks, 130
Santorin earth, 130
 —, use of, in manufacture of pozzolanic cements, 48
 —, island of, 130
Satin spar, 108
Sawdust, retarding action of, upon plaster of Paris, 117
Scagliola, 155
Schaffer hydrator, 123
Schmatolla's lime kiln, 42
Schneider cement kiln, 65
Schott's theory of selenitic cement, 19
Scoriæ, use of, as artificial pozzolanic material, 131, 132
 —, —, with lime in preparation of mortar, 124
Scott, General, experiments in calcining chalk, 19
 —, —, preparation of selenitic cement, 20
Scott's cement, 20
Scrim, 157
Sea-sand, 125, 126, 170
Sea-water, deleterious action of, upon Portland cement, 92
 —, not suitable for the preparation of mortar, 170
Secondary period, occurrence of limestones in formations of, 23
Seeger and Cramer's method of distinguishing slag cement from Portland cement, 180
Selector cement, 73
 — sifting machine, 73, 74
Selenite, 108
Selenitic cement, 19, 20
Semi-wet method of mixing raw materials in the manufacture of Portland cement, 51
Separators, air, 59, 74
Septaria nodules, 99, 100, 103
Septaria, Berthier's analyses of, 100
 —, calcination of, 101
Set, final, 185, 186
 —, hard, 185
 —, initial, 185, 186
Setting coat, 150
 — of plaster of Paris, 116
 — of Portland cement, 80, 87, 88, 89, 90, 91
 — time of Portland cement, 73, 74, 77, 182, 185
 — time of Portland cement, thermometric method of determination, 187
Shaft kilns, 64, 65, 66
Shaking coolers, 71
Shale, use of, for aggregate in concrete, 142
 —, use of, in manufacture of Portland cement, 50
Shearing members, 147
Sidero cement, 93
Sieveless ball-mill, 73
Sieves, use of, for the determination of the fineness of cement, 184

- Sieves, use of, for the removal of coarse particles of ground clinker, 59, 74
- Silica, action of, during calcination of clayey limestones, 31
- , condition in which it exists in pozzolanas, 128
- , determination of, in limes, 176
- , —, in plaster cements, 181
- , presence of, in hydraulic limes and limestones, 7
- Silicates of aluminium in clay, 8, 13
- of calcium in hydraulic limes, 8, 13, 14, 31
- in Portland cement clinker, 81
- of sodium and potassium, influence of, upon lime, 47
- — —, in Portland cement, 79
- Silicofluorides, use of, for rendering cement waterproof, 160
- Silos, 62, 76
- Silurian system, occurrence of gypsum in formations of, 103
- , — of limestones in formations of, 24
- Slack, 72
- Slag, 124, 131
- , blast furnace, 48, 50
- Slag cements, 48
- Slag cements, analysis of, Seger and Cramer's method, 180
- —, modern method of manufacture, 49
- —, use of, as a substitute for Portland cement, 93
- —, —, in the preparation of cement mortar, 136, 140
- , granulated, 48, 49
- , sand, 48
- Slags, use of, as artificial pozzolanic materials, 131
- , —, for aggregate in concrete, 142
- Slags, use of, with lime in preparation of mortar, 124
- Slaked lime, 11, 120, 122, 150
- , setting and hardening of, 13
- , solubility in water, 12
- Slaking of limes, 11, 120, 150
- Slate, use of, for aggregate in concrete, 142
- , —, in manufacture of Portland cement, 50
- Slip or slurry, 51
- Slow-setting cements, 188
- Smeaton on hydraulic limes, 5
- , use of lime concrete by, 141
- , use of Watchet lime, 6, 25
- Soap, use of, for rendering cement waterproof, 159
- Soda, influence of, on artificial hydraulic limes, 47
- in Portland cement, 79
- Sodium chloride, accelerating action of, upon the setting of plaster of Paris, 117
- —, found in efflorescence on limes, cements, and plasters, 168
- nitrate, found in efflorescence on limes, cements, and plasters, 168, 170
- — in efflorescence upon work executed with seawater, 170
- oxalate, use of, for rendering cement waterproof, 159
- silicate, influence of, upon lime, 47
- — in Portland cement clinker, 79
- —, use of, for hardening plaster of Paris, 117
- —, —, for rendering cement waterproof, 159, 160
- silicofluoride, use of, for rendering cement waterproof, 160
- Soluble anhydrite, 110

- Soluble salts found in efflorescence on limes, cements, and plasters, 168
- Solubility of gypsum in water, 110
 — of plaster of Paris in water, 110
 — of quick lime in water, 11, 12
 — of slaked lime in water, 12, 13
- Soundness and constancy of volume, tests for, 182, 188, 189, 190
- Spain, use of Tosca in, 129
- Specific gravity, determination of, 183
 — of bitumen, 163
 — of gypsum, 110
 — of lime, 10
 — of plaster of Paris, 110
 — of Portland cement, 77, 183
 — of Roman cement, 102
 — of slag cements, 49
- Spissograph, Nicol's, 187
- Staff, 157
- Stage kilns, 64
- Standard briquette for testing the tensile strength of cement, 185
- Stationary kilns, 63
- Steel, employment of, in reinforced concrete, 146, 147
- Stein ribbed kiln, 66
- Stern on dyeing the colloidal constituents of Portland cement, 89
- Stokes, improvement of rotary kiln, 67
- Stone breakers, gyratory, 55
 —, swing-jaw, 55, 73
 —, broken, use of, for aggregate in concrete, 141, 142
 — lime, 27
- Storage bins, 78
- Strassburg, use of artificial pozzolanic materials at, 127
- Strength, crushing, of Portland cement, 77, 193
 — of lime mortar, 139
 — of Rosendale cement, 106
 —, tensile, of Portland cement, 77, 191
- Stucco, 117, 153
 — cement, 153, 157
 — lime, 153, 154
 — plaster, 153, 155
 —, polishing of, 155
- Stuccos, Italian method of preparing, 154
 —, methods of colouring, 154
 —, varieties of, 153
- Sturtevant ring roll mill, 62
- Sulphates, excess of, the cause of unsoundness in Portland cement, 189
- Sulphides, reaction with iron compounds in Portland cement, 79
- Sulpho-aluminates formed by the action of sea-water on Portland cement, 92
- Sulphur as sulphide, determination of, in lime, 179
 — in fuel employed for the calcination of limestone, effect of, 33
 — in materials used for the aggregate in concrete, effect of, 142
 — in Portland cement, action of, 79
 — in Portland cement, maximum amount allowed by the British Standard Specification (1915), 79
- Sulphur trioxide, determination of, in lime, 179
 —, —, in plaster cements, 181
- Super cement, 94, 95, 145, 161
 —, crushing strength of, 97
 —, tensile strength of, 97, 98
 —, use of for building storage tanks for petrol, 98

Swing-jaw stone breakers, 55, 115
 Sylvester's process for rendering
 cement waterproof, 159
 Synthetic method of investi-
 gating the constitution of
 Portland cement clinker, 81

T

Tar, coal, use of, as a substitute
 for natural bitumen, 164
 —, —, —, for rendering
 cement waterproof, 158
 Teneriffe, variety of pozzolana
 found in island of, 129
 Tensile strength of lime mortar,
 139
 — — — of Rosendale mortar,
 106
 — — — of Portland cement, 77
 187
 — — — of Super cement, 97,
 98
 — — —, determination of, 182,
 191
 — — —, machines for testing,
 192
 Tertiary period, occurrence of
 gypsum in formations of, 109
 —, — of limestones in for-
 mations of, 23
 Tests, physical and mechanical,
 of cement, 182
 Tetin, 129
 Tetmajor's apparatus for the
 determination of the setting
 time of cement, 187
 Thénard's litharge mastic, 166
 Thera, occurrence of Santorin
 earth in island of, 130
 Thermometric method of deter-
 mining the setting time of
 cement, 187
 Thick slurry, 52
 Toms, Mr. F. Woodland, use of
 Woodcock's apparatus in
 laboratory of, 187

Toothed rolls, 56
 Törnebohm on the different kinds
 of crystals found in Portland
 cement clinker, 83
 Tosca, 129
 Trap rocks, use of, as pozzolanic
 material, 131
 Trass, 129, 130
 — — — mortar, 136
 — — —, use of, in the manufacture
 of pozzolanic cements, 48
 — — —, — — —, with lime in the
 preparation of mortar, 124, 136
 Travertine, 22
 Trentaremi, pozzolana workings
 at, 129
 Treussart, General, on artificial
 hydraulic limes, 45, 47
 — — —, on the burning of
 lime, 31
 — — —, on the colour of lime
 as an indication of its quality,
 31
 — — —, on the proportion of
 the ingredients in lime con-
 crete, 143
 — — —, on the proportion of
 pozzolana to be mixed with
 lime, 137
 — — —, on the proportion of
 water to be used with natural
 cements, 107
 — — —, on the use of arti-
 ficial pozzolanas at Strassburg,
 127
 — — —, on the use of pozzo-
 lanas to render rich limes
 hydraulic, 135
 Tricalcium aluminate, 81
 — — — silicate, 81
 Trinidad asphalt, 163
 Trinidad, occurrence of asphalt
 in, 162
 Tube-mill, 53, 70, 73
 Tufa, 22
 Tunnel driers, 51, 62
 Tyrrhenians, improvement of the
 art of masonry by the, 3

U

- United States, occurrence of asphalt in, 163
- Unsoundness of cement, 189
- Upper, or white, chalk, 27

V

- Van't Hoff and Just on the dehydration of gypsum, 118
- Vassy cement, 103
- Vauban's mastic, 167
- Vegetable pitch, use of, as a substitute for natural bitumen, 164
- Venezuela, occurrence of asphalt in, 163
- Vertical kilns, 37, 63
- Vicat needle, 185
 - on hydraulic limes, 7
 - on the cause of the failure of mortars containing artificial pozzolanas when exposed to sea-water, 128
 - on the colour of lime as an indication of its quality, 31
 - on the preparation of artificial hydraulic lime, 8, 45
 - on the strength of lime mortar, 139
 - on the use of basalt as a pozzolanic material, 131
 - on the use of burnt clay as a substitute for pozzolanas, 127
- Vicat's classification of sands and other materials used with lime in the preparation of mortars, 132
 - experiments with limes in the preparation of mortar, 138
 - method of preparing artificial hydraulic limes, 45, 47
 - method of slaking hydraulic limes, 121
- Virgin sand, 125

- Vitruvius on mortars, 2, 3
 - on pozzolanas, 128
- Voids, proportion of, between the particles of aggregate, 143
- Volumemeter, Blount's, 183

W

- Wash mill, 51
- Watchet lime, use of by Smeaton, 6, 25
- Water, amount used in mixing concrete, 145
 - , amount used in slaking lime, 121
 - , estimation of, in lime, 174, 175
 - , —, in plaster cements, 181
 - glass, use of, for rendering cements waterproof, 159, 160
 - in Portland cement, 78
 - , lime, 14, 16
 - , quality of, for making mortar, 138
 - , sea, favours saltpetreing of limes, cements, and plasters, 170
 - vapour, action of, in lime kilns, 30
- Waterproof tests of Super cement, 98
- Waterproofing cement, 158
- Wax, paraffin, use of, for rendering cement waterproof, 158, 160
- Wet ball-mill, 52
 - edge-runner, 52
 - process, 51, 53
- Wetzel on the setting and hardening of Portland cement, 89
- Wheeling forced feed crusher, 55
- White, or upper, chalk, 27
- White Portland cement, 94, 157
- Winkler on hydraulic limes, 8

Woodcock's automatic apparatus for the determination of the setting time, 187	Z
Wood, use of, as fuel for the calcination of lime, 32	Zinc salts. use of, for rendering cement waterproof, 159, 160 — silicofluoride, 160

THE END

ADIE'S Cement-Testing Machines

used by

The Admiralty, War Office, Home, Indian, Colonial,
and Foreign Governments, County and other Council,
. . . Cement Manufacturers, Contractors, etc., etc. . .

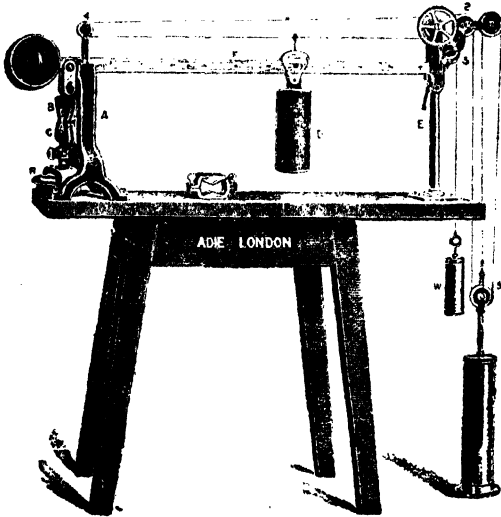

MOULDS, SIEVES, etc.

Made according to the British Standard Specification for Portland
Cement issued by the Engineering Standards Committee.

SURVEYING AND SCIENTIFIC INSTRUMENT MAKERS.

PATRICK ADIE,
45 Horseferry Road, Westminster, S.W.

Late of BROADWAY WORKS.

DATE OF ISSUE

This book must be returned
within 3, 7, 14 days of its issue. A
fine of ONE ANNA per day will
be charged if the book is overdue.

--

Dan caster
Limes & Cements

--	--