

Birla Central Library

PILANI (Jaipur State)

Engg College Branch

Class No :-

621.436

Book No :-

S 53 M 11

Accession No :-

31994

The Modern Diesel

*High-speed compression-ignition oil engines
and their fuel-injection systems*

Edited by

G. Geoffrey Smith,
M.B.E.

Revised and Rewritten by

Donald H. Smith,
M.I.Mech.E., Assoc.Inst.T.

*Illustrated with over 200 diagrams
and photographs*

Eleventh Edition



ILIFFE & SONS, LTD.

LONDON, BIRMINGHAM, COVENTRY, MANCHESTER AND GLASGOW

*Published by Iliffe & Sons, Ltd., Dorset House, Stamford Street,
London, S.E.1*

First Published	1932
Second Edition	1933
Third Edition	1935
Fourth Edition	1937
Fifth Edition	1939
Sixth Edition	1941
Seventh Edition	1942
Second Impression	December, 1942
Eighth Edition	1943
Second Impression	1944
Ninth Edition	1945
Tenth Edition	1946
Eleventh Edition	1949

*Made and printed in Great Britain at The Chapel River Press,
Andover, Hants*
(Bks. 183—3.49)

Contents

CHAPTER	PAGE
EDITOR'S FOREWORD	7
1 PRESENT PHASE OF HIGH-SPEED OIL-ENGINE DEVELOPMENT	9
2 THE TERM " DIESEL "	18
3 A GENERAL SURVEY	23
4 THE COMPRESSION-IGNITION CYCLE	35
5 FUEL-INJECTION SYSTEMS	47
6 CYLINDER-HEAD DESIGN	89
7 DIESEL FUEL AND LUBRICANTS	112
8 ROAD TRANSPORT	120
9 TRANSPORT ENGINES Typical Makes Reviewed	133
10 DIESELS IN RAILWAY SERVICE	199
11 MARINE SERVICE Typical Engines Reviewed	214
12 AIRCRAFT ENGINES	252
CHARACTERISTIC TABLES:	
British Road Transport Diesel Engines	270
High-speed Marine Engines	272
INDEX	275

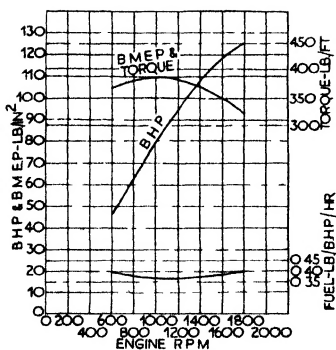
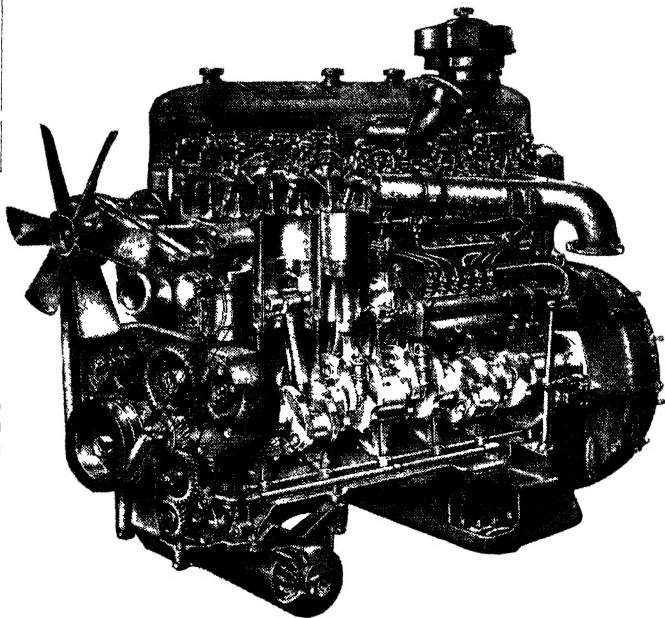

*TYPICAL BRITISH
HIGH-SPEED DIESEL
Sectioned view of a 9.6
litre 125 b.h.p. road transport
engine with performance
curves*

Editor's Foreword

BY reason of its economical rate of fuel consumption and its enduring reliability, the transport type diesel or compression-ignition engine has made great headway in the last twenty years. Definitely a slow-speed engine when the first edition of this handbook was prepared in 1930, constant development in the interim has resulted in a considerable rise in crankshaft speeds. Nevertheless, the term "high speed" when applied to the diesel is still relative only to the earlier slow-speed units.

Basically, the diesel cycle aims to maintain combustion at constant pressure during the period when the fuel oil is injected and spontaneously ignited in air highly compressed in the engine cylinder. Although the aim has never been fully realized, the thermal cycle contrasts sharply with that of the normal petrol engine in which a mixture of atomized fuel and air is compressed in the cylinder, ignited by means of an electric spark, and burnt almost instantaneously with a consequent sharp rise in pressure at virtually constant volume.

Thermal efficiency in internal combustion engines depends upon the compression ratio employed. In the orthodox petrol engine detonation will limit the ratio to about 7:1 but the diesel engine will function satisfactorily with ratios of 16:1 or 18:1. In practice an overall thermal efficiency of 34 per cent is attainable, which represents a 48 per cent increase on that realized by the petrol engine.

The heart of a compression-ignition engine is its fuel injection system. Meticulous workmanship is necessary to ensure the injection pump can raise the pressure of the fuel to, say 2,500 lb/in², accurately meter the amount injected for each working stroke and precisely time the moment of commencement of injection. Injection nozzles must finely atomize the fuel and give a clean cut-off. When it is realized that the oil charge for one cylinder of a 100 h.p. bus engine is only approximately the size of a pin head the amazing accuracy required will be appreciated. Technical advances in the development of diesel engines for road and rail transport have been beneficially reflected in marine and industrial engines.

Only in the air has the diesel engine lost ground, mainly by reason of the introduction of high octane fuels permitting the use of much higher compression ratios. There are, however,

EDITOR'S FOREWORD

important aircraft projects under test in which compression-ignition engines are compounded with the newer gas turbines. Apart from operational economy on long ranges, a big attraction of such power plants is the possible use of "safe" fuels.

The main features of leading compression-ignition engines and their fuel-injection systems, as well as explanatory notes on the basic principles involved are embraced in the 12 chapters of this, the 11th edition.

This handbook has served to familiarize many thousands with the characteristics of diesel engines and the intricacies of fuel-injection equipment. It has been possible to add much useful and informative material, notably details of representative American transport diesels and some notes on the war-time contraction of the high-speed diesel industry in Germany. Reference is also made to the revival of engine manufacture since the war in France and Italy.

GEOFFREY SMITH.

*Dorset House,
London, S.E.1.*

Present Phase of High-speed Oil-engine Development

SOME eighteen years ago the possibilities of the diesel or compression-ignition engine began to attract active interest for road-transport purposes as distinct from marine, rail-car and industrial fields in which it was already established. Obviously for this new sphere of usage some important and vital problems had to be faced. Easy starting and great flexibility over a reasonably wide speed range were obvious performance requirements, coupled with maximum fuel economy. Closely allied was the need for the lightest weight possible, together with a favourable weight/power ratio.

These requirements entailed considerable development of existing marine and industrial engines and their equipment, and it was not until about 1931 that true road-transport oil engines began to appear. Thereafter progress was continuous and more rapid in Great Britain than in any other country. The diesel became practically universal in British heavy goods and passenger transport vehicles. It also became exceedingly popular in European countries and somewhat later in the U.S.A.

Progress in this direction was reflected in marine application which enormously increased in extent in the class of vessel requiring a compact engine with good power output in relation to the total installation weight and fuel-storage capacity.

The advances in technique which led to the successful development of the road-transport oil engine in turn benefited rail, marine and industrial engines. Reference is made to combustion-chamber design, fuel-injection equipment and the solution of metallurgical problems to ensure satisfactory working life of crankshaft pins and journals, bearings, cylinder bores and other highly-stressed

THE MODERN DIESEL

components. Notable improvements were made in the quality of fuel oils and in the nature of the lubricating oils required to cope with certain factors peculiar to the compression-ignition engine.

Between 1931 and 1939 the modern high-speed diesel engine was developed from the experimental stage to something approaching finality in design. It may possibly be considered sweeping to use the word "finality" in this context but it may be justified by pointing to the fact that during the three or four years immediately prior to 1939 the number of engine types in production was generally being reduced, while several makers who had entered the market tentatively during the early development stages with more or less experimental high-speed diesels had decided to withdraw or to revert exclusively to their original activities in the purely industrial fields. There was also a marked tendency towards the almost general adoption of one type of combustion-chamber design.

The outbreak of war in 1939 very considerably affected the high-speed diesel industry. Oil engines were not so readily adaptable to military requirements as petrol engines and their rather specialized maintenance requirements did not suit them to the immediate use of untrained and semi-skilled military personnel. Production of civilian vehicles was virtually stopped except for essential replacements. Progress was thus almost completely arrested by the outbreak of the war and this state of affairs applied to all branches of high-speed diesel production.

In the air, for example, the high performance required of combat aircraft precluded further work on compression-ignition engines. As a short-term possibility the aircraft diesel was not sufficiently advanced to justify war-time development in competition with petrol engines. For any desired capacity, the specific weight of the diesel was substantially higher than the 1 lb per b.h.p. of the petrol engine.

It is true, of course, that the high thermal efficiency of the diesel engine, reflected in the low specific fuel consumption, gave it certain advantages in the matter of range. This had been illustrated by the fact that in 1938 the world's

PRESENT PHASE OF DEVELOPMENT

long-distance seaplane record was held for a time by an aircraft fitted with a two-stroke diesel engine, although a catapult-assisted take-off was necessary. The absence of carburettors certainly eliminated some of the difficulties of high-altitude flying. Range and altitude were not so important in the early stages of the war as they became subsequently and it was clear that improvements to existing petrol engines to realize the advantages offered by the newly introduced high-octane fuels, provided the most ready method of achieving the performance demanded by operational requirements.

Whether these factors will decide the line of progress from now on is not clear. The aftermath of war has left a very confused picture in which the fuel-oil resources of the world, the relative economics of petrol and diesel oils, the general economic and even the political situation appear to be inextricably mixed. Then again there is the development of the continuous-combustion turbine which uses a lower-grade fuel, is light in construction and is thermally efficient when operating at high speeds at high altitudes.

That the use of diesel engines for the direct propulsion of aircraft is problematical must be conceded. In an entirely new development, however, a highly-supercharged two-stroke diesel engine may be employed as a dynamic gas producer in conjunction with a gas turbine. Such a compounded plant has a low specific rate of fuel consumption and presents attractive possibilities for ultra-long range commercial and naval aircraft operating at medium speed and altitude.

It is in the road-transport field that the high-speed diesel has proved its usefulness and economy in operation. In most countries today the heavier types of both goods and passenger vehicles are equipped with oil engines. In Britain in particular, it has become the exception to find a petrol engine in any vehicle of 4 tons or more unladen weight and there are many machines of 3 tons unladen fitted with diesel engines; indeed rapid development in this latter field is now well in progress. For the most part the heavy British vehicle of the latest type now has a six-

THE MODERN DIESEL

cylinder direct-injection engine of from 7.5 to 10 litres capacity, developing from 100 to 130 b.h.p.

Thus the trend towards uniformity evident before 1939 has apparently been hastened by the war, since many engines with air-cell combustion chambers have been discontinued and post-war production has been resumed by all the leading manufacturers on direct-injection types with a form of piston crown known as the toroidal-cavity type. In conjunction with a directional inlet port or a shrouded inlet valve promoting an initial air swirl around the cylinder axis, a cavity of toroidal shape superimposes a second swirling movement in a plane at right angles to the first when the piston approaches the cylinder head. As a result the air follows a helical path whilst it progresses around the axis of the combustion space, as is more fully explained in a later chapter.

In America the most commonly used diesel engine in road vehicles, particularly in buses, is a six-cylinder two-stroke engine with forced induction. This type of engine has not been adopted in this country and no doubt the differences in operating conditions provide the explanation. Here, as a result of our taxation system, the primary aim is to achieve fuel economy, hence the popularity of the direct-injection four-stroke. American conditions demand high speed and high vehicle-performance; fuel cost is of much less pressing consequence. The two-stroke engine has a maximum power output about 66 per cent higher than that of a four-stroke engine of approximately the same capacity. The required performance is thus obtained without appreciable increase in the installation dimensions or weight of the engine. Fuel consumption is increased not only *pro rata* to the extra power, but there is also the fact that the specific rate of consumption is notably higher than that common to British engines.

Thus, power for power, fuel consumption of the American type is less favourable than the British direct-injection four-stroke. Nevertheless one British vehicle builder has developed a two-stroke engine which has a specific consumption very little heavier than the best four-stroke types. It is considered that actual vehicle consumption figures in

PRESENT PHASE OF DEVELOPMENT

terms of ton/m.p.g. will set a new standard, bearing in mind that specific fuel consumption, as defined by test bed results, does not provide a complete picture, since the final result in service is determined by extra power, reduced weight, better torque characteristics, improved acceleration and acceptance of load and smoother all-round performance. Four-stroke engines in America are based mostly on a German system of air-cell combustion chamber and are likewise not comparable with the average British engine in fuel economy, reduced thermal efficiency being accepted as the price to be paid for a more ready acceptance of lower-grade fuels in many parts of the world to which these engines were exported.

During the war little information could be obtained regarding the German high-speed diesel industry but the indications were that development and progress were virtually arrested. Subsequent investigation after 1945 reveals that not only had development work been stopped but that most of the factories concerned had been so heavily damaged by bombing that little could be expected for some years to come. Such records as could be traced showed, moreover, that real development had ceased by 1939.

Most of the other Continental countries had, for many years prior to 1939, based their oil-engine production on German designs and had made few original contributions to the development work that was a feature of the early 1930s. This applied particularly to Italy, France, Austria and Belgium, but an exception must be made in the case of Switzerland.

Like ourselves, the Swiss began by close adherence to German types of combustion-chamber design but the influence of a successful British direct-injection engine in the early 1930s led to the development in Switzerland of the toroidal-cavity piston or "dual-turbulence" direct-injection engine and this, as previously mentioned, has now become in one form or another the most commonly used combustion chamber design in British engines.

It would appear that the dual-turbulence type of direct-injection combustion chamber has limitations in the matter of speed because in 1937 Saurer introduced a range of

THE MODERN DIESEL

light high-speed engines capable of operation at 3,000 r.p.m. and over, and in this design the toroidal-cavity piston with the associated induction swirl was completely abandoned. No intake turbulence was provided at all and a simple oval piston cavity was used, the only turbulence effect being that resulting from the "squish" of air into the cavity when the piston reached the cylinder head, where minimum clearance was allowed. A new form of atomizer was relied on to promote adequate mixing of fuel and air.

In marine applications the conditions differ somewhat from those obtaining in road transport. The need for acceleration through a wide speed range is absent, while insistence on the most favourable power/weight ratio is not so pronounced. Fuel economy, however, is very important; likewise maximum reliability. In these latter directions the modern high-speed diesel fulfils all requirements.

It is interesting to recall that the first engine of what may be called the modern type applied to a road vehicle was a relatively light marine unit which, in 1929, was an innovation in its own field. Development of road-vehicle engines was so rapid that in the space of a few years they were being adapted for marine application; thus the original indebtedness was repaid in full measure and when the war came many of the high-performance engines produced by or for the road-vehicle industry were redesigned for marine use and gave impressive service in coastal patrol vessels, landing craft and suchlike applications.

Similarly the marine version of the American forced-induction two-stroke engine provided the power which enabled thousands of invasion craft to cross the Atlantic. The relatively small high-speed diesel has thus fully proved itself and for pleasure, fishing and utility craft its reliability, fuel economy and freedom from fire risks make its position assured.

Mention must also be made to rail traction because the use of diesel power was extending rapidly prior to 1939. Not only were large high-powered diesel locomotives in use for trains, particularly in U.S.A. and on the Continent, but there was an increasing application of the smaller engines to rail cars and shunting locomotives in this

PRESENT PHASE OF DEVELOPMENT

country. As in the marine field, there had been a similar conservatism towards development of the smaller units which fall within the scope of this book until the road-transport industry entered the scene. Thereafter many of the larger road-transport engines were adapted to rail-car propulsion.

In this application, however, the performance characteristics of the road-vehicle engine are not always necessary and perhaps the most important factor in rail-traction application is the development of a suitable transmission system of the automatic torque-converter type, since the desirable object is to deal with maximum loads at the speed of maximum engine torque; the heavy loading on the transmission

under these conditions precludes the use of normal manually-operated clutches and gear-change mechanisms of the type used on road vehicles. In this connection there is wide scope for the application of electric transmission.

There is an ever-increasing trend towards the use of diesel power units in small locomotives for work in mines and quarries, as well as for mechanical shovels, dumpers and bulldozers. Such engines are generally larger, heavier

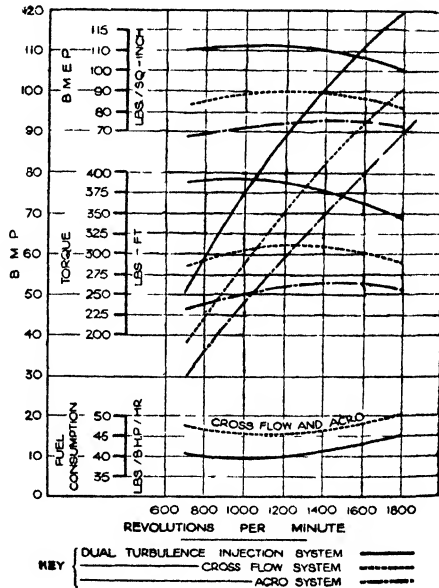

Performance improvement in development from pre-combustion to direct-injection systems in Saurer engines

THE MODERN DIESEL

and slower running than those fitted to road-transport vehicles, but they are far more closely related to them than to the industrial and stationary power units because of the wider variation in the demand put upon them both as to load take-up and speed.

From the point of view of the absence of electrical ignition equipment, non-volatile fuel and lower exhaust temperature, the diesel engine is a much smaller fire risk than the petrol engine when working in enclosed places and in the neighbourhood of inflammable material.

Throughout the whole of the development period of the high-speed oil engine since 1929, successive editions of "The Modern Diesel" have closely followed and recorded progress. It was the first handbook to be published setting out the basic principles involved in a manner which the ordinary user could understand. Some of the earlier editions contained details of a great variety of experimental engines, but by 1939 the industry was tending towards concentration both as to types of engines and as to the number of manufacturers in active production. Nevertheless, some particulars are retained of certain of the development types that had more than passing influence on the history of the modern high-speed oil engine. A study of these will enable the reader to arrive at a better understanding of the principles involved.

As to the future, it is not easy to visualize any changes from the current types of a magnitude comparable with those which marked the first ten years of development. It may be that forced induction will become more evident, not only on two-stroke engines, on which it is essential, but on four-stroke units as well. Mechanically, the supercharger has proved its effectiveness and reliability on the large numbers of American two-stroke diesels used during the war in both marine and land applications. The matter thus resolves itself into one of balancing increased power output against additional cost in the case of four-stroke engines. Power output can be increased up to 50 per cent, as already proved by a number of experiments and by actual operation over a period of years of supercharged oil engines on buses in a hilly town in the North of England.

PRESENT PHASE OF DEVELOPMENT

A large number of British-built supercharged four-stroke diesel bus chassis is at present being built for export to Holland, the standard 100 b.h.p. engine delivering 138 to 140 b.h.p. in its supercharged form.

At the other end of the scale little progress has been made with small diesel engines. In general it would seem that individual cylinder capacity cannot be reduced below three-quarters of a litre so that for six-cylinder engines of the automobile type a total capacity of about $4\frac{1}{2}$ litres is the smallest practicable size. In marine use there are, of course, single and two-cylinder models which are highly successful within their limitations.

Several transport engine makers who have hitherto concentrated on larger engines introduced new power units in the 5-litre class at the 1948 Earls Court, London, Transport Show. With one exception these new engines were six-cylinder models; the one maker favouring four cylinders holds that the six in this capacity class is too small in the bore and too restricted as to crankshaft bearing dimensions to provide optimum results and if this view is correct it implies that still smaller units such as might be suitable for private cars continue to remain a very remote possibility.

Indeed, having regard to the high cost of injection equipment and the limited availability in many countries of high-grade diesel fuel, the application of the diesel engine to motor cars, coupled with the limitation of cylinder bore reduction which is determined by spray penetration characteristics, the application of the diesel engine to motor cars (other than very special types) does not appear to be within the scope of practical automobile engineering either on technical or economic grounds.

Even if the former can be overcome, the latter, owing to the high cost of injection equipment and the relatively small saving in fuel cost when the annual mileage is low, present a seemingly insuperable problem.

The Term "Diesel"

BEFORE approaching the subject of this book in detail it is desirable to define the term "diesel" engine. Unfortunately the name is surrounded by a mass of acrimonious controversy which is probably unequalled in the whole field of mechanical development. At every stage there have been rival claims to the "invention" of this or that aspect of what we now call the diesel cycle and even in quite recent times there have been rumours of litigation concerning some of the quite modern developments of the basic system.

Of the earlier controversies, it can fairly be pointed out that the tragic end of Dr. Diesel absolves him from any share in the disputes, for on the night of September 29-30, 1913, he disappeared from the Antwerp to Harwich steamer in circumstances which were never explained.

It would seem that from time to time various subsequent enquirers were anxious to publicize their own "discoveries" by revealing what they regarded as prior claims to certain aspects of the diesel engine as we now know it and which was based originally on the hypothesis first published by Dr. Rudolf Diesel under the title "The Theory and Construction of an Economical Thermal Motor".

The first contentious point that arose was the insistent claim put forward that Diesel's subject matter was not original but in effect a transcript of theories propounded by Professor Linde of Munich University. Diesel was born in Paris of German parents in 1858 and studied at Augsburg and Munich, after which he went into the engineering works of Sulzer Bros. in Winterthur, Switzerland. He developed the theories of "the economical thermal motor" about 1890 and took out various patents including a British patent in 1892: the essential part reads—

Motive work by means of heated air . . . compressed to so high a degree, that by the expansion subsequent to the combustion

THE TERM "DIESEL"

the air is cooled to about atmospheric temperature, and that into this quantity of air, after its compression, fuel is gradually introduced. . . . At this compression the temperature becomes so high that the fuel employed is spontaneously ignited when it comes into contact with the compressed air.

It is clear from this patent that Diesel's claims were for an engine designed to conform to a particular thermodynamic hypothesis and his chief purpose was to avoid the two main sources of heat loss in an internal-combustion engine, controlling maximum temperature by introducing the fuel gradually and discarding only cooled exhaust gases. He argued that a large increase in thermal efficiency was impossible if any fuel-air mixture was present before ignition, owing to the amount of excess air allowable being limited by the possibility of igniting the mixture, compression and expansion ratio thus being limited entirely by the danger of pre-ignition.

The basic requirement of the diesel cycle was that at maximum compression pressure the fuel should be admitted in such a way that combustion would be maintained at *constant pressure* in the cylinder during the burning period, whereas in all previous internal combustion engines the fuel had been burnt instantaneously (or nearly so) without change of volume, that is, with great pressure rise at *constant volume*. Diesel's cycle was not primarily conceived with the idea of securing self-ignition of the fuel by the method of using a very high compression ratio; the self-ignition was incidental to the high compression ratio necessary to comply with the thermodynamic principle which he propounded and the aim of the cycle was to maintain the maximum compression pressure by introducing fuel during the most effective angular travel of the crankshaft during the power stroke.

In theory the pressure rise during combustion should not have greatly exceeded the maximum compression pressure and the result should have been a smooth development of power more akin to the thrust of the steam engine than the explosive blow on the piston of the normal internal-combustion engine.

Diesel's theory received wide and enthusiastic acceptance

THE MODERN DIESEL

among engineers and experimental work was undertaken both by Krupp and at the M.A.N. works at Augsburg. To quote his own words: "In 1897, after four years difficult experimental work I completed the first motor in the Augsburg works." The engine was first publicly exhibited at the Munich Exhibition in 1898 and a year later Diesel established his own works at Augsburg. Nevertheless, it is true to say that *no engine strictly supporting the diesel theory has ever been built!*

As originally laid down the diesel cycle provided for combustion at *constant pressure*, whereas the ordinary petrol engine gives combustion at *constant volume*, its combustion taking place rapidly when the compressed air-petrol mixture is ignited by an electric spark. These two conditions of combustion are shown graphically by the accompanying indicator diagrams reproduced opposite.

In petrol engines, with ignition timed at the usual angle before top dead centre, combustion should be very nearly at constant volume, as shown by the vertical part of the left-hand diagram. In slow-speed diesel engines combustion is approximately at constant pressure, as shown by the horizontal part of the right-hand diagram.

Modern high-speed compression-ignition engines, however, come between these two conditions according to the instant at which fuel injection is commenced. If injection is commenced just before dead centre the curve obtained is flat at the top, but as the moment of commencement of fuel injection is advanced, as it has to be in high-speed engines, the curve can be made sharper and sharper, with correspondingly higher maximum pressures, until practically constant-volume combustion is attained, as is shown in the third diagram.

From time to time there have been attempts to show that Diesel was anticipated, notably by Akroyd-Stuart, an English engineer, born in 1864, who took out various patents, one of which, dated 1890, described—

Means for preventing the premature or pre-ignition of an explosive charge of combustible vapour or gas and air when a permanent igniter (such as a continuous spark or a highly heated igniting chamber) is in communication with the interior of the

THE TERM "DIESEL"

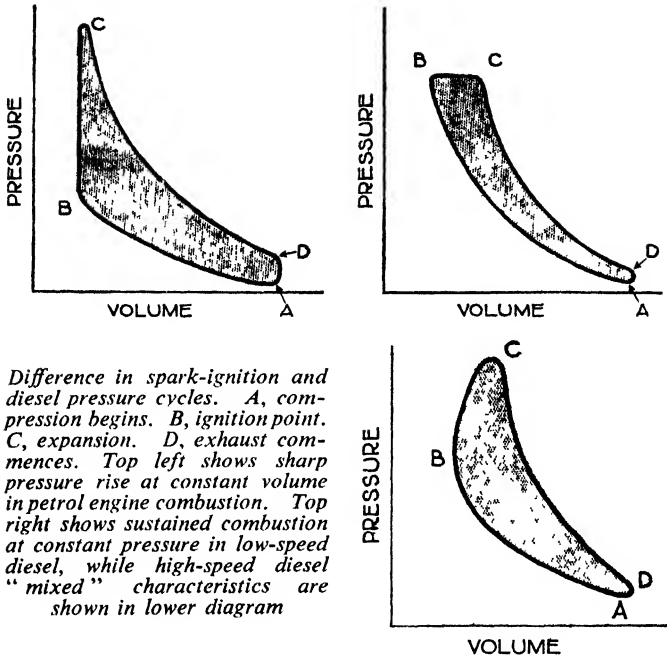

Difference in spark-ignition and diesel pressure cycles. A, compression begins. B, ignition point. C, expansion. D, exhaust commences. Top left shows sharp pressure rise at constant volume in petrol engine combustion. Top right shows sustained combustion at constant pressure in low-speed diesel, while high-speed diesel "mixed" characteristics are shown in lower diagram

cylinder, by first of all compressing the necessary quantity of air for the charge, and then introducing into this quantity of compressed air the necessary supply of combustible liquid vapour or gas, to produce the explosive mixture.

The difference here appears to be that whereas Diesel worked from a strictly logical thermodynamic hypothesis and propounded an engine from theoretical principles, Akroyd-Stuart simply aimed to eliminate a known defect of existing engines without apparently recognizing the basic principles involved. Diesel's principle recognized that self-ignition was fundamental to the compression pressure that must be attained to secure the desired result, whereas Akroyd-Stuart was endeavouring to avoid self-ignition even

THE MODERN DIESEL

in low-compression engines and did indeed rely upon an external ignition source or a "hot bulb." The gain in thermal efficiency resulting from high compression ratio was not his immediate aim.

Notwithstanding that an engine based upon the Diesel theory has never been fully realized in practice, there is no reason to quarrel with the general adoption of the name "diesel" as a generic term for all engines in which the intake air is compressed to a pressure sufficient to achieve self-ignition of the injected fuel. For a time there was a tendency to use the term "oil engine" but as this was not fully expressive in regard to the special type of compression-ignition engine referred to, the use of "diesel" has again become common.

A General Survey

THE rapid development of the diesel engine was one of the most notable features of engineering progress during the 1930s. Although the particular type on which so much thought has been expended is generally termed "the high-speed diesel", the description "high-speed" is only comparative; for the most part the class of engine under review has a practical range of speed up to about 2,000 r.p.m.

This speed may appear rather low to the petrol-engine user, who expects about 3,200 r.p.m. from his workaday bus and lorry engines, and who is not appalled at the thought of 6,000 r.p.m. or more for his specially-tuned car and motor cycle units. High speed in reference to oil engines, therefore, must be taken as referring to crankshaft speeds up to about 2,200 r.p.m. The high-speed oil engine as now used is essentially a recent development, and it owes its growth from a mechanical point of view to two important factors, the commercial production of the small high-pressure metering (or measuring) fuel pump and injection nozzles, and the vast store of mechanical and metallurgical knowledge already embodied in the high-efficiency internal-combustion engine.

Of these two important stepping-stones undoubtedly the fuel pump is the key to the whole forward movement. As is fully explained in later chapters, diesel engines have the charge of oil for each power stroke delivered to the cylinder under high pressure at the required moment, and the only controls of speed and power are the regulation of the quantity of oil at each injection, and of the moment of commencement of injection. If a single-cylinder engine of about 4 or 5 in cylinder bore runs at 2,000 r.p.m., a spot of oil "half the size of a grain of rice" must be injected at an exact moment in the cycle of operations one thousand times a minute, while when the engine is ticking over at 300 r.p.m. the size of each charge injected

THE MODERN DIESEL

will be smaller than the head of a very small pin. Between these limits the pump delivery must be capable of infinite variations and when a multi-cylinder engine is involved each cylinder must have an exactly equal charge for any setting !

Although it is difficult to trace the originator of the jerk pump, the invention has been attributed to a British engineer, the late A. E. L. Chorlton, while to Robert Bosch must go the credit for first making such a pump commercially. Claims have also been made that Richard Hornsby & Sons, of Grantham, were using jerk pumps in 1891 and that Ruston, Proctor & Co. used a similar type pump in 1909.

Controversy of this nature appears to have followed upon every development associated with the diesel engine, and as recently as 1945, in the course of investigations by the British occupying authorities into the diesel-engine industry in Germany during the war, a new claimant appeared in Franz Lang, inventor of the Acro and later the Lanova combustion chambers. Among other things, Lang stated that it was he who made the prototype fuel-injection equipment which he introduced to Robert Bosch prior to 1912.

Given the metering pump, the mechanical aspects of the c.i. (compression-ignition) engine presented no insuperable problems to those conversant with the design of the high-speed petrol engine, and so the way was clear. Why was it taken up and developed ?

The spark-ignition volatile-fuel engine, excellent as it is, is wasteful. Fuel has a certain heat value, and heat is work. The petrol engine delivers only 22-25 per cent of the theoretical work value of its fuel, while the heavy-oil c.i. engine delivers 30-36 per cent. Thus the latter is said to have the higher thermal efficiency, which in terms of ordinary usage means that there will be a more economical consumption figure for a given load.

Again, petrol ignites at a low temperature as compared with fuel oil, and this limits the compression ratio in the petrol engine, otherwise pre-ignition occurs. But it is known that the higher the compression the more efficient an engine becomes, and this gives the diesel engine its

A GENERAL SURVEY

Thermal Advantage of the Diesel Cycle

HEAT PROFIT AND LOSS

	<i>Petrol Engine</i>	<i>Oil Engine</i>
PROFIT	<i>Per cent</i>	<i>Per cent</i>
External work done	23	34
LOSS		
Internal work and friction ..	10	11
Cooling water and radiation ..	34	31
Exhaust gas	33	24

Showing how heat (fuel) put into the engine is returned. The external work delivered represents an economy of 48 per cent in favour of the oil engine

second advantage, because only pure air is compressed so that there is nothing to pre-ignite, the oil injection being timed to take place when it is wanted and not before.

The "torque" of the oil engine is high. Torque may be described as a "capacity for turning", or good "pulling power". The oil engine pulls well over all its speed range. It is "a good puller at low speeds" and is not easily stalled when the speed drops, which is a fault with the petrol engine. This is because the air admitted to the cylinder is always at maximum, there being no throttle to reduce volumetric efficiency at low speeds and no adverse carburation effects at high speeds.

So we begin to appreciate the attractions of the c.i. engine. It is economical of fuel, it is a "good puller", and the robust and mechanically accurate metering pump replaces the carburettor and electrical ignition apparatus.

The fact that it consumes a fuel which is not dangerously inflammable makes it additionally attractive in many ways, particularly for small pleasure and utility craft on the water, where fire has such dire consequences. That the fuel is not volatile is also important in the tropics, where diesel-engine lorries and buses can operate over great distances with safety because there is no evaporation loss from the tanks, a loss which may account for 50 per cent

THE MODERN DIESEL

on one journey when petrol is used. Increased range per tankful is also an important factor, especially in undeveloped countries.

Most of the credit for the pioneer work in the adaptation of the diesel engine to road vehicles must be given to Germany. During the war of 1914–18 petrol became so short in Germany that it had to be reserved exclusively for aviation. The limited number of road vehicles maintained in service had to run on fuel substitutes in many cases inferior in quality to the gas oils at present available for diesel engines.

Not infrequently the same factory, or factories having very close connections, had to face the double problem of building the greatest number of diesel marine engines and of making petrol lorry engines run on what was practically crude oil.

The Benz Company, at the Rheinische Gasmotoren-Fabrik, at Mannheim, was one of the biggest producers of submarine diesel engines. At the same time another branch of the Benz Co. was active in lorry and aviation engine construction. The Berlin-Marienfelde works of the Mercedes Co. were also occupied on submarine and lorry work, while the famous car factory near Stuttgart was producing aviation engines in quantities. After 1918, Benz and Mercedes amalgamated.

At Augsburg the M.A.N. (Maschinenfabrik Augsburg Nürnberg) was having a similar experience, while others who were influenced were Körting, Linke Hofmann-Busch and the Saurer factory at Arbon, in Switzerland, only a few miles from the German frontier.

In other countries, England, France, Italy and the United States, there was no shortage of petrol for the military forces, and, although some of these nations were quite active in the building of submarine diesels, there was no necessity to develop a heavy-oil engine capable of use on a road vehicle.

Immediately after the 1914–18 war, the Mercedes factory at Berlin-Marienfelde set to work on what can best be described as the modern diesels. The problem was to build small, light engines, into the cylinders of which fuel

A GENERAL SURVEY

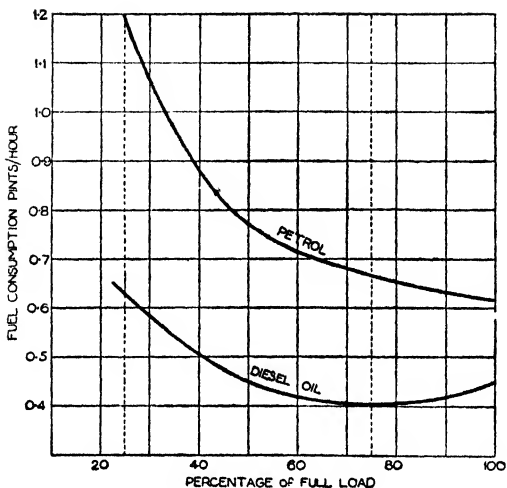

Curves showing comparative fuel consumption of equivalent 130 h.p. six-cylinder A.E.C. engines running on petrol and diesel oil

could be injected with meticulous accuracy and capable of running at 800 to 1,000 r.p.m. which, at that time, was a very high speed for a diesel engine.

The experiments carried out between 1919 and 1921 were so successful that on March 23, 1921, it was decided to build three 50 h.p. four-cylinder diesel engines, having a bore and stroke of 110 by 150 mm. This engine was fed by a two-stage compressor, but it was realized, even then, that means must be devised to avoid the use of an accessory of this nature.

One of these engines was mounted in a 4-ton lorry chassis and the other in a 2-ton shaft-driven bus chassis, and various road tests were carried out in Germany in 1923. Among these was a journey from Berlin to Stuttgart and return, a distance of about 780 miles, and a journey of about a thousand miles to Munich and southern Germany.

THE MODERN DIESEL

Other countries lagged behind Germany during these early stages. One branch of the Fiat factory, at Turin, had specialized on heavy-oil engines for years, but there was no attempt to apply that experience to road vehicles until Germany had shown the way. Renault, the biggest maker in France, had a diesel-engine department, but there was no connection between this and the lorry works. Probably the first lorry engines to be seen in France were the German Junkers, introduced by a branch of the Peugeot Company.

The Saurer Company, in their factory at Arbon, Switzerland, were also very early movers, for they had been able to follow the pioneer work in Germany and were closely connected with Bosch, the first Continental manufacturer to produce a metering pump. As early as 1923 Saurer had converted petrol engines to run on the diesel principle and followed this up with specially-designed heavy-oil engines.

It was not until 1927 or 1928 that serious efforts were made to develop the small c.i. engine in this country, for although much work had been done in the light marine field the conditions of that industry were not conducive to rapid development.

Marine motors run at fairly constant speeds; high revolutions are not called for, nor are there overwhelming advantages in extreme lightness of construction. Development in the air was likewise slow, from the commercial point of view, because of the high cost of essentially specialized experiments.

The interest of a strong, wealthy, and highly progressive industry was needed and, happily, some of the designers of heavy transport vehicles realized the possibilities of an engine that would run a 12-ton load for twelve miles on a gallon of fuel, against a petrol vehicle's five miles per gallon. British makers of heavy chassis were at the height of technical success in petrol-engined transport vehicles, while several well-established British makers of marine and stationary engines of c.i. type had for many years devoted attention to adapting it to purposes for which higher speeds and greater flexibility are required. Among these efforts may be instanced the application of Beardmore high-speed units to rail cars and airships.

A GENERAL SURVEY

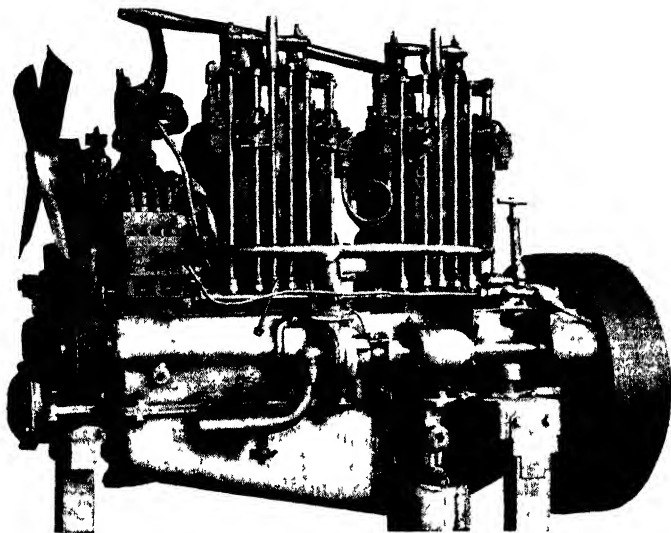

The 1921 Mercedes 50 h.p. four-cylinder diesel engine with two-stage compressor

In 1928, the Associated Equipment Co. Ltd., of Southall, built a six-cylinder c.i. engine of their own design and ran it experimentally in a bus from December of that year, conveying employees to and from their works. The engine, which was built under Acro licence, was later fitted to a heavy lorry and further tested.

A Mercedes-Benz heavy-oil lorry (with trailer) earned the Dewar Challenge Trophy for 1928 as a result of an R.A.C. test. Over a distance of 691 miles it consumed fuel at the rate of 13.48 m.p.g., equivalent to 156.5 gross ton miles per gallon.

At the Shipping, Engineering and Machinery Exhibition held in September, 1929, the first British examples of the modern c.i. engine appeared in commercial form for sale to the public. There were three four-cylinder units, a 36

THE MODERN DIESEL

h.p. Gardner direct-injection cold-starting engine, an 80 h.p. Gleniffer four-cylinder which had the ingenious air-starting motor which is later described in the marine section, and a 40 h.p. Ailsa Craig with electric starter. There was also a six-cylinder American Cummins of 60 h.p. which, after modification, was applied to a racing car which exceeded 100 m.p.h. at Daytona. The Gardner engine was installed in a bus by T. H. Barton, of Nottingham, and did good work.

At the Public Works and Transport Exhibition, also held in 1929, the Kerr Stuart heavy lorry, powered by a Benz-type engine made by McLaren's, of Leeds, was exhibited, while early in the following year the Sheffield Corporation put into service a Karrier six-wheeled bus chassis with a Mercedes-Benz engine. The late W. H. Goddard, A.M.I.Mech.E., of Leeds, an ardent pioneer of the heavy-oil vehicle, was responsible for the conversion, which gave good results.

In quick succession Leeds and Manchester Corporations ordered Crossley double-decker buses fitted with Gardner six-cylinder light marine engines, and obtained 10 to 12 m.p.g. against the 5 to 6 m.p.g. of petrol buses on town service work, while Frank Dutson, of Leeds, commenced the fitting of Gardner engines to existing lorries as a business undertaking and demonstrated remarkable economies.

Thus in a rapid succession of events grew an essentially British movement that set the entire heavy-vehicle industry by the ears, and factory after factory hastened into experimental work, so that by the end of 1931 over forty makers in Great Britain, Europe and America were producing c.i. engines for road-transport work, and most manufacturers of buses and lorries offered alternative petrol or heavy-oil engines.

Perfection was not reached at the first attempt, and, naturally, the pioneer vehicles mentioned had their limitations. Marine-type engines were slow, heavy and bulky, but in a decade of development weights were reduced from about 24 lb/b.h.p. to 10 lb or less, which is comparable with the best petrol practice in the case of

The Compression-ignition Cycle

THOSE familiar with the working of the ordinary petrol engine are aware that the motive power is produced by igniting above the piston in each cylinder a mixture of petrol vapour and air, causing an explosion (or sudden expansion of gases) which exerts pressure on the top of the piston. By these means the heat contained in the fuel is transformed into work, the reciprocating movement of the piston being converted into rotary motion of a crankshaft by a connecting rod.

The Otto, or four-stroke, cycle of operation is the one more commonly employed. This requires each cylinder to be provided with an inlet valve that admits a mixture of petrol vapour and air (drawn by suction of the engine from an atomizing instrument known as a carburettor) into the combustion chamber above the piston, and an exhaust valve which opens to permit the exhausted gases, after they have done their work, to be ejected.

To describe a complete cycle as it occurs in any one cylinder we will assume that the piston is at the top of its stroke with both inlet and exhaust valves closed. As it descends the inlet valve is opened so that the charge of explosive mixture is drawn into the cylinder. This is called the suction or induction stroke. Soon after the piston commences to rise again the inlet valve is closed, so that the mixture is compressed. This is called the compression stroke. When the piston reaches approximately its highest point, the mixture is ignited by means of an electric spark which is caused to pass between the points of a sparking plug inserted usually in the top of the combustion chamber. As both valves are closed the gas, suddenly expanding owing to its combustion, and having no outlet, forces the piston down the cylinder. This movement is known as the expansion or power stroke.

THE MODERN DIESEL

Before the piston reaches its lowest point, the exhaust valve is opened, and as the piston again rises it sweeps the burnt gas through the exhaust outlet, whence it is led through a silencer to the atmosphere. This is the exhaust stroke, and completes the cycle, which is continuously repeated. Thus it will be seen that there is one power stroke for every four strokes of the piston or two revolutions of the crankshaft.

It should be noted that the size of the combustion chamber above the piston (known as the clearance space) is considerably smaller than that part of the cylinder in which the piston travels. Thus at the end of the compression stroke the explosive mixture is compressed to a pressure varying in different engines from about 70 to 80 lb/sq. in. By such compression the mixture is heated to some extent, resulting in better vaporization of the fuel, and more intimate mixing of the vapour and air; it also causes the engine to work with higher thermal efficiency, to which further reference is made later.

Incidentally, the ratio of the total volume of the cylinder above the piston when it is in its lowest position to that of the combustion or clearance space when it is at its highest position is known as the compression ratio, and in modern commercial vehicle engines varies from about 6 to 1 to 7 to 1.

The operating cycle of the four-stroke heavy-oil (or c.i.) engine also requires each cylinder to be fitted with an inlet and exhaust valve that are opened and closed in a similar manner to those of the petrol engine. The four strokes are also known as induction, compression, expansion, and exhaust and occur in the same order. The first point of difference, however, is that on the induction stroke pure air only is drawn into the cylinder through the inlet valve, and, owing to the clearance space being much smaller than in the petrol engine and the compression ratio therefore considerably higher, the air during the compression stroke is very much more highly compressed by the rising piston. In practice the compression ratio varies from 12 to 1 up to 16 to 1, or more, and as the pressure reached may be anything between 400 and 550 lb/sq. in. or more, the

COMPRESSION-IGNITION CYCLE

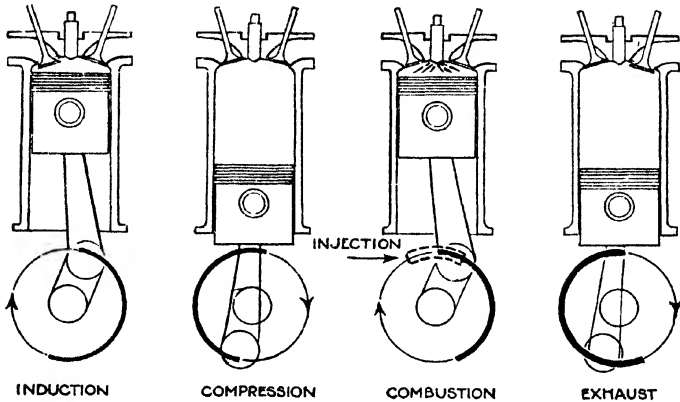

Four-stroke cycle of operations in a heavy-oil engine during two revolutions of the crankshaft

temperature of the air is raised to about 1,000° F. This is sufficient to ignite a mixture of heavy oil and air, and no electric spark is required.

So far we have reached the point in the cycle where there is only pure air in the cylinder. Just before the piston reaches the end of the compression stroke the heavy-oil fuel is injected into the combustion chamber through an injection nozzle, or sprayer, carried in the cylinder head, taking the place of the sparking plug in the petrol engine. The pressure at which the fuel is injected must necessarily, of course, be higher than the compression pressure and in general averages about 2,000 lb/sq. in. During injection the fuel is split up into finely-divided particles, and by atomization and admixture with the air forms an explosive mixture that is immediately ignited by the heat of compression.

Injection is continued for a short period, during which the piston passes its highest position and begins to descend on the power stroke. The effects of combustion only begin to be felt when the piston is, roughly, at the top of its stroke, and during the injection period the burning

THE MODERN DIESEL

fuel maintains a more or less constant pressure somewhat above that of compression ; when the fuel is cut off expansion of the gases continues, the pressure falling as the piston descends farther. The overall effect on the piston is a more sustained pressure than the sudden blow which the piston of the petrol engine receives upon combustion of the charge. The end of the power stroke is reached before the piston descends to its lowest point, and the cycle is completed when the exhausted gases are expelled by the rising piston.

To inject the fuel a special type of pump driven by the engine is employed, and this is a distinguishing feature of the heavy-oil engine, just as the carburettor and the magneto or coil and distributor ignition apparatus distinguish the normal petrol engine.

Mention must also be made of the two-stroke cycle for it is particularly attractive for adaptation to c.i. engines. In the two-stroke petrol engine the air-petrol mixture is drawn into the crankcase as the piston ascends the cylinder. The crankcase is made airtight and the carburettor is connected to it by a port in the cylinder wall which is covered and uncovered by the skirt of the piston.

As the piston descends the cylinder, the air-petrol mixture in the crankcase is compressed therein until such time as the top of the piston uncovers another port which is also in connection with the crankcase. The compressed mixture then rushes from the crankcase to the cylinder, that is, the transfer passage and port form a by-pass route from below to above the piston.

As the piston rises again it compresses the mixture in the cylinder and at the same time draws mixture from the carburettor into the crankcase. At about the top dead centre the compressed mixture is ignited by the electric spark and the piston is forced down on the working stroke, the mixture in the crankcase being at the same time compressed.

Near the bottom of the down stroke the top of the piston uncovers exhaust ports through which the spent gases can leave the cylinder, and they are assisted on their way by the transfer port being uncovered to admit the

COMPRESSION-IGNITION CYCLE

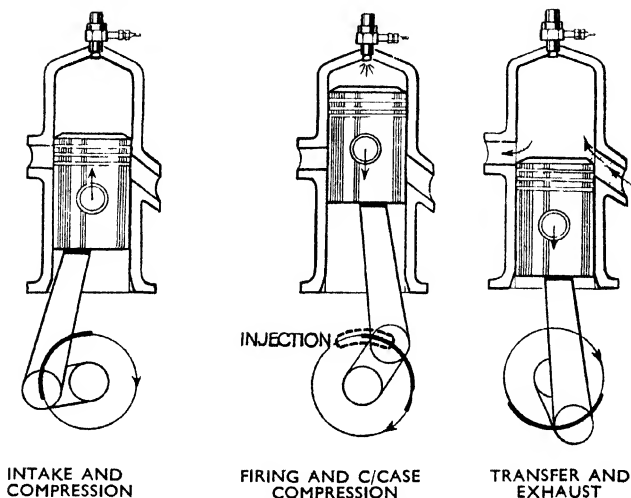

INTAKE AND
COMPRESSION

FIRING AND C/CASE
COMPRESSION

TRANSFER AND
EXHAUST

Showing the cycle of operation in a two-stroke heavy-oil engine

fresh compressed charge from the crankcase. So the cycle is repeated, each down-stroke of the piston being a power stroke. To prevent mingling of the fresh charge with the spent gases a deflector or ridge is formed on the piston crown at a point opposite the transfer port to guide the ingoing fresh charge to the top of the cylinder. Owing to imperfect scavenging, that is, failure to clear out completely the spent gases, this simple three-port type of two-stroke petrol engine is not very efficient. It may also be wasteful of fuel through loss of fresh charge through the exhaust ports.

Two-stroke heavy-oil engines work on a somewhat similar cycle, although the admission of air on the induction stroke may be direct into the cylinder, and may be controlled by a valve, such as a sleeve valve, which may also control the opening of the exhaust ports.

It is a comparatively simple matter to provide proper scavenging of the cylinder with air delivered from a rotary blower or scavenging pump, in which case it is immaterial

THE MODERN DIESEL

if some air is lost through the exhaust ports because injection does not take place until the air is compressed in the combustion chamber, therefore no loss of fuel occurs, as in the case of a two-stroke petrol engine.

While possessing none of the principal defects of its petrol-using prototype, the two-stroke oil engine has a number of important advantages. Since every down stroke is a power stroke, for a given output a smaller number of cylinders is required so that the overall length is reduced, permitting the use of a shorter and stiffer crankshaft, which is consequently less subject to torsional vibration. A further point of interest is that a continual downward pressure is maintained on the connecting rod bearings so that their longevity is a feature of the type, although this factor introduces certain lubrication problems.

When the "valveless" design is adopted the construction is much simpler, requiring fewer parts, and both the first cost and cost of maintenance are lower. In practice, however, the "valveless" type is rarely used for high-speed engines; modern two-stroke diesels have a conventional poppet exhaust valve in the cylinder head with the air only admitted through a piston-controlled port in the cylinder wall. This provides the "uniflow" system of scavenging, air being delivered from a blower into the cylinder at the bottom of the piston stroke to sweep the exhaust gases upwards toward the overhead exhaust valve through which they are expelled. The blower capacity is such as to provide excess air, some of which passes out with the exhaust, in the interests of complete scavenging. The opposed-piston type, of course, provides "uniflow" scavenging with a valveless construction. Examples are the Junkers and Sulzer units.

It might be thought that since the two-stroke engine exerts a power impulse at every revolution as compared with one every two revolutions in the case of the four-stroke unit, for a given capacity the former should give double the output of the latter. This, however, is not the case, for not only is power lost in charging and scavenging the cylinders, but also on account of the early opening of the exhaust port and the short inlet period.

COMPRESSION-IGNITION CYCLE

As already explained, the explosive mixture of the petrol engine is produced by a carburettor, but in the case of the heavy-oil engine the fuel supplied depends entirely upon pumps, one for each cylinder, which are usually operated by a camshaft. When it is explained that the amount of fuel that must be injected into each cylinder for each power stroke is extremely small, and that each charge must be measured, or metered, with great accuracy, it will be realized that efficient and economical running is largely dependent upon the fuel pump.

If the fuel charge is too small in any of the cylinders less power is produced in these than in the others; should too much fuel be injected some of it is not burnt and is either ejected with the exhaust gases or deposited on the pistons, valves, and other interior surfaces of the engine. It is important, therefore, that the fuel pumps be constructed with great precision in order that the quantities of fuel delivered by all are exactly equal. Moreover, the period of injection in relation to the position of the piston must be the same in each cylinder, and when injection ceases there must be no further issue of fuel from the injecting nozzles. A defective fuel-injection system is certain to cause a smoky exhaust and rough running accompanied by waste of fuel. These conditions represent a difficult problem for the pump and nozzle manufacturers, but even if perfection of fuel injection is attained this is no guarantee that the fuel will be burnt in the engine to the best possible advantage. Research carried out in order to obtain higher efficiency, fuel economy and quieter running have shown that different designs of combustion chambers, pistons, arrangements of valves, injectors, and other variables all make their contribution to those qualities.

Reference should be made to one other feature of the heavy-oil engine as applied to road-transport and marine purposes. This is the governor. It is not, however, the simple form of speed-limiting device sometimes used on petrol engines. The function of the diesel-engine governor is more complex. It must maintain a steady idling speed at one extreme and at the other must provide a definite cut-off when maximum permissible r.p.m. are attained,

THE MODERN DIESEL

while at intermediate speeds it must regulate fuel delivery in response to torque requirements rather than in simple relation to engine speed. Thus when the engine is subject to maximum load at low speeds the maximum fuel delivery must be made, but if it is running light at moderate speed the governor must respond with low fuel delivery.

In the C.A.V. mechanical-centrifugal governor, which is the type most commonly used, suitable springs controlling the centrifugal weights take care of idling conditions and other springs come into action to control the maximum speed cut-off; intermediate control is direct from the accelerator pedal, subject to the over-riding automatic action.

In another type of centrifugal governor, used on Gardner engines, the accelerator pedal does not act directly on the fuel-control rod at any time, but simply increases the pressure on the governor spring. Bearing in mind that the normal tendency is for the fuel control rod to move towards full delivery, the increased spring loading delays fuel reduction in relation to rising speed; the accelerator is thus to be regarded as a torque control rather than a speed regulator, fuel being delivered according to the load on the engine while speed automatically adjusts itself.

Another method of governing is the C.A.V. pneumatic system in which use is made of a venturi in the induction manifold and a valve controlled by the accelerator pedal, in conjunction with a diaphragm unit connected to the injection pump fuel control rod. Their action is such that the vacuum in the induction manifold regulates the position of the fuel-control rod, thereby determining the maximum and idling delivery; in this type of control the accelerator also is a torque control rather than a simple speed regulator. This pneumatic system is incorporated in the governor now standardized on the post-war range of Leyland engines to regulate the low-speed characteristics in conjunction with a simplified centrifugal governor which cuts off the fuel supply at the predetermined maximum speed. There is no mechanical connection from the accelerator pedal to the governor, all control being effected by the throttle in the intake manifold venturi unit from which a vacuum pipe is connected to the governor.

COMPRESSION-IGNITION CYCLE

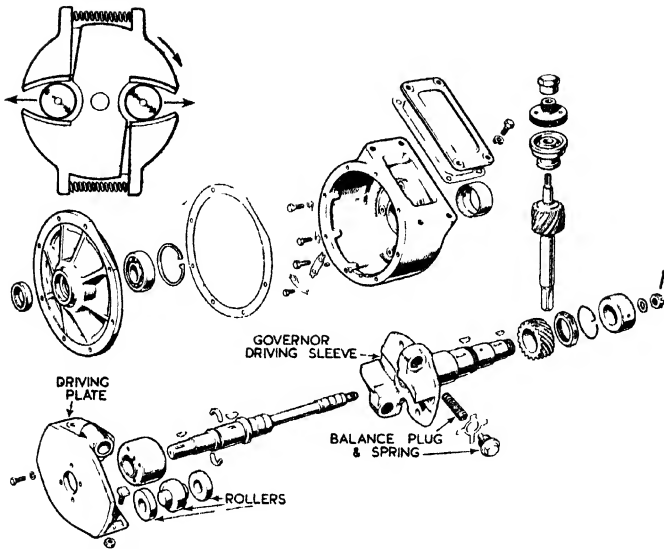

Automatic fuel pump variable timing device on Meadows engine

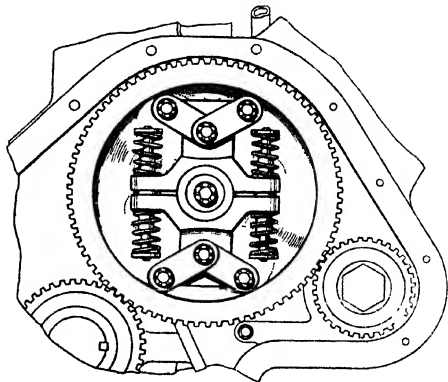

Albion variable injection timing mechanism in 5-litre engine

THE MODERN DIESEL

The hydraulic method of governing has long been attractive to injection equipment makers and in diesel engine circles the opinion has persisted that this method would eventually displace other systems. Saurer was early in the use of a hydraulic governor which depended on a gear pump driven by the injection pump camshaft. Two separate deliveries operate the governor mechanism which regulates the idling and maximum speeds, the quantity of fuel delivered and the timing of the injection period.

More recently a British hydraulic governor, the Bryce, was introduced in which fuel delivery is regulated by the variable pressure set up by a gear pump driven from the injection-pump camshaft in conjunction with an accelerator-controlled pressure release. Finally, late in 1948, a C.A.V. hydraulic governor was announced and since it is a development by the most prominent makers of injection equipment and mechanical and pneumatic governors it may indicate an important design change which will be reflected throughout the high-speed diesel industry. This C.A.V. governor also depends upon a gear pump which develops a pressure that actuates the pump control between low and high speed limits, intermediate control being regulated by the accelerator which increases the spring loading on a by-pass valve.

In some of the earlier stages of high-speed diesel evolution a variable timing device was introduced in the pump drive coupling, taking the form of a helically splined sleeve by means of which the angular relation between driving and driven shafts could be varied either by manual or automatic control. It was generally discarded in favour of fixed timing although such a device has always been incorporated in the Gardner engine where it is coupled to the accelerator control. On two of the most recent engines automatic timing variation is revived, the two examples being the large Meadows and the medium capacity Albion; in both cases, however, the helical splined coupling is avoided, angular displacement of the shafts being effected by centrifugally actuated devices.

From the above it will be realized that the fundamental difference between petrol and heavy-oil engines is that in

COMPRESSION-IGNITION CYCLE

the petrol engine the source of heat for igniting the charge, namely, an electric spark, is generated outside the engine, and is taken, as it were, into the waiting charge at the required instant. In the heavy-oil engine the source of heat for igniting the charge is created within the engine by compressing pure air to a degree that will initiate combustion and then injecting the fuel at the right time in relation to the movement of the crankshaft. It will have been gathered that, apart from their auxiliary features, petrol and heavy-oil engines are of very similar construction. But as the latter is called upon to withstand very much greater stresses due to higher pressures in the cylinders, it has necessarily to be of more substantial construction, and is thus heavier.

By careful design and by taking full advantage of the most advanced metallurgical technique the power/weight ratio of the high-speed diesel was substantially improved within the course of a very few years so that the weights of present-day engines do not appear to be capable of being reduced much further. The use of light alloys was explored in the development process but the permanent rigidity of castings in light materials did not prove to be satisfactory within the dimensional limits imposed by restrictions on engine units designed for use in road vehicles in some instances at least.

One of the greatest difficulties encountered in connection with the heavy-oil engine is to eliminate what is generally known as the characteristic "diesel knock", which is most pronounced when running at low speeds. This peculiarity of the diesel engine is associated with the "delay period", which is dealt with in the following chapter.

It will have been noted that in Diesel's basic patent he stated that fuel should be introduced "gradually". Recent development work, both here and abroad, has been directed to this aspect of injection and what is known as "pilot injection" has come to be regarded as probably the final solution of the problem of "diesel knock". The idea of pilot injection is to commence injection gradually so that the first atomized droplets of fuel are ignited and help to raise the temperature within the cylinder before the bulk

THE MODERN DIESEL

of the charge enters the combustion chamber. It is thought that if the whole charge enters so rapidly as to be within the chamber before the first droplets have time to ignite, their ignition is followed by an uncontrolled combustion or, indeed, detonation of the whole charge.

Since a progressively increasing rate of injection is not feasible in practice, the division of injection into two phases—the pilot injection followed by the main charge—now appears to be the system for which a satisfactory method is being actively explored.

Fuel-injection Systems

IN the c.i. engine, injection of the fuel not only replaces the carburation system of the petrol engine but it performs the *timing* function of the electric ignition system. Thus not only is speed and power regulated by the *quantity* of fuel injected but the moment of injection in the cycle of operation has an important bearing on efficient and economical running. Satisfactory functioning, therefore, largely depends on the accuracy of the injection system.

As originally designed, diesel engines had air-blast injection, that is, the fuel was injected by air pressure of a higher intensity than the compression in the cylinder, and this system is still to be found on large marine and stationary units. For many reasons it is unsuitable for small high-speed engines, and so the airless or "solid-injection" system, in which the fuel is pumped under high pressure into the cylinders through injecting nozzles or sprayers, came into being; separate pump and fuel spraying nozzle is provided for each cylinder. Generally the pumps are grouped together, forming a single unit, and they deliver the fuel through substantial steel tubing to the sprayers, which are secured in the cylinder heads. The pumps are usually hard-steel plungers reciprocated in the pump cylinders by cams on a shaft driven (like the magneto of a four-stroke petrol engine) at half the speed of the engine crankshaft (at crankshaft speed in two-stroke engines).

In exceptional cases the pumps are not grouped but are mounted separately on each cylinder head with the injector formed as an integral part of the assembly. Fuel from the pump is directed through drilled oilways to the injector nozzle, so dispensing with external piping. This system is commonly used on certain of the most popular American diesels. The combined pump and injector have not been used on British engines, but there are examples of British marine and industrial diesels on which a separate pump is

mounted on each cylinder head connected to a normal injector by a very short pipe. Though the delivery from the pump is under the direct control of the driver, as previously explained, it is found desirable to connect the control mechanism to a centrifugal or other type of governor, which automatically regulates the quantity of fuel delivered and controls the maximum and idling speeds of the engine.

Design and size of the combustion chamber and the position of the valves have an important influence upon efficient combustion. Other factors which all play their part are the physical and chemical characteristics of the fuel, temperature, the amount of excess air, turbulence, and compression pressure. The manner in which the fuel is injected is of equal importance, and whereas a given injection equipment may be satisfactory for one type of engine it may not suit another.

Combustion is affected by the timing, rate and duration of the injection period, the position of the spraying nozzle, the direction in which the fuel is sprayed and the injection pressure, upon which depends the degree of atomization of the fuel and its penetration and distribution in the combustion chamber.

Thus in every case injection must be considered in relation to what occurs before, during and after the injection period, but as the conditions vary with different makes and types of engine, it will be preferable to confine the present chapter to what may be regarded as the mechanical aspect of the injection problem.

Briefly stated, the function of the injection apparatus is not only to deliver extremely small and accurately metered quantities of fuel into the cylinder, but to assist in breaking the oil up into uniform particles of the smallest possible size and distributing them throughout the combustion chamber. The fuel must not be injected all at once, but over a period, commencing just before the piston reaches top dead centre on the compression stroke and ending after it has passed top dead centre, the duration of the injection period corresponding to about one-tenth of a revolution of the crankshaft. Obviously the pressure exerted by the pump must be much greater than the

FUEL-INJECTION SYSTEMS

maximum compression pressure in order that the fuel shall issue from the injection nozzle in a fine spray capable of penetrating the compressed air in the combustion space.

In this connection it is found that not only the size and shape, but also the length of the injection orifice in the nozzle have an important influence upon the formation of the spray. If the orifice is short, fine atomization of the fuel is obtained, whereas with a long orifice the spray penetrates more in the required direction. A compromise between these two desirable features is usually effected. In view of the very restricted quantity of fuel required to be injected for each power stroke the size of the orifice is extremely small, particularly in multi-hole sprayers.

Much research work has been carried out on the effect of the length-diameter ratio of the orifice on the spray characteristics, and a highly informative report was issued in 1931 by the National Advisory Committee for Aeronautics, in America, on this particular subject. A photographic record of the development of a single fuel spray is reproduced on page 50.

Another report issued by the committee in 1932, dealing with the work of Dana W. Lee in the same laboratory, dealt with spray developments in various conditions. High-speed spark photographs were taken of the sprays, one, reproduced on page 53, showing how spray development varies in air of different densities. For road-vehicle engines the type of injecting nozzle employed generally is that in which the passage to the orifice is normally closed by a spring-loaded needle valve that is opened by the oil itself when the required injection pressure is reached and shuts immediately it falls at the end of the injection period. Many different designs of nozzle are in use and

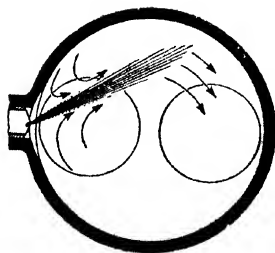

An instance of fuel injection tangential to an air-swirl induced by inlet valve design. In other examples the fuel may be sprayed through more than one orifice in the nozzle

THE MODERN DIESEL

the spray is variously directed according to the size and shape of the combustion chamber.

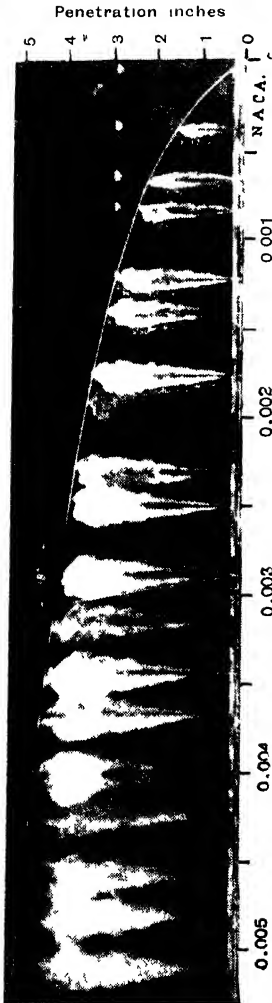

Spray photographs with lines drawn to show spray-tip penetration and spray cone angle. Orifice length = 0.056 in., orifice diameter = 0.014 in., injection pressure = 2,000 lb./sq. in., chamber air density = 1.35 lb./cu. ft. Plain stem

In ante-chamber designs atomization and penetration are less important than in direct-injection engines, so that the injection pressure can be lower and a single spraying orifice, of larger size than where a number are necessary, can be used.

In an important respect the reception of the fuel in the combustion chamber of a heavy-oil engine differs from that in the petrol motor. The fuel arrives in the latter in the form of an explosive mixture ready for ignition; immediately after the injection the c.i. engine fuel is not only still liquid, though in finely-divided particles, but considerably colder than the compressed air upon which its ignition depends.

An appreciable time must therefore elapse before combustion is in full progress, although the actual ignition is practically instantaneous. The time so occupied is known as "ignition lag" or "delay period", which it is

FUEL-INJECTION SYSTEMS

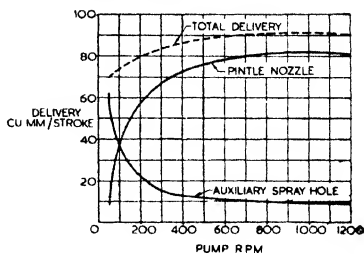
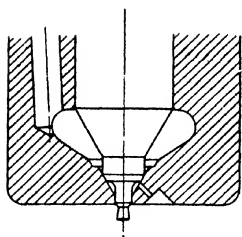

C.A.V. "Pintaux" nozzle showing auxiliary spraying hole beneath valve seat; the curves indicate its performance characteristics

obviously desirable should be reduced as much as possible when high speeds are required, and in order to reduce the rate of pressure rise and maximum pressure. Ignition lag, which varies with different kinds of fuel, can be shortened to some extent by fine atomization, and by admitting the fuel slowly at first, so that comparatively little is injected during the ignition period; during this stage and the subsequent burning of the fuel, a period of time elapses during which the piston passes over top dead centre.

Recent investigations proceeding here and in Sweden have been directed towards the possibilities of "two-stage" injection whereby the first part of the injection is at a relatively lower pressure, followed by the main bulk at higher pressure; this is effected by a double-lift cam on the pump camshaft. The object of "two-stage" injection is to initiate combustion in an orderly manner without the violent detonation or "diesel knock", and then to sustain the subsequent combustion more nearly according to the *constant pressure* cycle of the original Diesel concept. Applying the same principle in a rather different way, a special C.A.V.-Ricardo injector has recently been developed for use with the Ricardo Comet combustion chamber. Known as the "Pintaux" nozzle this is a pintle type sprayer with an additional side orifice so arranged that the first part of the injection is directed to the centre of the air cell where the highest temperature exists, the bulk of the fuel then being injected tangentially to the air swirl in the

THE MODERN DIESEL

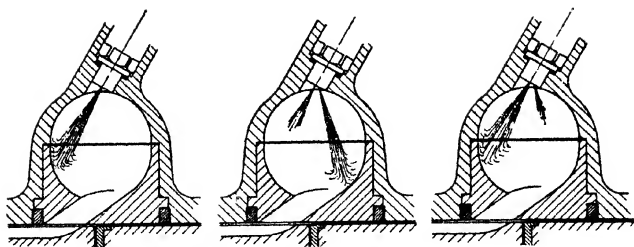

*(Left) Normal pintle nozzle spray in Ricardo Comet air cell.
(Centre) C.A.V.-Ricardo "Pintaux" nozzle operating at low speed with bulk of fuel injected towards centre of cell.
(Right) The same at high speed with small spray towards centre and bulk injection following normal pintle nozzle characteristics*

normal way after combustion has commenced. This injector facilitates cold starting and smoothes combustion.

Another modern contribution to the theory of compression ignition of great interest and originality was embodied in a paper ("A New Theory of Diesel Combustion") by Max G. Fiedler before the Franklin Institute of Philadelphia in 1942. Fiedler stressed the point that "diesel knock" was analogous to pre-ignition and that a study of indicator diagrams taken on diesel engines running in the knocking condition showed characteristics very similar to those obtained from the violent detonations when an internal combustion engine was run on pure hydrogen. From this he deduced that the hydrogen of the hydrocarbon fuel oil was dissociating from the bulk of the fuel injected and igniting in advance of the remainder, so causing the diesel knock. This theory was supported by the evidence of ciné films taken in the working cylinder which showed that the spray remained cohesive much longer than had previously been supposed and that there were indications, in the form of bright specks of flame, of early burning in a heterogenous way at points remote from the nozzle.

FUEL-INJECTION SYSTEMS

Fiedler's "new theory" did not attract the notice that his highly stimulating paper deserved; but it is worthy of study because it may well present a line of approach along which further improvements in the control of diesel combustion may be obtained.

To appreciate the difficulties of designing and constructing satisfactory fuel-injecting equipment for high-speed heavy-oil engines it is necessary to consider the exacting mechanical requirements that have to be fulfilled.



Fiedler's ciné film of a four-hole spray in the combustion chamber. White specks in (3) indicate early combust. of dissociated hydrogen

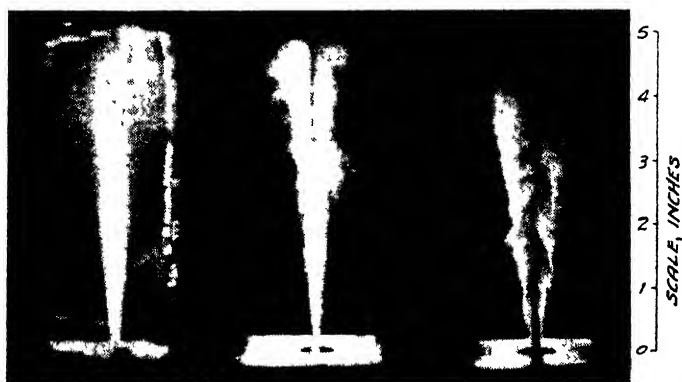

0.0005 lb/cu. ft.

0.076 lb/cu. ft.

1.1 lb/cu. ft.

High-speed spark photographs of fuel sprays injected into air having different densities. Injection pressure : 4,000 lb/sq. in

THE MODERN DIESEL

In the first place, it should be noted that the different kinds of oil used as fuel are to some extent compressible and vary in viscosity (that is, ability to resist being squeezed through small apertures, such as those in the injection nozzles). Further, they are affected by temperature, while the piping used to convey the fuel to the nozzles is subject to slight expansion under high pressures. When it is remembered that the quantity of fuel injected into each cylinder for each cycle of operations is no bigger than a pinhead, it is vitally necessary for each cylinder to have an exactly equal amount, and since injection takes place under high pressure many times per second, it will be realized that the variable factors mentioned increase the difficulties.

In addition, therefore, to great accuracy of workmanship, very rigid construction is also essential. Theoretically, the pipes connecting the pumps and nozzles should all be of the same length and as short as possible, although, in practice, neither condition is completely or consistently fulfilled; indeed, it seems to be more important that pipes should be adequately supported, especially in the region of bends. It is also important that the sizes of the pumps and passages in the delivery system be no larger than necessary and that the surfaces over which the fuel passes be smooth and free from cavities where air can be imprisoned and increase the elasticity of the fuel in the system. Fine filtering arrangements are essential in the fuel feed to the injection pump in order to remove impurities that are liable to cause damage to the highly finished surfaces of the injection equipment.

It is very important that the action of the pump should be such that the injection pressure at the nozzle be reached very quickly; that is, whilst the crankshaft turns through a fraction of a degree, and that at the end of the injection period it be reduced even more rapidly to zero. The latter requirement is particularly important to avoid any after-dribbling of fuel from the nozzle with consequent fuel waste, smoky exhaust, carbon deposit and choking-up of the spraying orifices. It is necessary, also, that the pressure be maintained evenly during the injection

FUEL-INJECTION SYSTEMS

period. These conditions, moreover, must be fulfilled at all speeds of the engine and be the same for each cylinder.

The pumps must be self-priming, otherwise trouble may be incurred by aeration of the fuel. The general design should be as simple and straightforward as possible so that its action is not affected by high working pressures, whilst great accuracy is required for the control of the time of injection.

Variable injection timing is rarely fitted to present-day high-speed diesel engines because whatever may be its theoretical desirability serious wear problems are involved in the usual type of helically-splined variable driving coupling involved and these troubles do not outweigh the gain achieved. Furthermore, owing to the power required to drive the pump such a coupling is not readily operated by any simple form of automatic control.

Automatic injection-timing advance is, however, provided on the Gardner engine, which appears to go most of the way towards producing the required conditions. The coupling of the fuel-pump drive shaft is capable of a limited degree of angular variation and this is controlled externally. It is not coupled directly, however, to a separate manually operated lever, but is linked to the accelerator, so that opening up of the latter also advances the timing.

Considerable variety was seen in the many designs of fuel-injection pumps put forward in the development stages of the modern diesel, but two main principles were generally followed. Regulation of the quantity of oil delivered was effected either by variation of the length of pump plunger stroke, or by the use of by-pass valves in conjunction with a constant stroke. By means of levers, with variable fulcrum points, or variable cams and eccentric devices, the plunger stroke of the former type can be lengthened or shortened to alter the quantity of fuel delivered as required for the load. In the latter type, which is now practically universal, the travel of the plunger is constant, but on each suction stroke a greater quantity of fuel is drawn in than is required to be delivered at maximum

THE MODERN DIESEL

load, and the actual amount injected is controlled according to requirements by by-pass or spill-valve regulation; that is to say, during the delivery stroke of the plunger communication is established between the delivery and suction sides of the pump so that at a desired point during the injection period the delivery pressure is suddenly reduced and injection ceases. This is usually effected by the plunger itself acting as a slide valve which uncovers relief ports in the cylinder barrel to terminate delivery in this manner; the plunger or the cylinder barrel is rotatable to provide the necessary control.

Many different designs of spraying nozzles have also been introduced, their construction and action being varied to suit different types of engines and forms of combustion chamber. They are either of the open or closed type, the latter being provided with some form of valve for closing the injection orifice until it is opened by the fuel pressure for the purpose of injection. The closed type is invariably used in high-speed diesels. Nozzles are of either the multi-orifice or single-orifice type, the former being employed to give better dispersion of the fuel in direct-injection engines.

The closed type of nozzle requires some means of eliminating any accumulation of air in the delivery system. This may take the form of a vent cock that can be opened by hand, although this fitting was generally discarded as improved injectors and non-frothing fuel came in to use. Venting is rarely necessary to-day as an ordinary running attention but it must be done if a connecting union in the delivery pipe becomes loose or after reassembly following repair or replacement. In such circumstances, in the absence of a venting cock or plug, the union on the injector is not finally tightened until the pump has been operated a sufficient number of strokes to deliver unaerated fuel after driving out all air from the pipe, when the union can be firmly tightened.

In some cases provision is made for operating the pump plungers by hand so that the pumps can be primed and the delivery pipes vented without turning the engine.

During the early development of the high-speed diesel

FUEL-INJECTION SYSTEMS

many fuel-pump designs were put before engine manufacturers but the Bosch equipment was the first and only type to be available in quantity. It will be recognized that the purely technical difficulties of producing such a high-precision component on a commercial scale were considerable, and in overcoming these the Robert Bosch A.G. of Stuttgart undoubtedly led the world; as has been mentioned earlier, that concern did indeed make possible the rapid progress of the modern type of diesel engine.

In 1933 the manufacture of pumps and injectors to the Bosch design was taken over in this country by C.A.V. Ltd., of Acton, London, and considerable further development has since taken place. Similarly in the U.S.A. equivalent diesel-injection equipment is produced by the American Bosch Co. But there are also other types of fuel pumps in extensive use in the U.S.A. which so far have not been introduced here—indeed, they are distinctive types which appear to be peculiar to some of the most extensively used American diesels. Practically all British engine makers use C.A.V. pumps although several of them manufacture their own injectors.

Another British make of pump and injector equipment which is supplied extensively as a standard alternative, particularly for public-transport buses, is the Simms, while a further type is the Bryce, which so far (1948) has only been used to a limited extent.

These various British pumps are similar in principle and basically follow the Bosch constant-stroke arrangement with variable spill control for power regulation; detail variations naturally are incorporated according to the particular designer's ideas on the factors necessary to increase efficiency and reliability. However, since the C.A.V. pump is in such general use it will be described first.

The C.A.V. pump is a self-contained unit embodying an operating camshaft which is driven from the timing gear of the engine. A governor is fitted as an integral assembly either on an extension of the camshaft in the case of the mechanical-centrifugal type or on the upper part of the end casing when the pneumatic type is used. The

THE MODERN DIESEL

mechanical governor is the type most commonly fitted to large engines, while the pneumatic governor is found mainly on small engines running at speeds above the general average; there is also a development in which the two types are combined. This was evolved by Leyland Motors, Ltd., in conjunction with C.A.V. during the war and its action is described in detail on a later page of this chapter. Still more recently a new C.A.V. hydraulic governor was introduced (September, 1948) and this also is described later in the chapter.

Apart from these subsidiary variations the pump itself is a standardized design that has not been subject to any great change since its introduction and the general description applies to all C.A.V. equipments in current use, irrespective of their age. Notwithstanding this generalisation a new model, the N-type, was exhibited at the 1948 Earls Court Show and was somewhat reduced in size although many mechanical improvements were incorporated, particularly an internal filter unit, larger bearing areas and improved adjustments for phasing and calibration; a diaphragm feed pump is incorporated. This new pump and governor effectively regulate idling speed down to 250 r.p.m.

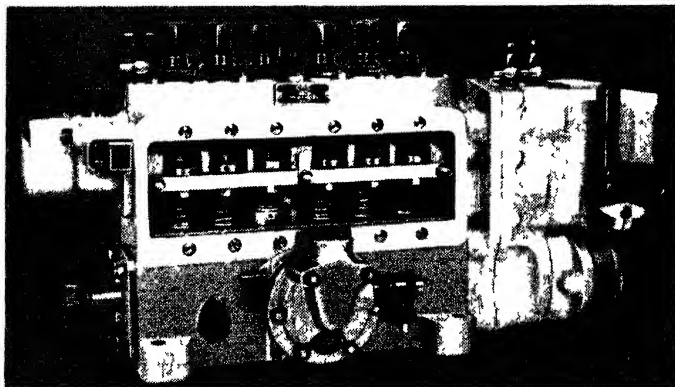

Latest C.A.V. N-type injection pump fitted with hydraulic governor

FUEL-INJECTION SYSTEMS

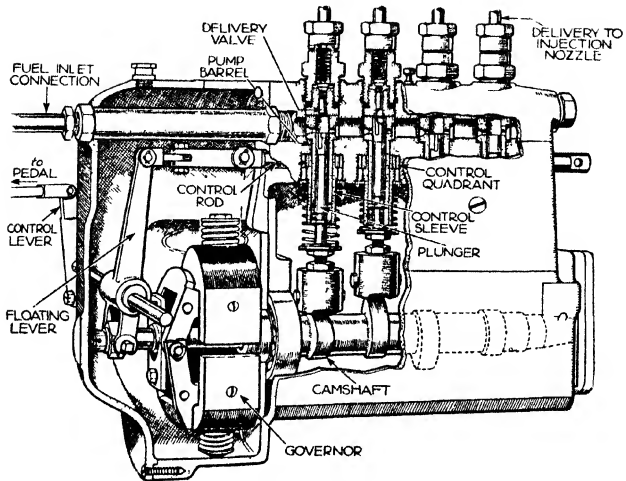

C.A.V. fuel pump and centrifugal governor in part section

For each cylinder of the engine a separate injection pump is required and therefore the pump is a multi-cylinder unit incorporating the requisite number of individual pump elements (up to six) in a single casing, each element comprising a steel barrel and a steel plunger, ground to a very high degree of accuracy. Operated by a camshaft mounted in ball bearings, each plunger is provided with a roller tappet carried in a suitable guide and held down by a coil spring on its respective cam. Near the upper end of the barrel are drilled two ports opening into a suction chamber which is common to all the pumps. Above and communicating with the pump barrel is a spring-loaded delivery valve, from which connection is made by steel tubing to the injection nozzle. The fuel is admitted into the suction chamber through the connection seen on the left in the partly-sectioned illustration of a four-cylinder pump unit, which appears above.

The manner in which the quantity of fuel delivered per stroke of the plunger is varied according to load

THE MODERN DIESEL

requirements can be gathered from the sectional illustrations opposite showing the plunger in different positions of operation. From these it will be seen that on one side of the plunger there is a vertical channel leading from the top edge to an annular groove, the upper edge of which forms a helix. The plunger is capable of being partly rotated by means of a control sleeve which has slots engaging with lugs at the lower ends of the plunger and fitted with a quadrant which meshes with a control rack.

In the first figure of the diagram of the injection-pump cycle mentioned the plunger is shown at the bottom of its suction stroke, and commencing the delivery stroke; the two ports in the barrel are uncovered so that the barrel is filled with fuel. As the plunger rises on its delivery stroke the fuel in the barrel is displaced and is forced back through the ports until these are entirely closed by the plunger. What fuel remains is forced upwards through the delivery valve to the injecting nozzle. So long as the ports are kept closed by the plunger, injection of the fuel is continued, but, as shown in the second sectional illustration, before the plunger reaches the top of its stroke the helical edge of the annular groove has partly uncovered the port on the right. The fuel above the plunger is then free to flow down through the vertical channel and annular groove and through the port into the suction chamber. The pressure is thus reduced so that the delivery valve is returned to its seat and injection ceases.

Fuel supply to the injection pump may be by gravity or by an integral pump actuated from the injection-pump camshaft. On road vehicles which have a vacuum-brake exhauster system, the "Autovac" method is very frequently adopted.

In the third diagram the plunger is again at the end of its suction stroke, but has been turned slightly by means of the rack and quadrant referred to, so that on the next delivery stroke the helical edge of the annular groove commences to uncover the relief port earlier, as shown in the fourth diagram, with the result that a smaller quantity of fuel is injected. When the plunger is turned to the

FUEL-INJECTION SYSTEMS

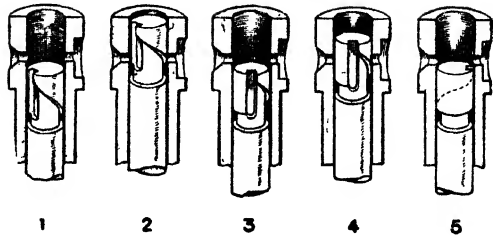

Illustrating the injection cycle of the C.A.V. fuel pump

- (1) *Commencement of delivery stroke*
- (2) *Termination of fuel injection under full load*
- (3 and 4) *Commencement of delivery stroke and termination of injection under partial load*
- (5) *Position of plunger for stopping engine*

position shown in the fifth diagram, throughout the whole delivery stroke the fuel is free to be passed down the vertical channel and through the relief port into the suction chamber so that no fuel is injected, and the engine stops. Thus it will be seen that by movement of the control rod, which is connected to the governor and to the accelerator pedal, the amount of fuel injected can be varied to suit local requirements. The maximum output of the pump is obtained when the plunger is in the position shown in the first diagram.

Reference has already been made to the importance of a quick cut-off at the end of the injection period so that there is no after-dribbling of fuel at the nozzle. This is guarded against by a special form of delivery valve, the function of which is to release the pressure in the fuel pipe between the delivery valve and injection nozzle immediately the pump pressure drops.

The delivery valve is mitre-faced, but is provided with a long cylindrical extension, which fits in a cylindrical guide and has an annulus dividing it into two parts, the lower portion being of cruciform section. The upper part forms a small piston very accurately ground to fit the cylindrical

THE MODERN DIESEL

guide below the valve seat, which is also accurately ground. On the delivery stroke of the pump the pressure lifts the delivery valve until the oil can escape through the longitudinal grooves and over the valve face on its way to the injection nozzle. Immediately the pressure is released in the pump barrel the delivery valve is returned to its seat by the spring and on account of the great difference of pressures in the pump barrel and the delivery pipe. During its closing the small piston, in passing down the cylindrical guide, increases the space in the delivery pipe (by an amount equal to the volume of the small piston part of the valve) before the valve actually reaches its seating. Thus the pressure in the pipe is suddenly reduced so that the valve in the injector nozzle snaps down on to its seat and the fuel spray is terminated without dribble.

The idling and maximum-speed governor is enclosed in a housing integral with the pump and is shown at the left in the drawing of the complete pump on page 59. It comprises two spring-loaded and centrifugally-actuated weights mounted on an extension of the camshaft and operating a pair of bell-crank levers connected to the lower arm of a floating lever, the upper end of which is coupled to the pump control rod. The floating lever is eccentrically

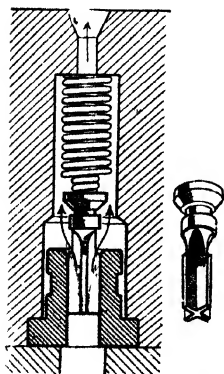

*C.A.V. anti-dribble
delivery valve*

mounted on a shaft fitted with a lever connected to the accelerator pedal. The action of the governor weights as the speed increases is to pull the control rod in the direction which reduces the fuel delivery. The operation of the accelerator pedal is independent of the governor, for when it is depressed it turns the eccentric shaft, moving the floating lever, and therefore the control rod, so that more fuel is delivered irrespective of the position of the governor weights. Each of the latter is controlled by an outer spring for regulating the idling speed and a stronger inner spring for controlling the maximum speed.

FUEL-INJECTION SYSTEMS

injection-pump cam-shaft to develop pressure in a hydraulic circuit in relation to engine speed and it uses the normal fuel oil drawn from the injection pump as its operating medium.

A maximum-fuel stop, which also incorporates an excess-fuel device for starting, is carried in a separate housing mounted

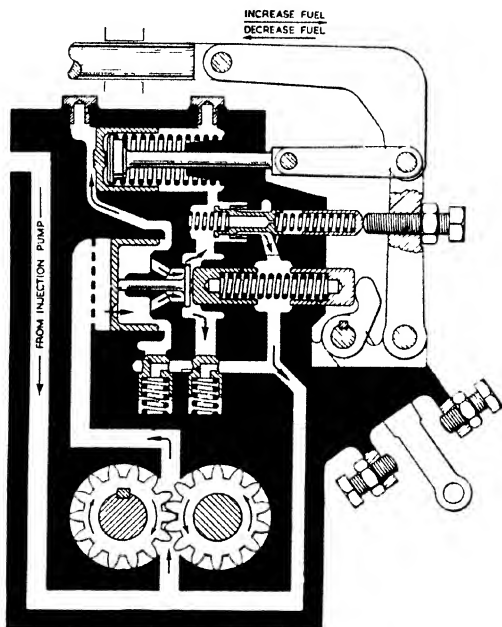

Oil circuit diagram of C.A.V. hydraulic governor

at the opposite end of the injection pump. Safety is ensured by the employment of a shut-down lever, which can be operated manually against the operation of the governor. In addition a servo spring will take the control rod back to zero if for any reason the pressure fails. The gear pump delivers oil under pressure through a diffuser to an amplifier chamber, from which it escapes through an orifice in the amplifier piston. The pressure drop through the orifice sets up an endwise thrust on the amplifier piston, depending upon the amount of fuel oil flowing, that is, upon the gear pump speed.

After passing through the amplifier piston the oil acts on a servo piston moving against a spring. This piston is coupled to the control rod which it moves towards the

THE MODERN DIESEL

“ open ” position, so increasing the pump fuel delivery. The pressure generated at this point is limited by a high-pressure relief valve. Excess of pressure causes oil to be released through this valve and back to the inlet side of the gear pump. End thrust on the amplifier piston causes it to bear against the stem of an amplifier valve, opening of which is resisted by a control spring, the load on which is varied by a lever operated through the accelerator pedal linkage. Depressing the accelerator increases the load on the amplifier valve, which therefore does not open until a higher pressure is reached. The oil which flows through the amplifier valve is led to the other side of the servo piston, where it assists the spring in opposing the “ opening pressure ” and brings the servo piston to a state of balance, depending on the difference between the “ opening pressure ” and “ closing pressure ”.

The closing pressure is limited by a low-pressure valve, which opens under excess pressure and returns fuel oil to the inlet side of the gear pump. Also in communication with the closing pressure is the idling valve, which allows fuel oil to escape to the gear pump inlet through slots in the idling valve body, which are opened or closed by a collar on the valve piston.

The governor lever is pivoted at its lower end and at its upper end is coupled through a swing link to the servo piston. The upper end also carries a drag link which is connected to the injection pump control rod. At an intermediate point the lever carries an adjusting screw against which the idling valve outer plunger bears. Thus the plunger also has a motion proportional to those of the servo piston and control rod. The screw is used to adjust the sensitivity of the governor at idling, while the arrangement of the idle valve assembly is such as to give it a high momentary rate suitable to maintain steady idling under conditions of rapid movement of the control rod, governor lever and outer plunger. For slow movements and permanent changes in position, the assembly operates to reduce the effective permanent rate of the governor, so that for any change of load or resistance at idling the resultant change in idling r.p.m. is small. Driving control is effected

FUEL-INJECTION SYSTEMS

by varying the loading on the amplifier valve; there is no mechanical connection between the accelerator and the control rod and the governor is of the torque responsive type. A point to be noted is that the hydraulic governor does not lend itself to hand starting since the initial speed of rotation must be sufficient to build up enough hydraulic pressure to move the control rod to its maximum fuel position.

Official investigations into the war-time German oil-engine industry made available in 1945-6, showed that the Robert Bosch concern also had been working on hydraulic governors, but owing to severe bomb damage and to the dispersal of their factories they had not reached finality in their design. A comment which they made to the interrogating officers was that the small pressures developed by the hydraulic pump at very low speeds made it difficult to apply sufficient power to operate the control rod with steadiness and precision for satisfactory idling at very low speed and that in consequence the minimum r.p.m. that could be held was higher than could be obtained with the mechanical or pneumatic governor.

The C.A.V. injector or nozzle is of the closed needle-valve type, the general construction of which is shown in the sectional drawing on page 71. It will be seen that the nozzle valve is held on a conical seating by a spindle and coil spring, the compression of the latter being adjustable by means of a screw and lock nut. The fuel-inlet connection is shown on the left, and the fuel is led through a drilled passage leading down to the bottom of the nozzle holder, and communicating with an annular semi-circular groove in the upper face of the nozzle. Thence a drilling in the nozzle body leads the fuel to an annular groove surrounding the tapered portion of the needle above the valve seat. The nozzle is secured in place by a cap nut, and its upper face, as well as the face of the holder against which it is tightened by the cap nut, is finely ground to ensure a fuel-tight joint. The spring compression is so adjusted that the valve is lifted from its seat when the required injection pressure is reached, and closed when it is reduced at the end of the injection period. Any slight leakage of fuel which

THE MODERN DIESEL

may accumulate above the valve passes into a chamber surrounding the spring, and, by means of a pipe connection, it is led back to the pump suction chamber or to a drain tank. Passing through the spring adjusting screw is a feeling pin which can be depressed with the finger on to the valve spindle, in order to ascertain whether the needle is operating when the engine is running.

The manner in which the fuel is sprayed depends upon the design of the combustion chamber. Thus the C.A.V. injectors are supplied with different types of nozzle, examples of which are illustrated.

The pintle type of nozzle, which is suitable for pre-combustion and air-cell engines, has an extension of the valve forming a pin or pintle which protrudes through the mouth of the nozzle body. By varying the size and shape of the pintle, a cone of spray from 4 degrees upwards can be provided according to requirements.

Certain engines, usually of the pre-combustion chamber type, require nozzles with modified spray characteristics in order that they can produce a stable performance when idling. This is obtained by the use of what is known as a delay nozzle in which, by a modification of the pintle, the rate of injection is increased towards the end of the delivery, the effect of this being briefly to lengthen the periods of injection at idling speeds without affecting combustion at higher speeds.

The single-hole nozzle has a single central orifice which is closed by the valve, and the diameter of this can be of any required size from 0.2 mm upwards. A variation of the single-hole type is known as the conical-end type. One hole only is used, but it is bored at an angle to the vertical centre line of the valve as required.

Multi-hole nozzles can have any number of holes up to seven bored through a central projection of the nozzle body. These holes are usually arranged radially in a single line with even pitch about the axis of the nozzle, the number, size and angle varying according to the needs of the engine.

Constant-stroke cam-operated injection pumps incorporating centrifugal governors, and in conjunction with which suitable sprayers are supplied, are made by Simms

FUEL-INJECTION SYSTEMS

Motor Units, Ltd., Oak Lane, London; they are used extensively on several makes of transport vehicles, particularly on buses in municipal transport services. The earliest model of this make was the Simms Uniflow pump, so called because the oil flow through the pump elements is constantly in an upward direction, avoiding the inertia effects of reversal.

The fuel first enters an annulus surrounding the barrel and passes through a drilling to an annular chamber round the plunger, a radial hole in which leads it into a vertical drilling in the plunger whence it reaches the working chamber. When the radial hole passes the upper edge of the annulus on the injection stroke the supply is cut off, the pressure in the chamber raises the discharge valve off its seat and injection commences. The cut-off point is determined by the angular position of the plunger as a helix cut in the latter is brought into coincidence with the helical edge on a recess in the barrel, whereby the fuel is spilled through the plunger helix tangentially into a spill annulus and returns to the supply tank, so that only fresh oil, unaffected by aeration, is delivered through the inlet port. By the overlapping of the edges of the helical channels in plunger and barrel, a very sudden release of pressure

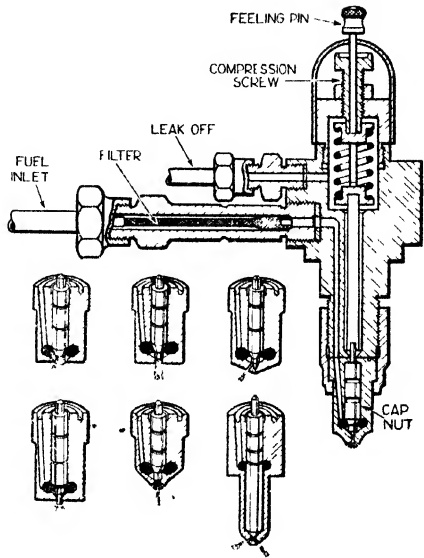

C.A.V. fuel injector and different types of nozzle

THE MODERN DIESEL

is obtained, with consequent sudden termination of the injection, preventing dribbling at the jet.

Variation of the cut-off, by hand control or governor, is accomplished by part rotation of the plunger by the usual rack-and-pinion mechanism, but individual vernier adjustment for each pump element is provided for by mounting the rack in eccentric bearings so that it can be moved out of engagement with the pinions, whilst flanges on the latter carry three steel pins which can be selectively engaged in a series of holes in the sleeve member by which the plunger is rotated. The relative angular positions of the piston and sleeve can be varied by about 1 degree.

Side loading on the plunger is effectively avoided. A needle roller bearing is used for the tappet roller, the spindle being carried in the body of the tappet, the top of which is detachable and has a slightly convex surface which bears against a large-diameter cylindrical sliding cylinder which takes the thrust from the plunger coil spring. The lower end of the plunger rests upon the bottom of the cylinder and also has a slightly convex surface. The camshaft is carried in ball bearings and has symmetrical cams

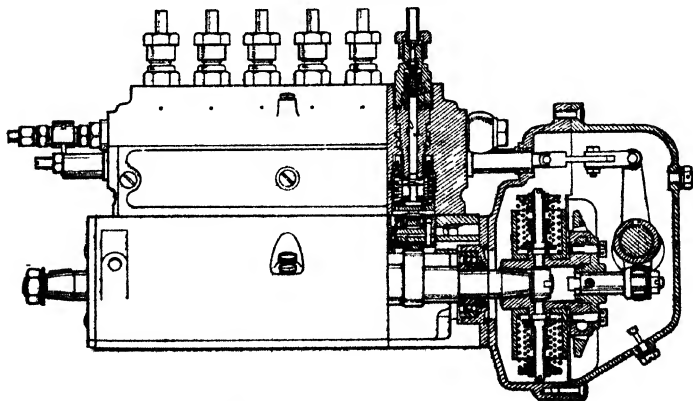

Part vertical section of the Simms Uniflow fuel pump and governor

FUEL-INJECTION SYSTEMS

so that the pump can be driven from either end. A governor is incorporated with the pump and is of similar design to that described for the C.A.V. pump. The makers have also introduced a very effective edge type of fuel filter.

An alternative and later design of Simms pump is known as the PA model. This is simpler and lighter than the Uniflow and is more accessible. The body of the pump is an

aluminium alloy die casting and it is possible to remove the upper half, containing the working elements, etc., without disturbing the camshaft, tappets or governor contained in the lower half. As before, the quantity of fuel delivered is varied by rotating the plungers in the barrels by means of rack-and-pinion mechanism. In place of the vernier means of adjustment the pinions are split and clamped by hardened steel screws, which only require to be slackened to permit individual adjustment of the pumping elements.

The plunger and barrel design has also been modified. A central hole in the top of the plunger communicates with a helical groove and in the barrel are a helical spill and inlet port and an auxiliary inlet port. When the plunger is at the bottom of its stroke, fuel enters the barrel through the inlet ports and on the up-stroke the plunger covers these ports so that injection commences. It ceases when the helical groove in the plunger meets the helical spill

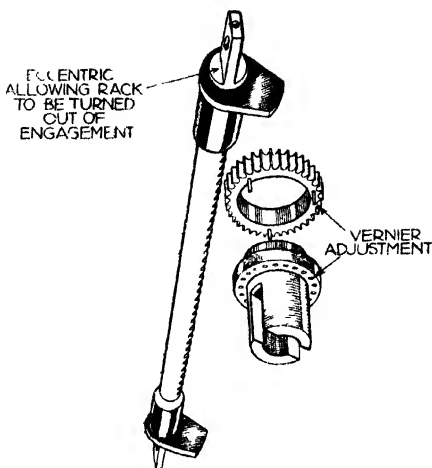

Control rack of the Simms pump can be moved out of engagement with the pinions, and vernier adjustment affords individual setting of each pump element

THE MODERN DIESEL

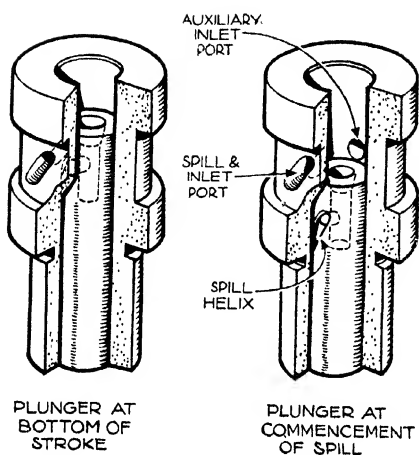

Showing the operating principle of the Simms PA model pump

port in the barrel and the spilled fuel then passes down the central hole in the plunger and out through the spill port. By rotating the plunger the quantity of fuel is varied and, as the control edges on both plunger and barrel are parallel, a very rapid pressure release is obtained. The centrifugal governor is provided on either side with safety plates so that in the event of failure of the cross pins on which the weights are pivoted, the latter are retained in place, thereby preventing damage. The fuel-inlet pipe is arranged outside the governor casing so that leakage is visible and does not dilute the governor lubricant. A detachable cover gives access to the adjusting pinions on the pump elements and tappets and provision is made for mounting a diaphragm type of fuel supply pump operated from the camshaft.

A range of Simms atomizers is also available. Special attention has been given to cooling; the needle guide is well up inside the injector body so that it is surrounded by the cylinder head water jacket, while the lower end of the needle valve and the nozzle is cooled by the fuel which passes down a clearance around the needle. The atomizer is thus working under more favourable conditions than where the needle guide is located in the nozzle itself. A further advantage is that the nozzle is automatically self-centred on a conical seat when the securing nut is tightened, ensuring perfect alignment of the needle and seat and

FUEL-INJECTION SYSTEMS

fuel tightness under all conditions. Adjustment of the spring pressure is effected by exchanging the shim at the top of the spring. The lift of the needle is similarly adjusted by varying the thickness of the washer at the bottom. Either the needle or nozzle can be replaced independently.

Another British-designed pump is the Bryce, manufactured by Bryce Fuel Injection, Ltd., Staines. It is also of the constant-stroke by-pass type. Each pump element comprises a plunger working in a fixed sleeve and control of the fuel delivery to the engine is effected by the co-operation of ports in the pump barrel and a helical groove on the plunger. The plunger is rotated by a control rod having teeth forming a rack engaging with a pinion and slotted sleeve which engages with the plunger and consequently rotates it to different relative positions as shown in the diagrams on page 77.

Fuel is supplied under gravity or by a delivery pump through suitable filters and led to the suction chamber in the pump housing around ports 1 and 2 in the barrel through which it flows when the plunger is at the lowest position. As the plunger rises it covers the ports and

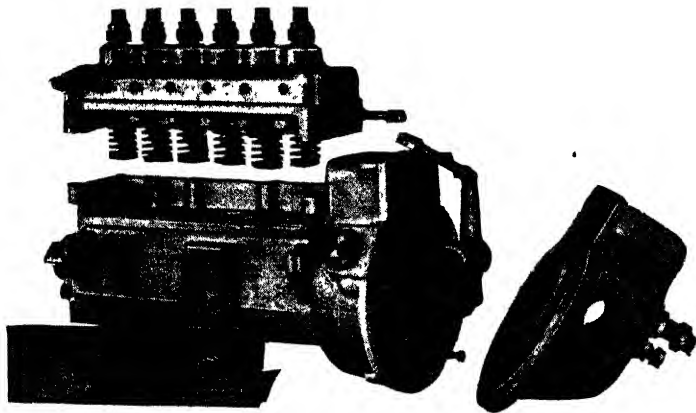

Simms PA pump partially dismantled

THE MODERN DIESEL

delivery continues until the helical groove reaches port 2, the oil escaping down the groove and through the port during further movement of the plunger.

The left hand pair of diagrams show the plunger in the angular position giving maximum output, whereas for normal delivery—that is, with the engine developing its rated horse-power—the plunger is in the position shown by the second pair of diagrams, the sequence being the same as for maximum delivery except that, owing to the different angular position of the plunger, the groove reaches port 2 earlier and delivery is reduced.

When it is required to stop the engine the plunger is rotated to the angular position shown in the right hand pair of diagrams; in this case, before the plunger has completely covered ports

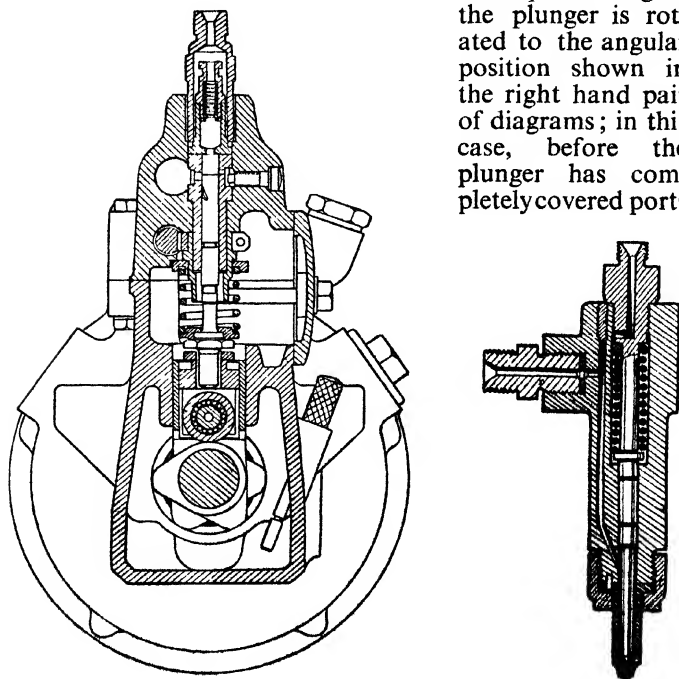

Cross-section of the Simms PA pump and (right) of the injector

FUEL-INJECTION SYSTEMS

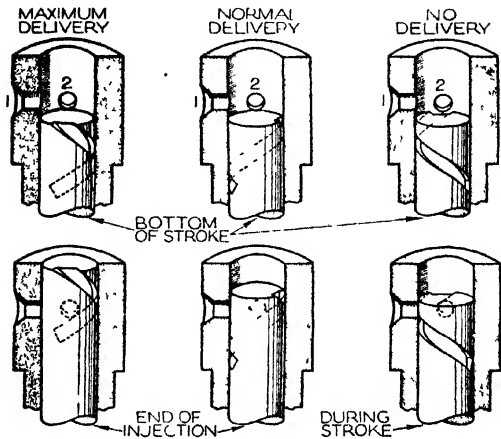

Operating cycle of the Bryce pump

1 and 2, and before it has passed port 2, it reaches port 1, the helical groove has reached port 2 and so communication is always maintained between the space above the pump plunger and the suction chamber *via* the helical groove and ports.

The delivery valve above each pump-plunger barrel incorporates important details to ensure adequate control of pressure in the delivery line at both large and small delivery quantities, having special regard to freedom of flow at maximum settings. This is effected by means of a conical-seated thimble valve with limited movement against a light spring. At small deliveries the oil passes through suitably-dimensioned holes above the seating into the interior of the valve body, thereby forcing it against its stop. When the delivery increases, the stop, which is itself positioned by a powerful spring, is in turn raised, so increasing the effective valve lift. The extra movement also allows oil to pass up flats milled on the valve body in addition to the flow through the interior.

Rapid unloading of the pressure in the delivery pipe to

THE MODERN DIESEL

the nozzle is another important function of the delivery valve and this is achieved mainly by the descent of the valve to its seat in conjunction with its carefully controlled lift. When the delivery from the pump ends the reseating of the valve results in an instantaneous fall of pressure in the pipe without any risk of leakage back into the pump as the plunger descends on its suction stroke.

Although the plunger illustrated on the previous page has but one helical groove, the plungers in the larger sizes of pump, while working on exactly the same principle, are made with two diametrically-opposite helical grooves so that they are completely balanced and there is no side thrust due to fuel pressure.

Another commendable feature of the Bryce pump is that a priming lever is provided in the tool kit which, in conjunction with fulcrum pins located opposite each tappet, enables the plungers to be raised manually in order either to prime the pipe lines or test the nozzles without rotating the engine. Where no such provision is made much damage has resulted from rough-and-ready tactics with

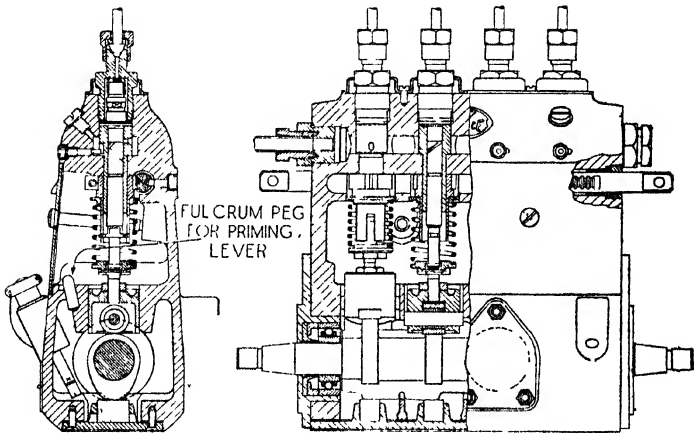

Bryce four-cylinder pump : the fulcrum peg for the hand priming lever opposite each tappet should be noted

FUEL-INJECTION SYSTEMS

screwdrivers or other chance levers.

In 1945 a new Bryce hydraulic governor was announced and it has already been used in experimental service on public-transport vehicles over considerable mileages. It is a self-contained device which can be fitted as a unit assembly to Bryce or other standardized injection pumps. Fuel oil drawn from the normal engine supply is the hydraulic medium and pressure is developed by a simple gear pump on the injection pump camshaft.

The oil pressure is directed to a hydraulic cylinder the piston of which pushes the pump-control rod towards the stopping position. A by-pass circuit has a valve controlled by the accelerator

pedal and when this valve is fully opened by maximum depression of the pedal the hydraulic pressure is released. Depending on the size of the passages pressure can only be built up by high engine speed. When the valve is closed the pressure build-up is rapid even at low speed.

In practice the hydraulic cylinder has a double-ended piston, one end being the operating member and the other acting as a balance. The operating end contains a shaped slot which uncovers a port through which oil at a variable pressure, according to engine speed and valve-port opening, acts in conjunction with a spring which also tends to move the control towards the stopping position. The advantages of this system are that its action is dead beat with variations of speed, the whole device runs in oil, the accelerator pedal

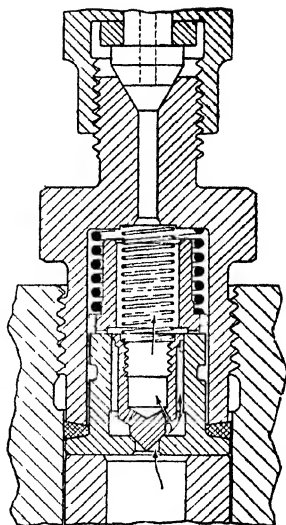

Flatted delivery valve on the Bryce pump. Flats on the side of the thimble valve provide free flow for maximum delivery

THE MODERN DIESEL

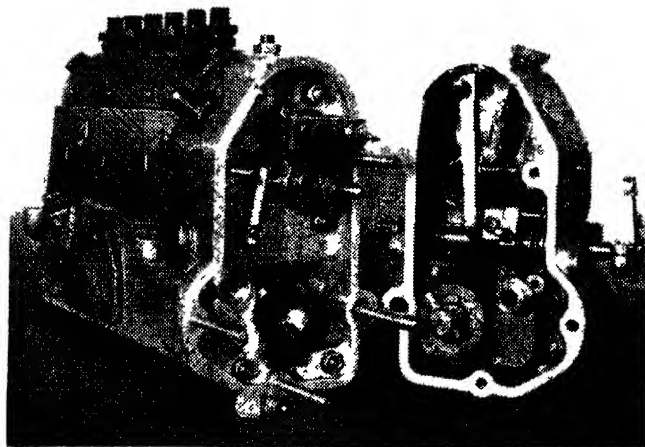

Bryce hydraulic governor for direct fitting to standard injection pump

has no heavy pressures to overcome (merely having to rotate the valve) and that the operating fluid is the same fuel oil used in the injection pump. Satisfactorily low idling speeds are obtained and there is no idle movement or lag between movement of the accelerator and governor response and therefore the engine is more lively and responsive to the driver's control.

Apart from the injection nozzles made by the various fuel-pump manufacturers, certain engine makers produce their own injectors, notably Gardner and Leyland. The direct-injection Gardner engine was a pioneer user of the multi-hole sprayer and had its own injectors when the modern high-speed type was introduced in 1929. Gardner injectors are of the four-hole non-adjustable type with remote valve seat, that is to say, the needle-valve seating is up inside the nozzle and well away from the tip, which projects into the combustion space and is subject to maximum heat. The top of the body is closed by a breech plug

FUEL-INJECTION SYSTEMS

having a guide rod which enters the hollow valve, and a spring is also carried on this rod bearing against the top of the hollow valve.

The fuel enters an annular space around the lower portion of the valve, and when the pressure exceeds that of the spring (which is usually set to give an injection pressure of about 2,000 lb/sq. in.) the valve is lifted and injection commences. The construction is very simple, and when taken apart for cleaning cannot be re-assembled incorrectly.

Venting of the delivery pipe and the testing of injectors is facilitated on Gardner engines by the provision of hand priming levers on each pump element, a feature incorporated in the Gardner camshaft and base on which the C.A.V. pump elements are mounted.

Leyland Motors, Ltd., in their earlier engines used C.A.V. injectors, but subsequently introduced an alternative of their own make. This was of very simple construction, of the single-hole type with remote valve seat. An interesting feature of this injector is that although it was of the single-hole type it was made for a direct-injection engine, thereby indicating that the use of multi-hole sprayers with direct-injection combustion chambers was not invariable in the early period of high-speed diesel history. No external adjustments were provided on the injector, the working injection pressure of about 160/170 atmospheres being determined by the needle valve spring which was pre-set between certain small limits

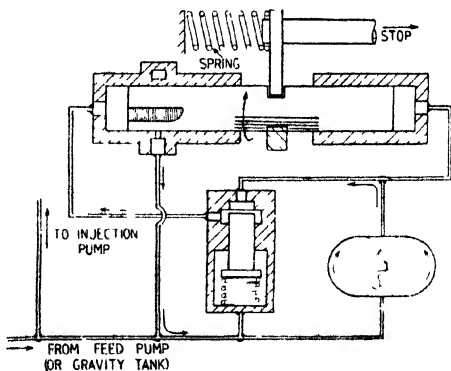

Schematic diagram of Bryce hydraulic governor

THE MODERN DIESEL

by the use of adjusting washers at its abutment against the leak-off plug at the top of the body.

Since the introduction of the post-war range of toroidal-cavity direct-injection Leyland engines a new Leyland four-hole injector is being used exclusively. This Leyland four-hole injector is of similar construction to the previous single-hole type, being non-adjustable apart from the shim-setting adjustment of the spring during assembly. A new and excellent feature is the simple and easily-cleaned edgewise filter incorporated in the fuel-pipe union.

Much the same process of evolution was apparent in the U.S.A. as in this country and in Europe. In the early period the pioneer diesel-engine makers produced their own pumps and injectors until the American Bosch Corporation came into being and made the necessary diesel apparatus available in standardized production form applicable to all

types of engine. It should be understood, however, that high-speed diesel progress was not nearly so rapid in the U.S.A. as it was here because the economic need to obtain the utmost fuel economy was not so pressing in a country in which cheap and untaxed petrol was in ample supply.

The American Bosch equipment is virtually identical with the original Robert Bosch designs in Germany and with the British C.A.V. components; minor differences occur in each, but the basic design and principles are the same. Several other pumps of the constant-stroke variable-spill control type are also made in America, the Adeco, Bendix-Scintilla, Demco, and

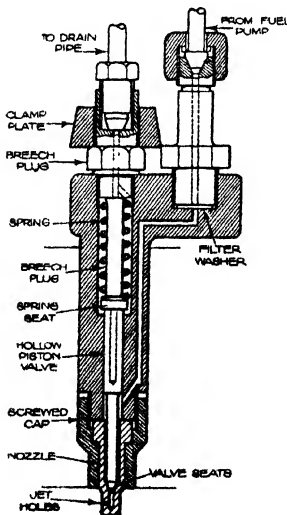

The Gardner injector

FUEL-INJECTION SYSTEMS

Timken being prominent. All have much the same outward appearance and internal construction, but the last named, made by the Timken Roller Bearing Corp., of Canton, Ohio, is unusual in that the pump elements, complete as sub-assemblies with their tappets, are individually removable from the main casing of the pump unit to facilitate servicing.

Another particularly interesting American pump is the Ex-Cell-O made by the Ex-Cell-O Corp. of Detroit; although of the constant-stroke type with variable-spill control it departs very distinctly from the standard "Bosch type" both in layout and detail because its pumping cylinders are arranged in a circle around and parallel with the central driving shaft which reciprocates the plungers through the medium of a swash-plate. Fuel is drawn from the supply tank by a reciprocating pump integral with the unit and is delivered to a reservoir space in a rotary distribution and control valve which is in communication with the inlet ports of the pump cylinders; the valve member is slidably mounted on the central shaft.

During its suction stroke each injection-pump plunger draws in a full charge of oil and ejects it on the return stroke through a delivery valve to the injector. The quantity delivered, however, is controlled by an extension

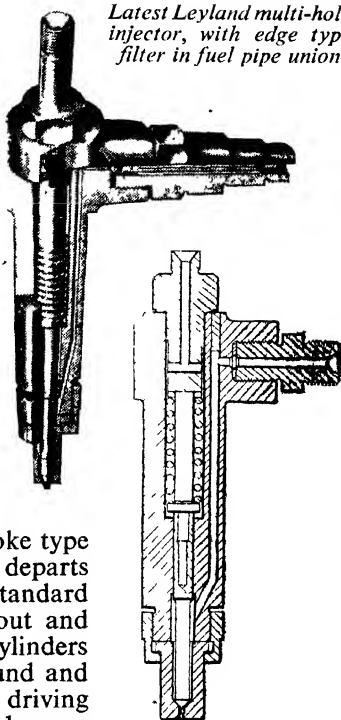

Early-type Leyland injector with single-hole nozzle

THE MODERN DIESEL

of the distribution valve on which triangular inclined "lands" are machined. By sliding the valve along the shaft the lands provide earlier or later communication with the pump ports and so correspondingly more or less of the oil is returned to the reservoir space instead of being forced through the delivery valve.

It is clear that this is a constant-stroke variable-spill device but the helical groove on the actual pump plunger of the "Bosch type" of pump is replaced by the tapered lands on the control valve. The position of the valve controls the amount of spill and governing is done through this medium, the valve being balanced between a coil spring in compression at one end and a push rod moved by a centrifugal swinging weight governor at the other. At its normal position the valve is in the full-power or maximum-delivery setting with the coil spring fully extended so that immediately the engine fires the valve is moved by the push rod from the governor toward the other extreme—to the idling or maximum spill position—giving minimum delivery to the injectors.

The accelerator control is not coupled directly to the

valve but applies pressure to the outer end of the valve-balancing spring, which thus resists more strongly the thrust of the governor push rod so that the valve is moved towards its closed position and more fuel is delivered to the injectors until the engine speed rises enough to enable the governor to overcome the increased re-

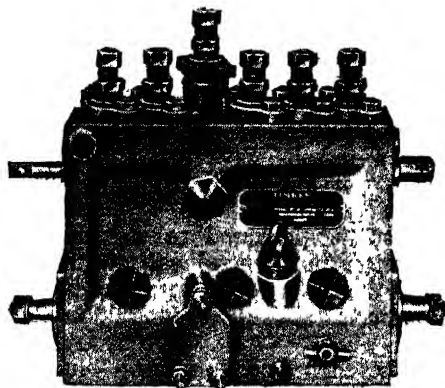

Timken six-cylinder injection pump with one detachable element partly withdrawn

FUEL-INJECTION SYSTEMS

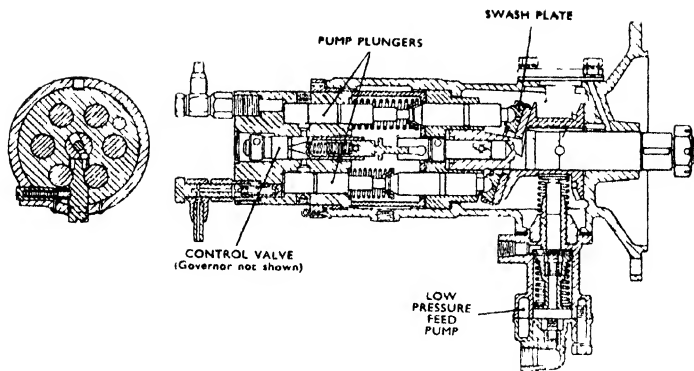

Flange-mounted Ex-Cell-O six-cylinder swash-plate injection pump

sistance of the spring. In that the accelerator increases the loading on the valve balancing spring and so delays the effective action of the centrifugal governor the system of control is exactly the same as that of the British Gardner engine (page 63) and the governor becomes a torque-responsive rather than a purely speed-responsive device.

Another form of injection equipment much used in America is the combined pump and injector in each cylinder head in place of the separate multi-element pump feeding individual injectors. The earliest of the modern diesels in the U.S.A. (the Cummins) was so equipped.

The Cummins system employs a low-pressure metering pump with a rotary distribution valve so that each injector is supplied with the correct charge, the oil being delivered into the nozzle before the compression stroke begins. The oil remains in the nozzle tip, being unable to flow through the fine spraying holes by gravity owing to their capillary effect. Discharge is effected by a plunger operated by a push rod and rocker, the oil being injected into the cylinder by the descent of the plunger to the full depth of the interior of the nozzle tip. During the compression stroke some air is forced into the nozzle so that a certain degree of aeration takes place prior to injection.

THE MODERN DIESEL

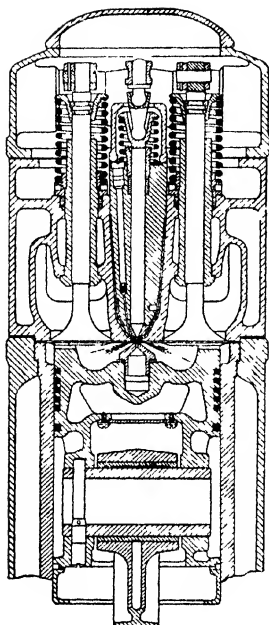

Cummins combined pump-injector

fuel oil is delivered directly from the one part to the other through drilled internal oilways and no external high-pressure piping or unions are involved; this, of course, is one of the major advantages claimed for the arrangement. On

The widely used G. M. C. two-stroke diesel also followed on similar lines but the usual constant stroke with variable-spill system is used, the pump and injector being formed in a single unit fitted into each cylinder head of the engine so that the pump plunger can be operated in the same way as the valves through a push rod and rocker from the engine camshaft. A feed pump delivers oil at low pressure to the injection pump and thereafter the process is the same as with other types of constant-stroke variable-spill equipment.

Since the injection pump is combined with the sprayer the

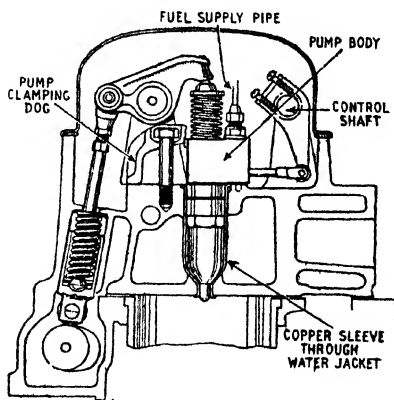

General arrangement of G.M.C. combined pump-injector and its operation from the engine camshaft

FUEL-INJECTION SYSTEMS

the other hand the control rod of each separate pump has to be coupled by external linkage to a control shaft from the governor. Thus, *phasing* of the pumps (arranging injection timing to be exactly the same for each cylinder) being a critical adjustment, is not so certainly effected when dealing with six individual pumps as with a compact multi-element pump

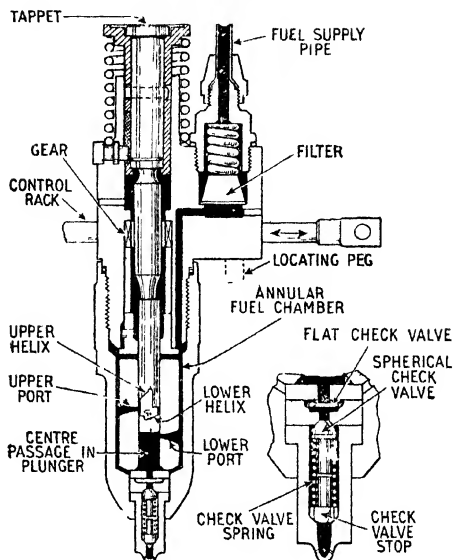

Section of G.M.C. pump-injector unit

which can be phased and calibrated at the bench on a pump test rig, after which it can be installed on the engine without risk of deranging the phasing by maladjustment of external control linkage.

Another possible objection to the combined pump and injector is that the whole unit must be removed for injector servicing, which is much more frequently required than attention to the pump. There is also the question of the desirability of having the pump subject to the heat of the cylinder-head position. It may be suggested that an objection could be raised against the mounting of the pump itself in a position where it is subject to the heat of the cylinder head, although this may be a matter that would be open to different arguments according to whether the engine be operated in hot or very cold climates.

The main factor affecting the choice of a combined pump

THE MODERN DIESEL

and injector for each cylinder as against a multi-element unit pump with separate injectors appears to be the mechanical consideration of their respective adaptability to the type of engine involved. British and other European engine makers had the Bosch multi-element unit pump available from the beginning and engine design invariably was laid out to accommodate it; competitive alternative pumps quite naturally were designed to be interchangeable with the Bosch type.

In America, the pioneer engine, the Cummins, preceded the wide availability of the unit pump in that country and the makers therefore designed a combined pump and injector assembly as integral component parts of their engine. Diesel development was rather slow in America for some years and then the G.M.C. two-stroke came into being and was soon produced in vast numbers. Once again a combined pump and injector was designed as an "own make" component incorporated in each cylinder head. The enormous production of these engines warranted the design and manufacture of special equipment in preference to the use of a proprietary article.

Thus the choice between the two main types of injection equipment appears to have been decided differently in Europe and in America as a result of the nature of the industry in the two continents rather than on any question of relative merit on technical grounds; although in this latter connection it may be observed that one of the limiting factors on valve dimensions is the amount of space taken up by even an ordinary injector. In the interests of volumetric efficiency, therefore, the more bulky combined pump-injector unit is open to objection.

Cylinder-head Design

IN the early stages of the development of the modern high-speed diesel the varieties of cylinder-head design were so numerous as to confuse the ordinary user. Each design was put forward with great claims for ease of starting, improved combustion, greater economy, smoother running, higher speed, freedom from "diesel knock", and so on. However, by 1939 design had settled down, the number of cylinder-head layouts had been reduced, and for each type the performance characteristics could be reasonably closely defined.

On the Continent the line of least resistance was followed, the aim being directed towards securing a steady and progressive burning of the fuel by a system of pre-combustion, the charge being ignited in a partially-separated chamber from which the more or less controlled expansion then passes to the working cylinder. There were very reasonable and logical grounds for pursuing this system, even though later experiment and development indicated that there was a degree of error in the basis of the reasoning.

The ante-chamber type of engine certainly has been very highly developed, and most engines employing the ante-chamber or some modification thereof are either of Continental origin or are based on Continental patents.

In the ante-chamber combustion head the piston rises to the limits of the cylinder head and the air is compressed into a chamber connected to the cylinder proper by a passage, or passages, of special form, termed the atomizer, which is in the nature of a cap through which a number of fine holes are drilled. By suitable design of the water jacketing the chamber is kept at a fairly high temperature.

Air compressed by the piston is driven into the ante-chamber, and some degree of turbulence is imparted to it in its passage through the connecting holes. Fuel is injected into the chamber, and ignition of a part of the

THE MODERN DIESEL

oil-air mixture gives rise to rapid expansion, which drives about three-quarters of the still unburnt fuel particles through the holes in the atomizer, giving a finely divided spray into the cylinder proper, where combustion continues. Modifications of the system lie chiefly in the disposition of the ante-chamber and the general shape of the cylinder head, but the main principle is the same in all engines of the true pre-combustion type.

Attractive as the ante-chamber arrangement appeared to be, it cannot be said to have been an unqualified success on small engines for transport and similar applications, where wide variations of load and speed prevail. A high compression ratio (up to 19 to 1) is called for, and almost invariably powerful electric starters and heater plugs have to be used.

In the confined space of the ante-chamber some of the fuel at any rate must come in contact with the hot walls of the atomizer, while the shape and size of the connecting holes must necessarily be planned with more regard to their primary function of atomizing than of imparting turbulence to the compressed air ; avoidance of partially burnt fuel and fuel carbonized on the hot walls may, in consequence, be difficult over a wide range of injected quantities of oil. Moreover, the volume of the ante-chamber is unswept by the incoming air, and although the products of combustion remaining after the exhaust valve closes may be drawn out during the induction stroke, they dilute the pure air in addition to imparting their heat to it before compression commences.

In popular terms, however, the combustion process in the ante-chamber engine was planned to give a more sustained push to the piston than would be the case if the burning of the charge took place in the open cylinder, for it has been estimated that in a diesel engine ignition is nearly twice as rapid as in a petrol engine. This high rate of ignition naturally gives rise to a severe blow on the piston, and the idea underlying "pre-combustion" is to minimize the resultant knock.

But it was found that the high ignition rate was not altogether unavoidable, and that more control could be

CYLINDER-HEAD DESIGN

achieved provided the fuel and compressed air could be more thoroughly mixed—that is to say, that if a more evenly distributed and homogeneous mixture of air and fuel could be achieved, the violent detonation effect could be reduced.

From the pure ante- or pre-combustion chamber, the next development was the air-cell. In this type of cylinder there is a separate chamber connected to the cylinder head by a shaped passage of venturi form, that is, with a narrow neck expanding on both sides of the constricted part. In this type of engine the rising piston compresses the air in the head and drives it into the air-cell. Usually the fuel jet is arranged to spray the oil into the communicating venturi passage. Ignition takes place, however, before the fuel completely enters the air-cell, and, as the piston descends, the air from the cell returns to the cylinder, a “blowlamp” effect being reproduced at the mouth of the venturi, still further mixing the fuel and air as the combustion continues.

The air-cell type of engine has shown good results up to a certain point, and even if it does not achieve its object of burning the fuel completely over the entire range of speed and load of which it is capable, it has certainly shown a capacity for comparatively high speeds.

Such shortcomings as it has seem to be traceable to the fact that a fairly large pocket remains unswept by the incoming air charge and a big percentage volume of the compression space is filled with hot inert gas at the commencement of compression ; thus the higher compression ratio employed has a somewhat fictitious value. The relatively large wall area with which the compressed air is in contact also accounts for an appreciable heat loss.

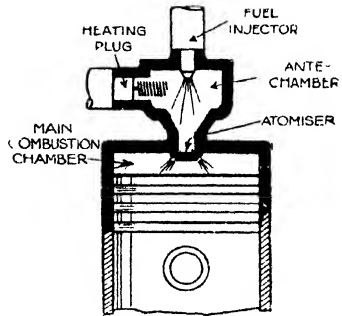

Ante-chamber or pre-combustion head

THE MODERN DIESEL

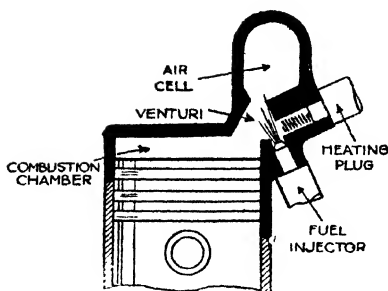

Air-cell (Acro system) cylinder head

The spraying problem in the air-cell type is also difficult. In the parent Acro system (of German origin) the spray is directed into the throat of the venturi and a very narrow angle spray is needed. Variations of the arrangement aim at passing the spray through the moving air stream at a slight

angle, but, according to the constricted shape of the venturi passage and the disposition of the water-jacketed parts of the head in the vicinity, either condensation or carbonization of the fuel may result during the delay period following ignition.

In common with the ante-chamber type, the air-cell engine requires a high compression ratio, and, often, heater plugs for starting. But, in its realization of the value of turbulence as a medium for the thorough mixture of fuel and air, it marked a distinct advance.

Several variations of the shape of the air-cell have been evolved, from the lobe to the spherical, with offset or symmetrical connecting passages and with wide conceptions of the best type of venturi, all being aimed towards the attainment of perfect combustion.

Of the type of air-cell engine in which the cell is located in the piston it is rather difficult to form any other opinion but that this was a passing phase planned chiefly with a view to avoiding costly production changes in existing types of power unit. When higher speeds are being sought it is desirable to reduce piston weight as much as possible, whereas the air-cell increases it. In addition it must be a difficult item to retain at a uniform temperature, and local hot spots are to be avoided in piston design.

Moreover, there seems no logical reason why the air-cell should not be in the cylinder, since the desired effect—

CYLINDER-HEAD DESIGN

especially when it is used merely to prolong the combustion period—should equally be attained whatever the location of the cell in the combustion space.

Reference should also be made to the Lanova air-cell combustion head developed by the German engineer Franz Lang, the originator of the Acro air-storage chamber. The Lanova system was adopted for the British Dennis and Meadows, the American Buda and German Henschel diesels and it is applicable to all types of two- and four-stroke engines and is designed to afford controlled turbulence or air flow with an exceptionally low proportion of excess air.

The combustion chamber employed takes the form of a figure 8. In line opposed and directed into the waist of the 8 are the fuel sprayer and a cone-shaped air-storage cell having a funnel-shaped opening communicating with the main chamber, and on the other side leading into a second air-cell through a passage that can be opened or closed by a plunger so that the capacity of the combustion space may be reduced, so raising the compression pressure to facilitate starting. After starting, the second air-cell can be brought into operation. Upon injection, the fuel enters the first cell and part of it also the second. In these cells it ignites, and the pressure in them immediately rises so that the burning charge is blown out into the main combustion chamber.

But as this process is throttled by the gas having to pass through the relatively small diameter apertures, the pressure rise in the main combustion space is gradual. Combustion is, moreover, considerably improved by the burning mixture of gas and fuel whirling round in the two loops of the 8, so that the air and fuel

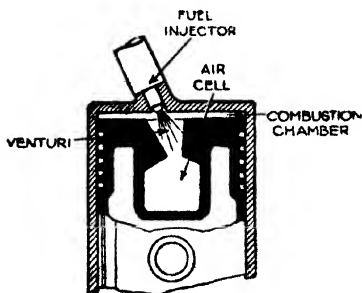

Acro air-cell piston

THE MODERN DIESEL

are intimately mixed, and tests show that 89 per cent of the complete air charge is used for combustion. The form of combustion chamber used and the location of the injection nozzle permit the use of large valves, resulting in high volumetric efficiency.

The Lanova system has found more favour in America than in Germany, its country of origin. It provides smoother performance than is associated with other German air-cell designs and permits reasonably high speeds, but the specific consumption is not particularly favourable, judged by British standards. Incidentally, the manually-operated closure of the second air-cell to raise the compression ratio for starting now appears to have been discarded, while in U.S.A. the combustion chamber has been modified as a single lobe.

Another air-cell system with controlled turbulence was the Oberhänsli, incorporating a cylinder-head design patented by the Omo A.-G., of Zurich. It was employed for the Vomag and Hansa Lloyd engines in Germany, and the Rochet Schneider in France; in this country it was used experimentally by Tangye, Ltd.

The principal feature was the special shape of combustion chamber, which was spherical and located at one side of the cylinder head with a passage communicating with the cylinder. Of thin metal, the chamber was detachable, and being surrounded by an air space took up heat quickly on starting. The combination of the chamber and communicating passage produced a condition of controlled turbulence on the compression stroke, during the greater part of which the air entered the chamber freely, producing a strong swirl into which the fuel was injected vertically downwards through a pintle-type nozzle, so that the fuel and air were intimately mixed; the combustion of the fuel occurred mainly in the chamber. Starting was assisted by an electric heating coil, inserted horizontally, but the spherical chamber very quickly reached the working temperature.

It should be recognized that pre-combustion and air-cell engines in general are not very critical as to fuel quality and this probably had much to do with their wide acceptance

CYLINDER-HEAD DESIGN

in both Europe and U.S.A., where the rigid standards of highly refined diesel oil as used in this country were not always insisted upon.

A great advance in combustion-chamber design was made in this country by H. R. Ricardo, the underlying principle being the projection of the fuel across a rapidly-rotating

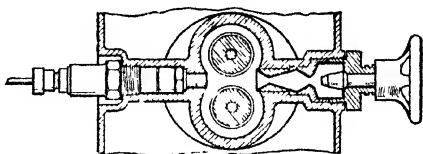
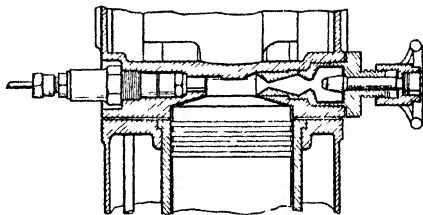

Lanova air-cell combustion head

mass of air in the combustion chamber in such a manner that the air has to find the fuel rather than the fuel the air. In the Ricardo Comet head this air rotation is produced during the compression stroke by forcing the air through a relatively large tangential passage into a partially-separated spherical air-cell into which the fuel is injected.

The Comet head gave greater flexibility and freedom from smoke than any previous air-cell design and it was adopted by many prominent British engine makers, notably A.E.C., Crossley, Dorman and Thornycroft, while overseas makers who adopted it were Berliet, Citroën and Renault in France, Fiat in Italy, Brossel in Belgium and Waukesha, in America.

A later design of Ricardo Comet head, known as the Mark III type, showed further improvement and was generally adopted by those makers who had used the previous type. The principal alteration is that two hemispherical depressions were provided in the piston crown on the same side of the cylinder as the spherical combustion chamber, which was of smaller capacity, while the injector was placed horizontally instead of being inclined at 45 degrees from the vertical as with the older head. The

THE MODERN DIESEL

tangential passage from the combustion chamber was placed so that the air-fuel mixture was directed down the sides of the depressions. With this design not only was the fuel consumption improved, but the running was smoother, especially at idling speeds, and there was a slight increase in power.

The purely British high-speed diesel movement was initiated by a direct-injection engine in 1929, and that principle has been adopted increasingly, even by the most persistent supporters of the air-cell combustion chamber. As a result, in the exacting field of road-transport work the direct-injection type is now almost universal in British heavy-transport engines. It does not follow that it is the "best", but rather that, on balance, it offers the most practical solution to many of the difficulties that have been associated with the application of diesel engines to transport vehicles. In marine, stationary and rail-car work other types are more frequently used with success.'

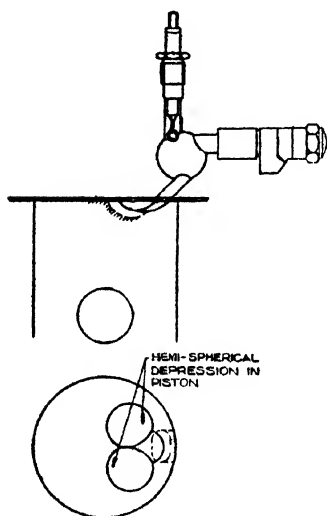

Ricardo Comet Mark III design

From what has been said of pre-combustion and air-cell designs it will have been appreciated that the requirements in the engine are (1) a high enough initial compression to produce the necessary heat for self-ignition and (2) a form of combustion chamber conducive to effective mixture of fuel and air. How are these met by the "open" cylinder?

In an "open cylinder" engine compression space can be reduced to give any desired compression ratio, and the only limiting factor is the provision of clearance between the valves and the piston top. Actually in a

CYLINDER-HEAD DESIGN

symmetrical cylinder head a compression ratio of about 12 or 13 to 1 (about 400 lb) provides sufficient heating of the air for ignition and for starting from cold. But in its simplest form this type of head does not give the turbulence desirable for the thorough mixing of the air and fuel. From the point of view of pumping in a full charge of air its efficiency is high, however, because the expulsion of the exhaust gas is practically complete and so the fresh charge of air induced is diluted very little by the remaining products of combustion from the previous cycle; it has in addition the obvious advantage of presenting the least surface area to the charge in the cylinder and therefore the heat loss to the walls of the combustion chamber is lower than in any other type.

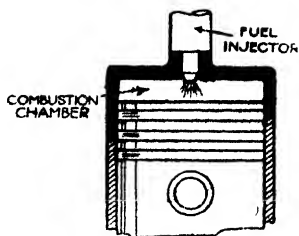

Direct-injection cylinder head

Thus we have the direct-injection engine, highly efficient from most points of view, capable of certain cold starting, but in its cruder forms liable to "roughness" and possibly to incomplete combustion, while the ante-chamber and air-cell engines are seldom true cold-starters, are somewhat less efficient, but tend to "softer" characteristics in running.

All design, however, is a matter of compromise, and the direct-injection engine has been intensively developed. By the use of suitable valve ports, by applying masking devices to the heads of the inlet valves, and by suitably designing the shape of the piston crown to displace the air violently as maximum compression is reached, a sufficient degree of turbulence can be obtained (coupled with the most suitable type and disposition of the spraying nozzle) to attain a satisfactory degree of mixture of fuel and air. This form of air displacement by means of piston crown shape is usually referred to as the "squish" effect.

It is significant that in recent marine installations and

THE MODERN DIESEL

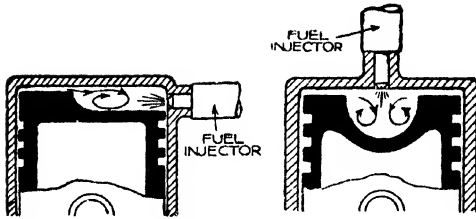

Showing use of piston crown contours to promote turbulence

on road-transport vehicles, where progress has been most rapidly and intensively made during the past few years, direct-injection engines are now accepted as the most popular type. The efficiency of the direct-injection engine needs no proof. It has been developed very rapidly by several British makers to a state of high perfection, and the practical results of the type both in road and marine operation are now acknowledged and are a credit to our engine manufacturers, for it provides not only easy starting but at least a 10 per cent improvement in thermal efficiency over other types, as well as more power, weight for weight.

Some of the most important considerations in the "open" cylinder engine are bound up with fuel injection, and the pressure of injection, the location, penetration and direction of the spray have all had to receive infinite care and attention. Atomization and turbulence, however, have reached a stage in which most satisfactory combustion is secured over a wide range, and the power-output figures for a given fuel consumption are generally better than in the case of any pre-combustion or air-cell type. Furthermore, the work on the direct-injection engine has shown perhaps more conclusively than in any other direction that the elimination of "diesel knock" is primarily a matter of proper combustion.



Masked inlet valve to direct swirl of entering air

CYLINDER-HEAD DESIGN

There is another type of direct-injection head combining the advantages of the open cylinder and the air-cell. A suitable chamber, which forms the bulk of the compression space or clearance volume, is arranged symmetrically at the top of the cylinder, and the valve heads form the side walls of this space, the valves moving horizontally. A type name for this construction now generally accepted is "clerestory head".

The clerestory chamber is connected to the cylinder by a constricted passage, and the piston top usually has a boss entering this. Air is drawn through the chamber to the cylinder and exhaust gas is discharged through it likewise, so that the scavenging of the whole cylinder space is as complete as on the open cylinder type.

Cold starting with this type of engine can be secured with compression ratios of the order of 15 or 16 to 1, and even with this ratio smooth running with minimum knock is obtained, while the speed range is excellent.

There is a danger with this type, however, of producing very high local temperatures on the piston crown, since the igniting spray impinges directly on the piston boss which is a feature of the type, and this part of the piston is not in contact with the water-cooled walls of the duct which it enters. The trouble can be overcome, however, by off-setting both the duct and the sprayer in the clerestory chamber, a layout which, in addition, gives greater turbulence

and better mixing. A further point about this type of head is that for small high-speed engines the spraying nozzle most commonly used is the pintle-type,

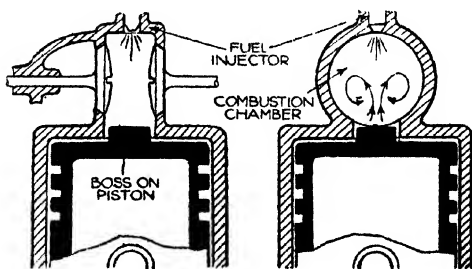

Clerestory head, showing valve arrangement, turbulence chamber and piston boss

THE MODERN DIESEL

while for the larger and slower speed engines it is often found necessary to employ a multi-hole nozzle having three or more holes drilled fan-wise in one plane.

Towards the end of 1934 the Saurer Co., of Switzerland, introduced a dual-turbulence system which was first applied in this country to the Armstrong-Saurer engines and has since been widely adopted by others. Its object was to combine the advantages (without the drawbacks) of the air-cell and direct-injection systems. By means of two masked inlet valves a horizontal rotational air movement was produced during the whole of the suction stroke. By means of a heart-section cavity in the top of the piston, a more or less radial air motion is superimposed on the tangential rotation and the combined effect of these movements is that the air moves spirally round the cavity,

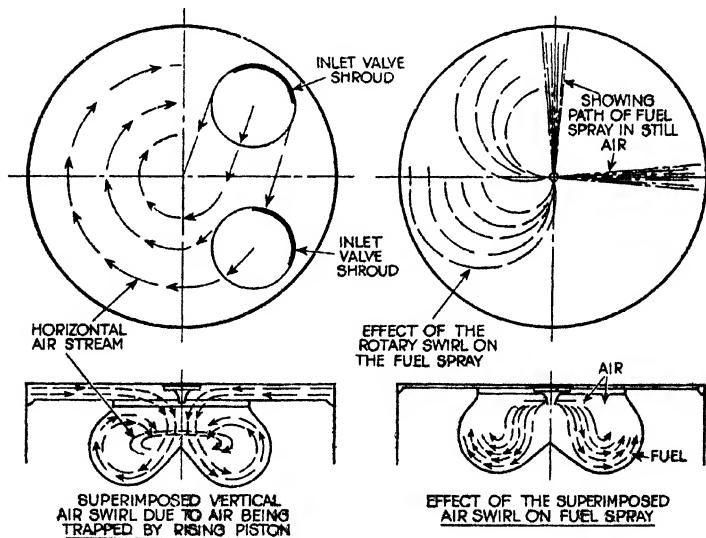

Showing how the horizontal and vertical air movements are produced in the Saurer dual-turbulence cylinder head and toroidal cavity piston, and their effect upon the fuel spray

CYLINDER-HEAD DESIGN

hence the description "toroidal". The fuel is injected into the piston cavity by a central multi-hole sprayer and is rapidly heated and oxygenated, with consequent reduction in the delay period. Engines with toroidal-cavity pistons but with two-valve as opposed to the original four-valve layout have now been adopted by the majority of makers of British transport units.

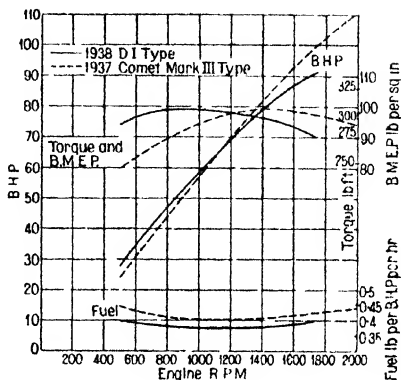

Comparison of A.E.C. air-cell and direct-injection engine performance

The characteristics of the toroidal-cavity direct-injection engine are well illustrated by the comparative performance curves of two similar A.E.C. engines, one with this type of combustion chamber and the other with the earlier Ricardo Comet Mark III air-cell combustion system. These show clearly that the air-cell engine permits of higher r.p.m. and a corresponding increase of power whereas the direct-injection engine, although limited in speed and power, shows a much better torque curve which is substantially flat over the working speed range; the consumption figure is noticeably better and it is this factor, more than any other, that has influenced the general adoption of this system.

In turn, the stress on fuel economy is the direct result of the relatively high cost of fuel in this country arising from the heavy tax which is imposed on imported hydrocarbon oils used in road vehicles.

The Aeroflow combustion system, adopted exclusively for Perkins engines, is distinguished by the fact that the oil is injected along a very high-speed air stream instead of at right angles to or wholly against it as provided for in

THE MODERN DIESEL

other systems. Thus it is claimed that the burning particles of oil and the unburned portion of the charge are retained in close contact and flame propagation is therefore accelerated. The action is strictly analogous to that which takes place in the blowpipe flame where air is injected in the same direction as that in which the gas is travelling. The same quantity of air projected across the flame would blow it out by spreading the burning particles of the gas and allowing them to cool down beyond the ignition point.

Contained in the head is a swirl chamber of "Dutch cheese" formation communicating with the cylinder through an ovoid-section passage. The injector is inserted at right angles to the passage, but the fuel issues in two jets directed towards the cylinder and swirl chamber at a very obtuse angle with one another, nearly parallel to the longitudinal centre line of the passage. On the compression stroke the contents of the cylinder are transferred to the swirl chamber, the proportions being chosen to give a very high rate of flow with consequent high turbulence in the swirl chamber. The spray orifices of the injector nozzle are of the same size, but, owing to the great difference of pressure between the two sides of the atomizer when the engine is running, the lower spray is turned round and carried by the air into the swirl chamber. The purpose of the lower spray is simply to attack the air immediately above the piston where it is hottest to ensure quick starting under all conditions.

A modified Aero-flow combustion system makes use of a three-hole sprayer and a transfer passage of a special venturi shape. At the point where the air reaches its maximum velocity two jets of fuel are directed tangentially into the air-cell, thus increasing the turbulence and accelerating the combustion process. The third and lower spray is, as before, injected downwards towards the rising piston. The object of these modifications is to reduce ignition lag and improve fuel consumption. One great advantage is that penetration of the spray is scarcely relied upon at all, and therefore the sprayer holes can be relatively large. The air, travelling in the swirl chamber, carries the particles of oil with it, ensuring complete combustion.

CYLINDER-HEAD DESIGN

Though the advantages of forced induction, or supercharging, to adopt the more popular term, as a means of increasing the quantity of air in diesel-engine cylinders in order to obtain more efficient combustion of the fuel are commonly known, relatively little progress in this direction has been made in the case of small four-stroke high-speed engines. Pressure charging has, however, been successfully employed for heavier stationary, marine and railway-traction engines, materially increasing the output of these units. The induction air is supplied under pressure by means of a blower, in some cases rotated by an exhaust gas-driven turbine. More recently very promising results have been obtained with blower scavenging applied to small two-stroke engines.

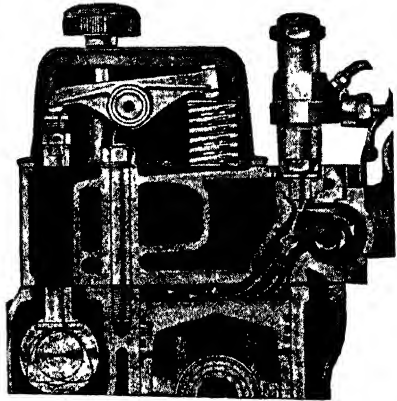

Perkins Aeroflow combustion head

With the normal unsupercharged engine it should be pointed out that the air drawn in during the suction stroke is at a lower pressure than atmospheric, as the volumetric efficiency is never 100 per cent and tends to decrease with an increase of speed. It is obvious, therefore, that not only can this deficiency be eliminated, but a greater quantity of air at a higher pressure than atmospheric can be supplied to the cylinders by means of a blower. Experiments carried out in the early 1930s with a Leyland road vehicle diesel engine with a supercharging pressure of 5-6 lb, showed that the power output was increased from 55 to 75 b.h.p. at 1,000 r.p.m.; from 80 to 110 b.h.p. at 1,500 r.p.m.; and from 95 to 125 b.h.p. at 2,000 r.p.m. The fuel consumption averaged under 0.4 pint per

THE MODERN DIESEL

b.h.p./hour and the torque curve was nearly flat. The blower ran at twice engine speed.

Other advantages of forced induction which the experiments revealed were smoother operation, better slow running and idling, and reduction in the delay period. It was estimated that on a power for power basis the overall cost of a diesel engine could be reduced by 15 per cent by supercharging, whilst the power-weight ratio might be improved by 22 per cent.

In 1938 several A.E.C. double-decker diesel-engined buses were put into service by the Halifax (Yorks) Passenger Transport Department. The conditions are particularly arduous owing to the long and severe gradients of the Pennines. Even with the largest engines available buses were underpowered when fully laden; they could not maintain good schedules owing to the frequency of stops on long adverse gradients.

Experimentally, therefore, a Centric supercharger was fitted to one bus, the results obtained being such that several other conversions were made and have been running ever since. The object was not to increase maximum performance, but "to flatten out the hills" and this object was achieved with a 6 lb air pressure. On the test bench it was found that the output of the 130 b.h.p. A.E.C. engine was increased to 175 b.h.p., while running was actually smoother and acceleration better.

Speeds of 27 m.p.h. were maintained on long climbs of 1 in 18, while, after stops to pick up passengers on gradients steep enough to preclude a return to top gear after restarting (in the unsupercharged form), the drivers could run through the gears and rapidly regain a satisfactory top gear speed. Fuel consumption of 7.3 m.p.g. was obtained, a figure since improved upon, and sufficient data was accumulated to suggest that this municipal undertaking was ahead of diesel-vehicle manufacturers. During the war years other of the Halifax fleet were supercharged but Roots-type blowers were fitted, the vane type not being obtainable.

Superchargers are a form of air blower or compressor, and may take a variety of forms. The vane type, such as the Powerplus and Centric, are true compressors, having a

CYLINDER-HEAD DESIGN

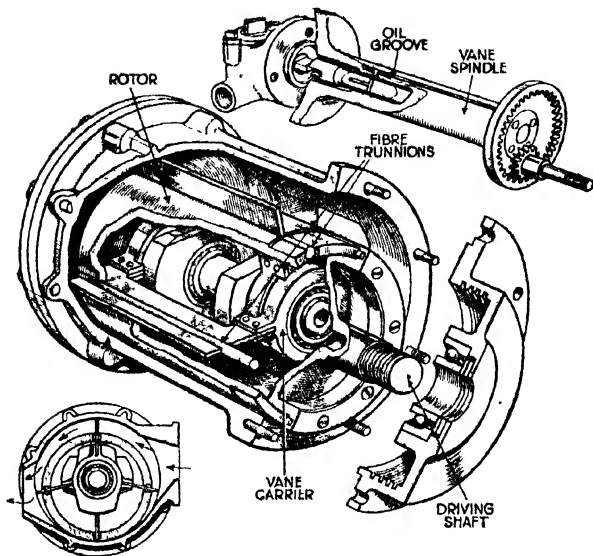

In the Centric supercharger the vanes are pivoted on the axis of the bore ; they pass through oscillating slotted guides in the eccentric rotor

series of rotating vanes driven by an eccentric rotor inside a cylindrical chamber. Features of the best vane type of supercharger are that they are efficient at quite low r.p.m. and that they need not operate at higher than engine speed. On the other hand the centrifugal blower—basically a fan or bladed disc running with considerable clearance in a casing—must run at very high speeds. Superchargers of this type are effective only at maximum r.p.m. and power output.

Between the displacement vane type and the fan-like impellor is the Roots pattern, in which two rotors of "dumb-bell" form set at 90 degrees to each other revolve in opposite directions. The action is really that of a gear pump and it combines to some degree both the impelling

THE MODERN DIESEL

and compressing functions of the other types and it can be very efficient, although the efficiency depends largely on the accuracy of the fitting of the rotors and upon the meshing of the driving pinions.

A modification of the basic Roots two-lobe arrangement is the three-lobe rotor; a further modification is the skewing of the three lobes in the manner of a helical gear, an arrangement used in the supercharger fitted to the American G.M.C. two-stroke diesels (*see* page 111).

Apart from mechanically-operated blowers there is the exhaust-turbo system which has been developed mainly in Switzerland by Sulzer and Brown-Boveri. The supercharging element is a high-speed centrifugal impellor driven by a turbine operated by the exhaust gas. Road- and rail-vehicle Saurer engines have been extensively used with turbo-blower equipment.

On road vehicles, however, power requirements vary widely in relation to engine revolutions and the positive-displacement blowers, which are more efficient at low speeds, are therefore more generally favoured. The effect of this latter type on engine performance throughout the entire speed range is well illustrated in the performance curves of the latest Crossley supercharged bus engines which are being supplied to the Netherlands Railways. Marshall (Roots-type) blowers are fitted, running at 1.7 times engine speed, and the power is increased by almost 50 per cent. These are the first British four-stroke engined buses with standardized supercharging.

It will be realized that engines of from 5 to 10 litres capacity may involve the transmission of 20 to 30 b.h.p. in the blower drive. The application of superchargers to existing engines presents installation problems for which the most ready solution is the use of V belt drive, but the power to be handled is somewhat considerable in relation to the space available and the short centres. In the accompanying photograph of the Crossley engine double V belts are shown but later experience indicated the need for an additional belt, making a somewhat bulky triple drive. Where an engine is originally designed as a blown unit a mechanical drive would naturally be incorporated and a

CYLINDER-HEAD DESIGN

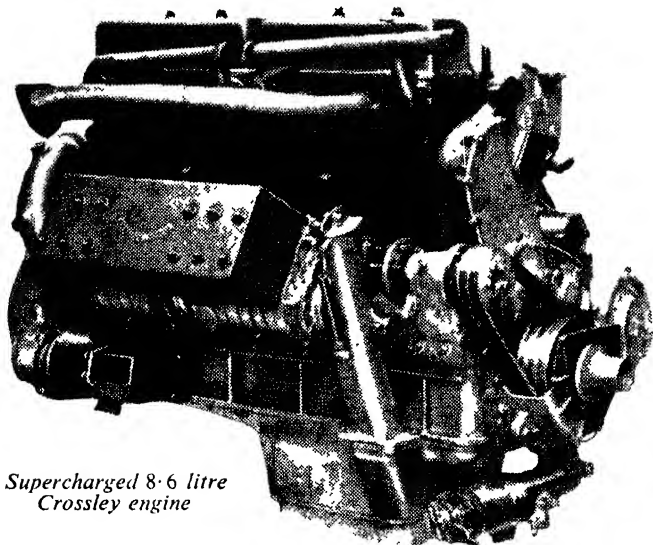

*Supercharged 8.6 litre
Crossley engine*

good example of this is to be seen in the Foden. Another item requiring special attention on blown engines is the fitting of an adequate air filter, not only to prevent serious damage from grit particles entering the mechanism but also to silence efficiently any irritating noise emanating from the supercharger.

The principal difficulty experienced by designers of two-stroke diesel engines has always been to ensure that after each power stroke all the burnt

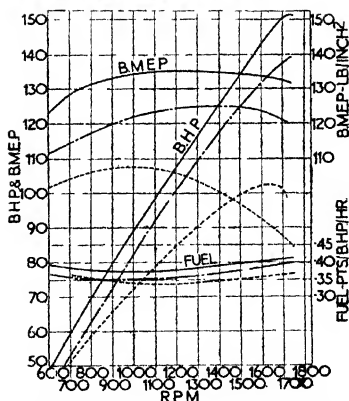

Performance curves of Crossley supercharged engine. (Solid line) maximum output; (chain dot) normal setting for 91 per cent load factor, and (dotted) without supercharger

THE MODERN DIESEL

gases are evacuated from the cylinders so that the latter can be completely recharged with fresh air during the compression stroke. It is, in fact, the efficiency with which the cylinders are scavenged that to an important extent determines the thermal efficiency of the engine.

Crankcase compression can be employed for scavenging and charging slow-speed two-stroke diesels, but an air pump or blower must be used for high-speed units. Reference may be made to the fact that by suitable arrangement of the exhaust and inlet characteristics of the engine, the fresh air charge, instead of being pumped into the cylinder, can be drawn in, due to a depression created by the outward movement of the exhaust gases. This phenomenon was applied in the Kadenacy system, which was based upon the opening of an inlet orifice when the rapidly outflowing exhaust column had formed a negative pressure wave which exerted a suction at the inlet orifice. By these means the entry of a fresh charge by atmospheric pressure was claimed and the return of the burnt gases was prevented by the action of the fresh charge in following the exhaust gases. It is significant that no engine on this system has gone into production other than those equipped with a mechanical supercharger, which implies that the "Kadenacy effect" is not alone capable of providing complete scavenging throughout the operating range of the engine although obviously it must lessen the work of the blower. The new Foden two-stroke transport engine is the most recent and complete example of utilization of the Kadenacy principle.

The cycle of operations is as follows: On its upward stroke the piston compresses the air. Fuel is injected tangentially in a cone-shaped spray by an inclined single-hole atomizer. There are two exhaust valves in the head and scavenging air is supplied by an external blower through ports which are tangentially arranged round the cylinder and are uncovered by the piston before it reaches bottom dead centre. As the piston nears the end of its downward stroke the exhaust valves are opened in such a timed relation to the uncovering of the inlet ports that the air flow is induced, assisted by the blower, and it passes

CYLINDER-HEAD DESIGN

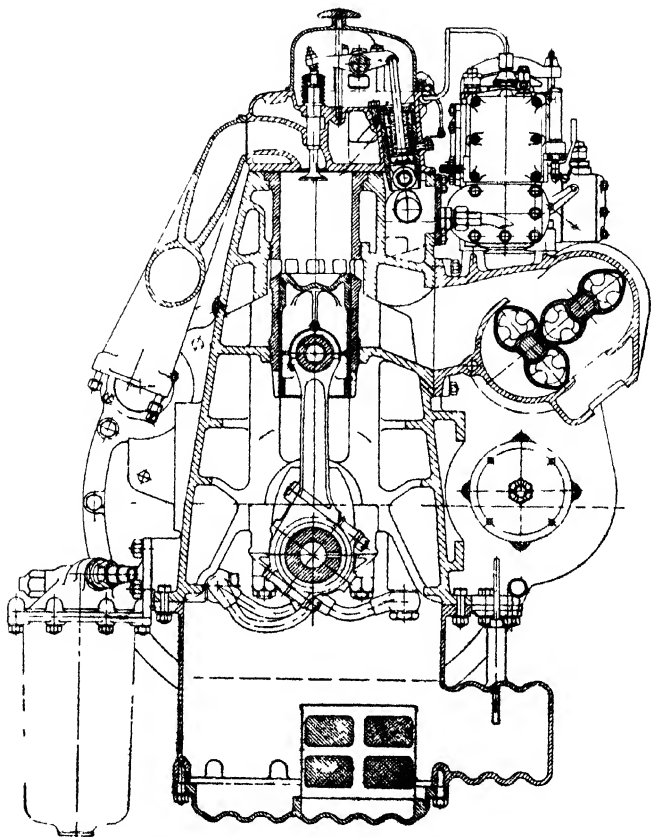

End section of the Foden two-stroke diesel engine

upwards, scavenging the cylinder and leaving a clean air charge therein when the exhaust valves close.

The air flow is thus unidirectional so that the burnt gases are completely expelled and, as the exhaust valves close slightly before the scavenge ports, the cylinder is fully recharged with clean air for the next stroke. The piston

THE MODERN DIESEL

continues to ascend on the compression stroke, and the cycle of operations is repeated. Due to the tangential arrangement of the scavenge ports the air stream is given a definite swirl, promoting turbulence which is augmented by piston "squish" into a shallow toroidal cavity in its crown.

A very similar arrangement, particularly in regard to unidirectional air flow, is followed in the two-stroke diesel engine built in America by the General Motors Corporation. Each cylinder has two vertical overhead exhaust valves operated through rocker gear and short push-rods

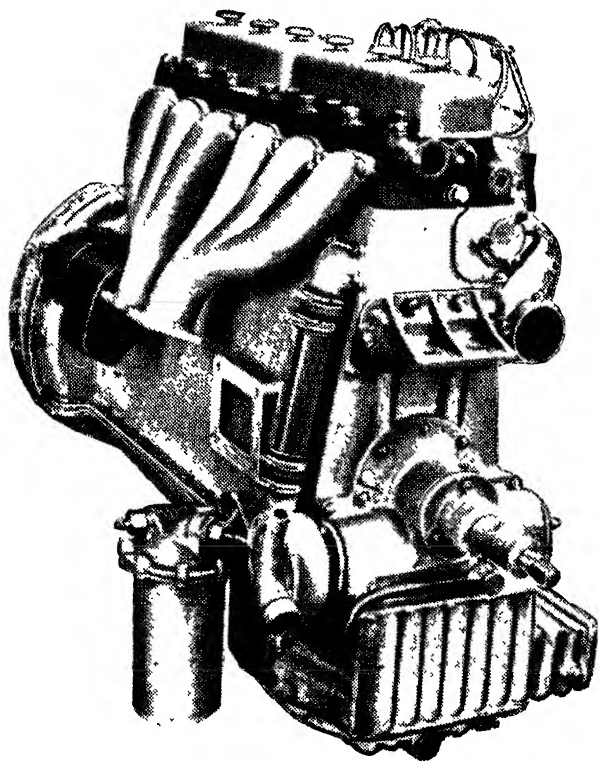

Off side of Foden engine, showing the exhaust manifold

CYLINDER-HEAD DESIGN

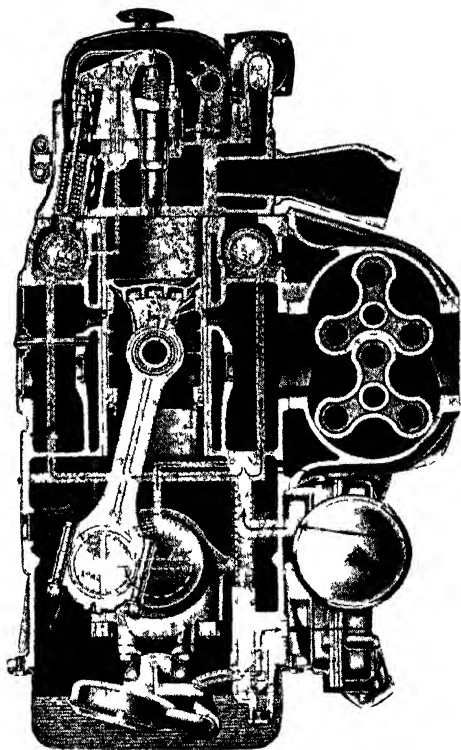

Arrangement of the blower on the G M C engine

from a camshaft high in the cylinder block. The multi-hole injection nozzle is placed centrally in the cylinder head and the combustion space, at maximum compression, is almost entirely in the piston crown, which is also of the shallow toroidal type. Air enters the cylinder through ports in the walls which are uncovered by the piston at the bottom of the stroke, and it is pressure fed by a Roots blower (with three-lobe skew rotors) which is mounted on the side of the cylinder block.

Diesel Fuel and Lubricants

LIKE many new developments, the high-speed c.i. engine had to withstand the effect of a number of exaggerated claims, and not the least of these being that vehicles or aircraft would be able to run on any kind of oil, even the waste oil from other machinery.

That the engine *will* run on such fuel is a fact, but that such running is not advisable is another matter, for actually the small high-speed diesel engine is distinctly more critical of its fuel than is the petrol engine.

Oil fuels for high-speed c.i. engines are produced from the crude oil from which motor spirit is distilled. Those mainly in use are gas oils, distilled from the crude or kerosene fractions, rather than residual oils obtained by removing the lighter fractions by distillation. There is a considerable demand for gas oil for the enrichment of gas, manufacture of petrol by cracking processes and for domestic heating, and the quantity obtainable from crude oil is necessarily limited, and as the number of high-speed oil engines in use increases, it is more than probable that the price of gas oil fuel will tend to rise.

Diesel oil is necessarily a refined oil, and at normal temperatures is quite fluid and translucent—in appearance it closely resembles kerosene with a slight trace of lubricating oil. Such specifically prepared fuels have contributed in no small measure to the progress of the modern diesel, particularly in this country, where the wide use of the direct-injection engine has required the provision of the highest grade of fuel oil.

In this connection a possible obstacle to diesel progress may one day present itself. Fuel for high-speed diesels is not residual oil in the sense that it is a somewhat unwanted by-product of petroleum distillation. It is a definite and particular "cut" and the quantity obtainable per ton of crude is limited. Recent developments in petroleum

technology have made it possible to extract more and more petrol by methods of breaking down the chemical structure of the heavier components and re-forming them; thus petrol yield still further reduces the amount of diesel oil. This is not to suggest that in time there may be no diesel oil but rather to make it clear that its price must always be tied with the price of petrol and that it may even become the more expensive fuel. Those who still think that the high-speed diesel has scope because it uses a "cheap" fuel may well ponder the remark common in oil circles that "it all comes out of the same barrel!"

For high-speed diesel-engine fuel the most important quality is its spontaneous-ignition temperature, which should be as low as possible; oils of paraffinic base are best, and those obtained from aromatic crudes are the least satisfactory in this respect. The spontaneous-ignition temperature of oil derived from coal is in every case higher than that of the most unsatisfactory petroleum oils.

Very little information within the scope of the non-technical user is available even today on the matter of the ignition rating of diesel oils. The ordinary user of petrol may talk quite glibly of "octane rating" at least knowing that a petrol of about 68 octane is usable in the average motor car even though it may be a little prone to pinking. He also knows that 80 octane can be regarded as an anti-knock spirit equivalent to a fifty-fifty mixture of petrol and benzol. Furthermore, it is common knowledge that exceedingly small additions of tetra ethyl lead to comparatively low-grade petrol will produce the same anti-knock rating.

Diesel oil seems much more complicated and mysterious, for whereas from petrol it is desirable to eliminate all its self-ignition (or knocking) propensities, it might be said that in using diesel oil it is necessary "to run on its knock"—in other words, the self-ignition quality is a vital requirement.

Here it might be thought that an otherwise suitable oil but one with a low ignition quality could be "doped" as is done with petrol for anti-knock. But this is not the case. Lead added to petrol acts as a catalyst to prevent certain

THE MODERN DIESEL

phenomena occurring but does not itself take any part in the combustion. Additives to fuel oil to increase rapidity of ignition are necessarily detonants themselves and no really satisfactory material has been found. The ignition quality appears to be entirely a matter of selection of the most suitable crude oil and then refining it correctly. Chemically stable fuels have a lower ignition quality than those that crack readily; thus oils of paraffinic base are best while those from aromatic crudes are least satisfactory.

Oils from coal, since they generally fall within the latter class, have not been a great success for diesel engines, although from time to time claims have been made, particularly with regard to oils derived from low-temperature distillation, which have been confirmed only by immediate results and not by long-term usage. Diesel oils are produced from the distillation of Scottish shale and are quite satisfactory, but the quantity available has never been other than negligible in relation to our total oil requirements.

Ignition quality is now indicated by the "cetane number" of the fuel and for high-speed engines this must be about 50. Assessment of the figure is difficult and involves the use of a special test engine and laboratory apparatus. It is notable that the British Standard Specification for diesel fuel which was published in 1937 did not include a cetane figure but a revised specification published in 1947 incorporated the rating, an accepted standard method of test having been established in the interim. The B.S. Specification is for diesel oils suitable for modern high-speed engines running under average British temperature conditions.

Apart from chemical suitability, physical cleanliness of diesel fuel oil for high-speed engines is of paramount importance, bearing in mind that the injection equipment is precision mechanism built to 0.0001 in working clearances. Usually there are both coarse strainers and one or more fine filters in the line between tank and engine. Provision is also made for raising the fuel to a reasonably high temperature before it reaches the injection pump by placing the main filter (or the final filter of a series) on or

DIESEL FUEL AND LUBRICANTS

1947 B.S. SPECIFICATION FOR HIGH-SPEED DIESEL FUEL

Cetane	Min. 45
Viscosity (100° F)	Max. 7.5 centistokes
Carbon (Conradson)	Max. 0.1 per cent
Distillation-Vol to 350° C	Min. 85 per cent
Flash point (closed)	Min. 150° F
Gross calorific value	Min. 19,000 B.Th.U./lb
Water	Max. 0.1 per cent
Ash	Max. 0.01 per cent
Sediment	Max. 0.01 per cent
Sulphur	Max. 1.5 per cent
Acidity	Nil
Corrosion (copper, at 212° F)	Negative

near the cylinder block so that it is heated to water-jacket temperature or thereabouts; this ensures that the fuel is of the correct viscosity when it enters the injection pump cylinder.

In the early days there was a tendency for wax to separate out of the fuel and choke the very fine fabric filter if it became too cold. However, highly-refined fuel oils were soon produced that remained fluid and unaltered under any conditions normally experienced in this country. For extremely low temperatures special grades of fuel oil are prepared.

In the search for alternatives to mineral-oil fuels for high-speed diesel engines, the possibilities of vegetable oils should not be overlooked. Tests carried out in this country and abroad have shown that satisfactory performance is obtainable with engines running on various vegetable oils, such as palm oil, cotton-seed oil, ground-nut oil and soya-bean oil, although careful filtering and preheating to reduce their viscosity were usually found necessary, and a loss of engine efficiency up to about 15 per cent was experienced. Further investigations must be carried out in order to ascertain whether the continued use of vegetable oils has a corrosive effect on engine parts and injection equipment and any harmful influence on lubricating oils.

THE MODERN DIESEL

During the war (1942) R. H. Seddon, on behalf of the Nigerian government, carried out work on a Seddon Diesel lorry which was equipped to operate on vegetable oils. A special filtering and liquefying tank was fitted to deal with semi-solids such as palm oil. The standard Perkins P6 engine ran satisfactorily on ground-nut, cotton-seed and palm oils, power and m.p.g. being very little below normal.

Closely allied with diesel fuel is the matter of lubrication. Since fuel oil is non-volatile any that is unconsumed by combustion in the cylinder may either become carbon deposit or find its way past the piston rings into the sump. Dilution of the oil was occasionally a troublesome fault with certain of the early engines although it was not generally a serious factor in regard to operation providing that the lubricating oil was changed fairly frequently. Of some of the early experimental engines, indeed, it was woefully said that they used as much lubricating oil as they did fuel, and although this was an exaggeration it exactly expressed the feelings of some of the pioneer operators.

Far more serious, however, was the excessive amount of carbon deposit in the head and on the piston tops, also the contamination of the sump oil by sludge and a new phenomenon, "varnish," which was a hard, polished brown deposit on the piston walls. Sticking of the top piston rings was also rather prevalent. These troubles were usually traced to excess fuel which was incompletely burned or to chemical decomposition of the lubricating oil at the high temperatures involved. Faulty injectors, if not changed at once, were (and are) a common cause of piston-ring sticking due to serious accumulation of carbon deposit in the ring grooves.

Another cause of the trouble arises from the mistaken notion that more power is to be obtained by increasing the amount of injection; this is only true up to a point. The amount of air taken in to the cylinder is the determining factor and the amount of fuel that can be injected for optimum power is the amount that can be burned in that particular volume of air, no more and no less. Thus any trace of black smoke in the exhaust under full-power maximum r.p.m. conditions indicates that excess fuel is

DIESEL FUEL AND LUBRICANTS

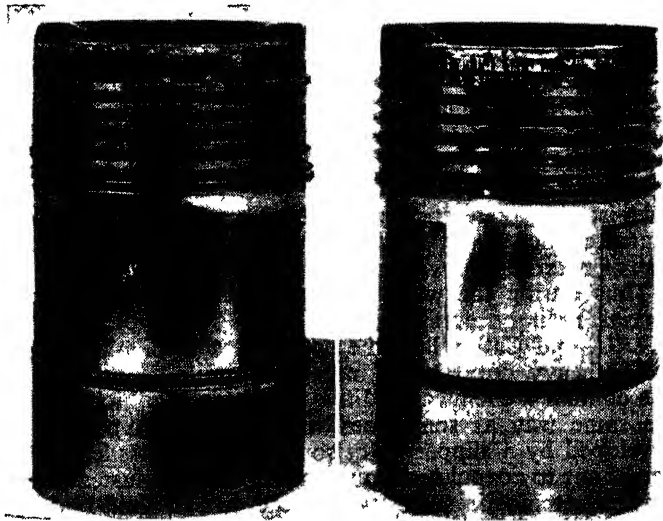

Piston from Caterpillar diesel after 375 hours run on straight mineral oil and after 2,000 hours on H D oil

being injected and that carbon deposit is being formed and sump oil is probably being contaminated.

In British engines the demand for the highest thermal efficiency (lowest fuel consumption) has produced exceptionally good combustion conditions so that dilution, carbon deposit and sludging do not present abnormally serious difficulties in a properly-adjusted unit. Fairly frequent oil changes and the use of high-quality oils are sufficient to maintain the engine in good condition and to keep lubrication costs within acceptable limits. Moreover, in the case of large fleets it is the usual practice to clean the drained-off oil by passing it through a centrifugal filter, the reclaimed oil being used for all intermediate topping-up or for mixture with an equal amount of new oil.

American engines presented the same problems but in a more acute form. The air-cell combustion chambers

THE MODERN DIESEL

favoured in the U.S.A. and the high-speed two-strokes, together with the efforts made to obtain speed and power comparable with petrol engines, have led to the American operator tolerating lower thermal efficiency with a consequent drop in fuel economy of about 25 per cent below the British standard. Sticking piston rings, contamination and sludging are therefore considerable troubles and the American diesel engineer handed his problem to the oil chemist in preference to improving the combustion characteristics of his engine and reducing r.p.m. with some loss of maximum power output.

Thus during the war, when a great deal of American special military equipment had diesel engines, notably G.M.C. and Caterpillar, the new detergent oils known as H.D. (heavy duty) came into great prominence. These oils contain a chemical additive or detergent which acts in the same way as soap does with dirt; each particle is enveloped by a slippery film so that it cannot stick to its neighbour to coagulate into a mass of sludge—instead each particle remains in suspension in the general fluid body of oil. In this way the accumulation of carbon behind the piston rings, on piston skirts, on the crankcase parts and on filters is prevented; the oil soon turns black but it does not lose its lubricating properties.

Detergent oils have been found to be a complete cure for sticking piston rings in engines previously prone to the trouble and remarkable improvement in freedom from sludge has been observed. Of course, H.D. oils are more expensive and have to be changed rather frequently.

Experiments with detergent oils in British engines indicate a decided advantage in internal cleanliness but the question is still open; this is largely a matter of off-setting their increased cost against the possible saving arising from an extension of the present mileage overhaul intervals. Another factor concerning British engines is that the fitting of a full-flow external oil filter has long been standard practice, while American diesels usually relied solely on the common type of coarse gauze strainer in the sump which, while adequate for petrol engines, will not cope effectively with the conditions in diesels.

DIESEL FUEL AND LUBRICANTS

Filtration is a special problem in connection with additive treated H.D. oils. It has been suggested, although not conclusively proved, that certain fine filters fitted to the engine, notably the by-pass type with chemically treated element, not only remove carbon particles but also remove the detergent additive itself. A. T. Wilford, Chief Chemist of London Transport, showed diagrams in a Paper read to the Institution of Mechanical Engineers (1947) indicating that he had found a rather high rate of additive depletion. Similarly those municipal bus undertakings which utilize oil reclamation schemes on a large scale have found that centrifugal filtration has removed the special qualities of H.D. oil along with foreign matter and transformed it back into "ordinary oil". Still another problem is that of incompatibility, whereby the detergent oil of one blender will not mix satisfactorily with oil from another source. With these difficulties in mind the British transport engineer remains somewhat averse to committing himself to the exclusive use of H.D. oils.

A recent development in connection with diesel fuel oil which is also closely allied with H.D. oils, has reference to the increased sulphur content peculiar to fuels derived from Middle East crudes. As a result of the world economic situation since 1946, increasing use has been made of crude oil from the Middle East and the sulphur content is appreciably greater than that associated with American crudes. It has not been found possible to reduce the sulphur content during normal refining processes and the world demand for oil is too pressing to await the erection of new large-scale refinery plant. Sulphur content of 1.5 per cent or over results in undue cylinder bore wear. Remedial measures suggested by Broeze and Wilson (I.Mech.E., March, 1949), technicians of the Shell organization, are: (1) rapid warm-up of engine coolant or preferably pre-heating, (2) complete avoidance of direct "once through" sea-water cooling systems as used on some marine engines, (3) protection of cylinder walls from hottest gases by containing combustion in piston or other cavity, (4) protection of cylinder bores by chromium plating, and (5) use of suitable chemical additives in lubricating oil to neutralize corrosive acids.

Road Transport

AT the risk of appearing to profess the obvious, it may be repeated that the rapid progress of the high-speed diesel is entirely due to the interest of the heavy-vehicle section of the British automobile industry. In 1930 heavy and onerous taxation was imposed upon goods and passenger road-transport vehicles in this country, with the result that everything which offered a reduction in operating costs was eagerly examined. In particular a substantial reduction in fuel consumption was of special consequence to heavy-vehicle operators since double-decker buses and heavy lorries only ran five to seven miles per gallon of petrol. The diesel engine offered from nine to twelve miles and there was the extra advantage at the time that fuel oil was not subject to the considerable tax on petrol. Such economy seemed too good to be true. That is the only expression that is descriptive of the state of mind of that period.

Of course, a tax equivalent to the petrol tax was very soon applied to fuel oil used for the propulsion of motor vehicles and although this brought the actual consumption cost into true perspective the economy in used gallonage was still very real and was sufficient to justify continued interest in the diesel. Unquestionably its fuel economy has been the reason for the diesel's replacement of the petrol engine almost completely in the British heavy vehicle, even in spite of certain not very pleasant characteristics in its performance which are inherent to it as a type.

Certain factors had to be accommodated when oil engines were first applied extensively to road vehicles. The diesel engine operates at rather lower crankshaft speed than a corresponding petrol engine so that, size for size, power tends to be rather less. On the other hand torque or "pulling power" is much better at low or moderate speeds and is more evenly maintained over the whole

ROAD TRANSPORT

speed range—an obvious indication of the more sustained thrust of the diesel pressure cycle. The type of performance, and in particular, the more orderly character of the acceleration, is favourable to reduced engine wear and tear which, in conjunction with the fact that robust design and the highest grade of steel and bearing metal is necessary, in turn reduces the amount of maintenance work.

Some undesirable characteristics have to be admitted. Mechanically the diesel is exceedingly reliable and trouble-free, while the injection equipment is far less subject to derangement than the carburettor and electrical-ignition apparatus of the petrol engine. The chief objection that can be raised against the diesel engine is that it is rough at idling speeds and accordingly causes a deal of vibration and noise while the vehicle is at rest with the engine running. This is a defect that appears to be insuperable since it arises from the fact that maximum air intake occurs at low speeds so that compression pressure is at its highest when, in similar circumstances in a petrol engine idling with almost closed throttle, the compression pressure is at minimum—in short, the petrol engine is a variable-compression engine with its “softest” characteristics in evidence when it is idling. This low-speed roughness, quite apart from the difficulty of building small multi-cylinder diesels, is the chief reason for the reluctance of motor-car designers to take any interest in the diesel engine as an alternative power unit.

To absorb the torque reaction or “kick” of the diesel engine when idling is one of the major problems of its application to road-vehicle chassis. Rigid engine mountings were in general use for many years even though it was well recognized that some form of damping system would be highly desirable in view of the considerable idling rock and torque reactions that occur. Not all the attempts to use those flexible mountings developed for petrol engines were successful, for they were inadequate to cope with diesel-engine characteristics. But there are today many successful types in use and, as distinct from the earlier efforts in which the engine brackets merely rested on rubber pads, they

THE MODERN DIESEL

suspend the unit so that it has relative freedom to swing on its supporting links or resilient bearings within the limits imposed by suitably placed rubber buffer stops or other means, while fore and aft positioning as well as axial alignment with the transmission, is maintained by suitably articulated connections, radius rods or the like.

It would also appear to be essential to suspend the unit so that its axis of oscillation coincides with the centre of gravity of the mass and with the neutral axis of the coupling to the driven shaft.

Now that the diesel has been applied to all types of heavy vehicles for so many years it may be taken that practice has become standardized in such matters as clutch dimensions, gearing and general transmission details. The low-speed high-torque characteristics of the engine have certainly produced steady improvement in clutch design. The flat torque curve and rather restricted speed

range of the diesel have directed attention to fluid clutches and hydraulic torque converters, which on the face of things would appear to be specially desirable. These devices have been applied to double-decker buses but have not been adopted on heavy goods vehicles, the reason being that hydro-kinetic units reach their maximum efficiency at the

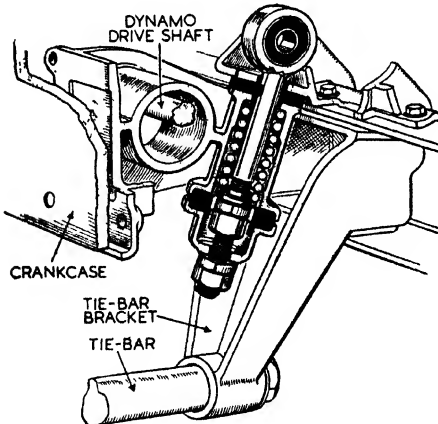

Gardner "two-rate" engine mounting applied to the Guy bus chassis

ROAD TRANSPORT

higher speeds and lower torque loading of the petrol engine.

As a general rule the final transmission ratio of a diesel-engined vehicle is slightly higher than would be used in a comparable petrol-engined chassis; thus the clutch is running at a relatively low speed and

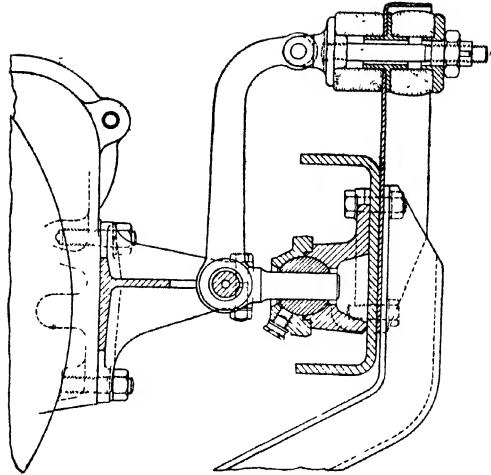

Albion flexible engine mounting

this, coupled with the moderate maximum engine r.p.m., does not provide the required kinetic-energy input for the hydraulic converter within the dimensional limits imposed by the weight and fixed size of existing chassis components. The result is a loss of transmission efficiency and a corresponding loss of fuel economy; this can be tolerated on public-service passenger vehicles where both ease of driving and passenger comfort are important considerations, but on goods vehicles the chief factor is economical running and mere refinement of performance is a secondary matter.

On very heavy transport vehicles, where the conditions of working are much more arduous, it was usual, in the intermediate stages of diesel-vehicle development, to combine a supplementary gear with the existing four-speed gear box. Sometimes this gear was used to step up the ratios so that a high road speed might be available at low engine revolutions when the vehicle was running empty, and this seemed to be a more desirable arrangement. But on the majority of vehicles the supplementary gear was a

THE MODERN DIESEL

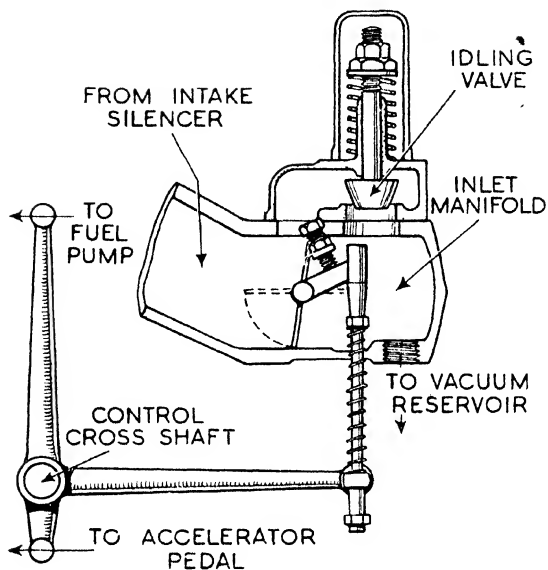

Albion vacuum braking device using intake manifold depression

the brakes are rendered all but useless. A very high vacuum reserve to counteract this defect is open to the objection that brake operation may be too powerful at the first and second applications, whilst subsequently it may be insufficiently effective. The ideal to be aimed at is to provide for the rapid restoration and maintenance of the most suitable degree of vacuum required for each vehicle concerned. The Clayton Dewandre rotary-vane type exhauster, which is used on the majority of British vehicles, is specifically designed for road-transport conditions. It is of the eccentric rotor type with six radial vanes maintained in their operative position by steel rings at the ends. The object of keeping the blades extended by mechanical means is to ensure immediate exhausting action as soon as

ROAD TRANSPORT

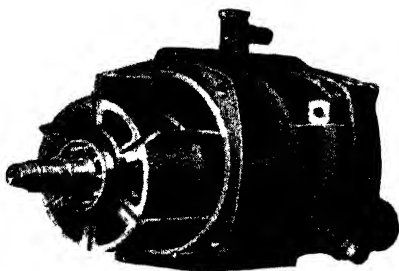

The blades of the Clayton Dewandre exhaustor are extended by loose steel rings on the rotor spindle

the vehicle starts, since in some of the earlier exhaustors in which the blades were extended only by centrifugal force cold congealed oil in the rotor slots prevented instant action following starting from cold.

Another feature of the Clayton Dewandre exhaustor is the sealing of the ends of the rotor-blade assembly by spring-loaded discs in the end covers of the machine, a device which allows for the lengthwise expansion of the blades under the heat of running conditions, so obviating an excessive cold clearance which reduces the exhaustor efficiency when starting up.

The Clayton Dewandre system includes a small reservoir tank coupled in series, through a diverter valve, with a larger one. The small reservoir is connected through a non-return valve with the source of vacuum and is used to enable a working figure to be obtained quickly. When the vacuum in this has reached, say, 17 in, the diverter valve comes into operation and exhausting of the large reservoir commences, the vacuum in that also rising to 17 in, after which both reservoirs are exhausted in unison until the

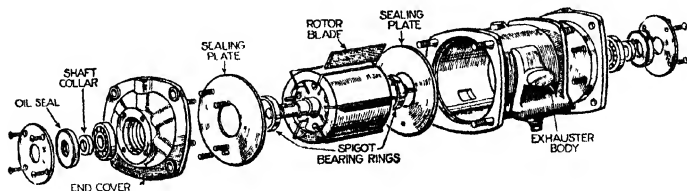

Constructional details of the Clayton Dewandre six-vane exhaustor, with special blade control and end sealing features

THE MODERN DIESEL

maximum vacuum is reached. A non-return valve incorporated in the diverter valve permits air to flow from the small to the large reservoir, but not *vice versa*. The brake cylinders are connected to the small reservoir, and although the vacuum therein is broken down when the brakes are applied it is instantly re-created because the capacity is small and the pump quickly brings it back to normal. There is also an immense reserve of vacuum in the large reservoir which assists in exhausting the small one, as air can flow freely from the latter to the former. The idea is to have one reservoir as small as possible for efficient brake application, and one as large as can be accommodated to provide an ample vacuum reserve. This system has been successfully applied to both air-pressure and vacuum-operated brakes.

Air-pressure braking for diesel-engined road vehicles is less widely used than the vacuum system in this country, but is largely employed in the U.S.A. Compressed air supplied by an engine-driven reciprocating pump is stored under pressure in cylindrical reservoirs. An even more recent development is the use of hydraulic servo assistance for brake operation and other subsidiary power requirements and where this is adopted an engine-driven pump may be incorporated.

Just as the engine is unsuited for the direct working of vacuum brakes, so it is unable to raise fuel to the pumps by means of the usual vacuum tank used on petrol engines. When a brake exhauster is fitted, however, the vacuum tank may be used, but the present tendency is to employ a mechanical pump driven from the injection-pump camshaft

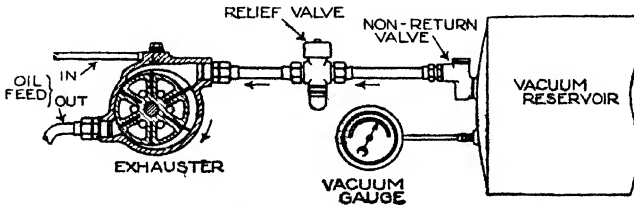

Schematic layout of a brake exhauster system

ROAD TRANSPORT

for lifting the fuel from the tank.

In the early days of modern diesel engines in road vehicles, starting presented some difficulty owing to the very high compression ratios employed on engines of the ante-chamber type. The simple direct-injection engine was easily started by hand, however, because the shape of the

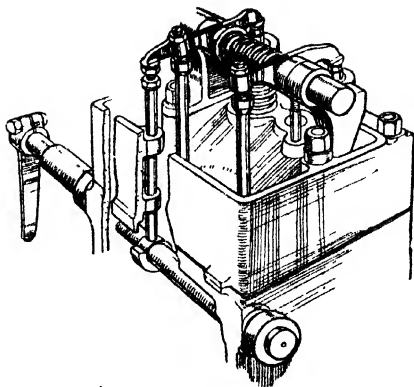

Decompressor system lifting exhaust valve

combustion chamber presented the minimum of cooling surfaces to the charge and even at hand-cranking speeds the heat loss to the cylinder-cooling system was not enough to reduce the compression temperature below that necessary for certain ignition. To facilitate initial movement it was customary to incorporate a decompressor device which lifted the valves so that a "swing" could be imparted to the flywheel, the decompressor being released when sufficient momentum was attained, the engine starting at once—more certainly, indeed, than a petrol engine of equivalent size.

The oil engine, once started, will accept load immediately since it does not suffer from the petrol engine's dislike of a cold carburettor and induction manifold. The only warming-up needed is due to the purely mechanical requirement of ensuring lubricating-oil circulation.

However, with one notable exception, the early direct-injection engines were not entirely satisfactory and a variety of more or less complicated combustion-chamber designs came into being. Owing to the great increase in surface area the loss of compression heat was considerable and it became necessary to increase compression ratio still

THE MODERN DIESEL

higher. The result of this was that it became impossible to hand-crank quickly enough to start, or indeed even impossible to rotate the engine against the high compression even if a decompressor was incorporated. Electric starting became essential and here again the original type of 12-volt starter was inadequate for the load. Additional heat was added to the cylinder by means of electric heater or glow plugs and eventually special 24-volt starters were developed.

In general, the electrical equipment of passenger vehicles and most goods vehicles is now of the 24-volt type and, with the practically universal adoption of the direct-injection system, heater plugs and other starting devices have disappeared from British road-vehicle engines although they are still used on some few marine types. Hand starting is very rarely employed on road vehicles today although it is usual to make provision for a starting handle for emergency use.

On those engines on which heater plugs are used they must be so fitted that their elements are clear of the fuel spray, which causes corrosion, and subject as little as possible to the scouring action of the burning gases. Two types are in use. Single-pole plugs are connected in parallel with a 2-volt battery and take a current of 25 to 40 amps each. Double-pole plugs have the advantage that a set for a six-cylinder engine can be connected in series to a 12-volt battery, from which they will take a current of only 30 amps as compared with 180 amps required for six 30 amp single-pole plugs connected in parallel to a single cell.

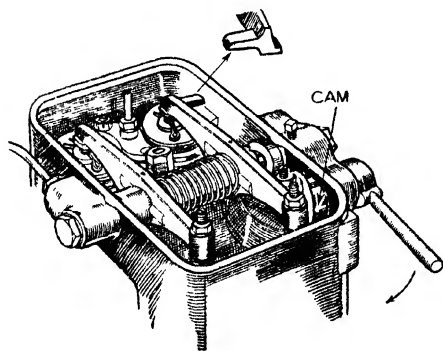

Variable-lift inlet valve on Gardner engine giving maximum air-charge for starting

ROAD TRANSPORT

When starting from cold it is necessary to inject slightly more fuel than is required for maximum power and all fuel pumps have what is known as an "excess fuel" device which allows for an increased delivery over and above the normal running maximum. In many cases there is a small plunger or trigger on the fuel pump which is lifted for starting. This allows the pump control to slide to the "excess fuel" position, but as soon as the engine fires the control is moved by the governor towards its reduced fuel position, the starting trigger springs back, and so prevents the control from passing the normal maximum setting during subsequent running.

During World War II a great deal of attention was directed to cold starting under extreme low-temperature conditions. This was a problem arising from the military necessity to operate engines in arctic territory. It had been found that only one make of transport diesel engine could be started with certainty at temperatures below 20° F (it was a direct injection unit). This engine would start down to 0° F, but at these low temperatures another problem was the drop in starter battery cell rating. Special multi-plate batteries were made to ensure rapid starter action.

Fuel additives were tried but were not satisfactory under normal working conditions in the field. The final solution was a small ether carburettor fitted to the intake manifold. The necessary small quantity of ether (about 13 c.c.) was contained in a metal capsule or "Sparklet" bulb. This sealed bulb was placed in the device and pierced to release its contents as the starter motor began to turn the engine. In most cases the engine fired within a few seconds even at temperatures of 0° F but at still lower temperatures it was necessary to use two bulbs of ether.

Whereas the operation of vehicles at these extremely low temperatures is rare, the use of such a method of starting is likely to be of great value in marine service.

Under normal conditions of winter cold in this country it is unusual to have excessive difficulty and even in the case of engines that have been unprotected in the open air during the night it is not usual to have any more elaborate

THE MODERN DIESEL

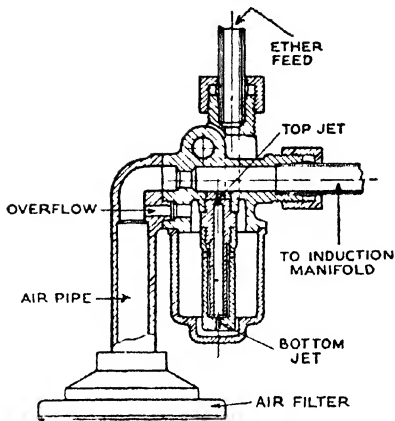

Solex-Ethalet ether starting carburettor

starting procedure. But in cold climates the ether Sparklet device is particularly useful because it is simple to use and by its nature is always available and can be relied upon since the hermetically sealed bulb retains the ether without risk of evaporation for an indefinite period.

Another device to assist cold starting is a heater coil connected to the electrical system and mounted inside the air intake.

Shortly before starting, current is switched on and the coil warms up so that some initial heat is given to the air drawn in when the engine rotates. This arrangement is of assistance in what might be classed as normal winter conditions but it will not cope with sub-normal temperatures.

Transport Engines

HAVING followed the general considerations dealt with in the previous chapters, the student of the modern transport diesel will be able to appreciate the points of difference occurring between the various makes and types of engines now to be reviewed. The details given are limited to the major items of mechanical specification and the chief performance characteristics which, read in conjunction with the preceding general information, will provide a reasonably clear picture of each engine mentioned.

In the main the engines reviewed are those which are in current production in 1947-8 or which, having been produced in the past, have had considerable influence on diesel development. British, American and European engines are dealt with and the information regarding the two former classes can be taken as correct at the moment of writing, but the references to European (and in particular to German) engines are necessarily derived from sources which may not be entirely authentic, although some very recent details of the state of the German diesel industry have been included.

It will be understood that in Germany development work on high-speed diesels was stopped by order in 1939. Production of current types was concentrated among certain makers and manufacture was dispersed; but only a limited number of types was included in this arrangement. In the later stages of the war bombing destroyed about half of this reduced productive capacity, drawings, records and experimental data in many cases being completely destroyed.

From the rest of Europe there was little reliable information during the war years. Prior to 1939 the majority of engines made in France, Belgium and Italy were based on German designs, although some of the leading British types were also made under licence. No doubt the German domination of the Continent brought all the countries

THE MODERN DIESEL.

involved within the scope of the same policy of restriction and concentration on a very few types.

Since the war ended many new models have been introduced in France, Italy, and Czecho-Slovakia, while British types are again being made in France and Belgium; on the whole, however, there is little that can be regarded as indicating any considerable forward progress since the basic principles are in all cases those which were applicable before the general upheaval. Even in Switzerland, where so many advances in the modern diesel have been made in the past, the post-war productions all had their counterparts prior to 1939.

Since the modern high-speed transport diesel first came into use more than fifty individual makes have appeared in Europe and America although not all of them survived, even in 1939. In the table on pages 270-271 are set out the main characteristics of all transport-vehicle engines of British make available in 1948-9.

Typical Makes Reviewed

A.E.C. (ASSOCIATED EQUIPMENT CO. LTD., SOUTHALL, MIDDLESEX.)

From 1928 a great deal of experimental work was carried out by the Associated Equipment Co. Ltd., the firm which produces the majority of buses operated in London. An experimental A.E.C. oil-engined works bus was running in December, 1928, and at the end of 1930 several buses were placed on the London streets. The engines of these vehicles were of the six-cylinder type and embodied the Acro air-cell type of cylinder head, but subsequently this design was abandoned in favour of a cylinder head evolved in conjunction with H. R. Ricardo. At the same time the bore of the engine was increased with the object of providing still more power.

Both in design and in choice of materials the importance of weight reduction was carefully studied in the production of the A.E.C. oil engines. The use of lead-bronze for the crankshaft and connecting-rod bearings assisted in reducing weight since with this material smaller bearing areas are permissible, so that, by reducing the length of the bearings, the engine is shortened. The cylinders were fitted with hardened liners by a special freezing-in process which eliminates any tendency to distortion which may be experienced where the liners are pressed in with an interference fit. The fuel consumption, smooth running and power output of the 6.6 and 7.6 litre six-cylinder models were much improved by the fitting of the new Comet Mark III head referred to in Chapter 6.

TRANSPORT ENGINES REVIEWED

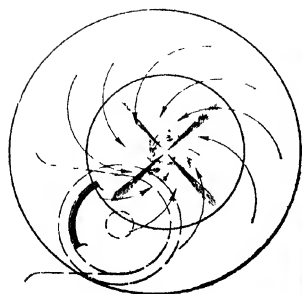

How the four-jet fuel spray cuts the air swirl induced by the masked inlet valve in the A.E.C. 7.6-litre direct-injection engine, shown in section on the right

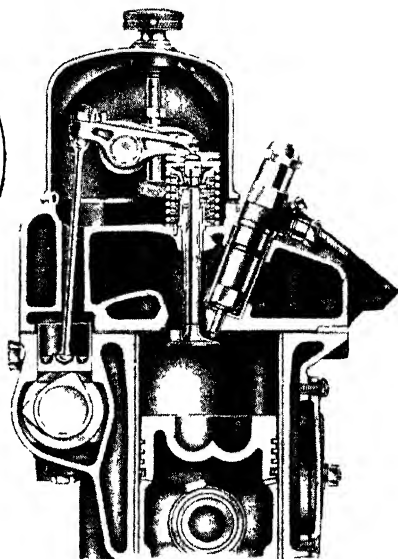

A somewhat smaller and lighter six-cylinder model had a bore of 105 mm and a stroke of 146 mm, giving a swept volume of 7.6 litres. This engine developed 128 h.p. at 2,200 r.p.m. and, complete with all accessories, weighed only 1,350 lb, or a little under 10.5 lb per h.p. The overall dimensions were such that it occupied no more space than the firm's standard petrol engine.

This model became the basis of a new direct-injection unit running at rather lower speed and with a lower power output but with a decided improvement in specific consumption. In this type of engine the whole of the air charge is compressed in a piston cavity of cup-like form, thus eliminating the mechanical and thermal losses which are caused by forcing the air through the small throat of a separate chamber. Further improvement in performance was obtained by the adoption of the toroidal piston cavity in conjunction with multi-hole injectors. Known as the "7.7-litre" engine, this was the only one in production for civilian vehicles during the war years; in its present form it now develops 98 b.h.p. at 1,800 r.p.m. A 9.6-litre engine appeared in 1939 which was used in London buses and also on G.W. railcars.

Like its forerunner, the 9.6-litre unit also began with a simple pot-cavity piston, but the toroidal cavity is now incorporated; the

THE MODERN DIESEL

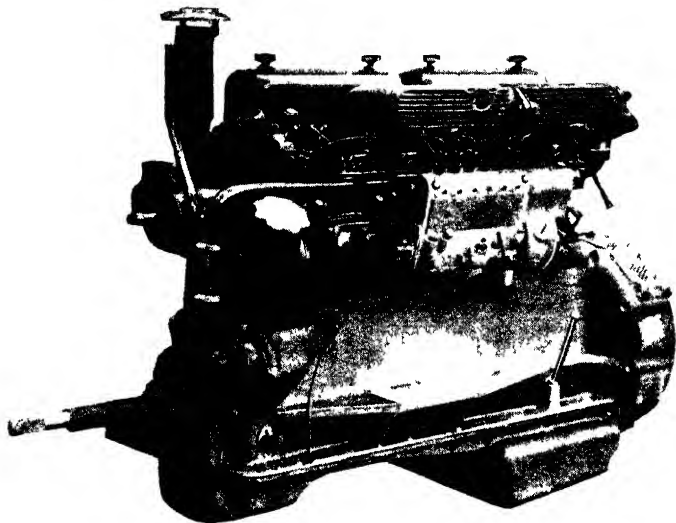

A.E.C. 7.7-litre direct-injection oil engine

power rating is 125 b.h.p. at 1,800 r.p.m. with an average specific fuel consumption of 0.38 lb/b.h.p./hr. This engine is now the standard power unit for the A.E.C. Regent Mark III bus and A.E.C. Mammoth Major six- and eight-wheeler goods vehicle. A departure from the layout of the smaller engine is that the camshaft, driven by a simple helical gear train, is mounted in a tunnel in the crankcase instead of in the cylinder block (*see Frontispiece*). The seven crankshaft bearings have a total load-carrying area of 55.30 sq. in with lead-bronze bottom halves and white-metal top halves. Lead bronze is used in the big-end bearings.

An engine of the same dimensions and capacity, with Ricardo Comet Mark III combustion system and running to a slightly higher maximum speed, is still in production for service in heavy vehicles for overseas use where greater power and speed are of more immediate consequence than the maximum fuel economy.

ALBION (ALBION MOTORS, LTD., SCOTSTOUN, GLASGOW, W.4.

- The Albion diesel is made in two models, having four and six cylinders, developing 78 and 120 b.h.p. respectively at 1,700 r.p.m. Working on the direct-injection principle, both engines are similar

TRANSPORT ENGINES REVIEWED

in all respects; the combustion chamber is the simple cavity-piston type. The overhead valves, which are unmasked, are carried in the two detachable cylinder heads, and are actuated by push-rods and rockers, the camshaft being situated high up on the off side of the cylinder block. The heads can thus be removed without disturbing the camshaft drive and valve timing. The cylinders are fitted with renewable dry liners. Lubrication is by forced feed, filtered oil being delivered under pressure to the main bearings, big-end bearings, camshaft bearings and valve rockers. Cooling is by a chain-driven fan and centrifugal water pump. C.A.V. fuel-injection equipment is installed and is supplied by a mechanical pump. All the auxiliaries, except the starter, are arranged on the near side, as required for forward-control vehicles.

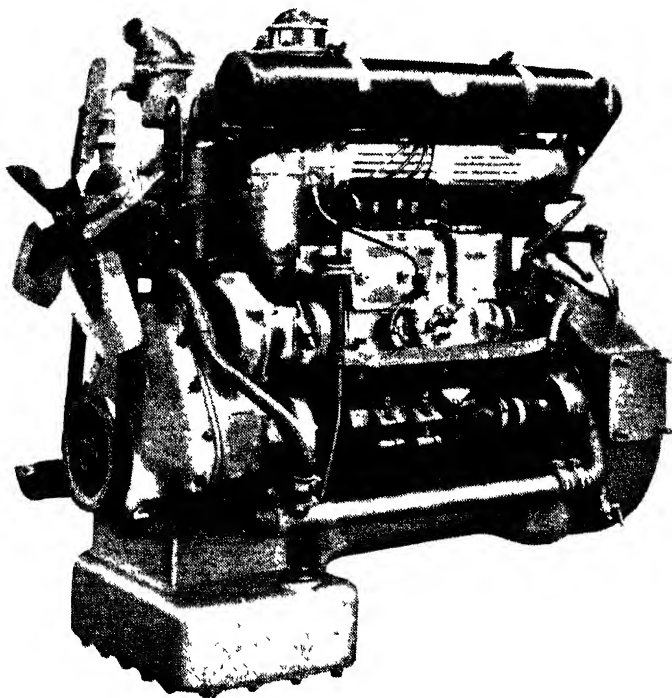

Albion 4,880 c.c. four-cylinder 75 b.h.p. engine

THE MODERN DIESEL

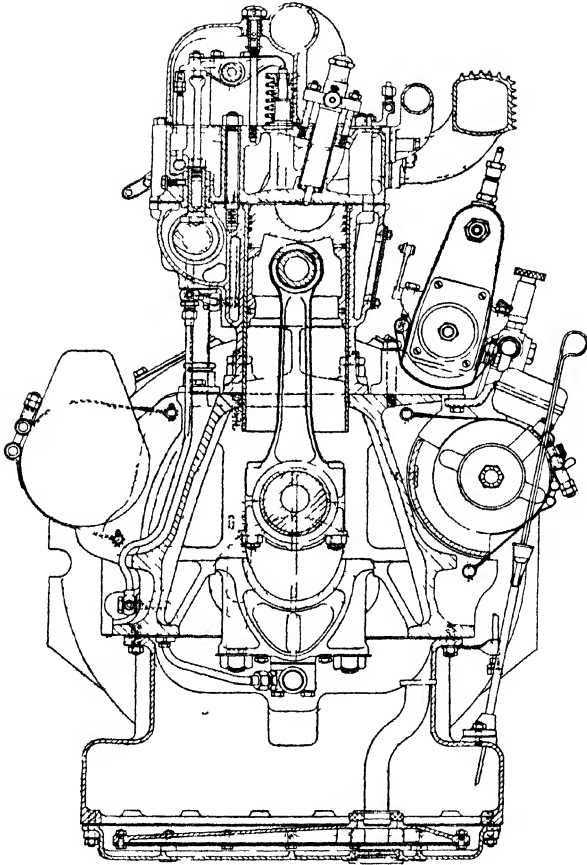

Section of Albion 78 and 120 b h p engines

In 1948 a new Albion engine, a four-cylinder model of 4,880 c.c. was introduced, it runs up to a maximum of 2,200 r.p.m. which is appreciably higher than the speed of the two larger bore units. The rated power of 75 b.h.p. is developed at 2,000 r.p.m. Injection is direct, with a two-hole sprayer in conjunction with a simple

TRANSPORT ENGINES REVIEWED

hemispherical cavity piston combustion chamber. Cylinders and crankcase are a monobloc iron casting with detachable "push fit" liners; the camshaft is located in the crankcase and is driven by gearing. To maintain the fuel filter at a reasonably high under-bonnet temperature it is flange mounted on an extension of the exhaust manifold. Injection is by C.A.V. pump and there is a centrifugally actuated variable timing device in its drive (see page 43). The complete engine, with accessories, weighs 1,100 lb and b.m.e.p. is 105 lb/sq. in. at 1,200 r.p.m. The four-cylinder unit was adopted in preference to a six because in an engine of under five litres capacity the four is more favourable to adequate bearing dimensions; the automatically variable timing device ensures a desirable smoothness of operation.

BERLIET (AUTOMOBILES M. BERLIET, VÉNISSIEUX, RHÔNE, FRANCE.)

For many years the Acro combustion head with an air-cell in the piston crown was employed for the Berliet range of road-transport diesels. At the Paris Salon, 1936, however, the company exhibited a new range fitted with Ricardo Whirlpool cylinder heads. In 1938 this head was abandoned in favour of the Ricardo Comet Mark III type and this is still in production; it was exhibited at the 1946 Paris Show.

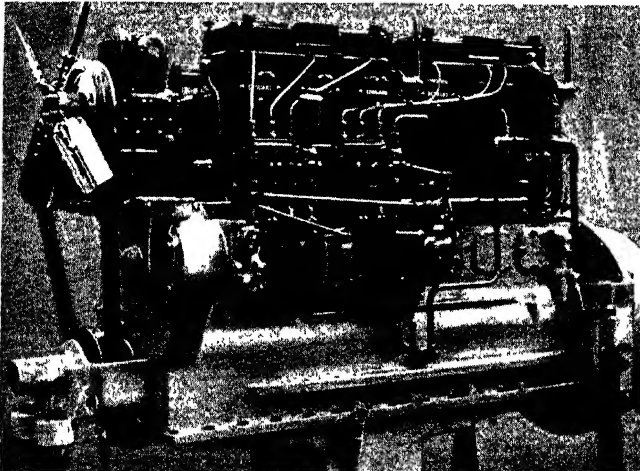

Bernard-Gardner, a French-made British design (see page 140)

THE MODERN DIESEL

BERNARD (113, AVENUE ARISTIDE-BRIAND, ARCUEIL, SEINE, FRANCE.)

This concern manufactures the British Gardner engine in France under licence and there are only very slight external differences in appearance.

B.M.M.O. (BIRMINGHAM & MIDLAND MOTOR OMNIBUS CO. LTD., SMETHWICK, BIRMINGHAM.)

One of the largest public-service vehicle operators in Britain, the "Midland Red" is also one of the few that builds its own engines. The latest B.M.M.O. power unit is a "flat" in-line six-cylinder of 113 by 133.3 mm bore and stroke (8,028 c.c.) with an output of 105 b.h.p. at 1,700 r.p.m.; b.m.e.p. is 105 lb/sq. in at 1,250 r.p.m., the fuel consumption at that speed being 0.35 pt/b.h.p./hr. The combustion system is direct injection with toroidal-cavity pistons, unmasked inlet valves and four-hole injectors.

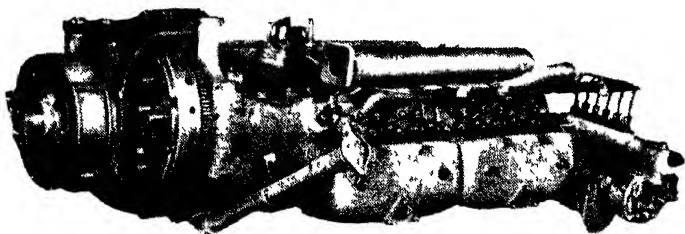

B.M.M.O. "underfloor" six-cylinder engine

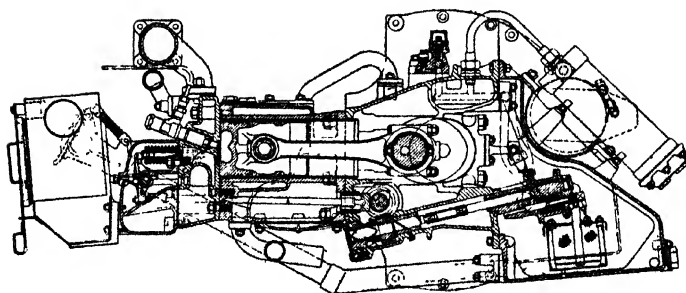

Section of B.M.M.O. horizontal engine

TRANSPORT ENGINES REVIEWED

Crankcase and cylinder block are an integral iron casting with push-fit cylinder liners. The crankshaft has nitrided journals and crank pins and runs in seven steel-backed composite bearings of lead-bronze and white metal; the big-end bearings are all lead-bronze. The camshaft is inside the crankcase and is driven by duplex roller chain; there is a bevel gear on its forward end to drive the injection pump, which is mounted vertically, parallel with the front of the cylinder block, in a very accessible position. The magnesium-alloy sump holds seven gallons of lubricating oil and, apart from a strainer inside, there is also an external by-pass filter.

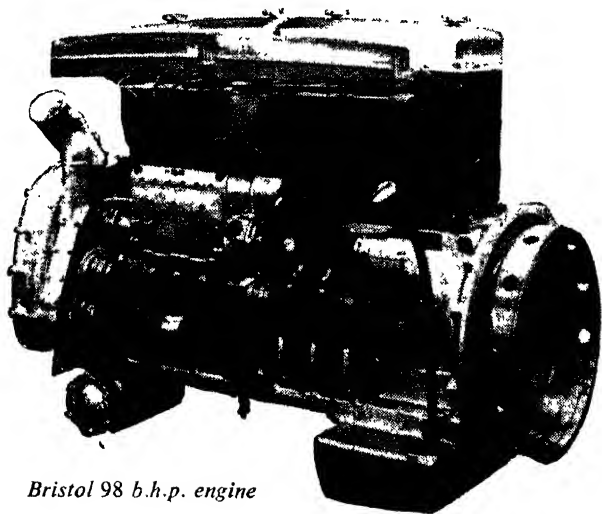

Bristol 98 b.h.p. engine

BRISTOL (BRISTOL TRAMWAYS & CARRIAGE CO., LTD., BRISTOL.)

Although Bristol buses had been powered for many years with Gardner engines, the firm built several prototype units of their own design in 1939 and these were tested in actual public-transport service during the war years. This engine has now been put into production and is available for current type Bristol buses. The engine is a six-cylinder of 110 by 143 mm bore and stroke (8,140 c.c.) developing 98 b.h.p. at 1,700 r.p.m. with an average consumption slightly under 0.34 lb/b.h.p./hr. The direct-injection system is followed, with toroidal-cavity pistons and three-hole sprayers. There is no masking of the inlet valves but the air passages

THE MODERN DIESEL

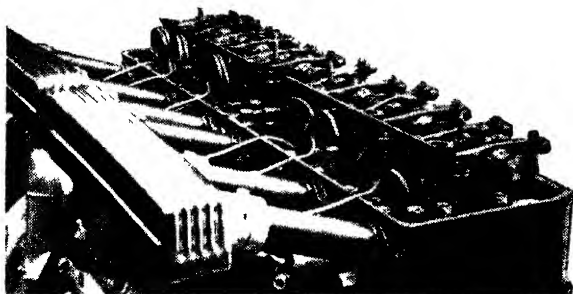

Valve rocker gear and air inlet pipes on Bristol engine

to the ports are straight and tangentially arranged; these pipes are some 8 in long, being coupled to an external intake manifold set well out from the cylinder head. In each pipe is a die-cast polished venturi adjacent to the port to increase air velocity and to promote swirl as the air passes the inlet valve.

The valves are push-rod operated and the camshaft is in the crankcase so that the triple chain timing gear is very compact; it is notable that for use in this country no cooling fan is fitted. Both the crankcase and the dry-lined cylinder block are cast iron; the cylinder holding-down bolts pass through the crankcase webs to secure the main bearing caps.

Either C.A.V. or Simms injection equipment can be supplied as standard and a special feature is that the injection pump is independently driven as distinct from the more usual method of coupling it in tandem with one of the other driven auxiliaries. Special

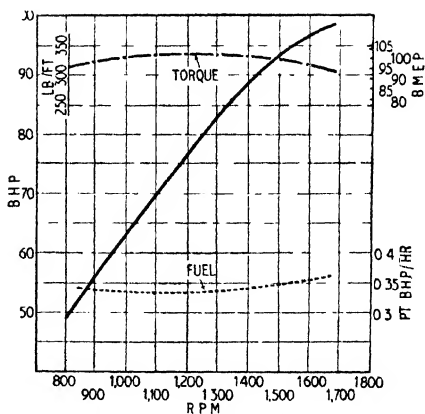

Performance curves of Bristol 8.4-litre engine

TRANSPORT ENGINES REVIEWED

attention has been given to cooling the injectors, which are fitted in copper sleeves which pass through the water space in the cylinder head; by this arrangement heat transference from the injector body to the cooling water is more effective than is the case when the injector is fitted in a cast-iron pocket formed in the cylinder head. Whether any great advantage in increased air swirl results from this method is a matter on which there are widely divergent points of view. For instance, in a Paper read before the Institution of Mechanical Engineers (Automobile Division) early in 1949, Mr. C. B. Dicksee stated that careful tests on venturi inlet passages had shown no marked effect on air swirl but that some slight advantage arose from the greater amount of metal in the head at a point where it is most needed to accommodate the injector.

BUDA-LANOVA (THE BUDA COMPANY, HARVEY, ILLINOIS.)

Four- and six-cylinder units are made, all with Lanova "figure-eight" combustion chamber combined with the separate "energy cell" directly opposite the single-hole sprayer (see page 95). The smallest engine is a four-cylinder, 226 cu in (3,560 c.c.), $3\frac{3}{8}$ in by $5\frac{1}{8}$ in (95 mm by 130 mm), developing 55 b.h.p. at 2,300 r.p.m. The engine has a one-piece crankcase and cylinder block with conventional layout, the camshaft (gear driven) being in the crankcase, with push-rod operated o.h.v. Oil-pressure lubrication is taken up the connecting rods to the small-end bearings. Bosch injection equipment is fitted.

A six-cylinder engine of 278 cu in (4,650 c.c.) $3\frac{1}{8}$ in by $4\frac{1}{2}$ in in bore and stroke (92 mm by 114 mm) of similar design develops 73 b.h.p. at 2,600 r.p.m., and another six, of 317 cu in capacity (5,300 c.c.), $3\frac{3}{8}$ in by $5\frac{1}{8}$ in (92 mm by 130 mm), is rated at 79 b.h.p. at 2,300 r.p.m. This engine is produced as an interchangeable replacement for Ford V8 trucks.

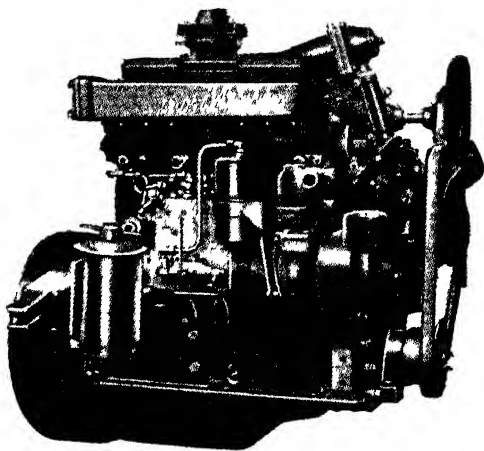

Buda-Lanova 55-h.p. four-cylinder engine (2,300 r.p.m.) for truck use. American Bosch injection equipment is fitted

THE MODERN DIESEL

BÜSSING-N.A.G. (BÜSSING-N.A.G. VEREINIGTE NUTZKRAFTWAGEN AKT.-GES., BRUNSWICK, GERMANY.)

The range of engines produced before the war was extensive and ranged from a three-cylinder of 48 h.p. to a six of 95 h.p.; bore and stroke throughout was 110 mm by 130 mm and a pre-combustion

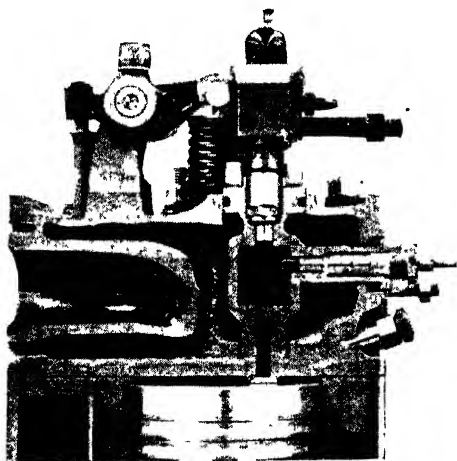

Sectioned Büssing-N.A.G. cylinder head, showing the positions of the pre-combustion chamber, sprayer and heater plug

chamber design was used; power output in relation to capacity was appreciably below that demanded of British engines of equivalent size. Under the Nazi rationalization programme only two vehicle engines were continued, both six-cylinders, the smaller having a monobloc cylinder and crankcase casting and the larger a light-alloy crankcase with iron cylinders in two blocks of three. Dimensions of the smaller engine were 110 mm by 130 mm (95 h.p. at 2,000 r.p.m.) and of the

larger, 130 mm by 170 mm (140 h.p. at 1,500 r.p.m.). Both had the same type of pre-combustion chamber in conjunction with Bosch pintle-type sprayer; an electric heater plug was necessary for starting. No post-war information regarding this concern has been forthcoming.

CITROEN (S. A. ANDRE CITROEN, 117/167, QUAI DE JAVEL, PARIS, (15E), FRANCE.)

In July, 1933, the Citroën Company decided to construct a diesel engine that would be interchangeable with their petrol motor as installed in light vans and private cars without any modification to the chassis. The four-cylinder model was finally introduced in 1937. Of 75 mm bore and 100 mm stroke, it had a piston displacement of 1,766 c.c. and developed a maximum of 40 b.h.p. at 3,500 r.p.m. The Ricardo-Comet turbulence chamber was adopted and a high compression ratio (20 to 1) was used. Fuel was injected by

TRANSPORT ENGINES REVIEWED

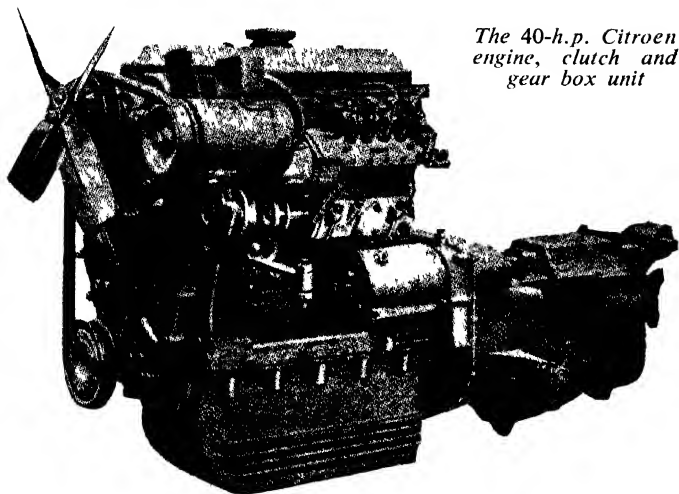

The 40-h.p. Citroen engine, clutch and gear box unit

a Lavalette-Bosch pump; heater plugs of the two-pole type assisted starting.

The cylinder block was of cast iron fitted with wet liners; overhead valves were carried in a single-piece head and operated by push-rods and rockers. The crankshaft ran in three bearings, lead-bronze being used for the connecting-rod big ends. Post-war production of this engine does not appear to have been resumed.

CONTINENTAL (CONTINENTAL MOTORS CORP., MUSKEGON, MICH., U.S.A.)

Following the usual American practice, this maker is using the Lanova combustion chamber. There are three high-speed six-cylinder engines of 5, 7½ and 9 litres capacity rated at 86, 112 and 150 b.h.p. respectively; the two smaller units run at 2,400 and the larger at 2,200 r.p.m.

COVENTRY DIESEL (COVENTRY DIESEL ENGINES, LTD., FRIARS ROAD, COVENTRY.)

Intended for light commercial vehicles and cars, a four-cylinder air-cell combustion-chamber engine was introduced under the name Tippen Colt in 1937 and subsequently developed by Coventry Climax Engines, Ltd. The commercial arrangements for this engine are now conducted by Coventry Diesel Engines, Ltd., the

THE MODERN DIESEL

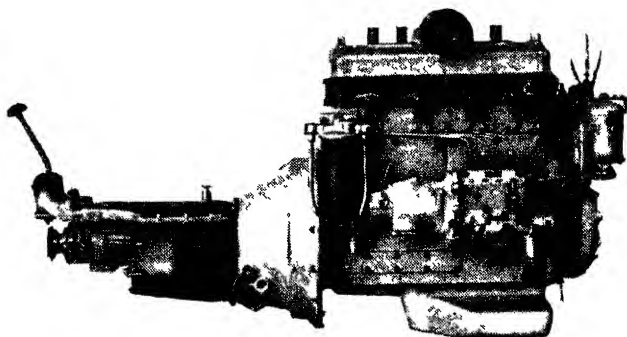

Godiva 2¼-litre engine with clutch and gear box for a private car

engine now being named the Godiva. The combustion system employed makes use of an offset turbulence chamber communicating through a venturi passage with the main cylinder. The top of the chamber is detachable and retained by a screwed locking ring. Fuel is injected into the chamber by a horizontal sprayer. Of 82.5 mm bore and 105 mm stroke, and with a compression ratio of 17.5 to 1, 45 b.h.p. is claimed at 2,700 r.p.m. The cylinder block and crankcase are cast in aluminium alloy and wet liners of centrifugally cast iron are fitted. The weight, with starter, dynamo and flywheel, is 13.7 lb per b.h.p. To facilitate starting decompression gear is provided: provision can also be made for the fitting of heater plugs.

This engine is one of the smallest diesels made and although it has been substantially in its present form for several years it has not figured in the specification of any road transport vehicle. It has been fitted into a private car for development work and is illustrated above as equipped with car gear box.

CROSSLEY (CROSSLEY MOTORS LTD., ERRWOOD PARK, HEATON CHAPEL, STOCKPORT.)

The Crossley was the first all-British fuel oil bus chassis with an engine designed and constructed in the makers' own works. The original engine was of the direct injection type. However, a general demand for quieter operation and higher r.p.m. led to the adoption of the Ricardo Comet type combustion chamber and for some years Crossley Motors concentrated on one model only, the six-cylinder V.R.6, of 112.7 mm bore by 139.7 mm stroke, giving a capacity of 8,365 c.c. It developed 62 b.h.p. at 1,000 r.p.m. and

TRANSPORT ENGINES REVIEWED

100 b.h.p. at 1,700 r.p.m. The compression ratio was 17·8 to 1, fuel being injected at 1,200 lb/sq. in.

Following the general trend mentioned in Chapter 1, the Crossley six-cylinder engine that now replaces the V.R.6 is of the direct-injection type with a toroidal cavity piston, although a novel modification of this arrangement has been patented. Within the cavity are concentric ridges or serrations which superimpose an additional motion on the toroidal swirl already provided by the shape of the cavity in conjunction with the intake swirl and piston "squish". The serrations induce local boundary swirl which enables the air to combine with the fuel particles by preventing their contact with the metallic surface. The effect is also to prevent overspill of unconsumed air from the cavity due to the pronounced "squish" effect; a four-hole injector nozzle is used which directs the fuel across the widest part of the cavity.

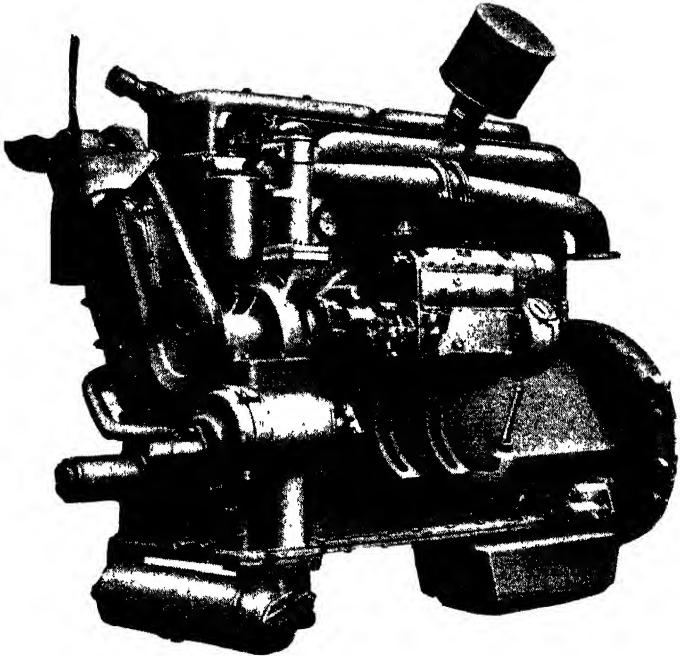

Crossley direct-injection six-cylinder 102·7 b.h.p. 8·6-litre bus engine

THE MODERN DIESEL

This combustion chamber produces particularly good results; diesel knock is eliminated and economical consumption is obtained. Cool running is a feature and, except in tropical conditions and with a radiator of slightly less than normal capacity on a heavy vehicle, a fan is unnecessary; to maintain the lubricating oil at a sufficiently high temperature the external oil filter no longer requires the cooling fins that were formerly embodied. The bore and stroke

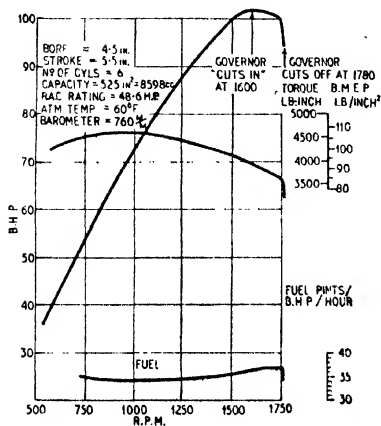

*Performance curves of Crossley
8-6-litre direct-injection engine*

are $4\frac{1}{2}$ in by $5\frac{1}{2}$ in, giving a total capacity of 8,601 c.c. The bearing areas of the crankshaft and big ends are rather greater than before but the engine is nevertheless slightly shorter. The big ends are of the four-bolt type and another important feature is that the crankshaft centre-bearing cap is also secured by four bolts, giving maximum support to the journal that is usually most subject to wear. The monobloc cylinder casting is fixed to the aluminium crankcase by long bolts passing through the bearing caps. The cylinder head is divided into two groups of three and the camshaft is high on the side of the cylinder block.

Distribution drive is by chain with a helical gear to the injection pumps. The space available on the near side of the crankcase permits the installation of the largest dynamo used on public-service vehicles, but if greater accessibility is required an

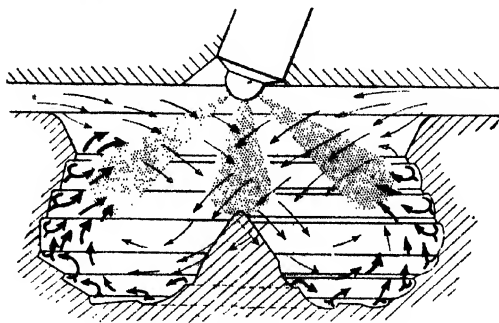

Crossley corrugated toroidal piston cavity

TRANSPORT ENGINES REVIEWED

alternative arrangement is to mount the dynamo alongside the gear box, driving it by a shaft extended from the normal coupling; this scheme was a feature of the first Crossley oil-engined buses made in 1931 and its reintroduction in 1944-45 confirms the value of the original conception.

The new engine develops 102 b.h.p. at 1,600 r.p.m., the maximum speed being 1,750 r.p.m. and the compression ratio being 15.3 to 1; these figures make an interesting comparison with those of the previous engine given above. Indicator diagrams show a great improvement in regularity and orderliness of combustion while there is better thermal efficiency, the fuel consumption averaging 0.34 to 0.36 pints/b.h.p./hr.

In 1947 large numbers of Crossley bus chassis were being equipped with superchargers to meet the special requirements of the Netherlands Railways. With compression ratio slightly reduced but with a boost pressure rising to 8 lb/sq in. the power output of the 8.6-litre engine is increased by almost 50 per cent at the governed speed of 1,750 r.p.m. (see page 107). Supercharging has been found to improve smoothness of combustion still further and this in turn is reflected in reduction of big end wear; crank pin life, within the permissible limits of ovality, has been noticeably extended.

CUMMINS (CUMMINS ENGINE Co., COLUMBUS, INDIANA, U.S.A.)

While British progress was particularly rapid since 1928, not quite the same interest was manifested in the c.i. engine in America, possibly because a plentiful supply of cheap petrol diverted attention from the undoubted fuel economy of the heavy-oil type. The Cummins marine engine was exhibited at the Shipping Exhibition in 1929, and early in 1930 the makers produced a series of engines suitable for road transport vehicles. Six- and four-cylinder types of 101.6 mm and 123.8 mm bore and 127 mm and 152.4 mm stroke were built, having a maximum governed speed of 1,800 r.p.m. At this speed the six-cylinder engines give 100 and 150 b.h.p. and the four-cylinder models 66 and 100 b.h.p. respectively.

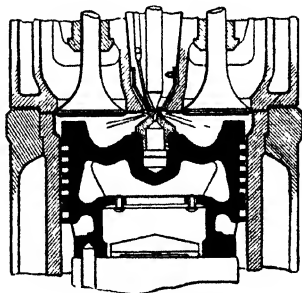

Cummins cylinder head

The injection system of this engine is distinctly interesting, the injector being placed vertically in the centre of the cylinder head and being push-rod operated in common with the overhead valves. A single pump, by means of a rotary distributor, supplies oil to the injectors at a comparatively low pressure, and during the compression stroke a certain quantity of air is allowed to mix with the oil waiting in the injector, and then this "wet" mixture is injected at the

THE MODERN DIFSL

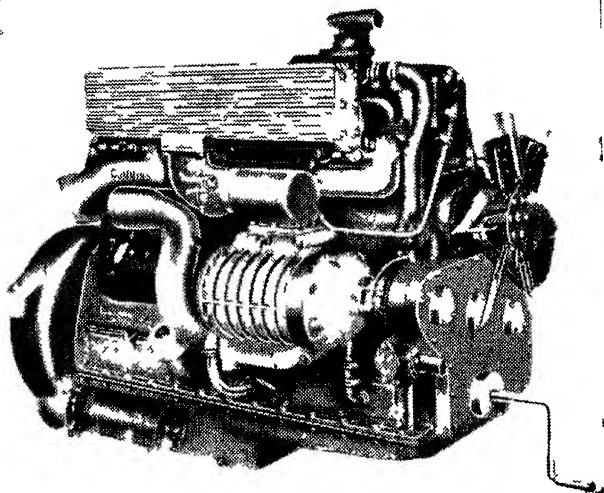

One of the earliest and still one of the most original American transport diesels, the Cummins 11,000 c c six-cylinder four-stroke engine, which develops 150 b h p at 1,800 r p m or 200 b h p when supercharged (as shown)

correct moment. The cylinder head is flat, the piston having a cavity not unlike the modern toroidal type but with a central boss of heat-resisting steel enclosing a small air cavity. During the injection, air from the space surrounding the boss flows inwards, causing turbulence and thorough mixing of fuel and air. On the expansion stroke, air compressed in the cavity keeps the injector nozzle clear of carbon partly by pneumatic action and partly by combustion.

For some years supercharged Cummins engines have been available, the blowers fitted are of the Roots type built into the unit and positively driven.

DAIMLER (TRANSPORT VEHICLES (DAIMLER), LTD, COVENTRY)

Towards the end of 1944 it was announced that a new oil engine would be produced in the Daimler works, the double-decker buses of this make having previously been powered by Gardner engines, although during the war some were fitted with A E C units. The new engine is a six-cylinder direct-injection type with simple off-set cavity pistons and four-hole sprayers. Total capacity is 8,601 c c.

TRANSPORT ENGINES REVIEWED

and the governed output is 100 b.h.p. at 1,800 r.p.m. Crankcase and cylinder block are formed as a single casting with dry-lined bores. The cylinder head is divided into two groups of three and the overhead valves are rocker operated through short push-rods from a high camshaft running in a tunnel on the off side of the cylinder block. Timing drive is at the rear of the engine from a helical pinion machined on the crankshaft adjacent to the flywheel flange; the distribution gears are alternately steel and cast iron.

Late in 1948 a 10.6-litre version of the Daimler engine was put in production; it is rated for 120 b.h.p. at 1,700 r.p.m. The general design is similar to that of the 8.6-litre unit, being a direct-injection engine with simple cavity pistons and four-hole sprayers; the timing gear is at the flywheel end of the crankshaft. Lubrication is pressure fed to all working parts, including the small end bearings.

An interesting development incorporated in the 10.6-litre engine as exhibited at the Transport Vehicle Show at Earls Court, London, in September, 1948, was a Lockheed hydraulic pump. Driven from the timing gear this pump delivers oil at high pressure to a hydraulic accumulator which is connected through suitable connections and controls to the steering gear, change speed mechanism,

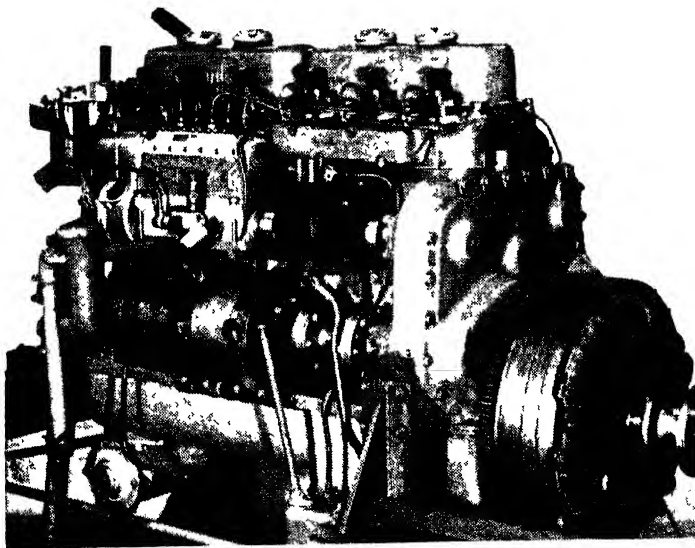

Timing gear drive at the rear is a feature of the Daimler direct-injection bus engine. A fluid flywheel is fitted

THE MODERN DIESEL

and brake actuation whereby the driver can control the vehicle with the minimum physical effort. This engine-driven hydraulic system is more positive and will deal with heavier operations than the vacuum systems hitherto in general use.

DE DION (DE DION BOUTON, PUTEAUX, SEINE, FRANCE.)

One of the most striking applications of the diesel is seen in the latest De Dion which has been exhibited at the last two Paris Shows.

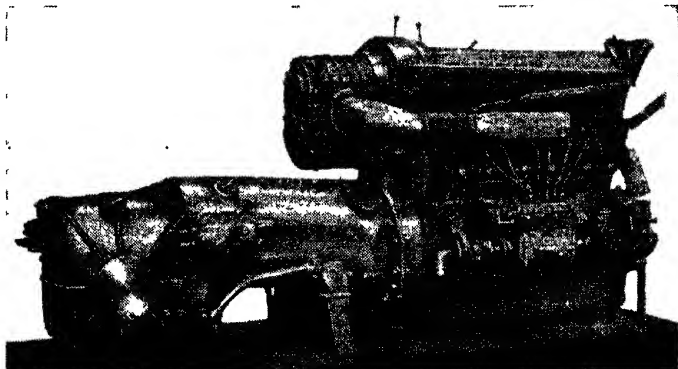

Supercharged De Dion Bouton two-stroke diesel (Junkers opposed piston type)

It is a six-cylinder version of the Junkers forced-induction opposed piston six-cylinder two-stroke. The blower is of the Roots type neatly flange-fitted to the rear of the engine block and directly driven from the uppermost of the two crankshafts peculiar to the Junkers layout. The engine unit is combined with a complete transmission system incorporating a rear axle with independent suspension.

DENNIS (DENNIS BROS. LTD., GUILDFORD.)

The first road-vehicle diesel engine manufactured by this company was introduced at the end of 1931. This was a six-cylinder unit incorporating the makers' patented air chamber and auxiliary air valve. It did not go into extensive production, however, and in 1936 a direct-injection engine was introduced. The pistons were formed with a toroidal cavity, and each cylinder had four valves symmetrically arranged round a multi-hole C.A.V. sprayer having six orifices. The exhaust valves on the near side and the inlets on the off side of the head were operated by push-rods and camshaft on the off side of the engine through neatly arranged rocker mechanism. The cylinders were cast with the crankcase and fitted with detachable wet liners. A special feature was that the connecting-rod big-ends were split at an angle of 30 degrees from the vertical instead of at

TRANSPORT ENGINES REVIEWED

right-angles so that they could be drawn up with the piston through the cylinder. Another unusual feature was that the timing gear was driven from the rear end of the crankshaft. This engine in its general details became the basis for the 7.6-litre six-cylinder 100-b.h.p. engine now available for post-war bus work. It has a bore and stroke of 105 mm by 146 mm (7,585 c.c.) and develops its rated power at 1,800 r.p.m. On this engine the timing drive is also by helical gears at the rear end, but the camshaft is raised high on the side of the cylinder block. Four-hole C.A.V. injectors have replaced the earlier six-hole pattern. The crankshaft is nickel-chrome-molybdenum hardened forging with $3\frac{3}{8}$ in journals and runs in seven steel-shell copper-lead alloy bearings. The crankpins are $2\frac{1}{8}$ in diameter. The four-valve head design is followed and each cylinder head casting covers three cylinders. A four-cylinder engine with the same cylinder-head design is also made. Its bore and stroke are 117.47 by 150 mm (6,502 c.c.), the power output being 80 b.h.p. at 1,800 r.p.m.

A new engine was added to the range in September, 1948; this

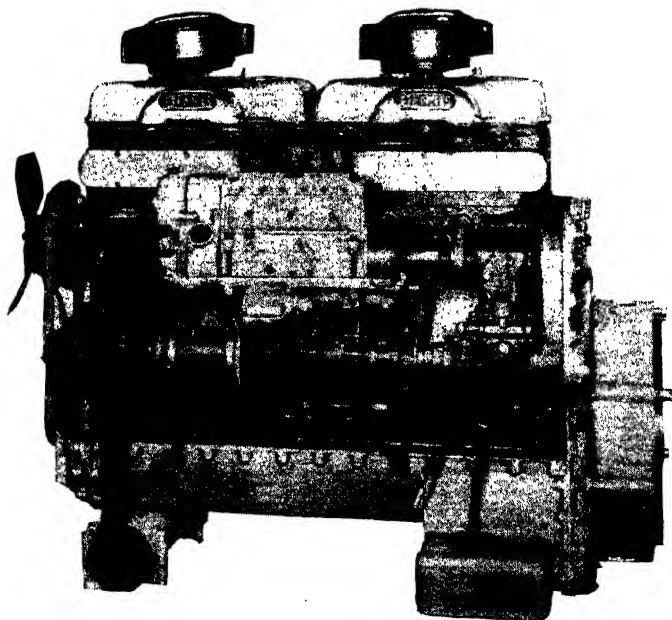

Dennis 7.6-litre six-cylinder engine

THE MODERN DIESEL

was a 5 6-litre six-cylinder unit developing 75 b.h.p. at 2,000 r.p.m. It departs from the four-valve arrangement hitherto a feature of Dennis engines. It has two valves per cylinder but is of the toroidal cavity piston type. The detail design is such that the unit can be supplied with accessories on one side or the other for installation in either right or left hand drive chassis. A feature worthy of note is

that by comparison with the generality of engines of this type the piston cavity is much more deeply shrouded by the lip of the opening in the crown.

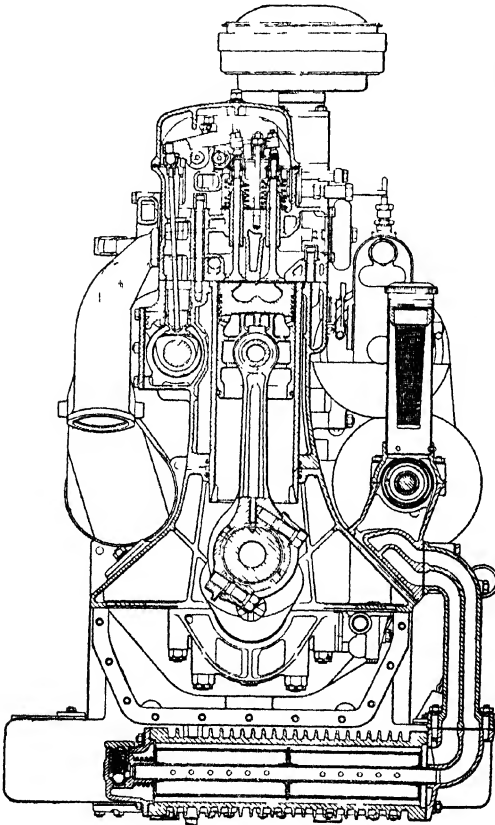

Dennis engine with four-valve cylinder head

TRANSPORT ENGINES REVIEWED

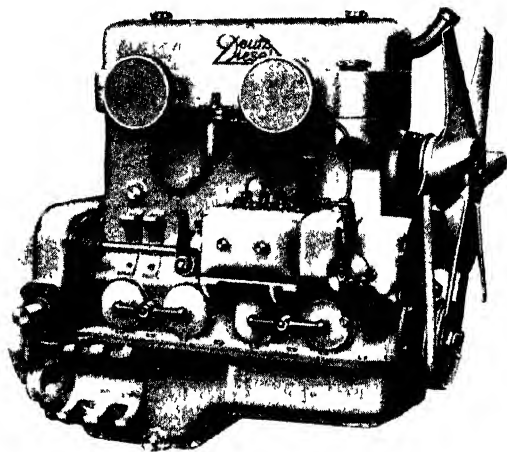

A horizontal fuel injection pump and detachable covers on the side of the crankcase are features of the Deutz engines. This four-cylinder model develops 50 b.h.p.

DEUTZ (HUMBOLDT-DEUTZ MOTOREN A. G., COLOGNE, GERMANY; AND BRITISH DEUTZ LTD., STAINES, MIDDLESEX.)

For road transport five different models were produced. A six-cylinder model of 100 mm bore and 130 mm stroke developed 90 b.h.p. at 2,000 r.p.m. With the same bore, but with a longer stroke of 160 mm, a six-cylinder type developed 110 b.h.p. at 2,000 r.p.m. Larger four- and six-cylinder models were of 120 mm bore and 170 mm stroke and developed 85 and 125 b.h.p. respectively at 1,500 r.p.m., whilst an eight-cylinder model of the same dimensions gave 170 b.h.p. at 1,500 r.p.m. All were of the pre-combustion type with the chamber offset to one side of the cylinder, the fuel being injected vertically downwards into the chamber at a pressure of about 1,100 lb/sq. in. No post-war production of road transport engines is evident.

DODGE DIESEL (CHRYSLER MOTOR CO., DODGE DIVISION, DETROIT, MICH.)

This is another engine based on the Lanova-type combustion chamber (page 95). It is very much laid out on automobile lines, having six cylinders, $3\frac{1}{4}$ in by 5 in bore and stroke, 331 cu. in. (95

THE MODERN DIESEL

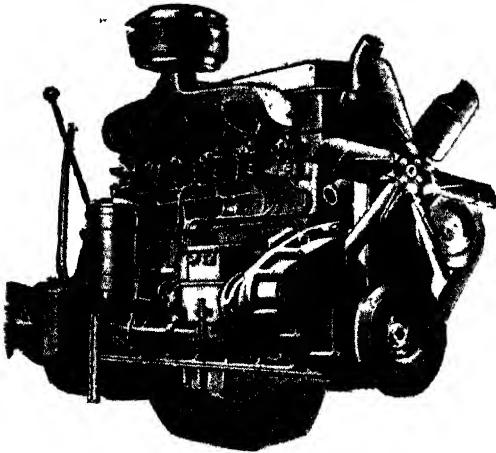

Claimed figures for the Dodge six-cylinder engine are 100 b.h.p. at 2,600 r.p.m. Lanova-type combustion chamber design is used

mm by 127 mm, 5,575 c.c.). Compression ratio is 14.75 to 1 and an output of 100 b.h.p. at 2,600 r.p.m. or 80 b.h.p. at 1,800 r.p.m. is claimed; by British standards these figures must be accepted with a certain reservation. Fuel consumption is 0.52 lb/b.h.p./hr at maximum power. Maximum torque is 240 lb/ft at 1,250 r.p.m., when the fuel consumption is 0.45 lb/b.h.p./hr. Injection equipment is the American Ex-cell-O swash plate pump, with single-hole injectors.

DORMAN (W. H. DORMAN & Co., LTD., STAFFORD.)

Introduced early in 1932, the Dorman-Ricardo engines followed the production of several types incorporating the Acro air-cell combustion head. Six-cylinder and four four-cylinder models were supplied, and large numbers were fitted to new chassis or used to convert petrol-driven vehicles during the early stages of diesel road-transport development. Ricardo "down-stream" and Comet Mark III heads were also incorporated and a direct-injection engine was also made. No transport engines are now in production and the makers are concentrating upon marine and industrial units. The marine units are referred to in Chapter 11 and it will be seen from the illustrations that they have a distinct affinity with automotive types.

TRANSPORT ENGINES REVIEWED

FIAT (FIAT, VIA NIZZA 250, TURIN, ITALY.)

Five different types of Fiat diesel engines were produced before the war, the smallest being a four-cylinder 108 by 125 mm unit of 4,580 c.c. capacity with a compression ratio of 17·4 to 1 and developing 55 b.h.p. at 2,200 r.p.m. A slightly larger model of the same cylinder bore but with a longer stroke of 152 mm and of 5,570 c.c. capacity had a compression ratio of 16 to 1 developing 60 b.h.p. at 1,800 r.p.m. The same cylinder dimensions were used for a six-cylinder model of 8,355 c.c. capacity, giving 80 b.h.p. at 1,700 r.p.m. A larger six-cylinder model, of 115 by 160 mm bore and stroke and 9,972 c.c. capacity had a compression ratio of 17·4 to 1, and developed 115 b.h.p. at 1,800 r.p.m.

The two largest and the smallest engines had the Ricardo Comet turbulence chamber, whilst the other two were of the direct injection type with central vertical sprayers injecting into concave-topped pistons; Fiat or Bosch injection equipment was used. The Fiat direct injection system was used also for the French Delahaye diesels. Production of the 115 b.h.p. engine was resumed in 1945; it is noteworthy that this engine, embodying as it does the Ricardo Comet head, once again emphasizes the prevailing tendency in the European countries to use the air-cell type in preference to direct injection as the most readily available form for production, no doubt because it is much less exacting in the demands made upon the characteristics of the injection equipment and fuel.

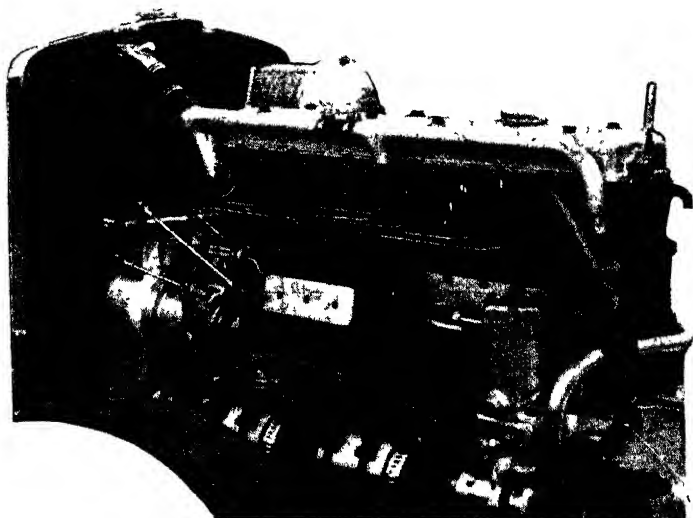

Fiat six-cylinder diesel installed in a bus chassis

THE MODERN DIESEL

FODEN (FODENS, LTD., ELWORTH, SANDBACH, CHESHIRE.)

One of the most interesting engines produced by the British transport vehicle industry is the 4.1-litre six-cylinder two-stroke unit first exhibited at the 1948 Earls Court Transport Show.

The monobloc casting is of aluminium with wet cast iron cylinder liners and cast iron heads. There are two overhead exhaust valves per cylinder operated by push rods and forked rockers from a high camshaft. Induction is forced by a gear-driven Roots type blower which delivers air to a chest at an average pressure of 5 lb/sq. in. The pistons at the bottom of the stroke uncover ports in the cylinder sleeves which co-operate with vanes in the air chest so that rotational swirl is given to the intake air. Toroidal cavity pistons and tangentially directed single hole sprayers are incorporated in the combustion system. At 2,000 r.p.m. the engine develops 126 b.h.p. with a specific consumption of 0.40 pt/b.h.p./hr. All auxiliary components including the blower are driven by helical gears at the flywheel end of the crankshaft. At the forward end of the shaft, however, there is a sub-unit assembly incorporated in the crankcase end cover which provides a geared drive for the water pump and also embodies an oil pump which supplies hydraulic power to the servo motor of the braking system. Injection equipment is made by C.A.V. and the latest hydraulic governor is fitted.

Main object in evolving this engine was to produce a power unit for double-decker buses and for heavy lorries which would give the requisite output with minimum weight and bulk and in these respects the specific weight is exceedingly favourable at 8½ lb per h.p., the equivalent size is reduced by about one third.

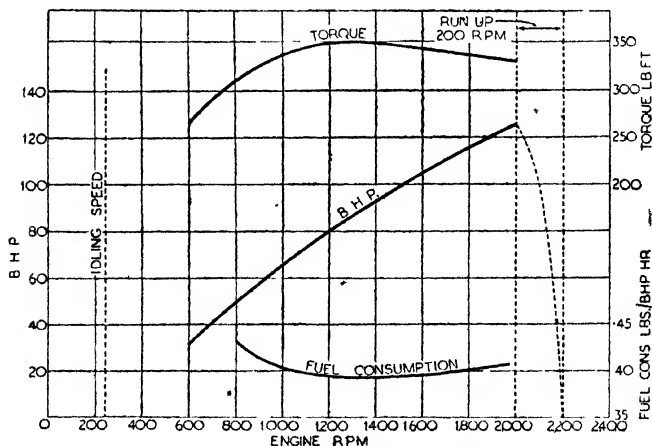

Foden two-stroke performance curves

TRANSPORT ENGINES REVIEWED

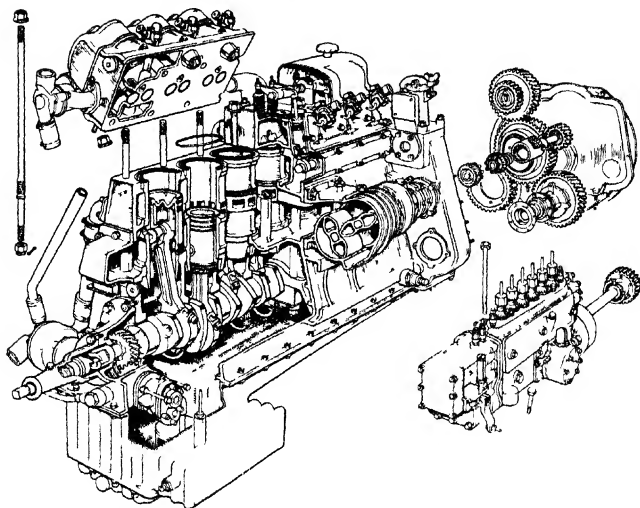

Blower, fuel pump and other auxiliaries are separately driven from rear timing gears on the Foden engine

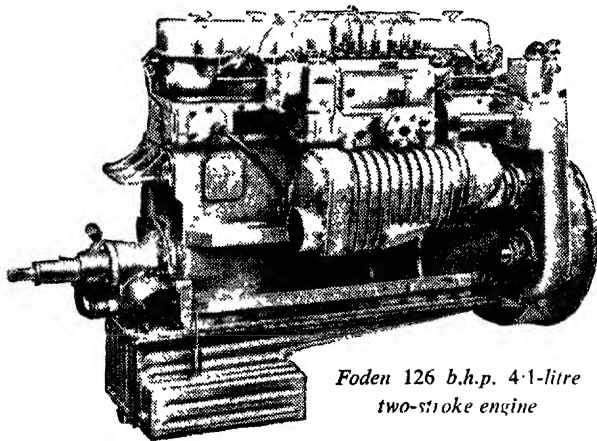

*Foden 126 b.h.p. 4.1-litre
two-stroke engine*

THE MODERN DIESEL

GARDNER (NORRIS, HENTY & GARDNERS LTD., PATRICROFT, MANCHESTER.)

Three types of engines are built. The original form, characterized by the type designation L2, is available in two-, three-, four-, five- or six-cylinder models, the cylinder blocks (now fitted with dry liners) being made up in groups of two and three to make this possible. Each cylinder head, however, was separate. The valves are vertical, and there is a shroud on the inlet valve head to impart a distinct whirling motion to the air entering the cylinder.

The L2 type engine, introduced in 1929, was originally intended for marine and stationary work. For road transport it is comparatively heavy, the weight per b.h.p. being about 26 lb in the six-cylinder model. Nevertheless, it was installed in a large number of heavy transport vehicles, mainly as a conversion unit, and its remarkable fuel economy, easy cold starting, excellent torque and robust construction discounted its bulk and weight. This engine undoubtedly had a most far-reaching influence upon the general acceptance of oil engines in British road-transport vehicles.

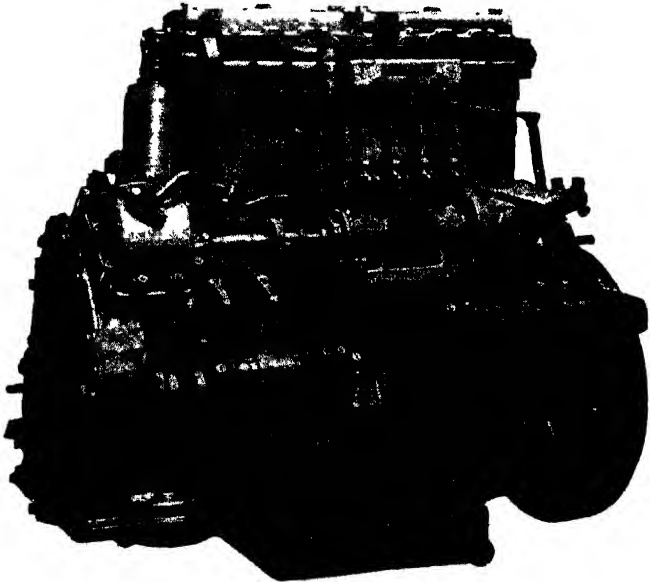

Gardner 4LK four-cylinder engine for medium-load vehicles

TRANSPORT ENGINES REVIEWED

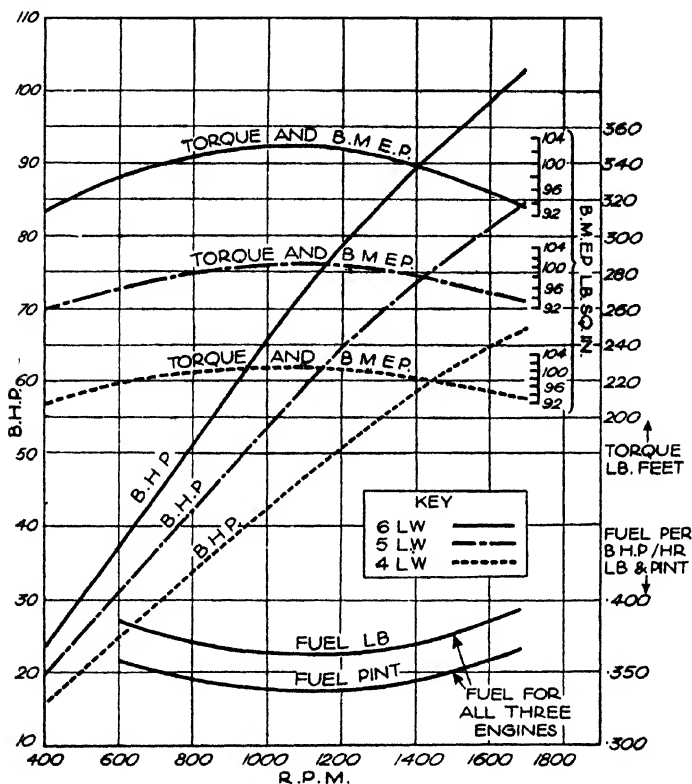

Performance curves of the Gardner six-, five- and four-cylinder engines.

But it was quite evident that an engine more suitable for a faster class of road transport vehicle was necessary, and in 1931 the Gardner LW engines were put on the market. Although in these the same general principles were followed, a considerable saving in weight and overall dimensions, and a great increase of power and speed were secured. As an example, the six-cylinder LW model, with its cylinders cast in two blocks of three, and aluminium crankcase, measured only 4 ft 8 in overall, and the weight was reduced to 14.6 lb/b.h.p., a figure later improved to about 13 lb.

THE MODERN DIESEL

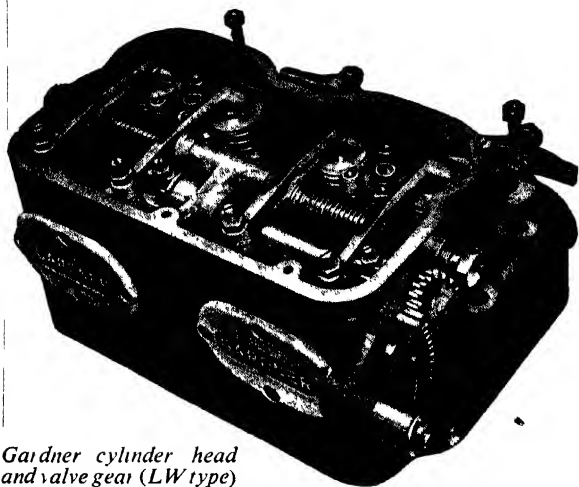

*Gardner cylinder head
and valve gear (LW type)*

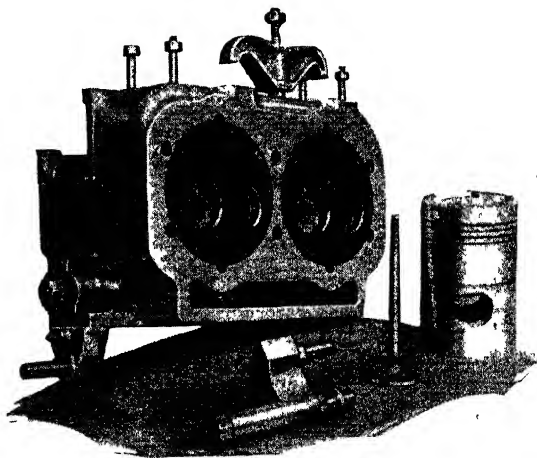

*Detachable valve seating plate (bronze) in the alloy
head of the Gardner 4LK lightweight engine*

TRANSPORT ENGINES REVIEWED

The same starting, injection and fuel pump arrangements were used on this engine, but the maximum speed permissible is 1,750 r.p.m. as against 1,300 r.p.m., with an idling speed of 395 r.p.m., and the maximum power developed is 102 b.h.p., while the consumption is rated at $\cdot 365$ to $\cdot 375$ lb/b.h.p./hour. All Gardner engines, however, are adjusted to about 70 per cent of the full power available to ensure long life and reliability. This conservative power setting ensures a remarkable standard of reliability and enables unhardened journals and crankpins to be used in conjunction with normal white-metal bearings. It may be pointed out that it has never been sought to reduce overall length of the engine at the expense of main bearing dimensions.

A new engine with eight cylinders in line but otherwise similar to the 6 LW and, indeed, having most of its parts interchangeable with other engines of the LW range, was developed during the war for special military vehicles. It has a maximum power output of 140 b.h.p. at 1,700 r.p.m., the capacity being 11.2 litres. Its application to normal road vehicles is somewhat limited on account of its high torque and the additional 12 in overall length but it is suitable for special vehicles for export and also to tractors, machinery haulage and other "exceptional load" vehicles.

To meet the growing demand for smaller four-cylinder diesels, the 4LK unit of $3\frac{3}{4}$ by $5\frac{1}{4}$ in bore and stroke, was introduced in 1935. The crankcase, cylinder block and cylinder head are cast in light alloy and inserted cylinder liners and detachable valve seating plates are fitted. Thus the weight, without electrical equipment, is less than 11 lb/b.h.p. A somewhat heavier version of this engine is also being made in cast-iron construction, all parts being interchangeable; this model has proved itself suitable for vehicles of about 9 tons gross weight.

An outstanding feature of all Gardner units is the ease with which they can be started by 12-volt motors or even by hand. They have been standardized on many notable British goods and passenger vehicles; past and present examples are the Bristol, Daimler, E.R.F., Foden, Guy, Karrier, Pagefield, and T.S.M. On the Continent they are manufactured under licence by Bernard in France, La Miesse in Belgium and Kromhout in Holland. The last named is of special interest because some models are supercharged with Marshall Roots-type blowers whereby power output is increased by some 40 per cent.

GENERAL MOTORS (GENERAL MOTORS CORPORATION, DETROIT, OHIO, U.S.A. and 14 HANOVER SQUARE, LONDON, W.1.)

Early in 1938 General Motors Corporation announced their intention of producing on a large scale a series of two-stroke blower-scavenged diesel engines having several interesting features. For road vehicles there are three models, all of $4\frac{1}{2}$ in bore and 5 in stroke, but built with three, four and six cylinders, giving outputs respectively of 83, 110 and 165 b.h.p. at 2,000 r.p.m. By the end

THE MODERN DIESEL

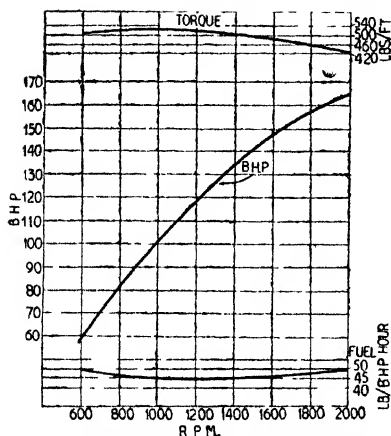

Performance curves of the G.M.C. six-cylinder two-stroke diesel

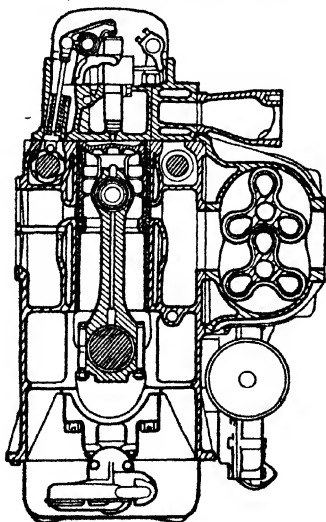

Section of the General Motors two-stroke engine

of 1941 upwards of 4,000 engines were in use in public service passenger vehicles, mostly the six-cylinder model. This unit is shorter than an equivalent petrol engine and not appreciably heavier, its complete dry weight with all accessories, including 1,800-watt dynamo and air-brake compressor, being 1,825 lb. In each case the cylinder block and upper half of the crank chamber form a single alloy-iron casting, in which dry cylinder liners are pressed.

The cylinder head is also a one-piece casting and carries two exhaust valves and an injector unit for each cylinder. A high-level camshaft and a balancing shaft on the other side of the engine are driven at crankshaft speed by helical gearing, which is encased at the rear of the engine and drives also the blower. The camshaft and balancing shaft rotate in opposite directions. Each cylinder has two exhaust valves and an axially mounted injector unit operated by rocker arms and short push-rods from the camshaft. The cam followers carry hardened-steel rollers on needle bearings and are held on the cams by coil springs. The blower is of the Roots three-lobe type and is carried on one side of the engine. It is driven at 1.94 times engine speed and at

TRANSPORT ENGINES REVIEWED

maximum speed creates an air pressure of about 7 lb/sq in in an air chamber which is contained in the cylinder block and communicates with the cylinder inlet ports. The inlet ports are drilled round the cylinder liners at an angle so that when they are uncovered by the piston at 48 degrees before bottom dead centre, the air enters with a rotary motion which thoroughly sweeps out all the burnt gases through the exhaust valves, and the compression stroke commences with a cylinder full of fresh clean air.

Fuel is supplied to the injectors at a pressure of 20 lb/sq in by a vane-type pump driven from the lower rotor shaft of the blower. It passes through an edge-type strainer in the inlet passage of the injector and into an annular supply chamber around a bushing which forms a high-pressure cylinder. A plunger operated by the rocker arm reciprocates in this bushing, the bore of which communicates with the annular chamber through two ports. Machined at the lower end of the plunger is a groove, the upper edge forming a helix, and by rotating the plunger by means of a control rack so that the closing of the upper port is advanced or retarded, the amount of fuel delivered is varied. The injection unit is fitted with a six-hole atomizing nozzle (see page 87).

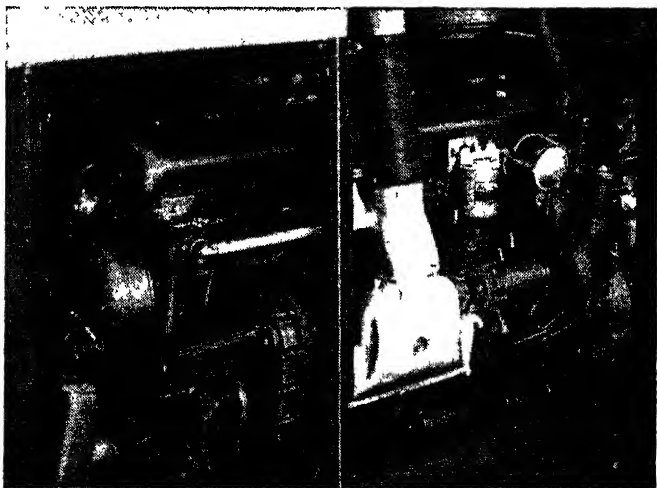

G.M.C. 7-litre six-cylinder forced induction two-stroke engine transversely mounted at the rear of an American bus. The adaptability of this engine to various methods of installation is an important feature

THE MODERN DIESEL

Tin-plated cast-iron pistons are used and are cooled by lubricating oil sprayed from nozzles fitted to the small ends of the drilled connecting rods. The upper ends of the latter are fitted with two-row needle bearings; the constant and "one-way" loading of the connecting rod bearings of a two-stroke engine is often advanced as a point in favour of the type, but it must not be overlooked that in four-stroke engines the reversal of pressure is of considerable assistance to small-end lubrication and permits a plain bush to be used for this bearing which is subject to limited oscillating movement only. Steel-backed lead-bronze-lined bearings are used for the big ends. The connecting rods, valves, pistons, main bearings and other parts are identical for all models and are therefore interchangeable. A further feature of interest also is that the symmetrical construction of the engines permits the blower and other auxiliaries to be mounted on either side, either the cylinder block or head can be reversed, while a simple change in the gearing gives either clockwise or anti-clockwise rotation.

During the war these G.M.C. engines were used for many military purposes and it is possible to increase the rated output of the six-cylinder unit to 205 b.h.p. at 2,100 r.p.m. for such work.

HANOMAG (HANNOVERSCHE MASCHINENBAU A. G., HANOVER, GERMANY.)

At the Berlin Motor Exhibition of 1936 Hanomag introduced a four-cylinder engine of 80 mm by 95 mm bore and stroke. Designed for installation in private cars, this was considered at the time to be the smallest four-cylinder diesel to be put into production. Of the pre-combustion chamber type and with a compression ratio of 20 to 1, this engine developed 35 b.h.p. at 3,500 r.p.m. Fuel was injected at a pressure of about 1,300 lb/sq in by a Bosch pump. Larger four- and six-cylinder Hanomag engines of 105 mm bore and 150 mm stroke were also produced. These were also of the pre-combustion chamber type and developed 55 b.h.p. and 100 b.h.p. respectively. Hanomag diesel engines apparently went out of production during the war.

HENSCHEL (HENSCHEL & SOHN, G.m.b.H., KASSEL, GERMANY.)

The Lanova air-cell combustion system was utilized for the Henschel range of road-transport diesels which comprised four- and six-cylinder models of 105 by 140 mm bore and stroke, a six-cylinder 110 by 160 mm engine, and six- and eight-cylinder types both of 125 mm bore and 160 mm stroke. The compression ratio in each case was 12.5 to 1, injection pressure being 1,500 lb/sq in. At the 1938 Berlin Show the company exhibited a new six-cylinder model of 135 by 180 mm bore and stroke, having a slightly higher compression ratio of 13.8 to 1 and developing 150 b.h.p. at 1,500 r.p.m. The six types were constructed on similar lines, being fitted with push-rod-operated overhead valves, aluminium-alloy pistons, wet cylinder liners and chrome-nickel crankshafts with hardened journals.

TRANSPORT ENGINES REVIEWED

HERCULES (HERCULES MOTORS CORPORATION, CANTON, OHIO, U.S.A.)

Several units are made to interchange with Chevrolet and Ford petrol truck engines. One is a four-cylinder of $4\frac{1}{2}$ in stroke with either $3\frac{3}{4}$ in or 4 in bore giving either 62 or 70 h.p. at 2,600 r.p.m. There are three flat engines (six cylinders) for mounting horizontally under the chassis; they are rated at 99, 142 and 260 h.p. respectively, all three running at 2,600 r.p.m. The combustion chamber is of the spherical air-cell type, not unlike the Omo used in the German Oberhansli (see page 94), with which some experiments were made in this country about 1932 but which made no headway. The Hercules consumption is given as 0.44 lb/b.h.p./hr at maximum torque, which suggests something in the nature of at least 0.5 lb at maximum power.

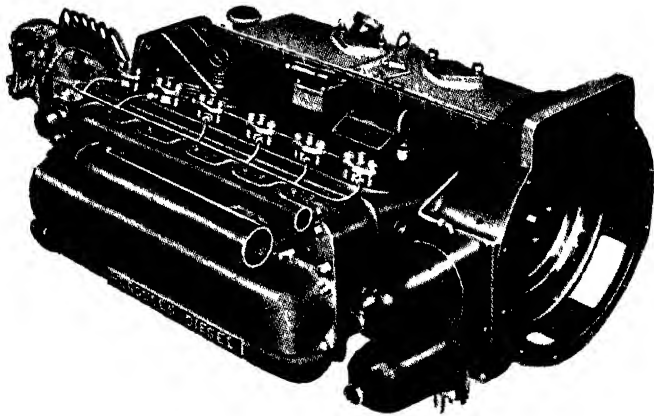

For underfloor installations, a Hercules flat engine

JUNKERS (FAHRZEUG- UND MOTORENWERKE G.m.b.H., VORM MASCHINENBAU LINKE-HOFMANN, WROCLAW, POLAND.)

The Junkers engine was not only a pioneer among high-speed c.i. engines, but its makers were faithful to the special two-stroke design with which their name was associated. A more complete description of the engine so far as its principles are concerned will be found in Chapter 12, which is devoted to aircraft engines. Although of German origin, the Junkers two-stroke diesel was

THE MODERN DIESEL

produced extensively in other countries, particularly in France prior to 1939 by the Société Lilloise de Moteurs and recently by De Dion (see page 152).

There are various models, with one, two, three and four cylinders, the last mentioned developing 110 h.p. at 1,500 r.p.m. Whatever the number of cylinders, the design is the same, these engines being characterized by two opposed pistons, the lower one, which uncovers the exhaust ports, being connected directly to the crankshaft, and the upper one, which uncovers the inlet ports, being connected to the crankshaft by connecting rods external to the cylinder bore.

The whole range of engines have a bore of 85 mm, the combined stroke of the two pistons being 240 mm. The stroke of the pistons, however, is not equal, in order to allow the exhaust ports to be uncovered in advance of the inlet ports. The exhaust ports are closed while the inlet ports remain open, thus assuring complete filling of the cylinder. The upper piston is made use of as an air pump to supply the fresh air necessary for scavenging the cylinders. When the two opposed pistons are coming together, and are almost at the end of their strokes, fuel is injected tangentially by means of a special pump. There is no war-time evidence of production of road-transport engines.

KAELBLE (CARL KAELBLE, G.m.b.H., BACKNANG, GERMANY.)

A range of six road-vehicle diesel engines was placed on the market in 1935 by this company, which produced stationary diesels since 1908 to the design of Haselwander, who claimed to be the

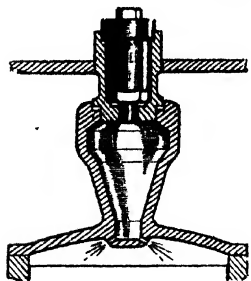

*Pre-combustion chamber
of the Kaelble engine*

originator of the pre-combustion chamber. The fuel sprayers are screwed vertically into the tops of the pre-combustion chambers which are cast in the cylinder heads. The chambers are roughly pear-shaped, tapering down to the main combustion spaces, their lower ends projecting slightly into the latter and being drilled with radial holes. Fuel was injected by a Bosch pump and sprayers at a pressure of 1,176 to 1,200 lb/sq in. A compression ratio of 17 to 1, gave a compression pressure of 497 lb/sq in. The Kaelble design is an interesting example of an early German pre-combustion system; it did not provide high efficiency.

KÄMPER (KÄMPER-MOTOREN, BERLIN-MARIENFELDE.)

The Kämper Company, despite a long and very successful experience in the building of c.i. engines, was relatively late in the field with engines primarily designed for road vehicles. The characteristic

TRANSPORT ENGINES REVIEWED

feature of Kämper engines was the form and arrangement of the air cell, which was of disc shape and arranged vertically on one side of the cylinder head with its plane at right angles to the crankshaft axis. This chamber was connected to the cylinder by a relatively large tangential venturi passage.

Another feature of interest was a petrol starting system; an additional chamber containing a sparking plug was connected to the cylinder head by a valve-controlled port. When starting from cold the valves of these additional chambers were opened and at the same time an induction pipe with a small petrol carburettor was connected, while the fuel injection pump and inlet valve were cut out.

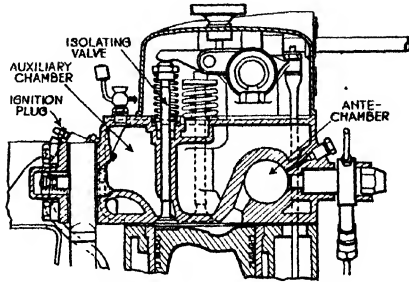

Cross-section of the Kämper cylinder head

KROMHOUT (KROMHOUT MOTORENFABRIEK, AMSTERDAM, HOLLAND.)

Based on the 6LW Gardner engine the Kromhout unit is made in

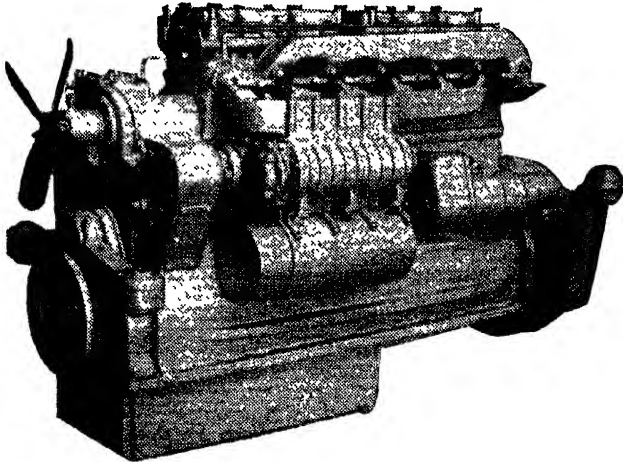

150 b.h.p. Kromhout supercharged engine

THE MODERN DIESEL

Holland under licence from the British makers. The essential design features are similar but the external structure is modified since the crankcase and cylinders form a monobloc casting in which the timing gear case, including a positive fan drive, is also incorporated. Kromhout has built Gardner engines for some fifteen years but their latest version, apart from the above-mentioned differences, is fitted with a Roots-type Marshall blower driven from the timing gear and directly flange coupled to a suitable air intake manifold. Boost pressure is from 2 to 4 lb/sq. in. and the standard 6LW performance of 102 b.h.p. at 1,800 r.p.m. is raised to 150 b.h.p. at 2,000 r.p.m.

KRUPP (FRIED, KRUPP, A.-G., KRAFTWAGEN-FABRIK, ESSEN, GERMANY.)

A horizontally-opposed four-cylinder air-cooled Krupp diesel engine was introduced early in 1933. At the Berlin Show of 1935, the company introduced a slightly larger model of 100 mm bore and 130 mm stroke, developing 55 b.h.p. at 2,200 r.p.m. A three-throw crankshaft was used, the centre throw accommodating two connecting rods side by side. The camshaft operated the valves in the cylinder heads through push-rods enclosed under the cylinders. The cylinder heads were of aluminium with cast-in steel valve seats. For cooling, a centrifugal blower, mounted on the front end of the crankshaft, delivered 4½ cu. ft. of air per second at 1,500 r.p.m., which was directed through a cowling on to the cylinder barrels, whence it escaped through the fins to the heads. The engine was of the pre-combustion type with 17 to 1 compression ratio, fuel being injected at 1,140 lb/sq. in. The ante-chambers were screwed into the cylinders near the head joint; light alloy pistons were fitted, the crown being cut away at one side to form a wedge-shaped combustion space directly under the pre-combustion chamber when the piston was at top dead centre. As usual with pre-combustion chamber engines heater plugs were a necessary fitting in the ante-chambers to facilitate starting. Injection was provided either by Deckel or Bosch fuel pump which was mounted centrally on top of the crankcase and gear driven from the rear end of the crankshaft; the lighting dynamo was mounted on top of the blower casing and was belt driven.

Various Krupp factories also built many types of normal in-line water-cooled transport engines, mostly following the typical German pre-combustion chamber layout except in certain units of the Junkers opposed piston two-stroke design.

Those who need information on maintenance should consult "Diesel Maintenance," a practical guide to the servicing of the modern transport diesel. The author is T. H. Parkinson, M.I.Mech.E., and the book is edited by Donald H. Smith, M.I.Mech.E., Assoc.Inst.T.

TRANSPORT ENGINES REVIEWED

LEYLAND (LEYLAND MOTORS, LTD., LEYLAND, LANCS.)

Although the Leyland Co. is one of the largest transport-vehicle producing firms in England, and had devoted considerable time to experimenting with many types of c.i. engines, it was not until the 1931 Motor Transport Show at Olympia that a Leyland diesel was offered as an alternative to the firm's petrol engines. The original engines were a 5.7 litre four-cylinder diesel of 114.3 by 139.7 mm bore and stroke and an 8.6 litre six-cylinder model having the same cylinder dimensions. They were of the direct-injection type and the basic design proved to be so successful that it was possible to claim that they were fitted to over 40 per cent of the total of oil-engined buses registered in the United Kingdom by the end of 1937.

Late in 1935 the company introduced a 4.7 litre six-cylinder air-cell engine specially for the lighter range of goods and passenger chassis known under the general name of the Leyland Cub.

In 1939, after eight years without substantial change, a new 100 b.h.p. six-cylinder heavy vehicle direct-injection type, having a toroidal-cavity piston, was being developed to replace the original 8.6 litre bus and heavy lorry engine but the war caused it to be diverted to military purposes; it was eventually released for civilian use in 1945 and is somewhat smaller (7.4 litres) than the original 8.6 litre engine, but develops rather more power at slightly lower speed and with better fuel economy.

In the case of the early direct-injection engines single-hole fuel sprayers of Leyland design were inclined at 15 degrees from the vertical in the head, so that the fuel was sprayed down one side of an offset cup-shaped depression formed in the top of the piston. Masked inlet valves ensured an air swirl during the induction stroke, turbulence being created by displacement of the air into the piston cavity towards the end of the compression stroke. Overhead valves were operated by an overhead camshaft driven by chain and helical gearing which permitted the head to be lifted without disturbing the chain or disconnecting any of the auxiliaries such as the fuel pump, exhaust, dynamo or fan. The exhaust valve seats were faced with Stellite and were screwed into position. High-duty aluminium-alloy top half shells and white-metal lined bottom shells were used for the big-end bearings, the crankshaft being case-hardened.



Cylinder liners on the latest Leyland engines are a light push fit in the block

THE MODERN DIESEL

The new 7.4-litre six-cylinder direct-injection engine is of the increasingly popular toroidal cavity piston type. The dry-lined cylinders form a simple monobloc casting which is bolted to a cast-iron crank-case, the overhead valves being carried in two separate heads, each serving a group of three cylinders. In the previous direct-injection engines an overhead camshaft was a feature but it is replaced by a camshaft in a chamber at the side of the cylinder block, the valve rockers being operated by short push-rods. A nitrided hardened crankshaft is now fitted and a triple roller chain is used to drive the camshaft and other accessory units and the cooling fan. C.A.V. injection equipment is used with four-hole Leyland sprayers; the new governor incorporating both the pneumatic and centrifugal-mechanical principles, which is described in Chapter 5, page 65, is used. The governed speed is 1,800 r.p.m. and at this speed the engine, which is of 110 mm by 127 mm bore and stroke (7,391 c.c.), develops 100 b.h.p. The compression ratio is 13.5 to 1 and the average fuel consumption is 0.355 pt/b.h.p./hr.

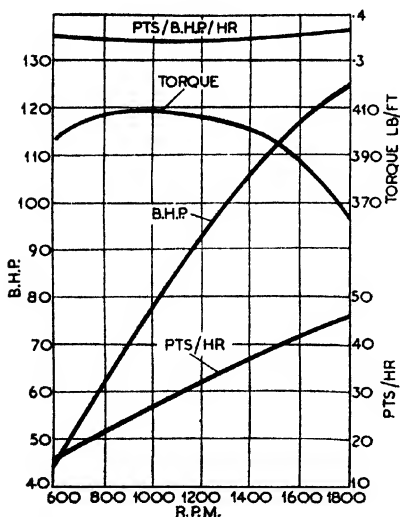

Power curves of Leyland 9.8-litre engine

hr at 1,200 r.p.m. rising to 0.36 at full speed and power. Injection is by Leyland four-hole sprayers and C.A.V. pump in co-operation with the Leyland-C.A.V. pneumatic-centrifugal governor. A later

During 1946 the Leyland range was extended by an entirely new engine, the "600", with a capacity of 9,783 c.c. (122 by 140 mm). Although it follows the same toroidal cavity combustion arrangement it is unlike the 7.4-litre unit in that the crankcase and cylinder block are one casting. The dry liners of the cylinder bores are an easy push fit so that they can be withdrawn or replaced without special tools or removal of the engine from the vehicle. The high camshaft is also displaced in favour of location in the crankcase, while the timing and distribution drive is entirely by gears. This engine has an output of 125-130 b.h.p. at 1,800 r.p.m. with maximum torque of 410 lb/ft at 900 r.p.m. Fuel consumption is 0.34 pt/b.h.p./

TRANSPORT ENGINES REVIEWED

*Leyland 7·4-litre 100
b.h.p. engine*

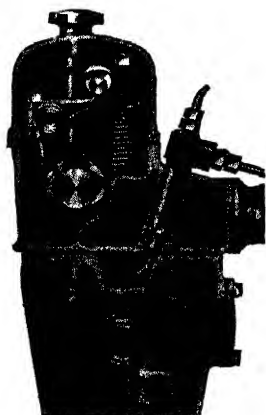
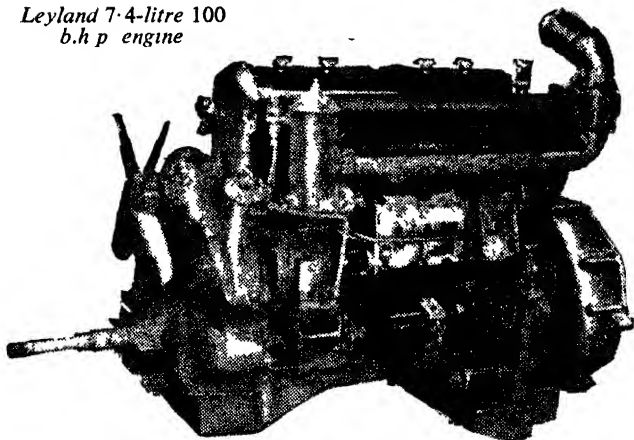

Original Leyland direct-injection cylinder head with simple cavity piston

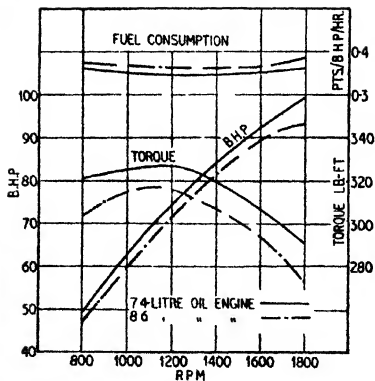

Comparative performance curves of the pre-war 8·6-litre Leyland engine and the latest 7·4-litre model

THE MODERN DIESEL

modification of this engine, a horizontal version for underfloor installation, was exhibited for the first time at the 1948 Earls Court Show.

A new Leyland six-cylinder engine of 5,020 c.c. (96.5×114.3 mm) was previously introduced for the 1948 range of Comet vehicles; it is on the same general lines as the 9.8-litre unit, having a cast-iron monobloc crankcase and cylinders with push-fit liners.

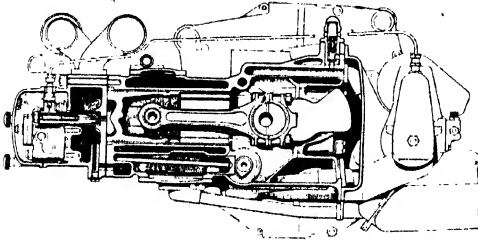

*Horizontal version
of the 9.8-litre
Leyland engine*

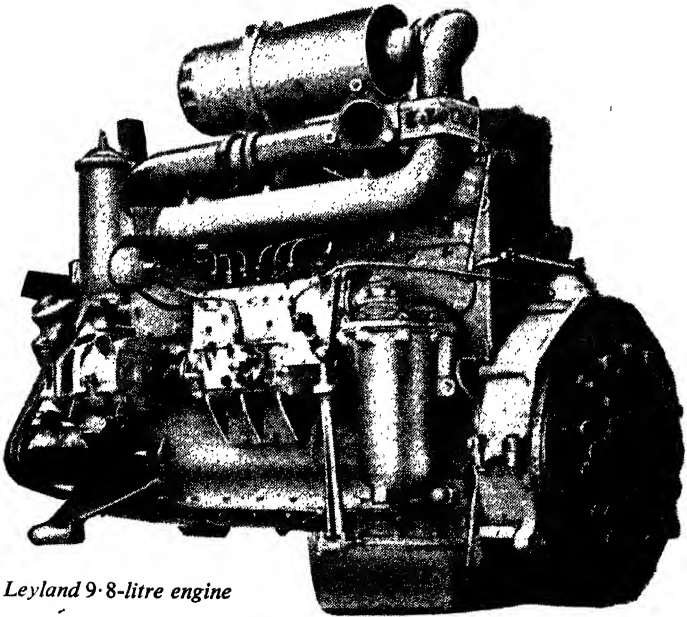

Leyland 9.8-litre engine

TRANSPORT ENGINES REVIEWED

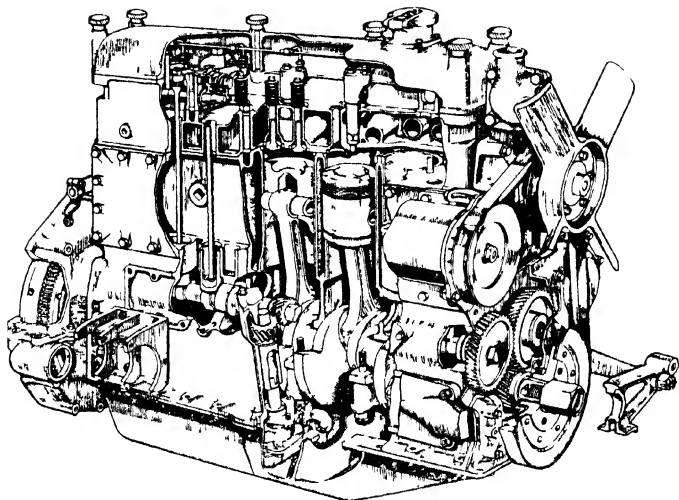

Leyland 5-litre 75 b.h.p. six-cylinder engine

At 2,000 r.p.m. the output is 75 b.h.p. and the power/weight ratio of the complete unit is 14 lb per brake horse power. Fuel is injected from a C.A.V. pump with a pneumatic governor giving low and high speed limits of 350 and 2,000 r.p.m. Full-load fuel consumption is 0.385 pt/b.h.p./hr.

MACK-LANOVA (MACK MANUFACTURING CORP., NEW YORK.)

Very much on the lines of other Lanova system engines (see page 93), there are six Mack transport engines, all with six cylinders, three for normal front mounting in truck chassis and three for transverse rear mounting in buses. The transport engines are 4 in by 5 $\frac{3}{8}$ in in bore and stroke, 405 cu. in. (101.6 mm by 136 mm, 6,630 c.c.), giving 107 b.h.p. at 2,200 r.p.m.; 4 $\frac{3}{8}$ in by 5 $\frac{1}{2}$ in, 518 cu. in. (111 mm by 146 mm, 8,490 c.c.), rated at 131 b.h.p. at 2,000 r.p.m.; and 4 $\frac{1}{2}$ in by 6 in, 605 cu. in. (120 mm by 152.5 mm, 9,920 c.c.), giving 144 b.h.p. at 2,000 r.p.m. Maximum torque is 308 ft/lb at 1,200 r.p.m.; 382 ft/lb at 1,300 r.p.m., and 455 ft/lb at 1,100 r.p.m. respectively. Bosch injection equipment is used, but no consumption figures are published. Resistance heater coils are fitted in the inlet manifold to assist starting. The three Mack bus engines are of similar sizes and performance range to the truck units, except that

THE MODERN DIESEL

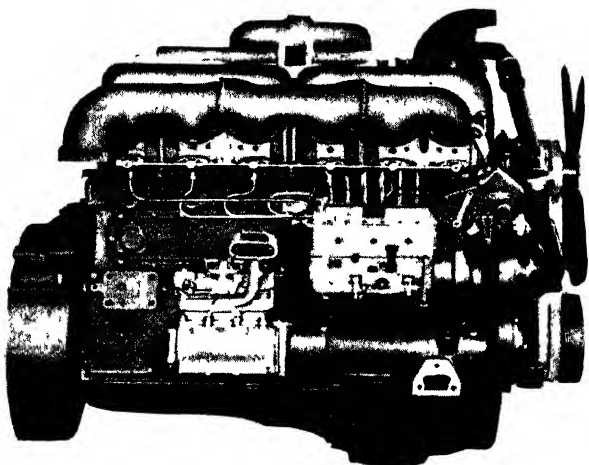

Mack-Lanova bus or truck engine (8.5 litres) rated for 131 b.h.p. at 2,000 r.p.m.

the smallest has a 4½ in cylinder bore against 4 in, and the power is 122 b.h.p. at 2,200 r.p.m. A centrifugal automatic variable timing device is fitted to the pump coupling on some of the Mack engines.

M.A.N. (MASCHINENFABRIK AUGSBURG NURNBERG A.-G., GERMANY.)

As stated in Chapter 2, the development of the original diesel engine is credited to the M.A.N. company. After four years' experimenting this was introduced early in 1897. There are thus more than forty years' experience behind the latest types of M.A.N. road-vehicle oil engines. Until 1933 the M.A.N. engines for road transport were of the direct injection type, but early in that year the company introduced two new smaller six-cylinder models of 105 by 130 mm and 105 and 140 mm bore and stroke, developing 80 and 90 b.h.p. at 1,800–1,900 r.p.m. respectively. These were fitted with a novel form of combustion chamber combined with an air cell, and by placing these to one side of the head, ample space for the valves was provided. The combustion chamber was cone-shaped and inclined at 45 degrees, with the larger diameter open towards the piston top, and in axial alignment at the other end was inserted a Bosch injector. Immediately below the combustion chamber was a horizontal air cell, having three orifices directed fanwise and slightly downwards. It was claimed for this design that a sudden

TRANSPORT ENGINES REVIEWED

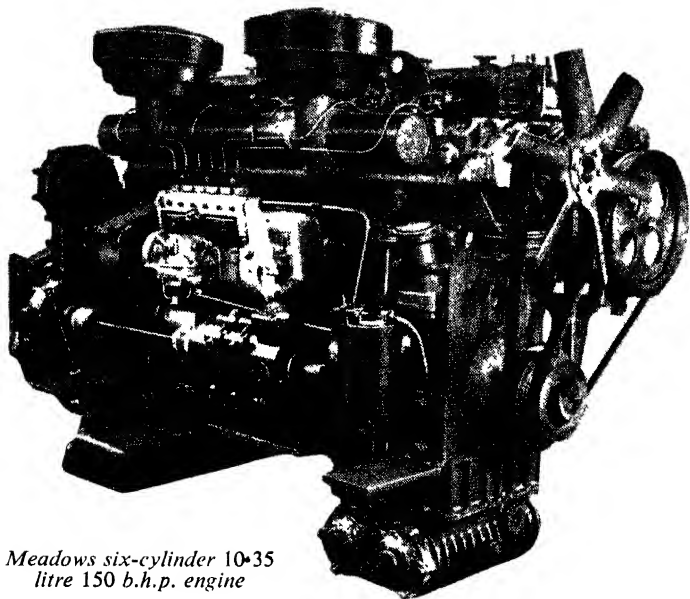

*Meadows six-cylinder 10.35
litre 150 b.h.p. engine*

changeable has an output of 85 b.h.p. at the same speed. Fuel consumption is at the rate of 0.38 lb/b.h.p./hr. There is also a horizontal model of the six-cylinder unit for flat underfloor mounting. Constructionally these engines are exceedingly robust and their adaptability in the matter of providing for the transference of auxiliaries from side to side or end to end gives them scope for wide differences of application.

MERCÉDÈS-BENZ (DAIMLER-BENZ A.-G., GAGGENAU [BADEN], GERMANY.)

This was one of the pioneers of heavy-oil transport. It operated on the pure ante-chamber system, being typical of German practice. Engines for light and heavy duty were made, and a point of special interest is that early in 1930 a Karrier six-wheel bus chassis was equipped with a Mercedes-Benz engine and put into service by the Sheffield Corporation, this being the first heavy-oil engined vehicle running on a municipal bus service in this country.

This particular engine had cylinder dimensions of 100 by 150 mm (7,069 c.c.), and its output was 77 b.h.p. at 1,650 r.p.m., with a maxi-

THE MODERN DIESEL

imum crankshaft speed of 1,750. In view of the date of this production the weight per h.p. was commendably low at 16½ lb.

The later engines were produced with six and four cylinders, both types having push-rod operated overhead valves. Originally arranged vertically in the centre of the head, the ante-chamber was later placed to one side and inclined, with the atomizer inserted in the top and similarly inclined. This modification gave increased space for the valves and rendered the ante-chamber and atomizer more accessible for removal. Two four-cylinder and two six-cylinder models developing 55, 70, 100 and 150 b.h.p. respectively were the leading types supplied for road transport vehicles. In the case of the largest, which was of 12.5 litres capacity, the cylinder block and upper portion of the crankcase were cast in light metal and fitted with wet cast-iron cylinder liners. In all cases the cylinder head is divided, the injection equipment is of the Bosch type and the compression ratio is 17.5 to 1, fuel being injected at a pressure of 1,250 lb. Heater plugs were necessary for starting. A feature of the Mercedes-Benz engine was that the fuel supply to three cylinders

could be cut out so that they might be used to create a vacuum for servo braking. A large saloon car with a 45-h.p. four-cylinder engine of the same type was exhibited in Berlin but it is doubtful if it reached the production stage. During the war Mercedes-Benz road transport engines were not built to any great extent and the present position is exceedingly vague.

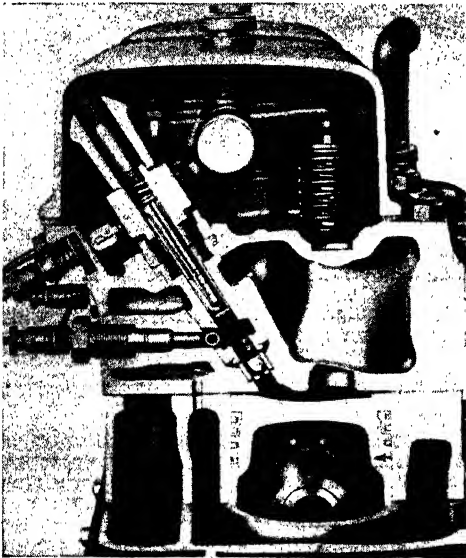

Pre-combustion chamber of the Mercedes-Benz engine in section

TRANSPORT ENGINES REVIEWED

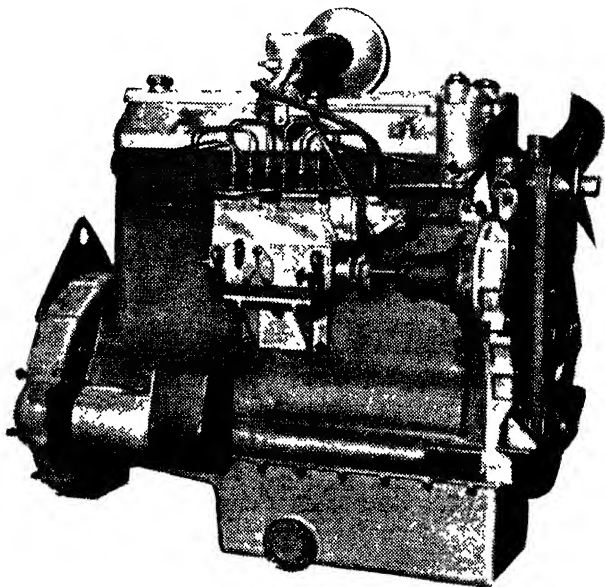

Morris (Saurer licence) 70 b.h.p. 4.25-litre engine

MORRIS COMMERCIAL (MORRIS COMMERCIAL CARS LTD.,
ADDERLEY PARK, BIRMINGHAM, 8.)

A licence to manufacture engines of Saurer design was obtained in 1938 after the production of Armstrong-Saurer vehicles at Newcastle-upon-Tyne had been discontinued. The war years prevented this development but it is now being revived and the Morris-built Saurer engine is of the lightweight high-speed type which the Swiss firm introduced in 1937. It is a direct-injection engine of 85 by 125 mm bore and stroke in four- and six-cylinder types (2,837 c.c. and 4,256 c.c.) developing 48 b.h.p. at 2,500 r.p.m. and 72 b.h.p. at 2,600 r.p.m. respectively. A simple oval-shaped piston cavity is used in conjunction with an annular slot sprayer which produces an exceedingly finely atomized fuel spray at all speeds and the engine will run up to very high speeds; it is governed to 2,500 r.p.m. in the four-cylinder model and 2,600 r.p.m. in the six. A C.A.V. fuel pump with pneumatic governor is used.

Lightness of construction is obtained by the use of aluminium alloy crankcase and cylinder block with cast-iron wet liners, which

THE MODERN DIESEL

are located in spigots at their lower ends. The crankshaft has hardened journals and crank pins, and all bearings are of the steel-shell lead-bronze type. A triple-roller chain drives the camshaft, which runs partly submerged in oil in a trough high on the side of the block casting so that short push rods only are used to operate the vertical overhead valves. On the original Saurer engine there were four valves per cylinder, but on the Morris version two valves are used and the inlet is unmasked. The air intake passage and port is vertical and direct, no restriction being introduced to promote air swirl, which is unnecessary with the new type of slot injector.

The six-cylinder engine weighs only 12 lb/b.h.p. completely equipped with all accessories and the performance range also makes the Morris engine a most suitable type for the medium-capacity class of goods vehicle on which the firm has concentrated.

M.W.M. (SÜDDEUTSCHE BREMFN-AKTIENGESELLSCHAFT, MUNCHEN 13, SCHLISSFACH 60, GERMANY.)

This company offered a range of four- and six-cylinder engines, all incorporating their own air-cell combustion head, and fitted with detachable cast-iron wet cylinder liners, with the exception of the 110 by 150 mm units, which had dry liners. The crank chambers, with one exception, were cast in silumin to reduce weight, while the pistons were of aluminium alloy. In all cases the compression ratio was 17.5 to 1, and the fuel was injected by Bosch pump and

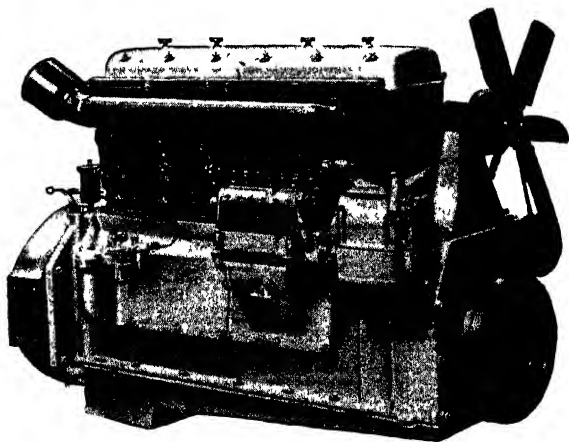

*Pre-war six-cylinder 130 × 170 mm M.W.M. engine,
which developed 150 b.h.p. at 1,600 r.p.m.*

TRANSPORT ENGINES REVIEWED

sprayers at a pressure of 2,130 lb/sq. in. The m.e.p. of these engines varies between 77 and 87 lb/sq. in. (a very low figure compared with British practice), while the weight, with flywheel, of the lightest, works out to 14.8 lb/b.h.p. No current information is available as to the continued production of this make.

OBERHÄNSLI (F. OBERHÄNSLI, MASCHINEN-FABRIK UND GIESSEREI, BREGENZ am BODENSEE, AUSTRIA.)

The Oberhänsli turbulence chamber combustion system described on page 94 was used for the Oberhänsli road-vehicle engines, of which five four-cylinder and one six-cylinder models were made. The smallest was the 65 mm by 110 mm bore and stroke unit which was demonstrated in an Amilcar two-seater private car, replacing a petrol engine of approximately the same capacity; 30 b.h.p. at 3,000 r.p.m. was claimed. With 80 mm bore and 120 mm stroke, the next four-cylinder unit developed 45 b.h.p. at 2,500 r.p.m. The other four-cylinder units were 100 mm by 140 mm developing 60 b.h.p. at 2,000 r.p.m., 120 mm by 160 mm developing 85 b.h.p. at 1,700 r.p.m., and 130 mm by 180 mm giving 100 b.h.p. at 1,500 r.p.m. The six-cylinder engine is of 100 mm bore by 160 mm stroke and had an output of 120 b.h.p. at 1,800 r.p.m. Present Oberhänsli activities are unknown.

PANHARD (PANHARD & LEVASSOR, 19, AVENUE D'IVRY, PARIS.)

For some years sleeve-valve engines in both four- and six-cylinder models were built but they were discontinued in favour of poppet valves in conjunction with the Lanova design of combustion chamber. A four-cylinder engine of this type was embodied as the power unit of a rear-engined Tubauto coach exhibited at the 1946 Paris Show; this engine was the only representative of the French industry at the Transport Show at Earls Court, London, in September, 1948.

PERKINS (F. PERKINS, LTD., QUEEN STREET, PETERBOROUGH.)

Since their introduction the following Perkins diesel engines have appeared: Wolf, 85 mm bore and 120.6 mm stroke, giving 45 b.h.p. at 2,500 r.p.m.; Lynx, 100 mm bore and 127 mm stroke, giving 55 b.h.p. at 2,400 r.p.m.; Leopard I, 100 mm bore and 127 mm stroke, giving 60 b.h.p. at 2,400 r.p.m. and Leopard II, 105 mm bore and 127 mm stroke, giving 75 b.h.p. at 2,400 r.p.m. This range is now superseded by the P series—the Aeroflow P4 four-cylinder model of 87.9 mm bore and 127 mm stroke, giving 56 b.h.p. at 2,600 r.p.m. and the Aeroflow P6 six-cylinder unit, having the same dimensions, but giving 85 b.h.p. at the same speed. All the above models are fitted with the Perkins Aeroflow combustion head described on page 101.

In this series of engines the atomizers are located vertically in the top of the cylinder head for the sake of simplicity and ease of maintenance; the cooling arrangements have been particularly directed to the atomizers and valve seats. The weight per b.h.p. in comparison with the earlier models was considerably reduced

THE MODERN DIESEL

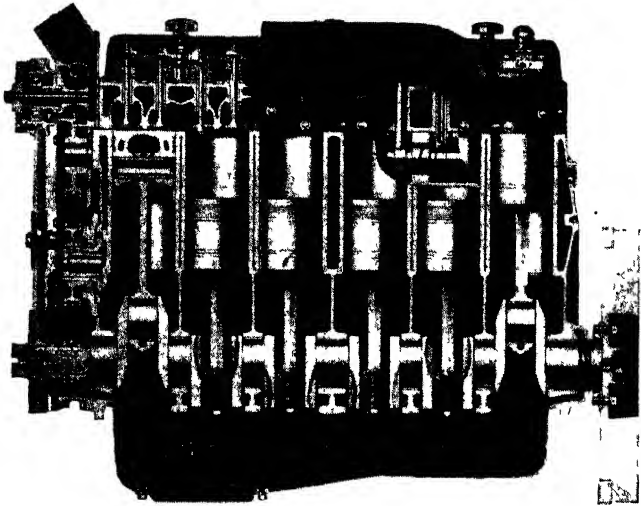

Longitudinal section of the Perkins P6 diesel

without sacrificing the rigidity and solidity of the general construction. Optimum fuel consumption is 0.35 pt/b.h.p./hr.

The cylinder block and crankcase form a one-piece chromium alloy iron casting of exceptional depth to give rigidity; it is fitted with a one-piece head also of chromium cast iron. The camshaft is carried at a high level on the cylinder block. The main and big-end bearings are of the composite type, with lead-bronze half shells taking pressure load, the opposite halves being white metal. Fuel is injected by a C.A.V. pump with pneumatic governor. For extreme cold starting conditions an air induction electric heater and Kigass paraffin injector are standardized additional equipment. Several Perkins engines, ungoverned, and with lightened reciprocating parts, were fitted to private cars prior to 1939.

RENAULT (SOC. ANON. DES USINES RENAULT, 8-10, AVE. EMILE ZOLA, BILLANCOURT, SEINE, FRANCE.)

The Renault range up to 1940 was a broad one and it included four engines designed for road transport: a four-cylinder of 100 by 150 mm bore and stroke, developing 65 b.h.p. at 2,200 r.p.m.; a four-cylinder of 125 by 170 mm, giving 85 h.p. at 1,600 r.p.m.; a six-cylinder of 125 by 170 mm, rated at 130 h.p. at 1,500 r.p.m., and a six-cylinder of 140 by 170 mm, giving 150 b.h.p. at the same speed.

TRANSPORT ENGINES REVIEWED

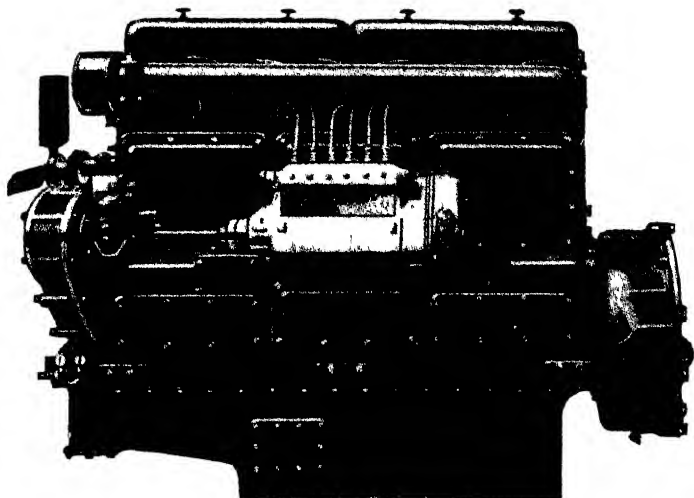

A pre-war French design, the 130 h.p. six-cylinder Renault

The smallest engine was of the air-cell type, while the three others were direct-injection units and similar in general design. The compression ratio was 16 to 1 in each case, the piston crowns being of the toroidal-cavity type. It is thought that as yet no post-war production has been resumed.

ROCHET-SCHNEIDER (CHEMIN FEULLET, LYON, FRANCE.)

A 120 h.p. six-cylinder engine was seen in the maker's own heavy lorry exhibited at the 1946 Paris Show. The bore and stroke are 115 by 150 mm (9,348 c.c.) and it is of the direct-injection type with an egg-shaped piston cavity. There are two inlet valves and one exhaust, all vertical and push-rod operated.

It should be noted that although this book does not attempt to provide a complete specification of every individual engine in current production, its object is to define and illustrate the latest practice in this and other countries, as well as to include references to certain engines no longer made but which had notable influence on development. If up-to-the-minute details of a particular range of engines is required communication should be made direct to the makers, whose full names and addresses are provided.

THE MODERN DIESEL

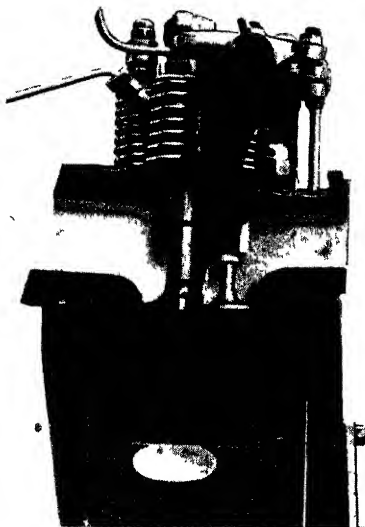

Three-valve Rochet-Schneider cylinder head and cavity piston—see page 185

SAURER (SOCIÉTÉ ANONYME ADOLPHE SAURER, ARBON, SWITZERLAND.)

It may, perhaps, truly be said that the Saurer Co. of Switzerland is largely responsible for the rapid growth of the c.i. engine in road transport, since this famous Swiss make was put on a production basis in 1928. For a number of years Saurer diesel engines were manufactured under licence by Armstrong Saurer Commercial Vehicles, at Newcastle-on-Tyne, but that company's production ceased in 1937.

Originally designed around the Acro pre-combustion system, the Saurer engine was modified from time to time until in November, 1934, the dual-turbulence design referred to in Chapter 6 was introduced. Improved volumetric efficiency and central location of the injector were obtained by adopting four valves per cylinder. These were operated by two rocker shafts and two sets of rockers for each pair of valves, the whole of the valve gear being carried in a silumin frame. One set was operated by vertical push rods from a camshaft on the near side of the engine, hardened-steel cup

TRANSPORT ENGINES REVIEWED

ends engaging with ball-ended adjusting screws on the outer ends of the rockers. The inner ends of the latter were fitted with hardened steel rollers bearing on the inner ends of the other set of rockers, which swung from the rocker shaft on the off side. Apart from the ball-and-socket adjustment on each push-rod, only one screw was required for adjusting both valves simultaneously. But the most important feature was the heart-sectioned depression with its central cone in the piston crown which became known as the "toroidal cavity"—a name descriptive of the path of the dual-turbulence air flow. This has had the most profound influence on British diesel-engine design, for in one form or another the toroidal cavity piston has become the most commonly accepted type, being incorporated in the engines of all but four of the leading British transport vehicle engine makers.

As previously, the crankcase and cylinder block of the latest types of the Saurer engine form a one-piece casting, and wet cylinder liners are inserted. For the larger models the crankshaft is a built-up assembly with a large-diameter roller bearing between each throw. Both four- and six-cylinder engines are available, the dimensions being 105 mm by 130 mm, 110 mm by 120 mm, 110 mm by 140 mm, and 110 mm by 150 mm bore and stroke.

These engines are fitted also with the Saurer fuel injector, which cannot be incorrectly assembled. It is carried in a housing screwed into the head through the water jacket, and the bottom of the injector body, in which the nozzle is fitted and which is exposed to the heat of combustion, is formed with three vertical slots so that

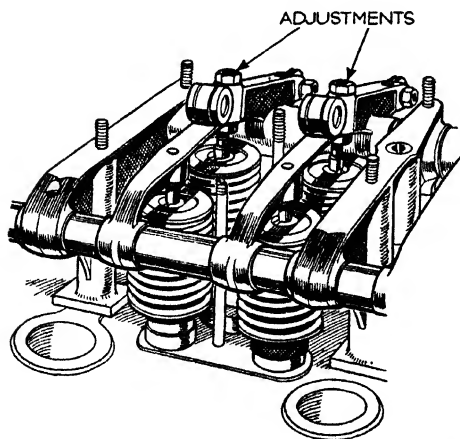

Showing how the duplicated valves of the Saurer engine are operated and adjusted

variations in the diameter of the bore, due to temperature fluctuations, is avoided. The needle is made in two diameters, the smaller leaving a clearance within the nozzle through which the fuel passes, the larger being a sliding fit in a guide above the nozzle where it is not affected by wide variations in temperature. The needle has two differential faces and there are four 0.25 mm nozzle orifices.

THE MODERN DIESEL

A range of smaller engines of 80 and 85 mm bore was introduced in 1937. These had an oval-shaped piston cavity and an annular slot nozzle, being designed for much higher speeds than had previously been used; engines of this type are now produced in this country by Morris Commercial Cars, Ltd. (see page 181), the only model being the 85 mm bore four- and six-cylinder units.

Experiments with exhaust driven turbo superchargers began in 1937 and resulted in 35 to 45 per cent increase of power. A six-cylinder 8-litre engine developing 100 b.h.p. at 1,900 r.p.m. with natural aspiration was stepped up to 135 b.h.p. at the same speed while retaining the very favourable consumption of 0.37 lb/b.h.p./hr at 1,300 r.p.m., the speed of maximum torque; at 1,900 r.p.m. and maximum power the consumption is 0.396 lb/b.h.p./hr.

For the heaviest classes of road vehicles V-8 engines of 110 by 140 mm bore and stroke were produced before the war, while at the 1947 Geneva Motor Show a 60 degree V-12 engine of 15.9 litres capacity was exhibited. It had the dual-turbulence combustion chamber and its output was 300 b.h.p., there being a Brown-Boveri exhaust turbo supercharger on each bank of cylinders. An unusual feature of this engine is that the inlet valves are rotatable by an external control whereby the position of the masks under the valve heads can be adjusted to modify the swirl of the ingoing air in relation to load and fuel delivery characteristics; it is not clear if the control is manually operated or if it automatically responds to speed and load.

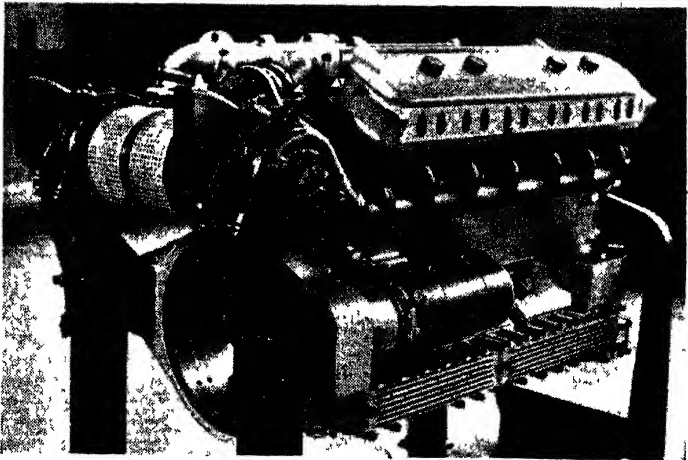

Saurer 300 b.h.p. V-12 engine with exhaust turbo blowers on each bank of cylinders

TRANSPORT ENGINES REVIEWED

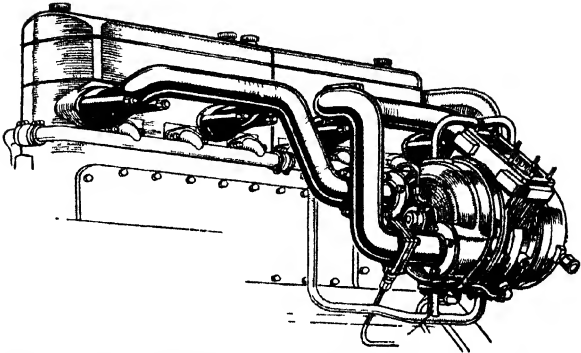

*Saurer engine with Brown-Boveri exhaust turbo-supercharger
The exhaust manifold is divided into two groups of three cylinders for connection to the supercharger, as discharge through a single manifold is not feasible in an application of this type*

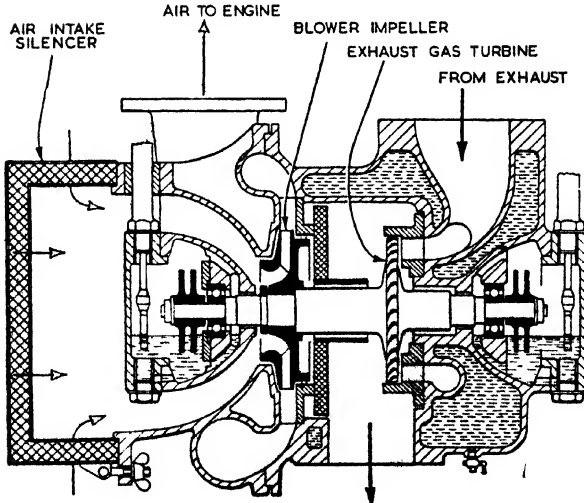

Sectional diagram of the Brown-Boveri blower

THE MODERN DIESEL

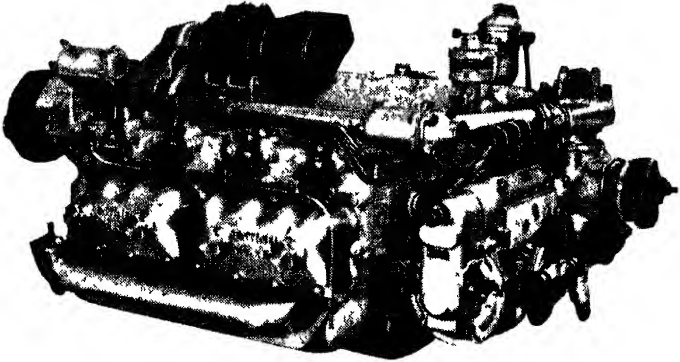

Sentinel-Ricardo engine for flat mounting under the chassis

SENTINEL (SENTINEL (SHREWSBURY) LTD., SHREWSBURY.)

In a new lorry introduced in 1946 is a Sentinel four-cylinder inline engine mounted horizontally beneath the chassis frame. This new engine has been designed for operation in this position, the cylinder block and crankcase being a single casting in iron with a large aluminium access plate on the uppermost side of the base chamber so the main and big-end bearings can be reached easily from above.

The total cylinder capacity is 6,080 c.c. (bore and stroke 120.6 by 133.3 mm) and the power developed is 90 b.h.p. at 2,000 r.p.m. Maximum torque is 255 lb/ft at 1,500 r.p.m. The Ricardo Comet Mark III air-cell combustion system is used, with pintle-type injectors; the C.A.V. injection pump is mounted vertically alongside the front of the cylinder block and is driven by bevel gear.

Dry liners are fitted in the cylinders, the connecting rods are of the four-bolted big-end type and the cast iron crankshaft runs in five bearings which have lead-bronze steel-strip liners. The cylinder head is divided into two pairs and the pistons can be drawn out from the side of the chassis without dropping the engine. Timing and auxiliary drives are by spur and bevel gears at the front end of the crankshaft, with duplex chain to the camshaft.

Towards the end of 1948 a six-cylinder engine of similar cylinder dimensions (9,120 c.c. capacity) was put into production. Most of its components are interchangeable with those of the four-cylinder unit or their design is basically the same. C.A.V.-Ricardo "pintaux" injectors are fitted. At the governed speed of 2,000 r.p.m. output is 135 b.h.p.

TRANSPORT ENGINES REVIEWED

SOMUA (BOULEVARDE VICTOR HUGO, ST. OUEN, SEINE, FRANCE.)

In 1946 a six-cylinder Lanova head engine of 110 by 150 mm bore and stroke (8,556 c.c.) was being fitted to the maker's heavy lorries; no specific details are available except that it is claimed to develop 120 b.h.p. at 2,000 r.p.m.

SULZER (SULZER BROS., WINTERTHUR, SWITZERLAND AND NEW YORK, U.S.A.)

An opposed-piston two-stroke engine was developed in Switzerland in 1937, known as the ZG9 type, and these were introduced in America during the war. Combustion takes place between the two pistons in a single cylinder, the pistons being connected through rockers to connecting rods which are carried on separate cranks at 180 degrees. Air charge and scavenging is provided by a separate reciprocating pump, the piston of which is driven from one of the rocking links. A small two-cylinder 35 h.p. engine is made for tractors; it has a bore and stroke of 69 mm by 101.6 mm. A larger engine (89 mm by 120 mm) is made for trucks in two-, three- and four-cylinder versions and a six- is being developed. A feature of the Sulzer engine is the ease of access to the pistons and internal mechanism.

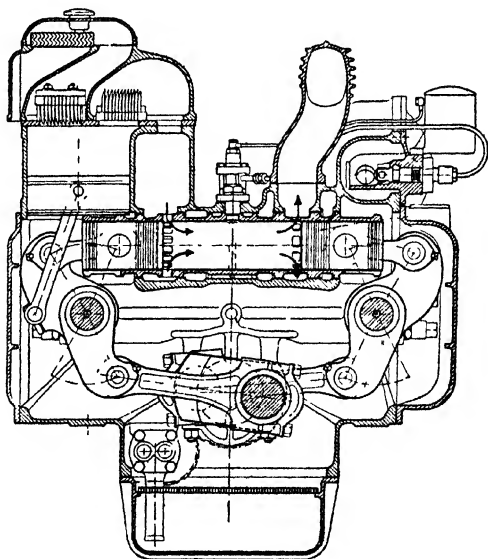

Cross-section of Sulzer two-stroke opposed-piston oil engine

THE MODERN DIESEL

TATRA (PRAGUE, CZECHOSLOVAKIA.)

In 1943 this firm was directed to develop an 8-ton lorry for the German army. It was powered by a V-12 air-cooled diesel of 14.8 litres to give 220 b.h.p. at 2,250 r.p.m. There were two push-rod operated valves per cylinder set at a very wide angle to each other. The cylinder heads were of aluminium and heavily finned. Two six-element pumps were mounted between the two banks of cylinders. In front of each cylinder bank was an axial cooling fan with guide vanes in front and diffusing vanes behind by means of which air was supplied to ducts along the cylinders. The air stream flowed along the blocks and passed over the heads; the air-cooling system and also the elaborate filtering of the engine air intake would suggest that this machine was intended for desert operation and it appeared to be purely a military design.

Experience gained with this engine is no doubt reflected in the introduction of a four-cylinder air-cooled engine as a post-war production; an example was staged at the 1947 Geneva Show.

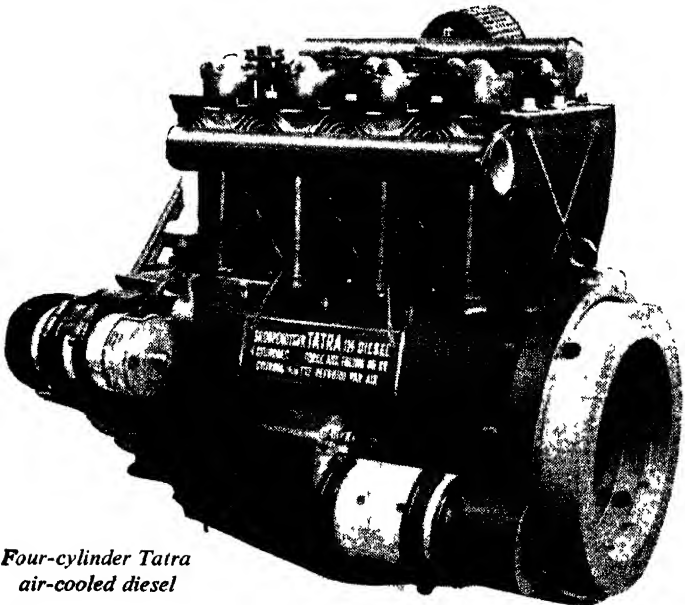

*Four-cylinder Tatra
air-cooled diesel*

TRANSPORT ENGINES REVIEWED



Sulzer opposed-piston two-cylinder two-stroke lorry engine showing accessibility when mounted in chassis (see page 191)

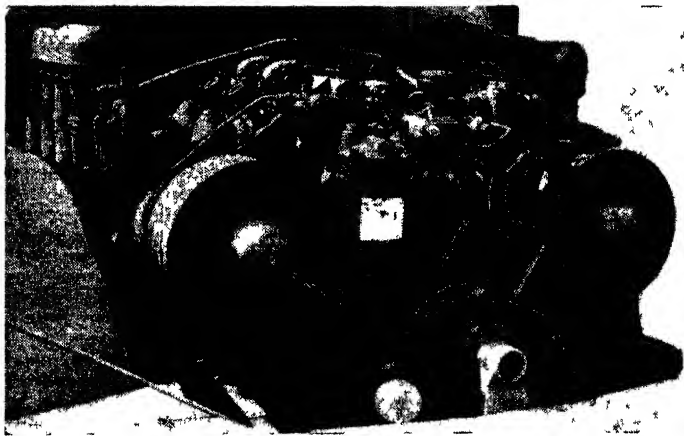

Tatra 220 h.p. air-cooled V-12 engine for military vehicles

THE MODERN DIESEL

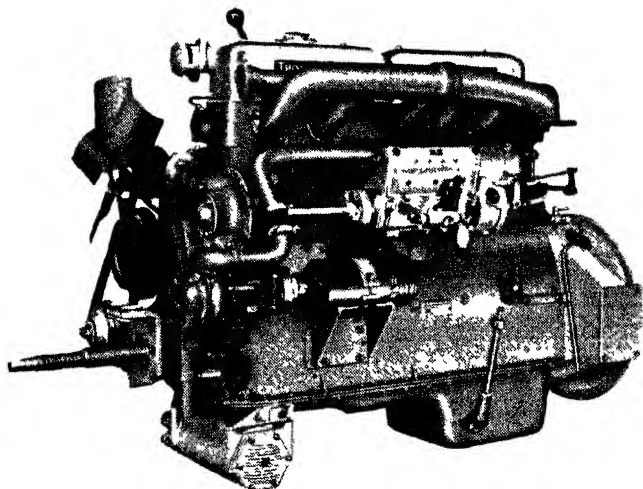

Thornycroft 7.8-litre direct-injection engine

THORNYCROFT (JOHN I. THORNYCROFT & CO., LTD., THORNYCROFT HOUSE, LONDON, S.W.1, AND BASINGSTOKE.)

The steady trend towards direct injection and the growing acceptance of the toroidal cavity piston is illustrated in the history and development of Thornycroft road transport oil engines. Air-cell combustion chambers were first used and one model, the TR6 (4.04-litres) still retains this combustion system in the form of Ricardo Comet Mark III cylinder heads.

A larger engine, the NR6, which was introduced about 1939, had a capacity of 7.8 litres. It was a six-cylinder unit developing 100 b.h.p. at 1,800 r.p.m. In its first form this engine had direct injection with multi-hole sprayers into simple piston cavity combustion chambers. Mechanically the unit was of conventional design, compactness being an important feature. This power unit has been subject to detail modifications from time to time and about four years ago the toroidal cavity piston was incorporated. Cylinders and crankcase form a monobloc casting with a very small timing casing. The crankshaft runs in steel-backed white metal bearings while the big-end bearings are composite with copper-lead top and white metal bottom halves.

At the 1948 Earls Court Show three new direct-injection units were exhibited. These were all of the toroidal cavity piston type and of substantially similar mechanical design with monobloc cast

TRANSPORT ENGINES REVIEWED

iron crankcase with dry cylinder liners, the camshaft being located in the crankcase.

These engines were respectively a small four-cylinder unit of 2.7 litres of 36 b.h.p. rating at 1,800 r.p.m. and two six-cylinder models of 4.04 and 5.5 litres capacity respectively; power outputs of these engines of 54 b.h.p. at 1,800 and 75 b.h.p. at 1,900 r.p.m. were tentatively quoted, but these units are not yet in production and specific details cannot be provided. The further development of the smallest of

these new engines will be observed with great interest because automotive type diesels of under three litres capacity have not hitherto been applied to road vehicles.

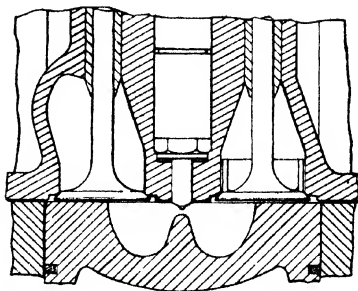

Toroidal cavity piston now adopted in Thornycroft engines

TILLING STEVENS (TILLING STEVENS, LTD., 114, GRAND BUILDINGS, TRAFALGAR SQUARE, LONDON, W.C.2, AND VICTORIA WORKS, MAIDSTONE.)

Designed expressly for under-frame mounting in order to make available the maximum floor space for pay loads, an eight-cylinder

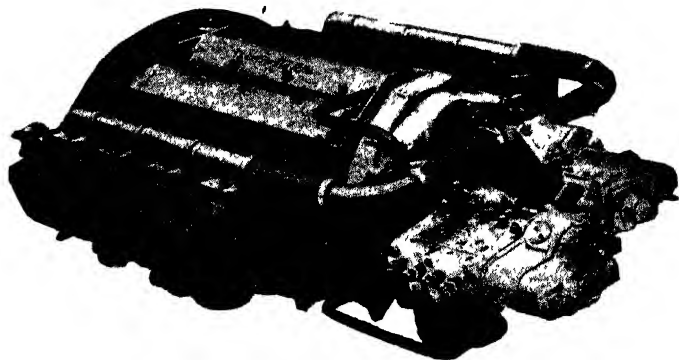

Tilling-Stevens horizontally opposed eight-cylinder flat diesel

THE MODERN DIESEL

horizontally opposed diesel was exhibited at the Earls Court Show in 1937. Of compact design, it was of the direct-injection type utilizing multi-hole sprayers which injected the fuel towards cavities in the pistons. The cylinders were bored to 110 mm diameter and the pistons had an exceptionally short stroke of 98 mm, the total swept volume being 7.45 litres. At a governed speed of 1,650 r.p.m., the rating was 90 b.h.p. with a maximum output of 110 b.h.p. at 2,250 r.p.m. Although of great technical interest because of its incorporation of many advanced features, this engine did not go into production and it was not applied to vehicles in normal use. Nevertheless it was a pointer towards the use of flat engines for underfloor mounting widely accepted in U.S.A. and which is showing signs of becoming a factor in transport vehicle development in this country.

UNIC (QUAI NATIONALE, PUTEAUX, FRANCE.)

Four- and six-cylinder engines of 118 by 150 mm bore and stroke (7,135 and 10,700 c.c.) are being built as the power units of Unic lorries. The combustion chamber is a flattened air-cell off-set to one side of the cylinder bore. The head of the exhaust valve forms the "roof" of this cell, while the inlet valve is positioned normally flush with the cylinder-head joint. On the top of the piston is a boss so placed that it enters the throat of the air-cell. An inclined plane on the boss directs the air swirl into the cell at the moment of "squish" from the cylinder. A three-hole injector sprays the fuel fanwise and in a somewhat downward direction in opposition to the air movement promoted by the helically formed plane on the boss.

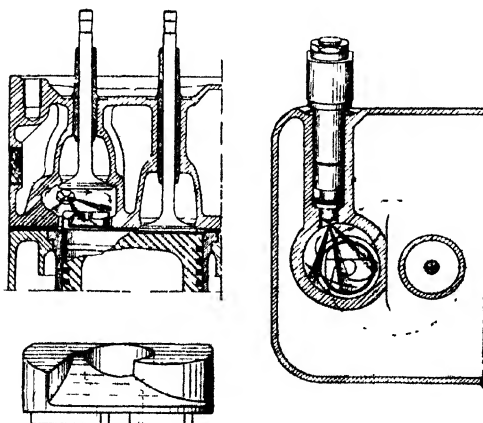

Unic air-cell combustion chamber

Heat distribution and cooling arrangements in this design are not without interest. Placing the exhaust valve in the combustion chamber will ensure maximum temperature of the compressed air while at the same time there is no serious restriction upon valve timing liable to affect good scavenging. Valve guides and seats

TRANSPORT ENGINES REVIEWED

and the injector body are adequately and evenly surrounded by water jacketing.

WAUKESHA (WAUKESHA MOTOR CO., WAUKESHA, WISCONSIN, U.S.A.)

The Ricardo-Comet type of combustion chamber and pintle-type sprayers are used for three six-cylinder engines of 92.07 by 114.3 mm, 111.12 by 130.11 mm, and 126.9 by 139.5 mm bore and stroke, with piston displacements of $4\frac{1}{2}$, $7\frac{1}{2}$ and $10\frac{1}{2}$ litres capacity. In all cases the compression ratio is 17 to 1 and the injection pressure 1,500 to 2,500 lb/sq. in. With normal speed range of 800 to 2,600 r.p.m., the smallest model develops a maximum of 80 b.h.p., the maximum b.m.e.p. and torque being 94 lb/sq. in. and 174 lb/ft at 1,700 r.p.m. The larger engines have a speed range of 600 to 2,200 and develop 100 and 140 b.h.p. The maximum b.m.e.p. and torque are developed at 1,200 r.p.m. and amount to 95 lb/sq. in. and 275 lb/ft, and 98.5 lb/sq. in. and 410 lb/ft.

Cast in molychrome iron, the cylinder block is fitted with renewable dry-type liners. The pistons are of aluminium alloy, and the crankshaft of heat-treated steel. All are fitted with heating plugs and 24-volt electric starters.

WILLÈME (ÉTABLISSEMENTS WILLÈME, RUE DE COLOMBES, NANTERRE, SEINE, FRANCE.)

Six- and eight-cylinder in-line engines fitted in this firm's heavy lorries are built under Deutz licence (see page 155). With bore and stroke of 130 by 170 mm these engines are of the large capacity of 13.5 and 18 litres respectively; the output of the six-cylinder model is 150 b.h.p. and of the eight 220–225 b.h.p., both at 1,600 r.p.m. Having regard to their size, the specific output is possibly a little below that of typical British engines but they are nevertheless

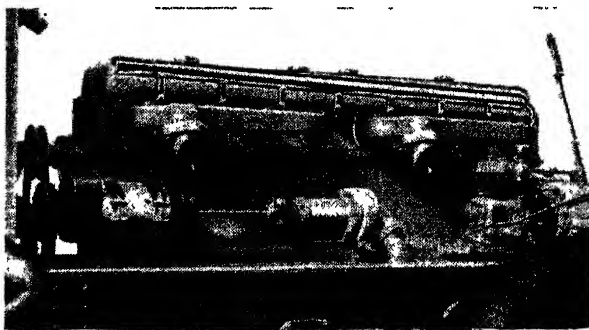

Willème eight-cylinder in-line 200–225 h.p. engine

THE MODERN DIESEL

impressive units and there is much to be said in favour of large engines working well within their limits for use in very large-capacity transport vehicles. It is quite obvious that the legislation which restricts British vehicle design does not apply in the same onerous way in other countries. Large power units have many advantages both from the vehicle performance aspect and also from the point of view of the provision of ample bearing areas. Nevertheless the premium placed upon minimum physical dimensions of the power unit by our taxation and constructional requirements have compelled British designers to exert a much more concentrated effort in the search.

Diesels in Railway Service

TO a large extent the introduction of the modern high-speed diesel engine into railway operation may be attributed to experience gained on the road. At the same time, the diesel engine would have made little progress in railway service had it not been for the fact that it offered important practical and economic advantages under certain operating conditions as compared with the steam locomotive which it was already extensively displacing in many countries prior to 1939.

The demand for higher speeds and greater frequency of services had, of course, in many cases been met by systems of electrification, but the high cost of conversion from steam to electricity is justified only where the volume of traffic handled is such as to necessitate fast and frequent services. Diesel-engined rail cars and locomotives are self-contained units and their employment by railway undertakings involves considerably less capital expenditure than is incurred by electrification, and, moreover, they can be substituted gradually as steam locomotives are withdrawn, and, like the latter, the entire system is not interrupted as in the case of electrical operation in the event of power station breakdowns.

In comparing the diesel-engined rail car or locomotive with the steam-driven type, it will be seen that it has many important claims for consideration. In the first place, its fuel economy is considerable, due to its relatively higher thermal efficiency. For example, a diesel-electric locomotive gives out at the drawbar the equivalent work of about 20 per cent of the heat units contained in the fuel as compared with 7 per cent in the case of a steam locomotive. The calorific value of oil fuel is higher than that of coal so that in a given storage space a very much greater quantity can be carried; in fact, the use of a tender is avoided. Refuelling is far less frequent, as well as quicker, easier

THE MODERN DIESEL

and cleaner than in the case of a steam locomotive, and with oil fuel both coal dumps and clinker pits can be abolished as well as considerable coal traffic, thus releasing many trucks for other work. The continual filling of water tanks is another inconvenience and cause of expense and delay which the diesel avoids, and which is a particularly important consideration in countries where large waterless areas are traversed, not to mention extremely cold climates. The chemical purity of water used for radiators is also less important than for steam boilers.

With the diesel engine, too, there is no cleaning of the fire-box or washing out of the boiler, nor has steam to be raised before getting under way. Its control is simpler than that of the steam locomotive, so that the driver's attention is less diverted from the signals and track and he does not require the services of a fireman. There is no smoke to interfere with the driver's vision or inconvenience passengers, fire risk is much reduced, whilst there is considerably less dirt deposited at stations, running sheds and along the permanent way. A further advantage from the operator's point of view is that there are no stand-by losses and the number of hours service obtainable per day is greater. From the maintenance point of view it has been found that the diesel engine shows to advantage, while it requires less special repair equipment than a steam engine and boiler.

The diesel engine has been employed for a wide variety of purposes. In addition to the self-contained rail cars used with or without trailers principally for short-distance and branch-line services, it has been found particularly suitable and economical for shunting locomotives and in the larger sizes is employed for main-line locomotives and high-speed streamlined articulated trains. The power required for the different classes of vehicle thus ranges from about 50 to several thousand h.p. It should be recognized, however, that the very large engines used in "high-speed" trains are not themselves "high-speed" diesels in the sense that the term has been used in the preceding chapters dealing with road transport engines. By virtue of their size and large cylinders the big rail locomotive engines give high power at

DIESELS IN RAILWAY SERVICE

relatively low crankshaft speeds. The true high-speed diesel is seldom rated at over 150 b.h.p. or exceeds 10 litres cubic capacity. There are one or two notable exceptions to this generalization, however.

The genesis of the high-speed diesel train was the Flying Hamburger of the German State Railway, built in 1932 and put into regular service in 1933. The German State Railway subsequently put into operation more than thirty such trains, most of them with two Maybach 410 b.h.p. or two Maybach supercharged 600 b.h.p. engines. They worked long-distance business services at overall speeds up to 77 m.p.h., with intermediate start-to-stop timings up to 82 m.p.h., and day after day ran for miles on end at 100-105 m.p.h.

In Holland thirty-five streamlined three-car trains, each with two 410 b.h.p. Maybach engines, and five trains with two 350 b.h.p. Stock-Ganz engines, were set to work in 1934, and in 1938 twenty further five-car trains with an installed capacity of 1,200 b.h.p. were ordered. In Belgium, France, Argentina and the U.S.A. multi-car high-speed diesel trains are used in numbers, and in Denmark and Italy there are also many in service. Single-unit rail cars in powers up to 500 b.h.p. became common all over Europe, France having over 600, Germany about the same number, Italy about 400, and Roumania 250. Perhaps the most spectacular main line train development was in the U.S.A. where, in the late 1930s enormous strides were made. Two engine types in particular were involved, the Alco, a four-stroke direct-injection six-cylinder unit of $12\frac{1}{2}$ in by 13 in bore and stroke and the G.M.C. "567" two-stroke with $8\frac{1}{2}$ in by 10 in cylinders mounted in V formation in six-, eight-, twelve- and sixteen-cylinder sizes. Neither of these engines comes within the "high-speed" definition since they operate at something below 800 r.p.m. but they have undoubtedly had great influence upon the acceptance by the public of diesel engine units.

The Alco engine develops 660 b.h.p. at 700 r.p.m. in normally aspirated form and this output is increased to 1,000 b.h.p. at 740 r.p.m. by means of a Buchi exhaust-turbo supercharger. The G.M.C. engines are of 600 to

THE MODERN DIESEL

1,350 b.h.p. at 800 r.p.m. and the basic principle of design is similar to that of the road transport units. Locomotives of up to 5,400 b.h.p. are built by installing from two to four power units.

In Argentina there were over 250 diesel rail cars before the war, and there, as in Australia and elsewhere, they had displaced certain main-line steam trains. This book, however, is more concerned with the smaller types of high-speed diesel engine as used for self-contained rail cars and small locomotives, which have gone a long way to solve some of the difficult railway problems that resulted from road vehicle competition.

In one important respect the diesel compares unfavourably with the steam engine. This is due to its torque characteristics, which render it incapable of exerting a high tractive effort at low crankshaft speeds. The steam engine can be coupled direct to the driving wheels, whereas the diesel requires some form of intermediary gearing or torque-converter. In some cases the friction clutch and change-speed gear combination is employed, though electric drive has important advantages and has been widely used, whilst various forms of hydraulic transmission systems have also given satisfactory results. The question of weight is another matter which has received careful attention. For locomotives reduction of engine weight is not important, or even desirable, since it is required to maintain adequate wheel adhesion, but for rail cars the power unit represents only a part of the total weight and it thus becomes a component on which weight can be saved with advantage.

So far as design is concerned modern rail high-speed diesel engines frequently differ materially from those of the same makes applied to other purposes. Even those originally adapted from road engines are now in certain cases of quite different designs. Since the maximum power output of a road-vehicle engine is only used intermittently and infrequently a high rating can be used without impairing reliability. On rail, however, the demand on the engine is heavy and constant, so that the maximum power output may be restricted by 15 or 20 per cent.

DIESELS IN RAILWAY SERVICE

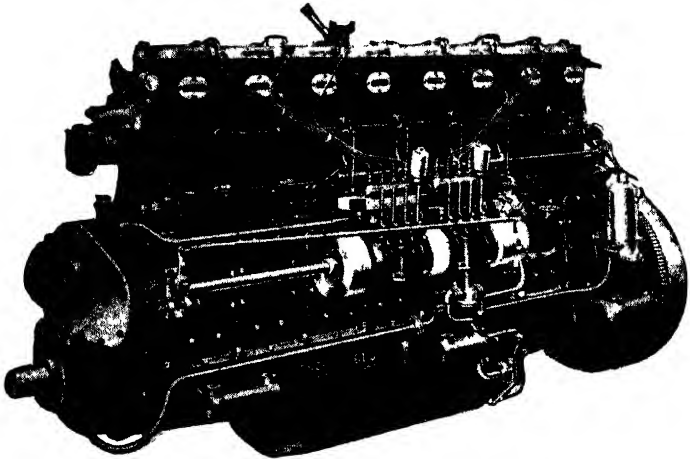

Gardner 8L3 eight-cylinder diesel rail-car engine, developing 204 b.h.p. at 1,200 r.p.m.

Supercharging is proving an asset in the production of economical engine and vehicle designs. One of the most successful supercharging systems is the Buchi-Brown Boveri, which makes use of a turbo-blower driven by the engine exhaust gases, and as an example of the increased output so obtained reference may be made to a M.A.N. engine which normally developed 650 h.p., but which with forced induction gave a maximum of 950 b.h.p.

Comparatively little progress has been made with two-stroke engines, and only the American Winton, the Burmeister and Wain, Harland-B. & W. and the opposed piston C.L.M.-Junkers types have been used to any extent. In both the two- and four-stroke types, there are in-line and V-type cylinder arrangements, and a pre-war development for which the Germans were chiefly responsible was the introduction of horizontal-type engines having six, eight and twelve cylinders, either opposed or in line, and adapted for underframe mounting in order to increase the loading space.

THE MODERN DIESEL

Among British builders Wm. Beardmore & Co., Ltd., Parkhead, Glasgow, were early in the field in applying the diesel engine to rail cars, and in 1922 built a high-speed six-cylinder unit developing 500 b.h.p. at 1,200 r.p.m. Three years later they constructed a number of 200 b.h.p. and 400 b.h.p. engines of more robust design which were fitted to rail cars operated by the Canadian National Railways. The latter also constructed a locomotive for hauling heavy main-line passenger and freight trains. This was fitted with two Beardmore V-type twelve-cylinder diesels which developed 1,300 b.h.p. at 800 r.p.m.

One of the most popular British railway engines in the smaller sizes is the Gardner, which is used for rail cars (principally the LW engines) and locomotives (the L3 range). The LW type has already been described in Chapter 9; it is used in over a hundred rail cars in Argentina and considerable numbers were used in Belgium, Ireland, India, and in Australasia. The L3 type is a slower-running series with cylinders of $5\frac{1}{2}$ in bore and $7\frac{3}{4}$ in stroke. There are three-, four-, five-, six- and eight-cylinder models, but the favourite railway types are the 5L3, 6L3, and 8L3, developing 127, 153, and 204 b.h.p. respectively at 1,200 r.p.m. A feature of the design is the use of renewable dry liners located inside wet liners.

Another make of road-vehicle diesel which gave good service on the rail was produced by the Associated Equipment Co. Ltd. of Southall. Of 115 by 142 mm bore and stroke, and developing 130 b.h.p. at 2,000 r.p.m., it was very similar to the A.E.C.-Ricardo road transport engine, but had a cast-iron crankcase, fitted with a special design of sump to reduce its height. The first of these engines put into service was installed in a single-engined A.E.C. rail car supplied to the Great Western Railway early in 1934. This was the first streamlined rail car seen in this country, but the Great Western Railway subsequently took seventeen more A.E.C. rail cars, the latest types being fitted with two 130 h.p. engines. This fleet of rail cars covered about 1,000,000 miles a year, and was maintained by the A.E.C. under contract.

Another British road vehicle type of diesel engine was

DIESELS IN RAILWAY SERVICE

supplied for rail cars by Leyland Motors, Ltd. This was a 10-litre engine developing a maximum of 130 b.h.p. at 2,000 r.p.m., and limited sometimes to 120 b.h.p. at 1,900 r.p.m.; it was superseded for certain applications by a new $8\frac{1}{2}$ -litre engine developing 125 b.h.p. at 2,200 r.p.m. in six $4\frac{1}{2}$ in by $5\frac{1}{2}$ in cylinders, compared with the $4\frac{3}{8}$ in by 6 in cylinders of the 10-litre model. There was also an $8\frac{1}{2}$ -litre engine, which in the four-wheeled rail cars on the L.M.S.R. was set to give 95 b.h.p. at 1,900 r.p.m. The Leyland Co. acquired a licence to produce the Buchi supercharging equipment, but this development was interrupted by the war. At the moment Leyland engines are not being produced for this field.

Four-stroke engines of 180 b.h.p. upwards made by the English Electric Co. Ltd., are of two general types. First, a series running at 1,500 r.p.m., and developing 33 to 37 b.h.p. per cylinder, according to the duty, in 6 in by 8 in cylinders. Secondly, the K series, with 10 in by 12 in cylinders, developing 64 b.h.p. per cylinder at 685 r.p.m. The first type was used in rail cars and the second type in locomotives.

Paxman-Ricardo engines, although not used in rail cars, have proved very popular for small locomotives over the range from 65 to 200 b.h.p. The 65 b.h.p. engine develops that output at 1,000 r.p.m. in six $4\frac{5}{8}$ in by $5\frac{7}{8}$ in cylinders, and thus has an m.e.p. of 88 lb/sq in and a piston speed of



Arrangement of six-cylinder diesel engine and transmission on A.E.C. rail cars supplied to the Great Western Railway

THE MODERN DIESEL

only 980 ft per min. The weight is about 2,100 lb without flywheel. Cast-iron construction is used and the cylinder block and upper crankcase are in an integral casting of this material, and have hardened cast-iron dry-type liners inserted. C.A.V. fuel-injection equipment is used and in many installations Auto-Klean filters are inserted in the lubricating oil circuit. The larger Paxman-Ricardo engines run at 900–1,000 r.p.m. and have a cylinder size of $6\frac{1}{2}$ in by 10 in and a cylinder output of 30 to 33 b.h.p.

Although a number of Brotherhood-Ricardo engines were suitable for railway service, only the six-cylinder sleeve-valve engine developing a maximum of 165 b.h.p. at 1,200 r.p.m. was actually used. The cylinder size was $5\frac{5}{8}$ in by $8\frac{1}{2}$ in, and two-, three-, four-, five-, and six-cylinder models were built, the unit weights in all cases being over 30 lb/b.h.p.

The Fowler-Diesel two-way swirl combustion chamber is a distinctive feature of the heavy-oil locomotive engines manufactured by John Fowler & Co. (Leeds) Ltd., Leeds. Two-, three-, four- and six-cylinder models of $4\frac{1}{4}$ by $6\frac{1}{4}$ in bore and stroke develop respectively 30, 45, 60 and 90 b.h.p. at 1,500 r.p.m., while a six-cylinder unit of 120 by 180 mm gives 112 b.h.p. at the same speed, and four- and six-cylinder engines of 7 in bore and 9 in stroke have respectively outputs of 132 and 200 b.h.p. at 900 r.p.m.

The combustion chamber is dome shaped and contained in the head to one side of the cylinder. Fuel is injected into the chamber by a horizontal sprayer and at the beginning of the compression stroke the displaced air is rotated in one direction in the chamber. As the piston reaches the top of the compression stroke, however, it displaces the air sideways so that it rotates in the opposite direction, and this two-way swirl causes very rapid and thorough mixing of the air and fuel. Single large-hole sprayer nozzles are employed, and starting does not depend on heater plugs. A decompression gear is fitted to facilitate starting incorporating a device which restores full compression automatically after a few revolutions of the crankshaft.

A very wide range of railway type diesels is manufactured

DIESELS IN RAILWAY SERVICE

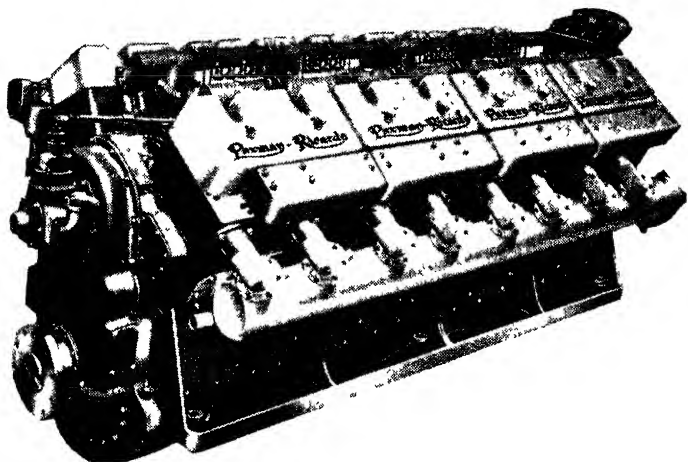

Paxman-Ricardo V-16 1,000 h.p. rail-car engine

by J. & H. McLaren, Ltd., Midland Engine Works, Leeds, ranging from 30 to 350 b.h.p. One series of two-, three-, four-, five-, six- and eight-cylinder engines, all of 135 by 200 mm bore and stroke, develops $17\frac{1}{2}$ b.h.p. per cylinder at 1,000 r.p.m. Another series of four-, five-, six- and eight-cylinder units, of 190 by 240 mm bore and stroke, gives 40 b.h.p. per cylinder at 1,000 r.p.m., whilst $43\frac{3}{4}$ b.h.p. per cylinder at the same speed is obtained from an eight-cylinder type of 200 by 240 mm bore and stroke. Like those originally supplied for road transport, all the McLaren railway-type diesels utilize the pre-combustion chamber system.

The Ricardo air-cell combustion system was adopted for the engines produced by Ailsa Craig, Ltd., Chiswick, London, W.4. Single-, two-, three-, four-, six-, eight- and twelve-cylinder models are all of $4\frac{1}{8}$ in bore and $5\frac{1}{2}$ in stroke, with outputs ranging from 12 to 144 b.h.p. at 1,600 r.p.m.

W. H. Allen & Sons, Ltd., Bedford, manufacture five-,

THE MODERN DIESEL

six- and eight-cylinder locomotive engines, all of 145 by 180 mm bore and stroke. Of the direct-injection type, these develop respectively 100, 120 and 160 b.h.p. at 1,200 r.p.m. A distinctive feature, giving easy crankshaft accessibility, is the use of a crankcase having one side completely detachable. Wet cylinder liners are fitted and there are two inlet and two exhaust valves to each cylinder. Either electric or compressed air starting is available.

The direct-injection system with clerestory type of combustion chamber is a characteristic of the Blackstone rail-type engines, with two, three, and four cylinders of $3\frac{7}{8}$ in by 5 in bore and stroke, and developing respectively 18.75, 28 and 37.5 b.h.p. at 1,500 r.p.m. There are also two six-cylinder units of 4 and 5 in bore and $4\frac{5}{8}$ in stroke, giving 73 and 91 b.h.p. at 1,800 r.p.m. All have C.A.V. fuel injection equipment and wet cylinder liners. The two-, three- and four-cylinder units are started by hand, whilst the six-cylinder engines are started either by electric motor or an auxiliary petrol engine.

The range of engines suitable for locomotive work built by Gleniffer Engines, Ltd., Anniesland, Glasgow, comprises six- and eight-cylinder vertical and twelve- and sixteen-cylinder V engines with an output of 20 b.h.p. per 6 in by 7 in cylinders at 900 r.p.m. They have clerestory-type combustion chambers contained in separately-cast cylinder heads, the pistons being of the displacer type having a projection on the crown which enters the combustion chamber, thereby causing the displaced air to produce high-velocity turbulence with thorough mixing of air and fuel. Compressed-air starting is relied upon, using a four-cylinder radial air motor with Bendix-type pinion engaging with a gear ring on the flywheel. A lever controlling the decompressor gear also opens the air-motor starting valve, which is closed when the lever is returned to the running position.

A National direct-injection engine, more fully referred to in the marine section (page 242), is built in a form suitable for rail propulsion; it is either normally aspirated or supercharged and ranges from 22 h.p. (two cylinder, normal) to 120 h.p. (six cylinder, forced induction). The

DIESELS IN RAILWAY SERVICE

main frame casting of the engine is so designed that all parts are accessible and can be removed without completely dismantling the engine or lifting it from its bed.

Paxman were responsible for the introduction of some notable new engines in 1938, using the V layout in eight-, twelve- and sixteen-cylinder models. The bore and stroke was 7 by $7\frac{1}{2}$ in and the output was 50 b.h.p. per cylinder at 1,500 r.p.m., with a one-hour maximum-load capacity of 62.5 b.h.p. at 1,750 r.p.m. Ricardo-Comet Mark III air-swirl combustion system was used. The sixteen-cylinder model did not require a flywheel and the dry weight of the unit, 5,160 lb, gave the remarkable power/weight ratio of 3.2 lb/b.h.p.

Other British engines which have been used to a small extent for light locomotive work are the Dorman, Lister, Perkins, Ruston and the Crossley two-stroke. In larger sizes, that is, from 175 b.h.p. upwards, the Harland-B. and W. two-stroke type has also been used for rail cars and locomotives.

Striking progress in the development of rail-car and small locomotive diesels was made in Europe prior to 1939 and numerous different types were evolved by the leading road-vehicle manufacturers and diesel-engine builders; all this work came to an end when the war began and as far as can be gathered from official investigation reports only restricted manufacture and no development has since taken place. Most of the factories have been extensively damaged by bombing. The use of loco-tractors, or small shunting locomotives, of up to 100 b.h.p. had become very common, and the German State Railway alone had several hundreds of such units.

The first Continental high-speed engine was that produced in 1923 by the Maybach Motorenbau G.m.b.H. It was a six-cylinder air-injection engine developing 150 b.h.p. at 1,300 r.p.m. From this was developed a 175 b.h.p. six-cylinder engine running at 1,400 r.p.m., and then came the well-known 410 b.h.p. twelve-cylinder V engine running at the same speed. In 1938 the range comprised six-cylinder 210 b.h.p. and twelve-cylinder 410 b.h.p. unsupercharged

THE MODERN DIESEL

engines and a 600 b.h.p. supercharged version of the 410 b.h.p. engine. All had 160 by 200 mm cylinders and a normal top speed of 1,400 r.p.m. They had balanced crankshafts with rollers for both the big end and main bearings. The injection was direct with Deckel fuel pumps as standard. The Buchi supercharged 600 b.h.p. engine weighs less than 9 lb/b.h.p.

An extensive range of rail diesels (M.A.N.) was built by the Maschinenfabrik Augsburg-Nurnberg A.G., the limits being 65 and 1,400 b.h.p. Above about 250 b.h.p. six- and eight-cylinder engines running at 700–900 r.p.m. were generally used, although there was a 420 b.h.p. twelve-cylinder V engine running at 1,400 r.p.m. The normal rail-car range began with a six-cylinder engine developing 150 b.h.p. at 1,500 r.p.m. in 150 by 180 mm cylinders, but above that there was a series giving 210 to 420 b.h.p. at 1,400 r.p.m. with the unusual cylinder dimensions of 175 mm bore by 180 mm stroke. Others again, within the same power range, had cylinders 175 by 220 mm, but they ran at only 1,000 to 1,200 r.p.m. Although direct injection was used exclusively by M.A.N. for many years, some of the later models up to 250 b.h.p. incorporated a pre-combustion chamber.

Numerous types of Deutz engines were used for rail-traction work, and those up to 150 b.h.p. were simply the road-transport models. Above that output were three designs from 200 to 335 b.h.p. and also a twelve-cylinder V engine giving 360 b.h.p. at 1,400 r.p.m. The Daimler and Mercedes engines, all with the Benz pre-combustion chamber, ranged from a 75 b.h.p. engine running at 1,750 r.p.m. to a 450 b.h.p. twelve-cylinder V engine running at 1,400 r.p.m. The 75 and 95 b.h.p. six-cylinder engines were much used for small rail cars, and the 135–150 b.h.p. engine, running at 1,600–1,700 r.p.m., and with six cylinders 125 by 170 mm, was built both in Germany and under licence in France. Engines of the D.K.W., Krupp, Kamper, M.W.M., Büssing-N.A.G., Magirus, and Junker (two-stroke) makes were also used in vertical forms, and in general were simply the road transport models of the respective builders.

DIESELS IN RAILWAY SERVICE

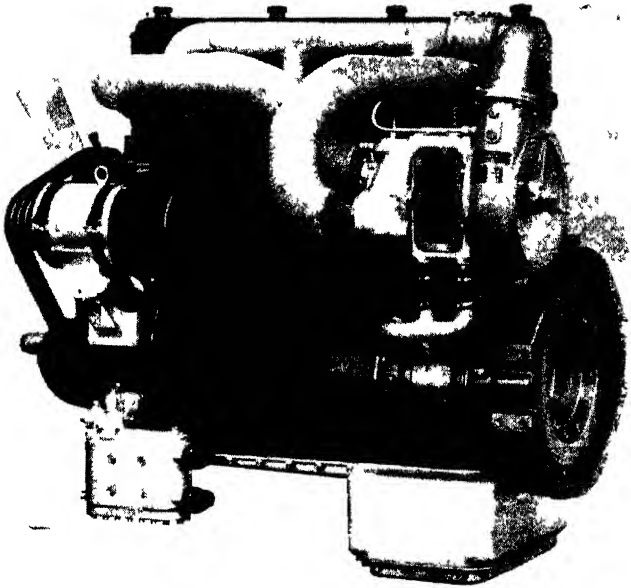

Saurer supercharged rail-car engine, developing 125 b.h.p.

A characteristic of French railway diesel practice was that Berliet was the only manufacturer who used road-transport engines with Ricardo-Comet Mark III combustion-chamber design, all the others having special rail-car models. There were four Renault models. (a) 120 b.h.p. in six 125 by 170 mm cylinders at 1,500 r.p.m.; (b) 150 b.h.p. in six 140 by 170 mm cylinders at 1,500 r.p.m.; (c) 300 b.h.p. in twelve 140 by 170 mm cylinders at 1,500 r.p.m., and (d) 500 b.h.p. in sixteen 156 by 180 mm cylinders at 1,500 r.p.m. Weight was 16–17 lb/b.h.p. and the last two were V engines. All were of the direct-injection type. The earliest models of the C.L.M.-Junkers two-stroke opposed-piston engine gave 80 and 110 b.h.p. at 1,500 r.p.m., but the later engines were of 150, 250, and 500 b.h.p. the first-named running at no less a speed than 2,100 r.p.m., and

THE MODERN DIESEL

the two others at 1,500 r.p.m. The weight was about 12 lb/b.h.p. and the fuel consumption at full load 0.355 to 0.375 lb/b.h.p./hr.

The Ganz rail-car engine has been used in rail traction throughout the world, and was made under licence from the Budapest firm by Metro-Vick in this country, by Stork Bros in Holland, by Carels in Belgium, and by Als-Thom in France. The range extended from 95 to 400 b.h.p. in nine models, but the most used were six-cylinder and eight-cylinder engines with a bore of 170 mm and a stroke of 240 mm, with a maximum speed of 1,450 r.p.m. Normally they are limited to 220–240 b.h.p. at 1,250–1,300 r.p.m. (six-cylinder), and 320–365 b.h.p. at 1,250–1,350 r.p.m. (eight-cylinder). All types have the Jendrassik pre-combustion chamber.

Fiat had four rail-car engines; the smallest, a six-cylinder engine giving 75 b.h.p. at 1,550 r.p.m. had direct injection for cylinders 108 by 152 mm. Ricardo heads were used for the remainder, comprising an engine giving 150 b.h.p. at 1,625 r.p.m. from six 115 by 160 mm cylinders, another giving 135 b.h.p. at 1,550 r.p.m. from six 125 by 175 mm cylinders, and a twelve-cylinder V engine with a normal output of 400 b.h.p. at 1,500 r.p.m. and a maximum

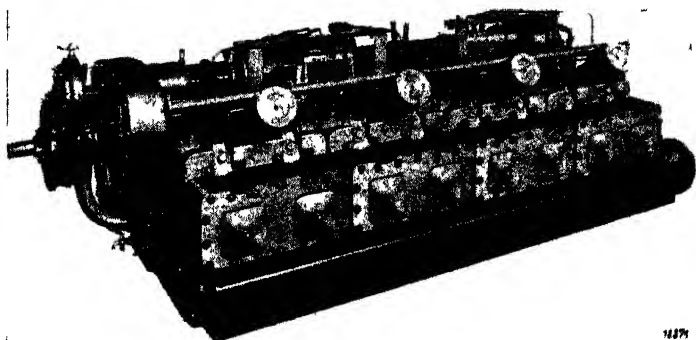

Vomag 200 h.p. eight-cylinder rail-car engine, horizontally arranged for underframe mounting

DIESELS IN RAILWAY SERVICE

output of 550 b.h.p. at 1,800 r.p.m., the cylinders being 160 by 180 mm. Breda, of Milan, built engines under licence from A.E.C., while other makes used extensively were Frichs, Sulzer, Saurer, Skoda, S.L.M., Simmering, and Atlas. Sulzer had four types of special railway engines, giving 290, 290, 450, and 500 b.h.p. respectively, and a feature of the construction was the use of a combined cast and welded construction for the framing. Saurer rail-car models ranged from 95 b.h.p. to 300 b.h.p., the most popular being the 150-160 b.h.p. six-cylinder BXD engine running at 1,500 r.p.m., and having 130 by 180 mm cylinders. All have the special Saurer crankshaft with roller main bearings encircling the crank webs, and the dual-turbulence combustion system. The Buchi supercharging system has been extensively applied to Saurer engines.

Practically all railway diesels in the U.S.A. are of 300 b.h.p. or over, including the six-cylinder 600 b.h.p., twelve-cylinder V 900 b.h.p., and sixteen-cylinder V 1,200 b.h.p. Winton two-stroke engines, and the Westinghouse 300, 400 and 800 b.h.p. engines. The Cummins engine is used in its 150, 250, and 500 b.h.p. sizes and the Caterpillar eight-cylinder V engine producing 160 b.h.p. at 1,000 r.p.m. has recently been adopted. Other types, such as the Hercules and Waukesha, are suitable for small shunting tractor use, but are too small for American rail-car requirements.

Horizontal engines were mainly introduced by German firms, and began with the eight-cylinder two-bank D.K.W. engine giving 180 b.h.p. at 1,500 r.p.m. In conjunction with the German State Railway, a standard twelve-cylinder two-bank horizontal engine giving 275 b.h.p. at 1,500 r.p.m. was evolved, and it was made by D.K.W., Deutz, M.A.N., and Daimler. Deutz had another 175-200 b.h.p. single-bank eight-cylinder engine which could be used either for road or rail service, Vomag had a six-cylinder engine of the same capacity, while Skoda had double-bank engines of 120 and 160 b.h.p.

Marine Service

SINCE first the marine high-speed diesel was launched upon the market progress has been remarkable. Whereas some fifteen to twenty years ago a high-speed diesel installation was the exception, it is now the rule.

Since low weight is not of such pressing importance, and high revolutions are not entirely desirable, the weight per horsepower of marine engines does not compare favourably with that of road-transport units. Also it is usual to quote the weight of marine engines complete with reversing gears, thus further increasing the figure; of course, this may be regarded rather as a trade custom than as a logical method of assessing the power/weight ratio of the engine unit. Obviously, therefore, an exact comparison between road vehicle and marine engine weights is not easy because of this and certain other conventions and usages in the respective industries. But it is clear from makers' published weights that engines deriving from a purely marine background are appreciably heavier than those associated with road transport experience. Taking six cylinders of about $4\frac{1}{4}$ in bore as a standard, an automotive engine of this size has a specific weight in the region of 12 to 14 lb/b.h.p. while marine units based on such engines run from 18 to 25 lb/b.h.p. On the other hand equivalent engines deriving purely from the marine industry often weigh up to 50 lb/b.h.p. This is a somewhat astonishing comparison and the growing popularity of the automotive type in marine installations indicates in no uncertain way the influence which the development of the high-speed diesel in road transport has had in recent years. It must be understood of course that in marine service, engines are rated for continuous running and the normal power output is therefore restricted as compared with an automotive unit which is only called upon to deliver maximum power for short and intermittent periods.

MARINE SERVICE

Fuel consumption is another matter on which there is not quite the same approach. In marine service a corresponding figure to road vehicle m.p.g. is not readily available; the most useful statement of consumption is the rate at governed speed in terms of gallons per hour. Engine makers often prefer to quote the optimum test-bed figure in pints per b.h.p./hr which is of undoubted academic interest but is likely to involve an owner in some frantic mental arithmetic if, in the midst of a passage, some uneasiness arises as to the number of operating hours still available in the fuel tanks ! In such circumstances gallons per hour provide the operating engineer with a far more acceptable basis for rapid assessment of the position than do the pints per b.h.p./hr of the test-house attendant.

The next consideration is that of fire risk. A fire on board ship is infinitely more dangerous than one on shore. The fuels normally used in oil engines do not evaporate in ordinary atmospheric conditions, consequently there is no invisible and violently sudden danger attendant upon a leak in the fuel system. That the reduction of fire risk is very real is reflected in the lower insurance rates which are obtainable in respect of diesel-engined vessels; there is no specific percentage reduction but it is general for underwriters to quote lower premiums than those applicable to equivalent petrol installations.

As regards performance, conditions afloat are in no

SPECIFIC WEIGHT (lb/b.h.p.)

MAKE	AUTOMOTIVE	MARINE
A.E.C.	12·5	25
Ailsa Craig	—	35
Gardner	14	27·5
Leyland	14	23
R.N.	—	42
Ruston	—	52
Thornycroft	14	23

Substantially equivalent types compared. It is evident that road transport development has been mainly responsible for weight reduction in marine units

THE MODERN DIESEL.

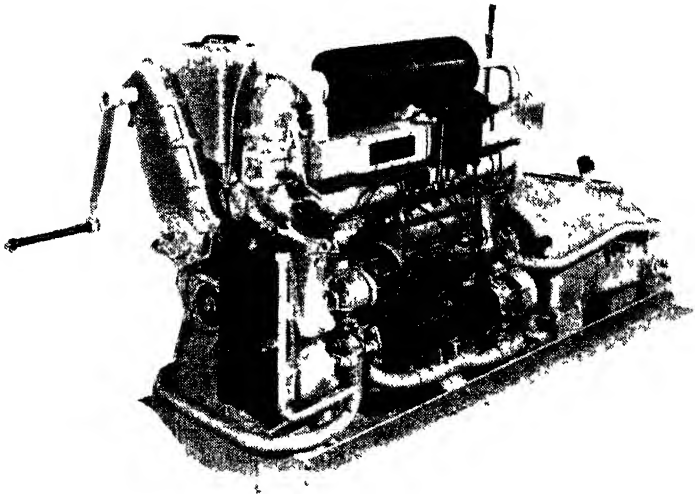

The influence of the high-speed road transport oil engine in marine work is well illustrated by this Leyland T & T 7 4 litre 85 b.h.p. marine unit

way as variable as those on shore. The average marine engine is almost a constant-speed unit. It is designed to operate continuously at its pre-determined governed power output for any reasonable length of time. A spell of a hundred hours should be well within its scope. A certain amount of flexibility is required, but this is usually interpreted to mean an ability to turn over very slowly under the control of the governor and accept without hesitation the engagement of either the ahead or astern clutches without reference to the hand-throttle control.

At this kind of flexibility the oil engine excels as the governor controls the amount of fuel injected. In other words the governor takes care of variations in torque loading and the "throttle" is purely a speed control. With a petrol carburettor violent opening of the throttle will sometimes lead to "stalling", but rarely so with a

MARINE SERVICE

diesel engine. It will thus be realized that in marine service the engine is generally operating well within its safe limits.

In construction the compression-ignition engine must of necessity be of robust design and by virtue of its performance characteristics also it is predisposed towards reliability. In most cases the crankshafts exceed Lloyd's requirements for open sea service, being made thus to eliminate any likelihood of torsional vibration in "sixes" and "eights". In fact, it is generally true that the margin of safety allowed by the makers in all stressed portions is considerably greater than in the case of petrol or paraffin units. Since weight is not of critical importance, as already explained, except in so far as it affects first cost and perhaps installation, the designer has every encouragement to err on the heavy side if he is in any doubt about the stresses involved. So we have here another factor which contributes further towards the innate reliability

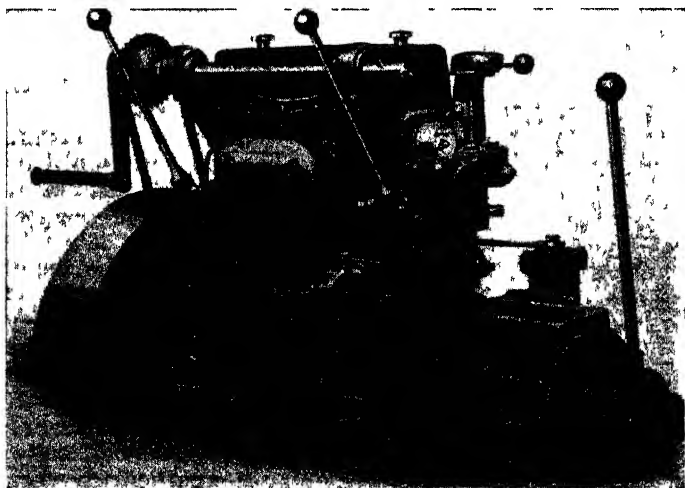

The lever operating athwart the 14 h.p. Lister controls the double-ratio combustion chamber or decompresses for hand starting

THE MODERN DIESEL

of the type. As time goes on there is no doubt that weights may be reduced slightly; but even if light alloys resistant to sea-water corrosion are now available experience in the road-transport field has shown that requirements of crankcase rigidity generally dictate cast iron for this major component.

Reference may be made in passing to the semi-diesel (so-called) or "hot-bulb" engine. This class of power unit may use paraffin or diesel oil which is sprayed into a hot chamber connected to the cylinder head (see the reference to the Akroyd-Stuart engine in Chapter 2). Another type using diesel fuel, which is made in several countries (notably Sweden and U.S.A.), operates on the Hesselman system. In this case the fuel is injected into an open cylinder with a deep-cavity piston by means of more or less normal diesel-injection equipment, but the compression ratio is too low for self-ignition and a normal spark-ignition system is used. Since no semi-diesel or Hesselman engine has anything like the high compression ratio of the diesel, they do not make as good use of their fuel, and thermal efficiency is very inferior by comparison.

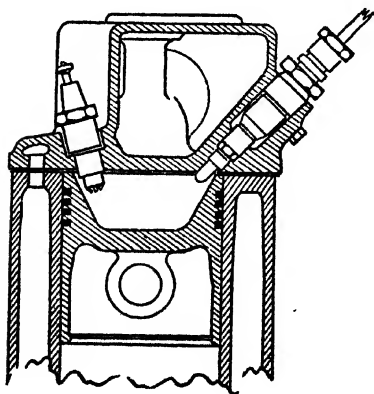

Hesselman low-compression spark-ignition fuel-injection combustion chamber

Certainty of starting has been mentioned as a *sine qua non* of a good marine engine. At first sight it would appear that the diesel answers all requirements by virtue of its simplicity and the positive nature of its operation. In certain cases this is true, but in others starting presents some difficulty.

It is particularly when starting from cold that complications arise. Unless the engine is turned

at a fair speed the heat resulting from the high compression is conducted away by the cold walls of the combustion chamber. There is, as it were, a time element introduced—the time taken in losing the necessary heat.

As wear takes place the engine tends to become more difficult to start. It will readily be understood that as the compression ratio is high in high-speed diesels a relatively small amount of wear, or the slightest leakage past the rings, will result in a noticeable drop in compression pressure. This in turn results in a drop in temperature. In extreme cases the temperature may be insufficient for combustion at

any speed at which the engine can be turned by hand.

There are three ways out of this difficulty. First, to provide means whereby the engine is spun at a sufficiently high speed; second, to supply, usually by an electric heating element, a certain amount of additional heat in the combustion chamber; and third, to raise the compression temporarily during the starting period by mechanical means.

Taking these in order, the first is best applied to larger engines. If compressed air is used for starting it may be admitted direct to the cylinders, or, as first introduced in 1929 on Gleniffer engines, applied to an air-starting motor. Either of these methods can be relied upon to spin the engine well past the critical speed. If electric power is used it is not quite so easy to turn the engine fast enough owing to the low gear ratio between the starter motor and the crankshaft.

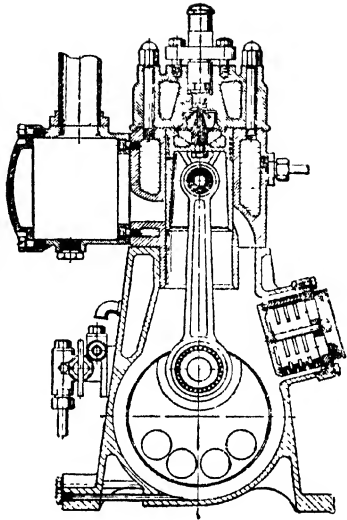

Section through the little Stuart 3 h.p. unit, the smallest British diesel on the market

THE MODERN DIESEL

The admission of compressed air direct into the cylinders is not without its disadvantages; due to the expansion of the air a considerable drop takes place in the temperature of the cylinder head and walls. The use of heating elements has not found much favour among marine-engine manufacturers, because of their susceptibility to moisture-laden atmosphere.

In the case of engines having cylinders of less than 5 in bore either hand or electric starting is generally used. With electric starting the question of attaining sufficient speed is usually solved, although in some cases provision is made for variation of the compression ratio. Where human power alone is relied upon it is common to take this precaution either by altering the dwell of the inlet valve, as in the Gardner, or by mechanically altering the size of the combustion chamber.

In marine conditions there is no doubt that only the very smallest engines operating on the compression-ignition principle should be started by hand. It is so often nearly impossible to exert full power on the starting handle when the engine is installed, since, in many cases, the location of the handle and the movement of the ship combine to make matters difficult.

Prior to 1939, several manufacturers had investigated very carefully the possibilities of employing superchargers and were offering, with complete confidence, engines thus equipped. Two makers in particular deserve mention as pioneers, Gleniffer and Paxman. Not only has supercharging been applied to small units, but to V-twelves and V-sixteens having outputs up to 1,500 h.p. A power increase up to about 30 per cent is commonly attained without loss of reliability so that, for example, the Gleniffer V-sixteen, normally rated at 320 h.p., develops about 450 h.p. with only a very small increase in speed.

While on the subject of forced induction, reference should be made to two outstanding units employing the two-stroke cycle, the latest Sulzer with opposed pistons and positive scavenging pump, and the General Motors diesel with Roots-type blower. In each instance a small amount of supercharge is obtained since the inlet port remains open

MARINE SERVICE

for a very short time after the exhaust port or valve is closed. Although the application of the diesel system to the two-stroke cycle has undoubted attractions, marine-engine manufacturers, with one notable exception, have not shown any marked tendency to exploit this type in the smaller sizes running at high speed. When speeds become lower and engine sizes increase in proportion, the two-stroke finds more favour, and there is a great number produced to turn at 650 r.p.m. or less.

The four-stroke is unquestionably supreme in the class of power unit of small size but relatively high output. Not so many years ago 1,000 r.p.m. was considered to be a high speed, but there are now many diesel craft in commission with engines turning at up to 2,000 r.p.m. and driving through reduction gears. It seems logical that this line of development is one which will be followed more and more generally in future years, for the result will certainly be a reduction in the specific weight and cost of machinery for a given power.

In the following pages will be found a review of marine diesel engines which is representative of the majority of types available on the British markets; many of these are of pre-1939 design. During the war it is true that a certain amount of development was undertaken. But much of that work was on high-performance engines for fast coastal craft for Service requirements. Power units in this class are not usually sufficiently economical for normal civilian use and the swing over to direct-injection combustion systems which was so marked in the road-transport field has only now begun to make itself evident in marine usage.

In a general way engines of about 125 b.h.p. (maximum rating) at up to 2,000 r.p.m. are now almost exclusively based on automobile types. The trend which is now being extensively adopted, and which was popularized in the American G.M.C. engine, of building the main "heart and body" of the unit in a form common to many applications and then applying different sumps, end covers and such components according to the required usage, will assuredly result in closer relationship between road and marine engine practice in the appropriate sizes.

THE MODERN DIESEL

Typical Engines Reviewed

A.E.C. (ASSOCIATED EQUIPMENT CO., LTD., SOUTHALL, MIDDLESEX.)

Three units were produced prior to 1939, two four-cylinder engines of 47 and 58 b.h.p. and a six-cylinder developing 100 b.h.p. They had Ricardo Comet air-cell combustion chambers and ran at speeds up to 2,400 r.p.m. Clockwise or anti-clockwise rotation could be provided to suit twin-screw craft. These engines were based on the maker's road-transport units but were built to Lloyd's and Admiralty standards.

The six-cylinder 9.6 litre marine engine is now the standard production. Naturally, in view of their prominent position as road-vehicle manufacturers, vast experience acquired in that direction has been drawn upon. But the A.E.C. marine engine is a specialized type entirely designed for its purpose, being built to Lloyd's, Board of Trade and other recognized marine standards. Indirect injection with Ricardo Comet air-cell combustion system is used, the output at continuous rating being 100 b.h.p. at 1,500 r.p.m., with a 10 per cent overload factor for intermittent duty.

Crankcase, cylinder block and sump castings are iron and dry cylinder liners are fitted. Steel-backed lead-bronze bearings are used. There are two models which are dimensionally the same but which are "mirror images" of each other, so that twin installations can readily be arranged in handed pairs. Lubrication is on the dry-sump system, while fresh-water cooling with thermostatic control is standardized. Most of the parts of the two engines are interchangeable and a feature is that the plant is self-contained,

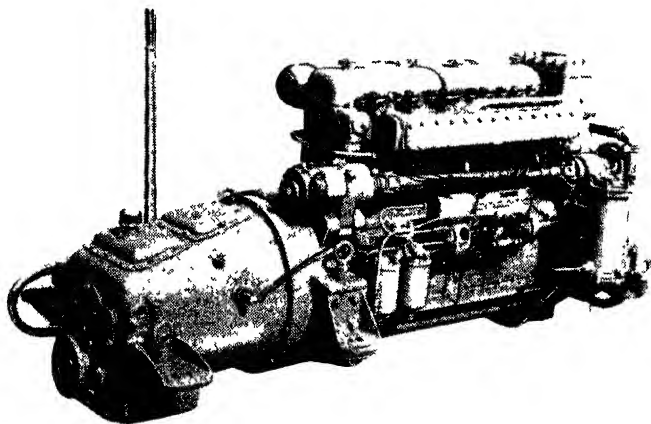

9.6 litre A.E.C. marine engine

MARINE ENGINES REVIEWED

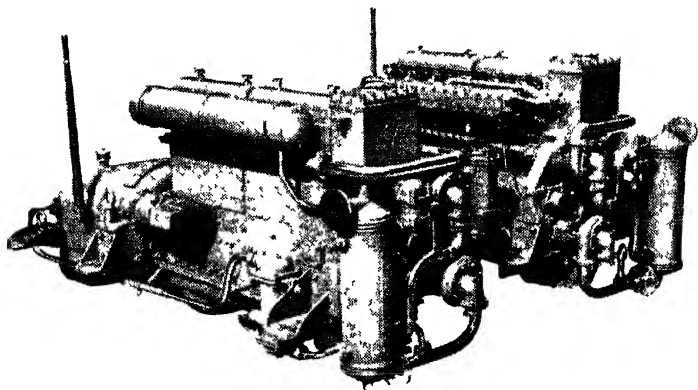

"Handed pair" of A.E.C. engines

so that there is the minimum of external equipment and very few connections have to be made by the shipbuilder. Reversing clutches and water-cooled helical-gear reduction boxes are available, provision being made in these units for dealing with propeller thrust.

AILSA-CRAIG (AILS CRAIG LTD., ASHFORD, KENT.)

In their long association with marine equipment Ailsa Craig must be counted among the pioneers of the high-speed diesel. They made one of the first British units in this class, using the Acro combustion system with the air-cell in the piston crown as distinct from its more common location in the cylinder head. Subsequently the Ricardo Whirlpool type of combustion chamber in the cylinder head was adopted.

Engines of various sizes and with up to 12 cylinders have been built in the past but from 1939 onwards it was decided to concentrate on the RF series having a common bore and stroke of $4\frac{1}{2} \times 5\frac{1}{2}$ in. in a range of engines of from one to six cylinders with powers from 10 to 60 b.h.p. These engines have a speed range of from 300 to 1,200 r.p.m.; they are of robust construction with monobloc castings having wet cylinder liners and large crankcase access covers whereby *in situ* overhauling is facilitated.

The vertical overhead valves are push-rod operated from a camshaft in the crankcase and the C.A.V. fuel pumps are also driven from the valve camshaft by gears which mesh with a pinion on the pump camshaft which is carried in a detachable crankcase cover plate or "pump box"; there is thus no external shaft or exposed

THE MODERN DIESEL

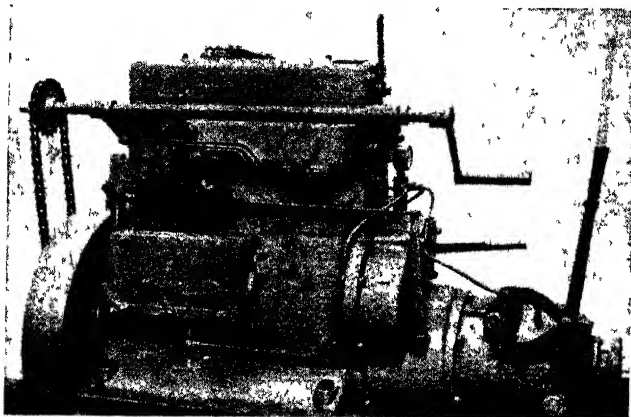

Hand starting of the smaller Ailsa-Craigs presents no difficulty. This is the 30 h.p. three-cylinder model

coupling in the fuel pump drive mechanism. An open flywheel is carried on the forward end of the crankshaft, the camshaft drive being at the opposite end. On the aft end of the engine there is also an integral epicyclic reversing gear unit and a 2 to 1 reducing gear can also be fitted. The specific weight of the six-cylinder 60 b.h.p. engine (less gearing) is 35 lb/b.h.p. and the full-load specific consumption is 0.43 pt/b.h.p./hr.

ALLEN (W. H. ALLEN, SONS & Co., LTD., QUEEN'S ENGINEERING WORKS, BEDFORD.)

High-speed Allen marine engines include units having from two to eight cylinders, covering powers from 30 to 160 b.h.p. The engines are of the vertical direct-injection four-stroke type.

The Allen engine design affords exceptional accessibility to all working parts. The cylinder block and engine bedplate consist of a single casting of C frame design, the front being enclosed by a longitudinal steel plate carrying inspection covers. Large doors are also provided on the back of the engine. The removal of the front plate permits withdrawal of the bearings and crankshaft laterally in a very confined space.

Separate fuel-injection pumps are used for each cylinder, actuated direct from the camshaft which is carried high in the frame, and the injection pipes are short and of equal length. Immediate starting from cold in all climates is effected by means of compressed air

MARINE ENGINES REVIEWED

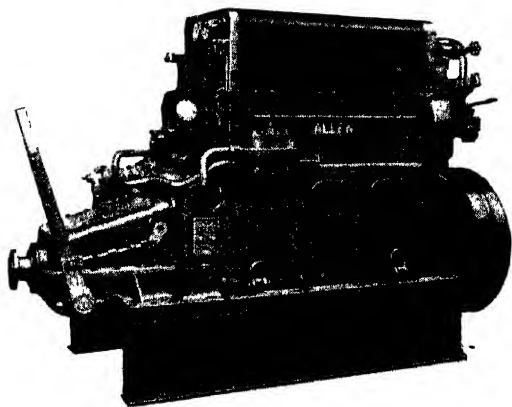

Three-cylinder 94/116 h.p. Allen marine diesel with mechanical reverse gear

admitted to the cylinders. The reverse gears, which are an integral part of the engine unit, are of the mechanical type, but in cases where large power with slow propeller speed is most suitable, oil-operated reverse-reduction gears are employed.

BOLINDER (AKTIEBOLAGET BOLINDER-MUNKTELL, SWEDEN, and BOLINDERS Co., LTD., 4, LLOYDS AVENUE, LONDON, E.C.3.)

This well-known Swedish maker produced a considerable range of crankcase-compression two-stroke semi-diesel engines before introducing a high-compression true diesel, also operating on the same cycle. There are two models, single and twin cylinder, of 4.725 by 5.9 in bore and stroke, rated at 10 and 20 b.h.p. respectively, at 1,000 r.p.m. Compressed-air, electric motor or hand starting is available and reversing or reversing-reduction gearing can be provided as an integral component of the unit. The engine is of the valveless type and is exceedingly clean and simple in design. Bosch fuel-injection equipment is used and the consumption is 0.39 lb/b.h.p./hr; semi-residual fuel oil may be used.

BUDA (THE BUDA COMPANY, HARVEY, ILLINOIS, U.S.A.)

Although for several years the American Buda diesels employed a combustion chamber design made under M.A.N. licence the whole

THE MODERN DIESEL

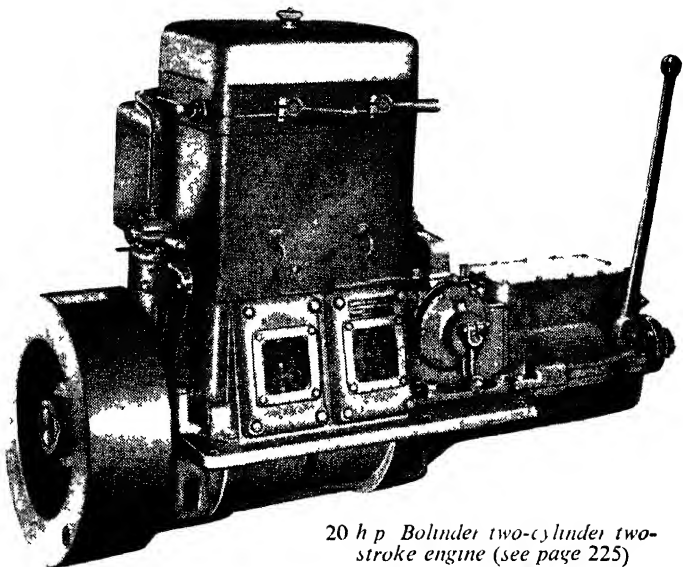

20 h p Bolinder two-cylinder two-stroke engine (see page 225)

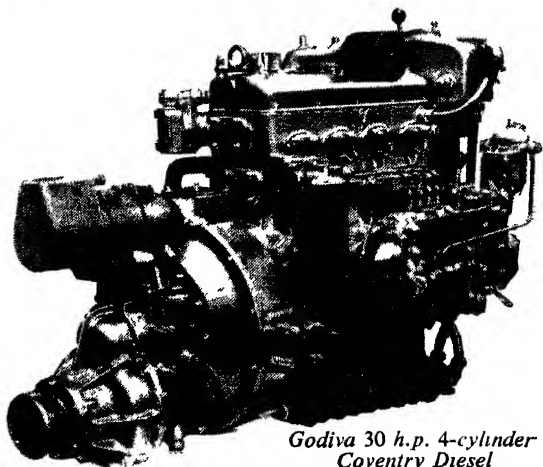

Godiva 30 h.p. 4-cylinder Coventry Diesel

MARINE ENGINES REVIEWED

range was subsequently converted to heads of Lanova "figure 8" form. Compression ratio is $12\frac{1}{2}$ to 1, and electric glow plugs are provided for starting in very cold weather. A characteristic of these engines is that they run at appreciably higher speeds than British engines of equivalent size. In America Buda engines are available in a range from 30 to 200 h.p. but they are at present represented here by a 30-40 h.p. four-cylinder and a 45-60 h.p. six. At continuous rating the specific weight (inclusive of 2 to 1 reduction gear) is 43 and 33 lb per h.p. respectively.

COVENTRY DIESEL (COVENTRY DIESEL ENGINES, LTD., FRIARS ROAD, COVENTRY.)

A four-cylinder four-stroke engine of 137 cu. in. capacity (3.25 by 4.15 in bore and stroke) is being produced under the name Godiva. It has a continuous rating of 36 h.p. at 2,400 r.p.m. and consumes 0.38 pt/b.h.p./hr. It is basically the same as the road-transport unit described on page 146, but it is fully modified and equipped for marine requirements and has fresh-water cooling arrangements.

CUB (CUB OIL ENGINES LTD., ATLANTIC WORKS, WISHAW, SCOTLAND.)

This engine is one of the smallest and lightest marine propulsion diesels on the British market. The two horizontally-opposed cylinders of 80 mm by 100 mm bore and stroke engine are fitted with detachable wet cast-iron liners. The connecting rods have roller big-end bearings, this type of bearing being also used for supporting a built-up two-throw crankshaft, an auxiliary ball-bearing being fitted to locate the shaft and take end thrust. The camshaft is

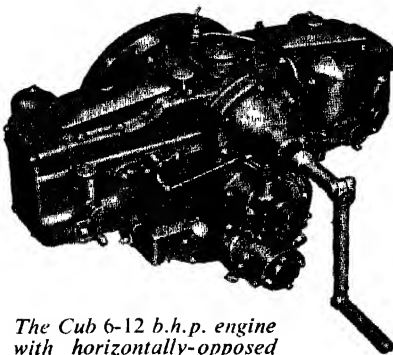

The Cub 6-12 b.h.p. engine with horizontally-opposed cylinders

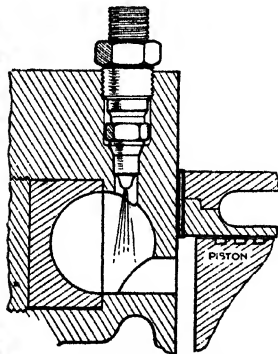

Cub combustion chamber

THE MODERN DIESEL

mounted centrally above the crankshaft and is driven by a duplex roller chain; it operates the valves through mushroom-headed tappets, push-rods and rockers. Large covers on the top give easy access to the valve mechanism. The starting handle is applied to the end of the camshaft. A C.A.V. fuel pump mounted on top of the engine, and operated from the camshaft, injects the fuel vertically downwards at 1,800 lb pressure into a spherical combustion chamber carried in the detachable head and having a venturi passage leading into the main cylinder. The fuel pump and injectors are entirely enclosed, but are easily accessible by removing the top covers. Low overall height makes the Cub engine particularly suitable for installation below cabin or cockpit floors in small craft either as a propulsion unit or for driving auxiliary plant. The engine weighs 327 lb with aluminium crankcase or 405 lb in cast iron; dynamo, starter and reduction and reversing gear add 150 lb.

DORMAN (W. H. DORMAN & CO., LTD., STAFFORD.)

In two of the pre-war Dorman range the Ricardo combustion chamber was employed. These were four-cylinder units of 22 h.p. and 31 h.p. respectively; the D.W. series 115 mm by 130 mm and the D.L. series, 120 mm by 180 mm, had direct injection. The smaller series, marketed in twin- and a four-cylinder form, had an output of 10 h.p. per cylinder at 1,000 r.p.m., while in the D.L. series the power was 16 h.p. per cylinder, units having two, three, four or

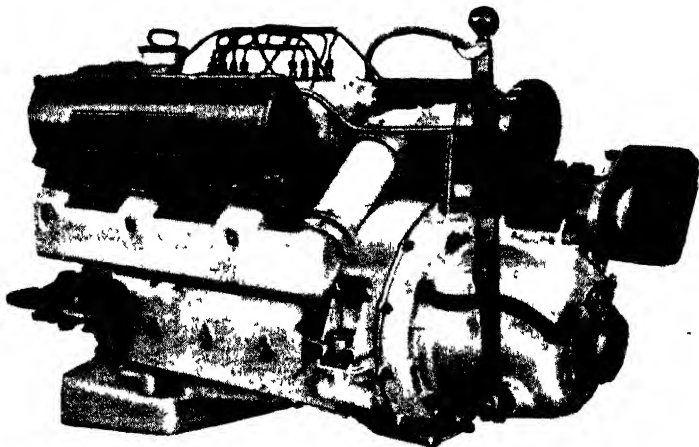

*Dorman 8VRM two-bank V-type marine 100 b.h.p. engine
with reverse gear*

MARINE ENGINES REVIEWED

six cylinders. Some revision of sizes has been made for current production and direct injection is used throughout the range of engines from two to six cylinders. There are two two-cylinder units of 10 and 19 b.h.p. respectively; three four-cylinder engines of 22, 40 and 65 b.h.p.; and one six-cylinder of 97 b.h.p. In addition there is a V8 of 100 h.p. at 2,300 r.p.m., which speed is more than double the rated speed of the other Dorman engines. This engine was developed during the war period and has Ricardo air-cell combustion chambers.

FOWLER (JOHN FOWLER & Co. (LEEDS) LTD., LEEDS.)

Complete enclosure of all parts is the chief feature of the latest Fowler 2DY diesel marine unit. It has cylinder dimensions of $3\frac{3}{4}$ in by $4\frac{1}{2}$ in and is continuously rated at 11/15 h.p. at 1,000/1,500 r.p.m. Two-way swirl combustion chambers are used and at all normal temperatures hand starting without heater plugs is possible. Electric starting can be fitted and provision is made for heater plugs for use in arctic climates. Wet cylinder liners are fitted; they register on to rubber rings in the base of their crankcase seatings. The mounting of the massive three-bearing crankshaft is interesting in that the fore-and-aft bearings are bushes, the centre bearing only being split. Lubrication is fully pressure fed and, in order to permit

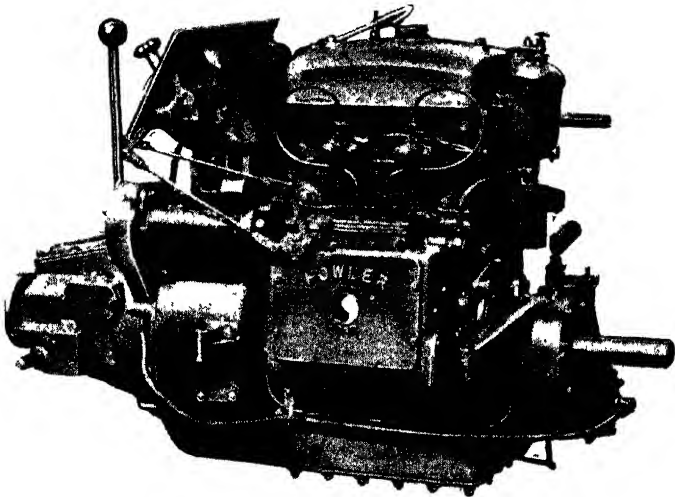

The 11/15 h.p. Fowler 2DY and its control gear is completely self-contained

THE MODERN DIESEL

the engine to be mounted with minimum clearance under the sump, a hand-operated suction pump for removing used oil is built in. Another practical feature is the way in which the starting dog of the chain-driven hand-starting device is engaged. Normally it is held away by a spring and so is out of action and needs no lubrication, but is engaged by foot operation only when required. A decompressor is fitted to facilitate hand starting. All auxiliary fittings, including the C.A.V. fuel pump, are fully enclosed behind readily-detachable cover plates. A Parsons clutch and reverse gear is generally standardized, being bolted up to the flywheel housing as a complete unit. Reduction gears can also be fitted. A neat control and instrument panel is also built on to the unit above the flywheel housing. The bare weight of the engine is 7 cwt and its fuel consumption is 0.42 pt/b.h.p./hr.

GARDNER (L. GARDNER & SONS LTD., PATRICROFT, MANCHESTER.)

The name Gardner has the highest repute in marine engineering, and the range of high-speed oil engines bearing the name have been established on the market so long as to be accepted by the public and regarded with respect by practical and technical men alike.

Two Gardner ranges are built up with cylinders in blocks of two or three, and include five-cylinder units which are still something of a novelty. A combination of a shrouded inlet valve with a simple cavity piston gives excellent results; hand starting is easily effected

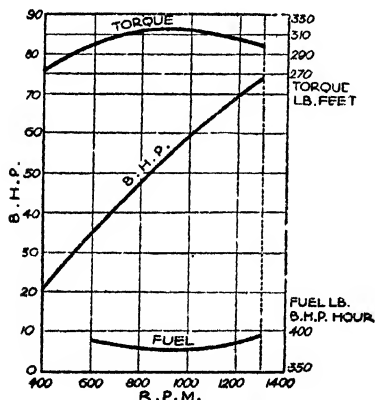

Performance curves of the Gardner 6-cylinder L2 type engine

in all models by an ingenious decompressor, which has three positions: normal running, fully decompressed, and super compression. This last is obtained by closing the inlet valve at bottom dead centre instead of some degrees later, as in the normal running position. At low speeds the effect of this is to obtain a full charge, which ensures the ignition temperature discussed in earlier sections of this book, although the compression ratio is only 13 to 1. Electric starting is provided on all models if required or compressed air may be used on the larger models.

MARINE ENGINES REVIEWED

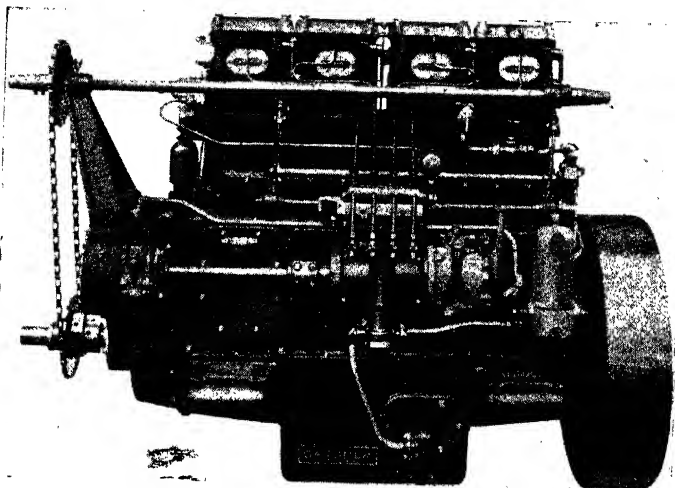

Four-cylinder 4L3 Gardner marine engine

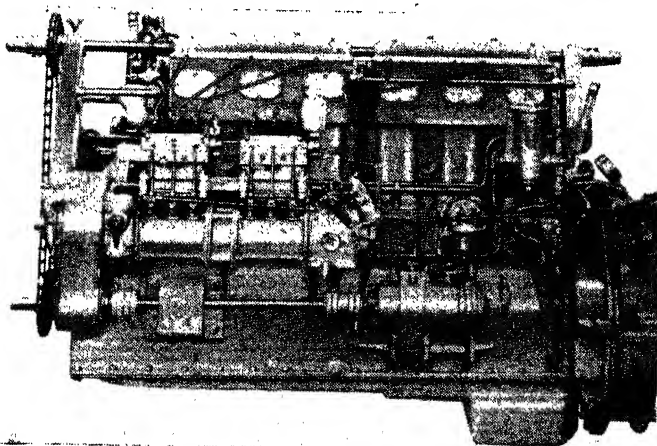

Developing 100 b.h.p., the LW type high-performance six-cylinder Gardner marine unit

THE MODERN DIESEL

Following the development of Gardner engines for road transport work, a much lighter version of the smaller series in units having three, four, five or six cylinders was introduced, operating at speeds up to 1,700 r.p.m., and engines of this type with aluminium crank, reducing and reversing gear casings weigh approximately 20 cwt in the six-cylinder 100-b.h.p. size; they are specially suited to high-speed craft. For yachts and cruisers the same engine in iron construction weighs 24 to 25 cwt and is governed to 1,500 r.p.m., the power output being 90 b.h.p., while for commercial craft and continuous heavy duty operation the speed and power output are reduced to 1,200 r.p.m. and 72 b.h.p. In cast iron construction this unit weighs 24 cwt with direct drive and reverse gear or 25½ cwt with 2 to 1 reduction gear. These units are built directly on to the engine and have epicyclic reversing and helical reduction gearing with their own self-contained pump lubrication system.

GLENIFFER (GLENIFFER ENGINES LTD., ANNIESLAND, GLASGOW.)

Immense rigidity is secured in this well-known design by casting the upper half of the crankcase and the water jackets in one block, the wet cylinder liners being inserted from above. The crankshaft is carried in the base, where it is extremely accessible. Horizontally-opposed valves are used in a clerestory head, giving high turbulence. The valves are operated by a camshaft just below the cylinder-head joint, and the rockers are completely immersed in oil, but are notably accessible. Starting is by a four-cylinder radial air motor with a Bendix-type pinion engaging with a gear ring on the flywheel. This motor is very powerful and economical in air consumption, and over thirty starts can be made from a 3½ cu. ft. air bottle, which is then recharged as necessary from one of the main cylinders.

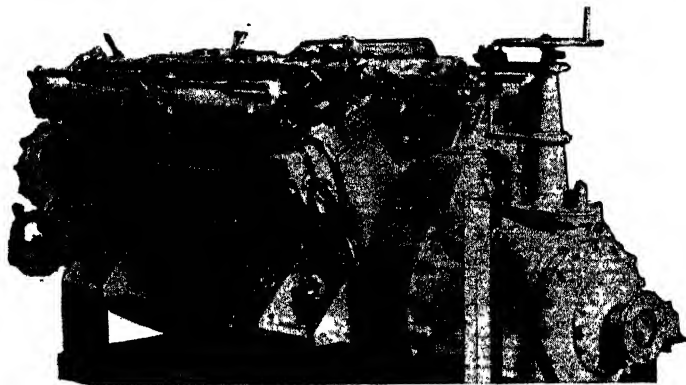

The first British V-twelve, the 240 h.p. Gleniffer

MARINE ENGINES REVIEWED

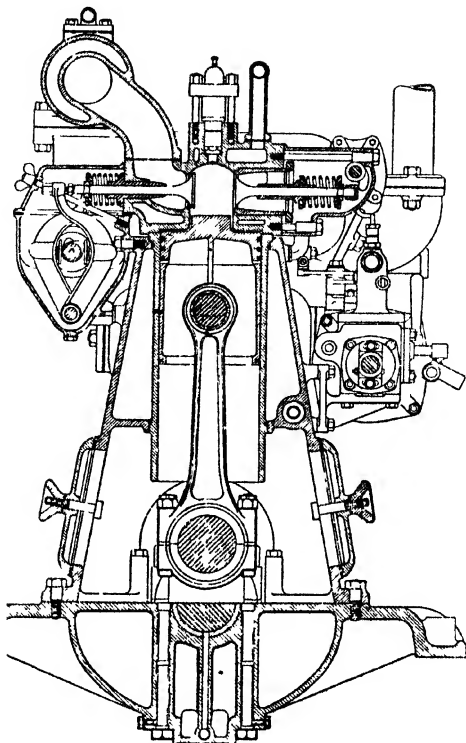

Great structural rigidity is obtained in the Gleniffer design

C.A.V. pumps and injectors are used throughout. The reverse gear has self-engaging metal-to-metal cone clutches, and 2 to 1 reduction gearing is supplied if required. The largest models, the V12 of 240 h.p. and the V16 of 320 h.p. have their crankshafts carried in the main cylinder casting, and their flywheels at the aft end. An articulated connecting rod is used, but a great many of the parts—pistons, cylinder heads, etc.—are interchangeable with those of the normal 6 in bore range.

In addition to the above range, Gleniffer build a further group of smaller units, of 4½ in bore, designed on exactly the same principle and with a V-type air motor interchangeable for cradle position with an electric starter.

THE MODERN DIESEL

**G.M.C. (GENERAL MOTORS CORP., DIESEL ENGINE DIVISION,
DETROIT, U.S.A., and 23 BUCKINGHAM GATE, LONDON, S.W.1.)**

Previously known as the Gray, this forced-induction two-stroke engine reverts to its name of origin, G.M.C. Present conditions apparently cause its temporary withdrawal from the British market, but its great technical interest and the war-time contact with it that many Services people experienced make its inclusion in these pages very desirable. It is more fully described as a road-vehicle engine on page 163 and it is a remarkable feature of a brilliant mechanical

design that the basic engine, by the adaptability of its various components and auxiliaries, can become a road-transport, industrial or marine unit yet in each form it is complete and fully equipped for the particular application involved. Not only is this the case but all parts can be transferred from one side to the other or from end to end, so that rotation in either direction and port or starboard fitting of accessories and manifolds can be adopted, while mirror or handed pairs can be made up for twin installations, either as separate units or coupled through a transfer gear to drive a single output shaft.

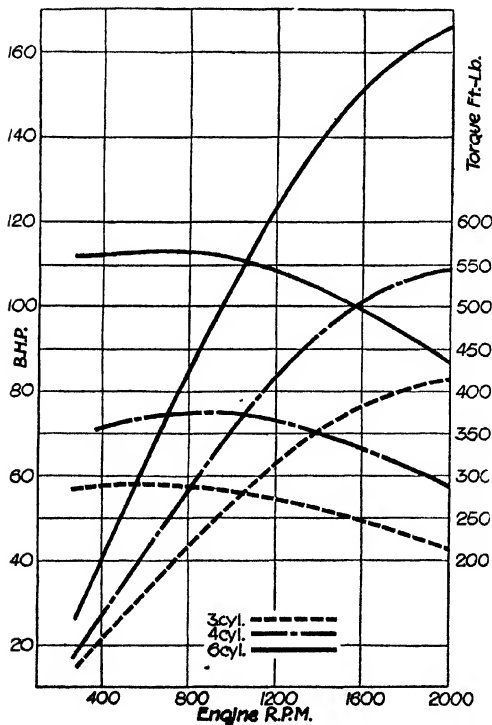

Performance curves of the three standard G.M.C. diesels

MARINE ENGINES REVIEWED

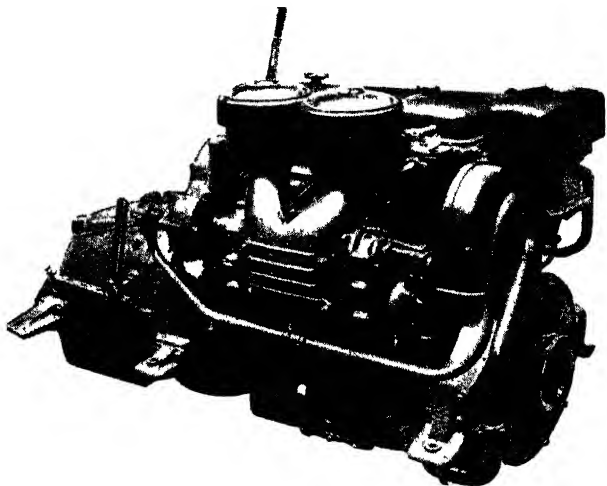

The four-cylinder 110 h.p. G.M.C. two-stroke

Three models are produced, units of three, four and six cylinders. At 2,000 r.p.m. the powers are 82 h.p., 110 h.p. and 165 h.p. and in accordance with modern practice reduction gears of various ratios are available. A closed-circuit fresh water cooling system is employed and the three direct-drive units weigh only 1,650 lb, 1,900 lb and 2,250 lb respectively.

Their reliability was fully demonstrated during the late war by their widespread use as the power unit of invasion craft.

KELVIN-DIESEL (THE BERGIUS CO., LTD., 254 DOBBIE'S LOAN, GLASGOW.)

As might be expected from one of the largest producers of marine engines in this country, a concern which has supplied a very large number of engines to fishing craft, Kelvin-Diesels are exceedingly robust. An interesting feature is the method employed for starting, so that even a six-cylinder unit of 132 h.p. may be set in motion by hand, the first impulses being obtained by a small charge of petrol.

The J models, of 4½ in bore by 6¾ in stroke, can be supplied with this standard petrol/hand starting arrangement, or for starting by hand only without the use of petrol. The K models, of which the cylinder dimensions are 6 in and 9 in bore and stroke, are available with air starting in addition to, or in place of, the petrol/hand system. Electric starters are also available on all models,

THE MODERN DIESEL

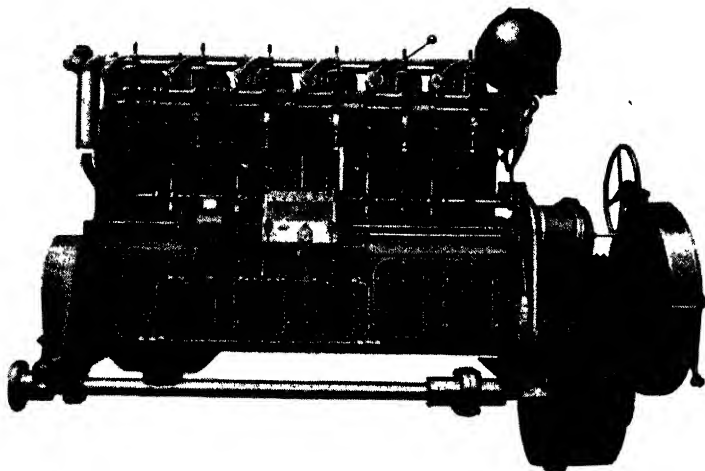

In order that the engine may be installed well aft in the ship the reversing reduction gear of this 136 h.p. Kelvin model K.R.C. is situated forward

and the 88 h.p. and 136 h.p. units can be supplied with a reduction gear situated between the engine and the flywheel forward where cyclic variations are at a minimum. The drive is then taken back under the crankshaft in such a manner as to facilitate an installation very far aft and very low down in the ship. The diesel combustion chamber incorporates the Ricardo spherical air-cell; C.A.V. fuel pumps are used on all models.

KERMATH (HERCULES MOTORS CORPORATION, CANTON, OHIO, U.S.A.)

Based on the American Hercules road-transport diesel, three six-cylinder marine units are marketed under the name of Kermath, developing 84 h.p. at 2,600 r.p.m., 113 h.p. at 1,800 r.p.m. and 160 h.p. at 1,600 r.p.m. These speeds are much higher than are common among British marine diesels and the specific weights of the engine are very low.

A very neat two-cylinder engine, the 2-113 model, developing 27 b.h.p. at 1,800 r.p.m., is also made. Crankcase, cylinder block and flywheel housing are a single iron casting with 4 in by 4½ in bore and stroke cylinders with dry liners. Combustion chambers are of the Hercules air-swirl detachable-cell design with sprayers directly across at the opposite side of the cylinder. The two cylinder heads form a single casting in which are vertical overhead valves

MARINE ENGINES REVIEWED

operated by push rods from a camshaft which also actuates the separate fuel pumps built into the crankcase; also enclosed in the crankcase are the governor and fuel delivery control mechanism. Lubrication is by submerged pump delivering oil under pressure to all parts, including overhead valve gear and the gudgeon pins; not only are the normal strainers fitted but there is also a by-pass pressure filter abaft the cylinder block. Cold starting is a feature of the engine. With direct drive and reverse the weight is 870 lb (940 lb with Upton reduction gear and reverse).

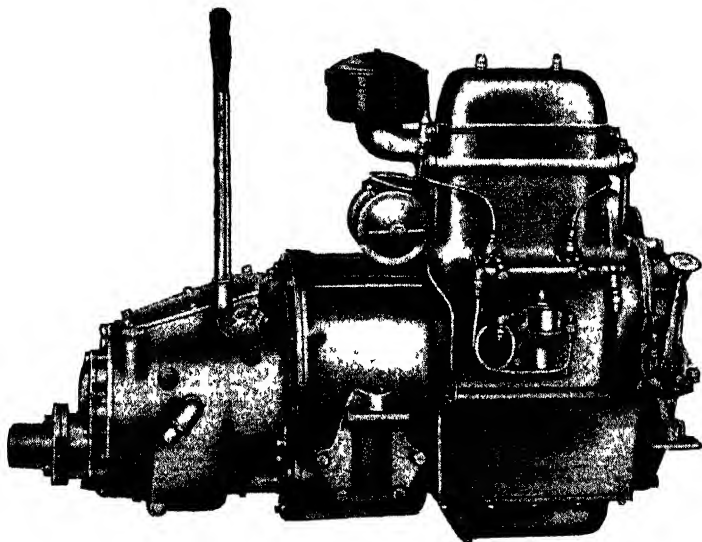

External cleanliness of design is the distinguishing feature of the Kermath 2-113 27 h.p. engine

LEYLAND (LEYLAND MOTORS LTD., MARINE UNITS DIVISION, LEYLAND, LANCS.)

Marine versions of the road transport engines (see p. 171) are now produced. Fresh water cooling is provided, two centrifugal pumps being fitted, one for the coolant and the other for supplying sea water to the heat exchanger. On the 5-litre engine, which delivers 55/75 b.h.p. there is a 2 to 1 reducing gear with oil-operated heavy duty manoeuvring gear. In the case of twin engine installations propeller rotation is set as required by modification of the

THE MODERN DIESEL

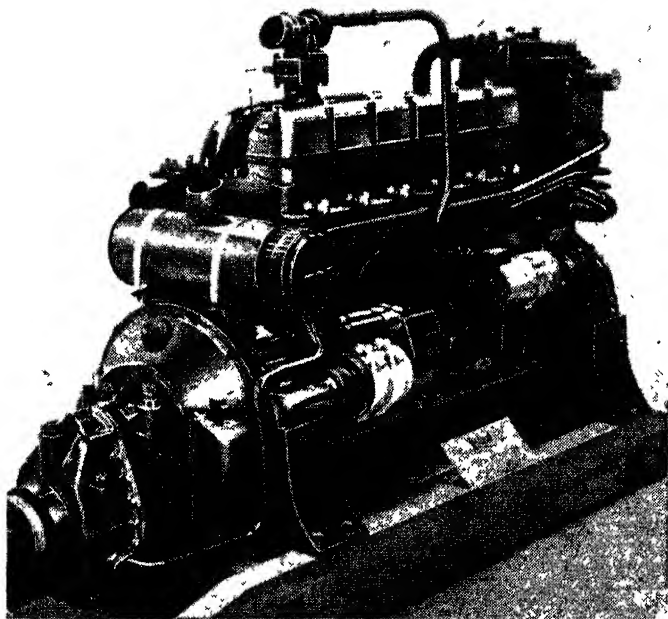

Leyland marine 9.8 litre 95-125 b.h.p. engine

reduction gear of the port engine. Very similar modifications are embodied in the 9.8-litre engine which has a 95/125 b.h.p. rating. The manœuvring gear is direct in this case, being of the Self-Changing Gear Co.'s oil-operated water-cooled type.

Another Leyland transport engine is the 7.4-litre model and this is manufactured in marine form by Thomson & Taylor (Brooklands) Ltd., Cobham, Surrey. For continuous rating it is governed to 1,650 r.p.m. with an output of 85 b.h.p. In all basic mechanical detail the specification is similar to the road transport unit but the external oil cooler is adapted as an oil/sea water heat exchanger while the main cooling system is either by direct sea water with gear pump circulation, or by closed circuit fresh water cooling by centrifugal pump circulation with a header tank and intercooler, the latter being fed by sea water by means of a gear pump.

The engine sump has a modified base for marine installation and a high-level shaft is provided with provision for a starting handle either fore or aft of the unit. Hand starting with the direct injection

MARINE ENGINES REVIEWED

system is quite easy, being facilitated by the provision of a foot operated decompressor. For arctic conditions an ether starting device is available which gives an instant start at extreme sub-zero temperatures; normally, electric starting is used and full electrical equipment (24 volt) is fitted as standard.

A "Twin Disc" 2 to 1 reduction and reversing gear is mounted directly on the flywheel housing. The gear is designed for full power operation ahead or astern, has its own lubrication system and is waterjacketed in series with the engine cooling system.

LISTER (R. A. LISTER (MARINE SALES), LTD., DURSLEY, GLOUCESTERSHIRE.)

Lister marine diesels are of the totally-enclosed type. Type CD, the smallest engine of the range, is a single-cylinder model developing 7 b.h.p. at 1,000 r.p.m. Type FC is a twin-cylinder engine developing 14 h.p. at 1,000 r.p.m. Type 2 JPM twin-cylinder, develops 18 b.h.p. at 1,000 r.p.m.

These engines incorporate the Lister patent double combustion chamber, which comprises two spherical chambers connected by a

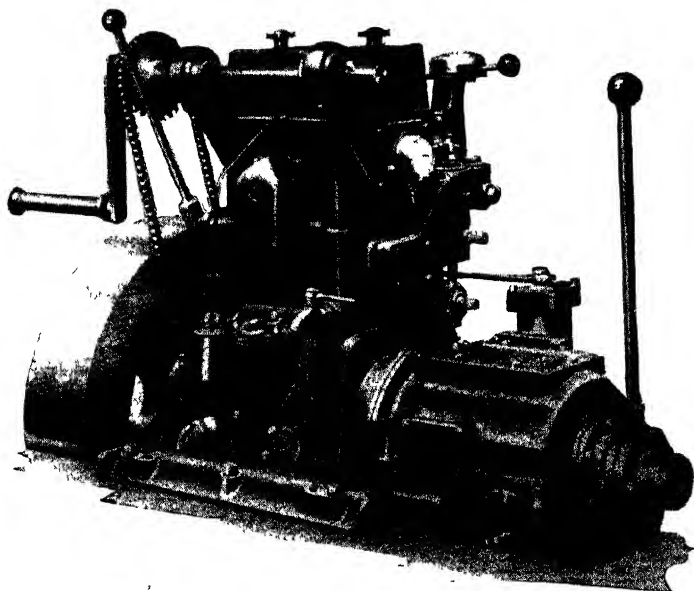

The Lister marine units are designed for hard work

THE MODERN DIESEL

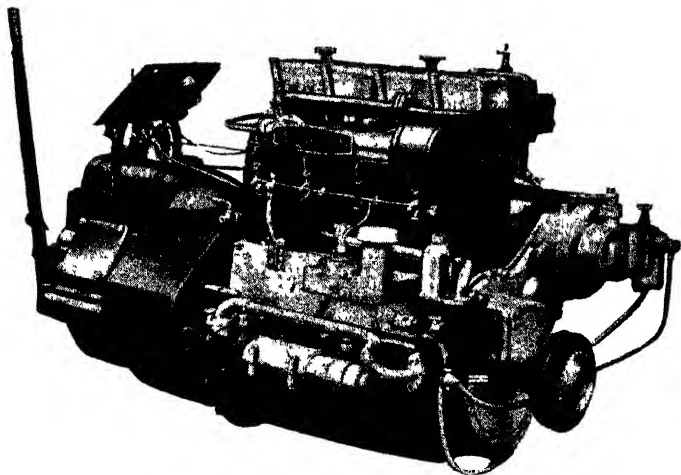

The smallest four-cylinder in the McLaren-Ricardo range

hand-controlled valve. This valve is closed when starting and a compression ratio of 19 to 1 is obtained. When the engine is running the valve is opened and the engine works on a compression ratio of 15 to 1. Dry-sump lubrication is utilized. Starting is by hand, but electric starting can be supplied, and in the case of the 2JPM engine, compressed-air starting is available. Reverse gear, with or without reduction gear, is fitted on all models.

McLAREN (J. & H. McLAREN, LTD., LEEDS.)

The McLaren-Ricardo engines embody the Ricardo Comet Mark II head. Wet cylinder liners are fitted and C.A.V. fuel-injection equipment is used. Two ranges of engines are made, the smaller having $4\frac{1}{8}$ in by 5.9 in cylinder dimensions and the larger $5\frac{1}{8}$ in by 7.9 in; two-, four-, five- and six-cylinder units are built in either cylinder size, with an additional three-cylinder model in the larger range. The engines are combined in a unit with Parsons reduction and reversing gears as required. Shaft horse power at continuous rating ranges from 18–22½ to 90–120, the smaller engines running at 1,000–1,250 r.p.m. and the larger 750–1,000 r.p.m.

MEADOWS (HENRY MEADOWS LTD., FALLINGS PARK ENGINE WORKS, WOLVERHAMPTON.)

Prior to 1939 two engines (four and six cylinders) were made embodying Lanova combustion chambers. These have now been

MARINE ENGINES REVIEWED

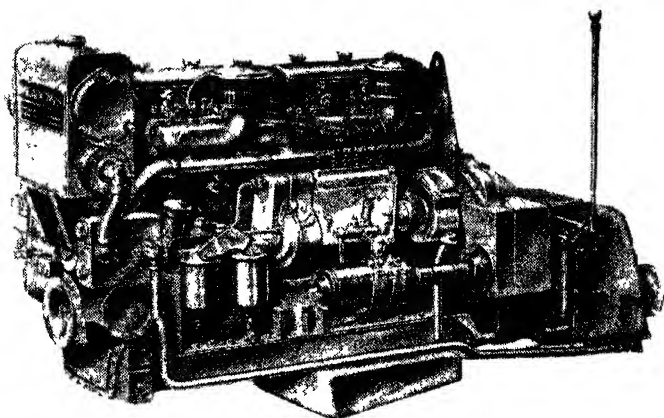

All controls, including change-over oil filters and change-over circulating and bilge water pumps, are mounted on the forward end cover of the Meadows

replaced by two direct-injection units with toroidal-cavity pistons. Both have $5\frac{1}{2}$ in bore and stroke, the capacity respectively being 420 and 630 cu. in.; continuous power rating is 60 and 90 b.h.p. at 1,600 r.p.m. Fresh-water cooling is provided, and sea-water and bilge pumps are fitted. All auxiliary equipment can be transferred from side to side of the cylinder block, while the crankcase end covers are so made that they can be changed over end for end. This versatility greatly facilitates the assembly of handed pairs for twin-engined craft, the main frame of the engine being the same in each case; the general arrangement of the basic unit is described in its road-transport form on page 177. Helical reduction gears of various ratios are available and epicyclic reversing gears are also provided.

Although in size and power output somewhat outside the scope of this book a larger version of this range of engines and of substantially the same design and characteristics is produced. The six-cylinder unit is of 950 cu. in. capacity, developing 130 b.h.p.

MIRRLEES-RICARDO (MIRRLEES, BICKERTON AND DAY, LTD., STOCKPORT.)

The Mirrlees-Ricardo engines incorporate the Comet type of combustion chamber and are built in three-, four-, five- and six-cylinder models, all with bore and stroke of $5\frac{3}{8}$ by $6\frac{1}{2}$ in. They are robust engines of normal type. (See table on page 273 for details.)

THE MODERN DIESEL

NATIONAL (THE NATIONAL GAS AND OIL ENGINE CO. LTD.,
ASHTON-UNDER-LYNE.)

Many types of National engines have been built in sizes falling within the limits covered by this handbook. Some very successful models had horizontal valves in high-turbulence combustion chambers. In the case of the larger models starting was effected by means of an air motor with Bendix drive to the flywheel, or by a small single-cylinder diesel with a fast and loose flat-belt drive. The smaller models are started either by hand or electrically. A very interesting combined reducing and reversing gear, oil operated, is employed, and a variety of reduction ratios is available. The gear incorporates an oil pump which, *via* a control, passes oil under pressure to expanding clutches in either the chain or the gear drive, to give the desired direction of rotation, the operation being quite smooth and devoid of shock.

A new range of $4\frac{1}{2}$ in by 6 in bore and stroke National engines in three-, four-, five- and six-cylinder models was introduced in 1943; direct injection is employed, with masked inlet valves and cavity pistons. There are many novel constructional features. Every part is totally enclosed when in running order, even to the electric generator and starter motor (or compressed-air starter if this alternative is adopted), yet in spite of this complete protection, accessibility is above the average and valve operation, fuel pumps, camshaft, big ends and crankshaft can be fully exposed for inspection or repair without disturbing any running adjustments. Crankcase, cylinders and flywheel housing are an iron casting of somewhat

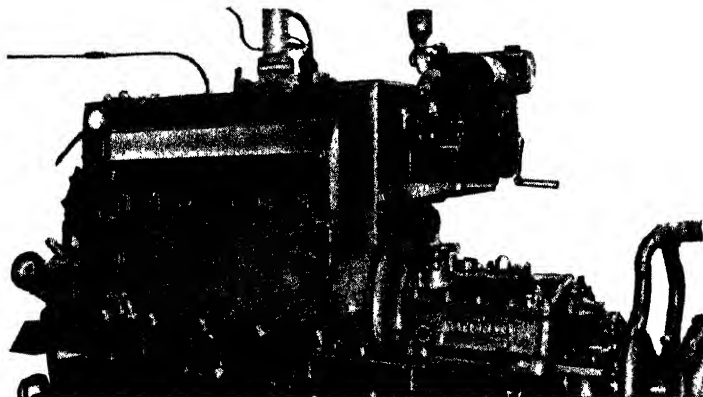

*Six-cylinder ($4\frac{1}{2}$ in by 6 in) National direct-injection engine,
with single-cylinder petrol starting motor*

MARINE ENGINES REVIEWED

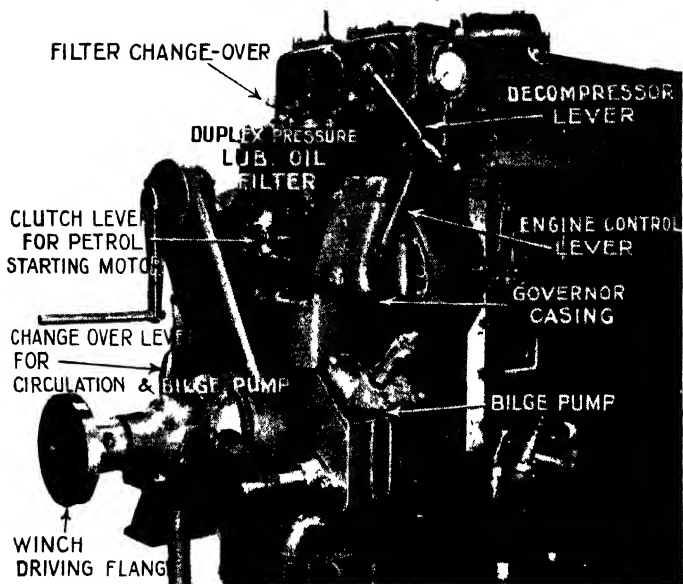

All controls, including change-over oil filters and change-over circulating and bilge water pumps, are mounted forward on the timing gear cover

box-like form. The cylinders have wet liners and the camshaft is placed rather high on the side of the crankcase above the crank chamber proper. The rocker-operated overhead valves are slightly inclined from each other, each rocker oscillating on its own separate pedestal on the cylinder head. Short push rods transfer the cam action to the rockers. Between each pair of valve cams is a pump cam and a separate C.A.V. pump is mounted adjacent to each cylinder head, delivering the fuel oil through a short pipe to the multi-hole C.A.V. nozzle. On the forward end of the camshaft is a centrifugal governor which moves the control rod of the fuel pumps. The timing gear and auxiliary drive is by a duplex roller chain. There is a hand adjustment on the governor to set the desired speed, which is then automatically maintained within close limits. Two reciprocating water pumps are fitted, one for cooling and the other for bilge, but there is a change-over device whereby, in the case of a cooling-pump stoppage, the bilge pump can take on its duty while the other receives attention.

THE MODERN DIESEL

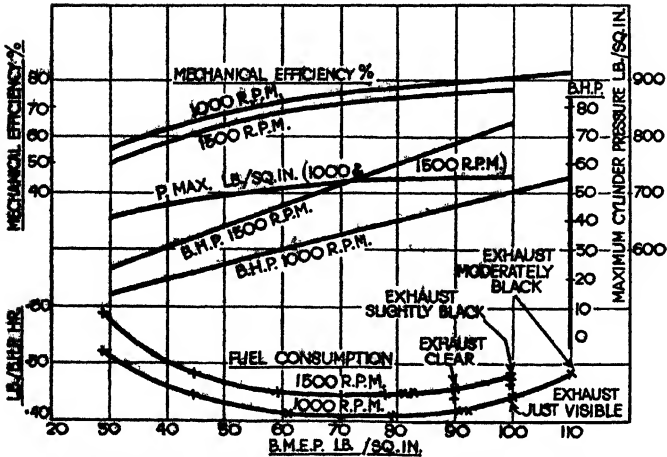

Curves indicating in full the technical qualities of the four-cylinder 44-60 h.p. Paxman-Ricardo

PAXMAN-RICARDO (PAXMAN & Co. (COLCHESTER) LTD., STANDARD IRON WORKS, COLCHESTER.)

The smaller units which are within the scope of this book are very substantially built and of eminently sound design, with great rigidity and large bearing areas. Combustion chambers of Ricardo type are employed.

Additions to the range made just before the war were several high-powered, high-speed, units of eight, twelve and sixteen cylinders; these were two-bank V engines and certain models were supercharged.

PERKINS (F. PERKINS LTD., QUEEN STREET, PETERBOROUGH.)

Details of the Aeroflow combustion system peculiar to Perkins diesel engines are given on page 183, while particulars of the P4 and P6 engines are included in the transport section. These engines are now produced in marine form, both being six-cylinder units. The smaller engine (P6M) is dimensionally equivalent to the P6 transport engine, having $3\frac{1}{2}$ in bore and 5 in stroke. It has a maximum output of 70 b.h.p. at 2,200 r.p.m. and a continuous cruising rating of 65 b.h.p. at 2,000 r.p.m. The specific consumption of this type is most economical, being of the order of 0.36 pt/b.h.p./hr. The other engine of substantially similar design is the S6M with

MARINE ENGINES REVIEWED

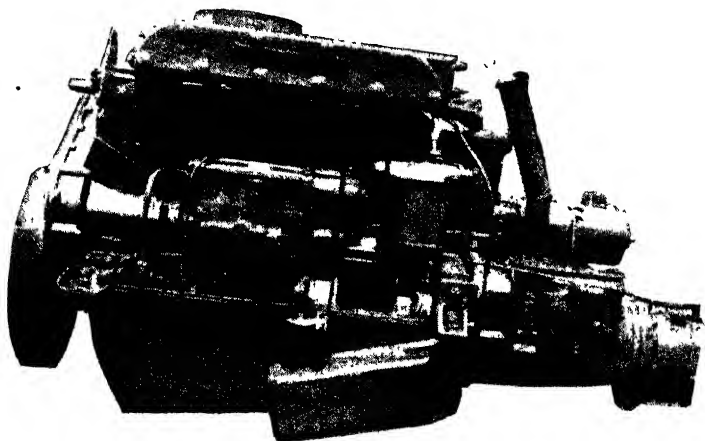

Perkins P6M (65 b.h.p. at 2,000 r.p.m.) with 2 to 1 reduction gear and reverse

the cylinder bore increased to $4\frac{3}{8}$ in, with other details correspondingly dimensioned. Renewable dry cylinder liners are fitted to the smaller engine but they are not specified in the larger version. Maximum output is 130 b.h.p. at 2,250 r.p.m., the cruising rating being 100 b.h.p. at 2,000 r.p.m. The P6M engines have been extensively used in R.A.F. seaplane tenders and in Thames police patrol launches.

R.N. (RUSSELL, NEWBERY AND CO., LTD., ESSEX WORKS, DAGENHAM AND ALTRINCHAM, CHESHIRE.)

R.N. high-speed diesels embody the fruits of many years' experience of stationary work, before the firm turned its attention to marine requirements. Built in sizes of 7 to 100 h.p., they are comparatively small in size and hand or electric starting presents no difficulties. Valves are horizontally opposed in the off-set clerestory-type combustion chamber and are operated by push-rods from two camshafts in the crankcase. A C.A.V. pintle injector sprays tangentially into the combustion chamber. Accessibility of valve gear and moving parts is a leading feature. The C.A.V. fuel pump is mounted across the engine on the top of the timing gear case. As regards flexibility and freedom from "knock", these engines set a very high standard.

The flywheel is on the forward end of the crankshaft and there is an integrally built-in R.N. fluid-operated reverse gear which

THE MODERN DIESEL

enables the helmsman to have full control of the engine and reverse gear by the simple movement of a ship's telegraph. The gear may be direct or may incorporate a reduction ratio between crankshaft and propeller shaft.

The smoothness and quietness of operation has made these engines in the smaller powers very popular for driving electric generators and other auxiliary uses in large craft.

RUSTON (RUSTON AND HORNSBY, LTD., LINCOLN.)

Of the very wide range of engines produced there are two twin-cylinder and one three-cylinder in the smallest series developing 10 h.p., 15 h.p. and 22½ h.p. respectively at 1,000 r.p.m. Sensibly robust units these, with a minimum of delicate or vulnerable parts. The next series comprises three-, four-, five- and six-cylinder units, of very different general design, even more substantial than the smaller series. The output is 10 h.p. per cylinder at 1,000 r.p.m.

The third series is in units of two, three, four, five and six cylinders of 17½ h.p. per cylinder at 1,000 r.p.m. These are decidedly heavy-duty engines with horizontal valves in high-turbulence combustion chambers. Starting is normally effected by compressed air and extreme accessibility is probably the most outstanding feature of the range. A further series developing 20 h.p. per cylinder was added later. It was a new design with vertical valves, employing the Mark 37 Ruston atomizer.

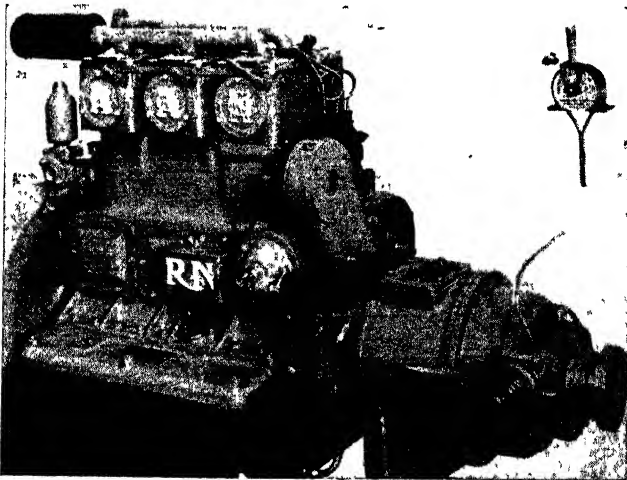

R.N. three-cylinder 30 b.h.p. diesel, showing fluid-operated reverse gear and the remote control

MARINE ENGINES REVIEWED

STUART (STUART-TURNER LTD., HENLEY-ON-THAMES.)

The tiny 2-3 h.p. two-stroke diesel marketed by this company is probably the smallest diesel that has been offered to the public.

This engine has several interesting features. It employs crankcase compression and is of the valveless type. The combustion chamber is formed in a steel plug screwed into the piston crown and taking the form of a protruding cup with a central pip, and there are tangential ports in the walls of the cup at the base through which the burning gases are ejected to initiate a rotary swirl within the cylinder in which the combustion is completed; the engine runs at speeds up to 1,500 r.p.m. C.A.V. injection equipment is employed. As the power unit of an electric generating set it is particularly suited for service in the larger type of yacht, since in using the same fuel it introduces no additional fire risk.

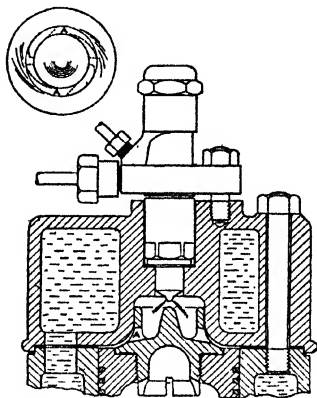

Section of the Stuart combustion chamber showing the heat-resisting steel plug in the piston head

TANGYE (TANGYES LTD., BIRMINGHAM.)

Great strength and rigidity of construction characterize the Tangye marine diesels, as one would expect since they come from a firm which has made a name for itself in the stationary engine market. Ricardo-Comet combustion chambers are employed and special attention has been paid to accessibility of all parts. All units having three or more cylinders have all pumps and accessories grouped conveniently at the forward end. Reversing and reducing gears of Parsons make are fitted and ratios of 2 to 1 or 3 to 1 are available, according to the series for which the engine is intended.

THORNYCROFT (JOHN I. THORNYCROFT & Co. LTD., THORNYCROFT HOUSE, SMITH SQUARE, LONDON, S.W.1.)

Five models are now in production and both air-cell and direct-injection systems are used. The two-cylinder (20 b.h.p.) unit has hand while the four- and six-cylinder engines have electric starting.

For the two-cylinder engine direct sea-water cooling is the standard method but on the four- and six-cylinder models a closed fresh-water

THE MODERN DIESEL

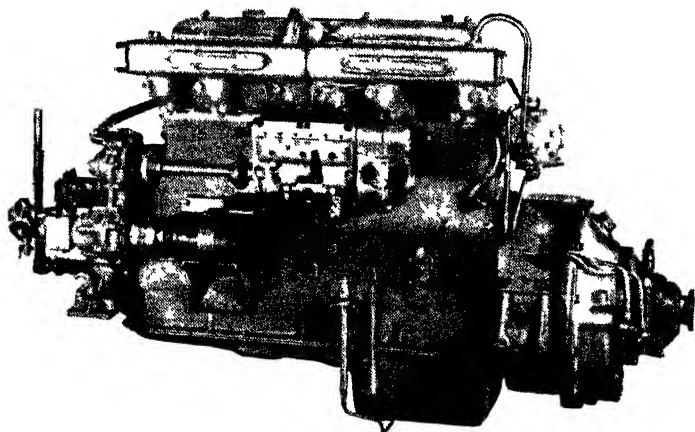

Thornycroft 60/90 b.h.p. six-cylinder marine engine with oil operated reversing gear

cooling circuit can be provided with sea-water-cooled heat-exchanger as an alternative if required. The two-cylinder engine has integral reducing gear of 1 to 0.65 ratio combined with ahead and astern clutches and reverse gear. The four- and six-cylinder units are available for direct propeller drive or may be fitted with 2 to 1 reducing gear. In the case of the two largest six-cylinder engines, viz., 60/90 b.h.p. and 90/130 b.h.p., a 3 to 1 ratio gear is also available.

Features of the 60/90 h.p. engine are oil operated reverse gear and patented combined reverse and pump controls. These engines are of the direct-injection type with toroidal cavity pistons.

TURNER (TURNER MANUFACTURING CO. LTD., WULFRUNA WORKS, VILLIERS STREET, WOLVERHAMPTON.)

A neat 68 degree V twin of $3\frac{1}{2}$ by $4\frac{1}{2}$ in bore and stroke was introduced during 1946 with a rated output of 15 b.h.p. at 1,500 r.p.m.; it has an interesting form of air-cell combustion chamber. The cell is oval, set to one side of the cylinder head and there is a shallow tapered groove diametrically across the piston crown so that air "squished" as the piston approaches the cylinder head rushes along it into the cell, into which the fuel is injected horizontally from a C.A.V. pintle-type sprayer. Fuel consumption is just over 0.45 lb/b.h.p./hr. Mechanically the engine is of simple and robust design, the single-throw cast crankshaft being of massive one-piece

MARINE ENGINES REVIEWED

construction with balance weights; the camshaft is in the crankcase between the two cylinders, and the push rods and overhead rocker gear are completely enclosed. Reversing gear (or reduction and reversing gear) is fitted directly on to the flywheel housing, above which a control and instrument panel is also fitted. Hand or electric starting is available and the unit starts from 40° F without heater plugs. A single-cylinder model of the same type is also made; it is rated at 7½ b.h.p. at 1,500 r.p.m. while more recently a four-cylinder unit developing 30 b.h.p. has been introduced. It is of V type similar in layout to the twin model.

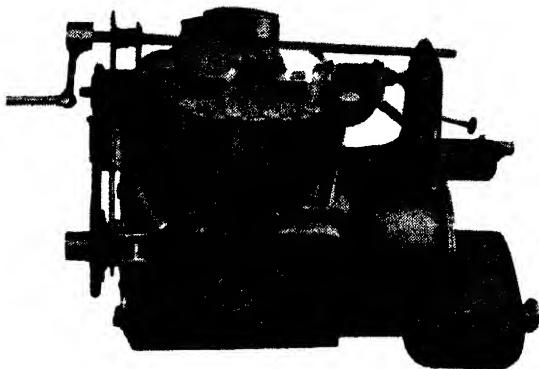

30 h.p. Turner V-four engine

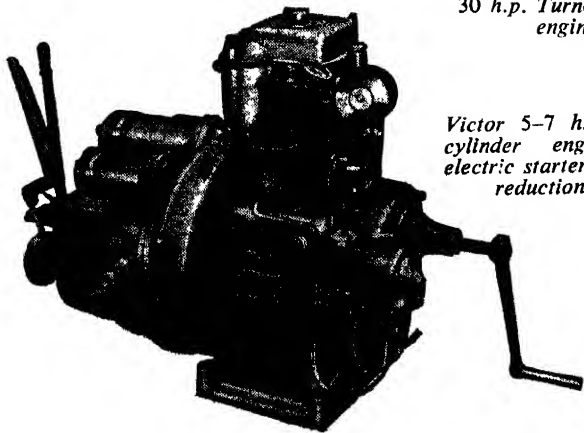

Victor 5-7 h.p. single-cylinder engine with electric starter and 2 : 1 reduction gear

THE MODERN DIESEL

VICTOR (COVENTRY VICTOR MOTOR CO., LTD., COX STREET, COVENTRY.)

Two single-cylinder engines are made which are very suitable for auxiliary power for sailing vessels up to about 14 tons. The same general design is common to both units, the smaller one, rated at 5-7 h.p. having a bore and stroke of 80 × 100 mm while the larger has an output of 7-9 h.p., the bore being increased to 85 mm, the stroke remaining the same.

Vertical overhead valves are fitted, these being push-rod operated from a camshaft in the crankcase; the enclosed starting-handle dog mechanism engages with the camshaft. All working parts of the engine are enclosed within the main castings. The crankcase is of non-corrosive aluminium alloy and the weight of the engine is approximately 214 lb without gear box; either 2 to 1 or 3 to 1 reduction and reverse gears can be supplied. The combustion system is of the air-cell type with C.A.V. pintle nozzle and the rated continuous output is delivered at 1,500 r.p.m.

WIDDOP (WIDDOP & CO. LTD., KEIGHLEY, YORKS.)

Characterized by an exceptionally smooth exterior, the Widdop diesel engines have no moving parts visible except the flywheel and coupling. Hand starting is easy, all cylinders being decompressed until the flywheel is turning fast enough. Then, by means of a hand lever, full compression is cut in on first one and then the remaining cylinders. Horizontally-opposed valves with a turbulent clerestory combustion chamber are used, and the cylinders are in the form of loose liners inserted in the main block. In this engine the base chamber is carried to the extreme aft end of the reverse gear, making installation a particularly straightforward job. An engine thus encased should remain clean, a point of great importance on

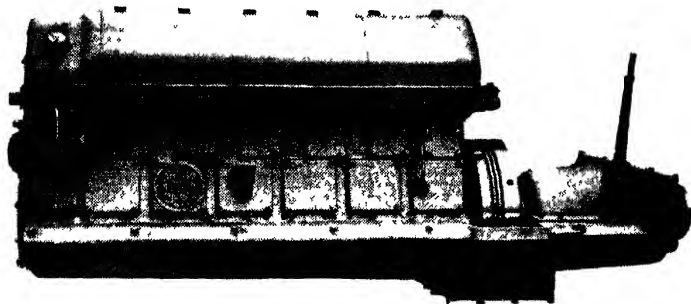

Complete enclosure of all vulnerable parts is a feature of the six-cylinder 72-h.p. Widdop

MARINE ENGINES REVIEWED

a yacht, while the generous provision of hand hole covers in the crank chamber and the easy detachability of the overhead-valve gear cover make this a convenient engine to adjust and maintain with the minimum of dismantling.

Although Widdop engines are somewhat outside the range of size dealt with in this book and are not strictly to be described as "high speed", these notes have been included in order to draw attention to their clean design and to the accessibility combined with complete enclosure which the clerestory type of head provides.

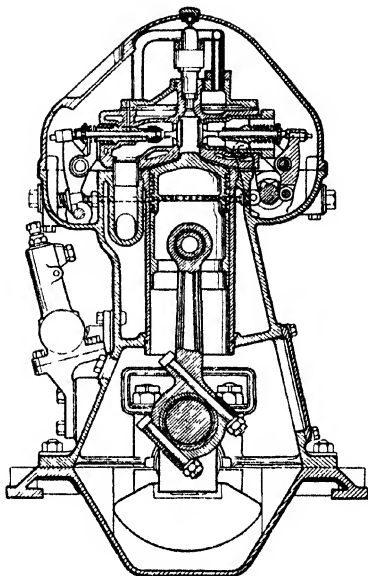

Inclined big-end bolts facilitate servicing all Widdop diesels

Aircraft Engines

FOR reasons which will be apparent when the following pages have been read, diesel engine development has had very little influence upon the evolution of aircraft. Nevertheless a great deal of experimental work was carried out in the 1930s and it is of some historical interest to recapitulate this, for even if it had no permanent effect in its own field, the knowledge acquired was of indirect help in other directions, if only in the sense that certain avenues of unprofitable endeavour were revealed.

The diesel presented new problems and was more difficult to adapt to aircraft than the petrol engine. As it was a relatively "new" unit and lacked the many years of research, experiment and operational experience associated with the spark-ignited engine it suffered an initial handicap. The prime factor, however, was the essentially military character of aircraft development and the consequent insistence upon high performance. Reliability, fuel economy, improved safety and long-range operation had all to give priority to maximum performance and low specific weight. Improvement in the knock rating of aviation petrols and the intensive development of supercharging systems enabled rapid and substantial advances to be made in petrol engines which further widened the gap between the two types.

It may be argued that the general attitude was justified. In the military sphere, which became paramount from 1937 onwards, the existing diesel engine had no place. Military aircraft called for engines of high power output with minimum weight. Cost of operation was of no consequence providing the required performance was obtainable. Even safety and reliability were only relative terms to be off-set against performance. Safety and reliability conditions were satisfactorily fulfilled if, within their limits, a particular class of operational duty could be performed. The diesel engine had safety and reliability in a more absolute sense

AIRCRAFT ENGINES

than that, but for normal short-range operation was unduly heavy. It could not well be otherwise in a type which is not responsive to special adjustments for a temporary increase of power output.

The petrol engine, on the other hand, can readily have its power boosted well beyond its normal safe maximum providing the overload is not maintained for more than a few minutes, thus for take-off, for high rate of climb, and for excess speed in combat, the military-aircraft engine must be capable of developing well over its normal rated power. This type of performance is entirely outside the scope of the diesel.

For civilian aircraft, the diesel promised long-term reliability, and lower maintenance costs, while the use of a non-volatile fuel provided an enormously increased safety factor in reducing fire risk both in flight and in the event of a crash landing. The latter consideration alone might have been regarded as ample justification for the use of diesel power for civilian machines. On the score of operating costs, too, there was the fact that the high thermal efficiency of the diesel reduced specific fuel consumption. The diesel engine consumed from 0.35 to 0.40 lb/b.h.p./hr compared with the petrol engine's 0.45 to 0.50 lb/b.h.p./hr on the 87 octane fuel, the normal aviation spirit for some time before 1939. This difference in consumption was sufficiently favourable to be attractive, since it meant that the same weight of fuel would permit an increase in range of from one-quarter to one-third for engines of the same power. Power for power, the diesel engine as a dry unit is considerably heavier. Apart from specially-constructed air-cooled engines there has been no indication that the diesel can be built to a better specific weight than 2 lb/b.h.p. The civilian type of aircraft petrol engine, however, can be built to a weight of 1 lb/b.h.p.

Having regard to the fact that the road transport diesel has a weight of 10 to 12 lb/b.h.p., the figure of 2 lb/b.h.p. for aircraft diesels is a truly remarkable achievement and the fact that it has stood for so long without change suggests that the limit has been reached. It appears to be inevitable that the diesel must remain of higher specific weight than

THE MODERN DIESEL

the petrol engine, bearing in mind the characteristics of the diesel combustion cycle. The high compression pressure, the more sustained combustion pressure and the momentarily high ignition pressure make a substantial structure essential. The highest pressures, moreover, are developed at the lower range of crankshaft speed, so from that aspect alone the stiffness of the crankshaft and crankcase assembly is imperative.

To sum up, the diesel uses a "non-flam" fuel, uses that fuel economically and therefore, on a given tankage, has a longer range. Since there is no electrical ignition system there is improved reliability, while the absence of a carburettor eliminates fuel distribution and freezing troubles. To off-set these most desirable advantages, the weight of metal in the engine structure is at least double that of the petrol engine, while the power from any given cylinder capacity is appreciably lower. These disadvantages undoubtedly weigh heavily against the diesel and are responsible for its limited use. It is significant that all the engines later described in this chapter were designed and made prior to 1938-39 and that only one, the German Junkers, was actually used in commercial flying.

When the war came in 1939 the acceleration of petrol-engine development was spectacular. High performance was urgently demanded and the petrol engine responded with the necessary quick results. Fuel technology marched step by step with engine design. High-octane petrols were developed that permitted higher compression ratios to be used in spark-ignition engines and thus the advantage of the high thermal efficiency of the diesel tended to be levelled out. Incidentally, diesel oil is not responsive to "improvement" by chemical additives or "dopes". Highly-supercharged petrol engines soon attained power/weight and power/capacity ratings which left the diesel far behind.

At a later stage in the war came the development of the gas turbine and the jet-propulsion unit, light in weight and using a fuel of volatility well below petrol and only a little above diesel oil. Indications are that the gas turbine will entirely displace the reciprocating engine in the largest and fastest high-altitude transport planes. In the smaller

AIRCRAFT ENGINES

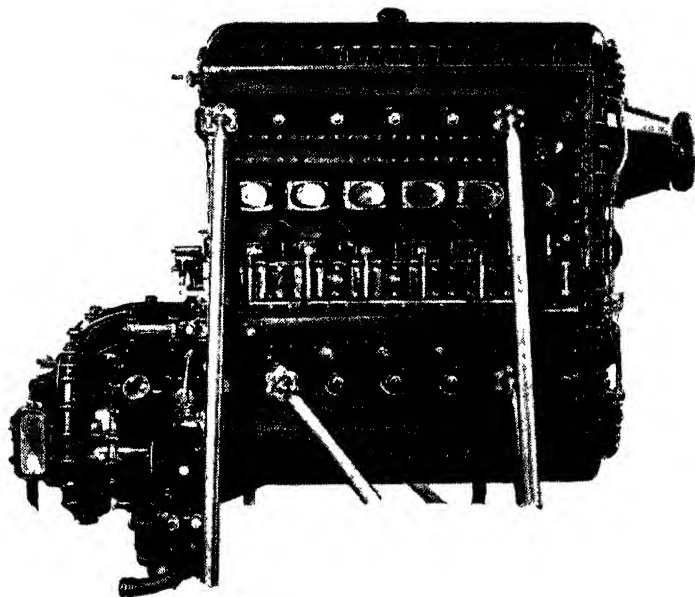

A 720 h.p. two-stroke Junkers heavy-oil engine fitted with a Rateau two-stage blower

aircraft in which reciprocating engines are likely to be used for a long time to come, the diesel remains a possibility where reliability and economy takes precedence over performance. Even for private aircraft it may find a place. As a pointer it may be mentioned that a four-cylinder horizontally-opposed air-cooled diesel engine was built experimentally in the U.S.A. at the end of 1946. It develops 125 h.p. at 2,600 r.p.m. and propels a small aircraft at 85 m.p.h. on a fuel consumption of less than 3 gal/hour.

Interesting aircraft-propulsion projects are under development in which a two-stroke diesel engine is compounded with a gas turbine. The engine functions as the high-pressure stage in which the combustion of fuel is effected. All power from the crankshaft is utilized to drive a blower

THE MODERN DIESEL

to produce a high degree of supercharge in the engine. Driven by the exhaust gas from the engine the turbine serves as the low-pressure stage and furnishes all the propulsive power. In effect, the engine operates as a dynamic (as distinct from the more usual static) gas producer feeding the turbine. The scheme is a logical exploitation of the frequently-quoted fact that more heat energy escapes by the exhaust pipe than is delivered by the shaft of a reciprocating engine.

For airscrew-propelled aircraft operating at medium speeds at medium altitudes it offers extreme economy of fuel, even lower than a straightforward diesel engine, and appears to be specially suitable for ultra-long range craft of both military and commercial types. However, this is an application outside the scope of this book.*

Since it must be tacitly agreed that the aircraft diesel did not "arrive" in the past, the review of pre-1939 aircraft engines that follows must be regarded as an historical summary. It completes the picture of high-speed diesel development in a field wherein its particular and very real advantages fail to compensate for the seemingly insuperable technical problems inherent in the type so long as maximum power output and minimum weight per unit capacity are the first requirements. Only for long-range work can the diesel be seriously considered at the present stage of development.

Although many aircraft diesels had been in the experimental stage over a long period, the Junkers Jumo 205 was the only engine in commercial production in 1939; it is described on page 261. No definite information regarding further progress came out of Germany but it was known that development resulted in the Jumo 205E, which was said to give 700 h.p. at 2,500 r.p.m.; this was followed by the 205D giving 880 h.p. for take-off. A still more advanced engine, the Jumo 207, of the same size but with an exhaust-driven turbo supercharger, was credited with a take-off power (not confirmed) of 1,000 h.p.

Air-cooled radials appeared to offer diesel designers the

* See "Gas Turbines and Jet Propulsion," by G. Geoffrey Smith (distributed by Iliffe & Sons, Ltd.)

AIRCRAFT ENGINES

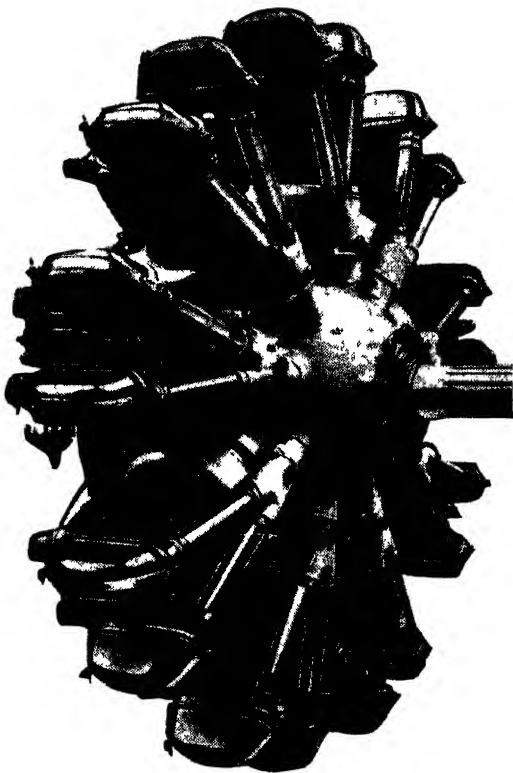

*Czechoslovakian Zbrojovka nine-cylinder
two-stroke diesel*

greatest scope and B.M.W. was engaged in 1938 on converting a Pratt & Whitney Hornet to diesel operation on the Lanova combustion system; nothing more was heard of this. A 300 h.p. nine-cylinder radial of 120 mm bore and stroke (13,232 c.c.) was under active development in Czechoslovakia; this engine, the Zbrojovka, was a two-stroke with two overhead exhaust valves. Intake was pressure fed from a Rateau centrifugal blower *via* ports

THE MODERN DIESEL

in the cylinder barrels uncovered by the pistons. No more has been heard of it.

Under the sponsorship of the French Air Ministry, Clerget was at work on a fourteen-cylinder two-bank air-cooled radial, 140 by 140 mm bore and stroke, rated at 520 h.p. at 1,900 r.p.m. The weight ratio was 2.53 lb/b.h.p., which was not so good as the Clerget liquid-cooled V16 diesel (180 by 200 mm) with Rateau turbo blower. This unit had a power/weight ratio of only 2.47 lb/h.p.; it had a fuel consumption of '0.375 lb/b.h.p./hr, which was estimated to represent a saving of one ton of fuel per 6½ hours flying time in comparison with a petrol engine of equivalent power. Also during 1939 another new version of the Guiberson was announced in America; this was a nine-cylinder air-cooled radial of 310 h.p. rating, but it did not go into production.

So far as Great Britain is concerned the original aircraft diesel was the Beardmore "Tornado" which was used in the airship R101. It had eight cylinders in line of 8¼ by 12 in bore and stroke and a cruising output of 585 h.p. at 900 r.p.m. with a maximum of 650 h.p. The fuel pump was a compact unit of Beardmore design at the rear of the engine, with pipes leading to the injection nozzles

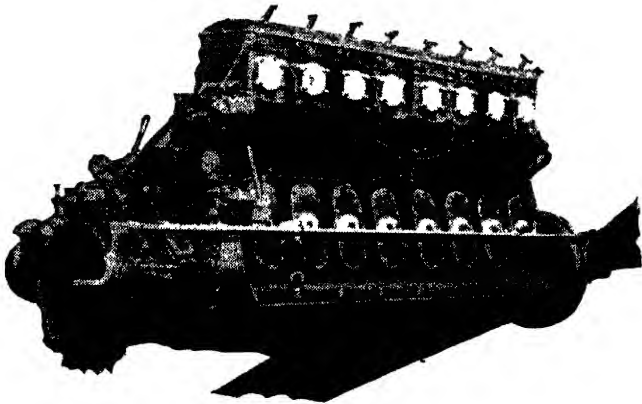

Beardmore Tornado Mark III eight-cylinder airship engine

AIRCRAFT ENGINES

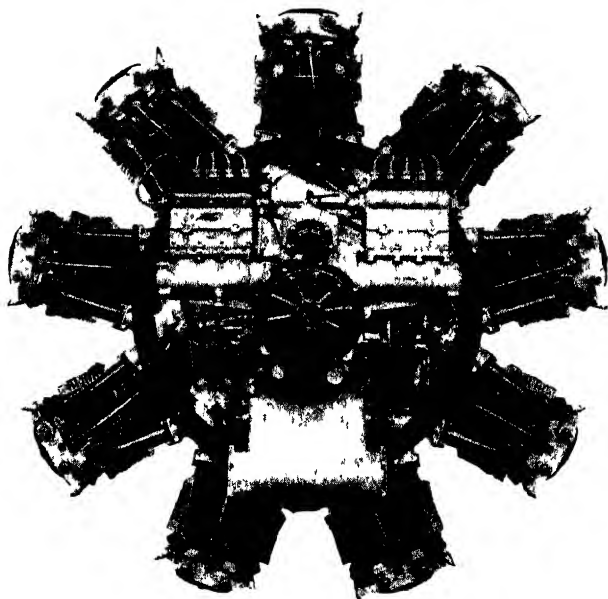

Bristol Phoenix diesel aero engine from the rear, showing the arrangement of the fuel pumps

or atomizers mounted in the centre of the cylinder heads between the two inlet and exhaust valves. Starting was effected by an auxiliary engine, which drove a Bendix pinion with a reduction gear of 20 to 1, which ran the main engine up to a speed of about 100 to 120 r.p.m., at which it immediately started. Fuel consumption proved to be 0.385 lb/b.h.p/hr at continuous full power, which was a saving of about 30 per cent as compared with contemporary petrol engines. At nine-tenths full power the consumption was 0.38 lb/b.h.p/hr.

The specific weight of this engine was nearly 7.5 lb/b.h.p., and while this could be considered feasible for an airship, it was obvious that such an engine was too heavy for use in an aeroplane. It only delivered 7.5 b.h.p. per litre of cylinder capacity.

THE MODERN DIESEL

Later, the British Air Ministry, as a result of single-cylinder research, directed its own development work along two distinct lines, the one employing the directed-spray system of injection and the other using the sleeve valve and an organized air swirl. The former was applied to a Rolls-Royce Condor while the latter was used in converting a Rolls-Royce Kestrel engine.

Owing to the introduction, in 1934, of petrol fuel of a higher octane number than any previously allowed in Great Britain, the development of the aircraft diesel engine was rather slowed down, for the new petrol fuel made possible a specific consumption so low that only in flights of very many hours duration could the heavier c.i. engine compete with the petrol engine when the combined weight of engine and fuel was taken into account.

In 1933 the Bristol Aeroplane Co. Ltd. had meanwhile introduced a radial air-cooled compression-ignition engine, known as the Phœnix. This engine made its first public appearance at the R.A.F. Display at Hendon that year, and in May of 1934 it established a new world's altitude record for c.i. engines by reaching a height of 27,453 ft when installed in a Westland Wapiti.

Of the same capacity as the Bristol Jupiter petrol engine, the Bristol Phœnix c.i. engine was a nine-cylinder air-cooled radial with a bore of 5.75 in and a stroke of 7.5 in, giving a swept volume of 1,753 cu. in. (28.7 litres). The normal speed of the engine was 1,900 r.p.m. and the maximum speed 2,000 r.p.m. The rated power at normal r.p.m. was 415 b.h.p. and the power at maximum r.p.m. 430 b.h.p. For take-off at normal r.p.m. the power was as high as 470 b.h.p. or about 16 b.h.p. per litre. The fuel used during the altitude record flight was Persian gas oil of 0.839 specific gravity. The weight of the engine complete was 1,090 lb.

It was in Germany, however, that the first commercially successful aircraft diesel was produced. This was the Junkers Jumo 205, which was particularly interesting, being a six-cylinder two-stroke of a very novel design. There were two opposed pistons per cylinder, the upper set being connected to a crankshaft above the engine and the

AIRCRAFT ENGINES

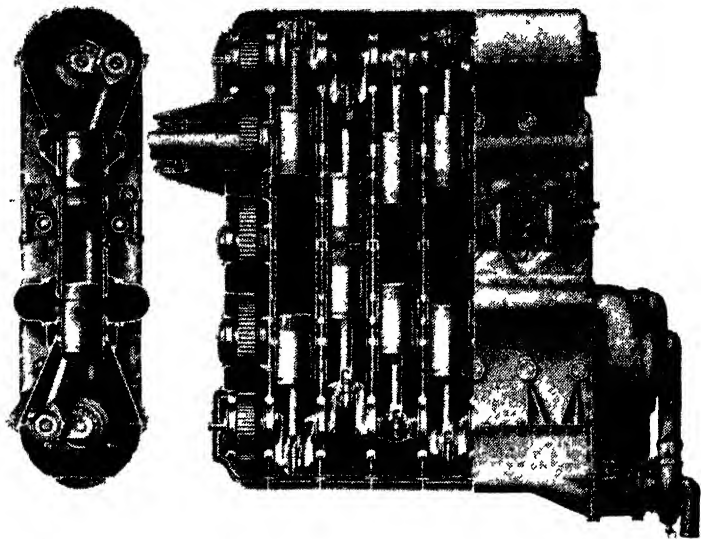

Junkers two-stroke opposed piston aero engine. The centrifugal scavenging pump is seen at the right

lower set to a crankshaft beneath it, the two shafts being geared together at the front to a common airscrew reduction drive.

Combustion took place between the two pistons, and the cylinders, which had a bore and stroke of 4·13 by 6·3 in, had inlet ports at the bottom of the bores and exhaust ports at the upper ends. The upper pistons uncovered the exhaust ports and the lower pistons the inlet ports; by means of unequal travel for the two pistons a slight lead was given to the exhaust opening. A gear-driven blower of the centrifugal type supplied air for scavenging and for charging the cylinders, a Rateau two-stage compressor being used on certain models in order to maintain the power at high altitudes. The inlet ports were formed tangentially so that the air was given a swirling

THE MODERN DIESEL

action within the cylinders. Fuel was injected by two pairs of nozzles on opposite sides of the combustion space, and each pair of nozzles had its own fuel pump set close to it, so as to reduce the length of pipe between pump and nozzle to a minimum.

According to maker's figures the normal output of the Jumo 205 was 510 h.p. at 2,100 r.p.m. At maximum r.p.m. (2,220) 600 h.p. or 20 b.h.p. per litre was available, with a fuel consumption at normal output of 0.353-0.375 lb/b.h.p./hr. Without airscrew hub the engine weighed 1,144 lb.

Neat in outward appearance, the cylinders and upper part of each crankcase were a single light alloy casting, in which long cylinder liners were inserted, the cooling

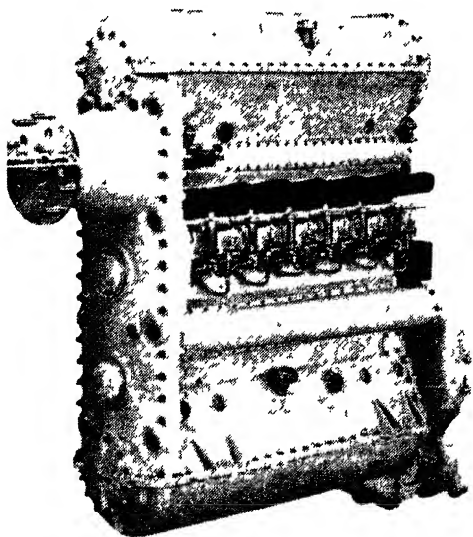

Junkers twelve-piston vertical two-stroke engine showing injector nozzles at the centre of the cylinder barrels

AIRCRAFT ENGINES

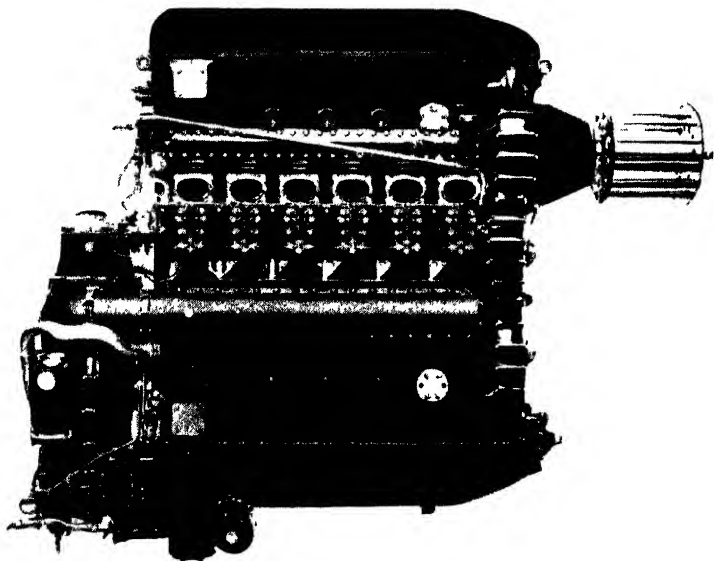

The Napier Culverin—a six-cylinder opposed-piston two-stroke, built under licence from Junkers

water being in direct contact with them. Each crankshaft was carried in seven large-diameter ball bearings, and another bearing was provided for the gear wheel on each shaft.

Air blower and water pump were driven from the lower crankshaft at the rear of the engine, and large delivery pipes from the blower ran along each side to supply the rings of inlet ports. There was also a camshaft at each side to operate the injection pumps, these being driven from the centre gear wheel of the train of five at the front of the engine which united the two crankshafts. A larger model of similar design, known as the Jumo 204, developed 600 h.p. at 1,720 r.p.m.

Similar engines were produced in France by the Compagnie Lilloise des Moteurs and a licence to manu-

THE MODERN DIESEL

facture two models was acquired by the Napier Company. A French engine which made its *début* at the 1936 Paris Aero Show was the Coatalen. Of twelve-cylinder V-type, the blocks of six cylinders were set at 60 degrees. Normal speed of this 36,100 c.c. engine was 2,000 r.p.m.; output was 550 h.p., which was not particularly good having regard to the capacity.

Twenty years ago, in America, the Packard company developed a nine-cylinder radial air-cooled engine which was particularly admired for the clever layout of details. The bore and stroke were $4\frac{1}{8}$ by 6 in and it was rated at 225 h.p. at 1,950 r.p.m. The specific weight was about $2\frac{1}{4}$ lb/b.h.p., the fuel consumption 0.35 to 0.4 lb/b.h.p./hr, and the output was about 16 h.p. per litre.

In the arrangement of this engine there was a striking departure from usual practice in that a single valve in the head served for both inlet and exhaust, and the single rocker-arm box, which was inclined in the direction of

the spiral of the slip-stream, considerably reduced air resistance and gave the engine a very clean external appearance.

To promote efficient mixing of the fuel and air for proper combustion, the ingoing air was given a rapid whirling motion, this being done by the shape of the inlet port, which was also arranged tangentially to the cylinder bore. To the same end, an eccentrically situated pocket was formed in the head of the piston, the result being

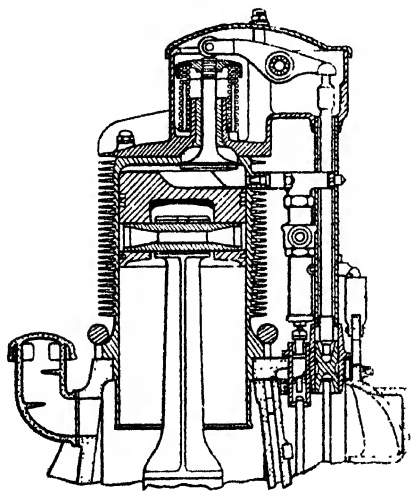

Arrangement of fuel pump and injector on the Packard cylinders

AIRCRAFT ENGINES

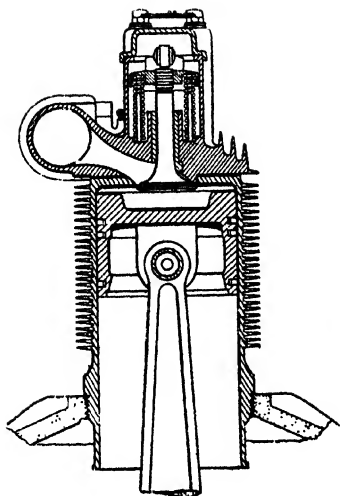

Section of a Packard cylinder and piston showing the shape of inlet port and piston crown to promote air swirl

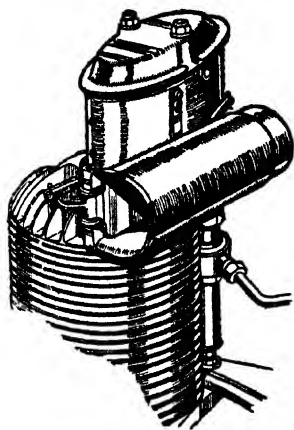

Showing Packard arrangement of air intake and fuel pump

that at high speed the circulation of the air in the cylinder was at a rate which permitted of one revolution of the mass of air around the circumference of the cylinder during the time available for combustion.

Compression-ignition engines in America, however, were not very strenuously developed and the undoubted achievement of the designer of the Packard (who lost his life in a flying accident) was not at once followed up, apart from the Guiberson nine-cylinder radial, built by the Guiberson Diesel Engine Co., of Dallas, Texas, in 1931.

Another American engine that received considerable notice was the Deschamps, introduced in 1934 by the Lambert Engine and Machine Co., Moline, Illinois. This was an inverted V-12 supercharged two-stroke with a 10,000 ft power rating of 1,200 h.p. at 1,600 r.p.m. rising

THE MODERN DIESEL

to a maximum of 1,350 h.p. at 1,750 r.p.m. Bore and stroke of 6 by 9 in gave a capacity of 50.04 litres. Its b.m.e.p. was 98.16 lb/sq. in.

In France also, the scope which the low working temperature of the c.i. engine allows for air cooling had been appreciated, and prominent among French diesel aircraft engines were two Clerget models built by the Hispano Suiza Company. One of these, the 9T, had nine radial air-cooled cylinders, while the 14F-2 was of the same general design, but with fourteen cylinders. Its cylinder dimensions were 130 by 170 mm ($5\frac{1}{8}$ by $6\frac{1}{8}$ in) bore and stroke, compression ratio 16 to 1, nominal horse-power at 1,900 r.p.m. 300, and maximum horse-power at 2,100 r.p.m. 400, and its fuel consumption 0.396 lb/b.h.p./hr. Weight in running order was 726 lb.

The French Salmson Motor Company exhibited some years before the war a very interesting radial engine built

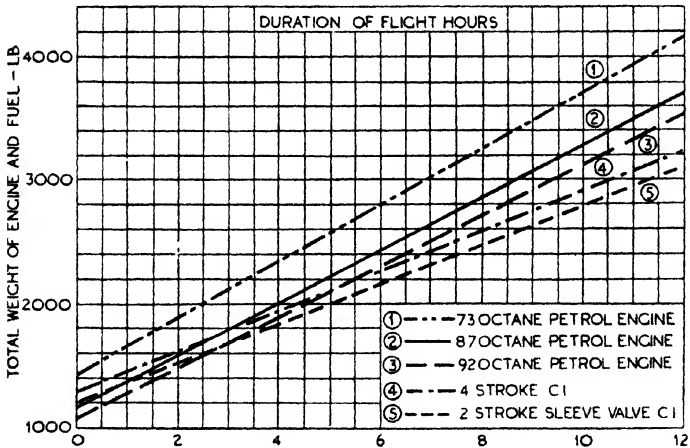

Comparison of combined engine and fuel weights of two diesel engines and a petrol engine using fuels of different octane values. This chart was prepared by Sir Roy Fedden

AIRCRAFT ENGINES

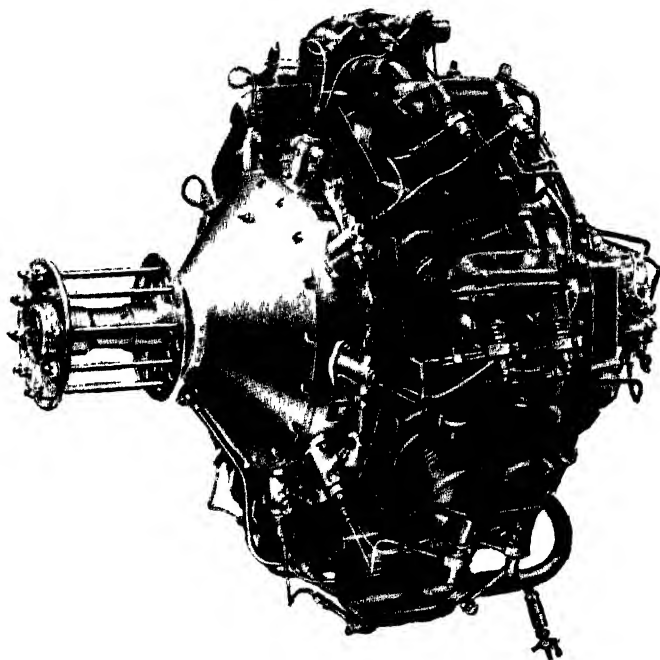

The Salmson SH 18 was a double nine-cylinder radial two-stroke in which each pair of cylinders had a common combustion chamber

under Szydlowski licence; this was a double nine-cylinder water-cooled two-stroke, incorporating a certain degree of supercharging. The interesting feature of the Szydlowski system of operation is the use of pairs of cylinders, one cylinder being in line with the other when viewed from in front, each pair having a common combustion chamber. The crank pin on which the connecting rods of the front cylinders works is some 30 degrees ahead of the crank pin of the rear cylinders.

Pure air is delivered to the cylinders by ports uncovered by the rear pistons, these ports communicating with the

THE MODERN DIESEL

induction manifold into which the supercharger delivers its air. The exhaust ports have, by then, already been uncovered by the front piston, the crank pin of which is in advance of that of the rear piston. Complete scavenging is claimed to have been achieved by the time the exhaust ports have been closed, and as the induction ports are still open, compressed air continues to enter from the supercharger until these ports are covered. The air is then compressed by the rising pistons, and when top dead centre has been nearly reached the fuel oil is delivered into the common combustion chamber.

As previously mentioned, in 1934 the British Air Ministry decided to approve fuels of a higher knock rating than those which had been in use up till then. Other nations had previously taken this step, but in Great Britain the authorities deferred their decision until experience had shown that the new leaded fuels had no harmful effects on the engines. For a time, the fact that British aircraft manufacturers were compelled to use fuels of 73 octane value only, while foreign constructors used fuels of octane values as high as 90, proved something of a handicap in that less power could be taken from the British engines, and the performance consequently suffered in competition with foreign constructors in the world market.

When the new 87 octane fuel was approved it became possible to increase compression ratios, and in addition to the extra power which this increase made possible, there was another advantage in the form of lower specific fuel consumption. While the introduction of the new leaded fuel greatly assisted aircraft and petrol-engine manufacturers, it represented a considerable set-back as far as the fuel-oil compression-ignition engine was concerned in that the duration of flight necessary before the diesel engine became worth while was correspondingly increased.

THE MODERN DIESEL

CHARACTERISTICS OF BRITISH

The road vehicle engines below

Make of Engine	No. of Cylinders	Bore and Stroke (mm)	Piston Displacement (c.c.)	Camshaft Location	Normal Speed Range (r.p.m.)	Max. b.h.p. at — r.p.m.	Max. b.m.e.p. lb/sq. in. at — r.p.m.
A.E.C.	6	105 × 146	7584	Cb	400-1800	98 : 1800	109 : 1050
"	6	120 × 142	9636	Cc	"	125 : 1800	106 : 1000
Albion	4	108 × 133.3	4880	Cc	400-2200	75 : 2000	105 : 1200
"	4	117.4 × 152.4	6610	Cb	380-1850	78 : 1750	105 : 1000
"	6	117.4 × 139.7	9084	"	"	102 : 1750	100 : 1000
B.M.M.O.	6	113 × 133.3	8028	Cc	350-1700	103 : 1700	105 : 1250
Bristol	6	110 × 143	8140	"	"	98 : 1700	102 : 1200
Coventry Diesel	4	82.5 × 105	2246	"	400-2700	45 : 2700	109 : 1500
Crossley	6	114.3 × 139.7	8600	Cb	380-1750	102 : 1600	110 : 1000
Daimler	6	114.3 × 139.7	8600	"	350-1800	100 : 1800	100 : 1200
"	6	127 × 140	10618	Cb	350-1700	123 : 1700	104 : 820
Dennis	4	117.4 × 150	6502	Cc	300-1800	97 : 1750	115 : 1250
"	6	105 × 146	7585	Cb	350-1800	100 : 1800	108 : 1250
"	6	98 × 112	5060	Cc	300-2000	75 : 2000	107 : 1000
Foden	6	85 × 120	4090	Cb	250-2000	126 : 2000	120 : 1200
Gardner	4	95 × 135	3801	Cc	400-2000	53 : 2000	98 : 1100
"	4	108 × 152.4	5579	"	395-1700	68 : 1700	103 : 1100
"	5	108 × 152.4	6974	"	"	85 : 1700	103 : 1100
"	6	108 × 152.4	8369	"	"	102 : 1700	103 : 1100
"	8	108 × 152.4	11200	"	"	140 : 1700	101 : 1100
Leyland	6	96.5 × 114.3	5020	"	350-2000	75 : 2000	106 : 1100
"	6	110 × 127	7391	Cb	400-1800	100 : 1800	109 : 1100
"	6	122 × 140	9783	Cc	"	125 : 1800	103 : 900
Meadows	4	130 × 130	6900	Cb	"	85 : 1900	100 : 700
"	6	130 × 130	10350	"	"	130 : 1900	100 : 800
Morris	4	85 × 125	2837	"	400-2500	48 : 2500	88 : 2000
"	6	85 × 125	4256	"	400-2600	72 : 2600	88 : 2000
Perkins	4	87.9 × 127	3150	"	300-2200	46 : 2200	106 : 1200
"	6	87.9 × 127	4729	"	"	70 : 2200	100 : 1200
Sentinel	4	120.6 × 133.3	6080	Cc	400-2000	90 : 2000	98 : 1500
"	6	120.6 × 133.3	9120	"	"	135 : 2000	90 : 1200
Thornycroft	6	104.8 × 152.4	7883	"	400-1750	99 : 1750	103 : 1300
"	6	92 × 104.8	4042	"	350-2100	65 : 2100	—

Abbreviations : Al, Aluminium alloy. Cb, Cylinder block. Cc, Crankcase. C.I., P.x, "pintaux."

Combustion chamber design : (a) Direct injection with simple cavity piston.

Daimler weight includes fluid

BRITISH TRANSPORT ENGINES

TRANSPORT DIESEL ENGINES

are in current (1949) production.

Max. Torque lb/ft at — r.p.m.	Dry Weight with Val Accessories (lb)	Type of Nozzle	Combustion System (See Note)	Compression Ratio (— to 1)	Injection Pressure (lbsq. in.)	Wet or Dry Cylinder Liners	Crankcase Material	Crankshaft Bearings		Torsional Vibration Damper ?
								Diam. of Journals	Diam. of Crank Pins	
								mm	mm	
337 : 1050	1490	MH	b	16.0	2572	Dry	C.I.	85	68	No
415 : 1000	1600	16.0	2572	95	75	..
208 : 1200	1100	..	a	14.5	2570	82.5	76.2	..
283 : 1000	1297	MH	b	14.2	2550	..	Al	—	—	..
367 : 1000	1620	..	c	14.2	—	—	Yes
343 : 1250	1568	..	b	17.0	2500	..	C.I.	79.5	70	No
337 : 1200	1894	16.0	2020	92	72.2	..
96 : 1400	580	P	..	17.5	1550	..	Al	58	56	..
387 : 1000	1420	MH	..	15.5	1500	83	76	Yes
350 : 1200	2064	..	a	15.0	2200	..	C.I.	85	71	No
445 : 820	1997	15.0	92.5	76.2	..
302 : 1250	1500	..	b	14.0	1875	Wet	..	86	79	..
331 : 1250	1550	15.0	2200	84.6	79.4	..
220 : 1000	1030	15.75	79.4	66.7	..
350 : 1200	1100	SH	b*	14.0	Al	76.2	66.7	..
148 : 1100	684	MH	a	13.5	2500	Dry	..	—	—	..
228 : 1100	109	13.0	83	—	..
284 : 1100	1256	13.0	83	—	..
348 : 1100	1447	13.0	83	—	Yes
458 : 1100	1956	13.0	92	—	..
220 : 1100	1200	..	b	16.0	2400	..	C.I.	73.6	60.9	..
316 : 1100	1721	15.3	2600	82	72	..
410 : 900	1724	15.75	2450	89	76	..
280 : 700	1350	—	—	85	85	No
420 : 800	1750	—	—	85	85	..
101 : 2000	615	Sl	a	19.0	3000	Wet	Al	77.7	61	..
167 : 2000	800	77.7	61	..
123 : 1200	512	MH	c	16.5	1800	Dry	C.I.	70	57	..
184 : 1200	686	16.5	70	57	..
255 : 1500	1100	P	d	17.0	1650	92	76.2	..
380 : 1200	1450	Px	92.5	76.2	..
328 : 1300	1680	MH	b	16.0	2940	89	76	..
169 : 1300	1068	P	c	18.2	1690	63.5	54	..

Cast Iron. El, Elektron. O, Overhead. MH, Multi-hole. P, Pintle. SH, Single hole. Sl., Slot.

(b) Direct injection with toroidal cavity piston. (c) Air cell. flywheel. Perkins weight does not include flywheel.

* Two-stroke.

THE MODERN DIESEL

HIGH-SPEED MARINE DIESEL ENGINES

Table showing principal characteristics of units running at 1,000 r.p.m. or over

<i>Name</i>	<i>Cyls.</i>	<i>Bore (in)</i>	<i>Stroke (in)</i>	<i>B.H.P.</i>	<i>R.P.M.</i>	<i>B.M.E.P. (lb/sq in)</i>	<i>Weight (lb)</i>
A.E.C.	6	4.72	5.59	100	1500	102	3280
Ailsa Craig	1	4.125	5.5	10	1200	97	610
" "	2	4.125	5.5	20	1200	97	870
" "	3	4.125	5.5	30	1200	97	1120
" "	4	4.125	5.5	40	1200	97	1430
" "	6	4.125	5.5	60	1200	97	2100
Allen	5	5.71	7.09	100	1200	72.7	6130
" "	6	5.71	7.09	120	1200	72.7	6470
" "	8	5.71	7.09	160	1200	72.7	9270
Bolinder*	1	4.725	5.9	10	1000	40.8	1355
" *	2	4.725	5.9	20	1000	40.8	1850
Buda	4	3.625	4.5	40	2000	85	985
" "	6	3.5	4.75	70	2350	85.9	1250
Cub	2	3.11	3.94	12.5	2000	86	480
Dorman	2	3.54	4.74	10	1000	—	—
" "	2	4.52	5.12	19	1000	—	—
" "	4	3.54	4.74	22	1000	—	—
" "	4	4.52	5.12	40	1000	—	—
" "	4	4.74	7.08	65	1000	—	—
" "	6	4.74	7.08	97	1000	—	—
" "	8	4.125	4.125	100	2300	—	—
Fowler	2	3.75	4.5	15	1500	—	784
Gardner	2	4.25	6	30	1500	98	1624
" "	3	4.25	6	45	1500	98	1792
" "	4	4.25	6	60	1500	98	2016
" "	5	4.25	6	75	1500	98	2248
" "	6	4.25	6	90	1500	98	3124
Gleniffer	2	4.75	6	24	1000	89.4	2350
" "	3	4.75	6	36	1000	89.4	2770
" "	4	4.75	6	48	1000	89.4	3025
" "	6	4.75	6	72	1000	89.4	4230
G.M.C.*	3	4.25	5	82	2000	71.6	1650
" "	4	4.25	5	110	2000	71.6	1900
" "	6	4.25	5	165	2000	71.6	2250
Godiva	4	3.25	4.15	36	2400	90	555
Kelvin	2	4.25	6.375	22	1000	96.36	1354
" "	3	4.25	6.375	33	1000	96.36	1610
" "	4	4.25	6.375	44	1000	96.36	1866
Kermath	2	4	4.5	27	1800	—	870
" "	6	3.75	4.5	84	2600	85.6	1355
" "	6	4.325	5.25	113	1800	104	2100
" "	6	5	6	160	1600	112	3100

* Two-stroke.

BRITISH MARINE ENGINES
HIGH-SPEED MARINE DIESEL ENGINES

(Continued)

<i>Name</i>	<i>Cyls.</i>	<i>Bore (in)</i>	<i>Stroke (in)</i>	<i>B.H.P.</i>	<i>R.P.M.</i>	<i>B.M.E.P. (lb/sq in)</i>	<i>Weight (lb)</i>
Leyland	6	3.8	4.5	55	1750	86	2065
"	6	4.375	5	75	1600	87	2800
"	6	4.8	5.5	95	1600	83	2928
Lister	1	4.5	4.325	8	1200	75.3	1120
"	2	4.5	4.325	16	1200	75.3	1428
"	2	4.5	5.5	21	1200	78.75	1775
"	3	4.5	5.5	31.5	1200	78.75	2185
McLaren-Ricardo	2	4.33	5.90	22.5	1250	87.5	1070
"	4	4.33	5.90	45	1250	87.5	1950
"	2	5.56	7.90	40	1000	90	2404
"	4	5.56	7.90	80	1000	90	3590
"	6	5.56	7.90	120	1000	90	6050
Meadows	4	5.125	5.125	60	1600	—	—
"	6	5.125	5.125	90	1600	—	—
Mirreles-Ricardo	3	5.625	6.5	60	1200	81.6	3472
"	4	5.625	6.5	80	1200	81.6	4144
"	5	5.625	6.5	100	1200	81.6	4704
"	6	5.625	6.5	120	1200	81.6	5624
Morris	6	3.7	4.9	60	2000	88	1575
National	3	4.125	6	33	1250	—	—
"	4	4.125	6	44	1250	—	—
"	5	4.125	6	55	1250	—	—
"	6	4.125	6	66	1250	—	—
Paxman	8	7	7.75	400	1500	88	—
"	12	7	7.75	600	1500	88	—
"	16	7	7.75	800	1500	88	—
Perkins	4	3.5	5	43	2000	—	800
"	6	3.5	5	65	2000	—	1010
"	6	4.375	5	100	2000	—	1315
R.N.	1	4.125	6	9	1000	89.1	896
"	2	4.125	6	18	1000	89.1	1232
"	3	4.125	6	27	1000	89.1	1568
"	4	4.125	6	36	1000	89.1	2072
"	3	5.125	7.25	48	1000	84.6	3080
"	4	5.125	7.25	64	1000	84.6	3640
"	6	5.125	7.25	100	1000	84.6	4740
Ruston	2	4	4	10	1000	78.5	1460
"	2	4.5	4.5	15	1000	82.5	1840
"	3	4.5	4.5	22½	1000	82.5	2175
"	3	4.5	5.5	26	1000	81.0	3024
"	4	4.5	5.5	36	1000	81.0	3360
"	2	5.375	8	35	1000	77.5	3024
"	3	5.375	8	52	1000	77.5	4480
"	4	5.375	8	70	1000	77.5	5040
"	5	5.375	8	88	1000	77.5	5930

THE MODERN DIESEL
HIGH-SPEED MARINE DIESEL ENGINES

(Continued)

<i>Name</i>	<i>Cyls.</i>	<i>Bore (in)</i>	<i>Stroke (in)</i>	<i>B.H.P.</i>	<i>R.P.M.</i>	<i>B.M.E.P. (lb/sq in)</i>	<i>Weight (lb)</i>
Ruston	6	5.375	8	106	1000	77.5	6830
Stuart*	1	2.75	4	3	1500	33.3	—
Tangye	1	4.5	5.75	12	1200	86.1	—
..	2	4.5	5.75	24	1200	86.1	—
..	3	4.5	5.75	36	1200	86.1	—
..	4	4.5	5.75	48	1200	86.1	—
..	5	4.5	5.75	60	1200	86.1	—
..	6	4.5	5.75	72	1200	86.1	—
Thornycroft	2	4.125	6	20	1200	82	1456
..	4	3.562	4.125	40	2100	92.5	1176
..	6	3.562	4.125	65	2250	92.5	1500
..	6	4.125	6	90	1600	92.5	2500
..	6	4.75	6.5	130	1600	93	3850
Turner	1	3.75	4.5	7½	1500	80	800
..	2	3.75	4.5	15	1500	80	950
..	4	3.75	4.5	30	1500	80	1300
Victor	1	3.15	3.9	5	1500	87	214
..	1	3.34	3.9	6.7	1500	103	214

* Two-stroke.

Index

- ACRO system, 24, 92
A.E.C., 29, 32, 134, 204, 222
Aeroflow system, 101
Ailsa Craig, 30, 207, 223
Air cell, 12, 91
Aircraft application, 10, 252
Aircraft fuel, 11
Akroyd-Stuart, 21
Albion, 121, 136
Alco, 201
Allen, 207, 224
American conditions, 12, 57
American Bosch, 82
Ante chamber, 50, 89
- BARTON, T. H., 30
Beardmore, 204, 258
Benz, 26
Berliet, 139, 211
Bernard, 139
Blackstone, 208
B.M.M.O., 140
Bolinder, 225
Bosch, Robert, 24
Braking, road vehicle, 126
Bristol, 141, 259
Brotherhood, 206
Brown-Boveri, 203
Bryce, 44, 57, 75
Buchi, 203
Buda, 143, 225
Büssing, 144, 210
- CAR (private) applications, 17, 31, 32
C.A.V., 42, 57
Centric supercharger, 104
Cetane rating, 114
Chorlton, A.E.L., 24
Citroen, 145
Clerestory head, 99
Clerget, 258
C.L.M. (Junkers), 211
Combined pump-injector, 85
Combustion, 20, 48, 52
Combustion chamber design, 89
- Comet-Ricardo, 95
Compression ratio, 24, 97
Continental, 145
Coventry Diesel, 32, 146, 227
Crossley, 30, 146
Cub, 227
Cummins, 30, 85, 149
- DAIMLER, 150
Decompressor, 129
De Dion, 152
Delay period, 50
Delivery valve, 61, 78, 79
Dennis, 152
Detergent oil, 118
Deutz, 155, 213
Diesel, Dr. Rudolf, 18
Direct injection, 12, 96
D.K.W., 213
Dodge, 155
Dorman, 156, 228
Dual turbulence, 13, 100
Dutson, F. H., 30
- ELECTRIC starting, 130
Engine speeds, 23
English Electric, 205
European progress (post 1945), 133
Ex-cell-O pump, 83
Excess fuel (starting), 131
- FEDDEN, Sir Roy, 266
Fiat, 157
Filtration, 119
Fiedler, Max G., 51
Foden, 108, 158
Four-stroke cycle, 36, 108
Fowler, 206, 228
Fuel, 112
Fuel
 aircraft, 10, 252
 coal oil, 114
 cost, 34
 ignition quality, 114
 injection, 56, 69, 82

INDEX

- Fuel
 injection pumps, 23, 44, 57,
 70, 75
 shale oil, 114
 specification (B.S.I.), 115
 vegetable oil, 115
- GANZ, 201, 212
 Gardner, 30, 32, 42, 63, 82, 121,
 160, 203, 220, 230
 Gas turbine, 256
 German development, 13, 26
 Gleniffer, 30, 208, 220, 232
 G.M.C., 85, 110, 163, 201, 234
 Goddard, W. H., 30
 Godiva, 146
 Governors, 41, 44, 62
 Gray, 234
 Guiberson, 265
- HANOMAG, 166
 H.D. oil (*see* Detergent)
 Heater plug, 130
 Henschel, 166
 Hercules, 167
 Hesselman system, 218
 Historical, 12, 14, 18, 26, 29, 201
 Hydraulic governor, 44, 66, 79
- INJECTION, direct, 12
 Injection equipment, 23, 47, 57,
 71
 Injectors, 56, 69, 82
 Inlet valve, masked, 97
- JUNKERS, 31, 40, 168, 256, 261
- KADENACY system, 108
 Kaelble, 169
 Kämper, 169, 210
 Kelvin, 220, 235
 Kermath, 236
 Kerr-Stuart, 30
 Kromhout, 170
 Krupp, 20, 170
- LANG, Franz, 24
 Lanova system, 20, 26
 Leyland, 42, 65, 81, 124, 171,
 216, 238
- Lister, 217, 239
 Lubrication, 116
- MACK, 175
 M.A.N., 20, 26, 176, 210
 Marine application, 14, 214
 Marine service, 215
 Maybach, 201, 209
 McLaren, 207, 240
 Meadows, 177, 240
 Mercedes Benz, 24, 29, 32
 Mirlees-Ricardo, 179, 241
 Morris-Commercial, 181
 Motor car application, 17, 31, 32
 M.W.M., 182, 210
- NAPIER, 263
 National, 208, 242
 Nozzle (*see* Injection)
- OBERHÄNSLI, 94, 183
- PACKARD, 264
 Paxman, 206, 220, 244
 Perkins, 32, 101, 183, 244
 Pilot injection, 45, 51
 Pneumatic governor, 42, 64
 Power braking, 126
- RAILWAY application, 14, 199
 Renault, 184
 Ricardo, H. R., 51, 95
 Road transport, 120, 133
 Rochet Schneider, 186
 Rolls-Royce, 260
 Roots blower, 104, 111
 R.N., 245
 Ruston, 246
- SALMSON, 266
 Saurer, 26, 66, 100, 186, 213
 Sentinel, 190
 Simms, 57, 70
 Sludge (lubrication), 117
 Somua, 191
 "Squish" effect, 97
 Starting, 129
 Stuart, 219, 247
 Sulphur (in fuel), 119

INDEX

- Supercharging, 16, 103, 106, 146,
189, 203
Suspension, engine, 121
Sulzer, 18, 40, 191
Swiss development, 13
- TANGYE, 247
Tatra, 192
Taxation, effect of, 120
Thermal efficiency, 24
Thornycroft, 194, 247
Tilling Stevens, 195
Timing, variable injection, 43, 44,
55
Timken pump, 83
Toroidal cavity, 12, 101
Torque characteristics, 25
- Transmission, Road vehicle, 125
Turner, 247
Two-stroke cycle, 39
- UNIC, 196
- VACUUM exhauster, 126
Varnish (lubrication), 116
Victor, 250
Vomag, 212
- WAUKESHA, 197
Weight reduction, 30, 214
Widdop, 250
Willème, 197
- ZBROJOVKA, 257

LODGE

HEATER PLUGS



SINGLE POLE TYPE

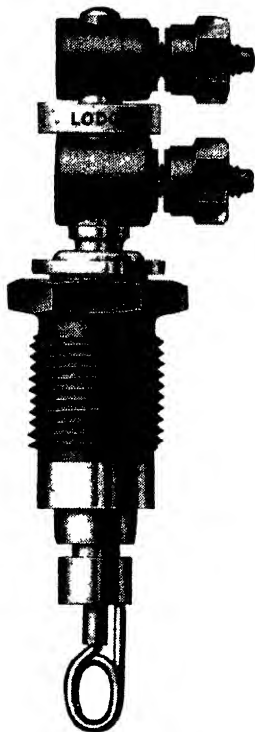

DOUBLE POLE TYPE

In the case of single pole type the plugs are connected "in parallel" from a single electric cell (2 volts). The double pole type is connected "in series," from the standard 12 volt or 24 volt lighting-starting battery. This avoids the need for a separate battery and the provision of special facilities for recharging it, also the current consumption is relatively small.

*Write for particulars and prices of Lodge heater plugs to the makers,
Lodge Plugs Ltd., Rugby.*

A Diesel in Difficulties

BARIMAR is proud of this "ticklish" job

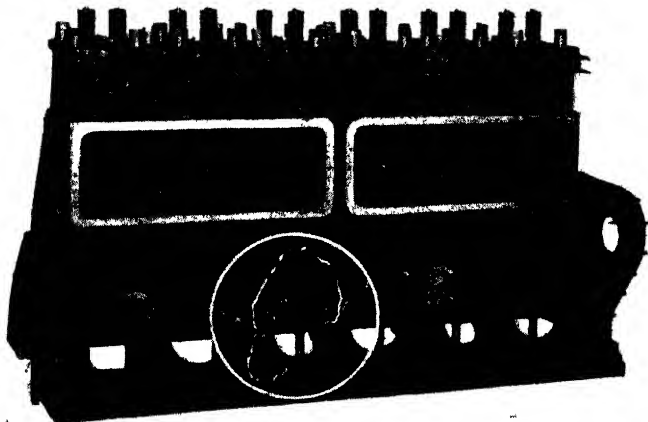

A glance at the illustration shows the seriousness of the damage to this combined Diesel cylinder block and crankcase. It *looked* bad—and was quite as bad as it looked! Fractured at the centre of one side of the casing, the problem of welding it effectively was a tough one.

But **BARIMAR**, familiar with "tough propositions," used their Low Temperature Welding Process, with marked success. The fracture, as will be seen, was close to two of the main bearing housings. Yet **BARIMAR** carried out the repair without disturbing the alignment.

*Completed within four days, covered by the **BARIMAR** Money-back Guarantee, the cost was comparatively trifling.*

BARIMAR FOR SCIENTIFIC WELDING REPAIRS TO
HEAVY DIESEL AND PETROL ENGINES

PRECISION — ECONOMY — RELIABILITY — SPEED

BARIMAR
LTD.

NOTE—Broken parts
should be sent
to **BARIMAR**
Carriage Paid

Barimar House, 22-24 Peterborough Road, Fulham, London, S.W.6

Telephones : RENown 2147/8.

Telegrams : "Bariquamar, Walgreen, London."

Barimar Branch Factories :—BIRMINGHAM, 12 : 116-117 Charles Henry Street.
MANCHESTER, 13 : 67 Brunswick Street, Ardwick Green. NEWCASTLE-
UPON-TYNE, 1 : 31 The Close. GLASGOW, C.2 : 134 West George Lane.

Users of
THORNYCROFT

**Road-Vehicle, Marine and Industrial
DIESEL ENGINES
are in good company!**

Prominent operators include:

Anglo-Saxon Petroleum Co. Limited, Australian Government, Brazilian Government, British Admiralty, British War Office, Calcutta Customs, Co-operative Wholesale Society Ltd., Crown Agents for the Colonies, Cunard White Star, British Railways, H.M. Customs and Excise, Iraq Petroleum Co. Ltd., Lourenco Marques Railway, Petroleum Board, Port of London Health Authority, São Paulo (Brazilian) Railway Co. Ltd., South African Railways and Harbours Board and the Union-Castle Line.



Further particulars of these engines can be obtained from the appropriate sections of this Manual, or from: John I. Thornycroft & Co. Limited, Thornycroft House, London, S.W.1

DORMAN

RANGE
6 to 120
BHP

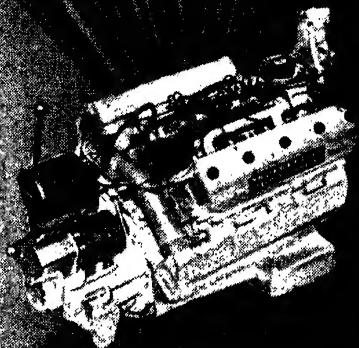

OIL ENGINES

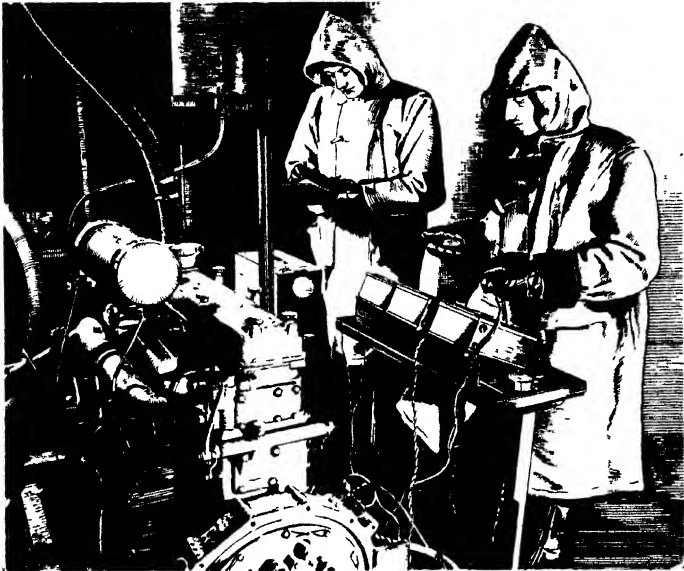

Engine startability at -20°F

Low temperature testing forms a vital part of the research work in the C.A.V. laboratories. In this refrigerated chamber ambient temperatures down to -40°F . can readily be obtained, enabling starting characteristics to be investigated under sub-normal conditions. Besides experimental work on fuel injection equipment, fuels, lubrication, and electrical equipment, development work on engine details in order to achieve optimum performance is carried out in collaboration with the designers. The full facilities of the laboratories, their equipment and the wide experience of C.A.V. technical staff are available to engine manufacturers.



Fuel Injection Specialists

C.A.V. LIMITED - ACTON - LONDON - W.3

WIDDOP DIESEL ENGINES

5 H.P. to 300 H.P. 2 Cycle and 4 Cycle

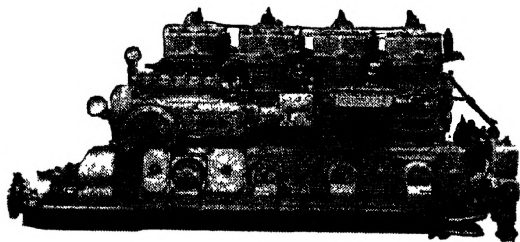

EMX4 Widdop Diesel. 120 H.P. at 400 r.p.m.

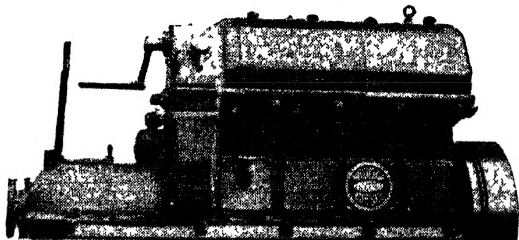

D4. Widdop Diesel. 45/60 H.P. at 800/1000 r.p.m.

● *SIMPLICITY* ● *DURABILITY*
H. WIDDOP & CO. LTD.
HEAD OFFICE & WORKS
GREENGATE, KEIGHLEY, ENG.

Telephone: Keighley 3727-8

Telegrams: Widdop, Keighley

Codes ABC 6th Edition, Bentley's, Bentley's Second

CROSSLEY

First-class

Diesel-
engined
Transport

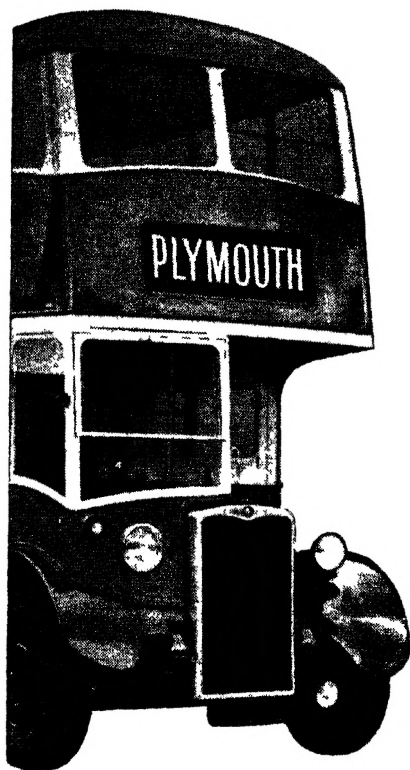

BUSES • COACHES
TROLLEYBUSES

CROSSLEY MOTORS LTD
ERRWOOD PARK
STOCKPORT
AND 50 PAGE STREET
WESTMINSTER, LONDON
S.W.1

RUSTON OIL ENGINES

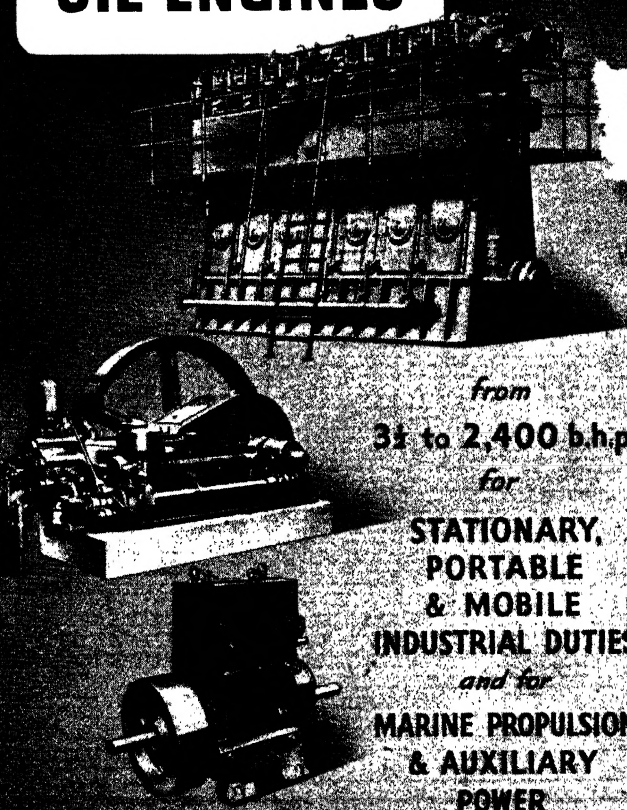

from
3½ to 2,400 b.h.p.

for

**STATIONARY,
PORTABLE
& MOBILE
INDUSTRIAL DUTIES**

and for

**MARINE PROPULSION
& AUXILIARY
POWER**

RUSTON & HORNSBY LTD · LINCOLN

Associated with DAVEY, PAXMAN & CO. LTD., COLCHESTER

