

BIRLA CENTRAL LIBRARY
PILANI (Rajasthan)

Class No 621.319

Book No U134I

Accession No. 32091

**INTERIOR
ELECTRIC WIRING
AND
ESTIMATING**

By

ALBERT UHL

Electrical Contractor
Formerly with Henry Newgard & Company
Member, Chicago Electrical Estimators Association
and

ARTHUR L. NELSON

Formerly Superintendent, Interior Wiring Department,
Commonwealth Edison Company, Chicago
Formerly Member, Western Society of Engineers
and

CARL H. DUNLAP

Head, Electrical Engineering Department,
American School
Associate Member, American Institute
of Electrical Engineers

=====
THIRD EDITION
=====

1941

American Technical Society

Publishers

Chicago, U. S. A.

COPYRIGHT, 1929, 1940, 1941, BY
AMERICAN TECHNICAL SOCIETY

COPYRIGHTED IN GREAT BRITAIN
ALL RIGHTS RESERVED

No portion of this book may be reproduced by
the mimeograph process or by any other process
without permission from the publishers.

Printed in the U. S. A.

PREFACE TO THE THIRD EDITION

The previous edition of this book, published in 1940, was sold within a year. Since that edition was published, the National Board of Fire Underwriters has made important changes in the National Electrical Code. Where formerly ratings were given on three kinds of insulation for electric wires, the new Electrical Code gives ratings for 17 different kinds of insulation. The current-carrying capacities of wires using these different insulations, and the different conditions under which each type is to be used, have been included in this Third Edition of *Interior Electric Wiring and Estimating*.

Over fifty pages of new material have been added to this book. In addition to the new material, all the illustrative problems have been gone over and revised to comply with the new current-carrying capacities of wires under the different service conditions stipulated in the problems.

A new section on Cable Wiring has been written in the "how-to-do-it" style so that the beginner, by following the instructions, can rapidly increase his skill in installing this material. These instructions include the wiring and installation of outlets in houses that were built many years ago, and in which electric wiring was never installed.

Many special drawings have been prepared which show the construction of these houses, how the floor boards can be removed, how the floor joists are bored and the cable installed through the joists, how old plaster can be held in place when cutting an outlet opening, how an opening can be cut in the ceiling to gain access to an attic, and how a neat cover for the attic opening can be built. By help of these explanations, wiring can be installed in an old house with the least damage to the plaster and interior decorations, and without inconvenience to those occupying the house.

ALBERT UHL
CARL H. DUNLAP

Chicago, Ill.
Feb. 1, 1941

INTRODUCTION

INCREASED demands for electricity in industrial lines and in the homes, as well as an extended use for exterior lighting, has brought about the necessity for better methods of generation and distribution. Permanent installations require safeguards for life and property, and methods of wiring differ greatly from those permitted a few years ago. Standards of practice have been set up by engineering societies and boards of underwriters, the object sought being the safety of the public and property in general. Not the least problem in electric wiring is the matter of economy, and only by thorough acquaintance with up-to-date appliances and methods can jobs be done and estimates be given which will provide adequate but economical installations.

Ten years ago the total connected wattage of lamps in the average American home was about 1,000 watts. At that time the director of a lighting laboratory built a home in which he laid out the lights to the best "seeing" arrangement which had a total connected load of 6,600 watts. Recently, he built a new home and arranged the lighting to the best advantage, with a total connected lamp load of 9,000 watts. This shows an increase of more than one-third in the lighting load in ten years time, and is representative of the trend toward the use of more lighting.

The Federal Government of the United States has been pushing and extending electric lines through the rural districts for some time. In order to enable the rural families to take advantage of and use electricity even where the income is low, it is necessary to use methods of wiring which are safe and at the same time low in cost. This has led to the development and use of non-metallic sheathed cable. This method of wiring for frame buildings is especially advantageous in the rural districts where it is impossible to obtain good ground connections.

This has brought about two general systems of wiring—one in which the wires are enclosed in an iron or steel conduit or covering and this steel covering permanently connected to the city water

INTRODUCTION

system and to the ground. The other is the non-metallic sheathed cable and non-metallic outlets, boxes, switch boxes and plates, in which all the wiring coverings are insulated from the ground.

The subject of electric wiring is so broad that it has seemed best to confine the contents of this volume to interior electric wiring. This concentration and effort on one subject has enabled the authors to show in detail how the work is best done to meet modern needs.

The authors have included the special technical terms used by the everyday workmen, so that the beginner may become familiar with them. The authors also have shown in detail how to do many operations in the easiest manner, in order to help the beginner to become a proficient workman.

Eight blueprints giving the architectural drawings for a one and a half story house are included in the back cover of this book. These, together with the electrical specifications for the wiring work in the house, are used to show how an electrical contractor proceeds in preparing an estimate and a bid for wiring that house. Detailed instructions are given, showing how the electrical contractor would estimate the different electrical quantities and materials needed, so that he can order them from his electrical jobber.

Then finally methods are shown how the electrical contractor can keep a record of the labor and material cost on this particular house and how to revise his figures so that on future bids he will have a more accurate estimate figure. This will enable him to build up a file of accurate cost data. The latter section of the book shows the wireman how to start in business for himself with the assurance that he will be successful in bidding on jobs.

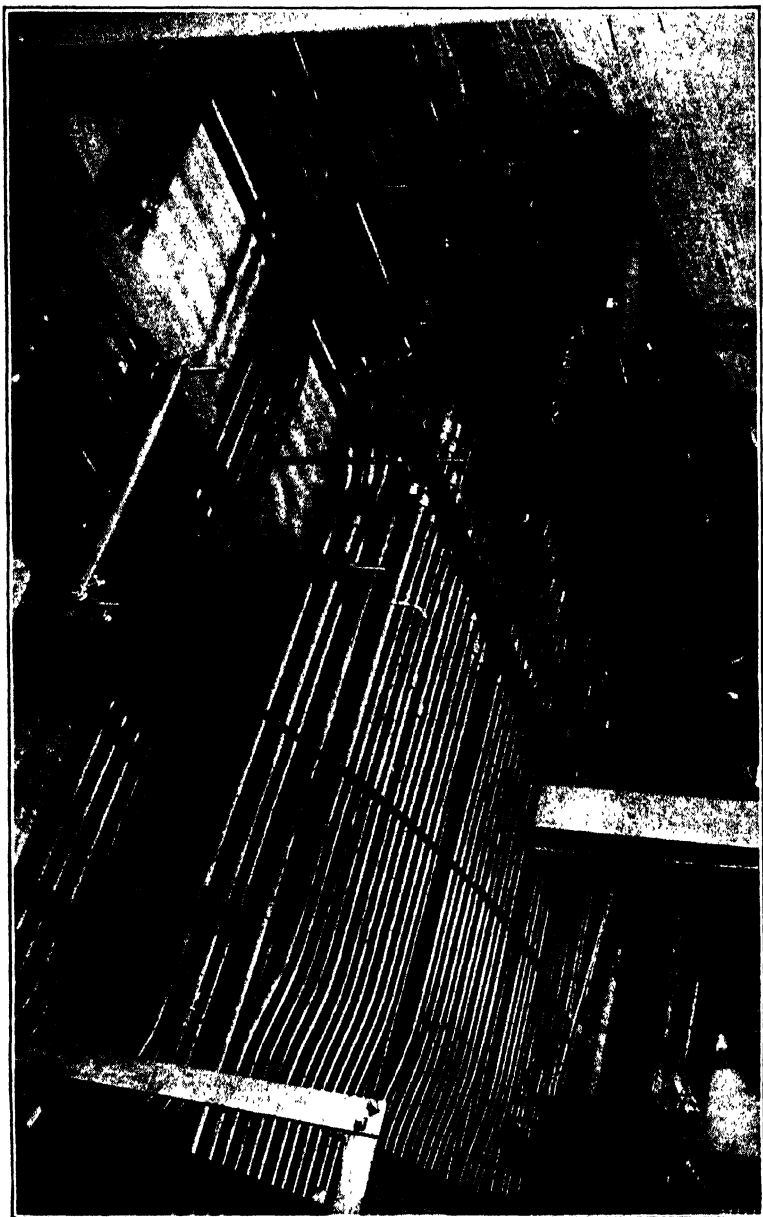

CONDUIT INSTALLATION IN A DEPARTMENT STORE
Courtesy of The Youngstown Sheet and Tube Company, Youngstown, Ohio

CONTENTS

	PAGE	
Service Wiring	*11	
Methods of wiring		
Service wiring		
Locating outlets and switches		
Knob and Tube Wiring	27	
Open conductors		
Concealed knob and tube wiring		
Splicing wires and cables		
Carrying capacity of wires		
Types of insulation		
Maximum wires in conduit or tubing		
Cable Wiring	55	
Protected conductors		
When and where to use cable		
Outlet and junction boxes		
Equipment ground		
Outlet box connectors		
Installing cables and boxes		
Concealed work in new buildings		
Concealed work in old buildings		
Wiring switches		
Planning wiring installations		
Industrial light and power installations		
Conduit Wiring Materials	107	
Rigid conduit	Steel boxes and cabinets	
Conduit fittings	Conduit supports	
Thin-wall conduit	Anchoring or fastening devices	
Grounding	Wire capacity of conduit	
Conduit Wiring, Tools, and Methods	161	
Tools and their uses	Installing outlet boxes	Conduits in concrete
Apartment Building Wiring	215	
Obtaining contract	Finishing work	
Preliminary work	Final work	
Roughing in conduit		
Factory Building Wiring	249	
Location of outlets, light and power cabinets		
Layouts, circuits, outlets, and switches		
Installing meters and switches		
Lighting fixtures		
Estimating Electrical Wiring	301	
Specifications—Building Plans†		
Index	351	

* For page numbers, see foot of pages.

† A complete set of blueprints (Plates 1 to 8) accompanies this text. The plates or blueprints, are inserted in an envelope attached to the back cover.



INSTALLATION OF CONDUIT IN A SERVICE TUNNEL
Courtesy of The Youngstown Sheet and Tube Company, Youngstown, Ohio

SERVICE WIRING

METHODS OF WIRING

Approved Methods of Interior Wiring. The National Electrical Code is the rule book for doing electrical wiring work. It is issued by the National Board of Fire Underwriters, an organization supported by the fire insurance companies and whose work is to reduce the loss of life and property due to fires.

The instructions in the Code give safe wiring methods to be used to prevent fires and personal injury to anyone through coming in contact with the conductors.

The following methods of wiring have been approved by the National Board of Fire Underwriters:

1. Open conductors
2. Concealed knob-and-tube work
3. Conduit work
4. Surface metal raceways
5. Armored cable
6. Underfloor raceways
7. Nonmetallic sheathed cable
8. Electrical metallic tubing
9. Cast-in-place raceways
10. Wireways and busways

In large cities the municipal authorities have established local electrical inspection bureaus whose duties are to apply the Underwriters' rules to their local requirements in the form of a city electrical code, to pass on all installations, and issue certificates of inspection on the same. This local code is, naturally dependent upon the type of building construction peculiar to the city's industries and upon possible fire hazards. Cities with congested manufacturing districts and thickly populated apartment sections naturally evolve rules for the safest and most up-to-date electrical installations. Interior wiring therefore requires a liberal knowledge, not only of the National Code, but also of the code of the locality where the work is to be done.

As a general rule in the cities and towns having a city water system and water pipes into each home, the conduit, surface metal raceways, armored cable, and electrical metallic tubing methods are preferred, because the metal covering for the wires can be connected easily and permanently to the water pipes and the earth to form a good ground connection. Where this water piping system is not available and it is not practicable to secure a ground connection of permanently low resistance, the use of a wiring method which does not employ metal covering for the wires is recommended unless the character or use of the building is such as to require the use of a metal-enclosed wiring system. Thus the buildings on the farms and in the smaller rural towns use either open conductors, concealed knob-and-tube, or nonmetallic sheathed cable methods of wiring.

TABLE I

Method of Wiring	Relative Cost
Knob-and-tube.....	1
Nonmetallic sheathed cable.....	1¼
Armored cable.....	1½
Electrical metallic tubing.....	1¾
Rigid conduit.....	2

Cost. The knob-and-tube method of wiring is the lowest in cost of those approved by the Underwriters. A comparison of the cost of some of the methods is given in Table I. These costs include all labor and material but do not include the lamps, lighting fixtures, receptacles and switches, which would be about the same regardless of the wiring method used.

Important Rules. The first rules for electric wiring should be as follows:

Always treat conductors as bare, however well insulated they may be, so that under no conditions, present or future, can short-circuits, grounds, or leakages occur.

Exceptional care should be given the mechanical execution of the work. Avoid damage to property. Take pride in neat-appearing runs, tight splices, and perfect soldering of joints. Be sure the tape holds tightly.

Set all boxes and cabinets straight and level, and be sure they are properly secured.

Wires in cabinets and boxes should be without kinks and laid out in straight lines so that they may be traced easily.

Planning Wiring Installation. If a new building is being built, the locations of the lights, switches, and receptacle are shown on the plans prepared by the architect. The arrangement of the wires from the service switch to the outlets is always left to the judgment of the man doing the wiring. Also, the calculation as to the sizes of wire and the number of circuits needed in residences and small buildings is left to the wireman.

If a residence or building already constructed is to be wired, the owner usually takes the wireman through it and shows him where he wants the switches, outlets, and different receptacles located. The wireman should write down their location because it may be several days or weeks before work is done, due to delays caused by the power company having to extend their electric line to serve this customer or to other causes. This written record also aids the wireman in determining the number of circuits needed and the size of service switch for the job. In the case of a residence, the probability of an electric range, hot water heater, or other large current-using devices being installed in the future should be considered, and provision made for them. A few dollars spent for this provision will save many dollars later on when it is desired to install and use them.

SERVICE WIRING

Locating Service Entrance. There are many factors that must be considered when determining the location of the watt-hour meter, service switch and branch circuit fuse cabinets. The most important of these are:

- Location of electric light pole nearest house;
- Location of porches on house;
- Location of electric range (when installed in future);
- Location of branch circuit fuses.

If the electric light and power company already has a 120-volt 2-wire line or a 120-240-volt 3-wire pole line passing the house, it is not difficult to determine the best place to bring the service into the house. If the light company will have to build an extension of

SERVICE WIRING

their lines to serve this house, then the wireman should find out from the company just where their poles will be located and just where the service will enter the house. In the past the light company installed the meter alongside of the service switches and fuses inside the house, usually in the basement (not the cellar) or kitchen. Since the companies manufacturing watt-hour meters have been able to

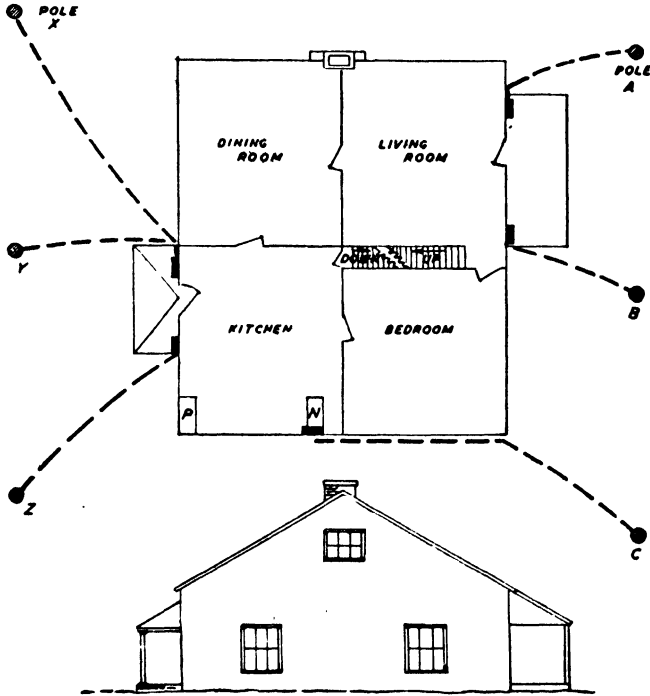

Fig. 1. Locating Service Entrance

build weatherproof, water-tight meters, the light company prefers that the meter be placed outside the building so it can be read by the meter reader without delay. The outside type meter also tends to prevent the theft of electric current.

If there is a porch on the front, side or rear, it is usually desirable to mount the meter, service entrance switch, and branch circuit fuses on the side of the house where they will be protected by this porch.

In wiring a small home, Fig. 1, if the nearest pole is near A, the

service would be run to that side of the house, as shown by the heavy dotted lines. With the pole at *B*, the service wiring would be run to the other end of the porch. With a pole at *C* the service could be run to same point on porch as from pole *B*, but if there is

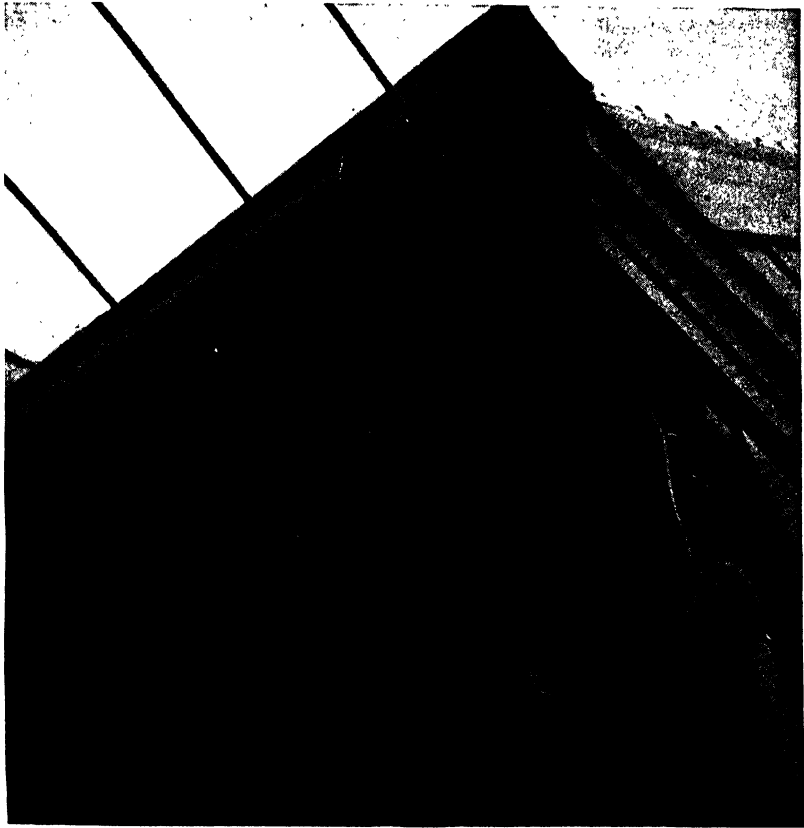

Fig. 2. Service Wires, Conduit, and Service Head
Courtesy of Kellems Products, Incorporated

any possibility of an electric stove or range being installed within the next 10 years, the service switch should be located in the kitchen near *N* or *P*. This service can be run from *N* or *P* directly to pole *C*, but if there are trees in its path, it is better to run the service conduit or cable on the side of the house to the corner and then directly to pole *C* or *B*.

Sometimes the poles may be located at the rear of the house as at X, Y or Z. If there is a porch or a "lean to" over the rear door and if there is room for the meter, service switch, and branch circuit fuses at the side of the door, then they should be installed there;

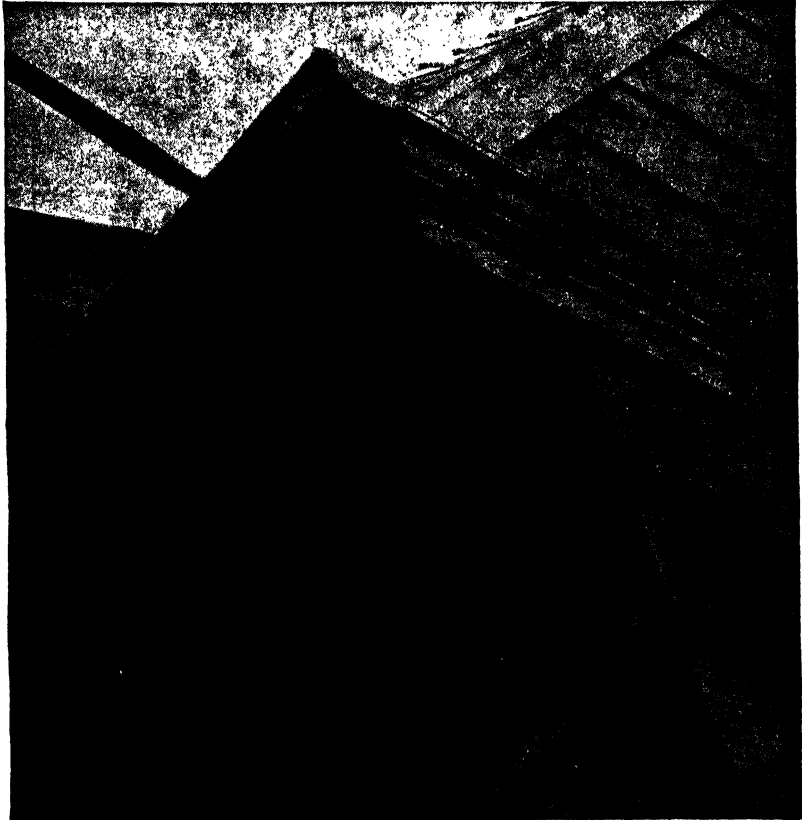

Fig. 3. A Three-Conductor Service Cable Installed
Courtesy of Kellems Products, Incorporated

otherwise the meter would be installed on the side of the house and the service switch and fuses on the inside of the kitchen.

Kind of Service Entrance. In the past, rigid conduit has always been required and used to inclose the service wires to the watt-hour meter service switch, regardless of the kind of wiring system used in the rest of the building. When the watt-hour meters were placed

outdoors, its use still continued where the local electrical code required it.

In many localities, armored service entrance cable is used instead of pipe or rigid conduit. The wireman installs the conduit or

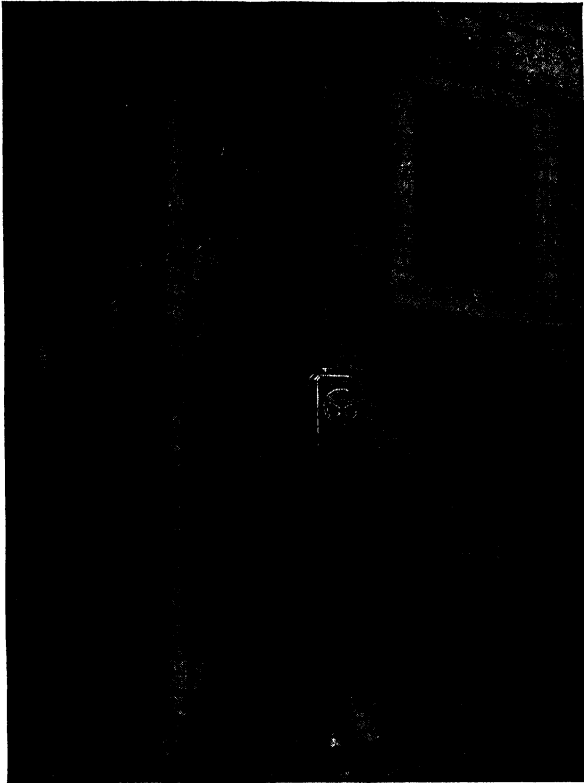

Fig. 4. Outdoor Installation of Meter in Protective Case
Courtesy of General Electric Company

service entrance cable up the side of the house to a height at least 10 feet above the ground and not more than 30 feet.

A service entrance cap is installed at the top of the conduit or cable and the two or three wires are brought out through holes in an insulating fitting as shown in Fig. 2. The wireman must leave about three feet of wire outside the service head so the lighting and power company linemen can connect them after they install the

wires from the pole to the house. The wires outside the service head must be long enough to form a drip loop so the water will not run inside the service cap. Some of the power companies use a service cable, Fig. 3, from their pole to the house and meter. When they install this cable to the outdoor meter fitting, they form a drip loop in it just before it enters the meter box.

Meter Fittings. An installation of rigid conduit service with an outdoor meter mounted inside a protective case is shown in Fig. 4. An entrance elbow is used at the bottom of building to turn the

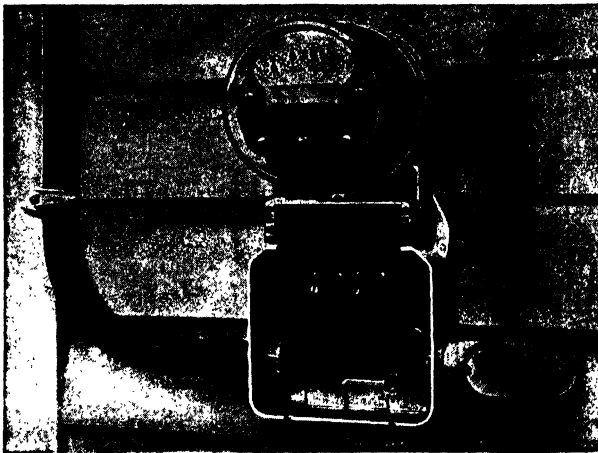

Fig. 5. Interior Wiring of Meter Connection Box That Can Be Used either Indoors or Outside
Courtesy of Sangamo Electric Company

conduit into the basement where the service entrance switch and fuses are located.

A view of another type of connection box is shown in Fig. 5. This is arranged for horizontal entrance and exit of the service conduit. The connections of the wires in Fig. 5 are clearly shown for a single-phase, 3-wire, 120-240-volt watt-hour meter. There are four terminals at the bottom of the watt-hour meter. The two left-hand terminals are always marked and connected to the "line" and the two right-hand ones are always connected to the "load." The two outer terminals are connected together by the winding inside the watt-hour meter, and the two center terminals are likewise joined together. If wires of three colors are used on the service wiring (such

as black, white, and red) the white wire, which is the neutral or grounded wire, is run directly through the connection box. Two wires of one color (either color) go to the two outer terminals below the watt-hour meter, and the other two wires, which are of the other color, go to the two center terminals. The neutral wire is always white but sometimes all other wires are black.

When installing the neutral wire it is better to have enough slack in the meter box so it can be looped up to the meter terminals should the lighting company ever desire to install a 2-wire meter.

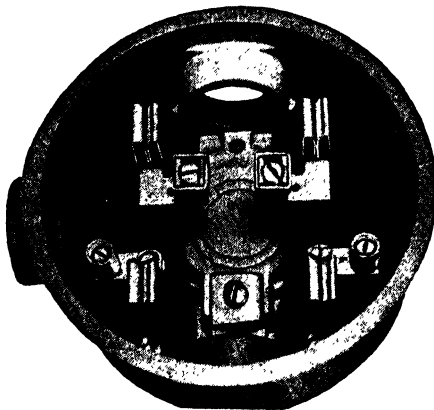

Fig. 6. A Three-Conduit Meter Socket for Vertical Mounting
-Courtesy of General Electric Company

The neutral wire should not be cut at this box, but looped under the connection screws. The connection box is grounded to the neutral wire by the clip in the box, as shown in Fig. 5.

When the building being wired is small and an electric range or water heater will never be installed, a 2-wire service and meter would be installed. The terminal connection box is wired the same as Fig. 5, except the lower wire going straight through the box is omitted. Then a black and a white wire are used from the service at left to the load at the right. The white wire is usually connected by looping it up and under the screws of one of the inner "line" or "load" terminals of the watt-hour meter block. The white wire is also grounded to the clip on the connection box in the same way as the lower wire in Fig. 5.

A type of meter connection box that is being used very extensively both for inside and outdoor mounting is the socket type, Fig. 6. The type of watt-hour meter to be used with this box, has, on its back, four blades that are inserted into the four clips. A clamping ring fits around the socket and holds the watt-hour meter in place. These socket fittings are also made without the conduit opening which is shown at the left in Fig. 6, in which case the service

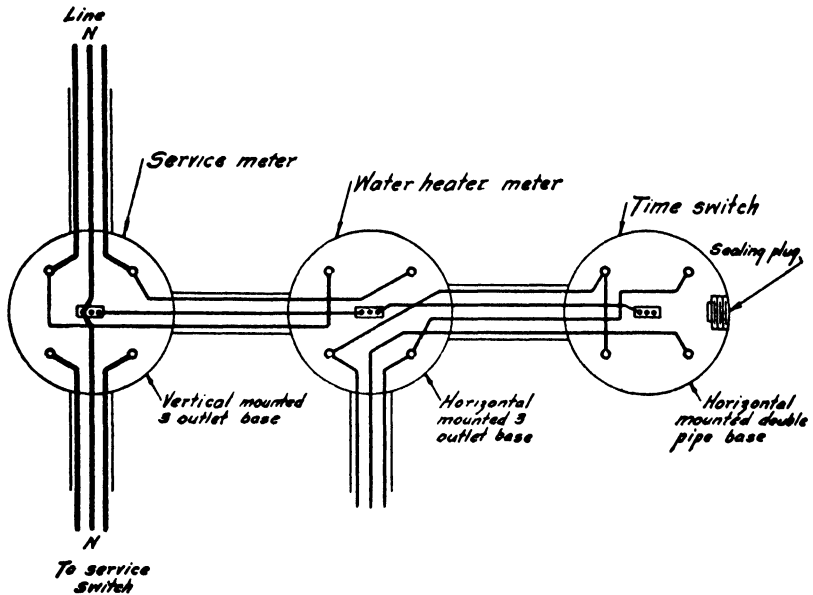

Fig. 7. Service Wiring for Regular Service Meter, an Off-Peak-Load Meter, and Time Switch

Courtesy of Wisconsin Power and Light Company

conduit is run vertically as in Fig. 4. Another type of socket fitting with the openings on each side is used when the service conduit is run horizontally as shown in Fig. 5. In all installations the clips must be vertical as in Fig. 6, and the line wires are connected to the top two clips by fastening them to the screw connectors. The load wires are always connected to the two bottom clips. The neutral or grounded conductor on a 3-wire service is run straight through the fitting and grounded to it by fastening it under the screw above the lower conduit opening.

The wireman installing the service wiring can obtain the proper

meter fitting from the light and power company, who should be consulted before the service wiring is installed.

The lighting and power companies often offer a low rate for a load that is not used during the time of the peak load on their system. This rate is often used where a hot water heater is installed. A separate meter is installed and a time switch is used to shut off this load during the peak hours. The method of wiring two socket-type meter bases and a time switch is shown in Fig. 7. A similar

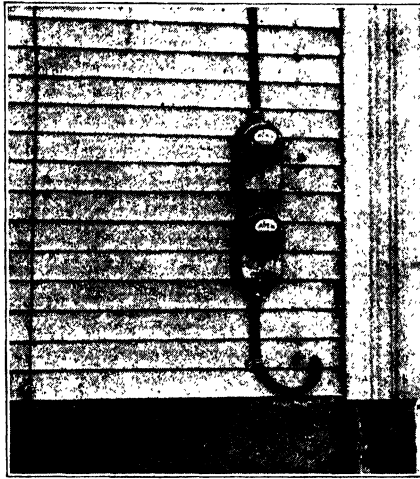

Fig. 8. Service Entrance Cable Installed on a Two-Family Meter Service
Courtesy of Anaconda Wire and Cable Company

method would be used when installing two meters to measure the current used in a two-family house, except that the second meter would be wired in the same manner as the first one, and the wiring to the time switch would be omitted.

In localities where the use of approved service entrance cable is permitted, the cost of the service wiring for a house can be reduced from about \$21.00 with rigid conduit to \$11.00 when service entrance cable is used. Such an installation is shown in Fig. 8 for a house occupied by two families. A 3-conductor cable is used, the neutral and one line wire being connected to the upper meter, and the neutral and the other line wire are connected to the lower meter. The wiring of the meters, entrance switch, and branch circuit fuses, is shown

in Fig. 9. The power company will use 2-wire watt-hour meters and will connect the wiring of one family between one outside wire and neutral. The wiring for the other family is connected to the other outside service wire and neutral.

Service or Entrance Switch. The entrance switch, watt-hour

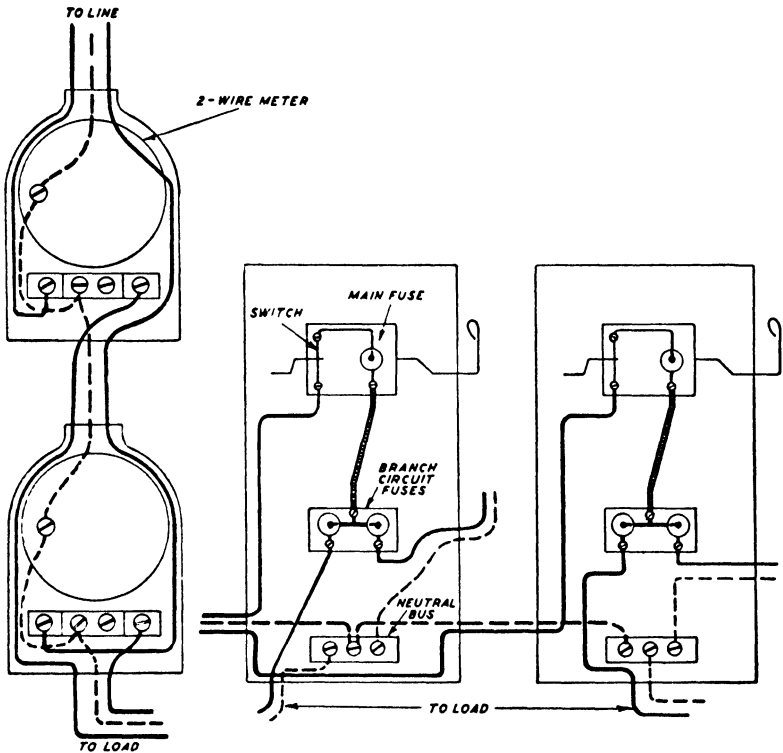

Fig. 9. Wiring Diagram of Two-Family Meter Service. At Left, a Diagram of Outside Wiring; at Right, a Diagram of Inside Wiring

meter, and branch circuit fuses may be located on a porch or in the basement when the basement extends under all the house. There are several types of entrance switches. When the meter is installed inside the building, the type shown in Fig. 10 is often used. The two service wires enter at the bottom and the "hot" or "live" wire goes to the left-hand clip on the porcelain block. Then the circuit is through the switch operated by the lever to the right of the box, through the service fuse in the top left-hand side of the porcelain

block, through the left-hand wire up to the line side of the watt-hour meter, through the watt-hour meter to right-hand load side and to the center contact of the two plug-fuse sockets. The wiring diagram is shown in Fig. 11. The wiring sequence or order for this arrangement is Switch-Fuse-Meter and is often abbreviated S-F-M.

The neutral wire does not have any fuse in its circuit, being connected solid, as shown in Fig. 11, to the center connection. The neutral wires of the branch circuits are connected to this terminal.

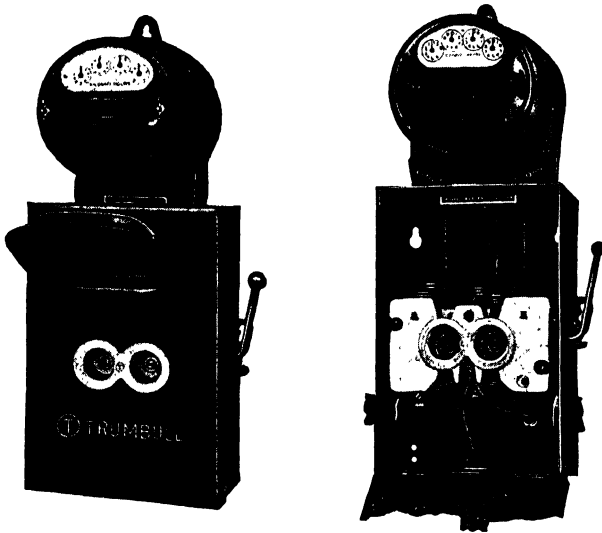

Fig. 10. Two Views of a Meter Service Switch Having Two Branch Circuits
Courtesy of Trumbull Electric Manufacturing Company

The left-hand view, Fig. 10, shows the auxiliary cover open so that the branch circuit fuses can be inserted in the sockets. After they connect their watt-hour meter, the main cover is usually sealed by the light and power company in order to prevent any theft of current.

The fuse-puller dead-front type of switch, Fig. 12, is often used inside the house when the watt-hour meter is located outdoors. The left-hand view has the main fuse to left of four branch circuit fuses. A view of the fuse puller removed is shown in the lower right-hand corner of Fig. 12. It serves the purpose of both a switch and fuse

holder and has the advantage that the fuse clips are dead when the customer has to replace a fuse. The wiring order or sequence is Meter-Switch-Fuse.

One of an inexpensive type of combined switch and fuse holder

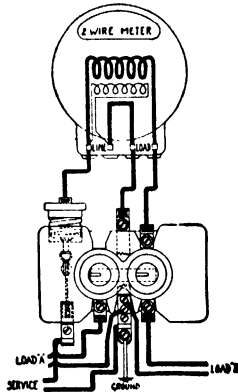

Fig. 11. Wiring Diagram
of a Trumbull Two-Wire
Meter Service Switch
*Courtesy of Trumbull
Electric Manufacturing
Company*

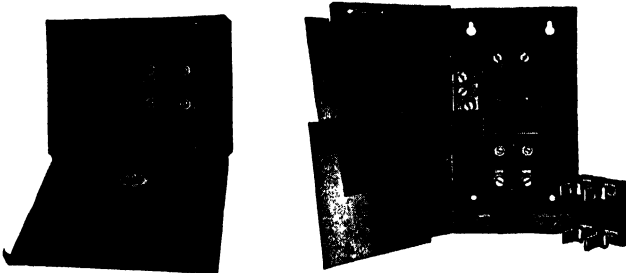

Fig. 12. Fuse-Puller Type Switches
Courtesy of Trumbull Electric Manufacturing Company

that is used when an electric range may be installed in the future is shown in Fig. 13. This type is provided with two 60-ampere cartridge-type fuses on the incoming main line (left-hand fuse puller) and 35 to 60-ampere fuses in the range circuit which is the right-hand fuse puller.

Plug-fuse receptacles are provided for four branch circuits.

Some local electrical codes and lighting companies may not approve the fuse puller as taking the place of the service switch, but the use

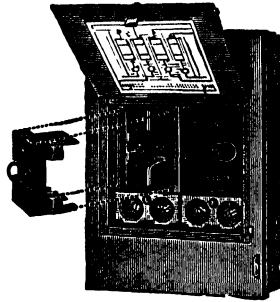

Fig. 13. Combined Main and Range Switches, Fuse Puller, and Branch Circuit Fuses
 Courtesy of The Arrow-Hart and Hegeman Electric Company

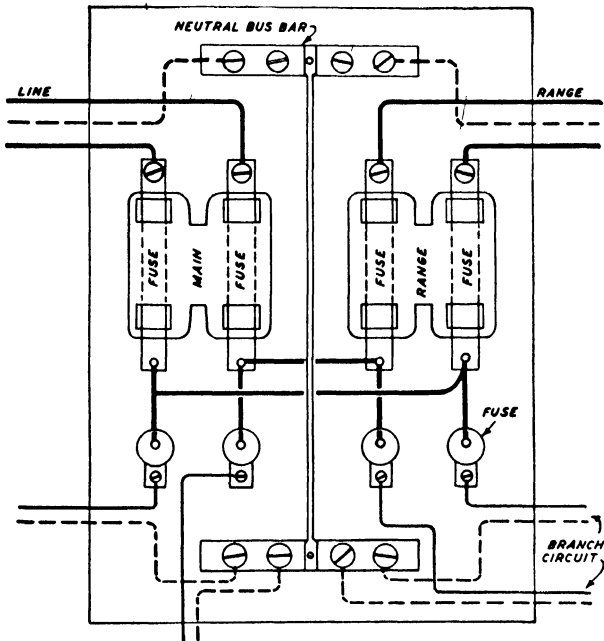

Fig. 14. Wiring Diagram for Enclosed Pull-Out Switch

of this type is increasing. The advantage of this type is that all wiring is completely inclosed and the fuses can be replaced without touching any live parts. The wiring diagram is shown in Fig. 14.

The 3-wire 120-240-volt line from the watt-hour meter enters at the left, and the neutral wire is connected to the bus bar at top and bottom of cabinet. There are no fuses used in the neutral, which is the white wire. The main and range fuses are of the cartridge type and the sockets will hold fuses rated at 35 to 60 amperes. The branch circuits use the regular plug-type fuse. There is no fuse used in the neutral (white) wire of the branch circuits going to the lamps. The range fuse circuit could be used for motors when a range is not used. The motors can be wired for 240 volts by using the two wires from the top of the range fuses.

All of the service switches should be mounted at a convenient height. The top should not be more than six feet from the floor or the bottom nearer than three feet to the floor. They should not be mounted in a damp location or where water will drip on them, or under water or gas pipes.

LOCATING OUTLETS AND SWITCHES

The wireman should study the arrangement of the household furniture before deciding on the location of the ceiling or wall outlets. A ceiling outlet is usually located in the center of rooms that are about square. When the room is nearly twice as long as wide, it is better to divide the room into halves and install a ceiling outlet in each half. The use of wall or bracket outlets is decreasing because better light is obtained by the use of portable floor lamps attached to convenient outlets.

When locating switches, the use of the different rooms should be considered. The house in Fig. 1 may be located in the country where the driveways and gates are arranged so that every one will naturally use the kitchen door. Then the switch to control the kitchen light should be at the side of the door and opposite the hinges, the living-room switch should be located on the stair wall or at the side of the doorframe of the stairway, and the dining-room switch should be at the side of the door leading into the kitchen.

When the house is located so that the outside door of the living room is the one which is used most often, then the living-room switch should be located at the side of the outside door. Then the switch for the dining room will be at the doorway into the living room, and

the kitchen light switch will be at the side of the door into the dining room.

One very important rule is never to place a switch where it will be back of a door when the door is open. Switches are installed four feet above the floor.

Convenience outlets are located either in the baseboard or in

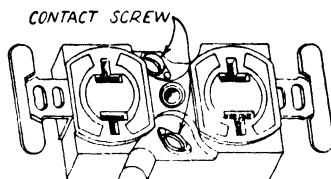

Fig. 15. Duplex Receptacle

the plastered walls at a height of 14 inches. In houses that are wired after being built, the baseboard location is preferred. If the wiring is installed as the house is being built, the outlet is mounted on the side wall, 14 inches above the floor. The duplex type receptacle, Fig. 15, should be used except for electric ranges, when the type shown

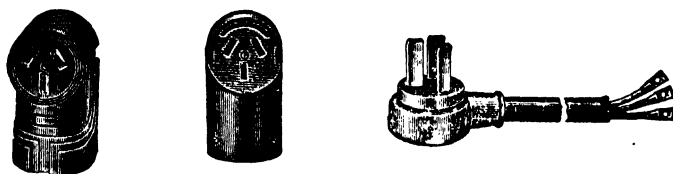

Fig. 16. Electric Range Outlet Receptacles and Plug with Cord
Courtesy of The Arrow-Hart and Hegeman Electric Company

in Fig. 16 should be used. The three lugs of the cord set are attached to the terminals of the range. Then to attach the range, the prongs of the cap are inserted in the receptacle.

OPEN CONDUCTORS

City Codes. Exposed wiring on insulators, while permitted by the National Code, is not permitted by many of the local city codes except in buildings where moisture or acid fumes are present, in

which case special permission must be secured before the work is started.

Insulators. The rules for open work are simple and easy to follow. Insulators should be free from checks, rough projections, or sharp edges which might injure the insulation of the wire. Wires must be single-conductor throughout. Small conductors, No. 14 to No. 10 B.&S. gage, are usually supported on two- or three-wire cleats,

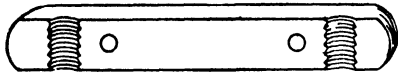

Fig. 17. Standard Two-Wire Cleat

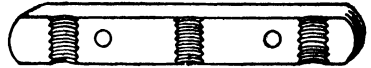

Fig. 18. Standard Three-Wire Cleat

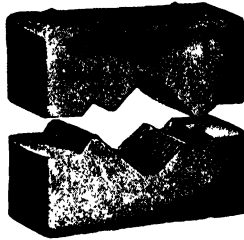
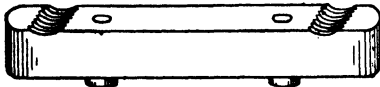

Fig. 19. Standard One-Wire Cleat

*Courtesy of General
Electric Supply
Corporation*

Figs. 17 and 18, secured by screw or nails and leather heads. Wires of No. 8 B.&S. gage and up are best supported on one-wire cleats, Fig. 19, secured by two screws.

Separation of Conductors. At least a $\frac{1}{4}$ -inch separation should be maintained between the supporting screws or nails and the conductor. Cleats for voltage up to 300 volts must separate the conductors $2\frac{1}{2}$ inches from each other and $\frac{1}{2}$ inch from the surface wired over. Conductors larger than No. 8 B.&S. gage, when supported on solid knobs, Fig. 20, should be secured by wires having the same type of insulation as their conductors. In Figs. 21, 22, 23, and 24 are shown the correct and incorrect methods of making a cross-

over. Porcelain bushings may be used for crossovers and should be fastened, as in Fig. 23, to prevent moving along the wire.

A split porcelain knob, Fig. 25, is used for wiring when con-

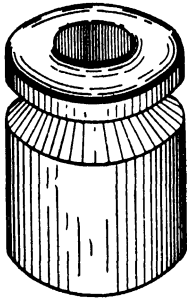

Fig. 20. Standard Solid Porcelain Knob



Fig. 21. Single Porcelain Crossover

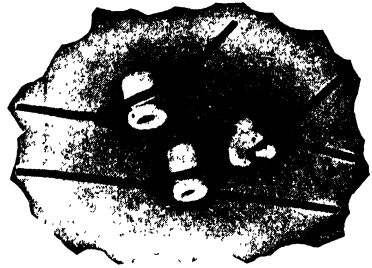

Fig. 22. Method of Securing Conductors to Knobs and Use of Crossovers

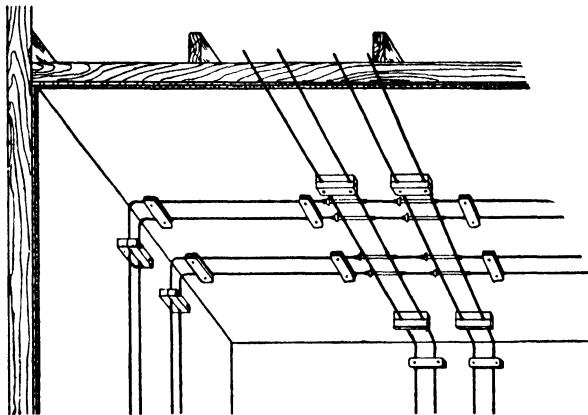

Fig. 23. Correct Method of Crossover, Insulator over Inside Conductors

If nails are used to fasten insulators, they should penetrate wood-work one half the length of knob or the thickness of cleat and should also be provided with leather heads or washers to prevent injury to insulator.

ductors size No. 8 or smaller are used. It is provided with a groove on each side of the nail so that two wires of the same polarity and circuit can be attached. A special use is where a tap has been taken off one conductor for an outlet. Never attach two wires of different color or polarity or circuits to the same porcelain knob. When a tap is made off the main wire of a circuit, both conductors must be supported within 6 inches of the tap.



Fig. 24. Incorrect Method of Crossover
 Note that flexible tubing is drawn over outside in place of inside conductors.

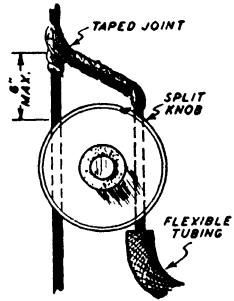
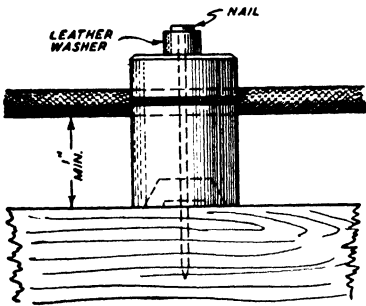

Fig. 25. Split Knob and Tap Splice

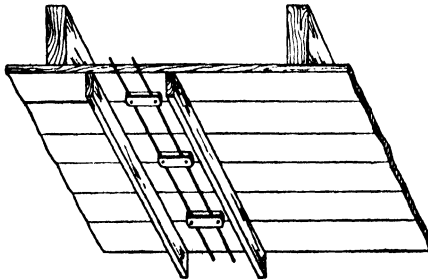

Fig. 26. Guard Strips on Low Wood Ceiling

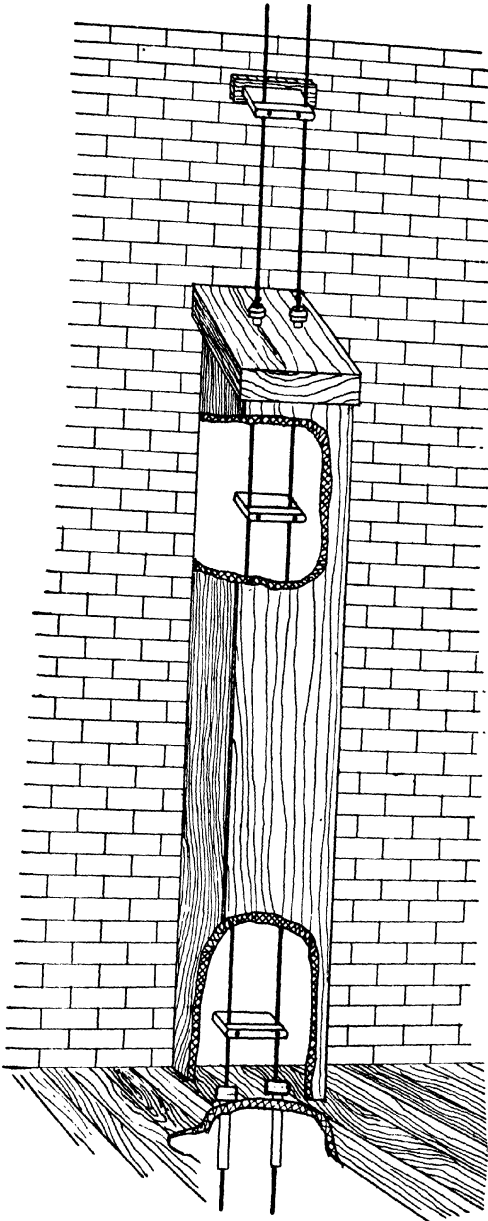

Fig. 27. Wood Boxing for Side Wall Protection

Protection on Ceiling, Side Walls, and Floors. On low ceilings, guard strips should be installed, Fig. 26. These should not be less

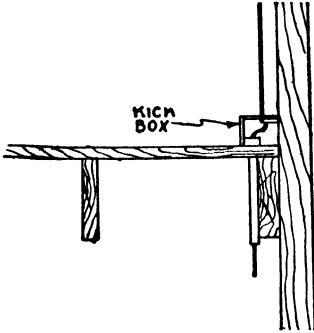

Fig. 28. Kick Box for Protection at Floor Line

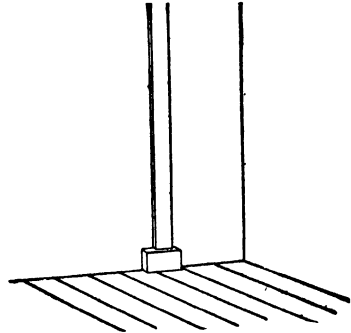

Fig. 29. Front View Showing Width of Kick Block to Allow Proper Spacing of Porcelain Tubes

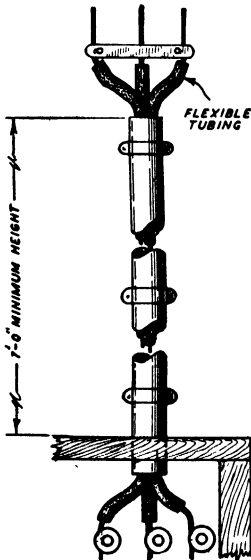

Fig. 30. Protecting Wires When They Pass Through the Floor

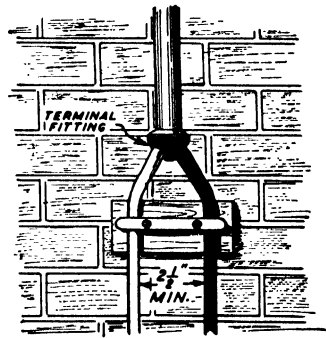

Fig. 31. Method of Changing from Open Wiring to Conduit

than $\frac{7}{8}$ inch in thickness and should be spaced so that the guard strips are about one inch from the end of the cleats or knobs. Guard strips should be at least as high as the insulators they protect.

Protection on side walls must extend not less than 7 feet from the floor. It must consist of a substantial boxing, Fig. 27, retaining an air space of 1 inch around the conductors, and must be closed at the top, the wires passing through bushed holes. When porcelain knobs are used instead of cleats, the wires must be at least three inches apart. Wires passing through floors should be properly

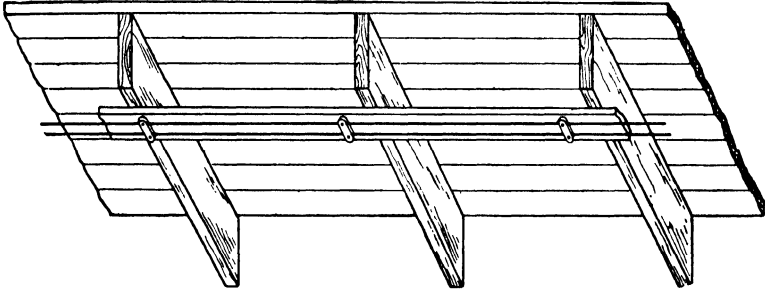

Fig. 32. Running Board for Cleat Work on Widely Spaced Beams

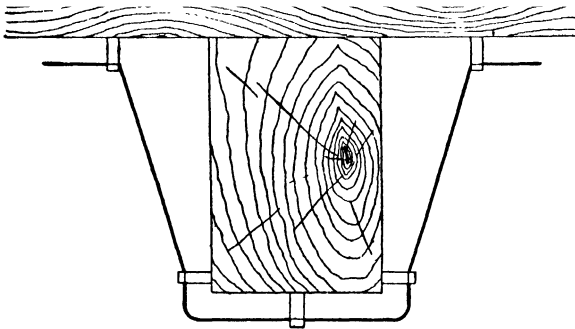

Fig. 33. Breaking Around Beams with Cleats

bushed, and a kick block should be used to protect and raise the tubes from the floor, Figs. 28 and 29.

The wires may be protected from mechanical injury by the use of pipe or conduit, Figs. 30 and 31. When wires pass through the pipe or conduit, Fig. 30, each wire must be inclosed in a separate nonmetallic flexible tubing, often called loom. The tubing must be in one piece and must extend from the porcelain support of the wires at the bottom, to their support at the top. With conduit, a terminal fitting having a separate, bushed hole for each conductor, Fig. 31,

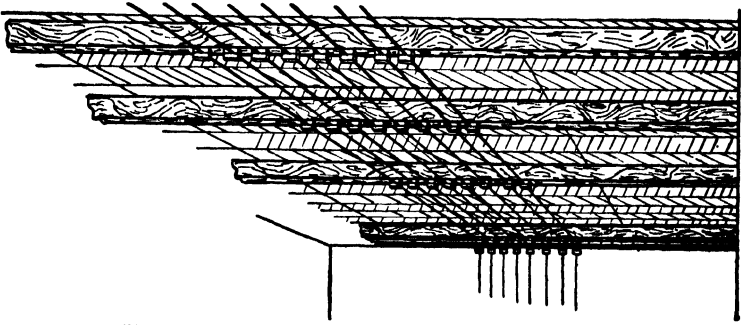

Fig. 34. Large Conductors Supported on Widely Spaced Beams

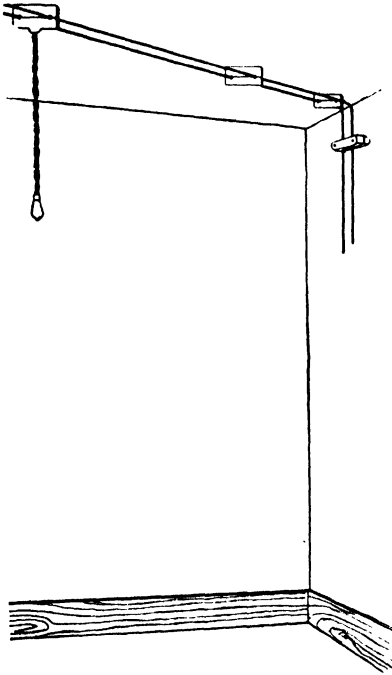

Fig. 35. Drop Cord Suspended from Cleat



Fig. 36. Standard Drop Cord Cleat

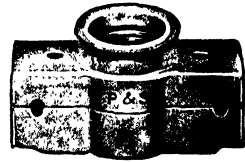

Fig. 37. Standard Keyless Socket Cleat

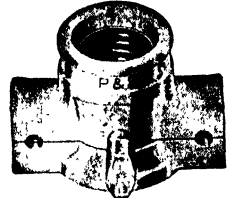

Fig. 38. Standard Key Socket Cleat
Courtesy of Pass and Seymour



Fig. 39. Standard Snap Switch Cleat
Courtesy of General Electric Company

may be used. The bushings are of insulating material. This method is also used when the open wiring system is changed to conduit. The wires in the pipe and conduit, Figs. 30 and 31, must not contain any splices.

Supports for Wires. Wires require rigid support even under ordinary conditions. On a flat surface, supports should be provided at least every $4\frac{1}{2}$ feet. Where the wires are liable to be disturbed, the distance between supports must be shortened.

In Fig. 32 is shown a method of supporting wires when widely spaced beams are encountered. The method of breaking around

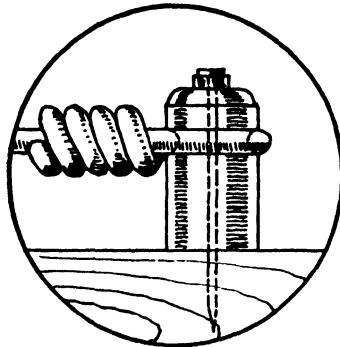

Fig. 40. Dead-Ending a Wire at a Knob
Courtesy of James Steel Mahan

beams with cleats or split knobs is illustrated in Fig. 33. In buildings of mill construction, mains of not less than No. 8 B.&S. gage cable (where not liable to be disturbed) may be separated about 6 inches and run from timber to timber without breaking around, Fig. 34. For proper support, drop cords should be attached to the circuit wires through a cleat, Figs. 35 and 36. The best installation of wall sockets and switches is with special cleat-work fittings, Figs. 37, 38, and 39. Other fittings, when used, should be mounted on small porcelain knobs. Never dead-end conductors except on a knob or a cleat, and bring the wire back over the cleat or knob, Fig. 40, and wrap the end around the conductor.

Precautions against Dampness and Acid Fumes. The rules for open work in buildings subject to moisture or acid fumes are some-

what changed as regards insulator supports. Porcelain or glass knobs must be used. When installed on brick, concrete, tile, or plastered walls or ceilings, these insulators should be attached to wooden or metal strips or blocks, fastened independently by means of expansion or toggle bolts, Fig. 41. Nails or screws driven into wooden plugs are neither durable nor desirable, nor permitted by most local codes.

Wires should have standard rubber insulating covering for

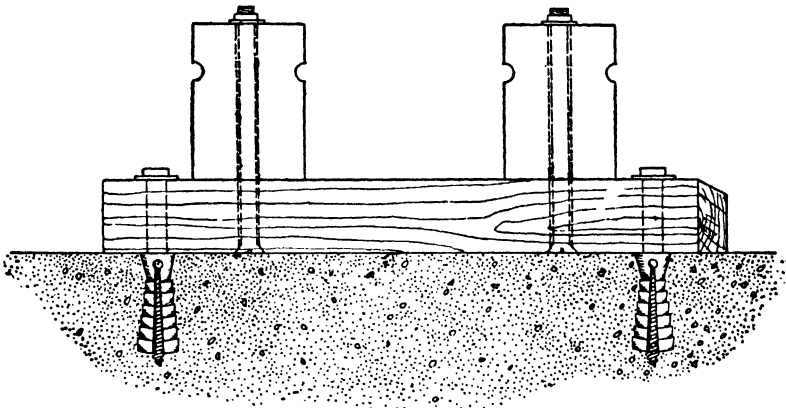

Fig. 41. Wood Strip Independently Fastened by Toggle Bolts for Supporting Porcelain Insulators in Damp Places

protection against water and against corrosive vapors. Weather-proof or rubber-insulated conductors should be separated at least 1 inch from the surface wired over. An inverted wooden trough and wooden boxing similar to the installation illustrated in Fig. 42 are required. This construction is also recommended when the wiring is to be subjected to dripping from overhead piping. Sockets should be of weatherproof type, Fig. 43, and drop lights should be hung on No. 14 B.&S. gage standard rubber-covered wire.

Cutouts and switches should be mounted on small knobs in iron cabinets. The method of installing cutout centers in damp places is illustrated in Fig. 44. Note the wood boxing protection from the floor to the cutout cabinet, also the method of bringing out circuit wires through 45-degree porcelain bushings and the forming of drip loops in order to keep the water from entering the cabinet. Glass knobs and tie wires are used to support the conductors.

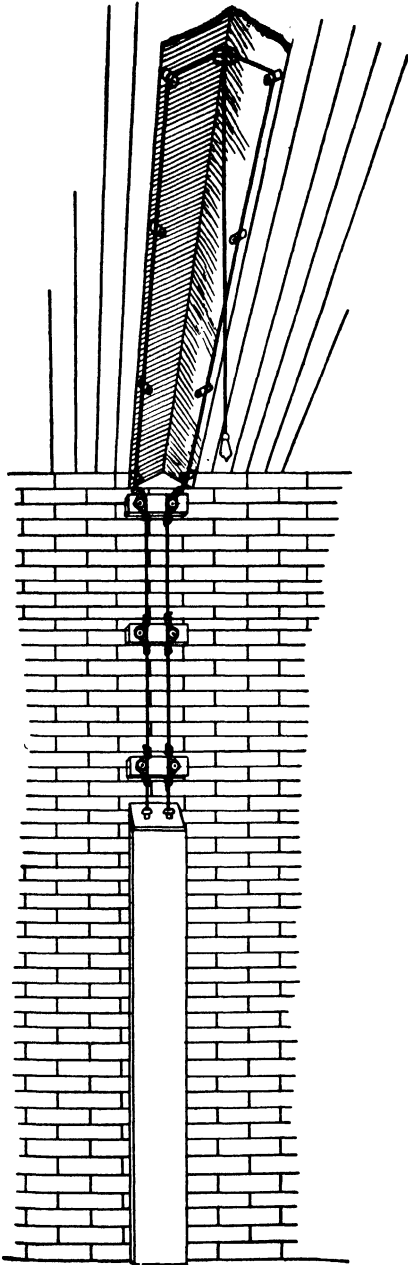

Fig. 42. Typical Installation of Open Work in Damp Places



(A)



(B)



(C)

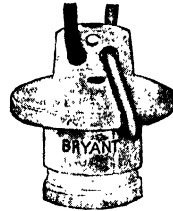

(D)

Fig. 43. Various Types of Weatherproof Sockets. A, Soft Rubber Socket with 6-inch No. 14 Stranded Wires; B, Bakelite Pin Type Socket with Pointed Terminals which Pierce the Wire Insulation when the Cap Is Screwed On; C, Porcelain Socket with Shadeholder Groove; D, Porcelain Socket with Driphood. The Extension Skirt Acts as a Watershed. Courtesy of The Bryant Electric Company, Chicago, Illinois

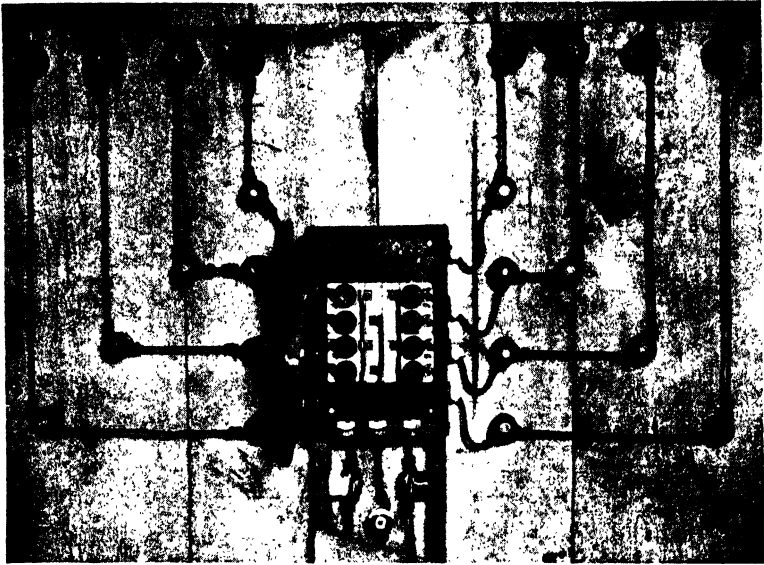

Fig. 44. Typical Cutout Cabinet Installation for Damp Places

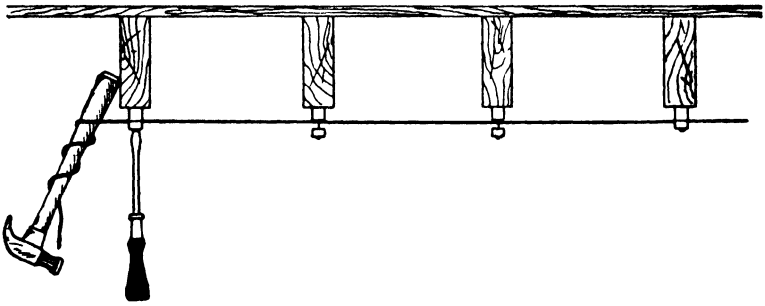

Fig. 45. Method of Taking Up Slack in Small Conductors

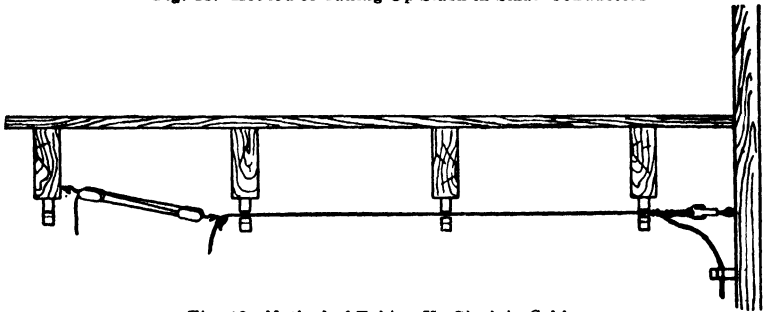

Fig. 46. Method of Taking Up Slack in Cables

Stringing Wires. A good method of stringing wires on porcelain supports is to first fasten both or all three conductors to a double row of supports on one end of the line, then string the conductors along the floor joists to the other end of the run and there install the last cleat or knob. If the wires are small, take one or two turns around the handle of a hammer or bar, as shown in Fig. 45, which will give good leverage. When the wires are drawn taut, fasten

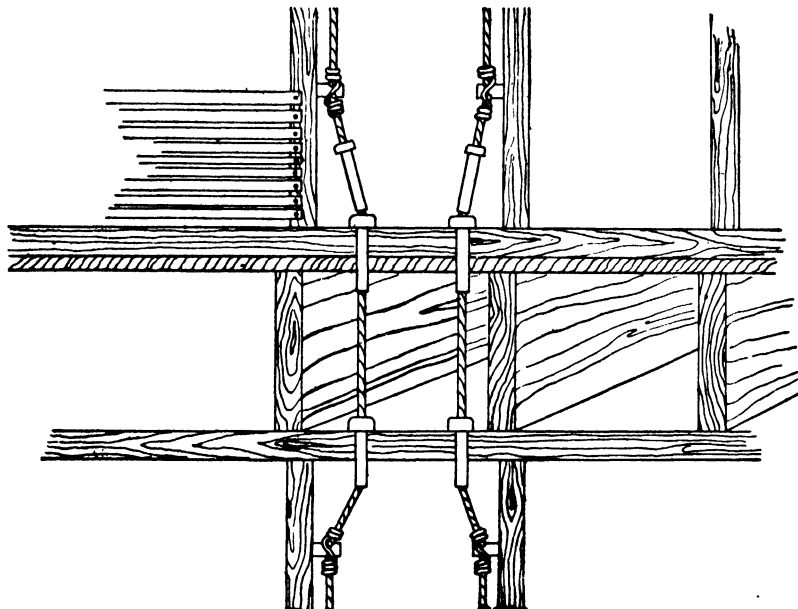

Fig. 47. Conductors Passing through Cross Timbers

them securely to the insulator and fill in the remaining cleats or knobs along the run in accordance with the required spacing. When installing heavy cables, a small block and fall, as in Fig. 46, will give satisfactory results in pulling up the slack, and by the use of a turnbuckle or strain insulator at one end of the run the final slack can be taken up.

CONCEALED KNOB AND TUBE WIRING

Where Used. Concealed knob and tube work, like wiring on insulators, is not permitted in the larger cities where stringent inspection rules prevail, but because of cheapness of construction it

is generally used in small towns for residence and store wiring, and in farmhouses. It is also commonly used in houses that are located near rivers and within reach of the flood waters. This applies alike to buildings in course of construction and to old buildings.

Conductors. Conductors should be run singly on separate timbers or studdings and must be kept at least 3 inches apart. When passing through cross timbers in plastered partitions, conductors

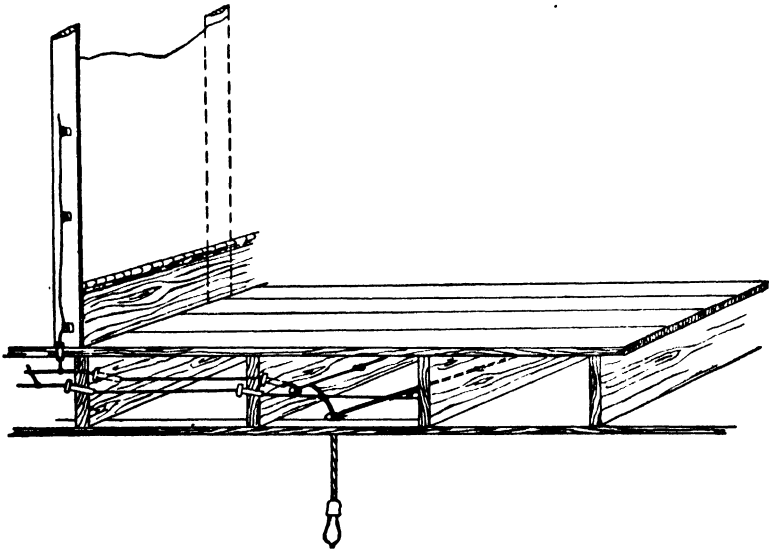

Fig. 48. Concealed Knob and Tube Wiring

must be protected by an additional tube extending at least 4 inches above the timbers, Fig. 47. When grooved knobs are used, the insulation of the binding wire should be the same as that of the conductor; of course when split knobs, Fig. 25, are used, no binding wire is necessary. When the conductors are run at right angles to the beams, the beams should be bored with a carpenter's brace and bit, and porcelain tubes inserted; when conductors are run paralleling beams, knobs should be used, Fig. 48.

Outlet Boxes. The standard metal outlet and switch boxes may be used with knob and tube wiring. There has recently been developed a line of porcelain octagonal outlet boxes and covers, Fig. 49, having dimensions corresponding to metal boxes. There is also

a line of porcelain "Ready" outlet and switch boxes and covers, Fig. 50, to which regular tumbler, toggle, or push-button switches can be attached. These porcelain outlet boxes have six thin wall openings

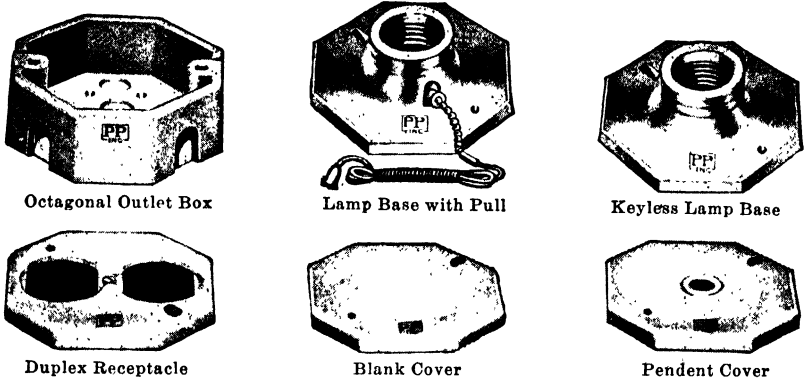

Fig. 49. Porcelain Outlet Box and Covers
 Courtesy of Porcelain Products Incorporated

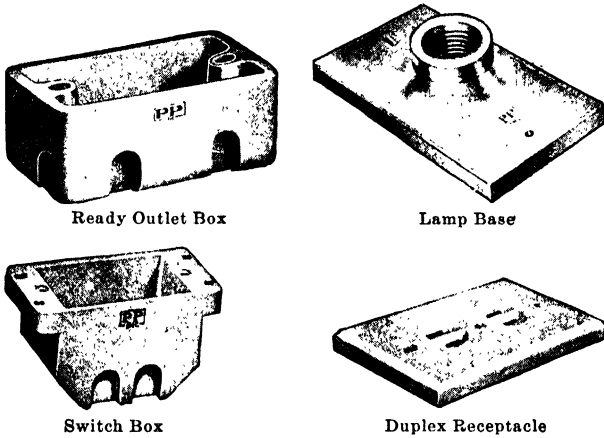

Fig. 50. Ready Outlet Box, Switch Box, and Covers
 Courtesy of Porcelain Products Incorporated

that can easily be knocked out with a hammer or screw driver. Two openings will allow a pair of single conductors, two will allow a pair of two-wire nonmetallic sheathed cables, and two will allow a pair of three-wire nonmetallic sheathed cables to enter the box.

Nonmetallic flexible loom tubing must be used to cover the individual wires from the last support to the outlet box. When metal

boxes are used, the flexible tubing must extend inside the box and be securely attached by clamps to the box, Fig. 51. When the porcelain boxes are used, the flexible tubing need extend only to the outer surface of the box, where it will end. The porcelain walls of the outlet box provide insulation for the conductors. This is very desirable in buildings located within reach of the flood waters from rivers.

Wall Switches. The tumbler type of wall switch is much more convenient to use than the push-button type, and it presents a much neater appearance than the exposed snap switch and is preferred for residence wiring. These can be mounted in either metal or porcelain

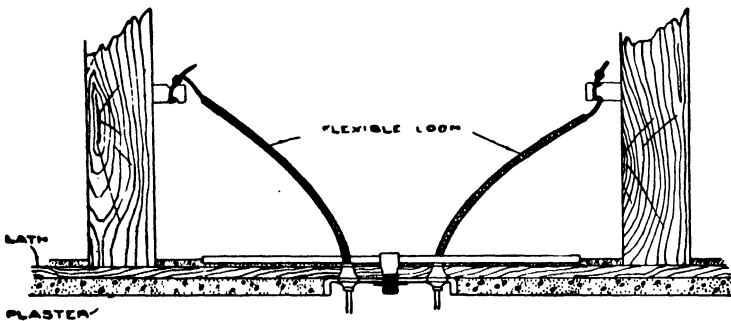

Fig. 51. Shallow Outlet Box Supported by Metal Box Hanger Laid Across Lath

switch boxes, but for knob and tube wiring the porcelain boxes, Fig. 50, are the best. Also the plate cover placed over the switch should be of porcelain, glass, Bakelite or similar insulating material, in preference to the usual metal switch plate. The use of these insulating materials will prevent the experiencing of a slight shock due to static electricity when turning on the lights. Such shocks are produced when the air is very dry, by walking across a varnished or highly waxed floor or a woolen rug and then touching the metal switch plate. A similar shock may also be caused by walking across the room and touching a stove or other metal object. Such shocks are not serious or dangerous to any person. However, this must not be confused with the shock that a person might receive if the edge of the metal box cut through the insulation and made contact with the copper of the wire, and that person were standing on a wet floor or touching any metal object connected to the earth.

Heat Insulation. There have been developed, during the past few years, many types of thermal insulation which is placed between the plaster and the outer walls. Where concealed knob and tube wiring is to be installed in a new building in which the hollow spaces between the walls and ceiling are to be filled with a thermal insulation, the wireman should see that it is an approved noncorrosive, noncombustible, and nonconducting material and that it is applied so that there will be no strain upon the wires or their supports. Some of the thermal insulation comes in the form of batts, that are pushed into place between the studding, rafters and floor beams. Aluminum and many other heat-reflecting types of insulation are metallic in nature and are conductors. This type of insulation *should not* be used with knob and tube wiring. Where this type of insulation is to



Fig. 52. Nonmetallic Flexible Tubing
Courtesy of The M. B. Austin Company

be used, some other approved form of wiring should be used instead of concealed knob and tube wiring.

Wiring Old Buildings. Flexible Tubing. In wiring old buildings where it is not possible to take up flooring, nonmetallic flexible tubing, Fig. 52, may be fished in partitions and between the floor and ceiling. Only one wire is permitted in each tube, and the tubing must be continuous from outlet to outlet or from knob to knob. This tubing may not be run across notched beams or joists, as is done with armored cables, but must be fished through existing channels in partitions or over ceilings. By removing baseboards, fishing parallel with the floor beams, going through floor plates with porcelain tubes, and picking up the circuits in the attic and the basement, a very safe and acceptable installation can be put in with flexible tubing at about two thirds of the cost of an armored cable installation.

SPlicing WIRES AND CABLES

General Instructions. Insulation should be cut away as one would trim the wood of a lead pencil, care being taken not to nick the conductor. Scrape the copper wire bright and clean with the back of a knife blade. The joint should be mechanically and electrically secure before the solder is applied. Soldering paste is the most convenient flux for small joints. For lugs, sleeves, and cable joints, a noncorrosive fluid is recommended.

Solid Wires. *Western Union Splice.* The Western Union splice, Fig. 53, is made by holding the two conductors with one pair of pliers

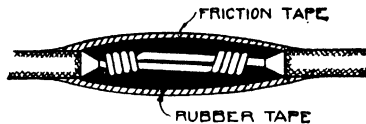

Fig. 53. Western Union Splice



Fig. 54. Western Union Splice for Small Conductors

and, with the second pair, wrapping the free ends around the conductor in opposite directions toward the insulation. This splice is generally used in open work and can be soldered with a torch or a grooved soldering iron.

The Western Union splice can be made on wire of size Nos. 12 and 14 B.&S. gage, by twisting the conductors with the fingers, after which the ends of each conductor should be wrapped around (with pliers) as shown in Fig. 54. The twisted wires are heated with a torch or soldering iron until they will melt the solder so that it flows over them.

A splice on rubber-covered wire must be covered with rubber tape until its insulation is the same as that on the original wire. This is done by removing the glazed cloth backing from a piece of rubber tape about 6 to 8 inches long. Gripping the ends between the thumb and first finger of both hands, stretch the tape three or four times, like a rubber band. The rubber tape should be stretched from three to five times its original length. Then hold one end of the tape against the edge of the rubber-covered wire and tightly wind the stretched

rubber tape (it should not be narrower than half its original width) spirally around the soldered copper wires, allowing about half of the width of the tape to lap over the previous wrap. The side of the rubber tape next to the cotton glazed backing on the roll should be outward on the splice. Wind the rubber tape over the splice to the rubber on the other wire, then continue winding in the same direction around the wire and back to the starting point. If the rubber is not twice as thick as that on the conductors being spliced, another layer or two can be applied in the same manner. A layer of $\frac{3}{4}$ -inch friction tape is then wound, under tension, around the joint, lapping it half

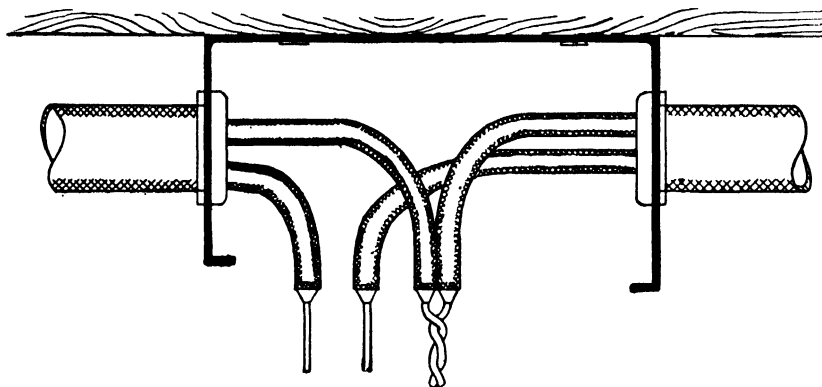

Fig. 55. Pigtail Splice, Showing One Pair of Wires Spliced and One Pair Ready to Splice

the width of the tape and overlapping the braided insulation at least $\frac{1}{2}$ inch.

Other types of joints, with the exception of the pigtail splice, are soldered and taped in similar manner.

Pigtail Splice. In making a pigtail splice, Fig. 55, bend at right angles to the outlet the two or more conductors to be joined. Hold the insulated end of the wires with the left hand, cross the bare conductors about 1 inch below the insulation, and twist with pliers until secured. This splice is convenient for joints in junction and outlet boxes. A small ladle containing hot solder, into which the end of the joint may be dipped, is preferable to either torch or soldering iron. The twisted wires should be held in the hot solder until they have a silvery appearance caused by a thin coating of solder sticking to them.

A low-priced handy soldering ladle for pigtail splices can be made by taking a 1-inch iron pipe cap and drilling two holes near the edge of the rim diametrically opposite each other. The holes should be about the size of No. 9 steel wire. A handle for the ladle is formed by taking a piece of No. 9 steel wire about three feet long, bending

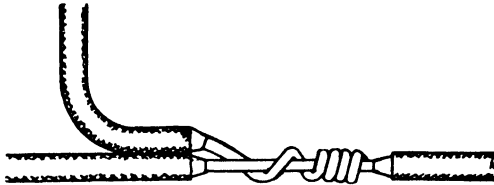

Fig. 56. Tee Tap on Solid Wire

it in the center into a hairpin loop and twisting the wires together to within four inches of the end. An U-shaped fork is formed by the ends of the wire, and the tips are bent inward at right angles and pushed in the holes drilled in the pipe cap. The U-shaped forked wire handle should be bent and adjusted so that the pipe cap ladle will rock and swing freely in it and the open end will always remain upward when the handle is swung under it.

The pigtail splice is taped in a manner similar to that used on the Western Union splice. It is a little hard to apply the tape near the ends of the twisted wires, and there the tape cannot be pulled as tightly; however, the ends of the wires must be covered with rubber tape. Friction tape is applied in similar manner, starting on the rubber-covered wires and taping over the newly applied rubber insulation to beyond the end of twisted wires, bending the tape tip thus formed back on itself and continuing to wrap the tape around the splice, working back to the rubber-covered wires.

Tee Tap Splice. The T-tap splice, Fig. 56, is made by holding the two conductors with one pair of pliers and, with a second pair, wrapping the free end around the conductor. This splice should be soldered and taped as directed for the Western Union splice.

Cable Splices. Cable splices are started as shown in Fig. 57. The outside layer of wires should be spread, pulled out straight, and thoroughly cleaned. Cut the core short and butt the ends. Then fan the strands, one side alternating with the other. The next move, which is to lay the strands parallel with the cable, is shown in Fig. 58.

Take one strand from each end, cross the strands, and wind in opposite directions. This will form the first turn of the splice directly in the center. Where the first turn of the wire ends, pick up another strand,

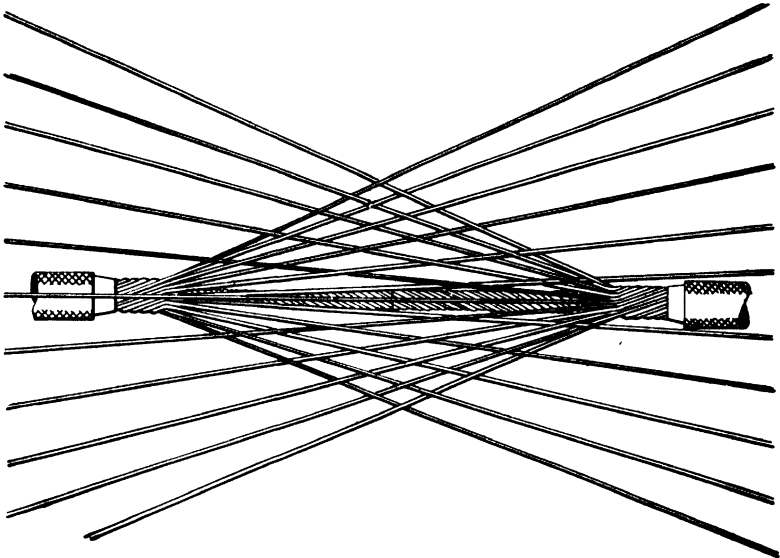

Fig. 57. Cable Splice, Alternating the Wires

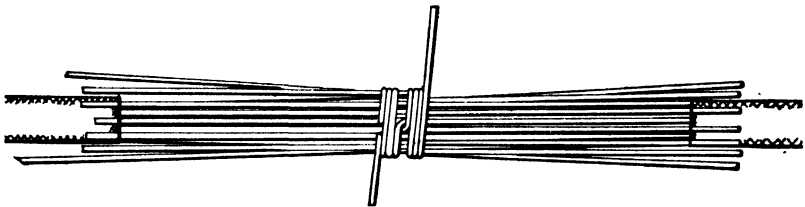

Fig. 58. Cable Splice, Making the First Turns



Fig. 59. Ready to Solder

and continue the operation with each wire. Three or four winds for each strand will be sufficient. The splice completed, ready for soldering, is shown in Fig. 59. Cable joints are soldered by pouring, from a ladle, molten solder through and over them. The joint is then taped as directed for Western Union splices.

Tee Taps on Stranded Conductor. The method of making a T tap on a small stranded conductor, shown in Figs. 60 and 61, makes the most perfect joint possible. All strands of the tap cable are pulled out and laid parallel with the feeder cable. Each strand is then wound separately around the cable as shown. A T tap on a large stranded conductor, Fig. 62, is made by separating and equally divid-



Fig. 60. Tee Tap on Small Stranded Conductor

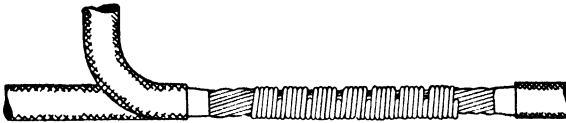

Fig. 61. Tee Tap on Small Stranded Conductor

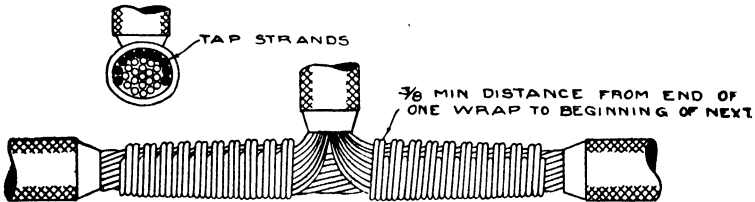

Fig. 62. Tee Tap on Large Stranded Conductor

ing the strands of the cable to be attached to the feeder. They are then laid flat on the feeder cable, and each strand is given two or three turns around the cable. Solder should be poured over the tap and it should be taped in a manner similar to that described for the Western Union splice.

Sleeve Joint. A simple and easy method by which to join stranded conductors is shown in Fig. 63. This method is used principally on underground cables. The sleeves are slotted either their full length or sufficiently to allow for their being filled with solder. The cables should be cut evenly so as to butt squarely and fit snugly in the sleeve. Each cable should be stripped, thoroughly cleaned and scraped, dipped in soldering flux, and tinned. The sleeve also

requires cleaning and tinning before the cables are inserted. Apply heat to the sleeve with the blow torch, and then pour molten solder

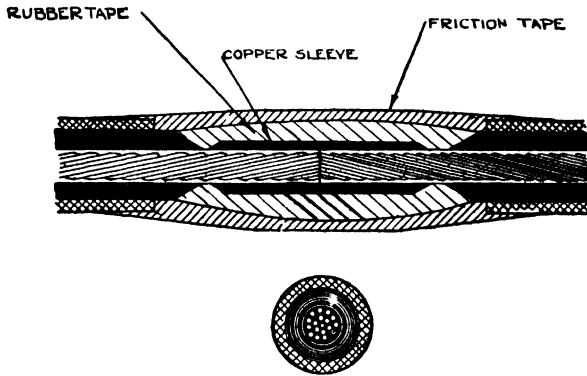

Fig. 63. Sleeve Joint in Cable

into the slot with a ladle. Damp asbestos string or tape wound around the bare cable on each end of the sleeve will prevent the solder from running out of the ends of the sleeve. The joint is then taped as shown.

ALLOWABLE CURRENT-CARRYING CAPACITIES OF CONDUCTORS IN AMPERES

(Based on Room Temperature of 30° C. 86° F.)

TABLE 1—Not more than 3 Conductors in Raceway or Cable

4 to 6 Conductors, Multiply by 80%; 7 to 9, Multiply by 70%

Size AWG or MCM	Rubber Type RW Type R	Synthetic Type SN		Rubber Type RH		Synthetic Type SNA		Asbestos Type A		Impreg- nated Asbestos Type AI	Impreg- nated Asbestos Type AV	Synthetic Type SNA	Rubber Type RH	Rubber Type RP	Rubber Type R	Size AWG or MCM
		Type RU	Type RW	Type RH	Type RW	Type AV	Type AV	Type SNA	Type SNA							
14	15	18	22	22	26	28	32	32	32	39	40	30	29	24	20	14
12	20	23	27	27	36	36	42	42	42	48	49	40	37	34	32	12
10	25	31	37	37	47	47	54	54	54	61	61	54	50	42	38	10
8	35	41	49	49	60	60	71	71	71	80	80	71	69	58	48	8
6	45	54	65	65	80	80	95	95	95	105	105	99	94	78	66	6
5	52	63	75	75	94	94	110	110	110	125	125	115	110	92	80	5
4	60	72	86	86	107	107	122	122	122	145	145	133	125	105	87	4
3	69	83	99	99	121	121	145	145	145	170	170	155	146	122	101	3
2	80	96	115	115	137	137	163	163	163	195	195	179	170	142	118	2
1	91	110	131	131	161	161	188	188	188	225	225	200	196	164	136	1
0	105	127	151	151	190	190	223	223	223	265	265	245	230	193	160	0
0	120	145	173	173	217	217	250	250	250	295	295	275	267	223	185	0
0000	138	166	199	199	243	243	284	284	284	335	335	310	310	259	215	0000
0000	160	193	230	230	275	275	330	330	330	385	385	355	355	298	248	0000
250	177	213	255	255	315	315	372	372	372	435	435	405	405	338	280	250
300	198	238	285	285	347	347	415	415	415	485	485	455	455	373	310	300
350	216	260	311	311	375	375	445	445	445	520	520	490	490	405	350	350
400	233	281	336	336	405	405	480	480	480	560	560	530	530	435	380	400
500	265	319	382	382	460	460	550	550	550	640	640	610	610	490	430	500
600	293	353	422	422	505	505	600	600	600	700	700	670	670	550	480	600
700	320	385	461	461	550	550	650	650	650	760	760	730	730	610	525	700
750	330	398	475	475	570	570	680	680	680	800	800	770	770	650	565	750
800	340	410	490	490	590	590	710	710	710	830	830	800	800	680	600	800
900	360	434	519	519	620	620	750	750	750	880	880	850	850	720	640	900
1,000	377	455	543	543	650	650	790	790	790	930	930	900	900	750	670	1,000
1,250	409	493	589	589	700	700	850	850	850	1,000	1,000	970	970	800	720	1,250
1,500	434	522	625	625	750	750	900	900	900	1,050	1,050	1,020	1,020	850	770	1,500
1,750	451	544	650	650	770	770	930	930	930	1,080	1,080	1,050	1,050	890	810	1,750
2,000	463	558	666	666	790	790	950	950	950	1,100	1,100	1,070	1,070	910	830	2,000

Courtesy of National Board of Fire Underwriters

TABLE 2—Single Conductor in Free Air

Size AWG or MCM	Rubber Type R	Rubber Type RP	Rubber Type RH	Synthetic Type SNA	Asbestos Type AV	Impreg- nated Asbestos Type AI	Asbestos Type A	Synthetic Type SNA	Rubber Type RH	Rubber Type RP	Rubber Type RH	Synthetic Type SNA	Asbestos Type AV	Impreg- nated Asbestos Type AI	Asbestos Type A	Slow- burning Type SB
14	15	18	22	22	26	28	32	32	32	32	32	30	29	24	20	23
12	20	23	27	27	36	36	42	42	42	42	42	40	37	34	30	43
10	25	31	37	37	47	47	54	54	54	54	54	54	50	42	38	52
8	35	41	49	49	60	60	71	71	71	71	71	71	69	58	48	69
6	45	54	65	65	80	80	95	95	95	95	95	99	94	78	66	80
5	52	63	75	75	94	94	110	110	110	110	110	115	110	92	80	91
4	60	72	86	86	107	107	122	122	122	122	122	133	125	105	87	100
3	69	83	99	99	121	121	145	145	145	145	145	155	146	122	101	110
2	80	96	115	115	137	137	163	163	163	163	163	179	170	142	118	125
1	91	110	131	131	161	161	188	188	188	188	188	200	196	164	136	150
0	105	127	151	151	190	190	223	223	223	223	223	245	230	193	160	200
0	120	145	173	173	217	217	250	250	250	250	250	275	267	223	185	225
0000	138	166	199	199	243	243	284	284	284	284	284	310	310	259	215	275
0000	160	193	230	230	275	275	330	330	330	330	330	355	355	298	248	325
250	177	213	255	255	315	315	372	372	372	372	372	405	405	338	280	372
300	198	238	285	285	347	347	415	415	415	415	415	450	450	373	310	425
350	216	260	311	311	375	375	445	445	445	445	445	490	490	405	350	500
400	233	281	336	336	405	405	480	480	480	480	480	530	530	435	380	600
500	265	319	382	382	460	460	550	550	550	550	550	610	610	490	430	750
600	293	353	422	422	505	505	600	600	600	600	600	670	670	550	480	900
700	320	385	461	461	550	550	650	650	650	650	650	730	730	610	525	1,050
750	330	398	475	475	570	570	680	680	680	680	680	770	770	650	565	1,200
800	340	410	490	490	590	590	710	710	710	710	710	800	800	680	600	1,500
900	360	434	519	519	620	620	750	750	750	750	750	850	850	720	640	2,000
1,000	377	455	543	543	650	650	790	790	790	790	790	900	900	750	670	2,500
1,250	409	493	589	589	700	700	850	850	850	850	850	970	970	800	720	3,000
1,500	434	522	625	625	750	750	900	900	900	900	900	1,020	1,020	850	770	4,000
1,750	451	544	650	650	770	770	930	930	930	930	930	1,050	1,050	890	810	5,000
2,000	463	558	666	666	790	790	950	950	950	950	950	1,070	1,070	910	830	6,000

NATIONAL ELECTRICAL CODE STANDARDS

CARRYING CAPACITY OF WIRES

The carrying capacity of wires used in electric wiring work depends upon the ability of the insulation, wire and covering on the wire to radiate the heat (which is produced by the current flowing through the wire) without injuring the insulation on the wire. The ability to radiate heat depends upon (1) circulation of air around the wires; (2) the number of wires inside the conductor covering; and (3) the temperature of the room. The higher the room temperature, the less the heat that can be radiated by the insulation before the temperature of the insulation exceeds the safe maximum.

Conduit Wiring. The maximum allowable current-carrying capacity for the different sizes of conductors or wires, expressed in amperes and based upon a room temperature of 86°F., is given in Table 1. This table assumes that there are not more than three conductors inside the raceway or covering of the cable. When 4 to 6 conductors are run in a raceway or cable, the allowable current-carrying capacity of each conductor shall be reduced to 80% of the values in Table 1. If 7 to 9 conductors are run in a raceway or cable, the allowable current-carrying capacity of each conductor shall be reduced to 70% of the values in Table 1.

Knob and Tube Wiring. Table 2 gives the allowable current-carrying capacity of conductors when installed as single conductors in free air. This type of construction is used with open conductors on insulators, concealed knob and tube wiring, switchboards and controller wiring, and work of similar type.

TYPES OF INSULATION

Table 3 gives facts regarding the different types of insulation, the Underwriters' type letter designation for each particular type of wire, and also the general trade name by which it is known. The type letter is an abbreviation of the material used in the insulation. Thus *R* is used for *rubber insulation*. This is the type of rubber-covered wire that has been used in the past for interior wiring and is now known as *Code-Grade type R* because it meets the National Board of Fire Underwriters' Code requirements for wiring. Type *R* wire is the lowest priced wire, and the one most commonly used in

**TABLE 3. Conductor Insulations
For Wiring Circuits under 600 Volts**

Trade Name	Type Letter	Maximum Operating Temperature	Insulation	Outer Covering	Use
Code	R	50C (122F)	Code Grade Rubber	Moisture-Resistant Flame-Retardant Fibrous Covering	General Use
Moisture Resistant	RW	50C (122F)	Moisture Resistant Rubber	Moisture-Resistant Flame-Retardant Fibrous Covering	General Use or in Wet Locations
Performance	RP	60C (140F)	Performance Grade Rubber	Moisture-Resistant Flame-Retardant Fibrous Covering	General Use
Heat-Resistant	RH	75C (167F)	Heat-Resistant Grade Rubber	Moisture-Resistant Flame-Retardant Fibrous Covering	General Use
Small Diameter Building Wire (Heat-Resistant)	RHT	75C (167F)	Heat-Resistant Grade Rubber	Moisture-Resistant Flame-Retardant Fibrous Covering	General Use
Small Diameter Building Wire (Performance)	RPT	60C (140F)	Performance Grade Rubber	Moisture-Resistant Flame-Retardant Fibrous Covering	Rewiring Existing Raceways
Type RU Wire (See Note)	RU	60C (140F)	90 Per Cent Unmilled Grainless Rubber	Moisture-Resistant Flame-Retardant Fibrous Covering	Rewiring Existing Raceways
Solid Synthetic (See Note)	SN	60C (140F)	Solid Flame-Retardant Moisture-Resistant Synthetic Compound	None	Rewiring Existing Raceways
Asbestos Synthetic	SNA	90C (194F)	Synthetic and Felted Asbestos	Cotton Braid Thickness, 20 Mils	Switchboard Wiring
Asbestos Varnished Cambric	AVA	110C (230F)	Impregnated Asbestos and Varnished Cambric	Asbestos Braid 45 Mils	General Use Dry Locations
Asbestos Varnished Cambric	AVB	90C (194F)	Same as Type AVA	Flame-Retardant Cotton Braid 14-250. 20 Mils 300-1000. 26 Mils	General Use Dry Locations
Asbestos Varnished Cambric	AVL	110C (230F)	Same as Type AVA	Lead Sheath 14-3. 3/64 in. 2-4/0. 4/64 in. 250-500. 5/64 in. 550-1000. 6/64 in.	General Use Wet Locations
Slow Burning	SB	90C (194F)	3 Braids Impregnated Fire-Retardant Thread	Outer Cover Finished Smooth and Hard	For Use Only in Dry Locations Where the Room Temperature Exceeds 85C (185F)
Slow Burning Weatherproof	SBW	90C (194F)	2 Layers Impregnated Cotton Thread	Outer Fire-Retardant Coating	

Rubber-covered conductors of the lead-sheathed or multiple-conductor type do not require a flame-retardant, moisture-resistant outer covering over the individual conductors, but all such conductors shall have a fibrous covering.

Finished conductors of Type RPT and Type RU shall be equivalent mechanically and electrically to Type R conductor.

Synthetic insulation may stiffen at temperatures below freezing and care should be used in its installation at these temperatures.

Courtesy of National Board of Fire Underwriters

wiring work. Where the maximum operating temperature may exceed 122°F., it is necessary to use a higher quality of rubber insulation, which is known as the Performance Grade, type *RP* wire. If the temperature exceeds 140°, then the heat-resistance type wire, *RH*, must be used. The three types, *R*, *RP*, and *RH* are the only types permitted for concealed knob and tube wiring.

Type *RW* which is known as the moisture-resistant rubber insulation is intended for general use, especially in "wet locations." A wet location is one subject to saturation with water or with other liquids; for example, locations exposed to the weather, wash rooms in garages, etc. Installations underground, or in concrete slabs or masonry in direct contact with the earth, shall be considered as wet locations. This wire is used where condensation and accumulation of moisture within the raceway is likely to occur.

The type *RHT* is an insulated wire of small diameter covered with heat-resistant rubber. It can generally be used where the types *R*, *RP*, and *RH* insulations are satisfactory. Its special use is in conduit wiring work when it is necessary to get a greater number of wires inside the given size of conduit than would be possible with other regular types of wire.

The type *RPT* is a small diameter rubber-insulated wire with the Performance Grade of insulation which can be used to rewire existing raceways when it is necessary to increase the current-carrying capacity of the circuits in a building. This is used when it is not desirable to install additional conduit.

The type *SN* wire does not have any rubber insulation; instead, a solid synthetic material is used. It is used for rewiring existing raceways, usually in sizes 14, 12 and 10.

The varnished cambric insulation is denoted by the letter *V* and is generally intended for dry locations. There is no rubber used in insulating the conductors; the insulation is composed of layers of a closely woven cloth called cambric, to which an insulating varnish has been applied. These layers of cambric are usually wound in opposite directions spirally around the conductors. When the cable is covered with a lead sheath, as is the type *AVL*, it can be used in wet locations.

Wire covered with insulation of the slow-burning type, *SB*, and the slow-burning weatherproof, *SBW*, can only be used in dry

**TABLE 4. Number of Conductors in Conduit or Tubing
One to Nine Conductors Rubber-Covered—Types R, RW, RP, RH, and †RHT—600 V.**

Size of Conductor	Number of Conductors in the Given Sizes of Conduit or Tubing								
	1	2	3	4	5	6	7	8	9
No. 18	1/8	1/8	1/8	1/8	1/8	1/8	1/8	1/8	3/8
16	1/8	1/8	1/8	1/8	1/8	1/8	3/8	3/8	3/8
14	1/8	1/8	1/8	1/8	3/8	3/8	3/8	1	1
12	1/8	1/8	1/8	3/8	3/8	1	1	1	1 1/8
10	1/8	3/8	3/8	3/8	1	1 1/8	1 1/8	1 1/8	1 1/8
8	1/8	3/8	*1	1	1 1/8	1 1/8	1 1/8	1 1/8	1 1/8
6	1/8	1	*1 1/8	1 1/8	1 1/8	2	2	2	2
5	3/8	1 1/8	1 1/8	1 1/8	1 1/8	2	2	2	2
4	3/8	1 1/8	*1 1/8	1 1/8	2	2	2	2	2 1/8
3	3/8	1 1/8	1 1/8	1 1/8	2	2	2	2 1/8	2 1/8
2	3/8	1 1/8	*1 1/8	1 1/8	2	2	2 1/8	2 1/8	2 1/8
1	3/8	1 1/8	1 1/8	2	2	2 1/8	2 1/8	3	3
0	1	1 1/8	2	2	2 1/8	2 1/8	3	3	3
00	1	2	2	2 1/8	2 1/8	3	3	3	3 1/8
000	1	2	2	2 1/8	3	3	3	3 1/8	3 1/8
0000	1 1/8	2	2 1/8	2 1/8	3	3	3 1/8	3 1/8	4
250000	1 1/8	2 1/8	2 1/8	3	3	3 1/8	3 1/8		
300000	1 1/8	2 1/8	3	3	3 1/8	3 1/8			
350000	1 1/8	2 1/8	3	3 1/8	3 1/8	4			
400000	1 1/8	3	3	3 1/8	4	4			
450000	1 1/8	3	3	3 1/8	4	4 1/8			
500000	1 1/8	3	3	3 1/8	4	4 1/8			
550000	1 1/8	3	3 1/8	4	4 1/8	5			
600000	2	3	3 1/8	4	4 1/8	5			
650000	2	3 1/8	3 1/8	4					
700000	2	3 1/8	3 1/8	4 1/8					
750000	2	3 1/8	3 1/8	4 1/8					
800000	2	3 1/8	4	4 1/8					
850000	2	3 1/8	4	4 1/8					
900000	2	3 1/8	4	4 1/8					
950000	2	4	4	5					
1000000	2	4	4	5					
1250000	2 1/8	4 1/8	4 1/8	6					
1500000	2 1/8	4 1/8	5	6					
1750000	3	5	5	6					
2000000	3	5	6						

*Where a run of conduit or electrical metallic tubing does not exceed 50 feet in length and does not contain more than the equivalent of two quarter-bends from end to end: three No. 6 stranded conductors may be installed in a 1-inch conduit or tubing. For services only, three No. 8 insulated conductors may be installed in a 3/4-inch conduit or tubing; two No. 6 insulated and one No. 6 bare conductors, or two No. 4 insulated and one No. 4 bare conductors may be installed in 1-inch conduit or tubing; and two No. 2 insulated and one No. 2 bare conductors in 1 1/4-inch conduit or tubing.

†Table 4 shall be used for the installation of Type RHT, small diameter building wire, except for rewiring in existing raceways. *Courtesy of National Board of Fire Underwriters*

locations and within certain limits of room temperature. They are not used to a large extent in interior electric wiring work.

MAXIMUM WIRES IN CONDUIT

Table 4 gives sizes of rigid conduit and thin wall tubing and maximum number of rubber-covered wires that can be installed. It applies to a complete conduit system. When the distance does not exceed 50 feet, and for services, the number of wires may be increased as explained in the footnote. This table does not apply to short sections of conduit used for the protection of exposed wiring from mechanical injury.

CABLE WIRING

PROTECTED CONDUCTORS

There now are available for the interior wiring of buildings several types of multiple-conductor assemblies, which are an improvement upon the knob-and-tube method. These consist, in general, of two or more rubber-insulated wires encased within a protective covering or sheath. They fall into two broad classes as follows: (1)



Fig. 1. Durax Non-Metallic Sheathed Cable

The copper conductors (at right end) are covered with rubber insulation (black) then braided threads and a tough spiral paper cover. The space between the two conductors is filled with a jute filler and rip cord before a heavy paper and outer braid covering (extreme left) is applied.

Courtesy of Anaconda Wire & Cable Company, New York City

those whose outer covering consists of a cotton braid or similar material, called Non-Metallic Sheathed Cable, and (2) those having a flexible metallic covering (usually steel) called Armored Conductors or Armored Cable.



Fig. 2. Three-Conductor and Two-Conductor Covered Neutral Cable, Type CNX

Courtesy of General Cable Corporation, New York

Non-Metallic Sheathed Cable. This cable is made up with two or three insulated conductors, either with or without an additional bare conductor for grounding purposes.

Fig. 1 shows the construction of "Durax," one of the brands of non-metallic sheathed cable now on the market. There are various makes, such as BraidX, TrieX, RomeX, etc. RomeX was the first on the market and to this day many in the trade refer to any make of this kind of material as RomeX, which, of course, is incorrect.

Fig. 2 shows the construction of CNX cable, a make which is also known as Trial Installation Cable. The field of application of this cable, however, is quite limited by the restrictions placed upon its use by the Code-enforcing agencies.

Armored Cable. This cable was first introduced under the trade name of BX, and very often it is still referred to by this name, regardless of whose make it may be. Fig. 3 shows the construction of armored cable, referred to as type AC in the National Electric Code. It can be had with either one, two, three or four conductors.



Fig. 3. Type AC Armored Cable

Courtesy of Anaconda Wire & Cable Company, New York City

The single conductor is used mostly for the running of grounding wires.

Fig. 4 shows the construction of type ACL armored cable. The lead sheath just under the steel armor or outer covering is to make the cable suitable for use in wet locations.



Fig. 4. Lead Covered Armored Cable—Type ACL

Courtesy of Anaconda Wire & Cable Company, New York City

The correct way to designate the wire size and number of conductors in either type AC or type ACL armored cable is as follows: Cable having two No. 14 wires is called fourteen-two, written 14/2; one with four No. 12 wires is called twelve-four, written 12/4; one with three No. 10 wires is called ten-three, written 10/3, and so on throughout the range of sizes and combinations. The gauge number of the wires is given first, followed by the number of conductors. It is advisable to specify whether the type AC or the type ACL is meant, even though in the trade, in the absence of type letter designation the type AC is understood to be meant. If you have the leaded type in mind, specify it as follows: 14/3, type ACL; 14/3, leaded or ACL, 14/3. Neither one of these types as indicated gives room for guesswork.

Service Entrance Cables. These cables are primarily intended

for bringing the Power Company's lines into a building from the point of attachment of the service drop. Under certain conditions they may be used for interior wiring also. They fall into two general types as follows: (1) those equipped with a metallic tape between the conductors and the outer braid or sheath, and (2) those without such metal armor.

Fig. 5 shows the construction of armored service entrance cable, Underwriters' type SE, style A. The armor is in contact with the bare



Fig. 5. Armored Service Entrance Cable, Type SE, Style A

The two copper wires (extreme right) are covered with rubber insulation (black) and then a braid of cotton or kraft paper (one black and one lighter). The bare stranded neutral wires are covered with a spirally wound galvanized steel tape. Two wrappings of a rubberized tape and a heavy outer cotton braid impregnated with a moisture resisting, flame retarding compound protects the wires.

Courtesy of the M. B. Austin Company, Chicago, Illinois

neutral conductor, the two being usually bonded together. This cable is favored by many Power Companies because the armor renders it current-theft-proof. There is also available a cable with interlocking metal armor; in this type the neutral conductor is not in contact with the armor.



Fig. 6. Unarmored Service Entrance Cable, Type SE, Style U

Courtesy of the M. B. Austin Company, Chicago, Illinois

Fig. 6 shows the construction of unarmored service entrance cable, Underwriters' type SE, style U, which can be had with either one or two insulated conductors and a bare neutral.

Either the style A or the style U can be had with the neutral conductor insulated, instead of bare, but they are not regularly carried in stock in this style of construction.

Service Drop Cable. This type of cable is intended for the connection between the pole line and service-head, but it may be extended to the meter inside the building, provided the run is encased in conduit and the voltage of the service does not exceed 150 volts to

ground. Its construction is similar to the cable shown in Fig. 6 and it is known as Underwriters' type SD.

WHEN AND WHERE TO USE CABLES

The National Electric Code gives detailed, specific rules and information as to just where, under what conditions, and how each of the foregoing types of cables may be installed, which you must study and learn. Your familiarity with and knowledge of them will be a major factor in the progress that you make in this line of work.

The Code is altered, amended, and modified (1) to meet conditions imposed by new construction methods and materials, (2) because of the ever widening field of application of electric current to new processes, (3) as short-comings in materials and installation methods due to these changes become manifest, and (4) as improvement in the design and construction of wiring materials, together with the use of more suitable substances in their composition, increases their usefulness and factor of safety, thus widening their scope of application and use.

Two other factors relative to the Code which demand attention are (1) the local or individual interpretation of the intent and meaning of the Code rules, and (2) the fact that some cities and states have regulations that materially differ from and sometimes go considerably beyond Code requirements, generally due to the existence of special conditions in the particular locality. Neither of these two factors apply with equal weight nor to the same extent in any two jurisdictions. Therefore it is necessary to confer with the local enforcing or inspection authority relative to their specific deviations from the Code before doing any work in a strange locality.

Non-Metallic Sheathed Cable, Fig. 1, can be used for either concealed or exposed work, for service not exceeding 600 volts, in buildings whose interiors are always dry, and where the cable is not subject to moisture nor to mechanical injury. It cannot be embedded in plaster, masonry, concrete, nor in any type of cinder or concrete fill; neither can it be run underground.

It cannot be used in garages large enough to accommodate more than two motor vehicles; in the hatches of dumb-waiters, elevators or hoists; in storage battery and electro-plating rooms; in theatres; in moving-picture studios; in breweries, cold-storage houses and ice

plants; nor in similar locations subject to dampness, fumes or vapors which are harmful to rubber insulation (chicken-houses, dairy-barns and similar structures not being considered as falling into this class); nor in "hazardous locations" as defined in the Code.

Wet Locations, such as breweries, cold-storage houses, ice plants and similar locations where the fumes and vapors are only mildly corrosive, and the service does not exceed 300 volts between conductors, nor more than 150 volts to ground, some local enforcing agencies permit the use of a type of non-metallic sheathed cable having an outer covering of rubber, instead of braid or fabric. However, the circuit conductors of such cable must be of No. 12 gauge, or larger, except that, in some of these localities, the conductor used for the grounding of equipment may be of a smaller size.

Trial Installation Cable, Fig. 2, is limited to use where the service voltage from any conductor to ground does not exceed 150 volts; but in each case specific approval of the local inspection agency must be obtained for the particular installation before starting the work.

Surface Extensions from existing outlets to additional receptacle outlets within the same room may be installed with non-metallic sheathed cable, Fig. 1, in office or residential occupancies, under the specific conditions set forth in the Code.

Armored Cable, type AC, can be used under the same conditions and limitations as given for non-metallic sheathed cable, except that it may be used for the final connections (not to exceed 24 inches in length) to motors or other equipment on cranes or hoists where flexible connection is necessary; also, it may be embedded in the plaster finish of brick, tile or other masonry walls or ceilings that are not excessively damp.

Armored Cable, type ACL, is intended for use where the run is exposed to oil, grease, gasoline or other substance that is harmful to the rubber insulation; where the run is underground; where it is embedded in fill or masonry; and where it is exposed to the weather. However, this does not make as good a job as would the use of conduit, to say nothing about the added advantage of being able to withdraw defective wires from the conduit in case of necessity, which cannot be done where the armored cable is buried directly in the structure.

Underplaster Extensions from existing branch circuits in build-

ings of fire-resistive construction may be made with armored cable, type AC, secured directly to tile, masonry or similar walls or ceilings and embedded in the plaster finish, subject to the specific conditions laid down in the Code for such work. For this purpose it is best to use a type of armored cable which is flat, instead of round in outline, the conductors being laid parallel, that is, side by side, under the metal armor; this type can be buried under less plaster thickness than the round type. This flat type is known in the trade as Ovalflex and is shown in Fig. 7.



Fig. 7. Ovalflex Armored Cable

A special oval shaped fiber "anti-short" bushing is inserted between the armor and rubber covered wires.

Courtesy of National Electric Products Corporation, Pittsburgh, Pa.

Service Entrance Cable, as its name implies, is used primarily for extending the Power Company's service drop into the service switch and fuse cabinet. However, it is sometimes used for interior wiring also, and when so used it comes under the same rules for its installation as govern the use of non-metallic sheathed cable or armored cable, respectively, depending on whether the particular cable used has a non-metallic or a metallic sheath.

The extent to which service entrance cable can be used for interior wiring depends upon whether the neutral conductor is bare, or individually insulated; cables having the insulated type of neutral conductors may be used throughout a building. But cables with bare neutral conductors may be used only for range circuits, as feeders from a master service equipment to feed other buildings, or as service conductors to other buildings, only under the following conditions:

That the cable has a final non-metallic outer covering.

That the supply is alternating current and not exceeding 150 volts to ground.

That there is at least one ground at the transformer or elsewhere in addition to the ground at the service equipment.

When service entrance cable having a metallic armor or sheath is used for interior wiring, the metal sheath of each run must be effectively grounded.

OUTLET AND JUNCTION BOXES

At each point where there is to be an outlet for a lighting fixture, motor, receptacle, switch, or any other type of current-consuming

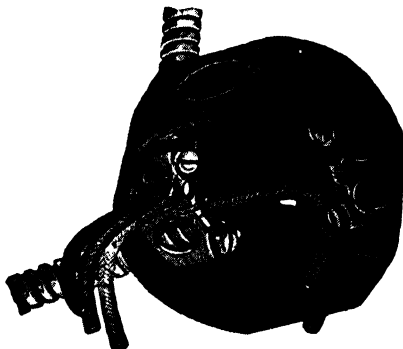

Fig. 8. Octagon Box with Armored Cable Clamps

Courtesy of National Electric Products Corporation, Pittsburgh, Pa.

or current-controlling device, all of the wires to be brought to this location must enter an outlet box installed for this purpose. Fig.

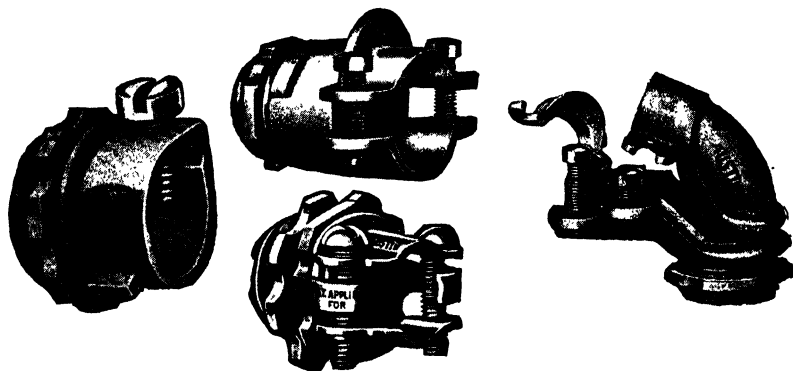

Fig. 9. Outlet Box Connectors

The screw type (left) can only be used on armored cable. The clamp type can be used on all types of cable. The 90° connector (right) is used when there is not enough space for cable to go straight out from the box opening.

Courtesy of the M. B. Austin Company, Chicago, Illinois

8 shows a 4-inch octagon box, 1½ inches deep, with one 2-wire armored cable entering the side and one 3-wire entering the bottom or back of the box, both being secured by a set-screw type of cable clamp. Non-metallic sheathed cable enters the box and is secured

thereto in the same manner. An alternative method of securing the cable to the box is by the use of outlet box connectors, Fig. 9.

Fastening the Box. The box can be mounted directly on the ceiling or wall by screws passing through holes in the bottom of the box into the ceiling, or wall structure, for exposed work. For concealed work it is necessary to use a support of some kind to secure the box to either the joists or studding. Fig. 10 shows two standard cleat hangers, or offset hangers, made for this purpose. The box is secured to the upper hanger by means of two stove bolts; the entire assembly is then secured to the joists or studdings by nails passing through holes in the ends of the hanger and driven into the joists or studdings. This hanger also can be used with a square box. At an

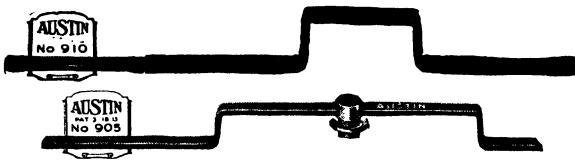

Fig. 10. Universal Box Cleat (Top) and Offset Bar Hanger with Fixture Stud

Courtesy of the M. B. Austin Company, Chicago, Illinois

outlet where a fixture stud is wanted, use the lower hanger shown in Fig. 10, which has a fixture stud. After the locknut is removed from the stud, the stud is inserted through the knockout hole in the bottom of the box, and then the locknut is screwed back onto the stud and set up tight; this assembly is then nailed to the joists or studding, depending on whether it is intended for a ceiling or for a wall outlet. Adjustment for the position of the box can be had by slacking off on the locknut and sliding the box over to the exact position wanted, after which the locknut is set up again.

Choosing Location of Box. At each point where a splice in or a tap to the cable is to be made, the wires or cables affected must all enter a junction box, installed for this purpose. Any regular outlet box can be used if it is large enough to accommodate all of the wires and still have room to make the splices. Frequently, these boxes are used for this double purpose. However, where this would require an unduly long run of cable, it may be cheaper to install a separate junction box. Install this box in the same manner as a regular outlet box and run the cable ends into it. Be sure to "pole"

the wires correctly, that is, couple them up in proper relation to each other. Then connect, solder and tape them. Push the wires and joints well into the box and close the latter by putting on a solid cover, that is, one without any openings in it. Use machine screws which pass through holes in the cover and into tapped holes provided in the box or the box-ears for this purpose. The cover usually is of the same material as the box.

It is advisable to leave as much slack in the wires in the junction box as can be readily disposed of, so that there is enough of the free end left to work with should it become necessary later to cut the connections for testing or for some other purpose. About 4 or 5 inches, exclusive of the connection, is as much as there is room for in a 4-inch box, 1½ inches deep, with two or three sets of

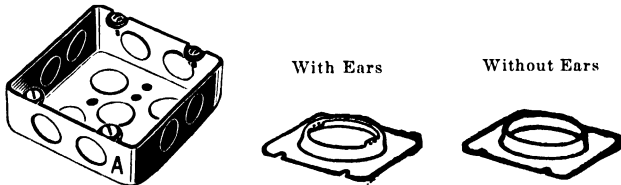

Fig. 11. Square Outlet Box and Plaster Ring Covers, with and without Ears
Courtesy of the M. B. Austin Company, Chicago, Illinois

No. 14 or No. 12 wires coming into it. No box smaller than this size should be used, if it can be avoided.

A junction box should be located convenient to the worker. It always should be readily accessible and, after the building has been completed the cover must be easily removable without disturbing plaster, wall-paper, or other type of building finish.

Determining Right Size of Box. For No. 10 or No. 8 wires, use a 5-inch square box (the actual size inside is only 4¾ inches) and 2 inches deep is preferred, if there are more than two pairs of wires to be connected. If there are more wires, or if their size is larger, use a 6-inch or even an 8-inch box. There is too much time lost connecting and disposing of a relatively large number of wires, or even a smaller number of wires whose size makes them stiff, in proportion to the difference in price between the smaller and larger boxes.

When it is necessary to bring, say, more than four cables together at one outlet, it is good practice to use a 4-inch, or even a 5-inch, square box, Fig. 11, even though the outlet may be intended for

a fixture location, to provide room for connecting the wires and for placing them in the box. In such a case a plaster cover or plaster ring, Fig. 11, placed on the box, will reduce the size of the opening in the plaster to $3\frac{1}{4}$ inches, thus requiring no over-size fixture canopy. The connecting, soldering, taping, and disposal of the wires within the box is usually done before the plaster ring is put on. This makes the original job easier but is rather tough on the troubleshooter later on, if he has to open up the connections, because of the difficulty in getting at the wires through this small opening. Therefore, lay out your job in such a way that not more than four, preferably only three, cables enter any one box; also use box connectors for securing the cables to the box, rather than cable clamps, because the latter take up more room in the box than the former.

Selecting Proper Kind of Boxes. Outlet boxes are of two general types, (1) those made of metal, and (2) those made of an insulating substance, such as porcelain, bakelite or other compounds. The metal boxes can be used almost anywhere, but the latter only in knob-and-tube wiring and with non-metallic sheathed cables, only in locations where they are not subject to mechanical injury. This means, not nearer than 5 feet of the floor. Non-metallic boxes are brittle, hence subject to breakage to a greater or lesser degree, depending on the substance from which they are made.

Non-metallic boxes are safe enough for use in concealed work because, once they have survived the onslaughts of the plasterer's trowel or straight-edge, no further accident is likely to befall them. The plasterer is the wireman's troublemaker; if one of these boxes projects beyond the plaster finish line, the plasterer breaks it with gusto; and if the projecting box is of metal, he takes a fiendish delight in pushing it back below the finish line and plastering over it. Therefore set your boxes correctly and support them firmly.

There is one point in connection with the use of non-metallic boxes that deserves attention. Fixtures that require the use of a fixture stud for their attachment to the box are practically out, (1) because of the difficulty of mounting a fixture stud in them, and (2) the frequent breakage of boxes that would occur, when so equipped, by the stresses imposed on them in screwing the fixture up tight on the stud.

In exposed wiring the outlet boxes always are subject to me-

chanical injury, more or less, depending on their location. Consequently, non-metallic boxes are permitted on exposed work only in locations such as dairy barns, chicken houses, and buildings of similar use. In these locations there is usually dampness, with fumes and vapors arising from animal excrement. Even though this is considered as only mildly corrosive for Code-interpretation purposes, it is nevertheless strong enough in many cases to attack the ordinary stamped steel outlet box. A variety of porcelain devices for such use is shown in Fig. 12. The base fitting will take any of the devices shown; it contains the binding screws for connecting the in-coming

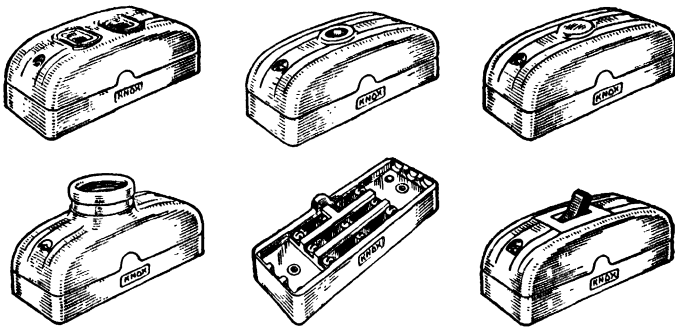

Fig. 12. A Porcelain Surface Mounted Duplex Receptacle, Pendent Outlet (Top Row Center), Junction Box, Keyless Receptacle (Lower Left), Interchangeable Base and Toggle Switch

Courtesy of Knox Porcelain Corporation, Knoxville, Tenn.

and out-going wires and has thin, easily removable end-walls closing the wire entrances.

The covers used with non-metallic outlet boxes should be made of an insulating material, and the screws holding them to the box should enter the latter in such a manner that there is no chance of a current-carrying device within the box coming in contact with them.

EQUIPMENT GROUND

Metal outlet boxes, cable armor, as well as the metal frames or enclosures of any current-consuming or current-carrying device, must be grounded in order to eliminate fire hazards and to avert shock, injury, and possibly death, to persons who, while in electrical contact with the ground, also make contact with a metal enclosure which may have become **live** through the failure of the insulation on some

current-carrying member within it. This is called the equipment ground, and is entirely separate from the system ground, discussed elsewhere.

It is good practice to use galvanized outlet boxes, rather than those which are black-enameled, because the former provide a much better contact surface for the connection between the box and the box connectors.

How to Ground Armored Cable. When armored cable is used, the boxes and cable armor are electrically connected together through the box connectors or cable clamps used for securing the one to the other and to the fuse cabinet from which the circuit feeds. At this fuse cabinet, or at the main cabinet, if there is one, an adjustable



Fig. 13. An Adjustable Ground Strap

Courtesy of the M. B. Austin Company, Chicago, Illinois

ground strap, Fig. 13, is attached to each cable entering the cabinet, also to any conduit that may be entering it. The flat strap is passed around the metal armor, the nut is removed from the bolt and the latter inserted through the nearest inside hole that will meet the bolt, then the nut is put on and screwed up tight. The short U-shaped end usually is tinned on the inside; if it is not tinned, it should be done before putting the clamp on the cable. To do so clean it well, heat a soldering iron and flow the solder over the entire inner surface of the cup, using the regular soldering paste as a flux; or, heat it in the flame of a blowtorch and apply the wire solder directly to the cup. The ground clamps are then all connected together by a copper wire, which must be of a size in keeping with the ampere capacity of the service fuse. The wire may be bare and sweated into the cups. It is then connected to a grounding conductor, which, in turn, is extended to and connected to a permanent ground connection.

A solderless type of ground clamp, Fig. 14 (Left), is somewhat handier to install than the strap type. Fig. 14 (Right) shows a type of ground clamp for connecting the grounding conductor to the ground

rod or to a water pipe; the two slotted holes permit separating the two parts of the clamping ring after the two side screws have been slacked off; the two members are then put in place on the pipe or ground rod and the screws set up tight; the grounding conductor is secured to the

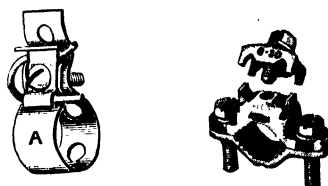

Fig. 14. Two Solderless Types of Ground Clamps
Courtesy of the M. B. Austin Company, Chicago, Illinois

clamping member by means of the grooved cap and binding screw.

Driving the Ground Pipe. In the absence of a water pipe connected with an underground water supply system or with a deep well on the premises, you must provide an artificial ground, either by means of a suitable ground plate buried in permanently moist earth, or by driving a $\frac{3}{4}$ -inch, galvanized pipe or conduit (or regulation



Fig. 15. Point and Cap
 for Driven Ground Pipe
*Courtesy of the M. B. Austin
 Company, Chicago, Illinois*

ground rod) not less than 8 feet into the ground, which is done with a heavy hammer or sledge. Fig. 15 shows a point for the lower end of a pipe to be used as an artificial ground, and a protecting cap for the upper end, to facilitate the driving. The galvanized pipe used for this purpose should not have any lacquer or other coating on the outside, because such a coating would tend to reduce the quality of the ground contact.

Securing Low Resistance. Further, to be effective as an equipment ground the metal armor must be of low resistance, not exceeding one ohm per 100 feet for No. 14-2 cable. Some manufacturers

make their armored cable with an interlock tight enough to meet this requirement. Others make it with the interlock comparatively loose, thereby claiming greater flexibility of the cable.

In order to bring the resistance of the armor of the loose interlock type of construction down to within the prescribed limits, there is built into the assembly of these cables a round or flat, galvanized copper bond wire, running the entire length of the cable just beneath the armor, Fig. 16. The red fiber anti-short bushing should be slipped on inside of this bond wire.

Opinions differ as to whether this bond wire should extend into the box, as shown in Fig. 17, or whether it should be folded back over the outside of the armor before the box connector is slipped on and

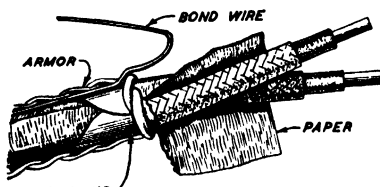

Fig. 16. Armored Cable Bond Wire

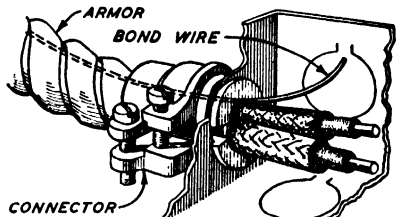

Fig. 17. Method of Attaching Cable, Bond Wire and Connector to Outlet Box

clamped to the armor. We favor the latter method because, (1) there is a positive connection between the armor and the bond wire, by means of the box connector, and (2) there is then no chance of using the bond wire as a bare neutral or as a grounding conductor for a *system ground*. It must be remembered that this wire is only a bond wire for the cable armor and should never be used for any other purpose.

Grounding Non-Metallic Cable. With non-metallic sheathed cable wiring, the meter, switch, fuse, and outlet metal boxes are grounded through a grounding conductor, which can be either bare or insulated, built into the structure of the cable. In each box the grounding conductor of each cable entering such a box must be connected to the latter, either by connecting all of the grounding conductors together and sweating them into the sleeve of one lug, or by sweating a lug onto the end of each of the wires. The lugs are secured to the box by means of a machine screw passing through

the flat portion of the lug and into a tapped hole in the box. When more than one lug is used, each of them must be individually secured to the box, two lugs under one screw not being good practice. At the main cabinet for the circuits, all of the grounding wires are connected to a common grounding conductor and extended to a ground connection.

Grounding Portable Motors. Although non-metallic outlet boxes do not require grounding, there are nevertheless occasions when it is good practice to run a cable with a grounding conductor to the motor; for example, when it is desired to mount upon such a box a device

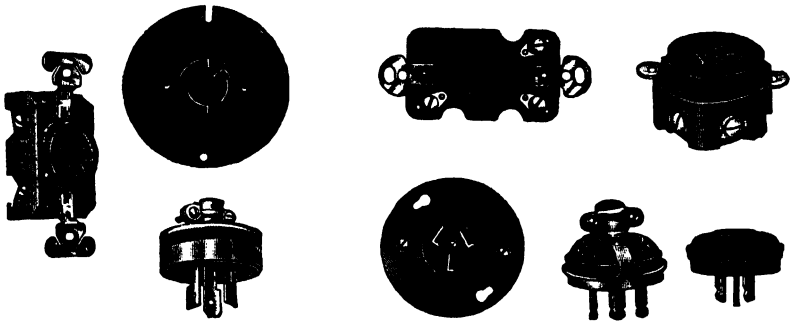

Fig. 18. Two Styles of Three-Wire Receptacles, Plates, and Caps, for End of Cord
Courtesy of Arrow-Hart & Hegeman Electric Co., Hartford, Conn.

having a metal case or frame, in a location accessible to a person standing on a wet floor, or within reach of a water pipe, gas pipe or other metal structural member leading to ground; or for a receptacle intended for the plugging-in of a portable tool in like surroundings. In either case, the metal housing should be grounded in order to avert shock to a person handling it while some part of his body is in electrical contact with the earth, water pipes, or other grounded objects when there is a leakage of current from a **live** part within to the metal housing.

The inspector having jurisdiction may or may not permit the use of the neutral conductor of the circuit for grounding purposes. If he does not, then a grounding conductor would be required, and the receptacle would have to be 3-pole, polarity type, Fig. 18, so the plug can be inserted in only one way. One of the terminals of the receptacle will be whitish in color; connect the neutral wire of the

circuit to this terminal. The other two terminals will be brass; use one of them for the other circuit conductor and the remaining one for the grounding conductor. Use a 3-conductor cord for the tool; one of the conductors should have a white or a gray braid. Connect this wire to the white terminal in the cap or plug and connect the other two wires to the brass terminals. At the tool the neutral and circuit conductors are attached to the tool terminals. Sweat a lug onto the end of the grounding conductor and fasten the lug to the frame or housing of the tool in the same way as it is fastened to an outlet box.

If the use of the neutral circuit conductor for the equipment ground is permitted, a 2-pole polarized receptacle and a 2-conductor cord can be used, but the neutral would have to be connected to the frame or housing of the tool, as well as to the tool terminal.

The grounding conductors of all cables entering non-metallic boxes must be connected together and soldered. They may be left bare, provided that there is no danger of them making contact with any live part within the box. Such a thing could happen where a receptacle with side wiring connections is installed; in such a case the grounding conductor should be well taped.

OUTLET BOX CONNECTORS

Outlet box connectors are used for securing the cables to the outlet boxes, as an alternative to the use of cable clamps within the boxes. They come in many types, shapes, and sizes, several of them being shown in Fig. 9. At one end there is a standard conduit thread for the locknut; some come with hexagon locknuts, requiring pliers or a wrench for tightening them. Others come with locknuts of the drive type; these have notches in the edge, which permit them to be set up with a hammer and screw driver or other blunt tool, an advantage in close quarters. Sizes range from $\frac{1}{2}$ inch conduit on up, increasing by regular conduit sizes, $\frac{3}{4}$ inch, 1 inch, etc., for the larger cables. This means that they will fit the standard conduit knockout openings.

The other end of the connector is slipped over the cable, bond wire (when used), and the fiber bushing, Fig. 19. Turning the set-screw provides the grip on the cable. The clamp type connector, Fig. 9, provides a better hold on the cable and can be used with either

armored or non-metallic cable. The set-screw type can be used with armored cable only, as the end of the set-screw would damage the sheath of non-metallic sheathed cable.

There also is a smaller line of these connectors made for use with armored lamp-cord, in which the nipples, or male ends have either $\frac{1}{8}$ or $\frac{3}{8}$ inch standard conduit thread or pipe thread.

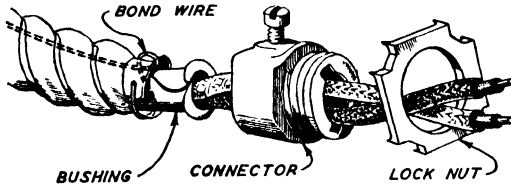

Fig. 19. Method of Inserting Fiber Bushing, and Connector on Armored Cable

INSTALLING THE CABLES AND BOXES

The method of installing the several types of cable in building interiors is identical, except for certain details here and there, largely brought about by the difference in the character of the outer covering. For this reason they are treated in common here. However, the marked differences of application and handling will be pointed out, where either occurs.

Polarity Grouping Under Armor. All of the wires of an alternating-current circuit (two, three, or more) when encased in conduit or armor, must be within the same enclosure. If they were divided, that is, one or two of them installed within one enclosure and the remaining ones within another enclosure, serious heating of the latter would occur. Direct-current circuits do not cause this when split; however, it is advisable to install them in the same manner as for alternating-current use, so that no change in the wiring would have to be made at some later date when the character of the service is changed.

Preparing Cable. When preparing either armored or non-metallic sheathed cable for connections, it is necessary first to take off the outer covering.

The outer sheath of non-metallic sheathed cable can be stripped off with a knife or with a tool made for this purpose, called a cable

stripper. Some of these cables have a ripping-cord under the outer covering; pulling on this cord breaks open the sheath and makes its removal easy. The procedure following this is the same as it is for any rubber-covered wires. Cutting of the smaller sizes, not having a concentric neutral, can be done with pliers. Larger sizes and those with concentric neutral require a hacksaw for ready cutting.

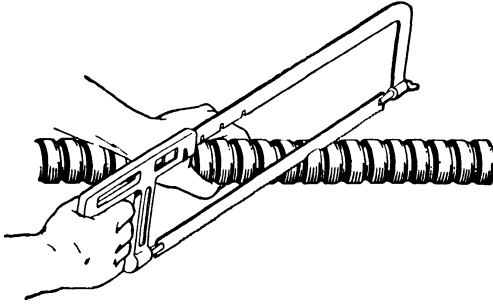

Fig. 20. Cutting Armored Cable

Courtesy of National Electric Products Corporation, Pittsburgh, Pa.

Cutting Cable. Armored cable is cut with a hacksaw, regardless of size. After it is cut, saw through one of the convolutions of the armor, about 6 inches back from the end, Fig. 20, or as much farther

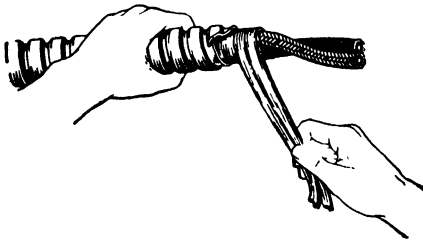

Fig. 21. Removing the Paper Wrapping

Courtesy of National Electric Products Corporation, Pittsburgh, Pa.

back as you need to for the amount of slack that you may want. Grasp the cable with both hands and bend the end (beyond the cut) back and forth a few times and the armor will break off at the cut, permitting it to be easily slipped off. Untwist or unfold the paper wrapping, Fig. 21, back to the armor, and tear it off with a sharp yank. If the cable has a bond wire, cut off all but about 1 inch beyond the armor and bend the end back over the outside of the armor.

Put on the red fiber anti-short bushing, Fig. 22, by compressing it, and sliding it down over the wires and inside of the armor, Fig. 23, and then finish the operation as shown in Fig. 24.

Attaching Connectors. Put on the box connector, sliding it down over the armor until the latter is against the shoulder, or stop inside of the body of the connector; and then tighten up the set-screw, firmly securing the cable and connector together. Next, remove the locknut from the end of the connector, Fig. 19, insert the wires and



Fig. 22. Inserting Anti-Short Bushing
Courtesy of National Electric Products Corporation, Pittsburgh, Pa.

threaded end of connector into the knockout hole in the box until the shoulder on the outside of the connector is against the box. Thread on the locknut and set it up tight in order to make a good ground connection from the cable armor to the box.

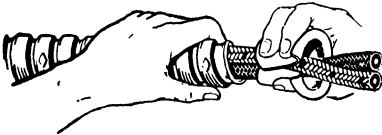

Fig. 23. Compressing Anti-Short Bushing
Courtesy of National Electric Products Corporation, Pittsburgh, Pa.



Fig. 24. Armored Cable Ready for the Connector

When cable clamps are used the armor must extend beyond the clamp. The bond wire, if any, is then bent back over the armor so that the clamp will have bearing on it. The red fiber anti-short bushing should be put on the cable before the latter is inserted under the clamp.

Spotting the Boxes. Determine and mark on ceiling or wall the place where the respective box is to be mounted. You can do your measuring and marking directly on the ceiling or you can do it on the floor; the latter method will save you much climbing of ladders. In order to transfer an outlet location point from floor to ceiling you use a plumb-bob. Set the ladder near the mark on the floor, then

climb up the ladder and hold the line of the plumb-bob against the ceiling, the bob just clearing the floor; move your hand with the line until the point of the bob centers the mark on the floor. The point on the ceiling where the line is held is the center of the outlet; mark it.

Preparing the Boxes. Remove the knockouts from all of the entries that you intend to use, but no more, and install fixture studs, Fig. 25 (Right), in each of the boxes that require them. The fixture stud, Fig. 25 (Left), is used when the back of the box must hug the



Fig. 25. Fixture Studs

Courtesy of the M. B. Austin Company, Chicago, Illinois

surface upon which it is mounted, as is usually the case in exposed wiring. The fixture stud can be installed in the box by means of short machine-screws passing through the holes in its feet and into tapped holes in the back of the box. Where the nature of the surface permits, the same screws that are used to mount the box also can be



Fig. 26. Knockout Closers

Courtesy of the M. B. Austin Company, Chicago, Illinois

used for securing the stud, by passing the screws through both, box and stud, and into the wall or ceiling. For concealed work, the base (or feet of the stud) is usually placed on the outside of the box, the center knockout being removed; the threaded end is inserted through the hole; and then the box and stud are secured together by means of four stove bolts. The stud on the right is mounted in the box in the same way, except that it is secured to the box by means of the lock-nut threaded onto the male member.

Knockouts are removed by striking them sharply with a hammer or with the end of fairly heavy pliers. Usually they come out readily

enough even when you hold the box in the hand while doing this. When they do not, place the box on a firm support while driving them out. Box openings that are not used should be closed by means of circuit or knockout closers, as shown in Fig. 26. One of the types shown snaps into place similar to a glove fastener. The other type is put on by inserting the two prongs through the hole and bending them over.

Mounting the Boxes. Mount the boxes firmly in position with not less than two wood screws; nails should not be used for this purpose. If the surface is tile, the boxes are secured by means of toggle-bolts, but when it is concrete or masonry, expansion shells and machine-screws or Rawl plugs are used.

Uncoiling Armored Cable. Open the coil of cable. Your next step is dependent on whether the cable run is to be long or short. If the run is only about 20 feet or so, pull a few feet more than this from the coil; measure the distance from one of the boxes to the other, between which the run is to be made, and cut the cable 1 foot longer than this, to give you 6 inches of slack in each box. However, when one end of the cable terminates in a cabinet, the amount of slack you must allow at that end depends on the size of the cabinet and the point inside of the cabinet where the terminals are located to which you want to make connections. It is good practice to leave enough slack in the cable to reach the terminals of any circuit within the cabinet.

For a long run do not pull the cable from the coil because of its tendency to kink and become snarled, especially if you are working alone. This kinking makes the cable hard to handle. When pulling only a short length from a coil, this kinking, provided that you are careful, is not likely to become serious, but in a long run it slows up the work very much. In such a case, take the coil to the starting point of the run and stand it on edge; with the outside end pointing out behind you, roll the coil along the floor in the direction that the run is to go until you have enough cable strung out on the floor to reach your destination. Do not cut this cable until you have installed it close enough to its final box to enable you to correctly determine the length that you need. Start putting up the cable from the free end.

Putting Cable in Place. Extend say 6 inches of cable into the

knockout hole of the first box; secure it to the box either by the cable clamp in the box or with a box connector. With a non-metallic sheathed cable, the sheath can be left on until you are ready to make the connections in the box, but with an armored cable the armor must be removed before the cable enters the box. The armor should terminate at the shoulder on the inside of the box connector, Fig. 9, or inside the box just beyond the cable clamp, depending on which type of fastener is being used. It is better practice to use box connectors instead of cable clamps with armored cable; if clamps are used they must seat on the armor, not on the wires.

Securing Cable in Place. Secure the cable to the wired surface with a cable strap, Fig. 27, not more than 1 foot from the box. Extend the cable along the surface to be wired to the next outlet, putting



Fig. 27. Non-Metallic Sheathed Cable Straps

*Courtesy of the M. B. Austin Company,
Chicago, Illinois*

on a strap as often as is necessary to make the cable hug the surface, but in no case not more than $4\frac{1}{2}$ feet apart. The cable should be run in a straight line, paralleling or at a right angle to the building walls, bends to be made with a radius not shorter than five cable diameters; in the case of flat or oval cables, this means the major diameter. When you reach the next box, enter the cable into it as you did in the first box and put on a strap not more than 1 foot from the outlet box.

When an outlet is to be installed in a location that requires extensive preparations to reach it, as, for example, either by a scaffolding or by a heavy ladder, all of the work to be done at that outlet should be completed in one operation; that is, poling, connecting, soldering, taping, installing the fixture or other device, including screwing in a lamp, if one is required.

Non-metallic sheathed cable does not have to be secured to the box if it is secured to the building structure within 6 inches of the box. However, if the cable does not entirely fill the hole through which it enters the box, the opening must be closed with cement. Since a box

connector completely fills the hole of a metal box and also makes a better job, its use is recommended.

Neither box connectors nor cable clamps are used with non-metallic boxes. Nor can armored cable be used with them. The non-metallic sheathed cable may enter the boxes through one entrance, or the individual wires in the cable may each enter a separate hole.

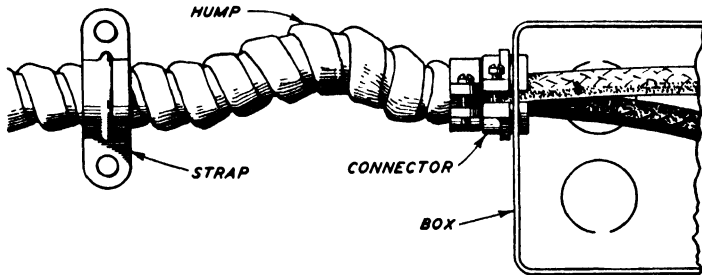

Fig. 28. A Good Workman Does Not Make a Hump in the Cable

When trimming off cable armor, preparatory to mounting a connector on the cable at the end of a run, it must not be overlong, because the excess length will cause an ugly-looking bulge

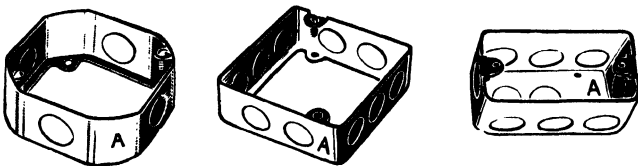

Fig. 29. Extension Rings for Outlet Boxes

Courtesy of the M. B. Austin Company, Chicago, Illinois

hump in the cable between the box and the last support, as shown in Fig. 28. It is better to have it a bit short than too long.

Exposed Extensions to existing concealed wiring require the removal of the fixture or other device in place on the outlet from which the extension is to be made, in order to provide access to the wires and to permit the mounting of an extension ring on this box, Fig. 29, which must be of the same size and shape as the outlet box upon which it is to be mounted. The extension ring is secured to the box by means of machine screws entering tapped holes in the box.

If the box has no tapped holes, they must be made in order to make secure the electrical connection between the box and ring, as otherwise you would not have a good equipment ground.

Entry of the cable into and connection to the extension ring will be by means of a box connector entering through one of the knock-out holes in the extension ring. After the connections of the wires in the box have been made, the device or fixture that has been removed is re-installed. If this is mounted on a fixture stud, it will be necessary to extend the latter so that the fixture stem can reach it; this is done by means of an extension nipple. If the device is a flush switch or receptacle, you will be unable to use the old plate with it, but will have to provide a new cover similar to one of the types shown in Fig. 30, which serves as a box cover and switch or receptacle plate.

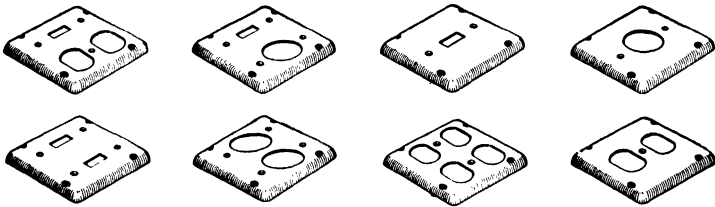

Fig. 30. Covers for Exposed Outlet Boxes
 Courtesy of the M. B. Austin Company, Chicago, Illinois

Extend the cable to the new outlets, which are generally additional receptacles, all within the same room as the outlet from which the extension is made. Connections are made in the box-extension at the feeding outlet and the device that has been removed is re-installed. At the new outlet location use one of the types of covers shown in Fig. 30, which best suits the particular case.

Water-Proof Wiring, (non-metallic) as defined in the Code, is done with non-metallic cable having an all-rubber sheath, circuit conductors to be No. 12 gauge or larger, and run on insulators not over 3 feet apart. Boxes must be of cast metal or other material approved for the purpose (stamped steel boxes prohibited), and the entry of cables to them must be done in a manner to prevent the entry of moisture at those points. Its use is limited to locations that usually are wet and where fumes or vapors, if present, are only mildly corrosive. Such conditions are to be found in breweries, cold-storage and ice plants and locations of similar character. Special

approval from the local enforcing agency must be obtained for each particular installation before the work is done. Armored cable cannot be used for this purpose.

CONCEALED WORK IN NEW BUILDINGS

In this type of work the cables are run through or along the side of joists and studdings. Holes are bored through these members along the line where it is desired to run the cables; no insulating tube or bushing need be used at any such points. When the cables are run along the joists or studding, they are secured thereto by

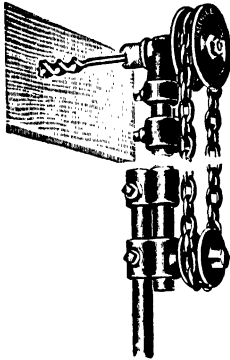

Fig. 31. Joist Boring Machine

Courtesy of Greenlee Tool Company, Rockford, Illinois

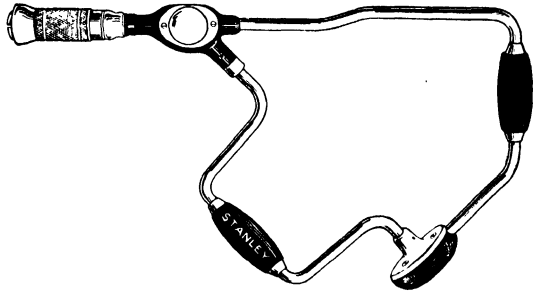

Fig. 32. Corner Bit or Angle Brace

Courtesy of Stanley Tools, New Britain, Conn.

means of straps, without the use of insulators. In fact, staples can be used for this purpose if care is taken not to damage the armor or sheath. When staples are used with non-metallic sheathed cable, a protective saddle of some sort should be used between the staple and the cable to prevent the possibility of the sheath being injured by the cable.

Boring Joists. Joists can be bored best by the use of a regular joist boring machine, Fig. 31. With this tool the boring can be done from the floor and the holes are bored horizontally, making the pulling-in of the cables easier than when the holes are aslant, as is the case when the boring is done with a brace and bit. The next choice of tool is the corner bit or angle brace, Fig. 32. The holes will be somewhat aslant, the degree being dependent on how far away from the edge of the joists the holes are bored.

The use of the regular bit brace is justified only when neither of the preceding tools are available. The sharp angle at which the holes must be bored, in order to provide hand clearance for the sweep of the brace, makes the slant of the holes very pronounced, thus making the pulling-in of the cables very slow and laborious. It will help some to use an auger bit-extension, Fig. 33, to lengthen the bit, thus reducing the boring-angle required.

Slanted holes should be bored one or two sizes larger for a given size of cable than would be required if the holes were horizontal, or even larger if the joists spacing is less than the usual 16 inches from

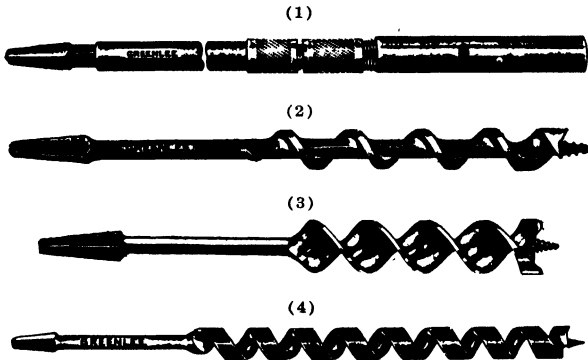

Fig. 33. (1) Auger Bit Extension; (2) Single-Spiral, Single-Cutter Bit; (3) Double-Spiral, Double-Cutter Bit; (4) Single-Spur Car-Bit or Ship-Auger

Courtesy of Greenlee Tool Company, Rockford, Illinois

center to center. Although this makes the boring harder it will pay for itself in the reduction of pulling-in effort.

Choosing Auger Bits. No matter which of the three boring tools you use, be sure that the cutting edges of the bit are in good condition. For this type of boring (that is, new construction work), a bit with a coarse pitch of thread on its screw point for fast feeding and a single cutter-head for easy cutting is preferred, such as the single-spiral, single-cutter bit, shown in Fig. 33. The double cutter-head bit with double-spiral, is also shown in Fig. 33.

For boring holes in old-house-wiring, the best bit to use is the one shown in Fig. 33, called ship-auger by some or single-spur car-bit by others. Nails are struck much oftener in this type of work than in new construction work, because there is so little leeway in the

choice of hole locations. This style of bit is not damaged so easily as are the other types, Fig. 33, and it also is somewhat easier to put into shape again after it has been damaged by striking a nail. However, it does not bore quite so easily as the former.

Sharpening Auger Bits. The single cutter-head is sturdier than the double-cutter head, and it also is easier to file after you have struck a nail or other hard substance. For this type of filing you should use a small file with a fine cut. Fig. 34 shows a file made expressly for this purpose. On one end it has teeth in the flat sides and none in the flat edges, and on the other end it has teeth in the edges

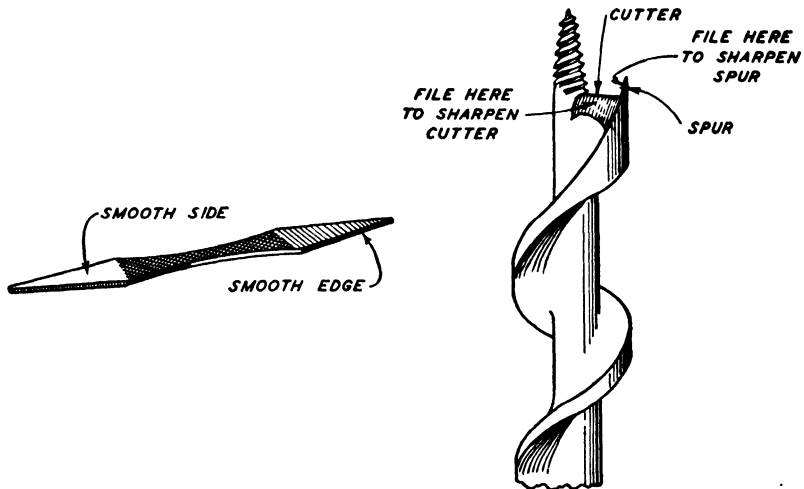

Fig. 34. Auger Bit File and Enlarged Detail of Cutter

and none in the sides. These file sides or edges without teeth are called "safe side" or "safe edge," respectively.

File the outlying spur on the inside only, as shown in Fig. 34, because the spur must cut at the point of maximum diameter for easy boring. The cutter, that is, the edge at the end of the spiral that cuts and lifts the chip, should be filed mostly on its upper or lifting face, Fig. 34, although a bad nick or bulge in the lower face should be filed out. The "lead" of the spur, that is, the distance that the spur extends beyond the edge of the cutter, should never be less than the thickness of the chip. The original angles of the cutting edges should be maintained as closely as possible. Otherwise, the bit will not cut well.

Connecting Cables to Boxes. After the holes have been bored in the joists and studdings, mount the outlet boxes, securing them firmly to the structural members of the building. There is no objection if you do this part of the job before the boring is done, except that sometimes a box will be in the way of the boring bit. The cables are now installed from box to box and to the cabinet by threading them through the holes that have been bored, or running them along the side of the stud or joist, as the case may be. Since the work will be concealed after the building finish is on, little attention need be given to the straightness of run or close hugging of the surface wired over by the cable. However, the cable should be supported by a cable strap at least every $4\frac{1}{2}$ feet.

CONCEALED WORK IN OLD BUILDINGS

This class of work frequently is called "old-house-wiring." It covers the installation of wiring with a minimum amount of damage to or removal of finish in non-fire-proof buildings, that is, those entirely of frame construction, or those whose interiors consist of wood floors and joists, walls of studding, lathed and plastered, even though the exterior walls are of fire-resisting material. As the cables must be fished from outlet to outlet, this type of wiring is always a two-man job.

Locating the Outlets. The first step is to spot the outlets in ceilings and walls. The locations are determined by the owner or his representative. Ceiling outlets usually are placed in the center of the room. If the ceiling is paneled, an outlet may be put in some or all of the panels, or, perhaps at the juncture of the stiles or beams. In the choice of location for the wall outlets, discretion and a knowledge of building construction is essential in order to avert unnecessarily high cost, as some walls are more difficult to fish cables in than are other walls. For example, it is difficult, sometimes even impossible, to fish cables in the space behind the lath on a brick wall that has been furred with the regulation $\frac{7}{8}$ -inch furring strip, even when the flat or oval-shaped cable is used.

If the plastering job is a good one, the plaster-keys, Fig. 35, that is, the bulge of plaster overhanging the laths on their inner surface, thus anchoring or keying the plaster to the laths, may be so pronounced as to seriously impede fishing the cables. Or, the space

between the top of a wall and the roof may be so small that access to the hollow space inside the wall is impossible.

There are still other structural conditions, too numerous to mention, that materially raise the cost of installing an outlet at a particular location. In most cases, the owner's choice for the location of a wall outlet is largely a matter of whim, his needs being met just as well by an outlet in an adjacent wall as in one that may be difficult to fish or to get into. Therefore, when an owner selects such a location for an outlet, point out to him the additional cost entailed due to structural or other difficulties.

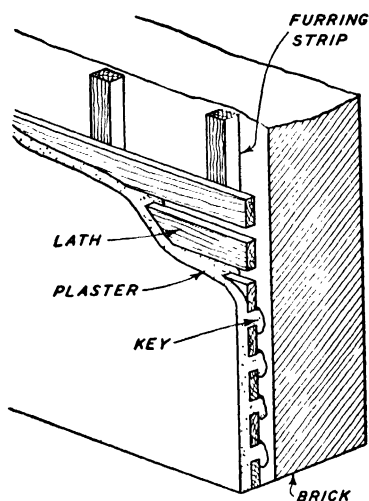

Fig. 35. Plastered Wall Construction in a Brick House

CUTTING OPENINGS

The second step is to cut the holes for the outlet boxes. Cut them carefully and only large enough to take the boxes without forcing them. For ceiling outlets the boxes will be round and from $\frac{1}{2}$ to $\frac{3}{4}$ inch in depth, depending on the thickness of the plaster. Boxes for switches or receptacles will be 2 x 3 inches, and of a depth to suit the particular conditions. Bracket outlet boxes will be either round or rectangular, depending upon the style or shape of the canopy or mounting plate that is to be used on the bracket for that particular location.

Ceiling Outlets. Fig. 36 shows a handy tool to use for cutting holes for round outlet boxes, and the method of using it. If you do not feel like buying one, get a round outlet box, file notches in the edge of the box and secure it to an appropriate centering stem for mounting in a bit-brace. Cut out the plaster only, the lath being left intact; it will probably be necessary to notch the lath to permit

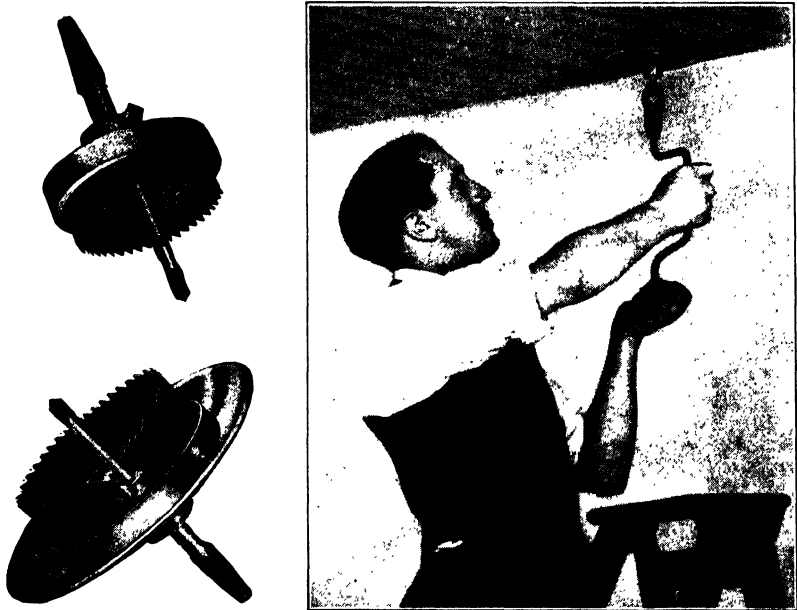

Fig. 36. (Left) Rotary and Ceiling Hack Saw; (Right) Method of Cutting a Circular Opening

Courtesy of Misener Mfg. Co., Inc., Syracuse, New York

passage of the cables and outlet box support; if so, notch them no deeper than is necessary.

Fig. 37 shows a ceiling outlet box and fixture hanger. The upper view is with the hanger legs in closed position being inserted into the hole. The lower view shows the hanger legs extended for supporting the box, being locked in open position by the locknut on the center stem, which serves also as a fixture stud. A key, through the center of the nipple, locks the wings securely in a horizontal position. Another type of hanger is shown in Fig. 38, in which the stud slides freely along the bar. With the stud at one end of the hanger, the other end is inserted into the hole all the way and

the stud also pushed in. Then with one hand holding the stud, the other hand pulls on the wire sticking out through the stud, thus sliding the bar along until the stud is centrally located on the bar. The locknut is removed and the outlet box, with cables attached, is put on the stud. The locknut is then put on and set up tight,

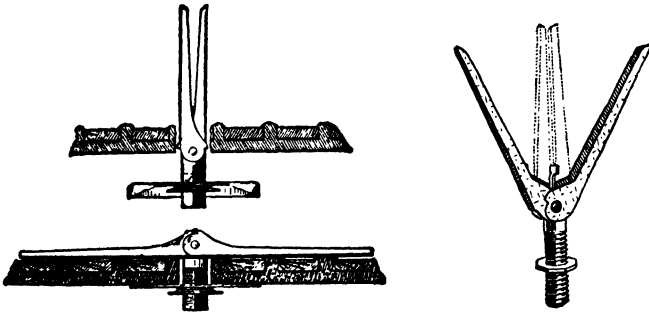

Fig. 37. Ceiling Outlet Box and Fixture Hanger

Courtesy of the Paine Company, Chicago, Illinois

thus securing the box and hanger in place. This hanger requires a hole about $1\frac{1}{2}$ inches in diameter, somewhat larger than the first type. However, it will go into a shallower wall, which is an advantage at times. With either type, of course, the entire weight of the fixture must be borne by the lath. Be sure to insert the hanger so that the ears or bar will bear on as many laths as possible.



Fig. 38. Old-Work Bar Hanger

Courtesy of the M. B. Austin Company, Chicago, Illinois

Switch Outlets. Cutting a hole for a switch outlet is different from the previous cutting operations, for you must cut through the laths as well as through the plaster. The hole should be 3 inches vertically and 2 inches wide, or very little more, for a standard switch box such as is used in this class of work. As a lath is $1\frac{1}{2}$ inches wide and the spacing between laths is, on the average, $\frac{1}{4}$ inch, it follows that you must cut out one lath entirely and cut $\frac{1}{2}$ inch from each of the two adjacent laths to make a hole 3 inches in length vertically.

At the exact point on the wall where the switch is to be installed, you dig out just enough plaster to locate the middle lath; outline the size of the hole on the wall, using the center of the exposed lath for the center of the hole, and carefully remove the plaster within this outline, Fig. 39. Cut a section 2 inches wide out of the center lath with a narrow, fine-toothed saw; also cut out a $\frac{1}{2}$ -inch strip, 2 inches long, from the lath above and from the one below the center lath. Do not cut out two entire laths, for if you do there will be no support for the outlet box, as the hole would then be approximately $3\frac{3}{4}$ inches

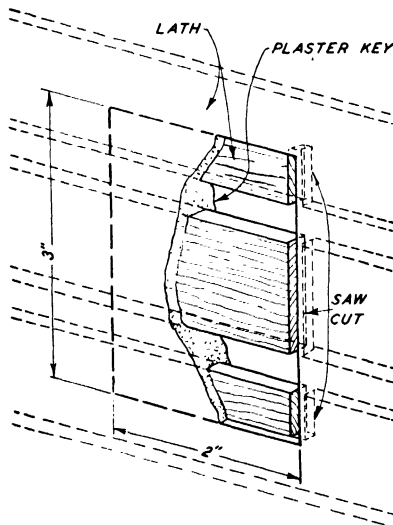

Fig. 39. Wall Construction Showing Location for Cutting Opening in Plaster for Switch Box

long. The reason for cutting out only part of the upper and lower laths is so that each of them will give firm support to the box.

The saw should be in good condition and used carefully when sawing out the laths, especially after the first cut has been made, because the support for the laths still to be cut may be a considerable distance away and the spring of the laths tends to crack the plaster.

There are walls in which the plaster is too crumbly to sustain even the most careful cutting of the laths without cracking. In such a case use a wooden anchoring strip, which may be from 1 inch to $1\frac{1}{2}$ inches wide, $\frac{1}{2}$ inch or more in thickness, and 8 or 10 inches long.

Bore three holes in line through the center of the strip, and to dimensions shown in Fig. 40, large enough for the screws to pass through. The strip should be put on as shown in Fig. 40, the center screw to go in the center of the outlet. Use No. 6 or not larger than No. 8 wood screws, either round-head or flat-head, long enough to go entirely through the lath, setting them up snug; pilot holes should be drilled

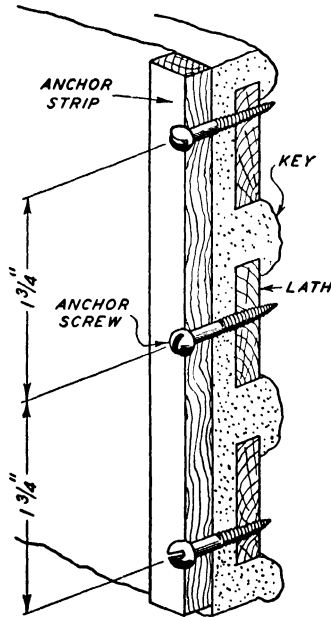

Fig. 40. Wall Construction Showing Method of Supporting Plaster When Cutting Opening for Outlet

through the lath for the screws, to avert splitting the lath which would impair the solidity of the support for the box. Then saw the lath, remove upper screw and lower screw and remove the strip, the short section of the middle lath will come with it. It would be better, of course, to have two such strips, one on each side of the hole to be cut, but the objection to that is that it might be difficult to conceal the holes left in the plaster by the screws, the switch plate being too small to cover them.

Receptacle Outlets. Receptacle boxes, when they are to be installed in lath and plaster walls, in this type of work, should be

mounted with their long dimension vertical instead of horizontal, thus providing better support for them. An alternative is to mount them in the baseboard, which provides splendid support, but the one objection is that it is too low for comfort for "plugging in" purposes.

Two types of rectangular boxes used for either switches or receptacles are shown in Fig. 41. The type with beveled corners is easier to get into a hole after the cable is connected to it. The ears on each of these boxes are reversible, adapting them for use in either plaster or in wood-surfaced walls.

Where a bracket fixture of the "French" type, that is, one with a narrow back is to be used, the plaster cover on the outlet box

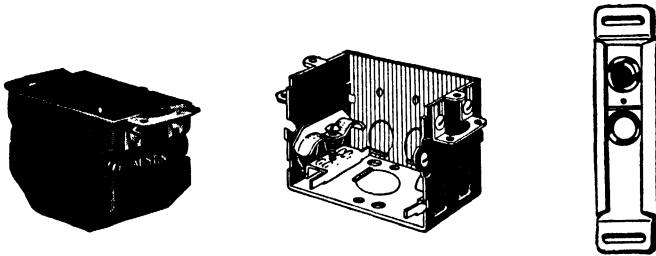

Fig. 41. Two Types of Switch Boxes, and an Adjustable Fixture Bar
Courtesy of the M. B. Austin Company, Chicago, Illinois

should have a rectangular opening, instead of a round one. If it is not convenient to mount such a fixture on the fixture stud, you can use an adjustable switch box fixture bar, Fig. 41. This fits the ears of any standard switch box or switch cover; the slotted holes in the ends permit lateral adjustment. The fixture stud is mounted on a movable back plate, permitting vertical adjustment; screwing the fixture onto the stud locks the back plate firmly in place.

Scuttle Hole to Attic. In a one-story building, or on the top floor of one having several floors, when there is enough attic space to get about and work in, the job of fishing cables is simple. Usually there is a scuttle hole in place to give access to the attic space. If there is none you must make one, which should be done in some out-of-the-way location, but not where the roof rafters are so near the ceiling joists that there is not enough room for a workman to pass through.

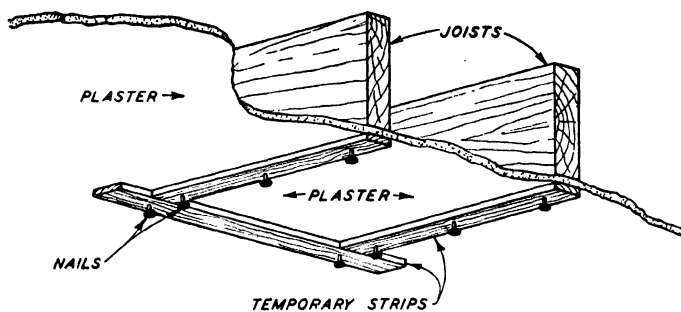
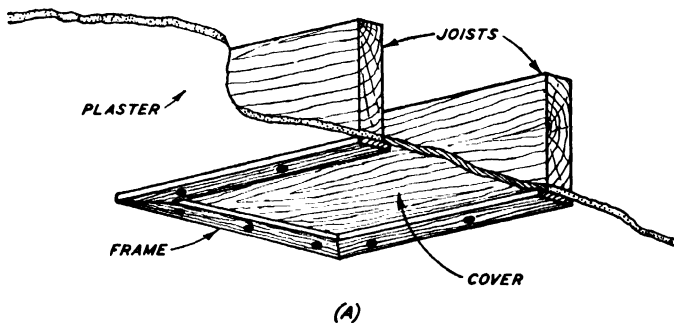
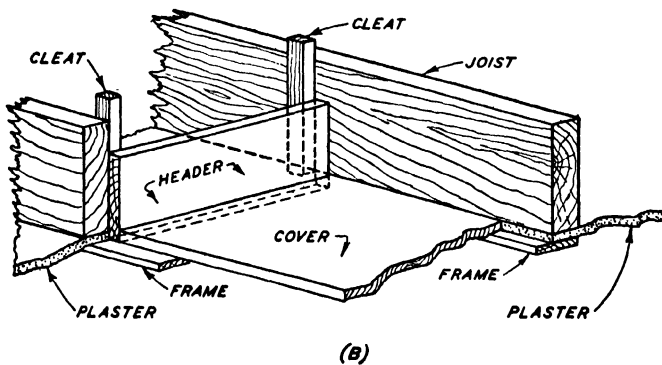

Fig. 42. Temporary Strips for Supporting Plaster When Cutting a Scuttle Hole



(A)



(B)

Fig. 43. Frame and Cover for Scuttle Hole

Locate the floor joists and remove the plaster from the space between two neighboring joists and from a dozen laths. Then nail a temporary wooden strip, 26 inches long, to each of the two joists, Fig. 42, letting the ends extend beyond the laths that are to be removed. The edge of the strips which are adjacent to the hole to be cut should not extend beyond the joists where the laths are to be cut, so that you can cut the latter flush with the joists. Drive the nails only part way in, in order to facilitate their removal after the laths have been cut out. These strips will avert cracking plaster when sawing the laths. After the laths have been sawed, remove these strips and put up permanent frame, as shown in Fig. 43 at (A). The headers can be toe-nailed to the joists instead of using nailing cleats. The bottom of the headers should finish flush with the plaster ceiling line. Make the cover from tongue and groove flooring, cleated together on the concealed side or use a plywood board. Cut the cover to fit loosely and to rest on frame as shown in Fig. 43 at (B).

FISHING CABLES

It makes little difference where you begin putting in the cables. But fish the wall outlets before running the ceiling outlet cables. A wall outlet usually feeds from some ceiling outlet. Get all of the cables that meet at any one ceiling outlet over to the opening in the ceiling and push the cables down through the hole. Your helper on the floor below, can then connect them to the box and put the box into its place.

Fishing down to a wall outlet from an attic space is not complicated. Bore a hole, large enough to take your cable readily, through the partition plate over the point where the outlet is to be located. You can get this point by measurement on the floor below. The partition plate is a 2 x 4 (sometimes double) between the tops of the studding and the joists. Drop a length of sash chain down through this hole, long enough to extend below the outlet which you are fishing. Your helper below fishes for it with a piece of iron wire (or copper) having a hook on the end of the wire. Rattle the chain so that the sound will tell him where the chain is. When he has pulled the chain through the hole, he attaches the cable to it. Now draw up the chain and as much of the cable as is needed to reach the outlet box. Your helper cuts the cable, connects the outlet box to it,

secures the box in place and is ready for the next one. While you are in the attic, examine the exterior wall where the roof line meets the wall and you will at once see the difficulty in fishing down at this point; there is no room to use a brace and bit, and sometimes there is not even enough room to use a very short chisel and hammer in order to make an opening in the ceiling.

Where there is an unfinished basement under the floor which is being wired, the wall outlets are sometimes fished from there, especially those in the lower section of the walls, the cables from

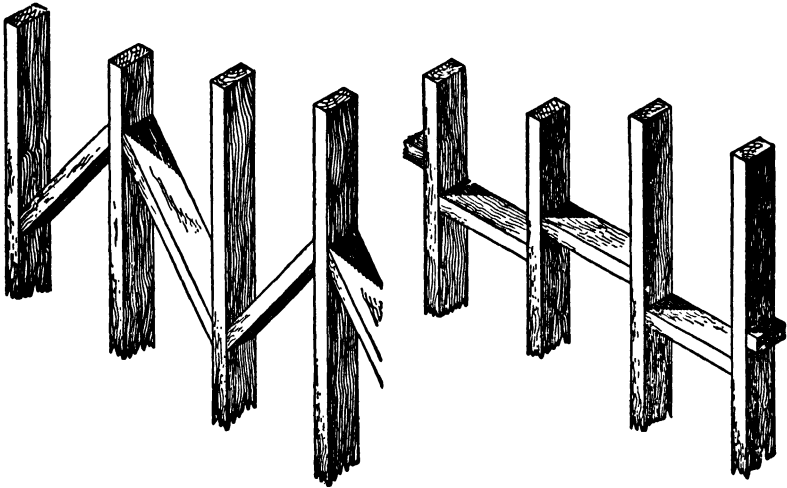

Fig. 44. Diagonal and Horizontal Bridging

outlet to outlet being run on or through the basement ceiling joists. Here you bore through the floor plate, or shoe, of the partition from below, unless conditions make it advisable to remove the baseboard from the wall in question, in which case you can bore down from above. Instead of dropping down a chain, insert a wire from below for your helper to hook. If the baseboard has been removed, you can pick up all of the outlets in that wall by boring through the studding, or notching them, behind the baseboard, until a door opening is reached.

Passing Obstructions. In practically every frame wall there is a brace from each stud to its neighbor on each side. These braces consist, generally, of short pieces of 2 x 4, extending at an angle of

45° from stud to stud and toe-nailed thereto, Fig. 44 (Left); occasionally, they run straight across, Fig. 44 (Right). In either case they stop the fishing. Suppose this has happened where a switch is to be installed near a door below the bracing. Take off the doorstop, which is 1½ inches wide or more. Bore a hole through the door casing and the stud, or door buck, into the wall space above the brace that stops the fish chain; this hole should be in the center of the space covered by the doorstop that you have removed. Bore another hole into the wall space below the obstruction in the same way as the first one. With a gouge, that is, a half-round wood chisel, gouge a furrow or channel in the door casing from one of the holes to the other, slanting off the corners where channel and hole meet, to ease the sharp bend of the cable at these two points. Now fish around the obstruction, nail back the doorstop, and, provided you have kept within the limits of the doorstop in your cutting, no trace remains of how you did the work.

Now suppose that the outlet is, say, 3 feet away from the door casing, which would be between the second and third stud away from the door. Drop the fish chain down in the space adjacent to the door opening and proceed as before. After boring the hole below the bracing in the wall, put on a bit-extension, two if necessary, and bore straight through the next two studs, which should be done at the same level as the outlet. Next, pass a straight wire through the three holes, and have your helper catch the other end with his hook, and you are all set. If this stunt fails or if the outlet is too far over, then cut the channel, in the door casing behind the doorstop, down until it reaches below the top of the baseboard; bore through the door frame at that level, remove the baseboard, and either notch or bore the studs for the passage of the cable; then fish the cable up to the outlet.

A door-opening can be crossed in a similar manner, that is, by removing the carpet-strip or threshold running from one side to the other side of the opening, and gouging a channel in the floor. If there is no such strip, cross over the top of the door-opening.

Removing Wood Trim. When taking off a piece of interior trim use a thin, wide tool, similar to a wide chisel, so as to distribute the prying pressure over as large an area as possible; a narrow tool is apt to leave a mark that will be hard to remove or conceal. Start

the prying operation at a point above or below the normal line of vision so that the marks left by the tool will not be observed.

Removing Floor Boards. When cables must be installed through floor joists, at right angles to them, the finished floor being in place and the joists inaccessible from below, the general practice is to take up the floor where required. In doing this begin where two pieces of flooring meet, so as to have a loose end available when you begin prying up the floor. First, however, you cut the tongue on each side of the strip of flooring you want to take up. If you do this with an ordinary key-hole saw, you are apt to cut away too much of the stock from the edges of the flooring strip so that the cracks, after

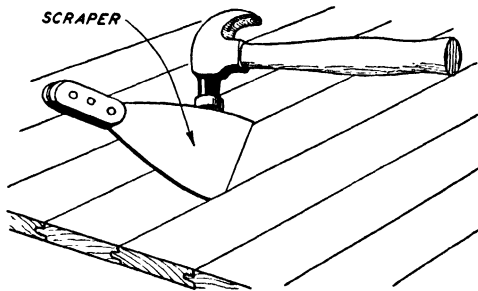

Fig. 45. Showing Method of Cutting Tongue in Floor Board

replacing the flooring, will be objectionably wider than they were before. An improvement over this is to use a hacksaw blade, which is thinner and has finer teeth than a key-hole saw and will remove less stock in the cutting. The hacksaw blade must be inserted so as to cut on the up-stroke, because there would be too much buckling of the blade if the cutting were done on the down-stroke. This would result in many broken blades, probably injury to your hands and damage to the floor also.

So far as we know, there is no holder on the market that can be attached to a hacksaw for this type of work. You can either make one or tape the end of the blade to protect your hand. The blade should be 12 inches or more in length, in order to give you a fairly long stroke. The disadvantage in using any type of saw is that there must be a hole through the floor large enough to admit the end of the saw before you can begin sawing, to which there may be serious

objection. In such a case a tongue in the floor board must be cut by driving a thin cutting tool through the board.

A good tool for this purpose is a painter's scraper. This looks somewhat like a putty knife but is wider and stiffer. Do not set it in the crack vertically and try to drive it through by hammering on the end of the handle. Set one of the corners of the blade in the crack and strike rather smartly with a hammer on the side which is uppermost, Fig. 45. Experience will soon teach you how hard to strike for best results. You may have some trouble with the flooring nails, especially if they are not driven fully home. When you do, cut the tongue as close to the nail as you can; what little of the tongue that

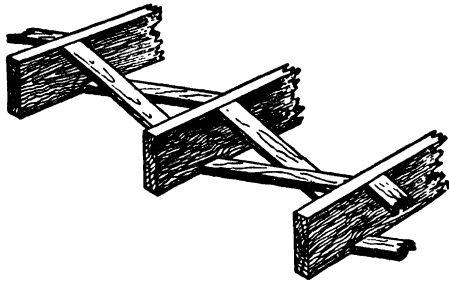

Fig. 46. Cross Bridging Between Floor Joists

remains will break off without damaging the adjacent strip of flooring if you are careful when lifting it. Keep a close watch on the strip which has its groove next to the strip being removed to make sure that the upper lip of the groove is not split out by a projection of the tongue that you failed to cut properly. If you notice any bulging at the edge of an adjacent strip, have your helper apply pressure on it, right at the edge. With care you will be able to remove the flooring strip without damage. There then remains only the rough under-flooring to be cut.

The floor board is removed from the floor above the ceiling that is to be wired, because this is quicker, cheaper and less messy than the removal and replacement of lath and plaster. It is also done for the purpose of extending wiring from an outlet on one wall to an outlet on another wall on the same floor or story. Before taking up any flooring be sure to locate the cross bridging, between the joists, Fig. 46. Do not take up a strip of flooring just above it, for if you

do you will have to take up one or two adjoining ones in order to get working space. Cross bridging consists of wood braces extending from the bottom of one joist to the top of the next one, in each direction, toe-nailed to the joists. Wood braces are usually made from 1 x 3-inch lumber and are usually located half way between the supports for the floor joists. You can locate the braces easily enough through the hole cut for the outlet in the plaster of the ceiling below.

Removing Baseboards. To get the wiring down to a wall outlet from the ceiling, remove a baseboard in the wall, Fig. 47, which is

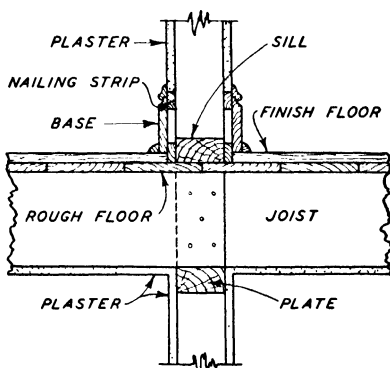

Fig. 47. Construction of Partition Wall

over the outlet on the floor above, that is, the floor on which you have taken up the strip of flooring. This will expose the sill of the partition, usually a piece of 2 x 4, to which the studding is nailed. At a point where the cable is to drop down to the floor below, cut an opening through this sill large enough to get your hand through. Locate the partition plate of the partition below and bore a hole through it large enough for the cable. Then fish the outlet in the wall, as already explained, after which push or fish the cable over to the point where the floor has been opened and run it to the ceiling outlet to which it is to be connected. If preferred, a pocket can be cut in the floor, instead of removing the baseboard, for the boring of the hole through the partition plate. You also cut a pocket in the floor in case there is no partition above the partition down which you want to drop wires for an outlet.

Cutting a Pocket. Cutting a pocket in a floor means removing a piece of flooring between two neighboring joists. If possible, locate the pocket where there is an end in a strip of flooring, so that you will not have to saw the flooring at that point. Sometimes it pays to start at one or two joists beyond the point where the pocket is wanted, in order to avert having to saw the flooring, in which case proceed as explained earlier. Cut the tongue about one joist space farther than

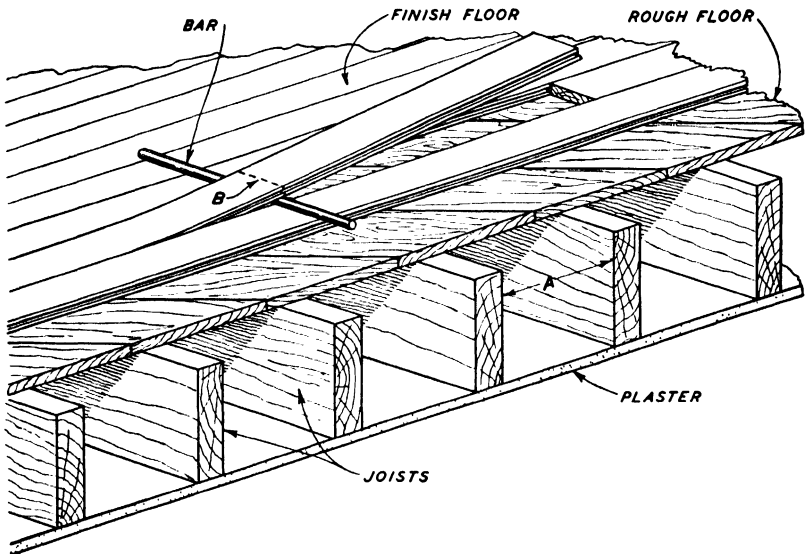

Fig. 48. Raising a Floor Board

the pocket is to be located, even one joist farther if necessary, to avert the sawing of a floor strip. Begin raising the strip from the end and continue as far as the tongue which has been cut will permit and insert a bar, chisel, or similar object between the floor and the raised strip, Fig. 48. This may give enough room to do the required work in space A. If it does not, and the other end of the floor strip is too far away to justify taking up the entire strip, then cut it at point B, that is, in the center of the joist, in order to get support for both ends of the strip. Use a very thin saw for this, so as not to cut away too much stock.

When a pocket is to be cut where a floor strip, no longer than the space from one joist to its neighbor can be removed, it will be neces-

sary to bore a $\frac{1}{4}$ -inch or $\frac{3}{16}$ -inch hole through the floor strip to be cut, Fig. 49; this hole should be as close to the joist as possible. Insert a thin key-hole saw and cut straight across the whole strip. Repeat the process at the other joist; cut the tongue and remove the

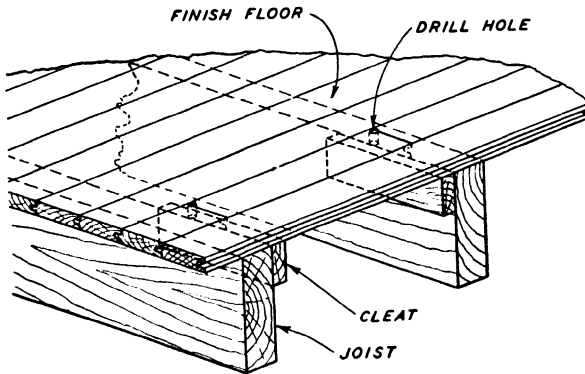

Fig. 49. Floor Construction Showing Method of Supporting Floor Strip

strip. Before replacing the strip that you removed, nail a substantial cleat firmly to the face of each of the two joists, using not less than two 10-penny nails in each cleat, to support the floor strip, Fig. 49.

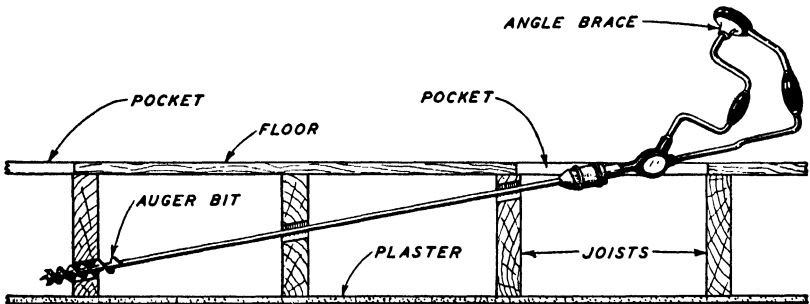

Fig. 50. Boring Floor Joists with an Extension Bit

These cleats must rest tight against the bottom of the undisturbed flooring and should be not less than 8 inches in length nor less than 3 inches in width.

Occasionally, time can be saved by cutting a pocket in one joist space and another two or even three joist spaces away, as shown in Fig. 50, instead of taking up the strip all the way across. Bore

through the three joists in one stretch. Tape a piece of thin twine or fine wire to the bit above the spiral on the farther side of the last joist. Lay it in the grooves of the spiral and tie it to the feeding screw to hold it in place. Then have your helper withdraw the bit as smoothly as possible while you do the feeding of the wire so that it does not kink or get hung. If preferred, the joists can be fished with a fish wire instead.

Do not cut a floor that is finished in parquetry (inlay or mosaic work). If your cables must cross such a floor at right angles to the joists, take off the baseboard along one of the sidewalls and either bore or notch the studding for the passage of the cable. If a door opening must be crossed, remove the threshold or carpet strip and gouge a channel in the floor beneath it, lay the cable in it and replace the threshold. If there is no threshold, remove the door stop on the two sides and at the top of the door casing and gouge the cable channel in the space beneath the stops.

At whatever point in the wall that it may be necessary to tap this cable for feeding an outlet in the ceiling below, or for any other purpose, a junction box must be installed in the wall for making the connection, the box being closed by a blank cover afterwards. If desired, a receptacle can be mounted in this box, thus making it do double duty.

Replacing Wood Floor. Replacing a floor strip is a hard task. The rough flooring must be replaced, at least over the joists, as well as the paper or other lining which may be between the rough and finished floors, in order that the replaced strip will be at its original level. The nailing must be well done, as otherwise the floor will "creak" when walked upon. You may find it helpful to drill small holes through the strip for the nails. Use flooring nails at each joist, driving them well down into the wood with a nail-set; close the nail-holes with putty or plastic wood, stained to match the color of the flooring.

WIRING SWITCHES

Push-Button Switches. When using the knob and tube method of wiring, it is customary to use round snap switches. The circuit is completed by giving the knob of the snap switch a quarter of a turn. It is customary to use push-button switches with conduit

or armored cable wiring. A push-button switch is shown in Fig. 51. The position of the plungers on a push-button switch indicates whether the switch is on or off. When the plunger that has a white disc in the center end of it is sticking out farther than the other one, it indicates that the circuit is open and the lights are off. When it is necessary to turn the lights on, the white plunger is pushed in all the way, which causes the mechanism inside of the switch to make connections between the two wires fastened to the switch. The wires are fastened under the screws near the top and bottom of the switch. The metal part of the switch extending above and below the plungers is for the purpose of fastening the switch to the

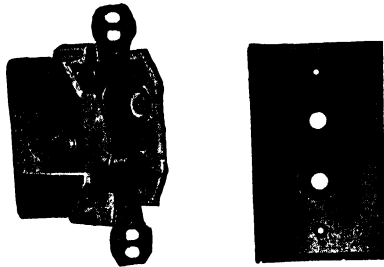

Fig. 51. Double-pole Push-Button Switch and Plate
Courtesy of Bryant Electric Company

metal switch box by the use of two machine screws. The term "single pole" means that one side of the circuit, or one wire of the circuit, is opened or closed when the switch is operated. A "double-pole" switch has two sets of blades, insulated from each other, that open or close both sides of the circuit at one time. A double-pole switch can be used to open or close one side of two circuits. A single-pole switch has two screw heads to which wires are attached and a double-pole switch has four screw heads, as in Fig. 51.

The method of wiring a push-button switch when the outlet is already supplied with current from another outlet is shown in Fig. 52. The light and heavy lines indicate polarity wiring. The light or thin line is the neutral or grounded conductor. It is the wire with the white insulation on it and must be connected to the screw shell of the socket. The heavy black line indicates the "hot" conductor, or "live" conductor as the electricians term it. At the

outlet box or switch box a sharp bend or curve in the drawing indicates that a pig tail splice is made. The live wire coming from the last outlet box, Fig. 52, is connected through the switch to the

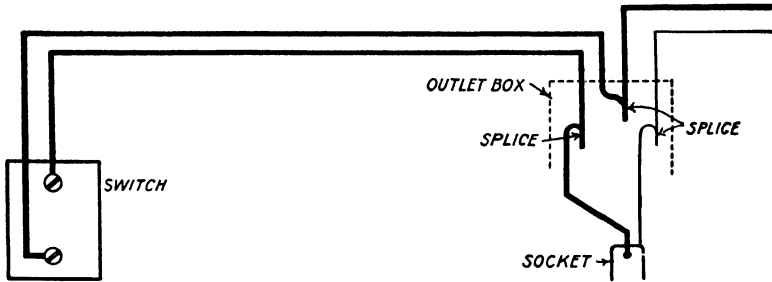

Fig. 52. Wiring of a Push-Button Switch

center contact of the socket. The grounded conductor must always be connected to the shell of the socket. This is called "polarity wiring" and means that the grounded and live conductors are permanently identified.

When installing a switch box and an outlet box, it is sometimes more convenient to have the wires run up through the switch box and from the switch box on through to the outlet and then

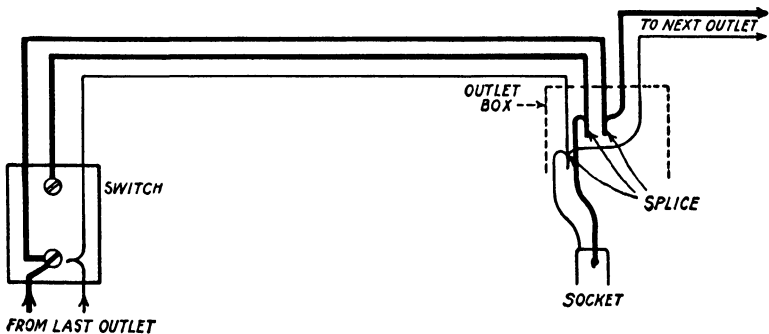

Fig. 53. Method of Wiring When Current Is Fed from Switch to Outlet and on to Next Outlet

from that outlet on to the next outlet. The method of wiring such a switch is shown in Fig. 53. The wires with the white insulation are spliced at the switch box but they do not make any connection with the push-button switch. The live wire from last outlet is

fastened to one terminal of the push-button switch and one of the black wires going to the outlet box is also fastened under this same screw of the push-button switch. This wire, which is fastened to the live side of the push-button switch, is also connected by means of a splice at the outlet box to the black wire going to the next outlet box. The wire going from the top of the push-button switch is connected to the center of the socket at the first outlet. When armored cable is used for such a wiring job, a three-conductor armored cable should be run from the switch to the outlet box.

It is sometimes desirable to be able to turn on two lamps from one place by means of two switches, as shown in Fig. 54. In this

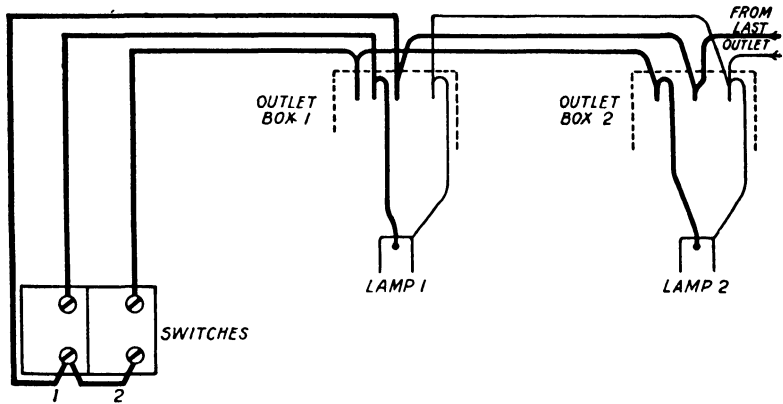

Fig. 54. Method of Wiring Two Switches at One Box

particular case the current for the lights is obtained from the last outlet and is fed into outlet box 2. This makes it necessary to run these wires from outlet box 2 to outlet box 1 and to push-button switches 1 and 2. The live wire, which feeds the current from the last outlet, is spliced at outlet boxes 2 and 1, and then carried to the bottom terminals of push-button switches 1 and 2. Then from the top of these push-button switches two wires are run to outlet box 1 and one of these wires is run on to outlet 2 and lamp 2.

The method of wiring two outlets and two push-button switches when the current is fed through the switch boxes is shown in Fig. 55. The grounded conductor is spliced at the switch box but there is no connection made to the switches.

Three-Way Switches. It is often desirable to be able to turn a light on at one point and turn it off at another point. This can be accomplished by the use of two three-way switches located at the two points. The exterior of a three-way push-button switch, Fig. 56, is similar to Fig. 51 except that there are only three screw heads instead of four. The three-way switches can be obtained either in the rotating snap or push-button types. The push-button three-way types are made to fit in a standard switch box the same as the single-pole switches.

In wiring three-way push-button switches, remember that you must connect the two screws at the end of the switch, top or bot-

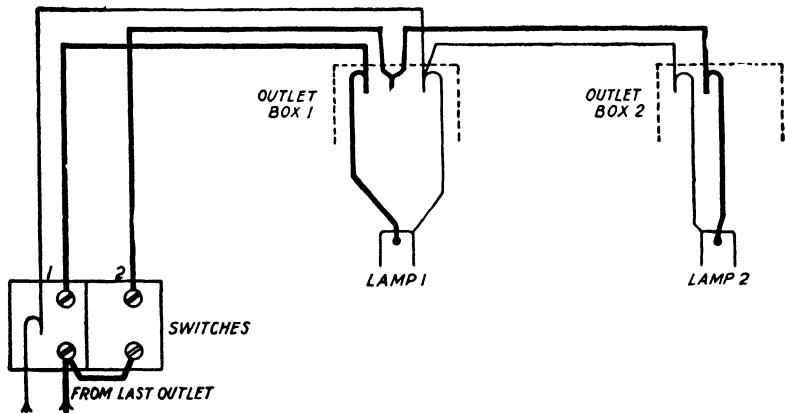

Fig. 55. Another Method of Wiring Two Switches at One Box

tom, to the two screws at the end of the next three-way switch. This is shown in Fig. 57. Remember that the single terminal which is at the top of the switches is connected in one case to the line and at the next switch it is connected to the center terminal of the socket. It is very important to remember that the two terminals at one end of the three-way switch must be connected to the two terminals of the next three-way switch.

In Fig. 58 a wiring diagram is shown using snap switches. In a snap switch there are four terminals; one of the terminals does not have any screw connected to it but is joined to the other terminal by means of a copper connection made by the switch manufacturers. This is indicated in Fig. 58 by the dotted line.

The operation of three-way switches is understood by noting that the diagonal lines which are between the screwheads in Fig. 58 are turned one-quarter of a turn each time the switch is operated. The same condition happens to push-button switches although the

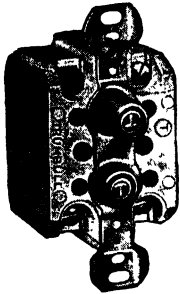

Fig. 56. Three-Way Push-Button Switch

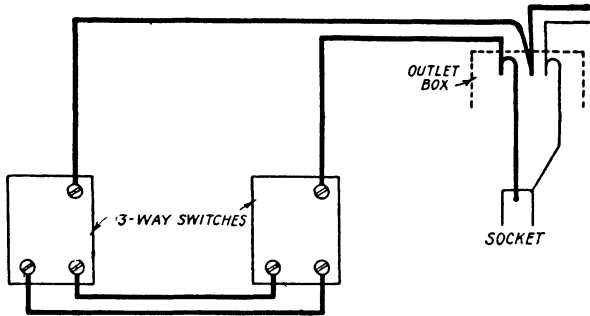

Fig. 57. Wiring Two Three-Way Push-Button Switches

mechanical method of performing this is different from that of the rotary snap switch. The flow of current is from the outlet box through the black wire to the lower left-hand terminal of switch 1, then across to the upper right-hand terminal and through the

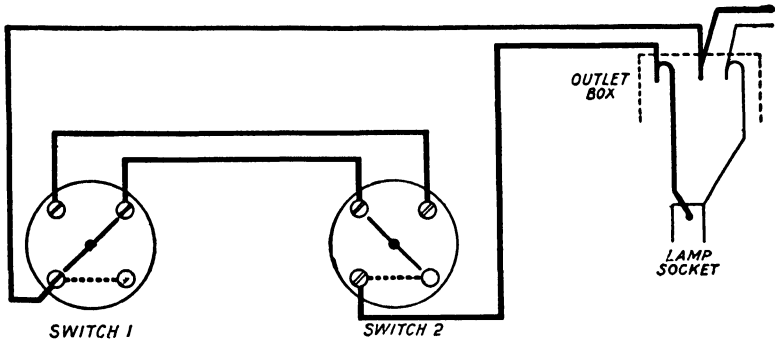

Fig. 58. Wiring Two Three-Way Snap Switches

wires to the left-hand terminal of switch 2; then across the diagonal line to the lower right-hand terminal of switch 2, which is connected to the lower left-hand terminal by a metal connection; then to the center terminal of the socket and through the filament of the lamp to the shell of the socket.

When either one of the diagonal lines of switches 1 or 2 are turned one-quarter of a revolution, the flow of current will be interrupted because the circuit is open at the other switch. As soon as the other switch is turned one-quarter of a revolution, then the circuit would be completed again and the lamps would light.

The method of wiring two three-way switches when the current is fed through the first switch box, then on through to the second

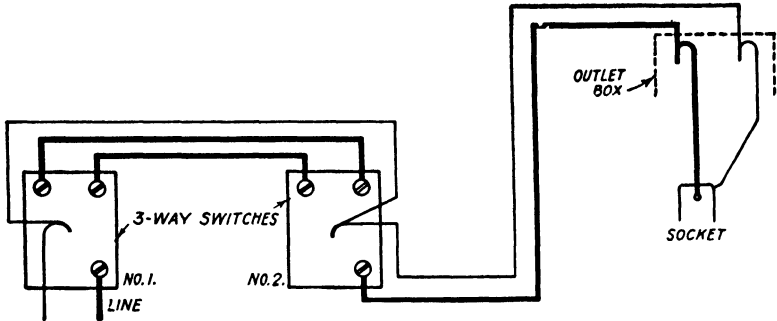

Fig. 59. Wiring Three-Way Switches with Current Fed to First Switch

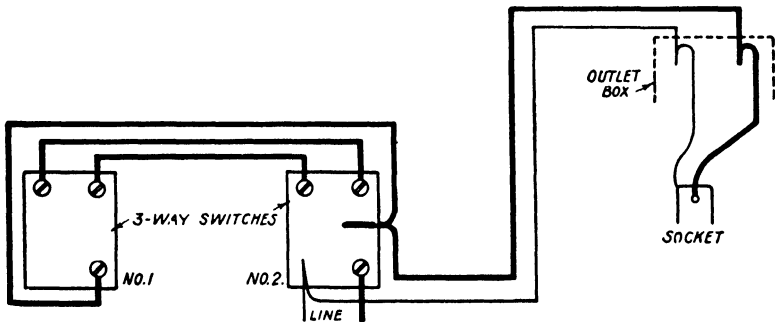

Fig. 60. Another Method of Wiring Three-Way Switches

switch box, and from there to the outlet or lamp, is shown in Fig. 59. The grounded conductor, which is the wire with the white insulation, is spliced at the switch boxes 1 and 2 but is not connected to the switch. Three wires are installed between the two three-way switches.

Fig. 60 is a wiring diagram for two three-way switches when the current is fed to the three-way switch nearest the lamp controlled by those switches.

Master Switches. It is sometimes desirable to have the residence wired so that all the lights can be turned on from one point. The switch that turns on all the lights is referred to as the "master switch" and is usually located in the bedroom occupied by the owner of the residence. This master switch makes it possible to press a button which will turn on all the lights in the residence at once. And the lights can only be turned off by the same master switch. When the master switch is in "off" position, the lamps

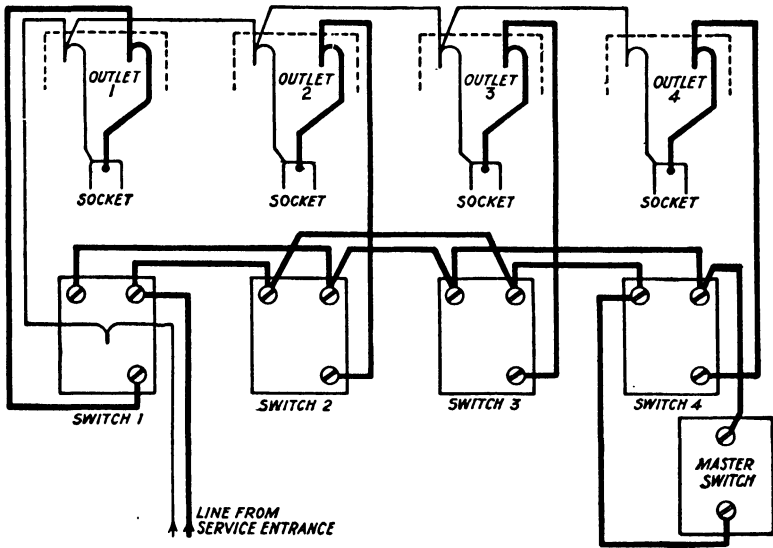

Fig. 61. Master Switch Wiring

can be controlled by the switch in each room. In order to do this it is necessary to use a three-way switch for controlling the individual lights instead of a single-pole push-button switch. The wiring for this is shown in Fig. 61. The line wires enter push-button switch box 1 where the white insulated wire is spliced and then go on through to outlet 1. The hot or "live" wire is connected to one of the two common terminals of the three-way switches which are, in turn, joined to all of the other three-way switches. The grounded wire is run from switch 1 to outlet 1, then to outlets 2, 3, and 4. In actual practice, however, this wire, which is a white insulated wire, must be enclosed in the same conduit as the other wires of

the circuit. It might be more convenient to run the two wires from the top of push-button switch 1 through the outlet 1 then to outlet 2 and then back to switch 2, etc. In this case there would be two more wires to be placed in the conduit between these outlets than is shown in the sketch. If it is more convenient to run the wires from switch box 1 to switch box 2, then to outlet 2, etc., the grounded conductor which is represented by the light lines should be run from switch box 1 to switch box 2, then to 3, and 4, and then in turn run from switch box 2 to outlet 2; from switch box 3 to outlet 3, switch box 4 to outlet 4. It is not necessary to connect the master switch to switch 4, or the last one in the group, in a residence. The master switch can be connected to any two of the upper terminals of a three-way switch. In fact, you can connect it to the three-way switch that is nearest to the location of the master switch. The current that is fed from the "line" or service entrance can be fed to any one of the three-way switches and then on to the outlets, as in Fig. 61, or it can be fed into the outlet box and one wire brought down to one of the terminals of the three-way switch.

In installing the three-way switches in connection with the master switch the important point is to remember to connect the two upper terminals of the three-way switches together. That is, one upper terminal of one three-way switch must be connected to one upper terminal of the next, and the next, until they are all connected together. Likewise, the other upper terminal of the three-way switch must be connected to the other upper terminal of the second three-way switch, etc., in regular order. The use of the three-way switches and a master switch tends to complicate the wiring, and it is always well to make out a complete diagram showing how the wires would be installed from the switch to the outlet and on to the next outlet or switch, etc., in order that the electrician may have in mind the number of wires that must be installed between various points and provide the proper size of conduit to take care of this work.

CONDUIT WIRING MATERIALS

There is nothing as effective as metal conduit for providing an easy and always accessible means of installing and removing electric wires in buildings without disturbing the floors or walls of the structure. Metal conduit also protects the wires from injury and it almost entirely eliminates the danger of fire from over-heated wires.

The two general types of conduit in use are as follows:

Tubing made from a mild, soft steel, having both inside and outside diameters of approximately the same dimensions as those of standard gas pipe; this commonly is called "rigid conduit," to distinguish it from a much lighter type of steel conduit, commonly called "thin-wall conduit," which has come into extensive use in recent years. The latter is called electrical metallic tubing in some publications. In order to avert confusion, the terms "rigid conduit" and "thin-wall conduit," respectively, will be used in this text. In each type the nominal inside diameter is the same, and is the size by which the respective conduit is known to the trade.

RIGID CONDUIT

Tubing. This comes in 10-foot lengths, threaded at each end with a regular conduit taper pipe thread, with a coupling at one end only. See Table 1 for physical data of both kinds of conduit.

All burrs, scale, and other rough spots are removed from the interior to avert damage to the insulating covering and to permit easier "pulling-in" of the wires and cables. The tubing is coated, inside and outside, for protection against rust or corrosion.

There are two general types of coating. One type is a black enamel, baked on, which will not readily crack or peel off. Conduit so finished is called "enameled conduit" or "black conduit." The other type has a zinc coating, applied either by a galvanizing, hot-dipping, or a sherardizing process. Conduit so finished is called "galvanized conduit" or "white conduit."

Black-enameled conduit should not be used out of doors; in damp locations; nor where it is exposed to acid fumes, salt sea atmos-

phere or corrosive vapors. Neither should it be installed in cinder concrete, nor in a cinder fill which is likely to contain moisture; as, for instance, a fill on bare earth, because of the sulphur residue in cinders, left from the coal, which, in combination with the moisture, sets up a chemical action that soon corrodes black conduit and poorly galvanized conduit as well. Also, if you want a good paint job on conduit you should use galvanized finish rather than the black finish.

TABLE 1. Conduit Data, Dimensions and Weights

THIN WALL			Trade Size Inches	RIGID			
Weight Per Foot Pounds	Diameter Inches			Diameter Inches		Threads Per Inch	Weight Per Foot Pounds
	Outside	Inside		Outside	Inside		
0.321	0.706	0.622	1/2	0.840	0.622	14	0.852
0.488	0.922	0.824	3/4	1.050	0.824	14	1.134
0.711	1.163	1.049	1	1.315	1.049	11 1/2	1.684
0.985	1.508	1.380	1 1/4	1.660	1.380	11 1/2	2.281
1.141	1.738	1.610	1 1/2	1.900	1.610	11 1/2	2.731
1.470	2.195	2.067	2	2.375	2.067	11 1/2	3.678
Not Made			2 1/2	2.875	2.469	8	5.819
			3	3.500	3.068	8	7.616
			3 1/2	4.000	3.548	8	9.202
			4	4.500	4.026	8	10.889
			4 1/2	5.000	4.506	8	12.642

Elbows. While conduit follows closely the regular dimensions of standard gas pipe, see Table 1, there is a marked difference in the elbows, usually called "ells." Gas-pipe ells are castings with short radius, for 90-degree or 45-degree bends, but conduit ells are standard only for 90-degree bends. They are made from conduit tube bent to a long radius to facilitate the pulling in of the wires. This radius varies from nearly six diameters (inside) for 1-inch ells to four diameters for 4-inch ells, (see Table 2, the column headed "offset" being important). Reference to Fig. 1 will show that the offset is greater than the radius, because beyond the completion of the 90-degree arc there is, at each end, an added straight length, roughly equal to 2 inches in the smaller sizes, increasing to nearly 5 inches in the largest size. This must be allowed for in the cutting of a conduit to length for use with an ell that must fit into a fixed dimension. Since the offset is not always the same for all ells of any specific conduit size, it is wise not to cut the conduit until the ell to be used is

on the job. Also, it is wise to check the ell to make sure it makes a true 90-degree angle, especially if there are two or more to be installed side by side.

The 1/2-inch and 3/4-inch ells are usually bent on the job from a length of conduit, with either an elbow former, a hickey, or by hand in a pipe vise, and are not listed in Table 2. No conduit elbow should be bent to a shorter radius than six times the inside diameter of the conduit.

Sweeps. Instead of standard ells there also are used bends of longer radius, commonly called sweeps, especially where multi-conductor, lead-encased cables are to be installed. These sweeps are not carried in stock by supply houses, but must be ordered from the factory. They also can be bent on the job from a length of conduit by means of a hydraulic bender. Such a bender also makes offsets quickly and accurately, once its use has been mastered.

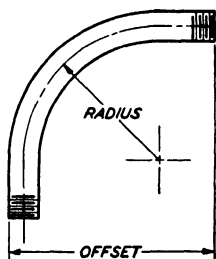

Fig. 1. Diagram Showing Offset and Radius of Conduit Elbow

TABLE 2. Conduit Elbow Data and Weights

THIN WALL			Trade Size Inches	RIGID		
Weight Each Pounds	Radius Inches	Offset Inches		Radius Inches	Offset Inches	Weight Each, Pounds
1.00	5.75	8.625	1	5.75	8.625	2.01
1.50	7.25	10.000	1 1/4	7.25	10.000	3.13
2.00	8.25	11.000	1 1/2	8.25	11.000	4.41
2.75	9.50	13.625	2	9.50	13.625	7.07
Not Made			2 1/2	10.50	15.687	14.11
			3	13.00	17.750	18.50
			3 1/2	15.00	20.000	29.79
			4	16.00	21.312	35.28
			4 1/2	18.00	23.500	43.10

Couplings. Conduit couplings are similar to standard gas-pipe couplings except that they are finished just like conduit. In a pinch gas-pipe couplings can be used.

CONDUIT FITTINGS

These come in a variety of types, but only the basic types will be mentioned here.

Bushings and Locknuts. Where a conduit enters any kind of a box or other housing through a hole that is not threaded, the junction

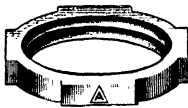

Fig. 2. Lock Nut

Courtesy of the Appleton Electric Company, Chicago

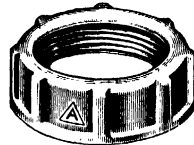

Fig. 3. Conduit Bushing

between the two is made firm and secure by means of a locknut, Fig. 2, and a bushing, Fig. 3. The locknut is screwed onto the threaded end of the conduit on the outside of the box and the conduit is then passed through the conduit hole in the box; the bushing is then screwed onto the conduit as far as it will go and the locknut set up tight against the side of the box.

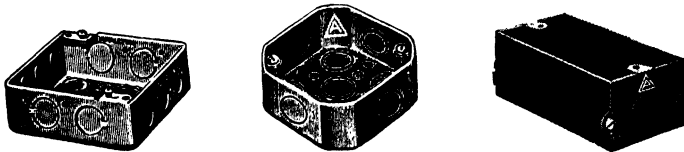

Fig. 4. The Square, Octagonal, and Rectangular Outlet Boxes

Courtesy of the Appleton Electric Company, Chicago

Some localities require two locknuts, one inside the box in addition to the bushing, and the other on the outside of the box, under all conditions; others only under some specific condition, as, for example, where the voltage to ground of any conductor within that conduit system exceeds 150 volts. When in doubt consult the local code and the electrical inspector.

Outlet Boxes. There must be an outlet box or housing of some kind at every point in a conduit system where access to the enclosed wires is wanted. Outlet boxes fall into three general classes, the

square, the octagon, and the rectangular, Fig. 4. Each of these comes in several variations of size, depth, and knockout arrangement. There are knockouts in the sides and bottoms for readily making an entry for a conduit. The knockout is a round disk punched out of the metal of the box, but left attached with a narrow strip and forced back into the opening; the knockout can be removed easily with a hammer or pliers. Bushings and locknuts are used to secure the connection between this type of box and the conduit. The boxes can be had in black-enameled or galvanized finish and can be used for either concealed or open work where there are no volatile, ex-

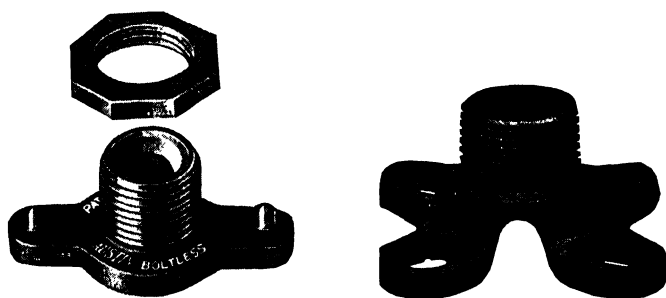

Fig. 5. The Boltless Type (left) and the Bolted Type (right) or Open Slot Hickey Type Fixture Stud
Courtesy of the M. B. Austin Company, Chicago

plosive or flammable vapors, dust or similar hazards present, and where the boxes are not exposed to the weather.

Although there is no hard and fast rule as to what type of box to use for any particular purpose, the general practice is to use the octagon type for lighting outlets and the other two types for switches and receptacles. Outlet boxes are also used for junction-boxes, and pull-boxes, in place of ells when making 90-degree turns, and they are used for sundry other purposes.

In addition to the conduit knockouts, there is also a knockout for a fixture stud in the center of the bottom or back of both, the octagon box and the 4-inch square box. Fixture studs must be provided where the outlet is intended for a lighting fixture. In the boltless type, Fig. 5, the threaded part passes through the knockout hole and the locknut holds it in place; the two pins on the flange portion, entering two small holes in the box, keep the stud from turning when the fixture is screwed on. The bolted type, Fig. 5, is secured to

the box by means of four stove bolts passing through small holes in the back of the box; the flange of the stud may be either outside or inside of the box. Two different types of fixture studs are shown in Figs. 6 and 7—one in combination with a straight bar hanger and



Fig. 6. Straight Bar Hanger with Fixture Stud



Fig. 7. A Deep Offset Bar Hanger
Courtesy of the M. B. Austin Company, Chicago

the other with an off-set bar hanger. These hangers are used to secure the box to the building structure.

Covers for boxes are of numerous types, each having its particular use. The “blank” or “blind cover” closes the outlet entirely; the “drop cord cover,” Fig. 8, is the same, except that it has a hole in



Fig. 8. Drop Cord, Plaster Ring, and Raised Switch Box Covers
Courtesy of the Appleton Electric Company, Chicago

the center for the passage of a lamp cord. The “plaster ring,” also shown in Fig. 8, is used on outlets in lath and plaster ceilings or walls to serve as grounds for the plaster. Octagon boxes do not always require plaster rings; their need is governed by structural conditions on the particular job and the size of fixture canopies that are to be used. You are the judge of the former but the Architect determines the latter. Do not use a plaster ring cover if one is not necessary, as it only makes harder work pulling-in the wires and splicing the fixture connections. Square boxes used for lighting outlets must always have a plaster ring. All styles of plaster rings can be obtained with internal ears drilled and tapped for machine screws to mount devices on them; while seldom required, they are useful when needed.

Covers of one manufacturer will usually fit the same type of box made by another manufacturer, except in a very few cases, but

you must state whether they are wanted for an octagon or a square box and, in the latter case, also whether for the 4" or the 4¾" (sometimes called 5") box.

Then there is the "switch cover," shown also in Fig. 8, used on square boxes, for switch and receptacle outlets. The rise of the opening in the cover is to permit the use of devices having rather deep bodies and to serve as plaster ground. These covers can be had with several degrees of rise, from ¼ inch to ¾ inch, to accommodate varying depths of plaster.

There is also the "French" cover, used on bracket outlets where it is intended to use fixtures with narrow back-plates instead of round canopies. It has an opening similar in size and shape to the

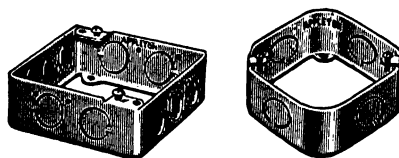

Fig. 9. Octagon and Square Outlet Box Extension Rings
 Courtesy of the Appleton Electric Company,
 Chicago

opening in the regular switch cover, except that the corners of the opening are rounded somewhat, instead of being square. It is difficult to pull-in the wires and to properly make the fixture connections when this type of cover is used, because the fixture stud and stem take up so much of the working space.

No covers are made for the rectangular boxes because they are intended only for switches and receptacles, the tapped holes in their ears being so spaced that they will take the ears of these devices without the use of a cover.

The octagon and square outlet box extension rings, shown in Fig. 9, come in several variations of depth from 1½ inches up. They are similar to the outlet boxes in every way, except that instead of being closed in the back they are open, having only a narrow flange to serve as a seat when mounting them on a box. These rings are used where it is necessary to bring the edge of the outlet box out to the face of the plaster in case the box is too far back in the wall, or when an extra deep box is wanted.

Condulets and Unilets. These are the trade names of two parallel lines of threaded conduit fittings to cover almost any conceivable purpose or condition of exposed conduit installation; they cannot be used for concealed work. Although the two terms are often used interchangeably in the trade, the two lines are separate and distinct from each other. The covers of one line will not fit the bodies of the other. Condulets are made by the Crouse-Hinds Co., of cast or malleable iron, whereas Unilets are made by the Appleton Electric Co., generally in pressed steel, although a number of types may be had in cast or malleable iron also. Both lines come regularly in galvanized finish only. A separate line is made for each, rigid and thin-wall conduit, both alike, except for the interior of the hubs. Adapters can be had to make them interchangeable.

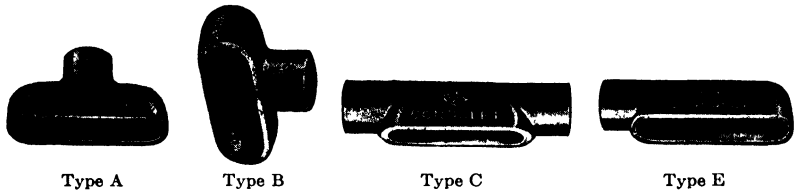

Fig. 10. Condulet Fittings
Courtesy of the Crouse-Hinds Company, Syracuse, N. Y.

These fittings differ from those of the knockout type in that conduit entry is by way of a threaded inlet or "hub." Since they come with a fixed number of entries and are tapped for a fixed size of conduit, and have no knockouts, their flexibility of use is not as great as that of knockout boxes. Extra entries cannot be made nor can entries be enlarged. The only lee-way you have is to close an unused hub with a pipe plug or to bush down a hub to a smaller size by use of a pipe bushing.

Owing to the wide range of styles and shapes in which these conduit fittings come only a few of the basic types will be mentioned here. Fig. 10 shows the following types: A, B, C, and E; Fig. 11 shows three types, LB, LL, and LR; Fig. 12 shows a type T unilet fitting, a cover plate and a type FS fitting which is used for switch and receptacle outlets.

Metal or insulating covers for these particular fittings can be had for various purposes. Fig. 13 shows a few typical styles.

Gaskets are used between the cover and body for any of the "proof" installations, such as weatherproof, waterproof, vapor-proof, etc.

These fittings can be used only for exposed work. However, the threaded hubs make a better electrical and mechanical connection than bushing and locknut, and the variety of shapes available makes possible a much better looking job than with knockout boxes. By their use a job can be made vapor-proof and weatherproof.



Fig. 11. Unilet Fittings
 Courtesy of the Appleton Electric Company, Chicago

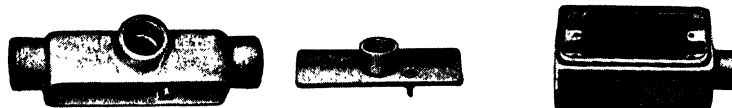

Fig. 12. Type T Unilet Fitting, Rectangular Cover, and Type FS Unilet Fitting
 Courtesy of the Appleton Electric Company, Chicago



Fig. 13. Rectangular Unilet Covers: Porcelain, One-, Two- and Three-Wire; Flanged Blank Steel
 Courtesy of the Appleton Electric Company, Chicago

These bodies being of small size, the work should be laid out to avoid wire splices and taps as much as possible, for a thinly-taped connection crowded into a narrow metal case frequently causes a serious ground or short-circuit.

Wire and Cable Supports. When installing a vertical conduit run, or "riser," as it is called, you must use a cable support at certain intervals, varying with the size of wires to be used. Since the National Electric Code gives full and explicit instructions relating thereto, we do not include them here.

There are several home-made, more or less crude, ways of supporting wires in risers but the best way is by use of the cable

support shown in Fig. 14, which consists of a collar put on the conduit in place of the bushing. The wire grips are dropped in place after the wires have been pulled in.

Conduit Expansion Joints. Long conduit runs exposed to wide temperature changes expand and contract to a degree that may break them or pull them loose from their supports. To avert this a conduit expansion joint, as shown in Fig. 15, is installed at one or

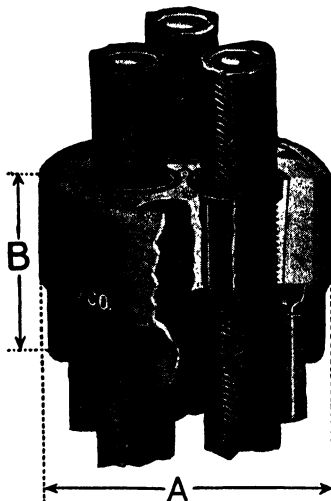

Fig. 14. Cross-Sectional View of a Cable Support for a Vertical Cable Run
*Courtesy of the
 Russell & Stoll Company, New York City*

more points in the run, depending on its length and the degree of temperature variation likely to prevail. A gland at each end, packed with flax keeps the sliding joint vapor-and-weather-tight. A bonding jumper or strap, as shown, is needed to maintain grounding continuity, as the conductivity of the flax may become impaired by the to and fro movement of the conduit under expansion or contraction. These joints can be had with expansion ranges up to 12 inches of conduit movement.

Thread-Less Connectors or Couplings. At times it becomes necessary to connect two runs of conduit neither of which can be turned for screwing into a coupling, on account of the manner in which they are placed in the building structure or because of having a

long ell on the end. The connection can be made in the following four ways: (1) by a running-thread; (2) by a right-and-left coupling; (3) by companion flanges; and (4) by threadless or no-thread couplings or connectors.

The running-thread method requires a regular thread on the end of one of the conduits to be joined and on the other a thread as long as an entire coupling. The latter is run onto this thread all the way, the ends of the two conduits brought into line with each other and the coupling screwed up on the second conduit, while being unscrewed from the first end. This does not make a firm joint and if you must use it you should run a locknut up on the running-thread ahead of the coupling, which, after the latter has joined the

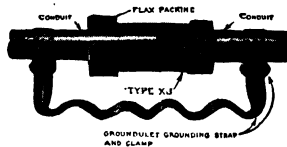

Fig. 15. Conduit Expansion Joint

*Courtesy of Crouse-Hinds
Company, Syracuse, N. Y.*

two conduits, is screwed tightly against the coupling, thus preventing the loosening of the joint by vibration. Running-thread is not approved by the National Electric Code, therefore you should not use it if there is any other way of doing the job.

The right-and-left coupling has a regular right-hand thread at one end but a left-hand thread at the other. One end of the conduits to be connected must also have a left-hand thread. The two conduits are aligned, the coupling placed between them, the coupling turned to engage both threads simultaneously, and screwed up tight. The objection against it is the necessity for a left-hand die.

The "companion-flange" consists of two similar flanges, the faces machined to a true surface. They are screwed up tight on the ends of the two conduits to be joined, the two ends are aligned and fastened together by means of bolts and nuts, holes being provided in the flanges for the passage of the bolts. Usually a gasket is placed between the two flanges. This is a good joint but obviously unsuited for use where the conduit is run on, or very close to, a wall or ceiling.

The threadless or no-thread coupling is open to none of the

foregoing objections. Its use does not require that the conduit be threaded. The fitting consists of a body with ends split in line with the axis of the conduit. The bore will slip the conduit when the glands are loose. The split ends are externally threaded, to take the



Fig. 16. A No-Thread Conduit Coupling
Courtesy of the Appleton Electric Company, Chicago



Fig. 17. Self-Threading Connector
Courtesy of Crouse-Hinds Company, Syracuse, N. Y.

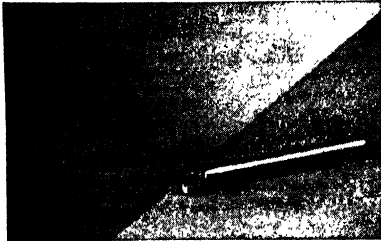

Conduit Accidentally Broken After Concrete is Poured



Conduit Cut off and Concrete Cut Out Around Conduit Ready to Apply Type CCT Self-Threading Connector



Type CCT Self-Threading Connector Installed and Ready to Continue Conduit with Rigid Threaded Connection

Fig. 18. Broken Conduit is Cut Off and Self-Threading Connector is Installed
Courtesy of the Crouse-Hinds Company, Syracuse, N. Y.

internally-threaded glands, as shown in Fig. 16. To install, slack off the two glands, slip the entire fitting on one of the conduits to be joined; bring the two ends together, slip the fitting along the conduit until half of it extends over each end and screw both glands up tight. This compresses the split sleeves, thus making a firm, tight joint.

Self-Threading Connectors. In poured concrete construction it

happens often that the smaller sizes of conduit are broken off at the point where they emerge from the concrete, the break being so near the latter that a die cannot be used for threading the end, nor even the gland of a threadless coupling screwed up. The application of a self-threading connector, as shown in Fig. 17, comes in handy at this point. The broken end of the conduit, Fig. 18, is dressed off as straight as possible and the ragged edges removed from the interior of the conduit. The concrete around it is removed sufficiently to permit the use of a wrench on the body of the connector for screwing the latter onto the conduit. The connector cuts its own thread.

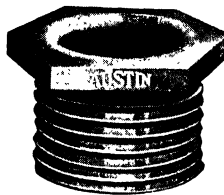

Fig. 19. Chase or Conduit Nipples

Courtesy of the M. B. Austin Company, Chicago

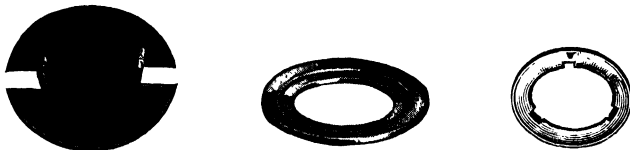

Fig. 20. Knockout Plug and Knockout Reducers
Courtesy of the M. B. Austin Company, Chicago

Chase Nipples. When it is necessary to mount a box or cabinet, with conduit entering from two opposite sides, so that it can be removed without moving the conduits, or if a fitting with a female-threaded hub is to be mounted directly against the box, connections can be made with Chase nipples, as shown in Fig. 19. In the latter case the Chase nipple is passed through the hole in the box and screwed tight into the fitting. In the former case, a coupling on the conduit is butted up against the box and the Chase nipple is screwed into the coupling, the side of the box being clamped tightly between the end of the coupling and the shoulder of the nipple.

Knockout Closers and Reducers. Unused conduit openings in a box should be closed with a device shown at the left in Fig. 20. The

two prongs are inserted in the conduit hole and bent over. When a hole is larger in size than the conduit which goes into it, use two reducers, one inside and the other outside the box, clamping them firmly to the box with a bushing and locknut placed on the conduit. Two styles of reducers are shown, one being provided with a recess and the other having lugs for centering on the conduit hole of the box.

Conduit Pennies. Conduits leaving wall boxes in a downward direction should have their openings closed, on jobs where considerable time elapses between the roughing-in and pulling-in of the wires. Use conduit pennies for this purpose. They are fiber or metal disks inserted in the bushings before the latter are put on the end of the conduit.

FITTINGS IN HAZARDOUS LOCATIONS

Some years ago Industry put the Chemist on its payroll, with the result that many new processes of combining, handling and treating raw materials were evolved that created hazards theretofore not present, or, if present, not recognized. Unfortunately, many tragic events occurred before the existence of these dangers were realized.

Many of these processes utilize substances that are in themselves highly flammable, or emit flammable vapors, dust, lint or other flyings, some of which, when combined with air become highly explosive, requiring but a small spark to set off a detonation carrying destruction and death in its wake.

Since the operation and control of electrical apparatus is inseparable from the production of arcs, sparks or temperature rise, it is clear that in buildings or rooms where these hazards are present proper precautions must be taken to prevent ignition of such substances or vapors.

As a means to this end an extensive line of devices and fittings were designed, which, when correctly selected and installed, render the operation of electrical apparatus safe under all conditions. Although the manufacturers have done a splendid job in meeting the exacting requirements imposed by the conditions, their achievements alone can not assure safety; they can only produce the means of attaining this state. The man who installs these devices, or the one who maintains them in their operation, is of equal if not of greater

importance, for improper selection of devices, slip-shod installation or careless handling of them can set at naught all of the costly design and the precision of the machining of metal surfaces at the joints and the integrity of the screw threads fabricated into the fittings by the manufacturers. Therefore, be extra careful when making an installation in a hazardous location, thus doing your full share toward the elimination of danger to life and property.

The use of the various "proof" or "tight" fittings depends upon whether the particular installation comes under Class I, II, III, or IV, as defined by the National Electric Code, which fully covers the subject. While the code is specific in its requirements of the type and

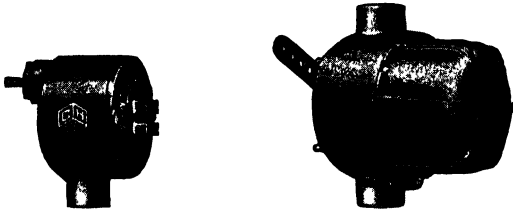

Fig. 21. Explosion-Proof Switch (left) and Dust-Proof Switch (right)
Courtesy of the Crouse-Hinds Company, Syracuse, N. Y.

construction of fitting to be used under each of the four classes, it is not possible to describe every case or situation in this book. An explosion-proof fitting may or may not be acceptable in an area where dust-tight fittings are called for, depending on, (1) whether the device enclosed in the housing creates a rise in temperature through its operation or not; and (2) whether the design and shape of the housing enable it to radiate the heat rapidly enough to keep the housing at a safe temperature. Since there is a blending or overlapping of the two, it is not possible to clearly define the line of demarcation between them. The distinction is largely on functional grounds, that is, the purpose which the fitting is to serve in its respective location.

In Fig. 21 this distinction is exemplified. Each fitting is intended to serve the same purpose, namely, to enclose a mercury switch, the operation of which generates heat. The fitting shown at the left is classed as explosion-proof, whereas the one at the right is classed as dust-tight. Note the difference in the design of the two housings, the dust-tight fitting has a much greater surface area for heat radiation

than the former and remains at a safe temperature even when blanketed with a substantial layer of dust. The former is acceptable for Class I locations but not for Class II; the latter would do for both. Most dust-tight fittings are acceptable in Class I locations, if they are provided with a sealing fitting, as shown in Fig. 22, on each of their conduit entries.

Fig. 21 shows a sealing fitting for insertion in a single, vertical line of conduit; it also can be had for horizontal use, as well as for a multiple number of conduit entries in several directions. Splices, taps or other wire connections are not permitted in any sealing fitting.

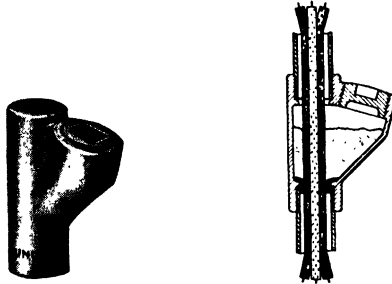

Fig. 22. Conduit Sealing Fitting and Cross Section Showing Wires Sealed in the Conduit

Courtesy of the Appleton Electric Company, Chicago

After the wires have been pulled through the fitting, the sealing compound is poured in, to prevent the passage of vapor or of an explosive flash from one conduit to another. The compound is poured either through the inlet provided in the fitting for this purpose, or through an unused, upward pointing conduit entry. The hole, in either case, is closed with a pipe plug after the pouring of the compound. This plug must engage at least five full threads.

The thickness, or depth of the compound must be not less than the inside diameter of the conduit being sealed, but never less than $\frac{5}{8}$ of an inch. If there are two conduits entering the fitting from above, the compound must be made to rise into them as far as the diameter of the larger conduit. This may require the putting of a nipple into the filling-hole to provide the "head" for forcing the compound (which has rather a sluggish flow) up to the required height. The end of this nipple must be at least 1 inch higher than the point

to which the compound should reach in the conduit; the nipple is left in place and capped with a standard pipe cap.

When there is no conduit entering the fitting from the top, use a fitting with a top entry for use as an air vent when pouring the compound, to avert formation of an air pocket that might prevent entry of the compound to the proper depth in a conduit; this hole to be closed with a pipe plug after the fitting has been filled with compound.

Before pouring in the compound, the space between the wires and the conduit must be packed, to hold the compound. The packing can consist of prepared fillers as first choice, and for second choice, asbestos of fairly long fiber, oakum, and cotton waste. This filler is shown in solid black in the cross-sectional view of Fig. 22.

Pull the wires toward you and pack the filler in well behind them to the required depth, using a small, flat, hardwood stick or a screwdriver not sharp enough to damage the insulating covering of the wires. Then push the wires back (or wedge them, if large), separate them to permit packing between them; then pack the remaining vacant space in the conduit. Only the downward pointing and horizontal conduits must be packed, those pointing upward do not need packing.

In the selection of the correct fittings for any particular installation, much depends upon the layout of the plant. In any given industry there are differences in the type or character of the materials handled or processed. The relative size of the room or area in which the hazardous operation is carried on, and the distance between the building (containing the hazard) and other buildings, depend upon fittings or devices that would be acceptable. The fittings that are safe for one plant might be unsafe for another plant. For this reason, and because the final chapter of safety regulations has not yet been written, it is wise to consult the local enforcing authority when in doubt.

Class I Locations. In these locations highly flammable gases, flammable volatile liquids, or other highly flammable materials are processed, used, handled, or kept in other than original containers. The liquids include such substances as acetone, alcohol, benzol, ethyl-ether, gas, (manufactured or natural) gasoline, lacquer solvents, naphtha, petroleum, and others. They will be found in

chemical works and laboratories, distilleries, dry-cleaning and dyeing plants, certain sections of hospitals, paint-spray plants, varnish plants, certain plastic material (pyroxylin, for example) manufacturing plants, petroleum refineries, filling stations, bulk-oil stations, dip-tank paint shops, artificial silk factories, fabric and paper coating factories, certain sections of rubber, leather, soap and other manufacturing plants, the list of which is expanding by leaps and bounds.

In all Class I locations you must use explosion-proof apparatus and fittings, which means "enclosed in a case designed and constructed to withstand an explosion of a gas or dust within it and to prevent the ignition of gas or dust surrounding the enclosure by an escape of the flash of an explosion within it." This means that every conduit entering or leaving a housing containing a motor starter, switch, circuit breaker, or any other device that may produce an arc or spark must have a sealing fitting, like the one shown in Fig. 22. This fitting prevents the entry of explosive gases into the housing through the conduit and prevents the flash of an explosion within the housing from being communicated to other parts of the system through explosive gas that may be in the conduit. Also, a conduit run between a hazardous and a non-hazardous location should be sealed off so that gases cannot pass from the former into the latter. Only rigid conduit, explosion-proof joints and fittings with threaded connections can be used; no bushings nor locknuts may be used.

Class II Locations. Many substances when being processed for use as food, for commerce and industry, or for the arts and sciences produce a fine dust, which partly remains in suspension in the air and in part settles upon any exposed surface. Nearly all of these dusts, if present in sufficient quantity become explosive mixtures and all of them are highly flammable. When they are allowed to collect on lamps, the windings of motors, or other devices, normal radiation of the generated heat is prevented, which causes burn-outs and fire. The latter travels so rapidly in the dust-laden atmosphere that the effect is akin to an explosion.

Among these dusts are those of cereals, cocoa, dextrine, flour, dried milk, spice, sugar, coal, cork, carbon-black, wood, metal, sulphur, rubber and others. They are present in flour and feed mills, grain elevators, coal elevators, corn starch and rice mills, sugar refineries, wood or cork pulverizing plants, certain sections of

wood-working plants, breweries and distilleries, and other plants.

These locations require fittings that are dust tight, which the Code defines to mean that "the enclosing cases shall be dust tight and that the temperature which such enclosures reach when covered with dust shall not be high enough to reach the ignition temperature of the particular dust concerned." Since some dusts are worse than others, Group E, the metal dusts being the worst, Group F, the coal or carbon-black next, Group G, the grain dusts not quite as bad as those in Group F. Apparatus designed for Group E locations will be acceptable for Groups G and F locations, but the reverse is not so.

Only rigid conduit can be used. Threaded connection must be made to all enclosures containing devices that may produce an arc, such as switches, fuses, controllers, etc., but connections to junction and pull boxes may be made with bushings and locknuts, provided that all conduits entering such boxes are bonded together independently of the boxes. Conduits do not have to be sealed off.

At distribution and meter centers a reasonable quantity of auxiliary steel gutter may be used, but if the conduits are secured to them by bushings and locknuts they must be bonded together independently of the gutters.

Class III and IV Locations. In these locations readily ignitable fibers or substances that produce lint or other combustible flyings are processed, or where such materials are stored only. The Code makes a distinction between the two insofar as apparatus goes, but the conduit and fittings and their installation is practically the same for both. Therefore, since this text covers conduit work only, the two classes are treated as one.

Some of the materials are cotton, cocoa fiber, cotton waste, cotton linters, excelsior, hemp, jute, kapok, oakum, sisal, tow, Spanish moss, and the like. They are found in cotton gins, cotton mills, cotton compresses, cotton-seed-oil mills, mattress and cordage factories, upholstery plants, and others.

Dust-tight housing of arcing devices and rigid conduit installations, as called for under Class II, are required.

THIN-WALL CONDUIT

Tubing. This is made from mild, soft steel and comes in 10-foot lengths, in galvanized or sherardized finish only. No coupling is

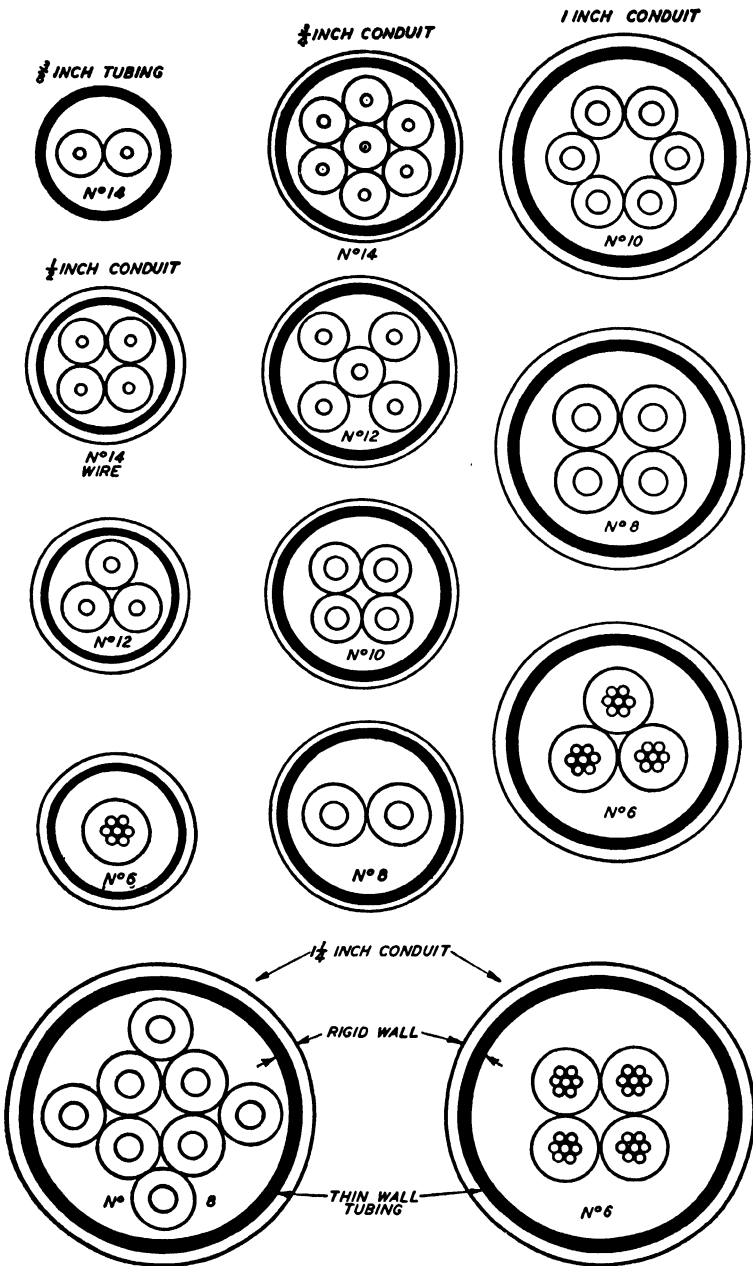

ACTUAL SIZE OF METALLIC TUBING AND RIGID CONDUIT, SHOWING THE MAXIMUM NUMBER OF WIRES (TYPE R INSULATION) INSTALLED IN THEM

included with the tubing, nor is the latter threaded, and one must never try to thread it. The wall is too thin to permit threading. See Table 1 for diameters, weights, and sizes available. By comparison with diameters of rigid conduit, as given in Table 1, it will be found that the wall thickness of thin-wall conduit is about 40% that of rigid conduit. The full-page illustration, page 20, clearly shows this difference in wall thickness between the two types, as well as the maximum number and size of wire combinations permissible within them. The solid black line shows the thickness of the thin wall tubing. The thickness of rigid conduit wall is distance between the inner and outer circles.

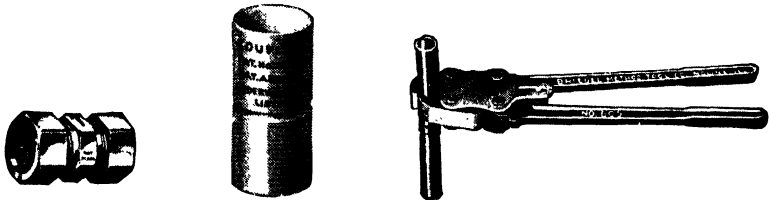

Fig. 23. Couplings for Thin Wall Tubing, and a Special Tool Called the Indenter to Use with Couplings Like the One Shown in Center
Courtesy of the M. B. Austin Company, Chicago, and the Briejel Method Tool Company, Moline, Ill.

Couplings. Since there are no threads on the tubing, the coupling is an important factor, for upon the integrity of its installation depends the electrical and mechanical continuity of the system.

Thin-wall conduit couplings are of two general types: Those for use anywhere that thin-wall conduit is permitted, commonly called "watertight" and those permitted in dry places only.

Watertight couplings consist of a short body having a bore that slips on the tube. Each end of the body carries a male thread, the ends being split in line with the axis of the bore. A gland screwed up on the threaded end of the body compresses the split end, thus tightly clamping the coupling on the tube, see Fig. 23.

Couplings for use in dry locations are usually of the set-screw type, or of the indented type, as shown in Fig. 23. In the latter type the tube is slipped into the coupling. A special tool, Fig. 23, is then used to indent the coupling at several points, thus holding coupling and tube together.

Ells. Regular factory ells can be had, bent from the thin wall tubing in sizes from 1 inch to 2 inches to the dimensions shown in

Table 2. It will be noted that both the radius as well as the offset, is practically the same as in rigid conduit ells. Ells can also be bent from tubing on the job.

But, while thin-wall conduit bends easier than rigid conduit, greater care is necessary for the operation, as it flattens more readily. Special benders and hickies should be used. Radius of elbow should not be less than six times the internal diameter of the tubing.

Connectors. These consist of a body which is similar to a coupling at one end, to take the thin-wall tubing, and a short male-threaded extension on the other end, Fig. 24, for insertion into an outlet box. A locknut is then threaded on, clamping the side of the

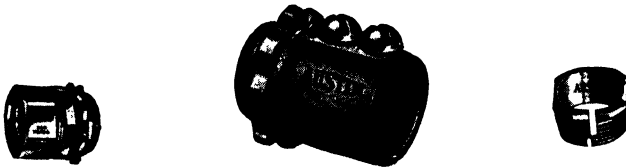

Fig. 24. Water-Tight and Set Screw Type Connector and Adapter
Courtesy of the M. B. Austin Company, Chicago

box between the locknut and a shoulder on the body of the connector. The connectors come in either compression, set-screw or indenting types, same as the couplings.

Adapters. The adapter, Fig. 24, is used when it is necessary to secure thin-wall conduit to a conduit fitting having a threaded hub. Screwing the adapter, previously slipped onto the thin-wall tubing, into the threaded hub causes the adapter to grip the tube and hold it in place.

GROUNDING

Grounding, in the sense in which it is meant or used in relation to interior electric wiring, comes under two headings, (1) "System Ground," and (2) "Equipment Ground." The purpose of the two is separate and distinct from each other.

System Ground. This is an electrical connection of low resistance and ample carrying capacity (as compared with the K.W. capacity of the connected load of the installation) between a certain point, generally the service side of the service switch, in the wiring system, and the earth, or ground, as it is commonly called. The requirements for

grounding the wiring installed in conduit are the same as those for other types of wiring systems.

Equipment Ground. The purpose of this ground is to eliminate fire hazards, and to avert shock, injury, and possibly death, to persons who are in electrical contact with the ground or earth, and who contact conduit, or other metal structure used for enclosing electric wires or other devices, that may have become "live" through the failure of the insulation of the wires or devices enclosed within the

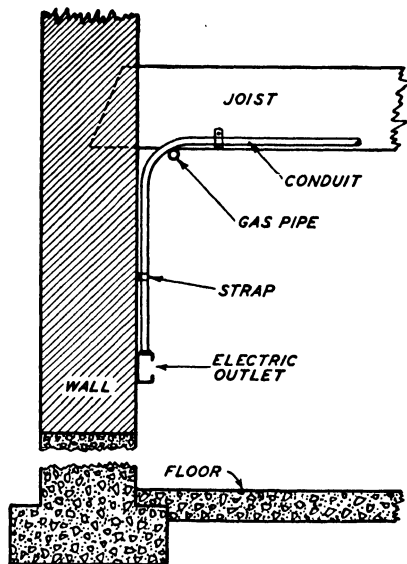

Fig. 25. Illustrating How Current Can Flow Through Ungrounded Conduit to Gas Pipe or Other Grounded Object

conduit system. The equipment grounding requirements are the same for both, rigid and thin-wall conduit.

Since practically all electric current, supplied to consumers at 600 volts or less, comes from a source having one "leg" or side of the circuit grounded, then a person in contact with any metal part of the plumbing, gas-piping, or other conductive material leading to ground, would be subject to a dangerous, possibly fatal shock upon touching a conduit that has not been grounded and which has become "live" through such failure of insulation within the conduit system. The flow of current would be from the "live" conduit

through all or part of the person to the grounded part of the structure with which the person is in contact at the moment, thence to ground, thence to the source of supply through the grounded conductor.

Further, such a live, ungrounded conduit would be a potential fire hazard. Consider, for example, a conduit wiring installation in an ordinary dwelling, wherein the materials of the building structure normally keep the conduit out of electrical contact with the ground. Suppose the installation, as shown in Fig. 25, was in the unfinished basement of this building. Fig. 25 shows a conduit running along the side of a joist, near its lower edge, and down to an outlet on the wall. A gas-pipe has been installed which runs across the bottom of the joist, at right-angles to it. At the point the gas-pipe and conduit cross they are in light contact with each other. A wire becomes grounded to the conduit in the building, making a live conduit. At the point of contact between the two pipes, an electric current flows from the conduit to the gas-pipe, thence to ground, thence to the source of supply through its grounded conductor.

The flow of current however may not be enough to blow the fuse, but is heavy enough to set up an arc between the two pipes at the point where they touch, due to the light contact. It would then be only a matter of time until this arc burns a hole through the gas-pipe, bringing the arc into contact with the gas. The result would be a fire, possibly even an explosion.

Or, if the contact between the gas-pipe and the conduit were sufficiently good that a flow of current would set up neither an arc nor a dangerous heating at that point, there would be yet another hazard. Farther along the gas-pipe, say at the meter, the connection may be poor because the threads are corroded or not well set up. The result would be a rise in temperature at that point, perhaps to such a degree as to detonate the gas.

The grounding of the current-carrying conductors to the conduit system could be brought about by a defective insulating base of a current-carrying device, a poorly-taped joint, or a breakdown of the insulating covering of the wires.

Grounding the conduit system averts this danger because, with the conduit effectively grounded, there can be no appreciable difference of potential between it and the ground. For this reason the

grounding of conduit should always be done in the best manner and with the greatest care possible.

In order to ensure the integrity of the electrical or metallic connection throughout the entire conduit system, it is essential that every section of conduit be screwed up tight into its coupling or the threaded hub of its fitting. Where compression-type, set-screw or indented types of thin-wall conduit couplings or connectors are used, it is necessary that each of these be set up tight. Where boxes of the knockout type are entered, the bushing must be threaded on the conduit as far as it will go and the locknut set up tight. As already



Fig. 26. Adjustable Ground Strap (left) and Bonding Bushing (right)
Courtesy of the M. B. Austin Company, Chicago

stated, it may be necessary to use two locknuts, one inside, the other outside the box, which makes a better job.

Only outlet boxes presenting flat sides to the entry of conduits can be used when the latter are to enter the sides of the box, as only a flat side gives a good seat for bushing and locknut. Galvanized boxes provide a better ground than the enameled, because the enamel, unless completely removed, greatly reduces the area of contact surface between the face of the box and the faces of bushings and locknuts.

Where a large number of conduits enter the main distribution cabinet, it is good practice to install a ground strap, which is shown in Fig. 26, on each of the conduits entering this cabinet and connect all of the ground clamps together with wire or strips of copper, to ensure a good electrical connection. Some localities require that such cabinets have a galvanized finish, instead of the usual black asphaltum. Others require a locknut on the outside of such cabinets and both a locknut and bushing on the inside. In hazardous locations conduit entry must be made through threaded hubs that are a part of, or permanently attached to, the cabinet; bushings and locknuts being prohibited at these points.

The National Electric Code gives detailed requirements of sizes of ground conductors, bus-bar, pipe or wire; the respective method of installing and the points of attachment under all conditions of use and character of electric service supply. For this reason these various details are omitted from these pages. The code requirements change from time to time, as experience and new developments point to better ways of safeguarding persons and property. The sum of these changes constitutes the National Electric Code of today.

The reader must bear in mind that the Code, severe as some of its regulations may seem, stipulates only the minimum requirements acceptable for the respective conditions. Further, that although the Code is used almost universally, there are some local jurisdictions whose requirements go beyond what is called for in the Code. These extra requirements will be found in every part of the work, as well as those relating to grounding. Therefore, it is necessary to confer with the local enforcing authority relative to their specific requirements for the work.

Putting on the equipment ground requires the grounding of all wire-enclosing metal raceways, as well as all metal enclosures of current-carrying equipment, including the exposed parts of the metal frames of motors and kindred devices, through a low-resistance conductor. This is accomplished by the firm setting-up of all bushings and locknuts, bolts and nuts, screws and conduit threads that serve to combine the sundry separate items into one complete metallic structure, which is continuous (electrically as well as mechanically) from the service entrance to every part of the system; and connecting the whole to a good ground by means of suitable grounding conductors.

From the largest conduit on the system, preferably the point where the conduits are bonded together, a grounding conductor is run to the point where the water-service pipe enters the building. This conductor is connected to the water pipe on the supply side of the meter, either by means of a threaded connection or a ground clamp firmly attached to the water pipe.

Be sure to thoroughly clean the water pipe, or any other pipe or conduit before you put on a ground clamp; if the conduit is black-enameled, scrape off the enamel completely, to ensure a good ground connection. Set up all threads, screws, bolts and nuts tightly.

If the ground connection is made on the house side of the water meter put a ground clamp on the water pipe on each side of the water meter, connecting the two clamps together by a bonding jumper, that is, a copper wire or strap of ample size, so that the removal of the water meter will not leave a gap in the ground connection.

If there are any boxes or other metal enclosures to which conduits are attached with bushings and locknuts (intervening between the point of attachment of the ground conductor to the conduit system and the point of entry of the service conduit), a bonding jumper should be put on at each of these points, so that reliance for ground will not be upon bushings and locknuts alone.

Attachment of bonding jumpers to boxes or ground clamps should be made with lugs sweated onto the jumper wire.

If there is a well on the premises its casing may be used as a ground, in the absence of regular water service.

The grounding conductor may be a wire, bare or insulated, bus-bar, conduit or other pipe; wire of No. 4 size or larger, or a bus-bar, may be run exposed or concealed on the surface of or within the walls or ceiling of the building structure, with or without insulators. Conduit used as a grounding conductor must be installed in the same manner as wire-carrying conduits. But whatever is used for a ground conductor, it, as well as bonding jumpers, must be of the capacity specified in the code for the kilowatt connected load of the particular job.

The system ground conductor of a wiring system (not of the race-ways nor enclosures) should have an insulating covering at least as good as that of the installation which it serves, unless it is used as a common grounding conductor, that is, used for both "system" and "equipment" ground. This can be done in some jurisdictions but not in others.

When used only as a system ground, the best practice is to run it in conduit just like the rest of the installation. In this case the conduit containing the ground wire must also be grounded. However, when this ground wire serves as a common ground for both, system and equipment, and has a capacity equal to No. 4 wire or larger, it may be bare and be run exposed or concealed, with or without insulators, provided it is not exposed to mechanical injury.

In some jurisdictions this ground wire must be run in conduit under any condition. Other jurisdictions do not permit a common ground. You must be guided by local conditions in all cases.

Grounding connections to the frames of motors which are set on slide rails, to permit belt tightening, is made by a short length of flexible metallic conduit between the end of the rigid or thin-wall and the terminal housing on the motor.

STEEL BOXES AND CABINETS

Use. Steel boxes, larger than regular outlet boxes, are used for enclosing fuse-panels, switches, motor-starters, circuit-breakers, relays and kindred devices; for making splices and taps in wires; for breaking a long run of conduit to make its fishing and the pulling-in of the wires easier. They are used in place of ells; also to change the plane of a conduit run; and to change the relative position that the wires occupy in a group without having to cross them after they leave the conduit. The boxes are also used in a combination of two or more of these purposes.

A splice of a conductor in a conduit wiring system can be made only in a metal box of some sort. Also, there is a limit to the length of a run of conduit that can be readily "fished" or "pulled," especially with several ells, or their equivalent in offsets, in the run. Fishing a long run is not easy.

Size. The size of the box is important. Do not use one that is too small. Remember that you must have room for connecting the conduits to the box as well as room for the pulling-in of the wires. Saving twenty-five cents in the price of the box many times wastes several dollars in the pulling-in labor. The smaller the box the more abrupt will be the angle at which you must pull, greatly increasing the friction; also, what is worse, the small box makes it difficult to effectively feed the wires into the conduit when pulling through the box, to say nothing of getting the final loop or bight of the wires into it to permit putting on the cover. In addition to making the box large enough to properly serve its purpose it also is important that the conduit entries into it be placed at such points, relative to the bottom and to the sides, that the maximum ease of wire installation results from its use. Much of the advantage accruing from the

ample size of the box can be lost entirely by an incorrect spacing of the conduit entries.

Construction. Before going further let us make clear just how these boxes are made and how they are laid out. Fig. 27 shows how a "screw cover" box appears to an observer looking at the open front of the box. There is a flange on all four sides at the front of the box extending inward and being usually one inch in width. It serves to stiffen the box and to provide a rest or backing for the cover plate,

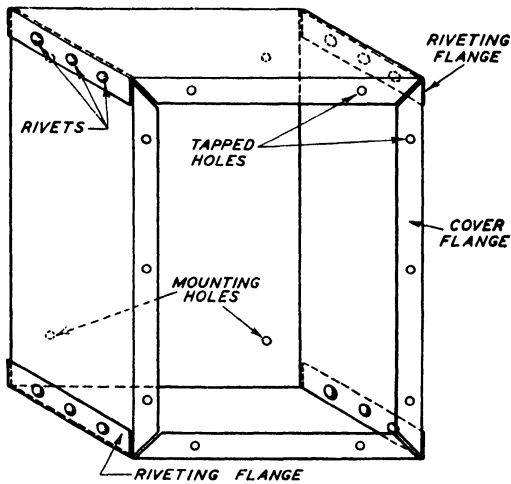

Fig. 27. Construction of Sheet Steel Pull Box

which is secured by machine screws passing through it and engaging the tapped holes in the flange. These holes are omitted from boxes of the "hinged cover" type. Dotted lines at the four corners indicate the riveting flange, which secures the adjacent sides to each other. The flange is turned to come outside the box in the figure but some box makers put the flange on the inside of the box.

When considering the number of conduits that you can get into any one side, top or bottom of a box, remember that you lose one inch of space in that side, top or bottom to which this flange is riveted, at each end, because you must keep the conduit far enough away from the inner edge of the flange to permit the locknut to clear it. If you fail to do this the locknut will ride on the flange, making it impossible to draw its face properly against the box. In the case of a

box that is being made for a particular location, the box maker will take care of this, because he can arrange to have the flange on either the sides or the ends. But when considering a box already made, for use in a location with most of the conduits entering from one direction, be sure to ascertain the arrangement of the riveting flange in the box first, to save unnecessary expense later.

The cover flange sometimes is a source of annoyance, too, because it reduces the work space by 2 inches in each direction. This is of comparatively little consequence in the case of large boxes, but in

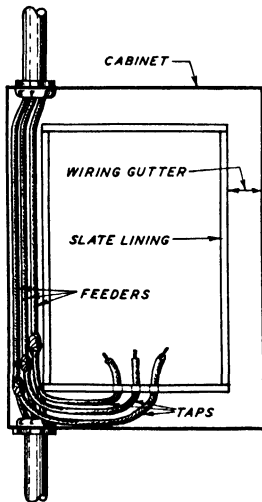

Fig. 28. The Correct Way of Running a Feeder Through a Gutter-Type of Cut-Out Cabinet

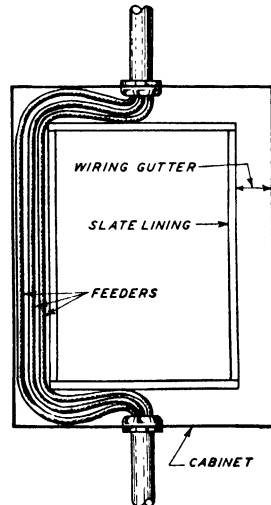

Fig. 29. The Wrong Way of Running a Feeder Through a Cabinet. Note the Four Sharp Bends in the Wire

the smaller ones it is important enough to warrant making allowance for it. Consider, for example, the case of a box which is 6 inches wide by 8 inches long. Deducting the one inch of flange width all around leaves only 4 inches by 6 inches of work space.

CONNECTING FEEDERS AND RISERS TO DISTRIBUTION BOXES

The feeders can enter a distribution box that has a wiring space back of the fuse panel at any point, regardless of their size, whereas in a gutter type of box this is so only if the feeders are relatively small, or if they terminate therein. If the feeders pass through the box, on their way to the next one, they should enter at either the

right or left-hand side of the box, as shown in Fig. 28, not at the center, as shown in Fig. 29. Reference to Fig. 29 shows that there are four 90-degree bends in the feeders, one at the bottom conduit, turning to the left, one turning upward, one at the top turning to the right and one turning upward into the top conduit. This is very bad practice because there is not enough room in the gutter for making these bends without injury to the insulating coverings of the wires. True, there are bends in the tap wires extending from the feeder to the terminals of the panel, but these need give you no concern, because they are of much smaller size than the feeder to which they connect.

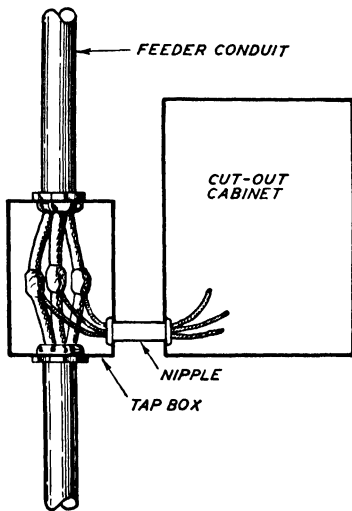

Fig. 30. Method of Joining Cut-Out Cabinet to Feeder Tap Box by Using Short Nipple

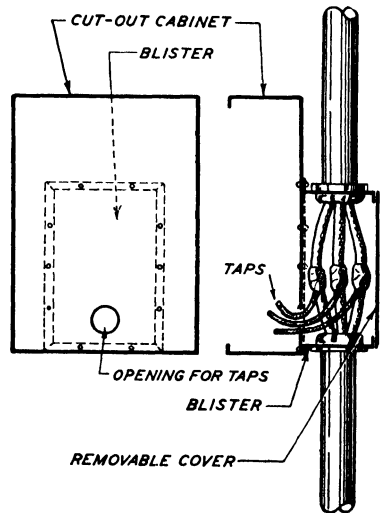

Fig. 31. Method of Attaching Feeder Tap Box to Back of Cut-Out Cabinet. (The dotted lines are outlines of blister bolted or riveted to back of cabinet)

There are instances due to space limitations, or to the relatively large size of the "riser," as a vertical feeder is usually called, when it is not practical to run the feeder through the cabinet. In such a case the riser is run behind, or to the side of, the cabinet, a "tap box" or junction box being installed above, or alongside of the cabinet, as shown in Fig. 30. The feeder is tapped in the tap box and the tap wires extend over to the cabinet through a short piece of conduit.

An alternative method is shown in Fig. 31, the tap box forming

a blister on the back of the cabinet and being either bolted or riveted thereto. The riser is run through the blister, in which, also, the tap is made. A hole is provided in the back of the cabinet for the passage of the tap wires. A Chase nipple, passing through this hole and secured to the box with a bushing at its threaded end, averts a cutting of the insulating covering of the wires by the sharp edge of the hole. A hinged or screw cover, as shown, gives access to the tap box. This form of construction can be used only where the back or the side of

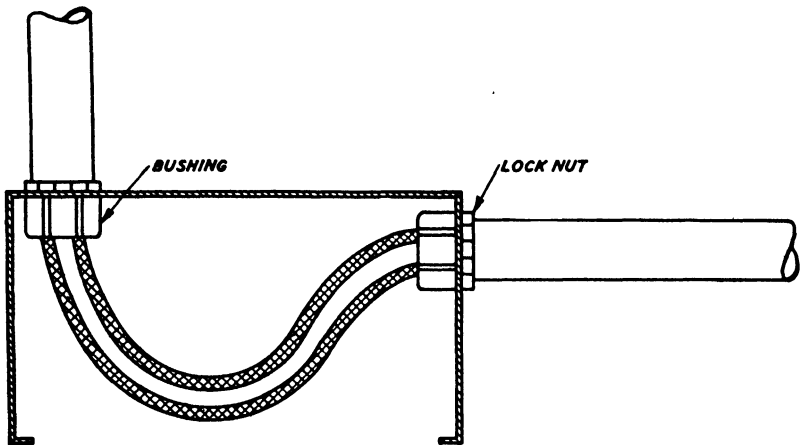

Fig. 32. Showing Sweep of Wires in Pull Box

the blister is accessible, which would be the case, for example, where there is a pipe shaft provided for the running of conduits and other piping, which is common practice in even medium-sized buildings.

Connection of a tap wire to a feeder of much larger size, without fuse protection, as in the cases shown, is permissible, on account of the short length of unprotected wire involved.

LOCATING PULL BOXES

When a pull box is to take the place of an ell, be sure to make it deep enough to take the sweep of the wires to be pulled. The length of the box should be not less than seven conduit diameters and the depth not less than four diameters.

The sweep of the wires in the pull box is shown in Fig. 32. As this box is relatively deep, the width should be at least 50 per cent

more than given for a straight-through box. Remember that you need room in the box for your hands when feeding-in and, if the wires are large, there must be room even for your arms in the box for effective feeding.

Fig. 33 shows a conduit coming up through the floor, near the angle of two walls, extending up to the ceiling and turning to the left on the latter, a pull box being needed in the run to facilitate getting the wires into the conduit. Fig. 33 shows the box in the

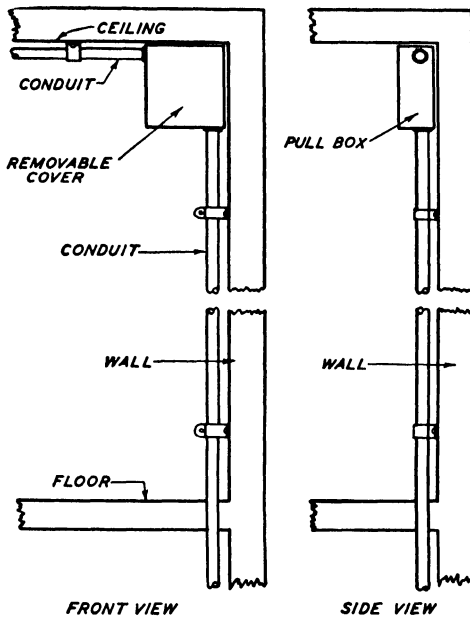

Fig. 33. Showing Pull Box in Wrong Location

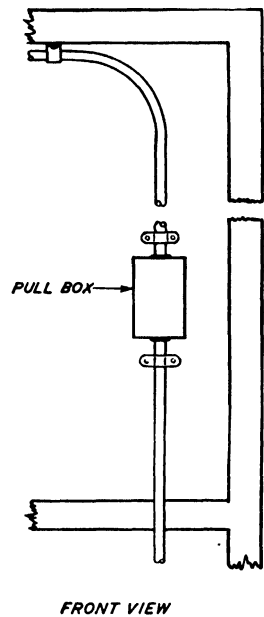

Fig. 34. Showing Pull Box in Correct Location

wrong location. Feeding-in and pulling-in of the wires under this arrangement can only be done by a man standing on a ladder or on a scaffold of some sort; moreover, he has no room in which to make a pull. Neither can he do effective feeding, for, in addition to the restricted feeding space, he is further burdened by having to lift the length of the wires between the ceiling and the floor.

The proper place for the pull box is down on the wall, as shown in Fig. 34. The workman can then stand on the floor when mounting the box and pulling-in the wires. He has a free, comfortable pull,

either up or down, and favorable conditions for feeding, without being subjected to excessively tiresome strain, as is the case in the preceding method.

The angle of two walls, or of ceiling and wall is the worst place in which to put a pull box, especially if the pulling-in is likely to take

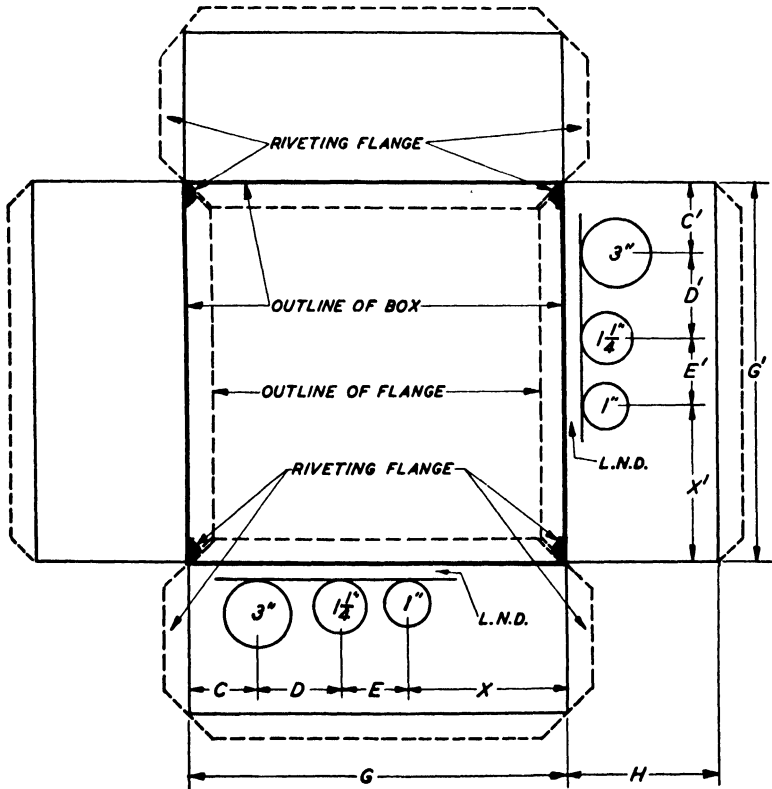

Fig. 35. Sheet Steel Box Layout for a Surface Mounted Pull Box with Screw Cover

some elbow-grease. Remember that you must pull enough slack through the box to reach the next one. You can not make much of a pull when there is only a foot or two of space to do the pulling in. Also, you need clear space on the floor for the loop, or bight, of the wires, to effectively feed them into the conduit on the second pull. Therefore pick a location that provides the room you need, and, if the run is heavy enough to require a winch or block and tackle for

the pull, it will permit you to readily rig-up your tackle or set the winch for making the pull. Remember that it is easier to work while standing on the floor than it is when you are on a ladder.

Box Layout. Fig. 35 shows the layout for cutting the steel and making the box. The heavy line is the outline of the box, and the dotted line on the inside is the outline of the flange at the opening. The light solid lines outside the box denote the development of the box, that is, the outline of the four sides as they would appear if bent outward to lie flat. It is in this space that the dimensions and locations of the conduit entries are shown. On the outside of the light solid lines are dotted lines, which indicate the development of the flange. The flange to the right and left of the top and bottom members is the riveting flange, for holding the box together. In laying out the box it is assumed that it is lying flat with the open side up.

Drilling Template. To give the box maker the information that he needs for making a box that will fit the job, so that it can be installed without changes in its structure, you prepare a drilling template, similar to Fig. 35. In the rectangles lying outside the central square, that is, the outline of the box, you draw a circle for each conduit entry coming from the respective direction; these circles may vary according to the relative size of conduit to go into it, or they may all be of the same size. Inside of each circle you place the number denoting the trade size of the conduit to enter at that point; remember that you indicate the size of the conduit, not the size of the hole you want. If you are limited as to space and are not adept at making legible small figures you may have difficulty in marking the conduit sizes, which are expressed with a whole number and a fraction. In such a case do not designate the sizes by inch dimensions but use a numbering system instead, such as Number 1 for $\frac{1}{2}$ -inch conduit, Number 2 for $\frac{3}{4}$ -inch conduit, and Number 3 for 1-inch conduit. Be sure to put a notation on the template explaining the use of the numbers.

The next thing to put on the template is the spacing of the conduits and the spacing from the side of the box to the first conduit, respectively; also how far out from the back of the box the conduits are to be constructed. For your convenience in determining these spacings refer to Table 3, which is to be used when the conduits are in line on their tangents and, refer to Table 4, which is to be

used when the conduits are in line on their centers, or their outside circumference. These distances are not the same for the two methods of alignment of conduits, although the difference in the case of one size and the next following conduit size is negligible. But when there is a spread of six or eight sizes between adjacent conduits the difference in spacing between the two methods of alignment becomes quite pronounced.

These spacing dimensions are always taken to mean the distance from the center of one conduit to the center of another, or from the center of the conduit to the back or side of the box, unless otherwise mentioned.

The template should also state whether the box is intended for surface or wall mounting, that is exposed, or whether it is wanted for flush mounting, that is, concealed; whether it is to have a screw cover or a hinged cover and, in the latter case, how the cover is to be held shut, that is, with screws on the open side or by means of a catch. Screw covers for use on flush-mounted boxes are usually made large enough to extend one inch beyond the box all around, in order to cover the point where box and plaster meet. Hinged covers for flush-mounted boxes are not fastened directly to the box, but to a mat, which, in turn, is secured to the box by means of

TABLE 3. Center to Center Spacing of Holes for Conduits. With Conduits Aligned on Tangents to Give $\frac{1}{8}$ " Minimum Clearance of Locknuts on Long Diameter. All Dimensions Are in Inches

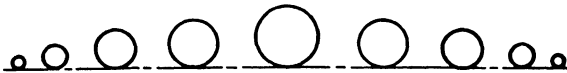

Conduit Size Inches	$\frac{1}{2}$	$\frac{3}{4}$	1	$1\frac{1}{4}$	$1\frac{1}{2}$	2	$2\frac{1}{2}$	3	$3\frac{1}{2}$	4	$4\frac{1}{2}$
$\frac{1}{2}$	$1\frac{1}{4}$	$1\frac{7}{16}$	$1\frac{9}{16}$	$1\frac{11}{16}$	$1\frac{13}{16}$	2	$2\frac{1}{8}$	$2\frac{3}{8}$	$2\frac{1}{2}$	$2\frac{11}{16}$	$2\frac{5}{8}$
$\frac{3}{4}$	$1\frac{7}{16}$	$1\frac{9}{16}$	$1\frac{3}{4}$	$1\frac{7}{8}$	2	$2\frac{1}{4}$	$2\frac{3}{8}$	$2\frac{11}{16}$	$2\frac{7}{8}$	3	$3\frac{1}{8}$
1	$1\frac{9}{16}$	$1\frac{3}{4}$	$1\frac{7}{8}$	$2\frac{1}{16}$	$2\frac{3}{16}$	$2\frac{5}{8}$	$2\frac{7}{8}$	$2\frac{7}{8}$	$3\frac{1}{16}$	$3\frac{1}{4}$	$3\frac{3}{8}$
$1\frac{1}{4}$	$1\frac{11}{16}$	$1\frac{7}{8}$	$2\frac{1}{16}$	$2\frac{1}{4}$	$2\frac{7}{16}$	$2\frac{5}{8}$	$2\frac{7}{8}$	$3\frac{3}{16}$	$3\frac{7}{16}$	$3\frac{3}{8}$	$3\frac{3}{4}$
$1\frac{1}{2}$	$1\frac{13}{16}$	2	$2\frac{3}{16}$	$2\frac{7}{16}$	$2\frac{9}{16}$	$2\frac{11}{16}$	$3\frac{1}{16}$	$3\frac{3}{8}$	$3\frac{5}{8}$	$3\frac{3}{4}$	4
2	2	$2\frac{1}{4}$	$2\frac{3}{8}$	$2\frac{5}{8}$	$2\frac{9}{16}$	$3\frac{1}{16}$	$3\frac{3}{8}$	$3\frac{5}{8}$	4	$4\frac{3}{8}$	$4\frac{3}{4}$
$2\frac{1}{2}$	$2\frac{1}{8}$	$2\frac{3}{8}$	$2\frac{5}{8}$	$2\frac{7}{8}$	$3\frac{1}{16}$	$3\frac{3}{8}$	$3\frac{11}{16}$	$4\frac{1}{16}$	$4\frac{3}{8}$	$4\frac{9}{16}$	$4\frac{3}{4}$
3	$2\frac{3}{8}$	$2\frac{11}{16}$	$2\frac{7}{8}$	$3\frac{3}{16}$	$3\frac{3}{8}$	$3\frac{3}{4}$	$4\frac{1}{16}$	$4\frac{7}{16}$	$4\frac{9}{16}$	$5\frac{1}{16}$	$5\frac{1}{4}$
$3\frac{1}{2}$	$2\frac{7}{8}$	$2\frac{7}{8}$	$3\frac{1}{16}$	$3\frac{7}{16}$	$3\frac{5}{8}$	4	$4\frac{3}{8}$	$4\frac{11}{16}$	$5\frac{3}{8}$	$5\frac{3}{8}$	$5\frac{5}{8}$
4	$2\frac{11}{16}$	3	$3\frac{1}{4}$	$3\frac{9}{16}$	$3\frac{11}{16}$	$4\frac{3}{8}$	$4\frac{9}{16}$	$5\frac{1}{16}$	$5\frac{3}{8}$	$5\frac{5}{8}$	$5\frac{7}{8}$
$4\frac{1}{2}$	$2\frac{13}{16}$	$3\frac{1}{8}$	$3\frac{3}{8}$	$3\frac{3}{4}$	4	$4\frac{3}{8}$	$4\frac{3}{4}$	$5\frac{1}{4}$	$5\frac{5}{8}$	$5\frac{7}{8}$	$6\frac{1}{8}$

machine screws. The mat overhangs the sides of the box in order to cover the plaster joint, as in the case of the screw cover.

Templates for cabinets, that is, boxes to be used for the housing of fuse or distributing panels, should show (in addition to the style of mounting, surface or flush,) whether back-wiring pocket, wiring-gutters, or both, are wanted. If these are wanted, make a notation on the template, as follows: Cabinet to have 4-inch (or whatever width you may want) gutters all around. If you want the top or the bottom gutter to be wider than those at the sides, for greater ease in handling the feeder ends, be sure to give this information as well as the width wanted. The wiring-gutter width, as shown in Fig. 28, is the distance from the inside of the box to the liner. The notation for the back-wiring pocket may be as follows: Back-wiring pocket to be 8 inches deep, or whatever depth you may want.

The back-wiring pocket is a space between the back of the panel and the box, used to bring the wires to their respective point of connection, for tapping the feeder, and for its passage through to the conduit extending to the next floor. The depth of the back-wiring pocket is governed by the size and number of wires that must be handled therein; keep in mind that these taps and connections are made after the panel is mounted in the box. Access to this

TABLE 4. Center to Center Spacing of Holes for Conduits Aligned on Their Centers, to Give 1/8" Minimum Clearance of Locknuts on Long Diameters. All Dimensions Are in Inches



Conduit Size Inches	1/2	3/4	1	1 1/4	1 1/2	2	2 1/2	3	3 1/2	4	4 1/2
1/2	1 1/4	1 7/16	1 9/16	1 3/4	1 15/16	2 3/16	2 7/16	2 7/8	3 3/16	3 7/16	3 11/16
3/4	1 7/16	1 9/16	1 11/16	1 5/8	2 1/16	2 5/16	2 5/8	3	3 3/8	3 5/8	3 7/8
1	1 9/16	1 11/16	1 13/16	2 1/16	2 3/16	2 7/16	2 3/4	3 1/8	3 1/2	3 3/4	4
1 1/4	1 3/4	1 15/16	2 1/16	2 1/4	2 7/16	2 11/16	2 5/8	3 3/8	3 1/2	3 11/16	4 3/16
1 1/2	1 15/16	2 1/16	2 3/16	2 7/16	2 9/16	2 13/16	3 1/8	3 1/2	3 7/8	4 1/8	4 3/8
2	2 3/16	2 5/16	2 7/16	2 11/16	2 15/16	3 1/16	3 5/16	3 3/4	4 1/8	4 3/8	4 5/8
2 1/2	2 7/16	2 5/8	2 3/4	2 15/16	3 1/8	3 3/8	3 5/8	4 1/16	4 3/8	4 5/8	4 7/8
3	2 7/8	3	3 1/8	3 3/8	3 1/2	3 3/4	4 1/16	4 7/16	4 15/16	5 1/16	5 5/16
3 1/2	3 3/16	3 3/8	3 1/2	3 11/16	3 7/8	4 1/8	4 3/8	4 5/8	5 1/8	5 3/8	5 5/8
4	3 7/16	3 5/8	3 3/4	3 15/16	4 1/8	4 3/8	4 5/8	5 1/16	5 3/8	5 5/8	5 7/8
4 1/2	3 11/16	3 7/8	4	4 3/8	4 3/8	4 5/8	4 7/8	5 5/16	5 5/8	5 7/8	6 1/8

back-wiring space is provided by making the back of the box, or one (sometimes both) of its sides removable and held in place by hinges and screws, or by screws entirely. A box with removable sides must be wall or surface-mounted, as otherwise the sides would not be accessible. A box with removable back must be mounted in such a way that there is free access to its back.

In determining the size or location of a box, find out if it is necessary to cut the length of conduit. Many times the shifting of a box a short distance, or an increase of one of its dimensions by a few inches, will avert the necessity for a cut in the length of conduit needed in the run between one box and another box. It is in risers that you are most likely to encounter such situations, although the possibility of their occurrence in horizontal runs should not be ignored.

Fig. 35 shows the conduit entries in a box to be mounted on either wall or ceiling and used for making a 90-degree bend in the conduit run. There is considerable space from the lower right-hand corner of the box to the first conduit, in each direction, the spaces being marked X and X' , respectively. These spacings should be large enough to provide a radius from six to seven times the inside diameter of the respective conduits. This radius is necessary to provide an easy sweep for the wires to be pulled in and through the box.

Example 1. Make a drilling template for a box where there is a 3-inch, a $1\frac{1}{4}$ -inch, and a 1-inch conduit entering the bottom of the box and the same number and sizes of conduit entering from the right. The conduits come up through the floor to the box. The conduits on the right side are fastened to the wall. They must enter the box near its back and the alignment will be on their tangents. Determine the height, width, and depth of the box.

SOLUTION. On a sheet of paper draw an outline of a drilling template similar to Fig. 35, except that you need not show any of the dotted lines nor any of the flanges. The lines may all be of the same weight or thickness. In the lower rectangle of the template draw a light guide line parallel to and a little below the outline of the bottom side of the box. This space should be marked LND (lock-nut dimension) similar to Fig. 35.

Next, draw three circles (may all be of same size) below and touching this guide line; put the respective conduit size in each of these circles. Draw a light line downward from the center of each circle, and then draw in the dimension lines and arrow points to show the spacings C , D , E and X , but omit the letters. Next, draw a light line down from the left-hand and the right-hand corner of the rectangle, drawing in the dimension line and arrow points for spacing G , the width of the box. Perform each of these operations in the rectangle on the right-hand side of the box, omitting the letters.

Draw in guide and dimension lines with arrow points for H , the depth of box.

In this example the conduits align on their tangents. By referring to Table 3, determine the distance between the 3-inch and the 1¼-inch conduit by going down the first column, headed "Conduit Size," to the number 3, then horizontally to the column headed 1¼. The number 3⅝ is the value of *D* and *D'*, Fig. 35. The spacing between the 1¼-inch and the 1-inch conduit is obtained by going down the first column in Table 3 to the number 1, then horizontally to the column marked 1¼ at top. The number 2½ is the dimension *E* and *E'*.

Six times the diameter of the 1-inch conduit (6 inches) is not enough for spacing *X* and *X'*. Since you are making a 90-degree turn of all conduits, you need a radius six times the inside diameter of the 3-inch conduit. This radius is the distance between the 3-inch conduit to the side of the box in the direction of the turn. This dimension is 18 inches. Therefore deduct from 18, the sum of *D* and *E* (3⅝ + 2½ = 5¾). Thus, 18 - 5¾ = 12¾, which is the value of *X* and *X'*.

The dimensions *C* and *C'* are obtained from Table 5 by going down the first column headed "Conduit Size" to the number 3. From the second column headed "Distance Center to Back or Side of Box" follow down to the number 2⅝, opposite the number 3 in the first column, which is the dimension of *C* and *C'*.

The width and length of the box are determined by adding the values of *C*, *D*, *E* and *X* together, Fig. 35. Thus, 2⅝ + 3⅝ + 2½ + 12¾ = 20⅜ inches. This is dimension *G* and *G'*. The depth of the box, *H*, should be not less than twice the outside diameter of the largest conduit, or 2 × 3½, that is, 7 inches.

TABLE 5. Conduit, Locknut, and Cable Support Data

Conduit Size Inches	Distance Center to Back or Side of Box Inches	Size of Hole to Take Conduit Inches	Size of Drill for Female Thread Inches	Maximum Locknut Diameter Inches	Russell & Stoll Cable Supports	
					Over-All Diameter Inches	Height or Length Inches
½	⅝	⅜	⅜	⅜
¾	¾	⅜	⅜	⅜
1	1	⅜	⅜	⅜	1⅜	1⅜
1¼	1¼	¾	¾	¾	2⅞	1⅞
1½	1⅜	2	1⅞	2⅞	2⅞	2⅞
2	1¾	2½	2⅞	2⅞	3⅞	2⅞
2½	2	3	2⅞	3½	3¾	3⅞
3	2⅜	3⅝	3¼	4⅝	4⅞	3¾
3½	2⅝	4⅝	3¾	5	5	3¼
4	3	4⅝	4¼	5½	5⅞	3⅝
4½	3⅜	5⅞	4¾	6	6¼	3⅞

TABLE 6. Weight per Square Foot and Thickness of Sheet Steel U.S. Standard Gauge

Size Gauge	Weight Pounds	Thickness Inches
16	2.6	.0625
14	3.2	.0781
12	4.5	.109
10	5.8	.141

Weight of Boxes. A rough-and-ready method of computing box weights, which is close enough for practical purposes, is given below. Since you may not have access to a table when you want to find the weight of a box, it would be well to memorize the following method.

Take the width of the box in inches, plus the depth in inches, plus 1 inch; call the sum of these three, value *A*.

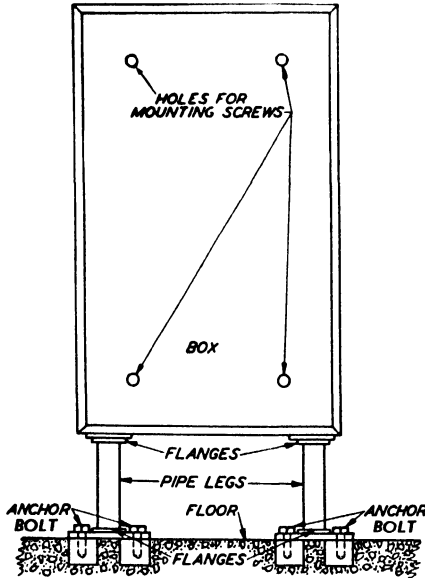

Fig. 36. Method of Mounting Large Pull Boxes on a Floor

Take the length of the box, in inches, plus the depth in inches, plus 1 inch; call the sum of these three, value *B*.

Now, multiplying, $A \times B \times 2$ equals the square inches of steel in the box. Dividing this product by 144 gives us the number of square feet.

Multiplying this product by the weight per square foot of the gauge steel in Table 6, which we want to use, will give us a weight of box and cover.

Mounting Pull Boxes. For mounting pull boxes on wall or ceiling there are usually two, four or even more holes in the back of the pull box, of a size to take 10-24, 14-20, $\frac{5}{16}$ inch, $\frac{3}{8}$ inch, or larger, machine screws, depending on the size of the pull box and

what is to go into it. These holes should be large enough to give the supporting screws plenty of clearance. It is impossible to locate and drill holes in a brick or concrete wall to precision measurements, and the large holes are put in the box to allow for this variation. They will enable you to start the screws in the expansion shells quickly and to align the box on wall or ceiling so that it will set plumb or square with its surroundings. No harm is done if these

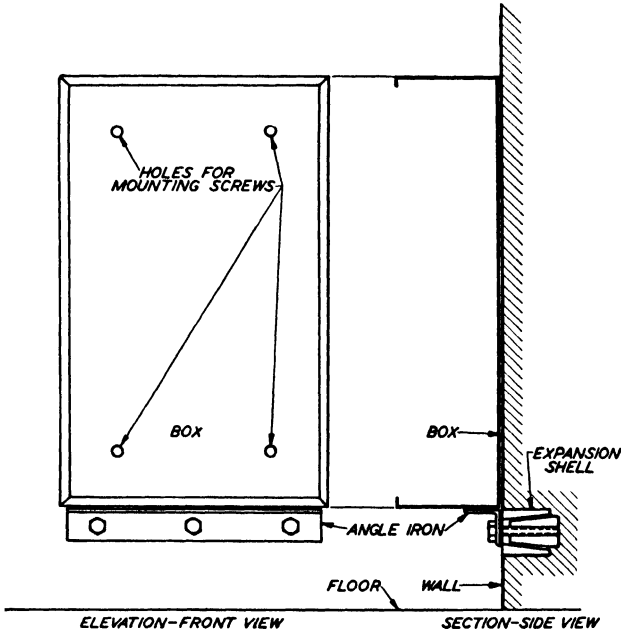

Fig. 37. Method of Mounting Large Pull Boxes on the Wall
(Expansion Shell Is Enlarged to Show Detail)

mounting holes are large enough to permit the head of the mounting screws to pass through; in this case you use a washer between the screw-head and the box to get "bearing" or holding margin.

The box should be mounted firmly on wall or ceiling, independent of the conduits. A box that is very large and heavy or is intended to house heavy equipment should have pipe legs and flanges, as shown in Fig. 36, or rest on a length of angle-iron previously bolted to the wall, as shown in Fig. 37.

If a box is to be "free-standing," that is, to be set up where it will not be supported by a wall or column, it should have four legs,

instead of two as shown in Fig. 36. As an alternative, braces, extending from near the top of the box to the floor and bolted thereto, can be used instead of, or in addition to, the four legs. This method is preferable if the box is to house equipment that requires considerable pressure toward the back of the box, as, for instance, large

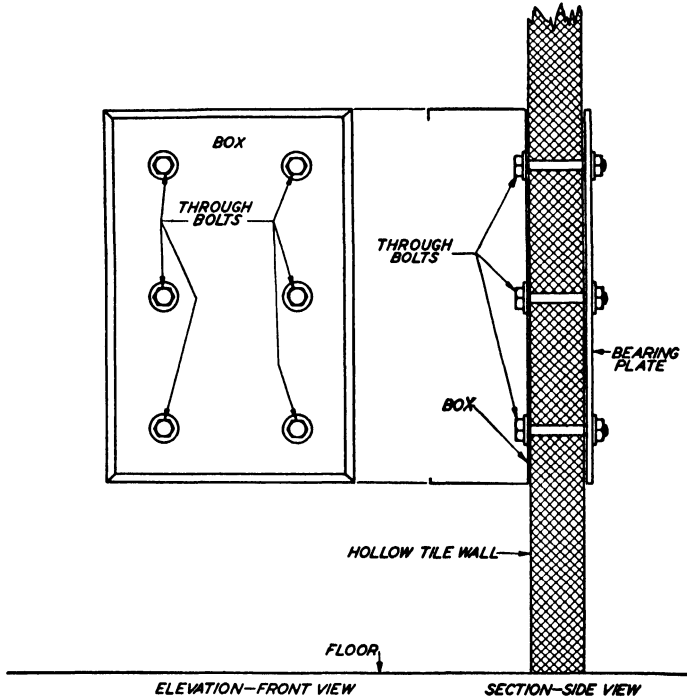

Fig. 38. Method of Mounting a Large Pull Box to a Hollow Tile Wall

knife switches or circuit breakers that require an inward push of the operating handle for closing.

It must be borne in mind that, in many cases, the box must serve as a support for the conduits also, and should be built strong enough to withstand the stress of pulling in the wires or cables.

When mounting a heavy box on a wall, block it up from the floor to its mounting height, thus eliminating the strain upon the person holding it in place while the mounting screws are inserted and tightened up.

In general, boxes should be in place before the conduit is run, although this is not always convenient.

Mounting a heavy box on a ceiling is more difficult and requires more preparation than mounting it on a wall. Arrange a safe temporary support to take the weight while the mounting screws are inserted and tightened up. Put up a scaffold to work from rather than to take a chance on a ladder.

In all cases provide the holes for the mounting screws before putting the box into position. Lay out the location of the holes on wall or ceiling by measurement. If the surface is wood, bore with a brace and bit the correct size of hole for the size of wood screw or lag screw you intend to use. If the surface is brick, stone, or concrete, use a star-drill or pipe-drill of the correct size for the size of expansion shell you are going to use and drill a hole to the required depth.

Insert the larger end of anchor in the hole, tap the outer end lightly a few times with a hammer and punch, or a hammer only if you have no punch, and the anchor is there to stay.

If a box is to be mounted on hollow tile, use toggle bolts. If a heavy box or other equipment is to be mounted on a tile wall, it is wise to use through-bolts, with a bearing-plate on the other side of the wall, as shown in Fig. 38. In this way the load is distributed over a larger area, making for a much firmer support.

CONDUIT SUPPORTS

Pipe Straps. When conduits are run along a flat surface, pipe straps of either the one-hole or two-hole type are used as supports. If the surface is wood, you secure the straps with wood screws or lag screws; nails are sometimes used but we do not recommend them. If the surface is of brick, concrete or stone, use expansion shells and machine screws, Rawl plugs and wood screws or Rawl drives. If of metal, drill and tap for machine screws. If of hollow tile use toggle bolts.

When drilling holes in metal to be tapped for machine screws, remember that these screws come under the coarse thread series of the American National Thread (Formerly U. S. Standard). The fine thread series are used in the automobile industry. The correct size of drill for a given size screw is important. Standard machine shop

practice is to drill the hole of a diameter that will give a 75 per cent thread. Out in the field such a close fit will result in many broken taps, especially with men not used to handling them; also, these precision sizes of drills are hard to get in other than the larger industrial centers. For these reasons we give the next larger common fraction size of drill, in Table 7, following:

TABLE 7. Common Fraction Size of Drill

For Screw Size	Use Drill Size	For Screw Size	Use Drill Size
6-32	$\frac{7}{64}$	$\frac{5}{16}$ -18	$\frac{17}{64}$
8-32	$\frac{9}{64}$	$\frac{3}{8}$ -16	$\frac{5}{16}$
10-24	$\frac{5}{32}$	$\frac{7}{16}$ -14	$\frac{3}{8}$
$\frac{1}{4}$ -20	$\frac{13}{64}$	$\frac{1}{2}$ -13	$\frac{27}{64}$

As all of the foregoing drills will give quite a bit less than 75 per cent of thread (except the one for the $\frac{3}{8}$ -16 screw) you should not use any drill of larger size, for if you do you may not have a dependable thread.

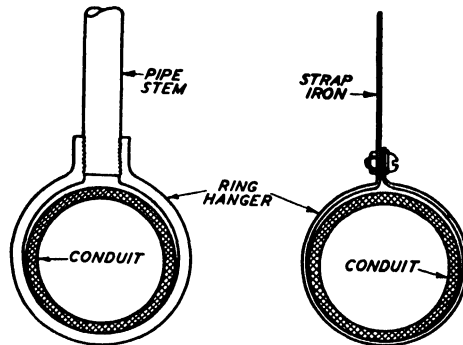

Fig. 39. A Single Ring Conduit Hanger

Pipe Hangers. Where the surface to be run over is broken up by projections, where piping or other obstructions are in the way or the ceiling is unduly high, it is customary to suspend the conduit by means of a single ring hanger, Fig. 39, if there is only one conduit in the run or by a trapeze-hanger, Fig. 40, or a plate-hanger, Fig. 41, if there are two or more conduits. The hanger is made to extend from the point of structural support down to the height at which the conduits are to be run.

Fig. 39 shows two single hangers, one an iron ring with a threaded pipe stem at left and the one at the right is made from a piece of perforated strap iron. Fig. 40 shows two trapeze hangers; the one at the left is made from sections of pipe and ells; the one at the right is made from a section of pipe and two pieces of perforated strap

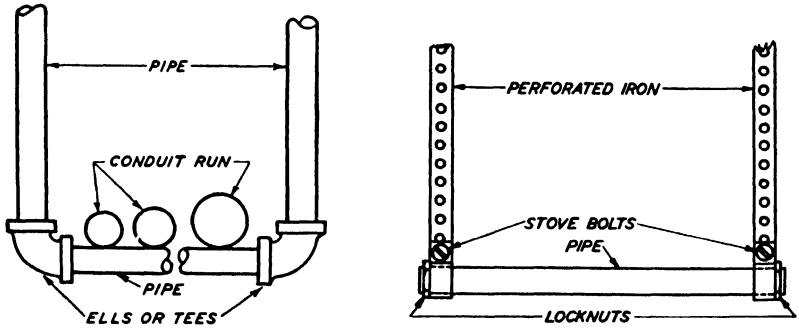

Fig. 40. A Trapeze Conduit Hanger

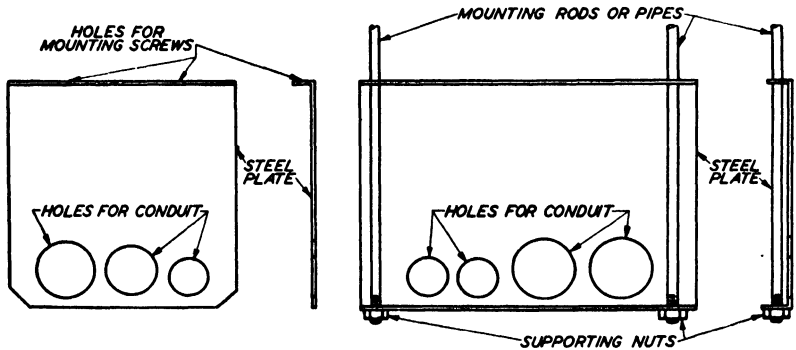

Fig. 41. A Plate Hanger for Supporting Several Conduits

iron. Fig. 41 shows two plate hangers, one for ordinary, the other for heavy construction. These plate hangers are made from steel of suitable size and thickness, and are provided with holes for the passage of the conduits. Do not have the holes fit the conduits too snugly; give the latter from $\frac{1}{16}$ inch to $\frac{1}{8}$ inch clearance. These hangers are secured to the ceiling in the same manner as described under pipe straps.

Pipe Clamps. For supporting vertical conduits of the medium and larger sizes the pipe hanger (sometimes called split-hanger),

Fig. 42, comes in handy. It is clamped on the conduit just above and in contact with a structural member or floor construction heavy enough to carry the weight of the conduit and wires. If there is a coupling in the line of conduit at this point, it will help to keep the conduit from slipping in the clamp.

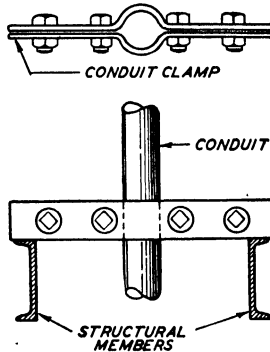

Fig. 42. A Split Hanger for Supporting Vertical Conduit

Beam Clamps. For running at an angle to or parallel with an angle-iron, I-beam or similar structural member, clamps similar to the ones shown in Fig. 43 (left) can be used for single runs of medium sized and smaller conduits. The one shown in Fig. 43 (right) is suitable for two conduits.

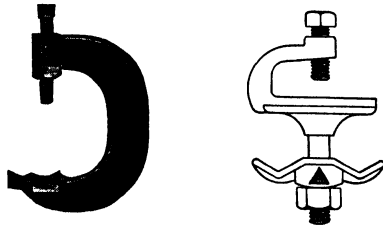

Fig. 43. Clamps for Fastening Conduit to Structural Steel

Courtesy of the M. B. Austin Co. and the Appleton Electric Co., Chicago

Supports on Steel-Truss Roofs. In buildings with this type of roof construction the chord, or bottom member of the truss, Fig. 44, frequently consists of two angles, set side by side. The two vertical legs of the truss are adjacent, but separated by steel gusset-plates, to which the struts and other members are riveted. Through this

space, varying from $\frac{5}{16}$ inch to $\frac{1}{2}$ inch, a hook bolt can be passed to hold the conduit. The threaded upper end is provided with a washer and nut. The arrangement of a single and double run of conduit is shown in Fig. 44. The nut and washer on the bolt will "ride" better if the bolt is made at least twice as long as the outside diameter of the conduit. Instead of the hook-bolts you can use plate hangers, also shown in Fig. 44.

These trusses are usually spaced on something like 20 foot centers, so you will need two intermediate supports for the conduits between each pair of trusses, or in each bay as the space is generally called. You can use perforated strap iron passed around the

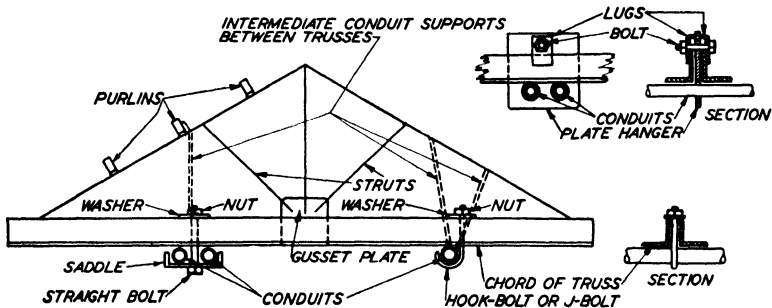

Fig. 44. Method of Attaching Conduit to Steel Roof Truss

conduit and bolted, the other end extending to the roof planking or to one of the purlins supporting the latter, as shown by the dotted lines in Fig. 44. Put on two such straps if the conduit is so far off-center from a purlin that a single strap would pull the conduit out of line, as shown in connection with the single conduit run; or, place an auxiliary member between the purlins, for supporting the conduit.

This method is recommended only for the smaller and the medium-sized runs. If heavy conduits must be run in this manner, be sure to confer with the Architect or the Structural Engineer who designed the truss as to whether it is safe to put the additional weight upon it. Heavy runs should be run in the floor wherever possible, or along the wall of the building.

Catenary or Messenger-Cable Support. Installing the lighting circuit conduits in this type of building within reasonable labor

costs is often a problem, as the lighting units generally are wanted at or near the high point of the roof and in the bays between the trusses. In this case the catenary suspension method affords a good, safe means of support for the lighting units and the conduits.

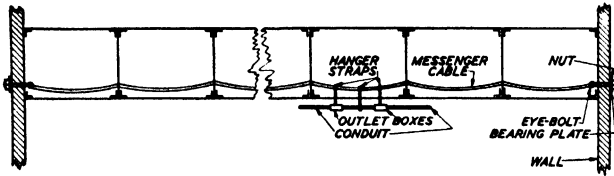

Fig. 45. Method of Supporting Conduit on a Messenger Cable

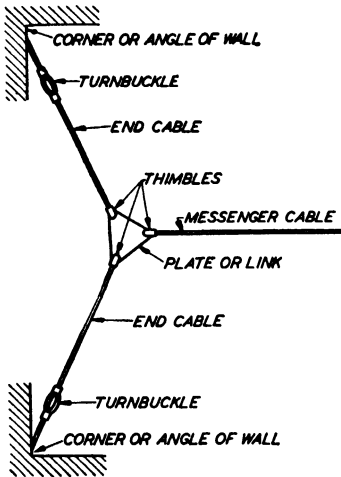

Fig. 46. Detail of Securing Messenger Cable to End of Building

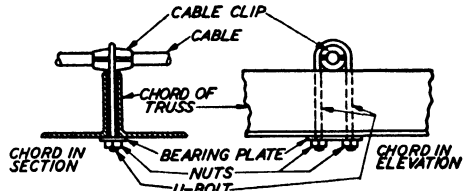

Fig. 47. Method of Holding Messenger Cable to Truss

A stranded steel messenger cable is strung over the chord of the trusses, see Fig. 45, anchored at each end to the building wall with eye-bolts and turnbuckles to adjust the tension. If the wall or end truss is not strong enough to stand the pull, transfer the pull to the columns or, if no columns, to the two corners of the building by a sort of flat Y arrangement, as shown in Fig. 46. It is a good plan to secure the messenger cable to each of the trusses, as shown in Fig. 47. This materially reduces the pull upon the end anchorage for any given amount of sag in and load upon the cable.

A Crosby or other type of cable clip placed on the cable on each side of the supports eliminates all danger of serious damage to the

run in case one of the end supports should give way or the cable should break due to a weak spot or from some other cause.

After the messenger cable is anchored in place, a cable clip is fastened to it above each lighting unit outlet box and at each intermediate point of conduit support if there is considerable sag in the cable; otherwise, the supports would slide along the cable when the weight comes on them and you would not be able to level the conduit run. Extend a perforated strap or other support from these clips to the outlet box or conduit and fasten it in place. These

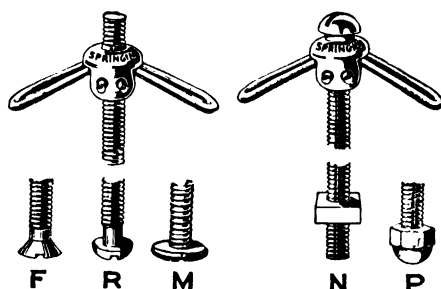

Fig. 48. Toggle Bolts with Different Types of Screw Heads

Courtesy of the Star Expansion Bolt Company, Chicago

individual supports are to be of a length to hold the conduit run level. If the cable is supported at each truss, there will be so little sag in it that there will be practically no tendency to slip, making it possible to omit the clips; just loop the strap iron over the cable and bolt it.

It must be understood that only a general idea can be given since structural conditions vary on different buildings. Details should be changed to suit the requirements of the specific job.

ANCHORING OR FASTENING DEVICES

There are many devices on the market for securing objects to walls, ceilings or floors of other than wood construction.

Toggle-Bolts. These bolts come in two types, as shown in Fig. 48. One type shows the toggle hinged to the nut, and, the other type shows the toggle hinged to the head of the bolt. The toggle arms are normally held outward by the action of springs within them. Toggle-bolts can be used only on hollow walls or ceilings,

or similar locations. The type with toggle on the nut is somewhat handier to use than the other one. To install, drill or punch a hole large enough to pass the toggle arms. If you use the type with the toggle on the nut, unscrew the latter from the bolt. Push the bolt through the hole in the base of the device to be mounted; then screw the nut on the bolt a few threads, so that the arms of the toggle



Fig. 49. Rawl Anchor and Caulking Tool
Courtesy of the Rawlplug Company, New York City

will fold back over the bolt. Next, push the toggle through the hole in the wall and screw up on the bolt until it is tight. You may have to pull out on the bolt to give the toggle a friction hold inside the wall, as that is the only way you can keep it from turning. The toggle will take hold eventually.

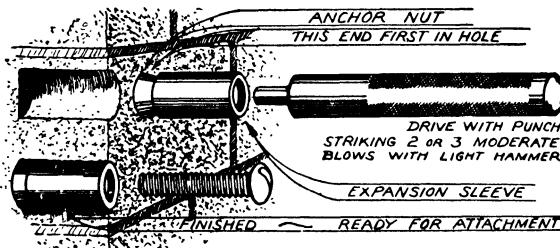

Fig. 50. Method of Setting A-J Anchors

If you use more than one toggle-bolt to hold the device you are mounting, all of them must be inserted into their holes before the first is screwed up, because you need clearance between the base of the device and the wall for holding the toggles. This space will no longer be available once the base rests against the surface of the wall.

Screw-Anchors or Expansion-Shells. These are made in various types, Fig. 49 showing the Rawl anchor and caulking tool and Fig. 50 showing the Ackerman-Johnson expansion shell. To install, drill a hole the proper diameter and depth, insert the anchor or shell, and expand it by using a tool provided for this purpose and a hammer.

The anchor is there to stay. The smaller sizes are made for machine screws only, but the larger sizes are made for lag screws and machine screws. Their hold depends on the expansion of a lead sleeve. This expansion is caused by the wedge action of the conical nut, which is drawn up into it by the threads of the screw.

Rawl Plugs. These are made from jute, see Fig. 51, chemically treated and compressed, and are used with wood screws. The screw,



Fig. 51. Construction of Rawl Plug
(Fibers run longitudinally)

Courtesy of the Rawlplug Company, New York City

the hole, and the plug to be used should all be the same size. The plug must be deep enough in the hole so that the unthreaded shank of the screw does not reach the plug. To install, drill the hole, insert the plug, put in the screw and tighten it up. The threads will force the fibers of the jute tightly into the small crevices in the wall of the hole, thereby providing a firm anchorage. The plug should fit the hole snugly, a sliding fit, but not loose. If you have drilled the hole over-size use the next larger size of screw and plug.

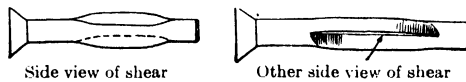

Side view of shear

Other side view of shear

Fig. 52. Construction of Rawl Drives

Courtesy of the Rawlplug Company, New York City

Rawl Drives. A one-piece device, shown in Fig. 52, for making attachments to masonry and kindred substances. To install, drill a hole of the exact size of the drive, insert the latter and force it home with a hammer, as you would a nail. The hole must be deep enough so that the end of the drive does not reach bottom. These drives will not hold in crumbly, weak or yielding substances.

Home-Made Anchorage. When the need arises for one or more stud anchorages in masonry and there are no suitable ready-made devices available for the purpose you can make them. Get the required number of machine bolts of the size you need. Drill holes into the masonry large enough to take the heads of the bolts and of

a depth that the shoulder of the head will be, say, two hole-diameters below the surface. Under-cut the side-walls of the holes as shown in Fig. 53, and clean out the dust. Insert the head of a bolt in the hole, placing it at right angles to the surface of the masonry. Next, fill the hole with molten lead and caulk it well. Old-timers claim that a small piece of sulphur put into the hole first will make the lead take a better hold. If the masonry is cold it is a good idea to warm up the adjacent area so that the lead does not chill before it can fill the small indentations in the walls of the holes. A washer on the bolt in the hole is recommended where heavy pulls are made

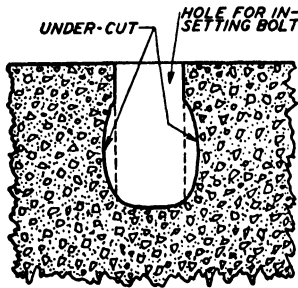

Fig. 53. Home-Made Anchorage

on the stud. The lead must be confined in the hole, as otherwise a sustained heavy pull would cause it to flow, and the bolt would pull out.

Putting these in a floor is easy. In a wall it can be done by using a dam of plastic clay. Be sure to keep your face to one side when you pour the lead into the dam, for the heat on the wet clay may create enough steam to cause some flying about of lead.

WIRE CAPACITY OF CONDUIT

The number of wires permitted by the National Electric Code is the same for rigid and thin-wall conduit, size for size. It is based on the ratio of the combined cross-sectional area of the wires required to the cross-sectional area of the bore of the conduit. The full-page illustration, page 20, shows the actual size of the thin-wall conduit (solid black circle) and of rigid conduit, and the maximum number of wires of the different sizes that can be installed. For more

than four braided wires, not more than 40 per cent of the conduit area can be used, and for lead-encased cables not more than 35 per cent can be used.

It should be noted that, from the installer's viewpoint, it is preferable to use three single-conductor, lead-encased cables than one 3-conductor. First, the pull is much easier; second, there is not so much waste if the terminals to which they are to connect are not close together.

For braided wires, the National Electric Code permits not more than a total of four 90-degree bends in a run of conduit between any two boxes. It is better to limit them to three, especially for the larger sizes of wires.

For lead-encased cables, the Code limits you to two 90-degree bends in one run and recommends, though does not yet demand, long radius sweeps, with a minimum radius ten times the internal diameters of the conduit.

Although the wire capacity of conduit, as given in the full-page illustration, page 20, is fairly well-established the country over, there are localities where they are more stringent. It is advisable therefore to get a copy of the local Code.



A NEAT INSTALLATION OF ALUMINUM CONDUIT IN A BLOWER BUILDING OF A SEWAGE DISPOSAL PLANT
Courtesy of Aluminum Company of America, Pittsburgh, Pa.

CONDUIT WIRING, TOOLS, AND METHODS

TOOLS AND THEIR USES

Pipe Vice. This is used to hold conduit firmly when being cut, reamed, and threaded. Fig. 1 shows a vise to be bolted to a work-

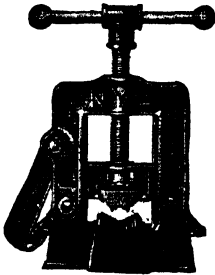

Fig. 1. Self-Locking
Vise

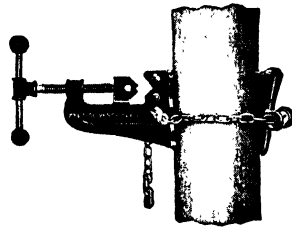

Fig. 2. Portable Pipe Vise
Which Can Be Attached
to a Column or Post

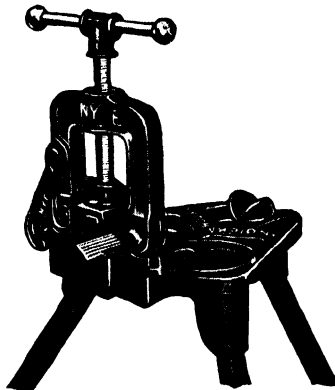

Fig. 3. Pipe Vise Stand and Bender
*Courtesy of The Nyc Tool & Machine Works,
Chicago*

bench; Fig. 2, a vise to be clamped to a post or column; Fig. 3, a portable vise-and-stand combination, which includes a bender, convenient to move around and sturdy enough to handle up to medium-sized conduit.

2. CONDUIT WIRING, TOOLS, AND METHODS

Hack Saw. This is used for cutting conduit in preference to regular wheel pipe cutters used for cutting gas and water pipe. The latter leave a pronounced burr or inward bulge in the conduit, as shown in Fig. 4. This bulge is hard to get rid of and, if left in,

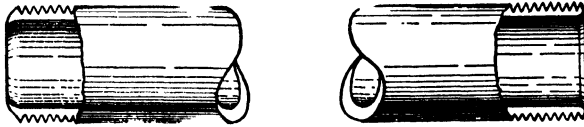

Fig. 4. *Left, Result of Cutting Electrical Conduit with an Ordinary Pipe Cutter. Right, Proper Method of Cutting and Reaming Electrical Conduit*

seriously interferes with “fishing” and pulling-in the wires in the conduit run. Fig. 5 shows a typical hack-saw frame. Use blades 12 inches in length, to provide a long stroke, with 18 or 24 teeth to the inch for rigid conduit and either 24 or 32 teeth for thin-wall conduit. The “Milflex” brand of hack-saw blade, and perhaps others,

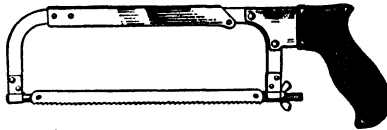

Fig. 5. *Adjustable Hack Saw Frame
Courtesy of The M. B. Austin Company,
Chicago*

can be had with fine teeth (32 to the inch) in the first two inches of length and with coarser teeth for the remainder of the blade. The fine teeth make the marking for the cut and the starting of it more accurate and faster than do the coarse teeth, since the latter tend to jump all over the conduit until the cut is well started, resulting in considerable inaccuracy. These fine teeth are in the front end, which usually gets less use than the middle and rear end. Make full strokes with the hack saw, pushing it away from you, and do not “ride it” or bear down on the return stroke.

When cutting a length of conduit to be attached to a box with bushing and locknut, allow $\frac{3}{8}$ inch for wall thickness of box and thread for bushing in the case of the small conduits. For larger conduits or heavy wall boxes, allow $\frac{1}{2}$ inch; where a locknut and bushing is required inside the box, allow extra conduit length for the locknut thickness, approximately $\frac{1}{8}$ inch.

Reamer. A cut, even one made with a hack saw, leaves a burr or ragged edge on the inside of the conduit, which, if not removed, may damage the insulation on the wires when pulling the wires into the conduit. For the removal of the burr a reamer is used. Fig. 6 shows one suitable for conduit up to 2 inches; a regular bit-brace is



Fig. 6. Spiral Flute Reamer

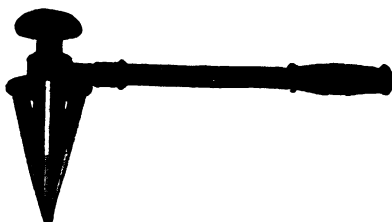

Fig. 7. Ratchet Reamer for Large Size Conduit

Courtesy of The Nye Tool & Machine Works, Chicago

required for this tool. For conduit up to 3 inches there is a self-contained reamer, see Fig. 7, with a ratchet handle. When the con-

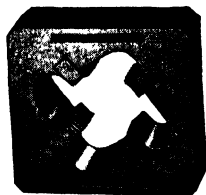

Fig. 8. Die for Threading Conduit
Courtesy of The Nye Tool & Machine Works, Chicago

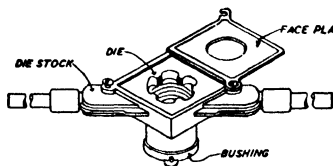

Fig. 9. Die Stock

duit is too large for a reamer use a half-round file instead and remove the inside burr by filing.

Die and Die-Stock. These are of two general types, the solid stock and the adjustable or receding die stock. In the solid type we have a single block of steel, as shown in Fig. 8, which carries the thread-cutting teeth. These dies are held in a stock, Fig. 9, having two handles of suitable length. On the side opposite from the die there is an extension of the body of the stock, for holding the bushing or "guide," to align the stock and die with the axis of the conduit, so the thread will be cut straight. With this type of stock, Figs. 9 and 10, the die and guide must be changed for each conduit size. A stock with adjustable guides is made, which, by pushing a lever about

4 CONDUIT WIRING, TOOLS, AND METHODS

a quarter-turn, adjusts the tool to any size of conduit within its range. But even with this provision there is still loss of time in changing dies. Some relief from this is gained by the use of a "triplex" die stock, Fig. 11, on which three dies can be mounted. The body of this stock has a hole opposite each die, of correct size to serve as a guide for the corresponding size of conduit. This is useful for the smaller jobs, but, being quite heavy, it is too tiring on a job where much threading must be done.



Fig. 10. Solid Malleable Die Stock

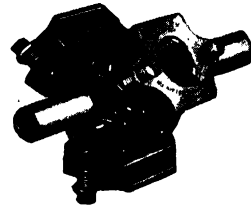

Fig. 11. Triplex Die Stock

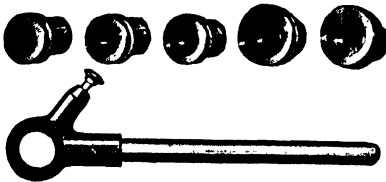

Fig. 12. Ratchet Die Stock with Assorted Dies

Courtesy of The Nyc Tool & Machine Works, Chicago



Fig. 13. Three-Way Die Stock Equipped with Solid Round Dies

A later type of solid stock is shown in Fig. 12, consisting of a ratchet handle terminating in a head with circular opening. This opening is a round piece containing the thread cutters and their corresponding guide, held in place by an internally threaded cap screwed onto the head. The ratchet handle is of advantage since it enables the operator to cut in the position most favorable to him. There is also a three-way stock available, Fig. 13, for this style of die.

The adjustable stocks overcome the objection of time-loss due to change of dies and guides. These stocks have their cutting teeth on sliding cutters mounted in the housing in such a way that the shifting of the lever will set the cutters correctly for the size of conduit to be threaded, a thumbscrew locking the setting. This stock, Fig. 14, can be had with either solid or ratchet handle. On the lower right-

hand part of the body a short lever may be seen. A quarter-turn of this lever opens or closes the cams forming the adjustable guide. On the lower left-hand part of the body a device resembling the handle of a vise may be seen. This locks the stock in position on the conduit after being centered. Between the ratchet-housing (center) and cutter-housing (top) screw-threads may be seen. These threads have the same pitch as those of the conduit sizes within the range of the stock. Their function is to pull the die up onto the conduit at the start of the cut, thus relieving the operator from much back-breaking labor. When the cutting of the thread has been completed it is not necessary to back the stock off in order to remove

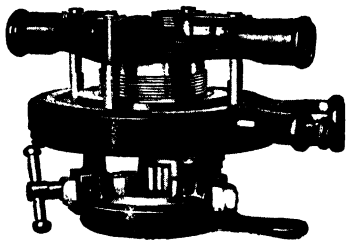

Fig. 14. Die Stock with Adjustable Guide

Courtesy of The Nye Tool & Machine Works, Chicago

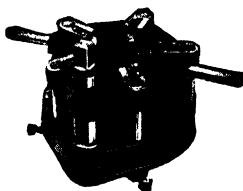

Fig. 15. Die Stock for 2 1/2 - to 4-Inch Conduit

it from the conduit. A quarter-turn of a lever, not visible in the illustration, releases the cutters so that the stock can be pulled off straight without a turn. A push on this lever in the opposite direction closes the die, without resetting. The range of this size of stock includes 1- to 2-inch conduit.

When it is considered that the threads of all sizes of conduit are cut by the same chasers it will be obvious that the range of sizes for which any stock can be built is limited to those sizes that have the same pitch of thread, that is, the same number of threads per inch.

In Fig. 15 is shown an adjustable stock for 2½-inch and larger conduits. This tool is geared so that one man can operate it. A ratchet type of handle generally is used for this. The tool has the same mechanical features as the smaller one just described. The cutters or chasers used are shown in Fig. 16, four being required for the smaller and five for the larger size of stock.

When cutting threads be sure to cut a full thread, which means

that the die should be run up on the conduit until part of one thread sticks through the die, so that the conduits will come close together in the coupling, or will "bottom" in the hub of a threaded fitting. However, when working with couplings or fittings that have been tapped "over-size" or "under-size" run the die up a bit farther in the latter case and not quite so far up in the former case if your die is a solid one; if your stock is an adjustable one set it to cut either over or under size, as may be needed.

"Conduit" Dies. Until comparatively recently conduit was threaded with dies of the same type used for threading gas or water pipes, and on many jobs still are so threaded. A few years ago

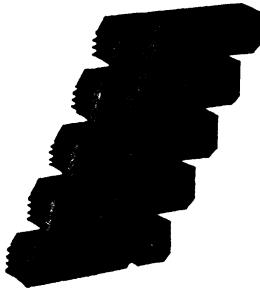

Fig. 16. Chasers for
Receding Type Die
Stock

*Courtesy of The Nye Tool &
Machine Works, Chicago*

a line of dies designed especially for conduit work came on the market. The difference lies in the degree of taper of the threads.

In the regular pipe dies this taper is equal to $\frac{3}{4}$ inch to the foot, whereas in the "conduit" die it is $\frac{5}{16}$ inch to the foot, which is the standard adopted by the Conduit Fitting Manufacturers' Association. Use of this die reduces threading effort and permits better seating of conduits in couplings and fittings.

Pipe Pliers, Wrenches, and Tongs. For making up the small sizes of conduit into their couplings or fittings many workmen use a pair of husky pipe pliers, Fig. 17, about 10 inches long, with either straight or angle jaws. For the medium sizes a pipe wrench, Fig. 18, is used. For the larger sizes, say $3\frac{1}{2}$ inches and larger, pipe tongs, or chain pipe wrenches, see Fig. 19, are preferred by most men.

These tools are much abused and shamefully neglected, very

likely because they belong to the "boss," and not to the mechanic. But the quantity and quality of their service lies in their "bite," which means their ability to grip and hold the pipe. It is slow work and often difficult to make up a tight joint with a wrench that slips on the pipe. The teeth in the jaws must be sharp and clean to give the tool a firm hold. Many bruises, skinned knuckles, and even broken bones have been sustained by workmen for lack of attention to the condition of tongs or wrenches.

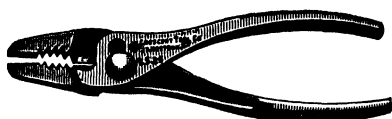

Fig. 17. Pipe Pliers



Fig. 18. Pipe Wrench



Fig. 19. Chain Pipe Wrench

Courtesy of W. D. Allen Manufacturing Company, Chicago

Benders and Hickeys. In Fig. 20 is shown a device for making bends and elbows in the smaller sizes of rigid conduit rapidly and with precision, serving also as a pipe vise. It should be mounted on a substantial bench or other firm support, hence it cannot be carried about readily. For bending thin-wall conduit a bender of the type shown in Fig. 21 should be used. This bender will handle only a single size of tubing.

As a portable conduit-bending tool the hickey stands alone. It comes in a variety of designs, to take conduits of $\frac{1}{2}$ -, $\frac{3}{4}$ - and 1-inch sizes. The Lakin, Fig. 22, comes in three sizes, one for each of the three sizes mentioned; the "Boss," Fig. 23, will handle from $\frac{3}{8}$ - to 1-inch sizes inclusive. Each of these is suitable for rigid conduit only.

Method of Operation: Say a 90° bend is required when running conduit over floor joists and you want to enter a ceiling or wall outlet on the floor below, or from an exposed ceiling run to a box on the wall, etc. In the first case assume a drop of 13 inches is needed.

8 CONDUIT WIRING, TOOLS, AND METHODS

Put the hickey on the conduit about $7\frac{1}{2}$ to 8 inches from one end and bend to about 45° , see Fig. 24. Move the hickey an inch or two farther down and bend about 15° to 20° more; shift the hickey again and bend another 15° . Put a rule on the bend sticking up to see how near



Fig. 20. Conduit Vise and Bender



Fig. 21. Thin-Wall Conduit Bender



Fig. 22. Conduit Bending Hickey

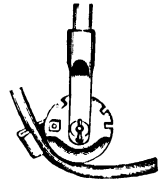

Fig. 23. Self-Adjusting Conduit Hickey

Courtesy of The M. B. Austin Company, Chicago

you are to 13 inches. If it appears to be short take a bigger bite with the hickey to finish; if long, take a smaller bite. No doubt you will have to straighten the bend here and there until you acquire the knack



Fig. 24. Bending Conduit with Hickey. Note Saddle Bend and Offset in Conduit in the Foreground

of bending with assurance and precision. It is quite a help to have the other end of the conduit against a wall or post during the bending operation to take the backthrust. If there are many such bends on the job you should have an elbow-former, Fig. 25, for this purpose.

If you want to make a 90° bend, to come say 62 inches from one end, measure this distance out from a wall on the floor. Place one end of the conduit against the wall, put the hickey $4\frac{1}{2}$ to 5 inches ahead of the mark and proceed as before, except that instead of measuring

up from the floor with your rule to see how your bend is coming you sight along the vertical leg and align it with the mark on the floor.

For 90° bends in conduit 1 inch and larger it is the general practice to use factory ells, unless there is a hydraulic bender on the job.

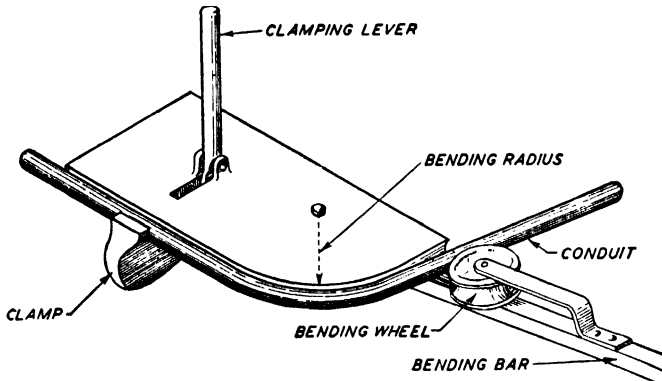

Fig. 25. Bench Type Conduit Bender for 1/2- and 3/4- Inch Conduit

When running exposed conduit it is sometimes necessary to carry the run to the right or left and then continue straight on. In this case you make an offset or "dog-leg," see Fig. 26, in the conduit. First determine how much offset is needed and how far from the

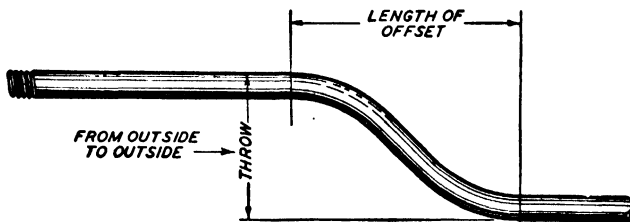

Fig. 26. Measurements for Making Offset Bend in Conduit

end the first bend is to be. If the "throw" of the offset is say a couple of inches and the obstruction to be cleared is 20 inches from the end of the conduit, put the hickey on 16 or 17 inches from the end of the conduit and make a bend of 15° to 20°; then move the hickey farther up on the conduit, about the width of the hickey, and make a bend of the same degree as the first but in the opposite direction. Take care that you keep the hickey in alignment with the conduit, so that the "run" of the latter will be straight. The amount of the offset, or throw, needed determines the degree of the bend; the

greater the throw, the greater the degree of bend. Do not make this greater than required to clear the obstruction for, the greater the degree and number of bends the harder it will be to pull in the wires.

When an offset is needed in a conduit running vertically on a wall it will look better if the offset is put in as high as possible, to keep it out of the direct line of vision. Should you have to cross a pipe already in place on ceiling or wall with conduit, you do this by making a saddle in the conduit with a hickey, see Fig. 24. Say you want to cross a $\frac{1}{2}$ -inch pipe 17 inches from the end of a conduit. With conduit on the floor put the hickey on say 12 inches from the end and make a bend of 30° in the conduit; move the hickey to the inside of this bend, but as close to it as possible, and make a bend of the same degree but in the opposite direction, which gives an offset of 1 inch, or a bit more; move hickey up again, as before, and make another 30° bend in the same direction as the one you made last; move the hickey again, keeping it as close as possible to the third bend, and make another 30° bend, but in the opposite direction from the preceding two. That finishes the saddle, and if you were careful to keep the hickey lined up with the conduit the run of the saddle will be straight.

It must be borne in mind, however, that the dimensions and angle of bend are to be considered merely as guides and not as accurate or definite values, because no two pieces of conduit are of the same degree of hardness, and no two men bend with the same rate or vigor of movement—two governing factors. It will require a large amount of practice to make good bends quickly. Do not be discouraged if your first attempts do not achieve perfect results.

As a rule saddling is done only with $\frac{1}{2}$ - and $\frac{3}{4}$ -inch conduits. Larger sizes are run far enough out from the surface to pass the obstruction without saddling.

Thin-wall conduit flattens and kinks more readily than does rigid conduit and therefore greater care is needed in bending it; rigid conduit bending tools are unsuited to this work. Fig. 21 shows a bender suitable for use with thin-wall conduit.

Hydraulic Bender. For making bends and offsets in conduit on the job nothing equals this tool, see Fig. 27, for rigid conduit and Fig. 28 for thin-wall conduit. But, while they are splendid tools,

owing to their cost and weight their use is justified only on medium and heavy work. Several makes are on the market, no two of which operate alike.

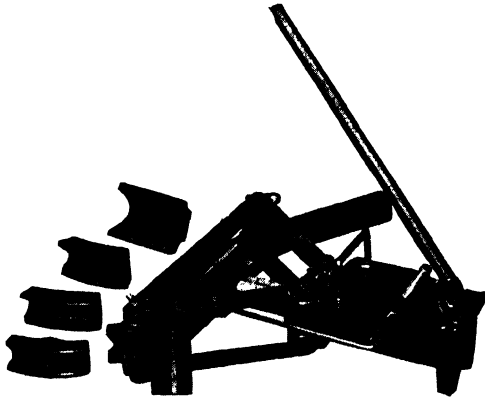

Fig. 27. Hydraulic Type Conduit Bender

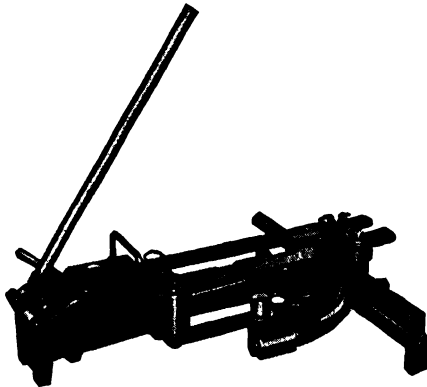

Fig. 28. Hydraulic Conduit Bender for Thin-Wall Tubing
 Courtesy of Greenlee Tool Company,
 Rockford, Illinois

Knockout Cutters. When you need additional or larger holes in a cabinet or pull-box for conduit you can cut them with a hammer and cold-chisel, enlarge them with a reamer, or do the job in one-fourth the time with the use of a knockout cutter or punch. Fig. 29 shows a punch for this purpose that comes in a range of sizes from $\frac{1}{2}$ to 3 inches, a separate punch for each size of conduit. Fig. 30 shows a cutter that is adjustable for any size from $1\frac{1}{2}$ - to 3-inch

12 CONDUIT WIRING, TOOLS, AND METHODS

conduit. In each case there must be a hole through the side of the box where the new conduit hole is wanted, large enough to take the center-bolt of the punch or cutter. These tools will cut steel up to

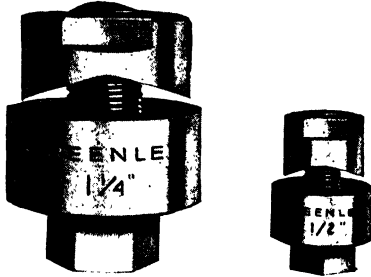

Fig. 29. Knockout Punches and Container
Courtesy of Greenlee Tool Company, Rockford, Illinois

and including 10-gage, or $\frac{1}{8}$ inch in thickness. The use of the punch, Fig. 29, is apparent at a glance. For the cutter, however, some explanation is required. See Fig. 30. The long middle portion carries a

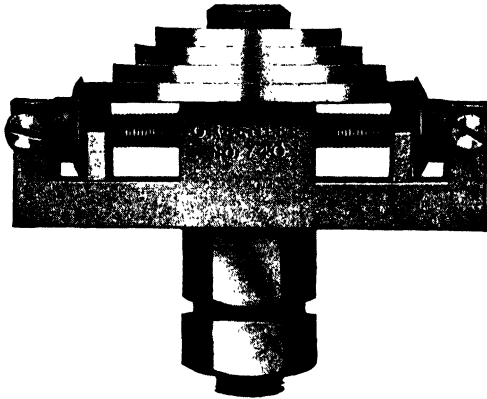

Fig. 30. Knockout Cutter
Courtesy of Greenlee Tool Company, Rockford, Illinois

horizontal screw, on each end of which is mounted a circular cutter, which can be moved inward to any point and secured there. Above the cutter-wheels is a series of disks, each of the diameter of a conduit knockout, held in place by a through-bolt having a nut at its lower end by which the cutting disk is held tightly against the metal being cut. The long, horizontal middle-piece or body has a hexagonal extension or boss on its lower side. By means of a wrench applied

to this boss the body and cutter-wheels are revolved, while the slack resulting from the biting of the cutter-wheels into the metal is taken up by turning up the nut at the bottom.

The Nipple-Chuck. Sometimes boxes, cabinets, or other housings are so close together that a very short piece of conduit is required to make the connection but are not close enough to permit use of a Chase nipple. Such a short section of conduit or other pipe is called a "nipple."

Cutting a thread on a short nipple is a problem. The first thread is simple. Take any length of conduit, of the desired size, having a threaded end, or, if not already threaded, cut a thread on it, and cut off the length of nipple you want, which, let us say, is 2 inches, the size being $\frac{1}{2}$ inch. To cut the thread on the unthreaded end a nipple-chuck for holding the nipple is required, because the nipple is too short to be threaded in a pipe vise. The method is as here described.

Take a piece of $\frac{1}{2}$ -inch conduit of any convenient length, clamp it in the vise, threaded end toward you, and screw on a coupling, making it up tight. Screw the nipple into this coupling. Place a $\frac{1}{2}$ -inch die and a $\frac{3}{4}$ -inch guide into your die-stock and proceed to thread the nipple. The $\frac{3}{4}$ -inch guide will slip over the coupling and align the die with the conduit, thus cutting a straight thread. If the stock is of the adjustable variety you simply set the die chasers for $\frac{1}{2}$ -inch conduit and the guide cams for $\frac{3}{4}$ -inch conduit.

If the coupling is humpy, or over-size, dress it down with a file or on an emery wheel. If the coupling splits, on account of the wedge action of the taper-thread of the conduit, run a locknut up on the latter first and then put on the coupling. The locknut stops further movement of the coupling along the conduit. You may have to trim the corners of the locknut to take the guide.

A die-stock with receding dies is handier for the work than one with a solid die and guide, because it does not have to be backed off. When trying to back off a solid die-stock it sometimes happens that the nipple is backed out of the nipple-chuck instead. In that case the die and nipple are taken out of the stock, the die is clamped in a vise and the nipple is backed out with a wrench or pliers.

A short conduit connection can also be made with a piece of "running thread," which is a piece of conduit threaded throughout

its length. However, this does not make up a tight fitting joint and most inspectors condemn the practice.

Also, stock pipe nipples can be purchased. These are of three classes: (1) the *close* nipple, (2) the *short* nipple, (3) the *long* nipple. The close nipple is very short and in many cases has a thread of so little taper as practically to be a running thread, hence open to the same objections. The short nipple has a full taper-thread at each end with an unthreaded section between, of a length equal, roughly, to one-half the inside diameter of the respective size. The length of either of the preceding two is a fixed factory standard. The long nipple comes in standard lengths, in even inch and half-inch variations, as ordered, with a full taper-thread at each end.

Some local enforcing authorities prohibit the use of regular pipe-nipples on the ground that they do not conform to the specifications covering the finish of conduit. If you do use them, remember that their threads have a much steeper taper than that of conduit, and that doubtless they will have a sizable burr inside of each end.

Drills and Drilling. In conduit work comparatively few holes will be made with the auger bit. Therefore, in this section we will discuss only the tools for the drilling of "hard stuff," which falls, broadly, into two divisions, (1) metals and (2) masonry, the latter covering brick, concrete, stone (other than marble or slate) and tile. For drilling metal, marble, or slate you use rotating drills, commonly called twist drills; for masonry you use percussion drills, that is, drills struck by either hand- or power-operated hammers.

Twist Drills. When the holes to be drilled are few in number the bit brace serves for driving a twist drill; the geared hand-drill or breast-drill, however, is much better for the purpose, and the portable electric drill is best of all.

The twist drill is a much-abused and little-understood tool. When properly ground it will do a truly prodigious amount of work for its weight. The grinding should be done by a mechanic skilled in this work.

Cutting-speed, that is, the distance traveled by a point on the circumference in a given length of time, is of first importance in the use of the drill. Hence, the smaller the diameter the greater the number of revolutions it should make per minute. That is why the bit brace is of so little value for driving the twist drill.

Next in importance is the feeding pressure. The faster the drill is run the less feeding pressure is needed. An excess of speed is not as harmful as an excess of pressure. The latter is sure to crack the drill up its center, whereas the worst that excess speed will do is to cause undue wear at the outer corners of the cutting edges. Copper, being stringy, tends to choke the drill, causing it to stick in the hole, unless the heel-clearance is reduced to about 5° , or less, for a short space back from the lip. This averts sticking, because the bite is reduced, but more pressure is needed to force the drill through. Also, a drill ground in this way is difficult to center in a center-punch mark.



Fig. 31. Four-Point Star Drill
 Courtesy of Star Expansion Bolt Company,
 New York City

Drill a small pilot-hole first, then follow with a drill for the size hole wanted.

Then comes lubrication for the cut; for soft steel, wrought iron and the like, lard-oil is best, though lubricating oil will do; for hard steel use turpentine or kerosene; for aluminum or soft alloys use kerosene; cast iron or brass should be drilled dry. Lubrication is of little use on copper; what is needed is "elbow-grease."

Percussion Drills. For drilling small and medium-sized holes in masonry the percussion drill, either hand or power operated, has been used for many years. Masonry is drilled dry.

In the hand type, the cutting end is set to the point at which the hole is wanted, the other being repeatedly and smartly struck with a hammer, the drill being rotated meanwhile to keep it from getting stuck in the hole. A widely known drill of this type is shown in Fig. 31, the star-drill. This does its work well when sharp, but the corners soon wear away, necessitating repair.

Do not use a hammer that is too heavy or strike a blow that is too vigorous for the size of the shank of the drill, nor use a small diameter drill that has too long a shank, because the vibrations set up in the shank by one or more of these things are painful and tiring to the holding hand. Comparatively light, rapid blows are more effective than heavy ones and are also easier on the drill.

16 CONDUIT WIRING, TOOLS, AND METHODS

In Figs. 32 and 33 is shown a drill which can be sharpened on the job by an average mechanic with the aid of an emery wheel, Fig. 34. The manufacturers of this tool also make a rubber holder, or grip, see Fig. 35, for giving a better and less tiring hand hold on their drills.



Fig. 32. Three-Point Drill and Holder

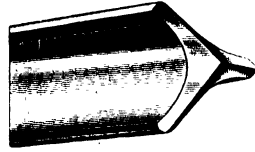

Fig. 33. Detail of a Three-Point Drill

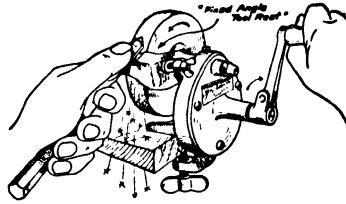
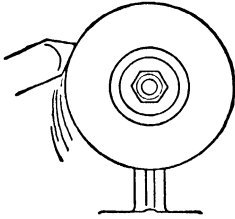

Fig. 34. *Left*, Proper Method of Holding Drill When Sharpening; *Right*, Sharpening Three-Point Drill on Hand Grinder
Courtesy of The Rawl Plug Company, Inc., New York City



Fig. 35. Three-Point Rubber Drill Holder

Courtesy of The Rawl Plug Company, Inc., New York City

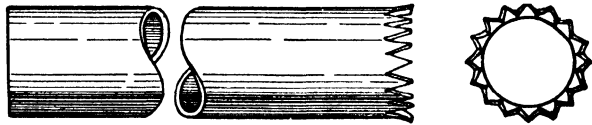

Fig. 36. Home-Made Drill for Drilling Brick Walls

As a makeshift, for drilling one or two holes in an ordinary brick wall, file some teeth in the end of a piece of pipe or conduit of the same size as the hole desired, see Fig. 36, should you be without a regular drill. If a fire is handy heat the end after filing and quench in cold water; then you will not have to file the teeth quite so often. Of course such a drill is useless in concrete or even in hard brick walls.

For the larger-sized holes and for breaking up concrete, where no power drive is available, you have recourse to the tool shown in

Fig. 37, the reliable "bull-point." Operated by one man, the hammer used should weigh two pounds or more. The best results are had when one man holds the bull-point with bull-point tongs and another man lustily wields a twelve or sixteen-pound sledge; or two men, each using a sledge, strike alternate blows.

Power equipment for these drills consists of either an electric

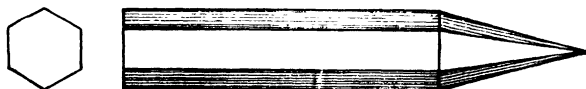

Fig. 37. Bull Point

or pneumatic hammer. The electric hammer is the lighter of the two but seemingly more apt to give trouble than the pneumatic.

Rotary drills are not used for this kind of drilling, because the materials being cut wear away the sides of the drill, thus making

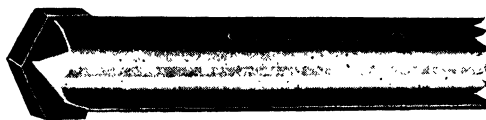

Fig. 38. Carboly-tipped Rotary Drill
Courtesy of Carboly Company, Inc., Detroit, Michigan

the tool conical, that is, smaller toward the point than in the body, causing it to bind in the hole.

However, there is now on the market a rotary drill, called the "Carboly" drill, which appears to overcome this difficulty, see Fig. 38. The cutting edge consists of a tip made of an exceedingly hard metal set into a shank. The tool can be sharpened on certain kinds of emery or carborundum wheels without being retempered. It is higher in price than the plain steel drill, but it is said that it will drill more holes, at a faster rate, than any other type of percussion drill.

The Fish Tape. After the conduit is all in place and connected to the various boxes, cabinets, and other housings, and the plastering is complete, you are ready to pull in the wires and cables. On a short run between two outlets and only one or two bends you can probably push the wires through, that is, the smaller sizes. For most runs, however, you will need a fish tape.

The most vexatious item in the pulling-in operation is the fish

18 CONDUIT WIRING, TOOLS, AND METHODS

tape or "snake," and making it behave is an achievement. It is made of tempered steel, .030 or .060 inch thick and either $\frac{1}{8}$, $\frac{3}{16}$ or $\frac{1}{4}$ inch wide, the .060 inch x $\frac{1}{8}$ inch being the most widely used. The wider ones are used for fishing the large diameter runs. It usually comes in 100-foot lengths, smoothly and evenly coiled, see Fig. 39, to a small diameter. Uncoil no more than you need, for once it gets away from you it is like a mischievous youngster, beyond control. Use a few wrappings of friction tape to hold the coil together.

The tape will very likely have a loop or hook in the end; if it does not, make one with your pliers about an inch or two long. This

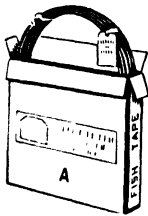

Fig. 39. Coiled Fish Tape

Courtesy of The
M. B. Austin
Company, Chi-
cago

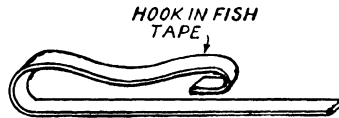

Fig. 40. Hook on Fish Tape

type of hook, Fig. 40, will not get caught on the ends of the conduit in the couplings and open up when pulling-in wires.

Insert the tape into the conduit and keep pushing. At first it will walk right in, but the first ell will slow you up and instead of being able to push it forward in long, even strokes you will now have to resort to "knocking at the door"—a series of backward and forward motions each following the other briskly. You will get along fairly well until the end of the tape reaches the second elbow. Keep up your rapid motions and you will gain an inch now and then until you can progress no farther. Now pull it back and try to go forward again, varying the rate of back and forth movements. Soon your knuckles will be sore from rapping them on the bushing. Hold the snake with your pliers and push. Ah, that's better, should have thought of it long ago. At last you get to where nothing that you can think of to do will advance the tape another bit. Now you get another snake, see that it has a hook in the end and insert it into the other end of the run that you are fishing and push it in to a point well

beyond where the end of the first one is; you then twist this second snake round and round until you think you have wound up your grandfather's clock and then pull it slowly toward you, hoping meanwhile that your twisting has resulted in the one getting hung on the other and that it will come along and behave. Oh, it came a little but did not hold; well, try again and when you start to withdraw have a man at the other end and let him try feeding in with short, rapid strokes, using his pliers. Do not give up too soon, if it still seems to stick. If the run is exposed have a third man tap the conduit about where the end of your first snake is, while you try to hook on and the second man tries to push in; the tapping may get the snake started past the obstruction. You just have to get that fish tape

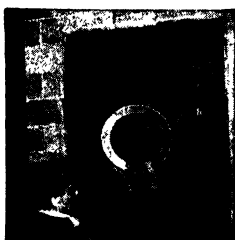

Fig. 41. Fish Tape
Line Holder

*Courtesy of The M. B.
Austin Company, Chicago*

through, for the only alternative is to open up the run and put in a pull box, and what would the boss say then! Well, the next time you will do a better job of laying out your runs, be more careful with your reaming and make up your couplings so that the two ends of the conduit come together, and remember that a pull box is good for something else besides disfiguring a wall or ceiling.

A handy gadget for taking care of a fish tape is shown in Fig. 41, which also helps when pulling in the wires by giving a good hand hold on the tape.

Pulling-in Equipment. The small and medium-sized wires are usually hooked onto the loop in the fish tape and pulled in by pulling on the latter with a pair of pliers, or by placing the body into a bight in the tape, the free end being held in the hands, and then walking away with it.

The larger wires are pulled with a rope or steel cable, either by

hand, block and tackle, or a winch; the latter sometimes is power-driven. A steady, continuous pull is best, for it takes less power to keep the wires moving than to start them again after they have been allowed to come to a stop.

But no matter how you pull in, nor what method you use there is one indispensable factor, that is have one or more men at the

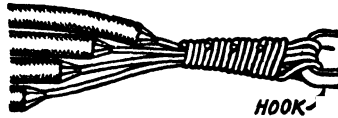

Fig. 42. Method of Fastening Wires to Fish Tape

end where the wires enter the conduit for the purpose of feeding them in without kinks, twists, or riding upon one another, that is, changing their respective position in relation to the other wires, from that in which they were started. This crossing tends to cause binding of the

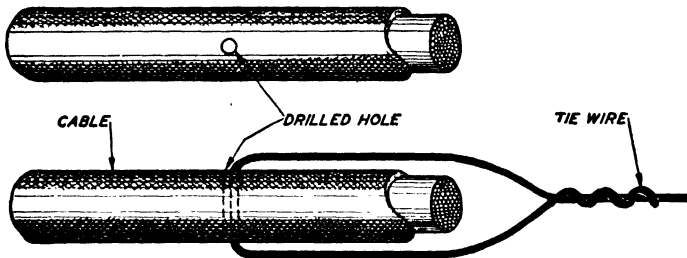

Fig. 43. Method of Attaching Pulling-In Rope to Large Cable

wires when passing around a bend. The one who is feeding should push in on the wires hard enough to force them around, or at least well into, the first ell, to ease the pull at the other end.

There are times when lubrication is needed to help the wires along. For lead-encased cables you use oil or grease, but not for braided wires or cables. For these, use soapstone or talcum powder and no inspector will object; graphite lubricates better but it is messy and some inspectors object to it.

There is another substance which is very good, although it is in disfavor with most inspectors and we should, therefore, perhaps not tell you about it. This substance is soap and water, made into an emulsion or paste. It should be used only after everything else

has failed. But if you must have recourse to it use nothing but Ivory soap (not Ivory soap chips), which is a mild soap.

Method of Attachment. In Fig. 42 is shown a method of attaching small and medium-sized wires to the fish tape. Fig. 43 shows one of a number of methods of attaching larger wires to a pulling rope. Large wires or cables should be attached so that their ends are



Fig. 44. Patented Cable Grip
Courtesy of Kellems Products, Inc., New York City

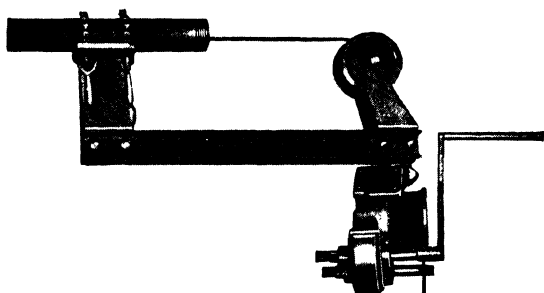

Fig. 45. Cable Puller Used with Large Conduit
Courtesy of Greenlee Tool Company, Rockford, Illinois

staggered, that is, one to come an inch or two (or even more in very large ones) farther back than its predecessor, to give a more graduated approach to an ell, permitting an easier bending in the ell. The tie wires used should be of varying lengths, with the loops so arranged that the make-up turns do not all come in the same place. Wrap a generous amount of tape over the ends of all of the wires, after your hook-up is complete, to prevent projecting insulation catching somewhere in the run, which, if serious enough, would force the insulation back into a bulge or lump as the pulling-in proceeds, resulting either in stopping the pull or breaking the hook-up.

Fig. 44 shows a cable grip, useful for pulling the larger wires and cables.

Fig. 45 shows a wire-pulling device, which is said to be highly effective. It is a comparatively new device and we have had no opportunity to see it in operation on a job.

Pay-Out Reels. The smaller sizes of wires usually come to the job in 500-foot coils. Much valuable time is lost trying to feed from a coil into a conduit run, especially when three or more are to be pulled in one conduit, for they invariably snarl, kink, and ride one another.

In Fig. 46 is shown a device for mounting two coils of wire, permitting pay-out without twisting or kinking. The stand can be moved about readily with the coils of wire mounted on it.

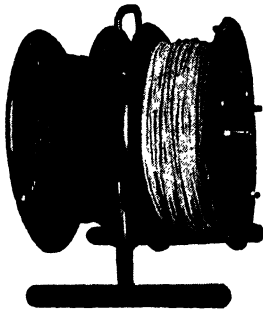

Fig. 46. Two-Wire
Reel Stand
*Courtesy of Rick & Selleg,
Chicago*

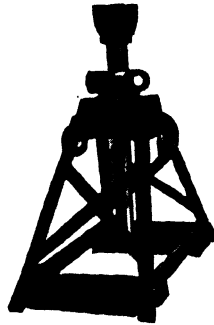

Fig. 47. Simple
Cable Reel or Drum
Jack
*Courtesy of Templeton,
Kenly, and Company, Chi-
cago*

Wire Reels and Jacks. The larger wires and cables should come, and usually do come, on regular reels. These reels are set up on screw-jacks, see Fig. 47, a steel bar or piece of conduit serving as the axle. There should be a separate reel for each "leg" of the run, that is, if it is a three-wire feeder there should be three reels. An alternative method is to order the feeders cut to length by the supplier and reeled "two abreast" or "three abreast" on one reel, depending on whether it is a two-wire or a three-wire run. They will then pull off together and you have only one reel to jack up.

Of course, wires and cables can be, and in many cases are, strung out on the floor for a pull-in, instead of being mounted on reels, but this is not nearly as handy nor as fast as when reels are used.

When a long, vertical run or "riser" is to be pulled, especially if it is a heavy riser, ample precautions are necessary. You will very likely take the cables to the top of the riser to feed them down, Fig. 48, calling gravity to your service. There is nothing wrong with

this provided that, before you begin feeding in, you mount a stout plank in such a way that you can use it as a brake upon the reel to check the speed of pay-out when the weight of the cable in the vertical conduit has become great enough to overcome the friction.

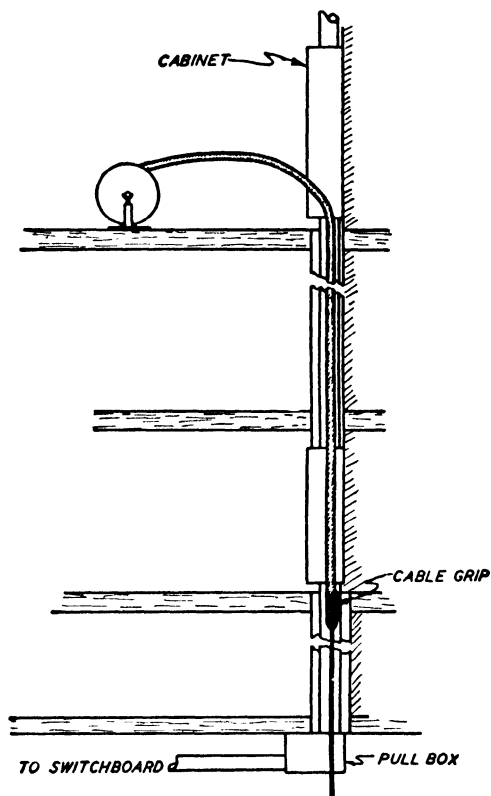

Fig. 48. Cable Being Fed into Vertical Conduits

For if this cable gets away from you nothing will stop it until it lies tangled in a heap at the bottom.

A half-hitch around the wires with a rope will take care of the smaller risers, if skillfully done. When you have all the slack you need at the lower end you place the inserts into the collar of the cable supports, then put the tapered bushings or grips over the individual cables or wires. You then gently slack off the tension on the brake, but be prepared to use the latter should the support fail to hold. There will be some "give" as the weight of the cables pulls the grips

into position. The supports will hold if you have given the supplier of the cable supports the correct over-all diameter of the wires, and have installed the number of supports called for by the code for the height of the riser. If the support should not hold put on an additional support; there is a split type made for use where cables are already in place. You must not let the weight of the cables come on the terminal studs of the apparatus to which they connect. Remember also that you need some slack for expansion and contraction if the riser is subject to wide temperature changes.

When mounting wire-reels arrange them so that the coiling favors the pay-off, Fig. 48, in order that the man who does the feeding is not compelled to do a lot of unnecessary work. When wires feed downward it is better to mount the reel so that the top rolls toward the cabinet or pull box as the wire pays out, rather than the other way. For wires feeding up it is generally better the other way, especially if the reel is high, although there may be other conditions present that offset this.

When pulling a run that contains a pull box there arises the question of what end to feed into, or of feeding both ways from the pull box. If you have bad set-up or feeding conditions at the ends then you should feed both ways from the pull box, for, at the latter conditions should be good since you picked its location yourself. Barring this one condition, however, it is better to feed from an end, and the long one at that, if the pull box is not midway of the run, so you will have only the short bight of the wires instead of the long one to fuss with at the pull box. The advantage of a straight-through pull over a two-way pull—that is from pull box both ways—lies in the fact that you have only one hook-up to make and do not have any unnecessary slack in the wires. With the two-way method, enough slack must be taken off the reels or coils to reach the final destination, unless you want to pull all the wire on the reels or coils through the conduit. If you cut the wires too short they will have to be spliced; if too long, there is waste of wire. This uncertainty is not present with the straight-through method of pulling-in.

INSTALLING OUTLET BOXES

Spotting the Box. This means to determine the exact spot in wall or ceiling the outlet is to occupy. It is assumed that your working

drawings give full information on this. You find each location on ceiling by measurement from columns, walls, beams, girders or other fixed points. When measuring from an exterior wall measure from the outside of the wall rather than from the inside, because there is less likelihood of variation on the outside face, that is, in case of brick or stone walls. Wall outlet locations are found and marked in the same way. There are usually four heights for these: one for convenience outlets, usually 18 inches above floor, one for switches, usually 4 feet high, one for brackets, usually 5½ feet high, and one for wall fans, at least 6 feet high. These are the usual heights in a residence. In most cases these heights are the same for all outlets of any one kind throughout the job. The architect will give you these, if they are not shown on the plans. Unless otherwise specified, these heights are from finished floor to center of outlet box. To save time, get a stick of a length equal to the height of the highest outlet on the job and put a notch in the stick for each of the other wall outlets needed. Use this stick to get all of the heights throughout the job rather than measure them separately.

There is a case now and then when even the architect cannot tell you exactly where an outlet is to be, as in the case of paneled walls, which, as a rule, are not detailed until long after the "roughing-in" is done. This is of little concern in studding partitions but in tile it is often troublesome. In such case the general practice is to rough-in a "floating outlet." Use a foot or so of flexible metallic conduit from the end of the rigid conduit to the outlet box and then, later, after panel details have arrived, shift the outlet to the most suitable location.

An important point in the larger buildings, where partitions are numerous, is to be sure that you start your laying out from the same end of the building from which layout of partitions starts. In many plans there are errors in the dimensions of partition layouts which, of course, cancel out in the length of the last room on the floor. If, in such a case, you start measuring from one end and the partition-man starts from the other end some of your outlets may be quite a bit off center. Also, if any of your outlets are to align with a plumbing fixture, say a lavatory, do not overlook checking with the plumber as to just where his fixture will center. These points are vital in fire-proof construction, though of less consequence with wood joists, as

in the latter it costs little to shift. Further, in a concrete column and girder job do not place complete reliance on the precision of location of the "forms" for these members, especially when you are locating the point of drop of a conduit down to a wall outlet. Check them occasionally by measuring in from the outside face of an exterior building wall. In a steel-frame job you have nothing like this to fear, for it cannot be erected anything but straight and it cannot shift.

Preparing the Box. Bracket and ceiling boxes are prepared by punching out the proper number of knockouts from each, assuming that you have a layout of the conduit runs; if not, make one before



Fig. 49. Adjustable Straight Stud Bar Hanger



Fig. 50. Medium Depth Offset Bar Hanger
Courtesy of Appleton Electric Company, Chicago

going farther. You also punch out the center knockout, to take the fixture stud. If the box goes on a solid wall or ceiling you use a boltless form of stud. For lath and plaster walls or ceilings, with wood joists and studdings, you use a combination stud and hanger, the latter either straight or offset type, Fig. 49 and Fig. 50, depending on which best serves your purpose. The switch and convenience outlet boxes require no fixture stud. The fan outlet may or may not need one, depending on the type of fitting you are using.

Placing the Box. At the point you have marked for the respective outlet you secure the box by means of the type of hanger required by the particular conditions, nailing the hanger to the joists or studding.

Care should be taken to mount the outlet boxes level and true. The edge of the box, at the opening, should be far enough out from the lath to reach the surface of the finished plaster line, but no farther. The plane of the box should be parallel to the plane of ceiling or wall in both directions; in other words, the opening or face of the box should be in line with the surface of the plaster. Switch and plug receptacle boxes (convenience outlets) should, in addition to the foregoing, be set so that their long dimension stands or lies either vertically

plumb or horizontally level, according to the way the box is to go. While the slotted mounting ears of the devices that are to go into them permit of some adjustment, this is limited. Remember, the edge of the box should be flush with the surface of the plaster.

Another point to look out for when mounting switch boxes, aside from placing them on the open, or striking, side of the door, is to set the box far enough away from the door framing (or "buck" if it is in a tile wall) so the door casing does not extend beyond the space needed for the switch plate; nor should the plate be too far away from the door. Two inches of clearance between edge of switch plate and door casing is plenty; some architects want practically no clearance. Whatever amount of space you decide upon, make it uniform throughout the job. You should confer with the foreman of carpenters as to the width of casing and how far the edge will come beyond the rough door framing. When the walls are of studding there usually is considerable clearance between the door casing and the rough door framing, and when the door casing is set most of this clearance may be taken up in the direction that will give you the most trouble if you are not on the lookout for it.

In tile partitions the "buck," that is, the framing of the door opening, in many cases serves also as the door casing, and where it does not, the clearance generally is less than with studding partitions. Now here you can support the switch box on one side only, hence the regular box hanger is useless. A good method of mounting a switch box is shown in Fig. 51, which is practically self-explanatory. The spacing block should be of a thickness that will go into the tile recess of the buck. The length of the block, that is, the dimension in line with the hole, is governed by the width of the door casing and the amount of clearance wanted between this and the switch plate. The same length of block can probably be used for the entire job. You can use lag screws of diameters other than those shown, but holes in the blocks and washers may have to be changed. The washer must be larger than the knockout hole; if a smaller lag screw is used two washers may be required, one small enough to engage the screw head, the other large enough to span the knockout hole. The lag screw should be as long as can be used without having its point protrude from the buck, because the face of the latter may form the door casing. With this or a similar method of mounting a box no other

support for the conduit is needed between box and ceiling unless the latter is unusually high; in such case put an offset or dog-leg in the conduit to bring the conduit over to the buck and secure the two together with a pipe strap. Now put a switch cover, of a depth to correspond to the plaster thickness, on the outlet box and fill the latter with paper.

It is customary among plasterers to push back into the wall anything that they strike with their straightedge and fill the cavity

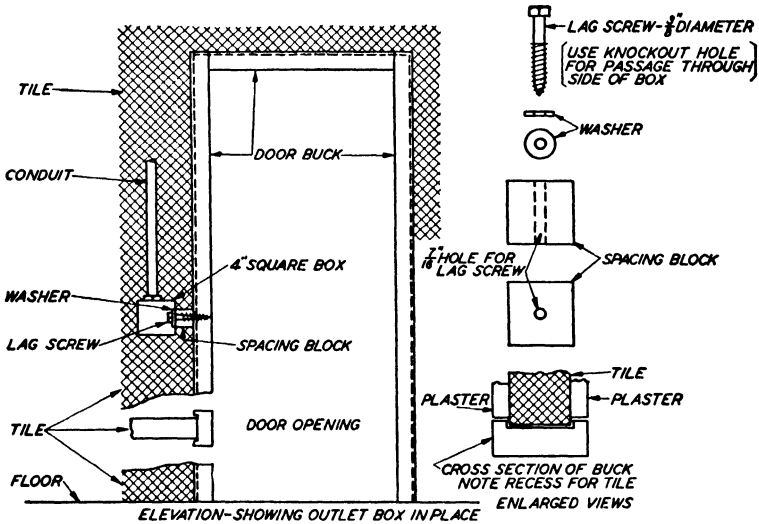

Fig. 51. Method of Fastening Outlet Box to Door Buck in a Tile Partition Wall

with plaster. Hence, mount all outlet boxes so firmly that they cannot be forced back, and fill them with paper, rags, or similar materials, so that they cannot be filled with plaster readily. Keep a record of exact outlet locations, for an outlet that has been fully plastered over is hard to locate.

Other wall outlets in tile walls present more of a problem, because usually there is nothing to which to fasten them. In these cases you drop a conduit of proper length from the ceiling above the point where the outlet is to go, and work with the tile-setter when he builds the wall, to make sure that the outlet is correctly set. It is not necessary that you stay there until the tile is built all the way to the ceiling; you remain only until the box is set in the tile, for

then the box will stay in place. Put on a cover of a kind suited to the outlet and fill it with paper.

Flat-Slab Concrete. This is just what the term says, a flat slab of concrete, reinforced with a grid of steel bars or rods of varying number and thickness, according to design. These rods are placed in the lower third of the slab, for tensile strength. They should not be moved out of position to any considerable degree; a lateral or

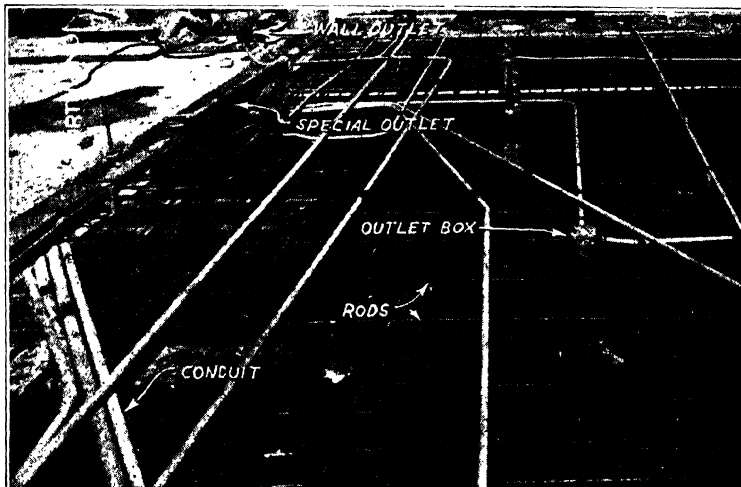

Fig. 52. Installation of Thin-Wall Tubing and Outlet Boxes before a Concrete Floor Slab Is Poured
Courtesy of Steel and Tubes, Inc., Cleveland, Ohio

sidewise movement is not quite as objectionable as raising them. Neither should they be lowered much, for they require the proper thickness of concrete below them for protection against excessive temperature in case of fire.

A good view of the arrangement of reinforcing rods and the electrical "thin-wall" conduit just before the concrete is poured on top of it is shown in Fig. 52. The reinforcing rods and conduit are wired together at various points to hold them in position securely on the "false-work" deck while pouring the concrete. The outlet box has been filled with paper and is ready for the cover. This box is for a ceiling light of the floor below, and the conduit comes up through the floor from the fuse cabinet. In the picture a wall outlet is installed and a conduit is run to the fuse cabinet (not shown) installed on this floor.

Octagon boxes, see Fig. 53, are used for this work. This box consists of two parts, the sleeve, or box proper, and the removable back. The sleeve has conduit knockouts in the end near the back, the purpose being to place them high enough so that the conduits connecting the boxes will clear the reinforcing steel without offsetting. Concrete boxes can be had in several depths up to 6 inches, to meet various structural conditions, but in all cases the knockouts are near the back of the box.

When "spotting" a concrete box you bore with an auger bit, say a $\frac{3}{4}$ -inch hole, through the false-work deck. This marks the outlet location and, after pouring of the slab, permits fluid concrete that may seep into the box to drain out instead of filling up the box. After the sleeve has been prepared nail it to the deck, there being external ears on it for this purpose. Conduit is run from sleeve to sleeve,

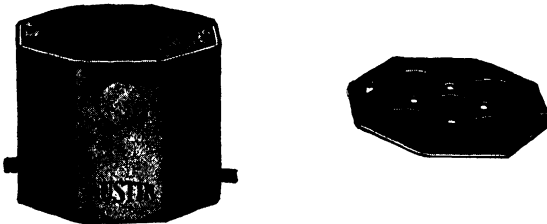

Fig. 53. Octagon Concrete Floor Box and Plate
Courtesy of The M. B. Austin Company, Chicago

secured to them with bushings and locknuts, and the sleeve filled with paper. The removable back, equipped with a fixture stud, is then fastened in place. If there is sagging of the conduit between the outlets you must raise it at the low points with a wire or other metal saddle to prevent the accumulation of moisture in the conduit.

Fig. 54 is a good picture of a conduit installation in a building with floors of flat-slab, reinforced concrete construction. Most of the reinforcing steel (dark lines) is in place, some of it resting on metal saddles to keep it at the correct height above the form. At several points can be seen a group of four vertical steel bars, extending approximately three feet above the form. These are the vertical column reinforcing bars. What appears to be a gap in the form, at several points, is a trough for forming a concrete girder extending from column to column.

The conduits and outlet boxes for the ceiling outlets of the floor below the one shown are in position and the covers are on the boxes. Note that the box in the foreground has four conduit entries, one 1-inch, one $\frac{3}{4}$ -inch and two $\frac{1}{2}$ -inch. Very likely two, perhaps three, circuits enter the box through the 1-inch "home run" between this box and the fuse cabinet, radiating from that point to various other outlets. This is done to save conduit between the fuse cabinet and the first outlet. When the home run is short, the item of saving by this means compared to running each circuit in a separate conduit

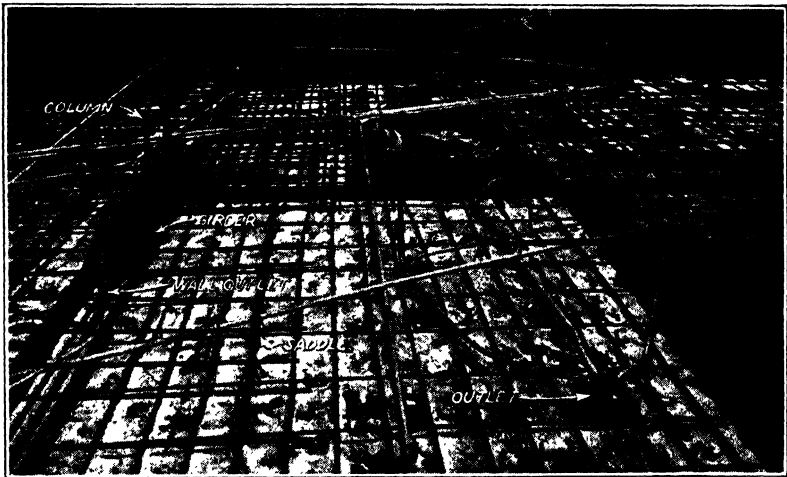

Fig. 54. Installation of Thin-Wall Tubing and Reinforcing Rods before Concrete Joist and Floor Is Poured
Courtesy of Steel and Tubes, Inc., Cleveland, Ohio

direct from the cabinet to the first outlet on the respective circuit is open to question. On medium and long runs there is a saving worth considering. The reason why the saving in the case of the short run is in question is that in a short run the wires generally can be pushed through the conduit without the use of the fish tape, provided that there are not too many ells in the run and that there is no time lost in separating the wires into correct pairs. In the group method the home run must be fished and pulled and the wires cut at the first outlet; then they are "poled-up" with the respective legs of the circuit to which they belong, entering the box from the various other directions, that is, re-grouped for correct polarity in each pair of

circuit wires, spliced, soldered and taped and the "through" wires buried in the box. There is none of this with the former method, and we doubt that on a home run of less than 40 feet there is any saving worth mentioning. Even for a run of this length the saving is a matter of conjecture.

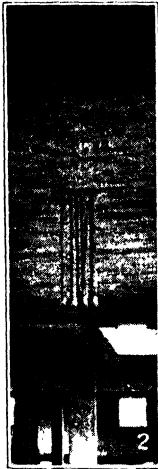

Fig. 55.
Installation of
Four Conduits
through Floor
Slab to
Partition
Location



Fig. 56.
Bracket Fastened
to Floor Form
for Supporting
Outlet Boxes

Courtesy of Steel and Tubes, Inc., Cleveland, Ohio

Fig. 55 shows several conduits coming down through the floor at a partition location. Couplings are attached at the end of these for nipling down to cabinet later on. There are two outlet openings in the ceiling.

At various points in Fig. 54 can be seen conduits stubbed up for the wall outlets, each supported by a bracket secured to the forms. Such a bracket is shown in Fig. 56, formed from a light channel section. The conduits and brackets are wired together with stovepipe wire, as shown in Fig. 57 and in Fig. 58. The black cylinders in Fig. 57, resembling large firecrackers, are sleeves set by the plumber or the steamfitter for the passage of their pipes through the concrete floor. Fig. 59 shows a long, coil spring being withdrawn from a conduit stub. This conduit was out of line with its partition and had

to be edged over. This was thin-wall conduit, which kinks very easily. To avert the kinking the spring was inserted into the con-



Fig. 57. Workman Securing Conduit and Box to Supporting Bracket



Fig. 58. Method of Fastening Conduit to Supporting Bracket and Outlet Box

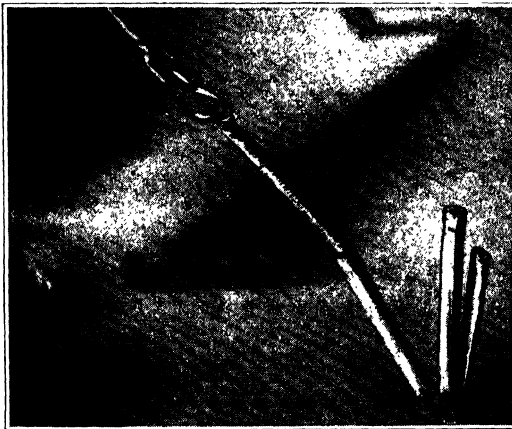

Fig. 59. Withdrawing Spring, While Bending It, after Use in Thin-Wall Conduit
Courtesy of Steel and Tubes, Inc., Cleveland, Ohio

duit, and to facilitate withdrawal the spring was twisted in the direction of tightening the coils, which, by decreasing the diameter, permitted an easier withdrawal.

Numerous places can be seen where conduits are wired together and to the reinforcing steel, at crossing points, to keep the conduits in position. It is not clear from the picture just how the blocking up of long conduit runs for the prevention of moisture pockets, due to sagging of the conduit between points of support, was taken care of. No doubt the saddles put in for this purpose are there, even though they are not in evidence.

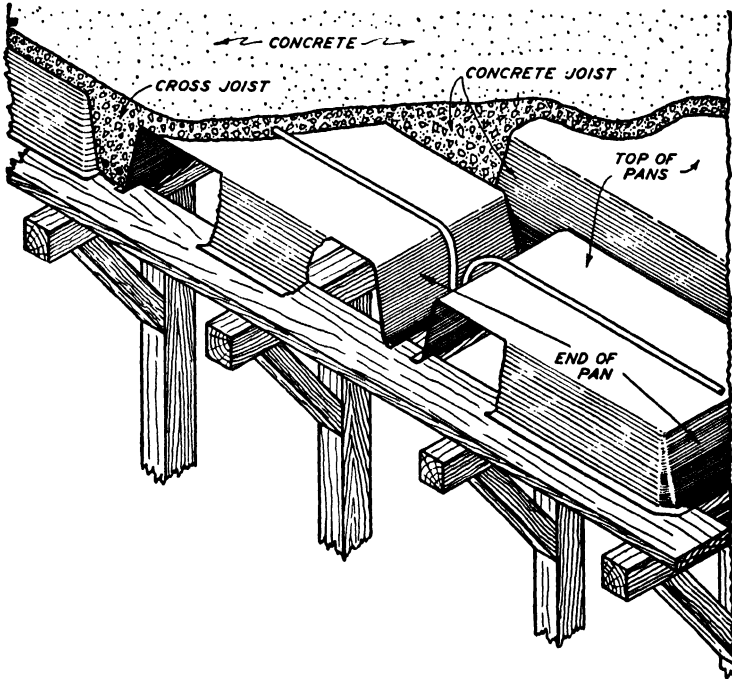

Fig. 60. Method of Installing Outlet in a Cross-Joist by the Use of Pans

Concrete Slab and Joists. In this type of concrete construction the reinforced concrete floor joists and the flat floor slab are of one piece. The space for the concrete floor joists, cross joists, and bridging is formed by the use of either steel or wood pans. These pans are assembled on wood plank decks, Fig. 60, which support them and the concrete when it is poured. After the concrete has hardened and set the required time, the support, decking, and pans are removed from the ceiling of the floor below. The method of mounting the outlets on the deck planks which support the pans and concrete

when it is poured is shown in Fig. 61. The outlets are placed in the space between the ends or sides of the pans, Fig. 60, and between the reinforcing rods, Fig. 61. Then when the concrete is poured in this

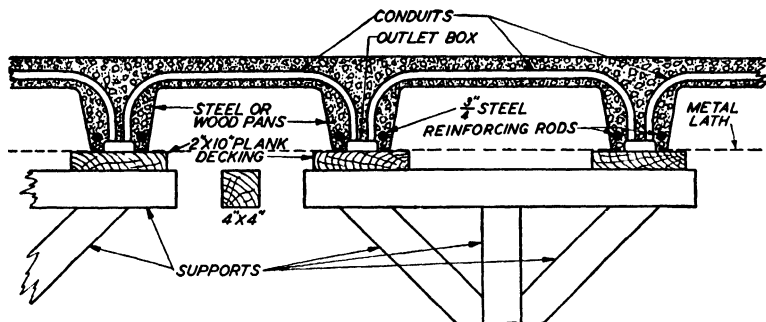

Fig. 61. Cross Section of Installation of Outlet Box and Conduit in Concrete Slab and Floor Joist

space and over the top of the pans the floor slab, joists and cross joists are formed with the outlet boxes embedded in place.

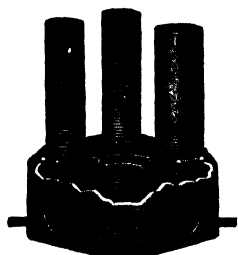

Fig. 62. Cutaway View of Installation of Conduit to Concrete Box, Using Bushlocks and Clamping Plates



Fig. 63. 1/2-Inch Bushlock



Fig. 64. Bushlock for 3/4-Inch Conduit

Courtesy of The M. B. Austin Company, Chicago

A special assembly, consisting of outlet box, holding-plate, fixture stud and bushlocks, Fig. 62, is required. The outlet box has four 3/4-inch knockouts in the back, or bottom. Located centrally between them is a hole threaded for the fixture stud. The holding-plate has its outer edge hollowed out to register with the conduit knockouts in the box and has also a hole in the center that will slip the fixture stud. There are two bushlocks, the one shown in Fig. 63 being threaded for 1/2-inch conduit and the one shown in Fig. 64 for

$\frac{3}{4}$ -inch conduit; the other end of either of them will fit a $\frac{3}{4}$ -inch conduit knockout hole. Each is provided with an internal shoulder for seating the conduit and an external shoulder to seat against the outlet box.

To install, bore a hole through the plank where the outlet is to go, remove the knockouts from the box and nail it to the plank.

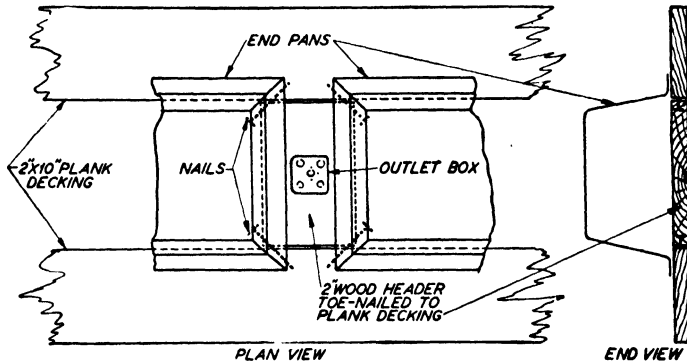

Fig. 65. Method of Attaching Wood Header for Outlet Box Location Between Concrete Forms

Take a length of conduit with its end threaded and put a 90° bend in the end. The length of this bend will be determined by the depth of the pans. Screw a bushlock on the end of the conduit, or as many of them as are required for that outlet, and place them into the knockout holes in the box, drop the holding-plate into place, put the fixture stud into the center hole and screw it tight.

Sometimes an outlet box will come in the space between the concrete joists, Figs. 54 and 60. In that case put in a header between the two deck planks at the point where the outlet box is to be, as shown in Fig. 65; the pan-setter will then set two end-pans at that point, Fig. 60, to form a cross-joist, Fig. 54, between the two regular joists; that is where you install the outlet box.

Fig. 66 shows a conduit installation in a building with floors of concrete slab and joist construction which offers a variation from general procedure. In this building the metal lath was placed upon the form supports before the pans were placed (Fig. 61, dotted line), in order that the concrete, during the pouring operation, would fill the interstices or openings in the metal lath, embedding the latter

in the concrete joists, thus supporting the plastering to be put on later.

The more common practice is to secure "pencil rods" to the joists at proper intervals by means of tie wires after the forms have been removed, the metal lath, in turn, being wired to the pencil rods. The electrician puts the plaster rings on the boxes before the lather installs the metal lath and the lather then cuts the holes in the lath for the outlets.

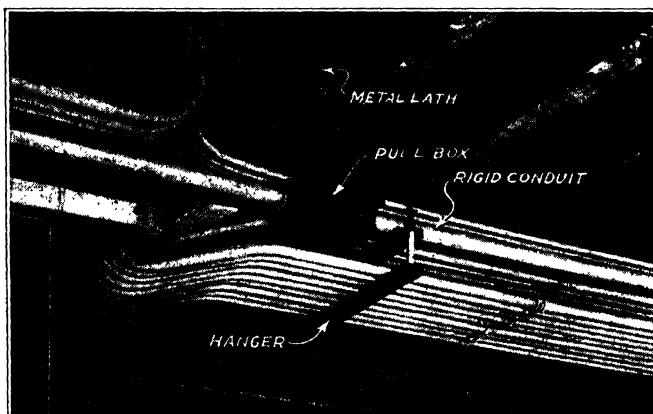

Fig. 66. Installation of Thin-Wall Tubing and Rigid Conduit
Courtesy of Steel and Tubes, Inc., Cleveland, Ohio

Sometimes it is necessary for the other pipe trades to run their piping below the concrete joists, in which case, if the ceiling is to be plastered, it is suspended from the joists far enough to conceal such piping. In this case, sections of light steel channel, approximately $\frac{3}{8}$ " x $\frac{3}{4}$ " in size, are put up first, being suspended from the joists either by tie wires or light suspension rods. The pencil rods are wired to these channels and the metal lath is wired to the pencil rods. If this drop is only a few inches, the outlets are extended to the plaster line by means of box extensions. However, when the drop is longer—and there are times when it is 2 feet or more—the conduits are run over the pencil rods, or over the channels, as best meets the conditions of the job, instead of in the concrete slab. This requires knowledge of the occurrence of the suspended ceiling before the conduits are roughed-in in the concrete. If the information comes after the conduits are in the concrete it is cheaper to abandon them and

run new ones over the metal lath than to extend those in the concrete down to the new ceiling level.

Installation of the metal lath, as shown in Fig. 66, opens the question of whether the holes for the outlets are to be cut in the lath by the lather or by the electrician. Off-hand it would seem that the latter would be compelled to do it. The metal lath must go in ahead of the conduits and outlets, in fact, even before the pans are set. The lather cannot be expected to know where the outlets are to go, and he can hardly be expected to spend time finding out. Now, if the electrician must do the work, the question is, When is he to do it? Shall he do it before placing the outlet box, or shall he wait until he puts on the plaster rings and cut the holes at that time?

Let us consider the facts and factors of each of the two methods. If the metal lath is cut before the outlet box is placed the cutting must be done down in the bottom of the narrow channel between two adjacent pans, with a temporary wooden form support as the anvil; this means that the blow of the hammer does not fall upon a firm base; further, it will be difficult to set the chisel to the best cutting angle or to wield the hammer effectively, because the sides of the pans are in the way. The advantage derived from cutting the hole before placing the box is that a drain hole can be bored through the planking of the false-work, and, because the box rests with its open side directly upon the wood form, there is little likelihood of concrete entering the box. However, the concrete men are right on your heels, because of the extra time that your roughing-in operation takes, and before you know it they will be pouring concrete.

If the cutting is done after the removal of the forms, we will have a firm base to take the hammer blows, because the outlet box will be buried in concrete, and we can set the chisel to the most effective angle and wield the hammer in any direction, unhampered by obstructions. A pair of curved snips might do the work better than hammer and chisel. The disadvantage lies in the difficulty of readily finding the box after removal of the forms, because the concrete very likely will have filled the entire space between the box and the form by trickling through the openings in the metal lath; in fact, you might find a goodly quantity of concrete in the box if you were neglectful in the matter of filling the latter with paper or other material. A seepage of concrete, as described, seems to have oc-

curred, for close scrutiny of Fig. 66 fails to show anything in any of the concrete joists that positively can be identified as an outlet. It is unlikely that there are none in the entire area in the picture.

First, we try cutting the holes as part of the roughing-in operation and keep a record of the time required for the cutting. After having done a number of them, the time for this work may not be excessive and we may be able to keep ahead of the concrete men. Perhaps we will use a circular cutter, similar to that used in old house wiring for cutting holes in the plaster for outlet boxes. But, even if this method is apparently satisfactory, we will leave a few outlets to be done by the other method, that is, to be cut after the removal of the forms, and keep a record of the time required, as a comparison between the two methods. With this data at hand the choice of method can be based on reasoning, whereas without it the decision would represent merely a guess.

Refer again to Fig. 66, and note the cut-away section of metal lath to permit passage of the conduits to a cabinet on the floor above. No data as to the size of these conduits is available but the wide variation in the sizes between the individual runs leads to the belief that they are feeders or motor runs, rather than branch lighting circuits. With one exception, to be mentioned later, they all are thin-wall conduits, judged by the couplings used. The work is a good example of first-class conduit work. Note the "double-deck" trapeze hanger, supporting the two tiers of conduit, formed out of two sections of channels, supported from the floor construction above.

One item, however, is open to question, namely, the relative size of the pull box in the run of large conduit in the foreground (Fig. 66). A run of conduit goes straight through it, and, to judge from the conduit hole visible in the side of the box, it is intended also to take off a tap-feeder at this point. Note that this run is of rigid conduit, not thin-wall conduit, as are all of the other runs, as evidenced by the locknut visible on the conduit at the pull box. There occurs to us only one valid reason for making this one run of conduit different from the rest, and that is that it is of a size not available in thin-wall conduit, in which 2-inch is the largest size. Therefore the inference is reasonable that this conduit is at least 2½ inches in diameter. Applying a scale to the conduit and the box shows the latter to have a length of only four conduit diameters, that is 10

inches, on the basis of the conduit being of $2\frac{1}{2}$ -inch diameter. However, the ratio would be the same no matter what conduit size were taken as a base. The width appears to be not over 8 inches, if that much. The wires to be pulled into a $2\frac{1}{2}$ -inch conduit would hardly be less than three No. 4/0—conceivably a size larger. Deducting the width of the 1-inch flange all around the opening of the box, we get a work space of only 6" x 8" for making the pull through this box; this is not enough, even if the tap-off is left out of the con-

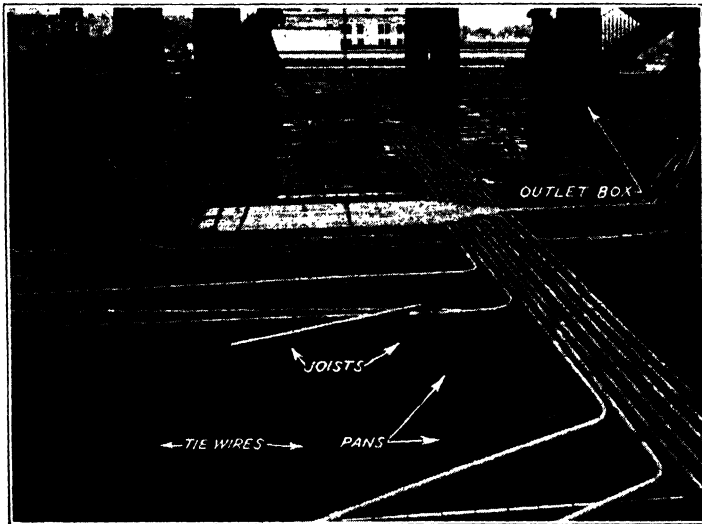

Fig. 67. Installation of Thin-Wall Conduit before the Concrete Floor Is Poured in Erection of an Office Building
Courtesy of Steel and Tubes, Inc., Cleveland, Ohio

sideration. Money would be saved if the length of the box were doubled and the width made $1\frac{1}{2}$ times that shown.

A view of concrete slab and joist floor construction carried on a steel column and I-beam frame is shown in Fig. 67. The picture shows a beautiful and symmetrical fanning-out of the branch circuit conduits from the point where they come up through the deck, from the fuse cabinet location below, to their respective destinations. However, noting that the conduits extend 8 or 10 feet to the right, only to make a complete U turn and go the same distance, and even more, right back again, the reason for it not being apparent, one wonders just what the circumstances were that necessitated such a layout.

In this illustration are seen numerous wires protruding from the deck, each wire terminating in a double loop or coil; these wires extend below the deck a sufficient length to serve later as tie wires for the pencil rods to be used for attaching the metal lath. The coils above the deck serve to anchor the wires in the concrete.

On the first column on the right can be seen an outlet box fed by a conduit coming down along the column from above. After the tile fireproofing is placed around the column nothing of this will be visible except the opening of the box. No doubt the box is temporarily held in place by a hanger or bracket of some sort, although it does not show in the picture.

Tile and Concrete Joists. This type of construction is shown in

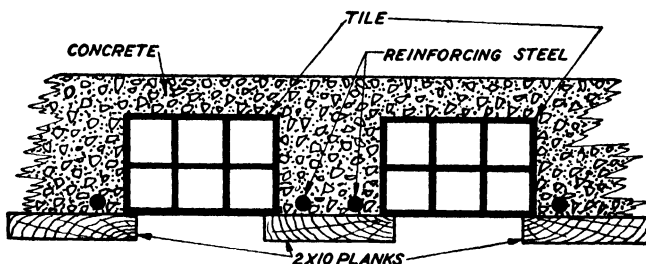

Fig. 68. Cross-Section View, Showing Forms, Reinforcing Steel, and Tile Used in Floor Construction

Fig. 68; the installation of outlet box and conduit is the same as in concrete slab and joist construction.

Tile-Arch Construction. In this type of floor construction the entire area is of tile, 12" or more in depth, with 2 or 3 inches of concrete over the tiles, see Fig. 69. Wood nailing strips or "sleepers," are laid on top of this, to which the finish floor is nailed, a cinder fill being placed between the sleepers under the finish floor. For this construction use a box assembly as shown in Fig. 70, which is similar to the one used for concrete slab and joist construction, with the addition of an adjustable extension to the fixture stud, terminating in a crossbar, with a sleeve to take the entire assembly.

At the outlet location you set the sleeve on the wood forms or false work and nail it thereto before the tile is placed; the tile-setter then fits the tile around them.

After the removal of the wood forms there will be a vertical opening in the tile arch for each outlet. Prepare the 90° conduit

bends, as explained for concrete slab and joist construction, place the required number of conduits, with bushlocks, Fig. 63, into the holes of an outlet box, complete the assembly by putting on the holding-plate and screwing the fixture stud with hanger rod in place and drop the assembly into the sleeve.

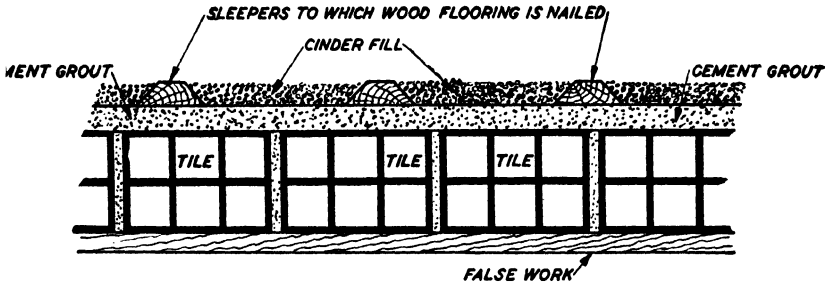

Fig. 69. Cross Section of Floor Construction, Using Hollow Tile

If outlets are close together you may have trouble getting an assembly into the sleeve, because there may not be enough "give" to the short run of conduit already fastened to a preceding outlet.

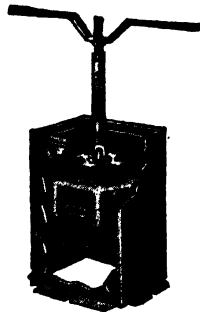

Fig. 70. A Tile-Arch Conduit Anchor Outlet Box
 Courtesy of The M. B. Austin Company, Chicago

In such case you cut this disturbing conduit in two at any convenient point, make up the assembly with the short ell in place, drop it into its sleeve and couple the two conduit ends together with a threadless connector. Running threads are no longer permitted.

Fig. 71 shows a conduit installation on a floor of tile-arch construction, all ready for the cinder fill, which is to go on top of it.

In the foreground, to the right and left of center, conduits can be seen, which go down to the ceiling outlets for the floor below. Note that the hole that had been provided for the passage of outlet box and conduit has been filled with pieces of tile and cement or

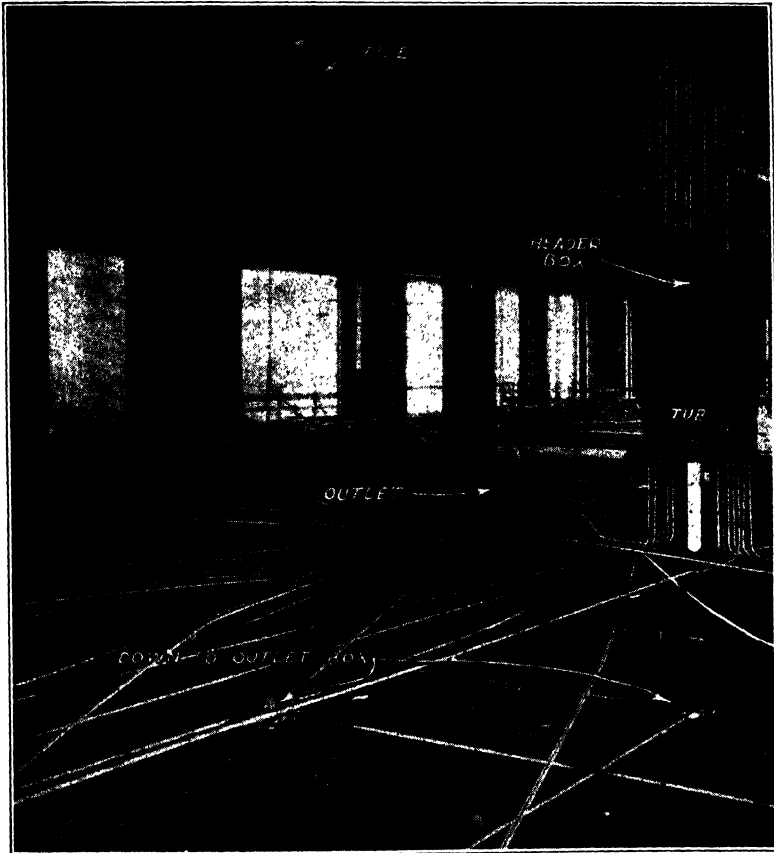

Fig. 71. Conduit Construction in Large Building, Using Tile-Arch Construction
 Courtesy of Steel and Tubes, Inc., Cleveland, Ohio

mortar. These outlets are fed from the fuse cabinet on the floor below, not from the floor in the picture.

Note also the roughing-in of the "tub," or box, for the fuse-panel controlling the branch circuits on the floor shown in the picture. Some of the conduits extend from the tub to the floor, running on the top thereof to the various outlets in the columns and walls

on this floor. The conduits feeding the ceiling outlets do not enter the tub proper, but terminate, instead, in a "header-box" at the top of the tub. This particular type of assembly probably was required on account of certain structural conditions not apparent from the picture. The header-box seems to be considerably deeper than the tub. In such case it could very readily be used as a feeder tap box as well, so that the heavy feeder would not have to be taken through the tub. As a large conduit is shown between the floor and tub but does not enter the tub, it is a fair deduction that it was used for this purpose. The large conduit from the header box to floor above is concealed by the smaller conduit.

The columns have not yet received their tile fireproofing, but the ceiling beams and girders have been so encased. The columns will get their fireproofing tile after the fill is in place. Near the base of the column, an outlet has been roughed-in, a bracket, secured to the column, holding the box away from the latter far enough to finish flush with the tile after the latter is in place.

Outlets Exposed on Ceiling. Be sure to mount these so that they will align with each other and so that the conduits connecting them will be run straight. Locate the point of installation for the box at one end of the row, and if the ceiling is of wood construction drive a nail into it at the place where one of the supporting screws for the box comes; if of concrete drill for, and secure in place, a screw-anchor and put in a screw. Attach one end of a chalkline to this screw and see that the line will be held snug against the ceiling; then chalk the line, using a color of chalk that will show up well on the ceiling. Do the same thing at the other end of the row of outlets. Take a turn with the chalkline around this nail or screw, against the ceiling, and pull it up tight with one hand. With the other hand reach out as far as you can conveniently, pull the line away from the ceiling a foot or two, holding it tight meanwhile, and let it snap back against the ceiling. This gives you a line to follow for drilling the holes for the box supports. The same method can be used for aligning the holes for the pipe strap fastenings.

An outlet box at the end of a run should always be secured to the ceiling independently of the conduit, but when conduit enters the box from opposite sides it may be used to support the box, provided you put a pipe strap on each conduit close to the box.

Outlets in Thin Partitions. Occasionally you will encounter the so-called "solid-plaster" partition. These are little more than 2 inches thick from face-to-face of plaster finish, usually consisting of metal lath supported on 1-inch channels set vertically on about 16- to 24-inch centers. Therefore, when roughing-in for a wall outlet to come in one of these partitions be careful to locate its center when installing the conduit for it down from the decking, or up from the floor, as otherwise the conduit may show, on one side or the other. Further, just as important, if not more so, is the fact that the construction of thin partitions makes it impossible to run conduit horizontally in them. This means that the outlets in them can be reached with vertical conduit only, that is, from ceiling above or floor below. There is one redeeming feature, however; the outlet can easily be tied in place with iron wire so that it will stay put.

For switches and convenience outlets in thin partitions shallow boxes, not more than 1½ inches deep must be used, because it is impossible to get plaster coverage for deeper ones.

Frame (Wood) Construction. For ceiling outlets with concealed conduit the outlet box is provided with a hanger and the latter nailed to the joist at the outlet location; all outlets are mounted before conduit is run.

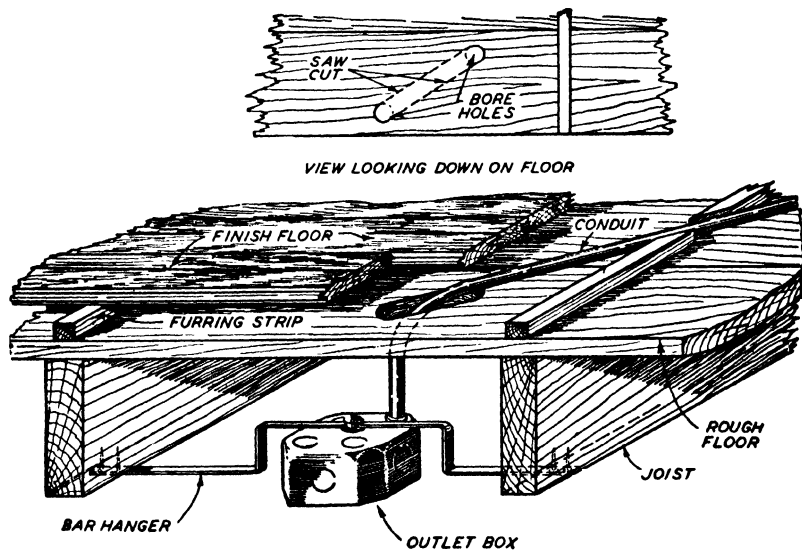

Fig. 72. View Showing Installation of Conduit in Wooden Floor Construction

There usually is a false or rough floor on top of the joists, laid at right angles or diagonally across them. The conduit is laid over this. On top of the false floor are nailed 1" x 2" "furring-strips," to which is nailed the finish floor. Above the outlet saw a slot in the false floor, Fig. 72, for each conduit; these must extend several inches beyond the box to take the throw of the bend in the conduit going down to the outlet. To provide an easy way to break out the tongue of wood formed by the two saw cuts, bore a hole through floor as far

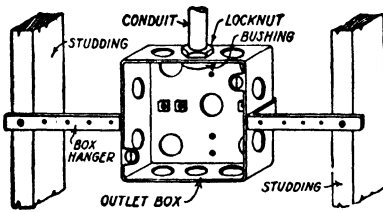

Fig. 73. Method of Mounting a Square Outlet Box on a Wood Studding Partition

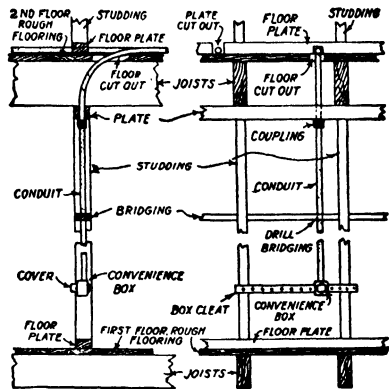

Fig. 74. Installation of Conduit in a Wood Partition Wall

away from the box as the slot is to go, in the direction the conduit will run. Bore a hole through the false floor above the box and make two saw cuts from this center hole to the first one, in line with the edges of the holes. The slot must be wide enough for the conduit. The latter may run diagonally or straight, between outlets. Where it crosses a furring-strip notch the latter, but no wider than necessary, for, at such notches there is nothing to which to nail the finish floor. It is better if the conduit runs diagonally to the strips, so that these breaks do not all come under the same length of flooring. To install the conduit, make a bend at the end of a length, long enough to reach the box; couple another piece onto the long end, if necessary to reach the next outlet, and put a bend in that end. Then fasten each conduit end to its outlet box with bushing and locknut.

If there is no false floor, notch the tops of the joists, never the bottoms, as this weakens them too much, and proceed as before.

Wall outlets should all be mounted before conduit is run, Fig. 73. At the top of the studding there is a partition plate, or header, Fig. 74, consisting of one or two two-by-four's; you can either bore them or notch them for the conduit.

When necessary to run conduit horizontally across a studding partition, do not notch the studs deeper nor wider than you must. The

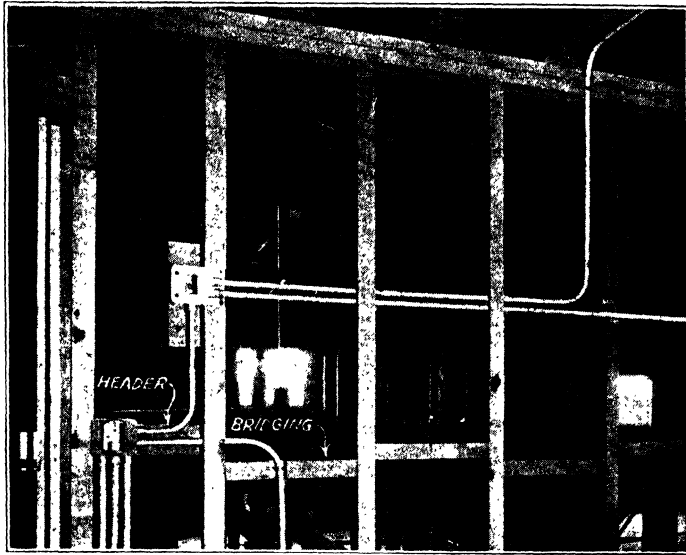

Fig. 75. Installation of Thin-Wall Tubing in a Wood Studding Partition Wall

Courtesy of Steel and Tubes, Inc., Cleveland, Ohio

former weakens the stud, the latter creates objectionable gaps in the bearing and nailing surface for the lath, which may cause plaster cracks.

It is not necessary to fasten conduits to joists when running over them. But a conduit of considerable length running between and parallel to joists or studs should be brought alongside and strapped to one of them; in that way vibration is not so likely to crack the plaster at the outlet.

Fig. 75 shows two outlet boxes installed in a studding partition. The lower one consists of a standard square outlet box with a two-gang switch cover. There are two $\frac{1}{2}$ -inch and one $\frac{3}{4}$ -inch conduits entering the box from the bottom, and two $\frac{1}{2}$ -inch conduits

going out of the box, on the right-hand side. One of these turns down in the wall, evidently going to a convenience outlet beyond the limits of the picture. The other goes to a standard square outlet box above and a little to the side of the first outlet.

The upper box is for a bracket outlet, being equipped with a "French" cover, that is, a cover with a rectangular opening, similar to the opening in a single-gang switch cover except that the corners of the opening are rounded. The end of the fixture stud can be seen in the back of the box. This outlet evidently is intended to take a bracket fixture with a narrow back-plate, instead of with a regular canopy.

Note that the conduits entering the lower box from the bottom are plugged, to prevent the entrance of nails, plaster, or other matter that would interfere with the fishing and pulling of the run. The $\frac{3}{4}$ -inch conduit probably is the home run to the fuse-cabinet for two or more circuits, which are distributed from this switch box. The job looks good, with the exception of the wooden headers used, instead of metal hangers for the support of the outlets.

Floor Boxes. There are two types of these, Fig. 76, the adjustable, and Fig. 77, the nonadjustable. The latter is much cheaper to buy, but unless you are sure you can set it level so that it will stay level and at the correct height to bring the top of finish plate flush with the finished floor, you will be money ahead by buying the adjustable type at double the difference in price.

Conduit entry to the floor box is by way of threaded holes, the unused holes being closed with threaded plugs. A bushing is used on the conduit inside the box; a locknut is not required.

The nonadjustable box comes with a plug receptacle in a metal ring that seats in a recess in the body of the box. The adjustable type takes standard plug receptacles, the upper face of adjusting ring being recessed for the mounting ears and having tapped holes for the mounting screws.

The difficulty in setting these boxes level lies in the absence of a base to which they can be firmly attached during the roughing-in operation. You can not block up from the false-work below them, for the concrete man wants concrete there. Even if you devise an unobjectionable means of holding the box in correct position it is very doubtful that it will withstand the hard use to which it is subject dur-

ing the rough construction period. The best advice we can give is to enlist the full cooperation of the concrete man during the pouring of the concrete and to remain on the job to see what happens during this operation.

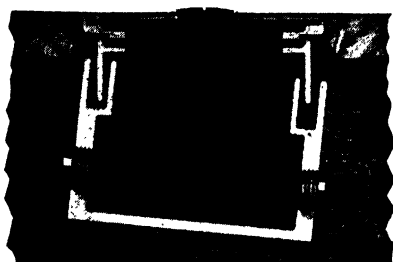

Fig. 76. Adjustable Floor Box

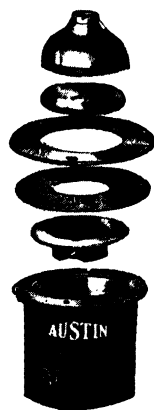

Fig. 77.
Assembly View
of Parts for
Floor Box

Courtesy of The M. B. Austin Company, Chicago

Outlets in Concrete Columns. In general, the forms for square concrete columns are of wood, whereas those for round or octagon columns are of steel. To secure an outlet box and conduit in one of these forms is not a simple task even with the help of the man who sets the forms; the obstacle is the reinforcing steel. The reinforcing usually consists of a steel spiral several inches less in diameter than that of the column (similar to a long, drawn-out coil spring) with a number of heavy vertical bars wired or otherwise secured to the coils, forming a complete unit; it is dropped into the form after the latter is fixed in place and usually it is a close fit for the outlet box between the form and the reinforcing steel.

With wood forms you fasten box and conduit (use two locknuts, one outside, the other inside the box, in addition to bushing) to one of the sides of the form, see Fig. 78, at the point where you want the outlet, before the form is set up, and arrange with the form-setter for the placing of this panel on the correct side of the column. Before doing that check with the form-setter to find out whether the panels are interchangeable or whether they are framed to go into a definite

relation to each other; otherwise your outlet might be on the wrong side of the column. Leave the upper end of the conduit straight, to make the form-setter's work easier; you can bend it over after the form is complete. By putting a coupling in the conduit run, with a conduit support against it on the lower side, as shown, the entire jolt does not come on the box in case the reinforcing steel, in its

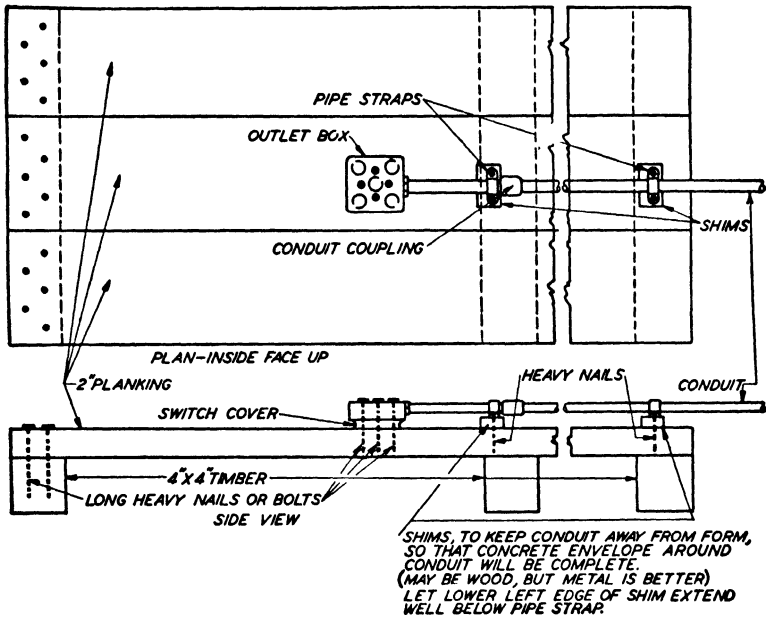

Fig. 78. Method of Attaching Conduit and Outlet Box to Wood Forms for Concrete Columns

descent, happens to strike the box. Use as narrow and shallow a box as you can, preferably one with round corners.

A method for use with steel forms is shown in Fig. 79. While each of the four sides of a wood form is in one piece, the steel form usually is sectional. If the form-setter will cooperate you can mount box and short section of conduit on a section of form, but if this is too troublesome for the form-setter you wait until the section in which the outlet comes is in place before mounting the box. Use two long slim bolts passing through box and through holes, drilled or punched through the form, for mounting the box. The heads of the bolts should be back of the box. Before removal of the form

the nuts can be taken off or cut off with hammer and chisel, which latter can also be used for cutting off the bolts in the box.

If forms and steel are set ahead of you, locate on the form the place where the internal ears of the box will come; put a hole through the form at each of these points, allowing plenty of clearance. Make up a box and conduit, which one man drops down from above

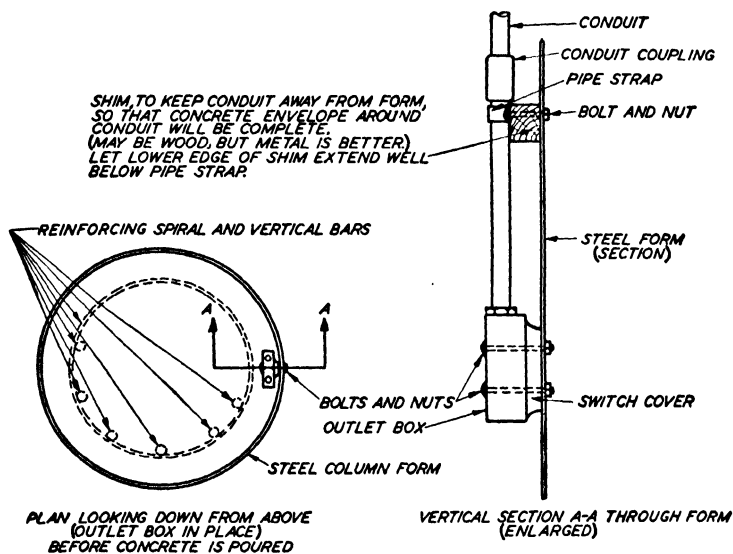

Fig. 79. Method of Attaching Conduit and Outlet Box to Steel Forms for Circular Concrete Column

to correct position. A man below passes a size 6-32 machine screw, with a washer to cover the hole-clearance, through the holes in the form, engaging the threaded holes in the ears of the box, and tightens the screw. The bolts must be greased so that rusting will not cause them to stick in the box. Fill the box well with paper or rags, on account of the pressure upon the concrete at such a low point.

Do not install a two-gang device in a round column of relatively small diameter. A flat plate of such width would leave an unsightly gap between its edges and the round face of the column.

CONDUITS IN CONCRETE

Here we have two different conditions to meet: (1) a concrete slab resting directly upon a soil or a filled surface, (2) a slab over an

excavated area, with an air space beneath. Before going further we want to bring out the importance of not leaving oil or grease on conduits that are to be encased in concrete, as this prevents a good bond between the two.

Case One. Assuming that it has been placed on firm soil, the slab is entirely in compression when loaded. Therefore the position that the conduits occupy in the slab is not of great importance, because the slab has support at every point; however, they should not be too near the surface. There is such a large difference in the coefficient of expansion of steel and that of concrete, that is, the amount that the respective material contracts or expands for each degree of temperature change, that cracks may appear in the surface of concrete in which the conduits are too near the top, when there are wide variations of temperature. For this reason they generally are placed near the bottom of the slab. There should be a cover of 3 inches of concrete over the conduit and 2 inches between the latter and the soil. This calls for a shallow trench in the soil under the conduits if the thickness of the slab is a bit skimpy. If there is a cinder fill under the concrete and the conduits are placed in this fill, the conduits should be galvanized. The enamel-coated conduit does not resist as well as galvanized conduit the corrosive action of the dilute acid formed by water acting on the sulphur in the cinders.

Case Two. In this case the slab is supported at its edges only, the upper half being in compression, the lower half in tension. Therefore the conduits should never be below the "median line," that is, the center line of the slab, because of the weakening effect of the conduits upon the slab when placed below this line. The outside diameter of conduit to be run in a flat slab should in no case be greater than one third the slab thickness. In a type of construction wherein the slab forms an arch, supported on two opposite sides only, instead of being flat and supported on all four sides, there is more leeway for conduit size, at least in the direction at right angles to the supporting members. Also, near the supporting members the slab is usually thicker than near the center of the span and in these "haunches" you have more conduit space. However, always consult the architect or structural engineer before running conduits of larger size than is commonly used for lighting branch circuits in such slabs, or in any other questionable zone.

SOME DO'S AND DON'T'S

When working black enameled conduit you must clean the threads before trying to couple it, because at the factory it is threaded and the coupling is put on before being dipped. This leaves the threads full of sticky substance and if you do not remove it you will be unable to make up a tight joint, sometimes not even to start the thread. Put the conduit in the vise and run the stock and die over the thread; reverse the conduit in the vise, take off the coupling, reverse it and screw it onto the conduit, with pipe pliers or wrench, as far as it will go. It is not necessary, as a rule, to clean the threads on galvanized conduit, although some mechanics do it as a matter of precaution.

Be sure to use a liberal quantity of a good lubricant on the cut when threading conduit. This makes the job easier. Lard oil, or one of the several compounds put out for this purpose, should be used. Lard oil does not flow freely when cold, therefore use the oil called "winter-strain" in winter. You cannot save money by using cheap oil.

Do not leave open the uncompleted ends of conduit runs in the floor, nor those of conduits pointing upward out of a floor. They should be closed, in order to keep out concrete or other objectionable materials which may block the run. The best thing to use for this purpose is a standard pipe cap screwed on tight. Do not use wood plugs, because moisture causes them to swell to such an extent that sometimes it is next to impossible to remove them.

When drilling or tapping steel use oil on drill or tap, but on cast iron or brass these operations are done dry, that is, without oil.

When a conduit coming up out of a concrete floor, or extending down from a concrete ceiling, must be bent over, do not do this work with only one hickey, for if you do, you very likely will break the conduit off short where it comes out of the concrete, because there is no give at this point. Use a second hickey to hold against the pull of the first, so that no pressure comes on the conduit at the point of emergence. If the bend must come near this point, cut the concrete away for an inch or two into the floor or ceiling, get the conduit "plenty hot" with a blow-torch or two, and put the pressure on gradually.

Do not lay out a conduit run with one ell following the preced-

ing one immediately; try to arrange the run so that there will be at least one full length of straight run between the two ells. When pulling three or more wires through an ell a sort of wedge action occurs, caused by one of the wires lying in the hollow between the other two. At the turn, the wire that is on the outside will have a somewhat longer distance to travel than the inner ones, by reason of the longer bending radius. Because it is forced farther down between the others binding occurs and this makes the pull harder. A straight length following the bend tends to relieve this binding. But when two ells are end-to-end this relief hardly gets a chance to become operative after the first turn is made before the next bend is reached; therefore the pull is that much the harder. Also, it is more tedious to fish one of these end-to-enders than it is to fish two ells with a substantial length of straight conduit between them.

When, in order to save conduit, the wires of two or more lighting circuits are run together in one conduit, through one or more outlets on the way, slack should be left at these boxes in only those wires that are to carry the load of that particular outlet. The other, or through, wires should be "buried," that is, pulled tight in every box through which they merely pass. This precaution minimizes the likelihood of connecting some of the "near-by" load to the through wires, instead of to the "local" wires, thus guarding against overloading the one and underloading the other set of wires.

Where several feeders are to be pulled through a pull box, one of which is considerably larger than the others, the smaller wires should be pulled in before the large ones, because the small wires can be pushed back into the box, out of the way of the pulling-in of the larger wires, which cannot be done readily with the large wires, owing to their size and stiffness.

APARTMENT BUILDING WIRING

Kind of Building. The building we are about to wire is constructed of brick and is three stories in height and is commonly known as a three-story apartment building. The entrance to the stairway leading to the upper floors is through the public vestibule. There is a public hall on each floor, from which a door opens into the reception hall of the apartment. Each tenant must pay for the electric light used in his apartment, but the light in the public halls and basement is furnished by the owner of the building and is placed on a separate meter.

The plan of the building is shown in Fig. 1. In this drawing the general outline and dimensions of the rooms are given. The dimensions are taken from the center of one partition to the brick wall, or from the center of one partition to the center of the next partition. This drawing also shows the location of the various outlets and symbols and is similar to the drawing that an electrical contractor would receive from an architect. Usually on an architect's drawing, however, there are various other dimensions and figures which refer to various types of work to be done by other workmen, such as sewers, steam pipes, etc.

In Fig. 2 an elevation of this building is shown in order to give more detailed information in regard to the construction of the building. The front porch is composed of brickwork while the rear porch is of wood and timber. The service wires, conduit, switch, and meters are shown in place like when the job is completed. The partitions between the rooms are wood studding with lath and plaster on each side. The wood floor joists run from the edge of the north brick wall to the south brick wall, and are supported in the center by iron beams and columns, which are not shown on the drawings. In this type of building it is desirable that the electric wiring be made as safe as possible and for this reason rigid or thin wall conduit is the only kind of wiring that should be used. These must be installed as soon as the rough flooring is nailed in place and the partitions are located by the carpenter. In this work the carpenters and the electricians are working on the building at the same time.

Steps in Wiring. In a building of this type there is usually considerable preliminary work and planning between the electrical

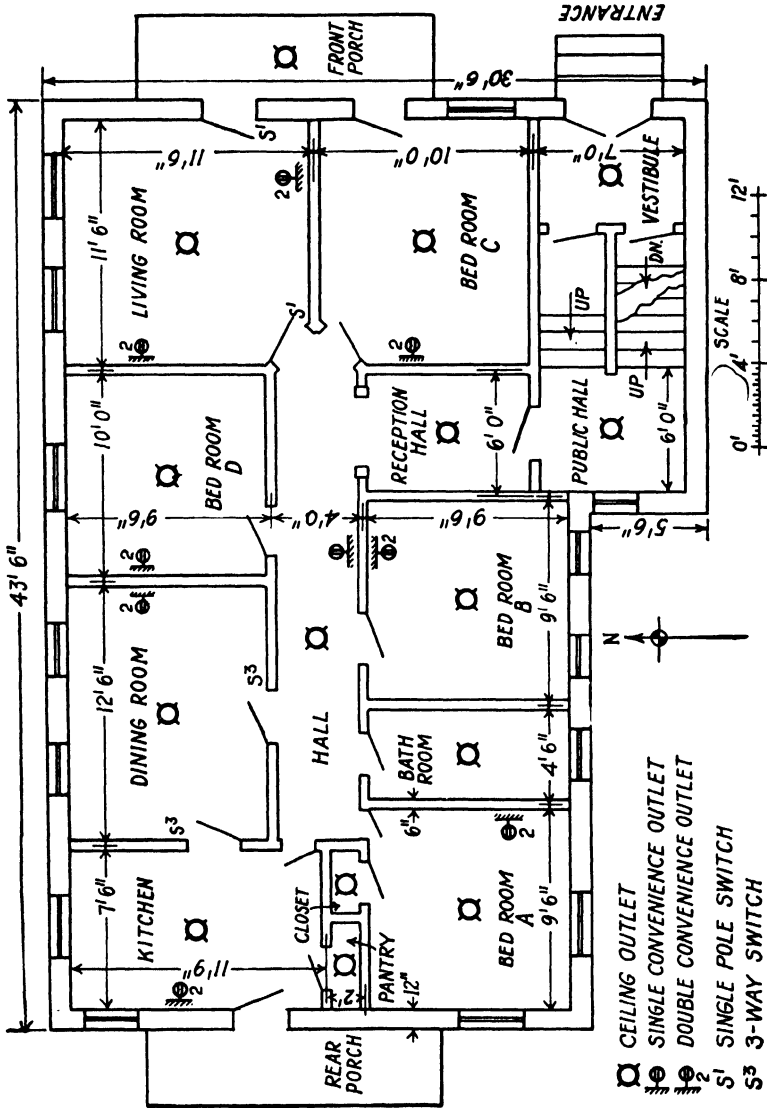

Fig. 1. Floor Plan of Apartment Building, Showing Location of Electrical Outlets

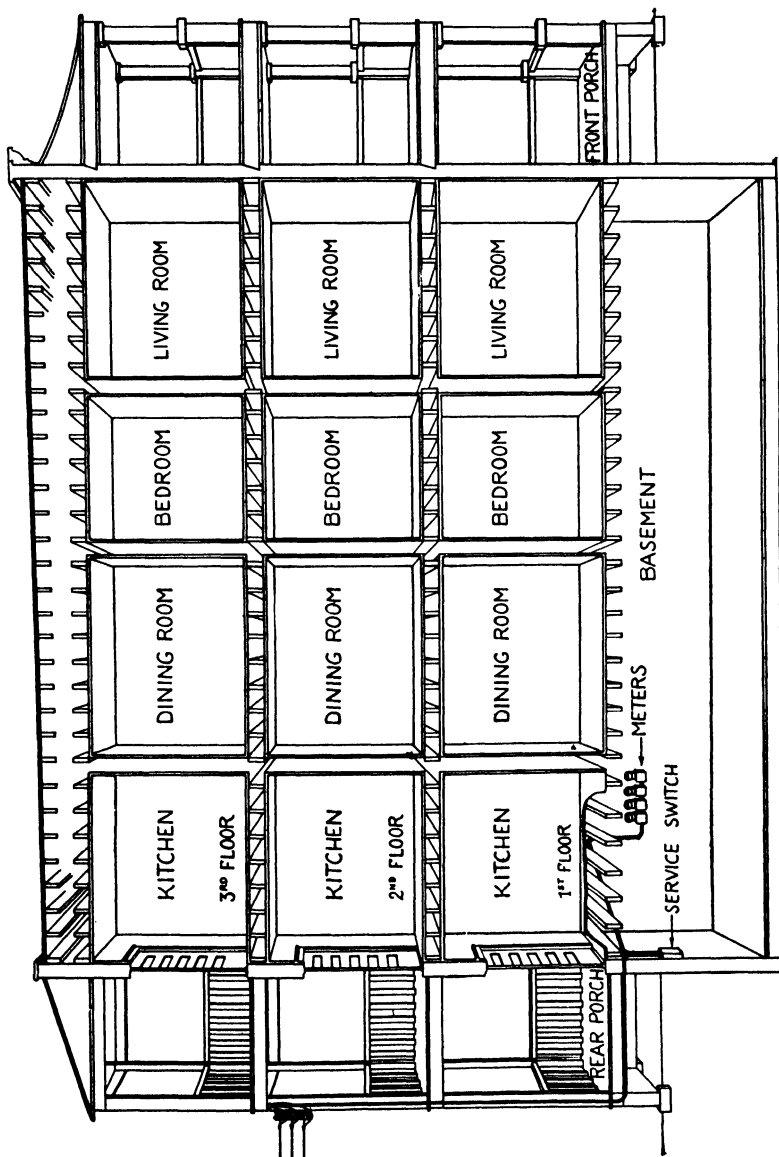

Fig. 2. Cross-section of Three-Story Apartment Building

APARTMENT BUILDING WIRING

Table I

STEPS IN WIRING AN APARTMENT BUILDING

Obtaining contract	<ol style="list-style-type: none"> 1. Obtain drawings from architect 2. Preparing schedule of outlets, switches, and receptacles 3. Estimating materials required 4. Estimating labor required and submitting bid to architect
Preliminary work after contract is obtained	<ol style="list-style-type: none"> 1. Selecting materials and supplies 2. Ordering materials and supplies from jobbers 3. Issuing work order sheets 4. Laying out work for wiremen 5. Delivering tools and materials to the job
Roughing-in Conduit	<ol style="list-style-type: none"> 1. Bending conduit 2. Installing switch and outlet boxes 3. Installing wood racks for watt-hour meters 4. Installing service conduit and switches 5. Installing conduit for ground wire 6. First examination by electrical inspector
Pulling in wires	<ol style="list-style-type: none"> 1. Cleaning conduit runs and switch boxes 2. Fishing conduit runs and pulling in wires between outlet boxes 3. Pulling in wires from branch circuit fuse block to first outlet 4. Pulling in service wires
Finishing	<ol style="list-style-type: none"> 1. Grounding conduit and service wires 2. Testing out, splicing, soldering, and taping 3. Installing branch circuit fuse blocks and wiring for meters 4. Installing switch and receptacle plates 5. Installing lighting fixtures
Final Work	<ol style="list-style-type: none"> 1. Final testing out 2. Final adjustment, if necessary 3. Final electrical inspection 4. Removing tools and materials from the job

contractor and the architect before the building is ready to have the conduit installed in place. The workman who installs the conduit seldom has a chance to see how this part of the work is handled and for this reason a complete list of steps that a contractor usually follows is given in Table I. On some jobs the order may be slightly different due to special or different conditions. In some cases two or more steps may be combined into one operation or step.

OBTAINING CONTRACT

Preparing Schedule. When the contractor obtains the drawings and specifications from the architect, he prepares a schedule showing the number of outlets, switches, and receptacles. Only twelve outlets on a branch circuit are allowed by the National Electric Code. In some cities, such as Chicago, for example, the rules for apartment buildings are that there shall be at least two circuits for each apartment of five rooms or more. Also that the wattage shall be figured on a basis of one watt per square foot of floor surface inside the brick walls, including the partitions. Therefore, the contractor must be familiar with the local code or rules. In Chicago, the requirement as to the number of outlets on a branch circuit is eliminated in order to encourage the installing of additional convenience receptacles when the building is being constructed, and thus reduce the number of additions made after the wiring has been installed.

In figuring the wattage of each outlet, it is customary to consider the lamps and convenience outlets or receptacles as being 60 watts, unless definitely specified by the architect. This applies to both single and double receptacles. In a three-story apartment building there will be four meters installed. The hall lights and the lights in the basement are operated on a separate meter, because the owner of the building has to pay the lighting company for the current used by these lights while each tenant in the apartment pays the company for the current that is used in his apartment.

In the schedule of lights and outlets, Table II, the first floor is figured in detail. The second and third floors each have the same outlets and the same total wattage as the first floor. It pays to take time and prepare a neat schedule like Table II, because there is less chance to skip over any item in the plans and the schedule can be checked back against the plans quickly. The same is also true of the estimate sheets used for estimating the labor and material. Omitting one or two outlets when preparing the bid may lose all the profit on the job, and putting in one or two additional outlets will make your bid too high, causing you to lose the job. When a complete schedule has been prepared and the contract is awarded, all the information in regard to size and amount of conduit, wire, outlet boxes, etc., is available on the estimate sheets and the material can be quickly ordered without going over the drawings again.

Table II

SCHEDULE OF LIGHTS AND OUTLETS

60-Watt lamp per socket and receptacles (single or double)

Location	Ceiling Outlet	Convenience Receptacles	Switches	Number Lights	Number Watts
Living Room.....	1	2 Double	1 Single	3	300
Dining Room.....	1	1 Double	2—3-way	3	240
Kitchen.....	1	1 Double		1	120
Bedroom "A".....	1	1 Double		1	120
Bedroom "B".....	1	1 Double		1	120
Bedroom "C".....	1	1 Double		1	120
Bedroom "D".....	1	1 Double		1	120
Halls.....	2	1 Single		2	180
Bathroom.....	1			1	60
Closet.....	1			1	60
Pantry.....	1			1	60
Porch.....	1		1 Single	1	60
First Floor Total...	13	9	4	17	1560
Second Floor Total..	13	9	4	17	1560
Third Floor Total...	13	9	4	17	1560
Public Halls.....	4		1 Single	4	240
Basement.....	2			2	120
Building Total.....	45	24 Double 3 Single	7 Single 6—3-way	57	5040

Estimating Cost of Job. There are several methods used by wiring contractors in estimating the cost of the job for the three-story apartment building. One method is to estimate the number of switch boxes, outlet boxes, outlet box hangers, conduit, wire, etc., required on the job, and then from this information estimate the cost of material and also the cost of labor. This requires considerable work and the shorter and simpler method of comparative costs is more often used.

It has been found that the cost of installing a ceiling outlet or convenience outlet is about the same, no matter whether the building

has three, six, or more apartments, provided of course the buildings are of the same type of construction. Thus an item called the "job cost" is used, which includes the cost of installing the service wires, fuse cabinet, rack for watt-hour meters, meter wiring, wiring of branch circuits to first outlet on that circuit, permits, inspection fees, etc., in connection with the job. This estimating schedule is obtained by keeping records of the cost of similar jobs. It is arranged for the number of circuits and number of meters in the building, because the greater the number of meters or the number of circuits, the higher will be the cost. Then in addition to the job cost, the cost of the ceiling outlets, convenience outlets, and switches must be figured and added to the job cost, in order to find the total cost. The section on estimating gives detailed information on both the job cost and cost of other items.

Submitting Bid to Architect. The contractor's bid to the architect is a simple written or printed form stating that for a certain sum of money the contractor will install so many ceiling outlets, convenience outlets, switches, etc., according to the specifications furnished by the architect. This sum of money mentioned in the contractor's bid includes all material, labor, permits, overhead, and profit. The item called "overhead" includes the cost of securing job, hauling material to the job, lost or broken tools, store or office help, etc.

PRELIMINARY WORK

Ordering Materials. As soon as the contract is obtained, the schedule and estimate sheets should be gone over and the conduit, outlet boxes, box hangers, switch boxes, wire, and other fittings ordered from the electrical jobber for delivery on or before the date that the building is ready for the electrical contractor to start work on. If the construction of the building is being rushed, the electrical work is usually started as soon as the brick masons have started on the third floor, and the carpenters have nailed the rough flooring and studdings for the partitions on the first floor in place; otherwise the electrical work is not started until after the roof is on and the carpenters have finished their work.

Laying out Work. A large contractor usually issues a work order sheet which is assigned a number so that all the workmen

working on that particular job will charge their time to this number. The purpose of this is to aid the contractor in keeping a record of the material and labor on this job so that at the end he can tell whether he made any profit and how much. In case his bid was too low to make any profit, he will know it and can prevent making the same mistake on the next job.

The contractor will show on the blueprint that he has of the building, by yellow or red pencil mark, how the conduit is to be run, and show the size if any part of it has to be larger than one-half inch. In laying out the conduit runs, the length of conduit should be as short as possible and at the same time avoid complicated bends or difficult construction. A conduit diagram such as would be marked on the blueprint for the wireman is shown in Fig. 3. The layout on the three floors is the same. A wiring diagram, Fig. 4, shows how the conduit is wired. It will be seen by studying these two diagrams that there are four wires in the conduit from the watt-hour meter in the basement to the closet outlet where one circuit passes on to the dining room outlet.

A $\frac{3}{4}$ -inch conduit is used in this run because there will be four or five quarter or 90-degree bends from the meter to the outlet, and it would be rather hard work to pull four No. 14 rubber-covered wires this distance and through this number of bends in a $\frac{1}{2}$ -inch conduit. The saving of a half hour of time of two men in pulling the wires into this conduit will usually be more than the increased cost of $\frac{3}{4}$ -inch over $\frac{1}{2}$ -inch conduit. When determining the size of conduit to use, such conditions must be considered if the work is to be done at the lowest cost.

The conduit is run from the watt-hour meters in the basement up to the ceiling and along the floor joist to a point directly under the partition, between kitchen and closet. Then the conduit is bent and run up the partition between the closet and the kitchen, and through the top plate (a piece of wood 2 inches thick and 4 inches wide) over the studding where it is again bent and run over to the outlet in the closet. This particular conduit will contain four No. 14 rubber-covered wires, as it carries the two circuits from the meter in the basement to the wiring on the first floor. Then from the outlet in the closet, $\frac{1}{2}$ -inch conduit is run up through the rough floor and across the top of the rough flooring to the location

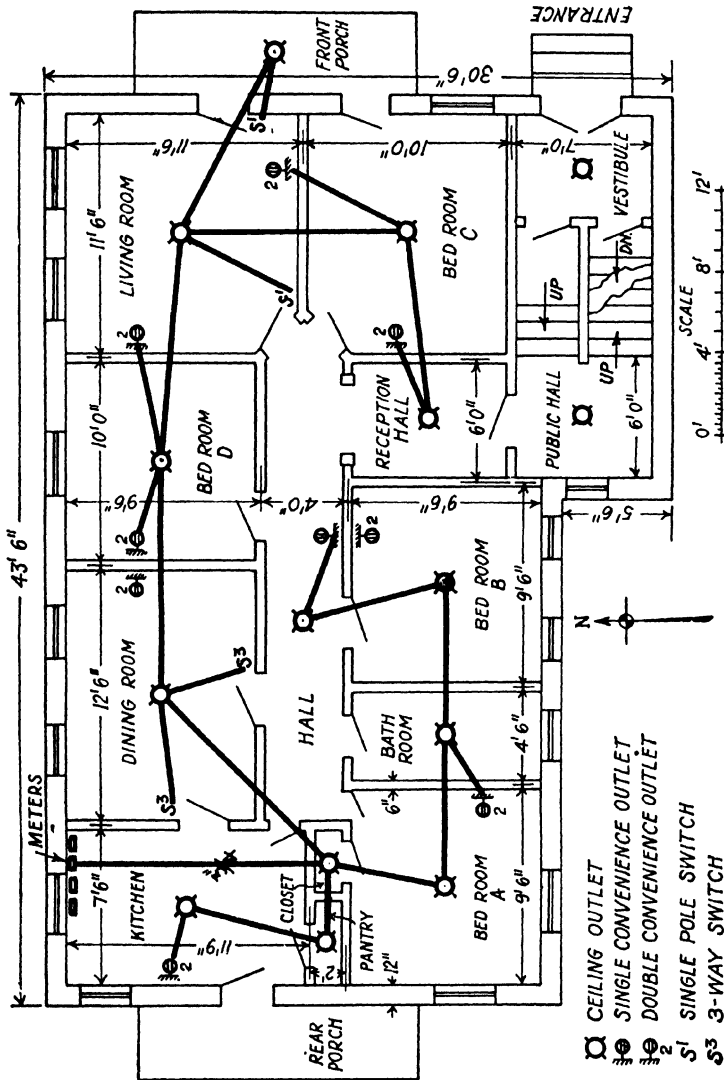

Fig. 3. Layout of Conduit Run in Apartment Building

of the dining room outlet, down through the rough flooring and into the outlet box in the dining room on the first floor. Two more conduit are run in like manner from the meters in the basement to the outlet in the closet on the second and third floors.

It might require less material if the conduit was run from the meters up the brick wall to the floor joist, on the second floor, and then across on this rough flooring to the kitchen outlet, instead of across to the closet outlet, as shown in Fig. 3. However, in a building of this type it is usually necessary to chisel or channel out a space for the conduit in the brick wall in order that it will not interfere with plastering work. This cutting out the brick is rather hard work and takes more labor and time than the extra cost of the conduit would amount to, by running the conduit up through the partition to the closet outlet.

It also might appear as advisable to run the conduit from the meters to the three-way switch in the dining room, on the partition between the dining room and kitchen. If this is done, there would be four wires coming into the switch box from the meters which would have to be spliced, two of them going in the conduit to the kitchen outlet and two going to the dining room outlet besides the two wires for the three-way switch. This would make the wiring much more complicated, and there is usually not sufficient space in a standard switch box to allow this number of wires to be spliced or connected together.

In the conduit diagram, Fig. 3, no attempt is made to show how the conduit is bent. The purpose of this diagram is to show what outlet boxes are connected together by conduit, and how many are being run from certain centers, as the dining room, bedroom, living room, etc.

ROUGHING IN CONDUIT

Bending Conduit. Four runs of conduit is the maximum number that can enter a ceiling outlet box, because in a ceiling box there are only five knock outs and the center one, Fig. 5, is bolted to the ceiling box hanger, Fig. 6. The method of supporting the outlet boxes by means of the box hanger bar is shown in Fig. 7. In this figure there are two conduit entering the outlet box, as in the case of the pantry and kitchen outlets, Fig. 3. In the case of

the closet outlet, Fig. 3, there would be two more conduit entering the outlet box at right angles to those shown in Fig. 7, which would make four conduit to that box.

The conduit is bent to proper shape and cut and threaded to the right length so that when it is laying flat on the rough floor,

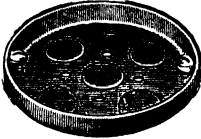

Fig. 5. Shallow Ceiling Box

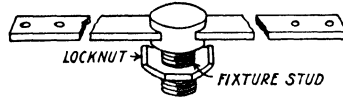

Fig. 6. Ceiling Box or Bar Hangers with Stud and Lock Nut

Fig. 7, it can be fastened to the outlet box by means of a lock nut above the outlet box and a bushing inside the outlet box. On short bends, near the outlet box the conduit is threaded before being cut to the right length. The conduit must not bend, raise, or lower the outlet box from its proper position.

The bottom edges of the outlet box, Fig. 7, must be between $\frac{1}{2}$ to $\frac{3}{4}$ of an inch below the bottom of the joists in order that the outlet box will be flush with the plaster. The lath, which are about

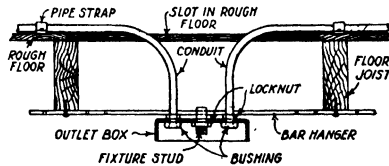

Fig. 7. Method of Supporting Outlet Boxes and Fastening Conduit to Them

$\frac{1}{4}$ to $\frac{3}{8}$ of an inch in thickness, are nailed to the under side of the floor joists. The plaster over the lath is about $\frac{1}{4}$ to $\frac{3}{8}$ of an inch in thickness. It is sometimes best in ceiling outlets to use a shallow ceiling box that is 4 inches in diameter and either $\frac{1}{2}$ or $\frac{3}{4}$ of an inch in depth. After the conduit has been cut, threaded, and fastened to the outlet box, Fig. 7, it is securely fastened to the rough floor by means of pipe or conduit straps.

It is the usual practice in apartment buildings of this type to lay the rough floor with boards about an inch thick and nail

them on the floor joists as soon as the floor joists are put in place. Then the brick wall is built up to the next floor and the floor joists and rough flooring laid for that floor.

After all the electrical conduit, water, steam, gas, and sewer pipes have been installed, and the building has been lathed and plastered, the finished floor is laid. This floor is usually laid on 1-inch to 2-inch strips of wood, called furring strips, that have been

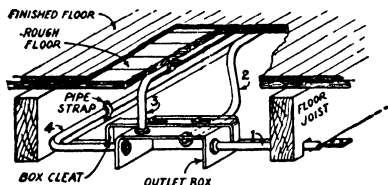

Fig. 8. Installing Conduit to Square or Octagon Outlet Box

nailed to the rough floor. The space between the furring strips is often filled with some kind of sound-proof material or deadening felt in order to prevent the noise or sound in the apartment above being carried to the floor below. The use of furring strips between the floors enables the electricians to lay the conduit on the rough floors as shown in Fig. 7.

When the finished floor is to be laid on top of the rough floor without furring strips, the method of installing conduit is shown

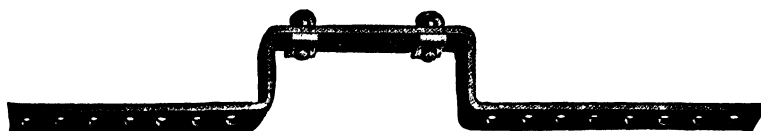

Fig. 9. Universal Box Cleats Used Chiefly on Side Wall Construction

in Fig. 8. A universal box cleat, Fig. 9, is nailed to the under side of the joists and is used to support an octagon or square outlet box, shown in Figs. 10 and 11.

When the conduit is run at right angles to the floor joists, a notch is cut in the floor joist, Fig. 8, as deep as the diameter of the conduit, and the conduit is fastened in the notch by driving two nails diagonally into the joist. When the conduit is run parallel

to the floor joists, it is fastened to the rough floor like conduit 3, Fig. 8; or fastened to the joists like conduit 2 and 4. When there is only one conduit coming to the outlet box, either one of the three methods can be used to enter the outlet box.

Another method of running the conduit at right angles to the floor joists is to cut out a strip of the rough floor about an inch



Fig. 10. Octagon Outlet Box and Cover

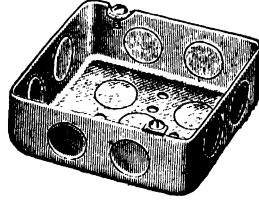
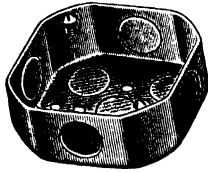

Fig. 11. Square Outlet and Switch Box

wide and lay the conduit in this strip. In order that the conduit will not extend above the floor it will be necessary to cut a notch about half an inch deep in the top of the floor joists. A shallow outlet box, Fig. 5, and box hanger, Fig. 6, mounted like Fig. 7, can be used if the conduit that is run parallel to the joists is installed like conduit 3, Fig. 8, and fastened to the under side of the rough floor.

The style of switch box that is used for switches and convenience outlets is shown in Fig. 11, and the cover for the box in

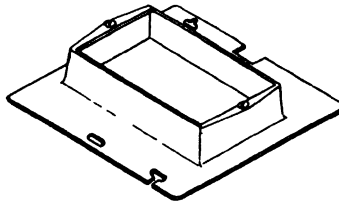

Fig. 12. Switch Box Cover for Square Outlet Box

Fig. 12. This cover is made in different heights, in order that it will be flush with the plaster. A universal box cleat, Fig. 9, is bolted to the back side of the switch box by means of the stove bolts that pass through the universal box cleat. The universal box cleat is fastened to the studding by driving nails through the holes

in the cleat. The method of mounting the square outlet or switch box to the studding is shown in Fig. 13. When the cover, Fig. 12, is placed on the outlet box, the front edge of the cover should extend $\frac{1}{2}$ to $\frac{3}{4}$ of an inch out into the room from the front edge of the studding, in order that the edge of the cover of the box will be flush with the plaster.

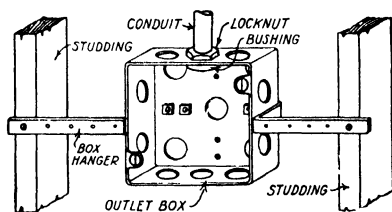

Fig. 13. Method of Mounting Convenience Outlets or Switch Boxes

The method of running the conduit from the outlet in the center of the room down through the partitions to the convenience outlet is shown in Fig. 14. A hole is drilled through the plate and bridging with a one-inch wood bit or auger, so that the conduit can be passed

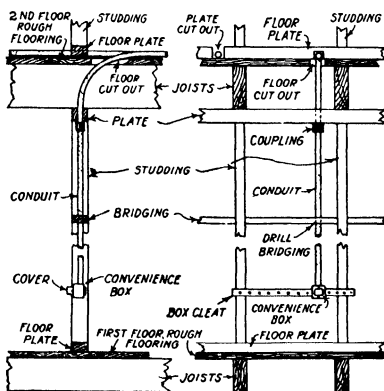

Fig. 14. Method of Installing Conduit to Convenience Outlets or Switch Boxes

through them. The rough floor is cut out so that the bend in the conduit can be dropped into position. If the bend is near the end of a piece of conduit, it may not usually be necessary to cut out part of the floor plate of the partition on the floor above in order to

get the conduit in position. A straight piece of conduit can be coupled on the bent conduit directly below the plate through which it passes. The convenience outlets are usually located about 15 inches above the rough floor. Outlets for switches are usually located about $4\frac{1}{2}$ feet above the rough floor.

When the conduit is being run from one ceiling outlet to the next and has to pass across a partition, the floor plate of the partition is cut or notched out, as in Fig. 14, so that the conduit will lay flat on the floor. If there is any tendency for the plate that has been cut to spring out of place, a piece of board can be nailed across the top of the plate after the conduit is in place. The width of this board must be less than the width of the plate, which is about $3\frac{1}{2}$ inches.

The construction of the partition between the living and the dining room and the method of installing the conduit for the convenience outlets is shown in Fig. 14. When two outlets are located on opposite sides of the partition, like the bedroom *B* and the hall convenience outlet, Fig. 3, two boxes, Fig. 11, are bolted back to back with the box cleat or hanger, Fig. 9, between them, after two knockouts opposite each other have been removed. A piece of half-inch steam or water pipe that is about $\frac{3}{4}$ inch long and threaded full length (called a nipple) is pushed through the knockouts and a conduit bushing screwed on each end of it. The wires are pushed from one box to the other through this nipple.

The conduit is bent and installed, in like manner, from one ceiling outlet to the next and to the switches and convenience outlets, as shown in Fig. 3, until all the work on each floor is done.

Service Conduit and Meter Wiring. The old method of meter wiring was to mount the meters directly below the iron box containing the branch circuit fuses and to run open wires or else wires in non-metallic loom to the meters as shown in Fig. 15. In this figure there are eight electric meters in the right center of the picture, which indicates that there are eight apartments supplied from this meter installation. There are two gas meters shown at the extreme left of the picture. It is dangerous to have a number of wires hanging around the meters as shown in Fig. 15, so the practice of inclosing all the wires in conduit to the meters was adopted. This method is illustrated in Fig. 16. In this picture the meter

wiring for six apartments is shown although only five of the seven meters are installed. The other two meters will be installed by the power company when needed. A wiring diagram of this installation is shown in Fig. 17. Fig. 16 does not show the service switch or the iron box containing the fuse, plug cutouts, and fuse plugs for the branch circuits. There are fuses in the iron boxes below the meters which protect the wiring through the watt-hour meters to the fuses in the branch circuit. These fuses are indicated on the wiring diagram by small circles below the watt-hour meters.



Fig. 15. Old Method of Installing Meters

The Electrical Code usually requires that the main service switch be located at the nearest and easiest accessible point of the entrance of the service conduit into the building. In some cities the local ordinance limits the length of conduit inside the building to the service switch to a certain limit. In Chicago, for example, it is limited to 3 feet. In choosing the location of the service entrance, the best place is near the doorway that leads into the basement from the outside. Whenever possible, the service switch should be on the side of the doorway, opposite the hinges, as shown in Fig. 18, instead of placing it in a position that it will be back of the door

when the door is open. The service switch should be made as easily accessible as possible.

The National Electric Code requires that the service wires shall not be smaller than No. 8 except in very small buildings that need only one branch circuit; there No. 12 can be used. To determine if this

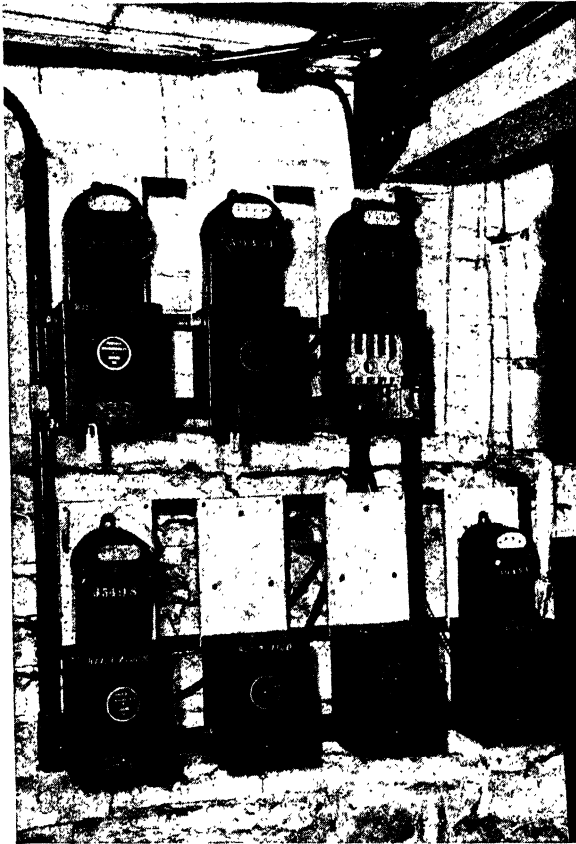

Fig. 16. Another Method of Installing Meters

size of wire is large enough for this installation, it is necessary to estimate the amount of current required. In a building of this type, a 3-wire 115- to 230-volt system of distribution is used by the lighting or power company. The meter switches and watt-hour meters are usually connected so that there is a 2-wire 115-volt service to

each apartment that can be used. The wiring diagram for a similar installation is shown in Fig. 19. In this diagram the branch circuit

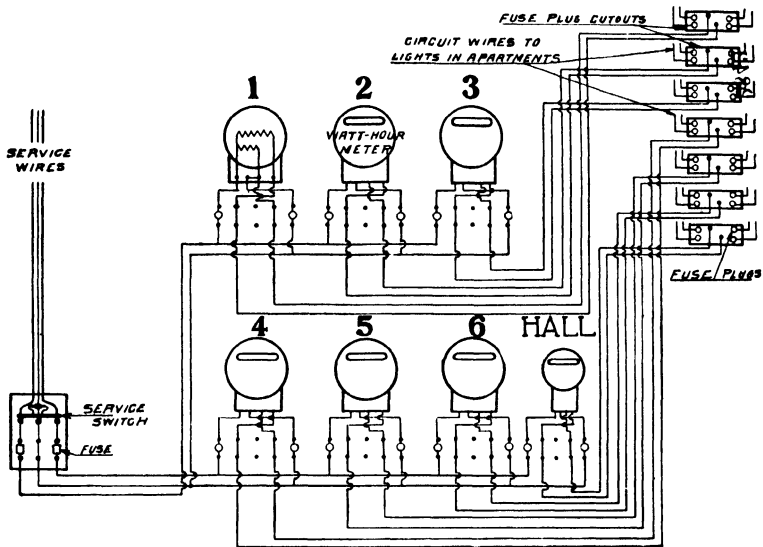

Fig. 17. Wiring Diagrams of Meter Installation Shown in Fig. 16

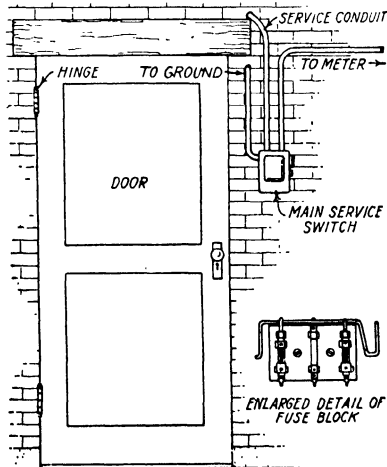

Fig. 18. Location of Main Service Switch and Details

fuses are placed in a separate box. By studying the wiring diagram, it will be seen that the first and third apartments are connected to

the same outside line wire. The total load of these two apartments, Table II, is two times 1560 watts, which is 3120 watts. Then by Ohm's Law, the current, which is equal to the wattage divided by the voltage, will be about 27 amperes.

The carrying capacity of No. 10 rubber-covered wire is 25 amperes. The next larger size is No. 8 wire, which has a carrying capacity of 35 amperes, and would have to be used as a service wire. Thus, there will be 3 No. 8 wires brought in from the porch

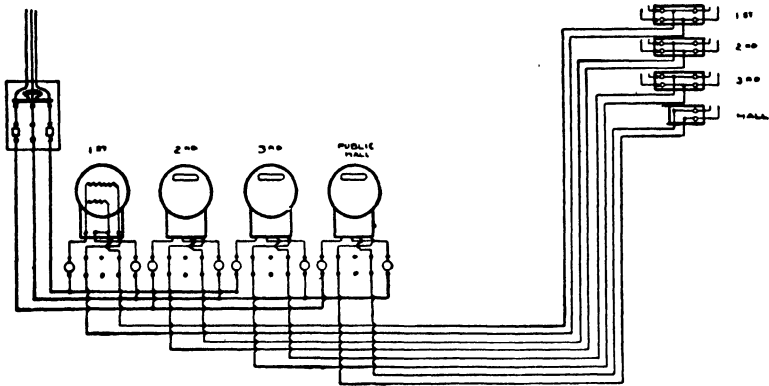

Fig. 19. Service Wiring Diagram for 3-Story Apartment Building

to the service switch. These will be connected by the lighting company to their line, located in the rear of the lot on which the building is located.

The size of conduit required for 3 No. 8 wires is 1 inch, although a special exception is made, and 3 No. 8 wires can be installed in a $\frac{3}{4}$ -inch conduit when there are not too many bends. In this building there are only two or three bends and the smaller size conduit might be used, but the time and labor required to pull the wires into the smaller conduit will be greater than in a larger conduit.

The location of the service head or service outlet is obtained from the electric light and power company, and in this particular case, they choose the southwest corner of the rear porch, Fig. 2, because that particular point happened to be the nearest and the best location for the light and power company to run their wires from a pole located at the rear of the lot on which the building is

located, to the building. The electric light and power company should always be consulted before the service is installed on the building in order that the best location be secured for the wires. If this is not done, it may be necessary sometimes to make a change in the service conduit after it has been installed.

In this building, the service conduit is fastened to the corner post, Fig. 2, and run down the post to the floor joists under the first floor porch; then across and over the doorway and through the brick wall to the service switch. The service conduit is fastened

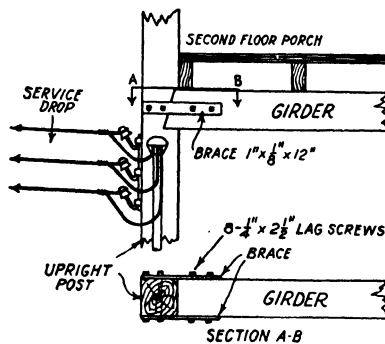

Fig. 20. Method of Bracing Girders

to the post by pipe straps, and is also supported to the floor joist of the porch by pipe straps.

There will be considerable strain or pull on the upright post of the porch when the electric light wires from the pole at the rear of the lot are attached to the bracket on the post. In order that the post may not be pulled away from the girder which supports the floor joists and floor, it is usually necessary to bind the girder and the post together by means of an iron bar or brace, as shown in Fig. 20.

Switch and Meter Panels. The service switches and meters are fastened to wooden panels. The panels are made by nailing boards to strips of wood fastened to the brick wall. The size of wooden panel for the service switch will be about 18 to 24 inches, or a little bit larger than the service switch. The meter panels must be large enough so that the universal meter switches and watt-hour meters can be mounted on the panels. There are four watt-

hour meters and four meter service switches, which will require a panel about 3 feet wide by about 5 or 6 feet in length, so that these switches can be mounted on the panel without crowding them. This wooden panel is fastened to the brick wall by the use of expansion bolts.

A view of the main service switch installed on the wall is shown in Fig. 18. In this type of service switch the fuses are located in outside wires, as shown in the enlarged detail, and the neutral is solid and does not have a fuse. The neutral wire will be connected from the service switch to the grounded water pipe when the wiring job is completed.

A 60-ampere service switch and fuse switch mounting are required for this job, although the size of service fuse will be 35

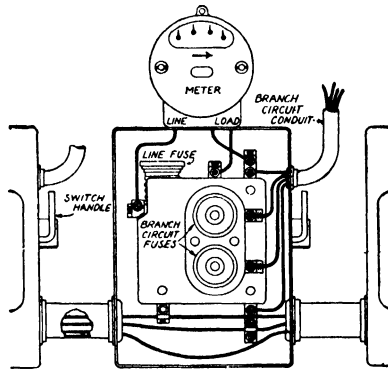

Fig. 21. Meter Service Switch Boxes and Wiring

amperes, which is the carrying capacity of No. 8 wire. The reason a 60-ampere service switch is used is because switches are always rated at the maximum current that they will carry. The standard size and rating of service switches is 30, 60, and 100 amperes. The fuse clips on a 30-ampere switch will take all fuses having a rating of 30 amperes or less and a 60-ampere switch will take fuses between 31 and 60 amperes.

The meter service switches are mounted near the bottom of the wooden meter panels, leaving room at the top for the watt-hour meters to be mounted by the lighting company after all the wiring has been completed and passed by the inspector. Each meter

service switch is connected to the next one by a short piece of conduit, Fig. 21, so that all the wiring will be in conduit. A special opening or hinged cover opposite the branch circuit fuses in the service switch provides access for the placing of fuses on the branch circuit without opening the door of the switch. Fig. 21 gives a view of the universal service switch with the cover open, showing the branch circuit wiring, fuse block, and meter wiring as it will look when completed. Only the conduit and the service switch box is installed at this time, the wires being installed later.

Conduit in Basement and Hall. The location of the outlets and conduit in the basement is shown in Fig. 22. In the basement

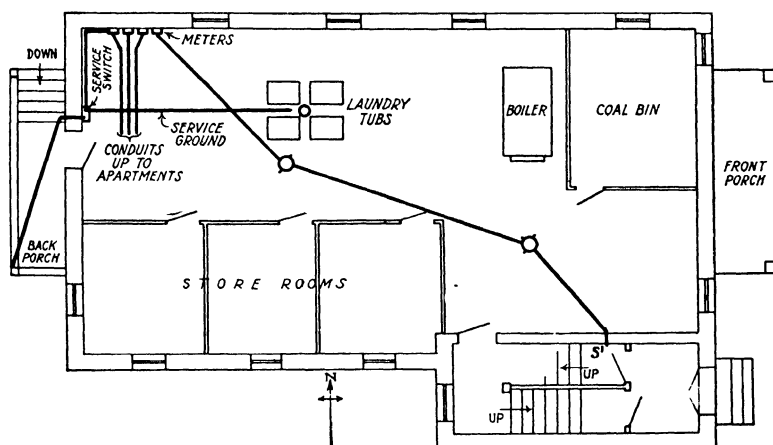

Fig. 22. Conduit Layout in Basement

outlets a drop cord is connected to the wires in the outlet box and supported by means of a bushing in the cover of the outlet box. One of the outlets is located opposite the laundry tubs and the other outlet is opposite the boiler and coal bin. The conduit is run from the hall meter box or service switch to the outlets in the basement and then to the switch located in the stairway. The purpose of a switch at this point is to turn the light on and off in the hallway.

In the basement the conduit is run across the floor joists and fastened to them by pipe straps. If the basement ceiling is to be plastered, a small notch is cut out of the floor joists where the conduit crosses them and the conduit is set flush with the lath. The

conduit is run from the switch box in the hallway at the foot of the stair, up the brick wall, Fig. 23, to the row of brick supporting the landing joists, over the vestibule, then horizontally along this

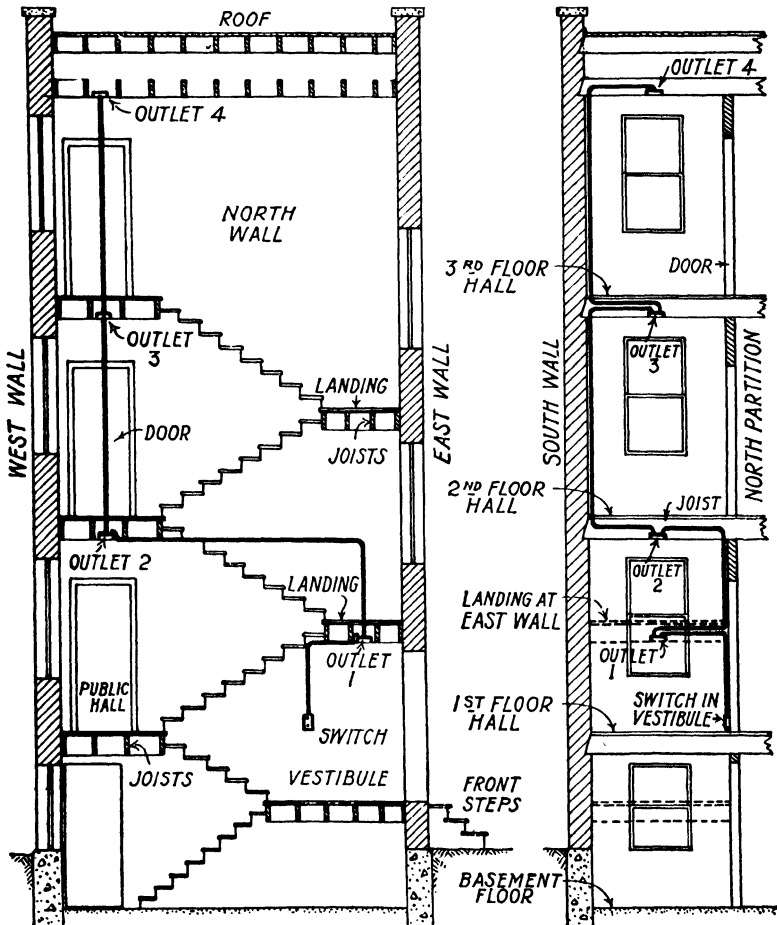

Fig. 23. Elevation of Stairway and Public Hall

row of brick. The conduit is bent upward a few inches between the second and third joists *A*, Fig. 24, and then bent over to the outlet box in the center of the landing. When the conduit is run into the side of the outlet box, a square or octagon outlet box must be used

with an offset box hanger, as shown in this figure. When all the conduit enter the box from the top like *B*, Fig. 24, a straight bar hanger and a round shallow outlet box can be used.

When placing conduit on a brick wall that will be plastered, it is usually necessary to channel or cut a groove in the brick wall so that the conduit can be partly recessed out of the way. Before lathing, a wood strip (called a furring strip) about $\frac{3}{4}$ inches thick and $1\frac{1}{2}$ inches wide is nailed or fastened on to the brickwork. The lath are nailed to this strip. This makes it necessary to recess the conduit in the wall. It is easier to cut out the mortar between the bricks than to cut through the brick. Thus horizontal runs of con-

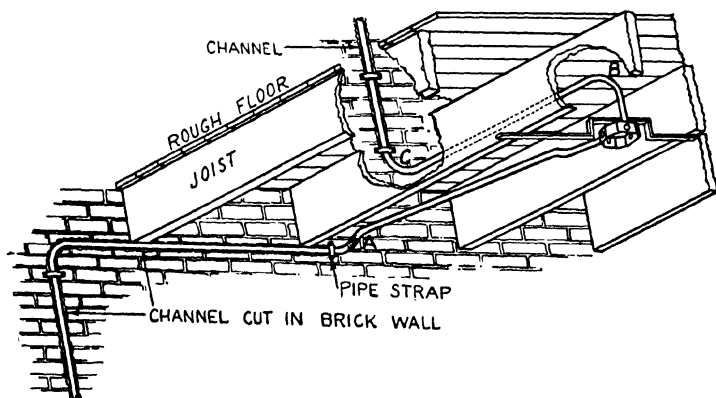

Fig. 24. Method of Installing Conduit to Outlet Box over the Vestibule in Public Hall

duit are placed between the rows of brick and vertical runs are made at the joint between bricks, cutting through the center of the brick in the other rows, Fig. 24. This method requires less labor for channeling than if the conduit was run diagonal on the brick wall.

The lath on the ceiling of the landing is nailed directly to the under side of the floor joist of the landing. There is a rough floor placed on top of the floor joist for the landing, and on top of this the finished floor is laid.

The conduit is run vertically from outlet 1 over the vestibule, Fig. 23, up the side of the north partition (the side towards the apartment) to the row of bricks under the floor joists on the second floor, where it is bent at right angles and run horizontal to the outlet

2, Fig. 23. The conduit is bent under the floor to this outlet in the same manner as *A*, Fig. 24. The conduit is then run from outlet 2 between the joists to the south wall where it is bent upward and laid in a channel cut in the brick wall, like *C*, Fig. 24, to the landing above where the conduit is bent and run to outlet 3. The conduit is next run from outlet 3 to the south wall, Fig. 23, and up to outlet 4 in the same manner.

A one-half inch conduit for the ground wire is run from the service switch, Fig. 18, up the brick wall to the floor joists and across the floor joists to a point near the cold water pipe at the laundry tubs, Fig. 22, where it is bent down parallel to the water pipe. If the basement ceiling is to be plastered, notches must be cut in the floor joists and the conduit fastened in these notches or else run over the rough floor in the apartment above.

This completes all the conduit work there is to be installed. The electrical inspector is notified that the conduit is ready for inspection, if the local inspection bureau makes such an inspection. A card containing the name, address, and telephone number of the wiring contractor or wireman doing the work should be tacked on the meter panel along side of the meter service switches in order that the owner, architect, inspector, or other contractors can notify him of any changes that must be made.

The conduit work and outlets in each apartment and basement is usually checked by the wireman or contractor to see that all have been installed as called for on the plans and are securely fastened in place. The switch outlets and convenience outlets are sometimes stuffed with newspapers at this time in order to keep the plaster out of the boxes. It will be several weeks before the building is ready to have the electrical wiring completed because the lath must be nailed in place, the building plastered, and the finished floor laid.

FINISHING WORK

Cleaning Conduit Runs and Switch Boxes. After the building has been plastered and the finished floor laid, the next step is to clean out the conduit runs, switch boxes, and outlet boxes. The switch boxes and outlets on the side walls should be cleared of the old newspapers at this time.

A piece of tin or galvanized metal, about 1 inch or 2 inches

wide and 6 inches to 8 inches long, bent in the form of a letter L can be used to scoop out the loose plaster from the bottom of the switch boxes and receptacle outlets located on the side walls, when it cannot be reached with the hand.

Pulling in Wire. In a building of this type where the length of conduit from outlet to outlet is short (not over 20 or 30 feet) and has only one or two right angle elbows and there are only two No. 14 rubber-covered wires installed in the half-inch conduit, it is customary to push the wires in place. This can usually be done without any difficulty because there is sufficient space in the conduit. When four wires are placed in a $\frac{3}{4}$ -inch conduit, as from the watt-hour meter service switch in the basement to the outlet in closet,

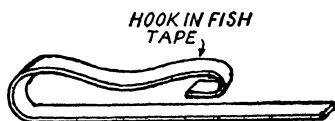

Fig. 25. Hook on Fish Tape

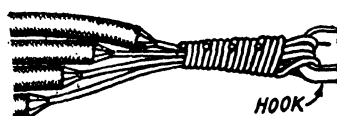

Fig. 26. Method of Fastening Wires to Fish Tape

Fig. 3, it will be necessary to use a steel fish line or wire to pull the conductors into the conduit. When the wires are pulled or pushed in place in the conduit, about six inches of wire is left projecting from the end of the conduit at each of the outlet boxes.

In fishing in the wires into the conduit a white wire and a black wire are used. In Fig. 4 the light line represents the white wire. In the case of a three-way switch, three black wires must be used. In the case of the conduit coming from the watt-hour meter in the basement up to the closet outlet, it is necessary to use two black wires and two white wires.

When pulling four No. 14 rubber-covered wires into a $\frac{1}{2}$ - or $\frac{3}{4}$ -inch conduit, it is well to use care in fastening the wires to the fish tape or fish wire. This is done by cutting off the rubber insulation for about six inches from the end of each one of the wires, staggering them, and fastening them to the hook on the fish tape, Fig. 25, in the manner shown in Fig. 26. The rubber insulation on each wire is cut back about 1 inch further from the fish tape than the other one. The purpose of fastening these wires in this manner is so that the wires will not pull out, and that there will not be a lump or bunch

of wire starting through the conduit together. Friction tape is then wound very tightly over the loop on the fish tape and back over the rubber-covered wires so that there will be no rough projections that would tend to stick out and get caught in the conduit at the couplings.

The hook of the fish wire and the bared ends of the rubber-covered wires that have been taped are covered with powdered soapstone so that they will slide more easily through the conduit. Then the fish tape and the wires are pushed into the conduit from the outlet box, and more soapstone is applied to the wire. As the helper pulls on the fish tape at the other outlet box, the wires are fed into the conduit. These wires are arranged in the form of a square, so that there will not be any danger of the wires becoming crossed in the conduit. When there are several bends in the conduit, powdered soapstone is applied to the rubber-covered wires as

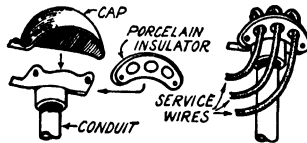

Fig. 27. Service Head or Entrance Fitting

they are fed into the conduit. After the wires have been pulled into the conduit, about six inches of wire is left in each of the outlet boxes.

Installing Service Wires. In this building a three-wire 110- to 220-volt service installation is used and there will be three No. 8 rubber-covered wires installed in the conduit. Two of the rubber-covered wires will have black insulation and the third wire will have white insulation in order to identify the grounded conductor. A fish tape or wire is pushed through from the service switch in the basement to the top of the service head and the wires are fastened to the fish tape in the same manner as for a branch circuit. The wires are then fed into the top of the service head, Fig. 27, which is fastened to the post of the porch near the second floor, Fig. 2. Powdered soapstone is used to aid in pulling the conductors into the conduit and is rubbed on them as they are being pulled into the conduit. The three wires are arranged in triangular form and fed into the conduit in this manner.

After the wires have been pulled through to the service switch, a four-foot length of each wire is left outside of the top of the conduit at the service head. This length of wire is used by the lighting company's men in connecting the service to the service drop which they will install from their lines on the poles at the rear of the building after all of the wiring in the building has been completed and has passed inspection. The cap of the service head, Fig. 27, is now placed in position.

The ends of the three service wires in the service switch are soldered to copper lugs and connected to the top of the fuse block, Fig. 18. The white wire is connected to the center terminal which does not have a fuse. This is known as the neutral or grounded wire.

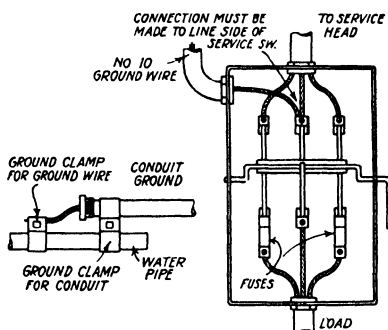

Fig. 28. Method of Grounding Conduit and Neutral Wire

The neutral service wire must be grounded to a water pipe main. The size of the neutral ground wire must not be less than No. 8 rubber-covered wire when the service wires are of this size, but when the size of service wires is No. 8 or larger, the local rules may require a larger size conductor for grounding than the No. 8 wire. This wire must be enclosed in the conduit from the service switch to a point very close to the water pipe. In this apartment building the nearest water pipe is that supplying cold water to the laundry tubs. A run of $\frac{1}{2}$ -inch conduit is made from the service switch, across the floor joist to a point near the water pipe, where it is fastened to the water pipe by means of a ground clamp, Fig. 28. There is another ground clamp placed on the water pipe and the No. 10 rubber-covered wire is connected to this clamp. This

connects the neutral wire to ground. The neutral wire is the wire connected to the shell of every light socket in the building. The clamp connecting the conduit to the water pipe grounds all the conduit in the building. The purpose of the conduit, which is run from the service switch to the water pipe, is to protect the wire and prevent it from being broken or injured. The Electrical Code requires that this ground wire must be run in a separate conduit, and it cannot be placed inside of a conduit containing circuit wires.

Meter Wiring. The branch circuit fuse block and the wiring to the meter service switches are next installed and connected in

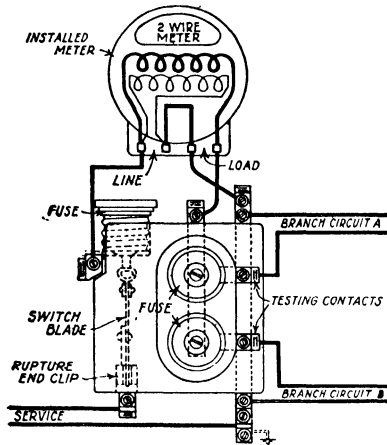

Fig. 29. Wiring Diagram of Meter and Service Switch

place. There are many types of branch circuit fuse blocks used with meter service switches and boxes. One of the types used with polarity wiring is shown installed in a cabinet, Fig. 21. In this particular fuse block there are two sets of fuses. The fuse at the top is in the live or "hot" side of the circuit coming from the main service switch to the meter and protects the meter. The two threaded sockets in the front part of the block are for the branch circuit fuses. Only one fuse is required for each branch circuit with polarity wiring, but this fuse must be placed in the "live" or "hot" wire. A wiring diagram of the meter service switch is shown in Fig. 29. A 10- or a 15-ampere fuse is used in the branch circuits

and a 25-ampere fuse should be screwed in the top of the fuse block. The power company installs the meter directly above the meter service box. This enables them to seal the meter terminals and the cover of the meter switch box so there will be no opportunity for the wires to be tampered with. There is an opening in the front cover of the meter service switch box, Fig. 21, which enables the customer to replace the fuses on the branch circuit without breaking the seal on the meter service switch.

Splicing and Testing Wires. The next step is to shave off about two inches of the rubber-covered wires at each of the outlet boxes and connect the black wires by a pigtail splice and the white wires by a pigtail splice. It is sometimes necessary to identify the conductors at the outlet boxes so that certain wires can be connected to certain points on the switches, as in the three-way switch located

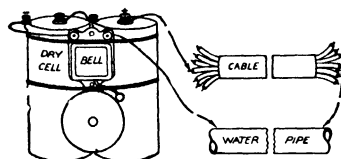

Fig. 30. Method of Connecting Dry Cell and Bell for Testing

in the dining room. In the outlet box in the closet where there are two circuits, it is also necessary to identify the wires of each circuit. Where two men are working on a job, one man can pull on the conductor in one outlet box while the other man identifies it in the other outlet box.

When only one man is working on a job, he can test it out by connecting one of the wires to the conduit, and then testing at the other outlet box with a door bell and battery. In performing this test, a door bell is connected in series with a battery or two dry cells, Fig. 30. One terminal of the bell is connected to the outlet box or conduit, instead of the water pipe, and the other terminal of dry cells is connected first to one wire and then to the next one, in that outlet box. When the bell terminal is touched to the wire that is connected to the conduit at the other outlet box, the bell will ring. Each wire can be identified or traced in the same manner.

Installing Switches and Receptacles. The next step is to install the switches and receptacles in each of the switch and receptacle outlets in the apartment building. At the same time that this work is being done, the lighting fixtures if they are available, should be fastened to the stud in the outlet box. In connecting the fixture always be sure that the wire connected to the shell of the socket in the fixture is connected to the grounded or white wire in the outlet box. The shell is the threaded part into which the lamp is screwed.

Some local ordinances require that the fixture be insulated from the conduit, while others require that the fixtures be connected



Fig. 31. Insulating Joint

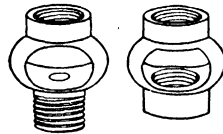

Fig. 32. Hickeys

or grounded to the conduit. If the fixture must be insulated, a special insulating joint, Fig. 31 is used. The "hickeys" shown in Fig. 32 are often used to attach the fixture to the stud.

When the fixtures have been installed, all the splices in the different outlet boxes are soldered and taped, first with rubber tape and then with friction tape.

FINAL WORK

Testing for Grounds. The wiring can be tested by connecting a dry cell or battery to the two upper right-hand terminals, Fig. 29, to which the branch circuits are connected. Touch the terminals of a door bell to the center and shell of each fuse socket, Fig. 29. If the bell rings, there is a short or ground on that branch circuit.

To test for short circuit, disconnect the white service wire, Fig. 29, from the fuse block and test as before. If the bell rings, there is a short circuit between the two wires of that branch circuit, which must be located and cleared.

To test for a ground in the wiring, connect the bell and battery in series, Fig. 30, and connect one terminal of the bell to the conduit and touch the other terminal of the battery to each wire. If the bell rings, that wire is grounded.

In attempting to locate grounds or short circuits, first examine the pigtail splices at each outlet, as the cause is often discovered here because of wrong connections or failure to properly tape the wires.

After all grounds and short circuits have been cleared, each socket and receptacle should be tested to see that it is connected. This is done by connecting a dry cell or battery to the two upper right-hand terminals, to which "Load" wires are fastened, Fig. 29, and touching the terminals of the door bell to the center and shell of each and every socket and receptacle. If the wiring is correct, the bell should ring when the switch on the wall and the socket is turned on, also when touched to the terminals of a receptacle.

Inspection. This completes the work and the electrical inspector is notified that the building is ready for second inspection. The lighting company is notified that the wiring is completed and ready for them to inspect, install, and connect the watt-hour meter and the service drop from their distribution system to the service wires of the building. The Electrical Contractor then removes all tools and surplus material from the job.

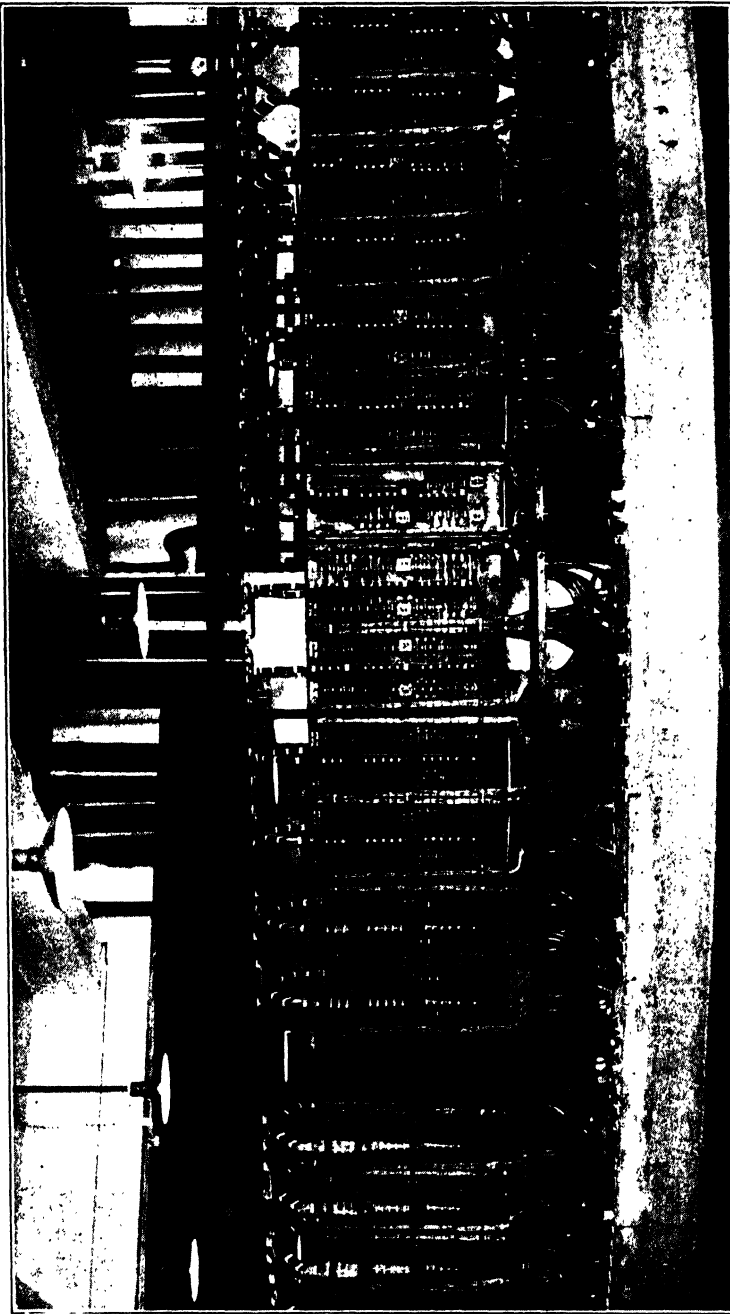

© Underwood & Underwood

WIRING BENEATH THE SWITCHBOARD IN A LARGE POWER HOUSE

FACTORY BUILDING WIRING

— FOR LIGHTS —

CONSTRUCTION OF BUILDING

The building to be wired is a factory building, shown in Fig. 1. It is three stories high with a basement. The length of the building is 150 feet and the width is 75 feet. The height from one floor to the next is 15 feet. The walls of the building are of brick, and the floors are wood, supported by wood floor joists and beams. The windows are large so as to provide good light on each floor. The freight elevator is located in one corner of the building, and the electric motor and elevator machinery are placed in a small house on top of the roof. A loading platform is located at the rear of the building, at which point trucks deliver freight and receive finished merchandise to be shipped out. There is a chute leading from the loading platform to the basement for the merchandise to slide down.

The basement and first floor are to be occupied by the owner, who operates a rubber manufacturing establishment. The second and third floors are rented out. The second floor will be used as a machine shop and the third floor will be used for a tailoring shop.

In order to get a general view of the inside of the factory building, let us assume that the side of the brick wall which is nearest you in Fig. 1 is removed, and it will then look like Fig. 2. There are four rows of nine posts each, which are used to support the floor. These posts are located 15 feet apart, and the rows of posts divide the building off into 50 sections or bays, each one being 15 feet square. Thus a post is located at the corner of each section or bay, but partitions have not been put in between each and every one of these sections.

The method of supporting the floors is shown in Fig. 3. Wooden columns or supporting posts 14 inches square are used. On top of these columns are caps, of the same material and dimensions as the posts, on which the floor beams rest. There are four rows of floor beams extending the full length of the building. The floor joists,

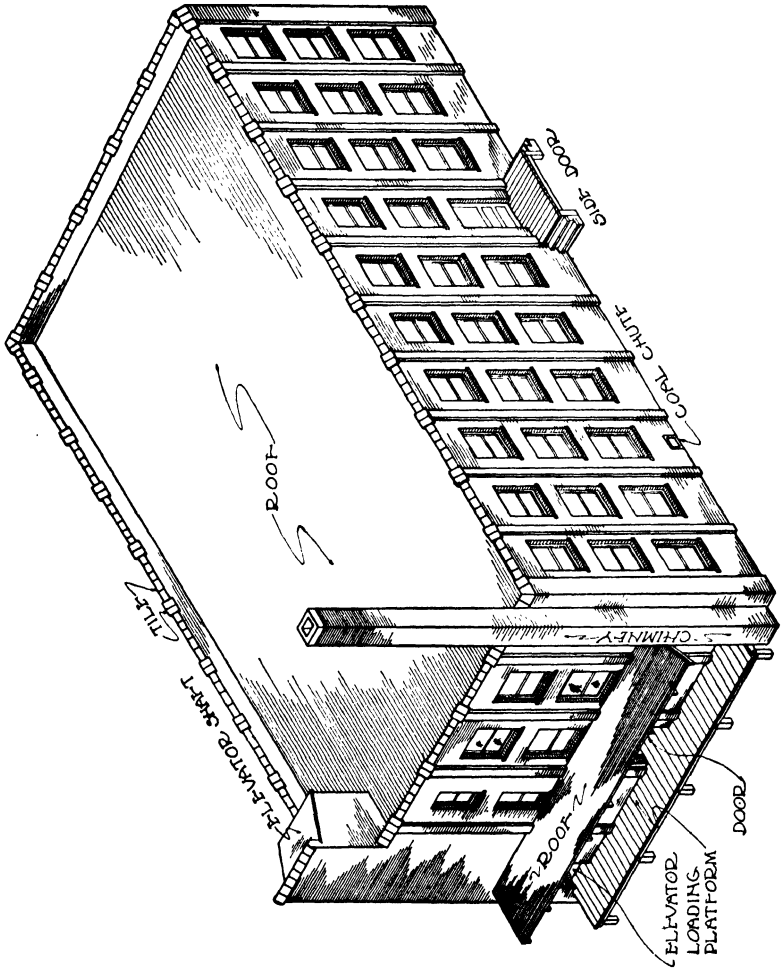

Fig. 1. Isometric Drawing of Outside View of Factory Building

which are 12 inches wide and 3 inches thick, are placed about 18 inches apart, and extend from the brick walls or from one row of floor beams to the next row of floor beams. A heavy wood floor about $1\frac{1}{2}$ inches thick is laid on top of the joists.

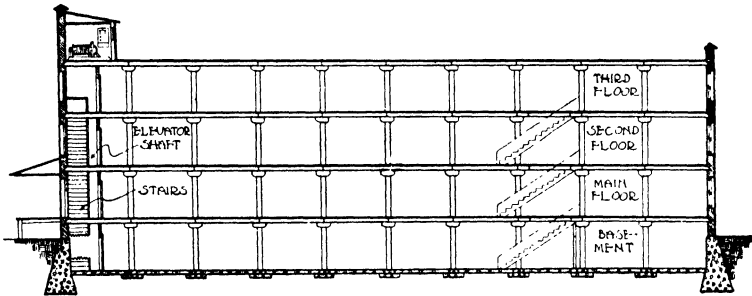

Fig. 2. Elevation Looking through Factory Building

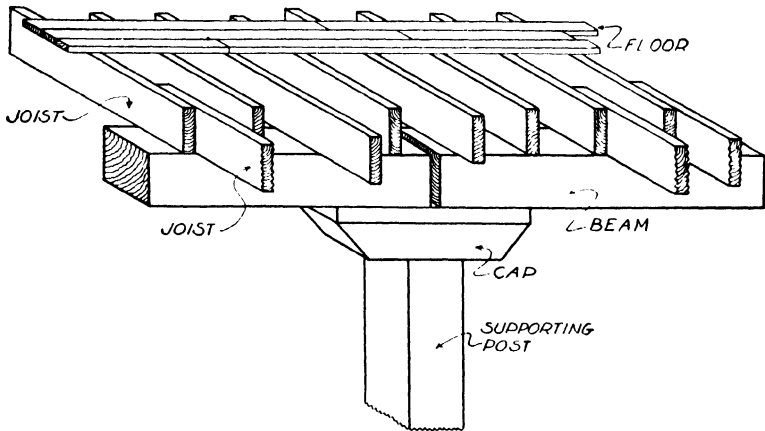

Fig. 3. Details of the Construction of Floors and Supporting Posts

REQUIREMENTS FOR POWER

The electric light and power wires will be installed in rigid conduit, which will be run exposed and fastened to the floor beams or joists by the use of conduit straps. The electrical energy which will be used for light and power in the building may be purchased from the Power Company either by the owner or by the tenants occupy-

ing the different floors. In this particular building at the present time all the light and power will be purchased by the owner, who will pay for that used by the tenants and include it in their rent. In many factory buildings it is usually desirable to have each tenant purchase his own electric light and power directly from the Power Company, and for this reason the wiring for the meter and service should be arranged so that this change can be made without removing the old service and installing an entirely new one.

The Power Company has a 3-phase distribution line at the rear of the building. The transformers are placed on poles across from the loading platform. The Power Company specifies that the service is to be brought into the building at the rear, somewhere near the chimney. The Power Company supplies 230-volt 3-phase alternating current for power, and 115-230 three-wire single-phase alternating current for lighting purposes. The 3-phase system uses three conductors or wires with a voltage between any two of these wires of 230 volts. The single-phase system uses three wires, one of which is permanently connected to ground and is called the "neutral" or "grounded" conductor; the other two wires are called the "hot" or "live" wires. The voltage between the neutral wire and either one of the "hot" or "live" wires is 115 volts, but the voltage between the "live" wires is 230 volts.

The Power Company requires a separate service for the lighting load, and it usually installs a separate transformer, because if the lights were connected to the same service and transformer as the motors, there would be a flicker or blinking of the lights every time a large motor was started. This is due to the fact that a motor when starting takes a large current from the line, which reduces the voltage at the lamp. This reduction in voltage, called "voltage drop," is caused by the large current flowing through the wires. This voltage drop is also called the $I R$ drop, because it is the product of the current I flowing through the wire or conductor and the resistance R of the wire.

LOCATION OF OUTLETS

The architect usually shows on his drawings a general location of the lighting outlets and other special outlets that may be needed. In Figs. 4, 6, 7, and 8 all symbols, dimensions, etc., shown for the

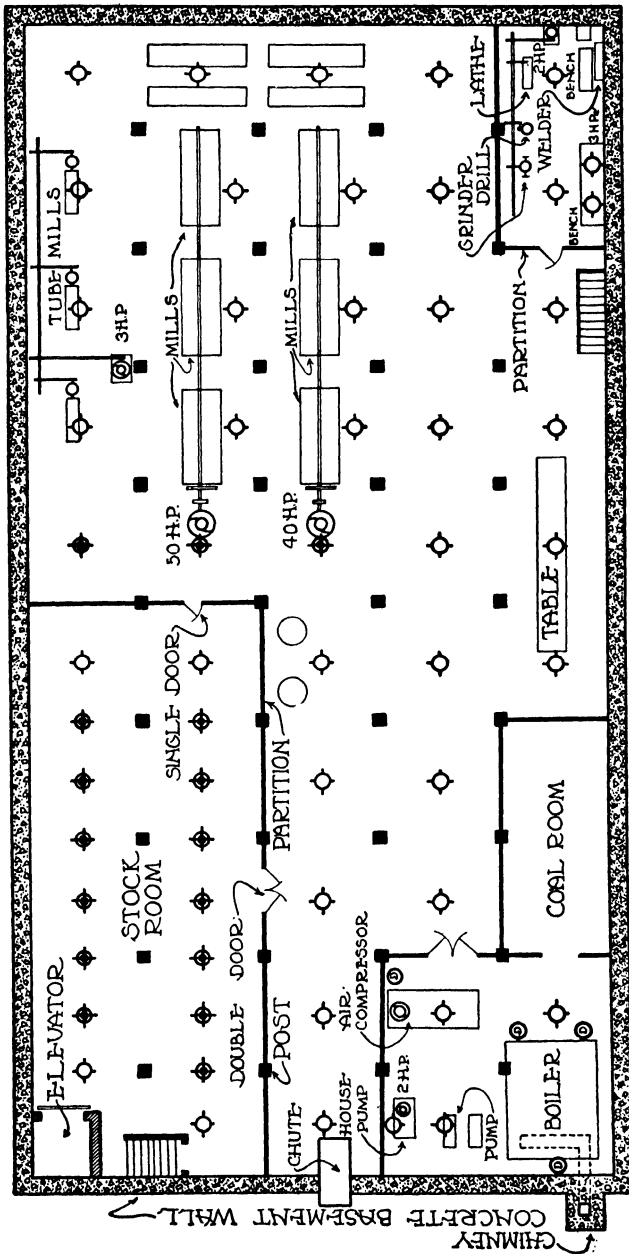

Fig. 4. Location of Outlets in Basement

other workmen on the building have been omitted and only those are shown which concern the electrician in order to give a clear view and avoid confusion.

The architect usually has bids for the wiring job submitted by several wiring contractors with the intention of giving the job to the lowest bidder. The wiring contractor is required to submit a sketch, showing the number of lights, the different circuits, and the method of controlling them. These sketches are usually made with red, white, or yellow pencil lines on the blueprints furnished by the architect.

It is necessary for the wiring contractor to be posted on the proper and best methods of laying out the lighting outlets, the size

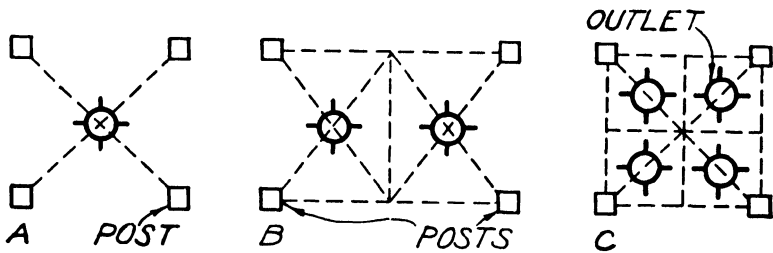

Fig. 5. Method of Locating Outlets in Bays

of lamps required, and the kind of reflectors; also to be able to figure the size of wires and conduits required for that job. Whenever the wiring contractor finds places where the architect failed to provide a sufficient number of outlets, switches, and receptacles or failed to specify the proper size of lamp, he should call this to the architect's attention and sell the architect on the idea of having an adequate and properly lighted building.

It is well to plan the circuits and the location of the lighting outlets in a building of this type not only for present but also for future requirements, in case the building should be used by other tenants for different kinds of work. The method of locating outlets is shown in Fig. 5. The center of the bay is determined by drawing diagonal lines from one post to another as shown at *A*, Fig. 5. When the kind of work to be done in any bay or section requires very close details or very accurate work, it is subdivided into smaller bays, and an outlet is located in the center of each one. A large rectangular room will usually be divided into two bays, as shown at *B*, Fig. 5;

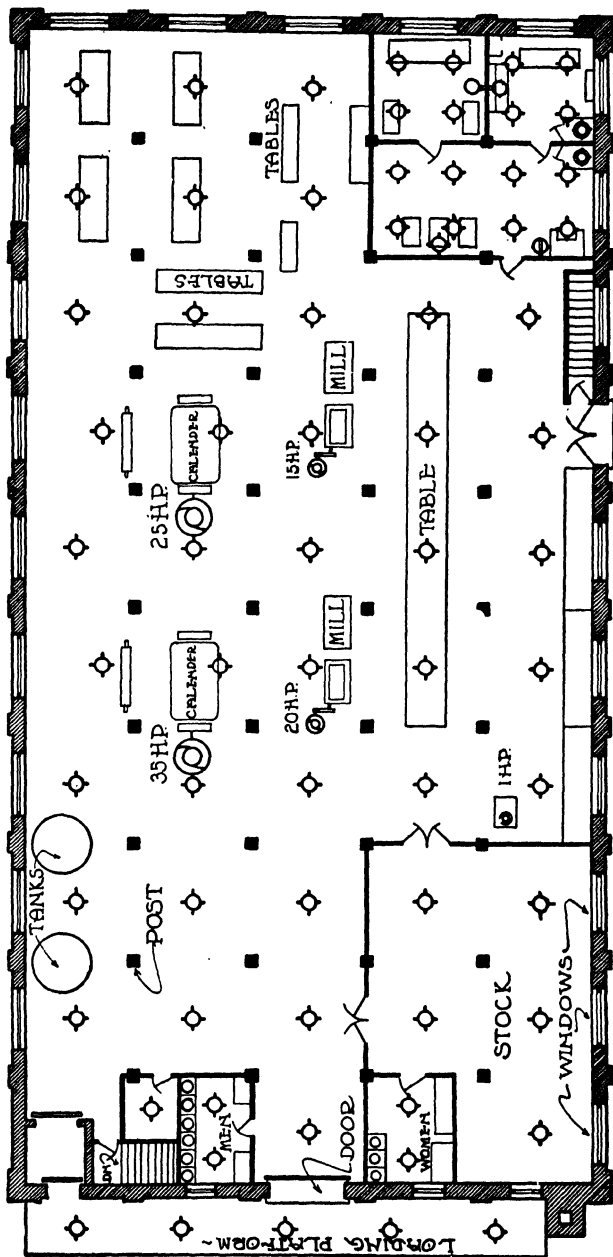

Fig. 6. Location of Outlets on Main Floor

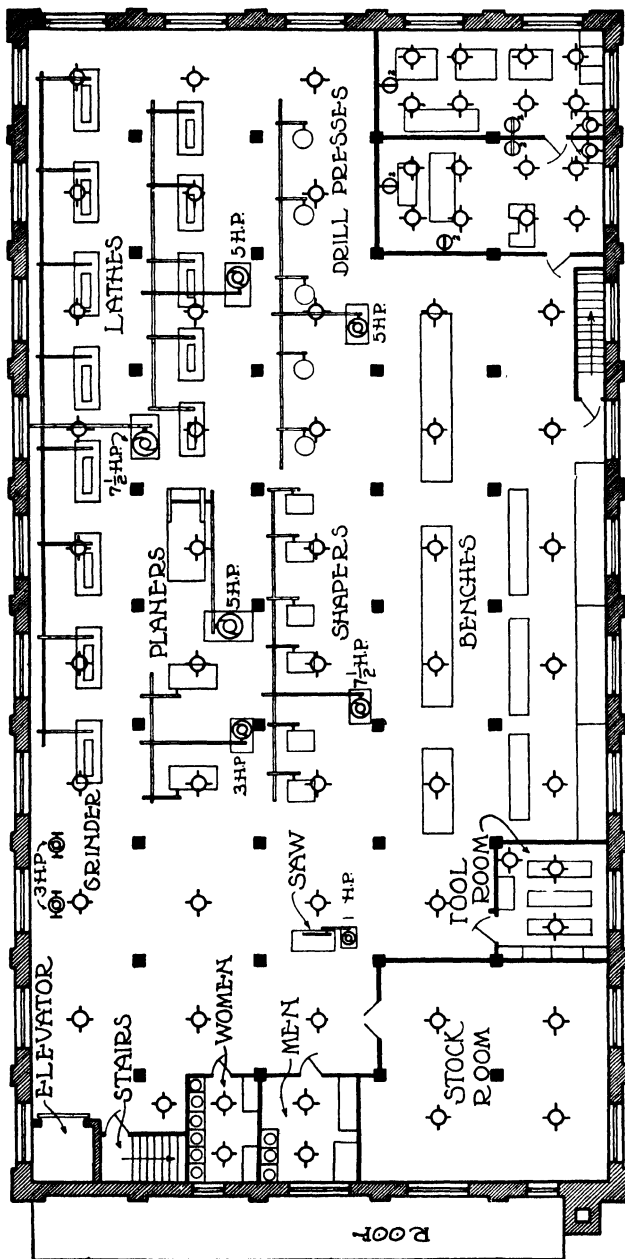

Fig. 7. Location of Outlets on Second Floor

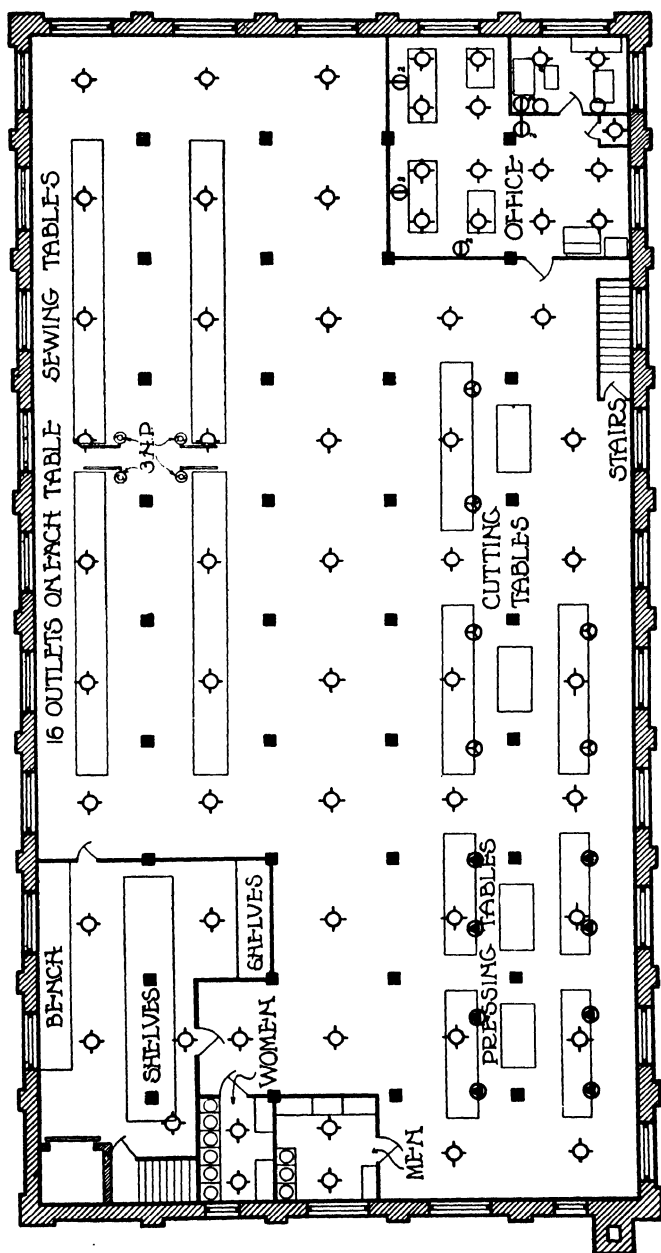

Fig. 8. Location of Outlets on Third Floor

TABLE I
Amount of Light Required for Different Kinds of Work

Kind of Work	Watts per square foot	Size of Lamp for 15' x 15' Bay	
		No.	Watts
Aisles and stairways.....	0.15 to .3	1	— 60
Cutting and pressing cloth goods.....	1.5 to 4.	1	— 300
Sewing dark goods.....	2.0 to 15.		Special
Drafting rooms.....	2.5 to 4.	4	150 or 200
Machine shop.....	1.0 to 2.5	1	— 300
Office—close work.....	2.5 to 3.	4	— 100
Office—no close work.....	1.0 to 2.5	1	— 300
Receiving and shipping.....	0.6 to .8	1	— 150
Rubber calenders and mills.....	1.0 to 1.5	1	— 300
Stockrooms.....	0.3 to .6	1	— 100
Toilet and washrooms.....	0.6 to .8	1	— 150

while a square room can be divided into two bays, it is usually better to divide it into four bays, as shown at *C*, Fig. 5, because a more uniform lighting can be obtained. With four lamps in a large bay, the outlets are located halfway between the posts and the center of the room. A large number of outlets make it possible to use a smaller size lamp for each outlet and at the same time secure a more uniform lighting with less shadows on the work.

SIZE OF LAMPS

The size of lamp required in each bay for different kinds of work may be obtained from Table I, which is standard for lighting. The area in square feet in each bay of this factory is 15 times 15, or 225 square feet. The size of lamp required is found by multiplying the number of watts per square foot required for a certain kind of work by the area in square feet in that bay. Where great accuracy is required for each class of work given in Table I, the higher number of watts per square foot should be used in determining the size of lamp for that bay.

The standard sizes of lamps used for lighting factories, office buildings, and other large rooms are rated at 60, 150, 200, 300, and 500 watts. In considering the number of lamps and the size on each circuit, it is well to use a value between the minimum and maximum number of watts per square foot given in Table I. The

general tendency in all factories is to use more lights and brighter illumination because with good lighting better and higher grade work can be done.

The "watts per square foot" given in Table I is for a large room which would have several bays, as is the case in this particular factory building. If the room was smaller in size and had a smaller number of bays, the largest number given in this column should be used. If the room is very small or has only one or two rows of lights, the largest number of watts per square foot must be used; in many cases the number of watts per square foot should be increased to a value slightly higher than that given in Table I.

LOCATION OF LIGHT AND POWER CABINETS

The contractor decides upon the location of the light and power cabinets on the different floors by studying the light and power requirements for each particular floor. These light and power cabinets should be located near the center of the room whenever it is convenient to do so. Likewise, the location of these cabinets on the main, second, and third floors should be directly above their location in the basement whenever it is possible to arrange them so.

As the power requirement for this building will be much greater than that for the lighting, it will require larger sized cables and conduits, therefore, the power cabinet will be given preference as to the best location in the building, which is near the center. It would be about the fifth post from each end of this building. The only exception to this rule would be in a factory building where the large motors are located near one end of the building, then the power cabinet should be located near these motors rather than in the center of the building. In this building the light cabinet will be located on the post nearer the service entrance than the power cabinet. Due to the large number of conduits and circuits going from the light and power cabinet, these cabinets will be located on different posts instead of putting them both on the same post.

CIRCUITS—OUTLETS—SWITCHES

The contractor decides on the number of outlets for each circuit, the size of the lamps, and the method of controlling them. He indicates the conduit on the architect's drawing, Fig. 4, and also prepares a schedule, Table II, of the number of circuits, the

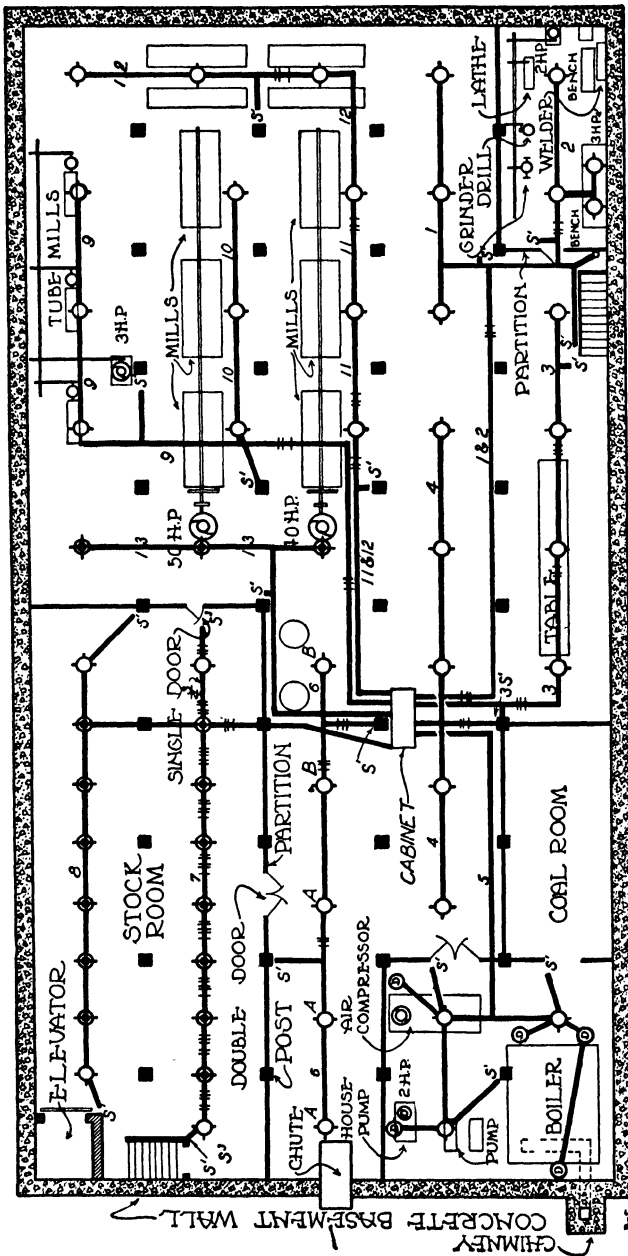

Fig. 9. Diagram of Conduit Runs for Basement

number and the size of the lamps, etc. The contractor also makes a record either on the drawing or on the schedule of the number of wires (if more than two) and the size of conduits (if greater than one-half inch) so as to aid him in estimating the amount of wire and conduit of the different sizes that will be required. This he works out step by step for each circuit and when completed, the architect's drawing shown in Fig. 4 will look like Fig. 9.

There are several methods of controlling the lamps that can be used in a factory building. The lamps can be controlled by key sockets, by pull chain switches at each outlet, by single-pole wall

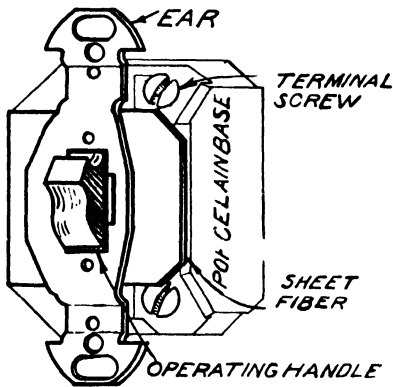

Fig. 10. Tumbler Switch

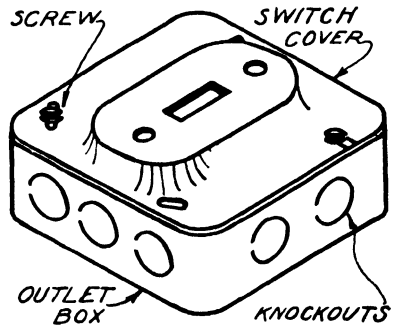

Fig. 11. Standard Outlet Box with Tumbler Switch Cover

switches for controlling one or several lamps, or by a circuit switch at the fuse cabinet, which is usually located near the center of each floor. The key socket is the best for use on drop cords. The pull chain switches, or pull switches as they are called, can be used in stockrooms and other places where they will be operated by only a few persons and where there is little chance of the pull switch or cord becoming caught or damaged by persons passing. Pull switches are not as strong and reliable and will not last as long as the single-pole tumbler type of switch which is mounted on the wall.

In Fig. 10 a single-pole tumbler switch is shown. This switch can be placed inside a 4-inch outlet box and fastened to a tumbler switch cover, Fig. 11. This type of switch should be located, whenever it is possible, on the post or column nearest to those working

TABLE II
Basement Lighting Schedule

Circuit	Light	Size	Total Watts	Switches
1	3	200	600	1 single-pole wall
2	3	60	900	1 single-pole wall
	2	60		Key sockets
3	2	300	700	1 single-pole wall
	3	200		1 single-pole wall
4	1	100	800	1 single-pole wall
	3	200		1 single-pole wall
5	2	100	560	1 single-pole wall
	2	60		2 single-pole wall
6	4	60	600	1 single-pole wall
	4	100		Drop cords with key sockets
7	1	200	720	2 single-pole wall
	12	60		Two 3-way and 1 single-pole wall switch, 7 pull sockets
8	8	60	480	6 pull sockets and 2 single-pole
9	3	300	900	1 single-pole wall
10	3	300	900	1 single-pole wall
11	3	300	900	1 single-pole wall
12	3	300	900	1 single-pole wall
13	3	100	300	1 single-pole wall switch and pull sockets
Total	67		9260	

under the lamps. This arrangement will enable the workman to turn the lamps on, when he needs light, and to turn them off when he does not need light, which is much better than if all the lamps were turned on and off at the fuse cabinet or lighting cabinet in the center of the room. However, switches are usually provided at the lighting cabinet as it may be desirable to control some of the circuits from that point. This arrangement also makes it possible to turn off all the lamps from one point, in case the individual workman should leave without turning them out at night.

LAYOUT OF BASEMENT

The large heavy machinery in this factory building is in the basement. It consists of two large rubber mills which are operated by separate motors, Fig. 4. At the end of these rubber mills, racks are provided on which the rubber can be dried and cured after it

has been passed through the mills. There are three tube mills located near the basement wall which are driven by an electric motor. In one corner of the basement there is a small machine shop where repairs to the machinery installed in the basement and first floor can be taken care of. In another corner of the basement near the freight elevator is a large storeroom. While in another corner of the basement are the boiler room and coal bin, and here the electrically driven house pump and air compressor are located. The house pump is used to force water to the upper floors of the building when the city water pressure is not strong enough to do it. The air compressor is used to furnish compressed air for the various manufacturing operations throughout the building. The boilers are not only used to furnish heat for the manufacturing operations required in rubber work, but also for heating the building during the cold weather.

ARRANGING OUTLETS ON CIRCUITS IN BASEMENT

The contractor must bear in mind that the total load on each circuit, when No. 14 rubber-covered wire is to be used, should not exceed 1000 watts.

Circuit 1 will have three outlets. These outlets are located in that part of the building near the machine shop, Fig. 9, which has not been assigned for any definite use but it could be used as an inspection room, a stockroom, a storeroom, or a stock storage space. A 200-watt lamp will be used at each outlet, Table II, because the lamps on this circuit are to furnish additional light for those working on the rubber mills in the next bays.

Circuit 2, which will supply the light for the machine shop and in the front stairway, will have seven outlets. A 300-watt lamp will be used in the center outlets in the machine shop, and a 60-watt lamp in the outlets placed over the bench, Fig. 9. There will be three bracket fixtures in the front stairway, and the lamps will be controlled by a single-pole wall switch located just inside the stair doorway on the first floor. The conduit will be run along the basement ceiling at the side of the stairs and then up through the floor to the switch. Conduit will also be run from the basement upward to a bracket outlet at the head of each stair. A watchman is usually stationed near the front door on the first floor, when the factory is

working, to direct customers to the proper offices and floors and to see that no undesirable persons pass into the factory. This switch will make it handy to turn on the light when needed.

Circuits 1 and 2 will form a 3-wire branch circuit which will be run from the cutout cabinet to the junction box installed at the corner of the machine shop. This 3-wire circuit will consist of the neutral or "grounded" wire, which has grey or white insulated covering, and one black wire from each side of the fuse cabinet

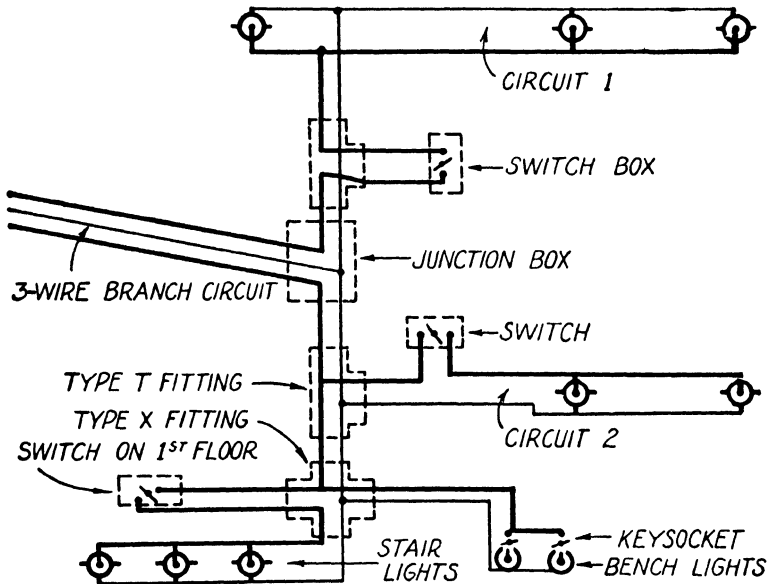

Fig. 12. Wiring Diagram of Circuits 1 and 2 in Basement

At the junction box the neutral wire from the branch circuit will be connected to circuits 1 and 2, Fig. 12. The use of a 3-wire branch circuit eliminates the use of an extra neutral wire in the same conduit.

The three wires in this $\frac{1}{2}$ -inch conduit are indicated on Fig. 9 by a symbol. This symbol consists of three short lines drawn across the line representing the conduit. The voltage between the two black wires in the conduit is 230 volts; while the voltage between the neutral, which is the white wire, and each one of the black wires is 115 volts. Under no circumstances can both black wires be connected to the same side or the same bus bar at the fuse cabinet, because this would not make a three-wire circuit. The wire that is

connected to the single-pole switch is the black wire or conductor and is often referred to as the "hot" or "live" wire. In Fig. 12, the white wire is represented by a thin line and the black wire is represented by a heavy line, and the outline of the switch box, junction box, and other fittings used in wiring work is represented by a light dotted line.

Circuit 3 will have four outlets, Fig. 9. The three outlets over the table will each be equipped with a 200-watt lamp; the outlet near the entrance to the machine shop door, or alongside the stairway, will have a 100-watt lamp, Table II. The switch for operating the three 200-watt lamps will be located on the post at the corner of the coal room. The switch for operating the 100-watt lamp will be located at the side of the stairs. It will be necessary to run three wires, two black and one white, between the junction of the conduit leading to the switch at the corner of the coal room and the first outlet; and then from this outlet to the next two outlets on that circuit.

Circuit 4 will have five outlets. A 100-watt lamp will be put in the two outlets at the side of the coal room and a 200-watt lamp in each one of the other three outlets on this circuit, Fig. 9. The two 100-watt lamps will be controlled by one wall switch and the three 200-watt lamps by another wall switch. Both of these wall switches will be mounted on the post at the corner of the coal room and along side of a switch for circuit 3. The space under the outlets on this circuit have not been assigned to any particular use by the architect, so it is assumed that the bays at the side of the coal room will be used for storage purposes and the bays under the 200-watt lamps will be used for inspection work.

Circuit 5 will have eight outlets. A 100-watt lamp will be used in the outlet over the air compressor and in the outlet over the pump. A 60-watt lamp will be used in the other six outlets on this circuit. A separate wall switch will control each one of the three outlets in the center of the bays in the boiler room. The other outlets, indicated in Fig. 9 by the letter "D," will have drop cords with key sockets attached.

In the architect's drawing, Fig. 4, the outlet over the house pump is shown as a ceiling outlet, but it would be more convenient to have it a drop cord outlet, because the 100-watt lamp in the

ceiling over the other pump will supply plenty of light for those working around the house pump, and a drop cord could be moved around whenever it is necessary to obtain more light.

Circuit 6 will have five outlets, Fig. 9. A 200-watt lamp will be put in the outlet between the two presses. These presses are located between the lighting cabinet and the stockroom and are indicated on the drawings, Fig. 4 and Fig. 9, by two large circles. A 100-watt lamp will be put in each one of the other outlets on this circuit. The lamps in the three outlets marked "A" will be controlled by a wall switch mounted on a post near the stockroom door. The lamps in the outlets marked "B" will be controlled by a wall switch mounted on the post at the rear of the lighting cabinet. This arrangement of switches will enable the workmen to turn on the lamps in outlets "B" when working around the presses or moving material from the mills to the stockroom, for the lamps in outlets "A" would need to be turned on only when handling material that is near the chute.

Circuit 7 will have twelve outlets, nine of which are in the stockroom and three in the rear stairs near the elevator. A 60-watt lamp will be put in each outlet. The lamps in the three outlets in the stairs will be controlled by a wall switch mounted on the corner of the stairs in the basement. The lamp in the outlet at each end of the stockroom, Fig. 9, will be controlled by either one of the 3-way switches which will be placed at each end of the stockroom. One of these 3-way switches will be mounted on the corner of the stairs, and along side of the switch for controlling the lamps in the stairs, while the other 3-way switch will be placed at the side of the single door in the other end of the stockroom.

The lamps in the other seven outlets, which are between the two outlets that will be controlled by 3-way switches, will be controlled by pull switches, which will be operated by a small cord or chain from directly under each outlet. This arrangement of switches will enable a person entering the stockroom, either from the stairs or through the single door, to turn on a lamp at each end of the stockroom so that they can see their way about the stockroom. Then if more light is needed at any particular place, it can be obtained by using the pull switches. The 3-way switches at each end of the stockroom will enable the night watchman to turn on a lamp at

each end of the room as he enters and turn them off at the other end of the stockroom as he leaves.

The number of wires that will be installed in the conduit between each outlet on circuit 7 is shown in Fig. 9, for all runs of conduit except that between the switches at the corner of the stairs and the nearest outlet. Four wires will be installed in this run of conduit. A $\frac{3}{4}$ -inch conduit must be run between the outlets on circuit 7 in the stockroom because only four wires are permitted in a $\frac{1}{2}$ -inch conduit.

The wiring diagram for circuit 7, Fig. 13, shows how these wires will be connected. The "hot" or black wire of circuit 7 will

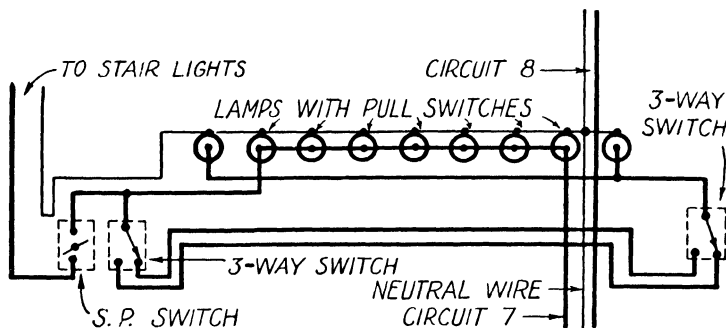

Fig. 13. Wiring Diagram of Circuit 7 in Basement, Showing Use of Three-Way Switches

be connected to one terminal of each one of the pull switches and to one terminal of one 3-way switch and to one terminal of the single pole wall switch mounted at the corner of the stairs. The other terminal of each of the pull switches will be connected to the center contact of each lamp socket. The neutral wire, which will have white or gray insulation, will be connected to the screw shell of all the lamp sockets. There will be two black wires run from the terminals at the bottom of one 3-way switch to the similar terminals on the other 3-way switch. A black wire will also be run from the top of the 3-way switch near the stockroom door to the center contact of the two lamp sockets holding the lamps which will be controlled by the 3-way switches. The heavy black line representing the "hot" or black wire of circuit 8, Fig. 13, is not connected to any of the lines that it crosses.

Circuit 8 will have eight outlets, Fig. 9, and a 60-watt lamp will be put in each outlet. The lamp in the outlet near the elevator will be controlled by a wall switch mounted at the side of the elevator door. This will enable the elevator man to obtain light in this part of the stockroom whenever he needs it. The lamp in the outlet at the other end of the stockroom will be controlled by a wall switch mounted on a post. A pull switch will be used for each one of the other six outlets on this circuit. This arrangement of switches will enable any person on entering the stockroom through the single door to light up each end of the stockroom by operating the 3-way switch; then he can operate the wall switch for the next lamp at this end of the room; and then he can operate a pull switch for any particular lamp under which he wishes to work. Circuits 7 and 8 will be run as a 3-wire branch circuit.

Circuits 9, 10, 11, and 12 will each have three outlets, and a 300-watt lamp will be put in each outlet. The lamps on each circuit will be controlled by a wall switch mounted on a nearby post. The outlets on circuits 10 and 11 will not be located in the center of each bay but in front of the mills, because with this type of machine it is better to have the light over the workmen than over the mill. Circuits 9 and 10 will be run as one 3-wire branch circuit and circuits 11 and 12 as another 3-wire branch circuit from the lighting cabinet to the first outlet on those branch circuits.

Circuit 13 has three outlets. A 100-watt lamp will be put in each outlet, and each lamp will be controlled by a pull switch in addition to a wall switch. These lamps will be located over the motors and in the passageway, and will only be used when it is necessary to inspect the motors or to get something from the stockroom. The use of pull switches will make it possible to turn out the lamps that are not needed and to control the others by the wall switch.

LAYOUT OF MAIN FLOOR

On the main floor there are two large rubber calenders, two rubber mills, and a large number of tables for inspection purposes. A rubber calender is a machine having a very large roll or rolls, which forces a rubber compound into cotton goods, making a rubber sheeting which can be used for making overcoats and other

rubberized products. Likewise the location of the mill in front of the calender and also the arrangement in the building would indicate that when there are not enough work orders to operate the mill at full capacity one of the rubber mills and calenders would be operated while the other would be shut down. This arrangement of the machinery can be better served by three lighting outlets connected on the same circuit directly over the mill and calender of these respective units.

ARRANGING OUTLETS ON CIRCUITS ON MAIN FLOOR

The contractor arranges circuits 1 to 6, Fig. 14, with three outlets each. Each circuit will be controlled by a wall push switch, located on the post between the mill and the calender.

Circuits 1 and 2 will be run as a 3-wire branch circuit from the lighting cabinet to the first outlet of either circuit. The same arrangement will apply to circuits 3 and 4 and circuits 5 and 6. The installing of the conduit and its direction may be different from that shown on Fig. 14, because sometimes obstructions are encountered that do not appear on the blueprint. 300-watt lamps will be used in the outlets on circuits 1, 3, 4, 5, and 6. Circuit 2, which is located in the bays midway between the calenders and mills, will be equipped with 200-watt lamps, because it is not necessary to have as bright a light at these points as it is directly above the mills and calenders.

Circuit 7 will have three outlets, Fig. 14. A 300-watt lamp will be used in each outlet. The lamps on this circuit will be controlled by a wall switch which will be placed on the opposite side of the post on which the switch for circuit 1 is placed, because there will be less chance of material being stored around this post and it will be easier to reach the switch.

Circuit 8 will have six outlets, Fig. 14. The space which will be lighted by the lamps on circuit 8 was not assigned to any definite use by the architect, Fig. 6, so it is assumed that it will be used as a storage space until it becomes necessary to install additional machinery. For this reason, smaller size lamps can be used in these outlets than in the outlets near the machines. The three outlets in the bays near circuit 7 will each have a 200-watt lamp. A 100-watt lamp will be used in each of the three outlets between the tanks and

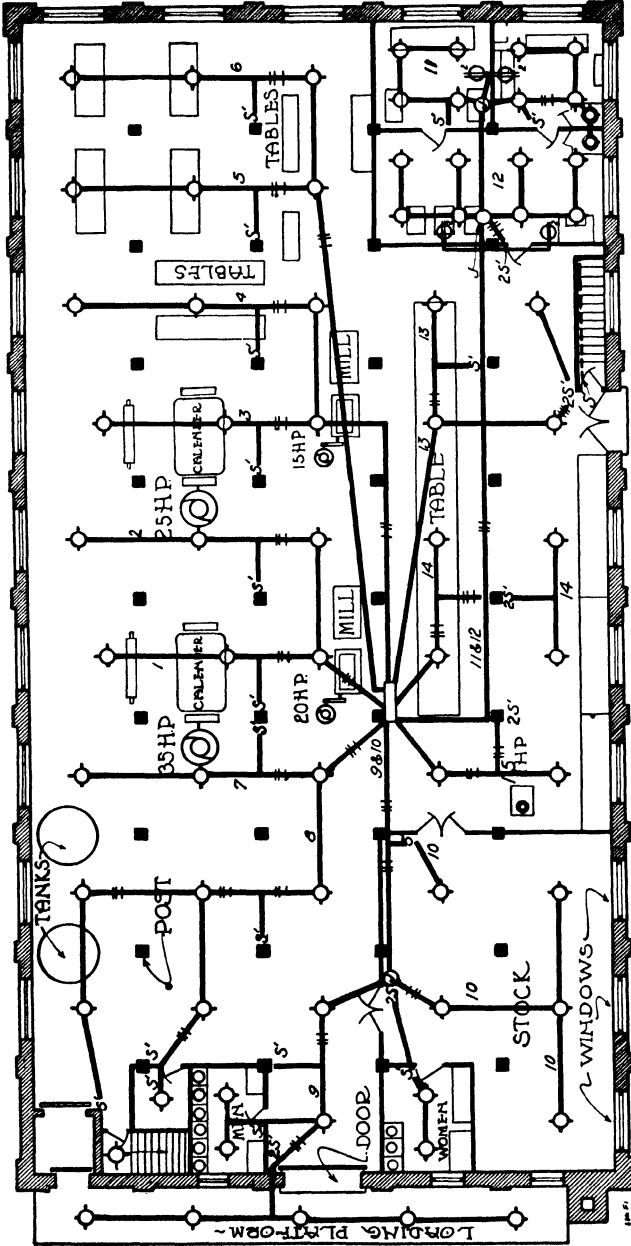

Fig. 14. Conduit Runs on Main Floor

the elevator, in the small room near the stairs, and in the bay at the side of the men's room. A wall switch will be mounted on a post, Fig. 14, which will control the 200-watt lamps. A switch will be mounted at the side of the elevator shaft and will control the 100-watt lamp that will be used in the outlet between the tank and the elevator. The switch which will control the 100-watt lamp in the small room will be mounted on the wall inside of that room near the door and a switch will be mounted outside of the small room which will control the lamp in the bay at the side of the men's room. This switch will be directly opposite the switch on the inside of the small room.

It is quite likely that smaller size lamps will be placed in the sockets of the outlets when the wiring is completed than is given in Table III. Anyone preparing such a schedule should make allowance for larger size lamps than will be needed for present use in order to prevent overloading the circuits at a later time.

There will be three wires, two black and one white, run in the conduit between the three outlets that will use 200-watt lamps. Three wires will also be run in the conduit between the outlet in the bay at the side of the men's room and the switch controlling the lamp in that outlet. Circuits 7 and 8 will be run as a 3-wire branch circuit from the lighting cabinet to the first outlet on circuit 7.

Circuit 9 will have nine outlets, Fig. 14. A 100-watt lamp will be placed in each of the two outlets located in the center of the two bays opposite the stockroom door and in front of the loading platform door. A 60-watt lamp will be placed in each of the five outlets over the loading platform and in each of the two outlets in the men's room.

A wall switch will be placed on the post at the corner of the men's room which will control the lamp in the outlet opposite the stockroom door. Two wall switches will be placed on the wall and at the side of the door to the loading platform. One of these switches will control the five lamps over the loading platform and the other will control the lamp in the center of the bay opposite the loading platform door. The two lamps in the men's room will be controlled by a switch placed on the wall on the inside of that room and at the side of the door.

FACTORY BUILDING WIRING

TABLE III

Main Floor Light Schedule

Circuit	Lights	Size	Total Watts	Switches
1	3	300	900	1 single-pole wall
2	3	200	600	1 single-pole wall
3	3	300	900	1 single-pole wall
4	3	300	900	1 single-pole wall
5	3	300	900	1 single-pole wall
6	3	300	900	1 single-pole wall
7	3	300	900	1 single pole wall
8	3	200	900	1 single-pole wall
	3	100		3 single-pole wall
9	7	60	620	2 single-pole wall
	2	100		2 single-pole wall
10	5	100	620	3 single-pole wall
	2	60		1 single-pole wall
11	8	100	1040	2 single-pole wall
	4	60		2 convenience outlets
12	8	100	920	2 single-pole wall
	2	60		2 convenience outlets
13	2	300	800	1 single-pole wall
	2	100		2 single-pole wall
14	2	300	1000	1 single-pole wall
	2	200		1 single-pole wall
15	2	100	200	2 single-pole wall
Total	75		12100	

It will be seen in Fig. 14 that each one of the lamps in the bays from the loading platform door around to the elevator will be controlled by a separate wall switch. This will enable the men receiving or shipping out material to turn on the lamps whenever light is needed.

Circuit 10 will have seven outlets, Fig. 14. The five outlets in the stockroom will be equipped with 100-watt lamps, and the two outlets in the women's room will be equipped with 60-watt lamps. The lamps in the three outlets near the windows in the stockroom will be controlled by one wall switch and the lamp in the outlet opposite the women's room will be controlled by another. These two switches will be placed at the side of the double door of the stockroom. The switch for the lamps in the women's room

will be placed on the inside of that room and at the side of the door. Another switch will be placed on the inside of the stockroom at the side of the double door opening into the factory, which will control the lamp in the center of the bay near this door. The reason that the switch will be placed at this door, instead of controlling this lamp from the same switch that controls the lamp opposite the door to the women's room, is because this switch will be more convenient for the women from the factory and office who will pass through this door and end of the stockroom when going to their restroom, and this one lamp will provide plenty of light in the stockroom for this purpose.

A junction box will be placed on the ceiling directly above the two switches at the side of the stockroom door, Fig. 14, because it will be necessary to make many splices in the wires at this point and the regular Condulet or Unilet fittings do not provide enough space. There will be three wires, one white and two black, from the junction box to the outlet in the center of the bay opposite the door to the women's room. Three black wires will be run from the junction box on the ceiling to the two switches directly below.

Circuits 9 and 10 will be run as a 3-wire branch circuit from the junction box, Fig. 14, to the lighting cabinet. A T-type fitting will be installed in the conduit just inside the stockroom. Conduit will be run from this fitting to the wall switch and to the outlet for the lamp controlled by this switch. When installing the wires for this outlet and switch, a splice will be made in the T-type fitting. When making this splice, the wireman should connect the black wire from the wall switch to the black wire of circuit 10 and not to the black wire of circuit 9.

Circuit 11 will have twelve outlets. The four bays in one corner of the main floor, Fig. 6, will be used as an office. This office is divided into three rooms. The large room will be used as a general office, and occupies two bays. The other two rooms will be used as private offices. As it is desirable to have more uniform lighting in these offices than would be obtained by using only one outlet in the center of each bay, four outlets will be used in each bay. There will be a 100-watt lamp in each of these outlets. Each of the private offices will have a wall switch at the side of the door and these switches will control the four lamps in each office, respectively.

There are two small closets, Fig. 6, between the window in the large office and the window in the small office. There is a wash bowl in each closet, represented by a circle in Fig. 6. In Fig. 14, the symbol for an outlet is made smaller than usual and is put inside the circle representing the wash bowl. These outlets in the closets will be fitted with drop cords and key sockets and a 60-watt lamp will be used in each outlet.

A junction box will be placed on the ceiling directly over the partition between the two private offices, Fig. 14. The conduit from the junction box to the convenience outlet, on each side of the partition, will be run down this partition. There will be three wires between two of the outlets in one of the private offices.

Circuit 12 will have ten outlets, eight of these will be ceiling outlets in the general office and two convenience outlets. A 100-watt lamp will be used in each of these ceiling outlets. There will be two wall switches on the inside of the large room and at the side of the door entering this room. One of these switches will control the four lamps in one bay and the other switch will control the four lamps in the other bay. A junction box will be installed between outlets, Fig. 14. Three wires will be run in the conduit from the junction box to the two switches. An X-type "Unilet" or "Condulet" fitting will be installed where the conduit from this junction box to the lighting cabinet passes through the partition. A splice will be made in this fitting and two wires will be run in the conduit to the double convenience outlet on each side of the general office. Circuits 11 and 12 will be run as a 3-wire branch circuit from the lighting cabinet to the junction box in the general office.

There are ten outlets on this floor that have not been assigned to any circuits. These outlets are between the office and the stock-room. Four of these outlets will be located over a table, Fig. 4, which will be used for inspection work and where a good light will be needed, therefore, a 300-watt lamp will be needed in each outlet. To prevent over-loading it will be necessary to use three circuits.

Circuit 13 will have four outlets—two outlets over the table near the office and two outlets near the stairs. A 300-watt lamp will be used in each of the outlets over the table, and a 100-watt lamp will be used in each of the outlets near the stairs. A wall switch will be placed on the side of the post which will control the

two lamps in the outlets over the table. Two wall switches will be placed at the side of the stairs—one will control the 100-watt lamp in the outlet in front of the outside door, and the other will control the 100-watt lamp in the outlet in front of the office door, Fig. 14.

The conduit inside the stairs, shown by a dotted line, Fig. 14, is the conduit for circuit 2, Fig. 9, and is located on the ceiling of the basement. The symbol for the switch on the first floor, Fig. 14, is for the same switch shown on circuit 2, Fig. 9.

Circuit 14 will have four outlets—two outlets at the end of the table near the stockroom, Fig. 14, and two outlets in front of the windows. A 300-watt lamp will be used in the two outlets over the table. A 200-watt lamp will be used in each of the two outlets in front of the windows. Two switches will be placed on a post between these outlets. One switch will control the lamps in the two outlets over the table and the other switch will control the lamps in the two outlets in front of the windows.

Circuit 15 will have two outlets along the end of the stockroom, Fig. 14. A 100-watt lamp will be used in each outlet. These lamps will be controlled by separate wall switches which will allow any one of the lamps to be turned out when it is not needed. It will also enable the night watchman to turn on one light so he can see his way about the factory at night.

LAYOUT OF SECOND FLOOR

The second floor of the factory building will be rented to a tenant who will use it for a machine shop. The machines will be arranged as shown in Fig. 7. One outlet will be located in each bay, except in the office and in the small rooms. A 300-watt lamp, Table I, will be needed in each outlet over the machines in the machine shop. The number of these lamps on a circuit cannot exceed three, without overloading the circuit.

The lamps over the machines located near the center of the room will have to be turned on before those near the windows. The lamps and outlets in the bays along the windows should be placed on the same circuit whenever possible. When this is impossible, a switch should be used to control the lamps in the bay near the window. The shapers, drill presses, planers, and lathes are arranged in rows lengthwise of the building, Fig. 7.

ARRANGING OUTLETS ON CIRCUITS ON SECOND FLOOR

Circuit 1 will have three outlets, Fig. 15, which will be located over the shapers. A 300-watt lamp will be put in each of these outlets and will be controlled by a wall switch mounted on the opposite side of the post from the lighting cabinet.

Circuit 2 will have three outlets which will be located over the planers. A 300-watt lamp will be used in each of these outlets and will be controlled by a wall switch placed on the post under the 3-horsepower motor. This motor is on a platform near the ceiling.

Circuit 3 will have three outlets over one end of the row of lathes. A 300-watt lamp will be put in each of these outlets and will be controlled by a wall switch, placed on the post between the lathes and planers. Circuits 2 and 3 will be run as a 3-wire branch circuit from the lighting cabinet to the junction box between the outlets over the planers.

Circuit 4 will have three outlets over the drill presses, Fig. 15. A 300-watt lamp will be used in each of these outlets and will be controlled by a wall switch placed on the post near the 5-horsepower motor operating the drill presses.

Circuit 5 will have three outlets. These outlets will be over the short row of lathes at the end of the row of planers. The 300-watt lamps in these outlets will be controlled by a wall switch placed on a post.

Circuit 6 will have three outlets over the lathes. The 300-watt lamps in these outlets will be controlled by a wall switch placed on a post, Fig. 15. Circuits 5 and 6 will be run as a 3-wire branch circuit from the lighting cabinet to the junction box located between the outlets on circuit 5.

Circuit 7 will have three outlets near the windows at the end of the drill presses and lathes. A 300-watt lamp will be put in each of these outlets and will be controlled by a wall switch mounted on the post between the drill presses and lathes. Circuits 4 and 7 will be run as a 3-wire branch circuit from the lighting cabinet to the first outlet on circuit 4. The number of wires that will be pulled into the conduit between the different outlets, Fig. 15, is shown by short lines drawn across the heavy line representing the conduit. Remember that when the conduit is not marked, two wires, one

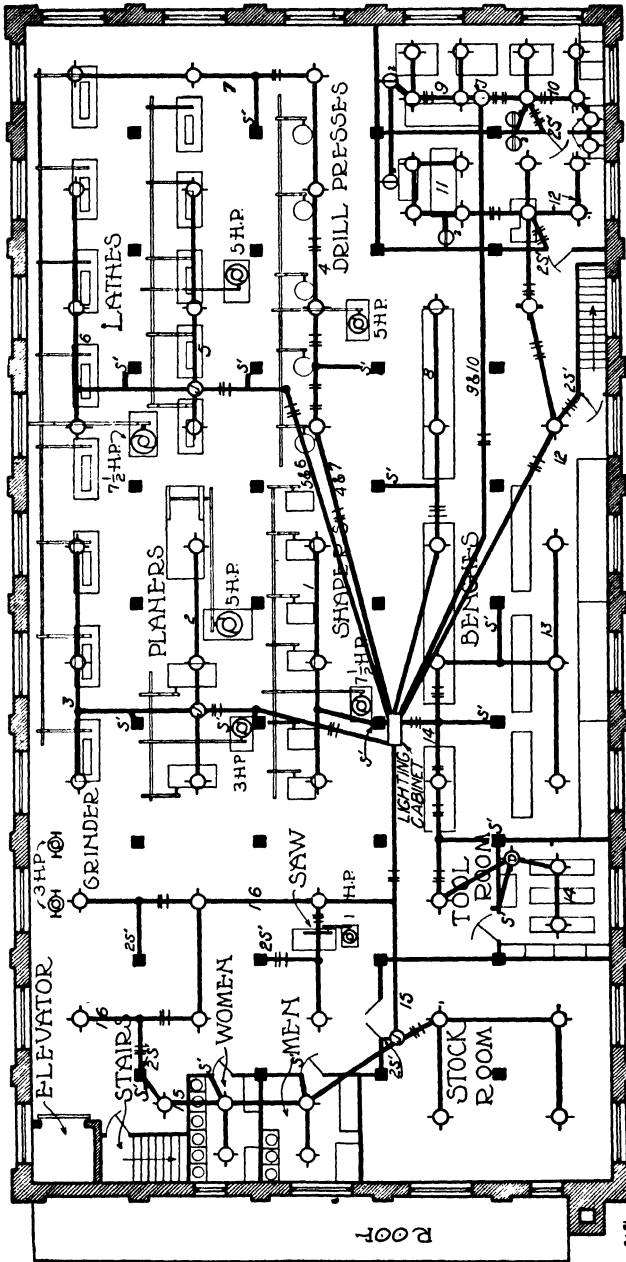

Fig. 15. Conduit Runs on Second Floor

black and one white, are to be used, except when there are two wires run to a switch. Then black wires must always be used.

Circuit 8 will have three outlets. These outlets are located over a bench, Fig. 15, where machinists will work and a good light is needed. A 300-watt lamp will be put in each outlet and will be controlled by a wall switch mounted on a post.

The four bays used as an office on this second floor are divided into two rooms, Fig. 7. The room along side of the windows will be used for a drafting room, and the room nearest the factory will be used for a general office. As better lighting will be required for the drafting room than for the office, a 200-watt lamp will be put in each one of the ceiling outlets in the drafting room. Circuit 9 therefore, will have four ceiling outlets in one end of the drafting room and two double convenience outlets located along the partition that separates the office and drafting room from the factory.

Circuit 10 will have six outlets in the other end of the drafting room and two double convenience outlets on the partition between the drafting room and office. A 200-watt lamp will be used in each of the four ceiling outlets, and a 40-watt lamp will be used in each of the two outlets in the closets. Two wall switches will be placed at the side of the door between the office and the drafting room. One of these switches will control the lamps in the four ceiling outlets on circuit 9 and the other switch will control the four ceiling outlets on circuit 10. The lamps in the outlets in the closets will be controlled by key sockets.

Four black wires will be run in the conduit between the two wall switches at the side of the drafting room door, Fig. 15, and the ceiling outlet. Three black wires and one white wire will be run between this ceiling outlet and the junction box. Three wires will be run between the junction box and the first outlet on circuit 9. (This is not shown in Fig. 15 because of lack of space.) Circuits 9 and 10 will be run as a 3-wire branch circuit from the lighting cabinet to the junction box in the drafting room.

Circuit 11 will have four ceiling outlets and one double convenience outlet. The four ceiling outlets are in the factory end of the general office. A 100-watt lamp will be put in each of these ceiling outlets and will be controlled by one of the wall switches mounted at the side of the door between the factory and the office.

Circuit 12 will have six outlets. Four of these outlets will be at one end of the general office and the other two outlets will be in the factory opposite the office door. A 100-watt lamp will be put in each of the four outlets in the general office, Fig. 15, and will be controlled by a wall switch placed at the side of the office door. This switch will be mounted in the same box as the switch for the four lamps on circuit 11. A 100-watt lamp will be put in each one of the two outlets in the factory. The space in the factory under these outlets will be used for storage purposes and for a passageway to the stairs and office. The two outlets in the factory will each be controlled by a wall switch. These switches will be located at the corner of the stairway. Circuits 11 and 12 will be run as a 3-wire branch circuit from the lighting cabinet to the first outlet on circuit 12.

Circuit 13 will have three outlets. These outlets will be located between the benches opposite the windows. A 300-watt lamp will be used in each of these outlets, because a good light will be needed for accurate work on the bench. A wall switch will be mounted on one of the posts to control the lamps.

Circuit 14 will have six outlets, Table IV. A 300-watt lamp will be put in each one of the two outlets over the benches opposite the lighting cabinet. A good light will be needed here in order to do accurate work. A 100-watt lamp will be put in the outlet in the bay in front of the tool room door as this space will be used for a passageway and storage room. A 60-watt lamp will be put on a drop cord outlet. A 100-watt lamp will be put in each one of the two outlets over the tool racks in the tool room. The two lamps over the tool racks will be controlled by a wall switch placed along side of the tool room door. The 100-watt lamp in the bay in front of the tool room door will be controlled by a wall switch placed on the corner post of the tool room. The two 300-watt lamps over the benches in front of the lighting cabinet will be controlled by a wall switch on the post in front of the lighting cabinet.

Circuit 15 will have nine outlets, Fig. 15. A 100-watt lamp will be placed in each one of the four outlets in the stockroom. A 75-watt lamp will be placed in each one of the outlets in the men's room and the women's room. A 100-watt lamp will be placed in the outlet in the small bay between the women's room and the elevator.

FACTORY BUILDING WIRING

TABLE IV
Lighting Schedule for Second Floor

Circuit	Lamps	Size	Total Watts	Switches
1	3	300	900	1 single-pole wall
2	3	300	900	1 single-pole wall
3	3	300	900	1 single-pole wall
4	3	300	900	1 single-pole wall
5	3	300	900	1 single-pole wall
6	3	300	900	1 single-pole wall
7	3	300	900	1 single-pole wall
8	3	300	900	1 single-pole wall
9	4	200	920	1 single-pole wall
	2	60		2 convenience receptacles
10	4	200	1000	1 single-pole wall
	2	60		2 convenience receptacles
	2	40		2 key sockets
11	4	100	460	2 single-pole wall
	1	60		1 convenience receptacle
12	6	100	600	3 single-pole wall
13	3	300	900	1 single-pole wall
14	2	300	960	1 single-pole wall
	3	100		1 single-pole wall
	1	60		drop cords and key socket
15	5	100	800	3 single-pole wall
	4	75		2 single-pole wall
16	2	200	800	2 single-pole wall
	4	100		4 single-pole wall
Total	73		13640	

Two wall switches will be used to control the lamps in the stock-room. These switches are mounted on the inside of the stockroom partition wall and along side of the door directly below the junction box which will be placed on the ceiling. One of these wall switches will control the lamps in the two outlets near the windows. The other switch will control the lamps in the two outlets near the factory. Wall switches will be placed at the side of the door of the men's room and at the side of the door of the women's room and will control the lamps in these respective rooms. A wall switch will be placed on the post near the elevator to control the light in the small bay.

Circuit 16 will have six outlets, Fig. 15. A 200-watt lamp will be placed in each of the outlets in the center of each bay near the saw and near the grinder. Better light will be needed at these machines than in the bays used for passageway and storage. A 100-watt lamp will be placed in each of the other outlets on this circuit, Table IV. The lamp in each outlet on this circuit will be controlled by a wall switch. The switches for each two lamps will be mounted in the same box and placed on the same post in order to save conduit and wire. Circuits 15 and 16 will be run as a 3-wire branch circuit from the lighting cabinet to a point opposite the first outlet on circuit 16.

LAYOUT OF THIRD FLOOR

The third floor will be rented to a tenant who will use it as a tailor shop. The equipment used in a tailor shop consists of sewing machines, pressing irons, small motors for cutting cloth, and a number of tables for inspecting the finished garments. This kind of work requires more light than is needed on the other floors, because the work is more exacting, and dark goods absorb a large amount of light. White objects or goods reflect light while dark objects or goods absorb it. It will be necessary to have very bright light on the cloth as it is being run through the sewing machines. Therefore, special lighting will be used for each individual sewing machine in addition to the light from the lamps in the ceiling outlets.

ARRANGING OUTLETS ON CIRCUITS ON THIRD FLOOR

Circuit 1 will have three outlets, Fig. 16. A 200-watt lamp will be put in each outlet. A wall switch for controlling these lamps will be mounted on the opposite side of the post from the lighting cabinet. The space under these outlets has not been assigned to any definite use, Fig. 8, so it is assumed that the space will be used for storage, inspection tables, or additional sewing tables. As maximum size lamps would be required for inspection work, this should be kept in mind when determining the size of lamps.

Circuits 2 and 3 will each have three outlets. A 200-watt lamp will be put in each outlet, Table V. Two wall switches, mounted on a post between the two sewing tables, will control the lamps in

TABLE V
Third Floor Lighting Schedule

Circuit	No. Lamps	Size	Total Watts	Switches
1	3	200	600	1 single-pole wall
2	3	200	600	1 single-pole wall
3	3	200	600	1 single-pole wall
4	3	200	600	1 single-pole wall
5	3	200	600	1 single-pole wall
6	3	200	600	1 single-pole wall
7	3	200	600	1 single-pole wall
8	8	100	980	2 single-pole wall
	3	60		3 convenience outlets
9	6	100	780	2 single-pole wall
	3	60		1 key socket and 2 convenience outlets
10	2	300	800	3 single-pole wall
	2	100		
11	3	300	900	1 single-pole wall
12	3	300	900	1 single-pole wall
13	3	300	900	1 single-pole wall
14	3	300	900	1 single-pole wall
15	2	100	440	2 single-pole wall
	4	60		2 single-pole wall
16	3	100	480	2 single-pole wall
	3	60		3 single-pole wall
17	16	40	640	Key sockets
18	16	40	640	Key sockets
19	16	40	640	Key sockets
20	16	40	640	Key sockets
Total	133		13840	

circuit 2 and circuit 3. Circuits 2 and 3 will be run as a 3-wire branch circuit from the lighting cabinet to the center outlet in circuit 2.

Circuit 4 will have three outlets, Fig. 16. A 200-watt lamp will be put in each outlet. These lamps will be controlled by a wall switch mounted on a post located near the sewing tables.

Circuits 5 and 6 will each have three outlets over the sewing tables. A 200-watt lamp will be placed in each outlet, Table V. Two wall switches, mounted on a post between the sewing tables, will control the lamps on circuits 5 and 6. Circuits 5 and 6 will be run as a 3-wire branch circuit from the lighting cabinet to the outlet on circuit 5 over the end of the sewing tables, Fig. 16.

Circuit 7 will have three outlets located at the end of the sewing tables and in front of the windows. A 200-watt lamp will be put in each outlet. A wall switch for controlling these lamps will be mounted on a post. Circuits 4 and 7 will be run as a 3-wire branch circuit from the lighting cabinet to the first outlet on circuit 4.

The four bays in one corner of the third floor, Fig. 8, will be used as an office. A small room occupying about three-fourths of a bay will be used as a private office. There will be four outlets in each bay, the same as in the office on the floors below.

Circuit 8 will have eight ceiling outlets, Fig. 16, and three double convenience outlets. A 100-watt lamp will be put in each of the ceiling outlets. Two wall switches, mounted on a post near the office door, will control the four lamps in each bay.

Circuit 9 will have nine ceiling outlets and two double convenience outlets, Fig. 16. A 100-watt lamp will be put in each of the six ceiling outlets. The two ceiling outlets at the edge of the partition in the private office will not be used at the present time or have any lamps put in them. The reason for putting the two outlets so near the partition is to give a uniform arrangement in all bays. Whenever this partition is removed, as when enlarging or changing the office, the outlets will be ready for use. The outlet in the small closet at the side of the private office will have a 60-watt lamp fitted with a drop cord and key socket. Conduit will be run from the double convenience outlet on the partition of the private office up to the ceiling outlet above. A wall switch for controlling the two lamps in the private office will be placed on the partition at the side of the door. Another wall switch will control the lamps in the four outlets on circuit 9 in the general office. This switch will be mounted on the same post and along side of the two switches for the lamps in circuit 8.

Instead of using two runs of conduit from the outlets to the three switches on the post near the door, Fig. 16, five wires could be installed in one conduit. This, however, would require a $\frac{3}{4}$ -inch conduit instead of a $\frac{1}{2}$ -inch conduit, and there would be more wires to splice in the outlet. This arrangement would be more complicated in wiring and would probably cost more than the arrangement in Fig. 16. Circuits 8 and 9 will be run as a 3-wire branch circuit from the lighting cabinet to the first outlet on circuit 8.

Circuit 10 will have four outlets. A 300-watt lamp will be put in each of the two outlets over the cutting table. A 100-watt lamp will be put in each of the two outlets near the stairs. Each 100-watt lamp will be controlled by a separate wall switch mounted on the side of the stairs, Fig. 16. The two 300-watt lamps will be controlled by one wall switch mounted on a post near the tables.

Circuit 11 will have three outlets. A 300-watt lamp will be put in each outlet. Circuit 12 will have three outlets. A 300-watt lamp will be put in each outlet. Two wall switches will be mounted on a post between the cutting tables. One switch will control the lamps on circuit 11 and the other switch will control the lamps on circuit 12. Circuits 11 and 12 will be run as a 3-wire branch circuit from the lighting cabinet to the first outlet on circuit 11.

Circuit 13 will have three outlets. A 300-watt lamp will be put in each one of the three outlets, Table V. Circuit 14 will have three outlets. A 300-watt lamp will be put in each one of the three outlets. Two wall switches will be mounted on the post between the pressing tables. One of these switches will control the three lamps on circuit 13 and the other switch will control the lamps on circuit 14. Circuits 13 and 14 will be run as a 3-wire branch circuit from the lighting cabinet to the first outlet on circuit 14.

Circuit 15 will have six outlets, Fig. 16. A 100-watt lamp will be put in each outlet in the center of each bay. The lamp in each outlet will be controlled by a separate wall switch mounted on a post near each outlet. A 60-watt lamp will be put in each of the other four outlets on this circuit. The two lamps in the men's room and the two lamps in the women's room will be controlled by wall switches mounted at the side of the door in each one of these rooms.

Circuit 16 will have six outlets. A 100-watt lamp will be put in each of the two outlets between the bench and the shelves and the outlet between the shelves, Fig. 16. A 60-watt lamp will be put in each of the other three outlets on this circuit. The lamps in the two outlets between the bench and the shelves will be controlled by one wall switch, located at the side of the door opening into the factory. A separate wall switch will be used to control the lamps in each one of the other outlets on this circuit. Circuits 15 and 16 will be run as a 3-wire branch circuit from the lighting cabinet to the first outlet on circuit 15.

Circuits 17, 18, 19, and 20 will each have 16 outlets. These outlets will provide a lamp for each sewing machine, Fig. 17. The size of these lamps will be determined by actual test and will depend upon the color and kind of goods being sewed. They may be either 15, 25, 40, or 60 watts. It will be assumed that a 40-watt lamp will be the size used. There will be one circuit for each sewing table.

The conduit for circuits 17, 18, 19, and 20 is fastened to the ceiling of the second floor as indicated by dotted lines on Fig. 16. A neater and better arrangement is thus obtained than if the conduit

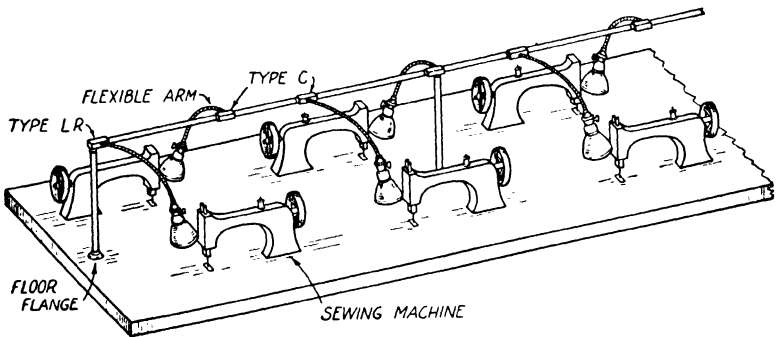

Fig. 17. Lighting for Sewing Machines

were placed on ceiling of the third floor. Circuits 17 and 18 are run as a 3-wire branch circuit from the lighting cabinet to the table nearest the cabinet. Circuits 19 and 20 are run as a 3-wire branch circuit from the lighting cabinet to the table nearest the cabinet.

A frame for holding the lamps in position on the sewing tables will be built up of short lengths of conduit, conduit fittings, and flexible arms, Fig. 17. Floor flanges will be fastened to the top of the table by four large screws. The upright pieces of conduit will be screwed into the floor flanges. The covers for the opening in the conduit fittings used in building this frame are fitted with a threaded part to receive the flexible arm. A key type socket is fastened to the other end of the flexible arm. A reflector throws the light on the work that is being sewed. On the cutting tables there are six special outlets to which small electric motors will be connected. These motors will be used for cutting cloth. On the pressing tables there are also six special outlets to which electric irons will be connected. The electric irons will be used for pressing the clothes made

on this floor. Part of the conduit for these outlets will be run on the ceiling of the floor below as indicated by dotted lines. The conduit that will be run on the ceiling of the third floor is indicated by solid lines. An iron box holding a set of fuses will be mounted on the post between the pressing tables and a similar box will be placed between the cutting tables. These special outlets will be connected to the power circuits, and not to the lighting cabinet or lighting circuits.

TOTAL LIGHTING LOAD FOR THE BUILDING

The total number of ceiling outlets, convenience outlets, switches, and circuits for the basement, Table II, for the main floor, Table III, for the second floor, Table IV, and for the third floor, Table V, is given in Table VI. This data is repeated so that the total number of ceiling outlets, convenience outlets, switches, and circuits for the building can be easily obtained by adding the numbers in each column.

The total number of ceiling outlets in the factory building is 348. This includes those outlets that will have drop cords and key sockets, as well as a few outlets that will not have any lamps. The outlet boxes which are used as junction boxes are not included in these tables because such boxes are used by the contractor for making the wiring job easier.

There will be 14 convenience outlets installed in the offices of this building. Each convenience outlet will have a double or duplex receptacle, so that two extension or portable cords can be connected to the same receptacle. The convenience outlets are convenient for connecting desk lamps and office devices operated by small electric motors.

There will be 108 tumbler type wall switches, Fig. 10, used in this factory to control the ceiling lights. There will be 64 branch circuits. A fuse must be inserted in the "hot" or "live" side of each branch circuit in order to protect that circuit from overload. When all the lamps on a branch circuit are controlled by wall switches, the circuit switch at the lighting cabinet may be omitted if desired. However, the convenience of being able to turn off all the lights on a floor from one place, which is the lighting cabinet, is usually well worth the extra cost of these circuit switches.

FACTORY BUILDING WIRING

TABLE VI
Total Building Outlets

Floor	Ceiling Outlets	Convenience Outlets	Number of Switches	Number of Circuits
Basement	67	0	22	13
Main	75	4	30	15
Second	73	5	29	16
Third	133	5	27	20
Total	348	14	108	64

TABLE VII
Total Building Load

Floor	Connected Load in Watts	Amperes at 230 Volts	Size of Wires	Size of Conduit Inches
Basement	9260	40	3 No. 6	1½
Main	12100	53	3 No. 4	1½
Second	13640	59	3 No. 4	1½
Third	13840	60	3 No. 4	1½
Total	48840	212	350,000 c.m.	3

The total number of watts that would be used on each floor if all the lamps on that floor were turned on at once is called the total connected load for that floor. This total figure, which is given at the bottom of Tables II, III, IV, and V for each of the floors, respectively, is given in the first column of Table VII.

The second column of Table VII gives the current in amperes that the wires from the meter to the lighting cabinet in each floor will have to carry. This is obtained by dividing the load in watts by the voltage between the two "hot" or "live" wires, which is 230 volts for this factory building. Thus $9260 \div 230 = 40.3$ (or $40\frac{3}{10}$) amperes. This method of estimating the maximum current assumes that the load is balanced, which means that the load in watts connected between the neutral and each "hot" wire is approximately the same. An approximate balanced load will be obtained in this factory by connecting every other one of the "hot" or black wires of the branch circuits to the same "hot" wire or bus bar at the light-

ing cabinet. Thus the black wire of the odd numbered circuits—1, 3, 5, 7, etc.—will be connected to one of the “hot” bus bars in the lighting cabinet and the even numbered circuits—2, 4, 6, 8, etc.—to the other “hot” bus bar. The white wire of all the branch circuits will be connected to one neutral bus bar in the lighting cabinets.

When the load on a 3-wire system is not balanced, the current in each “hot” wire must be calculated separately. This is done by adding together the loads of all the branch circuits connected to the same “hot” bus bar or wire at the lighting cabinet and dividing this sum by the voltage between the “hot” wire and neutral, which is 115 volts. The “hot” wire having the largest current will be the one which determines the size of wires for a 3-wire circuit, because all wires must be large enough to carry the maximum current without exceeding the safe-carrying capacity allowed by the National Electrical Code.

The size of wires required to carry the current to the different floors can be obtained from any table that gives the carrying capacity of rubber-insulated wires. Such tables always give the maximum current that the wires or cables will carry without becoming hot enough to injure the insulation. A wire or cable can always carry less current than is given in the tables. The carrying capacity of No. 8 rubber-insulated wire is up to 35 amperes, No. 6 is up to 45 amperes, and No. 4 is up to 60 amperes. The size of conduit required for three No. 6 wires or three No. 4 wires is $1\frac{1}{4}$ -inch. It is quite likely that No. 4 wire will be used to carry the current from the meter to the lighting cabinet on each floor because the length of wire required is short and it would cost more to buy a short length of No. 6 than the difference in cost between No. 6 and No. 4.

INSTALLING METERS AND SWITCHES

After the lighting and power requirements have been determined for this building, the contractor decides where it is best to install the meters and switches for the light and power circuits. A wooden frame will be put between the fourth and fifth posts, Fig. 9, counting from the boiler room end of the building to which the meters and switches will be attached. This frame is made by

nailing a 2 x 4 piece of wood to the side of each post and then fastening one-inch boards to the 2 x 4.

A 400-ampere inclosed service switch, similar to the one shown in Fig. 18, will be mounted on a wooden frame fastened to the concrete basement wall between the chute and the boiler room partition. A 225-ampere fuse will be inserted in the fuse clips located directly below the hinge of the switch. Sometimes the neutral, which is

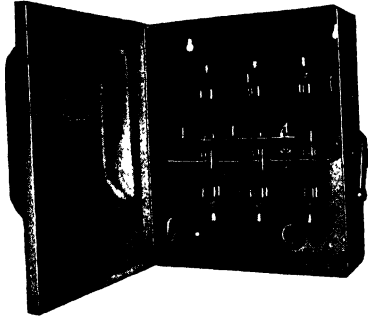

Fig. 18. 400-Ampere Service Switch
Courtesy of Trumbull Electric Manufacturing Company

the middle wire, is not fused because on lighting circuits this wire is permanently connected to ground. When the neutral wire does not have a fuse at the switch, it is referred to as a "solid neutral." A switch that is provided with fuse clips in the neutral can be converted to "solid neutral" by replacing the fuse with a solid bar of copper.

The standard ampere rating of switches is 30, 60, 100, 200, 400, and 600 amperes. Switches are rated at the maximum current that they will carry and are constructed so they cannot take a larger size fuse.

The three service wires, 350,000 c.m., are pulled in a 3-inch conduit which is run alongside of the beams supporting the floor joists, Fig. 3, to a point directly over the meter panels, and then down and into the bottom of the meter test cabinet, Fig. 19. An interior view of the meter test cabinet is shown in Fig. 20. The contractor must install a meter test cabinet in order to make it easy for the power company to make regular periodical tests on the watt-hour meter which the power company will install directly above the meter test cabinet. This meter test cabinet consists of a number of copper

links mounted on a slate base, which can be removed when the meter man is testing the watt-hour meter.

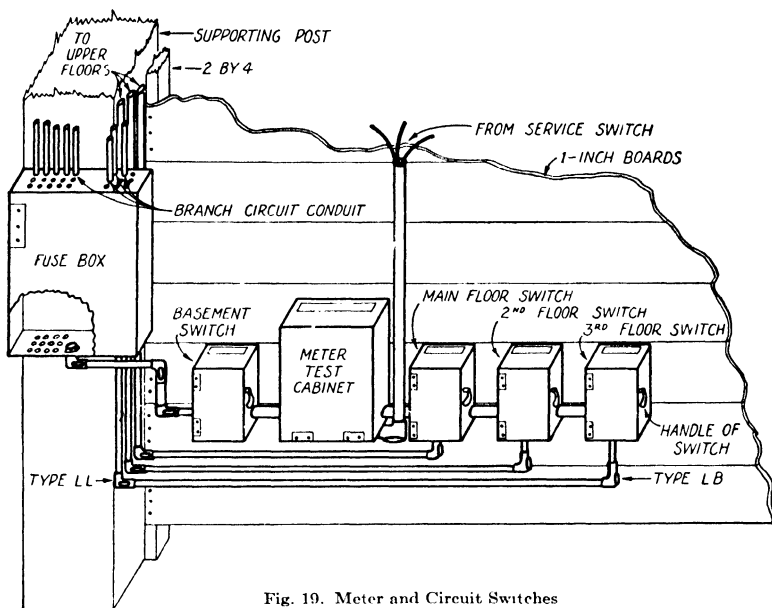

Fig. 19. Meter and Circuit Switches

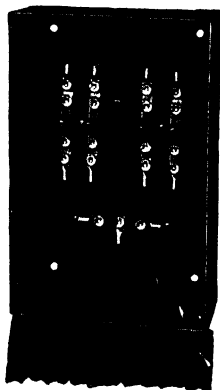

Fig. 20. Meter Test Cabinets
Courtesy of Trumbull-Vanderpool Electric Manufacturing Company

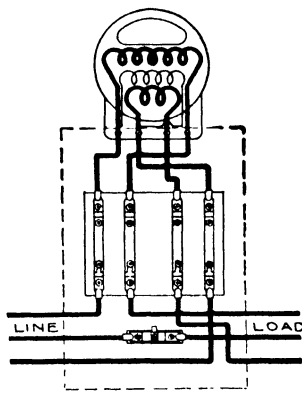

Fig. 21. Wiring Diagram of Meter Test Cabinet
Courtesy of Trumbull-Vanderpool Electric Manufacturing Company

The method of wiring the meter test cabinet is shown in Fig. 21. The contractor will connect the neutral wire to the small test block

at the bottom of the cabinet and the "hot" wires to the bottom terminals of the upper test block. The power company will install the wires from the top of the test block terminals to the watt-hour meter.

The electric light and power company usually requires that the top of the meter test box shall not be higher than 4' 6" from the floor for the large size meters, which are usually of a capacity of 50 to 200 amperes, or more. The meter and circuit switches will be mounted at the side of the meter test cabinet. These switches

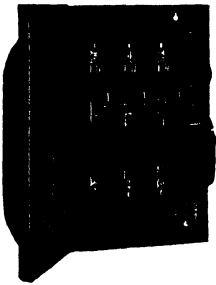

Fig. 22. Meter Switch for Each Floor
Courtesy of Trumbull Electric Manufacturing Company

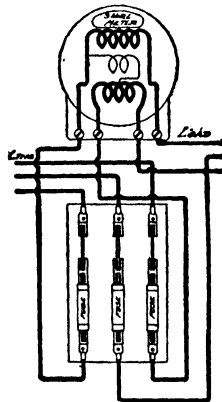

Fig. 23. Wiring Diagram for 3-Wire Switch and Meter
Courtesy of Trumbull-Vanderpool Electric Manufacturing Company

will control the lighting circuit to each floor. An interior view of one of these circuit switches is shown in Fig. 22. This arrangement of circuit switches for each floor will enable the owner of the building to turn off all the light on any particular floor at any time that he desires to do so. This arrangement also makes it possible, in case the owner of the building does not care to include the electric light used on any floor in the rentals, for the power company to install a meter over the switches in order to measure the energy used on each floor.

The rated capacity of these circuit switches is 60 amperes. The method of wiring these switches is shown in Fig. 23. Three large wires are to be run from the meter test cabinet through the conduit, Fig. 19, to the top terminal of each switch, Fig. 22. Then the cables will be run from the bottom of each switch to the meter,

Fig. 23, when there is a meter for each floor, or through the conduit to the lighting cabinets located on each floor. The circuit switch for the basement will be located between the lighting cabinet or fuse box and the meter test cabinet, Fig. 19.

CONDUIT FITTINGS

Special fittings, which are called "Unilets" or "Condulets," will be used in wiring the switches for a much neater job will be obtained than if an attempt was made to bend the rigid conduit. These "Condulet" fittings make it easy to pull the wires through the conduit, Fig. 24, because when the cover is removed, the wires can be pulled through a straight run of conduit. These fittings are manufactured by the Crouse-Hinds Company, Syracuse, N. Y. "Unilets," a similar type of fitting, is manufactured by the Appleton Electric Company, Chicago. Both types of fittings use the same trade symbols. The fitting shown in Fig. 24 is known as an "LB." The letter "L" means an elbow fitting, and the letter "B" means that the opening is on the back. (Assumed that the fitting stands upright with the long side upward and you are looking into the short end into which the conduit is inserted.) The type "LL" fitting, Fig. 25, is an elbow fitting and has the opening on the left-hand side. The second letter "L" means left. A fitting with the opening at the right-hand side, Fig. 26, is designated as "LR," and when the opening is on the front of the bend it is designated as "LF," Fig. 27.

The "Condulet" fittings are also made with an angle of 45 degrees ($\frac{1}{8}$ of a circle) instead of a right-angle bend, as in the case of the "LB" fittings. The 45-degree type fitting is designated by adding the letter "B" to the other two symbols. Thus the "LB" fitting shown in Fig. 24 with an angle of 45 degrees is called an "LBB," and the "LL" and "LR" fittings would be "LLB" and "LRB."

The "T" type fitting, Fig. 28, is used where a branch circuit is taped off the main conduit run. The wires for the tap are pulled through the opening, Fig. 29. Then the other wires are pulled slightly outside the opening in the fitting, when making a splice, Fig. 30. After the splice is made and has been taped, it is pushed into the box, Fig. 31, and a cover is fastened to the opening with screws. The "X" type fitting, Fig. 32, can often be used in place of a junction box where the conduit runs will be at right angles.

FACTORY BUILDING WIRING

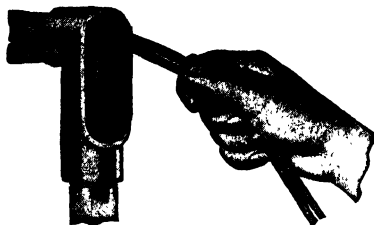

Fig. 24. Pulling Wires through "LB" Conduit
Courtesy of Crouse-Hinds Company



Fig. 25. Type "LL" Conduit
Courtesy of Crouse-Hinds Company



Fig. 26. Type "LR" Conduit
Courtesy of Crouse-Hinds Company



Fig. 27. Type "LF" Conduit
Courtesy of Crouse-Hinds Company



Fig. 28. Type "T" Conduit
Courtesy of Crouse-Hinds Company

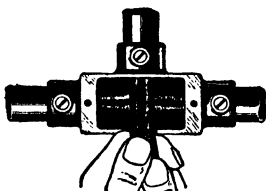

Fig. 29. Pulling Wires through
Conduit Fitting

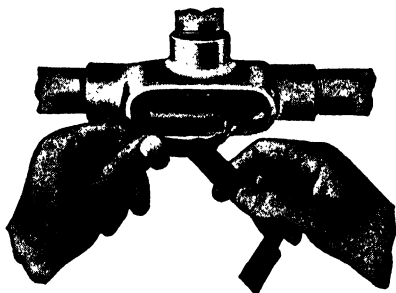

Fig. 30. Taping Splice in Conduit Fitting
Courtesy of Crouse-Hinds Company

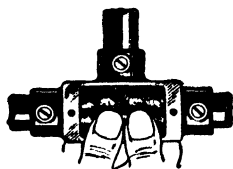

Fig. 31. Pushing Splice in Conduit Fitting



Fig. 32. Type "X" Conduit
Courtesy of Crouse-Hinds Company

INSTALLING LIGHTING FUSE CABINETS

An interior view of the lighting fuse cabinet which will be used for controlling the circuits on each floor is shown in Fig. 33. Twenty circuits can be controlled by this cabinet, and Fig. 34 shows a cabinet for twenty-eight circuits. The panel boards, inside the lighting cabinet are built up out of single sections, such as shown in Fig. 35, and are assembled side by side and bolted to the two bus bars. The two "hot" or "live" wires or cables from the basement circuit switch, Fig. 19, will be connected to lugs at the bottom of the bus bars, Figs. 33 and 34. The neutral wire or cable will be fastened to a copper bar at the top of the cabinet. Each one of these switches will control a circuit and there will be one fuse for each circuit. No fuse will be used in the neutral wire of the branch circuit because the neutral will be permanently connected to the ground.

The sectional units for the lighting cabinets, Figs. 33 and 34, are designated by the name or type symbol "NTP." The letter "N" means that the neutral is solid and without any fuse; the letter "T" means that a tumbler switch is used; and the letter "P" means that the plug type of fuse is used. This same type of units can usually be furnished by the manufacturer with the cartridge type of fuse instead of the plug type, in which case they are designated as the "NTC" section or unit. One of these units, Fig. 35, will accommodate or handle four circuits, thus as many units as needed can be quickly assembled in the lighting cabinet. This same type of unit will be used in the lighting cabinets on each of the other three floors.

The branch circuits will be protected by 15-ampere plug fuses and the wires or cables to these switches will be protected by fuses at the meter switches, Figs. 19 and 22. In some cases it might be desirable to have a set of fuses on the large cables where they enter the fuse cabinet, Fig. 36. This view, however, shows the units as they would appear in the lighting cabinet as they are being installed and the wiring is being done. When the wiring is completed, the front of the cabinet will be fastened in place, Fig. 37. A metal cover with a door is used to cover the fuses and the cables coming into the bottom of the box. A cover is also placed over the neutral bus that is at the top of the cabinet, Fig. 36.

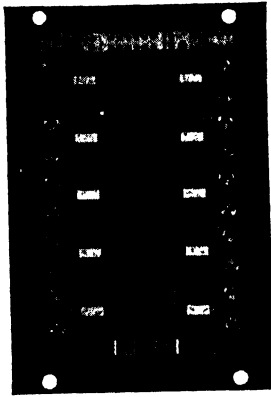

Fig. 33. Interior View of a 20-Circuit Lighting Cabinet
 Courtesy of Mutual Electric & Machine Company

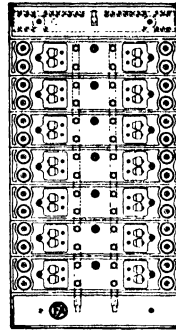

Fig. 34. View of a 28-Circuit Lighting Cabinet
 Courtesy of Frank Adam Electric Company

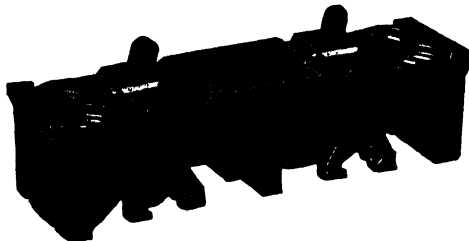

Fig. 35. Sectional Units "NTP" for Cut-Out Cabinets
 Courtesy of Mutual Electric & Machine Company

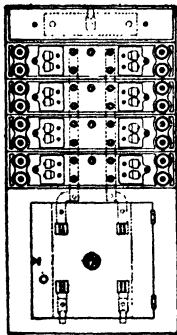

Fig. 36. Cabinet with Fuses in Mains
 Courtesy of Frank Adam Electric Company

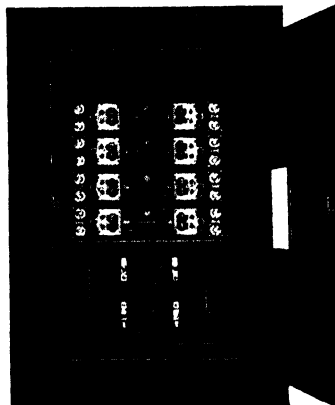

Fig. 37. Cabinet after Wiring Is Completed
 Courtesy of Frank Adam Electric Company

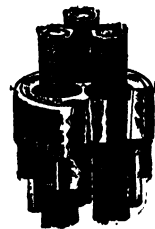

Fig. 38. Methods of Supporting Cables in Vertical Conduit
 Courtesy of Russell and Stoll Company

When wires or cables are run vertically from one floor to the other, it is necessary to use some method of holding the cables because the weight of the cables is greater than the lugs will support. This is done by using tapered wedges of insulating material, which are inserted between the cables at the top end of the conduit. These wedges grip the cables so that the conduit carries their weight. There are several different types of wedges and methods of holding the cables. In Fig. 38 the insulation of the cable is gripped and held by insulating blocks which fit inside of a metal collar that is screwed on to the end of the conduit. This collar is usually placed inside of metal cabinets.

INSTALLING LIGHTING FIXTURES

The dome type of reflector, Fig. 39, is used in the center of bays for lighting factories. This shape of reflector, known as the "RLM" dome reflector, was adopted as a standard reflector for factory work by the Reflector and Lamp Manufacturers. The height that this reflector is mounted above the floor will depend upon the distance between outlets as given in Table VIII. In this factory the spacing between lights is about 15 feet and the reflector should be mounted at least 13 feet from the floor; the distance from the outlet boxes to the floor will be about 14 feet because the distance between floors is 15 feet and the floor joists are about 1 foot wide. In this factory the top of the reflector can be attached to the outlet box without using the pipe extension, Fig. 39. The top of the reflector and socket can be fastened to a special blank outlet box cover, Fig. 40, by removing the top flange which clamps the socket to the reflector, Fig. 39, and then putting the pipe part of the socket, Fig. 41, through the blank cover, Fig. 40. The assembled reflector and blank cover are fastened to the outlet box, Fig. 40, by two screws.

All 115-volt incandescent lamps in sizes of 25, 40, 50, 60, 100, 150, and 200 watts have what is called a medium screw base which will screw into the ordinary socket, while lamps larger than this—300, 500, 750, and 1000 watts—have a screw base that is much larger and is called a "Mogul" base. When a lamp larger than 200 watts is used, the Mogul socket, Fig. 42, must be used. The medium screw base socket, Fig. 41, can be changed to a Mogul socket by removing

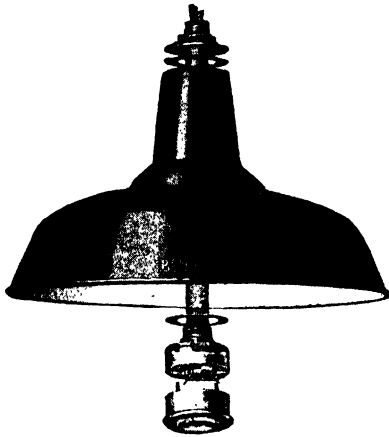

Fig. 39. Method of Assembling Reflector and Socket
 Courtesy of Benjamin Electric Manufacturing Company

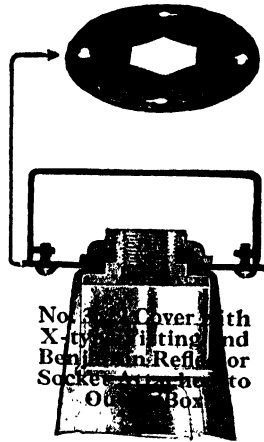

Fig. 40. Fastening Reflector to Outlet Box
 Courtesy of Benjamin Electric Manufacturing Company



Fig. 41. Medium Base Socket for Reflector
 Courtesy of Benjamin Electric Manufacturing Company



Fig. 42. Mogul Socket
 Courtesy of Benjamin Electric Manufacturing Company

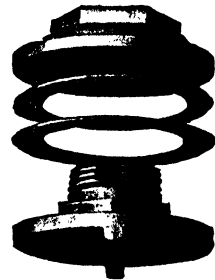

Fig. 43. Iron Fitting for Socket
 Courtesy of Benjamin Electric Manufacturing Company

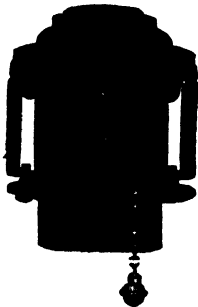

Fig. 44. Pull Chain Socket
 Courtesy of Benjamin Electric Manufacturing Company

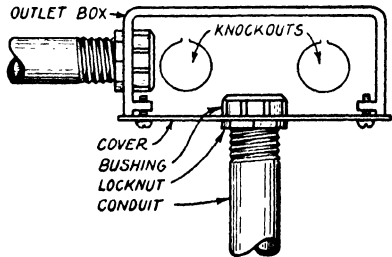

Fig. 45. Fastening Reflector to Outlet Box

TABLE VIII

Height and Spacing Distances for RLM Reflectors

Spacing Distance Between Lights	Height of Reflector from Floor not Less Than	Spacing Distance Between Lights	Height of Reflector from Floor not Less Than
7 feet	8 feet	14 feet	12½ feet
8 feet	8½ feet	16 feet	14 feet
9 feet	9 feet	18 feet	15 feet
10 feet	10 feet	20 feet	16 feet
11 feet	10½ feet	22 feet	18 feet
12 feet	11 feet	24 feet	20 feet

two screws that hold the porcelain to the iron fittings, Fig. 43, and then fastening the Mogul socket to the iron fittings in the same manner. When putting the reflector and the socket together, the reflector should be clamped between the two washers, Fig. 43, by the top flange, which is screwed down tight to the lower flange fastened to the porcelain of the socket. A pull chain socket, Fig. 44, is attached to a reflector in the same manner. This type socket should not be used on lamps larger than 200 watts because the switch parts are not heavy enough to carry a larger current than is required for that size lamp.

In offices where there are four lamps to each bay, the distance between lamps will be about $7\frac{1}{2}$ feet. The reflector can be mounted any desired height that is greater than 8 feet, Table VIII. The lower the reflector is hung, the brighter will be the light on the desks in the office; while the higher it is hung, the more uniform the light will be in the different parts of the room and there will be less shadows from objects on the desks. A good mounting height for a reflector is about 10 feet, and a 4-foot length of $\frac{1}{2}$ -inch conduit should be used to fasten a reflector to an outlet box. A standard blank outlet box cover with a $\frac{1}{2}$ -inch "knockout" is fastened to the supporting pipe, Fig. 45, by placing a lock nut on the pipe and inserting the pipe through the knockout and placing a conduit bushing on the end of the pipe.

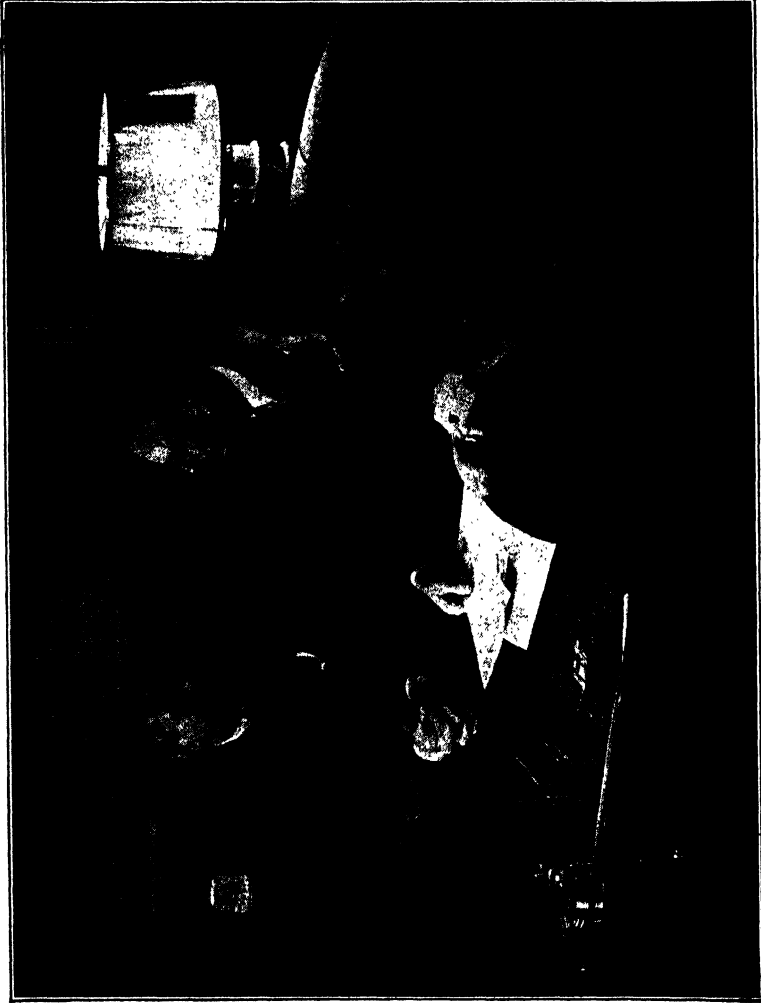

THE ELECTRICAL CONTRACTOR SHOULD DISCUSS THE WIRING OF THE NEW HOME WITH THE OWNER
Courtesy of Steel and Tubes, Inc., Cleveland

ESTIMATING ELECTRICAL WIRING

It will be necessary for you to use a different method of studying the following pages on estimating from that used in reading an ordinary book. The reason is that on the pages which follow you have the electrical specifications which an architect furnishes, together with drawings, to the bidding contractors, so that they can make an estimate of the cost of doing the wiring.

The architect usually does not show details of wiring on the building plans. This you will observe by carefully studying the blue prints inside the back cover of this book. The architect shows where ceiling lights, wall or bracket lights, convenience outlets, wall switches, electric motors, heating appliances, etc., are to be located. We have reproduced the electrical part of the complete specifications on the four pages following.

It is suggested that when you study this section on electrical estimating you take the blue prints and lay them flat on a table, so that you can refer to them as you read each sentence in the specification data. You will notice that there are many symbols on the blue prints with which you are unfamiliar. Many of these are architectural symbols denoting details which pertain to the various trades involved in construction. Likewise there are many notes and references on these drawings which are not of special significance to the electrical contractor or wireman except as they indicate a place in a wall or partition in which a pipe, heating duct, etc., is concealed, thereby causing interference with the installation of wires. As an example, in Plate 1 in the recreation room on the Basement Plan, a rectangle is shown with the notation, "Ceiling Grille." That tells you that there will be an opening at that point in the ceiling and therefore electric wires may not be run through that space.

The architect does not always use the standard symbols for outlets, switches, etc., used by the electrical draftsman. The reason for this is that many of the standard electrical symbols are similar in character to those used by other trades.

ELECTRICAL WORK

GENERAL. These specifications, general conditions, and accompanying drawings are intended to provide for all material and labor required to furnish and install in the building mentioned on the Title Page a complete electrical system from the electric supply sources to the lighting outlets, switches, plugs, and receptacles as indicated on the plans or as specified.

SYSTEM. The wiring shall be the "Romax" system. The service shall be the Edison Three-Wire Service as per the Schedule. No outlet shall be wired for less than 60 watts and outlets not marked shall be so wired. Base plugs and wall plugs, unless otherwise specified, shall be wired for 220 watts. Outlets for special wattages are as indicated on plans.

INSPECTION AND APPROVAL. Any material or manner of installation not specifically mentioned in these specifications shall be strictly in accordance with the requirements of the rules of the National Board of Fire Underwriters and the Edison Company. The installation shall be subject to the inspection of the local inspection bureau and the approval of the architect and engineer.

LOCATION OF OUTLETS. Check height of switches and brackets with owner and superintendent. Base plugs to be located vertically with their center 18" above finish floor level.

METER AND MAIN SWITCH. This contractor shall run the incoming service in accordance with the rules and regulations of the local utility company. This includes the incoming conduit, the conduit meter box, wire, and all connections. The meter box shall be mounted in the location approved by the local utility company and the architect and engineer. The main switch shall be placed on the inside of the building in an accessible location where directed, and feeders shall be run to a range box and to various distribution centers located in central and approved locations.

DISTRIBUTION CABINET. Provide and install complete Frank Adams, Bulldog, or other approved dead front distribution cabinet where shown or where directed. For size of cabinets and number of circuits refer to Schedule of Outlets. With the approval of the architect and engineer, the distribution cabinet specified may be divided into smaller cabinets installed in accessible locations if available and not interfering with the appearance of the work. The total number of circuits shall not be less than that indicated in the Schedule.

WIRES. No wires shall be smaller than No. 14 B. & S. gauge. All wires shall be rubber and single-braided covered and shall bear the stamp of the Underwriters' Inspection Bureau. The acceptance of a standard make shall be made by the superintendent before any work is done. White wires shall be used for the neutral wire.

The wiring shall be "Romax" cable. All conductors shall be continuous from outlet to outlet, and no splices shall be made except in outlet boxes. Basement wiring shall be installed so all ceilings may be plastered as specified or as at owner's option.

Wires shall be of sufficient length at outlets to make connections without straining. Wires shall carry full insulation well into the boxes and provision shall be made to keep all wires in place.

LOCAL SWITCHES. Local switches shall be General Electric Tumbler type, or other approved manufacture. Switches to be approved by architect and engineer before being installed. Where more than one switch occurs in the same location, furnish an approved gang box with plate to cover all switches.

PLUG RECEPTACLES. General Electric Hubbel Flush type, or other approved manufacture, complete with two outlets per plate. All plug outlets to have individual circuits where so marked or as specified. All plug receptacles shall have an approved rating of 120 watts, 250 volts, and be wired for 120 watts per double outlet or receptacle.

RADIO PLUGS. Locate as directed on the plans or as indicated. An aerial wire shall be run in attic or where indicated or directed and shall then drop to the basement with an ample loop and return to the aerial connections on the plugs. Ground connections on the plugs are to be thoroughly grounded in the basement.

SWITCH AND PLUG PLATES. Unless otherwise specified in the electric schedule, all local switches and plug receptacle outlets to be furnished complete with Bakelite plates.

OUTLET BOXES. All boxes to be metal of approved manufacture. All outlet boxes for bracket and ceiling lights to be 4" standard type, with 3" plaster ring. All boxes to have approved fasteners for cable.

BELLS AND BUZZERS. Provide and install where indicated on Schedule, complete with all bells or buzzers, transformers, wiring, and push buttons. Exterior bells or buzzer stations to be ornamental push buttons to match finish hardware. (Plates and buttons are provided under finish hardware contract.) Interior bell or buzzer stations shall be standard metal boxes and single polarity plug with plates, and shall be equipped with ten feet of approved cord per station having one end terminating in a push button and the other end equipped with plug. Location of bells and buzzers to be as indicated on plans or as directed. All equipment to be approved.

FIXTURES AND FUSES. All fixtures to be provided and installed by owner. All fuses to be General Electric, Bussman Mfg., or Economy Fuse & Manufacturing Company make. All fuses for branch lighting circuits to be 10 ampere, 125 volt plug type fuses. Special fuses to be provided for special circuits.

The contractor shall deliver to the superintendent a complete duplicate set of fuses for the entire building and get a receipt for same.

UNIT PRICES. The contractor shall mention in his bid unit prices for all types of outlets. These prices are to be used in cases of adjustments.

TELEPHONES. This contractor shall notify the architect and engineer when the building is ready for telephone wiring and shall check the installation of same before lathing or before placing plaster base. This contractor shall provide standard boxes and telephone plates for the main telephone and branch extensions. The local telephone company to run their wires to these boxes.

TESTING. On completion of the work, the installation shall be entirely free from grounds or short circuits. A thorough test shall be made with a magnet.

GUARANTEE. This contractor shall guarantee against all mechanical defects in material or workmanship, or both, covered by these specifications and shall repair or replace at his own expense any defective work, material, or part which may develop in the installation of the work within the period of one year after final acceptance and completion of the work by the architect and engineer.

ELECTRICAL SCHEDULE

BELL STATIONS. Exterior stations to be push buttons to match finish hardware, with plate provided under finish hardware contract. Interior stations to be standard type metal boxes with polarized plugs and plates and ten feet of bell cord per plug. Cord to have a pearl push button on one end and a plug on the other and to be portable. Bells to be of recessed type. Edwards Flush Call.

TELEPHONE STATIONS. This contractor to provide and set standard box and plate at stations indicated on plans or in schedule. Provide and install a $\frac{1}{2}$ " conduit for telephone service, complete with all accessories.

KITCHEN VENTILATING FAN. This contractor to allow \$35.00 in his bid to cover the cost of this unit. The entire amount to be available to the owner for the net cost of the fan. All wiring for and installation of this unit shall be included under the electrical contract. See Installation Schedule.

CONCEALED OUTLETS. See plans. Cooperate with fixture contractor and carpenter.

ELECTRIC SERVICE. Edison Three-Wire.

INCOMING SERVICE. 3 No. 8 R.C.S.B. wires.

INCOMING CONDUIT. 1" conduit.

MAIN SWITCH. 30 amp. 250 volt.

ELECTRICAL INSTALLATION SCHEDULE

ROOMS	Outlets		Switches				Wall Plug	Motor	Radio Plug	Bell Plug	Tel. Plug
	Brkt	Ceill	S	P 3	P 4	P					
Recreation Room..		2	1				4				
Fruit Storage Room.....		1									
Heater Room and Laundry.....		2	2					2			
Hall 4.....		1	1								
Porch 1.....		1	1								
Living Room.....				2	1		5		1		
Front Entrance... Vestibule.....	1	1	1							1	
Hall 1.....		1		2							1
Dining Room.....		1		2			2			1	
Kitchen.....		2	1	2	1		3	2			
Hall 2.....		1	1								
Toilet.....	1	1	1				1				
Porch 2.....		1	1							1	
Garage.....		1	1				1				
Hall 3.....		1		2							
Bedroom 1.....		1	1				4		1	1	
Closet 1.....		1									
Closet 1A.....		1									
Bedroom 2.....		1	1				3				
Closet 2.....		1									
Attic.....		1	1								
Bedroom 3.....		1	1				4				
Closet 3.....		1									
Bathroom.....	2		1				1				
	4	24	17	10	2	28	4	2	4	1	

SPECIAL WATTAGES. Dining room, kitchen and bedroom center ceiling outlets.

DISTRIBUTION CIRCUITS. 2 circuits - Bracket and ceiling
 6 circuits - plugs
 1 circuit - heating plant
 1 circuit - kitchen ventilating fan and refrigerator
 1 circuit - washing machine
 1 circuit - extra
 12 circuits

Place two distribution centers where directed.

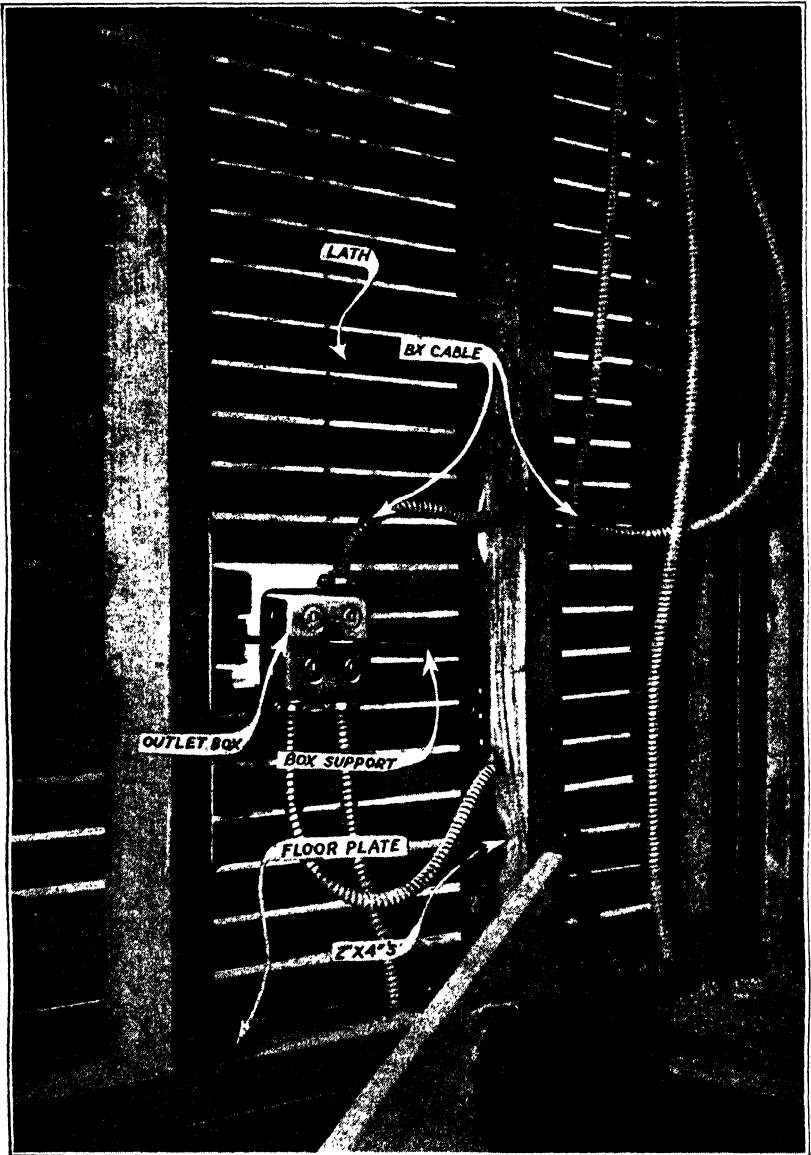

INSTALLATION OF BX CABLE IN A PARTITION DURING CONSTRUCTION OF THE BUILDING

Courtesy of National Metal Molding Co.

GENERAL PRINCIPLES PERTAINING TO AMOUNTS OF ELECTRICAL MATERIALS

300. What is the first thing that an electrical contractor does when he hears of a new house that is to be built?

Answer. The electrical contractor will try and find out the name of the person contemplating building this new house. Then he will call on the owner and architect and ask to be given a chance to assist them in planning the electric lighting. He would also ask for a copy of the plans and specifications whenever they are ready.

301. What does the electrical contractor or electrical estimator do when he gets a copy of the plans and specifications on a new house?

Answer. When an electrical contractor or estimator receives these plans and specifications from the architect, he first reads through the electrical specifications to get an idea of the important requirements of the specifications. He, also, notices any requirements which differ from those that he usually encounters when wiring similar types of buildings.

He next makes a special notation of the important facts from the specifications and blueprints which for the 1½-story residence are as follows:

1. "Romax" or nonmetallic sheathed cable, sometimes called loom wire is to be used.
2. Ceiling and bracket outlets, 60 watts, except dining room, kitchen, and three bedrooms. Plug receptacles or convenience outlets 120 watts each.
3. All other baseboard or wall plugs 220 watts each.
4. Meter box to be mounted outside the house; the main service switch inside, preferably in the basement.
5. Two distribution centers to be provided.
6. Outlet boxes for bracket and ceiling lights, 4-inch standard, with 3-inch plaster ring, and approved cable clamps.
7. Concealed outlets in the top of telephone stand in hall 1, and in kitchen cabinet over sink.

302. What is an electrical schedule? Who prepares it and how?

Answer. An electrical schedule gives the number of ceiling outlets, bracket outlets, single pole, three-way and four-way switches, wall plugs, and other special plugs in each room. The estimator for the contractor will prepare such a schedule, going over the blueprint drawings and locating all of them. Usually this is done by taking a white or yellow colored pencil and circling each one of the outlets on the blueprint when it has been located and written down on the electrical schedule.

Where the architect and engineer has prepared an electrical schedule, then the estimator would compare this schedule with the blueprint, marking on the blueprint a circle for each of the outlets. Oftentimes, when an electrical schedule is prepared by the engineer, the location of the switches may not be given on the plans. The estimator would locate the switches on the blueprints when reading through the specifications and electrical schedule line for

line. In this way there is less chance to overlook outlets that were not shown on the blueprints and which are included in the electrical schedule of the work, or outlets shown on the blueprint, which were not included in the schedule.

303. What is a branch circuit and how is the load decided?

Answer. It is the wires from the fuse box to the ceiling outlets, bracket outlets, wall plugs, motor plugs, etc.

The load on each branch circuit is decided by the electrical contractor or estimator. The maximum current that a No. 14 rubber-covered wire is permitted to carry is 15 amperes. This is the smallest size wire that can be used for branch circuits. The maximum load in watts is voltage (115) times amperes (15) which is 1,725 watts. In a new building it is not good practice to skimp on the wiring. The connected load on each branch circuit should not exceed 1000 watts, except in special cases.

In the 1½-story residence separate circuits are to be provided for the motors. This requires one circuit for the washing machine, another circuit for the heating plant, and a third circuit for the ventilating fan and the refrigerator. Wherever possible, the bracket and ceiling outlets should be kept on separate circuits from the plugs or convenience outlets. This is required in the specifications for this residence.

The plans and specifications do not give the rating of the dining room, the kitchen, and the bedroom ceiling outlets, and this information must be supplied by the electrical contractor or estimator. A five-bulb fixture is often used in the dining room; the bulbs are usually not larger than 60 watts each, or a total of 300 watts for that outlet. In the kitchen, there is one center fixture in which a bulb of 100, 150, or, if a very bright light is desired, 200 watts would be installed. It is well to consider this a 200-watt outlet. Bedroom 1, which is the largest of the bedrooms, would have a more elaborate fixture, possibly a three-socket fixture, or a total of 180 watts. Bedroom 2, a smaller bedroom, could have a two-socket light fixture. The wattage there would be 120. Bedroom 3, being the smallest of the bedrooms, might have either a single or a two-socket fixture. The rating would be 120 watts. All the rest of the rooms are studied and the estimated load placed in Table 1.

304. How is the total connected load obtained?

Answer. It is the sum of the load in watts for each room. For the 1½-story house in the specifications it is the sum of all the load in the last column of Table 1, which is 6,600 watts. This is checked by determining the load for different kind of outlets as follows:

Connected Load

Style	Number	Load, Watts
Concealed outlets	2	120
Bracket outlets	4	240
Ceiling outlets	23	2,000
Wall plugs	28	3,360
Motor plugs	3	880
Total connected load		6,600

Table 1. Branch Circuit Schedule

Circuit No.	Floor	Room or Use	No. Switches	Number Outlets	Kind of Outlets	Watts Load
1A	Basement	Recreation.....	1	2	Ceiling	120
5A	Basement	Recreation.....	..	4	Plug	480
1A	Basement	Fruit.....	..	1	Ceiling	60
1A	Basement	Heater and Laundry	..	2	Ceiling	120
2A	Basement	Heater.....	..	1	Motor	220
3A	Basement	Washing Machine..	..	1	Motor	220
1A	Basement	Hall 4.....	1	1	Ceiling	60
1A	1st	Porch 1.....	1	1	Ceiling	60
6A	1st	Living Room.....	2-3-way 1-4-way	5	Plug	600
1A	1st	Front Entrance...	1	1	Bracket	60
1A	1st	Vestibule.....	1	1	Ceiling	60
1B	1st	Hall 1.....	..	1	Concealed	60
1A	1st	Hall 1.....	2-3-way	1	Ceiling	60
1A	1st	Dining Room.....	2-3-way	1	Ceiling	300
4A	1st	Dining Room.....	..	2	Plug	240
2B	1st	Kitchen Sink.....	1	1	Concealed	60
2B	1st	Kitchen.....	2-3-way 1-4-way	1	Ceiling	200
3B	1st	Kitchen.....	..	1	Plug	120
4A	1st	Kitchen.....	..	2	Plug	240
5B	1st	Vent. Fan and Refrigerator.....	..	1	Motor	440
1A	1st	Hall 2.....	1	1	Ceiling	60
1A	1st	Toilet.....	1	1	Bracket	60
5A	1st	Toilet.....	..	1	Plug	120
2B	1st	Porch 2.....	1	1	Ceiling	60
1A	1st	Garage.....	1	1	Ceiling	60
5A	1st	Garage.....	..	1	Plug	120
1A	2d	Hall 3.....	2-3-way	1	Ceiling	60
2B	2d	Bedroom 1.....	1	1	Ceiling	180
1B	2d	Bedroom 1.....	..	4	Plug	480
2B	2d	Closet 1 and 1A..	..	2	Ceiling	120
2B	2d	Bedroom 2.....	1	1	Ceiling	120
4B	2d	Bedroom 2.....	..	3	Plug	360
2B	2d	Closet 2.....	..	1	Ceiling	60
2B	3d	Attic.....	1	1	Ceiling	60
2B	2d	Bedroom 3.....	1	1	Ceiling	120
3B	2d	Bedroom 3.....	..	4	Plug	480
2B	2d	Closet 3.....	..	1	Ceiling	60
2B	2d	Bathroom.....	1	2	Bracket	120
3B	2d	Bathroom.....	..	1	Plug	120
Total						6,600

305. How do you arrange the circuits in the 1½-story house?

Answer. The electrical contractor will mark the location of any omitted switches and outlets on his blueprints.

All switches in the basement are shown in the drawings. The switch for the vestibule light, first floor, was not located on the original blueprints. It could either be located alongside of the switch for the front entrance bracket light, or alongside of the 3-way switch for the hall 1 light. The latter is preferable, as a person coming from the living room, dining room, or down the stairs from the second floor could turn on the hall light, and then the vestibule light.

There are no ceiling or bracket outlets in the living room. The five wall plugs are controlled by two 3-way switches and a 4-way switch. These were not located on the original blueprints. The logical place for them is at the side of the doorway. The passageway from the dining room through hall 1 to the living room does not have any doors and switches and could be located on either side of the doorway. However, it is more convenient to have them at the side of the doorway nearer the fireplace and stairs, in view of the fact

that there is a concealed light above the telephone stand, which is in the recess between the stairs and the doorway into the living room. Likewise, it would be more convenient for people going through a passageway to reach to the right to turn out the lights.

In hall 2 there are four places where the switch controlling the ceiling light could be located. One is at side of the stair door. Another is at the living room door frame. A third is at the kitchen door frame. A fourth is at the toilet door frame. It would not be good practice to have this switch located alongside of the switch which controls the lights for the basement stairs, as there is danger of turning on the light located in hall 4 at the same time the hall 2 light is turned on. As the basement door usually is kept closed, it would not readily be noticed that this light downstairs had been turned on. In the next two locations the switch outlets would have to be mounted inside the wood trim which is not good practice. The location most convenient for the electrician is near the door into the toilet room.

In arranging the load on an Edison 3-wire system, it is advisable to divide it as near as possible on equal sides of the system. The circuits in fuse boxes are usually numbered counting horizontally left to right and from top to bottom. Thus circuits 1A, 3A, and 5A are on the left side of the system, and circuits 2A, 4A, and 6A are on the right side. As an example, the ceiling lights on the first floor, on circuit 1A, are on one side of the system, while the convenience outlets in the living room are on circuit 6A. Also, the recreation room wall plugs, circuit 5A, are on the other side of the system, from the living room lighting which is by floor lamps attached to wall plugs, circuit 6A. This one point gives the customer less variation in brightness of lamps and lower voltage drop, and utilizes the wiring to the best advantage. This fact should be kept in mind and provision made for such an arrangement when convenient to do so.

There is a total connected load of 2,240 watts in ceiling and bracket outlets, not including two concealed lights of 60 watts each. The architect has specified two circuits for these; it is necessary to divide them up carefully. This means some of the ceiling lights on the first floor will have to be fed from the second floor circuit. No. 14 rubber-covered wire used in branch circuits can carry a total load of 15 amperes. The architect has specified 10 ampere fuses, which means the load cannot exceed 10 times 120 or 1,200 watts on each of the two circuits. There are, however, some ceiling lights which are not likely to be turned on and used at the same time all other lights are being used: those in the fruit storage room, laundry, and heating plant in basement; garage; toilet and two porches on the first floor; and four closet and attic lights on the third floor. Thus there are approximately five such lights on the third floor, four such lights on the first floor, and three in the basement, which ordinarily would not be turned on when all the rest of the ceiling bracket lights were being used for lighting. This really reduces the active load on the ceiling lights which might be turned on at one time when lighting up the full house to 1,520 watts. This load can be safely carried by two branch circuits, protected by 10 ampere fuse.

306. What is service entrance wiring and what does it include?

Answer. It is all wires from outside the house through the watt-hour

meter, and service switch to the cabinets containing the fuses for the branch circuits.

The service wires must be rubber covered and not smaller than size No. 8. (In very small buildings where the total load will never be more than one branch can carry, No. 12 wire may be used.) The wires from the outside of the building to the service switch must be enclosed in rigid conduit or electrical metallic tubing, or an "approved" service entrance cable used.

307. Where and how will the service wiring be installed in the 1½-story house?

Answer. The service wiring will be in rigid conduit fastened to the west side of the house near porch 2, at a height of about 14 feet above the ground. This height will vary with different residences but must be at least 10 feet from the ground and not more than 30 feet. It usually is preferable to install it about the height of the second-floor ceiling or midway between the first- and second-floor ceilings. The location usually is determined by consultation between the electrical contractor and the representative of the light and power company.

Where outdoor metering is used by the power company, as in this case, it is advisable to locate the watt-hour meter on side of porch 2, where it will be sheltered from the weather. The service switch is located in the basement on the wall directly below the entrance door from porch 2 into the kitchen.

308. Where should the distribution panels be located?

Answer. The distribution panels are also called fuse cabinets or fuse boxes. They may contain fuses or circuit breakers and switches to open the branch circuits. Often they contain just one fuse for each circuit, which is connected to the black (hot) wire of the circuit. Hence the name "fuse box." When the fuse boxes are placed in partitions they are about three inches deep and are set in the walls between the 2x4 studs. The side containing the door is removable and is not put on until after the walls have been finished. The box is set so the removable side of box will be flush with the finished wall surface.

The electrical specifications for the 1½-story house call for two or more distribution panels, and twelve circuits. Thus two boxes with six individual circuits, or a 4- and 8-circuit box would be used. The 6-circuit box has approximate outside dimensions of about 12x8 inches. These boxes must be placed where there is little likelihood of their being covered with furniture or other objects. They must be in a convenient location and at the same time they should be in as inconspicuous a place as possible. The best location for one of these would be inside of the stairway going from hall 2 to the basement. Placing the fuse box about a foot in from the door frame enables the light from hall 2 to light up the box when it is necessary to replace fuses. The other fuse box is located on the second floor behind the door that opens into the bedroom 2. These locations are convenient for wiring, because one is located almost directly above the other.

309. How is the wiring to the fuse cabinets determined?

Answer. In determining the size and number of wires from the service

switch to the fuse boxes either two separate 2-wire or 3-wire circuits could be used, or else one 3-wire circuit run from the service switch to the first fuse box and then from this box to the second fuse box. If two separate circuits are used the wire size can be smaller, but two sets of fuse receptacles will be required at the service switch. This requires a separate fuse box near the service switch as well as extra work, since more footage of wire will be installed with two circuits.

The current carrying capacity of No. 8 wire is 35 amperes and the next size smaller, No. 10, has a carrying capacity of only 25 amperes. A 30-ampere fuse is specified by the architect for the service switch. Thus, instead of providing two sets of fuses at the service switch, it is more economical to run

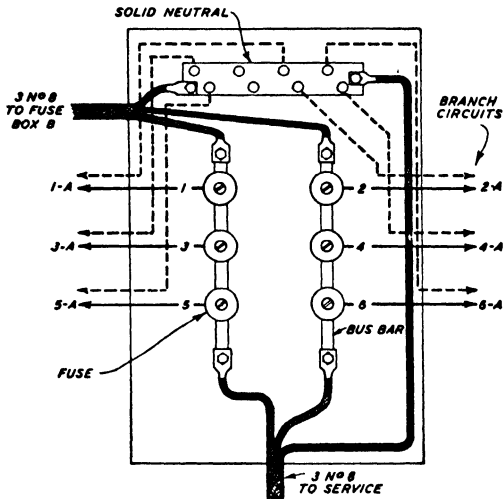

Fig. 1. Wiring Diagram of Fuse Box A

a 3-conductor No. 8 cable from the service switch into the bottom of fuse box A and a cable of the same size from the top of fuse box A to fuse box B. The load is balanced at each cabinet by using a 3-conductor cable. The wiring diagram of fuse cabinet is shown in Fig. 1. Some fuse cabinets do not have provision for attaching the lugs at the top of the bus bars. Then they will be connected at the bottom of the bus bar.

310. How are the branch circuits laid out?

Answer. The electrical contractor, estimator, or engineer will retrace on thin vellum paper the building outlines and the location of all outlets, switches, etc., shown on the architect's blueprints, in order that he can plan the wiring from one outlet to the next. The building outlines for the 1½-story residence are shown in Figs. 2, 3, and 4. Sometimes it may be necessary to show an elevation of certain details that are otherwise hard to see. A drawing showing the stairs, fuse cabinets, height of floor, etc., aids in determining the vertical runs of wiring.

311. How is the first circuit of the 1½-story house laid out?

Answer. The first circuit from fuse cabinet A will be for the basement and first-floor ceiling lights. There are several different ways in which this work can be laid out, but the one which will use the least material and encounter the

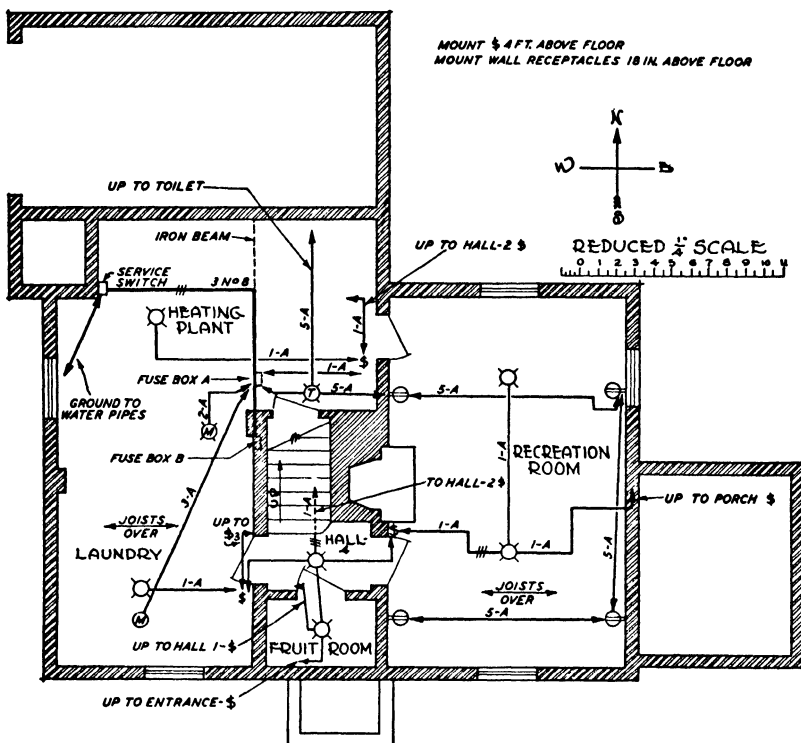

Fig. 2. Wiring Plan of Basement in 1½-Story Building

least boring of the studding and floor joists (thus reducing labor cost) is the preferred one.

Circuit 1 will go from the fuse box A to the hall 4 switch, which is located on the outside of the door leading from hall 2 down the stairs to the basement, Fig. 5. The wires from this switch to ceiling outlet in hall 4 will be 3-conductor cable in order that one side of the circuit will not be controlled by the switch. This is indicated on the drawing by 3 short lines across the cable run, Figs. 2 and 5.

Then from ceiling light hall 4, a 2-wire cable goes to the fruit storage room ceiling outlet, Fig. 2. Here it branches, one run going up to the front entrance light switch in the vestibule, Fig. 3. From this switch the wires run through the wall to the bracket outlet on the outside of the building. Another branch from the fruit storage room outlet, Fig. 2, goes up to the hall 1 single-pole switch for the vestibule light and 3-way switch for hall 1 light.

An enlarged detail of the wiring plan of the 3-way switches for controlling the lights in hall 1, hall 2 and hall 3, is shown in Fig. 6. The dotted lines indicate the white wire which is the neutral or grounded conductor. The connection of the wires at switches is indicated in the enlarged section inside

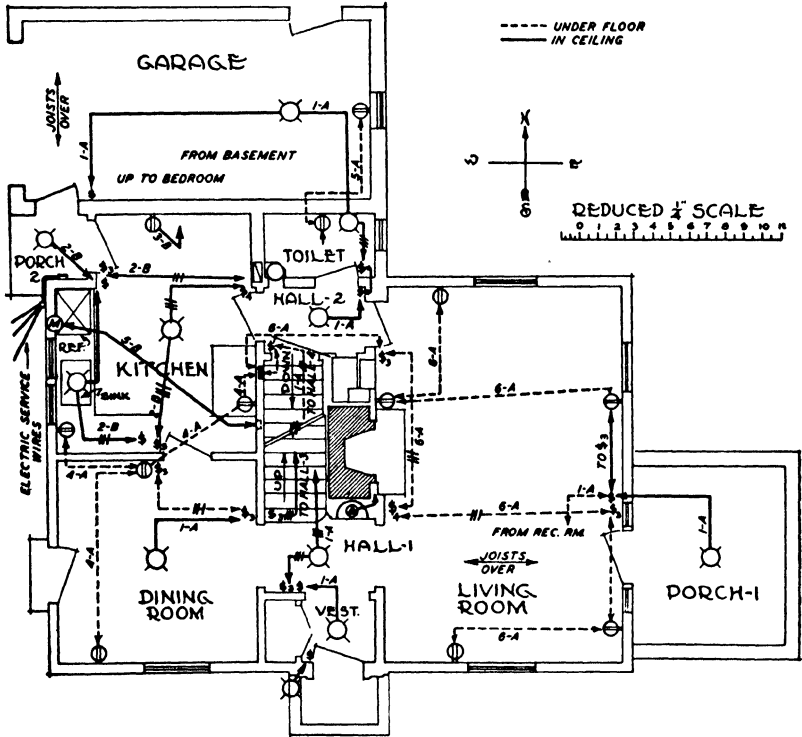

Fig. 3. Wiring Plan of First Floor of 1 1/2-Story Building

the circles. All the splices are made inside the metal switch boxes, except with the concealed knob-and-tube method of wiring.

A run of cable goes from hall 4 ceiling outlet to the switch in the recreation room, Fig. 2. From this switch, a 3-wire cable is run to the first outlet in the recreation room in order that current can be carried on up to the single-pole switch for controlling the light on porch 1, Fig. 3. This porch switch is located north of the window at the side of the door between the living room and the porch. From this switch, the wiring goes up the studding partition to the porch ceiling, and then across to the porch outlet.

There is another cable from hall 4 light outlet to the single-pole switch controlling the laundry light over the laundry tubs. Then a cable from this laundry light switch goes up through the ceiling to the 3-way switch at the side of the door between the dining room and hall 1 on the first floor, Fig. 3. There are two 3-way switches for controlling the light at the head of the

stairs on the second floor in hall 3, Fig. 4. One of these 3-way switches is on the opposite side of the partition from the dining room switch, and the wiring is shown in large detail in Fig. 6.

In the dining room, Fig. 3, there are three wires from one 3-way switch to the 3-way switch at the side of the door which opens into the kitchen, Fig. 3. This enables the dining room light to be turned on or off from either

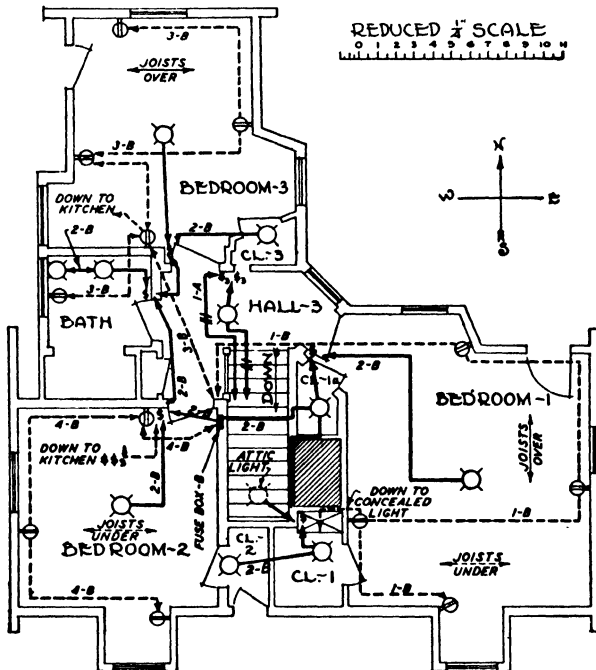

Fig. 4. Wiring Plan of Second Floor of 1 1/2-Story Building

switch. The 3-way switch at the side of the stairs going to the second floor enables the ceiling light in hall 3 to be turned on at the bottom and turned off at the top of the stairs, or the reverse. The cable arrangement of the lighting in the south part of the basement and first floor has been taken care of and marked on the drawings.

It is more convenient to return back to fuse box A or to the single-pole switch in hall 2 for the rest of the circuit in the basement. There is a distance of only a foot or two between the fuse cabinet and switch box for hall 2 switch. It is better practice to run the circuit from fuse box A. This circuit (1A) then drops down the stair partition to the basement ceiling through the floor joists and over to the heating plant switch located at the side of the door between the heating plant and the recreation room, Fig. 2. The cable is run parallel to the floor joist from the wall switch to heating plant ceiling light. Then the cable is run from heating plant switch up through the ceiling of the basement to a wall switch located in hall 2 near the toilet room door,

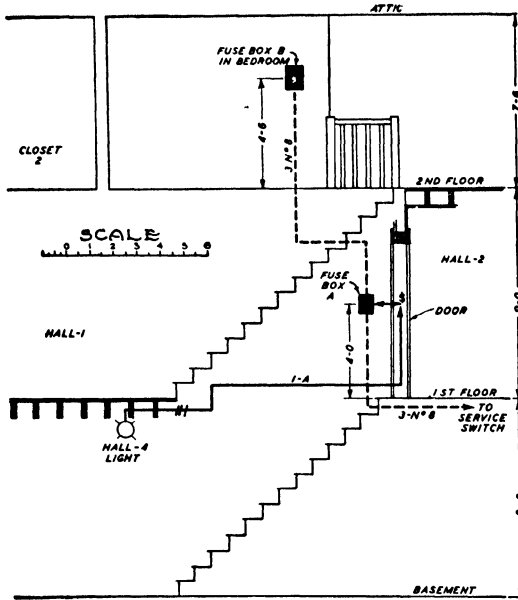

Fig. 5. Elevation Drawing Showing Location of Feeder to Fuse Boxes and First Branch Circuit

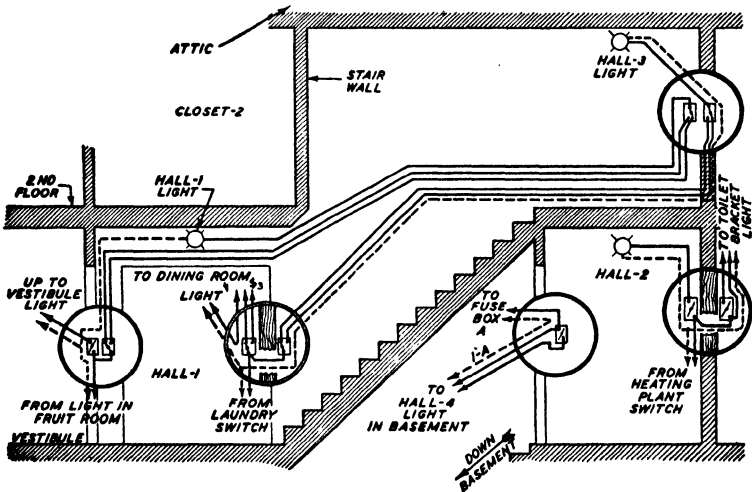

Fig. 6. Enlarged View of Three-Way Switch Connections in Stairway

Fig. 3. This switch controls hall 2 ceiling light, Fig. 6. A short loop of cable is made from this switch box through the partition to the switch controlling the toilet room bracket light. A 3-wire cable is run from this switch to the bracket light in order that current can be carried on to the garage ceiling light. From the garage ceiling light, two wires are run to the garage switch located near the door between porch 2 and the garage. This enables the garage lights to be controlled from near the door.

The total connected load on circuit 1A is 1,140 watts or approximately one-half of the total ceiling and bracket lighting load in the residence. This leaves the kitchen light on the first floor to be controlled from the other circuit.

312. Is not the load on circuit 1A too great?

Answer. The architect specified 10-ampere fuses, which on a 115-volt

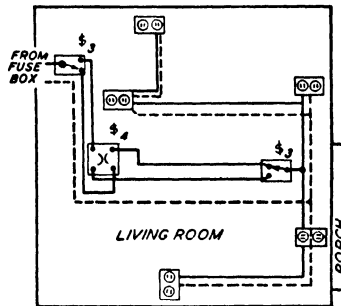

Fig. 7. Wiring Diagram of 3-Way and 4-Way Switch Control of Receptacles in Living Room

circuit is 10x115 or 1,150 watts. The current carrying capacity of No. 14 rubber covered wire is 15 amperes and this size fuse could be used later if needed. Also the architect was very liberal in the number of circuits in residence and provided a large number of plug outlets. During the past few years there has been an increase in the use of floor lamps connected to wall plugs for residence lighting. Rarely if ever, will all the ceiling lights on this circuit be turned on at one time, or larger size lamps be used. Due to the above conditions, a load of 1,140 watts would not be excessive or considered poor circuit layout practice.

313. Are there any unusual features on the layout of the rest of the circuits?

Answer. The only unusual feature is the living room convenience outlets or wall plugs which are controlled by two 3-way switches and a 4-way switch, Fig. 3. The switches are located near the doorways of this room so that a person entering the living room by any door can turn on the lamps connected to the wall plugs. The lighting in the living room will be by the use of floor lamps attached to the convenience outlet or wall plugs. A wiring diagram of this layout is shown in Fig. 7. Notice that there are 3 wires from the 3-way switch to the 4-way switch and on to the 3-way switch. Since

this is on a separate circuit from the ceiling lighting, there is no connection between the circuit of the single-pole switch controlling porch light 1 and the 3-way switch in circuit 6A controlling the living room lights. Those switches, however, are mounted in the same metal box, side by side, and one gang plate covers all of them.

314. What are the circuits from cabinet B called?

Answer. The six circuits from fuse cabinet B are called 1B, 2B, 3B, etc., and are laid out on the drawings in the same manner as circuit 1A. The ceiling lighting is placed on circuit 2B so if the electricians arrange the three-colored wire of the three-conductor No. 8 cable in the same order into fuse box A and B the ceiling light load will be about the same on each side of the 3-wire system. When the cable runs for all the circuits are completed the drawings will look like Figs. 2, 3, and 4.

MATERIAL CALCULATIONS

315. How is the amount of branch circuit wire or cable determined?

Answer. The most tedious part of electrical estimating is determining the quantity of wire that will be needed for the branch circuits. This is best done by starting with the first circuit and tracing it from the fuse box to the first switch, or outlet, then on to the next and following that circuit clear through to the end. Where that circuit branches off follow one of the branches to the end, then go back to the beginning of that branch and pick up the other branch and follow that through to the end. Doing this in systematic order will prevent errors by omitting some of the wiring work. It is well to make notations on the detail sheets, as you scale the drawings, of the number of feet down, north, south, east, west, and up. These figures will enable you to recheck the work should you have occasion to do so.

Where an estimator is busily engaged day in and day out on estimating electrical circuits a map measuring device, which consists of a small wheel on a handle is usually used to run over the blueprint, and the length of cable is measured off in this manner. Of course, in going through from circuit to circuit it is necessary to estimate roughly the feet of material used vertically—as from the switch box to the floor or from the outlets to the floor. This device saves time, but it is not quite as accurate as the point-to-point method of measuring the branch circuits and scaling the drawing.

316. Is there any other material or data that should be taken off the plans when measuring the wire or cable?

Answer. Yes. All special outlet or switch boxes, box hanger-supports and special material, pigtail splices to be soldered and taped, holes to be bored through studding, and floor joists should be listed. When the knob-and-tube method of wiring is used the number of single and double holes to be bored, the number of 3-inch, 4-inch and 6-inch porcelain tubes needed, the number of split porcelain knobs, the number of feet of "Loom," and the number of pigtail and tap splices should be recorded. The term "double holes" refers to two holes that are bored about 4 inches apart in one operation with a boring machine, so that the two separate wires of the circuit can be drawn through them after porcelain tubes, 3-inches long, have been inserted.

317. What does a detail work sheet look like, and are any special symbols used?

Answer. A view of part of a large detail work sheet is shown in Table 2. This table is for only one of the twelve circuits in the 1½-story house. The "Item Number" is for the estimator's use in referring to a particular run of cable. The "Figure Number" and "Floor" entries are to aid you in locating the cable on the drawings. The numbers in the table below the headings, "2-14" and "3-14" are the number of feet of cable, "Romax" or nonmetallic sheathed cable. This cable is composed of two or three copper wires, size No. 14, that are insulated with rubber and a cotton thread braid. Each wire has a tough Kraft paper wrapping and then two or three wires are assembled and covered with cotton braided threads forming a 2- or 3-conductor cable. The word "cable" signifies 2-conductor cable. The abbreviation "3¢" is used for three-conductor cable.

The heading Rawl Plugs refers to a device used to fasten outlet boxes, cable straps, and switch boxes to brick, stone, or concrete walls. Some contractors will use Ackerman-Johnson (abbreviated A-J's) expansion anchors or lead expansion anchors.

The heading "Calculations" gives the lengths of cable in different directions, which are abbreviated by the first letter of the words, *North, South, East, West*, and *down*. This column also contains any special items needed in this run of cable. The last column "Holes to Bore" gives the number of ¼-inch holes that will have to be bored through the studding, floor joists, and top and bottom floor plates in order that the cable can be "fished" through them.

318. How does the estimator proceed in determining the quantity of wire, holes to bore, etc., for circuit 1A of the 1½-story house?

Answer. In estimating the length of wire or cable, it is customary to figure the scale on the drawing to the nearest foot and allow a one-foot slack for connection to each box, or a total of two feet of cable more than the actual measured distance, except where the distance is short and the runs are straight. In those cases one additional foot of cable may be sufficient.

In Table 2 Circuit 1A goes from the fuse box to the switch in hall 2 at the side of the door into the basement, hall 4. The distance is 2 feet, plus 1 foot at each box for slack, or a total of 4 feet. There will be 2 studs to be bored to allow the cable to pass through them.

Item 2 (Table 2) is from the switch at the basement door to light in hall 4, Figs. 2 and 5. This is a 3-conductor cable, since it was desired to feed outlets beyond the ceiling light in hall 4 from the same circuit and not have them controlled by this switch. The cable goes down from the switch alongside of a 2x4 and is pushed through holes bored in the 2x4's in the wall at the side of the stairs, then down through the top plate of the partition through the floor joist, and along the ceiling and floor joist over hall 4. The cable goes down 5 feet to the floor, south a distance of 13 feet, and then east 3 feet to the outlet. This, plus 2 feet allowance, gives a total of 23 feet. There are about 7 studs to be bored, a bottom plate and two floor joists. A cable strap will be used to support the 3-foot length of cable from the hall partition eastward to the ceiling light.

Table 2. Estimating Wire for Branch Circuit 1A

Item No.	From	To	Fig. No.	Floor	2-14	3-14	Rawl Plugs	Calculations	No. of Holes to Bore
1	Fuse Box A—Hall 4 \$		5	1	4	2N (Allow 1 ft. in each box)	2
2	Hall 4 \$—Hall 4 Light		5	B	..	23	..	5D-13S-3E 3¢	10
3	Hall 4 Light—Fruit Rm. Light		2	B	6	4S	3
4	Fruit Rm. Light—Entrance \$		2 & 3	B & 1	11	2S-2W-5 up	2
5	Entrance \$—Entrance Bracket		3	..	5	2 up-1 through wall	..
6	Fruit Rm. Lgt.—Vestibule \$		2 & 3	B & 1	10	2N-1W-5 up	3
7	Vestibule \$—Vestibule Light		3	1	12	5 up-2E-3S	3
8	Hall 1 \$—Hall 1 Light		3	1	..	10	..	5 up-2N-2E 3¢ (2 Splices)	2
9	Hall 1 Light—Hall 3 \$		3 & 5	1 & 2	..	26	..	3W-17N-4 up 3¢	16
10	Hall 4 Light—Recreation Rm.		2	B	13	..	4	4E-2N-5D (Handy Box)	2
11	Recreation Rm. \$—Recreation Rm Lights		2	B	11	15	2	5 up-8E-1S-3¢	12
12	Recreation Rm. Light—Porch 1 \$		2 & 3	B & 1	17	7E-3N-5 up	3
13	Porch 1 \$—Porch 1 Light		3	1	15	5E-5 up-3S	4
14	Hall 4 Light—Laundry \$		2	B	11	..	3	3W-2S-4D (Handy Box)	1
15	Laundry \$—Laundry Light		2	B	12	6W-4 up	..
16	Laundry \$—Dining Rm. \$		2 & 3	B & 1	14	4N-8 up	3
17	Dining Rm. \$—\$ and Light		3	1	16	21	..	6W-3N-5D & 5 up 3¢ (6W-3S-5 up)	7
18	Stair \$—Hall 3 \$		3 & 5	1 & 2	..	25	..	14N & 9 up 3¢	12
19	Hall 3 \$—Hall 3 Light		4	2	10	5 up-3S	3
20	Fuse Box A—Heating Plant \$		2	B	19	..	4	5D-6E-2N-4D (Handy Box)	3
21	Heating Plant \$—Light		2	B	20	..	1	4 up-12W-2N	1
22	Heating Plant \$—Hall 2 \$		3	B	13	..	1	4 up-4N-4 up	4
23	Hall 2 \$—Hall 2 Light		3	1	12	5 up-2S-3W	2
24	Hall 2 \$—Toilet \$		3	1	2	4
25	Toilet \$—Bracket Light		3	1	..	10	..	1E-4N-2N-1 up 3¢	6
26	Toilet Bracket Light—Garage Light		3	1	14	3 up-6N-3W	3
27	Garage Light—Garage \$		3	1	25	..	5	11W-5S-7D (Handy Box)	9
		TOTAL			272	131	20	4 Handy Boxes	120

Item 3 (Table 2) is for the cable connecting hall 4 ceiling light with the fruit storage room light. The distance is approximately 4 feet, going through floor joists that are spaced approximately 16 inches apart. Three joists will have to be bored. There are two other leads of cable from hall 4 light outlet which are taken up after the end of the fruit storage room run is reached. At the fruit storage room outlet there are two branches. The first branch goes up to the switch in the front vestibule, Fig. 3, which controls the bracket

light on the outside of the building. In Item 4 the cable is run 2 feet south, 2 feet west, and 5 feet up to the switch. One floor joist and one floor plate will be bored, and one strap will be needed to support the cable. The switches are usually mounted 4 feet, or 4 feet 6 inches, above the finished floor. This is approximately 5 feet above the outlet box fastened to the underside of the floor joists. Item 5 is a short run, because the cable goes up about a foot and through the wall to the brackets at the side of the front entrance door.

In Item 6 (Table 2) we return to the fruit storage room ceiling light, and follow the other branch up to the single-pole and 3-way switch in hall 1, Fig. 3. The single-pole switch controls the vestibule light, and the 3-way switch, the hall 1 light. The cables run 2 feet north, 1 foot west, and 5 feet up. Holes will have to be bored through two floor joists and a bottom plate. Item 7 is from the single-pole switch in hall 1, Fig. 6, up to the vestibule light. Cable is run up to the ceiling 5 feet, then 2 feet east along the floor joist, and 3 feet south. It is necessary to drill the top plate of the partition and two floor joists.

In Item 8 (Table 2) we return to the box having the single-pole and 3-way switch in hall 1, in which a 3-conductor cable is run up to the ceiling light in hall 1. This run goes up 5 feet to the ceiling, then 2 feet north, and 2 feet east. As the distance east is between 1 and 2 feet, only a 1 foot allowance is made for cable at the box, due to the fact that the cable would probably not be run clear up to the floor above. The height of the first floor from floor to floor is 9 feet, Fig. 5. Two of the wires do not make any connection in this box, as shown in Fig. 6. However two pigtail splices will have to be soldered and taped.

Item 9 (Table 2) is the 3-conductor cable from hall 1 light up to the 3-way switch on the north wall of hall 3, second floor, Fig. 4. The cable undoubtedly will be run 3 feet west from hall light 1 parallel to the floor joist, to the partition wall at the side of the stairs going up to the second floor; up through this partition wall, or through the floor joist on the second floor, to a point directly under the two 3-way switches on the north wall of hall 3; then up the partition wall to the switch box. It is approximately 3 feet west, 17 feet north and 4 feet up to the switch, a total of 26 feet including wire in each box. It will probably be necessary to bore through approximately fourteen floor joists and most likely two floor plates, as well as use two straps to support the cable when running parallel to the floor joist.

In Item 10 (Table 2) we return to hall 4 ceiling outlet in the basement. Item 10 will estimate the wiring going eastward. The wiring is run from hall 4 ceiling outlet parallel to the floor joist, 4 feet east, and then across the floor joist 2 feet north, and 5 feet down to the switch, a total of 13 feet, and pass through one floor joist and one top plate. This switch will be mounted on a concrete block or concrete partition wall. This means that the nonmetallic sheathed cable will be strapped to the concrete wall by the use of either the Ackerman-Johnson expansion bolts or lead screw anchors, or Rawl plugs. The Rawl plugs consist of jute fiber strands glued together. These are inserted in holes drilled with a star or 3-point drill in the concrete or cement block. The Rawl plugs usually are used for straps and outlet boxes. The switch box is what is known as the "Utility," "Brownie," or

"Handy" box, fastened to the surface of the concrete wall with two wood screws that are forced into the Rawl plugs or lead screw anchors placed inside of the hole drilled in the concrete. If the recreation room is to be plastered on the side walls, there will undoubtedly be furring strips between the plaster laths and the wall. In that case it will be necessary to use a shallow switch box, 2 inches deep, and chip out the back space in the concrete so that the box will be flush with the finished surface. If concrete blocks are used for the wall, the cable can come down through the hollow center of the concrete blocks from the ceiling and into an opening drilled through the concrete blocks directly back of the handy box or regular switch box set flush with the concrete blocks. These "Handy" or "Utility" boxes are not equipped with cable clamps, and the regular cable connectors, similar to those used on B.X. cable, are used to attach the nonmetallic sheathed cable to the switch box.

In Item 11 (Table 2) the 3-conductor cable is run to the first outlet in the recreation room. It is run 5 feet up from the switch to the ceiling, 8 feet east, and 1 foot south to the first ceiling outlet in the recreation room. This item also includes the cable between the first and second light outlets in the recreation room. The outlets are 10 feet apart with 1 foot of cable allowance, since the cable is strung in a straight line.

Item 12 (Table 2) is the cable from the recreation room ceiling outlet, 7 feet eastward, 3 feet north, 5 feet up to the switch on the east wall of the living room (Fig. 3), for controlling the porch 1 light. Two straps will be used to support the cable when running parallel to the floor joists. The two floor joists will have to be bored as well as one bottom plate.

Item 13 (Table 2) is for the cable from the single-pole switch, which is mounted in the same box as the 3-way switch for the living room wall plugs (Fig. 3) up to the porch 1 ceiling light. It is approximately 5 feet up, 5 feet eastward, and then 3 feet south. One strap will be used, one top plate, and three floor joists bored.

Item 14 (Table 2) returns to the ceiling outlet in hall 4, in the basement, Fig. 2, and will take the last branch from that outlet. This branch goes to the switch at the door opening into the laundry. This switch box will have to be set like the one in the recreation room, using Rawl plugs and a "Utility" box; also, Rawl plugs are used to strap the cable to the wall that comes down from the ceiling to the switch box. The cable is run 3 feet west, 2 feet south, and 4 feet down. A hole will have to be bored in only one floor joist.

Item 15 (Table 2) is for the cable going up from the laundry room switch to the ceiling and then parallel to the floor joist to the outlet over the laundry tubs. The cable is fastened to the side of the floor joists with straps which are nailed to the joists. In Item 16 we return to the laundry switch, and have another run of cable up to the ceiling and across to a point directly below the 3-way switch at the side of the door in the dining room, Fig. 3. The wiring connections at this switch are shown in Fig. 6. The cable is run approximately 4 feet north, 4 feet up from the switch to the ceiling, and 4 feet from the basement ceiling to the switch in the dining room.

Item 17 (Table 2) includes the 3-way switch from the east door of the dining room to the 3-way switch in the kitchen door of the dining room, Fig. 3, and the 2-conductor cable from the east door of the dining room 3-way

switch to the ceiling light. The 3-conductor cable is run down from one switch under the floor across to the other switch, as indicated by the dotted line, Fig. 3. Thus approximately 21 feet of 3-conductor cable is used for the switches, and 16 feet of 2-conductor cable from the switch up to the ceiling and across to the ceiling outlet. Approximately three floor plates will have to be drilled and four floor joists. Two straps will be used to fasten the cable where it is parallel to floor joists.

Item 18 (Table 2) is for the wiring to control hall 3 light on the second floor at the head of the stairs between the first and second floors. The wiring diagram is shown in Fig. 6. A 3-conductor cable is run up through the stair partition to the floor joist under the second floor and then across through them to the partition in hall 3 and up to the 3-way switch. There is, also, another 3-way switch in the same box for controlling the lights downstairs, as previously described. The cable will run approximately 9 feet upwards and 14 feet north, with 1 foot at the boxes, or a total of 25 feet. This is a 3-conductor cable. Holes will have to be bored in two floor plates and ten floor joists. Item 19 is from the 3-way switch in hall 3 to the ceiling light above. Two-conductor cable is run 5 feet up to the ceiling, and 3 feet south. This completes all the wiring supplied by the cable of circuit 1 from the fuse box A.

Item 20 (Table 2) returns back to fuse box A, as it is a little easier to run the cable from this box to the switch in the basement at the side of the door between the recreation room and the heating plant (Fig. 2) than to run the cable over from the wall switch in the recreation room. Also, it is an added advantage on long circuits like this one to divide the circuit into two parts at the fuse box, so in case of trouble on one section, disconnecting one wire at the fuse box would enable the good section to be quickly returned to service. This advantage should be used when it can be obtained without increase in wiring cost. The switch box for the heating plant light will use a utility box and be fastened with Rawl plugs. The cable required will be approximately 5 feet down from the fuse box, 6 feet east, and 2 feet north, then 4 feet down to the switch box.

Item 21 (Table 2) is for the cable from the heating plant switch to that ceiling outlet. The wires run up 4 feet to the ceiling, then west parallel to the floor joists for 12 feet, and then 2 feet north. A Rawl plug is used to fasten the cable clamp to the cement wall.

Item 22 (Table 2) is for the cable from the heating plant switch, Fig. 2, up to the switch for hall 2 light (Fig. 3), located at the side of the door which opens into the toilet room. This cable runs 4 feet up the concrete wall to the ceiling, 4 feet north, up through the floor joist to the partition, and to the switch about 4 feet above the floor. One Rawl plug will be used and four holes will be bored in the floor joist and top plate.

Item 23 (Table 2) is for the cable from hall 2 switch to the ceiling light. The diagram of the wiring of this switch and light is shown in Fig. 6. Item 24 is for the cable from hall 2 switch in the wall as shown in Fig. 3 to the switch controlling the toilet light. These switches are near the door frames where double studs are often used, so it may be necessary to bore four holes.

Item 25 (Table 2) is for a 3-conductor cable run from the toilet room switch, 1 foot east through the partition and studding, to the east wall of

the toilet room, under the window in that room, around to the north partition wall, and then up to the bracket outlet on that wall. Three-conductor cable is used so that the "hot" side of the circuit can be run with the neutral wire to the garage ceiling outlets. A bracket light is being used in the toilet room, and less cable is required by running the wires around through the studding in the wall than by the usual practice of going up to the ceiling and across the floor joists and down on the opposite wall.

Item 26 (Table 2) is for the cable to the garage ceiling light. The cable is run up to the ceiling from the bracket outlet, a distance of approximately 3 feet, then 6 feet north, parallel to the floor joist, and then 3 feet west across the floor joists. Item 27 is for the garage light switch leg, which is the cable run from the garage ceiling outlet to the switch inside the garage at the side of the door from porch 2. The inside of the garage is of concrete block, and it is necessary to use approximately three Rawl plugs in strapping the cable to the wall coming down from the ceiling to the switch; also the switch box would have to be set with two Rawl plugs using the "Utility" type box and metal cover.

The total amount of 2-conductor No. 14 wire is 272 feet, and the total amount of 3-conductor wire is 131 feet for circuit 1A.

319. How are the total amounts of wire, cable, Rawl plugs, and special material obtained for the 1½-story house?

Answer. The other circuits are worked out in detail in the same way as for the first circuit. The summary of each circuit is given in Table 3. The total for the building is the sum of all circuits. This is given at the bottom of the table. This summary also includes the number of holes to bore, Rawl plugs, handy boxes, and all other special material that could not easily be taken off the Electrical Schedule.

Table 3. Summary of Branch Circuits Estimate

Circuit Number	Feet of Cable		Rawl Plugs	Holes to Bore	Handy Boxes	Handy Switch Covers	Handy Receptacle Covers
	2 No. 14	3 No. 14					
1A	272	131	20	120	4	4	..
2A	18	3	1	..	1
3A	27	9	1	..	1
4A	57	21
5A	141	..	30	20	4	..	4 (1 Blank Cover)
6A	103	43	..	44
1B	97	21
2B	211	64	..	86
3B	99	33
4B	50	20
5B	25	6
6B	(Spare circuit)		—	—	—	—	—
Total	1100	238	50	383	10	4	6

320. Is there any shorter way to estimate the amount of cable, holes to bore, etc., than by the laborious method of measuring each length?

Answer. Yes. Since the actual lengths have been determined the average lengths to the different type of switches, outlets, and receptacles can be obtained as in Table 4 and the average values used.

Table 4. Average Cable Lengths per Outlet

Cable to	No. of Lengths	Total Feet		Average Length	Holes to Bore	
		2-14	3-14		Total	Average
\$.....	16	222	..	14 ft.	58	4
\$s.....	7	53	93	8 ft. 2¢	54	8
				13 ft. 3¢		
Cable \$s to \$4.....	2	...	46	23 ft. 3¢	19	10
\$ to Light.....	20	294	..	15 ft.	94	5
Basement Lights.....	4	57	..	15	21	5
Basement Plugs.....	6	157	..	26	30	5
Plugs 1 and 2 floor...	22	374	..	17 ft.	122	5.5
Single Ckt Plugs.....	3	65	..	22 ft.	18	6

321. How are the average values obtained in Table 4?

Answer. The average length of cable required for different outlets is summarized in Table 4 by taking the individual length for that particular type of outlet from the detailed data sheet (part of which is shown in Table 2). This summarized average cable length is very useful in arriving at unit costs and quantities of material and labor for the different kinds of outlets.

The data in Table 4 is obtained by taking the number of lengths as measured from one outlet to the other including the 1-foot allowance at each outlet and adding to the total length. Then by dividing the total number of feet by the number of lengths in Table 4 the average length of cable required to a single-pole switch is determined as 14 feet. Likewise, the number of holes that had to be bored through floor joists, studding, or top or bottom plate of the partition for each length are added together and the total obtained. From this the average is determined. This average number of holes per outlet is of great help in determining the labor cost of installing the different types of outlets that will be used later.

In this table the average is given to the nearest foot. All runs only a few feet long are eliminated, because these do not represent the average condition. Likewise, a very long run of cable for some unusual purpose should be eliminated in taking these averages, because a special condition should be treated as such.

Your attention is called to the difference in length of cable required for convenience outlets or baseboard receptacles or plugs for the basement recreation room from that on the upper floor. This run should be treated as a special circuit.

Where armored cable type of wiring is used, the length of cable may be

a foot or two longer because it does not bend with as sharp a turn as non-metallic sheathed cable.

322. What is the next step in estimating after the lengths of cable, etc., have been obtained?

Answer. The quantities are transferred to the Electrical Survey-Estimating Form. The items are listed very briefly in this table but each particular one is described in more detail as the method of building up the estimating form progresses.

Note: Item numbers in answers to Questions 323 to 353 are those of the Electrical Survey-Estimating Form, pages 25-27.

323. How was the cable 2-14 and 3-14 for the 1½-story house obtained?

Answer. The Items 1 and 2 are nonmetallic sheathed cable often called "Romax." The numbers 2-14 and 3-14 mean that there are two or three wires, size No. 14 in the cable. The quantity in feet is obtained from the totals in Table 3. If armored or "BX" cable had been used it would have been obtained in the same manner. The sizes are designated in a similar manner.

324. Why is the boring of holes listed here?

Answer. Item 3 is a labor item that takes quite a lot of time when a large number of holes are to be bored through the floor joists, studding, and floor plates.

325. What are 1-hole straps?

Answer. They are small pieces of metal used to fasten the cable to the floor joists or studs when the cable is run parallel to them. A small hole is punched in one end so a nail can be driven through them to clamp the cable in place. They can be estimated by counting each one on the detail work sheets, which was done in this case in order to find the average per foot of cable. It is approximately one strap per 10 feet of cable. The same strap can be used for either 2- or 3-conductor cable.

326. What kind of outlet boxes are used, and how is the number determined?

Answer. In Item 5 the number of outlet boxes needed is taken from the Electrical Schedule (see "Specifications") and is 4 bracket, plus 24 ceiling, plus one in the heating plant room, Fig. 2, which is marked **T** in the outlet symbol. A bell-ringing transformer will be mounted in this outlet. The electrical specifications call for "4-inch standard type, with 3-inch plaster ring and approved fastenings for cable." The electrical contractor will use a 4-inch octagon box, 1½ inches deep fitted with offset bar hanger, fixture stud, and cable clamps or fasteners.

327. What are plaster and extension rings?

Answer. Items 6 and 7 are for a ring that fastens to the 4-inch box and reduces the opening in the plastered ceiling to 3 inches in diameter. The height of the ring is about 5/8 of an inch. This added amount of space is provided in the outlet boxes for the electrical wires and splices. The extension ring serves the same purpose, except that it is 4 inches in diameter and has ears to which a 4-inch outlet box type bell transformer can be attached.

328. How are the number of switch boxes determined?

Answer. The number is obtained from the electrical schedule and is the sum of 17 S.P. switches plus ten 3-pole, plus two 4-pole, plus twenty-eight wall plugs and four motor plugs. This totals 61 boxes, but in the basement there were 10 handy boxes used for surface mounting instead of a standard concealed switch box. The switch boxes will be 2½-inches deep, equipped with cable fasteners and mounting bracket so they can be nailed to the studding quickly.

The architect in the electrical specifications refers to 3-P and 4-P switches, more often called 3-way and 4-way switches. The boxes used for radio plug, bell plug, and telephone plug are explained under those subjects.

329. Why are cable clamps specified in Items 10 and 11 when cable fasteners are furnished in the outlet boxes?

Answer. These items are for use with the "Handy" boxes used in the basement and the 12 circuits leaving the fuse cabinets. The number is obtained by counting the number of cables to each fuse cabinet and "Handy" box in Figs. 2, 3, and 4. There are 12 cable runs from the cabinets which, with the cable to the "Handy" boxes, will require approximately 15 single and 7 duplex connectors. The duplex connector enables two cables to enter the metal box through one hole in the box.

330. How are Rawl plugs, screws, and nails estimated?

Answer. The number of Rawl plugs were counted on the branch circuit detail sheet Table 2, and summary, Table 3. A wood screw size No. 6, about 1 inch long, will be used with each Rawl plug to fasten the "Handy" boxes and straps to cement walls. It is well to double the quantity to take care of unseen needs, especially on small items costing only a few cents. The quantity of nails is estimated in a similar manner—a rough guess, perhaps a pound of several sizes on hand.

331. What is the difference between "roughing" and "finishing" work?

Answer. The term "roughing" refers to the work done before the building is lathed and plastered. It includes installing the outlet boxes, switch boxes, fuse cabinets, service switch, armored or nonmetallic sheathed cable, connectors or clamps, etc. The wires are folded back in the metal box and many wiremen stuff old newspapers in the metal switch boxes to keep them from becoming filled with plaster. After the plasterers have finished, the wiremen clean out the boxes and install the switches, receptacles, and plates. This work is called "finishing" because the wiremen are doing the things needed to "finish up" the job.

332. How are the number of switches, receptacles and plates determined?

Answer. These are taken directly from the electrical schedule. The number of switches that are located side by side, called "2-gang," are counted from the drawings, Figs. 3 and 4. There are five "2-gang" plates and these plates take care of 10 switches, leaving 19 single-switch plates. There are 4 switches in "Handy" boxes, Item 21, which leaves 15 bakelite switch plates, Item 18.

The same kind of plate is used on 3-way and 4-way switches as single-pole switches. The total number of duplex receptacles is the sum of motor and wall plugs, Item 23. The number of duplex bakelite receptacle plates, Item 20, is Item 23, less the number of "Handy" box receptacle plates, Item 22.

333. What does the service wiring include?

Answer. It includes all wiring from the outside of the building to the branch circuit wires. In many homes the branch circuit fuses are in the same box with the service switch. In the 1½-story house, two separate fuse cabinets are used, and naturally the service wiring includes these, and all wiring to them. There is such a wide variation in the different kinds of service, sizes of wire needed, and the distance to the watt-hour meter and branch circuit fuse cabinets that it is impossible to establish uniform prices or lists. There usually is more special material needed in service wiring than in branch circuit work. In some localities the watt meter may be installed inside the house, although more and more are the power companies requiring their installation in a protected location on the exterior of the house, as on an open porch. In some cities where brick construction is used the power companies insist that a recessed opening approximately 12" by 24" with at least a 6" recess be used. This provides an inconspicuous place for the watt-hour meter to be mounted. Other companies, especially when the building is already erected, install the meter on the outside of the house at a convenient location.

334. How is the service wiring estimated?

Answer. The service wiring is estimated by temporarily locating the service switch and fuse cabinets, and starting at the incoming line wires and listing all material as you trace through to the fuse cabinets. There may be two prospective locations for the power company to run their wires to the house, and both locations should be calculated. The list of material for the 1½-story house is shown in the electrical estimating form Items 24 to 47.

335. What is each of these items used for?

Answer. The electrical specification says "the service is to be three No. 8 rubber-covered single-braid wires in 1-inch conduit, with a 30-ampere 250-volt main switch." The service entrance cap and conduit is fastened to the side of the house near porch 2, Fig. 3, at a height of about 14 feet above the foundations. The watt-hour meter will be mounted on the side of the house and covered by porch 2 roof. The power company provides a meter base fitting for the wireman, who will mount it at a height of about 4½ feet above the porch floor. The service switch is mounted in the heating-plant room on the inside foundation wall of that room, Fig. 2. The service conduit will go from the meter fitting through the wall down and into the top of the service switch. It will require one length, 10 feet, of conduit from the entrance cap to the elbow at the corner of the house, and another length to meter fitting and service switch. It will require two pipe straps and four lag screws, size ¼x2", to fasten the vertical service pipe to side of house. A strap will be used to fasten the conduit near the meter fitting, and another strap and 2 Rawl plugs to fasten the conduit near the service switch. Two or three lag screws will be used to mount the meter fitting to side of house. Four lag

screws and Rawl plugs will be used to fasten the 30-ampere 250-volt 3-pole 2-fuse service switch to the cement wall. Two lock nuts and a bushing are used where the conduit goes into the switch and meter fitting.

The length of service wire is that of the conduit, 20 feet plus 3 feet left outside the entrance cap, plus 2-foot loop at meter fitting, plus an extra foot at service switch, or 26 feet. This times three wires gives a total of 78 feet. Items 35 to 41 inclusive are for use in grounding the service conduit and the neutral wire to the water pipes. A 1-inch ground bushing with connection for a No. 8 wire is used on the inside of the service switch to connect the conduit to ground. One length of ½-inch conduit is run from the service switch to a point near a water pipe where it is connected to that pipe with a ground

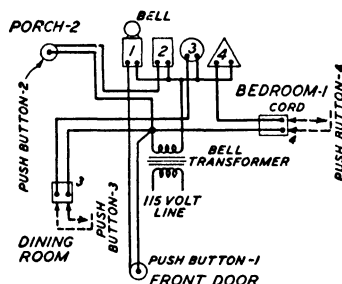

Fig. 8. Wiring Diagram of Bell Signal System in 1 ½-Story Building

clamp, Item 38. Some cities require that copper wire, size No. 8 or larger, be connected to the water pipes on each side of the water meter, so the grounding will be complete even if the water meter is removed. This is called a water meter shunt, Item 41.

Item 42 is for the fuse box or cabinet having a 3-wire feeder connection and six branch circuits. A 3-conductor "Romax" cable, size No. 8, is run from the service switch to the first fuse cabinet and then on to the second cabinet. The length of cable is estimated by scaling the drawing for horizontal and vertical heights, making due allowance for extra length looping in the cabinets. These lengths are always scaled at right angles to each other, because the cable is run parallel to floor joists and then across them.

The 30-ampere fuses are for the service switch and the 10-ampere fuses are for use in the branch circuits. A spare set of fuses is provided.

336. How is the bell wiring estimated on the 1 ½-story house?

Answer. The electrical specifications call for a particular type—the Edwards Flush call type—which is recessed in the wall. It is made to fit a standard 2½-inch deep switch box. Four of these boxes are ganged together in the kitchen wall and the bells are mounted inside of them instead of on the wall surface.

The wiring diagram is shown in Fig. 8. A switch box with plug plate is located in the dining room and in the master bedroom. A 10-foot electric cord with a pear shaped push button on one end and a plug on the other

end (inserted in the plug plate) is used to signal the person in the kitchen. The bell-ringing transformer is located in the outlet box marked **T** in the basement, Fig. 2.

No. 18 cotton-covered paraffin dipped wire, called bell wire, is used for wiring between the push buttons, bells, and transformers. It is fastened to the studding with insulated staples.

337. How is radio wiring installed?

Answer. The radio antenna will be installed in the attic, using one of the antenna radio kits that may be obtained from a radio dealer. The lead in wires will be run down to the basement and up to the living room outlet and bedroom 1. A twisted pair of lamp cords with a rubber-insulated ground wire will be run to these outlets, whose location will be directed by the owner or architect.

338. How is the material price and cost obtained?

Answer. Many electrical contractors or estimators maintain a cost and price record either in loose-leaf book form or on cards in which the list price, net cost, and retail price are entered from the bills of material purchased. This is of great help in estimating the material cost. The beginner will find the electrical catalogs of the large mail order stores, Sears Roebuck & Co., Montgomery Ward & Co., etc., of help in pricing the material in small lots.

339. Where is the ventilating fan to be used?

Answer. The ventilating fan is to be used in the kitchen window over the refrigerator. The electrical specifications state that the contractor is to include \$35.00 for this fan, which is to be wired by the electrical contractor.

LABOR CALCULATIONS

340. How is the labor calculated on a wiring job?

Answer. The labor time in hours is best obtained by reference to records of the time entered against previous wiring jobs. Such an itemization of "labor time" is given in Table 5 and will serve as a guide for the estimator who is starting to do this kind of work. Then he will add additional items and change the time unit to conform to local schedules. The time unit will also vary in different parts of the United States owing to the fact that in some regions the men work faster than in others.

341. What do the different items in Table 5 include?

Answer. In Table 5 the time units for doing certain jobs in wiring work are given. In electric wiring work, the electrician installs the outlet boxes, switch box receptacles, and ceiling outlets, and also the nonmetallic sheathed cable, before the rooms are plastered. This is called "roughing in." Then after the plasterers are through with their work the electrician installs the switches and convenience outlets in the boxes in the wall.

In the basement where the walls are brick, cement block, or concrete, it is necessary to use Rawl plugs to hold the outlet boxes to the wall. This takes a longer time than mounting the regular outlet box by means of a bar hanger on the studs or floor joists. A Rawl plug with a No. 8 wood screw

ELECTRICAL SURVEY-ESTIMATING FORM

NO.	ITEMS	AREA	PIECES OR LENGTH	EST. AM'T MAT'L	MAT'L PRICE	MAT'L COST	EST. HOURS	LABOR PRICE	LABOR COST	ACTUAL COST	
										AM'T MAT'L	HOURS LABOR
		Branch		Circuit	"Roughing"						
1	Cable 2-14		1100		.03	33.00	4.4				
2	Cable 3-14		238		.04	9.52	.9				
3	Boring Holes		333				16.6				
4	Straps-1 hole		133		.003	.40					
5	Outlet Box		29		.28	8.12	8.7				
6	Plaster Ring		28		.07	1.96	1.4				
7	Ext. Ring		1		.16	.16	.1				
8	Switch Boxes		51		.18	9.18	15.3				
9	Handy Boxes		10		.11	1.10	3.5				
10	Cable Clamps		15		.05	.75					
11	Duplex Clamps		7		.10	.70					
12	Rawl Plugs		50		.015	.75	3.5				
13	Screws		100			.25					
14	Nails			5 lbs.	.05	.25					
				Finishing							
15	S.P. Switch		17		.25	4.25	3.4				
16	3-W Switch		10		.40	4.00	4.0				
17	4-W Switch		2		.98	1.98	1.0				
18	Switch Plates		15		.06	.90					
19	2-Gang Plates		5		.12	.60					
20	Receptacle Plates		26		.06	1.56					
21	H-Sw. Plates		4		.09	.36					
22	H-Recpt. Plates		6		.09	.54					
23	Receptacles		32		.23	7.36	6.4				

ELECTRICAL SURVEY-ESTIMATING FORM

NO.	ITEMS	AREA	PIECES OR LENGTH	FST. AM'T MAT'L	MAT'L PRICE	MAT'L COST	EST. HOURS	LABOR PRICE	LABOR COST	ACTUAL COST	
										AM'T MAT'L	HOURS LABOR
			Service								
24	Conduit										
	1-in.		20 ft.		.135	2.70	1.8				
25	Straps		4		.04	.16					
26	Entrance										
	Cap		1		.60	.60	.3				
27	Entrance										
	Elbow		2		.65	1.30	.3				
28	Meter Fitting		1*				.3				
29	Service										
	Switch		1		4.50	4.50	1.2				
30	Screws										
	$\frac{1}{2}$ x 2		16		.01	.16					
31	Rawl Plugs		6		.02	.12					
32	Lock Nuts										
	1-in.		6		.015	.09					
33	Bushings										
	1-in.		3		.03	.09					
34	Wire No. 8		78 ft.		2.75	2.14	.5				
35	Ground										
	Bush										
	1-in.		1		.14	.14					
36	Conduit $\frac{1}{2}$ in.		10		7.20	.72	.5				
37	Wire No. 8		12 ft.		2.75	.32	.1				
38	Ground										
	Clamp										
	$\frac{1}{2}$ -in.		1		.65	.65	.2				
39	Lock Nuts										
	$\frac{1}{2}$ -in.		2		.01	.02					
40	Bushings										
	$\frac{1}{2}$ -in.		2		.01	.02					
41	Water										
	Meter										
	Shunt		1		1.10	1.10	.3				
42	Fuse										
	Cabinet		2		2.70	5.40	4.6				
43	Romax 3-8		42 ft.		14.00	5.87	1.8				
44	Straps		5		.02	.10					
45	Connectors		4		.10	.40					
46	Fuses 30A.		4		.04	.16					
47	Fuses 10A.		24		.04	.96					
	*Furnished by power company.										

ELECTRICAL SURVEY-ESTIMATING FORM

NO.	ITEMS	AREA	PIECES OR LENGTH	EST. AM'T MAT'L	MAT'L PRICE	MAT'L COST	EST. HOURS	LABOR PRICE	LABOR COST	ACTUAL COST	
										AM'T MAT'L	HOURS LABOR
				Bell Wiring							
48	Switch Box		6		.18	1.08	1.8				
49	Bell Wire			2 lbs.	.40	.80	2.0				
50	Bell and Buzzer		1		1.50	1.50	.2				
51	Buzzers		2		1.20	2.40	.4				
52	Pear Push		2		1.00	2.00	.4				
53	Plug Plate		2		1.00	2.00	.4				
54	Transformer		1		.70	.70	.2				
55	Staples		1 Box		.10						
56	Push Button		2 (In Hardware)				.4				
				Radio Wiring							
57	Antenna Kit		1			2.00	1.0				
58	Lamp Cord		100 ft.		1.10	1.10	1.0				
59	Ground Wire		50 ft.			.30	.5				
60	Radio Plugs		2		.50	1.00	.4				
61	Switch Box		2		.18	.36	.6				
62	Telephone Box		1		1.00	1.00	.3				
63	Telephone Plate		1		.10	.10	.2				
64	Ventilating Fan				35.00		3.0				
65	Permits, Inspection										

an inch long is used to fasten the one-hole cable strap which holds the non-metallic sheathed cable flat against the wall. On the outside of the building or in other places where conduit is 1" or larger it may be necessary to use $\frac{1}{4}$ " lead expansion anchor screws in the concrete to support the conduit. These are used for the service switch box in the basement.

The time required to nail straps to the floor joists with the nails provided is short and this is included in the time charged for installing the cable. In fact, it is easier to install the cable parallel to the floor joists with straps and nails than it is to "fish" it through the bored holes in the floor joists. Also, the average time required for boring holes and installing two No. 14 conductor cable or three No. 14 conductor cable is given as 1.8 hours per 100 feet of cable.

The letter "C" is the symbol for 100. It is preferable to give the time in hours per 100 feet of material where several hundred feet will be used. Where only small quantities of material are used the time usually is given per foot, as is the case with roughing in rigid conduit and various other items when it is likely that less than 100 are to be used.

In connecting externally operated switches the time in hours is given for the complete job, which includes mounting the box by means of wood screws, Rawl plugs, or lead expansion anchor screws. The time is, also, given for mounting on wood, brick walls, or concrete. These are often mounted on the concrete foundation walls, and sometimes the concrete foundation is carried up to the ceiling of the first floor. The 30-ampere switches are provided sometimes with lugs and sometimes without lugs. When provided with screw connections the wires are slipped under the terminal and screw connections made. In the larger sizes lugs are always used, and it takes a little longer time to solder the connection to the lugs than it does to attach the wire under the binding post with screw connections.

Sometimes in mounting the service switch, especially if the meter is inside the basement, a wooden board or panel is made which fastens to the brick or concrete wall. Such a panel has to be fastened to the brick wall by either large Rawl plugs or lead expansion anchor bolts taking a $\frac{1}{4}$ " screw. Size No. 8 wood screw is hardly large enough, especially if the meter service switch and branch circuit fuses are combined in the one cabinet. When using this combined switch in the 30-ampere size, it is best to charge the time unit indicated for those with lugs, because the additional complications take more time in wiring than does the plain externally operated switch.

In the $1\frac{1}{2}$ -story building the fuse cabinets are separate. Mounting connections to fuse cabinets includes the connecting of the service wires to the cabinet and, also, the connecting of branch circuits at the cabinet.

In determining the time unit required for pulling wires into conduit it is considered that three wires of that size are used in the conduit. The number of feet is the actual feet of wire used and is greater than three times the actual measured feet of conduit from one outlet or opening to the next.

The time unit given for conduit, service heads, meter, elbow, and ground fittings includes the extra work of roughing in and connecting the conduit to the fittings, as well as the extra work occasioned by the use of these fittings instead of a straight run of conduit. It, also, includes the operations of attaching the ground clamps to the water pipe and to the rigid conduit for

grounding to service, and attaching the shunt clamp and jumper around the water meter, where it is so required by local ordinance.



Fig. 9. Using a Joist Boring Machine
Courtesy of Greenlee Tool Co., Rockford, Ill.

342. How is each item of "roughing in" labor calculated for the 1½-story house?

Answer. The labor cost of installing cable either 2-14 or 3-14 is .4 hours per 100 feet. This multiplied by the number of feet gives the time in hours which is calculated to the nearest tenth of an hour.

In Item 3 of the Electrical Survey-Estimating Form, "Boring Holes," it is estimated that using a brace and bit about 3 minutes (.05 hours) will be required for each hole, while with a boring machine, Fig. 9, only .02 hours per hole is required. Thus the electrical estimator must be acquainted with the tools and equipment the contractor has available for use.

The operation of driving a nail through the "1-hole straps" to support the "Romax" cable to floor joists and studs is included in the time required to install the cable.

In Items 5 and 8, .3 hours (18 minutes) are required to mount an outlet, switch, or receptacle box on studding or floor joists. This includes the attaching of the "Romax" cable to the outlet box, and removing the outer braid from the wires in the outlet box.

It requires .05 hours to attach the plaster ring to the outlet box, Item 6, and also the same time to attach the outlet box extension ring. Since there is only one of these to be installed the time is .1 hours.

It requires .35 hours to install a handy switch box in the basement, using cable connectors. The boxes are attached to the wall, using Rawl plugs and wood screws. The time for drilling the hole in cement block or brick and inserting the Rawl plug is .07 hours for each hole.

343. How is each item of the "finishing" labor on the branch circuits for the 1½-story house calculated?

Answer. The time required to connect a receptacle or single-pole switch is 2 hours. This work is done after the building is plastered. These are Items 15 and 23 of the Survey-Estimating Form. This time includes the attaching of the switch or receptacle plate. The time to connect a 3-way switch, Table 5,

LABOR-TIME SCHEDULE

Table 5. Installing Nonmetallic Sheathed Cable

Operation	Time, Hours
Installing cable through holes already bored, and nailing cable clamps to joists and studs 2-14 and 3-14, per 100 ft.	.4
Boring holes by brace and bit, installing 2-14 or 3-14 cable, nailing clamps (average 30 holes per 100 ft. of cable) per 100 ft.	1.8
Boring holes by boring machine, installing 2-14 or 3-14 cable, nailing clamps (average 30 holes, per 100 ft. of cable) per 100 ft.	1.0
Installing cable through bored holes, and nailing cable clamps to joists and studs, size 3-8, per 100 ft.	3.0
Boring floor joists, studs and floor plate (2-14 and 3-14) with brace and bit, each.	.05
Boring floor joists, studs and floor plate (2-14 and 3-14) with boring machine, each.	.02
Boring floor joists for 3-8 cable with brace and bit, each.	.1
Boring floor joists for 3-8 cable with boring machine, each.	.04
Mounting ceiling cable box, including clamps and hanger, each.	.3
Mounting switch or recept. box on cement block, each.	.5
Mounting switch or recept. box on studs, each.	.3
Mounting bracket cable box, including clamps and hanger, each.	.3
Mounting conduit box, bar hanger, cable connectors, each.	.4
Attaching plaster ring, each.	.05
Mounting handy or utility boxes (using connectors) each.	.35
Rawl plug, wood screw No. 8-1½" in cement block or brick, each.	.07
Lead expansion anchor No. 12 screw in cement block or brick, each.	.14
Lead expansion anchor ¼-inch screw in concrete, each.	.25
Wood screw (cable strap fasteners) No. 8-1½", each.	.025
Connecting receptacle in box, each.	.2
Connecting single-pole switches in box, each.	.2
Connecting 3-way switch in box, each.	.4
Connecting 4-way switch in box, each.	.5
Soldering and taping splices in switch and outlet boxes, each.	.1

LABOR-TIME SCHEDULES

Table 5A. Installing Rigid Conduit*

On Wood		Hours	On Brick		Hours
Roughing in conduit, 1 1/4" per ft.		.12	Roughing in conduit, 1 1/4" per ft.		.15
Roughing in conduit, 1" per ft.		.09	Roughing in conduit, 1" per ft.		.11
Roughing in conduit, 3/4" per ft.		.07	Roughing in conduit, 3/4" per ft.		.09
Roughing in conduit, 1/2" per ft.		.05	Roughing in conduit, 1/2" per ft.		.07

*Items include one bend in each 10-ft. length.

Table 5B. Pulling in Wire in Rigid Conduit

Size	Hours
No. 8 and 6, per 100 feet of wire	.66
No. 12 and 10, per 100 feet of wire	.5
No. 14 and 12 in Residences, per 100 feet of wire	1.0

Table 5C. Installing Rigid Conduit Fittings

(Condulet, Service Head, Entrance Cap, Meter, Elbow, Ground Fittings—Including "Roughing In," Connecting, Pulling Wires Through)

Size	Hours	Size	Hours
1/2 inch	.2	1 inch	.3
3/4 inch	.25	1 1/4 inches	.4

Table 5D. Mounting and Connecting Externally Operated Switches

Size	On Frame	On Brick	On Concrete
2-Pole 30-Amp., no lugs	.7	1.0	1.5
3-Pole 30-Amp., no lugs	1.0	1.2	1.7
2-Pole 30-Amp., with lugs	1.2	1.5	2.0
3-Pole 30-Amp., with lugs	1.7	2.1	2.6
2-Pole 60-Amp., with lugs	1.6	2.0	2.5
3-Pole 60-Amp., with lugs	2.1	2.6	3.0

Table 5E. Mounting and Connecting Fuse Cabinets—Main and Branch Circuits

Operation	Hours	Operation	Hours
2-wire 2-circuit	1.2	3-wire 6-circuit	2.3
2-wire 4-circuit	1.5	3-wire 8-circuit	2.7

is 4 hours, and a 4-way switch, .5 hours. The 3-way and 4-way switches have three and four wires to be connected to them and it takes more time to check the connections than it does with single-pole switches.

344. How is the labor for installing the service in a 1 1/2-story house estimated?

Answer. There is such a large variation in the amount of material and labor used in service wiring that it is necessary to calculate the detail items of each service. In Item 24 (Survey-Estimating Form) the time to install one

foot of 1-inch conduit, Table 5A, is .09 hours, and for 20 feet it is 20x.09 or 1.8 hours. This includes the cutting, threading, bending, fitting, and fastening into place with pipe straps and nails, and attachment of regular couplings, lock nuts, and bushings. The time for attaching special fittings, Items 26, 27, and 28 is given in Table 5C for the different size of conduit.

The service switch used in the 1½-story house is a 30-ampere, 250-volt, 3-pole with two fuses (neutral is connected solid) and is mounted on the cement block wall in the basement by the use of Rawl plugs and screws. The clamp type terminal will be used instead of lugs, and it requires about the same time to mount it on a brick wall as on a cement block wall. Thus the time from Table 5D is 1.2 hours for Item 29.

The time required to pull the three single-conductor Size No. 8 service wires into the conduit is .66, or ⅔ of an hour per 100 feet of wire, Table 5B. In the 1½-story building only 78 feet of wire is used, and it would require about .5 hours. The time for connecting the wire to meter fitting and service switch is included under those items.

Items No. 35 to 40 inclusive are for protecting and connecting the neutral wire and service conduit to the water pipe system. In some cities the water companies require that a copper cable called a shunt or jumper be securely attached to the water pipes on both sides of the water meter in order to shunt electric current around the water meter and provide a complete circuit when the water is shut off and the meter removed.

The time required to mount and connect the wires to a fuse cabinet is given in Table 5E. The 1½-story house uses two fuse cabinets each having six circuits and it takes 2.3 hours per cabinet or 4.6 hours for both. The 42 feet of 3-conductor "Romax" cable will require 42/100 of 3, or 1.3 hours to install after the holes have been bored. To bore the 12 holes for the cable will take about 12 times .04 or .5 hours. This makes the total time for boring holes and installing cable about 1.8 hours.

345. How is the labor cost of the bell wiring estimated for the 1½-story house?

Answer. It is much more difficult to estimate the bell wiring labor time, because very few records of time have been kept in the past. It is best estimated by comparing with branch circuit wiring. Thus in Item 48 (Survey-Estimating Form) there are 4 switch boxes ganged together and the Edwards flush call bells of the recessed type installed in them. Also, two boxes are used for the plug plates to which the pear shaped push buttons are connected. The estimated time is the same as for installing a switch box on branch circuit wiring, which is .3 hours each.

There are about 140 feet of No. 18 bell wire to the pound, and about two pounds would be needed. It would probably require about two hours to string out the bell wire and tack it with insulated staples to the wood studding and other parts of the building.

The time required to connect each of Items 50 to 54 is about same as connecting a switch or receptacle, which is .2 hours each. There is a push button on the front entrance door and another on porch 2 door frame which will be furnished by the general contractor on his hardware purchase. They will require about the same time as connecting a switch or receptacle.

346. How long does it take to install a radio aerial?

Answer. The time to install the antenna kit is one hour and about an additional hour to run the twisted pair lamp cord to the different outlet boxes. A ground wire is run from the water pipes to each radio outlet for the "ground" connection, which takes about half an hour. The radio plugs installed in the switch boxes each take about the same time as installing receptacles and switches. The total time is three and one-half hours.

347. What are the uses of the telephone box?

Answer. The telephone box is a special metal box placed in the wall by the electrical contractor. The telephone company men will install the telephone wires to this box and mount the telephone ringer or box in or near it.

348. How long does it take to install the ventilating fan?

Answer. It is more of a guess on the time required because there are not enough details available to establish standard labor time. This fan may not be put up until some time after the wiring is finished. This will probably mean a special trip to the house to do this work, and while only an hour or so is required for the actual work, sufficient time should be included for traveling time. Thus three hours is allowed for this Item 64.

349. What rate of pay per hour of electricians is used in this estimate?

Answer. The rate of pay of a journeyman electrician varies in different cities in the United States, being about \$1.00 per hour in the southern states to \$1.75 per hour in the largest cities, New York and Chicago. The rate of helpers is usually half the journeyman's rate. A helper and journeyman always work together on a job and in some cities two helpers are permitted with a journeyman. In this estimate the time was figured in hours, and a rate of \$1.00 per hour was used as the average of journeyman and helper. Where the rate is greater or less in a particular locality the labor time can be multiplied by that particular rate.

350. What is the total cost of wiring the 1½-story building?

Answer. The total cost is the sum of the items on the electrical estimating form as follows:

Item	Material	Labor, Hours
Branch Circuits—roughing.....	\$66.14	54.4
Branch Circuits—finishing.....	21.55	14.8
Service.....	27.72	11.9
Bell Wiring.....	10.48	5.8
Radio and Telephone.....	5.86	4.0
Ventilating Fan.....	35.00	3.0
Permits, Inspection.....
Total	166.75	93.9

When the labor cost is \$1.00 per hour the total cost would be \$166.75 plus \$93.90 for labor, or \$260.65. This does not include overhead, fixed charges, or

profit for the contractor who would spend time in supervising the job; getting materials, making estimates and bids on jobs, etc.

351. Is there any way that the laborious detail work of making an estimate for a bid on a job can be shortened?

Answer. Yes. After a detail bid has been prepared the branch circuit wiring can be divided into different types of outlets as in Table 6, and the total cost obtained by multiplying the number of outlets by cost for that type outlet. A similar table can be prepared for service wiring from records of actual jobs of different types of residences, so that an approximate figure can be obtained quickly.

352. How does the accuracy of the short estimate method for branch circuits compare with the more detailed method?

Answer. It is usually sufficiently accurate for estimate purposes. Let us compare this method for branch circuit work with the results obtained by the detailed method. The cost of branch circuits by detailed method in Question 350 is the sum of the first and second lines of that table which with labor at \$1.00 per hour is \$156.89. The cost by the unit estimate basis is as follows:

Estimate by Unit Basis Method
(Labor and Material)

Item	Unit Cost	Number	Total Cost
Ceiling light in basement	\$1.46	6	\$ 8.76
Ceiling light, 1st and 2d floors	1.43	22	31.46
\$ in Basement	2.19	3	6.57
\$ on 1st and 2d floors	1.68	14	23.52
\$ ² on 1st and 2d floors	2.52	10	25.20
\$ ⁴ on 1st and 2d floors	3.36	2	6.72
Convenience Outlet, basement	2.96	4	11.84
Convenience Outlet, one per circuit	2.27	3	6.81
Convenience Outlet	1.84	24	44.16
		<hr/> 88	<hr/> \$165.04

The difference between these two estimates is about \$8.00 or about 5 per cent difference.

353. How can an electrical estimator or contractor improve his cost data for estimating purposes?

Answer. If the contractor will keep a record of labor time in hours on the different parts of a job he can develop accurate unit labor cost data, which will improve his estimates.

ELECTRICAL SYMBOLS FOR ARCHITECTURAL PLANS

CEILING WALL

○	○	Outlet.
⊙	⊖	Capped Outlet.
⊕		Drop Cord.
⊕	⊖	Electrical Outlet—for use only when circle used alone might be confused with columns, plumbing symbols, etc.
⊕	⊖	Fan Outlet.
⊕	⊖	Junction Box.
⊕	⊖	Lamp Holder.
⊕ Ps	⊖ Ps	Lamp Holder with Pull Switch.
⊕	⊖	Pull Switch.
⊕	⊖	Outlet for Vapor Discharge Lamp.
⊕	⊖	Exit Light Outlet.
⊕	⊖	Clock Outlet (Lighting Voltage).

CONVENIENCE OUTLETS

⊕	Duplex Convenience Outlet.
⊕ _{1,3}	Outlet other than Duplex. 1=Single, 3=Triplex, etc.
⊕ _{WP}	Weatherproof Convenience Outlet.
⊕ _R	Range Outlet.
⊕ _S	Switch and Convenience Outlet.
⊕ _R	Radio and Convenience Outlet.
⊕	Special Purpose Outlet (see Spec.)
⊕	Floor Outlet.

SWITCH OUTLETS

\$	Single Pole Switch.
\$ ₂	Double Pole Switch.
\$ ₃	Three Way Switch.
\$ ₄	Four Way Switch.
\$ _D	Automatic Door Switch.
\$ _E	Electroliner Switch.
\$ _K	Key Operated Switch.
\$ _P	Switch and Pilot Lamp.
\$ _{CB}	Circuit Breaker.
\$ _{WCB}	Weatherproof Circuit Breaker.
\$ _{MC}	Momentary Contact Switch.
\$ _{RC}	Remote Control Switch.
\$ _{WP}	Weatherproof Switch.

SPECIAL OUTLETS

○ _{a,b,c-etc.}	Any Standard Symbol with the addition of a lower case subscript letter may designate a special variation of standard equipment. They must be listed in the Key of Symbols on each drawing.
⊕ _{a,b,c-etc.}	
\$ _{a,b,c-etc.}	

PANELS AND CIRCUITS

	Lighting Panel.
	Power Panel.
—	Branch Circuit—Ceiling or Wall.
- - -	Branch Circuit—Floor, 2-wire.
///	Branch Circuit—Floor, 3-wire.
///	Branch Circuit—Floor, 4-wire, Etc.
—	Feeders, Heavy lines, numbered as listed in the Schedule.
	Underfloor Duct & Junction Box—Triple System. Note: For double or single systems eliminate one or two lines. This symbol is equally adaptable to auxiliary system layouts.

MISCELLANEOUS

	Generator.
	Motor.
	Instrument.
	Transformer.
	Controller.
	Isolating Switch.

AUXILIARY SYSTEMS

	Push Button.
	Buzzer.
	Bell.
	Annunciator.
	Telephone.
	Telephone Switchboard.
	Clock (Low Voltage).
	Electric Door Opener.
	Fire Alarm Bell.
	Fire Alarm Station.
	City Fire Alarm Station.
	Fire Alarm Central Station.
	Automatic Fire Alarm Device.
	Watchman's Station.
	Watchman's Central Station.
	Horn.
	Nurse's Signal Plug.
	Maid's Signal Plug.
	Radio Outlet.
	Signal Central Station.
	Interconnection Box.
	Battery.
- - - - -	Auxiliary System Circuits. Line without further designation indicates 2-wire circuit. For a number of wires designate as: 12-No. 18W-3/4"-C.; or by number as in schedule.
	Special Auxiliary Outlets. Letters refer to notes on plans or details in spec.

Courtesy of American Standards Association, New York, N. Y.

TABLE 7

Material and Labor Cost for Installing Knob and Tube Work in New House

ITEM	UNIT COST	CEILING OR WALL LIGHT OUTLET		CONVENIENCE OUTLET		SINGLE POLE SWITCH		3-WAY SWITCH		4-WAY SWITCH	
		Quantity	Cost	Quantity	Cost	Quantity	Cost	Quantity	Cost	Quantity	Cost
No. 14 Wire...	\$ 7.00	30 ft.	\$0.21	44 ft.	\$0.31	30 ft.	\$0.21	40 ft.	\$0.28	40 ft.	\$0.28
Loom.....	18.00	4 ft.	.07	4 ft.	.07	4 ft.	.07	5 ft.	.09	5 ft.	.09
Knobs.....	13.00	7	.09	9	.12	7	.09	9	.12	9	.12
Tubes.....	4.00	8	.03	12	.05	8	.03	11	.04	11	.04
Light Outlet Box.....	.11	1	.11								
Box Support...	.08	1	.08								
Switch Box.....	.11			1	.11	1	.11	1	.11	1	.11
Switch Box Support....	.14			1	.14	1	.14	1	.14	1	.14
Convenience Outlet.....	.30			1	.30						
Single-Pole Switch.....	.30					1	.30				
3-Way Switch.....	.40							1	.40		
4-Way Switch.....	1.75									1	1.75
Miscellaneous.....	.03		.03		.03		.03		.03		.03
Permit.....											
Labor—Hours.....	1.00	¾	.75	1¼	1.25	1	1.00	1¼	1.25	1¼	1.50
Total Cost....			\$1.37		\$2.38		\$1.98		\$2.46		\$4.06

ELECTRIC WIRING COSTS

Knob and Tube Work. Table 7 gives the average quantity of material and its cost, together with the amount of labor expressed in hours, required for installing a ceiling or wall electric light outlet, a convenience outlet, a single-pole switch, a three-way switch, and a four-way switch, using the knob and tube method of wiring. In this building the electric wires are installed as the house is being built, and are all in place before the building is lathed and plastered. The installing of the receptacles and switches is not done until after the plastering has been completed.

The column at the left of this table marked "Item" gives a list of the different materials that are used in connection with knob and tube electric-wiring work. It can be used as a guide in order to prevent overlooking other items. The item "convenience outlet" refers to the receptacle which is placed inside a switch box, and the brass cover or plate which is placed over the receptacle after it is put in place.

The term "miscellaneous" includes nails, screws, tape, solder,

and other small items used in connection with electric-wiring work, and can only be approximated as so much for each outlet. The cost of drop cords and sockets or fixtures is not given, because the cost of these will vary with different localities.

In some localities the owner will take out a permit, while in others the contractor will pay for it and include it in his price. This permit is obtained from the City Electrical or Inspection Department, which inspects the wiring after it has been completed. The labor cost is figured at \$1.00 per hour, and where wages are higher the labor cost can be easily obtained by multiplying the rate per hour by the time in hours.

The column marked "Ceiling or Wall Light Outlet" refers to an outlet installed in the center of the room or on the side wall. The word quantity refers to the number of feet or pieces of material required for that outlet. The next column marked "Cost" is the cost of the items listed under the heading "Quantity." Thus the cost of 7 knobs at \$13.00 per thousand is $\frac{7}{1000}$ of \$13.00, which is 9 cents, or \$.09. The column marked "Convenience Outlet" gives the cost and kind of material required for installing a convenience outlet. These convenience outlets are located on the side of the wall near the base-board or floor, and in some localities are referred to as base-board outlets or receptacles.

A single-pole switch is a switch that is used to turn on and off the light in the center of the room. This type of switch opens only one side of the circuit, as distinguished from a double-pole switch, which opens both sides of the circuit. A single-pole switch is always installed on the "hot" or "live" side of the circuit, which is the wire that is not grounded or connected to ground. This is the black insulated wire.

A three-way switch is used when you desire to turn on and off the lights from two places. Thus, two three-way switches would have to be installed in order to turn the light on and off from two places. The quantity of material listed is for each individual three-way switch. When it is desired to be able to turn on and off the lights from three places, two three-way switches and a four-way switch must be used. The list of material and the cost of a four-way switch are given in the last column of this table. The cost of an installation using two three-way and one four-way switches would

TABLE 8
Material and Labor Cost for Installing Armored Cable in a New House

ITEMS	UNIT COST	CEILING OUTLET IN BASEMENT		CEILING OR WALL LIGHT OUTLET		CONVENIENCE OUTLET		SINGLE-POLE SWITCH		3-WAY SWITCH		4-WAY SWITCH	
		Quantity	Cost	Quantity	Cost	Quantity	Cost	Quantity	Cost	Quantity	Cost	Quantity	Cost
No. 14 2-Con. Cable	\$37.00	20 ft.	\$0.74	16 ft.	\$0.59	25 ft.	\$0.93	14 ft.	\$0.52	8 ft.	\$0.30		
No. 14 3-Con. Cable	60.00									12 ft.	.72	20 ft.	\$1.20
Cable Box11												
Conduit Box . .	.08	1	.08	1	.08								
Box Support . .	.12	1	.12	1	.12								
Switch Box . .	.11					1	.11	1	.11	1	.11	1	.11
Switch Box Support . .	.10					1	.10	1	.10	1	.10	1	.10
3/4" Fixture Stud03			1	.03								
Cable Connectors03	2	.06	2	.06								
Cable Bushings01					2	.02	2	.02	2	.02	2	.02
Conduit Straps	1/4c	8	.02	4	.01	12	.03	3	.01	5	.01	4	.01
Convenience Outlet30					1	.30						
S. P. Switch30							1	.30				
3-Way Switch40									1	.40		
4-Way Switch . . .	1.75											1	1.75
Miscellaneous Permit03		.03		.03		.03		.03		.03
Labor Hours	1.00	1/2	.50	1/2	.50	3/4	.75	3/8	.66	3/8	.87	1	1.00
Total Cost			\$1.55		\$1.42		\$2.27		\$1.75		\$2.56		\$4.22

be two times the cost of a three-way switch plus the cost of one four-way switch.

Armored Cable Wiring. Table 8 gives the material and labor costs for electric wiring, using armored cable in a new house or residence that is being built. The armored cable is put in place when the outlet boxes are installed, which is before the building is plastered and lathed. Then after the building has been lathed and plastered, the switches and receptacles are placed in the switch and outlet box, and the brass plates are fastened in place.

In the column marked "Items" the different items that are used in connection with armored cable wiring are given in order to form a guide in estimating the material required for the different outlets. Armored cable is manufactured having either two wires or conductors or three wires inside of the steel covering. The cable box referred to in this column is an outlet box with the cable connectors fastened inside the box. This type is used in some localities in place

TABLE 9
Service for Two-Story House

ITEMS	UNIT COST	2-WIRE				3-WIRE	
		1 or 2 CIRCUITS		3 or 4 CIRCUITS		5 to 8 CIRCUITS	
		Quantity	Cost	Quantity	Cost	Quantity	Cost
3/4" Conduit.....	\$ 8.00	20 ft.	\$1.60	20 ft.	\$1.60	20 ft.	\$1.60
1/2" Conduit.....	6.00	15 ft.	.90	15 ft.	.90	15 ft.	.90
No. 8 Neutral Wire.....	18.00	40 ft.	.72	40 ft.	.72	40 ft.	.72
No. 10 Wire.....	14.00	25 ft.	.35	25 ft.	.35	50 ft.	.70
Meter Board.....		1	.75	1	.75	1	.75
Meter Service Switch.....		1	3.00	1	4.50	1	3.75
Double Branch Cutouts.....	.25					4	1.00
3/4" Type F E Condulet.....		1	.50	1	.50	1	.50
3/4" Type L B Condulet.....		1	.50	1	.50	1	.50
Ground Clamps.....	.05	8	.40	8	.40	10	.50
Fuse Plugs.....	.04	3	.12	5	.20	12	.48
Miscellaneous Material.....			.15		.15		.15
Permit.....							
Labor—Hours.....	1.00	7	7.00	7	7.00	9	9.00
Total Cost.....			\$15.99		\$17.57		\$20.55

of a conduit box and cable connectors. The conduit straps or pipe straps, as they are often called, are small clamps used to fasten the armored cable to the frame work of the building in order to hold it in place.

The column marked "Ceiling Outlet in Basement" refers to an outlet which is located in the basement. The basement is not usually plastered and therefore the cable is fastened directly to the under side of the floor joists of the floor above.

The other items in this table are very similar to those in Table 7. The cost of outlets does not include the cost of installing drop cords or electric-lighting fixtures. The reason for this is that each customer will select his own electric-light fixtures, and in many cases these are installed by the fixture wireman or by some one working for the dealer in electric fixtures. When drop cord lights are desired, then the cost of installing these can usually be estimated from the material required and the approximate time required to do this work.

Service Wiring. In Table 9 is given the list of material, quantity, and cost of installing a service having from one to eight branch circuits. These costs are for a two-story house occupied by one family. It is the customary practice to consider each circuit as having about 660 watts, which would be equivalent to eleven 60-watt lamps. The quantity of material required will, of course, vary in different localities, and with different types of residences. However, the quantity of material can be checked off very closely from an

installation already in place. In this way Table 9 can be revised, and likewise the cost changed, to correspond with the cost in each locality. By checking the estimate with three or four jobs the average quantity of material required can be easily obtained, and the total cost of the service could be estimated.

In this table, No. 8 wire was used for the neutral and for the ground connection. In some towns and cities the local ordinance requires that the neutral service-wire shall not be smaller than No. 8, while in other localities No. 10 neutral service wire is permitted and likewise No. 10 ground wire is permitted. In certain places $\frac{3}{4}$ -inch conduit is used for the service conduit, from the service head to the horizontal run, and a length of $\frac{1}{2}$ -inch conduit is used in the horizontal run to the service switch. In some places, the $\frac{3}{4}$ -inch conduit may be used all the way from the service head at the top or outside of the building to the service switch.

The amount of time or labor required is given as seven and nine hours. This will vary considerably, depending upon the type of building and whether or not it is necessary to drill through a brick wall or foundation. This will also vary, depending upon the speed and efficiency of the workmen doing the job.

Installing Outlets. In Table 10 the average time required to install various kinds of outlets in a new and old house is given. When installing ceiling outlets in the basement, the same amount of labor is required in a new house as in an old house, as it is not usually necessary to conceal this outlet in the basement. If the basement is plastered and it is necessary to run the armored cable or knob and tube wires back of the plaster, then the time required would be practically that for a ceiling or a wall outlet in that type of house.

When wiring an old house, which refers to a residence that has already been built, sometimes a single floor will be encountered, and sometimes there is a double floor. A single or soft-wood floor is usually nailed directly to the floor joist, while with a double or hard-wood floor, it is the customary practice to lay the finished floor on top of a rough floor which is nailed directly to the floor joist. When installing ceiling outlets, it is sometimes necessary to raise up the floor board in the floor above where the outlet is being installed, in order to make connections and to be able to install the armored cable or the wires with knob and tube work. When there is a hard-

TABLE 10
Time Required to Install Outlets

KIND OF OUTLET	ARMORED CABLE WORK			KNOB AND TUBE WORK		
	NEW FRAME HOUSE	OLD HOUSE		NEW FRAME HOUSE	OLD HOUSE	
		Soft- Wood Floor	Hard- Wood Floor		Soft- Wood Floor	Hard- Wood Floor
Ceiling Outlet in Basement. . . .	$\frac{1}{2}$	$\frac{1}{2}$	$\frac{1}{2}$	$\frac{3}{4}$	$\frac{3}{4}$	$\frac{3}{4}$
Ceiling or Wall Light Outlet. . . .	$\frac{1}{2}$	$1\frac{1}{4}$	2	$\frac{3}{4}$	$1\frac{1}{2}$	$2\frac{3}{4}$
Convenience Outlet.	$\frac{3}{4}$	$1\frac{1}{2}$	$2\frac{3}{4}$	$1\frac{1}{4}$	$2\frac{1}{4}$	3
Single-Pole Switch.	$\frac{3}{4}$	$1\frac{1}{2}$	$2\frac{1}{2}$	1	$1\frac{1}{2}$	3
Three-Way Switch.	$\frac{3}{4}$	$1\frac{3}{4}$	$2\frac{1}{2}$	$1\frac{1}{4}$	2	$3\frac{1}{4}$
Four-Way Switch.	1	$1\frac{3}{4}$	$2\frac{1}{2}$	$1\frac{1}{2}$	$2\frac{1}{4}$	$3\frac{1}{2}$
Rigid Conduit Service Fuse	1 to 4 Circuits	7	7			
Blocks and Cabinet, Wired Complete		9	9	9		

wood floor that must be removed, it is necessary to remove the floor boards, then cut out some of the rough flooring in order that the cable can be laid in place. This requires more time and work than with a single or soft-wood floor. Thus, when you encounter a single floor, you would use the column marked "Soft-Wood Floor" and when you encounter a floor that is laid on top of a rough floor, then use the "Hard-Wood" column.

There are, of course, many installations where the time required for installing these different outlets is much greater than that given in this table, due to special conditions. This table refers to the average conditions for a frame house, usually two stories high.

It is customary practice to use rigid conduit service wiring with armored cable work. This type of service is often used with concealed knob and tube work. Where this kind of service is used with knob and tube wiring, the labor costs would be identically the same as for armored cable work.

In this table the time for installing the service does not include the time required to run the wires from the meter box or switch box to the first outlet on the branch circuit. In the first outlet on a branch circuit the wires are run directly from the meter box to that outlet, and may require slightly more time than is given for outlets in this table. When the distance from the fuse box or meter to the first outlet is long and the wiring is rather difficult to install, then additional time should be added for branch circuit wiring to the first ceiling outlet. This table represents the average time re-

quired by workmen who are familiar with the methods of wiring certain type residences, using the same type of materials with which they are familiar. If the type of work should be changed from armored cable to knob and tube, or the reverse, and the workmen are not familiar with that kind of work, then the length of time would be much greater and could be easily double that given in these tables. Thus, when new men are doing that kind of work, the time should be increased in proportion.

Estimating Cost of Electric Wiring. The Tables 7, 8, 9 and 10 are presented in order to aid in determining the data and information which should be selected from wiring jobs in order to have enough information available to enable a wireman to estimate the cost of installing a similar job. The costs and amount of time required for a wireman to install various types of outlets, services, etc., as given in these tables, should not be considered as a fixed or arbitrary rule, to be followed in every case. The wiring conditions are different in each locality, and every wireman should keep a record of the approximate amount of material, labor, etc., required to install a certain job. Then from this, the cost of installing different outlets can be obtained. By doing this, a table very similar to those given in this section can be prepared and will be of great help to the wireman in preparing a bid on a job.

When preparing a bid on a job it is sometimes not advisable to take the time to go over the plans, or to take the necessary measurements in the case of a building already constructed, in order to calculate the exact amount of wire, cable, switches, outlet boxes, etc., that would be required for the job. Then the cost of wiring the building can be obtained by multiplying the cost of the different kinds of outlets by the number of outlets and adding the cost of service wiring, permit, etc.

There are a large number of factors that enter into the construction of a building, which determine the amount of time required to install the wiring in the building. Some of these causes are delays due to the lack of material, unable to carry on the work regularly due to interference from workmen of other building trades, lack of proper information for the location of outlets in the building plan, and in the case of buildings that are already constructed, encountering hidden and unexpected objects which take time to remove or pass around.

In all these tables the actual cost of labor and material has been considered. No calculation has been made to include the overhead and profit that the contractor should make on the job. It is considered best that the contractor know the actual cost of material and labor, and then he can determine the percentage that he would have to add for overhead and profit. The overhead is a term used to include the cost of securing the contract, and interest on the money the contractor has invested in the material he has purchased for the job, for which he will not receive any money until the job has been completed. Overhead also includes the cost of ordering the material, delivering tools and material from the contractor's shop to the job, and returning tools and unused material to the shop when the job is completed. It also includes the salary of any additional help who were employed in looking after the shop, answering the phone, and doing other similar work, which cannot be charged directly to any particular job. In fact a certain amount of time must be spent in preparing estimates on jobs for which someone else may receive the contract. These conditions must be determined by each contractor, and no definite rule can be given that would be of aid and assistance in doing this work. The overhead cost will usually be somewhere between 10 and 40 per cent of the labor and material cost.

INDEX

*The page numbers of this volume will be found at the bottom of the pages;
the numbers at the top refer only to the section.*

	PAGE		PAGE
A		Cable Wiring—continued	
Adapters	128	wiring switches	98
Anchoring or fastening devices	155	Capacities of conductors	50
home-made anchorage	157	Catenary or messenger-cable support	153
Rawl drives	157	Chase nipples	119
Rawl plugs	157	City codes	27
screw-anchors or expansion-shells	156	Code standards	50-54
toggle-bolts	155	Concealed knob and tube wiring	39
Apartment building wiring	215-247	conductors	40
final work	246	heating insulation	43
finishing work	240	outlet boxes	40
obtaining contract	219	wall switches	42
preliminary work	221	where used	39
roughing in conduit	225	wiring old buildings	43
Armored cable wiring	345	Conductors	40, 50
		Conduit dies	166
B		Conduit expansion joints	116
Beam clamps	152	Conduit fittings	110
Benders and hickies	167	bushings and locknuts	110
Bushings and locknuts	110	Chase nipples	119
		conduit expansion joints	116
C		conduit pennies	120
Cable splices	46	condulets and unilets	114
Cable Wiring	55-106	in hazardous locations	120
concealed work in new buildings	79	knockout closers and reducers	119
concealed work in old buildings	82	outlet boxes	110
cutting openings	83	self-threading connectors	118
equipment ground	65	thread-less connectors or couplings	116
fishing cables	90	wire and cable supports	115
installing cables and boxes	71	Conduit pennies	120
outlet box connectors	70	Conduit supports	149
outlet and junction boxes	61	beam clamps	152
protected conductors	55	catenary or messenger-cable support	153
when and where to use cables	58		

Note.—For page numbers, see foot of pages.

	PAGE		PAGE
Conduit supports—continued		E	
pipe clamps	151	Elbows	108
pipe hangers	150	Electric wiring costs	343, 349
pipe straps	149	Electric wiring rules	12
supports on steel-truss roofs	152	Electrical materials, questions and answers	307-350
Conduit tools	161	Ells	127
benders and hickies	167	Estimating electrical wiring	301-350
conduit dies	166		
die and die stock	163	F	
fish tape	177	Factory building wiring	249-299
hack saw	162	arranging outlets on circuits	
hydraulic bender	170	in basement	263
knockout cutters	171	on main floor	269
nipple chuck	173	on second floor	276
pay-out reels	182	on third floor	281
percussion drills	175	circuits—outlets—switches	259
pipe pliers, wrenches, and tongs	166	conduit fittings	293
pipe vise	161	construction of building	249
pulling-in equipment	179	installing	
reamer	163	lighting fixtures	297
twist drills	174	lighting fuse cabinets	295
wire reels and jacks	182	meters and switches	289
Conduit wiring materials	107-159	layout	
anchoring or fastening devices	155	of basement	262
conduit fittings	110	of main floor	268
conduit supports	149	of second floor	275
grounding	128	of third floor	281
rigid conduit	107	location of light and power	
steel boxes and cabinets	134	cabinets	259
thin-wall conduit	125	location of outlets	252
wire capacity of conduit	158	requirements for power	251
Conduit wiring, tools and methods	161-214	size of lamps	258
conduits in concrete	211	total lighting load for building	287
installing outlet boxes	184	Fish tape	177
tools	161	Fishing cables	90
Conduits in concrete	211	Flexible tubing	43
Condulets and unilets	154	Floor boxes	208
Connectors	128		
Couplings	110, 127	G	
Cutting openings	83	Grounding	128
D		H	
Die and die stock	163	Hack saw	162
Drills and drilling	174	Heat insulation	43
		Home-made anchorage	157
		Hydraulic bender	170

Note.—For page numbers, see foot of pages.

	PAGE		PAGE
I			
Installing lighting fixtures	297	Open conductors—continued	
Installing lighting fuse cabinets	295	protection on ceiling, side	
Installing meters and switches	289	walls, and floors	32
Installing outlet boxes	184	separation of conductors	28
Installing outlets	347	stringing wires	39
Insulations, conductor	52	supports for wires	35
K			
Knob and tube wiring	27-54	Outlet box installation	184
concealed knob and tube wiring	39	concrete slab and joists	194
conductor insulations	52	flat-slab concrete	189
current-carrying capacities		floor boxes	208
of conductors	50	frame construction	205
locating outlets and switches	26	outlets in concrete columns	209
methods of wiring	11	outlets exposed on ceiling	204
number of conductors in		outlets in thin partitions	205
conduit	54	tile arch construction	201
open conductors	27	Outlet boxes	40, 110
splicing wires and cables	44	Outlets and switches	26
Knockout closers and reducers	119	P	
Knockout cutters	171	Pay-out reels	182
L			
Labor calculations	330	Percussion drills	175
M			
Material, amounts of	307	Pigtail splice	45
Meter fittings	18	Pipe clamps	151
N			
National Board of Fire Under-		Pipe-hangers	150
writers' approved method		Pipe pliers, wrenches, and tongs	166
of wiring	11	Pipe straps	149
National Electrical Code		Pipe vise	161
standards	50-54	Pull boxes	146
carrying capacities of		Pulling-in equipment	179
wire	50, 51, 232	Push-button switches	98
insulation for conductors	51-53	R	
maximum wires in conduit	54	Rawl drives	157
Nipple chuck	173	Rawl plugs	157
O			
Open conductors	27	Reamer	163
city codes	27	Rigid conduit	107
insulators	28	couplings	110
precautions against dampness		elbows	108
and acid fumes	35	sweeps	109
		tubing	107
		Rules for electric wiring	12
		S	
		Screw-anchors or expansion-shells	156
		Self-threading connectors	118
		Service or entrance switch	22
		Service wires	242

Note.—For page numbers, see foot of pages.

	PAGE		PAGE
Service wiring	11, 26, 346	Tables—continued	
kind of service entrance	16	lighting schedule	272, 280
locating service entrance	13	material and labor cost	340, 343, 345
meter fittings	18	nonmetallic sheathed cable in-	
service or entrance switch	22	stalled in new frame	
Sleeve joint	48	house	336, 341
Solid wires	44	schedule of lights and outlets	220
Specifications for electrical work	302	service for two-story house	346
Splicing and testing wires	245	survey-estimating form	331-333
Splicing wires and cables	44	third floor lighting schedule	233
cable splices	46	time required to install outlets	348
sleeve joint	48	total building load	238
solid wires	44	total building outlets	238
Steel boxes and cabinets	134	weight per square foot and	
box layout	141	thickness of sheet steel	145
construction	135	wire for branch circuits	320
mounting pull boxes	146	Tee tap splice	46
size	134	Testing for grounds	246
use	134	Thin-wall conduit	125
weight of boxes	146	adapters	128
Steel-truss roof supports	152	connectors	128
Sweeps	109	couplings	127
Switches	98	ells	127
Switches and receptacles	246	tubing	125
Symbols	342	Thread-less connectors or cou-	
		plings	116
		Toggle-bolts	155
		Tubing	107, 125
		Twist drills	174
		W	
		Wall switches	42
		Wire and cable supports	115
		Wire capacity of conduit	158
		Wire reels and jacks	182
		Wiring costs	343, 349
		Wiring installation	13
		Wiring materials—see Conduit	
		<i>wiring materials</i>	
		Wiring old buildings	43
		Wiring order	24
		Wiring switches	98
		master switches	105
		push button switches	98
		three-way switches	102
		wall switches	42

Note.—For page numbers, see foot of pages.

DATE OF ISSUE

This book must be returned within 3/7/14 days of its issue. A fine of ONE ANNA per day will be charged if the book overdue.

--	--	--	--	--	--

