

BIRLA CENTRAL LIBRARY

PILANI (RAJASTHAN)

Class No. 591.954

Book No I 2 F

Accession No. 85223

THE FAUNA OF BRITISH INDIA,

INCLUDING

CEYLON AND BURMA.

*PUBLISHED UNDER THE AUTHORITY OF THE SECRETARY OF
STATE FOR INDIA IN COUNCIL.*

EDITED BY SIR ARTHUR E. SHIPLEY, G.B.E., Sc.D. Cantab., HON. D.Sc. Princeton,
HON. LL.D. Michigan, F.R.S.

HIRUDINEA.

BY

W. A. HARDING, M.A., F.L.S.,

AND

Prof. J. PERCY MOORE.

With an Historical Preface by the Editor.

L O N D O N :

TAYLOR AND FRANCIS, RED LION COURT, FLEET STREET.

CALCUTTA:
THACKER, SPINK, & CO.

BOMBAY:
THACKER & CO., LIMITED.

March, 1927.

CONTENTS.

	Page
Historical Preface. By A. E. SHIPLEY	v
Explanation of Plates	xxxiii
Systematic Index	xxxvii
Segmentation of the Hirudinea. By J. PERCY MOORE .	1
Rhynchobdellæ. By W. A. HARDING	13
Arhynchobdellæ. By J. PERCY MOORE	97
Appendix to the Arhynchobdellæ. By J. PERCY MOORE .	296
Alphabetical Index	299
Folding Map of India and Ceylon.	

HISTORICAL PREFACE

BY

Sir ARTHUR E. SHIPLEY, G.B.E., F.R.S.

LEECHES are so widely spread in the temperate and in the warmer areas of this world, and come into such close contact with humanity—or at any rate certain species of them do, that it is not surprising to learn they have been widely noticed in the literature of most of the leading nations of the world, both ancient and modern.

It seems difficult to discover the word for leech in Egyptian literature, and our expert in Egyptology in Cambridge (Mr. F. W. Green, of Jesus College) has not been able to find any allusions in Egyptian writings to leeches as blood-suckers. It seems improbable that leeches were used in Ancient Egypt for blood letting. However, in that country a learned doctor was using cupping somewhere about the fourth century B.C.

The record of the leech (colloq. *shui chih*; book language *ch'i*) in early Chinese literature is scanty, and no distinction of species was recognized until modern times. The earliest mention in Chinese literature occurs in the *Erh Ya*, if this work is really a B.C. book, which is very doubtful. This account has an illustration. In the *Lun Hêng* by Wang Chung, who flourished A.D. 27–29, there is a long story of a King who swallowed a leech with his salad. The King, who was suffering from constipation of blood, found himself cured by the action of this blood-sucking worm, “just as men suffering from the skin-disease known as *rat*, can be cured by eating a cat.”

The *Po wu chih*, an ancient work re-edited, says that if you chop a leech into three pieces, you will have three leeches.

There is no record that leeches in nature ever regenerate part of their body as is the case with earthworms and some other Chætopods, but it may be that the author mistook one of the Turbellarians for a leech.

I am indebted to the kindness and learning of Professor H. A. Giles, of Cambridge, for the above information.

In Assyrian literature there seem to be few references to leeches, but it has been suggested, with every probability, that the word *ilqitu* in Cuneiform Texts from Babylonian Tablets in the British Museum, xiv, Pl. 9, K. 4373, i-ii, 26, and Pl. 10, K. 4218, a, iv-iii, rev. 1, is the same as the Syriac *alqēthā* "leech," but we have no knowledge of it having been used in medical texts. The word *ilqitu* occurs in a scanty list of insects and animals probably drawn up for school use. These lists are very common in Assyrian texts. As a rule the lists are in two columns, a Sumerian word to the left and an Assyrian equivalent opposite. There are lists of gods, stars, officers, buildings, vessels, clothes, animals, in fact, of almost everything.

I am indebted for this information to Mr. C. P. T. Winckworth, Yarrow Lecturer in Assyriology at Cambridge, and to Mr. R. Campbell Thompson, of Merton College, Oxford.

Those texts which have come down from Assyrian times and which deal with medicine, are mainly confined to drugs rather than to minor operations, though frequently directions are given as to shaving the head and a preparation of poultices.

"The Arabs and Persians certainly used leeches for blood-letting, and under '*alak* (leech) Damiri's Zoological lexicon gives the following sentences : 'Certain black and red worms found in water, that cling to the body and suck blood. They are one of the remedies for (diseases of) the throat and inflammatory swellings, on account of their property of sucking blood in excess in any person. It is related in a Tradition of the Prophet, handed down by 'Āmir, that the best of remedies are leeches and cupping.'

There must be other references, but so far I have not been able to put my hand upon them." The quotation just given was sent to me by Professor R. A. Nicholson, of Trinity College.

Professor Rapson informs me that the leech is often mentioned in Sanskrit literature and that it has many names, the most common being raktapā, "blood-drinker"; jalauka, "water-dweller"; jala-sarpinī, "water-glider."

I have also had much help from Professor R. L. Turner, and both he and the Professor have drawn my attention to Jolly's book: [*"Medicin"* von Julius Jolly. Grundriss der Indo-Arischen Philologie und Altertumskunde (Encyclopedia of Indo-Aryan Research), Strassburg, Karl J. Trübner, 1901], where the following account is given of bleeding:—

"Bleeding. The mildest method of Bleeding is the use of leeches, which therefore are especially suitable for princes, wealthy people, children, old men, weak, nervous and delicate people and women. Avoiding the poisonous species, whose bite produces swellings, excessive irritation, fever, delirium and other bad symptoms, only the six non-poisonous species should be employed. The leeches must be kept in a large, new vessel, filled with mud and water from a pond, new water and food being given them every three days and the vessel being changed now and again. The places affected are rubbed dry with a powder of earth and dry cow-manure, then the leech is applied, after it has been irritated by painting its body with prepared mustard (literally mustard-dough) and by being immersed in water. If it will not bite in, a drop of milk or blood should be applied to the place or slight incisions made. If the leech, becoming greedy, will not let go, paint honey or powdered salt into its mouth. In order to make the leeches good for further use, they must be made to expel the blood they have imbibed. If the blood is still uncleansed the bitten places must be made to bleed by rubbing in honey and syrup. When (enough) blood has flowed the wound must be immediately rinsed out with cold water and covered with cotton, steeped in fat; in addition, sweet cold poultices, to contract the wound, should be made. When the bad blood is gone the swelling becomes soft, the burning redness and pain disappear."

Professor Turner, of the London School of Oriental Studies, tells me that there are a number of variants of the word for *leech* used in Sanskrit, including

- jalaukas, m. (Suśruta).
- jalaukasa, m. (Suśruta).
- jalauka, m. (Suśruta).
- jalaukā, f. (Mahābhārata).
- jalūkā, f. (Lexicographers).

Jalaukas is said to mean "having water as its home," derived from jala, water; okas, home. The modern languages (Sindhi jarū f., Hindī jalū f.) point to the form quoted by the Lexicographers jalūkā, and the form jalaukas is very likely a piece of learned etymology. The modern languages have another word reminiscent of, but not derivable from, the Sanskrit name (*e.g.* Nepāli juko m., Hindī jök f.). It appears likely that the Aryans borrowed the word for leech from the aboriginals, one form of the word being that which appears in Sanskrit jalūkā Sindhi jarū, etc., the other that which appears in Nepāli juko, etc.

In view of the fact that the word first appears in literature in the Mahābhārata (c. 500 B.C.?), it may be interesting to note that Sinhalese appears to have no derivative of the jalūkā-juko family. According to tradition Ceylon was colonised first by Aryans in c. 500 B.C., a date which agrees with the linguistic evidence.

The apparent absence of a common Indo-European word for leech supports the suggestion that the Indo-Aryan word was borrowed.

In his Introduction to the Arhynchobdellidæ, Professor Moore refers to the thirteenth chapter of the English translation of the Sushruta * Samhitā, by Kunja Lal Sharma. Unfortunately the date of this work is unknown, and very little is known about the author. The translator says—"In a country like India where life itself was regarded as an illusion, the lives of kings or commoners were deemed matters of little moment to the vital economy of the race,

* Nowadays Sushruta is usually spelt Suśruta.

and all historians and biographers were looked upon as the embodiment of the flimsy vanities of life." It is very probably earlier than 400 A.D.

I here transcribe certain portions of the chapter from the *Sushruta Samhita*, which are again discussed in Professor Moore's article (v. p. 116.).

Now we shall discuss the chapter which treats of leeches and of how and which to use (*Jalaukāvachāranīyam-adhyāyam*).

Leeches should be applied where the patient would be found to be old or imbecile, or a woman, or an infant, or a person of an extremely timid disposition, or a person of a delicate constitution, and as such is not fit to be surgically operated upon, since this mode of bleeding is the gentlest that can be possibly devised. The blood vitiated by the deranged wind (*Vāyu*), bile (*Pittam*), and phlegm (*Kapham*), should be respectively sucked through a horn, by leeches and a gourd appliance (*Alāvu-Yantra*) or with whichever of them is available at the time, irrespective of the cause of such vitiation, whenever such bleeding or sucking would be found to be imperatively necessary.

Authoritative verses on the subject:—A cowhorn is described in the *Shastras* as of a hot or heat-making potency, and as possessed of a slightly cooling (*Snigdha*) or soothing (*Madhura*) property. Accordingly it should be used in sucking the blood vitiated through the action of the deranged bodily wind. Leeches, which are born in water, are possessed of *Madhura* (sweet or soothing) properties, and hence they should be used in sucking the blood vitiated through a deranged condition of the bile (*Pittam*). The gourd (*Alāvu*) is pungent, parching and irritating in its potency and should be therefore used in sucking the blood vitiated through the action of the deranged phlegm (*Kapham*).

Mode of application:—The part from which the blood is to be sucked should be first scarified or slightly cut in two or three places, and then the mouth or the open end, of the horn, covered with a thin piece of muslin tied round its edges should be placed over it and sucked with the mouth.

through the aperture at its tip or top-end, or with a gourd appliance equipped with a lighted lamp placed in its inside.

The term Jalauká (leeches) may be etymologically interpreted to mean creatures whose life (Áyu) or whose longevity is in, or depends upon, water, whereas the derivative meaning of the term Jalauka (leeches) is based upon the fact of their dwelling ("Oka"—dwelling place) in water (Jalam). Leeches may be divided into twelve distinct species, of which six are venomous and six non-venomous. The six venomous species are named Krishná, Karvurá, Alagardá, Indráyudhá, Sámudriká and Gochandaná. The leeches of the first-named species (Krishná) are marked by thick heads, and of a colour resembling powdered lamp-black. The leeches of the Karvurá type have extended or elongated bodies like the Varmifishes, and are indented and thick at the waist. The Alagardá leeches are hairy, thick and round at the sides, and black at the mouth. The leeches of the Indráyudha species are marked on the surface with up-pointed rainbow coloured lines. The skins of the Sámudrikás are blackish-yellow, dotted over with white spots of a variety of shapes. Leeches which are provided with narrow mouths, and are marked by bifurcating line at the bottom like the scrotal sac of a bull are called Gochandanás.

A person bitten by any of the abovesaid venomous leeches has an irresistible inclination to scratch the seat of the bite which is marked by a considerable swelling. Fever, with burning, retching, drowsiness and delirium supervenes, and ultimately the patient loses all consciousness. The remedy consists in the administration of an anti-toxic medicine known as Mahágada, as snuffs, potions and unguents, etc. A bite by an Indráyudha usually proves fatal. Venomous leeches, as well as cures for their bites have thus been described.

The non-venomous species include Kapilás, Pingalás, Shankhamukhis, Musikás, Pundarimukhis, and Sarávikás. The Kapilás are coloured like Mauah-Shila (realgar) at the sides, and their backs are tinged with a glossy hue like that of a Mudga pulse. The Pingalás have a reddish colour, are round in shape, and capable of speedy locomotion. The

Shankhamukhis are marked by a blackish red hue like that of the liver, are provided with sharp elongated mouths, and are capable of sucking blood with the greatest swiftness. The Musikás are coloured like the common blind moles, and emit a fetid smell from their bodies. The Pundarimukhás are coloured like the Mudga pulse, and are so-called from the fact of the resemblance of their mouths to the full-blown lotus lilies (Pundarikas). The Sarávikás have cold bodies marked with impressions like lotus leaves and measure eighteen fingers' width in length, and they should be employed in sucking blood from the affected parts of lower animals. This exhausts the list of non-venomous leeches.

The countries, such as Turkestan (Yavana), the Deccan (Pandyá), the tract of land traversed by the Ghaut mountains (Sahya), and Pautana (modern Mathura), are the natural habitats of these leeches. The leeches found in the aforesaid countries are specifically non-venomous, strong, large-bodied, greedy and ready suckers.

The venomous leeches have their origin in the decomposed urine and fæcal matter of toads and venomous fishes in pools of stagnant and turbid water. The origin of the non-venomous species is ascribed to such decomposed vegetable matter, as the petrified stems of the several aquatic plants known as Padma, Utpalam, Nalina, Kumuda, Pundarika, and the common zoophytes which live in clear waters.

Authoritative verse on the subject:—The non-venomous leeches swim about in sweet scented waters, live on non-poisonous weeds, lie on the leaves of flowering water plants instead of on the dank and oozy beds of pools, and suck blood from the affected part of a human organism without causing any discomfort.

Leeches should be caught hold of with a piece of wet leather, or by some similar article, and then put in to a large-sized new pitcher filled with the water and ooze or slime of a pool. Pulverised zoophytes and powder of dried meat and aquatic bulbs should be thrown into the pitcher for their food, and blades of grass and leaves of water-plants should be put into it for them to lie upon. The water and the edibles should be changed every second or third day, and the pitchers should be changed each week (the leeches should

be transferred to a new pitcher at the end of every consecutive seven days).

The authoritative verse on the subject :—Leeches that are venomous, thick about the middle, elongated, of slow locomotion, look fatigued, do not readily take to the part they are applied to, and capable of sucking only a small quantity of blood, should be looked upon as not belonging to the proper or the commendable type.

Then having seated or laid down the patient suffering from a disease which requires the application of leeches, the seat of bleeding, if not previously ulcerated, should be roughened by dusting it over with a composition of loose earth and pulverised cowdung. Then the leeches should be taken out of their receptacles and sprinkled over with water saturated with mustard seed and pasted turmeric. Then for a moment they should be kept in a basin full of water, and after they have regained their natural vivacity and freshness, they should be applied to the affected part. Their bodies should be covered with a piece of thin and wet linen, or with a piece of white cotton. The affected part should be sprinkled over with drops of milk or blood, or slight incisions should be made into it in the event of their refusing to stick to the desired spot. Other fresh leeches should be applied even when the preceding measures should prove ineffectual. That the leeches have taken to the affected part may be inferred from the mouths of the leeches assuming the shape of a horse-shoe, and the raised and arched position of their necks after they had become attached to the seat of the disease. While sucking, the leeches should be covered with a piece of wet linen, and should be constantly sprinkled over with cold water.

A sensation of itching and of a drawing pain at the seat of the application would give rise to the presumption that fresh blood was being sucked, and the leeches should be forthwith removed*.

* The leeches, through a blissful dispensation of Nature in themselves, instinctively draw off the vitiated blood from a diseased part, attacking the healthy vital fluid (red blood) when the former has been completely tapped or sucked.

Leeches refusing to fall off even after the production of the desired effect, or sticking to the affected part out of their fondness for the smell of blood, should be sprinkled with the dust of powdered Saindhava (rock salt).

After falling off, the leeches should be dusted over with rice powder and their mouths should be lubricated with a composition of oil and common salt. Then they should be caught by the tail-end with the thumb and forefinger of the left hand and their backs should be gently rubbed with the same fingers of the right hand from tail upward to the mouth with a view to make them vomit or eject the full quantity of blood they had sucked from the seat of the disease. The process should be continued until they manifest the fullest symptoms of disgorging. Leeches that had vomited the entire quantity of blood sucked as above, would briskly move about in quest of food if placed in water, while the contrary should be inferred from their lying dull and inert. These should be made to disgorge again. Leeches not made to emit the entire quantity of the sucked blood stand in danger of being attacked with an incurable disease peculiar to their genus, and which is known as Indramada. The leeches should then be put into a new pitcher, and treated as before laid down, after they had fully emitted the sucked blood.

An ulcer incidental to an application of leeches should be rubbed with honey or washed with sprays of cold water, or bound up with an astringent (Kasháya) sweet and cooling plaster, according to the quantity of blood removed from the part*.

Authoritative verse on the subject:—The physician who is fully conversant with the habitat, mode of catching,

* In case of full and proper bleeding (Yoga) the ulcer should be rubbed with clarified butter technically known as the Shatadhautam (lit. hundred times washed) Ghritam (clarified butter), or a piece of cotton, soaked in the same substance, applied as a compress over the part. The ulcer should be rubbed with honey in a case of insufficient bleeding, while it should be washed with a copious quantity of cold water if excessive bleeding (Ati-Yoga) should set in. Similarly in a case marked by the absence of any bleeding at all (Mithyá-Yoga) a sour, sweet and cooling plaster should be applied over the ulcer.

pleased at the help which he receiveth, and hurteth not the sandpiper at all." (Tr. A. L. P.)

The bird that Herodotus here refers to appears to be the Egyptian Spur-wing Lap-wing (*Hoplopterus armatus*) which frequents the banks of rivers, lakes and canals. It is locally known as "Zic-zac." Mr. J. M. Cook, who has observed the habits of this lap-wing, records how the bird apparently hops into the open mouth of the crocodile—the crocodile opens its jaws, the bird hops in, the crocodile closes its jaws, and in a few moments the crocodile opens its mouth again and the bird flies away to the water's edge. What it did there the observer was unable to determine; but it repeatedly returned to the crocodile and entered its mouth, which was at once closed for about a minute. To put one's body into the mouth of a crocodile seems a rash and daring deed, but the bird showed no fear.

On the other hand, Gadow says that the bird described by Herodotus under the name *Trochilus* is supposed to be a Plover known as *Pluvianus aegypticus*. The latter writer makes no reference to the crocodile's jaws closing over the bird. He thinks they pick the teeth of the crocodiles while the animals are resting with their mouths wide open, and they are very watchful and have a well-known note of warning.

Dr. Gadow thinks they may be helpful in a second way to the crocodiles by giving them the alarm when danger is approaching.

Poirier et Rochebrune (1884, p. 1597) consider this leech to be *Lophobdella* (= *Ozobranchus*) *quatrefagesi*.

Johannson (1913, p. 13) regards it as his *Clepsine* (= *Glossiphonia*) *fibriata*.

Poirier et Rochebrune (A. T. de), 1884: "Sur un type nouveau de la classe des Hirundinées," in *Compt. rend. Acad. Sci.* t. xcviij, p. 1597.

Moquin-Tandon & Diesing describe this leech as *Lunatis nilotica*.

Celsus, who flourished about A.D. 50, wrote:—"If a leech have been swallowed, salt and vinegar must be drunk." (*De Medicina*, v, 27; tr. Alex. Lee, 1836.)

Pliny, who died in A.D. 79, devotes a good deal of attention to the leech, and I quote numerous passages from his *Natural History*.

“On the contrarie side, the horsleeches which wee call in Latine Sanguisugas (*i. e.* Bloudsuckers), are used for to draw bloud. And verily it is judged, that there is the same reason of them, as of ventoses and cupping-glasses used in physicke, for to ease and discharge the bodie of bloud, and to open the pores of the skin. But here is all the harme and discommoditie of these horsleeches, That if they be once set too for to draw bloud, the bodie will looke for the same physicke againe everie yeere after, about the same time, and be ill at ease for want thereof. Many physicians have thought it good to use them for the gout of the feet also. Well, set them to the hæmorrhoids, and where you will, they fall off lightly when they are full and satisfied, even with the verie weight of the bloud which pulleth them down; or else by strewing some salt about the place where they sticke too: and otherwhiles it falleth out, that they leave their heads behind them fast fixed in the place where they settled, and by that means make the wound incurable and mortall, which hath cost many a man his life: as it happened to *Messalinus* a nobleman of Rome, and who in his time had been a Consull, whose fortune it was to die thereupon, having set them to his knee: whereby we may see, that oftentimes they bring a mischief for a remedie; and the red ones are they that in this respect ought to be feared. To prevent therefore this daungerous inconvenience, they use with a paire of sizzers to clip them at the verie mouth as they be sucking; and then shall you see the bloud spring out, as it were at the cocke of a conduit, and so by little and little as they die they will gather in their heads, and the same will fall off, and not tarrie behind to doe hurt. These horsleeches naturally are enemies to Punaises, in so much as their perfume killeth them. Furthermore, the ashes of Bevers skins burnt and calcined together with tar, stauncheth bloud gushing out of the nose, if the same bee tempered and mingled well

with the juice of porret." (N. H. xxxii, 10 ; Transl. of Pliny throughout by Philemon Holland, 1601.)

Medecines against the shedding of haire. For to colour the haire of the head. Also against the accidents of the ears, teeth, and visage. "If one be disposed to colour the haire of the head blacke, let him take horse-leeches which have putrified and been resolved together in some grosse red wine for the space of threescore daies, hee shall find this to be an excellent medecine. Others there be who give order, to put as many horseleeches as a sextar will hold, in two sextars of vinegre, and let them putrifie within a vessell of lead as many daies together ; and when they bee reduced into the forme of a liniment, to annoint the haire in the sunshine for the same purpose. And *Sornatius* attributeth so much power unto this composition, that unlesse they that have annointing of the haire with it hold oile in their mouths all the while, their teeth also (by his saying) who have the doing of it, wil turn black." (N. H. xxxii, 7.)

"The same depilatorie effect, the ashes of Horseleeches are supposed to have, if they bee reduced into a liniment with vinegre, and used accordingly : Now must they bee burnt and calcined in a new earthen vessell that never before was occupied." (Ibid.)

"Moreover, horseleeches torrified in some earthen pan, and brought into a liniment with oile, work the same effect in the hairs (sc. 'depliatorie') : the very perfume or smoke which they cast as they be burnt or torrified, killeth Punaises But in using any depilatorie whatsoever, this one point is generally to be observed, That the haire be first pulled up by the roots, in any place, where you would not have them to grow." (N. H. xxxii, 10.)

"For the sting of Bees, Wesps, and Hornets ; for the biting also of these Horseleeches called Bloodsuckers, the Howlat is counted a soveraigne thing, by a certain antipathie in nature : also whosoever carrie about them the bill of a Woodpecker or Hickway, shall never be annoied with any of the foresaid vermine. The smallest kind of Locusts likewise, which are without wings and be called Attelabi, be adverse and contrarie unto them all." (N.H. xxix, 4.)

“As for the daunger that commeth by drinking Horse-leeches, Butyr made of Cows milke, is a singular remedie, if it be taken with vinegre, heat with a gad of steele. The same alone without any other thing is a good countre-poyson, for if oile be wanting, butter may serve the turn as well.” (N. H. xxviii, 10.)

(Of Punies or Wall-lice.) “Other receipts there be set down by our great masters in Physicke, as touching this foule vermine : but those which carie most modestie with them and have greatest respect unto manhood and humanitie, are these ; namely, to rub or annoint the place which is stung, with the said wall-lice and the bloud of a Tortoise together : also to chase away serpents, with the smoake or perfume of them : likewise, if any beast which hath swallowed down horse-leeches, doe take them in drinke, they will either kill them or drive them out, yea, and in what part soever they are settled and sticke fast, they will remove them and make them to fall off.” (N. H. xxix, 4.)

“Over and besides all which, there is not an hearbe growing in the garden that is so much used for the curing of foure footed beasts, whether it bee that they be broken winded and pursive, or otherwise bitten and stung with venomous beasts ; in which cases, there must be an injection made up into the nostrils, of the juice of Rue in wine. Also, if it chauce that a beast hath swallowed an Horse-leech in drinking, let it be taken with vinegre.” (N. H. xx, 13.)

“They (sc. elephants) are mightily tormented with paine, if they chauce in their drinking to swallow down an horsleech (which worme, I observe, they begin now to call, a bloudsucker) : for as soone as this horsleech hath settled fast in his wind-pipe, he putteth him to intollerable paines.” (N. H. viii, 10.)

Of one kind of creature that hath no passage to void excrements. “There is a creature as foul and ill favoured as the rest, which hath evermore the head fast sticking within the skin of a beast, and so by sucking of bloud liveth, and swelleth withal. The only living creature of all other that hath no way at all to rid excrements out of the bodie ; by

reason whereof, when it is too full, the skin doth cracke and burst, and so his very food is cause of his own death. In Horses, Asses, and Mules, these doe never breed. In Kine and Oxen they be common: and otherwhiles in dogs, who are pestered not onely with these tickes, but also with all other vermine abovenamed. And in Sheepe and Goats a man shall find none other but tickes. It is as strange a thing also to see, how the horseleeches which be nourished in standing waters of fennes, are thirsty for blood. For these will thrust their whole head into the flesh for to draw and sucke out blood." (N. H. xi, 34.)

"A fomentation with Oxycrat or water and vinegre is singular good upon burns," or reading *post hirudines*: "good after the sucking of Horseleeches." (N. H. xxiii, 1. Here the readings vary. Some read *Medetur post potas hirudines*; others *Medetur pota hirudini*; others *Medetur post uredines*, without any reference at all to horseleeches.)

Galen, who was born just before the middle of the 2nd century A.D., speaks of leeches in his treatise *De Hirudinibus*, ch. 1, but the origin of this passage is clearly the same as that of the following one from Oribasius, which is a better and fuller account. Oribasius, who lived in the 4th century A.D., has a chapter entitled *Of Leeches*. Taken out of the works of Antyllus, out of his treatise *Of Aids in Blood-letting*, which runs as follows:—

"Some go hunting for Leeches, and keep them closed up; and use the same ones many times; for those which are fresh from exercise do readily fasten upon the flesh, whilst others sometimes do not feel at home. Now we must apply the former straight from their trial; but those which have but now been taken you must keep for one day, and give them a little blood for sustenance; by that means the poison that is in them will be evaporated. Before you use them, let the part upon which they shall be set be rubbed over first with soap, and anointed with the blood of some animal, or with damp clay; or else let it be bathed, or scratched with the nails; the leeches will then cleave to it the more readily. You must put them into warm water in a clean roomy vessel, that they may move about and so rid

themselves of their poison; then catch them up in a sponge, and having wiped off the sticky substance from them, apply them with the hand. After they have all taken hold, we pour upon the place some warm oil, that it be not chilled. As touching the hands or the feet, put that part of the body into the water wherein are the leeches. Now, if there is still need for them to draw, after that they are entirely full, or if you have but few leeches, or else if but few take hold, then, after they are full, their tails must be clipped with a pair of scissors; for as the blood streams forth, they cease not to draw, until we sprinkle salt, or soda, or ashes, in their faces. When they are fallen off, if the place will bear a cupping-glass, we must apply it, and so draw off the poison: the glass must be firmly planted on the place, and quickly taken off. But if this may not be done, the part must be bathed with sponges, and if blood still ooze from the pricks, sprinkle upon them incense, or cummin, or wheatflour, and then wrap around them some wool steeped in oil. But if it bleed abundantly, apply to it linen bandages, or cobwebs steeped in vinegar, or a burnt gall-nut, or a new sponge dipped in liquid pitch, and burnt; then apply a sheet of paper sodden with vinegar, and bind it on. All this we must do when the place is situated on the trunk of the body; but for the free limbs it suffices to bandage it for to stay the blood. The bandage should be unbound the next day, and if the blood be stanch'd, wash the place; but if not, act as before. And here it must be noted, that the leeches do not draw the blood that is deep down in the body; they do but suck out that which is present in the flesh. We use them upon such persons as fear scarification; or upon those parts of the body which through their smallness or crookedness or unevenness do not admit the application of the cupping-glass. We pull them off when we reckon that one half of the blood has been drawn out, which we estimated to be requisite to be drawn off; and after that we allow the bleeding to continue, until enough be drawn off; and since the part of the body is chilled not only by the leeches (which are by nature cold) but also by the surrounding air, it must be kept warm; hence the flow

of blood may not be stayed by such things as chill the body, but by means of astringents and things that stop up the pores, as has been said." (vii, 21 ; tr. A. L. P.)

Galen himself has the following reference :—

Of Bugs (= *Cimex lectularius*). "Some have written concerning Bugs, that if they be drunk with vinegar they expel leeches that chance to have been swallowed. But for our part we have had no need of leeches, for we have expelled them through the eating of garlick." (*De Simpl. Med. &c.* xi, 43 ; tr. A. L. P.)

Themison was probably the first physician to use leeches, though they were known to Hippocrates. Themison was the founder of the ancient medical sect of the Methodici, and was one of the most eminent physicians of his time. He was a native of Laodicea in Syria, and a pupil of Asclepiades of Bithynia. Thus he lived in the 1st century B.C. He had travelled a good deal, for he mentions Crete and Milan as an eye-witness. He wrote several medical works, but it is not known in what language he wrote. He is said to have been attacked with hydrophobia, and to have recovered.

Caelius Aurelianus (fl. early 5th cent. A.D.) attacks Themison for recommending a course which irritates the body at a time of discomfort. "Themison in the first book of his Tardy Affections recommends the opening of veins. . . . Further, he applies many leeches to the forehead and shoulders, and to the temples of the head ; which thing is contrary to the discipline of the school" (sc. the Methodici). . . . (*Morb. Chron.* i, 1 ; tr. A. L. P.)

A curious reference to leeches is to be found in the *Canon* of Avicenna. Avicenna (Abū 'Alī al-Husain ibn 'Abdallāh ibn Sīnā), 980-1037, the Arabian philosopher, who was born at Afshena in the district of Bokhara, worked mostly in Bokhara, and there is evidence that he derived something from Indian medicine. It is said that the passage in which he refers to leeches is derived from the *Sushruta Samhita*. He writes, with reference to Blood-letting, thus:—

"The Indians have said, that the nature of certain Leeches is poisonous. Wherefore we must take care to avoid those Leeches which are of that sort that have great heads, whose

colour is antimony and black ; or whose colour is green ; or which have down upon them and are like Mezemeiz, and upon which there are threads of azure colour ; and whose colour is like unto that of a certain sort of serpents. For in all these there is poison ; and there arise from them deep-seated abscesses and swoons and bloody fluxes and fever and languor and bad sores. Neither do thou take the leeches from bad waters, wherein the slime of the bed is black and muddy and when it is stirred maketh the water turbid and filthy ; but choose those which are taken out of waters over which freckly growths come into being, and wherein frogs dwell. Neither do thou give heed to what some say, how that if they are in water wherein frogs dwell, they must be bad. Let their colour be like that of a thing wherein there is greenness, and let there be stretched over them two threads having the colour of orpiment ; or let them be red, and round, and of the colour of the liver. Also, those which are like unto small locusts, and which are like unto the tail of a mouse, and are extremely small with little heads—all these should be chosen. And none shouldst thou more readily choose than those which have red bellies and green backs, and especially if they be from running waters. Furthermore, the drawing of blood accomplished by leeches is deeper than that accomplished with the aid of cupping-glasses.

“ Now before the leeches be set upon the place, they must be collected for one day, and by squeezing be made to vomit, until that which is in their bellies come forth. If this can be done ; and if a little lamb's blood, or of some other animal be given them, that they may get sustenance thence before they be set on to the place ; then let them be taken up, and let their sliminess and filth be wiped off with a sponge or the like. Further, let the place whereon they must be set be washed with soap (soda), and reddened with rubbing ; then when you are ready to set the leeches upon it, let them be put into some sweet water and cleansed, and then set on. To make them hang on of their own will, anoint the place with . . . (text uncertain) . . . or with blood. When the leeches shall be full, and you will loose their hold, dust them

over with a little salt or ash or soap (soda) or burnt horse-hair, or linen, or burnt sponge, or burnt wool, and they will fall off. And it is better, after they be fallen off, that the place be drawn with a cupping-glass, and that a little of the blood of the place should be taken, for to remove the ill effect of their bite. If the blood be not staunched, let burnt gall-nuts, or chalk, or ash . . . finely powdered, be placed upon it, or some other of those remedies which staunch blood. These things must be ready to hand when any setteth leeches, and when they begin to take hold. The applying of leeches bringeth relief to maladies subcutaneous, as scabby eruptions (serpigo and impetigo), and the like." (*Canon*, lib. i. Fen 4 ; tr. A. L. P.)

Finally, one may mention an inscription at Epidaurus.

"A man of Torone, who had swallowed leeches. In his sleep he saw a vision. He thought that the god cut open his chest with a knife and took out the leeches, which he gave him into his hands. Then he stitched up his chest again. At daybreak he departed cured, with the leeches in his hand. He had swallowed them by his stepmother's treachery, while drinking a mixture of honey and wine into which she had put them." (C. I. G. iv. 951-2 ; tr. Mary Hamilton, *Incubation*.)

I am greatly indebted to Mr. A. L. Peck, of Christ's College, who practically compiled this section of my Historical Preface.

It is curious that although the leech is, as Dr. Breul says, common in the old German language as well as in Celtic, from which it is believed to have been borrowed, there seem to be no mention of sucking leeches either in German literature before the sixteenth century, although the adoption of leeches was certainly borrowed before 200 B.C. and were early adapted to Teutonic writings.

In French literature Professor Prior tells me that leeches are mentioned as being commonly used in the Middle Ages. "Here are two quotations, the first of which is I believe the earliest on record. It is taken from a glossary of the 12th

century, and says 'Irudo, inis, Sansue.' The second quotation comes from Edward the Confessor, and says 'Qui l'or vermeil et l'argent blanc—cuveite cum sangsus sang.' Finally, here is a quotation from the 14th century (H. de Mondeville): 'L'evacuation que est faite o ventouses, l'evacuation o sansues.' Strange to say there seems to be no old French proverb bringing in the word."

In Anglo-Saxon times the word leech was used both for the blood-sucking *Hirudo* and for the medical man or physician. But the only certain occurrence of the word læce for the animal is found in the glossaries, which were primitive dictionaries including lists of more or less rare Latin words explained by commoner Latin words or by Anglo-Saxon words. There is no context, and all we can learn is that the word was known. One or two places are mentioned, such as læces mere, *i. e.* the leech's pond or mere; and again to læces forda, *i. e.* to the leech's ford, or again læces ford, *i. e.* onto the leech's ford. But it may be, of course, that these localities were named after a local doctor, and not after the *Hirudo*. I have not been able to find any reference to the animal leech in Day and Payne's 'English Medicine in Anglo-Saxon Times' (Oxford, 1904). The book is unfortunately without an index. Anglo-Saxon literature is on the whole rather weak in Medicine, and the references to it as a science are comparatively rare. The word leech or doctor is very common, and occurs in all the early Teutonic languages as well as in Celtic, from which it is believed to have been borrowed some century or two B.C. On the whole it looks as if the animal got the name from the doctor and not the doctor from the animal.

Hirudo medicinalis *, the medicinal leech, is found in stagnant waters throughout Europe and the western parts of Asia. It is rather commoner in the southern parts of Europe than in the north. It used to be common enough in England, where at one time, it was bred; but already a hundred years ago its numbers were diminishing.

The following paragraphs, slightly modified, are taken from 'The Minor Horrors of War,' now out of print.

In a treatise on the Medicinal Leech, published by J. R. Johnson in the year 1816, he records:—"Formerly this species was very abundant in our island; but from their present scarcity, owing to their being more in request by medical men, and to the rapid improvements which have of late years taken place in agriculture—particularly in the draining and cultivation of waste lands—we are obliged to receive a supply from the Continent, chiefly from Bordeaux and Lisbon." In his time he considered that for every native leech employed at least a hundred foreigners were used.

The same scarcity was very apparent to the poet Wordsworth, whose insatiate curiosity is recorded in the following lines in 1802—Wordsworth was always asking rather fatuous questions:—

My question eagerly did I renew,
 "How is it that you live, and what is it you do?"
 He with a smile did then his words repeat:
 And said that, gathering leeches, far and wide
 He travelled; stirring thus about his feet
 The waters of the pools where they abide.
 "Once I could meet with them on every side;
 But they have dwindled long by slow decay;
 Yet still I persevere, and find them where I may."

In Central Europe, where the leech was once very abundant, it is now chiefly confined to the south and east; and in Germany it is still found in the island of Borkum and in Thuringia.

In 1842, leeches were occasionally found in the neighbourhood of Norwich, and there are villagers still living in Heacham in Norfolk who remember the artificial leechponds. In the middle of the last century the medicinal leeches "of late years . . . have become scarce," though they were still to be found in Ireland. Apparently this species is now almost extinct in England, although I know of a naturalist who can still find them in the New Forest, but he will not tell me where. If they were getting scarce in the beginning of the nineteenth century they are far scarcer now—for by *November, 1914, there was no leech in*

London—at least, there are only a dozen or two, and they, like those of the firm “Sawyer late Nockemorff” were second-hand, and I have heard that there is a similar shortage in North America. And yet leeches are wanted by doctors!

Harding tells us that :—

“*Hirudo medicinalis* is not the only leech which has been used in phlebotomy. *Hirudo troctina* (Johnson, 1816), occurring in North Africa and in Southern Europe, where it is perhaps an introduced species, was largely imported at one time for medical uses. . . .

“Several other species have been used for blood-letting in different countries. *Limnatis* (*Pæcilobdella*) *granulosa* in India, *Liostomum officinalis* in Mexico, *Hirudo nipponia* in Japan (Whitman), and *Macrobdeella decora* in the United States (Verrill), are or have been used in phlebotomy.”

“Our chief hope seems to lie in India.” These words I wrote in October 1914, and my hopes were justified. Owing to the energy of Dr. Annandale, of the Indian Museum, and the anxious care of the authorities of the P. & O. Company, I was able to land, early in 1915, a consignment of many hundred *Limnatis granulosa*—in sound health, good spirits, and obviously anxious to do their duty.

Leeches are still used much more than the public are aware. One pharmaceutical chemist in the West End of London tells me he sells between one and two thousand a year ; and as they were bought wholesale at about one penny each and sold retail at about sixpence, there is some small profit.

Probably the traffic in leeches reached its height in the first half of the nineteenth century. Harding reminds us that in the year 1832 Ébrard records that 57,500,000 of these annelids were imported from France, and by this time the artificial cultivation of leeches had become a very profitable industry. Although in a small way leeches may have been cultivated in special ponds in Great Britain, the English never undertook the industry on a large scale. In Ireland the natives used to gather the leeches in Lough Mask, and other inland lakes, by sitting on the edge of the pool dangling their legs in the water until the leeches had

fastened on them. But the native supply was totally inadequate, and the great majority of leeches used in this country were then imported. In 1842 Brightwell mentions a dealer in Norwich who always kept a stock of 50,000 of these annelids in two large tanks. The traffic, as we have seen, was very considerable.

The French leech-merchants recognized five classes, as follows :—

1. Les filets ou petites Sangsues, qui ont de un à cinq ans ;
2. Les petites moyennes, qui ont de cinq à huit ans ;
3. Les grosses moyennes, qui ont de huit à douze ans ;
4. Les mères Sangsues ou les grosses, qui sont tout à fait adultes ;
5. Les Sangsues vaches, dont la taille est énorme.

They also recognised many colour-varieties, of which we need only mention the speckled, or German leech, “Sangsues grises medicinales,” with a greenish-yellow ventral surface spotted with black, and the green Hungarian leech with olive-green spotted ventral service. Both are merely colour-varieties of *Hirudo medicinalis*—a species which shows great variation in colour, and often forms colour-races when bred artificially.

The varying sizes of the five categories mentioned above may be seen by the fact that one thousand of “les filets” weigh from 325 to 500 grammes, one thousand of “les petites moyennes” weigh 500 to 700 grammes, and one thousand of the “grosses moyennes” weigh 700 to 1300 grammes, and one thousand of the “grosses” 1300 to 2500 or even to 3000 grammes ; whereas one thousand of “les vaches” weigh up to 10 kilograms, and sometimes even more. To increase their weight the dishonest dealer sometimes gave them a heavy meal just before selling them.

They were transported from place to place in casks half-filled with clay and water, or in stone vases full of water. Sometimes they travelled in sacks of strong linen, or even of leather, and these had to be watered from time to time. Another mode of conveying them was to place them in

baskets full of moss or grass soaked in water, but care had to be taken lest they should escape. These baskets, again, could not be packed one upon another, or the leeches were crushed. In the old days each sack often weighed 20 to 25 kilograms; and travelling thus, suspended in a kind of hammock, *dans une voiture ou fourgon*, from Palota near Pesth, they reached Paris in from twelve to fifteen days.

They generally travelled via Vienna to Strasburg, where twelve great reservoirs, appropriately placed near the hospital, received them, and here they rested for awhile. Others collected in Syria and Egypt came by ship to Trieste, whence they were sent to Bologna, to Milan, and to Turin, or by water to Marseilles. Marseilles also received directly by sea the leeches from Levant and Africa and expedited them to Montpellier, Toulouse, and many another town in the south.

The best time of the year for their journey was found to be the spring and autumn. They were more difficult to manage in the summer, and they were all the better for having a rest every now and then, as they used to do at Strasburg. There were times when consignments of from 60,000 to 80,000 a day used to leave Strasburg for Paris. In 1806 a thousand leeches in France fetched 12 to 15 francs; but in 1821 the price had risen to 150 to 200 and even 283 francs. In the latter year they were retailed at 20 to 50 for 4 to 10 sous.

In France, however, as in England, the artificial cultivation of leeches is for the most part diminishing, though half a century ago leech-farms were common in Finistère and in the marshes in the neighbourhood of Nantes. There were some years when, if the season was favourable, the peasants carried to market 60,000 a day. Spain and Portugal also furnished leeches for a long time; but by the middle of last century the Peninsula had become almost depleted. But some leeches were still at that period being received from Tuscany and Piedmont. Perhaps the richest fields which still exist are the marshy regions of Hungary.

There is no doubt that the medicinal leech is one of the most beautiful of animals. Many of its cousins are uniform

and dull in colour—"self-coloured" as the drapers would call them; but the coloration of the medicinal leech could not be improved upon. It is a delicious harmony of reddish-browns and greens and blacks and yellows, a beautiful soft symphony of velvety orange and olive and black, the markings being repeated on each segment, but not to the extent of a tedious repetition. So beautiful are they that the fastidious ladies who adorned the *salons* at the height of the leech-mania, during the beginning of the nineteenth century, used to deck their dresses with embroidered leeches, and by repeating the design one after the other, constructed a chain of leeches which, as a ribbon, was inserted around the confines of their vesture.

Christ's College Lodge,
Cambridge.
December, 1926.

A. E. SHIPLEY.

EXPLANATION OF PLATES.

The originals of the coloured figures of Plates III-V were painted from living specimens by Mr. A. Chowdhary and other artists at the Indian Museum, except as noted, and copied for this work by Miss Helen Winchester. While doubtless representing the colours correctly, they have no value for annulation or other features of external morphology. The photographs (Plates VI-IX.) should be examined with a reading-glass to bring out details not otherwise evident.

PLATE I.

Diagrams of typical complete somites of representative genera of leeches (as named on the plate) having from two to fourteen annuli. This is not an evolutionary series, and within the limits of the genera illustrated other conditions may occur. The normal position of the nerve-ganglion is indicated. Dorsal metameric sensillæ, and in the genera of Erpobdellidæ, non-metameric sense-organs as well, appear as small circles, ventral sensillæ as solid dots. Large circles on *Pontobdella* represent cutaneous warts. Small funnels indicate the nephropores. Symbols representing the annuli appear at the right, and furnish a key to the homologous parts.

PLATE II.

INDIAN RHYNCHOBDELLE.

- Fig. 1. *Hemielepis marginata*, subsp. *marginata* (O. F. Müller), 1774. An individual gorged with blood, hanging by its posterior sucker. $\times 14$.
- Fig. 2. The same. Dorsal view of anterior part of the body. $\times 14$.
- Fig. 3. *Pontobdella loricata*, Harding, 1924. From a specimen preserved in alcohol, life size.

- Fig. 4. *Ozobranchus shipleyi*, Harding, 1909. A dark-coloured example in contraction. $\times 2$.
- Fig. 5. *Ozobranchus shipleyi*. A patch of eggs embedded in chitinous cement, stripped from the plastron of the tortoise, *Kachuga intermedia*, viewed by transmitted light as a transparency. $\times 7$.
- Fig. 6. *Ozobranchus shipleyi*. Dorsal view of a young individual, fully extended. $\times 3$.
- Fig. 7. *Placobdella fulva*, Harding, 1924. Dorsal aspect. $\times 3$.
- Fig. 8. *Pontobdella* (subgen. *Pontobdellina*) *macrothela*, Schmarda, 1861. Dorsal aspect of somites XIX and XX, showing the disposition of the tuberoles. $\times 5$.
- Fig. 9. *Helobdella nociva*, Harding, 1924. Dorsal aspect. $\times 8$.
- Fig. 10. *Glossiphonia weberi*, R. Blanchard, 1897. Dorsal aspect. $\times 8$.
- Fig. 11. *Paraclepsia prædatrix*, Harding, 1924. Dorsal aspect. $\times 5$.
- Fig. 12. *Paraclepsia prædatrix*. Dorsal aspect of another individual of a different colour. $\times 5$.

N.B.—Figs. 1, 2, 4–6, and 9–12 are by A. C. Chowdhary, of the Indian Museum, and figs. 3 and 8 by the late W. West, of Cambridge.

PLATE III.

INDIAN ARHYNCHOBDELLÆ.

- Fig. 1. *Hirudinaria javanica* (Wahlberg). Dorsal and ventral aspects. Natural size. From drawing by Dr. C. P. Sluiter, of living leeches at Batavia, Java.
- Fig. 2. *Hirudinaria manillensis* (Lesson). Dorsal and ventral aspects. Natural size. Specimen taken near Calcutta.
- Fig. 3. *Herpobdelloidea indica* (Kaburaki). Egg-capsule formed by a specimen taken at Kalka (Simla Hills). $\times 4$.

PLATE IV.

- Fig. 4. *Dinobdella ferox* (Blanchard). Dorsum. Natural size. Drawn at the Indian Museum from a living specimen taken at Ahmadabad. (See footnote, p. 178.)
- Fig. 5. *Hirudinaria granulosa* (Savigny). Dorsum and venter. Natural size. Muttra, Unit. Prov.
- Fig. 6. *Hæmadipsa zeylanica agilis* Moore. Dorsal, ventral and lateral aspects of a specimen from Almora, $\times 2$.

PLATE V.

- Fig. 7. *Hæmadipsa zeylanica* (Moquin-Tandon). Dorsum and venter, \times ca. $2\frac{1}{2}$. From sketch made in Ceylon by O. O. Whitman.
- Fig. 8. *Hæmadipsa zeylanica montivindicis* Moore. Dorsal, ventral and lateral aspects. \times 3. Kurseong, Darjeeling.
- Fig. 9. *Hæmadipsa sylvestris* Blanchard. Dorsal, lateral and ventral aspects. Natural size. Near Calcutta.
- Fig. 10. *Hæmadipsa sylvestris* Blanchard. Dorsal view of a small uniformly coloured specimen. \times 4. Near Calcutta.
- Fig. 11. *Hæmadipsa ornata* Moore. Dorsal, ventral and lateral aspects of type, from Darjeeling. Natural size.

PLATE VI.

- Fig. 12. *Erpobdella octoculata* (Linnæus). Dorsum of two examples from Srinagar. \times 2.
- Fig. 13. *Herpobdelloidea laterooculata* Kaburaki. Dorsum of four specimens of type lot. \times 2.
- Fig. 14. Same. Venter.
- Fig. 15. *Herpobdelloidea indica* (Kaburaki). Dorsal view of a specimen from Simla Hills. \times 2.
- Fig. 16. Same. Ventral view of three, showing different conditions of the male gonopore. \times 2. A spermatophore shows on the one to the right.
- Fig. 17. *Foraminobdella heptamerata* Kaburaki. Dorsum of type, showing gastric orifice, *go.* \times 3.
- Fig. 18. *Whitmania lævis* (Baird). Dorsal view of dissection of Thanga Island specimen, showing digestive tract and part of organs of reproduction. \times $\frac{1}{2}$. Same specimen as shown in text-figure 11.

PLATE VII.

- Fig. 19. *Myxobdella annandalei* Oka. Dorsal aspect of specimen from Dawna Hills, L. Burma. \times ca. $1\frac{1}{2}$.
- Fig. 20. Same, from venter.
- Fig. 21. *Whitmania lævis* (Baird). Dorsal aspect of Pagla Nadi specimen. \times 1.
- Fig. 22. Same. Ventral aspect of Pagla Nadi and Thanga Island specimens. \times 1.
- Fig. 23. *Dinobdella ferox* (Blanchard). Ventral aspect of parasitic individual from Naga Hills. \times 1.
- Fig. 24. Same. Dorsal view of dissected empty digestive tract of a free-living individual from Ceylon. \times 1.

PLATE VIII.

- Fig. 25. *Hirudo asiatica* (Blanchard). Dorsal view of partly dissected digestive tract and reproductive organs of a specimen from Cawnpore, Unit. Prov. $\times 2\frac{1}{2}$.
- Fig. 26. *Hirudo birmanica* (Blanchard). Dorsal view of two small examples to show colour-pattern. $\times 2$.
- Fig. 27. *Limnatis paluda* (Tennent). Ventral aspect of a partly macerated specimen from Baluchistan. $\times 2$.
- Fig. 28. Same. Dissection of a stomach filled with blood to show form of distended caeca. $\times 2$.
- Fig. 29. *Hirudinaria javanica* (Wahlberg). Dorsal aspect of a specimen from Chinese frontier of Burma. $\times 2$.
- Fig. 30. Same. Ventral aspect. $\times 2$.
- Fig. 31. *Hirudinaria viridis* Moore. Dorsal aspect of a specimen from unknown locality. $\times 1$.
- Fig. 32. Same. Ventral aspect. $\times 2$.
- Fig. 33. Same. Two specimens from Travancore to show change in colour-pattern. $\times 1\frac{1}{2}$.
- Fig. 34. *Dinobdella notata* Moore. Dorsal and ventral views of type from Palni Hills. $\times 2$.
- Fig. 35. Same. Partial dissection of reproductive organs of co-type, from dorsum. $\times 2\frac{1}{2}$.

PLATE IX.

- Fig. 36. *Hemadipsa zeylanica cochiniensis* Moore. Seven specimens from Kavalai in various positions to show colour-pattern and prehensile papilla. $\times 3$.
- Fig. 37. *Hemadipsa zeylanica montivindicis* Moore. Three egg-capsules from Pashok. $\times 3$.
- Fig. 38. *Hemadipsa montana* Moore. Three unfed specimens from Gantok in dorsal, ventral and lateral aspects. $\times 2$.
- Fig. 39. Same. A gorged individual from same lot and of same size. \times nearly 2.
- Fig. 40. Same. Dissection of a specimen from Gantok. $\times 2\frac{1}{2}$. The empty stomach is turned to the left, exposing the large, crowded testes, of which ten pairs are shown; the vaginal caecum is drawn to the left, and the right epididymis to the right side.
- Fig. 41. *Hemadipsa sylvestris* Blanchard. Dorsal and ventral aspects of specimens taken near Calcutta on Jan. 5th. $\times 2$.
- Fig. 42. *Hemadipsa ornata* Moore. Lateral view of type. \times ca. 2.

SYSTEMATIC INDEX.

	Page
Order HIRUDINEA	35
I. Suborder RHYNCHOBDELLÆ	35
I. Family ICHTHYOBDELLIDÆ	35
1. Genus <i>Ozobranchus de Quatrefages</i>	36
1. <i>shipleyi Harding</i>	36
2. Genus <i>Pontobdella Leach</i>	39
2. <i>loricata Harding</i>	39
3. <i>aculeata Harding</i>	41
Subgenus <i>Pontobdellina Harding</i>	44
4. <i>macrothela Schmarda</i>	45
3. Genus <i>Piscicola Blainv.</i>	48
5. <i>olivacea Harding</i>	48
6. <i>cæca Kaburaki</i>	52
4. Genus <i>Pterobdella Kaburaki</i>	54
7. <i>amara Kaburaki</i>	54
II. Family GLOSSIPHONIDÆ	57
5. Genus <i>Glossiphonia Johnson</i>	57
8. <i>complanata (Linn.)</i>	57
9. <i>heteroclita (Linn.)</i>	60
10. <i>weberi (R. Blanchard)</i>	62
11. <i>reticulata Kaburaki</i>	65
12. <i>annandalei Oka</i>	65
6. Genus <i>Helobdella R. Blanchard</i>	68
13. <i>stagnalis (Linn.)</i>	68
14. <i>nociva Harding</i>	70
7. Genus <i>Placobdella R. Blanchard</i>	72
15. <i>ceylanica (Harding)</i>	73
16. <i>emydæ Harding</i>	74
17. <i>inleana (Oka)</i>	76
18. <i>fulva Harding</i>	78
19. <i>undulata Harding</i>	78
8. Genus <i>Theromyzon Philippi</i>	81
20. <i>sexoculata (Moore)</i>	82
9. Genus <i>Hemiclepsis Vejdovsky</i>	83
21. <i>marginata (O. F. Müller)</i>	83
<i>Subsp. marginata (O. F. Müller)</i>	83
<i>Subsp. asiatica Moore</i>	87
10. Genus <i>Paraclepsis Harding</i>	88
22. <i>prædatrix Harding</i>	88
23. <i>vulnifera Harding</i>	91
<hr style="width: 20%; margin: 0 auto;"/>	
<i>Species inquirenda</i>	93

	Page
II. Suborder ARHYNCHOBDELLÆ.....	97
III. Family ERPOBDELLIDÆ	126
11. Genus <i>Erpobdella</i> <i>Blainv.</i>	130
24. <i>octoculata</i> (<i>Linn.</i>)	130
12. Genus <i>Barbronia</i> <i>Johansson</i>	135
25. <i>weberi</i> (<i>R. Blanchard</i>)	135
13. Genus <i>Herpobdelloidea</i> <i>Kaburaki</i>	140
26. <i>lateroculata</i> <i>Kaburaki</i>	141
27. <i>indica</i> (<i>Kaburaki</i>)	144
14. Genus <i>Foraminobdella</i> <i>Kaburaki</i>	149
28. <i>heptamerata</i> <i>Kaburaki</i>	149
15. Genus <i>Trocheta</i> <i>Dutrochet</i>	151
29. <i>quadrioculata</i> <i>Oka</i>	151
IV. Family HIRUDIDÆ	154
A. Subfamily <i>Hirudinæ</i>	158
16. Genus <i>Myxobdella</i> <i>Oka</i>	161
30. <i>annandalei</i> <i>Oka</i>	161
17. Genus <i>Whitmania</i> <i>R. Blanchard</i>	168
31. <i>lævis</i> (<i>Baird</i>)	169
18. Genus <i>Dinobdella</i> <i>Moore</i>	175
32. <i>ferox</i> (<i>R. Blanchard</i>)	175
33. <i>notata</i> <i>Moore</i>	185
19. Genus <i>Hirudo</i> <i>Linn.</i>	189
34. <i>asiatica</i> (<i>R. Blanchard</i>)	190
35. <i>birmanica</i> (<i>R. Blanchard</i>).....	192
20. Genus <i>Limnatis</i> <i>Moquin-Tandon</i>	199
36. <i>nilotica</i> (<i>Sav.</i>).....	200
37. <i>paluda</i> (<i>Tennent</i>)	201
21. Genus <i>Hirudinaria</i> <i>Whitman</i>	207
38. <i>javanica</i> (<i>Wahlberg</i>)	210
39. <i>manillensis</i> (<i>Lesson</i>)	218
40. <i>granulosa</i> (<i>Sav.</i>)	226
41. <i>viridis</i> <i>Moore</i>	239
AA. Subfamily <i>Hæmadipsinæ</i>	244
22. Genus <i>Hæmadipsa</i> <i>Tennent</i>	253
42. <i>zeylanica</i> (<i>Moquin-Tandon</i>)	255
<i>Subsp. zeylanica</i> (<i>Moquin-Tandon</i>)	255
<i>Subsp. cochiniiana</i> <i>Moore</i>	265
<i>Subsp. agilis</i> <i>Moore</i>	266
<i>Subsp. montivindicis</i> <i>Moore</i>	267
43. <i>montana</i> <i>Moore</i>	269
44. <i>sylvestris</i> <i>R. Blanchard</i>	276
45. <i>ornata</i> <i>Moore</i>	284
46. <i>dussumieri</i> <i>R. Blanchard</i>	289

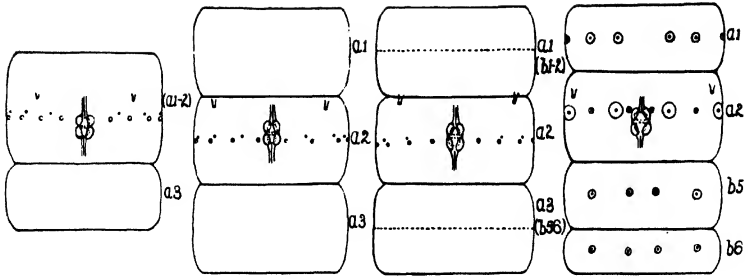

Oligobdella.

Glossiphonia.

Hæmentaria.

Pontobdella.

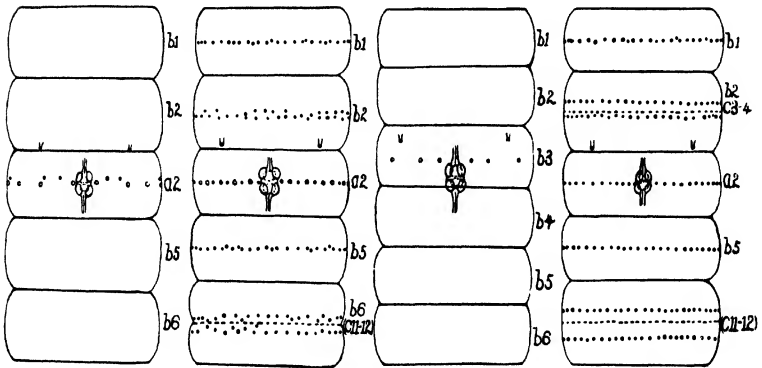

Hirudo.

Dina.

Trachelobdella.

Nephelopsis.

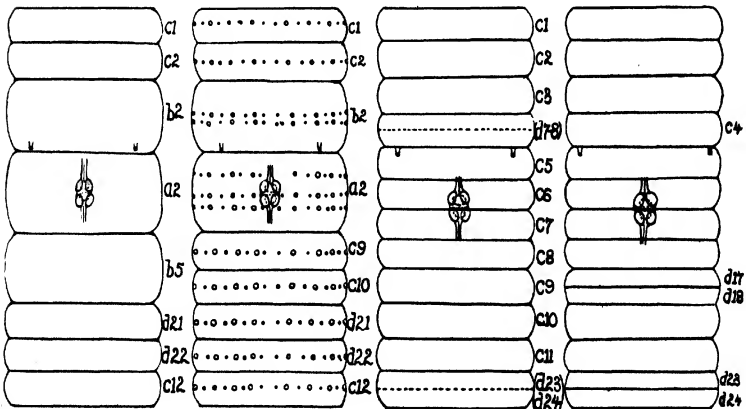

Trochæta.

Scaptobdella.

Piscicola.

Piscicola.

SOMITES OF REPRESENTATIVE GENERA OF LEECHES.

(For detailed Explanation, see p. xxxiii.)

HIRUDINEA.

THE SEGMENTATION (METAMERISM AND ANNULATION) OF THE HIRUDINEA.

BY

J. PERCY MOORE,

UNIVERSITY OF PENNSYLVANIA, U.S.A.

A NOTEWORTHY characteristic of leeches is the numerical constancy of their constituent segments, somites, or metameres, as they have been variously named. The first complete demonstration of this fact, as well as the recognition of its great importance in leech morphology, we owe to Whitman ('86, '92), whose work will long remain the standard of perfection for this group. Exactly thirty-four of these somites occur in all leeches that have been carefully studied, and there is no increase in number with age. They are designated by the Roman numerals I to XXXIV, and are grouped into five or six, more or less well-marked, regions: the head, or cephalic region, of somites I to VI, the pre-clitellar region of somites VII to IX (in the Ichthyobdellidæ often united with the genital and together commonly designated as the neck), the middle-body region of somites X to XXIV, further subdivided into the clitellar or genital region (somites X to XIII) and the post-clitellar region (somites XIV to XXIV), the anal region of somites XXV to XXVII, and the caudal region, or sucker, of somites XXVIII to XXXIV.

While the degree of differentiation of these regions differs considerably in the several families and even the genera of leeches, they are fairly natural morphological and physiological integrations, characterized by both internal and external features. Inasmuch as these distinctions are based largely upon modifications of the morphological unit, the somite, the characteristics of this unit must be considered first.

As has been so beautifully proven by Whitman ('86, '92), Apathy ('88), Livanow ('03, '04), *et al*, the segments of a leech's body are true metameres, homodynamous throughout, and quite equivalent to those of Oligochæta and Polychæta. Except at the extreme ends of the body, where they are much modified to form specialized apical and terminal organs, each somite includes, as in the chætopods, a typical segment of each of the organ systems across which it cuts or which passes through it. We recognize, therefore, as constituting a somite, a complete segment of the nervous system or neuromere, a muscle segment or myomere, a segment of the body-cavity or cœlomere, of the mesenchymatous connective tissue or scleromere, of the true circulatory system or vascomere, of the reproductive organs or gonomere, of the organs of excretion or nephromere (the last six collectively constituting a mesomere),* of the outer integuments and their products or ectomere, and of the digestive system or endomere. Except for certain shiftings that it would be out of place to discuss here, all of these parts are in substantial alignment.

This has not always been recognized: neither the true nature of the somites nor the alignment of the segments of the several organ systems. Even in some recent text-books of zoology the statement remains that the inner and outer segmentation of the leeches do not agree. While in a few cases this clearly refers to the older view of lack of agreement between external metamerism and internal metamerism, it generally means only that the external rings are more numerous than the somites. But the latter is equally true of most Oligochæta and Polychæta, the somites of which are almost always annulated. The difference lies mainly in the loss of parapodia and setæ in the leeches, with the consequent equalization of the rings and a masking of the somite limits.

Doubtless the earlier point of view minimizing the importance of the metamerism of leeches was largely influenced by the widespread belief in their platyhelminthine affinities. This in turn was based upon their superficial resemblance to ectoparasitic trematodes in the development of organs essential to the parasitic mode of life and in the suppression of a spacious body-cavity by the encroachments of a highly-developed muscular system and of parenchymatous connective tissue.

Although the great French naturalist Lamarck recognized the annelidan affinities of the leeches as long ago as the first decade of the nineteenth century, this view made progress slowly, and even after its wide acceptance the external annulation of leeches was looked upon as a purely integumental feature without close relation to the internal organization. It is true that several earlier writers on the medicinal leech referred to the repetition of certain external organs at intervals of five rings, but Gratiolet (1862) appears to have been the first to recognize a regular external metamerism in which each somite (zonite) embraces a certain definite number of annuli. The limits of these he determined by the repetition of the nephridial openings, colour-markings, and

especially of certain white or diaphanous spots now known as sensillæ, which he considered as distinguishing the first annulus of each somite. It remained, however, for Whitman ('92, '86) to give precision to these determinations, and to analyze the external morphology of the leeches to its logical completeness. Upon this analysis he based a method of diagnosing the genera and species that has served as the model for all subsequent systematic work on the group.

Very curiously, Whitman and his followers accepted Gratiolet's determination of the somite limits, apparently overlooking the very obvious and serious difficulties to which it leads in putting out of alignment the organ-systems. It especially throws into serious conflict the external metamerism of the annuli and the internal metamerism of the nervous system.

A new determination of the somite limits was therefore made in 1900 by Castle and Moore simultaneously and independently and on different material. This sets the anterior limit of the five-ringed somite two annuli farther forward than Whitman's method, and makes the annulus bearing the sensillæ or segmental sense-organs externally and the nerve ganglion internally the middle ring of the somite and not the first, as had been held previously. This has the important advantage of consistent agreement in the segmentation of the several organ-systems, and especially of the external metamerism and the internal neuramerism. The distribution of the segmental nerves corresponds exactly with that of the sense-organs and external somites throughout the body, and harmonizes with a great mass of anatomical and embryological facts, many of them of great interest to systematic workers. The disharmonies, on the other hand, are relatively few and readily explained. The details of the evidence, however, cannot be entered into here. This neuromeric standard of segmentation was very fully confirmed by Livanow ('03), and is now generally accepted.

The somites find their fullest expression and greatest elaboration (hence designated as complete somites) in the middle-body region (clitellum and post-clitellum). Externally they are divided by shallow integumental furrows into from two to fourteen annuli, the number being more or less characteristic of particular genera or higher groups. Thus the several genera of the Ichthyobdellidæ cover the entire range; the Glossiphonidæ very generally have triannulate, but may have biannulate or incipiently quinquannulate somites; the Hirudidæ usually have five-ringed somites, but rarely they may be three, four, six or seven-ringed; the Erpobdellidæ also are commonly five-ringed, but may have six, seven, eight or more rings. The number of annuli into which a complete somite is divided is not a haphazard matter, but follows an orderly sequence.

While it has not been possible to determine with certainty in just which stage of elaboration of the somite the Hirudinea arose from the Oligochæta, the weight of the evidence and the concensus

of opinion favours the triannulate somite as primary. This is indicated by its wide prevalence in both the Hirudinea and the Chætopoda, and by the triad character of the central neuromeres and the peripheral nerves and nerve-rings. In the Polychæta the principal annulus bears the parapodia, but smaller propodal and postpodal annuli are commonly differentiated, though subordinated to the somite. In many Oligochæta a middle annulus bears the setæ, and a presetal annulus, on which the nephropores open, and a postsetal annulus are usually easily recognizable. Substituting the sensillæ for the setæ, an exactly similar topography obtains in the Hirudinea. The sensory or neural annulus of the leeches is homologous with the setigerous annulus of the earthworms, and the nephridia open near the caudal margin of the presensory annulus, or its equivalent, of both.

Nevertheless, in the ontogenetic development of the leech somite uniannulate and biannulate stages precede and give rise to the triannulate stage. Not only is this true, but the biannulate condition in which the sensory and presensory regions are united into a larger anterior annulus, is characteristic of the complete somites of *Oligobdella* (*Torix*?) among the Glossiphoniidæ and of *Ozobranchus* among the Ichthyobdellidæ. In the young of nearly all leeches and the adults of many under favourable conditions of preservation and contraction, the relative size and grouping of the annuli and the relative depth of the interannular furrows is expressive of the influence of biannulation. Also, biannulate somites are found at both ends of all leeches. Illustrations of this will appear under the specific descriptions.

However, even should the primitive leech ultimately be proven to have been uniannulate or biannulate, the triannulate somite has a far wider prevalence in existing leeches, and for descriptive purposes it is more convenient to adopt it as basic. Extensive comparison of somites with more than three annuli shows clearly that they are derived from the triannulate condition by growth and subdivision of one or more of the three primary annuli. The quinquannulate somite is formed by the subdivision of the first and third, the sexannulate usually by the tertiary subdivision of the last or fifth secondary annulus, but in certain Ichthyobdellidæ by the binary division of all three primary annuli. The septannulate and higher multiples also may exhibit more than one possibility, each characteristic of different genera but reached only through further binary division of annuli of lower orders. In this process of annular elaboration the middle primary or sensory annulus is generally more conservative, and becomes less subdivided than either of the others. Thus in the five-ringed somite it remains quite undivided, and in the fourteen-ringed somite of *Piscicola* it stops with four tertiary annuli, whereas each of the other primary annuli has developed two, or the post-sensory annulus four, quaternary annuli. Increase in the number of annuli shows some correlation with increased flexibility and possibly with capacity for extension, which again is correlated with the mode of

life. It is a device for lengthening the body imposed by the fixity in the number of somites.

Turning from the middle-body region to the ends, we find a progressive simplification of the somite (fig. 1), the number of annuli passing successively through a four-, three- and two- to a one-ringed stage, a process which Whitman described as centrifugal reduction or abbreviation. Or if it be considered that the process of elaboration first appeared and proceeded farthest in the middle region and thence spread with diminishing effect towards the ends, then the latter would be more primitive and retarded and the process more properly described as centripetal elaboration. Whatever our theoretical preference, the full series of stages from the uniannulate apical somites to the complete middle somites exactly parallels the steps in the ontogenetic development of the somite. Furthermore, each place in this series from the biannulate stage onward is represented in the permanent complete somite of particular genera.

The exact position of the segmental sensillæ on the middle zone of the somite serves as an indicator and a measure of the growth process, and shows whether an annulus has arisen or is arising on the cephalic or the caudal end of a somite. A further test is found in the frequent arrangement of the non-segmental sense-organs in a transverse zone on each annulus, inasmuch as this zone often will exhibit more or less complete division into two zones before even an incipient furrow can be detected. Localized deposits of pigment also demonstrate the constancy and definiteness of these annular constituents of somites. In many species in which metameric pigment spots are limited to particular annuli of complete somites, they may be identified on incomplete somites as restricted with the greatest precision to the corresponding region, even though no furrow may be developed to cut off the annulus to which they belong from the more comprehensive annulus in which they are included.

As annuli arise and develop, the furrows delimiting them are at first very shallow and incomplete. Usually they appear first in the middle dorsal field, from which they extend laterally and around the sides to the venter, finally meeting and completing the furrow, which becomes progressively deeper as the annulus grows to full size. Rarely such furrows may be best developed on or even restricted to the venter. This occurs most frequently in the anal region, where also furrows may be deeper on or even confined to the margins, and very shallow or totally absent in the mid-dorsal and mid-ventral fields.

Exhaustive study of many genera and species of leeches demonstrates that the order of development of annuli, both in the ontogeny and in the morphology of successive homodynamous somites, of any grown leech, is very regular and constant. Beginning with a uniannulate somite, the post-sensory region first grows in length so that the sensillæ lie nearer to the cephalic border. A furrow then appears caudad of the zone of sensillæ,

THE SEGMENTATION

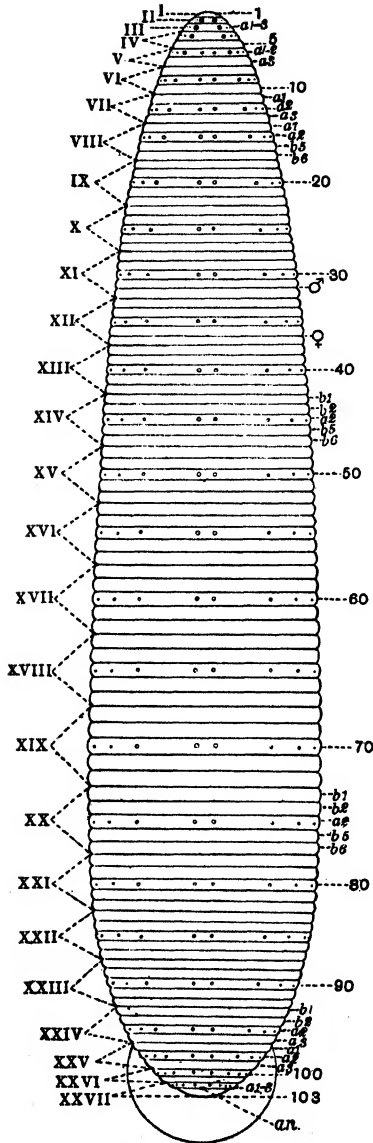

Fig 1.—Diagram of external metamerism and annulation of a typical ten-eyed leech (Hirudidae), slightly modified from a drawing by W. A. Harding based upon *Hirudinaria (Pacilobdella) granulosa* (Savigny). Metamerism indicated on the left side by Roman numerals, annulation on the right side, in the serial notation by Arabic, and in the genetic notation by Italic characters. Eyes, metameric sensillæ, nephropores, gonopores and anus are also indicated.

and, when completed, splits off a post-sensory annulus of a now biannulate somite. The cephalic annulus is the larger, and frequently bears the sensillæ nearer to its caudal margin. The more active growth process is now transferred to the pre-sensory region, a new furrow appears cephalad of the sensillæ and leads to the separation of the pre-sensory annulus of a triannulate somite. All three annuli continue to grow, but the post-sensory most rapidly, and if the leech is to develop beyond the triannulate stage, it is soon divided into two secondary annuli, thus completing the quadrannulate stage. This is converted into the quinquannulate somite by a similar division of the pre-sensory annulus.

Until an advanced stage in ontogeny, or until the middle body region of a grown leech is reached, the post-sensory portion of the somite leads in development the pre-sensory part. This condition may be reversed on certain of the incomplete somites at the caudal end of the body, in which the cephalic part of the somite may be the more elaborated or the caudal part the more simplified. In immature examples of most species, under favourable conditions of preservation of the adults of many species, and under all conditions of some species (most notably *Myxobdella*, Oka, 1917), the relative age of the several annuli may be traced in the differing depths of the furrows separating them, these furrows being more shallow in the exact order of their formation as described above. Great caution in interpreting these appearances is, however, necessary, as furrow depths are affected by many conditions.

In the head or cephalic region of a typical quinquannulate leech (fig. 1) the preocular and first two ocular somites (I-III) are usually uniannulate, sometimes (especially III) with a very faint furrow effecting incipient biannulation. These three constitute the prehensile portion of the cephalic sucker, and together with part of IV, are commonly designated the upper lip. In reality they comprise the dorsal halves only of the somites, as is indicated by the absence of the ventral sensillæ and nerve branches. Somites IV and V are usually biannulate, or the latter partially triannulate, and they enter into the posterior rim of the cephalic sucker, forming the buccal ring. VI is commonly fully triannulate, but the first and second annuli frequently coalesce ventrally to form the post-buccal ring. In the ten-eyed leeches this is the last oculiferous somite and completes the head-region, which receives its nerve supply from the cephalic ganglionic aggregation of six neuromeres. In the triannulate Glossiphoniidæ, VI (sometimes V) marks the beginning of the series of complete somites.

The next three somites (VII, VIII and IX) constitute the pre-clitellum or transition region between the much reduced somites of the head and the complete somites of the mid-body region. Usually VII is triannulate, VIII quadrannulate through the division of the post-sensory annulus into two, and IX is quinquannulate, but the pre-sensory annuli are seldom of full size, and the separating furrow is more shallow than the corresponding post-sensory one. This region receives its nerve supply from the

three distinct but not widely-separated ganglia of the ventral cord. It is peculiarly variable in the different genera.

With X generally begin the fully complete somites in leeches having five or more annuli, and they usually continue to XXII or XXIII or XXIV. But XXIV commonly exhibits post-sensory reduction or incompleteness, which in the true land leeches leads to the entire suppression of this part. The ganglia of this region are regularly and widely spaced and lie in the middle or second primary annulus.

Somites XXV, XXVI and XXVII of the anal region are invariably more or less incomplete, the first being most frequently triannulate, but often biannulate, the second usually biannulate, and the last, which (except in a few cases) bounds or includes the anus, is biannulate or uniannulate. In the true land leeches all three are uniannulate. The position of the sensillæ is of especial importance in this region in indicating the composition of the somites. As in the corresponding preclitellar transition region at the cephalic end, the ganglia are approximated but not aggregated into a mass.

The remaining seven somites, XXVIII to XXXIV, are quite simple and uniannulate and, indeed, so completely coalesced that the intersegmental furrows are suppressed. The location of the somites is indicated by their sensillæ, the full seven circles of which can be counted only in a few favourable genera, and even in these irregularities are usual. The segments of the caudal sucker differ from those of the cephalic sucker in being composed of both dorsal and ventral halves strung together, like so many disks or rings, on an axis and, therefore, all parallel with the rim of the sucker, which is formed of the last somite alone. The zonary arrangement of both dorsal and ventral sensillæ confirms this. In this construction it differs greatly from the oral sucker, the annuli of which (anterior to the buccal ring) cut the margin perpendicularly. See, however, the remarks in the systematic part on the ventral sucker ribs of *Hæmadiptera*. Corresponding to the concentration of the somites of this region the seven neuromeres are aggregated into a compact mass, which is made up of the typical ganglionic elements and nerve-trunks.

It is of interest to note how perfectly balanced are the two ends of the body, the five regions consisting of six, three, fifteen, three and seven somites respectively. From this description it will be seen that the morphology of a leech's body does not conform to a regular metabolic axial gradient system from end to end, but that the region of greatest growth elaboration is in the middle, and from this diminishes gradually both ways. Furthermore, each somite represents a somewhat independent centre of growth activity which follows a definite principle. This is, that the middle or sensory annulus is the most conservative and backward in development, and the end annuli the most active and advanced. Also the end of the somite directed toward the centre of the body usually progresses farther than the distal end. There are even

evidences that each of the annuli of the triannulate somite has acquired a moderate autonomy.

To designate the annuli into which complete somites may be divided, the following theoretical system of notation has been adopted and used by the writer on the assumption that each annulus may grow and undergo binary division, and these products in turn similarly grow and subdivide, as explained above. Beginning with the triannulate somite as primary, three successive subdivisions may take place, resulting in secondary, tertiary and quaternary annuli. No leech is known to have developed annuli beyond the fourth order, though there is no apparent reason why this may not occur. The four orders are indicated by the symbols *a*, *b*, *c* and *d* respectively, and the annuli in each order are numbered in the cephalo-caudal direction, as shown in the following table.

THEORETICAL TABLE OF ANNULI OF EACH ORDER.

Primary.	Secondary.	Tertiary.	Quaternary.
<i>a</i> 1	<i>b</i> 1	<i>c</i> 1	<i>d</i> 1 <i>d</i> 2
		<i>c</i> 2	<i>d</i> 3 <i>d</i> 4
	<i>b</i> 2	<i>c</i> 3	<i>d</i> 5 <i>d</i> 6
		<i>c</i> 4	<i>d</i> 7 <i>d</i> 8
<i>a</i> 2	<i>b</i> 3	<i>c</i> 5	<i>d</i> 9 <i>d</i> 10
		<i>c</i> 6	<i>d</i> 11 <i>d</i> 12
	<i>b</i> 4	<i>c</i> 7	<i>d</i> 13 <i>d</i> 14
		<i>c</i> 8	<i>d</i> 15 <i>d</i> 16
<i>a</i> 3	<i>b</i> 5	<i>c</i> 9	<i>d</i> 17 <i>d</i> 18
		<i>c</i> 10	<i>d</i> 19 <i>d</i> 20
	<i>b</i> 6	<i>c</i> 11	<i>d</i> 21 <i>d</i> 22
		<i>c</i> 12	<i>d</i> 23 <i>d</i> 24

a 2 is the primary sensory or neural annulus, the centre of balance of the somite, and the least subject to modification of the three primary annuli. A few Ichthyobdellidæ are known in which all of the six secondary annuli are equally developed, and a few in which all of the twelve tertiary annuli appear. No leech is known in which more than a few of the quaternary annuli are developed, and these are almost invariably in the post-sensory (*a* 3) region. A few diagrams (Pl. I.) will make clear the application of the system to the complete somites of typical genera.

Here we have examples of complete somites composed of 2, 3, 4, 5, 6, 7, 8, 9, 12 and 14 annuli, and there are many others exhibiting transitions between these. Each of these may be expressed by an easily comprehended formula embracing the symbols of all of its developed annuli. Thus the complete somite of *Glossiphonia* is expressed as $a\ 1 + a\ 2 + a\ 3$ or $a\ 1-3$, of *Hirudo* and most other typical quinquannulate genera as $b\ 1 + b\ 2 + a\ 2 + b\ 5 + b\ 6$, of *Trachelobdella* as $b\ 1 + b\ 2 + b\ 3 + b\ 4 + b\ 5 + b\ 6$ or $b\ 1-6$, of *Trochæta* as $c\ 1 + c\ 2 + b\ 2 + a\ 2 + b\ 5 + d\ 21 + d\ 22 + c\ 12$, of *Piscicola* as $c\ 1-8 + d\ 17-18 + c\ 9-10 + d\ 23-24$.

Inasmuch as the differentiation of annuli takes place by the gradual development of furrows both in depth and extent, it is obvious that interpretations by different students, or even by the same student at different times, will differ. The somite of *Dina*, for example, has been described by one as 5-annulate and by another as 6-annulate. This difficulty exists, of course, with any system or with no system of terminology, and much of the existing uncertainty regarding the status of species has arisen from this cause. For my own guidance in preparing descriptions, I have adopted and endeavoured to apply as accurately as possible the following rule. Whenever the furrow separating two annuli has become at least one-half as deep as the neighbouring furrows, and when it has extended at least across the entire dorsal half or ventral half of the circumference, the annuli are considered to be differentiated and worthy of being designated by their specific symbols. If the furrow is less developed than this, the annuli are regarded as being still in the incipient stage, and are designated either by the symbol of the inclusive annulus with the appropriate descriptive remarks, or by what is often better, the symbols of the incipient annuli enclosed by parentheses; thus the enlarged fifth annulus of *Dina* is expressed as ($c\ 11 + c\ 12$).

This terminology may be applied equally well to annuli of any degree of incompleteness. Thus somite VIII of many quinquannulate leeches is quadrannulate, but the pre-sensory primary annulus shows a very faint or partial furrow, and consequently is expressed as ($b\ 1 + b\ 2$). Frequently no furrow at all is discernible, but the undivided annulus is distinctly longer than its neighbours of the same order. In such cases it may nevertheless be desirable to express the latency of the annuli by the formula with the + sign omitted, thus, ($b\ 1\ b\ 2$). This is especially desirable in the case of biannulate somites occurring in the cephalic and anal

regions of nearly all leeches and throughout the body of *Oligobdella* as the complete somites. These have the formula $(a_1 a_2) + a_3$, or, if better developed, $(a_1 + a_2) + a_3$. The relative sizes or the exact ratios of the length of different annuli compared may be expressed in the formulæ by adding the appropriate mathematical symbols: =, >, < or the numerical quantities: thus, VII $a_1 <$ VII a_3 or VII $a_1 = 2/3$ VII a_3 . The same system is used to designate furrows also by writing the symbols of the bounding annuli in fractional form separated by a line: e. g., a_1/a_2 , and their relative depth may be expressed by using the mathematical signs or quantities: thus, VII $b_5/b_6 <$ VIII b_1/b_2 or IX $b_1/b_2 = 1/2$ IX b_5/b_6 . Conditions on the dorsum and venter may also be compared.

Although this terminology was proposed in 1898 (Moore ('98)), and has been used by the writer ever since, it has not been adopted by other student of leeches, only three being known to have used it. Nevertheless, the system possesses several merits. By means of it the development of the annuli of any leech may be expressed in detail by a brief and easily understood diagnostic formula, and a uniform basis for the exact comparison of the different species established. By combining the annulus symbols with the Roman numerals designating somites, any particular annulus of a leech's body may be indicated, and this without the necessity of counting all of the annuli. Under this system the source of any discrepancy between the counts of two writers may be instantly detected and located. Differences in dorsal and ventral annulation are also expressed exactly.

All systematic writers on the Hirudinea have laid stress on the importance of making exact counts of the number of annuli, and have used the annuli numbers to designate the position of other structures. Each writer has selected a fixed starting-point, but unfortunately, until recently, there has been no agreement upon the location of this point. There have been used the first pair of eyes, the last pair of eyes and the anus on the dorsal side, and the "mouth" (buccal rim) and first pair of nephropores on the ventral side, but as writers do not always state which system they employ, the resulting confusion is great. Whitman quite logically discarded all of the earlier unnatural systems, and numbered every annulus successively, beginning with the tip of the head. This is the system now generally in vogue, and would be satisfactory were it possible to apply it consistently. Unfortunately, however, annuli are not always perfectly definite parts. At the head end especially they may be obscure and ill-defined, and on poorly-preserved material are frequently totally obliterated. This results in diverse interpretations, frequent errors, and inconsistencies which affect the enumeration of the annuli throughout the length. In the absence of the original material it is often impossible to determine the exact source of confusion, and there may be much uncertainty concerning the species to which a description refers. An advantage of the system proposed is that any errors or

discrepancies are confined to the somite in which they occur, and consequently may usually be checked and interpreted by an experienced student. Other points on the body are not affected, as they are independently determined. The annulation of each somite is determined separately, and there are so many good criteria by which the somites may be delimited and counted that there is small excuse for errors. Of course, this system, like any other, is subject to the vicissitudes of the personal equation and human frailty, but it has the advantage of offering many objective checks and of limiting the error.

By using this terminology in connexion with that employed for mapping out the surfaces in longitudinal fields or tracts separated by the lines along which the sensillæ lie, we are provided with a system of coordinates, a sort of minute latitude and longitude, by which any point on a leech's body may be designated with the utmost precision and located very quickly.

In case objection is made to the theoretical considerations upon which this terminology is based, a great improvement over Whitman's system would be found in the employment of the Roman numerals to designate the somite and Arabic numerals to indicate the annuli of each somite. This would have the great disadvantage, however, that a given numeral (*e.g.* 5) would refer to quite different annuli in somites of different degrees of elaboration*.

While the determination of annulation is of the greatest importance for systematic descriptions, the too exclusive dependence upon it for diagnostic purposes has of recent years proved a detriment rather than an aid to progress. By some recent students the annulation, and especially the annular structure of the complete somite, has been depended upon as almost the sole criterion of generic diagnosis, to the nearly complete neglect of the internal anatomy. The result has been much confusion, an unnecessary multiplication of genera, and unnatural groupings. To put the Hirudinea upon a satisfactory taxonomic basis, it is important that the anatomy of all species not previously described should be placed upon record, and that the descriptions of all new species should include an account of the principal features of internal anatomy. Only by the accumulation of this information and a complete monographic study of the group can a satisfactory arrangement of the genera be reached.

* Since this was written, Oka (1925) has employed such a terminology, except that letters of the alphabet, instead of numerals, were used to designate the annuli.

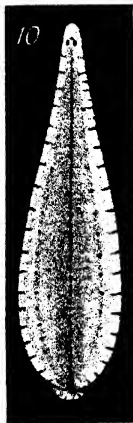
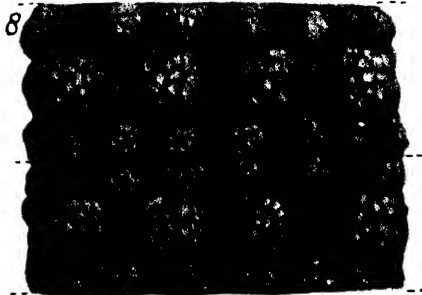
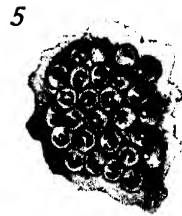

INDIAN RHYNCHOBDELLÆ.
 (For detailed Explanation, see p. xxxiii.)

INTRODUCTION
TO THE
R H Y N C H O B D E L L Æ.

BY

W. A. HARDING, M.A., F.L.S.

THE Suborder Rhynchobdellæ comprises leeches which suck the blood and juices of their prey by means of a protrusible proboscis. It contains no terrestrial or carnivorous forms. Its members are strictly parasitic, and consist, without exception, of freshwater and marine species, the latter being the only leeches known to inhabit the sea.

The proboscis, which constitutes so important a characteristic of this group, is an adaptation of the pharynx, which has become highly muscular, free and protractile, and so capable of being thrust through the small oral opening in the leech's anterior sucker into the tissues of its host.

Few Rhynchobdellæ are large, and none reach the formidable proportions attained by certain predaceous Arynchobdellæ. In the Indian region, where they are widely distributed, they are all, with the exception of a few marine species, of small size, ranging from about 6 mm. to 20 mm. in length, and on this account, combined with the fact that they are innocuous to mankind, they do not generally attract the attention of the ordinary observer.

The Suborder is divided into the three Families—Acanthobdellidæ (not represented in India), Ichthyobdellidæ and Glossiphonidæ. It must be noted, however, that opinion is not unanimous in regarding *Acanthobdella peledina*, the only representative of the first of these Families, as a leech. Notwithstanding its affinities with the Hirudinea, some authorities consider that its true position is with the Oligochæts. In the Rhynchobdellæ there is always a permanent, cupuliform or discoid posterior sucker, directed more or less ventrally and supported, as on a kind of pedicel, by the tapering portion of the body lying immediately behind it. An anterior sucker of very similar form is nearly always found in the Ichthyobdellidæ, but in a few members of this Family and in the Glossiphonidæ this is of a different type.

but we need only concern ourselves here with the segmental sense-organs or *sensillæ*. These are confined to the sensory ring of each somite, which in the middle part of the body overlies a ganglion of the ventral chain, and appear in strict series in definite longitudinal rows or lines. According to Livanow (1903) these lines occur on the dorsal and ventral surface in pairs with respect to a median line, and counting outwards from the median line, consist typically of (1) an inner and (2) an outer paramedian pair; (3) an intermediate pair; (4) an inner and (5) an outer paramarginal (or submarginal) pair; and finally (6) of a marginal pair coinciding with the edges of the body.

It must not be supposed, however, that *sensillæ* are always present on these lines in every species. Generally the number of pairs is reduced, and this reduction is noticeable in the *Rhynchobdellæ*. The *sensillæ*, which often appear as small white spots on the surface of the body, are frequently associated with colour-markings and more or less prominent cutaneous papillæ, and thus the sensory rings upon which they are borne are in most cases easily recognised by the eye.

Whitman and many others regarded these conspicuous sensory rings as the first rings of the successive somites of the body. Although, however, this method of determining somite limits was convenient, it presented many difficulties which need not be discussed here, and in 1900 Prof. J. Percy Moore and Dr. W. E. Castle, each working independently and upon different material, suggested a new method of somite delimitation based upon the nervous distribution, which they very properly regarded as of fundamental importance.

Under this system, which is now generally accepted, each somite is innervated by the ventral ganglion it contains. The sensory ring lies in the middle of the three- or five-ringed somite, and takes its place there as the primary ring from which the others have been derived by a process of growth and subdivision.

The *sensillæ*, which are retractile and provided with sensory hairs, in addition to functioning as tactile organs, appear to some extent to be sensitive to light. On the dorsal surface of the head-region they are often specially developed and modified into eyes, which consist essentially of a nerve axis surrounded by visual cells, surmounted by an epithelial cap and embedded posteriorly in a dense black pigment-cup, which, when viewed from above, is of more or less crescent-like form. Such organs can do no more than distinguish between light and darkness.

From one to four pairs of eyes may be present in the *Rhynchobdellæ*. In a few cases, as in some species of *Placobdella*, eyes which at first appear to be single are found on closer examination to be compound, and occasionally the typical number may be incomplete or even exceeded; nevertheless it cannot be denied that the eyes, both in number and arrangement, are of great diagnostic value.

In addition to the number of rings, the number and constitution

of the somites, complete and incomplete, the colour, markings, papillæ, eyes, vesicles, branchiæ, and the form of the body and its suckers, the openings in the body have still to be considered by the systematist. The position of the genital apertures in the ventral median line, and also that of the mouth-opening in the anterior sucker, are taxonomically of great importance; the situation of the anus in the dorsal posterior region is another useful diagnostic feature in the external topography, and the number and position of the nephridiophores upon the ventral surface, although often obscured in preserved material, should if possible be ascertained. The genital openings generally lie within the limits of the eleventh and twelfth somites, the male anterior to the female; occasionally a single slit-like pore encloses the apertures of both.

The mouth-opening, through which the proboscis is protruded, usually lies well within the cup of the anterior sucker, but sometimes it occurs at, or close to, its anterior extremity, thus leaving the interior face of the sucker imperforate. *Ozobranchus* and *Paraclepsis* afford examples of subterminal oral openings; a terminal opening is characteristic of *Placobdella*.

BODY-CAVITY OR CÆLOM.—The most notable and perplexing internal feature in the Ichthyobdellidæ and Glossiphonidæ is the cœlom. In the nearest allies of the Hirudinea, namely the Oligochæta, this consists of a fairly spacious body-cavity, divided intersegmentally by septa and containing the viscera; but among leeches this condition is seen only in the Siberian species *Acanthobdella*, which forms a connecting-link between the two groups. In the rest of the Rhynchobdellæ the body-cavity is split up into a series of longitudinal canals of varying size, connected by a complicated system of intercommunicating branches, which has been called the *lacuna system*.

Apart from the lacuna system, which is filled by the cœlomic fluid, or lymph, and entirely unconnected with it, there is present a vascular system containing colourless blood.

In typical species of the Glossiphonidæ, Oka (1894) finds that the lacuna system comprises five longitudinal trunks, namely (1) a median lacuna, (2 and 3) a pair of lateral lacunæ, and (4 and 5) a pair of intermediate lacunæ lying between them and connecting the median and lateral trunks by means of transverse lacunæ. In addition to these, a system of hypodermal lacunæ lie beneath the skin.

The median lacuna, which contains a series of imperfect septa, traverses the body from the head-region to the anus, and where the stomach and intestine occur becomes divided into a dorsal and a ventral lacuna, the two being separated by the portion of the alimentary tract referred to. The narrow dorsal lacuna encloses the dorsal blood-vessel, and the larger ventral lacuna contains the ventral blood-vessel, the nerve-cord and part of the reproductive organs.

The lateral lacunæ lie at the margins of the body, and also extend from the head-region to the anus. At both extremities they are connected with the median lacuna and each other by means of a circular canal passing round the margins of the anterior and posterior suckers. These lacunæ are not contractile like the lateral lacunæ of the Ichthyobdellidæ, and the cœlomic fluid in the Glossiphonidæ probably owes its circulation partly to the movements of the animal and partly to the pulsations of the dorsal blood-vessel in the median lacuna.

The intermediate lacunæ extend from the sixth somite to the anus, and, together with the transverse lacunæ, may be regarded

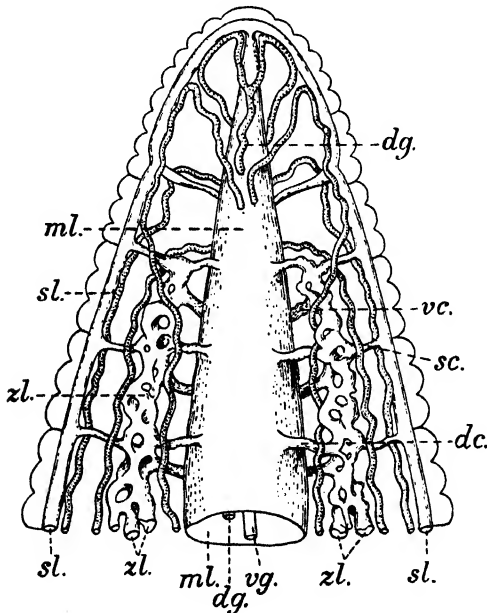

Fig. 2.—Schematic representation of the lacuna system in the anterior part of the body of *Glossiphonia complanata* (after Oka). *ml.*, median lacuna; *zl.*, intermediate lacuna; *sl.*, lateral lacuna; *d.c.*, *v.c.*, and *s.c.*, dorsal, ventral and lateral transverse lacunæ; *dg.*, dorsal blood-vessel; *vg.*, ventral blood-vessel.

merely as extensions of the median lacuna. They are not simple trunks, but consist of a continuous network of canals, which occupy the spaces between the dorso-ventral muscles, nephridial cells and the connective tissue of the body.

The hypodermal lacunæ encircle the body immediately beneath the skin, and communicate with the lateral and intermediate lacunæ. From one to four of these fine canals may occur in each annulus,

and by bringing the cœlomic fluid so near to the exterior surface they assist in the process of respiration.

In the Ichthyobdellidæ the lacuna system is much more variable in plan than in the Glossiphoniidæ, and the lateral lacunæ, which are rarely absent, are strongly contractile, with powerful muscular

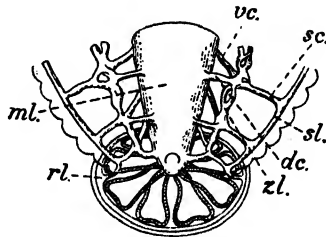

Fig. 3.—Schematic representation of the lacuna system in the posterior part of *Glossiphonia complanata* (after Oka). *ml.*, median lacuna; *zl.*, intermediate lacuna; *sl.*, lateral lacuna; *d.c.*, *v.c.* and *sc.*, dorsal, ventral and lateral transverse lacunæ; *rl.*, circular lacuna in posterior sucker. Blood-vessels indicated by dotted shading.

walls. The system attains its highest degree of complexity in those forms which, like *Piscicola geometra*, are provided with *pulsating vesicles*.

In this species, which has been investigated by Johansson (1896) and Selensky (1906), there is a median lacuna and pairs of lateral and intermediate lacunæ, agreeing in the main with the arrangement seen in the Glossiphoniidæ. The hypodermal lacunæ are absent, but capillary vessels, having a similar function, occur in allied species. In the middle of each of the first eleven somites (XIII–XXIII) posterior to the clitellum there is a pair of lateral pulsating vesicles and a *segmental lacuna* running within the circular body in the form of an irregular ring.

The vesicles lie in the body-wall between the skin and the muscle-layers, and outside the lateral lacunæ, with which they are connected. The segmental lacunæ form a communication between the median and intermediate lacunæ, and throw out on either side lateral branches which, again, communicate with the vesicles.

The pulsating vesicles, which in diastole arch up the conspicuous little hemispheres of skin already referred to, are rendered contractile by reason of their muscular walls. An incomplete muscular septum, formed by an invagination of the outer wall, lies somewhat loosely within each vesicle, and by flapping backwards and forwards acts as a valve, alternately covering and uncovering the opening forming the vesicle's inlet. In expansion, the cœlomic fluid is drawn into the vesicle from the lateral branch of the segmental lacuna, and after passing over the septum is forced, during contraction, into the lateral lacuna.

Johansson (1898 *b*), working for the most part upon material obtained in northern Europe, draws attention to three different types assumed by the lacuna system in the Ichthyobdellidæ. The first type, possessing pulsating vesicles, is that just described which, it must be noted, contains one genus, *Pontobdella*, where these organs are not apparent externally, being very small and unable to arch up the thick warty skin. In the second type the lacuna system is considerably reduced. The pulsating vesicles and also the lower halves of the segmental lacunæ, have disappeared, leaving only the upper halves to connect the dorsal and lateral lacunæ. Johansson's genus *Abranchus* (unrecorded from India) and, perhaps, *Piscicola cæca* (Kaburaki), described in these

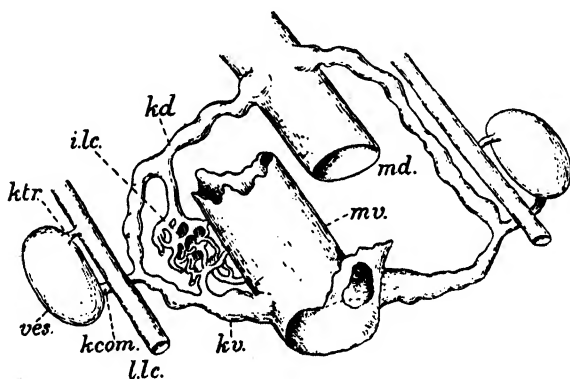

Fig. 4.—Schematic representation of the lacuna system in a somite in the middle part of the body of *Piscicola* (after Selensky). *md.*, dorsal lacuna; *mv.*, ventral lacuna; *l.lc.*, lateral lacuna; *i.lc.*, intermediate lacuna, shown on one side only; *kd.* and *kv.*, dorsal and ventral sections of segmental lacuna; *ves.*, pulsating vesicle; *ktr.*, canal connecting pulsating vesicle with lateral lacuna; *kcom.*, lateral canal running from segmental lacuna to vesicle.

pages, are representatives of this type. In the third type, exemplified by the genus *Platybdella* (Malm, 1863) as amended by Johansson (1898 *a*), the cœlomic system is reduced still further, little more than the ventral part of the median lacuna being left.

These types by no means include all the modifications exhibited by the lacuna system in the Ichthyobdellidæ, which still requires further investigation. Badham (1916) describes a remarkable Australian member of this Family, *Austrobdella*, having a pair of contractile marginal canals in place of pulsating vesicles.

In *Ozobranhus*, Oka (1904) finds that the contractile lateral lacunæ give off to each of the branchiæ a canal which breaks up into finer branches, of which two penetrate to the tip of every gill-thread, where they unite with a similar single fine branch com-

municating with the large and simple median lacuna. In diastole the lateral lacunæ draw the lymph through the inlet valves of the branchial canals connected with them, and in systole disperse it through the rest of the cœlomic system.

VASCULAR SYSTEM.—The true Blood-Vascular system consists essentially, in the Rhynchobdellæ, of a dorsal and a ventral vessel extending through the greater part of the body, and connected at each extremity by a series of convoluted branches. A section of the anterior part of the dorsal vessel is provided with specially muscular walls, which render it contractile and so able to perform the functions of a heart or hearts. The dorsal vessel, furthermore, almost always expands into, or is connected with, what has been termed an *intestinal blood sinus*, which more or less entirely envelops the intestine and its diverticula.

In many, if not in all cases, the peristaltic contractions of the muscular intestinal wall force the blood out of the intestinal sinus into the dorsal vessel, where, after passing through a series of valves which prevent regurgitation, its forward flow receives fresh impetus on reaching the contractile "heart."

The vascular system here broadly outlined is subject to considerable variation in detail. The intestinal blood sinus in the Glossiphoniidæ is described by Oka (1894) as an expansion of the dorsal vessel, entirely surrounding and following the contour of the intestine and its diverticula. In *Piscicola* and some other Ichthyobdellid genera this is formed in part by a separation of the epithelial and muscular layers of the intestinal wall. In *Branchellion* it takes very largely the form of a network of blood-vessels (Sukatschoff, 1912), and in *Ozobranchus* no proper sinus exists at all. In this genus, Oka (1904) finds that the dorsal vessel lies over the intestine, and the diverticula of the latter, which are very long and do not extend laterally, wind round the vessel so that it is in contact with the intestine on all sides. This close contact, which is always maintained between the dorsal vessel and the intestinal wall, whether by a sinus or by other means, enables the blood to absorb from the intestine food products which later are imparted osmotically through the walls of the dorsal vessel to the lymph surrounding it in the median lacuna.

Our knowledge of the vascular system in *Piscicola* is due to Johansson (1896) and Selensky (1907), and the latter gives a good description of the thickened muscular walls of the dorsal vessel forming the "heart" in this species (see fig. 5). These walls owe their contractility to the presence of closely-placed muscular bands surrounding the vessel, and extend from the second pre-clitellar somite to the posterior extremity of the clitellum, where they end abruptly. It will be observed that the muscular layer extends for a short distance along each of the branches given off by the dorsal vessel. In the Glossiphoniidæ, Oka (1894) describes a somewhat different arrangement, consisting of a series of fifteen contractile chambers separated by valves, acting as hearts.

The anterior branches connecting the dorsal and ventral vessels consist nearly always of four pairs, together with an odd branch which supplies the proboscis. Posteriorly the connecting branches spread out into paired loops in the posterior sucker. In some cases there are seven pairs of such loops corresponding to the seven somites absorbed by the sucker, but the full number is not always present.

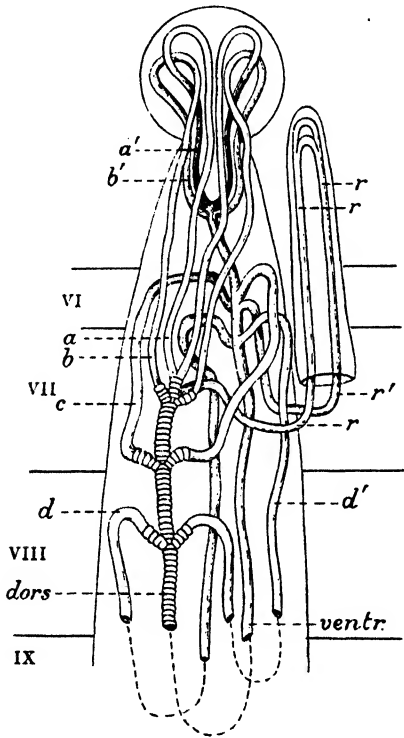

Fig. 5.—Schematic representation of the blood-vessels in the anterior part of the body of *Piscicola* (after Selensky). Somites numbered in Roman figures. *dors.*, dorsal vessel (the contractile portions are annulated); *ventr.*, ventral vessel; *a, a'* and *b, b'*, branch vessels forming loops in the anterior sucker and connecting the extremities of the dorsal and the ventral vessel; *c* and *d, d'*, other branches connecting the same, the latter looping backwards as far as the clitellum; *r, r'*, an unpaired connecting branch supplying the proboscis, here shown for the sake of clearness as external to the body.

It will be understood from what has been said that (1) in *Acanthobdella* there is a simple body-cavity and a closed vascular system, and that (2) in the Ichthyobdellidæ and Glossiphonidæ the

closed vascular system has become supplemented by a secondary circulatory system developed from the cœlom. These two systems are unconnected and, moreover, the blood flowing in the one and the lymph flowing in the other, although both almost colourless, bear no other resemblance to each other and react differently to stains. In the *Arhynchobdellæ*, it may be noted further, the true vascular system has disappeared, and the lacuna system, containing red-coloured lymph, alone remains in a modified form.

ALIMENTARY TRACT.—The buccal orifice or mouth perforates the hollow ventral surface of the anterior sucker at some point in the middle line. The diagnostic value of the position of this orifice either within or upon the anterior rim of this *oral chamber*, as it has been called, has already been noted in the description of external features. The mouth opens into a deep stomodæal cavity completely surrounding the pharynx, which takes the form of a cylindrical, bluntly-pointed protrusible *proboscis* moving freely within it. This cavity has received more than one interpretation, and has been variously termed the buccal sinus, peripharyngeal chamber, pharyngeal sac and proboscis sheath. The *proboscis sheath*, as it will be called here, is lined by ectodermal epithelium, which is continuous with that of the proboscis and its lumen.

The proboscis, which is controlled by retractor muscles lying behind it and protractor muscles situated in its sheath, is itself highly muscular and extensile, and in addition to its longitudinal musculature, possesses a system of radial and circular muscles which, by expanding and contracting its lumen, provide a means of sucking blood. The ducts of the unicellular salivary glands, which lie outside the median lacuna and are often of very large size, enter the base of the proboscis and penetrate upwards to discharge their contents, some into its lumen and some at its extremity.

The ectodermal lining of the digestive tract ends with the base of the proboscis, which is immediately followed by the "anterior endodermal gut" of Sukatschhoff (1912), lying in the clitellar region. This, which has sometimes been called the œsophagus, receives in many cases the ducts of a pair of lateral œsophageal glands. It may be distended owing to the development of paired lateral diverticula, or it may be somewhat long and slender, when it often undergoes a considerable amount of flexion during the retraction of the proboscis. This anterior endodermal gut is no more than an extension of the portion immediately following it, with which it is similar both in function and in structure, namely the long section of alimentary tract called by Sukatschhoff the "anterior thin-walled part of the middle gut," and referred to in the following pages by its more familiar names of *crop* or *stomach*.

The chief function of the stomach is to act as a place of storage for food, and its capacity is found to vary inversely with the difficulty experienced by the leech in finding a host.

The stomach is provided posteriorly with a capacious extension, which in the Ichthyobdellidæ takes the form either (1) of a single cæcum, (2) of a pair of cæca, or (3) of a cæcum partly divided by a series of median apertures, representing a stage intermediate between the other two. Johansson (1898 b), who first drew attention to the diagnostic value of these varying structures, regards the paired cæca seen in his genus *Abranchus*, and in *Ozobranchus*, as the primitive type from which the others have been derived by a process of fusion. The single cæcum or blind gut lies beneath the intestine, and is characteristic of *Pontobdella* and the intermediate type, where the paired cæca are partly fused together, appears to be of the most frequent occurrence, and is seen in *Branchellion* and *Piscicola*. In addition to the posterior cæcum or cæca there is a series of anterior, metamericly disposed pairs of cæca or diverticula, the several pairs occupying the middle part of successive somites. In *Branchellion* and *Callobdella* the narrow portion of the gut lying between each pair of cæca is provided with an annular muscle-band forming a sphincter, and there is little doubt that such sphincters, dividing the stomach into a series of chambers, occur in similar situations throughout the Rhynchobdellæ.

In the Glossiphonidæ all the diverticula of the stomach are paired and often developed to a conspicuous degree, the deeper indentations in the irregular but symmetrical form often assumed being due to the interference of the dorso-ventral muscles.

The thin-walled crop or stomach opens through a sphincter into the *intestine*, the "thick-walled, glandular section of the middle-gut" of Sukatschoff (*loc. cit.*). This consists of a moderately wide, median, longitudinal tube, part of which may be ciliated, provided generally with four pairs of diverticula. It is here that the processes of digestion and absorption take place. The relation of this portion of the gut to the blood-stream has already been discussed.

The intestine opens, again through a sphincter, into the thin-walled *hind gut*, of which the posterior part serves as a *rectum* and discharges its contents through the dorsal and median *anus*, situated nearly always within the limits of somites XXVI and XXVII.

GENERATIVE ORGANS.—Leeches are hermaphrodite. The reproductive system in the Rhynchobdellæ is of great systematic importance, owing to the considerable diversity in detail often presented by its several parts. The male, like the female organs, are paired, with the exception of their common portions situated in the middle line.

The male organs may be considered first. The testes are disposed segmentally, and in the post-clitellar region lie between the diverticula of the crop or stomach. The number of pairs of testes varies in different genera. Their cavities form parts of the original cœlom, having arisen, like the ovaries, as proliferations of the

epithelium of the lateral coelomic cavities, and within them the process of spermatogenesis takes place. Each testis, or testicular sac, communicates by a short vas efferens with the vas deferens of its own side, and this, at some point not far in advance of the first pair of testes, leaves the tissues through which it has hitherto passed, and expands into an ejaculatory canal with muscular walls, often swollen and contorted, lying free in the ventral lacuna. Here the terminal portions of each canal turn inwards to form a median common part or prostate chamber, followed by an ectodermal invagination, referred to below, ending in the male orifice.

The posterior part of the ejaculatory canal, generally much coiled and separated from the terminal part by a constriction, constitutes an epididymis or sperm-reservoir where the spermatozoa, swept into it from the ciliated lumen of the vas deferens, become cemented together in compact bundles, and are stored for future use. The ejaculatory canals may be modified in several ways. The sperm-reservoirs may be reduced, or in certain cases absent. In *Glossiphonia heteroclita* (fig. 23, p. 61) these canals assume what may be regarded as their typical form. In *Glossiphonia complanata* (fig. 22, p. 59) the greater part of each canal is somewhat slender, and takes the form of a long and sinuous loop extending backwards in the median ventral lacuna as far as the twentieth somite.

The spermatozoa are packed in *spermatophores* for conveyance from one individual to another. These little structures, which have an outer chitinous envelope, consist usually of two more or less adherent, often club-shaped tubes containing sperm-bundles, tapering anteriorly to a blunt point and united below by a pedicel traversed by canals leading from each tube to the exterior. The foot, with its adhesive basal disc, is formed in the median, common, unpaired part of the male organs, or prostate chamber, and each of the paired terminal portions of the ejaculatory ducts, often called the prostate cornua, contributes one of the two tubes (Whitman, 1890; Brumpt, 1900). The spermatophore, when first produced, is nearly white, and may be seen readily by the naked eye. That of *Glossiphonia complanata* (fig. 6) ranges from about 5 to 8 mm. in length, but spermatophores of considerably smaller size are not infrequent and larger dimensions are sometimes attained.

The terminal part of the male organs usually takes the form of a small eversible bursa. In *Ozobranchus*, however, where the reproductive system presents features probably unique among the Hirudinea, Oka (1904) notes the occurrence of a true copulatory organ recalling the penis found in the Hirudidae. The bursa, which is subject to a good deal of modification, is generally rudimentary in the Glossiphoniidae, consisting of little more than a small papilla pierced by the male pore. An exception to this is seen in *Theromyzon (Protolepsia) tessellata*, where the bursa is fairly large and has been observed to transfer spermatophores of

a reduced and simplified form from one individual to the female aperture of another (Brandes, 1900; Brumpt, 1900).

But although the well-developed bursa occasionally provides a means of copulation, fertilization, which may be reciprocal, is effected in the Rhynchobdellæ chiefly by hypodermic impregnation. This curious process consists (1) in the implantation by one leech of a spermatophore upon the body of another leech when (2) the contents of the spermatophore penetrate into the tissues of this other leech, and make their way to the ovarian sacs, where fertilization takes place. In the Glossiphoniidæ the spermatophore probably proves effective if attached to almost any part of the

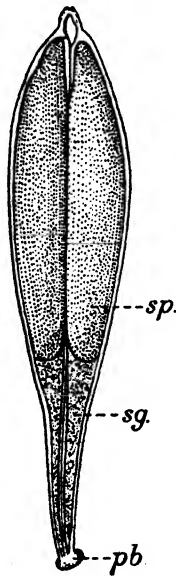

Fig. 6.—Spermatophore of *Glossiphonia complanata*, greatly enlarged (after Brumpt). *Sp.*, portion containing bundles of spermatozoa; *sg.*, granular secretion forming a temporary plug in the canal leading to the exterior through the pedicle *pb*.

body which happens to be accessible; its deposition, however, in many cases is made in the clitellar region. In most of the Ichthyobdellidæ, on the other hand, the spermatophore must be placed in a very restricted zone on the ventral surface, often differentiated into a *copulatory area* situated either close to the genital orifices or in some cases within the male atrium itself, when, occasionally, it may be brought to the exterior with the evaginated bursa. Beneath this area there lies generally the so-called *conductive tissue* (*tissu vecteur*) of Brumpt, serving as a

passage through which the spermatozoa travel to their destination.

The female reproductive organs consist of a pair of more or less elongated cœlomic sacs—the ovisacs—and these, which contain the true ovaries, unite anteriorly to form a common muscular oviduct opening to the exterior by the female pore. The ovisacs during the breeding-season increase in length, and become much distended by the egg-strings developing within them, and in the case of the Glossiphoniadæ and certain Ichthyobdellidæ lie free in the ventral lacuna.

In many Ichthyobdellidæ, however, the ovisacs form adherences either directly, or through the medium of conductive tissue, with

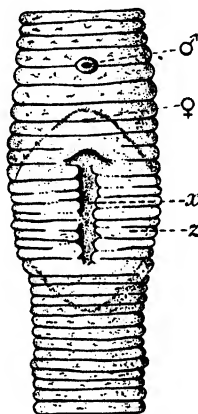

Fig. 7.—Ventral surface of clitellar region of *Piscicola geometra*, showing copulatory area *z*, provided with a longitudinal groove *x* (after Brumpt).

parts of the body-wall often marked exteriorly by a copulatory area of the kind to which reference has been made. This conductive tissue, which has sometimes been misinterpreted, varies very greatly in development and distribution, appearing in some cases as a fairly compact mass, and in others being reduced to a pair of bridle-like strands (fig. 8). It consists of a form of connective tissue arising as an outgrowth from the walls of the ovisacs, according to Brumpt (1901), who first drew attention to its special function, and to whose comprehensive work the reader is referred. The exceptional character of the male reproductive organs of *Ozobranchus* has already been mentioned. The female organs described by Oka (1904) in this genus are even more peculiar. Here there are two female apertures, that serving for fertilization being situated within the male atrial chamber and having no connection with the external female pore reserved for the deposition of eggs.

The eggs, in *Ozobranchus*, are embedded in a single layer in a chitinous sheet spread upon the plastron of the tortoise serving as a host (Plate II, fig. 5), but in most of the Ichthyobdellidæ they are enclosed in cocoons or egg-cases, which are attached to some submerged foreign body. These cocoons vary a good deal in form and size, but they are all made upon the same general plan.

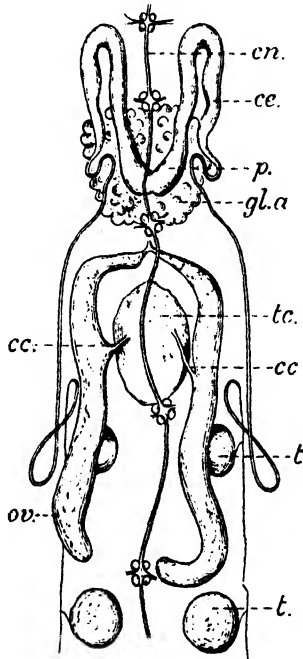

Fig. 8.—Reproductive organs of *Piscicola geometra*, showing conductive tissue (after Brumpt). *t.*, testis; *cc.*, ejaculatory canal; *p.*, its terminal portion; *gl.a.*, glands communicating with the terminal portion of the ejaculatory canal and secreting the walls of the spermatophore (these glands in most species lie in the walls of the terminal portion); *tc.*, mass of conductive tissue underlying the copulatory area; *cc.*, its paired connections with the ovaries *ov.* *cn.*, ventral nerve cord with ganglia.

Shortly before a leech is ready to lay, it makes itself fast by its two suckers to some convenient object, and the clitellum becomes covered with a chitinous layer secreted by glands situated within its walls and destined to form the future cocoon. At first this layer is nearly white and somewhat viscous, but it gradually hardens and eventually assumes a more or less deep brown colour. The leech has now to withdraw the anterior part of its body through this cylindrical layer, having first discharged its eggs

within it and caused it, by pressure, to adhere to the object upon which it rests. Swelling itself against the posterior extremity of its chitinous belt and dragging in the anterior extremity with it as it retires, this structure becomes invaginated until its two ends meet, thus preserving its contents from contamination by contact with the body passing through it. As soon as the cocoon is left free it evaginates itself, and its extremities close up, leaving a small operculum through which, when hatched, the young leeches issue into the surrounding water.

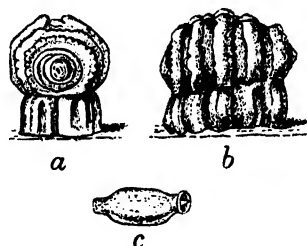

Fig. 9.—*a* end view, and *b* side view of cocoon of *Pontobdella muricata*, greatly enlarged; *c*, cocoon of *Piscicola geometra*, enlarged (after Harding).

In the Glossiphoniidæ the typical egg-case is made in much the same way as the Ichthyobdellid cocoon. It differs from the latter, however, (1) in being a very thin and transparent membranous sac, and not a horny structure, and (2) in being attached to the ventral surface of the body from which it arose. A leech bearing more than one of these bulky and easily detachable sacs remains, as far as possible, in one place, a circumstance which has led to the supposition that the Glossiphoniidæ brood over their eggs. The young leeches for some time after they are hatched adhere by their posterior suckers in heavy clusters to the ventral surface of the parent, who often directs the sides of her body downwards in order to afford additional protection and carries her brood to their first host. Instances are known of a dorsal gland secreting an adhesive substance whereby the young leech in its early stages is fixed to its parent. The dorsal chitinous plate conspicuous in *Helobdella stagnalis* is the remnant of such an attachment gland.

We have now given a brief sketch of the more important features, both external and internal, of systematic importance in the Rhynchobdellæ, without attempting, however, to enter into histological detail or to deal comprehensively with the morphology of the group. Johansson (1898*b*) first called the attention of the systematist to the nephridia, and their diagnostic value, particularly in the case of the Ichthyobdellidæ, is becoming better appreciated. Our knowledge of many known species of Rhynchobdellæ, it may be observed, leaves much to be desired, and there

can be little doubt that further species await discovery and investigation.

METHODS OF PRESERVATION AND STUDY.—The remarks upon the proper technique to be employed in the preservation and study of the Arhynchobdellæ made by Prof. Moore in this volume (pp. 117–120) apply equally well to the sub-order under consideration. Leeches are particularly difficult to preserve with their diagnostic features intact, and the greatest care should be exercised in their treatment after capture. Too often the well-meaning collector drops these sensitive worms alive into a preservative fluid frequently of unknown strength, with the result that they reach their destination in a condition which defies examination. The collector should endeavour to preserve his captives alive until he has leisure to examine them in their natural element, if necessary with the aid of a lens. Careful notes should then be made upon coloration, pattern, form, size, behaviour and any other points which attract the attention of the observer. Such notes, forwarded with the material concerned, often prove of great value.

Leeches invariably should be anæsthetized before being placed in the preservative fluid. This is most readily effected in all but the larger Rhynchobdellæ by immersion in water impregnated with carbon dioxide, obtainable nearly everywhere in the form of the beverage, soda-water. For the amateur 70 per cent. alcohol is the safest preservative to use; where possible, however, both alcohol or the still better preservative formalin should be applied as directed by Professor Moore.

In conclusion, I am greatly indebted to the late Dr. Annandale sometime Director of the Indian Zoological Survey, not only for the large amount of material placed in my hands, but also for valuable information upon the coloration and habits of many species, often supplemented by water-colour drawings of the living leech made by Mr. Chowdhary of the Indian Museum. I have received useful material and information from Miss Muriel Robertson, Prof. Clifford Dobell, F.R.S., Dr. Guy A. K. Marshall, C.M.G., Dr. Kaburaki, and also from Prof. Percy Moore, who, in addition to other courtesies, assisted me in connexion with *Placobdella ceylanica*, a species which owes its proper determination more to him than to me. My thanks are also due to Prof. G. H. F. Nuttall, F.R.S., for permission to reproduce from 'Parasitology' drawings of the cocoons of *Pontobdella* and *Piscicola* (p. 29) and of *Helobdella stagnalis* (fig. 27, p. 69); and also to Major B. B. Seymour Sewell, I.M.S., the present Director of the Zoological Survey of India, who has added materially to the value of these pages by lending the blocks of the various figures here reprinted from the 'Memoirs' and 'Records' of the Indian

Museum. These acknowledgments would be incomplete without reference to the courtesy of Prof. J. Stanley Gardiner, F.R.S., who allowed me to make full use of the Cambridge Zoological Laboratory, where much of this work has been carried out; and also to the kind assistance of Sir Arthur Shipley, G.B.E., F.R.S., the editor of this volume, to whom my special thanks are due for much valuable criticism and advice.

Cambridge, May 17th, 1926.

CONTENTS.

	PAGE
HIRUDINEA	85
Suborder RHYNCHOBDELLÆ	85
Family ICHTHYOBDELLIDÆ	85
Genus OZOBRANCHUS, de Quatrefages, 1852	3
1. <i>Ozobranchus shipleyi</i> , Harding, 1909	36
Genus PONTOBELLA, Leach, 1815	39
2. <i>Pontobdella loricata</i> , Harding, 1924	39
3. <i>Pontobdella aculeata</i> , Harding, 1924	41
Subgenus nov. <i>PONTODELLINA</i> , Harding	44
4. <i>Pontobdella (Pontobdellina) macrothela</i> , Schmarda, 1861	45
Genus PISCICOLA, de Blainville, 1818	48
5. <i>Piscicola olivacea</i> , Harding, 1920	48
6. <i>Piscicola cæca</i> , Kaburaki, 1921	52
Genus PTEROBDELLA, Kaburaki, 1921	54
7. <i>Pterobdella amara</i> , Kaburaki, 1921	54
Family GLOSSIPHONIDÆ	57
Genus GLOSSIPHONIA, Johnson, 1816	57
8. <i>Glossiphonia complanata</i> , Linn., 1758	57
9. <i>Glossiphonia heteroclita</i> , Linn., 1761	60
10. <i>Glossiphonia weberi</i> , R. Blanchard, 1897	62
11. <i>Glossiphonia reticulata</i> , Kaburaki, 1921	65
12. <i>Glossiphonia annandalei</i> , Oka, 1922	65
Genus HELOBDELLA, R. Blanchard, 1896	68
13. <i>Helobdella stagnalis</i> , Linn., 1758	68
14. <i>Helobdella nociva</i> , Harding, 1924	70
Genus PLACOBDELLA, R. Blanchard, 1893	72
15. <i>Placobdella ceylanica</i> , Harding, 1909	73
16. <i>Placobdella emydeæ</i> , Harding, 1920	74
17. <i>Placobdella inteana</i> , Oka, 1922	76
18. <i>Placobdella fulva</i> , Harding, 1924	78
19. <i>Placobdella undulata</i> , Harding, 1924	78
Genus THEROMYZON, de Philippi, 1867	81
20. <i>Theromyzon sexoculata</i> , Moore, 1898	82
Genus HEMICLEPSIS, Vejdovsky, 1883	83
21 a. <i>Hemiclepsis marginata</i> , subspecies <i>marginata</i> , O. F. Müller, 1774	83
21 b. <i>Hemiclepsis marginata</i> , O. F. Müller, subspecies <i>asiatica</i> , Moore, 1924	87
Genus PARACLEPSIS, Harding, 1924	88
22. <i>Paraclepsis prædatrix</i> , Harding, 1924	88
23. <i>Paraclepsis vulnifera</i> , Harding, 1924	91
SPECIES INQUIRENDÆ	98

HIRUDINEA.

Vermiform hermaphrodite Chætopoda provided with a sucker at both extremities, with median genital openings, without parapodia and rarely with branchiæ. With the exception of *Acanthobdella*, there are no setæ and the cœlom is broken up into a system of inter-communicating spaces.

The systematic position of *Acanthobdella* has been referred to in the Introduction.

The Hirudinea are divided into the two suborders, Rhynchobdellæ and Arhynchobdellæ.

Suborder RHYNCHOBDELLÆ.

Marine and freshwater Hirudinea with colourless blood, with an exertile proboscis, without jaws. The mouth is a small median aperture situated within the anterior sucker, or rarely upon its anterior rim.

Family ICHTHYOBDELLIDÆ.

Body cylindrical or flattened, often divided into two distinct anterior and posterior regions, and sometimes with paired lateral branchiæ and pulsating vesicles. The anterior sucker is generally, and the posterior sucker is always, a permanent cupuliform or discoid organ distinct from the body. Eggs either included in chitinous capsules, which are attached to foreign objects, or cemented to the body of the host. Marine and freshwater forms, largely parasitic upon fish.

In the case of Ichthyobdellidæ having the body divided into two regions, the anterior region includes the clitellum with the genital orifices, and the whole or part of somite XIII always forms the beginning of the posterior region. The anterior portion is conveniently termed the neck, and the posterior region is, similarly, called the trunk or abdomen. The somewhat heterogeneous assemblage of leeches contained in this Family obviously requires subdivision, and various attempts to split it up have already been made. That none of these attempts has proved entirely satisfactory gives no cause for surprise, since it is now generally accepted that external features alone cannot often be relied upon for purposes of classification, and our knowledge of the internal

morphology of the Ichthyobdellidæ leaves much to be desired. This knowledge necessarily must be slowly acquired, for the members of this Family are notoriously difficult to preserve in a satisfactory state, and the marine species, usually found in unexpected places and under unfavourable conditions, rarely fall alive into competent hands.

Genus **OZOBRANCHUS**, de Quatrefages, 1852.

Ozobranchus, de Quatrefages, 1852, p. 325.

Eubranchella, Baird, 1860, p. 311.

(?) *Lophobdella*, Poirier et de Rochebrune, 1884, p. 1597.

Pseudobranchellion, Apáthy, 1890, pp. 110 and 122.

Marine and freshwater Rhynchobdellæ parasitic for the most part upon turtles and tortoises. Body more or less flattened and divided into two distinct regions, a short, narrow, anterior "neck" and a large broad posterior portion or "abdomen." Posterior region with paired, lateral digitate branchiæ; without pulsating vesicles. One pair of eyes. The complete somite is bianulate anteriorly, but may become triannulate in the posterior region. Eggs cemented to the body of the host. Oral opening subterminal.

1. *Ozobranchus shipleyi*, Harding, 1909. (Plate II, figs. 4, 5, 6; and fig. 10.)

Ozobranchus shipleyi, Harding, 1909, p. 233.

Ozobranchus jantseanus, Kaburaki, 1921 *b*, p. 681 (not Oka, 1912).

Ozobranchus papillatus, Kaburaki, 1921 *b*, p. 692.

The first brief description which I gave of this species was based upon some small individuals taken from the terrapin, *Nicoria trijuga*, in Ceylon by Miss Robertson (*q. v.* 1910). These were not in a favourable condition for the examination of external features, and I stated at the time that the complete somite was formed of three rings. A careful re-examination of the original leeches and their comparison with fresh material has convinced me that the complete somite is really bianulate, consisting, in the neck, of two rings of almost equal size, and in the posterior region of a broad ring followed by a narrow one. The broad ring, however, on the abdominal dorsal surface often shows signs of transverse subdivision, but this is not carried far enough to resolve it into two distinct rings and so constitute a true triannulate somite.

Description.—Body flattened and translucent; the posterior region with eleven pairs of lateral digitate branchiæ, a pair occurring on the anterior ring in each of the somites XIII–XXIII.

The mouth opens in the anterior sucker in a subterminal position. Posterior sucker large, circular, centrally attached and about equal in width to the broadest part of the body (excluding the branchiæ).

According to the late Dr. Annandale, to whom I am indebted for

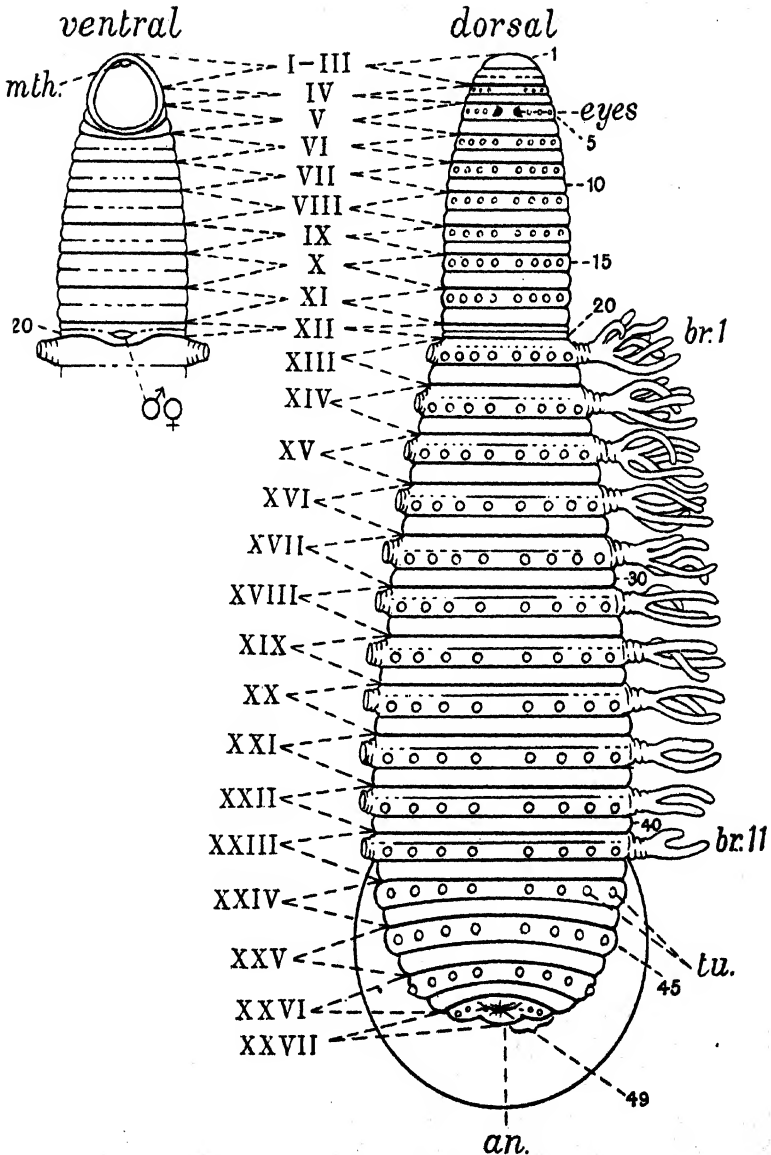

Fig. 10.—*Osobranchus shipleyi*, Harding, 1909. Diagram showing dorsal and part of the ventral surface. Somites numbered in Roman, and rings in ordinary figures. *mth.* Mouth. *an.* Anus. *br. 1*, *br. 11*. First and eleventh pairs of branchiae. (The branchiae are shown fully on one side only, for the sake of clearness.) *tu.* Tubercles.

notes on the appearance and habits of this species during life, the whole dorsal surface is dull yellow, delicately varied, especially at the margins, with dark green. Posterior sucker minutely speckled with the same green; branchiæ colourless and almost transparent.

Rings 49. The second and the forty-ninth rings show signs of subdivision, but are here regarded as single rings.

Complete somite formed of two rings, the anterior one being distinguished by a series of 10-12 papillæ of varying size situated on the dorsal surface. In the "neck" region these two rings are more or less of equal width, but in the posterior region, beginning with somite XIII, the anterior ring is conspicuously larger than the one behind it. The branchiæ, when present, spring from the lateral extremities of this broad ring, which, as in the case of Oka's leech, *Ozobranchus jantseanus*, represents rings 1 + 2 of a triannulate somite. This inference is emphasised by the fact that the papillæ present upon this ring occupy its posterior part, and are often, but not always, separated from its anterior part by a shallow transverse groove, as noted above.

Somites I-III are represented by the first two rings.

The twenty-three somites IV-XXVI are complete with two rings. Somite XXVII is uniannulate.

The single pair of eyes lie in ring 5 (the first ring of somite V).

The male and female genital ducts open by a common pore between the two rings (19 and 20) of somite XII. The reproductive organs are of the complicated type characteristic of the genus. There are four pairs of testes, occupying somites XVI-XIX. The small, spherical but somewhat flattened eggs have a tough shell provided with a minute circular aperture closed by a lid, which is broken through by the young leech when it emerges. These are laid close together in large groups on the carapace or plastron of the host, partly embedded in a layer of chitinous cement, which may be stripped in small sheets from the host's body. The anus opens in the anterior part of the last ring.

The long tubular crop, or stomach, increases in size posteriorly, and in somite XIX throws out two large lateral cæca, directed posteriorly, between which lie the intestine and rectum. The four pairs of intestinal cæca are not spread out laterally, but lie closely packed together in a longitudinal bundle, confined, as Oka (1904) has explained, within the median lacuna.

A typical branchia consists of a short, thick, circular, more or less annulated and sometimes bluntly-branched stalk with long vermiform unbranched appendages issuing from its distal end. The branchiæ are kept in constant slow motion when the living leech is at rest "as though the thumb and fingers of a hand were continually being slowly opposed to one another and as slowly withdrawn" (*Annandale*).

Dimensions.—Length, in alcohol, up to about 25 mm.; greatest width, not including the branchiæ, about 5 mm. Larger dimensions probably are attained. The Indian individuals were generally much larger than those from Ceylon, but this seemed insufficient evidence for regarding them as a separate species.

Hosts and Habitat.—This species has been found on *Nicoria trijuga*, Schweigg, in Ceylon. Indian examples have been taken from *Kachuga intermedia*, Blanf., collected in the R. Mahanaddi, Sambalpur, Orissa; from *K. smithii*, Gray, in the R. Ravi, Lahore; and from a single specimen of *K. dhongoka*, Gray. The last-mentioned tortoise originally came from the R. Ganges, but was in captivity in the Zoological Gardens, Calcutta, when the leeches were taken from it. They were adhering tightly, in a solid mass, to the plastron, and were difficult to remove.

Genus **PONTOBELLA**, Leach, 1815.

Albione, Savigny, 1822.

Marine leeches without eyes, pulsating vesicles or branchiæ. Body more or less claviform and covered by conspicuous tubercles, often very large and forming prominent warty protuberances. Crop (or stomach) with a single undivided cæcum. Complete somite composed of three and sometimes of four rings. Parasitic on fish, and chiefly affecting skarks, skates and rays.

Of the three species here described, two have the complete somite composed of three rings; in the third species, however, this is composed of four rings. Two species, again, have the typical claviform outline; *P. macrothela*, on the other hand, differs from them entirely in the form of the body. Although the number of rings of which the complete somite is composed is of great diagnostic importance, the genus *Pontobdella* is here regarded, provisionally at least, as being unique in possessing a variable complete somite. It may, perhaps, become necessary at some future time to re-arrange the various species now referred to this genus, when a clearer knowledge of their internal morphology has been obtained. It was not deemed advisable, however, to procure such knowledge, in the case of the three species dealt with here, by sacrificing the scanty and valuable material available. In any case, the striking difference in body-form shown by *P. macrothela* seems sufficient to justify its inclusion in a subgenus, which has here been named *Pontobdellina*.

2. *Pontobdella loricata*, Harding, 1924. (Plate II, fig. 3; and fig. 11.)

Description.—Body fusiform and of a uniform greyish-green colour in alcohol, unrelieved by special markings. Anterior sucker circular, cupuliform, excentrically attached, with three pairs of inconspicuous submarginal papillæ and with corrugated edges capable of being folded together so as to form a ventral, median, longitudinal slit. It comprises the first four somites and the greater part of the fifth.

Posterior sucker circular, centrally attached, with corrugated edges, not wider than the anterior sucker or the greatest width of the body.

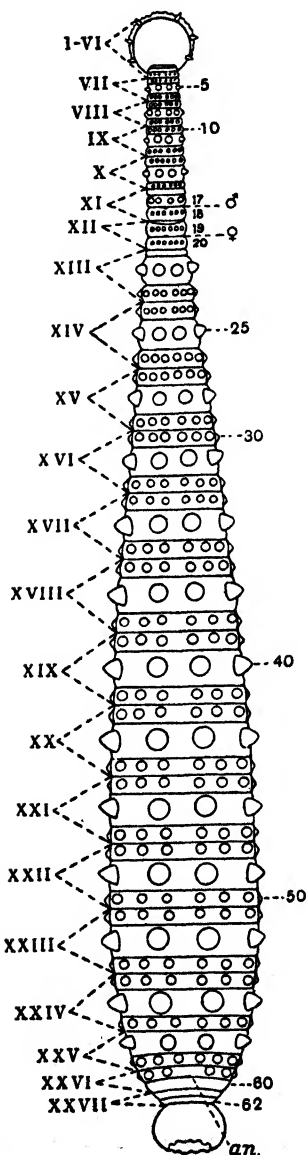

Fig. 11.—*Pontobdella loricata*, Harding, 1924. (After Harding.) Diagram showing external features of the dorsal surface. Somites numbered in Roman, and rings in ordinary figures. an. Anus.

Rings, 62 behind the anterior sucker. Complete somite formed of three annuli, consisting of a broad middle ring (lodging a ganglion of the ventral chain) situated between two smaller rings of equal width.

Somites VII–XI and XIII–XXIV complete with three rings; XII, XXV, XXVI and XXVII biannulate.

The conspicuous clitellum comprises the seven rings lying between the broad middle annuli of somites X and XIII. Portions of a ring may be detected between the 18th and 19th annuli. This appears to represent the first annulus of somite XII (here regarded as missing), but should an examination of further material prove it to be a constant feature, it might well be included in an enumeration of the annuli, thus bringing the total number of rings to 63 and rendering somite XII triannulate.

The warts or tubercles upon the rings vary a good deal in number, size and position, so that it is only possible, by striking an average, to arrive at what may be considered to be a normal arrangement. This normal arrangement, shown, as far as the dorsal surface is concerned, in fig. 11, may be described as follows:—

The broad middle ring of the somite bears on its whole circumference eight large conical tubercles, four above and four below. The exterior dorsal warts are submarginal, so that their points appear in a ventral view. The narrow rings on either side of the middle one each bear a total of fourteen tubercles, a pair of marginal tubercles being present in addition to six above and six below.

The warts here described may be occasionally missing or out of their normal position, and other tubercles, generally of small size, may be interposed between them. On the ventral surface of the middle ring of the somite a small tubercle often occurs between the middle pair of warts. The mouth-opening occupies a nearly central position within the anterior sucker.

The male genital orifice lies between rings 17 and 18, that is, between the second and third rings of somite XI; the female opening appears between rings 19 and 20, in the middle of somite XII. Crop (or stomach) with a sacculated, single, undivided cæcum.

The anus opens between rings 59 and 60, in the middle of somite XXVI, and so is separated by three annuli from the posterior sucker.

Dimensions.—Approximate total length, in alcohol, 74 mm.; approximate greatest width 7 mm.

Host and Habitat.—The host is not recorded, and the example here described is noted as having been taken at station 233, Marine Survey of India.

3. *Pontobdella aculeata*, Harding, 1924. (Figs. 12 & 13.)

Description.—Body fusiform, much attenuated anteriorly, more or less circular in transverse section. One of the two individuals examined, in alcohol, had assumed a uniform dull grey hue devoid

ICHTHYOBDELLINÆ.

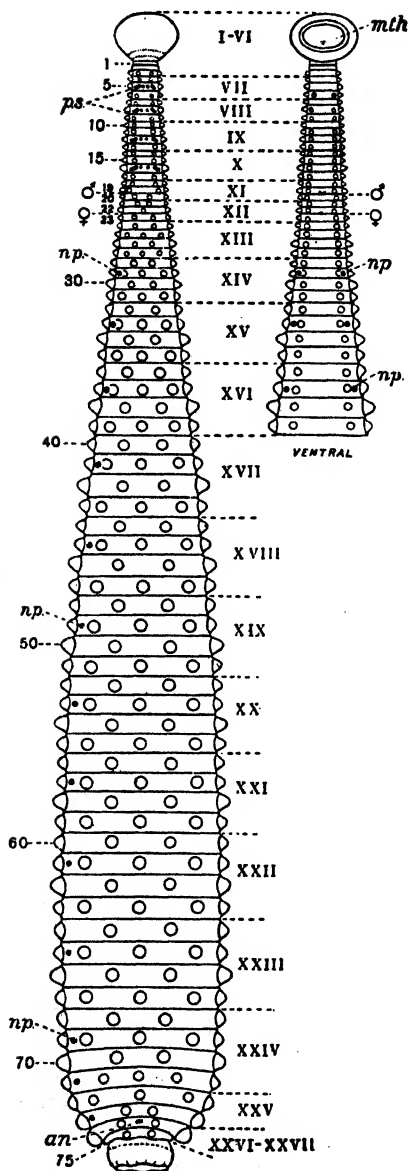

Fig. 12.—*Pontobdella aculeata*, Harding, 1924. (After Harding.) Diagram showing external features on the left of the dorsal, and on the right of part of the ventral surface. Somites numbered in Roman, and rings in ordinary figures. *ps.* Pigment spots. *mth.* Mouth-opening. *an.* Anus. *np.* Nephridiopores (on ventral surface).

of special markings; the other was of a reddish-brown colour with a dorsal pair of dark brown linear spots on the sensory ring of each somite. These spots appeared to recur metamerically throughout the body, but were difficult to detect owing to the imperfect preservation of the material.

Anterior sucker small, circular, without papillæ, having corrugated edges tending to close together in a transverse line and absorbing somites I-IV and the whole, or the greater part, of somite V.

Posterior sucker smaller than the anterior; with corrugated edges, circular and centrally attached.

Rings, 75 behind the anterior sucker. Complete somite formed of four annuli of nearly equal width. The third of these, conspicuous on account of its larger marginal papillæ, is here regarded as the primary ring of the somite, although it does not entirely



Fig. 13.—*Pontobdella aculeata*, Harding, 1924. Dorsal aspect, life size.

cover a ganglion of the ventral chain. The ventral ganglia, throughout the greater part of the body, lie almost exactly between this third ring and the one anterior to it. The ring in question, however, takes its proper position in the middle of the triannulate somites present.

Somites IX, X and XIII-XXIV complete with four annuli; VII, VIII, XI and XII triannulate; XXV biannulate; XXVI and XXVII uniannulate.

The clitellum is not conspicuous, and appears to comprise the seven rings 17-23. The arrangement of the warty tubercles on the body, shown in fig. 12, may be summarized as follows:—

(1) Each annulus bears two lateral tubercles, which, as already stated, are larger on the primary than on the other annuli of the

somite. These tubercles form two conspicuous rows lying along the margins of the body.

(2) Dorsally, the first and third rings of the complete somite bear a paramedian pair, and the second and fourth rings a paramarginal pair of tubercles together with a median one, so that, throughout the greater part of the body, the tubercles on the upper surface are disposed alternately in twos and threes, forming a symmetrical pattern.

(3) On the otherwise bare ventral surface of each ring is a paramarginal pair of prominent tubercles. These tubercles constitute two conspicuous ventral rows, which form a characteristic feature of the species.

The mouth opens in a nearly central position within the anterior sucker.

The male genital pore is situated between rings 19 and 20, the second and third rings respectively of somite XI: the female opening lies between rings 22 and 23, that is, between the second and third rings of somite XII.

The crop has a single undivided cæcum, and the anus perforates the seventy-fourth or penultimate ring. The nephridiopores open in a paramarginal position in the second ring of the complete somite. Thirteen pairs of these pores were observed, but the examination of fresh material will be necessary before their full number can be determined.

Dimensions.—Approximate size, in alcohol, of the larger example, total length 64 mm., greatest width 8 mm.; of the smaller, total length 35 mm., greatest width (gorged with blood) 6 mm.

Hosts and Habitat.—(a) Found on *Harpodon nehereus*, Estuary of the Bassein River, Burma (Marine Survey of India). (b) From the Gregory Isles, Mergui Archipelago, Burma (Marine Survey of India).

The teleostean fish *Harpodon nehereus*, Ham. Buch., when properly salted and dried, forms the table delicacy known as Bombay-duck. . . . "It is not known to occur at any great depth, and is not even restricted to the sea, being very abundant in the rivers and estuaries of Bengal and Burma" (G. A. Boulenger, 1904, p. 613).

PONTOBDELLINA, subgen. nov.

Marine leeches having the characters of *Pontobdella*, with the exception of the form of the body, which is sharply divided into two regions—a slender anterior "neck" and a broad, posterior "abdominal" region.

See note on the genus *Pontobdella*.

4. *Pontobdella* (subgen. *Pontobdellina*) *macrothela*, Schmarda, 1861. (Plate II, fig. 8; and figs. 14 & 15.)

(?) *Hirudo indica*, Linnæus, 1767, p. 1079.

(?) *Albione indica*, Moquin-Tandon, 1826, p. 130.

(?) *Pontobdella indica*, de Blainville, 1827, p. 243.

(?) *Pontobdella depressa*, Krøyer (see Diesing), 1850, p. 438.

Pontobdella macrothela, Schmarda, 1861, p. 6, Taf. xvi; R. Blanchard, 1897, p. 80; Goddard, 1909, p. 721.

The *Pontobdella depressa* of Krøyer appears to be synonymous with *P. macrothela*, but its description is insufficient to place its identity beyond dispute. According to the communication made to Diesing by Krøyer, his leech was found in West Indian waters, and had an ashy-yellow, flattened body with flattened and deeply furrowed warts. Regarding the *Hirudo indica* of Linnæus, another species of *Pontobdella* described as being flattened.

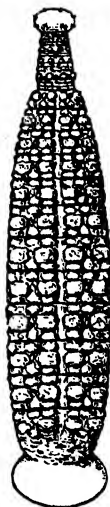

Fig. 14.—*Pontobdella* (subgen. *Pontobdellina*) *macrothela*, Schmarda, 1861. Dorsal aspect, life size.

(*depressa*), we can do no more than remark that it seems to bear a greater resemblance to *P. macrothela* than to the other Indian species of *Pontobdella* so far recorded.

Description.—Body much flattened and divided into two very distinct regions: a short slender “neck” and a long, bulky “abdominal” region comprising somites XIII–XXVII. Dorsal surface with a longitudinal median groove, conspicuous on the posterior region.

The colour varies from yellowish-brown to dark green. The example from India was, according to the collector’s note, in life.

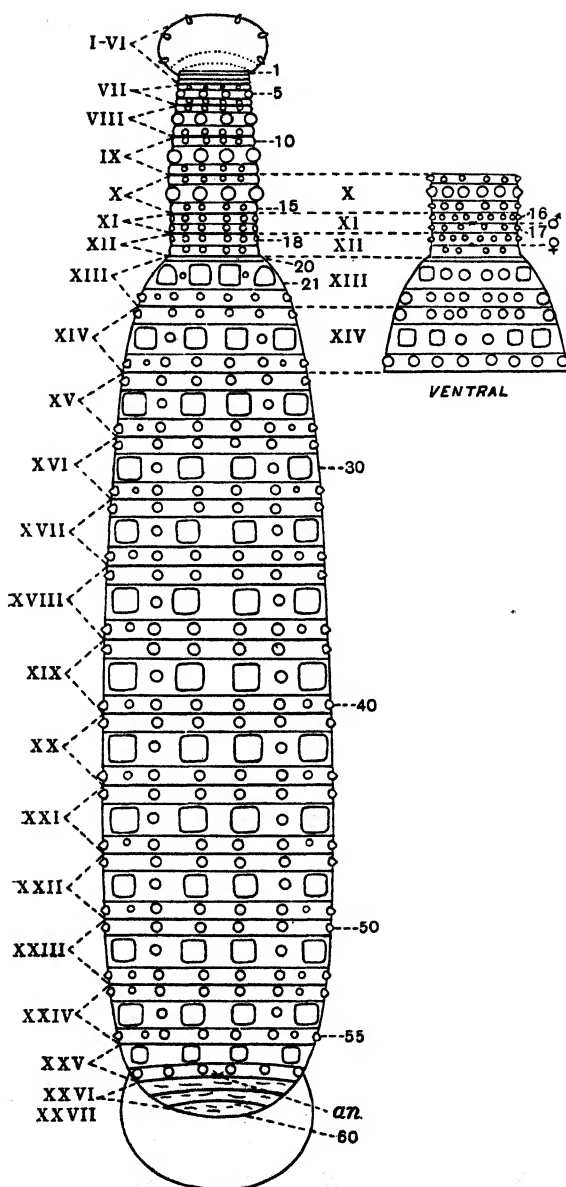

Fig. 15.—*Pontobdella* (subgen. *Pontobdellina*) *macrothela*, Schmarda, 1861. Diagram showing external features on the left of the dorsal and on the right of part of the ventral surface. Somites numbered in Roman, and rings in ordinary figures. an. Anus.

dark green. This had faded in alcohol to a pale greenish-brown hue, and the body was unicolorous, save for two dorsal, dark brown spots on the anterior sucker above the junction with the "neck," symmetrically placed one on either side of the median line. Both Schmarda and Goddard state the colour to be yellowish-brown: the former gives no indication of body-markings in text or figure, and the latter definitely notes their absence.

Anterior sucker slightly oval, having its long axis parallel to the annuli of the body; about half the width of the broadest part of the body; with six small, conical, submarginal, dorsal tubercles, and showing signs of annulation dorsally above the junction with the "neck." It appears to comprise the first five somites.

Posterior sucker large and oval, with its long axis lying along the middle line; about equal in width to the broadest part of the body.

Annuli 60; the first annulus to encircle the body completely, being the anterior ring of somite VI. Rings 58, 59 and 60 without warts, but deeply scored by irregular transverse furrows tending to render obscure the interannular grooves. Complete somite formed of three annuli, a broad one situated between two narrow ones. In typical somites the narrow annuli are of equal width and about half the width of the middle one.

Somites VII-X and XIII-XXIV are complete with three rings. Somites XI and XII (in the clitellum) with XXV and XXVI bi-annulate; XXVII uniannulate.

Throughout the greater part of the body the ventral ganglia lie in the broad middle ring of each somite.

The prominent, irregularly-shaped warty tubercles which cover the whole body have a rough, nodular surface, and are often of extensive area. In the "abdominal" region, where they tend to expand into and fill up the spaces between each other, they are separated by deep furrows, and, together with a series of large depressed warts of more or less quadrangular outline situated on the middle ring of each somite, present a striking appearance as of crocodile skin (Pl. II, fig. 8.)

The warts on the middle ring of the complete somite are twelve in all and arranged as follows: dorsally four large, more or less quadrangular warts, two on either side of the middle line, and between each of these two a small wart; ventrally six warts, the two lying on either side of the middle line being smaller and less conspicuously quadrangular than the others.

In the two narrow annuli of the somite, Goddard makes the number of warts, or "tubercular areas" as he calls them, the same, viz. eight above and eight somewhat smaller ones below. These observations apply to the Indian example here described, with the exception of the number of dorsal warts on the first annulus of the complete somite, where only six were usually present. No doubt some variation occurs both in their number and position.

Mouth nearly centrally placed within the anterior sucker. Male genital orifice situated between annuli 16 and 17, in the middle of

somite XI; female genital orifice situated two rings behind the male, between annuli 18 and 19, in the middle of somite XII.

The anus lies between annuli 57 and 58, that is, between somites XXV and XXVI.

Dimensions.—Size of Indian specimen examined (fairly extended, in alcohol): length, 64 mm.; greatest width, 13 mm.; anterior sucker, fully expanded, 6×5 mm.; posterior sucker, 13×11 mm.; length from beginning of "trunk" region (somite XIII) to extremity of posterior sucker, 55 mm.

Greater dimensions are recorded. Length (alive, but quiescent), 95 mm.; greatest width, 20 mm. (*Schmarda*): an example in alcohol, 80 mm. in length, 10 mm. in breadth (*Goddard*).

Habitat and Hosts.—The description here given is based on a single example of this species found, according to information supplied by its collector, attached to the side of a hammer-headed shark (*Zygæna* sp.) caught at a depth of 25–28 fathoms off Gopalpore, in the Bay of Bengal.

Blanchard records this leech from Tandjong, Lampongsche Districten, Sumatra; Goddard describes and figures an individual from the Brisbane River, Australia; and Schmarda founded the species on a solitary example taken in the harbour of Kingston, Jamaica.

The only host of *P. macrothela* yet recorded is the hammer-headed shark just referred to. The appearance of this leech in parts of the world so far apart as Kingston Harbour, the coast of New South Wales and the Bay of Bengal is consistent with parasitism upon certain sharks of wide distribution such as *Zygæna malleus* and *Z. tudes*, and its habitat probably includes sub-tropical as well as tropical seas.

Genus **PISCICOLA**, de Blainville, 1818.

Small freshwater and brackish-water leeches parasitic generally upon fish. Body much attenuated, smooth and cylindrical, the posterior region with paired, lateral pulsating vesicles. Suckers large and excentrically attached. Mouth-opening in the middle of the anterior sucker. Four eyes, generally linear in form, upon the anterior sucker. Complete somite composed of fourteen rings.

5. *Piscicola olivacea*, Harding, 1920. (Figs. 16 & 17.)

Piscicola olivacea, Harding, 1920, p. 512; Kaburaki, 1921, p. 663.

Description.—Body circular, long and slender, varying in colour from bright to pale olive-green, minutely speckled with black or with a deeper shade of green. A series of conspicuous white patches or spots occur, one on either side of each somite, on the margins of the body, and these are connected across the

dorsal surface by whitish, often indistinct transverse bands. Another series of white patches of more or less elliptical form lie in the mid-dorsal line, and these median patches, which may or may not be jointed together at their extremities, give the appearance of a somewhat ill-defined whitish mid-dorsal stripe.

Anterior sucker circular, whitish, with three brown dorsal transverse bands, one band near the anterior extremity, one following the junction with the body, and a third and broader one between the two, in the posterior part of the sucker. The mouth-opening lies in the centre of its interior cup.

Posterior sucker somewhat heart shaped, of the same green colour as the body, with seven pairs of whitish rays corresponding to the seven somites XXVIII-XXXIV, of which it is composed.

Eyes, two pairs, lying within the middle brown band on the anterior sucker, one pair on either side of the mid-dorsal line. The component eyes of each pair are linear in form and, without actually touching, are inclined together at an acute angle having its vertex pointing towards the margin of the sucker.

Complete somite formed of 14 rings. An accurate count of all the rings present in this little species could not be made in the material examined.

A pair of lateral pulsating vesicles occur in each of the eleven somites XIII-XXIII. These vesicles are centred in the transverse middle line of the somite and lie within the marginal white spots.

In the middle part of the body a ventral ganglion occupies rings 7 and 8 of the complete somite.

The anus is situated in the middle of the last ring.

The male genital opening lies in the posterior part of somite XI, and the female opening in the posterior part of somite XII.

The external features of this species are shown in fig. 16, and it is to be understood that the dorsal pattern, which is subject to some variation in its details, is merely indicated schematically. The internal investigation of *P. olivacea* has been undertaken by Dr. Kaburaki, to whom I am indebted for the information conveyed by fig. 17. There are six pairs of testes. The intestine leaves the crop (or stomach) at a point behind the sixth pair of lateral diverticula, between somites XVIII and XIX, and the posterior portion of the crop, consisting of a single, undivided cæcum, extends beneath it as far as somite XXV and is also provided with lateral pouches.

Dimensions.—Approximate total length when fairly extended, 10.75 mm., the greatest width of the body being about 1.50 mm.

Hosts and Habitat.—*Piscicola olivacea* has so far only been recorded in India from the Chilka Lake, where it is of frequent occurrence in more or less brackish water. It has been taken there:—

- (1) From the Sting Ray, *Trygon sephen*, Forsk. "On the lower surface of the body, in the gill-slits, near the anus

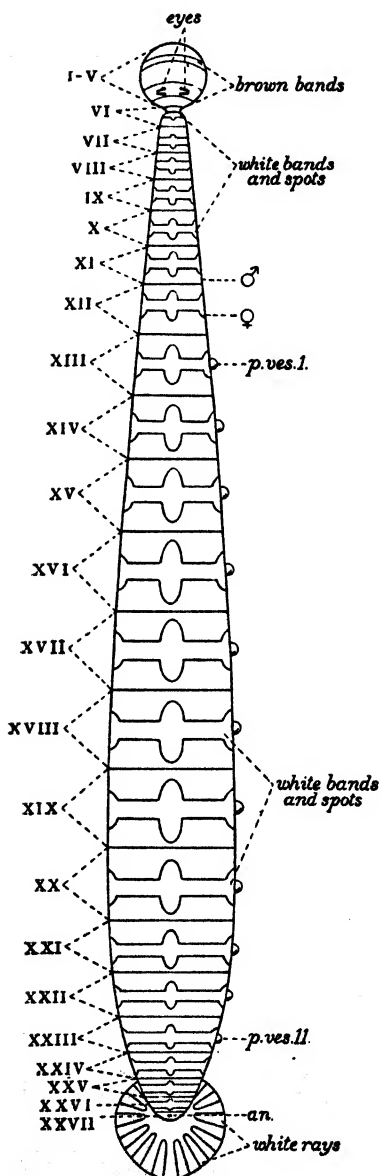

Fig. 16.—*Piscicola olivacea*, Harding, 1920. Diagram showing dorsal pattern and other external features. Somites numbered in Roman figures. *p. ves. I.*, *p. ves. II.* Pulsating vesicles (shown on one side only). *an.* Anus. (After Harding.)

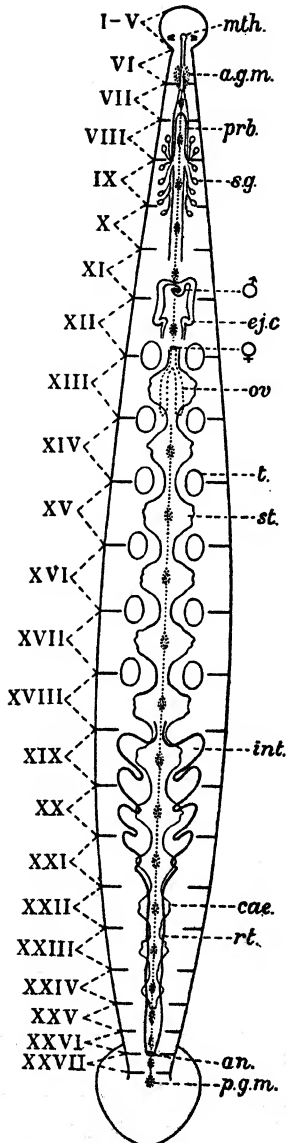

Fig. 17.—*Piscicola vivax*. (After Kaburaki.) Diagram showing alimentary tract, reproductive system and ventral nerve-cord. Somites numbered in Roman figures. *a.g.m.* Anterior ganglionic mass. *p.g.m.* Posterior ganglionic mass. *gang.* Ventral ganglion. *mth.* Mouth-opening. *s.g.* Salivary glands. *st.* Stomach. *int.* Intestine. *rt.* Rectum. *cae.* Caecum. *an.* Anus. *ejc.* Ejaculatory canal. *ov.* Ovary. *t.* Testis.

- and within the mouth on the palate." (sp. gravity of water 1·007-1·011).
- (2) From the Globe fish, *Tetrodon reticularis*, Bl. (sp. gravity of water about 1·026).
- (3) From *Chatoessus chacunda*, Ham. Buch.

The late Dr. Annandale recorded specimens from a small pool of almost fresh water on Barkuda Island, Lake Chilka, and noted that in this pool the only vertebrates were frogs (*Rana cyanophlyctis*).

P. olivacea also occurs in China, two specimens from Soochow having been described by Moore (1924, p. 346).

6. *Piscicola cæca*, Kaburaki, 1921. (Fig. 18.)

This species can only be referred to the genus *Piscicola* provisionally. Although possessing certain features seen in *Piscicola*, the absence of pulsating vesicles, with the important modification of the coelomic system which this absence implies, together with the absence of eyes, is sufficient to distinguish it from members of that genus. It would be unwise to dogmatise further, however, without additional investigation and until certain Ichthyobdellid genera which are still subjects of controversy are more clearly defined. The following brief diagnosis of *P. cæca* (of which no example has been seen by the writer) is based on the detailed description given by Kaburaki (1921, p. 666).

Description.—The slender, fusiform, translucent body is much flattened and has faded in alcohol to a uniform greyish-white colour without any trace of pattern.

Anterior sucker nearly circular, cup-shaped and about half as wide as the heart-shaped posterior sucker.

No eyes and no lateral pulsating vesicles.

Complete somite formed of 14 rings.

The male genital opening lies in somite XI, and the female opening in somite XII, fourteen rings behind the male. There are six pairs of testes.

The digestive tract closely resembles that of *Piscicola olivacea*. The mouth opens in the middle of the cupuliform anterior sucker, and the anus lies between somites XXVI and XXVII. The crop (or stomach) is provided with ten pairs of lateral diverticula. Six pairs of these diverticula lie in front of the junction with the intestine (between somites XVIII and XIX) and the remaining four occur in the single, undivided cæcum which extends beneath it.

Dimensions.—Length, 13 mm.; greatest width, approximately, 1 mm.

Hosts and Habitat.—The four individuals examined were taken from the brackish waters of the Chilka Lake. Three of these were found upon the Sting Ray, *Trygon sephen*, Forsk. "attached outside, close to the junction of the skin and teeth on both upper and lower jaws."

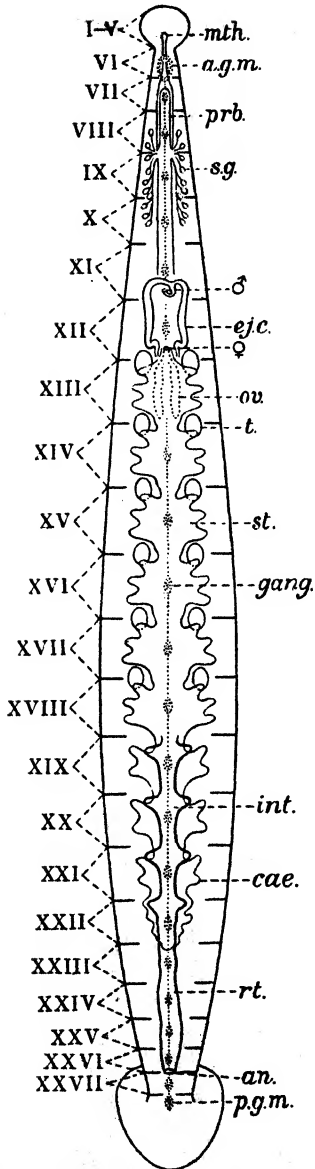

Fig. 18.—*Piscicola caeca*, Kaburaki, 1921. (After Kaburaki; the lettering slightly modified.) Diagram showing external and internal features. Somites numbered in Roman figures. *a.g.m.* Anterior ganglionic mass. *p.g.m.* Posterior ganglionic mass. *gang.* Ventral ganglion. *mth.* Mouth-opening. *prb.* Proboscis. *s.g.* Salivary glands. *st.* Stomach. *ca.* Caecum. *int.* Intestine. *an.* Anus. *ej.c.* Ejaculatory canal. *ov.* Ovary. *t.* Testis.

Genus **PTEROBDELLA**, Kaburaki, 1921.

Leeches inhabiting brackish water, ectoparasitic on fish. Body smooth and divided into three distinct regions, of which the anterior two are each provided with paired, lateral, fin-like processes. Without eyes or pulsating vesicles. Crop (or stomach) with five pairs of lateral diverticula and without a posterior cæcum. Five pairs of testes. Complete somite formed of fourteen rings (?).

7. *Pterobdella amara*, Kaburaki, 1921. (Figs. 19 & 20.)

Pterobdella amara, n. g., n. sp. Kaburaki, 1921, p. 688.

The brief notice here given of this remarkable species, which I have not had the opportunity of examining, is summarized from



Fig. 19.—*Pterobdella amara*, Kaburaki, 1921. Dorsal aspect, greatly enlarged. (After Kaburaki.)

Kaburaki's original description, and the diagnosis of the new genus which is added here, is based on information obtained from the same source.

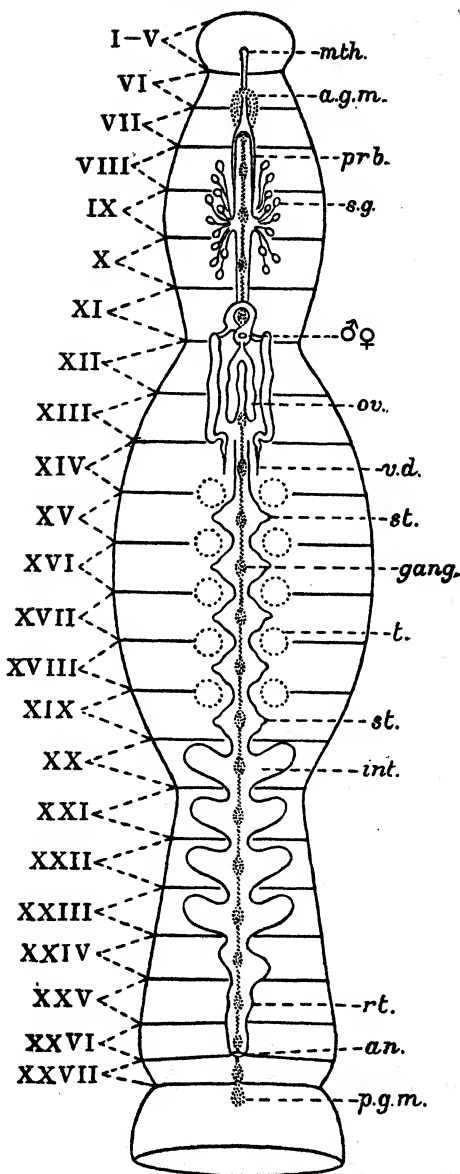

Fig. 20.—*Pterobdella amara*, Kaburaki, 1921. Diagram showing somites, ventral nerve-cord and the digestive and alimentary systems. (After Kaburaki.) Somites numbered in Roman figures. *mth.* Mouth. *a.g.m.* Anterior ganglionic mass. *p.g.m.* Posterior ganglionic mass. *gang.* Ventral ganglion. *prb.* Proboscis. *s.g.* Salivary glands. *ov.* Ovary. *v.d.* Vas deferens. *t.* Testis. *st.* Stomach. *int.* Intestine. *rt.* Rectum. *an.* Anus.

Description.—Body depressed anteriorly, nearly circular posteriorly, and divided into three well-marked regions. The two anterior regions are each expanded laterally into paired, flattened, fin-like processes, a combination of features seen in no other known leech (see fig. 19). Ground-colour of the body white, occasionally with numerous minute pink spots on the dorsal surface.

Anterior sucker small, excentrically attached and somewhat campanulate. Posterior sucker a centrally attached, thick, circular disc about equal in width to the posterior part of the body.

No eyes.

Rings, in the individuals examined (which were preserved in alcohol), merged into irregular groups and not sufficiently distinct to render a correct count possible. Complete somite, as far as could be judged, formed of fourteen rings.

The reproductive and alimentary systems, ventral nerve-cord and distribution of somites are shown in fig. 20. The reproductive organs are of simple structure and open by a common pore situated a little in front of the division between somites XI and XII. Five pairs of testes.

The mouth opens in the centre of the anterior sucker, the œsophagus is unusually long and the crop or stomach is provided with but five pairs of lateral diverticula. The posterior extension of the crop, characteristic of the Ichthyobdellidæ, which takes the form of a cæcum or of paired cæca, is absent. The anus opens between somites XXVI and XXVII.

There are no pulsating vesicles.

Dimensions.—Length, 10 to 12 mm.; width, 2 to 3 mm.

Hosts and Habitat.—The examples of *Pterobdella amara* described were taken in the brackish waters of the Chilka Lake, from the Sting Rays, *Trygon sephen*, Forsk., and *Trygon uarnack*, Forsk. Usually the leeches were found firmly adhering to the gums of their hosts.

Family GLOSSIPHONIDÆ.

Clepsinidæ, Apáthy, 1888 *b*, p. 784.

Freshwater Rhynchobdellæ with ovate, flattened, never cylindrical body. Anterior sucker ventral and fused with the body. Posterior sucker cupuliform, distinct from the body, with a more or less ventral aspect. Crop (or stomach) and intestine with conspicuous paired lateral cæca; the intestine always with four pairs. The eggs, enclosed in membranous sacs, are fixed and the young attach themselves to the ventral surface of the parent.

Genus GLOSSIPHONIA, Johnson, 1816.

Glossiphonia, Johnson, 1816, p. 25.

Glossopora, Johnson, 1817, p. 21.

Erpobdella, Blainville, in Lamarck, 1818.

Clepsine, Savigny, 1822.

Glossobdella, Blainville, 1828, p. 564.

Clepsina, Filippi, 1837.

Glossosiphonia, R. Blanchard, 1894, p. 24.

Glossiphonidæ generally of small size, with three or rarely with two pairs of eyes. Complete somite formed of three rings. Crop (or stomach) with six, or rarely with seven pairs of sublobate, lateral cæca, the last and longest pair reflected posteriorly. Mouth-opening within the anterior sucker.

8. *Glossiphonia complanata*, Linnæus, 1758. (Figs. 21 & 22.)

Hirudo complanata, Linnæus, 1758, p. 650; 1767, p. 1079.

Glossiphonia tuberculata, Johnson, 1816, p. 25.

Clepsine complanata, Savigny, 1822, p. 120.

Glossiphonia sexoculata, Moquin-Tandon, 1846, p. 353.

Glossiphonia cimitormis, Baird, 1869, p. 317.

Clepsine elegans, Verrill, 1872, p. 684.

Clepsine pallida, Verrill, 1872, p. 684.

Clepsine sexoculata, Apáthy, 1888 *a*, p. 154.

Glossosiphonia complanata, R. Blanchard, 1894, p. 27.

Glossiphonia elegans, Castle, 1900, p. 46.

(For complete synonymy and literature, see Harding, 1910, p. 158.)

Description.—The body of this well-known leech is ovate-elliptical, translucent and generally of a dull green or brownish colour. Typically there are six longitudinal rows of yellowish spots which lie on the middle or sensory annulus of each somite, and correspond to the inner paramedian, intermediate and outer paramarginal papillæ and sense-organs.

The coloration and markings are very variable, but the species can usually be recognized by two conspicuous longitudinal dark brown interrupted lines upon the dorsal surface which appear in an inner paramedian position, the interruptions being due to the paramedian spots on each sensory ring. A pair of similar, though less conspicuous, dark lines occur ventrally, but rarely traverse the full length of the body. Apáthy (1888*b*, p. 791) gives specific rank to a brownish form with six narrow longitudinal dark brown stripes (*G. concolor*) which, as Blanchard considered, is not more than a variety of *G. complanata*. Further investigation may lead to the subdivision of this widely-distributed species.

The six eyes lie in two close sub-parallel rows. The first and smallest pair, which sometimes may be absent, usually lie in the anterior part of somite III and are directed obliquely

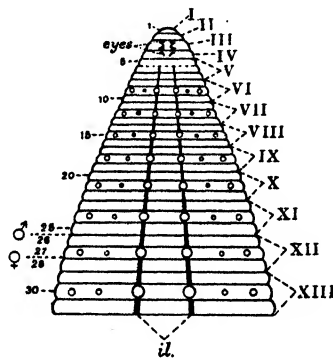

Fig. 21.—*Glossiphonia complanata*, Linn., 1758. Diagrammatic representation of anterior part of dorsal surface. Somites numbered in Roman and rings in ordinary figures. *i.l.* Interrupted dark lines.

forward. The second and largest pair, which are also pointed forward and to the side, lie in the posterior part of somite III. The last pair are directed obliquely backward and lie in the uniannulate somite IV.

Rings 68, of which two are usually preocular. Somites I-IV and XXVI-XXVII uniannulate, V-XXIV complete with three rings and XXV biannulate. Somite III shows signs of subdivision, and Moore (1924, p. 349) notes that this is more or less well marked in Indian examples. The first and second rings of somite V are usually imperfectly separated; the first ring forms the posterior boundary of the anterior sucker.

The male genital orifice lies between somites XI and XII, and the female orifice lies between the second and third rings of the latter somite.

The anus opens in the anterior part of somite XXVII. There are ten pairs of testes, and the crop or stomach has six pairs

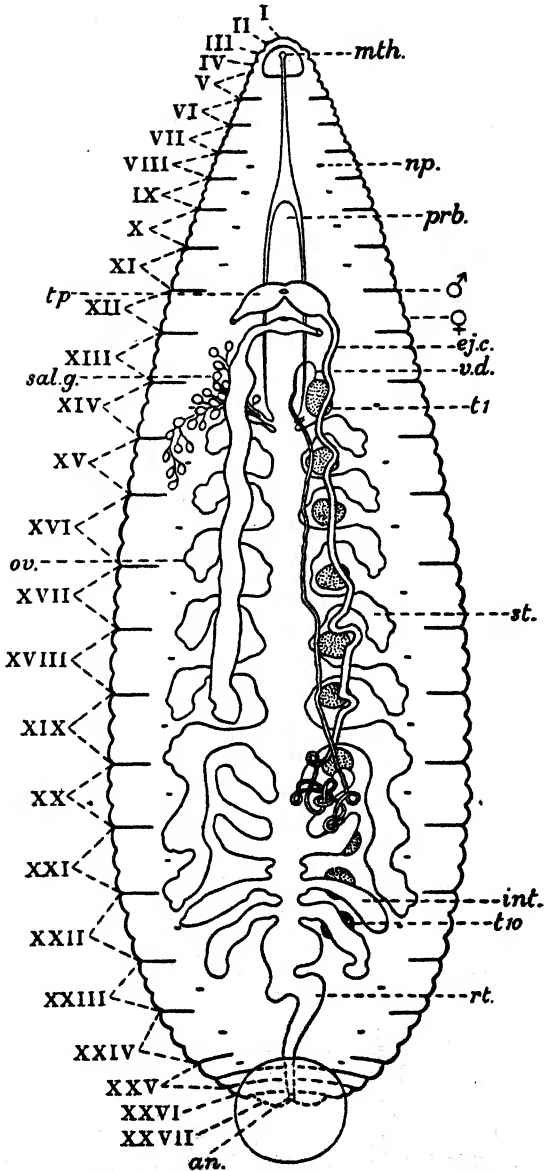

Fig. 22.—*Glossiphonia complanata*, Linn., 1758. Diagram showing alimentary tract, reproductive system and annulation. *mth.* Mouth-opening. *prb.* Proboscis. *sal.g.* Salivary glands. *st.* Stomach. *int.* Intestine. *rt.* Rectum. *an.* Anus. *np.* Nephridiopore. *ej.c.* Ejaculatory canal. *t.p.* Terminal portion of ejaculatory canal. *t1, t10.* First and sixth pair of testes. *ov.* Ovary. (After Harding; modified.)

of lateral diverticula, the last and longest, as usual, being reflected posteriorly.

The reader is referred to figs. 21 & 22, and it is to be noted that these are based upon an English individual.

Dimensions.—Length, at rest, 15–20 mm.; greatest width, at rest, 5–9 mm. Length, fully extended, up to about 35 mm. The Indian specimens referred to below ranged from 6·5 mm. to 21·2 mm. in length.

Hosts and Habitat.—*Glossiphonia complanata* has been recorded from India for the first time by Moore (1924, p. 348), who describes specimens taken at Srinagar and in the Jhelum Valley, Kashmir. These were not associated with a host.

The species is sluggish, and is found in ponds and slow-moving streams, often resting upon or beneath stones and on aquatic vegetation. It is parasitic chiefly upon freshwater snails. It is found in the United States and in Europe, where it is often exceedingly common; and its range appears to extend through Asia to Japan, where it has been recorded by Oka. That it wanders into parts of Northern India has now been shown by Moore.

9. *Glossiphonia heteroclita*, Linnæus, 1761. (Fig. 23.)

Hirudo heteroclita, Linnæus, 1761, No. 2085, and 1767, p. 1080.

Hirudo hyalina, O. F. Müller, 1774, p. 49.

Hirudo papillosa, Braun, 1805, p. 64.

Hirudo trioculata, Carena, 1820, p. 303.

Clepsine carena, Moquin-Tandon, 1826, p. 105.

Glossiphonia heteroclita, Moquin-Tandon, 1846, p. 358.

Clepsine heteroclita, Whitman, 1878, p. 2; Apáthy, 1888 a, p. 154; Oka, 1894, p. 81.

Glossosiphonia heteroclita, R. Blanchard, 1894, p. 26.

For complete synonymy, see Harding, 1910, p. 155.

Description.—The body of this well-known and widely-distributed species is ovate acuminate, flattened, smooth, transparent, and of a clear amber-yellow colour. Pigmented areas of a darker colour may or may not be present on the dorsal surface. Apáthy (1888 b, p. 790) describes a variety (*striata*) having a deep black, often interrupted transverse stripe upon every third ring, and notes the occurrence of transitional stages between this and the clear unpigmented form. Castle (1900, p. 42, pl. viii, fig. 38) finds in the United States all gradations between the clear yellow form and a form with an irregular longitudinal band and transverse striæ, due to aggregations of black, dark brown or orange superficial pigment-cells. The striæ occur on the first rings of successive somites. Individuals of the clear yellow type are the most frequent in Northern Europe. The three pairs of eyes vary to some extent in position. The first pair usually lie in ring 5, and the second and third pairs are situated respectively in rings 7 and 8.

The first and smallest pair of eyes are closely approximated; in typical cases the right and left components of the second and third

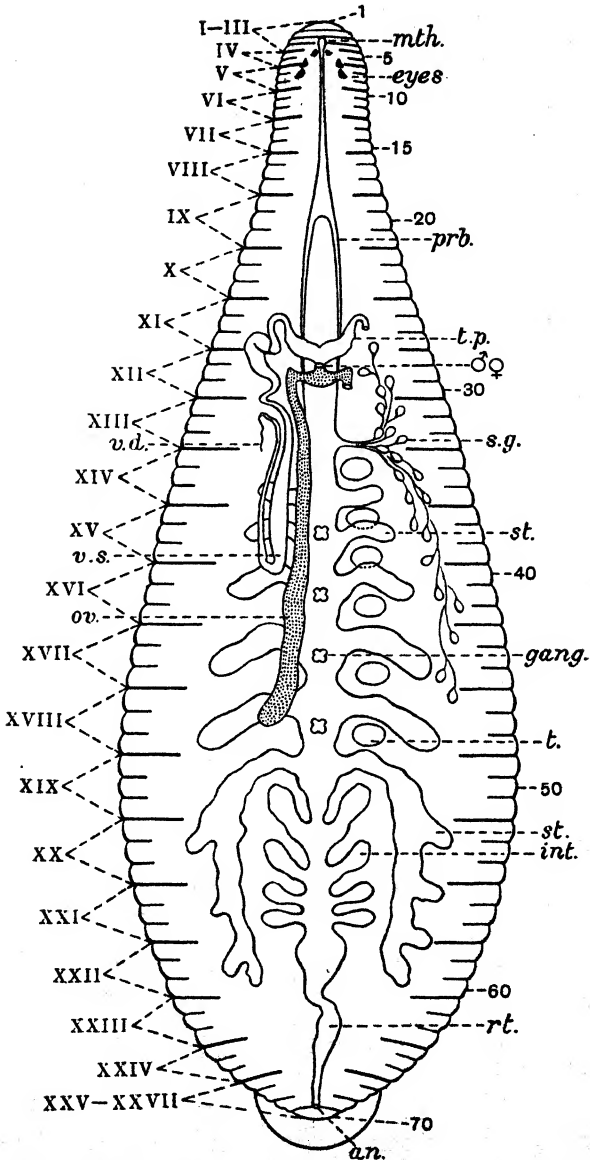

Fig. 23.—*Glossiphonia heteroclita*, Linn., 1761. Diagram showing annulation, alimentary tract and reproductive system. Somites numbered in Roman, and rings in ordinary figures. *mth.* Mouth-opening. *prb.* Proboscis. *s.g.* Salivary glands. *st.* Stomach. *int.* Intestine. *rt.* Rectum. *an.* Anus. *tp.* Terminal portion of ejaculatory canal. *v.s.* Vesicula seminalis or seminal reservoir. *v.d.* Vas deferens. *t.* Testis. *ov.* Ovary.

pairs (which are widely separated) also lie near together, and thus the eyes form three groups, corresponding to the points of an equilateral triangle. A similar arrangement is seen in *Glossiphonia weberi*. The full number of eyes is not always complete.

The male and female genital ducts open by a common pore between the first and second rings of somite XII. For further information regarding the annulation and anatomy of this species, the reader is referred to fig. 23.

Size.—Length at rest, 10–13 mm.; greatest width, at rest, approximately 4·5 mm. Individuals in full extension may attain a length of nearly 17 mm.

Hosts and Habitat.—This species is widely distributed in North America and Europe, and is parasitic for the most part upon Gasteropods.

Oka (1922, p. 522) describes four small leeches, of which one was taken in the Yawng-hwe Valley and three in the Inlé Lake, Southern Shan States, Burma, which he refers to this species, his identification being based chiefly upon the triangular disposition of the six eyes, which it shares, as noted above, with *G. weberi*. The three leeches from the Inlé Lake were taken from the Gasteropod, *Pachylabra maura*, Reeve.

10. *Glossiphonia weberi*, R. Blanchard, 1897. (Plate II, fig. 10; and fig. 24.)

Glossosiphonia weberi, R. Blanchard, 1897 (*b*), p. 332; Kaburaki, 1921 (*b*), p. 695, fig. 1; Moore, 1924, p. 351.

Much of the following diagnosis is based upon the detailed description given by Kaburaki. As that writer states, the real difference between *G. weberi* and the closely-allied and well-known *G. heteroclita* consists in the possession by the former species of numerous well-developed papillæ on the dorsal surface. The normal position of the eyes and of the common genital pore differs in each case, but these criteria are not reliable, since it is well known that the eyes in both species vary in position, and recently I have observed the same variability of situation in the genital orifice of *G. weberi*. In the case of material subjected to the accidents of preservation, when pigment may be washed out and papillæ obliterated, it is often difficult to decide to which of the two species it is to be referred. *G. heteroclita* often develops a certain amount of dorsal pattern, and *G. weberi* appears to be a tropical form derived from it which has just, and only just, attained to specific rank.

Description.—Body translucent, ovate-acuminate, in contraction nearly triangular, the dorsal surface with a roughened appearance, due to the presence of numerous small tubercles disposed transversely upon every ring.

In addition to these tubercles the dorsal surface bears a series of prominent metameric papillæ (see fig. 24), which form seven longitudinal rows extending from somite V to the posterior extremity. The papillæ composing six of these rows consist of a

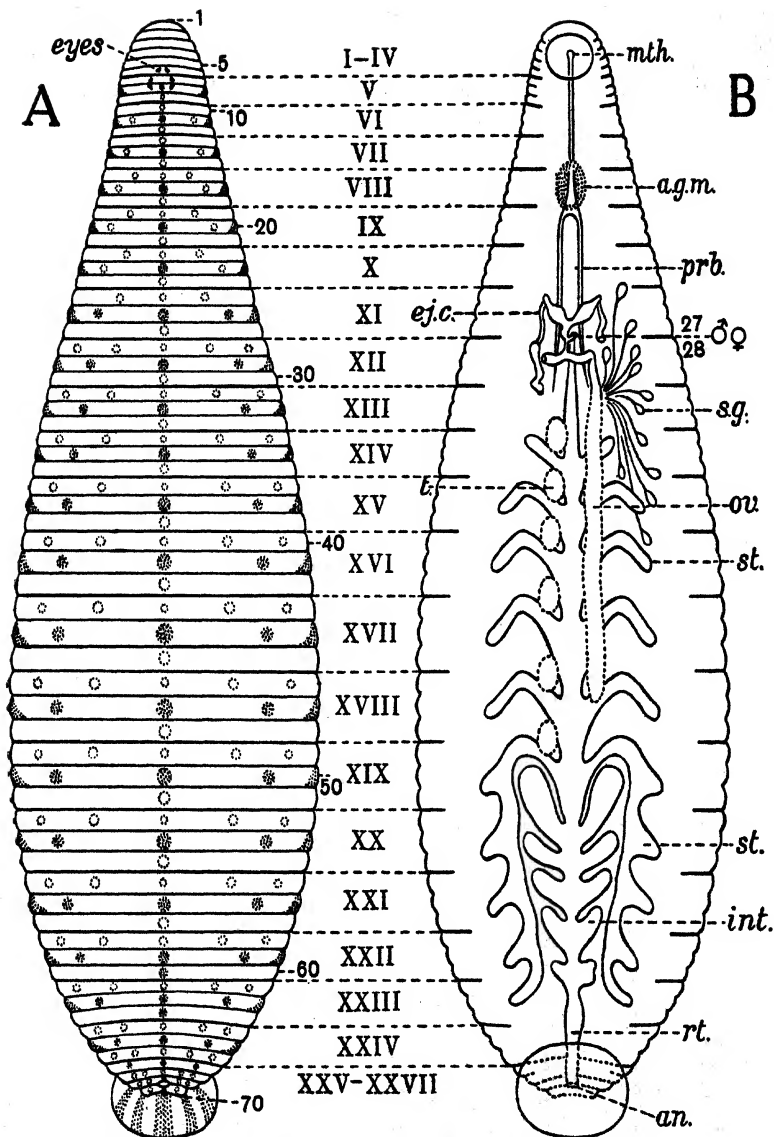

Fig. 24.—*Glossiphonia weberi*, R. Blanchard, 1897. Diagrams representing (A) dorsal aspect, showing external features, and (B) ventral aspect, showing reproductive organs, digestive tract, etc. (After Kaburaki; slightly modified.) The dorsal diagram (A) shows the seven longitudinal rows of papillae in dotted outline, the dark pigment being indicated by dotted shading. Somites numbered in Roman, and rings in ordinary figures. *mt*. Mouth. *a.g.m.* Anterior ganglionic mass. *prb.* Proboscis. *s.g.* Salivary glands. *st.* Stomach. *int.* Intestine. *rt.* Rectum. *an.* Anus. *ejc.* Ejaculatory canal. *t.* Testis. *ov.* Ovary. Certain parts are shown on one side only, for the sake of clearness.

paramedian and a paramarginal pair lying on the first ring of each somite, and of an intermediate pair situated upon the second ring. The papillæ forming an unbroken median row occur upon every ring, that situated upon the first ring of the somite being smaller than those upon the other two rings.

The general colour, in alcohol, varies from greyish or greenish-white to orange, and, usually, five longitudinal rows of dark brown or blackish pigment spots or patches traverse the dorsal surface. This pigment, during life, is described as "very dark and purplish-red." The pigment spots composing these rows occur only upon the middle ring of each somite, and consist of a pair of marginal patches and of three spots coinciding respectively with the median and intermediate papillæ. The papillæ and pigment spots referred to are apt to fluctuate in size and may not all be present, and the dorsal pattern, taken as a whole, is subject to considerable variation. In many cases this is reduced to a single median stripe, and, again, this stripe may be interrupted in each somite, and so be further reduced to a median row of spots.

Posterior sucker small, less in diameter than half the greatest width of the body and bearing on its upper surface paired radial stripes of the same dark pigment which occurs upon the body.

Rings 70, of which five are generally preocular. Rings 5 and 6 unite below to form the posterior margin of the anterior sucker.

Somites I-IV are absorbed by the head-region; the twenty somites V-XXIV are complete with three rings; somites XXV-XXVII are represented by the last four rings.

Three pairs of eyes, somewhat variable in position, but usually situated upon the three successive rings 6, 7 and 8. The first pair lie near together; the components of the second and third pairs (which are wider apart) are also closely apposed, and thus the eyes tend to form three groups corresponding to the points of a triangle.

The male and female genital ducts open by a common pore generally situated between rings 27 and 28, that is, between somites XI and XII. The position of this pore varies, however, from the middle of ring 27 (where R. Blanchard found it) to the groove between rings 28 and 29.

The anus opens between the last ring and the last ring but one.

The alimentary and reproductive systems are indicated schematically in fig. 24, and call for no special remark.

Dimensions.—Large individuals attain a length of about 12 mm., the greatest width being about 5.5 mm.

Hosts and Habitat.—*G. weberi* is widely distributed. R. Blanchard founded the species upon material received from Lake Manindjau, Sumatra, and it has since been recorded from (a) and (b) Bhim Tal, 4450 ft., Gurud Tal (near Sat Tal), 4550 ft., and (c) Naini Tal, 6300 ft., Kumaon, W. Himalayas; (d) a stream at Harwan, Kashmir; (e) Janikpur, Nepal; (f) Selai Kusi, Mangaldi, Assam; (g) N. end of Logtak Lake, Manipur; (h) Canal, Thantaung, W. side of Inlé Lake, Nyaungywe State, Burma;

(i) Lahore; (j) in and near Calcutta; (k) Diamond Harbour, R. Hoogli; (l) and (m) Cuttack, and Puri, Orissa; (n) S. end of Lake Chilka, N.E. Madras; (o) and (p) Chaibasa and Chakardharpur, Singbhum Dist., Chota Nagpur; (q) Burhanpur, Cent. Provinces; (r) Sangur, Cent. Provinces; (s) Itarsi, Hoshangabad Dist., Cent. Provinces; (t) Old bed of R. Narbada, N. of Babai, Hoshangabad Dist., Cent. Provinces; and (u) Whitefield, near Bangalore. *G. weberi* preys upon Gasteropods, the actual hosts hitherto recorded being species of *Ampullaria*, *Paludina* and *Limnaea*. It also attacks aquatic beetles, Dr. S. Kemp having found it upon the bodies of Dytiscidæ and upon a species of *Hydrophilus* at the end of a lake on Bhim Tal, Kumaon, W. Himalayas.

11. *Glossiphonia reticulata*, Kaburaki, 1921. (Fig. 25.)

The following brief diagnosis of this species is based upon the original description, given by Kaburaki, of a single individual in the possession of the Indian Museum.

Description.—Body slender, translucent, attenuated anteriorly, with the head-region somewhat dilated. Dorsal surface with a roughened appearance, due to the presence of numerous papillæ, and covered, like the ventral surface, with pigment, more or less reticulately distributed, which has faded in the preservative fluid to a uniform olive-grey hue.

Anterior sucker very small, less than half the width of the posterior sucker. Posterior sucker circular, nearly centrally attached and rather less than half the greatest width of the body.

Rings 72, of which three are preocular.

Somites I–IV are represented by the first six rings; the twenty somites V–XXIV are complete with three rings; somites XXV–XXVII are represented by rings 67–72.

Eyes two pairs; the first pair lie in ring 4, and the second and larger pair (in which the eyes are more widely separated) in ring 5.

Male genital orifice situated between rings 26 and 27 in somite XI; female orifice situated two rings behind the male, between rings 28 and 29, in somite XII.

The mouth opens within the anterior sucker, a little in front of the centre, and the anus lies between rings 70 and 71, being separated from the posterior sucker by two rings. The crop (or stomach) has 7 pairs of branching diverticula.

Dimensions.—Approximate total length, 11 mm.; approximate greatest width, 2 mm.

Host and Habitat.—The single specimen examined was found attached to the mantle of a species of *Anodonta* at Jullundhur.

12. *Glossiphonia annandalei*, Oka, 1922. (Fig. 26.)

The writer has not had the opportunity of examining examples of this remarkable species, and is indebted here to Oka's original description, which has been collated with the subsequent observations of Moore, 1924, p. 350.

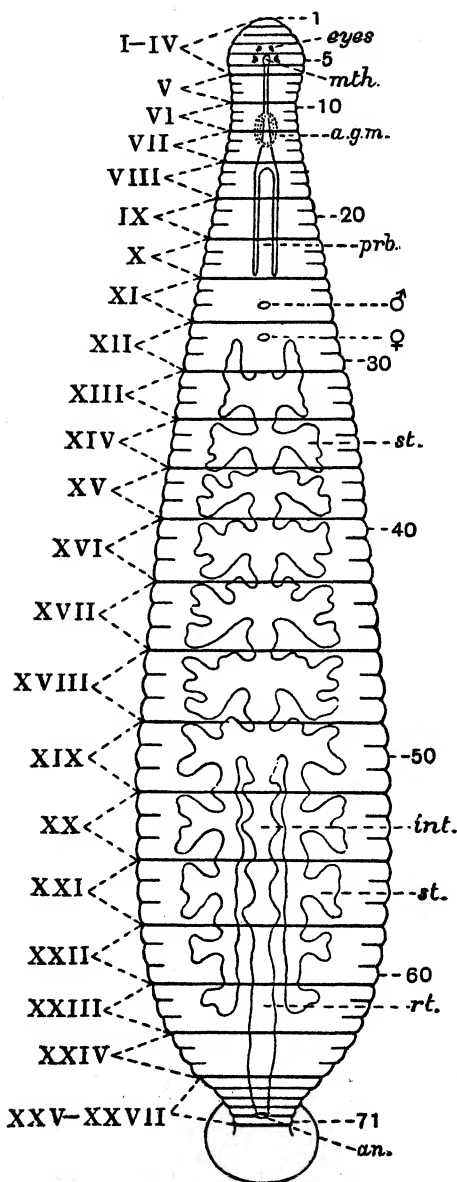

Fig. 25.—*Glossiphonia reticulata*, Kaburaki, 1921. (After Kaburaki; slightly modified.) Diagram showing external features and alimentary tract. Somites numbered in Roman, and rings in ordinary figures. *a.g.m.* Anterior ganglionic mass. *mth.* Mouth-opening. *prb.* Proboscis. *st.* Stomach. *int.* Intestine. *rt.* Rectum. *an.* Anus.

Description.—Body elliptic-lanceolate, little flattened, having a nearly smooth surface devoid of conspicuous papillæ, and the head-region very slightly dilated. Oka's specimens, in alcohol, are described by him as being of a uniform pale grey colour. Moore's examples, on the other hand, were accompanied by the collector's notes on the coloration during life, which is described as "pale flesh-colour with minute dark dots on the dorsal surface, tending to run into hair-like lines."

Anterior sucker bounded posteriorly by the fifth ring and perforated by the small mouth-opening a little in front of the centre of its cup. Posterior sucker circular, and less in diameter than the greatest width of the body.

Rings 68, of which three are preocular. Somites I–III and XXVII unianulate; IV biannulate, formed of an anterior broad

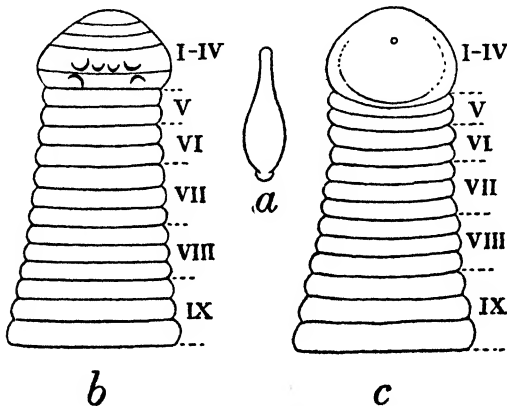

Fig. 26.—*Glossiphonia annandalei*, Oka, 1922. (After Oka.) a. Outline of entire leech, $\times 3$. b. Somites I–X, dorsal view showing eyes, $\times 30$. c. Somites I–IX, ventral view showing mouth-opening, $\times 30$.

and a posterior narrow ring; V and VI also biannulate, but formed of rings of almost equal width. The eighteen somites VII–XXIV are triannulate, with rings of equal size; XXV and XXVI biannulate, with the anterior ring about twice as broad as the posterior.

The three pairs of eyes occupy a position unique among the Glossiphonidæ, and so provide a ready means of recognizing this species. On the posterior part of ring 4 lie two pairs of eyes, consisting of a small median pair situated between the components of a much larger pair. Another pair of large eyes lie on ring 5, immediately below the large eyes on ring 4. The openings of the pigment cups of all the eyes on ring 4 are directed forward, those of the eyes on ring 5 being directed backward. The pigment-cups of the large pairs of eyes lying respectively on rings 4 and 5 touch at their bases. This arrangement is shown in fig. 26.

The genital orifices are separated by two rings. The male pore opens in the furrow between rings 24 and 25, that is, between somites XI and XII, and the female pore opens between rings 26 and 27. There are six pairs of testes.

The seventeen pairs of nephridiopores lie between the first and second rings of the somites involved.

Crop with six pairs of diverticula, of which the first five pairs are simple and unbranched. The anus opens behind the last ring.

Dimensions.—The largest member of this species examined by Oka measured 6 mm. in length, its greatest width being 2.8 mm. Moore describes three examples of equal size which were 6.5 mm. long with a maximum width of 1.2 mm.

Hosts and Habitat.—Oka's specimens were found in the central region of the Inlé Lake, Southern Shan States, Burma, on a snail of the Family Viviparidæ, *Taia intha*, Annandale. The examples examined by Moore were Indian, having been taken in a fresh-water pond on Samal Island, Chilka Lake, Madras Presidency. In this instance no host was recorded.

Genus **HELOBDELLA**, R. Blanchard, 1896.

Small Glossiphonidæ with one pair of eyes. Complete somite formed of three rings. Body generally without papillæ. Mouth-opening within the anterior sucker. Head-region continuous with the rest of the body. Crop (or stomach) with six pairs of simple lateral cæca, the last and longest reflected posteriorly. Sometimes with a dorsal chitinous scute.

13. **Helobdella stagnalis**, Linnæus, 1758. (Fig. 27.)

Hirudo stagnalis, Linnæus, 1758, p. 649.

Clepsine bioculata, Moquin-Tandon, 1826, p. 102.

Glossosiphonia stagnalis, R. Blanchard, 1894, p. 25.

Helobdellu stagnalis, R. Blanchard, 1896, p. 4.

[For complete synonymy, see Harding, 1910, p. 162.]

Owing to the courtesy of Dr. H. A. Bayliss, I was enabled, in 1922, to examine an individual of this species which had been sent to the British Museum of Natural History from the Himalayas.

Description.—This widely distributed species, here recorded from India for the first time, has a slender translucent body of a uniform greenish, yellowish or brownish hue finely speckled with black. A dorsal circular chitinous plate or scute, situated between the twelfth and thirteenth rings, forms the most striking external feature. A similar scute is present in the South American species *Helobdella scutifera* (R. Blanchard, 1900). Posterior sucker small, its width being not greater than about half the greatest width of the body.

Rings 68. The somites are not readily distinguished by external observation. Somites I-V are represented by the first five rings ;

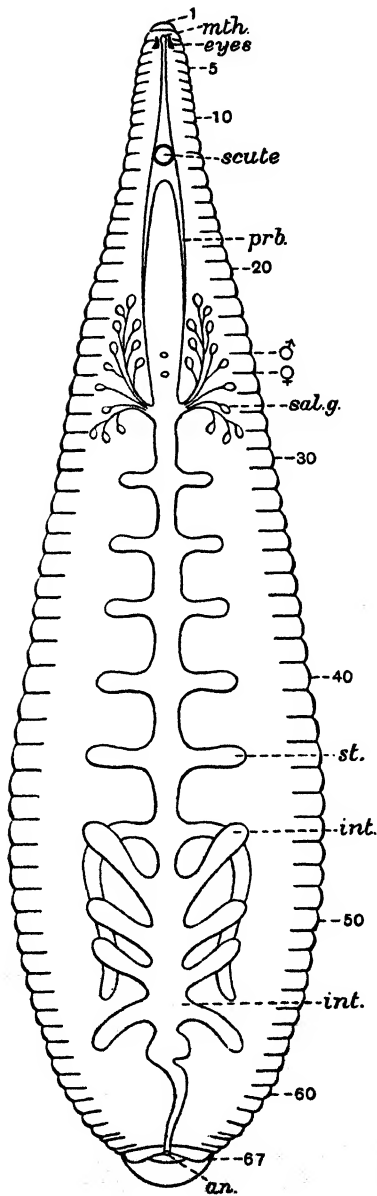

Fig. 27.—*Helobdella stagnalis*, Linn., 1758. (After Harding.) Diagram showing alimentary tract. *mth.* Mouth-opening. *prb.* Proboscis. *sal.g.* Salivary glands. *cr.* Crop. *st.* Stomach. *int.* Intestine. *an.* Anus.

somites VI-XXIV are complete with three rings, and somites XXV-XXVII are represented by rings 63-67 (see Castle, 1900, p. 22, pl. ii, fig. 4).

The two closely approximated eyes lie in the third ring or between rings 2 and 3.

The male genital orifice is situated between rings 24 and 25 (the first and second rings of somite XII), and the female orifice is situated one ring behind the male, between the second and third rings of somite XII. The anus lies between the sixty-seventh and the last and incomplete sixty-eighth ring.

The first five pairs of lateral gastric cæca, when undistended by food, may become retracted and consequently difficult to detect.

Dimensions.—Length, at rest, 8-12 mm.; approximate width, at rest, 4 mm.; length, fully extended, as much as 26 mm. The Indian example was approximately 6 mm. long and 2.5 mm. in width.

Hosts and Habitat.—*Helobdella stagnalis* is met with in lakes, ponds, ditches and sluggish streams, often resting upon aquatic plants, and although parasitic chiefly upon Gasteropods, it preys also upon a considerable variety of small freshwater invertebrates, and has been noticed occasionally on the bodies of frogs, newts and injured fish. It is found in Canada and in the United States from the Atlantic to the Pacific coast. In South America it has been recorded from Paraguay and the western slopes of the Andes, and its range extends throughout the greater part of Europe into Western Asia and the Himalayas. It probably occurs throughout the northern and southern temperate regions of the globe. The Indian example recorded here was accompanied by a note stating that it had been taken by Mr. M. E. Moseley from a stream at an altitude of 11,000-12,000 ft. in Kashmir.

14. *Helobdella nociva*, Harding, 1924. (Plate II, fig. 9; and fig. 28.)

Description.—Body claviform, slender anteriorly, with the head-region somewhat dilated, without a dorsal scute. Anterior sucker with fine transverse ribbing on its inner surface. Posterior sucker small, less in width than half the greatest width of the body. A water-colour drawing from life, for which I am indebted to the late Dr. Annandale, shows a translucent body (through which the dark contents of the digestive tract can be discerned), of a pinkish hue where thinnest, dull green in the thicker parts, with five brown, longitudinal dorsal stripes of which one is median, and having the bluish-grey posterior sucker rayed with white.

Rings 70. There are three precocular rings; ring 9 is the first to encircle the body, and so forms the first ventral annulus; ring 68 is double at the margins, but not entirely divided.

The single pair of eyes occupy ring 4.

Two dorsal pairs of papillæ (all that could be made out in the individuals examined) situated one pair on either side of the

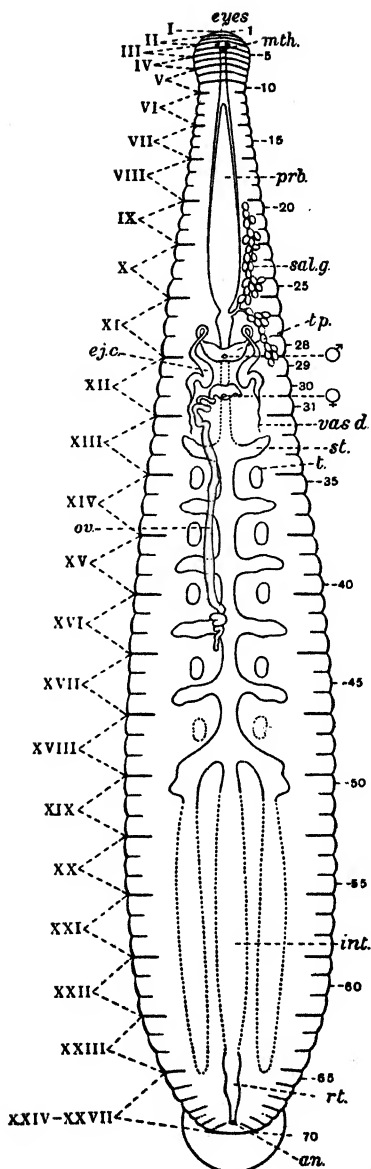

Fig. 28.—*Helobdella nociva*, Harding, 1924. (After Harding.) Diagram showing external features and the reproductive and alimentary systems. Somites numbered in Roman, and rings in ordinary figures. *mth.* Mouth-opening. *prb.* Proboscis. *sal.g.* Salivary glands. *ej.c.* Ejaculatory canal. *t.p.* Terminal portion of ejaculatory canal. *vas.d.* Vas deferens. *t.* Testis. *ov.* Ovary (shown on side only for the sake of clearness). *st.* Stomach. *rt.* Rectum. *int.* Intestine. *an.* Anus. The dotted portion of the alimentary tract could not be seen owing to the imperfect state of the material.

median line, distinguish the middle or primary ring of each somite. Somite I uniaunulate; II, III IV biannulate; the 19 somites V-XXIII complete with three rings. Somites XXIV-XXVII are represented by the six rings 65-70.

The reproductive and alimentary systems are shown in fig. 28. (The parts indicated by the dotted lines were not clearly seen, owing to the defective state of the material.)

The male genital orifice lies between rings 28 and 29, that is, between somites XI and XII. The female orifice is separated from the male by two annuli, being situated between rings 30 and 31 in somite XII.

The genital organs call for no special comment, with the exception of the ovaries, which are much coiled and very long, extending as far as somite XVI.

The mouth opens within the anterior sucker a little in advance of the centre. The six pairs of crop (or stomach) cæca are somewhat lobed. The anus opens between rings 69 and 70, being separated by the space of one ring from the posterior sucker.

Dimensions.—Approximate size of largest individual: total length, 7.5 mm.; greatest width, 1.5 mm.

Host and Habitat.—No host is recorded. The material examined came from two sources, and was accompanied by the following notes:—

- (a) "On stems of water plants and on under surface of *Canna* leaves dipping into the water, in a small pond of fresh water dug in sand and overshadowed by trees at Puri, Orissa." (Dr. N. Annandale and Dr. F. H. Graveley coll.)
- (b) "On under surface of bricks and broken earthenware pots in a tank at Kidderpore, Calcutta." (R. Hodgart coll.)

Genus **PLACOBDELLA**, R. Blanchard, 1893.

Body flattened, with a crustaceous dorsal surface and sometimes attaining considerable size. Complete somite formed of three rings. Anterior sucker imperforate, the mouth being situated upon its anterior rim. Usually one pair of eyes. Crop (or stomach) with seven pairs of branching diverticula. Parasitic chiefly upon turtles, batrachians and fish.

The largest species of this genus inhabit the United States, where examples of *P. parasitica* (Say, 1824) may be met with which attain a length of as much as 60 mm. when at rest, and more than 80 mm. when fully extended. The eyes of several of these American species, when subjected to refined methods of examination, have been found to be compound. The crustaceous or roughened dorsal surface seen in members of this genus is due to the presence of numerous small cutaneous papillæ closely set upon every ring, and the terminal mouth-opening, although not

peculiar to *Placobdella*, is somewhat uncommon and an easily recognized and valuable character.

The Indian species of *Placobdella* at present definitely known are of comparatively small size, and probably attack a wider range of hosts than are here recorded.

15. *Placobdella ceylanica*, Harding, 1909.

Glossiphonia ceylanica, Harding, 1909, p. 233.

Glossosiphonia ceylanica, Kaburaki, 1921 a, p. 671, fig. 5.

Placobdella ceylanica, Moore, 1924, p. 357, pl. xix, fig. 7 and pl. xxi, fig. 25.

In 1909 I received a single, imperfectly preserved example of this little leech, and published a brief, preliminary description of it which has proved to be not free from error. In 1921, Kaburaki, working upon further material from India, was able to make a more complete examination of the species, and his results, in 1924, were revised by Moore, who had received additional Indian examples. Thus, as I am glad to acknowledge, the credit of establishing this species is really due to these two authorities, upon whose work the following description is based. I here follow Moore in referring this species, provisionally at least, to the genus *Placobdella*, on account of the terminal oral opening and the seven pairs of gastric cæca; and notwithstanding the three pairs of eyes.

Description.—Body lanceolate, smooth, flattened, with the head-region slightly dilated. Posterior sucker small, its diameter being equal to about half the greatest width of the body.

Colour in alcohol pale buff, grey or brown, somewhat lighter below; dorsal surface with three longitudinal dark brown lines or rows of spots.

Mouth-opening very small, at the extreme anterior margin of the anterior sucker.

Rings 71, of which two are preocular.

Somites I uniaunulate; II biannulate (the groove between the two rings shallow); III perfectly biannulate, the twenty-one somites IV–XXIV being complete with three rings. Somite XXIV has the third ring reduced, XXV is biannulate and XXVI and XXVII are uniannulate.

Six eyes disposed in two subparallel rows. The first and second pairs of eyes lie respectively in rings 3 and 4; the third pair occur on the sixth ring (the sensory ring of somite IV). The separation of the second and third pairs of eyes by two rings is characteristic of the species.

Male genital orifice situated between somites XI and XII; female orifice two rings behind the male, between the second and third rings of somite XII.

Crop (or stomach) with seven pairs of cæca, the last and longest reflected, as usual, posteriorly. The first six pairs and the lobes of the last pair bifurcate at their extremities.

The nephridiopores pierce the middle ring of the somite, but their total number could not be ascertained in the material examined. The anus lies between the penultimate and the last ring.

Dimensions.—At rest, length approximately 8–13 mm.; greatest width, approximately, 3 mm.

Hosts and Habitat.—*G. ceylanica* was first recorded from Ceylon, on the Mud-turtle, *Emyda granosa vittata*. Kaburaki notes its occurrence in India at Rawalpindi, and on Barkuda Island, Chilka Lake, Madras Presidency, in a pond where *Rana cyanophlyctis*, Schmid., was the host. Moore records it from a small freshwater pond on Samal Island, Chilka Lake, off *Emyda granosa intermedia*, and also from a tank in the Government Garden, Buldana, Central Provinces.

16. *Placobdella emydæ*, Harding, 1920. (Fig. 29.)

Placobdella emydæ, Harding, 1920, p. 514; Kaburaki, 1921, p. 701.

Description.—Body with the characters of the genus; in extension elliptic-lanceolate; with the head-region somewhat dilated. The middle ring of the somite bears dorsally three pairs of metameric papillæ: a paramedian, an intermediate and a paramarginal pair, the intermediate pair being the largest.

The ground-colour varies from greyish-green to pale olive-brown, the gorged crop or stomach (in the individuals examined) appearing dull green through the translucent body. Dorsal surface with a white median stripe and profusely speckled with white and a darker green. Ventral surface smooth and olivaceous.

Anterior sucker with a shallow interior cup having a finely-ribbed surface somewhat resembling that of the human finger-tip. Posterior sucker circular, centrally attached, narrower than the widest part of the body, its upper surface bearing paired white rays.

Rings 71. The second and third rings are each subdivided at their margins; the fifth is confluent with the free ventral posterior edge of the anterior sucker. Rings 6 and 7 are sometimes so slightly divided above as to give the appearance of a single ring; the former disappears ventrally, leaving ring 7 to form the first ventral ring behind the anterior sucker.

Somites I–III uniannulate; IV, XXV, XXVI and XXVII biannulate; the twenty somites V–XXIV complete with three rings.

The single pair of eyes usually lie in the third ring, but sometimes appear between rings 2 and 3.

Male genital opening situated between rings 26 and 27, that is, between somites XI and XII. Female orifice two rings behind the male, between rings 28 and 29, in somite XII.

The more important external and internal features are shown in fig. 29. The anus opens between rings 69 and 70, and thus is separated by two rings from the anterior sucker. There are six

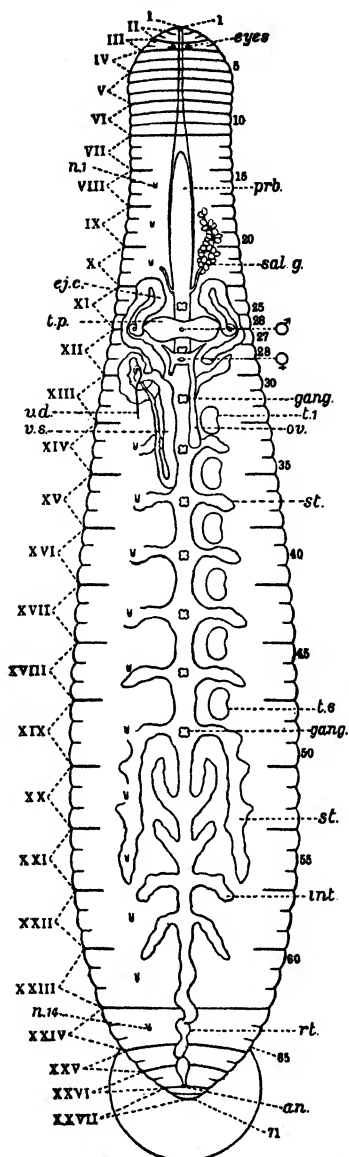

Fig. 29.—*Placobdella smydeae*, Harding, 1920. (After Harding.) Diagram showing external and internal features. Somites numbered in Roman and rings in ordinary figures. *prb.* Proboscis. *sal.g.* Salivary glands. *ejc.* Ejaculatory canal. *t.p.* Terminal portion of ejaculatory canal. *v.s.* Vesicula seminalis or seminal reservoir. *v.d.* Vas deferens. *gang.* Ventral ganglion. *st.* Stomach. *rt.* Rectum. *an.* Anus. n. 1, n. 14. First and fourteenth pair of nephridiopores (on ventral surface).

pairs of testes, and large sperm reservoirs connect the vasa deferentia and the much coiled ejaculatory canals. Nephridia 14 pairs. These, which first appear in somite VIII, are absent in the clitellar somites XI, XII and XIII. The nephridiopores open in the middle ring of the somite. Each pore lies about midway between the middle line and the margin of the ventral surface, and perforates the middle of the ring in which it appears.

Dimensions.—Total length, 13.5 mm.; greatest width, 9 mm.

Hosts and Habitat.—The only hosts upon which this leech has so far been found are Mud-turtles of the genus *Emyda*. It is probably fairly common throughout India, and has been recorded from the following places:—

(a) Outskirts of Calcutta. (b) Gatiagurgh Dist., Hoogli, Bengal. (c) River Mahanaddi, Sambalpur, Orissa. (d) The Chilka Lake [in the less blackish waters, sp. g. 1.007–1.011]. (e) Near Purulia, Chota Nagpur Div. (f) Nagpur, C.P. (g) Hoshangabad, C.P. (h) Taloshi (c. 2000 ft.), Koyna Valley, Satara Dist. Kaburaki also records it from Burma.

17. *Placobdella inleana*, Oka, 1922. (Fig. 30.)

Glossiphonia inleana, Oka, 1922.

The writer has not examined any example of this species and the diagnosis given below is a summary of Oka's original description, to which the reader is referred for further information. Although the mouth-opening is not absolutely terminal, its

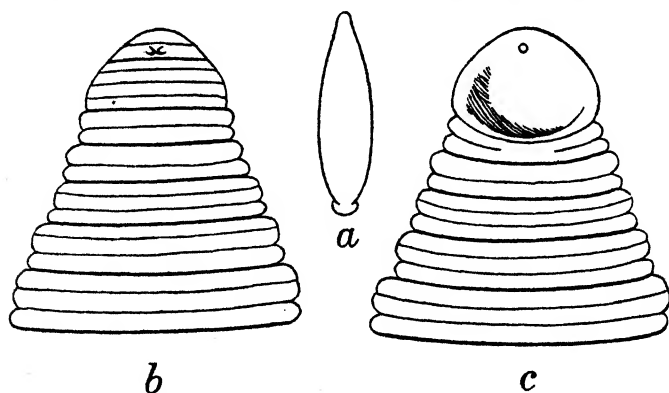

Fig. 30.—*Placobdella inleana*, Oka, 1922. (After Oka.) a. Outline of entire leech, $\times 3$. b. Somites 1-IX, dorsal aspect showing eyes, $\times 30$. c. Somites 1-X, ventral aspect showing mouth-opening, $\times 30$.

subterminal position, combined with the single pair of eyes and the seven pairs of crop diverticula, seem to indicate that this species is more nearly related to the genus *Placobdella* than to *Glossiphonia*, and it is referred here, at least provisionally, to the former genus.

Description.—Body ovate-oblong, somewhat convex both above and below, with the lateral margins sharply serrate. The examples examined were preserved in alcohol and had faded to a uniform pale grey colour with, however, indications of roundish spots arranged in regular series on the dorsal surface.

Anterior sucker bounded posteriorly by ring 6, with the mouth-opening situated in a subterminal position, immediately below the eyes. Posterior sucker about half the width of widest part of the body.

One pair of large and distinct eyes lie upon the second ring, with their bases back to back and nearly touching, the openings of their pigment-cups being pointed in a lateral and slightly forward direction.

The number of rings in adult individuals is usually 67; the annulation, however, presents remarkable peculiarities.

In this species, as in certain others, the somite limits are readily recognizable externally, owing to the furrows separating the rings of contiguous somites being more conspicuous than the other interannular furrows.

The interannular furrows of the three-ringed somites are not all of the same depth, the groove separating the first and second rings being shallower than that separating the second and third. Again, in most cases, the three rings of a somite are of different widths, the middle ring being the widest, the last ring somewhat less wide and the first ring always the narrowest. Some of the biannulate somites also have rings of unequal width, the anterior ring, in these cases, being the largest. Finally, the number of rings increases to some extent with growth, owing to certain rings which are single in the young leech becoming divided in the adult. It is possible, in this species, "to observe the various stages through which the primitive uniannulate somite of the ancestral leech gradually became the typical triannulate somite of the Glossiphoniæ."

Somites I, II, XXVI and XXVII are always uniannulate; V, VI and XXIV are always biannulate, and IX-XXII are always complete with three rings. The remaining somites vary in annulation with the growth of the individual, viz. III, IV and XXV are uniannulate in the young leech and biannulate in the adult; similarly VII, VIII and XXIII are originally biannulate, but become triannulate as full size is attained.

Genital openings separated by two rings. In adult fully annulated individuals the male pore lies between rings 26 and 27, and the female pore between rings 28 and 29.

There are six pairs of testes, sixteen pairs of nephidia and seven pairs of gastric diverticula.

Dimensions.—Full-grown individuals measure about 9 mm. in length and nearly 3 mm. in width.

Host and Habitat.—About sixty examples were taken from a tortoise, *Cyclemys dhor shanensis*, Annandale, at Fort Stedman, Inlé Lake, Southern Shan States, Burma.

18. *Placobdella fulva*, Harding, 1924. (Plate II, fig. 7; and fig. 31.)

I am indebted to the late Dr. Annandale for information regarding the colour during life of this elegant little species.

Description.—Body flattened, in extension claviform and very slender anteriorly. Upper surface of a bright reddish-yellow hue, having in addition to the deep brown markings described below a conspicuous longitudinal median cream-coloured stripe and a pair of broken, marginal cream-coloured bands. Ventral surface white. Dorsally each ring bears a large median papilla, and these papillæ form a prominent row corresponding to the median cream-coloured stripe. An intermediate and a marginal pair of papillæ present on the dorsal surface of the middle ring of each somite are covered by deep brown spots, which are connected longitudinally by dark brown lines. Head-region undilated and continuous with the body. Posterior sucker small, centrally attached, not wider than half the greatest width of the body, with paired cream-coloured rays.

Rings 67. Ring 5 forms the posterior boundary of the anterior sucker and is the first to appear on the ventral surface. Ring 63 is doubled at the margins but not entirely divided.

Somites V–XXII complete with three annuli.

The single pair of eyes lie within ring 2, there being one preocular ring.

The male genital pore is situated between rings 26 and 27, that is, between the first and second annuli of somite XI; the female pores open between rings 28 and 29, that is, between somites XI and XII.

The anus lies between rings 66 and 67, being separated by one ring from the posterior sucker.

(The accidental destruction of the two individuals upon which this species is founded prevented the complete investigation of their internal features.)

Dimensions.—Approximate total length, 13 mm.; approximate greatest width, 2 mm.

Hosts and Habitat.—There is no positive record of a host. The leeches examined were stated to have been found on the lower surface of a dead *Unio* shell at the edge of a stream, at Purulia, Manbhum Dist., Chota Nagpur Div., Bengal (“N. Annandale and F. H. Graveley coll.”).

19. *Placobdella undulata*, Harding, 1924. (Fig. 32.)

Description.—The typical elliptic lanceolate form of the body is modified in adult individuals by a slight constriction centred at the thirtieth ring, immediately behind the female orifice. Dorsal surface with a roughened appearance, due to the presence on each ring of numerous closely-set papillæ. Head-region somewhat dilated and distinct from the body. Posterior sucker circular or

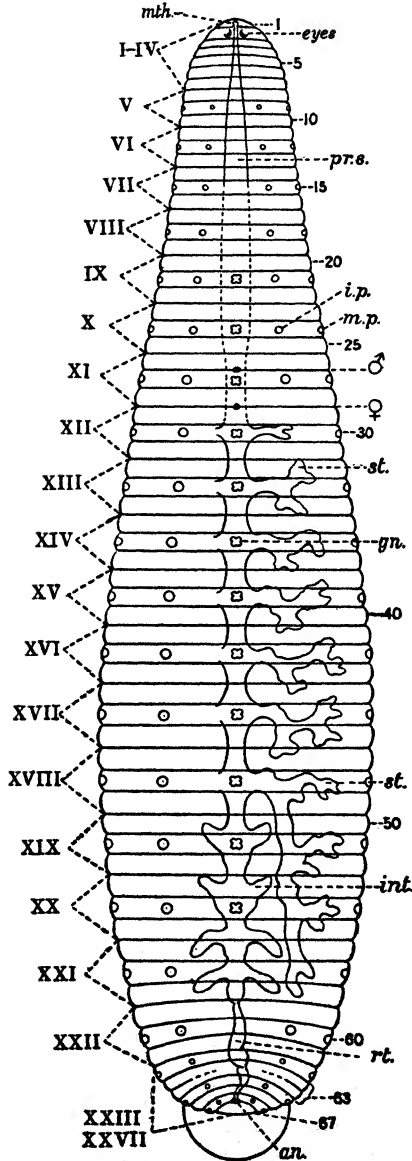

Fig. 31.—*Placobdella fulva*, Harding, 1924. Diagram showing external features, digestive tract and nerve-ganglia. Somites numbered in Roman, and rings in ordinary figures. *ip.* Intermediate papilla. *mp.* Marginal papilla. *mth.* Mouth. *prs.* Proboscis sheath. *st.* Stomach. *int.* Intestine. *rt.* Rectum. *an.* Anus. *gn.* A ganglion of the ventral chain. (After Harding.)

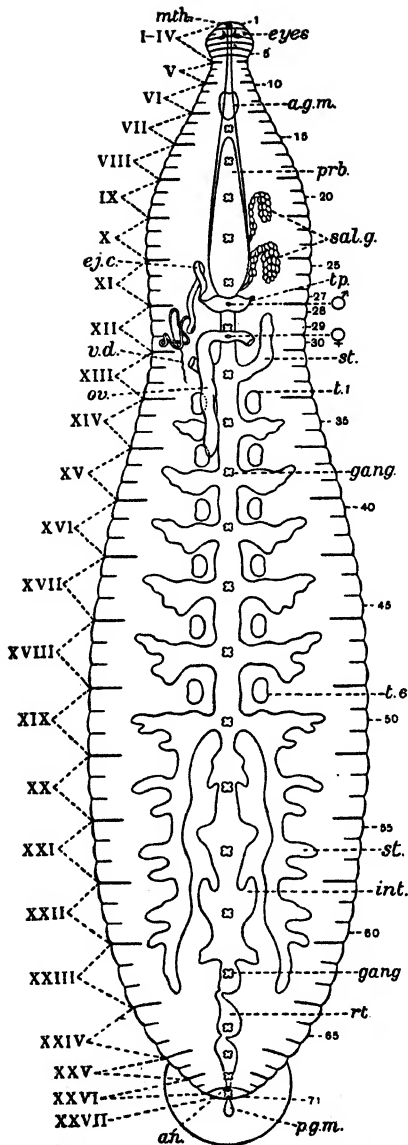

Fig. 32.—*Placobdella undulata*, Harding, 1924. Diagram showing external features, reproductive system, alimentary tract and nerve-ganglia. Somites numbered in Roman, and rings in ordinary figures. *mth.* Mouth. *prb.* Proboscis. *sal.g.* Salivary glands. *st.* Stomach. *int.* Intestine. *rt.* Rectum. *an.* Anus. *ej.c.* Ejaculatory canal (shown only on one side for the sake of clearness). *t.p.* Terminal portion of ejaculatory canal. *v.d.* Vas deferens. *t.1*, *t.6*. First and sixth pair of testes. *ov.* One of the ovaries. *a.g.m.* Anterior ganglionic mass. *p.g.m.* Posterior ganglionic mass. *gang.* A ganglion of the ventral chain. (After Harding.)

slightly oval, small, centrally attached, about equal in width to half the greatest width of the body. Colour faded in alcohol to a uniform buff hue.

Rings 71. Ring 2 is double at the margins but not entirely divided.

Somites I-IV, which could not be plotted with certainty in the material examined, appear to be represented by rings 1-6, which overlie the anterior sucker. Somites V-XXIV complete with three annuli; XXV and XXVI biannulate; XXVII uniaannulate. Rings 7 and 8, the first and second rings respectively of somite V, unite below to form the first ventral ring; somite V, therefore, is only triannulate dorsally.

There is one preocular ring; the single pair of eyes lie in the second ring.

Male genital orifice situated between rings 27 and 28, that is, between somites XI and XII. The female orifice lies two rings behind the male, in somite XII, between rings 29 and 30. The anus opens between rings 70 and 71, thus being separated by one ring from the posterior sucker.

The reproductive and alimentary systems are shown in fig. 32, and conform in all important particulars to the general plan characteristic of this genus. The mouth opens in the usual terminal position; the salivary glands form paired compacted masses; the seven pairs of gastric cæca are moderately lobate; the paired pouches of the intestine are somewhat less developed than usual.

Dimensions.—Approximate size of the largest example: total length, 17.5 mm.; greatest width, 4 mm.; width at the deepest point of constriction (ring 30), 2 mm.; greatest width of head-region, .75 mm.; width of posterior sucker, 2 mm.

Host and Habitat.—I am greatly indebted to Prof. Clifford Dobell, F.R.S., for the material upon which this species is founded. A note enclosed with the leeches examined states that they were said to have been taken from Koraliya fish (*Etroplus suratensis*) in the Colombo Lake, Ceylon.

Genus **THEROMYZON**, Philippi, 1867.

Glossiphonia, Johnson, 1816 (partim).

Clepsine, Savigny, 1822 (partim).

Hæmocharis, de Filippi, 1837 (partim); not *Hæmocharis*, Savigny, 1822.

Hemiclepsis, Vejdovsky, 1883 (partim).

Protolepsine, Moore, 1898.

Protolepsis, Livvanow, 1902.

Glossiphonidæ of medium size, with four pairs of eyes. Complete somite formed of three rings. Somite III is rarely and somites IV-XXIV are always complete. The crop (or stomach), which has more than seven pairs of lateral diverticula, extends anteriorly into the preclitellar region.

These are generally slender, elongate, soft, delicate, somewhat flattened leeches, of a more or less greyish-green or brown colour, with yellow spots upon the upper surface of the body and also of the posterior sucker, where they are disposed in a marginal series. During life they are often possessed of great powers of extension and contraction, and of extraordinary restlessness and activity, creeping rapidly with a looping movement upon the slightest disturbance. Most of the known species have been found in Lake Baikal, in Siberia, but two species, at least, have a wider distribution, namely the one under discussion and *T. tessellata* (O. F. Müller, 1774).

I here follow Moore (1924, p. 346) in giving Philippi's name *Theromyzon* precedence of the more familiar name *Protolepsis* applied by Livanow to this genus, which he was the first to place upon a satisfactory basis. Livanow divides the genus into two groups, distinguished by the following characters:—

(a) Genital orifices separated by two rings. In adults there is a shallow primitive form of vagina opening to the exterior by a single female pore. In undeveloped individuals there is no vagina and the oviducts open directly to the exterior, where they appear (in material which has been sectioned) as a pair of very small apertures situated one on either side of the median line.

(b) Genital apertures separated by more than two rings. The single female pore opens into a well-developed vagina.

The species referred to below belongs to the first of these groups, which contains but one other species, *T. garjawi* (Livanow, 1902).

20. *Theromyzon sexoculata*, Moore, 1898.

Protolepsine sexoculata, Moore (1898, p. 546).

Protolepsis meyeri, Livanow (1902, p. 345).

Moore (1924, p. 346) refers two specimens of *Theromyzon* from Manipur somewhat doubtfully to this species, with which they agree "in most features of annulation, the position of the genital pores, etc."

Description.—According to Livanow (*loc. cit.*), who describes it under the name of *Protolepsis meyeri*, this species has an elongate slender body, convex above and flattened below, and of an olive-green colour. The dorsal surface is traversed by six longitudinal rows of yellow spots. The spots composing four of these rows occur on the middle or sensory ring of each somite, and correspond to the outer paramedian and intermediate papillæ. (The inner paramedian papillæ are absent.) The spots forming the two remaining rows lie in an inner paramarginal position on the last ring of each somite.

The annulation is similar to that of the typical form, *Theromyzon (Protolepsis) tessellata*, with which it also agrees in the position of the eyes.

Somite I uniannulate; II usually biannulate, the second ring, however, being occasionally missing. Somite III so rarely triannulate that it may be regarded as typically biannulate, its first and second rings being nearly always merged together. Somites IV-XXIV complete with three rings, and XXV-XXVII biannulate.

Rings (when somite III is biannulate) 74 in number.

Eyes, four pairs (forming two subparallel rows), situated respectively upon rings 2, 4, 7 and 10 (on the sensory rings of the somites II, III, IV and V, in which they respectively lie).

The male genital pore lies between somites XI and XII, and the female pore two rings behind it, between the second and third rings of XII. The anus opens between rings 73 and 74, in the middle of somite XXVII.

Dimensions.—9 mm. long, with a maximum width of 3.1 mm. (Moore); 8 mm. long and 3 mm. wide (Livanow).

Hosts and Habitat.—One of the two Indian examples of *T. sexoculata* noted by Moore came from Loktak Lake, Manipur, Assam; the other was found in a small stream flowing out of this lake. Moore's original description of this species (1898) was based upon an example from Behring Island, Commander Islands, Siberia. Livanow's specimens came from Russia, and he notes the occurrence of this leech also in France and Sweden. The only host mentioned is Wild-duck. Probably, as in the case of *T. tessellata*, other waterfowl are also attacked.

Genus **HEMICLEPSIS**, Vejdovsky, 1883.

Glossiphoniæ of medium size, typically with two pairs of eyes. Complete somite formed of three rings. Head-region dilated and distinct from the rest of the body. The crop (or stomach), which has more than seven pairs of lateral diverticula, extends anteriorly into the preclitellar region. Mouth-opening within the anterior sucker.

21 a. **Hemiclepsis marginata**, subspecies **marginata**, O. F. Müller, 1774. (Plate II, figs. 1 & 2; and figs. 33 & 34.)

Hirudo marginata, O. F. Müller, 1774, p. 45.

Glossiphonia marginata, Moquin-Tandon, 1846, p. 375, pl. xiv, figs. 10-20.

Hemiclepsis marginata (in India), Kaburaki, 1921, pp. 694-695.

(For full synonymy and literature, see Harding, 1910, pp. 151-152.)

Description.—The flattened claviform and translucent body is usually richly pigmented, but the coloration is subject to considerable variation both in kind and in intensity. In typical examples the thin margins and extremities are colourless or hyaline and the ground-colour of the thicker parts is yellow, profusely sprinkled above with bright green. When, however,

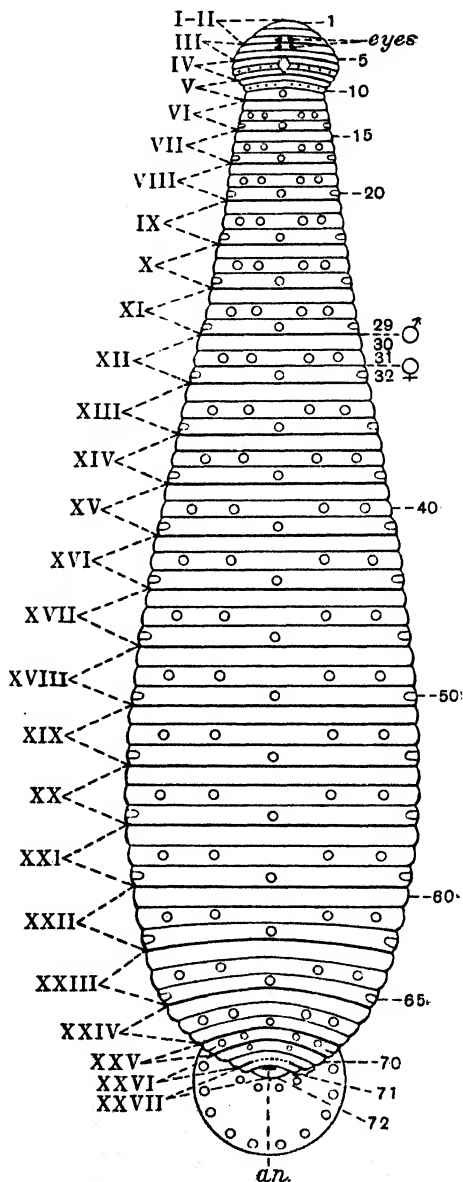

Fig. 33.—*Hemiclepsis marginata*, subsp. *marginata*, O. F. Müller, 1774. Diagram showing external features. Somites numbered in Roman, and rings in ordinary figures. Pigmented spots indicated in circular outline. an. Anus. (After Harding.)

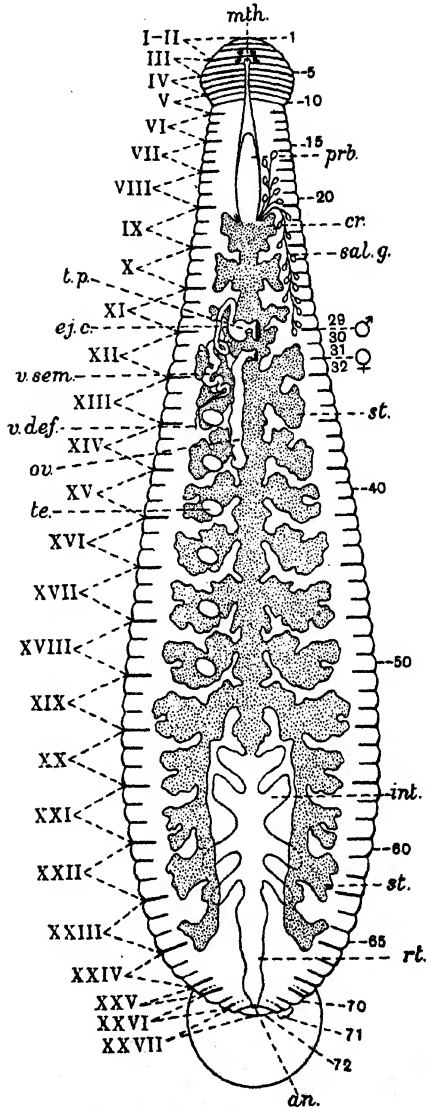

Fig. 34. *H. marginata*, subsp. *marginata*, O. F. Müller, 1774. Diagram showing alimentary tract and reproductive organs. The latter, and also the salivary glands, are shown on one side only for the sake of clearness. *mth.* Mouth. *prb.* Proboscis. *sal.g.* Salivary glands. *st.* Stomach (shaded). *int.* Intestine. *rt.* Rectum. *an.* Anus. *ej.c.* Ejaculatory canal. *t.p.* Its terminal portion. *v.sem.* Vesicula seminalis or seminal reservoir. *v.def.* Vas deferens. *te.* Testis. *ou.* Ovary. (After Harding.)

the crop is gorged with blood its scarlet hue, shining through the semi-transparent body modifies, and sometimes entirely eclipses, the green pigment.

Dorsal surface with seven longitudinal rows of lemon-yellow spots.

The spots composing four of these rows lie on the middle ring of each somite and correspond to the outer paramedian and intermediate sense-organs and papillæ. The spots forming a median row fall upon the third ring, and the two remaining series, which occupy a marginal position, occur upon the third, and sometimes also upon the middle ring of each somite.

Posterior sucker with an outer, and often with an inner series of lemon-yellow spots between which reddish-brown radial stripes are often present.

Rings 72, of which two are preocular. The seventy-first is partly subdivided and traces of subdivision appear in ring 69. The twenty-one somites IV-XXIV are complete with three rings.

The two pairs of eyes are situated respectively upon the third and fourth rings.

The male genital orifice opens between somites XI and XII, that is, between rings 29 and 30, and the female orifice lies two rings behind the male, between the second and third rings of somite XII. The anus opens between the last and the penultimate ring.

The alimentary tract and the reproductive organs are indicated in fig. 34.

Dimensions.—Length, at rest, 15-20 mm.; width, at rest, 3-7 mm.; length, fully extended, up to 30 mm.

Hosts and Habitat.—*Hemiclepsis marginata marginata* is chiefly a fish parasite, but it also attacks certain molluscs, and has been taken in India from a species of *Lamellidens* (by Dr. T. Southwell). It inhabits freshwater ponds, streams and lakes, where it is often found upon water-plants and various other submerged objects, lying in wait for its prey. Its range extends throughout the greater part of Europe to Western Asia and India, where it begins to be replaced by the subspecies *asiatica*. In India it has been recorded from the following localities:—(a), (b), (c), (d) Malwa Tal, 3600 ft., Sat Tal, 4500 ft., Bhim Tal, 4450 ft., and Naukuchia Tal, 4200 ft., Kumaon, W. Himalayas (Dr. S. Kemp coll.); (e), (f), (g) Janikpur, Chitauni, and Chukei Mukei, Nepal; (h) Igatpuri, W. Ghats, Bombay P.; (i) Puri, Orissa (Dr. N. Annandale coll.); (j) Bagra, Hoshangabad Dist. (Dr. F. H. Graveley coll.); (k) Bhandardaha Beel, Murshidabad Dist. (Dr. T. Southwell coll.); (l) in and about Calcutta (Dr. N. Annandale, Dr. F. H. Graveley, Mr. R. Hodgart coll.).

21 b. *Hemiclepsis marginata*, O. F. Müller, subspecies *asiatica*,
Moore, 1924. (Fig. 35.)

Moore (1924, p. 359) describes a subspecies of *Hemiclepsis marginata* which he names *asiatica* and states to be the most abundant and generally distributed of the Glossiphoniidæ in Kashmir. He regards this as a form intermediate between the typical *H. marginata* of Europe, with its four well-developed eyes, and Oka's species, *H. casmiana*, from China and Japan, which has only two eyes, but resembles the subspecies *asiatica* in colour and dorsal pattern. He suggests, further, that *H. marginata* should be divided into three subspecies, viz. *marginata*, representing the typical form, *casmiana* the Far Eastern form, and *asiatica* the form described here. This suggestion, as far as the Indian region is concerned, has been adopted in these pages.

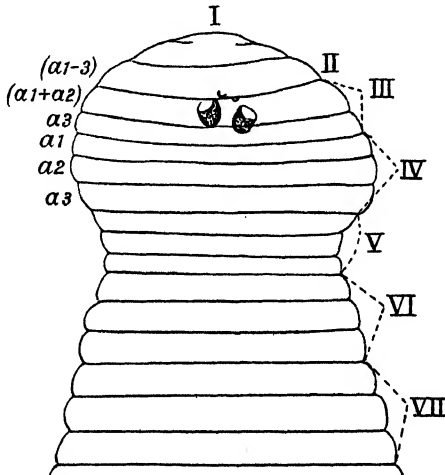

Fig. 35.—*Hemiclepsis marginata*, subsp. *asiatica*, Moore, 1894. (After Moore.)
Dorsal view of head-region showing eyes and annulation. Somites numbered in Roman, and rings in ordinary figures.

The subspecies *asiatica* closely resembles the typical subspecies *marginata* already described, but differs from it in certain constant characters of which the most important are given below. [Not having seen the subspecies, it is proper that I should here acknowledge my indebtedness to the work of Moore (*loc. cit.*), which has been my only source of information.]

(1) The first pair of eyes are closely approximated, and so minute that they may easily escape observation. They generally lie immediately in front of the conspicuous and more widely

separated posterior pair of eyes, on the anterior ring of somite III, but sometimes are placed further forward and appear in somite II. In some cases they may be in contact with the posterior pair of eyes, and even apparently obliterated.

(2) The annulation in *asiatica* is considerably reduced. Somites I and II are uniannulate and III is also typically uniannulate, consisting of a broad ring, which, however, may show signs of subdivision dorsally, behind the eyes. Somite IV is biannulate and V is triannulate dorsally, its first and second rings fusing ventrally to form the free posterior edge of the anterior sucker. Somites VI-XXII are complete with three rings; XXIII is still triannulate, but with the last ring reduced; XXIV is usually biannulate, and XXV-XXVII are uniannulate and progressively smaller.

(3) Colour (in alcohol) reddish-brown, paler towards the extremities. The median series of spots often coalesce to form a more or less distinct longitudinal pale yellow band; the spots on the sensory rings, again, tend to spread laterally, forming broken or sometimes continuous pale yellow transverse stripes.

Dimensions and Habitat.—The size of the largest example is given as 16.3 mm. in length, with a maximum width of 6 mm. All the members of this subspecies are recorded from Kashmir, chiefly from slow-running streams.

Genus **PARACLEPSIS**, Harding, 1924.

Glossiphonidæ of medium size, with three pairs of eyes. First and second pairs on two consecutive rings, second and third pairs separated by two rings. Complete somite formed of three rings. Mouth-opening subterminal, leaving the anterior sucker imperforate. The crop (or stomach), has more than seven pairs of lateral diverticula.

22. *Paraclepsis prædatrix*, Harding, 1924. (Plate II, figs. 11 & 12; and fig. 36.)

The ovate-acuminate body is smooth below, but has a roughened or crustaceous dorsal surface due to numerous small papillæ closely set on every ring. A series of larger dorsal papillæ are present on the middle ring of each somite, and these consist of three pairs, occupying respectively a paramedian, an intermediate and a paramarginal position. The head-region is separated from the rest of the body by a slight constriction.

I am indebted to the late Dr. Annandale for the loan of a water-colour drawing of a living individual collected by him and also for the following description of its coloration:—"Semi-opaque pinkish-white, profusely ornamented with dull green pigment-cells on the dorsal surface. On the anterior and posterior thirds of the body these cells formed a broad and somewhat irregular longitudinal band, interrupted along the middle by a colourless line; a transverse colourless line ran across the body just behind the

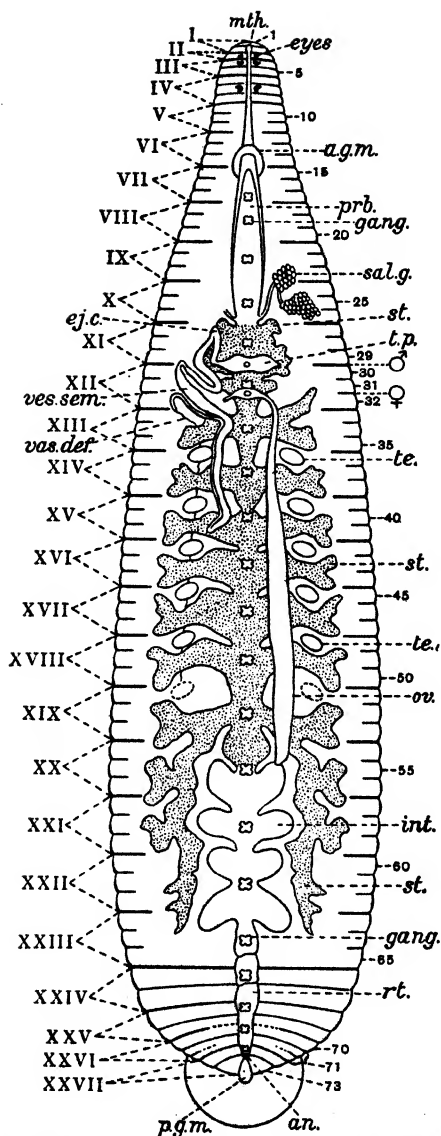

Fig. 36.—*Paraclepsis praedatrix*, Harding, 1924. Diagram showing external features, reproductive system, alimentary tract and ventral nerve-ganglia. Some of the paired organs are shown on one side only, in order to obtain clearness. Somites numbered in Roman, and rings in ordinary figures. *mth.* Mouth-opening. *prb.* Proboscis. *sal.g.* Salivary glands. *st.* Stomach. *int.* Intestine. *rt.* Rectum. *an.* Anus. *ej.c.* Ejaculatory canal. *t.p.* Its terminal portion. *ves.sem.* Vesicula seminalis or seminal reservoir. *vas.def.* Vas deferens. *te.* Testis. *a.g.m.* Anterior ganglious mass. *p.g.m.* Posterior ganglious mass. *gang.* A ganglion of the ventral chain. (After Harding.)

'head,' which was profusely covered with green pigment-cells. On the middle of the body the pigment-cells were arranged in a comparatively narrow stripe, still interrupted longitudinally, but giving rise to transverse bars, which were expanded and proliferated at their free extremity in such a way that a kind of network was produced. The posterior sucker bore faint, radiating green lines."

Anterior sucker with the characteristics of the genus and having its interior surface ribbed; resembling in this respect the tip of the human finger. Posterior sucker centrally attached and rather less in diameter than the greatest width of the body. It bears a series of submarginal papillæ.

Rings 73, of which two are precocular. Ring 71 is double at its margins, but is not divided throughout.

Somites I, III, XXIV, XXV, XXVI and XXVII biannulate; II uniannulate; the twenty somites IV-XXIII complete with three rings.

The three pairs of eyes are disposed in two subparallel rows. The first and second pairs lie respectively in rings 3 and 4; the third pair, separated from the others by the space of two annuli, lie in ring 7.

The male genital orifice is situated between rings 29 and 30, that is, between somites XI and XII; the female orifice lies two rings behind the male, between rings 31 and 32, in somite XII.

The reproductive organs and alimentary tract are represented schematically in fig. 36. Large sperm reservoirs connect the vasa deferentia with the ejaculatory canals and descend to about the fifteenth somite. Having reached its lowest point, each vesicula returns upon itself, and the ascending and descending portions are closely united for a considerable distance. The ovaries consist of paired simple sacs. The crop or stomach arises within the posterior margin of somite X. Its anterior portion expands bi-symmetrically but somewhat irregularly, and it is not until the twelfth somite is reached that the typical Glossosiphonid type of diverticula appear.

The salivary glands take the form of compact bunches closely resembling the same features in *Placobdella*.

The anus opens between the seventy-second and the last ring.

Dimensions.—Large individuals (in alcohol) attain a length of about 15.5 mm. and a width of about 4 mm.

Hosts and Habitat.—The only host noted is *Emyda granosa vittata*, and the leeches were found either upon their host or in ponds and pools frequented by this freshwater tortoise. The material, chiefly collected by the late Dr. Annandale, came from the following localities:—

(a) Tanjore, Trichinopoly District, S. India; (b) Bangalore, S. India, altitude circa 3000 ft.; (c) Kalka, at base of Simla Hills, altitude 2400 ft.; (d) Purulia, Manbhum District, Chota Nagpur Div., Bengal; (e) Selai Kusi, Magaldhai, Assam; (f) Igatpuri Lake, W. Ghats, Bombay Presidency.

23. *Paraclepsis vulnifera*, Harding, 1924. (Fig. 37.)

Description.—Body ovate-acuminate, with a somewhat roughened dorsal surface, due to the presence of numerous minute papillæ on every ring. (Accurate observations of papillæ and colour were prevented by the macerated state of the material.)

Head-region continuous with the body. Anterior sucker with the characters of the genus. Posterior sucker centrally attached, small, and less in diameter than half the greatest width of the body.

Rings 70. Rings 2 and 29 are double at their margins, but not entirely divided. Rings 7 and 8 unite below to form the first ventral annulus.

The first somite is uniannulate, and the second is represented by the anterior part of ring 2 containing the first pair of eyes. Somite III includes the posterior part of ring 2 together with ring 3. The twenty somites IV–XXIII are complete with three rings, and XXIV–XXVII are represented by the last 7 rings.

The three pairs of eyes are disposed in two subparallel rows. The small first pair are closely approximated in the anterior part of ring 2 (and may easily be overlooked); the second and larger pair lie in the posterior part of the same ring, and the third and largest pair are situated somewhat wider apart, in ring 5.

The male genital orifice opens between rings 27 and 28, that is, between somites XI and XII; the female orifice is separated by two rings from the male and lies between rings 29 and 30, the second and third rings of somite XII.

The reproductive and alimentary systems are shown in fig. 37. The large vesiculæ seminales seen in *P. prædatrix* are absent.

The salivary glands and crop bear a close resemblance to the same features in *P. prædatrix*. The crop arises in the anterior part of somite X. The anus lies between rings 69 and 70, being separated by one ring from the posterior sucker.

Size.—Length about 14 mm.; width about 8 mm. Living individuals probably attain a greater length.

Host and Habitat.—A note enclosed with the leeches states that they were taken from the branchial chambers of freshwater crabs (*Paratelphusa* sp.) at Mauganaltur, Tanjore District, Madras Province. They had been sent by Mr. Ballard, Government Entomologist, Madras Province, to Dr. Guy A. K. Marshall, C.M.G., Director of the Imperial Bureau of Entomology (Colonial Office), who was good enough to place the material at my disposal.

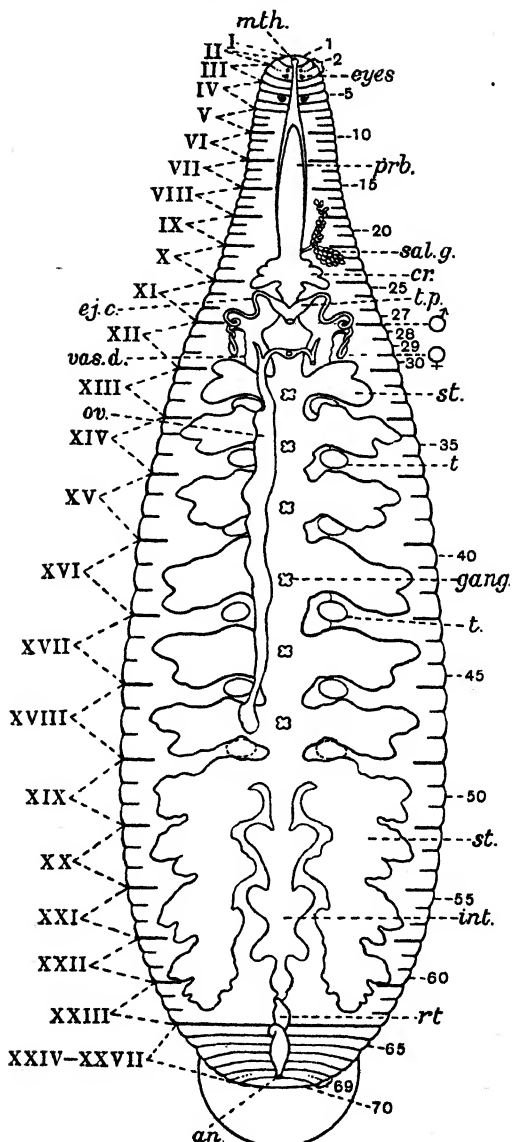

Fig. 37.—*Paraclepsis vulnifera*, Harding, 1924. Diagram showing external features, reproductive system and alimentary tract. Somites numbered in Roman, and rings in ordinary figures. *mth.* Mouth-opening. *prb.* Proboscis. *sal.g.* Salivary glands. *st.* Stomach. *int.* Intestine. *rt.* Rectum. *an.* Anus. *ej.c.* Ejaculatory canal. *t.p.* Terminal portion of ejaculatory canal. *vas.d.* Vas deferens. *ov.* Ovary (one ovary only is shown, for the sake of clearness). *gang.* A ganglion of the ventral chain. (After Harding.)

SPECIES INQUIRENDÆ.

Family ICHTHYOBDELLIDÆ.

Genus **BRANCHELLION**, Savigny, 1822.

This genus is represented in the waters of both hemispheres, and although no species of *Branchellion* has so far (1926) been recorded from the Indian Region, it seems likely that such a record will eventually be made. The following diagnosis of this genus, therefore, will not be without interest here:—

Marine Ichthyobdellidæ parasitic upon fish. Body divided into two distinct regions: a short anterior "neck" and a long posterior "abdomen," with paired, lateral, foliaceous, non-digitate branchiæ and pulsating vesicles. Complete somite formed of three rings.

(?) *Trachelobdella* species.

Moore (1924, p. 306) refers doubtfully to the genus *Trachelobdella* a small leech in the collection of the Indian Museum which was not in a sufficiently good state of preservation for satisfactory determination. The species, which is stated to have been taken off the Pier, Ross Island, Andaman Islands, in 1915, is described as being nearly 10 mm. in length, with a very large posterior sucker, a wide, broadly ovate anterior sucker, and with traces of a pair of eyes and also of pulsating vesicles.

Family GLOSSIPHONIDÆ.

(?) *Placobdella gracilis*, R. Blanchard, 1897.

A single imperfectly preserved specimen of a leech in the Indian Museum collection, about 5 mm. long, found at Nandi, Mysore State, upon *Limnæea acuminata*, is referred with some hesitation to this species by Kaburaki (1921 (*b*), p. 702). The original examples of this little species described by Blanchard (1897, p. 334, fig. 2) came from Buitenzorg, Java, where they had been taken from the branchial chamber of a freshwater-crab (*Paratelphusa* sp.).

(?) *Placobdella parasitica*, Say, 1824.

Oka (1922, p. 529) assigns "with much doubt" to this species a single, small and contracted specimen of a leech found upon *Taia shanensis*, Kobelt, in a canal on the western side of the Iulé Lake, S. Shan States, Burma. It was not deemed advisable to cut this single individual into sections, and after comparing it with the detailed description of *Glossiphonia (Placobdella) parasitica* given by Castle (1900, p. 51), Oka states that "it is certainly immature, and it is difficult to ascertain whether the slight but obvious discrepancies existing between this specimen and typical *P. parasitica* are due to difference in age or to specific distinctness."

BIBLIOGRAPHY.

- APÁTHY, S. (1888 a.) Analyse de äusseren Körperform der Hirudineen. Mitth. Zool. Sta. Neapel, viii, p. 153, pls. viii & ix.
- (1888 b.) Süßwasser-Hirudineen. Zool. Jahrb. iii, p. 725.
- (1890.) Ertesitő az erdélyi Museum-egylet orvos-term. szakosztályából, xv, 1890, p. 110 (in Magyar), and p. 122 (in German).
- BADHAM, C. (1916.) On an Ichthyobdellid parasite on the Australian Sand Whiting (*Sillago ciliata*). Quart. Journ. Micr. Sci. lxii, pt. 1, n. s.
- BAIRD, W. (1869.) Descriptions of some new Suctorial Annelides in . . . the British Museum. Proc. Zool. Soc. London, 1869, p. 310.
- BLAINVILLE, H. M. D. de. (1827.) Article "Sangus" in Dict. des Sci. Naturelles, xlvi. 8°. Strasbourg and Paris, 1816-1830.
- (1828.) Ibid. Article "Vers," lvii.
- BLANCHARD, R. (1893.) Courtes notices sur les Hirudinées. X. Hirudinées de l'Europe boréale. Bull. Soc. Zool. France. xviii, 1893, p. 93. (*Placobdella*.)
- (1894.) Hirudinées de l'Italie continental et insulaire. Boll. Mus. Zool. Torino, ix, 1894, No. 192.
- (1896.) Hirudinées. Viaggio del dott. A. Borelli nella Argentina e nel Paraguay. *Ibid.* xi, 1926, No. 263.
- (1897 a.) Hirudinées du Musée de Leyde, in 'Notes from the Leyden Museum,' xix, 1897, p. 73, pls. iv-vi.
- (1897 b.) Hirudinées des Indes Néerlandaises. Zool. Ergeb. einer Reise in Niederländisch Ost-Indien, Max Weber, Bd. iv, 1879, p. 332, fig. 1.
- BOULENGER, G. A. (1904.) Cambridge Natural History, vii (Fishes), p. 613. 8°. Cambridge, 1904.
- BRANDES, G. (1900.) Die Begattung von *Clepsine tessulata*. Zeitschr. f. Naturw., xxvii, pp. 126-128.
- BRAUN, J. F. P. (1805.) Systematische Beschreibung einiger Egelarten. 4°. Berlin, 1805.
- BRUMPT, E. (1900.) Reproduction des Hirudinées. Mem. Soc. Zool. France, xiii, pp. 286-430.
- CASTLE, W. E. (1900.) Some North American Freshwater Rhynchobdellidæ and their Parasites. Bull. Mus. Zool. Harvard, xxxvi, No 2, p. 147.
- FILIPPI, F. de (1837.) Memoria sugli Anellidi della famiglia delle Sanguisughe. 4°. Milano, 1837.
- GODDARD, E. J. (1909.) Proc. Linn. Soc. N.S.W. xxxiv, 1909, p. 721, pl. lvi.
- HARDING, W. A. (1909.) Note on Two New Leeches from Ceylon. Proc. Camb. Phil. Soc. vol. xv, p. 233.
- (1910.) A Revision of the British Leeches. Parasitology, vol. iii, 1910, No. 2, p. 130, pls. xiii-xv.
- (1920.) Fauna of the Chilka Lake: Hirudinea. Mem. Ind. Mus. vol v, No. 7, 1920, p. 510.
- (1924.) Descriptions of some New Leeches from India, Burma and Ceylon. Ann. & Mag. Nat. Hist. Ser. 9, vol. xiv, 1924, p. 489, pls. ix-xv.
- JOHNSON, J. R. (1816.) Treatise on the Medicinal Leech. 8°. London, 1816.
- (1817.) Observations on *Glossopora*. Phil. Trans. Roy. Soc. 1817, p. 21.

- JOHANSSON, L. (1896.) Ueber den Blutumlauf bei *Piscicola* und *Callobdella*. Festschrift Lilljeborg, pp. 317-330, pl. xvii. 4°. Upsala, 1896.
- (1898 a.) Die Ichthyobdelliden im Zool. Reichsmuseum in Stockholm. Öfv. af K. Vet.-Akad. Förh. lv, pp. 665-687.
- (1898 b.) Einige systematisch wichtige Thiele der inneren Organisation der Ichthyobdelliden. Zool. Anz. xxi, No. 573, pp. 581-595.
- KABURAKI, T. (1921 a.) On some Leeches from the Ohilka Lake. Mem. Ind. Mus. v, 1921, No. 9, p. 661.
- (1921 b.) Notes on some Leeches in the Collection of the Indian Museum. Rec. Ind. Mus. xxii, pt. v, 1921, p. 689.
- KRØYER, —. (1850.) See Diesing, C. M. Systema Helminthum. (2 vols. 8°. Vindobonæ, 1850.) Vol. i, p. 438.
- LAMARCK, J. B. de (1818.) Histoire naturelle des animaux sans vertébrés.—V. 7 vols. 8°. Paris, 1818.
- LINNEÆUS, C. (1758.) Systema Naturæ, 10th ed.
- (1761.) Fauna Suecica, 2nd ed.
- (1767.) Systema Naturæ, 12th ed.
- LIVANOW, N. (1902.) Die Hirudineen-Gattung *Hemiclepsis*. Vejd. Zool. Jahrb. (Abth. f. Syst.), xvii, pp. 339-362. 8°. Jena, 1902.
- (1903.) Untersuchungen zur Morphologie der Hirudineen. I. Das Neuro- und Myosomit der Hirudineen. Zool. Jahrb. (Abth. f. Anat.), xix, i, pp. 29-90, Taf. 2-6.
- MALM, A. W. (1860.) Svenska Iglar. Göt. Kongl. Vet. a. Vitt. Samh. Handlingar, viii, p. 153.
- MOORE, J. PERCY (1898.) Leeches of the U.S. National Museum. Proc. U.S. Nat. Mus. vol. xxi, No. 1160, pp. 543-563, pl. xl. 8°. Washington, 1898.
- (1900.) Description of *Microbdella biannulata*, with especial regard to the construction of the Leech Somite. Proc. Acad. Nat. Sci. Philadelphia, 1900, part i, pp. 50-73, pl. vi.
- (1924.) Notes on some Asiatic Leeches . . . principally from China, Kashmir and British India. Proc. Acad. Nat. Sci. Philadelphia, lxxvi, 1924, pp. 343-388, pls. xix-xxi.
- MOQUIN-TANDON, A. (1826.) Monographie de la famille des Hirudinées. 4°. Montpellier, 1826.
- (1846.) Ibid. Nouv. éd. with Atlas. 8°. Paris, 1846.
- MÜLLER, O. F. (1774.) Vermium terrestrium et fluviatilium, i, Pars 2. 4°. Havniæ et Lipsiæ, 1773-1774.
- OKA, A. (1894.) Beiträge zur Anatomie der Olepsine. Zeitschr. f. wiss. Zool. Bd. lviii, p. 79.
- (1902.) Über das Blutgefässesystem der Hirudineen. Annot. Zool. Jap. iv, pt. ii, 1902, p. 49.
- (1904.) Über der Bau von *Ozobranchus*. Annot. Zool. Jap. v, pt. iii, 1904, p. 133.
- (1910.) Synopsis der japanischen Hirudineen. Annot. Zool. Jap. vii, pt. iii, 1910, p. 165.
- (1912.) Eine neue *Ozobranchus*-Art aus China (*O. jantseanus*). Annot. Zool. Jap. viii, 1912, pt. i.
- (1922.) Hirudinea from the Inlé Lake, S. Shan States, Burma. Rec. Ind. Mus. xxiv, pt. iv, 1922, p. 521.
- PHILIPPI, R. A. (1867.) Kurze Notiz über zwei chilenische Blutegel. Arch. f. Naturg., 1867 (I) pp. 76-78.
- POIRIER et DE ROCHEBRUNE. (1884.) Sur un type nouveau de la classe des Hirudinées. C. R. Ac. Sci. xviii, 1884, p. 1597.

- QUATREFAGES, A. DE. (1852.) Études sur les types inférieurs de l'embranchement des Annelés. Mémoire sur le *Branchellion* d'Orbigny. Ann. Sci. Nat. xvii, Sér 3, 1852.
- ROBERTSON, M. (1909.) Further Notes on a Trypanosome found in the Alimentary Tract of *Pontobdella muricata*. Quart. Journ. Micr. Sci. lvi, n. s. pt. 1, pp. 119-139.
- (1910.) Studies on Ceylon Hæmatozoa. No. II. (*Hæmogregarina nicoriæ*). Quart. Journ. Micr. Sci. lv, n. s. pt. 4, pp. 741-762, pls. 32-41.
- (1911.) Transmission of Flagellates living in the blood of certain Freshwater Fishes. Phil. Trans. Roy. Soc. Series B, vol. ccii, pp. 29-50, pls. 1-2.
- SAVIGNY, J. C. (1822.) Système des Annélides . . . in Description de l'Égypte . . . publié par les ordres . . . de Napoléon le Grand. Fol. Paris. [The date of this volume is taken from C. D. Sherborn's bibliography in Proc. Zool. Soc. London, 1897, p. 285.]
- SCHMARDA, L. K. (1861.) Neue wirbellose Thiere, i, p. 2. Fol. Leipzig, 1861.
- SELENSKY, W. (1906.) Zur Kenntniss der Gefässsystems der *Piscicola*. Zool. Anz. xxxi, p. 33.
- SUKATSCHOFF, B. W. (1912.) Beiträge zur Anatomie der Hirudineen. I. Über den Bau von *Branchellion torpedinis*, Sav. Mith. Zool. Sta. Neapel, Bd. xx, 3, pp. 395-523, Taf. 18-24.
- VEJDOVSKY, F. (1883.) Excreci Soustava Hirudinei. Sitzb. des Königl. Böhm. Gesel. des Wissensch. Prag, pp. 35-51 and 1 pl.
- VERRILL, A. E. (1872-1873.) Synopsis of N. American Freshwater Leeches. Rept. U.S. Fish Commissioner for 1872-1873, pt. ii, p. 667.
- WHITMAN, C. O. (1878.) Embryology of Clepsine. Quart. Journ. Micr. Sci. xviii, n. s.
- (1890.) Spermatophores as a means of hypodermic impregnation. Journ. Morph., iv, pp. 361-406, pl. xiv.
- (1892.) Metamerism of Clepsine. Festschr. zum siebenzigsten Geburtstage R. Leuckarts, pp. 385-395, pls. xxxix & xl. 4^o. Leipzig, 1892.

ARHYNCHOBDELLÆ.

BY

J. PERCY MOORE.

INTRODUCTION.

Synonym. Gnathobdellæ.

The jawed-leeches or leeches without a proboscis.

Diagnosis.—No protrusible proboscis, the pharynx being fixed and not surrounded by a space enclosed in a proboscis-sheath; pharynx provided with longitudinal ridges, the median dorsal and paired ventro-lateral typically terminated by toothed jaws. Cephalic sucker scoop-shaped, not widely expanded, with a deep oral chamber, at the caudal end of which is the mouth. Blood red. Reproductive system complex, commonly with copulatory organs. Complete somites usually or fundamentally five-ringed.

In this suborder the Hirudinea may be said to reach their most complete and perfect expression. Here belong the typical leeches—those fully adapted to a sanguivorous or a predaceous habit, and, with a few exceptions, all of the largest forms, as well as those most intimately affecting human welfare. They are fresh-water or terrestrial, never, so far as known, truly marine.

External Characteristics (fig. 38, p. 98).—The size varies from a length of about an inch to a foot or even eighteen inches, the largest being an inch wide. Most of the species fall within the limits of two to six inches when normally extended.

Although jawed-leeches are individually very mobile and many are capable of a wide range of extension and contraction from a slender, linear, to a pyriform or egg-shape, the *form* is remarkably constant throughout the group. In a normal state of partial extension they are moderately depressed and regularly lanceolate-ovate, broader at the caudal end. Rarely they are cylindroid, or sub-cylindrical, never foliaceous, as are many Glossiphoniidæ, or conspicuously divided into regions, as in some Ichthyobdellidæ, and none are known to bear gills or pulsatile vesicles, as also in the latter.

The *texture* differs widely: some, like certain land-leeches and Erpobdellidæ, are so muscular and hard that they slip through the fingers like eels; others, like *Hæmopsis* and *Myxobdella*, in which

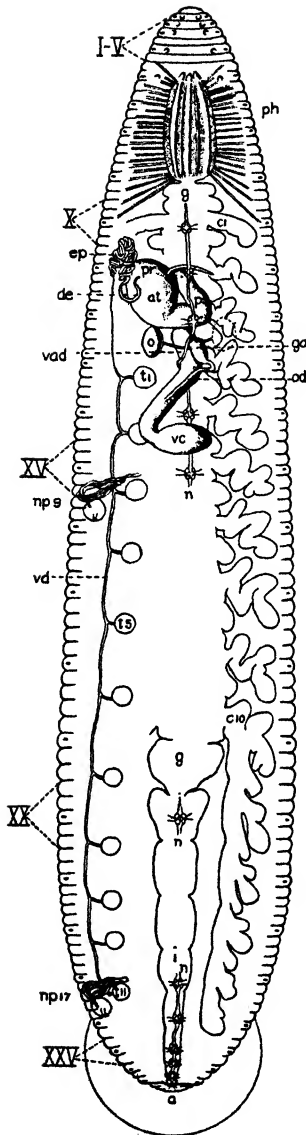

Fig. 38. — Diagram of general anatomy of a typical ten-eyed leech (*Hirudinaria* (*Pacilobdella*) *granulosa*). The somites are indicated by the supra-marginal sensillæ shown by elliptical outlines at the sides and by the Roman numerals. About twice natural size. *a.*, anus; *at.*, atrium; *c.* 1-10, gastric caeca; *d.e.*, ductus ejaculatorius; *sp.*, epididymis; *g.*, stomach; *g.a.*, glandula albuminigena; *i.*, intestine; *n.*, nerve-cord with ganglia; *np.* 9-17, nephridia; *o.*, ovary; *od.*, common oviduct; *ph.*, pharynx; *pr.*, prostate region of atrium; *p.s.*, penis-sac of atrium; *t.* 1-11, testes; *va.d.*, vaginal duct; *v.c.*, vagina caecum; *v.d.*, vas deferens.

the muscles are less developed and the botryoidal and parenchymatous tissue abundant, are soft and flaccid or œdematous, and when picked up may hang as an inert, shapeless mass.

The *cephalic sucker* is of moderate size, never widely explanate, but muscular and mobile and capable of extension and involution. The free anterior part or lip is more or less scoop- or spoon-shaped, passing caudally into a complete buccal ring with a deep oral chamber, which is coextensive with the mouth (*Erpobdellidæ*) or terminated by a transverse muscular septum (velum), perforated in the centre by the triangular mouth. There is often a narrow unsegmented rim, excepting which the dorsal or convex face of the sucker is annulated and metameric. The ventral or concave face is smooth, tessellated or furrowed, and in some genera is divided by a median longitudinal fissure. Many of the land-leeches possess a pair of membranous frills or lobes immediately within the buccal ring, at the base of which the first pair of nephridia may open. The head is richly supplied with eyes, touch-organs and taste-organs. As a whole it serves as an adhesive, locomotory and ingestive region, while the lip is chiefly prehensile and sensory.

The *caudal sucker* is well developed as a simple, highly muscular disk in all except the burrowing genus *Lumbricobdella*. It is bent beneath the anal region and directed chiefly ventrad. While it does not reach the size and depth of certain of the *Ichthyobdellidæ*, in many of the more strictly parasitic and sanguivorous genera it attains a very large size, while in the strictly predaceous and scavenger forms it is usually small and sometimes weak. The ventral face is often provided with radiating ridges ending in marginal papillæ, and the dorsal surface may be roughly tessellated, especially in Indian *Hirudidæ*. The sucker is a powerful organ of adhesion, serving for attachment and locomotion. It is provided with interlacing circular, radial and oblique muscle-fibres, in addition to the powerful erector and depressor muscles that join it to the body.

As in other leeches, the thirty-four somites are grouped in five *regions*. With the exception of the first and last, constituting the just-described suckers, these regions are not sharply distinguishable externally, the principal characteristics being found in the degree of development of the annuli. Those of the cephalic and caudal regions are mostly uniannulate, but some of the former are biannulate or triannulate. Those of the middle body are all or nearly all fully developed and complete, and those of the preclitellar and anal regions are transitional in development.

Internally there are many distinctive regional features of organography, especially in the nervous, digestive and reproductive systems. The *cephalic region* is characterized by concentration of the six neuromeres in a post-buccal mass, the inclusion of sucker, eyes, mouth, jaws or their equivalent, and the absence of definite nephridia. In the second region or *preclitellum* the three ganglia are distinct but not widely separated in agreement

with the intermediate state of development of the segments, the digestive tract contributes the pharynx and in some cases an œsophagus, and the anterior two pairs of nephridia occur.

The *middle region* is by far the largest and most highly elaborated. It is especially characterized by the presence of the reproductive organs, the regularly paired and metameric nephridia, the widely-spaced ganglia of the central nerve cord, each aligned with the neural annulus of its somite, and by the inclusion of the entire storage and digestive region of the alimentary canal, comprising the stomach and intestine. It may be further divided into the *clitellar* and *post-clitellar* subregions. The first embraces somites X to XIII, and includes the terminal organs of the reproductive system as well as the single pair of ovaries, the clitellum, and various accessory organs, probably related to copulation, such as copulatory glands, copulatory areas and conducting tissue, and copulatory pits. The gastric cæca of this region are usually small and irregular. The post-clitellar region is pre-eminently the digestive region, in which the gastric cæca are highly developed and when filled displace the other organs and distend the body to many times its normal size. Except that the first pair may lie partly or wholly within somite XIII and in many Erpobdellidæ all are scattered, the testes are placed intersegmentally in the muscular septa throughout most of this region, which also accommodates their ducts and in some cases other parts of the reproductive organs.

The *anal region* is a short transitional section of three incomplete somites with distinct but approximated ganglia, and contains the rectum and anus but no nephridia. Its chief function is to serve as the peduncle of the sucker, which exclusively constitutes the last or *caudal region*.

When complete and well-developed the *clitellum* usually extends, as a more or less continuous, thick layer of unicellular hypodermal glands, over three full somites or fifteen annuli, beginning with the fourth annulus (*b* 5) of somite X and ending with the third (*a* 2) of somite XIII. In some cases it extends beyond these limits, partially involving one or both of the contiguous annuli anterior and posterior, increasing the number to sixteen or seventeen. More frequently its extent is reduced, and sometimes the glandular areas are restricted to the ventral surface, or even to areas adjacent to the gonopores. While the clitellar region usually differs in colour and texture and is somewhat swollen and smoother than the neighbouring segments, the glandular coat seldom obscures the annulation.

The *gonopores* or external genital orifices are invariably median, the male in advance of the female. With few exceptions they open within the limits of somites XI and XII respectively, but rarely both may lie within XII, as is frequent with the Erpobdellidæ, or the male pore may be shifted into X and the female into XIII. In the Erpobdellidæ the orifices are usually separated by from two to four annuli, but may be further apart. In the Hirudidæ

by far the greater number of species have five full annuli intervening, but the number may be as few as two and one-half or as many as thirteen. Most frequently the gonopores open in the furrows, but may be situated within the annuli. The male gonopore is rounded or in the form of a transverse slit with more or less swollen, furrowed lips, upon which glands may open. It may lie within a disk or a more or less prominent papilla, or rarely in a depression or even in a pit. In the Hirudidæ a filiform penis may protrude. The female gonopore is usually smaller and a simple round orifice, flush with the surface, but may be slit-like and either elevated or depressed. Accessory copulatory organs take the form of special adhesive glands opening by pores or pits disposed in considerable variety on the ventral surface of the clitellar region and in some cases forming rather complex reciprocal systems. The only known Indian Arhynchobdellid leech possessing such structures is *Barbronia weberi*.

The *nephropores* or external openings of the nephridia are very constantly seventeen (they may be sixteen or nineteen) pairs opening on the caudal border or within the following furrow of the second annulus (*b* 2) of somites VIII to XXIV inclusive. In the true land-leeches (*Hæmadipsinæ*) they lie close to the lateral margins, while in all other Arhynchobdellæ they are nearly in the line of the ventral intermediate sensillæ. In the land-leeches also, the ducts of the first pair may be carried forward into the head to open at the base of the buccal lobes, and the last pair open either on the ventral face of the anterior lobe of the auricle, which is borne on XXIV *a* 2, or more rarely by a ventral median pore common to both nephridia.

The typical *complete somite* characteristic of nearly all members of the Arhynchobdellæ is five-ringed. This is especially true of the aquatic Hirudidæ, but the land-leeches include genera having from three to seven annuli in the complete somite. With rare exceptions these annuli are of approximately equal length. In the Erpobdellidæ, on the other hand, elaboration, especially of the post-sensory region, leads to the frequent development of six, seven, eight or nine annuli, often of very unequal length. In the higher multiples, annuli of every order from the first to the fourth may be present together. In such cases the sensory annulus may remain undivided and the post-sensory include as many as three tertiary and two quaternary annuli. Towards the ends of the body every stage from the uniaunulate to the complete somite will be found. Additional details are given in the section relating to annulation, which applies to the Hirudinea as a whole.

While the *integument* of many leeches is smooth, others have it marked out into subquadrate or polygonal areas by numerous short wrinkles passing between the true interannular furrows. These are more or less clearly related to the distribution of the non-metameric sense-organs and papillæ. As a rule each area includes either a single sense-organ or a group consisting of a larger or more prominent central sense-organ with smaller ones

clustered about it. Frequently they are elevated on papillæ, in which case the integuments may be rough and harsh, on preserved specimens at least.

In this suborder cutaneous papillæ, while sometimes well developed, never reach the large size which they attain in many Rhynchobdellæ. These sense-organs are partly tactile, partly responsive to chemicals and partly light-perceiving. They occur on every annulus, both dorsally and ventrally, and are usually arranged in an irregular line across the middle of the annulus or in two or three such lines, indicating the composite morphological value of the annulus.

The segmental sense-organs or *sensillæ* are of great interest, partly because of their value as indicators of metamerism and somite limits, partly because of their high degree of development and partly because of their modification into true eyes at the cephalic end. The *sensillæ* are confined to the sensory annuli, and their presence makes it possible to distinguish these annuli throughout the length of the body. Typically there are four dorsal pairs, named from the meson laterad: paramedian, intermediate, supra-marginal and marginal, and three ventral pairs, similarly named paramedian, intermediate and submarginal. The ventral paramedians are much more widely separated than the dorsal paramedians*. Homologous *sensillæ* form metameric series along a line bearing the same name.

These lines separate longitudinal areas or *fields* which are named after the line bounding them medially. Adding median fields, we have dorsal median, paramedian, intermediate, supra-marginal, submarginal, ventral intermediate, ventral paramedian and ventral median fields. For brevity these are sometimes designated as A to H respectively, though these symbols have been employed but little in the present paper. The use of this terminology in conjunction with the notation of the annuli makes it possible to describe exactly the position of a colour-marking, sense-organ or other surface structure, and to indicate the relative distances apart in fractions of the total circumference of each two *sensillæ*, the number of longitudinal muscle bands or the number of surface areas or cutaneous papillæ in the width of each field, and other characters of diagnostic value.

Not infrequently particular *sensillæ* are divided into two or three small ones, or one may be absent or in a changed position, but such cases are obviously individual variations. More confusing is the fact that all *sensillæ* may be retracted and nearly or quite invisible on one specimen, and on another of the same species raised prominently on papillæ. On living leeches they usually appear as small round, white or diaphanous spots, especially conspicuous if on a dark background. Those on the dorsal side are larger than the ventral, and they are especially large and

* Somewhat different terminologies have been employed by Whitman, Apatky, Livanow, *et al.* Consult Harding, Rhynchobdellæ, p. 16.

prominent in the land-leeches and the *Hirudinaria* group, and in the latter are elliptical in form. In the Erpobdellidæ metameric sensillæ cannot ordinarily be distinguished from the non-metameric sense-organs that occur on every annulus. In structure the sensillæ are aggregations of columnar cells bearing sensory hairs and often including a few visual cells. They are much simpler than the eyes and larger than the scattered non-metameric sense-organs.

In the Arhynchobdellæ, true eyes are confined to the cephalic end. They are glorified sensillæ, of especially large size in the land-leeches, and consist of a colourless transparent epithelial lens, a nerve-axis and optic ganglion surrounded by a tubular sheath of visual cells each containing a vitreous body, and, enclosing the whole, a dense pigment-cup. They are directed at various angles with the body axis—forward, sideways and backward—to receive beams of light along their visual axes. In the Hirudidæ there are almost invariably five pairs forming a regular arch on somites II to VI, suggesting the name of ten-eyed leeches, but some of the burrowing forms present variations of this plan. Anterior sensillæ may be transitional and include visual cells and pigment. The first pair of eyes of most Hirudidæ belongs to the paramedian, the others to the intermediate series. The Erpobdellidæ are more variable. They may lack eyes altogether, but most species possess three or four pairs in two groups, one on the dorsum of the lip, and the other on the sides of the buccal region. Two Indian species have additional eyes in the sub-marginal series of the posterior cephalic and the preclitellar regions, and other peculiar arrangements occur in certain South American burrowing forms. The eyes are not truly visual organs, as they probably form no images but are phototactic or light-perceiving organs.

Internal Anatomy (fig. 38, p. 98).—Unlike most of the Oligochæta and Polychæta, in which the body-cavity is spacious and regularly divided by septa, the *cælome* of leeches and especially of the Arhynchobdellæ is largely obliterated and reduced to a complex system of spaces surrounding the principal organs and of sinuses or lacunæ forming part or, according to some zoologists, all of the vascular system. This is due mainly to the great development of muscular, botryoidal and parenchymatous connective tissues. Both the septa and the body-walls become thereby greatly thickened and the body practically solid. The botryoidal tissue is a peculiar vasculated and pigmented tissue the exact relation of which to the organs of excretion and circulation is still controversial. The *musculature* is complex, consisting of a thin layer of oblique fibres running both ways at an angle of nearly forty-five degrees to the body axis, a thicker layer of circular fibres and a much thicker layer of longitudinal fibres. In addition there are longitudinal and transverse sheets and strands of vertical muscles. All of these become modified and further complicated at the ends of the body, especially in the suckers.

The *digestive tract* is divided into an oral chamber, buccal sinus, pharynx, œsophagus, stomach, intestine, rectum and anus.

The *oral chamber* or vestibule is the cavity of the cephalic sucker, bounded above by the over-arching lip and enclosed behind by the buccal ring. The margin of the lip is richly provided with so-called goblet-shaped organs, generally considered to have a gustatory or chemotactic function, and with tactile sense-organs. As a whole the cephalic sucker is an organ of attachment and ingestion, as has been described already. In the Erpobdellidæ, which swallow worms and insect larvæ entire, it is not delimited from the large mouth, which opens through a scarcely noticeable buccal sinus directly into the pharynx. A very similar condition exists in many of the predaceous Hirudidæ, but with the buccal sinus better developed. In such forms the name upper or pro-stomial lip applied to the free, prehensile portion of the sucker is appropriate. In the true sanguivorous Hirudidæ the oral chamber is separated from the buccal sinus by a transverse muscular fold or velum, in the centre of which is the relatively small, but expansive, trifold or triangular mouth, the median dorsal angle of which is often continued into a posterior median fissure on the roof of the oral chamber.

Immediately posterior to the velum is the annular *buccal sinus*, in which the pharynx ends, and the jaws, when present, lie. In the latter case there are three deeper crypts which accommodate the jaws and conceal them when at rest. When the jaws are functioning they are protruded prominently into the oral chamber, the mouth being stretched and the velum retracted to three triangular lobes, to permit their passage. One of the most distinctive characteristics of the suborder, upon which both of its names are based, is found in the structure of this region, the presence of jaws suggesting one and the restricted size of the buccal sinus, precluding the development of a proboscis, the other. In the Archynchobdellæ the buccal sinus is limited to this shallow space, into which the extreme anterior end of the pharynx, including the jaws, projects. The pharynx is therefore fixed and immovable, or relatively so. In the Rhynchobdellæ, on the contrary, the sinus is continued caudad, completely surrounding the pharynx for its entire length and forming an extensive peripharyngeal chamber in which the pharynx moves freely as an extensile and protrusible, muscular proboscis.

Definite *jaws* are absent in the Erpobdellidæ, but a few genera (*Barbronia*, *Odontobdella*) possess vestigial jaws bearing solitary styliform teeth. The *pseudognatha*, present in most members of the family and especially large in *Trocheta* and related genera, are small epithelial and muscular remnants of the velum. In the Hirudidæ also the jaws may be obsolete or obsolescent, but more usually occur as definite compressed muscular lobes terminating the three principal pharyngeal folds (dorsal and ventro-lateral). In their highest development (*Hirudo*) they become prominent projecting ridges with a semicircular profile and are largely

Page 105, *for hæmolysin read* anti-thrombin.

detached from and independent of the pharyngeal folds. Rarely the median dorsal jaw disappears, leaving the ventral pair only (*Moquinea*). The jaws may be entirely smooth and edentulous, provided with a few irregular chitinous plates, or bear true chitinous or partly calcified *teeth* (denticles). The teeth may form a single series (*monostichodont*) along the summit of a compressed ridge, or a double series (*distichodont*) the points of which meet at the ridge. Occasionally they are partly monostichodont and partly distichodont, indicating that the latter type of tooth is derived from the former by the separation of their bilobed bases. Usually, the salivary glands open on the ridge between the teeth, but in *Limnatis*, *Hirudinaria* and related genera they open on little button-shaped papillæ scattered over the flanks of the jaws. The jaws are built up of radial and transverse muscles which alter their shape, and are provided with central rotator (adductor) and peripheral rotator (abductor) muscles. In action they are pressed firmly against the skin of the animal attacked, and operate something in the manner of a circular saw. They rotate back and forth from and toward a centre, cutting a delicate trifid incision from which the blood flows freely when the flaps are lifted by suction. The saliva, which is poured into the wound and mixes freely with the blood, contains a hæmolysin (hirudin), which prevents coagulation and facilitates the blood-flow. This agent is extracted from the salivary glands and employed in surgery and, especially during the World War, when the supply of European leeches was cut off the leeches of India were a source of supply.

The *pharynx* (fig. 38, *ph.*) is essentially a muscular organ. In the Erpobdellidæ it is elongated and tubular, reaching to somite X or even to XIII in the genital region. It is triangular in cross-section, owing to the arrangement of the bundles of longitudinal muscles, except at the anterior end, usually in a ventral and a pair of dorsal, or less commonly a dorsal and pair of ventral, ridges, surrounded by a thick layer of circular muscles. The walls of the pharynx are practically continuous with the thick musculature of the body-walls, so that the whole forms a powerful crushing apparatus that is no doubt effective in preparing for digestion the small invertebrate animals that these leeches swallow whole. In the true sanguivorous leeches (monostichodont Hirudidæ) the pharynx is short and bulbous, usually confined to VII and VIII, and characterized by the great development of radial muscles connecting it with the body-wall. It is due largely to these divaricator muscles that its function as a suction bulb depends. The predaceous distichodont Hirudidæ present an intermediate condition, the pharynx being more elongated and extending to X, but somewhat bulbous. The radiating muscles are well developed and the mucous lining is thrown into six, nine or twelve longitudinal folds and at the caudal end, at the junction with the œsophagus, into a circular valve-like fold. The principal longitudinal folds are dorsal and ventro-lateral, and terminate in the jaws, when present. They may be flanked on each side

by smaller folds, making three sets of three, and alternating with these there may be three simple folds, or twelve in all. The salivary glands are bundles of unicellular glands, often of considerable size, lying at the sides of the pharynx, along which their ducts proceed to empty on the jaws as described above.

No definite *œsophagus* exists in most of the Arhynchobdellæ, but merely a short, narrow, anterior section of the stomach preceding the cæca. The *stomach* (*gg*), often called the *crop*, on the other hand, is by far the most extensive and important region of the digestive tract, and in its varied development offers valuable taxonomic characters. It reaches from the pharynx in IX or X to XIX inclusive. In the Erpobdellidæ the stomach is a straight, thin-walled tube with inter-metameric constrictions and annular valves dividing it into a series of simple chambers without cæca. Rarely a pair (or a single one) of small, simple cæca arises from the last chamber in XIX, but usually there is no trace even of these. In the distichodont Hirudidæ the stomach differs little from that of the Erpobdellidæ, except that the chambers are often more expanded, or even somewhat pouched, and the terminal cæca arising in XIX are always developed and extend caudad beside the intestine through several segments. The stomach attains its greatest development in the blood-sucking Hirudidæ. In these it serves chiefly to store the ingested blood, whence its designation as crop. It reaches from somite IX or X to XIX inclusive, and consists of a metameric series of axial chambers separated by inter-segmental constrictions and bearing pairs of lateral cæca. These cæca (*c.* 1-10) begin in X, and the pregenital pairs are usually small and irregular, the post-genital fully developed. Each chamber may bear a single pair, usually followed by a short pouch, or there may be two pairs of cæca, in which case the anterior is generally the larger, though they may be nearly or quite equal. They may be simple, slightly lobed or complexly branched, and the larger cæca may reach caudad into the next segment. The last pair, arising in XIX, resembles those of the predaceous Hirudidæ in being reflexed, but they are more extensively developed, reaching into XXIII, XXIV or even farther, and they are simple, lobed or branched according to the plan of the preceding cæca. The whole forms a spacious system for storing blood, thin-walled and capable of great distension. Many leeches will ingest at a single meal several times their weight of blood. After feeding they seek concealment in the dark, and remain quiet for from one to six months during the slow process of digestion. Indeed, leeches will live for upwards of a year without feeding.

The *intestine* (*i.*) is not always clearly differentiated from the rectum. It is a short, straight tube without cæca, such as occur in the Rhynchobdellæ, extending through the four somites XX to XXIII inclusive. In the Erpobdellidæ, while perfectly simple, it usually has a greater diameter than the stomach. In the predaceous Hirudidæ it is more or less sacculated or chambered, the first chamber being especially distinct both in form and

structure. The sanguivorous Hirudidæ have this first chamber clearly differentiated as a blood-digesting organ, which many zoologists designate the stomach, and which is probably functionally such. The rectum is a simple tube ending at the anus.

The *reproductive organs* are most important for taxonomic purposes. All leeches, so far as known, are hermaphroditic, and insemination may be reciprocal.

The male organs are most extensive, the terminal organs lying anterior, the testes posterior, to the female organs. Except for the minute subdivision of the testes, the simplest condition is found in the Erpobdellidæ, which closely resemble the Glossiphonidæ. In the arrangement of the *testes* the genera fall into two groups. In one they are disposed as in other leeches in regular intersegmental pairs, usually twelve in number, from XIII/XIV to XXIV/XXV inclusive, each connected by a short duct with a slender common *vas deferens* lying ventro-laterad of them. In the other group the testes are minutely subdivided into numerous (as many as sixty on each side of a somite) small ovoid bodies filling a large part of the entire length of somites XVIII (rarely XIV) to XXIV laterad of the digestive tract and surrounding the central stem of the *vas deferens* like an elongated bunch of grapes. So far as known, all Indian species belong to the latter group. At the anterior end of XVII (rarely XVIII) the *vas deferens* becomes abruptly enlarged to form a rather massive *epididymis* or *sperm-vesicle*. This portion of the *vas* is arranged in a great many close, transverse folds, and gradually diminishes in diameter to about somite XIV, where, with greatly lessened size, though still much larger than the *vas deferens* proper, and a less closely-folded course, it becomes the long *ductus ejaculatorius*, which finally empties into the atrium at the tip of the prostate or atrial cornu of the same side. Those genera in which the regularly-paired testes occur in somites XIV to XVII lack this form of sperm-vesicle, but instead the enlarged *vas deferens* is thrown back as a pair of long loops reaching beneath the stomach, even as far as somite XX, as in many Glossiphonidæ.

The *atrium*, or terminal male organ, is much simpler than in the Hirudidæ, resembling the condition found in the Glossiphonidæ in that the median unpaired penial portion is represented only by a small, eversible, genital bursa provided with a powerful sphincter muscle. This opens to the exterior, and by a smaller orifice above into the more dorsal, unpaired prostate chamber, which bifurcates as a prominent pair of atrial or *prostate cornua*. The ends of the latter receive the ducti ejaculatorii as described above. The prostate chamber with its cornua is richly provided with a layer of glands which secrete the chitinoid walls of the spermatophores. For the reason that it forms the spermatophores, the entire prostate region has been named the *spermatophore sac*. The *spermatophores* consist of an attaching disk formed in the unpaired chamber and of a pair of divergent or adherent, elongated, tapering sacs formed within the horns and containing

the bundles of spermatozoa. In functioning, the bursa alone may be everted as a penial disk with a single central opening, or the floor of the prostate chamber as well may be everted, forming a second or inner tier or platform of the disk in which appear the paired openings of the two cornua. This latter happens when the spermatophores are attached. During copulation there is frequently a mutual exchange of spermatophores, which are not attached at random to any part of the body, as in many Glossiphonidæ, but are usually placed on the clitellar region, which is often provided with a special copulatory area of so-called conducting tissue for directing the spermatozoa hypodermally to the ovarian sacs.

In the Hirudidæ the *testes* (fig. 38, t. 1-11) are most commonly nine or ten pairs, but more rarely from six to twelve pairs, disposed as in the first division of the Erpobdellidæ, beginning at XIII/XIV. These testes, like the ovaries, are really small cœlomic sacs enclosing the gonads and embedded in the thickened intersegmental septa close to the body-floor. Often they lie chiefly or wholly within the preceding somites, to which they probably belong. The *vas deferens* (*v.d.*) is covered throughout the testicular region with a thick lobulated layer of glands which disappear in somite XII or XIII, anterior to which the duct continues in a nearly direct course to the level of the atrium, where it bends sharply caudad to become a tortuously-coiled and folded, enlarged tube forming the compact massive *epididymis* or *sperm-vesicle* (*ep.*). The duct again leaves this mass, bends forward and mediad and acquires a thick muscular coat as the *ductus ejaculatorius* (*d.e.*), which in turn empties into the prostate cornua. Both epididymis and ejaculatory duct vary considerably in size, form and position, the latter being either a simple tube, or differentiated into an enlarged fusiform region with very thick muscular walls and a narrow duct-like portion. The former appears to serve both as a sperm-vesicle and a powerful sperm-ejector. There is a direct correlation between its size and the length of the penis-sac and penis. It is absent in such forms as *Cardea* and *Diplobdella*, which have no true penis, small in *Macrobdella*, well developed in *Hirudo* and related genera, and of maximum size in *Hæmopsis*, etc. The true *prostate cornua* rarely appear as distinct regions in the Hirudidæ, being involved in the wall of the prostate region of the atrium and buried beneath the glandular layer. They form small sperm-reservoirs which finally open into the prostate chamber.

Most characteristic of the male reproductive organs and exhibiting the greatest variety is the *atrium* (*at.*). Rarely it is developed little beyond the condition characteristic of the Erpobdellidæ, but typically it is a more or less prominent, pyriform structure consisting of an enlarged head, the *prostate region* (*p.r.*), and a narrower, conical or cylindrical body, the *penis-sac* (*p.s.*). The former encloses the prostate cornua and consists of epithelial lining, muscular coat and a thick layer of prostate glands dis-

charging into the more or less distinct median prostate chamber. The penis-sac is the greatly developed muscular region of the male genital bursa, forming a highly muscular tube, often greatly elongated. Within this is a coiled or filamentous tubular penis which reaches a great length and somewhat complicated structure in *Hæmopsis* and its allies. The penis is not a true introvert, but consists of a lining epithelium and a thin enveloping layer of muscle and connective tissue which are separated by a surrounding space from the outer thick wall or *penis-sheath*. Within this space the penis grows to a length double or more that of its sheath. The terminal part is capable of being everted through itself. Consequently, when protruded it is a double-walled tube covered within and without by epithelium. In some genera it bears upon the external face of its terminal portion many tactile papillæ. The Hirudidæ do not form spermatophores for external implantation, but practise a true copulation, during which the penis (often reciprocally) enters the vagina and deposits the sperm in its upper part.

Female reproductive organs are developed harmoniously with the male organs. In the Erpobdellidæ they consist of a pair of more or less elongated tubular sacs, each doubled on itself and extending from the female gonopore, within the ventral cœlomic space beneath the digestive tract, caudad for several somites. The greater part of this is a cœlomic sac (*ovisac*) enclosing the ovary and its developing products. The true *ovary* with the proliferating germinal epithelium occupies the narrow blind end of the organ close to the female gonopore and a portion of the recurrent limb of the ovisac, most of which, together with the entire procurrent limb, is filled with the developing egg-strings. The anterior end of the procurrent limb passes into a short transverse limb containing mature ova and known as the *uterus*, which connects by means of a very short narrow oviduct on each side with the inner end of the very small unpaired vagina or genital bursa lying entirely within the ventral body-wall. In other cases the tubular sac may be but little or not at all reflexed, the ovary being confined to the caudal end and the oviduct much elongated. Still more rarely the ovisacs are spheroid with small simple oviducts meeting at the minute bursa.

A few Hirudidæ possess female genitalia of the second type, *Cardea*, for example. This genus is quite unique in the addition to the ovaries and oviducts of a capacious female bursa anterior to the male atrium, with which it opens in common. A pair of slender ducts connect the oviducts with it. But in general the Hirudidæ possess female genitalia (fig. 38) of the same degree of complexity as the male organs. There is a single pair of rather small globular *ovisacs* (o.) situated anterior to the female gonopore at about XII/XIII, in a position corresponding to the testes. From these arise short *oviducts*, often provided with a slight enlargement, sometimes named the uterus, but preferably the *ovarian vesicle*. One oviduct passes beneath the nerve-cord and

unites with its fellow into a common oviduct (*od.*), which varies much in length and course, but finally empties into the vagina, usually at the internal blind end, but in certain genera at various points along its length. The oviduct is more or less embedded in a thick layer of *albumin glands* (*glandula albuminigenia*) (*g.a.*), which may be limited to the region of union of the paired oviducts or cover part or all of its length. When fully developed the *vagina* is frequently very large and spheroidal, pyriform, fusiform or tubular. Usually it is divisible into an enlarged saccular part and a narrow duct leading to the external orifice. At the point of entrance of the oviduct there is in some cases a small vaginal diverticulum. This may become greatly enlarged to form a distinct *vaginal cæcum* as in *Pæcilobdella*. The oviduct may also open at the point of union of the vaginal duct (*va.d.*) and cæcum (*v.c.*) as in *Pæcilobdella*, or along with the former into the external bursa as in *Hirudinaria*. There are many variations, some of which will be indicated in the generic diagnoses.

In the foregoing account no attempt has been made to deal with the entire anatomy of the Arhynchobdellæ. Those organs and structures only which are of primary interest to the systematist have been described. Other organs, such as the nervous system (*n.*), nephridia (*np.* 9, 17), blood-vessels and muscles have taxonomic value, but have been employed but little by systematists.

Coloration.—Four principle types of colour-pattern occur in Arhynchobdellid leeches: (1) uniform or self-coloured, (2) mottled or irregularly spotted, (3) longitudinally striped or metamericly spotted, and (4) transversely striped or spotted. Other patterns found in the Rhynchobdellæ are nearly or quite absent from this suborder.

Strictly self-coloured leeches are rare. Those appearing so in life are usually found upon close examination to be more or less mottled. When uniform shades do occur, the venter is usually paler, or differs otherwise in colour from the dorsum, and the two areas are separated by marginal stripes, often yellow or orange in colour. A median dorsal stripe, either continuous or broken, appears more rarely.

The non-metameric mottled pattern is common, and is due to the distribution of individual pigment-bearing excretophores widely and superficially in the integuments external to the principal muscle-layers; but pigment is not restricted to these superficial deposits. The colour of the spots appears darker when nearer the surface, lighter when deeper. In the strictly mottled pattern the spots may be so numerous and confluent that the effect is very dark and nearly uniform; or they may be widely scattered. The spots may be punctiform or large, sprawly blotches, or composed of quadrate areas largely conforming to the boundaries of the annuli.

The third type is by far the most prevalent, and may be strictly striped or combined with either of the other patterns. The

longitudinal stripes are determined by the arrangement of the longitudinal muscle-layer in bands or fascicles, between which the excretophores congregate. In some cases they collect in all of the intermuscular spaces, effecting a finely-lined pattern. More frequently they form heavier masses along the two or three pairs of broader intervals through which the dorsal-ventral muscle-sheets penetrate the longitudinal muscle-layer. This results in a corresponding number of dark stripes, the longitudinal muscles between appearing lighter. The median field may be pale or frequently the seat of a special dark stripe along the line of the dorsal blood-vessel. The longitudinal dark stripes are frequently composite, constituted of two or more narrower stripes which may approach and completely coalesce or separate or recede to greater depths or become more superficial, with the migrations, extensions or contractions of the excretophores. Frequently the darker stripes flank the series of sensillæ, and are modified by their presence. Usually this takes the form of constrictions or interruptions, breaking them into short lines, dashes or spots, occupying particular annuli and hence arranged metamerically. There are many other modifications. Other metameric spots, particularly the cream-coloured or pale yellow spots which so frequently include the sensillæ, are quite independent of the excretophore pattern and are due to aggregations of reserve cells.

The transversely-banded or spotted pattern, so common in the Ichthyobdellidæ, is rare in the Arhynchobdellæ, especially in the family Hirudidæ. When present in the latter it is most frequently expressed by the suppression of pigment and the extension of the pale spots on the sensory annuli. The same pattern may occur in the Erpobdellidæ, in which also every annulus may bear a heavy, transverse, solid band or a row of irregular spots enclosing the small sensory papillæ. The above account deals principally with the fixed pigments remaining in preserved specimens.

During life many species of leeches are brilliantly coloured in strikingly contrasting patterns, especially vivid in the water; but after death they rapidly fade. The greens, and the red due to hæmaglobin in the blood, rapidly dissolve out in the killing and preserving fluids, and are usually completely lost; the pale yellows also fade. But the darker yellow, red, brown and black pigments belonging to the melanin series resist the action of alcohol or formalin, and unless the leeches have been fixed in strongly acid reagents or exposed to the light, these pigments fade very slowly, and the patterns may be discernible after many years of preservation. The greens are commonly distributed uniformly superimposed upon the patterns, which gives the effect of alternate light and dark green stripes etc.

Geographical Distribution.—We can only speculate on the origin of the leeches. There is no palæontological evidence of value. The taxonomic, anatomical, embryological and physiological evidences point to their derivation from the Oligochæta in an area

of freshwater swamps and lakes supporting a rich fauna of amphibious and aquatic invertebrates and lower vertebrates to serve as food and hosts. We can scarcely more than guess at the location of this area, but a slight preponderance of evidence points to the central Palearctic Realm. However that may be, all of the four principal families now generally recognized have a practically world-wide distribution, being well represented in all of the zoogeographic realms. The continental forms are limited in their distribution both vertically and latitudinally by the line of permanent ice and snow. While the exact limits of their range have been fixed at but few points, enough is known to show that freshwater and swamp leeches are abundant in Alaska, Scandinavia and Siberia north of 60° and at the southernmost points of the South American, African and Australian continents. They cease to be definite elements of the fauna of the Frigid Zones. Vertically their known range is from sea-level in all regions to about 12,000 ft. in the Andes and about 10,500 ft. in the Himalayas. Like other animals similar physiologically, they cannot exist where the water upon which they are so dependent is frozen throughout the year. Their activities practically cease at a temperature below 40° F. It is noteworthy that the species reaching the altitudinal limits are chiefly the smaller Rhynchobdellæ, while the true blood-sucking Hirudidæ reach their full development in the warmer tropical and sub-tropical regions, where the warm-blooded mammals which they attack more habitually seek the cooling waters or the shade of the humid forests and jungles.

True marine leeches belong exclusively, with one possible exception, to the family Ichthyobdellidæ, and these transcend the limits imposed on continental leeches, for they are carried by their piscine hosts far into the Arctic and Antarctic areas and to considerable depths, the lower limit of which is unknown. No Arhynchobdellid is known to be marine or to inhabit even definitely salt water, though a few may live in water very slightly brackish. Some of the true scavenger species will collect in badly-polluted water for the sake of the food contained therein.

Notwithstanding that the collections of the Indian Museum, thanks to the energetic interest of the late Dr. Annandale and several of his excellent collectors, are rich in leeches, there are still many gaps in our knowledge of their distribution throughout the large territory covered by this report. This is true especially of the less conspicuous non-blood-sucking forms, which are readily overlooked. One of the principal uses of this work will be in indicating under each species the known distribution and the areas from which further collections are desired.

In a group so small as the Hirudinea, faunal generalizations are safe only when knowledge of distribution is very exact, for the limited number of species greatly increases the probable error based upon incomplete knowledge.

There are, however, a few rather definitely outstanding features of the Indian leech fauna. Kashmir, lying north of the main

axis of the Himalayas, is cut off from the remainder of India by high snow-clad peaks which form a barrier to the spread of leeches, except such forms as may be carried in the pharynges of the larger mammals. The Indus River, which might be expected to provide a migration route from the south to the Kashmir Valley, is itself largely isolated from Hindustan by the Indian Desert, which also is a barrier to the free passage of leeches. As a consequence, what little is known of the leech fauna of Kashmir points to closer affinities with the Eur-Asiatic fauna than with that of Hindustan.

The extreme north-western provinces along the Persian and Afghanistan boundary are separated from India proper by the Indian Desert, a dry region not known to be inhabited by any leeches, though one or two species may live in the springs and wells. While very little is known of the leeches of this region, two species belonging to the circum-Mediterranean fauna have been reported.

The remainder of India, including Ceylon and Burma, belongs definitely to the Indo-Malayan region with some African affinities. Ceylon and the southern portion of the peninsula approach the Malayan and Philippine Archipelagoes rather more closely, and the northern Himalayan region, in addition to the peculiarly rich fauna of true land-leeches, as will be pointed out in greater detail under the genus *Hæmadipsa*, shows some Chinese intrusions.

In addition to the abundance of true land-leeches, the Arhynchobdellan fauna of India exhibits two other peculiarities. First is the prevalence of vicious blood-suckers of the *Pacilobdella-Hirudinaria* group, which come much nearer to representing the aquatic stock from which the land-leeches arose than does *Hirudo*. The second is the presence of two strikingly characteristic genera of Erpobdellidæ described by Kaburaki and not known at present to occur elsewhere though related genera occur in Africa. Both of these are distinguished by the possession of several pairs of supplementary submarginal eyes. Our knowledge of the members of this family is especially deficient. Most of the species are rather small and their habits such that they readily escape attention.

The extensive areas of swamps, together with the cultivation of rice, the use of domestic animals that enter water, the habit of the natives of going bare-footed, and in most parts of the country the twelve months of growing weather, make India most favourable for the development of leeches. They are probably more abundant in the Indo-Malayan Region than elsewhere in the world, with the possible exception of tropical South America.

Economic Relations.—As referred to above, the great abundance and wide prevalence in India of both aquatic and terrestrial leeches, together with their close association with human habitations, gives to them unusual human importance. Nevertheless, extremely little definite information relating to this aspect of the subject is available from Indian sources. A most useful con-

tribution by a person favourably situated on the ground would be the collection of economic data and statistics. Some specific data are given under particular species.

The relation of leeches to human interests may be considered under five heads :—(1) as food for other animals, (2) as enemies that attack other animals of concern to Man, (3) as pests that annoy or injure Man, (4) as transmitters of human or animal diseases, (5) as surgical agents.

(1) Concerning North American and European species, much information exists relating to a great variety of animals that prey upon leeches and their egg-cases. Certain fishes, ducks, snipe, plover and other birds, as well as some of the small mammals, derive a considerable portion of their sustenance therefrom. The great abundance of leeches in India leads to the inference that there also similar animals similarly utilize them. With the single exception of Miss Robertson's statement that the "milk" turtle eagerly devours *Pecilobdella granulosa* (= *Hirudinaria manillensis*), I have been unable to find any confirmatory records, though it is possible that Indian naturalists and sportsmen may be familiar with many instances.

(2) Predaceous leeches destroy large numbers of worms, including other leeches, insect larvæ, mollusks, and other invertebrates, some of which affect human interests. A few records in the literature (*e.g.* Tennent, 1860) and some personal observations of stomach contents establish this fact for Indian species. Blood-sucking and parasitic species attack a great variety of vertebrates: fishes, frogs, toads, turtles, crocodiles, snakes, birds and mammals. Small and weak fishes, frogs and turtles are known to be killed outright or greatly injured by them, and the attacking numbers are sometimes so great that even vigorous hosts must lose in vitality. In America the economic drain on the fisheries from this source is quite appreciable, though not accurately computable, and doubtless the same holds true for India. Indian land-leeches sometimes attack snakes (Wall, 1914), and as a favourite point of attachment is the eye, as a result of which the victim may be blinded, it is possible that they may prove to be a factor in the control of venomous as well as of harmless snakes. They may also exert a repressive influence on the rodent population, thus diminishing the supply of these enemies of agriculture and the natural food of many serpents. It is, however, difficult to ascertain the actual facts of such relations. The attacks of land-leeches upon horses and other draft animals are well known and authenticated by the accounts of travellers and the narratives of scientific, military and other expeditions into their haunts. These animals are often driven wild by them and become intractable. Horses, cattle and dogs are sometimes blinded, and young or decrepit animals are killed by their attacks. The large aquatic medicinal leeches which so abound in the paddy-fields and tanks in the agricultural districts throughout a large part of India are a source of great annoyance and probably of some injury, especially

to buffaloes, which feed in swampy places and wade and wallow in the ponds where these leeches are especially abundant. Whether this species actually enters the nares of drinking cattle is not yet definitely settled, but this annoying habit is very characteristic of another and even larger species, the so-called cattle leech (*Dinobdella ferox*). While it has proved impossible to secure complete and accurate statistics covering the prevalence and the extent of the damage done by this species, it is obvious that it is widespread geographically, and in some districts, especially in the Punjab and Manipur, so abundant that a very large percentage of the cattle are infested. There is much evidence of the seriousness of its effects upon its hosts, which sometimes die as a result of the continuing hæmorrhage.

(3) There is general agreement that of all of the annoying pests of India and Ceylon the land-leeches are the worst. Few travellers, sportsmen or missionaries, whose quests have carried them into the humid valleys and jungles, have failed to bring back tales of bloody encounters with them. Some regions are reputed to be rendered uninhabitable for either man or beast because of their abundance and ferocity. Stories are told, and some of them at least appear to be well-authenticated, of persons lost or injured in the jungles who were killed outright by the loss of blood or badly crippled through the attacks of myriads of these little leeches. While the bite of the common land-leeches is nearly or quite painless, that of others, especially of those inhabiting the lower slopes of the Himalayas, of Sikkim and the hills of Assam, is reputed to be very painful. Whether as a result of accidental infection or as a direct effect of the bites, stubborn sores and ulcers often follow their attacks, and may lead to permanent crippling.

As the cattle leeches take up their abode in the pharynx and larynx of domestic animals, so do certain other leeches attack Man. This is especially true of *Limnatis nilotica*, which enters the Indian fauna from the Persian border, and may have a wider range than the actual records indicate. The related *Hirudinaria (Pæcilobdella) granulosa* is reputed and the land-leeches are known to indulge occasionally in the same habit.

(4) While no Arhynochbdellid leech of India has been definitely connected with the transmission of any disease of Man or the domestic animals, there is much reason to hold them under suspicion. Rhynochbdellid leeches are well known to play the role of intermediate host to certain metazoan parasites and to act as carriers of protozoan blood parasites of invertebrates and lower vertebrates. Miss Robertson (1909) has established *Glossiphonia* as the vector of the *Trypanosoma* of the milk turtle in Ceylon, and has shown that the common medicinal leech of that island will harbour and possibly transmit these same parasites. To the common paddy-field leech, *Hirudinaria manillensis* of the Philippines, has been attributed the role of carrier of the pathogenic organism of rinderpest (Boynton, 1913). This same species is the

common aquatic leech of Ceylon, and occurs to some degree throughout the lowlands of India. Also it is closely related and similar in habits to the very abundant and widely-distributed *Pœcilobdella granulosa*. Therefore suspicion should be cast upon these and related species as possible agents in the spread of that most injurious of all cattle diseases of India. The land-leeches of Java (Prowazek, 1904) are reputed to transmit the flagellate (*Herpetomonas*) causing gangrenous ulcer. As similar ulcers are reported to have followed the bites of land-leeches in Ceylon and India, it is probable that a similar relation exists here also. The habit of sanguivorous leeches of congregating about inflamed sores or wounds and abrasions that may be already infected, together with their proneness to pass from host to host, constitutes them almost perfect simple mechanical carriers of bacterial infections. There is little doubt that in India, as elsewhere, they are not guiltless in this respect. Boils and ulcers of various kinds are so prevalent in these tropical countries, and the bare legs and feet of the natives so expose them to the attacks of leeches, that the latter are suspected of contributing to the spread of these affections. It is altogether probable that both the land-leeches and the aquatic leeches of India may prove to play an important part in the dissemination of skin diseases and blood parasites. A thoroughgoing investigation of them from this point of view is much needed. Such leeches also are the intermediate hosts of immature verminous parasites, the final hosts of which will probably prove to be birds and fishes that prey upon them.

(5) Whether the practice of blood-letting by means of leeches originated among the Hindus and the knowledge was carried from India to other countries and peoples, or whether it originated independently in the latter, probably cannot be known with certainty. In any event, the most ancient records of phlebotomy by means of leeches pertain to the Indian region, where conditions would seem to be peculiarly favourable to the development of this art. Men must very early have had brought to their notice the relief resulting from the withdrawal of blood from local inflammations following the attacks of these natural blood-letters.

The use of leeches in Hindu medical practice is very ancient, and formerly was extensive. Even now they are employed largely by the native medical men, although little use is made of them by European practitioners. Most recent references to the subject are based on the very full account given in the two-thousand-year-old Sanskrit System of Medicine of Susruta. The following is taken chiefly from Dutt (1845):—"Leeches have been employed from time immemorial in Asia, but particularly in Bengal, where they are considered as the best means of removing blood from a part. They are used particularly for Rajahs, for women and timid persons, and for the very young and very old."

The Sanskrit name for leeches collectively is *Jalouka*, or *Jalukaha*, of which there are many variations in the several Indian languages. Susruta distinguishes twelve kinds, each.

having a distinctive name. Of these, six are described as venomous, and six as useful in blood-letting. Among the injurious varieties, the *Indrayudha*, the bite of which is reputed as fatal, may be *Hæmadipsa ornata*, as it is described as "having longitudinal lines along its back like a rainbow." Probably most of the others are varieties of *Hirudinaria* (*Pæcilobdella*) *granulosa* and related forms, the *Alagarda*, which are stated to "have hairs on their body," being large examples with prominently projecting sensory papillæ, such as are met with not infrequently.

"These deleterious leeches, when they are employed, produce heat, swelling, pain and itching of the part; followed by excessive irritation and fever, with spasms, sickness and syncope. The bites of the *Indrayudha* leeches are considered fatal. These kinds of leeches are found near putrid fish or animals, in foul, stagnant and putrescent water. Such leeches are consequently to be carefully avoided." This indicates that they carry septic bacteria.

Of the six kinds of good leeches, probably all, except the *Shabarika*, which is supposed to be *Dinobdella ferox*, are colour varieties of *Pæcilobdella* and *Hirudinaria*. "They are found in small numbers in clear and deep pools of water, which contain water lilies, and are surrounded by sweet-smelling plants. The middle-sized leeches are the best." Quaint directions are given for keeping and applying the leeches.

Leeches are also used as *materia medica* in the treatment of tonsillitis, hæmorrhoids and baldness. Hirudin extract is employed in modern hospitals as a hæmolytic agent.

The present-day use of leeches in phlebotomy will be referred to in the account of *Pæcilobdella granulosa*, which is the species principally employed in India.

Methods of Study and Preservation.—That the Hirudinea is a group of peculiar difficulty to the systematist is evidenced by the slow progress and many failures that have attended its study. Anyone who has studied this group as well as the related Oligochæta and Polychæta knows with how much greater ease the species of the latter two orders may be discriminated and characterized. Leeches lack the many salient external features of the former, and are much more difficult to dissect than the latter. The chief difficulty, however, arises from their changeableness, from their great capacity for contraction and extension, and their greatly altered appearance in surface-markings, colour, form, etc., with changes in the physiological conditions of nutrition, maturity, etc. Individuals of the same species may appear quite different or of different species so alike as to be confounded, according as their physiological states are diverse or similar. A leech that appears linear when extended may be egg-shaped in complete contraction. When unfed and resting, it may be greatly flattened, transparent, pale-coloured and rough, with protruded, alert, sensory papillæ, and when gorged with blood the same leech will be many times larger, distended, thick, opaque, dark-coloured and smooth. This is true of living leeches, which present wide ranges of variation.

Equally great or even greater differences result from the rough-and-ready methods of preservation employed by many collectors. Many nominal species have been founded upon artifacts, and many real species have been obscured by them. The systematist necessarily is compelled to depend for his material largely upon museum collections. Much of this is in such a bad state that the labour of studying it is very greatly multiplied, and even in experienced hands many important points must be left undetermined, especially such as the annulation of the incomplete somites, the location of sensillæ and nephropores, the characteristics of the teeth, arrangement of the gastric cæca, etc.

Under these circumstances the systematic student of leeches requires an abundance of material representing a variety of ages, seasons, localities, habitats and physiological conditions, which, together with the living colours, should be recorded as specifically as possible on the labels. The preserved leeches should be straight, moderately extended, undistorted, and, of course, neither macerated, overhardened nor dried. To insure these results a standard method of preparation should be adopted as far as possible, and it should be so simple that the general collector can apply it. The following is recommended. The leeches are placed in a vessel with a small quantity of water and are stupefied or anæsthetized with any one of the following: carbon dioxide (as in soda-water syphons), chloroform fumes, chloral or chloretone or cocaine hypochlorate (of about 1-1000 strength), weak nicotine or tobacco decoction, magnesium sulphate or alcohol added gradually, or very weak acids, like lemon juice, in which leeches usually die extended. When they no longer respond to pinching with forceps or similar stimulation, and before maceration begins, they are rapidly passed between the fingers to remove the surplus mucous, straightened out, and laid extended side by side in a flat dish. The fixing fluid is gently poured on, usually at first not quite enough to cover and float them. After allowing a few minutes for them to partially harden, sufficient of the fluid is added to completely immerse them, care being taken to prevent floating. For ordinary museum purposes 50 per cent. alcohol or 2 per cent. formaldehyde will answer perfectly, the latter being preferable as less likely to cause the cuticle to separate. After they have become fully stiffened the leeches should be transferred to stronger solutions, and finally preserved in generous quantities of 85-90 per cent. alcohol or 4 or 5 per cent. formaldehyde. They should be placed in tubes or vials of sufficient length and diameter to keep them straight and to avoid crowding and distortion.

For more special purposes of study special methods of fixation should be employed and should be noted on the label. Most of the methods recommended for earthworms are applicable to leeches (see Lee, 1921). For a general fixative a saturated solution of corrosive sublimate is excellent; Fleming's fluid used with the customary precautions is one of the best for faithful preservation of histological detail. To bring out more clearly the sensillæ and

surface-markings weak chromic acid (about $\frac{1}{2}$ per cent. aqueous solution or, better, equal parts of chromic acid 1-400 and platinum chloride 1-400), or Perenyi's fluid are useful, but too strong solutions, too long exposures, or failure to wash out very thoroughly are likely to be disastrous, chromic acid rendering the tissues very brittle, and Perenyi's fluid, or any strong acid, causing the connective tissues to swell and histolize.

By far the most satisfactory study of leeches can be made with living or recently killed specimens at hand, for these alone exhibit the true colours, normal proportions, etc. On the other hand, the details of annulation, surface sculpture, and most of the internal anatomy, can be worked out best on properly hardened specimens. Almost the entire anatomy of small leeches may be determined by subjecting living specimens to pressure and studying them with a microscope. Properly preserved specimens stained in Grenacher's alum carmine, and if necessary slightly de-stained, and mounted in diaphane, balsam or Farrant's medium, answer almost equally well. Specimens too large or too opaque for such treatment must be dissected, as a knowledge of the anatomy of the alimentary canal and reproductive organs at least is essential.

Ordinary museum specimens cleared in glycerine, or dehydrated and cleared in cedar oil or diaphane, bring out many points, such as the cæcation of the stomach, the exact position of the eyes, etc., often not determinable otherwise on entire specimens. For a study of the digestive system, examples partially distended with food should be selected, as the cæca often nearly or quite disappear in starved leeches, and become so greatly distended and crowded in gorged ones that the determination of their true form and relations becomes difficult. The teeth are best brought out by mounting the jaws in glycerine, glycerine jelly or Farrant's medium, either stained or unstained. On museum specimens the teeth are often lost, either through detachment along with the cuticle, or dissolution through the action of preservative media. The blood-vessels are often filled with coagulated blood, furnishing very perfect natural injections. When, as often occurs in formalin specimens not too old, the blood retains its natural colour, very complete dissections of the vascular system are possible without other preparation. In cases where the nephropores are obscure they may be demonstrated often by drying the surface with filter paper and then pressing on the region of the nephridial vesicles thus causing a minute drop of fluid to appear at each pore. Or the leech may be placed in a coloured fluid and the body alternately pressed and released, which fills the vesicles. The leech is then washed and placed in water under the dissecting microscope, when the coloured fluid may be seen diffusing from the pores. Of course serial sections are requisite to the study of the minute anatomy and the determination of special points.

For the mapping of metamerism the sensillæ furnish the most reliable criteria. When these are invisible in surface views, the eyes in the head-region, and the nephropores, relative depth of

annuli, colour-markings and nerve-ganglia in the other regions generally answer as substitutes. Final appeal in cases of doubt is made to the nerve distribution. The determination of the annular composition of the incomplete anterior and posterior somites is most important, and it is here especially that poorly-preserved material is misleading. Strong contraction deepens the furrows, obscures differences in relative depth, and brings into view or accentuates incipient furrows scarcely visible otherwise. Very faint furrows and other surface markings may be accentuated by drying the surface and examining in a strong light impinging at a right angle to the line to be demonstrated. It may also alter the relative position of furrows, eyes, integumental areas, etc., rendering interpretation difficult. Maceration or too great relaxation, on the other hand, tends to smooth out and equalize all furrows. Because of these conditions the diagrams of annulation so generally used with descriptions of leeches are often misleading, as nearly always all furrows and annuli are represented as of equal prominence and value which, as a matter of fact, they rarely possess at the ends of the body. As different observers studying material in differing states of preservation and extension will often arrive at different interpretations, considerable confusion results. While such diagrams are very useful, they should be supplemented by accurate drawings or photographs, made whenever possible from well-preserved extended specimens.

Among special desiderata are the smaller and more obscure species, especially of the Erpobdellidæ, and burrowing species, which have been little collected in India, individuals taken in copulation or recently in copulation with attached spermatophores, and egg-capsules, taken in connexion with the leeches which have fabricated them. Scarcely anything is known of the capsules of Indian species.

Classification.—So far as now known, the generally-recognized families (Erpobdellidæ and Hirudidæ) of the suborder Arhynchobdellæ are clearly defined. Various lower subdivisions, subfamilies, tribes, series, etc., have been proposed. Most of these are based upon single characters more or less clearly recognizable in typical forms, but rarely of sufficient constancy or importance to clearly define all of the members of a natural group. On the contrary, many of them are demonstrably artificial and limited, a fact that becomes increasingly evident as leech anatomy becomes better known. In a small group of animals like the Hirudinea minute taxonomic subdivisions above genera have not the practical urgency often found in large groups comprising many species. Only confusion results from the use of groupings not thoroughly substantiated. It is far better to wait until our knowledge reaches a point where true phylogenetic relations become clear and natural subdivisions evident. In the present book, therefore, some of these names have been employed as descriptive terms only, not as taxonomic groups. Above species, with one exception, only genera and families are recognized.

Acknowledgements.—The great bulk of the material upon which this report is based is the property of the Indian Museum, to the officers of which I am indebted for many courtesies. Much of this collection had been previously studied and reported upon by Harding (1920) and Kaburaki (1921). Their types and mine are deposited in the museum at Calcutta. This collection has been supplemented by small lots in my own collection, the Academy of Natural Sciences of Philadelphia, the U.S. National Museum, the American Museum of Natural History, the Museum of Comparative Zoology, the Colombo Museum, the Madras Museum, and the British Museum, the directors and staff members of which have my grateful acknowledgements. To many individuals I am indebted for single specimens or small lots or for information, and here are especially included those members of the Zoological Survey of India who contributed to the collections of the Indian Museum and who entered accurate data upon their labels. To several individuals special acknowledgements are due. First of all, to the late Dr. Annandale, who showed great interest in my work, and whose lamented death deprived me of the chief source of information regarding the habits of Indian leeches; to Mr. Prashad, his successor as acting head of the Zoological Survey, who has cheerfully furnished material and data; to the present Director, Maj. R. B. Seymour-Sewell, I.M.S., for a continuance of courtesies; to Mr. W. A. Harding, my collaborator on this volume, to whom my connexion with it was originally due and who has been especially generous in placing at my disposal his drawing and notes on *Hirudinaria (Pocilobdella) granulosa*; and, finally, to the Editor of this series, Sir Arthur Shipley, G.B.E., F.R.S., who, besides helping in various directions, has shown great patience over the delayed publication during my largely futile endeavours to secure first-hand information relating to the bionomics of the more important species. Other special acknowledgements are made in the proper places in the text.

As it is impracticable to illustrate fully every one of the species, the drawings have been selected for publication with a view to figuring not only selected diagnostic features of most of the species, but also the important characteristics and modifications of the *Arhynchobdellæ* as a whole. The coloured figures have been copied with the utmost fidelity by Miss Helen Winchester from the originals drawn from life mostly by Mr. A. Chowdhary for the Calcutta Museum, but some of them from other sources credited on the individual figures.

CONTENTS.

	Page
Suborder ARHYNCHOBDELLÆ (systematic)	125
Family ERPOBDELLIDÆ	126
Genus ERPOBDELLA	130
<i>Erpobdella otoolata</i>	130
Genus BARBRONIA	135
<i>Barbronia weberi</i>	135
Genus HERPODELLOIDEA	140
<i>Herpobdelloidea lateroculata</i>	141
<i>Herpobdelloidea indica</i>	144
Genus FORAMINOBDELLA	149
<i>Foraminobdella heptanerata</i>	149
Genus TROCHETA	151
<i>Trocheta quadrioculata</i>	151
Family HIRUDIDÆ	154
Subfamily HIRUDINÆ	158
Genus MYXOBDELLA	161
<i>Myxobdella annandalei</i>	161
Genus WHITMANIA	168
<i>Whitmania levis</i>	169
Genus DINOBDELLA	175
<i>Dinobdella ferox</i>	175
<i>Dinobdella notata</i>	185
Genus HIRUDO	189
<i>Hirudo asiatica</i>	190
<i>Hirudo birmanica</i>	192
Genus LIMNATIS	199
<i>Limnatis nilotica</i>	200
<i>Limnatis paluda</i>	201
Genus HIRUDINARIA	207
<i>Hirudinaria javanica</i>	210
<i>Hirudinaria manillensis</i>	218
<i>Hirudinaria (Pæcilobdella) granulosa</i>	226
<i>Hirudinaria (Pæcilobdella) viridis</i>	239
Subfamily HÆMADIPSINÆ	244
Genus HÆMADIPSA	253
<i>Hæmadipsa zeylanica</i>	255
Subspecies <i>zeylanica</i>	205
" <i>cochiniana</i>	265
" <i>agilis</i>	206
" <i>montivindicis</i>	267
<i>Hæmadipsa montana</i>	269
<i>Hæmadipsa sylvestris</i>	276
<i>Hæmadipsa ornata</i>	284
<i>Hæmadipsa duessumieri</i>	289
Bibliography	291
Appendix	296

Suborder ARHYNCHOBDELLÆ.

Of the Arhynchobdellæ there are recognized two families, characterized as follows:—

- A. Eyes never arranged in a regular arch of five pairs on contiguous somites of the head, but varying in number and arrangement, or even absent; metameric sensillæ obscure, not differing obviously from ordinary sensory papillæ; annuli of complete somites tending to multiply from the basic quinquannulate condition; male genitalia terminating in a spermatophore sac (atrium) lacking a filiform penis; female genitalia with vagina scarcely distinguishable; jaws absent or vestigial; teeth absent or single retractile stylets; pharynx elongated, with three muscular ridges; gastric cæca totally absent or at most a single pair of small ones **Erpobdellidæ, p. 126.**
- AA. Eyes forming a regular arch on contiguous somites of the head, nearly always five pairs; metameric sensillæ usually conspicuously distinct, complete somites generally quinquannulate and tending toward reduction rather than elaboration; male genitalia terminating in a complex atrium usually provided with a penis; female genitalia with a well-developed vagina corresponding in length with the penis; jaws typically present and tooth-bearing, but may be toothless or absent; pharynx short, bulbous, with strong radiating musculature; at least one pair of large gastric cæca, usually several pairs **Hirudidæ, p. 154.**

Family ERPOBDELLIDÆ.

Synonymy :

- Gnathobdellea*, Leuckart, 1863 (in part).
Gnathobdellidæ, Claus, 1885 (in part).
Nephelidæ, Whitman, 1886.
Nephelides, Blanchard, 1887.
Herpobdellidæ, Blanchard, 1894 (and subsequent writers).
Herpobdellinae + *Trochetinae*, Perrier, 1897.
Erpobdellidæ, Moore, 1924.
Pharyngobdellea, Johansson, 1913, 1914.

Type-genus, *Erpobdella* *, Blainville (in Lamarck), 1818.

General Characteristics.—The worm-leeches are of small or medium size and slender linear form, and possess great powers of extension. They are terete or subterete anteriorly, becoming gradually more flattened toward the caudal end, where the margins are often sharp or even flanged. No very definite expanded sucker at the anterior end, but rather a mouth over-arched by a prominently projecting lip. Caudal sucker also a relatively small, little expanded disk directed ventrad and broadly attached by a slightly differentiated pedicel. Body very muscular, firm and slippery, only rarely softened by the development of botryoidal and parenchymatous tissue.

Eyes usually in two groups, the more anterior (labial group) of one or two pairs close together on the dorsum of the lip (II or III) and directed chiefly forward; the posterior (buccal group) usually of two pairs of smaller eyes directed latero-caudad, on the sides of the buccal ring (IV). The latter, or even both groups, may be absent, or accessory eyes may be present in the dorsal paramedian and intermediate or the ventral submarginal series of the posterior cephalic and anterior post-cephalic somites. Sensory papillæ occur in one to three, more or less irregular, transverse rows on each annulus, both dorsally and ventrally, and the true segmental sensillæ cannot be distinguished from these by ordinary surface examination.

Clitellum typically better developed, or at least more conspicuous, externally than in the Hirudidæ, completely zonary, occupying about fifteen annuli—X b 5 to XIII a 2 inclusive, or their equivalent. Gonopores usually separated by less than five

* The spelling here adopted follows de Blainville's (1818) original. As this author employed the same orthography in two subsequent writings, there can be no question but that it was intentional and preferred. Consequently there was no justification for its later alteration by Agassiz (1846) and Blanchard (1894). Unfortunately the latter author has been followed by nearly all subsequent (including the present) writers, and the erroneous though probably orthographically preferable spelling is widely prevalent.

annuli (full somite), but may be from two to seven annuli apart. The male pore is large and usually on somite XII, the female small and on XIII, but both may be on XII or at its borders, and there is much variation. Rarely (*Barbronia weberi*) accessory copulatory (?) pores and areas occur anterior to the male and posterior to the female gonopore and may be connected with the ovisacs by directive or conducting tissue ("tissu vecteur," Brumpt). Nephropores situated as typical of the suborder, but in the strictly aquatic species, at least, they are small and much more difficult to detect than in the Hirudidæ.

Metamerism is more difficult to decipher than in the Hirudidæ owing to the obscurity of sensillæ and nephropores, and recourse to the nerve-ganglia is often necessary. Complete somites are fundamentally quinquannulate, but, in conformity with the tendency toward body elongation, there is a corresponding tendency toward multiplication of the annuli, one or more of which may be subdivided and resubdivided to form from six to eleven. This characteristic is expressed most frequently by far in the enlargement of annulus *b* 6. *A* 2 also is very commonly longer than the contiguous secondary annuli and may bear an incipient furrow, but subdivision rarely goes far enough to form distinct annuli. Further multiplication of annuli takes place in the presensory and postsensory regions, especially in the latter, as illustrated in the diagrams of *Nephelopsis* and *Trocheta* on Plate I. Annuli of the higher orders are often markedly shorter than those of the lower orders, and this condition is described by the term *epactodesmine* (subfamily Epactodesminæ, Blanchard, 1897), the equiannulate condition being *haplodesmine* (Haplodesminæ, Blanchard). The evidence, however, is against the actual "intercalation" of new annuli and in favour of their origin through growth and subdivision of the annuli of lower orders.

All four of the principal *colour types* occur in this family, but the longitudinally striped pattern is by far the most prevalent, the others decreasing in relative frequency in the order named:—(1) transversely banded or spotted, (2) irregularly blotched, and (3) self-coloured. There is much individual variation. In contrast to the condition usual in the Hirudidæ, the young of this family are nearly or quite unpigmented, and appear more or less pink or even bright red, due to the blood showing through the translucent tissues. Some of the species of small size seldom develop beyond this state.

The *alimentary canal* and reproductive organs have been described with sufficient fullness in the general account of the suborder (pp. 104–110). However, especial attention needs to be directed to the taxonomic value of the two types of pharynx, in one of which (*Euthylæmata*, Oka, 1923) the unpaired ridge is dorsal and the paired ridges ventro-lateral for the entire length, and in the other (*Strepsilæmata*, Oka) these positions are reversed except at the cephalic end of the pharynx, the posterior part having undergone an apparent rotation through 60°. With the

strepsilæmatous type are sometimes associated vestigial true jaws or solitary teeth (stylets) and usually pseudognaths of larger size (pp. 104, 105). Rarely the stomach is placed in communication with the exterior by a median dorsal pore or a pair of ventral pores, the function of which is unknown.

All that need be added to the account of the *reproductive organs* (pp. 107, 109) is to emphasize the importance for generic diagnoses of the modifications of the atrium and associated parts, as indicated under the several genera.

Nephridia have the general form and distribution usual in the suborder, but typical genera differ from typical Hirudidæ in that the nephrostomes lie in the ampullar instead of the testicular sinuses and remain open, and the nephridial vesicles are smaller.

The most noteworthy feature of the *vascular system* is the occurrence in most of the complete somites of double pairs of vesicles (ampullar sinuses) connected by transverse vessels with the dorsal and marginal longitudinal trunks. The blood, which Oka, Johansson, and others regard as cœlolymp, is bright red.

Most species of the worm-leeches are strictly aquatic, being inhabitants of fresh water of all kinds. They are found among the vegetation or under stones in the still waters of lakes, ponds and ditches, on the tidal flats of large rivers above the point of appreciable salt mixture, under stones in swift mountain brooks, and equally in sewage-polluted rivers and the pure cold water of springs. Some of them (*Trocheta*) are truly amphibious, and leave the water at night to fare far over the land in pursuit of earthworms. Others are more strictly terrestrial. These occur especially in South America and in Japan. None of them have been definitely reported from India, but they may be expected to occur in the damp hill-forests. They differ greatly in both appearance and habits from the true land-leeches. They are predaceous and, like the amphibious forms, wander about at night seeking earthworms, insect larvæ and similar food, and some are true burrowers.

The aquatic species include some of the most active of all leeches. They are powerful swimmers, moving with a graceful undulating motion with the body either in a vertical or horizontal position and sometimes with the head elevated above the surface. They are carnivorous and voracious, swallowing various kinds of worms, insect larvæ, snails, etc., either entire or in large pieces. Many also are scavengers, and will gather in large numbers at points where the wastes from slaughter-houses and fish-canneries are dumped. This habit leads them to collect in rivers polluted by sewage and on the lee shore of ponds and lakes where the dead bodies of fishes etc. often become stranded in large numbers. None are known to be true blood-suckers, but many will attach to bleeding cuts and abrasions of the skin and imbibe a meal therefrom.

In *reproduction* they unite in pairs and mutually exchange spermatophores, which are double-barreled tubes filled with

bundles of spermatozoa. These are attached preferably to the ventral face of the clitellar region, which is a specially receptive area, but may be attached elsewhere. The integument at the point of attachment undergoes partial histolysis, and the spermatozoa penetrate hypodermically and travel to the ovisacs, where fertilization occurs. The fertilized eggs are laid in small, flat, pouch-like and thin-walled capsules, formed by the clitellar glands and attached by one flat side to stones, sticks, plants, etc., in the water. Each capsule contains a small number of eggs suspended in an albuminous jelly. In development a remarkable metamorphosis is passed through, during which most of the embryo is discarded, and the body of the leech arises from a new and localized area of development. Seldom more than four or five young leave the capsule by one of the two tubular orifices, which may be closed by a plug previous to hatching.

So far as known, the Erpobdellidæ have little economic importance. The larger species make excellent bait for such fishes as bite on earthworms, their extreme toughness, vitality and activity being their chief merits. Immature nematodes and the larval stages of both trematodes and cestodes are common parasites, the latter probably finding their definitive hosts in fishes or fish-eating birds.

Our knowledge of the Indian species of this family is still very incomplete, and nearly all of what is known was contributed by Kaburaki (1921), who described several interesting new forms.

The genera here recognized are in need of further revision.

Key to Genera and Subgenera of Indian Erpobdellidæ.

I. Pharynx with muscular ridges at anterior end median-dorsal and paired ventrolateral, but immediately behind buccal region twisted spirally anti-clockwise through 60° and continuing for most of the length as median-ventral and paired dorsal ridges (*Strepsulemata*, Oka, 1923).

A. No dorsal canal from stomach to exterior.

a. No anterior vestigial jaws or teeth (stylets) in pharynx, no accessory post-cephalic eyes.

1. Complete somites quinquannulate, the last annulus (66) not obviously enlarged and subdivided; eyes limited to labial and buccal groups; atrium deeply divided, with prominent cornua, and ducti ejaculatorii with long preatrial loops

[p. 130.
ERPOBELLA (s. str.),

2. Complete somites variously subdivided into long and short rings, usually octo- or novem-annulate; eyes typically as in 1; atrium as in 1, but with cornua usually spirally wound

TROCHETA, p. 151.

- aa. One or two stiliform teeth on anterior end of each pharyngeal ridge; eyes variable; complete somites quinquannulate, but with $\delta 6$ more or less enlarged and subdivided; atrium not deeply cleft and ducti without long preatrial loops.
3. Eyes as in *Erpobdella*, no accessory post-cephalic eyes; accessory copulatory pores or areas at X/XI and XIII/XIV BARBRONIA, p. 135.
4. Submarginal accessory eyes on several post-cephalic segments. No accessory copulatory pores [p. 140.
HERPODELLOIDEA,
- AA. A dorsal canal between stomach and exterior.
5. Complete somites highly complex, much as in *Trocheta*; eyes one pair on dorsum of head [p. 149.
FORAMINOBDELLA,

Genus **ERPODELLA**, Blainville.

Synonymy :

Helluo, Oken, 1815; not *Helluo*, Bonelli, 1813 (Insecta).
Erpobdella, Blainville (in Lamarck), 1818, Blainville, 1827, 1828.
Nepheleis, Savigny, 1820 (1822).
Herpobdella, Agassiz, 1846.
Herpobdella, Blanchard, 1894, and subsequent writers.
Erpobdella, Moore, 1891.

Diagnosis.—Complete somites quinquannulate, all annuli of approximately equal size and development, or $\delta 6$ slightly longer but not obviously subdivided, at least not much more so than the others. Eyes usually three or four pairs, one or two pairs in a labial group on the dorsum of the lip, and two pairs on the sides of the buccal ring. Vasa deferentia in all known species form long preatrial loops reaching to ganglion XI; atrium deeply cleft, prostate cornua prominent, simply curved but not spirally coiled (goat-horned, not ram-horned).

Type, *Hirudo vulgaris*, Müller, 1774 (in part, excl. *Hirudo testacea*, Savigny, 1820 (1822)).

Only known Indian species: Eyes four pairs; gonopores separated by three ($2\frac{1}{2}$ – $3\frac{1}{2}$) annuli. *E. octoculata* (Linnæus).

24. *Erpobdella octoculata* (Linnæus). (Plate VI, fig. 12.)

Synonymy, European :

Hirudo octoculata Linnæus, 1758, p. 649.
Hirudo vulgaris Müller, 1774, p. 40 (in part).
Erpobdella vulgaris, Blainville (in Lamarck), 1818, p. 296 (in part).
Hirudo atomaria Carena, 1820, p. 295 (fig.).
Nepheleis atomaria, Moquin-Tandon, 1826, p. 128 (figures).

Herpobdella atomaria, Blanchard, 1894, p. 56 (complete European synonymy and figures).

Herpobdella octoculata, Johansson, 1909, p. 376.

Asiatic:

Herpobdella atomaria (Carena), Oka, 1910, p. 117 (Japan, very abundant, sex pores $\times 2 \frac{1}{2}$ ann.).

Herpobdella octoculata (Linnæus), Oka, 1917, p. 165.

Herpobdella octoculata var. *atomaria*, Oka, 1917, p. 175 (Lake Biwa, Japan).

Herpobdella lineata (Müller), Kaburaki, 1921, p. 703 (Lahore, India, all young examples, sex pores $\times 2 \frac{1}{2}$ ann.).

Erpobdella octoculata (Linnæus), Moore, 1924, pp. 363-367 (Kashmir, and Soochow, China).

Diagnosis.—Length up to 70 mm., but smaller in India. Colour in life clear or dull brown tinged with green, the dorsum with irregular, more or less confluent, dusky spots, intermixed with yellowish spots, which predominate on the sensory annuli (*a* 2), resulting in a characteristic pattern of pale, transverse bands on a dark ground; venter paler and unspotted. Eyes normally two pairs in each group, labial and buccal. Gonopores usually separated by three annuli ($2 \frac{1}{2}$ - $3 \frac{1}{2}$). Enlargement and subdivision of *b* 6 very slight.

Description.—Indian specimens probably do not equal the maximum size of the species in Europe, the largest of over two hundred examined being 49 mm. long, and most of them less than 35 mm. Other measurements of the large one are: length to male pore, 11.3 mm.; buccal width, 1.4 mm.; width at male pore, 3.7 mm.; maximum width (beginning of caudal third), 4.3 mm.; maximum depth (middle), 2.5 mm.; diameter of caudal sucker, 3.3 mm. This is a moderately extended example; contracted ones are relatively much broader and flatter.

Form somewhat more robust than most Indian species of the family, of nearly uniform width, but attenuated anterior to the clitellum, and in the caudal region tapered gently in a wide curve into the pedicel. Buccal and preclitellar regions terete, becoming, farther caudad, more depressed with elliptical cross-section, and then gradually strongly depressed, with sharper margins, but without distinct flanges at the caudal end.

Head relatively small, the lip semicircular with thickened rim all round passing into the buccal margin. Mouth of medium size and circular form. Eyes normally four pairs, the first on II, the second at the furrow II/III or chiefly within III, the third and fourth pairs at the sides of the buccal ring on IV *a* 2. The first two pairs are slightly larger and look chiefly forward, the buccals caudo-laterad. The eyes are subject to much variation. The first two may be coalesced on one or both sides, in the latter case forming a single large, either composite or simple, pair. In one case those of the first pair are coalesced into a single median eye. Any one or more may be absent or variously subdivided, and there may be other supernumerary eyes, especially on III.

Clitellum well marked in breeding individuals from 20 mm. long upward, extending over fifteen or occasionally sixteen annuli (X *b* 5 to XIII *a* 2 or *b* 5 inclusive). Gonopores normally in the furrows XII *b* 1/*b* 2 and XII *b* 5/*b* 6 respectively, that is, with three full annuli intervening; but either the male or, more rarely, the female pore may vary as much as half the length of an annulus in the caudal direction, resulting in intervals between them of from two and one-half to three and one-half annuli. This happens very much more frequently to the male pore, which in about half of the Indian examples lies just within the cephalic border of *b* 2 and may be as far as the middle, thus reducing the intervals between the gonopores to two and one-half annuli as in the Japanese race characterized by Oka (1910). The female pore is much more stable, but may lie within *b* 6 and in one case is close to the furrow XII/XIII, thus closely approaching the condition in *E. testacea*. There is nothing distinctive about the form or surroundings of the gonopores and there are no copulatory pores.

The nephropores are very minute and in the usual position of the caudal border of *b* 2 of somites VIII to XXIV inclusive. Anus large, with furrowed lips and situated at XXVI *a* 2/*a* 3 or XXVI/XXVII. Sucker circular, little expanded beyond the broad pedicel, directed ventrad, with four pairs of faint radiating ridges on the dorsum, and in most of these specimens rather deeply cupped on the venter. The sucker is relatively larger on young specimens.

Colour.—There is no information concerning the living colour of Indian examples. Harding (1910) thus describes and figures British specimens:—"Above usually fulvous or greenish brown, except at the anterior extremity with a transverse series of reddish or yellowish-white spots on every ring and generally with a black reticulated pattern. The third ring of each somite is rendered conspicuous by the accentuation of the yellowish-white spots which are often fused into a transverse band, and by the absence of black pigment. Ventrally paler and unicolorous."

In the preserved specimens the green colour of the soluble pigment and the red colour of the blood are lost, the ground being grey, pale yellow or whitish, usually paler and unspotted on the venter, but occasionally clouded on the more heavily pigmented individuals. Dorsally the pattern is quite typical. There is a more or less distinct reticulum, varying in size of mesh, of dark pigment, which, by sinking to a deeper level in a median field of about one-fifth of the body-width, becomes obscured, thus leaving a paler longitudinal stripe separating a pair of much broader dusky or brown stripes extending nearly to the yellowish margins. In these dark fields appear numerous rounded, or, in some cases, elongated pale yellowish spots which may be more or less confluent and usually become more numerous or larger toward the margins. The dark reticulum is usually deepest in intensity along the borders of this median pale field and diminishes toward the margins. It is also usually deeper in the

pharyngeal region, owing to a reduction in size of the pale spots and the consequent concentration of the pigment. On the neural or sensory annuli (a_2) the pale spots show a marked tendency to unite into cross-bands and to replace the black pigment, especially toward the caudal end, where the sensory annuli may be completely pigmentless and appear as metameric pale rings, very conspicuous on the darker specimens. On some specimens it is very striking that the larger annulus of the biannulate somite XXVI has the anterior half (a_1) dark and the posterior half (a_2) pale. The same is true to a less degree of XXVII.

From this strongly-marked type characteristic of the species there are frequent variations. A less-marked tendency toward depigmentation is often noticeable on the first annulus (b_1) as well. The pigment may fade in intensity generally, or it may, as is more frequent, fade and disappear more or less completely from the margins mediad, or from the caudal end cephalad, through all intermediate stages to the final condition of reduction. This last is characterized by a pair of narrow dark stripes, invariably constituted of a network or of irregular more or less confluent spots, bordering the median pale stripe. Or the pigment may be confined chiefly to the pharyngeal (preclitellar) region. One specimen in which the dark stripes were particularly well developed had them united across the median pale field by occasional dark bands, producing a ladder-like effect. The head is usually pale and the caudal sucker marked by irregular spots like the general pattern. Young individuals may be quite colourless and translucent or they may be grey or liver-coloured. Some of those found in clear, cold brooks are very dark brown or even almost black, with the reticulum very heavy or nearly solid and the paramedian stripes very dark and continuous.

Annulation.—Typical Indian specimens have the somites constituted as follows:—I and II, uniannulate; III, biannulate; IV, biannulate, with the first annulus larger and incipiently divided on the dorsum (a_1, a_2) $> a_3$, but united on the venter; V, biannulate; VI, triannulate, $a_1 = a_2 < a_3$; VII, quadrannulate, $a_1 = a_2 = b_5 = b_6$ or b_5 slightly $< b_6$; VIII to XXIV, quin-quannulate, $b_1 = b_2 = a_2 = b_5$ slightly $< b_6$. On XII to XXIII b_6 is not only slightly longer but has a very faint furrow on the dorsum, and a_2 also is slightly, though less, enlarged. XXV is triannulate, $a_1 = a_3 > a_2$ with a very faint furrow on the dorsum of a_1 ; XXVI, biannulate (a_1, a_2) $> a_3$, with the faint furrow a_1/a_2 limited to the dorsum; XXVII, one or two incomplete annuli. The principal variations are that XXIV rarely is quadrannulate and the incipient furrows on caudal annuli may be more or less deep.

Anatomy.—Testes numerous and small, occupying the sides of somites XVII to XXIV. Epididymes or spermatocystes much enlarged and closely convoluted, reaching from XIV to XVII. Ejaculatory ducts with long preatrial loops reaching to ganglion XI. Atrium with a pair of semi-erect, simply-curved, prostate

cornua, provided at the base with a layer of prostate glands, and a small unpaired globoid chamber eversible into the shallow bursa into which its ventral face projects. Ovisacs typical, as described for the family. Pharynx with the median muscular ridge ventral, except close to the anterior end, where a twist placing the right paired ridge in the median dorsal position occurs; no visible vestiges of jaws, very small pseudognaths; chambers of the stomach little differentiated.

Geographical Distribution and Bionomics.—This species is widely distributed throughout temperate Europe and Asia, from the British Isles to Japan and from Scandinavia and northern Siberia to the Mediterranean and the northern districts of India. In this great area many local races and varieties have been described, to which a long list of names have been given. Blanchard (1894) and Johansson (1910) especially have studied the synonymy and have determined the identity of these, but Johansson, whose conclusions have been followed here, has reversed Blanchard's application of the two names *H. octoculata* (Linnæus) and *H. testacea* (Savigny).

In northern India the species may differentiate into a geographical race or subspecies. The last annulus (*b* 6) of complete somites appears to be better developed than in Europe, thus approaching *Dina* more closely. Kaburaki (1921), indeed, was led to refer his examples to *Dina lineata* (Müller), but the difference between these and typical specimens of the latter from Palestine and Europe is very apparent.

Indian records are entirely from Kashmir, where the species is abundant and widely distributed, and from Lahore, in the Punjab, where also it is abundant. Doubtless it occurs much more widely. The greatest altitude recorded is 5500 ft. It lives in a variety of fresh waters, in swamps, ditches, ponds and lakes, and in sluggish streams, as well as in swift, cold mountain brooks. It is equally at home among aquatic plants, on muddy bottoms and under stones. Sometimes it is found in springs in association with *Hemiclepsis marginata asiatica*, a subspecies of another temperate European species.

The only food found in the stomachs of those examined was small oligochaete worms (Tubificidæ), sometimes in great numbers. Undoubtedly in India as in Europe they feed also on insect larvæ, molluscs, planarians and similar soft-bodied invertebrates.

No egg-capsules occur with the Indian specimens, but there is no reason to expect them to differ from the European productions as described and figured by Moquin-Tandon (1846) and Johansson (1909). They are broadly elliptical in outline, about 4-7 mm. long and two-thirds as broad, flattened, with the attached face flat, the exposed face convex, and a thin projecting margin all round. At each end is a short tubular projection, through which the young find exit and which is closed by a globular plug until needed. Colour translucent amber or brownish. Attached to stones, plants, etc.

Some of the Indian specimens are parasitized by larval trematodes and immature nematodes, as is frequently the case in Europe.

Genus **BARBRONIA**, Johansson.

Synonymy :

Barbronia, Johansson, 1918.

Dina, Blanchard, 1896, and Moore, 1924 (in part).

Diagnosis.—Size, form and external characters in general as in *Dina*. Complete somites quinquannulate, but with the last annulus (*b* 6) enlarged and divided by a more or less distinct tertiary furrow, as in *Dina*. Eyes normally one pair of larger labials and two pairs of buccals. Gonopores on XII and XIII, widely separated by a nearly full somite. Median ventral copulatory pits or areas at X/XI and XIII/XIV. Vasa deferentia opening directly into atrial cornua without preatrial loops. Atrium compact, spheroidal, with short simple cornua. Testes continued forward into somite XIV. Pharynx formed as in *Dina*, but each of the three muscular ridges bearing at its anterior end one or two retractile styliiform teeth.

Type-species, *Barbronia rouxi*, Johansson, 1918, pp. 383–390. Taf. XII and text-figs. New Caledonia. (?=*Dina weberi* Blanchard, 1897.)

One known Indian species, *B. weberi*.

25. *Barbronia weberi* (Blanchard).

Synonymy :

Dina weberi Blanchard, 1897, pp. 353–355 (figs. annulation). Type-locality, Java, also Sumatra and Celebes.

Herpobdella hexoculata Kaburaki, 1921, pp. 703, 704 (fig. annulation). Central and North-West Provinces, India. (Young without accessory pores.)

Dina weberi, Blanchard, Moore, 1924, pp. 368–370, fig. Kashmir, Naini Tal, Central Provinces, and Simla Hills, India.

? *Barbronia rouxi* Johansson, 1918, pp. 383–390, figs. 3–5 & pl. xii. N. Caledonia.

Diagnosis.—Small, 25–35 mm. long. Living colour unknown, probably reddish, as little pigment is present. Eyes normally three pairs, one large pair on dorsum of II, two smaller pairs on sides of anterior annulus of IV. Gonopores separated by four and one-half or nearly five annuli, the male situated at XII *b* 1/*b* 2, the female on the middle of XIII *b* 1; accessory copulatory pores and areas at X/XI and XIII/XIV and are very characteristic.

Description.—Length of extended preserved specimens rarely exceeding an inch, the largest 36 mm. long and 3.8 mm. in maximum width. One of nearly this size but less extended measures: length, 27.5 mm.; length to male pore, 12 mm.; buccal width, 1.5 mm.;

width at male pore, 3.5 mm.; maximum width (at XVI-XVII), 5 mm.; depth nearly uniformly, 1.5 mm.; diameter of sucker, 2 mm.

Form slender, like most small Erpobdellidæ of nearly uniform width behind the clitellum, and tapering anteriorly to the very small head; the caudal end broadly rounded to the sucker. Buccal and preclitellar region terete, the remainder of the body flattened and in the anal region provided with lateral flanges.

Lip narrow, unusually long and prominently projecting, often flat and less arched than usual in the family, ventrally with a marginal welt that passes into the buccal ring. Mouth small. Eyes normally three pairs, the first larger, close together and conspicuous, on the dorsum of the anterior part of the lip (II); the other two pairs small and on the sides of the buccal ring (IV a 2). Irregularities of eyes common.

Olitellum thick and rather prominent on all sexually active specimens, extending over fifteen annuli, X b 5 to XIII a 2 inclusive; on some specimens much wrinkled. Gonopores separated

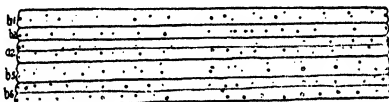

Fig. 39.—*Barbronia weberi*. A complete typical somite (XVI) from the dorsum, showing the annuli and sensory papillæ. $\times 16$.

by four and one-half to five annuli. Blanchard gives the latter as typical of specimens from the Malayan Islands, but Indian specimens almost invariably have the former. The male pore is usually at XII b 1/b 2 or slightly in b 1, the female pore on XIII b 1. This holds true for all of sixty Indian examples studied, with the exception of a specimen 35 mm. long from Nepal, in which the female pore is situated in the furrow XII/XIII, four annuli behind the male. For his *Herpobdella hexoculata*, Kaburaki gives the male pore as XI (XII as herein counted) b 2, the female XII (XIII) b 1/b 2. The male pore (fig. 40, ♂) varies much in appearance. In immature examples it is a small, simple round pore in the furrow. In fully mature ones it becomes a more or less conspicuous crescentic opening on the summit of a prominent conical or mammilliform papilla or, if the bursa be everted, an elliptical pad-like disk spreading over the two contiguous rings and with its greatest diameter transverse. The female pore (♀) is a small rounded or slit-like orifice which rarely varies from a middle position on the annulus. The accessory pores (fig. 40, c.p.) are very constant in position, but vary in size and appearance with the size and maturity of the worms. The first (c.p. 1) is at the furrow X/XI, the second (c.p. 2) at XIII/XIV.

When fully developed each presents a slightly swollen or rarely a sunken area of the integument extending over two, three or even four annuli, distinctly discoid when best developed and surrounding the actual pores, which have thickened lips. In such cases the pores are large and open. In sections these areas exhibit numerous unicellular glands and integumental blood-vessels. The pores themselves are merely the orifices of small pit-like deepenings of the furrows which exhibit no particular differential structure. The epithelium is slightly thickened and the glands and blood-vessels fewer. The posterior pore is most frequently conspicuously developed, but may be small or absent, even on mature leeches. The anterior pore is absent in about one-third of the individuals with developed clitella, and even all trace of the glandular

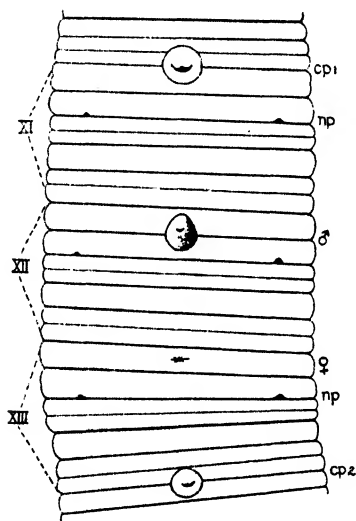

Fig. 40.—*Barbronia weberi*. Olitellar region (somites X to XIV), from venter. $\times 10$. ♂, male and ♀, female gonopores; *np.*, nephropores; *c.p. 1*, anterior, and *c.p. 2*, posterior, copulatory pores and areas.

thickenings may be absent. This is true of either one or both pores of some fully mature worms. On small and immature individuals there is often no trace of either pores or glandular areas. Some of the specimens described by Kaburaki as *H. hex-oculata* are such immature specimens, but three of the larger ones (17–19 mm. long) clearly show the accessory pores, so there can be no question of the identity of the two species. It is evident, therefore, that these structures are best developed at full maturity and probably seasonally. Their function is less certain as no direct observations have been made. Probably they serve as accessory

copulatory organs and receive the spermatophores, and consequently may be regarded as special copulatory areas with directive tissue. In the single one sectioned there is no trace of spermatozoa in the pits, but in another example in which the entire area surrounding the anterior pore is sunken, the depression is filled with a granulated mass which may contain spermatozoa.

Anus large, with raised and often furrowed margins, situated at XXVI/XXVII. Sucker relatively large, owing to slenderness of body sometimes of a diameter little less than the maximum width, but in no other way distinctive. Nephropores in the usual position on *b* 2, probably from VIII to XXIV inclusive, but very small, and the first and the last two pairs not certainly demonstrated.

Annulation (figs. 39, 40, 41, & 42) sharply defined throughout. Annulus *b* 6 is distinctly enlarged and subdivided into *c* 11 and *c* 12 on all complete somites and even as far forward as VII. Beginning with XXI it becomes less enlarged, but is clearly recognizable by its greater length as far as XXIII. *A* 2 also is slightly enlarged and subdivided. The remaining annuli of complete somites are very regular and equal. The sense-organs are very small, often scarcely discernible, but have the arrangement characteristic of the family. Somites I and II are uniannulate, III biannulate, IV biannulate, or triannulate if the furrow *a* 1/*a* 2 anterior to the eyes be considered sufficiently deep to be counted, all uniting ventrally to form the buccal ring; V bi- or triannulate. VI is regularly triannulate ($a\ 1 = a\ 2 < a\ 3$), the last occasionally with an incipient furrow; VII quadrannulate ($b\ 1, b\ 2 = a\ 2 = b\ 5 < b\ 6$), the last with an incipient tertiary furrow. VIII-XXIV are complete and quinquannulate, the first two or three having the formula $b\ 1 = b\ 2 = b\ 5 < a\ 2 < b\ 6$ (*c* 11, *c* 12), the last $a\ 2 > b\ 1 = b\ 2 > b\ 5 = b\ 6$. XXV is triannulate, occasionally, as in one figured, with faint furrows. XXVI biannulate ($a\ 1, a\ 2 > a\ 3$, and XXVII biannulate and post-anal. Occasional specimens exhibit very faint cross-furrows on most of the annuli, but these are much less developed than the distinct furrows on *b* 6 and *a* 2.

Colour.—There is no information concerning the living colour. Most of the preserved specimens are pale yellow and greyish, either without pattern or with faint lines or reticular marking. One specimen of the largest size from the Nepal Valley is marked with large, sprawly black blotches.

Alimentary canal of the form usual in the family, the pharynx strepsilæmatous, with ventral and dorso-lateral ridges except at the cephalic end, where their position is reversed. Small pseudognaths and vestigial jaws each bearing two (or one) retractile styli-form teeth arranged in tandem. Stomach sacculated, with walls excessively thin.

Reproductive organs little distinctive, the most important feature being that the small testes, normally developed from XXIV to XVII, continue in smaller number forward to XIV also. The exact number was not determined, but appears to be about eight

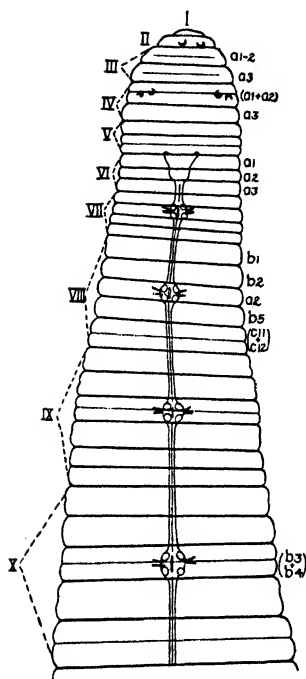

Fig. 41.—*Barbronia weberi*. Dorsal aspect of anterior end (I-X), showing annulation (notation on right side), eyes and position of nerve-ganglia. Relative depth of furrows is partly indicated by strength of the lines. $\times 16$.

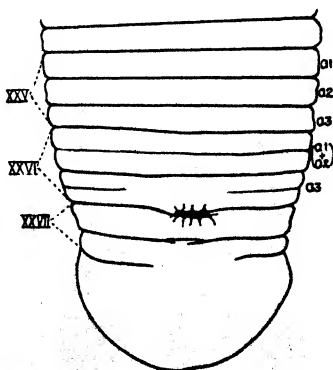

Fig. 42.—*Barbronia weberi*. Caudal end (XXV-XXVII), from the dorsum, showing annulation (notation at right), anus (a.) and sucker. $\times 16$.

or nine on each side of each segment. The sperm-ducts form no preatrial loop at all, but end abruptly at the sides of the atrium and empty into the apices of the prostate cornua. Epididymes or sperm-vesicles enlarged but nearly straight, unfolded. Atrium resembling that of *Dina microstoma*, short, thick, compact and spheroidal, the horns very short, suberect, simply curved, projecting dorso-laterad from the caudal end of the dorsal face of the atrium. Ovisacs in three dissected lack the long caudal extensions usually present, and consist of short, rounded, irregularly globoid bodies with short, thick, somewhat twisted, caudo-lateral lobes. From the former a pair of short oviducts pass to join in the middle line ventral to the nerve-cord and open at the female gonopore.

Geographical Distribution.—The type-locality is Java, and Blanchard has recorded the species from Sumatra and the Celebes also. The writer has numerous examples from Borneo and the Philippines, and has recorded (1924) examples from Kashmir, the Kumaon Lakes, Naini Tal, W. Himalayas, Pengona, Berar, Central Provinces and the Simla Hills, Punjab. Under the name of *Herpobdella hexoculata*, Kaburaki has described immature specimens from Burhampur and Hoshangabad, Central Provinces and Baitulgharib stream, Nowshira, Peshawar District, N.W.F. Prov. It is now possible to add a record from the Nepal Valley, E. Himalayas, at 4500 ft. The greatest altitude recorded is 6300 ft. in Naini Tal. Thus it will be seen that, although widely distributed in the islands south of India, all of the Indian records are from the highlands of the extreme northern districts. None have yet been reported from Ceylon or the greater part of Hindustan and Burma.

Nothing is known of the habits of the species, which occurs under stones in streams, ponds and lakes in association with *Glossiphonia annadalei*, and in one case with *Hæmadipsa zeylanica agilis*.

B. rouxi, Johansson, resembles this species very closely, but as described there are slight differences, especially in the reproductive organs, which may be diagnostic or due to the condition of the specimens.

Genus HERPODELLOIDEA, Kaburaki.

Synonymy:

Herpobdelloidea, Kaburaki, 1921, p. 705.

Nematobdella, Kaburaki, 1921, p. 706.

? *Salifa*, Blanchard, 1897, p. 7, text-fig. 8, Taf. iv, fig. 2.

Type-species, *Herpobdelloidea lateroculata* Kaburaki, 1921, pp. 705, 706, fig. 4. Central Provinces, India.

There is little doubt that this genus is a synonym of the African leech *Salifa*, Blanchard, the type-species of which (*S. perspicax*) is almost identical with *H. indica*, but as the pharynx is figured

without teeth it is safer to leave the question open until the anatomy of *Salifa* has been reinvestigated.

Diagnosis.—Small and slender. Eyes, a single dorsal pair on the head and several smaller submarginal pairs on the sensory annuli of somites IV to IX, or some of them. Complete somites showing a tendency toward enlargement and division of the fifth annulus (*b* 6) and to a lesser degree of the third annulus (*a* 2). Pharynx and atrium of the *Dina* type, but the former with two retractile teeth or stylets on each ridge. The variation in the number of accessory eyes in the two species indicates their derivation from a type having more numerous pairs, like *Trematobdella*.

Key to Indian Species.

1. Complete somites quinquannulate, division of *b* 6 incipient; gonopores separated by two and one-half to three annuli; first pair of eyes on IV; the accessory eyes variable, four or five pairs, on IV to IX *H. lateroculata*, p. 141.
2. Complete somites sexannulate, *b* 6 completely subdivided into two unequal annuli (*c* 11 and *c* 12); gonopores separated by five annuli; first pair of eyes on dorsum of III; the accessory eyes five pairs, on IV to IX inclusive *H. indica*, p. 144.

26. *Herpobdelloidea lateroculata* Kaburaki. (Pl. VI, figs. 13, 14.)

Synonymy

Herpobdelloidea lateroculata Kaburaki, 1921, pp. 705, 706, fig. 4 (annulation). Central Provinces, India.

H. lateroculata Kaburaki, Moore, 1924, pp. 370, 371. Manipur, India.

Diagnosis.—Size even smaller and form almost as slender as *H. indica*. In life translucent pale buff with darker alimentary canal. Eyes five, or rarely six, pairs, the first larger and dorsal, on IV, the others ventro-lateral, on IV to VIII, rarely IX, inclusive. Complete somite quinquannulate, with the last annulus (*b* 6) more or less enlarged and incipiently subdivided. Gonopores separated by two and one-half to three annuli, the male being in XII *a* 2 or *b* 2/*a* 2, the female very constantly XII/XIII. Pseudognaths well developed, and two anterior teeth (stylets) on each pharyngeal ridge. Atrium simple, globular; sperm-duct lacking preatrial loops.

Type in Indian Museum.

Description.—In life it is possible that this species does not ordinarily exceed an inch in length when extended. The largest well-extended example in the collection measures 17.5 × 1.1 mm.

Most of the others are under one-half inch in length, one such measuring 12 mm., with a maximum width and depth at caudal end of the clitellum of 1.8 and 1.1 mm. respectively and a sucker diameter of 0.7 mm.

Form slender, but probably somewhat less so than *H. indica*, subterete throughout except toward the caudal end, where the depth may be only one-half the width and the margins somewhat sharp, but in fuller extension rounded. Greatest width at the caudal end of the clitellum, from which the body tapers both ways, but very little caudally. Head small, but the lip much less prolonged and narrower than in *H. indica*, rather broadly rounded at the end, as well represented in Kaburaki's figures. Oral chamber and mouth small for the family, with thickened furrowed margins. First pair of eyes on dorsum of IV, unusually far behind the end of the lip, well separated, large and directed chiefly forward. Occasionally there is an additional very small eye on one or both sides close to the larger ones. Supplementary eyes variable in size, number and exact position, submarginal, on annulus *a* 2 or its equivalent of IV to VIII, V to VIII, and V or VI to IX; the pair on IV rarely present, that on V sometimes very small or absent, that on VIII rarely absent and then replaced by a pair on IX, the latter absent from most examples and on one specimen represented by a single eye. These are true eyes, having the same structure as the first pair, but never more than one-half as large. The pair on IV is directed cephalo-laterad, the others caudo-laterad. Those on IV represent the more posterior or buccal group of eyes of *Erpobdella*, the anterior or labial group of the latter being absent.

Clitellum well developed as an opaque glandular layer on specimens as small as 9 mm. long, of fifteen or sometimes sixteen (X *b* 5 or occasionally *a* 2 to XII *a* 2 inclusive), completely annular and sharply defined. Gonopores separated by from two and one-half to three annuli, the female being constantly at XII/XIII, the male at either XII *b* 2/*a* 2 or within *a* 2, close to the cephalic border or even as far as its middle. Both are small but open, rounded orifices, the male somewhat the larger and in some cases surrounded by a slightly thickened circular glandular area extending over the bounding annuli. Anus and caudal sucker as *H. indica*. Nephropores as usual, seen only in sections.

Colour described by Annandale from living specimens as follows: "pale buff without external markings. Anterior part of body [clitellum] opaque, posterior semi-translucent with a dark streak showing on each side and due to some internal organ" [testes and walls of stomach]. Preserved specimens are yellowish, without definite pigment pattern but with traces of fine lines between the longitudinal muscle-bands.

Annulation at the ends obscure and not fully worked out on the available material. Complete somites (VII to XXIV)

quinquannulate, *b* 6 usually slightly enlarged and subdivided, approaching *Dina*; VI is quadrannulate; V biannulate or triannulate; IV and probably III biannulate, and I and II probably uniannulate. At the caudal end XXIV has *b* 6 reduced nearly to the size of *b* 5, XXV triannulate, and XXVI and XXVII uncertain. All annuli are slightly roughened both dorsally and ventrally by small papillæ best developed on posterior segments. Except for their frequent enlargement on the margins of *a* 2, they appear to show no definite differentiation. Some specimens are thickly studded with small opaque glands not evident on others.

Anatomy of alimentary canal generally similar to that of *H. indica*. The pharynx has a ventral median ridge for most of its length, but near the anterior end a spiral twist of about 60° in a clockwise direction when viewed from in front places the right dorso-lateral ridge in the median dorsal position and the paired ridges ventrad, each ridge bearing two long conical teeth or stylets placed tandem near its cephalic end. The soft pseudognaths alternate with the ends of the three ridges, and are long, narrow triangular folds of epithelium and muscle. Intestine broader than stomach and bearing four pairs of short simple pouches.

Reproductive organs of the *Dina* type. There appear to be only about eight pairs of testes on each side of each segment from XXIV to XVIII. Much folded epididymes in XVII to XIV and no preatrial loops of the ducti ejaculatorii. The very small atrium is spheroid without the conspicuous muscular covering of *H. indica*, but with an aggregation of glands at the prostate end. Prostate cornua small, curved, running directly laterad from the atrium.

Geographical Distribution and Bionomics.—Little is known of the geographical distribution and bionomics of this species. Kaburaki's types came from Bushampur and Saugor, in the Central Provinces; other specimens are labelled "outside Farm Caves in Moulmein, Lower Burma"; "Khardi Nadi, Loktak Lake, Manipur, Assam, 2600 ft."; "Coviloar." They are found in small streams and ponds.

Dr. Annandale had the following note on the behaviour of specimens, the locality of which is not stated:—"This little leech is remarkably planarian-like in life. It moves rapidly along the surface of water-plants etc. without looping its body, the whole of which is kept in contact with the surface along which it is moving, while the posterior and anterior suckers are alternately attached and loosened and the body expanded and contracted. The anterior extremity is sharply pointed, and is often moved rapidly from side to side as if investigating the surroundings."

The stomach of one examined was filled with a mass composed of the remains of insect larvæ, entomostracans and debris such as is found in the bottom ooze or slime covering aquatic plants.

27. *Herpobdelloidea indica* (Kaburaki). (Plate III, fig. 3; VI, figs. 15, 16.)

Nematobdella indica Kaburaki, 1921, pp. 706, 707, fig. 5 (annulation), Simla Hills.

Diagnosis.—Size small, up to about 40 mm. long; very slender, much attenuated anteriorly. Living colour probably reddish; no pigment-pattern on preserved specimens. Eyes six pairs, the first on III, dorsal; the remaining five pairs smaller, submarginal, on V to IX inclusive. Complete somites of six unequal annuli ($b1 < b2 < a2 > b5 = c11 > c12$), the third ($a2$) being the largest and the sixth ($c12$) the smallest. Gonopores separated by five annuli, the male at XII $b1/b2$, the female at XII/XIII. Atrium a depressed ovoid sac with cornua concealed beneath outer muscular coat.

Type in Indian Museum.

Description.—Kaburaki's type measures 45×4 mm. Those studied by me are from 30 to 43 mm. long, the complete measurements of one being: length, 40.5 mm.; length to male pore, 9 mm.; buccal width, 0.7 mm.; width at male pore, 1.6 mm.; maximum width (XVI), 3.1 mm.; width at anus, 2 mm.; depth at male pore, 1.3 mm., at middle, 1.7 mm.; caudal sucker, 2.5 mm.

Form unusually slender, nearly uniform for most of length, but slightly wider at middle and tapering more to the very slender pointed cephalic end. Buccal region terete, becoming gradually more depressed and the margins sharper until at the caudal end small marginal flanges appear. Head very small, the lip narrowly subconical and elongated, projecting far beyond the small contracted orifice, finely furrowed on the venter and margin, as is the buccal rim also. Eyes six pairs, the first pair much the largest, dorsal, directed forward; on the third ring (III), occasionally divided into two on one or both sides. Supplementary eyes much smaller, variable, often increasing in size caudad, the second pair on the caudal half of the first annulus of V, the others on the middle annuli of VI, VII, VIII and IX directed laterad and increasingly caudad (fig. 43). The specimen figured has a small eye on IV, directed forwards. Other examples bear minute black marginal spots (not eyes) on every annulus of VII and VIII.

Clitellum well developed as a distinct glandular zone, smoother and darker-coloured than the rest of the surface, extending over eighteen annuli, or two full somites and parts of two others, from X $b5$ to XIII $a2$ inclusive. Several specimens have the clitellum covered with a thin layer of very tough mucous (forming egg-capsule?). Male gonopore at the furrow XII $b1/b2$ and the female five annuli behind at XII/XIII. The former differs much in appearance, but in all cases is a conspicuous opening. Most frequently it is a more or less wide open orifice with furrowed margins through which the smooth ventral face of the atrium with its pore may be seen projecting into the bursa. In others the bursa is more or less everted and the atrium appears as a smooth, low, conical

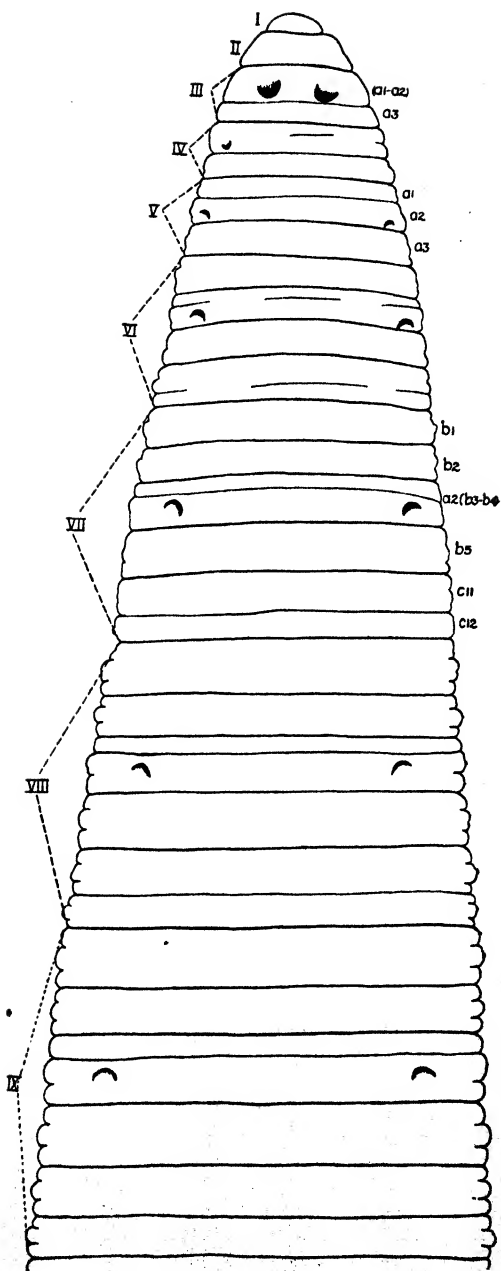

Fig. 43.—*Herpobdelloidea indica*. Dorsal aspect of somites I-X of a cleared specimen, showing annulation and pigment-cups of eyes. $\times 36$.
L

papilla in the centre of a soft ring or a single or double disk of mucous membrane. The female pore is a small round opening in the furrow. Anus the usual rather large opening at XXVI/XXVII, succeeded by from two to four small annuli. Caudal sucker a small, thin, simple disk directed ventrad and but little free from the body, as the peduncle is practically uncontracted. Nephropores as usual, but very minute and difficult to detect (Kaburaki).

Colour of preserved specimens opaque white or grey, with a slight buff tint most marked on the clitellum. No pigment except in the eyes and the minute black dots on the margins of annuli about VII and VIII. During life the red blood probably shows through the pigmentless skin, resulting in a pink colour.

Annuli sharply defined and either smooth or more rarely wrinkled. Each bears a ring or two rings of small pointed sensory papillæ, the principal ones being connected on successive annuli by fine raised longitudinal lines continuous for the entire length of the body. Somites I and II (fig. 43) are uniannular and form the prominent preocular lip. III is as long as I and II combined, has a faint $a2/a3$ furrow, and bears the first large pair of eyes. IV biannulate, $a3$ somewhat smaller, and united on venter to form the buccal ring; rarely bears small eyes submarginally on the sensory zone. V biannulate ($a1, a2 > a3$), eyes on $a2$. VI quadrannulate ($a1 = a2 < b5 < b6$), $b6$ being distinctly enlarged and incipiently subdivided. VII quinquannulate ($b1 > b2 < a2 = b5 < b6$ ($c11 > c12$)). VIII sexannulate ($b1 < b2 = a2 = b5 = c11 > c12$); $c12$ is much smaller than the others and, like $b1$, carries only one row of sense-organs, all of the others having two rows; $a2$ bears an incipient $b3/b4$ furrow. Throughout this preclitellar region the intersegmental furrows are deeper than the others and $c11/c12$ is much shallower. IX to XXIII sexannulate, differing from VIII only in fuller development. XXIV quinquannulate, with $b6$ reduced to the size of $a2$ and $c11/c12$ faint. XXV and XXVI together comprise five or six annuli, but, with XXVII, their exact composition is uncertain.

Alimentary canal nearly as in *Herpobdelloidea lateroculata*. Oral chamber very small, opening through mouth directly into very short buccal sinus, the velum being reduced to three (ventro-median and paired dorso-lateral) small, slender, triangular lobes (pseudognaths) alternating with the ends of the three pharyngeal ridges. Pharynx long and slender, reaching from VI to beyond the middle of somite XII, the median ventral and dorsal paired ridges low and flat, especially toward the caudal end, where the pharynx terminates in an annular valve separating it from the stomach. Near the anterior end the ridges turn spirally clockwise as viewed from in front until the ventro-median becomes the right ventro-lateral and the right dorso-lateral the dorso-median ridge. Teeth as in *H. lateroculata*. Stomach reaching from XIII to XIX inclusive, consisting of six chambers separated by slight intersegmental constrictions. The walls are thin,

translucent and with mucous lining thrown into fine, high, vermicular, longitudinal folds. Intestine similar to stomach, from which it is delimited by a deeper constriction, behind which is a pair of small pockets. Except that the walls are thicker and opaque and the mucous folds higher and more complex, the intestine does not differ from the stomach, being similarly slightly chambered. Behind XXIII these chambers become fainter and the intestine gradually tapers to the anus.

Reproductive organs approaching those of *Dina* most closely. Testes mostly in XXIII to XVII, about twenty on each side of a somite, but a reduced number continuing forward into XIII. Enlarged portion of sperm-duct (epididymis) much folded and confined to somites XVII to XV, anterior to this tapering to a very slender duct which opens into the middle of the atrium without preatrial loops. Atrium (fig. 44, *at.*) a low ovoid sac



Fig. 44.—*Herpobdelloidea indica*. Outline of terminal portions of reproductive organs, from the dorsum. $\times 10$. *at.*, atrium enclosed in its muscular envelope; *g. XII*, ganglion XII; *o.*, ovisacs; *od.*, oviducts; *vd.*, vas deferens.

without externally visible cornua and in the specimens dissected, which are mature and sexually active (taken in July), scarcely rising above the level of the nerve-cord. The entire organ is completely covered by a layer of the ventral longitudinal muscles, from which strands pass obliquely forward and laterally to the body-walls. When the muscular coat is dissected away, a pair of very short prostate cornua is brought into view, and the atrium proper is found to have the usual structure and to lie largely within an unusually spacious genital bursa. It is the mucous lining of the latter that is everted through the external male orifice to form the soft ring and disk described above, often carrying the free apex of the atrium with it. If the ovisacs are fully mature in these specimens, they present an unusual condition

(fig. 44, o.). They are a pair of small, irregularly globoid sacs, each bearing a small caudal appendage and continued antero-ventrally into a short oviduct (*od.*) which meets its fellow in a short median duct that passes vertically through the body-wall to the female orifice. The entire organ is concealed beneath the nerve-cord and the clitellar glands.

That these specimens are mature and sexually active is shown by the discovery of a spermatophore (fig. 45) filled with sperm attached close to the median line on annulus XI α 1. It measures



Fig. 45.—*Herpobdelloidea indica*. Outline of a spermatophore. $\times 36$.

slightly more than 2 mm. in length and is dead white with a brownish covering. An egg-capsule containing three young also was found along with the leeches, attached to a stone, and is shown in fig. 3 (Pl. III), as drawn from life. It measures 7×2.4 mm.

Geographical Distribution.—All known specimens of this species were taken at the base of the Simla Hills, Patiala State, in the Punjab, Kaburaki's types coming from near Dhuramapur Kooa and those described above from Kalka at an altitude of 2400 ft., July 21, under stones in a small pool. (See Appendix, p. 297.)

Genus **FORAMINOBELLA**, Kaburaki.

Foraminobdella, Kaburaki, 1921, p. 707.

Type-species, *F. heptamerata* Kaburaki, 1921, pp. 707-709, fig. 6 (annulation). Madras.

Diagnosis.—Size medium and form robust. Eyes a single dorsal pair on III. Complete somites consisting of seven annuli, the first four large and usually further incipiently and incompletely biannulate, the last three short and representing b_6 , ($b_1 + b_2 + a_2 + b_5 + c_{11} + d_{23} + d_{24}$). A dorsal opening into the stomach at XIV/XV. Little known of internal anatomy, but pharynx and atrium apparently as in *Dina*.

From *Trematobdella*, Johansson, 1914, which possesses an exactly similar opening into the stomach, this genus differs in the much more complex annulation of the somite and, so far as known, in the absence of accessory eyes and pharyngeal teeth. Completer knowledge of its anatomy may necessitate the union of the two genera.

The interpretation of the last three annuli of complete somites as c_{11} , d_{23} and d_{24} differs from that generally applied to related species, and is based upon the relative depths of the furrows, of which d_{23}/d_{24} is distinctly shallower than c_{11}/d_{23} , the slightly smaller size of the last two annuli, and the fuller development of the line of sense-organs on c_{11} . In most other related leeches c_{11} becomes subdivided into d_{21} and d_{22} while c_{12} remains undivided.

Only one Indian species known.

28. *Foraminobdella heptamerata* Kaburaki. (Plate VI, fig. 17.)*Synonymy* :

Foraminobdella heptamerata Kaburaki, 1921, pp. 707-709, fig. 6 (annulation). Madras, India.

Diagnosis.—Size medium, 40×5 mm., larger and more robust than either of the last three species. Colour (preserved) dark grey or slaty above, paler grey below. Eyes one pair, on III. Complete somites septannulate, consisting of four longer annuli, each again partially biannulate, and three shorter, simple annuli. Gonopores separated by a full somite, the male at XI/XII, the female at XII/XIII. A large dorsal orifice at XIV-XV, opening into the stomach.

Type in Indian Museum.

Description.—The unique type-specimen by which this species is known, when examined by me, measured: length, 39 mm.; length to male pore, 9.5 mm.; buccal width, 3 mm.; width at male pore, 5.5 mm., which is also the maximum width continuing to XXII; depth at male pore, 4 mm.; depth at XXII, 2.5 mm.; diameter of sucker, 2.8 mm.

Form robust, cylindroid or slightly depressed, most so toward the caudal end, of nearly uniform width, though somewhat tapered at the ends. Lip as preserved very short and broad, coarsely granulated below. Mouth large. Eyes one pair, on somite III, rather large, separated by about their diameter and directed forward.

Clitellum thick, sharply defined and completely zonary, extending over three full somites, twenty-one annuli, from X b 5 to XIII a 2, inclusive. Male gonopore at XI/XII, a large orifice with furrowed margins on the summit of a prominent conical papilla arising from the entire length of both bounding annuli. Female gonopore a small round pore deep in the furrow XII/XIII. On the dorsum, in the furrow XIV/XV (XIV c 11/c 12 according to Kaburaki) is a large slit-like orifice borne on the summit of a conical papilla similar in size and appearance to that bearing the male pore. This is the outer opening of a tubular invagination of the skin that meets a similar diverticulum from the roof of the stomach. The epithelial lining of the latter is thickened and both parts are folded longitudinally. Both in position and in structure this is exactly like a similar organ described in *Trematobdella persipicæ* by Johansson (1909). Nothing of its function is known, but as Michaelson has pointed out, it resembles the spermathecæ of certain Oligochæta.

Colour nearly uniform dark grey or slaty above: much lighter, with a slight yellowish tinge, below; the clitellum and areas surrounding the openings into the body distinctly yellowish. Kaburaki gives the colour of the specimen when examined by him in 1921 as black above, olivaceous below.

Annulation.—The surface of the body is much wrinkled in deep transverse integumental folds, making the interpretation of the annuli difficult. No sense-organs or papillæ are visible. Complete somites (VII–XXIV) consist of seven annuli, the first four being longer and each divided by an incipient furrow, the remaining three much shorter, but the last two are separated by a furrow much shallower than the others and might almost as correctly be counted as one. The formula would be, therefore, $b 1 = b 2 < a 2 > b 5 > c 11 = d 23 = d 24$, or, if the last two be counted as one, $< c 12$ or $< (d 23, d 24)$. In the latter interpretation $c 12$ is longer than any of the first four annuli and twice $c 11$. Somites I, II and III are uniannulate; IV is biannulate ($a 1 a 2$) $> a 3$, and bears the eyes on the large annulus; V triannulate, $a 1 = a 2 < (b 5, b 6)$; VI quadrannulate ($b 1, b 2$) $= (b 3, b 4) > b 5 = b 6$; XXV quadrannulate or triannulate ($b 1, b 2$) $> a 2 = a 3$; XXVI and XXVII probably both biannulate.

Anatomy.—As the specimen is unique and not available for dissection, only a few points of internal anatomy could be ascertained. The pharynx terminates anteriorly as does that of *Herpobdelloidea* in dorsal median and a pair of ventro-lateral ridges, but owing to the robustness and contraction of the specimen they are broad and truncate. Alternating with these ar

three slender pointed pseudognaths, dorso-lateral and median ventral in position. No teeth or vestigial jaws are apparent, but might be demonstrated were additional specimens or sections available.

Atrium globular, bilobed dorsally where it is divided into a pair of short, thick, divergent cornua into the ends of which the ducti ejaculatorii open without a preatrial loop, as in *Herpobdelloidea*.

The label attached to the type-specimen reads: "stream below coolie lines, Ossington Estate, Nedurattan, alt. 7200 ft. Nilgiri Dist., Madras. Sta. 70 M. I., 11-x-'19. R. B. S. S." [Seymour Sewell.]

Nothing is known of its habits. Although recorded as found in a stream, the structure suggests that it is amphibious and burrowing. The determination of the function of the gut-pore would be of interest, and more and better preserved specimens for anatomical study are very desirable.

Genus TROCHETA, Dutrochet.

Synonymy :

Trocheta, Dutrochet, 1817.

Trochetia, Blainville (in Lamarck), 1818.

Geobdella, Blainville, 1827 (not Whitman, 1886).

Nepheis (in part), Moquin-Tandon, 1826; Apathy, 1888.

Scaptobdella, Blanchard, 1897 (*teste* Oka, 1923).

Type-species, *T. subviridis* Dutrochet, 1817, p. 130. France.

Diagnosis.—Size variable, mostly large and robust. Eyes one to four pairs, confined to head. Complete somites typically of eight or nine rings, but variable (6–11 Harding), two or three annuli much larger than the others. General anatomy of typical species similar to *Erpobdella*, but the prostate cornua have a spiral turn (ram-horned).

One species known from India.

29. *Trocheta quadrioculata* Oka.

Trocheta quadrioculata Oka, 1922, pp. 530–533 (figs. annulation). Inlé Lake, Burma.

Diagnosis.—Size small for the genus. Form slender. Colour during life blood-red. Eyes, two pairs on IV and V. Complete somites novem-annulate ($c1 + c2 + b2 + a2 + c9 + c10 + d21 + d22 + c12$), the third ($b2$) and fourth ($a2$) about twice as long as any of the others. Gonopores separated by six annuli, the male close to XI/XII, the female XII $c10/d21$.

As this species is known only from Oka's two types, his description is largely quoted.

Type in Indian Museum.

Description.—"Both specimens are small and seem to be immature. The body is long and slender, almost cylindrical, being

only slightly wider in the middle than near the extremities. The head is rounded in front, forming the anterior lip of the spacious mouth. The hinder sucker is almost circular, a little broader than long and is directed ventrally and backward.

"The specimen from (a depth of) 9-12 ft. measures 24 mm. in length and 1.5 mm. in width; that from the first-named locality is 19 mm. in length and 1.3 mm. in width. The hind sucker is almost as wide as the body in both cases.

"External features:—The mouth is very wide and occupies the ventral surface of the first six rings. It is a spoon-shaped hollow directly continuous with the oesophagus. No jaws or so-called pseudognaths are visible externally.

"The eyes, in two pairs, are situated on the fourth and seventh rings, rather wide apart. In the individual from the first-named locality the posterior pair presents an anomaly in the fact that the right eye is placed one ring in front of the left eye, *i. e.* on ring 6. There is no marked difference in size between the anterior and posterior pairs.

"The genital apertures are small, almost invisible, except the male opening of the smaller specimen, which is rather prominent. The male pore is situated close to the posterior boundary of somite XI, the female pore just in front of the furrow separating ring 6 and ring 7 of somite XII; they are separated, thus, by a space equivalent to four rings of a five-ringed somite. The clitellum is not developed in either specimen.

"The colour is pale greyish, a little yellowish anteriorly. There is no indication that the animal possessed any pattern during life. The surface is perfectly smooth all over.

"As I have not studied the anatomy of the specimens, no comparison can be made with allied forms in regard to the structure of internal organs.

"*Annulation.*—The annuli are very numerous and of different widths. Except at the extremities they fall into groups repeated metamerically. A somite typically consists of nine small annuli arranged in the following order: two narrow, two broad, and five narrow."

Oka's figures indicate a somite constitution about as follows: I, II and III are uniannulate; IV is biannulate, bearing the first pair of eyes on the larger first annulus; V is triannulate, bearing the second pair of eyes on $a\ 2$ and forming the post-buccal annulus ventrally; VI is quadrannulate ($a\ 1 = a\ 2 = b\ 5 < b\ 6$; VII quadrannulate or quinquannulate ($b\ 1 + b\ 2 = a\ 2 < b\ 5 = b\ 6$; VIII is sexannulate ($b\ 1 = b\ 2 = a\ 2 = b\ 5 > c\ 11 = c\ 12$); the first four are approximately equal and twice as long as the last two; IX is octannulate ($c\ 1 = c\ 2 = 1/2\ b\ 2 = a\ 2 = \text{twice } c\ 9 = c\ 10 < c\ 11 = c\ 12$). X (presumably) to XXIV inclusive are complete and novem-annulate ($c\ 1 = c\ 2 = 1/2\ b\ 2 = a\ 2 = \text{twice } c\ 9 = c\ 10 > d\ 21 = d\ 22 < c\ 12$). In these the third and fourth annuli ($b\ 2$ and $a\ 2$) are the longest, twice the first, second, fifth, sixth and ninth, which are equal and distinctly larger than the seventh and eighth, the only represent-

atives of the fourth order. In the caudal region there is more uncertainty, but the following is indicated: XXV is quinquannulate ($b_1 = b_2 < a_2 = b_5 = b_6$) or sexannulate (Oka), XXVI triannulate or biannulate, and XXVII biannulate or uniannulate. The large anus is situated at XXVI/XXVII or XXVI a_2/a_3 .

Both of the specimens were taken in the central region of Inlé Lake, in the South Shan States, Burma; one, as stated on the label, on a muddy bottom in 9-12 ft. of water.

Although I have followed Oka in placing this species in the genus *Trocheta* and am satisfied that, in the absence of any knowledge of its internal anatomy and especially in view of the complex constitution of its somites, this is the best temporary disposition to make of it, I am by no means convinced that it really belongs here. Size, form and habitat are distinctly unlike typical *Trocheta*, and remind one of the, in the present state of our knowledge, distinctly Indian genus *Herpobdelloidea*. Also, if the eyes be situated actually on somites IV and V, this characteristic points the same way. It is possible that fuller knowledge of the species will determine its affinities with the latter genus, in spite of the much more elaborate annulation of the somites. A study of the structure of the pharynx and atrium would prove decisive.

Family HIRUDIDÆ.

Synonymy:

Gnathobdellea, Leuckart, 1863 (in part).

Gnathobdellidæ, Claus, 1885 (in part).

Hirudinidæ, Whitman, 1886 (and subsequent authors).

Hirudinides, Blanchard, 1887.

Gnathobdellidæ, Blanchard, 1894 (and subsequent authors).

Hirudinidæ, Perrier, 1897.

Hirudidæ, Pinto, 1823.

Hirudidæ, Moore, 1924.

General Characteristics.—The jawed-leeches, ten-eyed leeches, blood-suckers, etc., as the members of this family have been variously designated, present a more varied assemblage of forms than any other family except that of the fish-leeches (*Ichthyobdellidæ*) in the wide sense. As a group they are of medium to very large size, some of them attaining a length of fifteen or even eighteen inches and a width of one inch when fully extended. The smallest forms are found among the highly specialized land-leeches (*Hæmadipsinæ*).

Whether we consider the regulatory and growth-changes of individuals, or compare the individuals of a species or different genera and species, the variation in form far exceeds that of the *Erpobdellidæ*. The first results from a peculiar soft flaccidness of most of the aquatic forms due to the highly developed botryoidal and parenchymatous tissues, combined with great powers of extension and contraction, and the latter from a considerable range of adaptation to aquatic, amphibious, burrowing, terrestrial and arboreal modes of life and to predaceous, sanguivorous and truly parasitic habits of feeding. The same individual when swimming will be slender, elongated and flattened, like the *Erpobdellids*, and when resting or subjected to drying will assume the short, thick, rounded form of a hen's egg; and in either extension or contraction it may be flattened or cylindrical according to which set of muscles may be contracted. Only in the true land-leeches and a few of the burrowing, amphibious forms is the body firm and hard from the great development of muscles. The cephalic region, while never a permanently explanate disk, is, except in some of the strictly predaceous and burrowing genera, better developed than in the *Erpobdellidæ*, and in the sanguivorous leeches is often provided with an unsegmented margin capable of expansion into a functional sucking disk, especially prominent while feeding. The caudal sucker, while constant in general form and structure, differs greatly in size, being small and weak in the amphibious and predaceous forms, and often of a very large size in the more strictly parasitic forms. The dorsal surface may be tessellated and the ventral marked with radial or semiradial furrows and ridges ending in marginal scallops.

Eyes highly developed except in the burrowing and some of the more strictly parasitic species. Almost without exception there are five pairs arranged in a regular arch parallel with the margin of the head and borne on the dorsal surface of the sensory annuli of somites II to VI, inclusive. First pair derived from the paramedian and the others from the intermediate series of sensillæ. No accessory cephalic eyes and no caudal eyes are known. Metameric sensillæ, somewhat variable in number, highly developed, especially on the dorsum, usually conspicuous and easily distinguished from the numerous and widely distributed non-metameric sense-organs, but small and obscure in the burrowing and highly parasitic species. Papillæ may be present either in relation to the sensillæ or independent of them, and the integument may be quite smooth, variously marked by folds or short furrows or more or less regularly tessellated.

- Clitellum of the same extent and position as in the Erpobdellidæ, but seldom so evident, usually indicated externally, if at all, by a difference in the colour and a slight thickening, but no obscuration of annulation; internally by a thick layer of glands, which may extend in loose bundles nearly or quite to the wall of the stomach. Gonopores almost invariably separated by five annuli, the male on XI, and the female on XII, and usually both in the furrow *b*5/*b*6 or its immediate vicinity. There is some individual variation, and among the genera the interval between the pores may vary from two and one-half to nine annuli in the aquatic leeches, and from two to thirteen in the land-leeches. Very rarely are there modifications of the simple structure of the gonopores, the most noteworthy being in the American genera *Philobdella* and *Cardea*; nor are copulatory glands, such as characterize *Macrobdelella*, known in any Indian species. Nephropores seventeen pairs, usually conspicuous and opening on the caudal margin of VIII *a*1 to XXIV *b*2 inclusive.

Metamerism usually evident through the sensillæ, nephropores, colour-markings and other external segmental characters, but the size of the annuli and the depth of the furrows usually remain very constant throughout the region of complete somites. In the young of many species and in the adults of *Myxobdella* the intersegmental furrows are obviously deeper, and even the boundaries of the primary annuli are distinguishable from the secondary annuli by their greater depth. Strongly contracted leeches also often have annulus *b*1, especially on the venter, retracted below the level of the others by the principal muscular septum, thus indicating the position of the segments. In the aquatic leeches the quinquannulate composition of the complete somites is extremely constant, though the number of such somites may vary from twelve (Oka) in *Myxobdella* to seventeen in certain species of *Whitmania* and *Hæmopsis*, but is most often fifteen or sixteen. At the cephalic end the number of annuli increases very gradually through 1, 2, 3 and 4 for the first eight somites, while at the caudal end the reduction is usually more abrupt, from five to two

through four or five segments. In the land-leeches, on the contrary, though the number of complete somites remains very constantly fifteen or sixteen, the number of annuli, while most frequently five, varies from three to seven. At both ends of the body the somites are much more compact and the number of annuli much less than in the aquatic leeches. The general tendency in the Hirudidæ appears to be toward simplification of the somite rather than its elaboration, as in the Erpobdellidæ. Not infrequently it will be noticed that most of the annuli of preserved specimens of aquatic leeches are divided equally by a shallow transverse furrow. This may be due, not to the formation of a true tertiary furrow, but to the sinking of the integument into the collapsed transverse sinuses. The transverse folds which often stand up as prominent ridges across the annuli of contracted leeches are due to a somewhat similar artifact.

As in the Erpobdellidæ, the most frequently occurring *colour-pattern* is the longitudinally striped, but unlike that family the striping is very generally coupled with an often elaborate metameric pattern due to local intensifications, concentrations, enlargements, suppressions, interruptions or fusions of parts of these stripes, or to the addition to them of quite distinct elements. As the colours in life are often brilliant, these leeches are highly ornate as compared with the similar patterns and plain colours of the worm-leeches. Also, in contrast to the *Erpobdellidæ*, these patterns are most sharply defined in the young. As the leeches grow larger, the patterns become broken and ill-defined and often much modified, until, in the largest individuals of many species, they are largely suppressed and much obscured by scattered spots and diffused pigment. Mottled and solid patterns also occur, but true transversely barred patterns are very rare in this family. The patterns of many species are extremely variable, owing to the migrations of the excretophores and the different amounts of pigment which they carry, the first leading to changes in the depth and concentration of the stripes and spots, and to their union or separation in varied combinations, and the latter to a wide range of dilution and intensification and to variation in the general tint.

The *anatomy* of both the digestive and reproductive organs presents a considerable variety, but the essential features have been sufficiently dealt with in the general account of the suborder. A few features only require further elaboration. The jaws and teeth are of importance in generic distinctions. Typically there are three equally developed jaws, a dorsal and a pair of ventral, in both the aquatic and the land-leeches. In a few of the latter the dorsal jaw is absent, leaving the ventral pair only (Duognathoferæ, Harding, 1913), which are of large size. In the aquatic leeches they may have a very high arched, a semi-circular, or a flat curved profile, and vary greatly in size from the largest in the powerful blood-suckers to the smallest and weakest in certain predaceous genera and in the parasitic genus *Dinobdella*. Also jaws may be vestigial or quite absent, as occurs independently in two or perhaps

three genera not closely related. Teeth vary greatly in number in the monostichodont series from about thirty to one hundred and eighty, the exact number often being difficult of determination, as the series grades off in size very gently to the point of invisibility. The fully formed ones are sharp-pointed cones, either straight or curved. The completely edentulous *Dinobdella* also belongs to this series. In the distichodont series the teeth are larger, more irregular and much fewer, from three or four to about thirty pairs, or they may be replaced by irregular horny plates or be totally absent. Jaws may be absent in this series also, and in general they are weaker and less well armed with teeth than in the monostichodonts. Papillæ on which the salivary glands open are common among the Indian monostichodont blood-suckers.

The *nephridia* are commonly seventeen pairs, of large size, and richly supplied with blood-vessels, and their funnels, which lie in the testicular sinuses, have the nephrostomes occluded.

Reproduction in the species of this family, so far as known, occurs by true copulation. Spermatophores are not formed, but the sperm is introduced into the vagina by means of the more or less elongated, filiform penis. The fertilized ova are laid in a quantity of albuminous jelly or mucous in an ellipsoidal or spheroidal capsule or egg-cocoon covered with a thick outer spongy layer of large polygonal cells and composed of a firm horn-like secretion of the clitellar glands. Those of the aquatic species are deposited in damp earth by the side of the water and of the land-leeches under stones and logs in damp places. The breeding habits and cocoons of most of the Indian species are unknown, or at least the information is unpublished.

The habitats and varied modes of life of the Hirudidæ are described under the two subfamilies and particular species. The Hirudidæ have greater economic importance than the Erpobdellidæ, and practically all that is included in the general account of the suborder on this subject relates to this family. Further details will be found in the accounts of certain species.

In the classification of the Hirudidæ several subdivisions have been proposed, but the only one that it seems desirable to adopt here is that of the two subfamilies recognized by Blanchard. With the elimination of a few forms usually included in the *Hæmadipsinæ* these appear to be fairly well defined groups, each embracing a considerable number of genera.

They are separated as follows:—

- A. Complete somites quinquannulate; third and fourth pair of eyes separated by an annulus (IV α 3); somites XXIV at least triannulate and XXV and XXVI at least biannulate; dorsal sensillæ in eight, and ventral in six series; nephropores all opening ventrally on somites VIII to XXIV; no auricular appendages on anal region

[p. 158.
Subfamily *Hirudinæ*,

- AA. Complete somites most frequently quinquannulate but varying from tri- to septannulate; third and fourth pairs of eyes usually on contiguous annuli, only exceptionally separated by a more or less developed annulus; somite XXIV biannulate, and XXV, XXVI and XXVII uniannulate; dorsal sensillæ usually in six and ventral in four or six series, the marginals being absent; first pair of nephropores usually opening laterally on buccal ring, the last pair marginally on the ventral face of the first auricular lobes on XXIV or by a common median pore beneath the border of the caudal sucker, the remaining fifteen pairs marginally on the caudal border of IX *b* 2 to XXIII *b* 2 inclusive; buccal frill and anal auricular appendages usually present. Subfamily *Hæmadipsinæ*, [p. 244.

Subfamily HIRUDINÆ.

Synonymy.

Hirudinina, Blanchard, 1894, 1917.

Hirudinina, Perrier, 1897.

Natantia, Brandes (in Lenckart), 1901.

Hirudina, Pinto, 1923.

Type-genus, *Hirudo*, Linnæus, 1758.

General characteristics.—The structural features of this, the typical subfamily, require no further discussion, but brief mention may be made of the variety of forms and habitats. Although usually thought of as strictly aquatic animals, and, as a matter of fact, for the most part actually living in the water and so dependent upon it that they survive drying for a short time only, most of these leeches are more or less amphibious. They belong to the marginal zone of still waters—to what ecologists call the littoral lenitic habitat. The only Indian species that appears to habitually live in the rapidly running waters of streams is *Myxobdella annandalei*. When living in lakes and ponds the ordinary aquatic leeches inhabit the very shallowest water, wherever stones, logs, plants, etc., offer concealment. They often collect in large numbers under pieces of driftwood that are partly in, partly out of the water, and lie resting partly exposed to the air. While many of them are strong swimmers, moving as do the Erpbodellidæ, and ranging into the open waters, their wanderings are hunting excursions undertaken usually only under the urge of hunger. Satiated leeches are resting leeches. It will thus be seen that most members of this family are swamp animals rather than inhabitants

of the larger and deeper waters. India, with its extensive flood plain, freshwater swamps, rice-fields and numerous small, shallow, weedy lakes, ponds and village tanks, furnishes ideal habitats for these leeches, and their abundance shows that they have profited by the opportunity. The transition from aquatic to amphibious and then to terrestrial modes of life is therefore easy, and while no true burrowing leeches, like the *Hæmopsis*, *Semiscolax* and *Cardea* of other countries, have been found in India, it is very probable that they do occur.

Blanchard has divided this subfamily into the two tribes of Monostichodonta and Distichodonta, the first typified by *Hirudo*, with denticles in a single series, the second by *Hæmopsis*, with two rows of teeth. While these two types clearly represent divergent branches, they are so closely united by annectant genera that they cannot be utilized as definite taxonomic groups. The distichodonts are in many respects the most primitive, and in their predatory habits (feeding on worms, insect larvæ and other smaller invertebrates, varied by an occasional meal of blood) their relatively simple digestive tracts, weak and often edentulous or even vestigial jaws, they stand nearest to the Erpobdellidæ. On the other hand, their reproductive organs are the most complex of the suborder. *Myxobdella* and *Whitmania* belong here, but no true *Hæmopsis* is now known to occur in India. Several species have been reported, but all have proved to be monostichodonts, as indicated in the synonymies of species. The monostichodonts are more numerous in genera and species, and some of them very abundant in individuals, probably for the reason given in the general account on geographical distribution. Most of them have large, papillated jaws, and are exclusively or nearly exclusively sanguivorous. Just as there is an easy transition from aquatic to terrestrial life and between a solid carnivorous diet and a sanguivorous or liquid diet, so is there from those sanguivorous leeches which attach to hosts only long enough to partake of a meal of blood to the truly parasitic leeches that inhabit the air-passages of their hosts for long periods. These latter have very fine teeth or, like the great cattle-leech (*Dinobdella ferox*), no teeth at all, and are capable of piercing the delicate mucous membranes only.

Key to Genera and Subgenera of Indian Hirudinæ.

I. Jaws small and weak; teeth mostly in two irregular rows, few, blunt, irregular, coarse, often vestigial, or thin chitinoid plates, or absent. (*Distichodonta*, Blanchard.) Chiefly predaceous.

1. Complete somites 12-14, indeterminate, imperfectly 5-annulate, with furrows of unequal depth; head not attenuated; only 3-4 pairs of teeth; stomach cæcate; colour-pattern spotted

MYXOBDELLA, p. 161.

2. Complete somites 17 (VIII-XXIV), perfectly 5-annulate or nearly so, with furrows of equal depth; head attenuated; 15-20 pairs of teeth or none; stomach saccate; colour-pattern striped.. WHITMANIA, p. 168.
- II. Jaws typically well developed; teeth in a single graduated series, numerous (30-180), acute, regular and fine, rarely in part paired and rarely absent. (*Mono-stichodonta*, Blanchard.) Chiefly sanguivorous.
- a. Teeth absent or vestigial.
3. Complete somites 15 or 16 (IX-XXIII or XXIV), all but the last perfectly quinquannulate; gastric cæca highly developed, two pairs to each somite; both atrium and vagina simply tubular and much elongated; colour-pattern solid or simply striped. (Transitional between I and II) DINOBELLA, p. 175.
- aa. Teeth well developed.
- b. Salivary papillæ on jaws entirely absent or rarely a few very small ones; lip without median ventral fissure; caudal sucker medium size.
4. Teeth 40-100; somites as in 3; gastric cæca one large, little-lobulated pair in each somite; vagina fusiform, without cæcum. HIRUDO, p. 189.
- bb. Salivary papillæ on jaws numerous and large; lip with median ventral fissure; caudal sucker large.
- c. Reproductive organs as in *Hirudo*, vagina without cæcum; colour-pattern simple.
5. Teeth 30-100; complete somites 15 (IX-XXIII); two pairs of large, nearly equal, lobate gastric cæca to each somite; sensillæ circular LIMNATIS, p. 199.
- cc. Vagina with large cæcal pouch sharply differentiated from narrow duct; colour-pattern complex; sensillæ elongated.
6. Oviduct and vaginal duct opening into a short female bursa; no vaginal stalk HIRUDINARIA, p. 207.
7. Oviduct and vaginal duct opening into summit of elongated vaginal stalk PŒCILOBDELLA, p. 226

Genus **MYXOBDELLA**, Oka.*Synonymy* :

Myxobdella, Oka, 1917, p. 161.

Diagnosis.—Size and form approximating *Hæmopsis*, but caudal sucker much larger. Tissues peculiarly soft, tumid and œdematous. Complete somites imperfectly quinquannulate, with the furrows $b1/b2$ and $b5/b6$ much shallower than the others and often obsolete. Somite boundaries clearly indicated by deeper furrows or constrictions, even in the adult. Velum tumid, projecting into the oral cavity as a more or less prominent, rounded papilla, in the centre of which is the unusually small, trifid or triangular, pore-like mouth. Jaws very small, distichodont, with very few imperfect teeth. Stomach with gastric cæca as in *Hirudo*. Reproductive organs of the *Hirudo* type, except that there is a small vaginal cæcum. This genus, therefore, is transitional between the Monostichodonta and the Distichodonta in the strict sense.

Type-species, *M. annandalei*, Oka, 1917.

Two species, the above, which occurs in India as well as in China, and *M. sinanensis*, Oka, which is known only from Japan, and has the somites more highly elaborated and the colour-pattern with several series of metameric spots.

30. **Myxobdella annandalei** Oka. (Plate VII, figs. 19, 20.)*Synonymy* :

Myxobdella annandalei Oka, 1917, pp. 161-165, pl. vii, figs. 1-5 (exterior). Hong Kong, China.

Myxobdella annandalei Oka, Kaburaki, 1921, pp. 715, 716. Yercaud, Madras. (See also Appendix, p. 296.)

Diagnosis.—Length in life about 2-4 inches. Form robust. Sucker large, nearly equal to maximum width. Colour pale grey, more or less closely maculated with black or dusky blotches, which may be less developed on $a2$. Somites X-XXIII inclusive, complete, with the formula $(b1=b2)=(b5=b6) > a2$, in which the furrows $b1/b2$ and $b5/b6$ are constantly shallower than $b2/a2$ and $a2/b5$ but greatly variable, so that XXII and XXIII may be interpreted as incomplete.

Type in Indian Museum.

Description.—Exact form in life unknown, but probably differing little from that typical of *Hæmopsis*. All preserved specimens are strongly contracted, and the softness of the connective tissues, combined with the powerful musculature, indicate great changes in shape during life. Form of preserved specimens ovate or cuneate-ovate, very broad in the caudal one-fourth and tapered to the rather slender cephalic end; depressed, more or less strongly convex dorsally, concave or flat ventrally. Size varies from 15×7.5 mm. to 55×21 mm. Oka's examples measures 26 to 29 mm. long by 9 mm. wide. Kaburaki's single specimen was 17 mm. long by 4 mm. wide in the middle, thus being more slender and of more

uniform width than the others. The best preserved new example measures: length, 52 mm.; length to male pore, 9 mm.; buccal width, 3.5 mm.; width at male pore, 10.5 mm.; maximum width (XXII), 22 mm.; depth at male pore, 4 mm.; depth at XXI, XXII, 6 mm.; diameter of caudal sucker, 16.5 mm.

Cephalic end rather slender and slightly depressed; oral sucker of medium size (between *Dinobdella* and *Hæmopsis*), with a very mobile marginal fold, dorsal to which it is deeply lobate, owing to the projection of the tumid ends of the first four annuli. Ventral surface faintly and irregularly wrinkled, with the median furrow slightly developed or absent. Very characteristic is a small, rounded papilla, variable in height and prominence, projecting into the oral chamber from its caudal wall and bearing the notably small, trifid or triangular mouth at its centre and summit. This arises primarily from the tumid thickening of the central region of the velum, but its prominence may be accentuated by the forward projection of the pharynx. Dorsal surface of lip deeply and irregularly furrowed, the included areas often swollen. Eyes, five pairs, borne on somites II to VI inclusive, and arranged as in *Hirudo* and *Hæmopsis*, small, obscure and deeply placed as in the latter, especially on the larger specimens, which require clearing to make them visible. Buccal ring formed by the coalescence of both annuli of V ventrally with the addition of IV *a* 3 laterally; post-buccal of VI *a* 1 and *a* 2 completely united ventrally.

Clitellum fairly well indicated on the larger specimens by the hardening of the body-walls, due to the thickened layer of glands, but the annulation is unobscured and there is no obvious change in colour. It extends over fifteen annuli, from X *a* 2 to XIII *b* 2 inclusive. Gonopores separated by five annuli, the male at XI *b* 5/*b* 6 and the female at XII *b* 5/*b* 6. They vary in size with maturity, on the smaller specimens being small orifices without any special development of the surrounding areas. On the larger examples the male pore is a large, rounded orifice, in which the smooth, rounded, perforated end of the atrium appears, but in no case with a protruded penis. The female pore may be a still longer opening with furrowed margins. Nephropores seventeen pairs, situated on the caudal border of *b* 2, or its equivalent, of somites VIII to XXIV inclusive, small and seldom all visible in a single specimen. Anus of moderate size, intermediate between *Hirudo* and *Hæmopsis*, margins deeply furrowed, at base of sucker, behind somite XXVII.

On all except the smallest specimen the integument is curiously swollen and œdematous in areas between wrinkles, and somewhat translucent. The only leeches that I have studied which present a similar condition are *Placobdella pediculata*, *Cardea valdiviana*, *Theromyzon (Protolepsis, Livanow)* of several species, and to a slight degree *Hæmopsis grandis*. This results in a more or less tessellated surface, which, together with the numerous cross-connections between annuli, the smoothing out of the secondary furrows by the stretching due to distention of the gastric cæca,

and the characteristic variation in depth of the furrows, cause the peculiar appearance and notable variability of the species. Sensillæ very small and on these specimens obscure and difficult to see in surface views, but a sufficient number were detected to indicate that they have an arrangement similar to such forms as *Hæmopsis*. The great number of mucous glands obscures the non-metameric sense-organs.

Annulation.—Somites I to IV form the upper lip, and their boundaries are obscured by the wrinkling and areolation. I to III are clearly uniannulate; IV is larger, with a faint furrow $a2/a3$, the probably better development of which on their specimens led both Oka and Kaburaki to interpret IV as biannulate. V is more distinctly biannulate ($a1 a2$)= $a3$, on dorsum, but uniannulate and coalesced with IV on venter to form the buccal ring. VI is biannulate, or usually triannulate, on the dorsum, according to the degree to which the furrow $a1/a2$ is developed or interpreted. It is in all cases shallower than $a2/a3$, and completely disappears ventrally on the post-buccal ring. In one case there is a faint indication of the secondary furrow $b5/b6$. The furrow VI/VII is exceptionally deep, clearly delimiting the cephalic region. VII is triannulate all around, otherwise similar to VI, but better developed. VIII may be differently interpreted according to the specimen and the value given to the partially developed furrow $b5/b6$. Usually it is quadrannulate ($a1 > a2 > b5 = b6$), but may be triannulate by the slighter development of $b5/b6$. In any case the furrow $a1/a2$ is shallower than $a2/b5$ and deeper than $b5/b6$, the result being that the four annuli appear to be grouped in two pairs. IX again, which Oka and Kaburaki describe as quadrannulate, may be interpreted on the basis of three, four or five annuli, the view of the Japanese authors doubtless being the most reasonable and in accord with the most usual conditions. In this condition the formula is $a1 > a2 > b5 = b6$; the furrow $b1/b2$ is either faint or not at all visible, and $b5/b6$, while distinct, is shallower than $a1/a2$. The triannulate condition is found in a case where $b1/b2$ is obsolete and $b5/b6$ may be traced faintly across the venter and part of one side of the dorsum, but is totally absent from the other side of the dorsum. The quinquannulate condition found in one specimen differs from the following complete somites only in being slightly less well developed. X to XXIII, inclusive, are quinquannulate and complete, which agrees with Kaburaki's description but not with that of Oka, who describes XXII and XXIII as quadrannulate. These somites differ considerably in appearance, but the typical condition, which agrees fully with Oka's description, is as follows: the intersegmental furrows are the deepest, and often appear as constrictions between the swelling somites, a condition less obvious among the incomplete somites at the ends of the body. This delimitation is usually most conspicuous on the venter, where the furrows are deeper and the first annulus ($b1$), which is commonly smaller than the others, is retracted and often wholly or partly

disappears from view. Because of the greater depth of the primary furrows (a_1/a_2 and a_2/a_3) the annuli are arranged in three groups of two (b_1 and b_2), one (a_2) and two (b_5 and b_6), and because the furrow a_1/a_2 is shallower than a_2/a_3 there is a further grouping of the first three and the last two annuli. Exactly similar conditions are found on the dorsum of the smallest specimen, but on the others the furrows are more or less smoothed out. In the order of increasing depth the furrows are b_1/b_2 , b_5/b_6 , b_2/a_2 and a_2/b_5 , and this is also their order of constancy, a_2/b_5 being the deepest and most constant. The first furrow (b_1/b_2) is not only shallow but in nearly every case is partially or sometimes even wholly obliterated, and also lies nearer to the anterior than the posterior border of the primary annulus, so that b_1 is commonly much smaller than b_2 ; b_5/b_6 undergoes similar but less obvious and complete reduction, and occasionally even a_1/a_2 is similarly affected. XXIV is triannulate ($a_1 > a_2 = a_3$), the secondary furrows being very faint or entirely wanting, or in one case quadrannulate ($b_1 = b_2 < a_2$ slightly $< a_3$) on the right side and triannulate on the left. XXV is triannulate (a_1 slightly $> a_2 = a_3$) without trace of secondary furrows. XXVI and XXVII are each biannulate, with the first annulus larger and XXVII more reduced.

Oka has correctly emphasized the importance of this genus as throwing light upon the external morphology of leeches. It especially serves to verify recent theoretical conclusions concerning the delimitation of somites, the serial homology of annuli, and the order of origin and development and of reduction and suppression of annuli. Oka lays great emphasis upon the exact enumeration of annuli that he worked out from his material. Without wishing to detract in any way from the importance of the general considerations that he raises, I must point out that the very fact of the easy gradation of the development of annuli and furrows from somite to somite shows the impossibility of absolute determination of the number of annuli in each somite. The personal equation is a factor of large importance. In this enumeration Oka, Kaburaki and I disagree as to the constitution of certain somites. Oka's material was more abundant than mine, and doubtless it was better preserved. Apparently also it was more uniform, as no mention of variations was made. The four specimens examined by me present considerable variation, as indicated above, but they agree with one another and with Kaburaki's specimen, and differ from Oka's in the greater completeness of somites XXII and XXIII.

A fact of some interest is that in general the somites are more elaborated and the annuli more sharply defined in the smallest specimens. Among the anterior incomplete somites, beginning with V, and at the caudal end, especially on XXIV, the interpretation of the annulation places each one step in development beyond the corresponding somite of the larger individuals. This is just the opposite of the usual conditions. Very generally

young leeches exhibit a primitive inequality in depth of the furrows defining the somite limits and the primary annuli. Elaboration of the annuli and obscuration of the somite limits progresses with growth. Apparently the difference in this respect is due in at least part to the mechanical conditions resulting from the fact that the stomach is nearly or quite empty in the small specimen, whereas in the larger ones the cæca are much distended. This, together with the longitudinal contraction, results in a stretching of the integument and smoothing out of the furrows. It is noticeable that this proceeds farthest on the dorsal surface of the middle region, where the cæca are best developed, and that the mid-ventral field, which is protected from the pressure of the cæca, is least affected. This would indicate that the more elaborate development exhibited by the small specimen may be the normal of the species. However, it is more difficult to apply this argument to the incomplete somites, most of which lie outside of the sphere of influence of the gastric cæca.

Colour.—Light grey or ashy, paler below; maculated all over, but most thickly in the mid-dorsal field, with irregular blotches, often with slender branched processes, of varying size and appearing as black, brown or grey according to their depth below the surface; venter somewhat more sparsely spotted than dorsum. Different specimens differ in the size and the degree to which the spots become confluent. One of Oka's specimens is described as being thickly dotted with a darker shade and others as ashy-grey and unspotted, probably faded. There are indications that the neural annulus is less pigmented than the others and stands out as a paler transverse band. This is quite evident on one specimen from Suhil.

Alimentary canal combines characters of *Hirudo* and *Hæmopsis*. Jaws very small and weak. Teeth very few (three or four in each row,) large, blunt, irregular plates, in two rows. Pharynx a very small, muscular bulb in VI and partly in VII, followed by a distinct, narrow tubular oesophagus extending through VII, VIII and IX. Stomach cæcate, X, XI and XII, each with a single pair of long, slender, straight and simple cæca, reaching nearly to the sides of the body; XIII to XVIII have two pairs each, the anterior large, straight, laterally extended and faintly lobed, the second pair very small and between the bases of the larger. A large pair arises in XIX, and extends by the sides of the intestine to XXV. In another specimen the clitellar cæca are much smaller and the second pair in post-clitellar somites are reduced to obsolescence.

Reproductive organs (fig. 46).—Functional testes eight on the left, nine on the right side, in the caudal part of the segments (but reaching into the following segments) from XVI (XV on one side) to XXIII, inclusive. All of these are fairly large and globoid, the sacs, especially of the first three or four, with much brown pigment like the abundant botryoidal tissue. Anterior

to these and in the same serial position with them and with the ovisacs, in somites XIII to XV, that is, three on the left and two on the right side, are small, deep-brown sacs compressed to the body-floor. These appear to correspond with the anterior

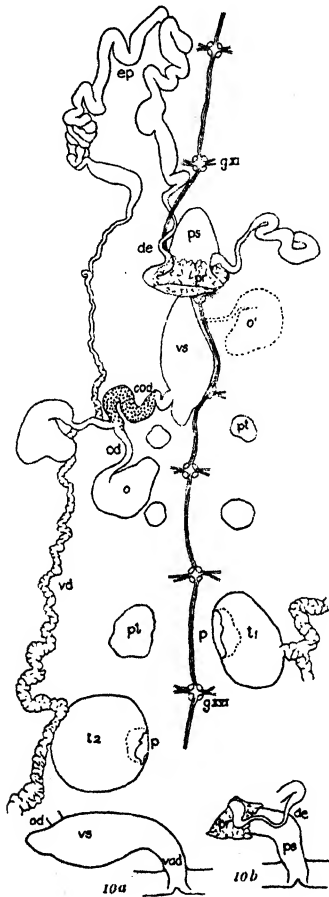

Fig. 46.—*Myzobdella annandalei*. Partial dissection of reproductive organs, from dorsum. Right epididymis cut away and left epididymis and ovisacs displaced to show atrium. $\times 5$. *c.od.*, common oviduct, enclosed in albumin gland; *d.e.*, ductus ejaculatorius; *ep.*, epididymis; *g.* XI–XVI, ganglia as numbered; *g.a.*, albumin gland; *o.*, ovisac; *o'*, normal position of right ovisac; *od.*, oviduct; *p.*, pigmented area on testes; *pt.*, pigmented areas in absence of testicular sacs; *p.s.*, penis-sac; *pr.*, prostate; *t. 1*, *t. 2*, testicular sacs; *v.s.*, vagina; *v.d.*, vaginal duct; *v.s.*, vaginal sac; *v.d.*, vas deferens; *10a* and *10b*, right elevation of vagina and atrium respectively.

ventral position of the testicular sacs, which at the point of exit of the vasa efferentia are similarly heavily pigmented. Oka records eight pairs of testes in his types. Vasa efferentia and vasa deferentia have the usual structure and position, the latter, as far forward as ganglion XVI, with an especially thick glandular covering. The slender, gland-free anterior part reaches to ganglion XI, where it arches mediad to join the cephalic end of the epididymis, this arched region being slightly enlarged to form a small, fusiform, soft-walled sperm-vesicle. Epididymis massive, much exceeding the atrium, lying at the side and anterior to it, and the right one largely covering it in this specimen. It consists of two distinct parts, an anterior smaller lobe constituted of a finer and more sharply folded duct, and the main body consisting of much larger folds of a much coarser duct. From the posterior ventral ends of the epididymes the delicate ducti ejaculatorii, which lack any enlarged bulb, arise and enter the prostate close to its latero-distal angles. Both are relatively short, somewhat less than the total length of the atrium, and the left passes beneath the nerve-cord. Atrium broadly pyriform, the length slightly exceeding twice the basal width. Penis-sac about three-fourths of total length of atrium, tapering toward outlet, the maximum diameter about one-third length. Prostate region very broad, flattened and angulated probably by pressure, covered by an unusually thick and extensive glandular layer.

Ovisacs relatively large, about equalling one-half of the size of the functional testes, each with a distinct, slightly projecting tubular lobe, from the end of which the oviduct arises. Paired oviducts about as long as diameter of ovisacs, the right one passing beneath nerve-cord. The two unite without a distinctly enlarged albumin gland into a wide, folded, common oviduct, which lies on the dorsal face of the vagina and opens into it a short distance below the blind end, leaving a small projecting cæcum. Vaginal sac two-thirds as wide as long, broadly curved, fusiform, with a short terminal cæcal lobe, not sharply differentiated from the tubular duct, which is about as long as the sac and tapers regularly to the gonopore. One of Oka's cotypes was dissected sufficiently to determine the agreement of the anterior part of the digestive tract and the terminal reproductive organs with the above account based upon the larger specimen (No. 3657) from the Dawna Hills.

Concerning the identification of the Indian specimens as *M. annandalei*, it should be pointed out that in certain features of annulation they approach Oka's description of *M. sinanensis* more closely than the former. This is considered to be due to varying condition of the specimens and to differences in interpretation, but it may be that we really have to deal with distinct species or subspecies which more abundant material should determine. As Oka has given no account of the anatomy of *M. sinanensis*, comparisons must be limited to external features.

Originally described by Oka from a small stream at an elevation of about 1000 ft. near Hong Kong, this species was subsequently reported from a hill-stream at Yercaud, Madras, by Kaburaki, the latter specimen belonging to the Indian Museum. I can now add the record of four additional specimens belonging to the Indian Museum: "ZEV 3657. From under surface of stones in a small jungle stream, 2500 ft. Dawna Hills, near Kawkaruk, Amherst District, Tenasserim, Lower Burma. Dr. N. Annandale, March 13, 1908." Two specimens, one dissected: "ZEV 4951, Suhil, East side of Dawna Hills, 2100 ft. F. H. Graveley, November 29, 1911. Under stones in streams."

The species appears, therefore, to inhabit hill-streams at slight elevations. It hides beneath stones, to the under surface of which it clings. According to Annandale the body in life is exceptionally soft, and it produces enormous quantities of mucous, which is in harmony with the appearance of the specimens studied by me. The large size of the caudal sucker, the unusual size of the pedicellar muscles attached to it, the great contractility and the unusual mucous function would adapt it to life in swift-running stony streams. From an examination of the stomach-contents Oka thought that the Hong Kong specimens had fed on the juices of invertebrates. Those from the Dawna Hills have the cæca filled with blood, which in the one studied for this purpose contained nucleated cells but no non-nucleated blood-disks. All that can be stated is that it is not mammalian blood.

Genus **WHITMANIA**, Blanchard.

Synonymy :

Microstoma, Whitman, 1884, p. 84. Not *Microstoma*, Cuvier, 1817 (Pisces).

Leptostoma, Whitman, 1886, p. 382. Not *Leptostoma*, Swainson, 1837 (Aves).

Whitmania, Blanchard, 1887, p. 155.

Whitmania, Oka, 1925, pp. 321, 322 (figures of annulation). Japan.

Diagnosis.—Size large. Robust body and slender, attenuated cephalic region very characteristic. Sucker of medium size. Eyes, sensillæ, gonopores and nephropores as in *Hæmopsis*. Complete somites of five equal annuli, seventeen in number, VIII to XXIV, inclusive. Colour-pattern longitudinally striped. Jaws small, with imperfect tooth-plates in two series, or none. Digestive tract of *Hæmopsis* type. Reproductive organs intermediate between *Hirudo* and *Hæmopsis* types, nearer to the latter, but the atrium and vagina much less elongated.

Type-species, *Microstoma pigrum* Whitman, 1884 (first species), Japan. (= *Hirudo lævis*, Baird, 1869.)

Of the four species referred to this genus by Blanchard (1886), *W. lævis* (Baird) [= *W. pigra* (Whitman)] and *W. edentula*

(Whitman) properly belong here; *W. acranulata* (Whitman) is a true *Hæmopsis* and *W. ferox* Blanchard is now made the type of a new genus, *Dinobdella*.

31. *Whitmania lævis* (Baird), Blanchard. (Plate VI, fig. 18; VII, figs. 21, 22.)

Synonymy :

Hirudo lævis Baird, 1869, p. 316. China.

Microstoma pigrum Whitman, 1884, p. 84. Japan.

Leptostoma pigrum Whitman, 1886, pp. 382-386, pls xviii, figs. 21-27 (exterior), xx, figs. 54, 55 (annulation), xxi, figs. 61, 62 (jaws), 67 (♀ organs). Japan.

Whitmania pigra, R. Blanchard, 1887, p. 155.

Whitmania lævis (Baird), R. Blanchard, 1896, pp. 326-328, fig. 6 (annulation). China.

Whitmania lævis, Plotnikoff, 1905, p. 145. China.

Whitmania pigra, Oka, 1910, p. 180, Japan. Var. *formosana*, p. 181, Formosa.

Whitmania lævis, Schegoleff, 1916, p. 251. Amur region.

Whitmania lævis (Baird), Oka, 1917, pp. 160, 175. China.

Whitmania lævis, Kaburaki, 1921, pp. 710, 711. Manipur, India.

Whitmania lævis, Moore, 1924, pp. 280-281. China, S. Shan States, India.

Diagnosis.—Length when mature 4-6 inches. Thick-bodied for most of length, contracting sharply with the abruptly-tapered anterior end and small head. Sucker of medium size. Colour in life olive-brown on dorsum, with five dark stripes, including pale yellow spots; venter paler, with a reddish or yellowish tinge streaked and spotted with black. Annuli VII α 3 and VIII α 1 fully divided into secondary annuli. Somite XXIV with b 5 and b 6 fully distinct and little smaller than the other annuli. Jaws bearing two series of thin chitinoid plates in place of true teeth. Distinguished from all known Indian Hirudidæ except *Dinobdella ferox* by the slender anterior end, and from that species by the smaller sucker and nearly uniform width, and the colour. Type in British Museum.

Description.—A large, robust, and fleshy-bodied leech of nearly uniform width for most of the length, but the first seven or eight somites abruptly attenuated (less so than in *W. edentula*). A large specimen swimming measures 165 by 20 mm. and fully extended 210 mm. long (Whitman). The largest example in the Indian Museum collection measures 143 mm. in length, 28 mm. to male gonopore; width of buccal ring, 2.6 mm.; width at male pore, 14.5 mm.; maximum width (middle of length) 17 mm.; depth at male pore, about 4 mm.; at middle, about 6 mm.; diameter of caudal sucker, 8.3 mm.

Cephalic region small and slender, relatively narrower than in *D. ferox*, the buccal width averaging one-fourth of the caudal sucker diameter, which does not exceed one-half the maximum body-width. The cephalic sucker is, therefore, very small and

weak, without expanded margin, and its caudal and buccal rim formed by somite V. Lip prolonged, its ventral face smooth, with no trace of median fissure. Eyes five pairs, small but conspicuous, those of the first pair largest, arranged as usual on somites II to VI inclusive, the first three pairs on contiguous annuli, the third and fourth separated by one and the fourth and fifth by two annuli; but owing to the narrowness of the head they form less of an arch, and appear to be in two parallel lines and more widely apart serially than in broad-headed species.

Clitellum seldom apparent externally, but when well developed forming a thick internal glandular layer embracing fifteen annuli, X *b* 5 to XIII *a* 2 inclusive. Gonopores separated by five or nearly five annuli, the male orifice being in the furrow XI *b* 5/*b* 6 or within the borders of *b* 6, sometimes as far as its middle, the female pore similarly placed on somite XII. Indian specimens usually present the latter, Japanese specimens the former (inter-annular) condition. One example has a filiform penis protruded to a length of 7.1 mm. with a diameter of 0.2 mm. at the base, from which it tapers to a truncate tip. Both gonopores are small, rounded or slightly slit-like orifices, flush with the surface and with slightly furrowed margins.

Nephropores seventeen pairs, in the usual position on the caudal margin of VIII *b* 2 to XXIV *b* 2 inclusive, or in the furrow *b* 2/*a* 2, constantly small but conspicuous. Caudal sucker rather small and weak, under ordinary conditions usually less than one-half the maximum body-width, about as in typical *Hæmopsis*, and especially small as compared with *Dinobdella ferax*. The pedicel is broad, the disk usually shallow with the margin thick and smooth.

Integuments perfectly smooth, without wrinkles or papillæ. Sensillæ small and unelevated, in six series dorsally and six ventrally, the marginals being absent or invisible; the interspace $A = 1/2 B$, $B = C$; on the venter $H = 1 1/2 G$, $G = 1 1/4 F$. On some individuals they stand out conspicuously as small, nearly white spots; on others they are obscure. Four to six in each series on the sucker.

Annulation.—Annuli flat and regular throughout, with clearly defined furrows of constantly equal depth. Somites I, II and III uniannulate, the last a rather long but apparently quite undivided ring, bearing the full set of dorsal sensillæ, the intermediates being the second pair of eyes. IV biannulate, the first annulus (*a* 1, *a* 2) being longer, and bearing the third pair of eyes; *a* 3 passes into the caudal rim of the sucker to unite with V in the buccal ring. V biannulate, with the first annulus (*a* 1, *a* 2) much larger than *a* 3, and showing a slight dorsal development of the furrow *a* 1/*a* 2, which practically disappears on the venter. VI triannulate (*a* 1 = *a* 2 < *a* 3), the furrow *a* 2/*a* 3 strongly developed on the dorsum, but fading out at the margins and disappearing on the venter. VII quadrannulate (*a* 1 much > *a* 2 much > *b* 5 = *b* 6) on dorsum, with *b* 1/*b* 2 often faintly indicated; *a* 1 slightly

$> a_2 = b_5 = b_6$ on venter, with the furrow b_1/b_2 constantly obsolete. VIII to XXIV inclusive quinquannulate, VIII having the formula $b_1 = b_2 < a_2 = b_5 = b_6$, IX to XI with the annuli slightly but regularly increasing in size; from XII to XXIII, inclusive, all are approximately equal. XXIV has the formula $b_1 = b_2 = a_2 > b_5 = b_6$, b_5 and b_6 each usually about two-thirds the size of the others and the furrow separating them shallower. XXV quadrannulate ($b_1 = b_2 =$ or $< a_2$ much $< a_3$), the furrow b_5/b_6 being partially developed, especially near the margins of the dorsum of some specimens. XXVI usually biannulate, the longer anterior ring in some cases showing traces of a_1/a_2 as, for example, figured by Blanchard; in other cases a_2/a_3 becomes reduced, leaving the somite nearly uniannulate. XXVII is biannulate or uniannulate.

Colour in life brownish-olive to olive-yellow with five dark brown or blackish lines, a median, and a pair each in the outer paramedian and intermediate fields. The median stripe is usually darker and more uniformly continuous than the others, which may be more or less broken and spotty. Frequently there is a broad, median dusky band about one-third of the total body-width and bordered by a somewhat darker third pair of brown stripes at the inner paramedian level, and occasionally there is a faint, narrow, supramarginal stripe or row of spots. Typically each of the five normal stripes, and, more rarely, of the supplementary paramedian stripes, bears a series of pale yellowish oval or quadrangular spots which vary greatly in degree of development. The largest and most constant spots are disposed metamERICALLY on annuli b_1 and b_5 . Occasionally similar, but usually smaller, spots fill the intervals on b_6 or, more rarely, on b_2 and a_3 . This condition is most frequent toward the anterior end of the body, where normally on the incomplete somites the spots become coalescent and form a yellow line. This occurs rarely and to a less degree on the immediate stripe also. Other variations are the occurrence of yellow spots along the obscure inner paramedian line, or their total absence from the median stripe of the middle somites, at least. The caudal sucker shows traces of the same pattern. The ventral surface is a pale brown, olive-brown or dull orange, with dusky submarginal stripes and numerous black or dusky spots, becoming more or less confluent as longitudinal streaks or even continuous stripes, most conspicuous in the paramedian and submarginal lines. Small flecks or spots of brown and black may be scattered on both surfaces. Margins clear yellow or orange bounded by supramarginal and submarginal dusky stripes. The sensillæ, nephropores and gonopores appear as paler spots, and the eyes stand out conspicuously black on a pale background (Whitman, from Japanese examples).

The material in the Indian Museum collection is insufficient to determine how fully the species, as occurring in India, conforms to the above colour description. Two well-preserved specimens from Manipur have the colour-pattern based on the typical plan

but differing in the following respects:—The dorsal ground-colour is dusky olive-grey. All seven dark stripes, the median and the outer paramedian, intermediate and supra-marginal pairs, are clearly discernible, but the yellow spots are so well developed on all except the outer or supra-marginals that they dominate the stripes, which appear as drab lines narrowly margined with black or dark brown. On most somites the spots occur on every annulus, but are smaller and more obscured by black on the sensory annuli (*a* 2), giving the impression that the stripes are narrowed or even interrupted on this annulus. A similar but less obvious and less frequent reduction of the spots may occur on annulus *b* 2, but on the first (*b* 1), fourth (*b* 5), and fifth (*b* 6) annuli of each somite the spots are constantly present and of conspicuous size, and under the lens are seen to be bordered with black. Supramarginal stripes lack these pale spots, and may be either solid black or dark brown, or made up of closely confluent small dark spots. The broad, median, dusky field is also very apparent on these specimens. A feature that does not appear on the Japanese examples, but is very conspicuous on these, is the white spotting of the areas including the dorsal sensillæ and the connexion of those of the intermediate and supramarginal series by narrow, pale, longitudinal lines, which, therefore, alternate with the set of stripes first described. Inasmuch as they are best developed on the sensory annuli, they alternate longitudinally also with the yellow spots, which are least developed on the sensory annuli. Furthermore, the sensillar markings appear to be due, not to yellow pigment, but to the total absence of pigment. The marginal yellow stripe is narrow, clearly defined, and pale or unpigmented spots occur on it in the position of the marginal sensillæ. Ventral surface dull orange, rather thickly speckled with irregular black spots, chiefly aggregated and more or less confluent as two pairs of broad paramedian and submarginal stripes.

A faded specimen from the He Ho Plain is uniformly dull grey without markings dorsally, pale yellowish grey ventrally, with a few scattered dusky spots and a pair of dusky or black submarginal stripes bounding the clearly-defined marginal yellow stripes. Baird's type agrees closely with this.

Alimentary Canal of Hæmopsis type (Pl. VI, fig. 18).—Jaws small, low, scarcely differentiated from the pharyngeal ridges which they terminate. No true denticles, but two series of fifteen to twenty thin, irregular, partly confluent, partly detached, brownish chitinous plates, much reduced in size at the ends and enclosing between them numerous minute, detached pieces of the same substance. Of the Indian Museum material only the S. Shan specimen has the jaws intact, and on this the dental plates are very thin and nearly colourless. Pharynx rather long and slender, reaching from somite VII to IX, thin-walled and weak, with six internal longitudinal folds or ridges, of which three, the dorso-median and paired ventro-lateral, are larger than

the alternating ventro-median and dorso-lateral, and terminate in the jaws. Stomach a slender, straight, thin-walled tube reaching from somite IX to somite XIX, where it terminates in a pair of simple, slightly sacculated, tubular cæca reaching to XXII only; caudad of the origin of these in XIX is a pair of short, wide pouches. The post-genital portion of the stomach is regularly slightly constricted intersegmentally, and in somites XIV to XVIII forms a series of small simply-expanded chambers without definite cæca. There is no clear distinction between œsophagus and stomach, the whole being lined with numerous fine vermicular longitudinal folds. Intestine very thin-walled and dilated anteriorly, provided in XX, XXI and XXII with two pairs of short, broad pouches, those of XXI being largest and completely covering the gastric cæca. Remainder of intestine tapering, with slight, irregular sacculations.

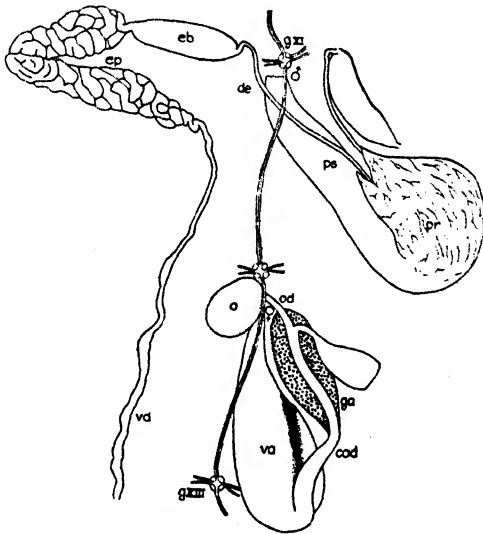

Fig. 47.—*Whitmania levis*. Partial view of dissected reproductive organs from the dorsum. $\times 3\frac{1}{2}$. σ and Q , respectively, indicate position of male and female genopores; *e.b.*, ejaculatory bulb; other lettering as in fig. 46.

Reproductive Organs (fig. 47) also resemble the *Hæmopsis* type, but the terminal organs are much less elongated and in other respects they approach *Hirudo*. The male atrium is slender and subpyriform, the penis-sac opening just caudad of the ganglion XI, subcylindrical and at its summit passing abruptly into the forwardly-reflected, short, bulbous prostate, which with its thick glandular covering reaches nearly halfway down the cephalo-dorsal face of the penis-sac. From the tapered end of the

prostate gland the long slender ejaculatory ducts run cephalad on the face of the penis-sac to ganglion XI, the left passing beneath the nerve-cord (right in Whitman's dissection). Here it bends sharply into the cephalic end of the well-developed, glistening, straight, fusiform ejaculatory bulb, which lies parallel to the nerve-cord and reaches to XI/XII, passing at this point abruptly into the epididymis. Epididymis extensively developed, consisting of a soft pale yellow, intricately convoluted tube of varying diameter arranged in two closely approximated limbs sharply folded on each other, the shorter limb about equalling the ejaculatory bulb in length and continuing in the same direction to ganglion XII, the longer limb lying on the ventral face of the shorter and of the ejaculatory bulb nearly to the cephalic end of the latter, where its tube again bends sharply caudad into the vas deferens. Vas deferens in the usual position on the longitudinal muscles of the body-floor, reaching to somite XXIII, very slender and smooth to the caudal end of XII, from which point it becomes more conspicuous, irregular and roughened, owing to the covering of unicellular glands. Testes ten pairs, intersegmentally in XIII to XXII inclusive, chiefly in *b*5 and *b*6, but extending into *b*1 of following somite, the first six and the last exposed by side of stomach and intestine, the seventh to ninth concealed by the cæca, elongate, ellipsoidal, lobed by moulding to muscles and other organs.

Female genitalia (fig. 47) exactly as figured by Whitman, consisting of a short, narrow, vaginal duct opening behind ganglion XII, and a large ovate or ellipsoidal vaginal pouch reaching nearly through or beyond (Whitman) somite XIII. The stout common oviduct enters the extreme summit of the vaginal pouch and occupies a groove in, or is closely adnate and adherent to, its cephalic or dorsal surface for its entire length, the distal part being extensively embedded in a loose mass of albumin glands compressed to a thin layer adherent to the vagina. Paired oviducts very short, the left passing beneath the nerve-cord. Ovisacs smooth, translucent, vesicles on each side of nerve-cord at XII/XIII. (Based on one dissection.)

Geographical Distribution and Bionomics.—The actually recorded distribution of this species is limited to Japan (Whitman, 1886, Oka, 1910, 1917); Formosa (Oka, 1910 var. *formosana*); China (Baird, 1869, Blanchard, 1896, Plotnikoff, 1905, Oka, 1917, Moore, 1924); Amur region (Schegoleff, 1916); India (Blanchard, 1896, Kaburaki, 1921, Moore, 1924). Kaburaki adds the Philippines and several of the East Indian Islands, but gives no authorities. Only three examples occur in the Indian Museum collection, two from Manipur (Thanga Island and Pagla Nadi), and one from the South Shan States (Ingauny, He Ho Plain). It seems probable, however, that these Burman localities do not indicate the extent of the distribution of this species in India. In China it has been reported from several coastal localities as far north as the Amur River (50° N, Lat.).

In both China and Japan this species is reported to occur in ponds, ditches and rice-fields, and by different observers to be fairly abundant, uncommon or rare. The Indian examples were taken in streams. Nothing relating to its habits is recorded except the following note by Whitman: "Very sluggish; not easily induced to swim, though swimming well when forced. Food unknown; probably carnivorous." It thus resembles *Hæmopsis*.

DINOBELLA, new genus.

Synonymy:

Whitmania, Blanchard, 1896, p. 322 (in part).

Whitmania, Moore, 1924, p. 377 (in part).

Diagnosis.—Size and form variable. Colour nearly solid, without definite pattern. Complete somites fifteen or sixteen, XXIV being either quadrannulate or quinannulate. Eyes small, normal in arrangement, but often obscure. Gonopores at XI $b\ 5/b\ 6$ and XII $b\ 5/b\ 6$. Jaws small, smooth and edentulous. Gastric cæca well developed, two pairs in each somite. Both atrium and vagina much elongated; vaginal sac little enlarged and little differentiated from either the vaginal duct or the common oviduct.

Type-species, *Whitmania ferox*, Blanchard, 1896.

Besides this type, a second Indian species (*D. notata*) is very distinct, as indicated below:—

- | | |
|---|---|
| <p>A. Diameter of caudal sucker often equalling or exceeding width of body; maximum width of body near caudal end; sensillæ and often eyes indiscernible; annulus VIII $a\ 1$ with a small cephalo-ventral partial annulus or lune cut off; principal gastric cæca long and bent caudad into succeeding somite, overlapping in successive somites; no distinctly enlarged ejaculatory bulb</p> | <p>[p. 175.
<i>Dinobdella ferox</i>,</p> |
| <p>AA. Diameter of caudal sucker much less than (about one-half in types) maximum width of body, which is near middle; eyes and especially sensillæ very conspicuous; annulus VIII $a\ 1$ undivided ventrally; principal gastric cæca of each somite straight, confined to somite of origin, and not overlapping; ejaculatory bulb large</p> | <p>[p. 185.
<i>Dinobdella notata</i>,</p> |

32. *Dinobdella ferox* (Blanchard). (Plate IV, fig. 4; VII, figs. 23, 24.)

Synonymy:

Trocheta subviridis, Murie, 1865, pp. 659-662 (Moluccas), not *Trocheta subviridis* Dutrochet, 1817.

Whitmania ferox Blanchard, 1896, pp. 322-325 (supposed Asiatic).

- Hæmopsis birmanica*, Kaburaki, 1921 (in part), pp. 712, 713, India (Darjeeling Dist., East Himalayas and Lahore) and Siam (Khumlam), not *Hæmopsis birmanica* Blanchard, 1894.
Whitmania ferox Blanchard, Moore, 1924, pp. 377-380, pl. xx, figs. 12-14 (exterior and reproductive organs). India (Mungpoo, Darjeeling).

Diagnosis.—Size very large, up to 8-10 inches or more in life, elongated, with greatest width far back, and anterior end slender. Colour in life dark green, entirely without markings. Head small, caudal sucker very large, often equalling or exceeding maximum width of body. Gonopores at XI $b5/b6$ and XII $b5/b6$, rarely within $b6$. Eyes five pairs, arranged as in *Whitmania* etc., but small, deeply placed and usually obscure. Somite VIII quadrannulate, with a small, usually lunate, portion cut off of the anterior margin of $a1$ on the venter. Complete somites sixteen (IX-XXIV), the last sometimes quadrannulate. Jaws small, smooth and completely lacking teeth and papillæ. Gastric cæca extensively developed, long and slender. Organs of reproduction very small in parasitic, and mature only in free-living individuals. Atrium strongly clavate, the prostate massive, ejaculatory duct lacking enlarged bulb. Vagina very long and slender, albumin gland on entire length of common oviduct.

Parasitic in air-passages of domestic and probably of wild mammals; also free-living in water.

Type in British Museum.

Description.—Size very large, probably the longest of Indian leeches, and when extended in life possibly exceeding a foot. Many strongly contracted museum specimens are upwards of six inches long. Complete measurements of a well-preserved example are: length, 158 mm.; length to male pore, 21 mm.; buccal width, 4.2 mm.; width at male pore, 13 mm.; maximum width (XXII-XXIV), 22 mm.; depth at buccal ring, 2.3 mm.; depth at male pore, 4.5 mm.; depth at XXIV, 7 mm.; diameter of caudal sucker, 22.5 mm. These proportions are typical. An excessively contracted specimen with an enormous sucker measures: length, 92 mm.; to male pore, 15.3 mm.; buccal width, 4.5 mm.; width at male pore, 14 mm.; maximum width (at XXIV), 20 mm.; and sucker diameter, 21.8 mm.

Form slender and graceful, much resembling the American *Hæmopsis lateralis* (Pl. VI, fig. 24), but with the maximum width characteristically far back, immediately anterior to the sucker, from which it tapers gradually and regularly to the head. In this form and the large caudal sucker parasitic individuals differ strikingly from any other Indian leech. Free-living individuals not distended with blood, however, usually have a more uniform width, with the maximum further forward, the caudal sucker relatively smaller and the head relatively larger. In parasitic individuals the ratio of sucker diameter to buccal diameter is 4.5-5 to 1; in the free-living ones 3-4 to 1. Usually strongly depressed with the dorsum slightly arched, the venter flat or even

slightly concave and the margins rather sharp and serrated. One lot, however, killed in chromic acid, is well-extended and nearly cylindrical.

Head-region in parasitic individuals small and rather narrow, the width at the buccal ring being one-fourth or even one-fifth of the diameter of the caudal sucker. Upper lip narrow but not much elongated as in *Whitmania levis*, formed of the first three somites, which are very slightly or not at all separated by furrows, and the first annulus of IV which is distinct. Dorsal surface much and irregularly wrinkled, the free margin furrowed and crenulate; ventral surface usually quite smooth and either unfurrowed or with a median furrow posteriorly which fades out in the anterior half. Buccal ring slightly thickened and furrowed, constituted of the nearly completely coalesced annuli of somite V, together with the second annulus of IV. Eyes very obscure and possibly actually absent from some of the larger parasitic examples. Usually they cannot be discovered at all in ordinary surface views. In other cases, only the first two of three pairs can be seen in surface views or after clearing in glycerine or dissecting away the integument. On one particularly favourable example all five pairs are visible in surface views, arranged in the usual arch on somites II to VI. All are very small and deeply sunken, the fifth pair being particularly minute and faint.

Clitellum apparently absent or at least not developed as a distinct glandular layer. In every specimen studied, even the largest, and those with mature genitalia, annuli of the clitellar region have exactly the same appearance as the others. Gonopores typically interannular, the male in the furrow XI $b\ 5/b\ 6$, the female XII $b\ 5/b\ 6$, but the male pore, and less often the female, may be slightly within the borders of $b\ 6$. Both pores may be very small and hidden in the furrows. When best developed the male is a rather conspicuous transverse orifice elevated on a papillæ supported equally on $b\ 5$ and $b\ 6$ or chiefly on the latter, and which may be low and flat or an elevated, fluted cone ending in five or six minute lobes surrounding the opening at the summit. Female pore commonly a minute round opening, but in actively breeding leeches a transversely elongated or elliptical orifice as large or larger than the male pore and sometimes on a flat, radially furrowed papilla. In only one case has a protruded penis been seen; in this about 2 mm. of its end projects from the male gonopore.

Nephropores usually large and located in the customary position from VIII $a\ 1$ to XXIV $b\ 2$, seventeen pairs in all. Sensillæ are entirely indiscernible on most specimens, but occasionally a few very small ones may be distinguished in the usual positions.

Anus at base of sucker behind XXVII. Caudal sucker very large on most specimens, equalling or even exceeding the maximum width of the body, four or even five times the buccal width. It is almost always expanded, flat and discoid, with all except the centre or peduncular portion of the disk very thin and

smooth and frequently with the oblique and circular muscles visible through the integument. Ventral surface lacking radial ridges and marginal crenulations.

Annulation usually very distinct, the furrows deep and the annuli serrate, usually with sharp transverse ridges, which in strong contraction form low folds. Somites I, II and III are uniannulate, largely coalesced, and the furrows obscured by numerous fine wrinkles. IV biannulate, the second annulus ($a3$) being smaller and well-defined, the first often incompletely separated from III. V biannulate ($a1, a2$) $> a3$, on dorsum, united to form buccal ring or peristomium on venter. VI is usually triannulate dorsally ($a1 = a2 < a3$ or $(a1, a2) > a3$), or the furrow $a1/a2$ may be so faint that it is disregarded, as on the venter, where it constantly fades out, leaving ($a1 a2$) as a single annulus. VII triannulate, complete both dorsally and ventrally ($a1 = a2 < a3$), $a1$ in one case divided by a faint ventral furrow, $a3$ more or less enlarged and occasionally with a faint furrow ($b5/b6$) on either dorsum or venter. VIII constantly quadrannulate ($a1 > a2 = b5 = b6$ or $a1 > a2 < b5 = b6$); $a1$ invariably enlarged and with a distinct furrow on the venter. This furrow is very characteristic, and, with very rare exceptions, occurs on free-living as well as on parasitic individuals. It may extend across the entire width of the venter, and occasionally even on to the sides and part of the dorsum, but usually it meets the preceding intersegmental furrow some distance short of the margins of the venter, thus cutting off a narrow crescentic segment or lune from the anterior margin of the annulus. Notwithstanding its constancy it is doubtful if this represents a true incipient annulus ($b1$), from which it differs in several respects. In no case does it include more than one-third of the length of $a1$, and usually it is much less. In only one specimen of forty-five studied is this furrow absent, making it a very distinctive characteristic of the species. Sixteen somites (IX to XXIV) are complete and quinquannulate, all five annuli being typically equal ($b1 = b2 = a2 = b5 = b6$), except that on IX $b1$ and $b2$ and on XXIV $b5$ and $b6$ are usually smaller than the others, and the latter much crowded together ventrally by the sucker pedicel. Rarely XXIV is quadrannulate, as described by Blanchard and on two specimens examined by myself. XXV triannulate ($a1 = a2 = a3$ or $a1 > a2 = a3$) or very rarely incipiently quadrannulate ($b1, b2$) $> a2 = a3$; $a2$ and $a3$ crowded together and occasionally united on the venter. XXVI and XXVII each biannulate, the latter smaller and its second annulus often divided by the anus.

Colour in life (Pl. IV, fig. 4) a uniform dark green without stripes, bands or spots (Blanchard and Murie)*. No mention

* The coloured sketch from which fig. 4, Plate IV., was copied was labelled *Linnæus granulosa*, but evidently was drawn from a specimen of *D. ferox* taken along with several of the former species and carrying the same Museum number.

of even a marginal stripe is made. It was this coloration as well as the slender, elongated form and inconspicuous eyes and jaws that misled Murie in determining his specimens as *Trocheta subviridis*. Several of the preserved specimens retain much of the original colour, being uniform dark green or drab-green without the slightest trace of even the marginal stripes so generally present in leeches. Most of the preserved specimens are faded or discoloured, being grey, brown or drab, but always uniform and quite without markings. Parasitic individuals frequently are much stained and discoloured by the blood of their hosts.

Alimentary canal (Pl. VII, fig. 23) of sanguivorous type. Jaws, however, very small and weak, terminating the principal pharyngeal ridges (dorso-median and paired ventro-lateral) and retractile into recesses of the buccal sinus; the dorso-median larger than the paired; all perfectly smooth, without papillæ and all perfectly edentulous. This statement applies to all of sixteen specimens studied, parasitic as well as free-living, and was verified on three series of sections. The salivary glands are largely developed and occur aggregated in small bundles or singly among the muscles of the pharynx. Their ducts form conspicuous bundles passing through the axis of the jaws and spreading in a fan-shaped plate to open along the apical ridge. Pharynx relatively small as in *Hirudo*, extending through VII and VIII only, fusiform, bulbous, with musculature of moderate thickness. Mucous lining with six longitudinal folds, the principal ones dorso-median and paired ventro-lateral, terminating in the jaws and alternating with three smaller ones. A well-marked transverse valvular fold separates the pharynx from the stomach at VIII/IX. Stomach very long and extensively developed, the median tubular portion reaching from IX to XIX inclusive. When empty or little distended this is slender, with the chambers only slightly enlarged and little lobed; when fully distended with blood, as is always the case with parasitic individuals, it presents numerous small lateral lobes between the bases of the cæca. The cæca are exceptionally well developed. Beginning in somite IX the first three or four pairs (to XI or XII) are small and irregular. Following these to somite XVIII there is a very short pair succeeding a long slender pair in each somite. The latter reaches to the lateral body-walls and bends back obliquely into the following somite. The last pair, arising in XIX, are very long and slender and continue by the sides of the intestine to XXV. They are tubular and curiously looped or festooned, especially in contracted leeches. When empty or nearly so the principal cæca are slender and tubular, not branched and lobulated as in many species, but plaited, folded and more or less compressed. This is especially the case with the last reflexed pair. When distended with blood the plaits open out, permitting the cæca to extend and expand and the main pairs to overlap extensively, to fit themselves to the muscles and to displace the softer organs. The result is the almost complete filling of the

body and the storage of an enormous quantity of blood. There is nothing distinctive about the intestine.

Reproductive organs (fig. 48) are fully developed and mature only in free-living specimens taken in water. Several such dissected agree fully. Testes eleven pairs, XIII/XIV to XXIII/XXIV; nothing noteworthy about them or the vasa deferentia. Epididymes rather small, lying in somite XI anterior to the prostate and concealing the anterior part of the penis-sac from above, the duct compactly folded into two limbs bent together. Ejaculatory duct rather shorter and decidedly coarser than usual and without an enlarged ejaculatory bulb. Either one may pass beneath the nerve-cord. Atrium of the *Hirudo* type, but noteworthy because of the relatively great length and slenderness of the penis-sac, which may be folded on itself. Prostate greatly

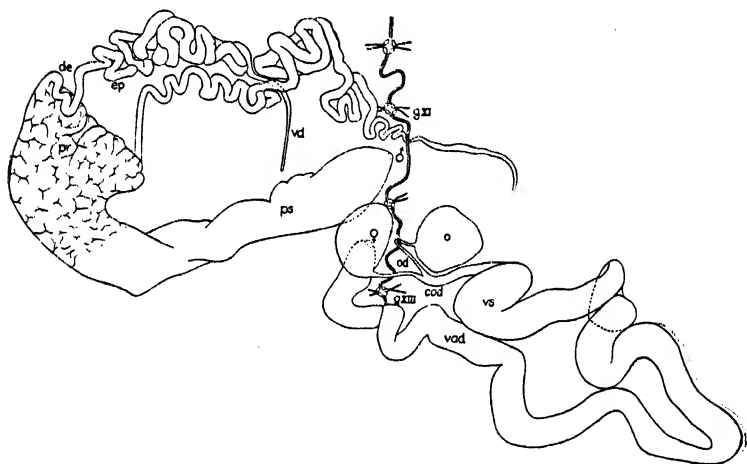

Fig. 48.—*Dinobdella ferox*. Female reproductive organs and terminal portion of male organs, from dorsum. $\times 4\frac{1}{2}$. Atrium and epididymes displaced to left, vagina separated and displaced to right. Drawn from a small (70 mm.) free-living example. Lettering as in fig. 46, p. 166.

enlarged, bent forward on the dorsum of the penis-sac, truncate and covered with a thick glandular layer. The ejaculatory ducts enter at or near its distal angles. None seen with the penis protruded. Female organs very distinctive. Ovisacs as usual, with short oviducts, either of which may pass beneath the nerve-cord. Common oviduct also short and wide, with the albumin gland distributed along most of its length as a thin layer, and entering the extreme end of the vagina without any conspicuous line of demarcation. Vagina usually folded into a compact mass, but consisting of a very long and slender tube lacking a cæcum.

and with little or no distinction between duct and sac. Specimens known to be parasitic or suspected of being so because of their source and condition, having the cæca filled with blood and the skin stained and smeared with blood, are invariably sexually inactive. The reproductive organs of such are very minute, often only two or three millimetres long or even less in the largest leeches. They may scarcely rise from the ventral body-walls above the nerve-cord, and frequently in even the very largest leeches are very difficult to find. Except for their minuteness and immaturity they depart little from the form just described. The atrium is less elongated, but the penis-sac is slender and the prostate much enlarged and bent forward on the former. There is no ejaculatory bulb, and the epididymis consists of a few open coils of the sperm-duct. Except that it is relatively less elongated and very much smaller, the vagina does not differ in appearance from the mature organ. Two of the free-living examples have reproductive organs somewhat smaller than the others but much larger than those of the parasitic individuals and intermediate in form.

The species as here determined includes two groups, the one of seven specimens known to have been taken from the water, the other of thirty-five specimens either reported as having been removed from all the air-passages of mammals or suspected of having had this origin because they are gorged with blood and bloody externally, and were collected by veterinary agents. Every one of the latter, without exception, is completely immature, while of the former, five have the reproductive organs obviously actively functioning and two of large size but less active. It is not a question of size or age, for the size of the parasitic forms varies from 49×13 mm. to 168×22 mm., and of the free-livers from 43×12 mm. to 128×17.1 mm.; nor of season, for, while the date of collection of many of the parasitic individuals is not stated, six of them were taken in June, when the reproductive organs of the other group are highly developed, and others in July.

Although they possess nearly all technical characters in common, the two groups also present some differences. One of the most striking is the shape of the body, which in the parasites has the greatest breadth very far back close to the sucker and tapers regularly to the small head. In the aquatic group the maximum width is near the middle, but there is little change throughout most of the length. This is probably merely the result of the fact that leeches of the first group are gorged with blood and that the distention of the great terminal pair of cæca gives a greater volume to the posterior region in which they lie. The caudal sucker of the parasites is very large, even exceeding the maximum of the body, and the head is relatively small. Free-living examples, on the contrary, have the caudal sucker invariably much less than the maximum width, thicker and evidently contracted, and the head relatively much larger. These differences it is possible to explain as regulatory or adaptive changes due to the different modes of life and the varying uses to which these organs are put, especially

should it prove that the free-living individuals wholly or partly prey upon insects, worms, etc., as Tennent (1860) states.

The question then arises, what is the relation between the two forms? Of course they may prove to be distinct species, but this seems improbable. Assuming, therefore, that the view here taken is correct and that leeches of both forms may originate from the same lot of eggs, what relationships are possible? There seem to be three: first, this may be an ordinary case of intermittent, facultative parasitism, in which any individual may at any time play the part of a parasite or of a free-liver; second, the relationship may be a periodical one, either seasonal or developmental; or third, it may be that a life of parasitism, having once been adopted, becomes habitual for that individual, and is persisted in either for life or for a long period. These three alternatives with questions based upon them were submitted to a number of Indian naturalists and veterinarians, but without eliciting any information relative to the settlement of the problem. Without presenting the pros and cons of each alternative at length, it may be said that the second seems the least probable for the reasons already mentioned, that both parasitic and free-living individuals occur of all sizes (no very small ones of either phase are known) and at all seasons. The first alternative is the one that *a priori* seems most probable, as it conforms more nearly with what is known of other leeches, many of which will make a meal almost indifferently upon small invertebrates or upon the blood of vertebrates. The line between parasites and predators is a fine-drawn one. This also is the life-history usually attributed to *Limnatis nilotica*, Sav., which is similarly parasitic on Man (Masterman, 1908). Tennent (1860), writing of the cattle-leeches of Ceylon (his *Hæmopsis paludum*, which I believe to be distinct from *D. ferox*), states that they live among the vegetation of tanks, feeding on aquatic worms etc. until an opportunity offers of attaching to the muzzle of a drinking animal, when they enter the nares.

There is considerable evidence that the period of parasitism in this species is of long duration and perhaps permanent for the individual. The original discovery of this leech by Murie (1863, see also Blanchard, 1896) was in the viscera of a posted specimen of a *Cervus moluccensis* which died in the London Zoological Gardens. This deer had first been sent to Amsterdam; and while there is no published record of the time elapsed between its departure from its native Moluccas and its death in London, it must have been a matter of several months, at least, during which the leech remained a parasite in its air-passages. Other cases are on record of these leeches being taken from the air-passages of yaks and buffaloes imported into the zoological gardens of Europe. The information gathered from correspondents in India (*q. v.* Borbhetta bullock, p. 185) indicates that once having entered the air-passages the leeches may remain there indefinitely. That they do leave their abode voluntarily at times is indicated by the fact that they have been found in drinking troughs after

their hosts had drunk, and that one of the methods practised in India for ridding cattle of them is to hold a bowl of water or milk at the animal's muzzle and when the leech appears at the nostril to grasp and extract it. The fact that so many of the parasitic leeches have reached so great a size, coupled with the dwindling of their reproductive organs almost to the point of disappearance and at all seasons of the year, indicates a prolonged period of residence within the host, and a possible complete loss of the reproductive function, improbable as this may seem. Should this prove to be the case and the reproductive function to be confined to those individuals that have remained free-living, then this would be a unique case among leeches of a non-reproducing parasitic and a reproducing free-living class or semi-caste; of a leech that under one set of environmental conditions responds in one way and under another set in quite a different way. Apparently this is exactly what happens in the artificial culture of *H. granulosa* (see p. 237), concerning which it is reported that individuals constantly employed for blood-letting lose the power of reproduction. Of course it may be that still other individuals may accept the first alternative and be intermittently parasitic and free-living. It is evident that this leech has an interesting and little-known life-history, and it is hoped that an Indian naturalist favourably situated will discover its breeding habits, the mode of life of the young, exact relation to the host, etc. With this information at hand it is quite possible that a course of procedure could be worked out to prevent or control infestation of domestic animals.

The cattle-leeches are widely distributed in India, Burma and Ceylon, but appear to be much more abundant in some regions than others. In the dry uplands and desert regions they are said to be absent except when introduced in imported cattle. Tennent (1860) states that in Ceylon they abound in the alluvial lands around the base of the mountain zone, where they infest the stagnant pools (*Hæmopsis paludum*, Tennent, *q.v.*). They are reported to be especially abundant in Manipur, and my own studies bear this out. They are plentiful in the Darjeeling District and parts of the Punjab also, and I have examined specimens from the United Provinces, Naini Tal, Ceylon and Khumlan, Siam. Landon's (1905) reference to land-leeches in the nares of bullocks in Sikkim possibly refers to this species (see p. 268). They range from low altitudes in Ceylon to 5000 ft. in the hills of Darjeeling and to 7500 ft. at Muktesar, in the United Provinces. It is not possible from the data at hand to state definitely in which parts of India they are indigenous and to which parts they have been carried by their hosts.

The following mammals are known to suffer from their attacks: yak, buffalo, domestic cattle, horse, dog and deer, and doubtless other domestic and wild animals are not immune. The domestic ruminants suffer greatly and frequently become much emaciated, or, when the leeches are numerous and large, may even die as a result of the constant loss of blood and the irritation. Having no

teeth these leeches are probably unable to penetrate the outer skin, but the soft, highly vascular mucous membranes of the air-passages offer an abundant supply of blood of which they take full advantage, attaching themselves sometimes in large numbers to the walls of the buccal chamber, nasal passages, pharynx and larynx.

Some data kindly furnished by correspondents and bearing on the infestation of domestic animals are of much value. Dr. J. F. Edwards, Director of the Imperial Institute of Veterinary Research at Muktesar, very kindly consented to have a record kept for one year of all the leeches occurring in animals examined post-mortem at the laboratory, and sent to me a very interesting report compiled by M. H. Cooper, Pathologist, which gives the only accurate statistics that I have been able to secure. In condensed form it is as follows:—

INFESTATION OF DOMESTIC ANIMALS BY CATTLE-LEECHES
AT MUKTESAR.

Month.	No. of animals examined for leeches.	No. infested.	Total no. of leeches found.
August, 1924 ..	120	5	5
September	183	9	15
October	135	2	3
November	108	0	0
December	55	0	0
January, 1925..	30	0	0
February.....	0	0	0
March	1	1	1
April	43	4	7
May.....	106	3	5
June	67	0	0
July.....	117	0	0
TOTAL	965	24	36

Two points are worthy of comment; first, the small percentage of infestation, less than 2·5 per cent. and the absence of any reported infestation during the winter, and again during June and July. The largest number of leeches taken from any one animal was four. These data might be taken to indicate that the leeches leave their hosts during the early summer to breed, did not the Indian Museum collections include twenty-one specimens with shrunken reproductive organs taken from hosts during these two months. The absence of leeches from the winter cases may be due to the small number of animals posted.

The following extract from a letter from Mr. Cooper is of interest:—"I have obtained, through the kindness of Mr. A. E. Andrews, Entomologist of the Tocklai Experimental Station, Annamara, Assam, a preserved specimen of a leech taken from the nostrils of a Manipuri bullock at Borbhetta on the 25th of July, 1923. The bullock was imported from Manipur some fifteen months ago and was at that time in good condition. After a period of a few weeks the animal began to lose condition, until finally it was in a poor condition. The Head Mohorir at the garden suggested that a leech in the nostril might be responsible, and the bullock was accordingly walked about in the sun for some time and then offered water to drink. This leech then appeared, and was removed and preserved. After removal of the leech, and without other treatment, the bullock rapidly picked up condition. The Mohorir states that parasitism of cattle imported from Manipur is extremely common, while local plains animals are not affected by this type of leech. Further, there is a tradition to the effect that infestation occurs during the crossing of a particular river on the road from Manipur." This leech is a typical example of the parasitic *D. ferox* with scarcely discernible reproductive organs.

In an earlier letter Mr. Cooper wrote: "Our experience here (Muktesar) is that a very large number of cattle are attacked by these leeches. During last winter a number of animals in nasal granuloma experiments underwent post-mortem examination, and special examination of the nasal membrane was made. In a majority of them leeches were found." Mr. S. H. Sen writes: "In Eastern Bengal 'cattle-leeches' are pretty numerous and are a source of nuisance, particularly during the rains. They may be frequently seen wriggling in the transparent water of ponds, eventually obtaining a foothold under logs of wood or on brick embankments, where they wait for an opportunity to attach themselves to their victims," and "cattle-leeches are of common occurrence at Muktesar, being frequently found in the nares of cattle." The gwallas extract them by holding a vessel of water close to the nostrils and securing the leeches as they partially come out of the nostrils, being attracted by the water. Mr. A. S. M. Ayyar (1922) states that he easily succeeded in dislodging all of the leeches from the nares of a buffalo by syringing the parts with betel juice when all other means of extracting them had failed.

33. *Dinobdella notata*, new species. (Plate VIII, figs. 34, 35.)

Synonymy:

Whitmania sp.? Moore, 1924, pp. 382, 383, pl. xx, figs. 15-18 (exterior and anatomy).

Diagnosis.—Size medium, in life probably 2-3 inches long when extended. Form and general external appearance as in *Hæmopsis*.

Living colour probably dark olive-green clouded with dusky, but without definite colour-markings; paler and less green ventrally. Sensillæ very conspicuous, elongated white dots. Head and caudal sucker of about normal dimensions, the latter much less than the maximum body-width. Gonopores at XI *b* 5/*b* 6 and XII *b* 5/*b* 6. Eyes small but clearly visible and typical in arrangement. VIII *a* 1 entire (not cut by a furrow) on venter. Somites IX to XXIII inclusive, complete; XXIV quadrannulate and XXV triannulate. Jaws small, smooth and edentulous. Gastric cæca well-developed, but not overlapping as in *D. ferox*. Both atrium and vagina elongated and slender; ejaculatory bulb well-developed.

Free-living and amphibious, so far as known.

Type in collection of Indian Museum, Palni Hills, 6850 ft., Aug., 1922, S. Kemp.

Description.—Known only from two strongly contracted specimens (Pl. VIII, fig. 34), the largest of which measures as follows: length, 37 mm.; length to male pore, 5·3 mm.; buccal width, 1·7 mm.; width at male pore, 8 mm.; maximum width (middle), 8 mm.; depth at male pore, 3 mm.; depth at middle, 2·4 mm.; diameter of caudal sucker, 3·7 mm. The form is elongate oblong-elliptical, with the ends nearly equally rounded and the width nearly uniform for most of the length; strongly flattened throughout, resembling contracted preserved specimens of *Hæmopsis*.

Head much contracted, lip lacking ventral fissure, and inrolled into oral chamber. It is formed of the first three somites and part of the fourth, and marked by two or three longitudinal furrows. Buccal ring composed of the united annuli of IV *a* 3 at the sides and somite V ventrally. Eyes small but clearly visible, on somites II to VI inclusive, and disposed as usual in *Hæmopsis*, etc.

Clitellum not developed in these specimens. Male gonopore a simple, somewhat transversely elongated opening in the furrow XI *b* 5/*b* 6, cutting slightly into *b* 5. From it protrudes a filiform penis, 9·5 mm. long in one and 10·5 in the other specimen, about 0·1 mm. in diameter at the base, clavately enlarged towards the end to about twice the basal diameter, tapered to a conical tip and slightly spirally sinuous. Female gonopore the usual simply-rounded small orifice in the furrow XII *b* 5/*b* 6. Nephropores conspicuously indicated by small white spots on the caudal margins, just mediad of the intermediate sensillæ, of *b* 2 of somites VIII to XXIV inclusive, 17 pairs. Anus a small orifice at the base of the sucker behind XXVII. Caudal sucker much smaller than in *D. ferox*, of the general proportions of *Hæmopsis*. In the contracted state the diameter is somewhat less than one-half the maximum width of the body, with a rather thick, furrowed margin, and the venter nearly flat with a shallow central depression. Integument smooth, no papillæ.

Sensillæ small and unelevated, but, owing to their clear white

colour on a dark background, very sharply defined and conspicuous throughout the entire length of the body. They are peculiar in that, instead of being circular dots as in *Hæmopsis*, they are short lines or dashes. This form is especially evident towards the caudal end and on the dorsal intermediate, supra-marginal, and marginal sensillæ, the axes of which are transverse, while the dorsal paramedians are oblique. Ventral sensillæ but little elongated. Dorsal intermediates much larger than any others, and dorsal paramedians the smallest. Dorsal marginals very close to supra-marginals and sometimes divided into two or three smaller sensillæ. In terms of percentages of the entire circumference the interspaces between sensillæ on somite XV are as follows: A=4.3, B=9.9, C=6.6, D=3.3, E=6.6, F=8.5, G=6.4, and H=13.2. On the ventral surface of each annulus are numerous scattered sense-organs not seen on the dorsum. The caudal sucker bears eight dorsal series of sensillæ of three or four each.

Annulation.—Except at the ends, where it is obscured by contraction, the annulation is very distinct, smooth, and regular. Somites I to III uniannulate, no interannular furrows being visible. IV biannulate, with a shallow $a2/a3$ furrow. V biannulate ($a1, a2 > a3$), the first annulus only slightly enlarged, with a shallow furrow dorsally, uniannulate ventrally as the buccal ring. VI also biannulate dorsally, with the furrow $a1/a2$ deeper than on V, but obsolete ventrally on the post-buccal ring. VII triannulate ($a1 = a2 < a3$), with $a3$ enlarged and exhibiting a faint secondary furrow; all annuli shorter on the venter. VIII quadrannulate ($a1 > a2 = b5 = b6$), $a1$ being enlarged and faintly divided on dorsum, quite simple and equal to $a2$ on venter. IX to XXIII, or fifteen annuli, quinquannulate ($b1 = b2 = a2 = b5 = b6$), the last two annuli slightly smaller on XXIII. XXIV quadrannulate, with $a3$ slightly longer than $a2$ dorsally, and with the secondary furrow at the margins of one specimen, but no furrow on the other; XXV triannulate, ($b1, b2 > a2 < a3$) on the dorsum, $a1 = a2 = a3$ on the venter. XXVI biannulate on one, imperfectly biannulate, with both primary furrows at the margins, on the other. XXVII uniannulate.

Colour in life unrecorded. Alcoholic specimens have the dorsum nearly uniform dark slaty-brown, tinged with olive-green and dusky, the latter more or less concentrated in an irregular transverse band across each annulus, especially $a2$, on which the white sensillæ stand out with great clearness. Venter an obscurely mottled lighter grey without definite traces of green or any distinct markings. Marginal stripes continuous, well defined and clear yellow, sharply separating dorsal and ventral colour-areas.

Anatomy.—Jaws very small and inconspicuous, relatively higher than in *D. ferox*, but, like those of that species, quite smooth and edentulous. Both specimens were examined and no teeth found in either entire mounts or sections of jaws. No papillæ. Pharyngeal folds very low, practically obsolete. Stomach reaches

from IX to XIX inclusive, and bears in each somite two pairs of cæca, the one very small, the other large and spacious but simple, with the somewhat bulbous end reaching almost to the body-walls, but not bent caudad and overlapping as in *D. ferox*. In XIX the terminal pair of large cæca arise, and continue by the side of the intestine to XXV. They are spacious, bear a lateral lobe in each somite and, like the rest of the stomach, thin-walled, with a vermiculately-folded mucous lining. Intestine begins in XX, is inflated but only obscurely chambered in the anterior part, tapers to the anus and is thin-walled with transverse mucous folds.

Reproductive organs (Pl. VIII, fig. 35) resemble those of *D. ferox*, but differ especially in the well-developed ejaculatory bulb. They are large and very well-matured in both specimens, notwithstanding the almost total absence of a clitellum, but only one was dissected. First pair of testes at XIII/XIV, of large size and the usual form and position. Owing to the fragility of the stomach the remaining testes and vasa deferentia were not exposed, the number, therefore, being undetermined. Epididymis very compact, ellipsoidal masses of a very intricately folded, fine, dull white tube, passing at its anterior end into the hard, thick-walled, lustrous, elongated, fusiform ejaculatory bulb, which is disposed transversely but with both ends involuted. Its medial end continues as a slender ductus ejaculatorius, the left one passing beneath the nerve-cord, to open into the prostate cornu of the atrium. Atrium lies to the right of the nerve-cord, and occupies most of that side of somite XI, being doubled and twisted on itself so that the end of the prostate lies immediately behind ganglion X and the penis-sac opens to the exterior behind ganglion XI. Penis-sac long, slender, cylindrical and highly muscular, about fourteen times as long as thick, and the diameter increasing slightly before it passes into the globoid prostate, which bears on the sides the prostate cornua, the ends of which project from beneath the margin of the glandular layer.

Ovisacs are pyriform and lie on the floor of the body on each side of the nerve-cord at XII/XIII. Oviducts short and slender, the right one passing beneath the nerve-cord to unite with the left in a common oviduct, which is provided with an albumin gland at the point of union, and continues as a slender tube with several folds to empty into the end of the vagina. Vagina, like the atrium, a simple, transversely looped tube, but on the left side of the nerve-cord, slightly longer than the penis-sac, but only about one-third to one-half its diameter. There is no distinct division into duct and sac, and no cæcum. Common oviduct and vagina are one continuous tube without break or external distinction, the part of the vagina corresponding to the sac being merely a slight fusiform enlargement.

The muscle-bands of this species are much more delicate than those of *D. ferox*, and on the venter may be counted through the translucent integument, there being nine in H, three or four in G, and four in F.

Geographical Distribution and Bionomics.—Known only from two specimens labelled “Kodaikanal, Palni Hills, S. India, Aug. 1922, 6850 ft., *S. Kemp*. Under stones at edge of swamp.”

Apparently the species is amphibious, and probably feeds indifferently on smaller invertebrates and the blood of vertebrates. The one dissected had the stomach partly filled with coagulated blood. (See also Appendix, p. 296.)

Genus **HIRUDO**, Linnæus.

Synonymy :

- Hirudo*, Linnæus, 1758, p. 649 (in part).
Sanguisuga, Savigny, 1820 (22), p. 114.
Sanguisuga, Moquin-Tandon, 1826, p. 114.
Iatrobdeella, Blainville, 1827, p. 254.
Hirudo, Moquin-Tandon, 1846, p. 326 (in part).
Hirudo, Whitman, 1886, p. 364.
Hirudo, Blanchard, 1894, p. 39.
Hirudo, Oka, 1910, p. 181.

Diagnosis.—Size medium to large. Colour-pattern usually longitudinally striped, but occasionally spotted or solid. Eyes five pairs, well-developed. Sensillæ four dorsal and three ventral pairs, typically conspicuous, but in the Indian species small and obscure. Somites IX to XXIII or XXIV (fifteen or sixteen), quinquannulate and complete. Male and female gonopores very constantly at XI and XII *b* 5/*b* 6. Clitellum X *b* 5 to XIII *a* 2. No copulatory glands or pores. Jaws prominent, but variable in length. Typically the salivary glands all open on the dentigerous ridges, and papillæ are entirely wanting. Teeth typically strictly monostichodont, acute, conical and from 40 to 100 on each jaw. (*H. birmanica* has traces of distichodonty at the central ends of the series, and on some specimens a few small salivary papillæ.) One pair of large, but little-lobed gastric cæca in each somite from X to XIX inclusive, the last pair reaching caudad to about XXV. Atrium typically pyriform, with the penis-sac not greatly elongated, but in the two Indian species much longer than usual. Ejaculatory bulb well-developed. Vaginal sac fusiform, without cæcum, varying much in relative length and diameter, the vaginal duct and the common oviduct always continuous with its outer and inner end respectively.

Type-species, *H. medicinalis*, Linnæus, 1758. Europe (for figures see Moquin-Tandon, 1846, and Harding, 1910).

Two recognized Indian species, as follows:—

- A. Colour uniform; no metameric features;
 XXV triannulate. *Hirudo asiatica*, p. 190.
 AA. Colour-pattern longitudinally striped,
 with metameric spots and constrictions;
 XXV usually quadrannulate. *Hirudo birmanica*, p. 192.

34. *Hirudo asiatica* Blanchard. (Plate VIII, fig. 25.)*Synonymy* :

Aulostomum gulo (*A. nigrescens*), Aitchinson, 1889, p. 105. Tirphul, Afghanistan border.

Hæmopsis asiatica Blanchard, 1894, p. 115. Same.

Hirudo asiatica Blanchard, 1896, pp. 320-322, fig. 4 (annulation of caudal end). Same.

Diagnosis.—Size similar to *H. birmanica*, but more slender than that species and with relatively larger sucker. Colour uniform dark olive or brown without markings. Sensillæ obscure. Complete quinquannulate somites fifteen or sixteen, IX-XXIII or XXIV. XXV triannulate. Jaws prominent but short, teeth monostichodont, about 50, no salivary papillæ. Stomach as in *H. birmanica* and reproductive organs differing little from that species. Attacks frogs.

Type in British Museum. Type-locality : Afghanistan.

Description.—A small species of the typical aspect of *Hirudo*, but with the caudal sucker rather larger than in other small species. Blanchard's largest specimen (in alcohol) measured 40 mm. long. Mine has a length of 37 mm.; to male pore, 7 mm.; width at buccal ring, 1.3 mm.; at male pore, 4 mm.; maximum width (XVIII), 4.8 mm.; diameter of caudal sucker, 3.6 mm.; depth at male pore, 2.2 mm.; depth at somite XVIII, 3 mm.

Form rather slender, with the greatest width just caudad of the middle and reaching to the caudal fourth, little tapered caudally, much more so toward the moderately small head; little depressed, most so near caudal end, nearly terete in pre-clitellar region.

Cephalic sucker of moderate size in contraction, tip broad with marginal furrows, but with no distinct median ventral fissure. Buccal ring formed by somite V (annuli 6 and 7) and in part by IV a 3. Eyes conspicuous, arranged as usual on annuli 2, 3, 4, 6 and 9 (somites II to VI). No externally visible clitellum. Male and female gonopores at XI b 5/b 6 and XII b 5/b 6 respectively, in the furrow or slightly on b 5, both small, the male on a slightly elevated area. Sensillæ indiscernible. Nephropores distinctly on the caudal margin of b 2 from VIII to XXIV inclusive, seventeen pairs. Caudal sucker somewhat larger than usual in species of *Hirudo*, two-thirds width of body in partial extension, circular, flat, smooth, freely pedicellate. Anus at base of sucker, behind somite XXVII, small.

Annulation well-defined, except on somites I, II and III, which are each uniannulate. IV biannulate ($a 1, a 2 > a 3$); V biannulate ($a 1, a 2 > a 3$, united ventrally and with IV a 3 to form the buccal ring. VI triannulate ($a 1 < a 2 < a 3$), the first two united ventrally as the post-buccal ring. VII also triannulate, but a 3 enlarged and with faint furrow b 5/b 6 limited to dorsum. VIII quadrannulate ($a 1 > a 2 = b 5 = b 6$), a 1 being larger than VII a 3 and exhibiting a rather deeper secondary furrow. IX-XXIII are quinquannulate, each of five approximately equal annuli, making

fifteen complete somites. XXIV is quadrannulate, but might with almost equal propriety be interpreted as quinquannulate. Blanchard unequivocally figures it as the former. In my specimens the formula is $b1=b2=a2 < a3$ ($b5+b6$); $a3$ is only slightly larger than the other annuli, but the furrow $b5/b6$ is so clearly defined all round that it may fairly be considered to be divided into the two annuli $b5$ and $b6$. XXV is triannulate ($a1 > a2 = a3$ or $a1 = a2 = a3$). XXVI is biannulate and XXVII similar but reduced in size, the exact constitution of the annuli being uncertain in the absence of definite criteria. No definite papillæ and no sensillæ can be detected.

The colour is stated by Blanchard to be a uniform dark olive without spots or stripes. The Indian Museum specimens are of a perfectly uniform dark golden-brown, probably due to the action of reagents and entirely lacking in any trace of pattern.

Anatomy.—The larger of the two specimens was dissected (Pl. VIII, fig. 25). Jaws smaller than usual in *Hirudo*, relatively high in proportion to the length, with strongly marked dentigerous ridge and entirely without salivary papillæ. Denticles monostichodont, according to Blanchard, fifty-two; in this specimen most of them are broken, but apparently the number is only slightly less. Pharynx reaches to IX. Stomach of the *Hirudo* type and partly filled with blood; begins in IX, in which and in X and XI there are three pairs of small cæca. In each post-genital somite from XIII to XVIII there is a pair of large, short, wide, little-lobulate cæca, and, alternating with these and covered by them, a much smaller posterior pair. In XIX the first pair of cæca are much enlarged and continue by the side of the intestine to somite XXV, bearing slight lateral lobes in each segment. The intestine begins in XXI with a small globoid "gastric" chamber, and continues as a thin-walled tube, slightly chambered by constrictions at the septa, but without definite cæca to XXIII, beyond which it becomes thicker-walled, and without further sacculations tapers to the anus.

The reproductive organs, if normal, show several peculiar characters. Testes, ten pairs, in the extreme caudal end of somites XIII to XXII inclusive, each extending somewhat into the next succeeding somite, small, especially the last, and globular. Vas deferens as usual. Epididymis a small, compact, globoid mass formed of a tortuously folded tube, occupying XI $b6$ and XII $b1$, its total diameter scarcely equal to that of the penisac. Ejaculatory bulb subfusiform, the largest end posterior in contact with the epididymis, tapering and strongly hooked toward the cephalic end just caudad of ganglion XI, where it passes into the ductus ejaculatorius; its total length, if straightened out, about one and one-half times the diameter of the epididymis, and its maximum diameter about two-fifths of its length. Ducti ejaculatorii slender, slightly tortuous tubes, the left passing directly to the extreme end of the atrium, the right beneath the nerve-cord to open into the atrium about twice its diameter from

the end. The atrium lies to the left of the nerve-cord and is remarkable in that it lacks altogether any prostate enlargement or investiture of prostate glands, but this may be abnormal for the species. It is throughout cylindrical, of uniform diameter and firm, muscular texture; unusually long and slender for a *Hirudo*, being about thirteen or fourteen times as long as thick, tapering slightly to a rounded end. From the point at which it emerges from the ventral muscles just caudad of ganglion XI it reaches to the end of XII, behind the opening of the vagina, and bends back on itself in a sigmoid dorsal limb which reaches to the anterior end of XI and is one and one-half times the length of the ventral limb. Female organs also on left of nerve-cord, much smaller than the male, the total length of the vagina being less than one-half of the atrium. Ovisacs small, about diameter of a nerve-ganglion, globoid, situated serially with the testes on each side of the nerve-cord ventral to the stomach at XII/XIII. Paired oviducts short, scarcely exceeding diameter of ovisac, the right passing beneath the nerve-cord and meeting the left in a large, irregular albumin gland. Common oviduct short and not clearly delimited from the vaginal sac, on the cephalic face of which it lies and into the tapering end of which it opens. Vaginal sac fusiform, its length about four times its diameter, which is one-half that of the penis-sac. Vaginal duct tubular, slightly bulbous at external opening, of same colour and texture as sac and about one-half its diameter, and slightly longer.

Geographical Distribution and Bionomics.—Little is known of this species. Blanchard's account is based upon six specimens in the British Museum taken in fresh water near Tirphul, Afghanistan, on the Persian boundary. The Indian Museum collection includes two specimens believed to represent this species taken at Anwarganj, Cawnpore District, United Provinces (No. 4911, Sept. 3, 1911, J. W. C.). Aichinson (1889, p. 105), who collected the types, remarks as follows: "At Puza-gish I found the frogs suffering from leeches attached to them; this leech, Mr. Geoffrey Bell tells me, is the common one of our own lakes, *Aulostomum gulo* (*A. nigrescens*), and that the presence of this species in Lake Baikal has been already signaled by Grube, but he does not know that it has been reported to attach itself to frogs."

35. *Hirudo birmanica* (Blanchard). (Plate VIII, fig. 26.)

Synonymy:

- Hæmopsis birmanica* Blanchard, 1894, pp. 115-117, Lower Burma, not *Hæmopsis birmanica*, Kaburaki, 1921, pp. 712, 713 (= *D. ferox*).
Hirudo nipponica fuscolineata Moore, 1924, pp. 373, 374, pl. xxi, figs. 27, 28 (exterior). Madras Prov. (immature).

Diagnosis.—In life, extended, 2½ inches long, slender and small-headed. Colour olive or olive-brown with seven dusky or

brown dorsal stripes, the outer (supra-marginal) of which includes darker quadrate spots on *b 6* and *b 1* of every complete annulus; a broad, clear yellow marginal and a dusky submarginal stripe. Cephalic sucker small and caudal sucker of medium size. Eyes arranged as usual, but small. Sensillæ very small and inconspicuous. Somite XXV usually quadrannulate, sometimes triannulate. Jaws short and high, usually without papillæ, occasionally with a few small ones, bearing 43-59 conical teeth. Atrium 10 to 15 times as long as diameter; ejaculatory bulb large; vagina of length corresponding to atrium; oviduct, vaginal sac and vaginal duct passing gradually into each other.

Free-living and sanguivorous.

Type in Genoa Museum. Type-locality: Karenni Mts., Lower Burma.

Description.—Form as in *H. nipponica*, a rather slender, small-headed leech, which in life probably does not exceed a length, extended, of three inches and when contracted of one inch. A moderately extended example measures as follows: length, 36 mm.; length from end of lip to male pore, 7.5 mm.; buccal width, 1.5 mm.; width at male pore, 4.7 mm.; maximum width (clitellum), 5.3 mm.; at middle of length, 5 mm.; diameter of sucker, 3.6 mm.; depth at male pore, 2.5 mm.; at middle, 3.5 mm. Others vary in length and width from 9×2 mm. to 46×11.5 mm. The form may be either subcylindroid, slightly depressed subfusiform, or strongly depressed with ovate-lanceolate outline, but invariably the preclitellar region is relatively tapering and slender.

Cephalic region small and narrow, approaching *D. ferox*. The lip very small and short, smooth, rounded and without expanded margins, constituted of somites I-IV, which are faintly separated. Except for the dorsal oral angle there is no permanent ventral fissure, but in contraction the lip is folded into a pair of lobes with a cleft between. The margins of IV *a 1* often form a pair of small triangular lateral buccal lobes projecting into the oral chamber. Buccal ring composed of IV *a 3* and all of V. Eyes five pairs, all small, disposed in the usual arch on somites II to VI, the last three clearly on the sensory zones of their somites, the first three on contiguous annuli, the fourth separated by one annulus and the fifth by two. Those of the first two pairs look forward, the third forward and laterad, the fourth caudad and laterad, and the fifth caudad.

Clitellum zonary, but thin and ill-defined, extending over fifteen or sixteen annuli, from X *b 5* or *a 2* to XIII *a 2* inclusive. When best developed this is the widest part of the body. Male gonopore strictly interannular, at XI *b 5/b 6*, the latter annulus usually somewhat enlarged medially, the orifice varying from a minute, scarcely visible, hidden pore in immature leeches to a fairly conspicuous, transverse slit with furrowed lips elevated on a low mound in fully mature ones. Penis rarely protruded up to 5.5 mm., with a diameter of 0.2 mm. at the base, filiform, slightly

enlarged and truncate at tip, spirally wavy. Female gonopore at XII $b5/b6$, or rarely slightly within the enlarged middle region of $b6$; invariably a minute round pore, often hidden in the furrow.

Nephropores seventeen pairs, on VIII to XXIV inclusive, very small and often invisible or hidden, opening on the caudal margin of the second annulus ($b2$) slightly mediad of the intermediate sensillæ. Anus situated caudad of XXVII, or in one case at XXVI/XXVII, small, with furrowed lips. Caudal sucker from one-half to two-thirds of maximum width according to state of extension, with central pedicel and thin wide free border, flat, discoid; ventral face with numerous shallow, radiating furrows ending in slight marginal notches.

Annulation very distinct and regular, with deep, sharp, smooth furrows. Surface smooth, without large papillæ, but each annulus bearing a transverse series of nineteen to twenty-eight dorsal, and as many ventral, minute, pale or white, slightly elevated sensory papillæ. Similar sensory papillæ are found on the sucker, arranged in concentric rows. Segmental sensillæ cannot be distinguished in surface views, and sections of this species have yet to be studied.

Somites have the following annular composition: I, II and III simply uniannulate. IV uniannulate or, if the faint $a2/a3$ be counted, biannulate. V distinctly biannulate ($a1, a2$) slightly $> a3$ on the dorsum, but united on the venter to a single buccal ring. VI biannulate. VII strictly triannulate ($a2 < a1 < a3$) both dorsally and ventrally, or occasionally $a1 < a2 < a3$, $a3$ being in all cases enlarged but not subdivided; furrow $a2/a3$ much $> a1/a2$. VIII quadrannulate ($a1 > a2$ slightly $> b5=b6$ or $a1 > a2=b5=b6$), $a1$ being distinctly enlarged, but, except in one case in which a faint secondary furrow completely encircles it, quite entire; in depth of furrows $a2/b5 > a1/a2 > b5/b6$. Fifteen somites (IX to XXIII inclusive) complete and quinquannulate ($b1=b2=a2=b5=b6$). While the furrows are generally of equal depth, in the preclitellar somites there is a marked tendency for the annuli to become grouped in threes ($b1+b2+a1$) and twos ($b5+b6$). XXIV is usually quadrannulate ($b1=b2=a2 < a3$), but $a3$ is subject to much variation. Most frequently and on nearly all of the best-preserved and most-extended specimens it is about one-fifth longer than $a2$, either with no $b5/b6$ furrow or with a very faint one of varying extent. This furrow may be deeper and limited to the mid-dorsal region or extend toward or to the margins, or even to the ventral surface, rarely completely encircling the annulus. When this furrow is sufficiently distinct, $b6$ is much smaller than $b5$, and in one case in which the furrow is undeveloped $a3$ is no longer than $a2$. In four strongly contracted specimens the furrow $b5/b6$ is so deep that the somite would undoubtedly be interpreted as quinquannulate if no other specimens were available. XXV also is normally quadrannulate, but in all parts much smaller than XXIV, and differs from it in

having the annuli normally grouped in twos ($b1 + b2 = a2 + a3$ or $b1 + b2 < a2 + a3$), but the furrow $b1/b2$ is constantly shallower than $a2/a3$ and often incomplete, in which case the somite might be interpreted as triannulate, $(b1, b2) > a2 = a3$. In some cases it is so little developed that no other interpretation is possible. Other recorded variations are a reduction in size of $a3$, which even may be incomplete ($b1 + b2 > a2 + a3$), and partial unions at the margins or on the venter, where these annuli are much crowded, between $a2$ and $b2$, and between $a3$ and XXVI $a1$. XXVI biannulate on most examples, consisting of a larger papillated anterior annulus and a smaller nearly smooth annulus, the former sometimes exhibiting traces of the furrow $a1/a2$ at one or both margins. On immature examples XXVI is usually uniannulate, with a faint or incomplete $a2/a3$ furrow. XXVII is invariably uniannulate, but may exhibit a faint cross-furrow. The only important respect in which this species differs from the typical annulation of *Hirudo* is in the better development of somite XXV.

Colour.—There is no authentic published description of the living colours, which are probably greener than the preserved specimens*. Ground-colour of alcoholic specimens pale yellowish-grey, clay-colour, olivaceous-yellow, or light brown, marked on the dorsum with a median and three pairs of dark stripes, and on the venter by a pair of broad submarginal dusky stripes; margins with a broad clear yellow stripe. On young specimens, up to about 25 mm. long and 6 mm. wide (when contracted), and rarely on those of larger size, the colour-pattern is remarkably sharp, definite, and complete, with regular and precise metameric features. On such the median stripe is sunk deeper in the tissues than the paired stripes, and consequently appears dusky or dull brown, continuous for entire length, except for a slight tendency to become constricted or paler (pale spot) on $b6$ of each somite, otherwise of very regular width and clearly defined. Paired stripes built up of clear, sharp black spots aggregated and coalesced. Supramarginal stripes in addition are more or less dusky for their entire width from the presence of deep-seated, diffuse pigment, especially evident along the lateral border. Full width of these stripes about twice that of the median stripe, with the following salient features:—From V to XXV usually appear on $b6$ and $b1$ clearly defined, transversely elongated, subquadrate black spots, leaving gaps on $b2$, $a2$ and $b5$ which are bridged by narrow, arched lines connecting the medial ends of the spots. On incomplete somites at the ends of the body the metameric spots often persist, and are confined to those portions of the primary annuli which

* Tennent (1861, p. 483) states that, besides the common medicinal leech, there is in Ceylon "a smaller tank leech of an olive-green colour, with some indistinct longitudinal stripes on the upper surface, the crenulated margin of a pale yellowish-green; ocelli as in the paddy-field leech; length one inch at rest, three inches extended." This is believed to be *H. birmantoa*.

would form $b6$ and $b1$ if separated. Paramedian narrowest of the seven stripes, about one-half width of median and more or less irregular, but sharply defined and constituted of a series of scallops or arched lines footing on $b6$ on more heavily pigmented spots reaching nearly to the median stripe, the result being that the pair of paramedian stripes together form a broad-linked chain enclosing the median stripe. Intermediate stripes begin at the cephalic end as a series of detached metameric spots, which extend both ways from the sensory annuli, increasing in size successively until, at about XI, they unite into a continuous stripe, which throughout its length exhibits intersegmental constrictions alternating with expansions attaining their maximum on $a2$. These enlargements thus alternate with the supra-marginal spots, and usually include one or more small white spots, thus having a chain-like appearance. Caudally the intermediate stripes are broken into spots by gaps on $b6$. Lips dusky, and caudal sucker with dusky spots derived from either the supra-marginal or the paramedian stripes. On one example the paramedian approaches the intermediate instead of the median stripe, and forms on each side a chain-like figure, the supra-marginals with their dusky lateral borders forming a second pair of chain-stripes. Rarely the entire median area between the paramedian stripes becomes a deeper, richer colour than the rest of the ground, thus forming a broad median field.

On larger examples there is exhibited a breaking-up and obscuration of this precise pattern, the median stripe alone remaining continuous on most specimens, but becoming dull brown and obscure. The other stripes disintegrate by the narrowing and final interruption of the connecting parts, resulting in the formation of irregular spots in which the constituent metameric elements are usually recognizable. The extreme is reached in those individuals in which all of the markings are very dull, obscure and much broken and disconnected, with traces only of the original pattern, and in a rarer type in which the spots are clearly defined and deeply pigmented, but altogether irregular, forming a more or less reticular pattern in which the original stripes, with the exception of the median, are unrecognizable. One of the latter type was found in which the spots are so numerous, small and uniformly distributed that the general naked-eye effect is of a nearly uniform slate-coloured dorsum. In addition to the submarginal stripes, which are constant, but vary in intensity and width, the venter may bear a very few small, distant black spots, but is usually immaculate yellowish-grey or clay-colour.

Digestive System.—Oral and buccal regions as in *H. nipponica*. Jaws small, but prominent, short and high, the two dimensions about equal, strongly compressed, in most cases lacking papillæ, but occasionally with a few small ones. Teeth rather large (about 0.0035×0.0012 mm. at middle of series), relatively short, conical, slightly curved, 43–49 (in four specimens), up to 59 in one, monostichodont with incipient doubling (or rather halving) of the

tapering to a very delicate and less tortuous duct that enters the caudal end of the epididymis. Epididymis a compact, globoid mass in somites XII and XIII by the side of the atrium and not much exceeding the penis-sac in diameter, constituted of the closely and intricately folded sperm-duct, which here has a diameter several times that of the vas deferens, without its glands, and irregular, soft and dead-white or slightly yellowish in colour. Its anterior end continues into the abruptly enlarged and prominent, strongly curved, fusiform, hard and lustrous ejaculatory bulb. This lies chiefly transversely to the body-axis, and tapers medially into the short, slender ejaculatory duct, which in turn enters the prostate cornu of the atrium on the ventro-lateral face of the prostate region, close to the point where it joins the penis-sac. Atrium consists of a long, cylindrical, muscular penis-sac and an enlarged gland-covered head or prostate, the former doubled sharply on itself at the level of ganglion XIII and more or less folded, so that the internal (dorsal) limb is about twice the length of the external or ventral limb, thus bringing the end of the prostate to the level of ganglion X, whereas the external end of the penis-sac lies caudad of ganglion XI. The penis-sac comprises about six-sevenths of the atrium and is about twelve (10-15) times its own diameter, nearly regularly cylindrical, of a yellowish colour and satiny lustre, and with a thick layer of longitudinal muscles, which often have a spiral twist and are more or less fluted or slightly ridged. Prostate a dull whitish enlargement about one-sixth as long as the penis-sac and nearly twice its diameter, ovoid or subconical in shape, and covered with a thick layer of often lobulated prostate glands, near the free border of which the prostate cornua emerge to meet the ejaculatory ducts. The prostate lies in XI and XII, usually concealing both ganglia and the terminal portion of the atrium from dorsal view.

Female organs are peculiar for their slender, elongated form, the slight differentiation of the vaginal sac and the easy gradation of all its parts in a continuous tube. Ovisacs of the usual form and size, one on each side of the nerve-cord between ganglia XI and XII. Oviducts short and slender, disappearing together into the end of a large pyriform albumin gland, from which the short, rather stout, usually nearly straight oviduct proceeds to the vagina, into which it gradually enlarges. Vagina consists of a long, slender, fusiform sac or pouch receiving the oviduct at one end and emptying into the vaginal duct at the other, the latter being much longer and much more slender than the former. The duct opens to the exterior by a small bulbous bursa, and usually extends caudad ventral to the stomach to about ganglion XIV, at which point it bends sharply forward on itself at the place of union of the duct and sac, this point being marked by a slight annular constriction. Both male and female terminal organs are situated indifferently to the right or the left of the nerve-cord. Twelve specimens of various sizes dissected all conform closely to the above description, except for slight differences in proportion,

due chiefly to different states of maturity and somewhat of contraction.

This species diverges from the type of *Hirudo* in several respects, especially in the elongation of the genitalia, the tendency of some of the teeth to split, the larger size of the accessory gastric cæca and the occasional presence of small papillæ on the jaws. In the first two it approaches *Hæmopsis*, and in the last two *Limnatis* and *Hirudinaria*. The reproductive organs have much in common with those of *Dinobdella* also. But the divergences from these genera are much greater than the resemblances, and its affinities with *Hirudo* are undoubted.

Geographical Distribution and Bionomics.—Widely distributed in Ceylon, Mysore, Madras, Bengal, Bombay, the Punjab, United Provinces, and in South Burma, from which latter it was originally described by Blanchard. It seems to affect especially the lower levels of the coastal belt and the great river-valleys, especially of the Ganges and Indus, but also ranges into the hills. Blanchard's types were taken on the Karenni Mts. at an altitude of 1200 m., and these collections include examples from Peradeniya, in Central Ceylon, at an elevation of 1500 feet; the Nilgiris Hills, in the centre of Madras Province, between 3000 and 6000 feet above sea-level; Bangalore, Mysore, at 3000 feet; and Sialkot, in Western Punjab, at above 500 feet.

It appears to be abundant, and is frequently found in rivers and streams, swamps, tanks or ponds, and even in wells, not infrequently associated with species of *Hirudinaria*. It is recorded as attacking men and buffaloes, but it doubtless extends its attacks to other domestic and wild animals. Two were taken from frogs. While engaged in railroad building in the swamp-lands between Sonali and Salmari in Bihar, in the Punjab, the workmen were much troubled by these leeches, which were very abundant there. The stomachs of most of the specimens are empty or nearly so, but a few are filled with hardened blood and one with a greenish coagulum. Nothing is known of its breeding habits or egg cocoons. (See also Appendix, p. 297.)

Genus LIMNATIS, Moquin-Tandon.

Synonymy:

Bdella, Savigny, 1820 (1822), p. 112; not *Bdella*, Latreille, 1796 (Arachnid).

Limnatis, Moquin-Tandon, 1826, p. 122; 1846, p. 349.

Palæobdella, Blainville, 1828, t. 57, p. 563.

Hæmopsis, Moquin-Tandon, 1846, p. 317; not *Hæmopsis*, Savigny, 1820 (1822).

Limnatis, Blanchard, 1894, p. 42.

Diagnosis.—Size of *Hirudo* but more robust. Colour plain or sparsely striped, marginal stripes yellow or orange. Fifteen complete somites, IX to XXIII. Head broad and caudal sucker equal to body-width. Sensillæ evident and circular. Gonopores

XI b 5/b 6 and XII b 5/b 6. Eyes as in *Hirudo* but smaller. Jaws prominent with salivary papillæ and acute monostichodont teeth, variable in number. Gastric cæca two pairs in each somite, the principal pair large and much branched. Reproductive organs as in *Hirudo*.

Type-species, *Bdella nilotica* Savigny, 1920 (1822), p. 113, pl. v, fig. 4 (Egypt). For figures see Moquin-Tandon, 1846, pl. vi (colour and anatomy).

Two species have been reported from India, as follows:—

- | | | |
|-----|---|--|
| A. | Dorsum olive or reddish, usually with four dark longitudinal stripes; teeth about one hundred | [p. 200.
<i>Limnatis nilotica</i> , |
| AA. | Uniform brown or brownish-yellow, no dark longitudinal stripes; teeth fewer than fifty | <i>Limnatis paluda</i> , p 201. |

36. *Limnatis nilotica* Savigny.

Synonymy :

Bdella nilotica Savigny 1820 (1822), p. 113.

Limnatis nilotica, Moquin-Tandon, 1826, p. 122; 1846, p. 349, pl. vi.

Palæobdella nilotica, Blainville, 1828, t. 57, p. 863.

Limnatis nilotica, Blanchard, 1894 b, p. 43 (full synonymy and description).

Limnatis nilotica, Annandale, 1920, p. 135 (Afghan-Baluch Desert).

Limnatis nilotica, Kaburaki, 1920, pp. 213, 214 (Baluchistan).

Hæmopsis sanguisuga, Kaburaki, 1921, p. 712 (Palestine).

Limnatis nilotica, Moore, 1924, pp. 374, 375 (Palestine).

? *Limnatis turkestanica*, Plotnikoff, 1907, pp. 142-144 (Turkestan and Persia).

Diagnosis.—“Length 100-150 mm.; width 10-15 mm. Colour of dorsum reddish or greenish with four black longitudinal stripes which are occasionally absent, also occasionally with a median greenish or yellowish stripe; lateral margins of body orange. Caudal sucker of noteworthy size. The ten pairs of gastric cæca lobed, and the last, as in *Hirudo*, very long” (*Brandes*). Sensillæ are conspicuous and circular. Lip broad and with a deep median ventral fissure reaching to the margin. Jaws bearing numerous and prominent papillæ on which the salivary glands open, and one hundred or more acute fine teeth. Type-locality: Egypt.

Geographical Distribution and Bionomics.—Widely distributed and abundant in a broad zone about the shores of the Mediterranean and eastward through Palestine, Syria and Persia. Recorded by Annandale and Kaburaki in Afghanistan and Baluchistan. No Indian examples were seen by me, but it is almost certain to have been introduced by being carried in the air-passages of men and domestic animals, and owing to the seriousness of its attacks the determination of its presence is of importance.

In the circum-Mediterranean countries this so-called “horse-leech,” which has been confused with *Aulastomum*, is much feared.

It lives in the springs and wells and enters the mouths of drinking men and other mammals, and takes up its abode in the pharynx and larynx, often causing serious injury or even death. For a full account of the species consult Blanchard, 1894*b*, and Masterman, 1908. Also see some remarks under the next species.

37. *Limnatis paluda* (Tennent). (Plate VIII, figs. 27, 28.)

Synonymy:

Hæmopsis paludum Tennent, 1859 (1861, p. 484). (Ceylon.)

? *Limnoddella grandis* Blanchard, 1894 (1892, 1893), p. 7. (Timor, Sumatra, and Ceylon.)

? *Limnatis turkestanica* Plotnikoff, 1907, pp. 142-144. (Turkestan and Persia.)

Diagnosis.—Form and size of *Hirudo medicinalis*. Cephalic and caudal suckers both large, the latter sometimes equalling or exceeding the body-width. Colour uniform brown or brownish-yellow with broad marginal stripes of orange or yellow. VII a 1 not subdivided ventrally; IX to XXIII inclusive, complete; XXIV usually quadrannulate, possibly occasionally quinquannulate. Sensillæ small, circular, obscure, especially on the dorsum. Jaws smaller than in *L. nilotica*, bearing numerous small papillæ and 30-47 acute monostichodont teeth; stomach with two pairs of much lobulated cæca in each somite. Atrium and vagina as in typical *Hirudo*, but short and remarkably small. Type-locality: Ceylon.

Free-living and also parasitic in air-passages of mammals.

Description.—General form and proportions of *Hirudinaria granulosa*, and, according to Tennent, attaining the full size of that species, but all of the specimens examined by me are much smaller. One of the best preserved examples measured as follows: length, 44 mm.; buccal width, 5.5 mm.; maximum width (XVIII), 8.5 mm.; maximum depth, 7 mm.; diameter of caudal sucker, 9.5 mm. A more fully extended one is 63 mm. long, 7 mm. in maximum width, 5.5 mm. in maximum depth, and 9.5 mm. in diameter of sucker. The range in length is 24 to 66 mm.

Form generally robust with greatest width in caudal third (except when the clitellum is well-developed, when it may be wider), but tapering relatively little either way; little depressed, most so in strongly contracted specimens with empty cæca, in which the depth may be only one-half the width. When the cæca are filled it may be two-thirds, three-fourths, or even equal the width, the cross-section being broadly elliptical with rounded margins or even nearly circular, but always with a more or less evident marginal ridge.

This is a broad-headed species, with the buccal width commonly exceeding one-half the maximum width. Upper lip constituted of somites I-IV, with dorsal annulation well-defined, broadly

rounded, with crenulated margin, and venter with a deep median fissure for entire length, and usually with one or two pairs of shallower longitudinal furrows, but otherwise smooth. Eyes five pairs, arranged as usual on annuli 2, 3, 4, 6 and 9 (somites II-VI), but smaller than those of *Limnatis nilotica*, about as in typical *Hæmopsis* and occasionally obscure. Buccal ring usually more or less inflated and rather coarsely crenulate, constituted of the second annulus (*a* 3) of IV and the first (*a* 1, *a* 2) of V, or all of V.

Clitellum seldom well developed, prominent in only one example in this collection, in which it forms a thick zonary layer extending over fifteen annuli, X *b* 5 to XIII *a* 2 inclusive. Gonopores strictly interannular, the male XI *b* 5/*b* 6, the female XII *b* 5/*b* 6. The male pore may be small and hidden in the furrow, but in mature examples is a rather conspicuous transverse elliptical opening, sometimes elevated on a prominent papilla rising from the two bounding annuli. In no case is the penis protruded. Female pore uniformly minute and usually depressed in the furrow. Nephropores rather small, seventeen pairs, in the usual position on the caudal border of *b* 2, from VIII to XXIV inclusive. Anus usually rather large and with prominent furrowed lips, cutting into somite XXVII or entirely caudad of it. Caudal sucker large but not excessively so, about twice width at peristomium, and, on extended examples, exceeding body-width, circular with wide free border.

Annuli clearly defined; on strongly contracted specimens *b* 1 is often retracted and the remaining annuli grouped in pairs, or *b* 1, *b* 2 and *a* 2 form a group of three annuli, alternating with *b* 5 and *b* 6 forming a group of two, thus clearly defining the somites. Integument everywhere and especially on the dorsum finely furrowed and divided into more or less quadrate areas which are much less conspicuous and elevated than in *Hirudinaria granulosa*. Minute, scattered sensory papillæ occur regularly on all segments of the middle region, but no constant number can be determined. Sensillæ are not readily detected on the dorsum, but show clearly on the venter of some of the specimens.

The total number of annuli is 102 or 103, dependent upon whether XXVII has one or two. Composition of the somites is as follows:—I, II and III are uniannulate, but quite often the furrows are scarcely discernible, especially II/III, in which case II and III form one broad annulus bearing the first two pairs of eyes. IV is very constantly biannulate, only one doubtfully uniannulate case occurring; the first annulus is the larger, and bears the third pair of eyes on its caudal half; the second annulus (*a* 3) forms the post-oral rim, and unites ventrally with V to form the buccal ring, and occasionally is more closely united to the latter, which then appears biannulate dorsally. V is biannulate on the dorsum, the first annulus being larger than the second and with a faint dividing furrow in its median dorsal field (*a* 1, *a* 2)

$> a_3$, the fourth pair of eyes being borne on a_2 ; on the venter it is usually uniannulate and closely united with IV a_3 , but rarely a_3 may remain distinct. VI is triannulate on the dorsum (usually $a_2 < a_1 < a_3$), but a_2 may equal or exceed a_1 and bears the fifth pair of eyes; on the venter it is biannulate, a_1 and a_2 being united. VII is typically triannulate both dorsally and ventrally ($a_2 < a_1 < a_3$, or rarely $a_1 < a_2 < a_3$); a_3 is distinctly enlarged, but in only one case shows a shallow secondary furrow b_5/b_6 ; furrow a_1/a_2 much more shallow on venter; VIII typically quadrannulate, a_1 much $>$ or rarely $= a_2$ slightly $> b_5 = b_6$; but on the venter all annuli are approximately equal or a_1 somewhat larger. One strongly contracted example has the furrow b_1/b_2 faintly developed, especially on the venter, but typically a_1 is quite entire; furrow a_2/b_5 constantly deeper than a_1/a_2 and b_5/b_6 . The fifteen somites IX to XXIII, inclusive, are quinquannulate, the annuli and furrows of the post-clitellar somites being equal, except that the second (b_2) and fourth (b_5) project somewhat above the surface of the others and are paler, thus exhibiting a metameric prominence that renders the counting of the somites easy. Preclitellar and clitellar somites, however, exhibit gradual transition states from the incomplete anterior somites. Somite IX of well-preserved specimens has the following formula:— $b_1 = b_2 < a_2 > b_5 = b_6$ and the interannular furrows, all of which are shallower than the inter-somatic, have the following depth-relations: $b_1/b_2 < b_5/b_6 < b_2/a_2 < a_2/b_5$ and on the venter b_1/b_2 becomes more shallow and the annuli b_1 and b_2 reduced in size. X and XI exhibit diminishing traces of the same characteristics. At the caudal end XXIII exhibits a slight reduction in size of b_5 and b_6 , and in depth of the furrow b_5/b_6 , which in one case (ZEV 4009, No. 2) proceeds to virtual suppression, leaving the somite quadrannulate ($b_1 = b_2 < a_2$ slightly $< a_3$). XXIV quadrannulate ($b_1 = b_2 =$ or $< a_2 > a_3$); on the venter b_1 and b_2 , and a_2 and a_3 sometimes unite as pairs separated by a deeper furrow. XXV triannulate ($a_1 > a_2 = a_3$ or sometimes $a_1 = a_2 = a_3$). XXVI biannulate ($a_1, a_2 > a_3$, or sometimes appearing as a simple broad annulus with faint dorsal furrows dividing it into three. XXVII variable, biannulate or uniannulate, in the former case the second annulus very small and usually cut by or following the anus.

Colour very simple. Tennent describes living *H. paludum* from Ceylon as a "uniform brown without bands unless a rufous margin may be so considered. It has dark striæ." The preserved specimens agree with this, being nearly uniform dull brown, reddish-brown, or faded to brownish-yellow or slaty-grey, the dorsum often becoming darker toward the margins and exhibiting narrow lighter and darker lines due to the longitudinal muscle-bands showing through the integument. The venter may be paler, and the margins invariably exhibit a broad orange or yellow stripe very sharply defined dorsally but less clearly ventrally.

Digestive System.—Jaws relatively small, high, compressed, bearing numerous rather small papillæ (0.054 mm. diam.), especially on the peripheral portion of the paired jaws. Teeth very small, acute and monostichodont, often very difficult to discern at all; those counted number from 30 to 47. Stomach and intestine of the *Limnatis* type. Gastric cæca two pairs in each somite beginning with X, the anterior ones small, the post-genital large. When empty they appear simple and little lobed, alternately wide and narrow, and both pairs reach nearly to the sides of the body. When distended with blood (Pl. VIII, fig. 28) their complexly lobed character appears; the more anterior pairs all continue to extend nearly straight laterad to the body-walls; farther caudad the wide or anterior cæca lose their more lateral lobes and become short and compact, while the lateral portions of the narrow cæca bend caudad external to the succeeding pair of wide cæca and give rise to numerous lateral lobes. This relation continues to somite XVIII. The second pair of XIX, corresponding to the narrower and progressively elongated cæca of preceding somites, are very large and extend on each side of the intestine similar to those of both pairs of cæca combined. Intestine and rectum as in *L. nilotica*, with an anterior globoid, gastric enlargement in XX, behind which it becomes a simple tube, slightly constricted by the intersegmental muscular septa.

Reproductive organs are remarkably small, and this appears to be a characteristic of the species, for it is true of both the male and female terminal organs in eight specimens dissected. These were taken from April to August inclusive, and several, including the large one with thickened clitellum, had well-developed testes containing functional spermatozoa, so that their maturity is evident. The atrium is very constantly between two and five millimetres long and, when least developed, scarcely rises above the level of the nerve-cord, but when largest passes to either right or left immediately caudad of ganglion XI and stands upright. It is strongly clavate, hooked or tobacco-pipe-shaped, consisting of a narrow, cylindrical, upright stem or penis-sac, contributing one-half to two-thirds of the total length, and a prominent and abruptly enlarged prostate of ovoid or globoid form which projects forward and is more or less hooked. From the antero-ventral face of the prostate arise the atrial cornua and ducti ejaculatorii, which are noteworthy for their coarseness and which bend latero-ventrad and then cephalad to pass into the complexly coiled epididymes, which when best developed form a pair of globoid masses about equalling the prostate in size and lying anterior to it near the median line or sometimes even in contact, in which case they cover ganglion XI. In no case can a distinct ejaculatory bulb be detected. The vas deferens has the usual form and position. The testes were completely dissected in two. In one there are eight, in the other ten pairs, the last in each case being one-half the diameter of the others. The first

pair is located at XII/XIII, and the first two pairs are in contact or nearly in contact dorsal to the nerve-cord, the others well separated.

The *female organs* are of similar size and lie caudad to ganglion XII and, similarly to the atrium, either ventral to or partly to the right or left, most frequently the latter, of the nerve-cord. Vagina fusiform or cylindroid, its length equalling or slightly exceeding and its diameter invariably exceeding the corresponding penis-sac. It is usually straight, but may be curved toward the head and at the apex usually passes gradually, in some cases more abruptly, into the common oviduct, which takes a nearly straight, or somewhat bent course, ventrad on the cephalic face of the vagina. The oviduct varies considerably both in length and diameter, in the former occasionally equalling the vagina, but usually much shorter. At its bifurcation into the paired oviducts there is a more or less enlarged albumin gland, which is sometimes not apparent. The oviduct that passes beneath the nerve-cord is usually nearly twice as long as the other, but never exceeds the diameter of the spheroidal ovisacs, which are often compressed by the distended cæca and occupy the serially homologous position of the testes at XI/XII. Nephridia are unusually conspicuous, and their principal masses are usually much compressed cephalo-caudally.

Geographical Distribution, Bionomics, etc.—Tennent originally described this "cattle-leech" from the island of Ceylon as follows:—"In size the cattle-leech of Ceylon is somewhat larger than the medicinal leech of Europe; in colour it is of a uniform brown without bands, unless a rufous margin may be so considered. It has dark striæ. The body is somewhat rounded, flat when swimming, and composed of more than ninety rings. The greatest dimension is a little in advance of the anal sucker; the body thence tapers to the other extremity, which ends in an upper lip projecting considerably beyond the mouth. The eyes, ten in number, are disposed as in the common leech. The mouth is oval, the biting apparatus with difficulty seen, and the teeth not very numerous." This description agrees fully with the specimens above described.

Blanchard refers a specimen from Ceylon, in the collection of the Senckenberg Museum, to his *Limnoddella grandis*, originally described from Timor. The only respects in which *L. grandis* is described as differing from *H. paluda* is in the greater elaboration of somites of the anal region, which may be simply a question of individual variation, or more probably of Blanchard's interpretation giving greater importance to incipient furrows than does mine, and the reputed absence of jaw papillæ in the genus *Limnoddella*. Blanchard does not specifically refer to either the papillæ or the teeth. Consequently it seems probable that his Ceylon specimen, at least, belongs to Tennent's species.

None of the Ceylonese leeches examined by me belong to this species, but there are six specimens taken in the Gujranwala.

District in the Punjab and ten collected in Baluchistan. This raises the question of the geographical and systematic relations of this species and *L. nilotica*. Concerning the latter, the two seem to be very clearly distinguished by the teeth, and among those studied by me there have been no intermediates. Whether the individuals reported by Kaburaki and Annandale from Baluchistan, Afghanistan, and within the borders of India were correctly identified as *L. nilotica* is unknown. If so, then the ranges of the two species must overlap. Our knowledge of their occurrence in India is so meagre that any further data will be of much value. It seems probable that hitherto the two or three species of cattle-leeches have been confused by veterinarians. *L. turkestanica*, Plotnikoff, from Turkestan and eastern Persia is described as having fifty teeth, and consequently as resembling this species rather than *L. nilotica*, with which all other observers have identified the species of that region. The matter evidently requires further and careful study.

None of the labels or accompanying letters gives any information concerning the habits of these leeches. Most of them are more or less filled with blood, and the condition of several indicates that they were removed from hosts. Tennent, however, who also may have failed to distinguish this species from *Dinobdella ferox*, makes the following interesting comments (1861, pp. 484, 485):—"There is another pest in the low country which is a source of considerable annoyance, and often of loss, to the husbandman. This is the cattle-leech which infests the stagnant ponds, chiefly in the alluvial lands around the base of the mountain zone, whither the cattle resort by day and the wild animals by night, to quench their thirst and to bathe. Lurking amongst the rank vegetation that fringes these deep pools and hid by the broad leaves or concealed among the stems and roots covered by the water, there are quantities of these pests in wait to attack the animals on their approach to drink. Their natural food consists of the juices of lumbrici and other invertebrates; but they generally avail themselves of the opportunity afforded by the dipping of the muzzles of the animals in the water to fasten themselves on their nostrils, and by degrees to make their way to the deeper recesses of the nasal passages and the mucous membranes of the throat and gullet. As many as a dozen have been found attached to the epiglottis and pharynx of a bullock, producing such irritation and submucous effusion that death has eventually ensued; and so tenacious are the leeches that even after death they retain their hold for several hours. Even men, when stooping to drink at a pool, are not safe from the assault of the cattle-leeches. They cannot penetrate the human skin, but the delicate membrane of the mucous passages is easily ruptured by their serrated jaws. Instances have come to my knowledge of Europeans into whose nostrils they have gained admission and caused serious disturbance."

Genus **HIRUDINARIA**, Whitman.*Synonymy*:

Hirudinaria, Whitman, 1886, p. 373.

Pæcilobdella, Blanchard, 1893, p. 28 (subgenus of *Limnatis*).

Limnatis (subgenus *Pæcilobdella*), Blanchard, 1897, pp. 337, 338; not *Limnatis*, Moquin-Tandon, 1826, p. 122 (as originally limited).

Diagnosis.—Size medium to very large. Form generally robust, widest near middle and tapered little to the ends. Colour variable, green, brown, or reddish, with a very precise pattern of black stripes and metameric spots, which becomes broken and dissipated with age. Complete somites IX to XXIII=fifteen. Broad-headed. Eyes large, five pairs, arranged as in *Hirudo*. Gonopores separated by five or seven annuli, the male at XI *b* 5/*b* 6, the female at XII *b* 5/*b* 6 or XIII *b* 1/*b* 2. Integuments rough and areolated or verrucose, especially at the ends. Sensillæ unusually large, linear, elevated on elliptical papillæ and transverse or oblique to body-axis. Jaws large, with numerous prominent salivary papillæ and more than one hundred acute monostichodont teeth. Gastric cæca nearly as in *Limnatis*; two pairs per somite, unequal, spacious and sometimes much lobulated. Atrium of *Hirudo* type, more or less pyriform, but differing much in length and proportions; ejaculatory bulb present. Vagina very distinctive because the sac or pouch forms a spacious cæcum which opens by a separate duct, but along with the common oviduct, either into the female bursa or into a vaginal stalk differing in length in the several species. Strictly sanguivorous so far as known.

Type-species, *Sanguisuga javanica* Wahlberg, 1856. Java.

Key to Indian Species of Hirudinaria.

- A. No vaginal stalk, both duct of vaginal cæcum and common oviduct opening directly into the bursa; ejaculatory bulb large; teeth very numerous, forming a long series fading into many very small ones. (*Hirudinaria*, *sen. str.*)
1. Gonopores separated by seven annuli, the female situated at XIII *b* 1/*b* 2; caudal sucker equalling width of body; colour very showy green and red; teeth about 140 (115-154)
 2. Gonopores separated by five annuli, the female at XII *b* 5/*b* 6; caudal sucker distinctly less than (about two-thirds) body-width; colour as in 3, but tending more to brown, often green on venter; teeth about 160 (140-166)

[p. 210.
Hirudinaria javanica,

[p. 218.
Hirudinaria manillensis,

AA. Vaginal stalk well developed, equalling or exceeding in length the vaginal cæcum, the duct of which it receives at its summit along with the common oviduct; ejaculatory bulb small; teeth less numerous, the series lacking the large number of very small ones. (Subgenus *Pæcilobdella*, Blanchard, 1893.)

3. Gonopores, caudal sucker and colour as in 2, except that there is less brown on dorsum and the venter is rarely green; vaginal stalk approximately equal in length to both duct and sac of cæcum; teeth about 100 (86-128).....

[p. 226.

Hirudinaria granulosa,

4. Like 3 externally, except that the colour is a brighter green and the pattern disintegrates much earlier in life; vaginal stalk approximately twice length of cæcum, and penis-sac correspondingly elongated; teeth about 100 (90-106)

[p. 239.

Hirudinaria viridis,

Some explanation of the nomenclature adopted in the preceding table seems necessary. Hitherto there have been recognized as belonging to this group only the two species, *H. javanica* and *H. granulosa*, which Blanchard and his followers have referred to the subgenus *Pæcilobdella* of *Limnatis*, making *H. granulosa* the type. Whitman long ago (1886) made the first the type of his genus *Hirudinaria*, and the soundness of that view has been supported by the present writer (1901, 1924). No one has questioned the specific distinctness or the homogeneity of *H. javanica*, and *H. granulosa* has generally been considered an inclusive species embracing in its synonymy all of the many related nominal species that have been described from the continent of Asia and the Indo-Malayan and neighbouring islands. So long as attention was confined to external characteristics only, this seemed fully justified, especially as Blanchard (1897) had studied such of the types as still exist in European museums. Detailed study by the writer of the exteriors of a large and varied collection has failed to afford any basis for further specific analysis, and appeared to confirm Blanchard's conclusion.

Dissection of the reproductive organs, however, makes it very clear that the Indian *Limnatis granulosa* (Savigny) is a composite of three species, and that all of them are sharply distinguished from the true *Limnatis* by the cæcate form of the vagina and other minor characteristics which they possess in common with *H. javanica*. In all, more than nine hundred specimens were studied, and of nearly every lot one or more representatives were dissected, in the case of the larger lots a selection of several of different ages being made. Thus a total of one hundred and eight dissections of the reproductive organs were made. These fall into the three specific types as follows: fifty-eight *H. granulosa*,

forty *H. manillensis*, and ten *H. viridis*, as here understood. The results were perfectly consistent. Except in a very few young individuals with quite undeveloped reproductive organs, there is never the slightest doubt as to which group they belong. There are no intermediates, and in every case in which several of the same lot were dissected all are of the same type, irrespective of the stage of maturity. As shown in the Key, these fall into two groups, correlated with other characters and corresponding to the two subgenera, *Hirudinaria* in the strict sense, and *Pocilobdella*.

While a careful study of the external morphology and variations of preserved material affords no basis for diagnostic separation, it does indicate the probability of statistical separation correlated with the differences in internal anatomy. There is every probability of a differential coefficient of variability of certain features of annulation and colour-pattern. It is also probable, if careful comparison of living or freshly preserved material prepared according to a uniform standard were made, that constant external differences would be detected, now that the lines of specific cleavage are known.

When the lots came to be plotted geographically, it was found that their distribution corresponded with remarkable fidelity with the two principal species, *H. manillensis* being a coastwise and lowland species, and *H. granulosa* an interior species of somewhat higher altitudes. *H. viridis* is represented by only four lots, and consequently has no significance in this respect.

There can be no doubt, therefore, that we have to do with three related species sharply differentiated internally but nearly or quite indistinguishable externally. But the selection of the correct names to apply to two of these is much more difficult. There is no reason whatever to believe that any existing names apply to *H. viridis*, which quite certainly is a new species; nor is there any reasonable doubt that the lowland species of India is specifically identical with *H. manillensis*; nor that most, if not all, of the names subsequently proposed apply to this same coastwise species. The real question concerns the application of Savigny's *Hirudo granulosa*. Unfortunately there appear to be no existent types, but Blanchard examined some specimens from the type-locality of Pondicherry. He gives no description of the anatomy of these, and up till now I have been unable to secure any examples of the medicinal leech of Pondicherry. I have, however, examined five lots from Madras State belonging to the Indian Museum and the Madras Museum, one of them being from the city of Madras, about one hundred miles from Pondicherry. These were expected to belong to the lowland species, but without exception, proved to be the upland form. The very region from which Savigny's types came is the one point at which the upland form approaches the coast. This, taken with the fact that leeches were brought from the interior to the coast towns for medicinal purposes, makes the chances at least equal that Savigny had

specimens of the upland species in hand. Consequently, in the absence of direct evidence to the contrary, his name is applied to the latter. Should the weight of evidence in the future turn the other way, this name will displace *H. manillensis*, and a new name will need to be furnished for the inland species*.

38. *Hirudinaria javanica* (Wahlberg). (Plate III, fig. 1; VIII, figs. 29, 30.)

Synonymy :

Sanguisuga javanica Wahlberg, 1856, pp. 233-234. (Java.)

Hirudinaria javanica, Whitman, 1886, pp. 373-376, pl. xx, fig. 56 (caudal annulation), xxi, fig. 60 (jaw).

Limnatis (Pæcilobdella) javanica, Blanchard, 1897, pp. 349-351, text-fig. 7. (Burma.)

Hirudinaria javanica, Brandes, in Leuckart, 1901, pp. 880-881.

Limnatis javanica, Kaburaki, 1921, pp. 711, 712.

Hirudinaria javanica, Moore, 1924, p. 377, pl. xix, figs. 10, 1. (exterior). (Assam.)

Diagnosis.—Attaining a very large size, up to 175 mm. or more, in life. Form relatively more slender and flattened than in other

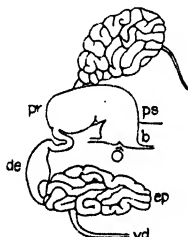

Fig. 50.—*Hirudinaria javanica*. Outline of male atrium with epididymies displaced, from right side. $\times 5\frac{1}{2}$. *b.*, terminal bursa. Other lettering as in preceding figures.

species of the genus. Colour in life exceptionally striking, the dorsum being olive-green varying to grass-green or olive-brown, with generic pattern of dark stripes and metameric spots, the margins yellow or orange and the venter, with the exception of the suckers, which are bluish, bright brick-red or occasionally green. Gonopores normally separated by seven annuli, the male

* Since this was written, through the kindness of Mr. O. C. A. Monro, I have been able to examine seven lots of *Hirudinaria* from Madras State in the collection of the British Museum. Of these, two lots (No. 37, Cochin, and No. ?, Nilgiris) belong to the upland species, and five lots (Nos. 38 and ?, Madras Dist., Nos. 41 and 42, Mysore Dist., and No. 62, Chingleput) to the coastwise species. It is obvious that this finding increases the possibility that Savigny's types belonged to the latter and that the inland species is without a proper name.

HIRUDINARIA.

at XI b 5/b 6, the female at XIII b 1/b 2. Sensillæ unusually large and prominent, elongated and oblique or transverse to the axis of the body. Integument areolated, especially toward the ends. Caudal sucker very large, often equal to the maximum body-width. Jaws very large, bearing numerous large salivary papillæ and usually many more than one hundred (about 140) acute teeth. Atrium very short, with relatively wide penis-sac; vagina also short, without stalk, the cæcum and common oviduct opening together into the bursa. Type-locality, Samarang, Java.

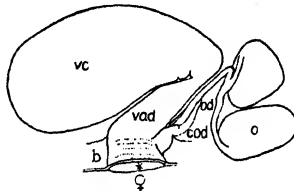

Fig. 51.—*Hirudinaria javanica*. Female organs from right side. Lettering as in preceding figures.

Description.—Size up to very large, living specimens reported from Java by Dr. Sluiter reaching a length of 175 mm. Probably it reaches an even larger size in India, as a preserved specimen in the Indian Museum collection has the following measurements: length, 170 mm.; length from tip of lip to male pore, 38 mm.; width at buccal ring, 8.2 mm.; width at male pore, 13.5 mm.; maximum width (XVII), 19 mm.; depth at male pore, 8.5 mm.; depth at XVII, 11 mm.; diameter of caudal sucker (much contracted), 12 mm. Generally much smaller than this, averaging below the average of *H. granulosa*. The smallest are about 20 × 2 mm., and one of average size measures as follows: length, 61 mm.; length to male pore, 12.2 mm.; buccal width, 4 mm.; width at male pore, 4.8 mm.; maximum width (XVIII), 6.2 mm.; depth at buccal ring, 4 mm.; at male pore, 3.2 mm.; at XVIII, 4.5 mm.; diameter of caudal sucker, 6 mm.

Form generally less robust and more elongated, more slender and flattened than related species; greatest width not far caudad of middle, from which it tapers but little and nearly equally both ways. Buccal and pharyngeal region subterete, the remainder of the body depressed, with rather sharp margins when empty; deep and rounded when filled with blood. Small individuals are nearly uniform in width and more depressed than the larger ones. Many individuals bear a striking general resemblance to *Hæmadipsa*.

Cephalic region broad, with large lip and spacious oral chamber, but without a distinct unsegmented margin; the lip in nearly every case projecting as a triangular point, its dorsal face rough and areolated, ventrally with a deep, narrow, median fissure extending from its anterior margin to the triangular sinus in the

velum anterior to the median dorsal jaw, and on each side of this usually three shallow longitudinal furrows ending in the marginal notches of the first three intersegmental furrows. Eyes five pairs, large and conspicuous, especially the first pair, arranged as usual in an arch on annuli 2, 3, 4, 6 and 9 (sensory zones or annuli of somites II to VI), the first two directed mainly forwards, the third latero-caudad, the fourth chiefly and the fifth entirely caudad. The first belong to the paramedian, the others to the intermediate series. Buccal ring formed of somite V, the $a2/a3$ furrow of which usually extends on to the venter, becoming obsolete only in the median field. Post-buccal formed of VI $a1$ and $a2$, which unite ventrally much as do the two annuli of V.

Clitellum not indicated externally in even the largest and most mature of these specimens, but internally, among and within the longitudinal muscles, and extending over the usual annuli (X $b5$ -XIII $a2$), is a thick and loose layer of glands, a diffuse extension of which partly covers and conceals the atrium. Gonopores separated typically by seven annuli, the male in the usual family position at XI $b5/b6$, the female in the furrow XIII $b1/b2$. In one specimen the female pore is shifted forward to XII/XIII, only six annuli caudad of the male pore, and in another the male pore is at XI $a2/b5$ and the female at XIII $b2/a2$, nine full annuli consequently intervening. Among minor variations either gonopore may open slightly within the borders of either the preceding or the succeeding annulus, in one case the female pore being advanced halfway across $b1$. Usually both pores are small, the male rounded, the female slit-like, but in some cases the male pore is larger and occupied by a flat disk. Nephropores seventeen pairs, on VIII to XXIII inclusive, the first on VIII $a1$, the others on $b2$ slightly anterior to the furrow, usually conspicuous and open. Anus at base of sucker, behind or cutting into last annulus of XXVII, margins deeply furrowed. Caudal sucker large, much exposed caudally, slightly wider than long, reaching forward to the anterior part of XXIII and often exceeding the body in width. Margins thin, and peduncle rather narrow. Dorsal surface rough, divided into small quadrate or polygonal areas each usually rising as a wart-like elevation, and bearing eight dorsal series of three to six sensillæ and a few of the ventral series. Ventral surface with rather irregular radiating ribs, about forty in number.

Annuli clearly differentiated throughout by deep, well-marked furrows and divided by longitudinal wrinkles into irregularly quadrate areas, each bearing a small papilla and sense-organ. On middle somites these number from twenty to twenty-four on the dorsal and as many on the ventral surface. An average example of their distribution in the inter-sensillar fields of a mid-body segment is as follows: A-1, B-4, C-2, D-1, E-1, F-2, G-1 and H-5, which, added to the fourteen bearing the sensillæ, makes a total of forty-two. In one specimen the number is doubled in each case. Commonly, but not invariably, a faint tertiary furrow

extends transversely across each annulus, dividing these areas into anterior and posterior halves. The result is a tessellated surface resembling that of *Hirudinaria granulosa* and *Hæmadipsa* but less rough. There is, however, much individual variation in the degree of roughness.

Sensillæ are exceptionally well developed in this species, and while they differ but little in arrangement from the plan typical of the family, their large size and peculiar form render them unusually favourable for study, inasmuch as they cannot be confused with the non-metameric sensory papillæ which occur on every annulus. Except on a few of the cephalic somites the sensillæ proper are short, raised, white lines, elevated on low, rounded, elliptical, smooth and greyish papillæ. These are so large on the dorsum that, with the exception of the paramedian field, the spaces

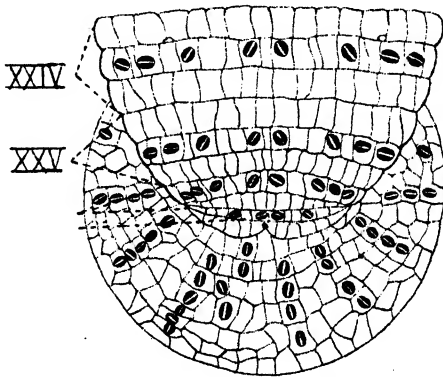

Fig. 52.—*Hirudinaria javanica*. Caudal end showing annulation and sensillæ. Modified from Whitman. $\times 9$.

separating them do not much exceed their length. The paramedians are inclined to the median axis of the body at an angle of about 30° , the intermediates at about 45° , and the supramarginals and marginals are directed nearly transversely.

Throughout the greater part of the length, from VI to XXIV inclusive, there is a full set of four pairs of dorsal and three pairs of ventral sensillæ, but on somites I to IV and XXV to XXVII the dorsal only are apparent. The presence of ventral sensillæ on V is uncertain and variable. Somite I bears very small paramedian and intermediate sensillæ: II, in addition to the paramedian eyes, has intermediate and supra-marginal sensillæ; IV and V have marginal sensillæ in addition to those on III. At the caudal end XXV and XXVI bear the full dorsal set of four pairs, and XXVII usually the paramedian and intermediate only, but not infrequently one or both of the others. As Whitman states, the caudal sucker is unusually richly supplied with sensillæ, which

are disposed in correspondence with the irregular rings of areas representing the somites. In the paramedian and intermediate series occasional specimens possess the full number of seven, but six, five, or four are more frequent; the number diminishes laterad and ventrad, the marginals being seldom more than three and the ventrals only one or two. Ventral sensillæ on the body are much smaller than the dorsal, not elevated on papillæ, and the linear form is less evident, but they remain conspicuous.

Somites are annulated as follows:—I is the preocular lobe bearing labial sense-organs. II is uniannulate and bears the first pair of large, forwardly-looking eyes belonging to the paramedian series and two or three small papillæ. III is uniannulate, and bears the second pair of eyes, the paramedian and supra-marginal sensillæ and about twelve small sensory papillæ. These three somites are frequently only obscurely separated. IV biannulate, ($a_1 a_2$) slightly $> a_3$, each annulus bearing about eighteen clearly defined and rather prominent papillæ, and the first in addition the third pair of eyes and the paramedian and supra-marginal sensillæ, while a_3 ends in a pair of small lateral buccal lobes and partly unites with V. V biannulate dorsally, with the sensillæ and fourth pair of eyes on the caudal part of the first annulus, and a full set of papillæ on each annulus. The furrow gradually fades out and disappears in the middle ventral field, where the two series of papillæ unite into one on the buccal ring; sometimes with a faint a_1/a_2 furrow in the middle dorsal field. VI triannulate ($a_1 = a_2$ slightly $< a_3$), a_1 and a_2 united on venter as post-buccal ring, the furrow extending well down the sides. Fifth pair of eyes and a full set of both dorsal and ventral sensillæ of typical form on a_2 . VII triannulate, similar to VI, but the furrows equally developed all round and a_3 distinctly larger and on some specimens with a supplementary row of papillæ on the venter close to the anterior border and occasionally separated from the principal series by a faint furrow. VIII quadrannulate ($a_1 > a_2 > \text{or} = b_5 = b_6$), a_1 occasionally showing faint trace of secondary furrow on dorsum or even on venter, where there is frequently a supplementary row of papillæ; first pair of nephropores on a_1 . IX to XXIII quin-quannulate, approximately $b_1 = b_2 = a_2 = b_5 = b_6$ on all but IX, on which b_1 and b_2 are slightly smaller. XXIV is quadrannulate, with usually $b_1 = b_2 = a_2 = a_3$, but sometimes $a_2 > a_3$, and more frequently a_3 exhibits a faint secondary furrow separating two rows of papillæ; seventeenth pair of nephropores on b_2 . XXV triannulate (a_1 much $> a_2 = a_3$ or more rarely $=$ or $<$ than a_3); a_1 may present the same conditions as XXIV a_3 . XXVI biannulate (a_1, a_2) much $> a_3$; the first may be twice as large as the second, and bears the sensillæ on its caudal half, sometimes showing a faint furrow anterior to them. The furrow a_2/a_3 often fades out at the margins. XXVII is usually biannulate, similar to but smaller than XXVI, but may be reduced to a single annulus. Anus sometimes followed by one or two small annuli, or more frequently it divides the last one.

Colour.—The colour of living specimens from the north coast of Java is thus described by Dr. Sluiter as quoted by Whitman ('86, pp. 374, 375):—

“Ground-colour of the dorsal side dull olive-green, sometimes inclining more to grass-green, at other times more to brownish shades. In the median line of this side there is a series of elongated black spots, from twenty to twenty-five in number, which never blend into a continuous stripe. Toward the head these spots are smaller and often more rounded, while in the middle and posterior region they are more elongated, stretching over three annuli. This series of black spots lies in a broad stripe of a lighter colour than the ground-colour, which is narrowed at each of the intervals left between the black spots. On each side of this broad stripe are two narrow, longitudinal yellowish stripes, each of which is bounded by two narrow black borders. These lateral stripes are interrupted from point to point, so that they do not form unbroken stripes. The entire dorsal surface is flecked with black, and these flecks are more numerous and larger along the yellow margins. The dorsal side of the margin is a clear yellow, while the ventral side is reddish-yellow. Often the yellow margins are very regularly dotted with black, a single dot occurring on each ring. A few irregular larger black flecks are also seen scattered along these margins.

“The ground-colour of the ventral side is brick-red; just inside the yellow margins of this side are two broad stripes of the same dull green as the ground-colour of the dorsal surface; these stripes are sharply defined against the brick-red middle zone by an admixture of black flecks, which for the most part blend together. The two suckorial surfaces are bluish-grey, the oral surface being a little lighter than the posterior sucker. The oral surface has a pale margin, which is not seen in the acetabulum.”

A colour variety differs as follows:—“The dorsal surface is less variegated in colour, without the lateral stripes, and darker green. The black flecks and stripes are the same. The ventral surface is not brick-red, but of the same green colour as the dorsal side, without the black flecks. The dark stripes inside the yellow margins are broader and have a larger admixture of black. Large and small individuals of both varieties were found.”

On preserved specimens the bright greens and reds of the living animals have been lost and the ground-colours are dull and faded, but the pattern has become thereby accentuated. It is most sharply defined on the smaller individuals up to about 70 mm. long. These have the dorsal ground drab-grey or dark clay-colour or distinctly yellow, or, on one, rich sienna-brown, with the median dark-brown broken stripe consisting of a series of dashes or streaks from about somite VIII to XXV or XXVI, each streak on complete somites extending over the three annuli (*b* 2, *a* 2 and *b* 5), but sometimes more restricted toward the ends of the body. The width of this stripe varies considerably, being, on some specimens, a mere line, on others, quite broad (nearly the width

between paramedian sensillæ), occasionally continuous, and rarely absent. The gaps in the median stripe are bridged by sharply defined dark-brown paramedian spots on *b* 6 and *b* 1: that is, intersegmentally. When best developed the effect is of a chain having alternately longer segmental and shorter intersegmental links. The supra-marginal spots are subquadrate or sometimes nearly crescentic, and occur regularly on the second (*b* 2) and fourth (*b* 5) annuli of each somite. On some specimens they are united by a narrow dark line arching across *a* 2 mediad of the marginal sensillæ, and more rarely there is a small supplementary spot on *b* 1. On the incomplete somites at the caudal end these spots occupy the caudal half of *a* 1 and the cephalic half of *a* 3. Two pairs of narrow, clear yellowish stripes, one in the outer paramedian field and the other, including the intermediate sensillæ, are bordered on each side by a narrow wavy black or dark brown line, so that there are four of the latter on each side between the median stripe and the supra-marginal spots. Occasionally these appear as two pairs of chain-like stripes. On some specimens the annuli *b* 2 and *b* 5, especially of posterior somites, are distinctly darker, and give the effect, with the paler contrasting sensory annulus included between them, of a cross-banded pattern. The caudal sucker is often darkly-blotched, and has four or three pairs of radiating paler lines. Venter plain dull yellow or orange, invariably clear and unspotted, with broad sharply-defined, dusky or black, submarginal stripes; marginal stripes clear yellow, narrow and very sharply defined.

With increase in size of the leeches the ground-colour becomes browner and often more speckled with minute flecks of black, the paired pale stripes tend to become obscure and their black margins much interrupted and broken. In the largest specimens only traces of these remain, but the supra-marginal spots and the median stripe are invariably well preserved.

Digestive system generally like that of *Limnatis*, but somewhat approaching the hæmopine type. Jaws very large, high and prominent, with strongly convex, compressed, dentinal margin, and a projecting angle at the central end of the base; the body thicker than the narrowly compressed supporting foot. Salivary papillæ large (0.12 mm. diam.), fungiform, arranged in about three or four longitudinal rows of four to six each. Teeth 115 to 154, straight, conical, radial, the largest (0.035 mm. long) at the central end and gradually diminishing in length peripherally until they disappear. Buccal sinus spacious, with deep recesses into which the jaws are retracted.

Pharynx short and broadly ellipsoidal or fusiform, extending through VIII and part of IX. Mucous lining raised into six low, rather broad and flat ridges meeting in pairs anteriorly to form three which pass into the jaw pedicels; separated from the very short, thin-walled œsophagus by an annular fold or valve. Stomach extending from IX to XIX, very thin-walled, saccate rather than cæcate, the constrictions at the septa being slight,

and each pouch or chamber divided laterally into short, broad, simple lobes. The second pair of XIX prolonged as a pair of long, spacious, simple tubular cæca which extend into somite XXV and lack lateral sacculations. Intestine a perfectly simple straight tube without lateral pouches. The conditions described appear in examples in which the stomach is nearly empty and in others fully distended with blood, except that in the latter the cæca are longer and more distinct.

Organs of reproduction (figs. 50, 51) of quite distinctive form and equally well developed in those with full and empty cæca. Testes, in the one specimen in which they were fully dissected, 12 pairs, in the usual position at the extreme caudal end of somites XIII to XXIV, globoid and rather small, those in XVII and XVIII especially so in the one dissected. Vas deferens a smoother duct, much less covered with a glandular investment than usual, becoming very slender as it approaches the epididymis, which it usually enters at about the middle and from the lateral side. Epididymis varying from a small knot consisting of a few coils of the tube to a more complex but unfolded mass two or three times as large, and usually lying dorso-caudad of the ejaculatory duct. Instead of being crowded to the body-floor by the distended gastric cæca as in most leeches, they are widely separated and crowded laterad, and often rise on each side of the stomach to a position more dorsal than usual. The position of the epididymes causes the enlarged, fusiform bulbs of the ducti ejaculatorii to flare widely in a semi-erect posture, the anterior end reaching forward to ganglion XI and giving rise to a short, narrow duct that enters the ventral face of the prostate. Atrium small and usually largely concealed in a loose mass of unicellular glands, part of which are the ventral clitellar glands. In most specimens it lies to the right of the nerve-cord and is bent forward in a procumbent posture nearly to ganglion XI. It is not clearly differentiated into penis-sac and prostate, but consists of a short, wide stalk and bursa opening to the exterior, and a globular or ellipsoidal, prostate portion which receives the ejaculatory ducts on its ventral face near the anterior end.

Ovisacs lie in the usual position on the floor of the body in the caudal end of somite XII or at XII/XIII, on each side of the nerve-cord but close to the median line. Oviducts short and rather wide, the left in two cases and the right in two cases passing beneath the nerve-cord. There is little indication of an enlarged albumin gland at the point of union, and the wider common oviduct passes with a few flexures along the ventral face of the vaginal duct and opens in common with and anterior to it in a very small bursa. Vagina consists of a short wide duct directed forward on either the left or right side of the nerve-cord, and a more or less massive saccular portion which usually bends sharply caudad on the dorsal side of the stalk and may reach to the end of XIII.

Geographical Distribution and Bionomics.—Originally described

seventy years ago from Java by Wahlberg (1856), and later reported from the same island by Whitman (1886). Blanchard (1897, p. 349) records the known distribution as Java, Borneo, Sumatra, Bengal and Burma. From the sixty examples examined by me it becomes possible to extend the range northward to Manipur, Assam, and the Mainman District on the Chinese frontier, where it is evidently abundant. No examples are included from Ceylon or Lower Burma, and none are known from the Philippines, Siam or the Malay Peninsula, though the species may be expected to occur at these places and throughout the plains areas of India. The known vertical range is from sea-level in Java etc. to 2600 ft. in Sikmai Turail, Assam.

Concerning this species as occurring in Java, Dr. Sluiter, as reported by Whitman (1886), writes as follows: "Both varieties are very abundant in the Sawahs (rice-fields) around Batavia and elsewhere on the north coast of Java. The Malayan name is Lintah. Both varieties are used for medical purposes." In India it is reported most frequently from cattle tanks, buffalo wallows and similar places, and lives largely at the edge of the water, which it sometimes leaves. As many of these pools dry up during the dry season, this leech, like others under like conditions, probably spends a period of semi-dormancy deep in the dried mud. It attacks domestic animals and Man, whose skin is easily cut by its powerful serrated jaws. There is no evidence that this species enters the nares or mouth of its victims, and it is not reported as used in India for blood-letting, although it is probable that it would not be rejected. The egg-capsules are unknown, and nothing relating to its breeding habits has been reported.

39. *Hirudinaria manillensis* (Lesson). (Plate III, fig. 2.)

Synonymy :

Hirudo manillensis Lesson, 1842, p. 8. (Philippine Islands.)

Hirudo sanguisorba Tennent, 1859 (1861, pp. 483, 484), text-fig. (Ceylon.)

Hirudo multistriata Schmarda, 1861, p. 3, text-fig. (of jaw) and Taf. xvi, fig. 14 (coloured). (Ceylon.)

Hirudo luzonice Kinberg, 1866, p. 356. (Manila.)

Hirudo maculosa Grube, 1868, pp. 39, 40, Taf. iv, fig. 6 (exterior and colour-pattern). (Singapore.)

Hirudo maculata Baird, 1869, p. 315. (Siam.)

Limnatis (Pæcilobdella) granulosa (Savigny), Blanchard, 1898, p. 28.

Limnatis (Pæcilobdella) granulosa (Savigny), Blanchard, 1897, pp. 338-349, text-figs. 3-6 (annulation and colour-patterns). (Throughout India, China, Siam, Malay Islands, Philippines, Celebes, etc., and introduced in West Indies etc. = *H. granulosa* et *manillensis*.)

Limnatis maculosa (Grube) et *granulosa* (Savigny) (in part), Brandes, in Leuckart, 1901, pp. 878-879.

Limnatis granulosa (Savigny), Robertson, 1909, pp. 676-679. (Habits in Ceylon.)

- Hirudo boyntoni* Wharton, 1913, p. 369-371. (Philippine Islands.)
Hirudo boyntoni Wharton, Boynton, 1913, pp. 509-521. (Carrier of rinderpest.)
Limnatis maculosa (Grube), De Qual, 1917, p. 9. (Siam.)
Limnatis (Pæcilobdella) granulosa (Savigny), Kaburaki, 1921, pp. 673-675.
Limnatis granulosa (Savigny), Kaburaki, 1921, p. 711 (in part).
Limnatis (Pæcilobdella) manillensis (Lesson), Moore, 1924, p. 376. (Philippines, Java, Ceylon, Siam and Southern India.)

Diagnosis.—In general resembling *Hirudinaria javanica* internally and *H. granulosa* externally. Size, form, annulation, sculpture, colour and colour-pattern, and other external characteristics like *H. granulosa*; the ground-colour more inclined to brown dorsally and more to green ventrally than in that species, the black pattern earlier and more completely disintegrated. Jaws all alike with prominent papillæ of two sizes. Teeth very numerous, about 150, about half of them very small and the series tapering to the vanishing point. Male reproductive organs with very large epididymes in a simple mass, and very large fusiform ejaculatory bulbs; atrium short, pyriform, completely covered with a layer of loose glands. Female organs without stalk, the common oviduct and the vaginal duct opening together directly into the female bursa.

Type-locality, Luzon, Philippine Islands.

Description.—A large, robust species, exceeding *H. javanica* in bulk if not in length, but probably not equalling the maximum size of *H. granulosa*. One of the largest examples in a state of moderate contraction measures: length, 103 mm.; length to male pore, 21 mm.; width at buccal ring, 9.5 mm.; at male pore, 14.5 mm.; maximum width (middle), 25 mm.; depth at buccal ring, 8 mm.; at male pore, 8 mm.; at middle, 10 mm.; caudal sucker, 14 mm. This specimen is relatively broader and flatter than usual, the depth commonly being about two-thirds width. A smaller and better preserved specimen has the corresponding measurements: 66, 16, 5.5, 6.3, 8.6, 3.5, 3.3, 3.6 and 6.5 × 6 mm. respectively. The largest specimen in the collection, an extended one taken near Calcutta, measures 180 × 17.5 mm.

Form as in *H. granulosa*, robust, broad-headed, circular in buccal region, broadly elliptical elsewhere with sides broadly rounded, little depressed; elongate-ovate with width nearly equal for the middle third, at least, but usually greatest at about XVII. Lip very broad and rounded, in all respects as in *H. granulosa*. Eyes, buccal region, clitellum, gonopores, nephropores, sensillæ and anus also as in that species. Gonopores very constantly in the furrow of *b* 5/*b* 6, but occasionally slightly within *b* 6. Nephropores in line with or a little laterad of ventral intermediate sensillæ.

Quadrates usually exceptionally strongly marked, about twenty-two to twenty-four on each surface, distributed in the inter-sensillar fields about as follows: A-1, B-4, C-2, D-1, E-2, F-2, G-3 and H 5. Each of these bears at its centre a larger

sense-organ surrounded by from forty to forty-five smaller ones, which tend to be concentrated centrally and scattered peripherally, like bullet holes in a successful target. Anterior to IX the larger non-metameric sense-organs only appear in surface views as a single transverse row, the aggregated arrangement becoming evident on X, IX being transitional. There is much variation among different specimens and lots in the prominence and roughness of the quadrate areas. Sometimes they are flat and nearly level, with the sense-organs flush with the surface or even retracted into minute pits; again they are rounded like pebbles, a condition frequently noted at the ends of the body; and in other cases they are elevated into somewhat conical prominences on which the sense-organs stand out roughly as conical papillæ. The latter condition appears to be not only due to a physiological response, but to be progressive with age, the large and old specimens becoming very rough and the sensory papillæ so prominent as to have gained for such individuals the name of "hairy leeches."

Sensillæ have the same form as in *H. javanica*, but are not quite so large. They are conspicuous throughout except on the segments of the head-region, where they are smaller and the elongated form less evident. Caudad of the clitellum each consists of a low, rounded, elliptical, translucent and colourless papilla bearing on the axis a raised, opaque white line. These are inclined cephalo-mediad with the median line at nearly constant angles estimated as follows: dorsal paramedians about 30-35°; intermediates 45-55°; supra-marginals, marginals and submarginals nearly 90°, but usually varying slightly from the exact transverse; ventral paramedians 0-10° or 12°, and ventral intermediates very small but apparently transverse. Toward the caudal end the dorsal paramedians tend to become more nearly longitudinal and the intermediates more nearly transverse.

Caudal sucker relatively smaller than in *H. javanica*, with a well-defined pedicel shaped like a truncated wedge or flattened cone. While often exactly circular it is more often slightly wider than long, its thin flat margin, when extended, reaching to XXIV a 2; dorsum marked by seven to eight irregular rings of irregularly quadrate, more or less elevated areas, bearing both sensillæ and non-metameric sense-organs. Owing to their variability and the irregularities of the surface the exact number of the latter is uncertain. They are, however, less numerous than in *H. javanica*, but, as in that species, they are arranged in ten visible, radiating, slightly elevated lines representing the eight dorsal series and the ventral submarginals. Traces of the other ventral series may be detected beneath the body. The number varies greatly, and two specimens seldom exhibit exactly the same arrangement. The dorsal paramedians and intermediates are best developed, having usually three or four in a series, but rarely as many as five or even six, while the ventral series are represented by one or two or none. Frequently

every one of the seven rings representing the seven caudal somites bears sensillæ of at least one series. On the venter the sucker is smoother, but marked with a variable number (about twenty-six) of radiating grooves ending in marginal notches.

Annulation.—There appear to be no constant differences between this species and *H. granulosa*. Both in the detailed features and in range of variation the two are in close agreement. In the frequency with which certain variations occur, however, there appears to be a difference. Thus elaboration of the incomplete somites toward both ends of the body proceeds less far in *H. manillensis* than in *H. granulosa*. This is evidenced especially on VII a 3, VIII a 1, XXIV a 3, and XXV a 1, all of which have the secondary furrow more or less well developed on most and practically complete on some specimens of *H. granulosa*, which conditions, while occurring on specimens of *H. manillensis*, are far less frequent and less advanced in the latter. Similar, though less obvious tendencies were noted on other incomplete somites. Otherwise the description of the annulation of *H. granulosa* will serve equally well for the present species.

Coloration.—Living colour as figured (Pl. III, fig. 2) and described (by Lesson, Grube, Tennent, Wharton and from notes on labels by Annandale and others), dark olive-green, varying to bright olive-green, or to olive-brown, yellowish-brown and brown on the dorsum, marked by a continuous or broken median dorsal line of black, dark brown, or green much darker than the ground-colour; irregular, wavy and narrow black lines on each side more or less broken or distinct, and black or dark green supra-marginal spots on every second (b2) and fourth (b5) annulus of each somite. Venter plumbeous, fulvous, reddish-brown, reddish-orange or, according to Wharton on Philippine examples, dark velvety olive-green, with broad black submarginal stripes and rarely with scattered black spots. Margins with a narrow, sharply defined stripe of yellow or orange. The submarginal stripe is frequently absent, about one-third of those examined exhibiting no trace of it. Probably these are the individuals with venters green in life.

As in other members of the genus, the black pattern is most complete and perfect on young leeches, and with increasing age and size becomes broken, dissipated, obscure and finally largely obsolete. This is especially true of the large, rough, brown individuals, in which the median line and the supra-marginal spots, or even only one of these, remain visible. The original perfect pattern is exactly like that of *H. granulosa*. All of the modifications that occur in *H. granulosa* occur in this species also, and Blanchard's diagrams of the pigmented pattern were undoubtedly based upon the two species indiscriminately. There is evidence, however, that they do not occur with equal frequency and there is little doubt that adequate biometric determinations based upon sufficient samples properly prepared and assorted with reference to size, season, locality and physiological condition would disclose

different coefficients of variability. Among the quantitative differences that appear in the tabulation of the characteristics of nearly nine hundred specimens of the two species are the following:— In *H. manillensis* the pattern breaks up earlier and more completely; the supra-marginal spots and the supra-marginal black lines are more often completely wanting; the median dorsal line is more persistent; the remaining three dorsal black lines are commonly less developed on *b* 6 and *b* 1 and frequently disappear, causing these two annuli to appear as paler transverse bands; the submarginal black bands, while commonly broader and more intensely pigmented, are, on the other hand, far more frequently totally absent; the dorsal ground-colour is much more dominated by brown and yellow and less by green; and the venter, on the contrary, which appears to be rarely green in *H. granulosa*, is frequently so in *H. manillensis*, especially in the Philippine Islands, where this variety appears to predominate.

Digestive System.—Oral chamber, velum and buccal sinus as in *H. javanica*. Jaws, as in that species, large, prominent, with strongly convex profile, but the median not averaging larger than the paired in the specimens dissected. Papillæ as in *H. javanica*, but apparently somewhat less numerous (36 on one counted), usually very prominent, spheroidal, those near the dentigerous ridge about one-half the diameter of those lower down on the jaw, which have a diameter of about 0.12 mm. Teeth as in *H. javanica* but even more numerous (140 to 166 or more), long, sharp, conical, the longest measuring 0.027 × 0.01 mm., reduced to half that length at the seventeenth and ending in a long vanishing series of almost indeterminate number and diminishing size, in this respect differing markedly from *H. granulosa*. Pharynx, stomach and intestine practically as in *H. javanica*, but the gastric cæca apparently longer and more lobate.

Reproductive organs (fig. 53) approaching in nearly all respects very closely to those of *H. javanica* and with that species diverging in several characters from *H. granulosa*. Testes eleven or twelve pairs in the usual position at XIII/XIV to XXIII/XXIV or XXIV/XXV. Vas deferens as usual, but with a reduced glandular covering continuing almost to the epididymis, into the medial, postero-ventral end of which it opens. Epididymis massive, at maturity equalling or exceeding in size the entire atrium and standing more or less erect at the sides of the latter, composed of an intricately and slightly folded tube in one mass not bent on itself. Ductus ejaculatorius chiefly a very large fusiform bulb arising from the dorso-lateral end of the epididymis, lying along its lateral face and curving round to enter by a slender duct the side of the rounded prostate near its end. Atrium relatively small, pyriform or clavate, the short penis-sac enlarging gradually into the rounded ovate prostate, which is flexed sharply on it either cephalad or caudad. The entire organ is coated with a loose layer of glands, some of which envelop the end of the ejaculatory bulb and others form a whorl round the external orifice.

Female organs (fig. 53, 18) almost exactly as in *H. javanica*, and differing strikingly from both *H. granulosa* and *H. viridis* in essential features. Ovisacs as usual leading by short oviducts into a common oviduct which at the point of union is enclosed by an ovate albumin gland, beyond which the widened common oviduct pursues a somewhat tortuous course to open into the female bursa along with the vaginal duct. Like the atrium the vagina is relatively small. It consists of a wider sac and a narrower duct of about equal length, which may be sharply differentiated by an abrupt change in diameter or even by a constriction, or may taper gradually into each other. The duct also tapers to its opening into the bursa, where it joins the common oviduct. Usually this takes place well within the ventral longitudinal muscle-layer, so that no stalk whatever appears free above the body-floor. Occasionally, however, the union takes

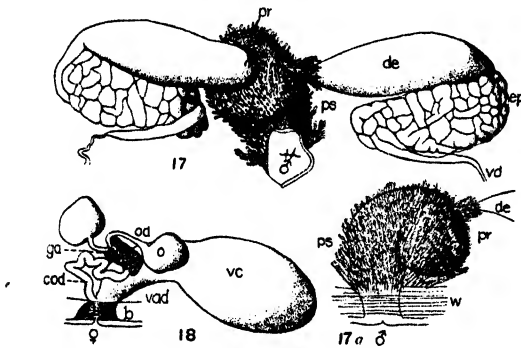

Fig. 53.—*Hirudinaria manillensis*. 17. Ventro-anterior view of removed terminal male organs. $\times 6$. Lettering as in preceding figures. 17 a. Right side of atrium; *w*, body-floor. 18. Female organs from the left side. $\times 6$. *b*, female bursa. Other lettering as before.

place above the body-floor. These essential peculiarities were constant for all the specimens examined, whatever the state of development of the organs.

Geographical Distribution and Binomics.—This is the common paddy-field leech, buffalo-leech or medicinal leech of the lowlands of India. It has always been confused with the next species, and may ultimately be proved to be the true *H. granulosa*. It occurs in a zone, roughly limited landward by the 500-ft. contour-line, throughout the coastal provinces of India. In Bengal and Upper Burma it ranges far into the interior over the broad plains of the lower Ganges and Brahmaputra drainage systems, where it is very abundant. Along the Kanhai River, south of Darjeeling, it reaches to the very base of the south escarpment of the foothills, and is also found in the valley of the Kusivara River, in

Cachar, southern Assam. In both of these localities it approaches close to the highlands, but the collections appear to have been actually made below 500 ft. It is very abundant, and reaches a large size in the neighbourhood of Calcutta, where it is the common medicinal leech. In Lower Burma it is abundant about Rangoon, from which place Prof. G. E. Gates has sent an excellent series, and extends up the valley of the Irrawaddy into the Amherst District and the South Shan States. Westward there is no evidence that it is found much beyond the mouth of the Indus, nor does its range extend far up the valley of that river, *H. granulosa* replacing it throughout North-West India and the Baluchistan frontier. So far as the available material indicates, it is the only leech of this group in Ceylon, where it is excessively abundant in the rice-fields, ponds and springs of the lowlands, but extends also into the centre of the island (Peradeniya), and consequently occupies the entire island except probably the highest hills. Outside of India it is very abundant in the coastal provinces of the Philippines and Borneo, and probably is the species recorded under various names from others of the Malayan Islands. I have also identified specimens from Siam (collected by Dr. H. M. Smith) and from points on the coast of China (collected by Professors Gee and Ping). Whether a highland species occurs in these countries also is at present unknown, but it seems probable.

Of course the 500-ft. contour is offered as an approximate and provisional division only between the ranges of the two species, not as a definite or determined one. *H. granulosa* is the dominant species above, *H. manillensis* below that elevation. The exact altitudes at which collections were made are rarely stated on the labels for either of these species, and only approximate determinations of elevations could be made by the use of topographic maps, but the agreement between distribution and specific characteristics proved to be striking. As in the case of other species there no doubt will be found interdigitations, isolated islands and admixtures of the two species. Nor can the mere altitude be considered a vital factor in their distribution. This must be sought in some other ecological condition or conditions correlated with altitude, and like the exact geographical relations of the two species, can be worked out only by a naturalist on the ground and familiar with physical and biological conditions.

The paddy-field or buffalo-leech inhabits the rice-fields, swamps, ponds, tanks, sluggish streams and springs, but seldom occurs where there are strong currents. They are especially abundant about the buffalo tanks and the drinking places of cattle, whose blood they suck, but there is no evidence that, like the true cattle-leeches, they enter the mouth or the nares. Their teeth are quite capable of cutting the more tender parts at least of the outer skin. They also attack Man when occasion offers, and have been found attached to frogs, snakes and turtles. Doubtless they prey upon many other vertebrates, especially mammals.

Dr. Annandale in an unpublished note states that "the species is very abundant in the swamps and rice-fields in Bengal and Burma. It rests among weeds beneath the surface of the water, through which it undulates rapidly when disturbed. Men and animals walking along the narrow embankments which separate the rice-fields are often attacked by them on their ankles." Major Seymour Sewell writes that once when collecting along a small freshwater stream on the coast of Burma "one of these leeches most persistently followed me up and down the stream, although I was not actually in the water." Major Wall (1914, 1920) refers to having found two heavily gorged leeches within the mouth of a rat-snake, and other similar cases are recorded. Miss Robertson (1909, pp. 678, 679) refers to their feeding on soft-shelled "milk" turtles (*Emyda vittata*) in Ceylon, where the leech is known to the natives as Duja Kudella. It "prefers to sit on the carapace attached by the posterior sucker and to fix its anterior sucker to the occiput, back of the neck or humeral angle (text-fig. 4, p. 678). The leech will stretch to an incredible extent when the tortoise puts out its head rather than let go." The tortoises often succeed in catching and eating the leeches, gulping them down with some difficulty but without breaking the skin. Miss Robertson refers to a fact that has been observed in other blood-sucking leeches and which is of importance in the possible transmission of infective agents: namely, that they frequently feed in two or more instalments; thus a leech would attach itself and feed for about an hour, and then cease and move about on the carapace or even leave the tortoise altogether, and upon being replaced would take a second meal. According to Miss Robertson the time required to digest a meal of blood is less than for some of the species of temperate climates. Usually 2 to 6 months, according to the size of the leech, are required, but one gorged with blood was nearly empty in 53 days. Some time may elapse between completion of digestion and search for more food. All leeches captured in nature were empty, but not all would feed. One leech fed on December 2 fed again on February 1. Evidently, like other species, this one, after feeding, conceals itself during the process of digestion.

There is no published information relating to the breeding of this species, nor have I been able to secure any reliable data. Probably the account given for *H. granulosa* will serve quite as well for this.

Several studies indicate that *H. manillensis* may be a factor of importance in the transmission of disease. Miss Robertson in her work on Ceylon Hæmatozoa fed these leeches on the blood of the turtle *Emyda vittata* infected with *Trypanosoma vittate*, and found the *Herpetomonas* and *Crithidial* division stages persisting in the stomach of the leech for as long as six weeks. As the leeches move from host to hostess, and as they frequently vomit some of the ingested blood, transmission of the parasite while feeding is easily possible. The parasites also orient them-

selves and swim against the blood-current. Miss Robertson, however, thinks that in this particular case *H. manillensis* is not the true intermediate host, but that that rôle is played by another leech (probably *Placobdella emydæ*), a normal parasite of the turtle.

More important economically is another series of observations made in the Philippines by Boynton (1913). Although these results require confirmation, they indicate that these leeches may be agents in the spread of rinderpest, which is by far the most serious epizootic disease prevalent in India (Edwards, 1924). These leeches, fed upon cattle stricken with rinderpest, retained the virus in virulent condition for at least twenty-five days. Positive infections were secured in cattle which drank water containing blood disgorged by these leeches, and this water remained infective for five days. The fact that cattle in early stages of rinderpest seek cool water and that caraboas seek water at all times exposes them to the leeches. There is also some evidence of a positive correlation between the rinderpest areas and the local geographical distribution of the leeches.

There is naturally some confusion concerning the relative extent to which this species and *H. granulosa* are employed for medical purposes, and the general remarks made under the latter apply to this species also. While the lowland species appears to be employed locally in the districts where it occurs, there is evidence that upland leeches are preferred, and that formerly, if not now, they were sent to the coast cities in trade. There were also favoured localities for the supply of the present species to considerable areas. Thus Layard (1853) states that most of the leeches used for medicinal purposes on the island of Ceylon come from a bubbling spring at Toniatao. They appear still to be gathered in large numbers in the swamps surrounding Calcutta, and the smaller ones sold in the markets for medical use of the natives. (See also Appendix, p. 297.)

40. *Hirudinaria* (*Pæcilobdella*) *granulosa* (Savigny). (Plate IV, fig. 5.)

Synonymy :

Sanguisuga granulosa Savigny, 1820 (1822), p. 115. (Pondicherry.)

Hirudo granulosa (Savigny), Moquin-Tandon, 1846, p. 347.

Limnatis (*Pæcilobdella*) *granulosa* (Savigny), Blanchard, 1893, p. 28.

Limnatis (*Pæcilobdella*) *granulosa* (Savigny), Blanchard, 1897, pp. 338-349, text-figures 3-6 (exterior morphology and colour-pattern of *H. granulosa* and *manillensis*). (In part.) (Widely distributed throughout the interior of Hindustan and Burma.)

Limnatis granulosa (Savigny), Khan, 1912, pp. 206, 207. (Culture.)

Limnatis (*Pæcilobdella*) *granulosa* (Savigny), Matthal, 1920, pp. 341-346, text-fig. 1 and pl. xviii (cocoon formation).

Limnatis (*Pæcilobdella*) *granulosa*, Kaburaki, 1921a, pp. 673-675. (In part.) (Ohilka Lake.) Kaburaki, 1921b, p. 711.

Limnatis (Pæcilobdella) granulosa (Savigny), Moore, 1924, pp. 375-377. (In part.) (Punjab.)

Other possible synonymy is omitted because of the uncertainty of determination.

Diagnosis.—Size large and form robust, and general external characteristics as in *H. manillensis*. Colour of dorsum varied shades of olive-green, often divided by one or two pairs of yellowish longitudinal stripes, and marked by a black pattern consisting of a median constricted or broken line, four pairs of narrow wavy lines bordering the yellow stripes, metameric paramedian spots on annuli *b* 6 and *b* 1, and similar supra-marginal spots on annuli *b* 2 and *b* 5. This pattern is variable and largely disappears with increasing size. Margins with a yellow or orange stripe and venter usually reddish-orange with submarginal black stripes. Gonopores at XI *b* 5/*b* 6 and XII *b* 5/*b* 6. Caudal sucker not exceeding two-thirds of body-width in normal extension. Sensillæ prominent, elliptical, and oblique. Teeth usually about 100 (86-128), not continued as a disappearing series. Atrium pyriform with penis-sac longer than prostate, which is covered with a compact layer of glands; ejaculatory bulb little enlarged. Female organs with a well-defined stalk common to the oviduct and vaginal cæcum and approximately equal to the combined length of the duct and sac of the latter. Sanguivorous and medicinal. Type-locality, Pondicherry.

Description.—Size reaching a maximum in life, when extended, of 10 inches long and $\frac{1}{4}$ in. wide. Common specimens are 3-6 in. long and $\frac{1}{4}$ to $\frac{3}{8}$ in. wide. The largest preserved specimen in the collection is 190 mm. long, 19 mm. wide and 10 mm. deep. A well-preserved example in about the usual state of contraction but more flattened than usual measures: length, 98 mm.; to male pore, 21 mm.; width at buccal ring, 6.5; at male pore, 18.4; maximum width (XX), 20.3 mm.; depth at buccal ring and male pore, 4.2; depth of flattened post-clitellar region, 3.5 mm.; diameter of caudal sucker, 8.7 mm. This specimen was bred artificially for medical use and was stated by the breeder to be two and one-half years old.

Form much more robust than *H. javanica*, similar to *H. manillensis*, except that young examples approach the former more closely in being more slender, flatter and having the caudal sucker relatively larger. Typically the outline is greatly elongated ovate, with the maximum width at the beginning of the caudal third, but individuals with the stomach completely empty have the maximum width farther forward near the middle, with a nearly uniform slope to the almost equally rounded ends. Much elongated, empty individuals may approach a linear form with parallel sides, which is especially characteristic of the young. Buccal region nearly circular, the remainder broadly elliptical in section, with the margins broadly rounded, whatever the degree of flattening.

Head very broad, the lip short and rounded, rarely exhibiting any tendency towards a triangular form as in *H. javanica*. Lip constituted of somites I to IV, which are wrinkled and more or less divided into quadrate areas obscuring the annulation; IV terminates at the sides in a pair of lateral buccal lobes, and the others in slight crenulations; ventral surface with a median longitudinal fissure extending for entire length and passing into the median dorsal angle of mouth, and on each side two or three shallow furrows which meet the segmental furrows at the sides of the lip. No apparent unsegmented margin. Eyes exactly as in *H. javanica*. Buccal ring formed by the union ventrally of the two annuli of V united laterally with IV *a* 3, and post-buccal ring of VI *a* 1 and *a* 2, the furrows in both cases completely disappearing on the venter.

Clitellum occasionally indicated externally by a more yellowish colour and a slight hardening and swelling, the anterior and posterior borders of which are obscure, and internally by a thick layer of yellowish glands among and within the longitudinal muscles and extending over fourteen to sixteen annuli, X *b* 5 or *b* 6 to XIII *a* 2 or *b* 5 inclusive. Gonopores in the typical position at XI and XII *b* 5/*b* 6, but frequently just within *b* 6 or more rarely *b* 5, and occasionally in the middle of *b* 6. Male orifice a minute circular pore in the centre of an elliptical or lozenge-shaped area extending half-way across the bounding annuli; female pore a larger transverse slit with rugous margins. Nephropores seventeen pairs, often conspicuous, in the usual position on the caudal margin of *b* 1 from VIII to XXIV inclusive, and exactly in line with the intermediate ventral sensillæ. Anus usually a conspicuous opening with furrowed lips either completely caudad of XXVII, dividing the last annulus into two halves, or most frequently between the two annuli of XXVII. Caudal sucker of moderate size, commonly reaching to XXV *a* 1, rather larger than in *Hirudo* but smaller than in *H. javanica*, circular or broadly elliptical, thin, flat and discoid, the dorsal surface areolate or even veruculate and bearing both large sensillæ and minute scattered sense-organs; the venter smooth and irregularly marked with radiating furrows of which about thirty are complete, with shorter ones between.

Annuli sharply defined and of equal length throughout the middle-body region. Short longitudinal furrows joining the annular furrows divide the surface into more or less regularly quadrate areas which become more irregular and often polygonal on the head and caudal sucker. At the middle of the body they number 44-52 on each annulus, distributed as follows, not counting those on which the sensillæ are situated: A 1, B 3-4, C 2, D 1, E 2, F 3-4, G 2, H 6-7. Each bears a larger central non-metameric sense-organ, about which are clustered numerous smaller sense-organs. The prominence of these varies greatly with the age, the physiological state of the specimen and the method of fixation. Normally they are prominent and the central

portion of each area rises as a roughened wart, especially prominent on annuli towards the caudal end. As is true of *H. manilleensis* also, some of the large individuals are so rough and the sensory papillæ so prominently extended that they have been named "hairy" leeches. Other individuals are nearly smooth with the sensory organs completely retracted, the position of the large ones often being indicated by a pore.

Sensillæ, while much larger and more prominent than in *Hirudo* or *Whitmania*, are smaller than in *Hirudinaria javanica*, but have the same peculiar form and inclination as in that species. Apparently their number and arrangement is exactly similar except that there are fewer on the caudal sucker. On the dorsum they appear as white opaque axial lines borne on elliptical translucent papillæ.

Annulation (fig. 38, p. 98).—Somites I, II and III uniannulate, but separated by only very shallow and often incomplete furrows, which are further obscured by the short longitudinal furrows; dorsal sensillæ only occur on these somites, and the marginals also are lacking. On III both the sensillæ and the second pair of eyes lie well within the anterior half, and traces of a furrow ($a2/a3$) may appear behind them. IV biannulate, the two annuli approximately equal or the first ($a1 a2$) slightly larger and occasionally with traces of the furrow $a1/a2$; rarely $a2/a3$ is nearly or quite wanting; the third pair of eyes and a full set of dorsal sensillæ on the caudal half of the first annulus, which terminates laterally in the triangular lateral buccal lobes, lying within the oral chamber; $a3$ extends part way down the sides of the buccal ring, uniting with V. V biannulate dorsally ($a1 a2$) larger, but rarely exhibiting any trace of a furrow, bearing fourth pair of eyes and sensillæ on caudal half; ventrally completely united to form the buccal ring. VI triannulate dorsally ($a1$ slightly $>a2$ much $<$ (about $\frac{2}{3}$) $a3$), biannulate ventrally ($a1 a2$)= $a3$), forming the post-buccal ring; fifth pair of eyes and a full set of dorsal and ventral sensillæ on $a2$; on the dorsum each annulus bears a transverse row of non-metameric sense-organs, but as the furrow $a1/a2$ fades on the venter, the two rows separated by it gradually approach and finally unite in the median field. VII triannulate both dorsally and ventrally, $a1$ slightly $>a2$ much $<a3$ ($b5, b6$) on dorsum, $a1=a2<a3$ on venter. VIII quadrannulate, $a1$ ($b1, b2$) much $>a2=b5=b6$, no trace of the furrow $b1/b2$ on venter. There is much variation in the degree of development of the secondary furrows on VII $a3$ and VIII $a1$. Invariably the former is much better developed, but in advance or recession the two vary together. These furrows may be totally wanting though the annulus itself is invariably enlarged, or they may be extended to the full width of the dorsum and according to Harding's notes, occasionally even across the venter, although I have found such cases only on very strongly contracted individuals in which they are largely artifacts. In any event such ventral furrows are not to be compared with the ventral divisions of the

homologous annuli of *Dinobdella ferox*. IX to XXIII complete and quinquannulate ($b\ 1 = b\ 2 = a\ 2 = b\ 5 = b\ 6$) except that on IX $b\ 1$ and $b\ 2$ are slightly shorter than $a\ 2$. All of these possess the external morphological characteristics (quadrate areas bearing papillæ with aggregated sense-organs on all annuli, metameric sensillæ, nephropores, metameric colour-markings, etc.) referred to elsewhere in this description, but there is the usual individual variation in the exact number of areas, the number and prominence of the sense-organs, and of the papillæ supporting them, and even in the exact position, number (some of them may be subdivided or united), size, and, within a range of perhaps 10° , in the angle of obliquity of the sensillæ. XXIV quadrannulate ($b\ 1 = b\ 2 = a\ 2 < a\ 3$); $a\ 3$ invariably enlarged and with the secondary furrow $b\ 5/b\ 6$ variously indicated; owing to crowding by the sucker pedicel it is usually both deeper and more extended on the venter than on the dorsum, and may be well developed below when no trace of it can be found above. XXV triannulate ($a\ 1 > a\ 3 > a\ 2$); the remarks just made concerning XXIV $a\ 3$ apply to XXV $a\ 1$ also; both $a\ 1$ and $a\ 3$ have incomplete secondary furrows on the dorsum and the former usually on the venter, and these may be developed asymmetrically even to the extent of complete separation of $b\ 5$ and $b\ 6$ on one side. XXVI biannulate ($a\ 1\ a\ 2$) = about $1\frac{1}{2}\ a\ 3$, and bearing the sensillæ on the caudal half of the first annulus, the marginals usually being absent or united with the supra-marginals. XXVII uniannulate or frequently more or less completely biannulate; in the latter case the first annulus much larger and bearing the sensillæ near the caudal border; $a\ 3$ may be incompletely or completely separated, in which latter case it is divided into halves or preceded by the anus. Caudal sucker usually shows its composition of seven somites in the arrangement of the areas more or less definitely into seven (sometimes eight) irregular circles, on which many of the dorsal sensillæ and a few of the ventral sensillæ may be recognized. Very rarely is a complete set of dorsal sensillæ present on any one annulus, but every annulus bears some of them and rarely are two specimens exactly alike.

Colour in life: dorsally usually olive, but varying through olive-green to nearly a sap-green in the one direction and through olive-brown to reddish-brown in the other, but evidently the olives predominate during life; ventrally orange, varying either to the yellows or orange-red; margins a sharply defined stripe of clear orange or yellow bounded ventrally by a broad black or dusky submarginal stripe and dorsally by a series of metameric black spots on $b\ 2$ and $b\ 5$, included in a variable supra-marginal black or dusky stripe. Dorsal ground-colour often divided by one or two pairs of metamericly more or less constricted or beaded stripes of olive-yellow, orange-yellow or reddish-yellow margined with black, into a median and a broader lateral field, and the latter again into a narrow outer paramedian or intermediate and a broader supra-marginal stripe, there being in the

latter case five olive, alternating with six, including the marginal, yellow stripes. In the median field there is a broken median black stripe and paramedian spots on *b 6* and *b 1*.

On preserved specimens the greens have almost entirely disappeared and the reds and yellows are much faded, leaving a predominantly brown, or brownish-grey or drab ground on which the black or dusky pattern appears more or less clearly. This pattern is very precise and definite on young leeches, but gradually becomes more obscure, variable and broken on individuals exceeding about two inches in length, and finally on the largest leeches is so dissipated as small scattered spots and obscured by the papillæ and tessellæ that the pattern is scarcely recognizable. Blanchard (1897, p. 346) has illustrated in a series of twelve diagrams the ideal pattern and its principal modifications. According to these no single element is entirely constant, but the medial dorsal line, supra-marginal spots and submarginal stripes are rarely wanting. Blanchard's description is based indiscriminately on both *H. granulosa* and *H. manillensis*, and probably will serve nearly equally well for both.

The ideal dorsal pattern (Blanchard's I), as found perfectly developed in young examples, consists of a narrow, median dorsal, black or dark brown line, paired paramedian quadrate spots on annuli *b 6* and *b 1*, similar supra-marginal spots on *b 2* and *b 5* and four pairs of narrow black or dusky lines tracing the boundaries between the olive and yellow stripes. The median line may extend from the first pair of eyes to the anus, but more frequently is absent or obscure on the first five or six and the last two or three somites. It may be continuous and of equal width, more or less constricted intermetamerically, or more usually definitely interrupted on annuli *b 6* and *b 1*, and consequently broken into a series of dashes on *b 2*, *a 2* and *b 5*, or it may be totally wanting, but this is unusual on small individuals. The supra-marginal spots are very constant, but differ considerably in size, intensity, form and relation to the black stripes. They accentuate the whiteness of the marginal and supra-marginal sensillæ which lie between them, and are themselves somewhat obscured by being included in the broad, supra-marginal dusky stripes. In addition to the complete somites, on which they usually occupy the full length of their annuli, they are usually found on two or three of the incomplete somites at the anterior (VIII, VII, VI) and three at the posterior end (XXIV-XXVI), on which they extend over exactly the morphological equivalents of their undifferentiated annuli. The paramedian quadrate spots are similar and so placed on *b 6* and *b 1* that they bridge the gaps in the broken median line and alternate with the supra-marginal spots. The result is that all annuli but the sensory (*a 2*) bear metameric spots. The paramedian spots are less constant than the supra-marginal and except in rare cases are confined to the complete somites, and even may be absent from some or all of these. The narrow black lines are most variable, and owing to the concen-

tration of pigment in different parts they appear to have different connections, and may be aligned with the other elements in various ways. Usually they seem to belong to the olive rather than to the yellow stripes, inasmuch as they are very sharply defined on the yellow, but diffuse on the olive side. Thus regarded, the most medial (inner paramedian) lines largely fade away on *b* 6 and *b* 1, but become intensified on *b* 2, *a* 2 and *b* 5 of the complete somites as a series of curved lines connecting the paramedian spots on *b* 1 and *b* 6 and enclosing the paramedian sensillæ and the median black line. As a consequence the median olive field may appear as a chain-like stripe with broad links, widest on the sensory annuli and constricted intermetamerically. The outer black line, situated in the intermediate field, bears an exactly similar relation to the border of the supra-marginal dusky or olive stripe, forming a series of more intensified arches on *b* 2, *a* 2 and *b* 5 and fading with the constriction of the supra-marginal stripes on *b* 6 and *b* 1. The two remaining black lines bounding the two borders of the narrow olive stripe regularly diverge in the middle of the somites and approach at their ends, the result being a chain-like stripe about one-third as wide as the median one. Both these and the median stripe may lose their olive colour and become yellow in the centre or even entirely yellow. When the yellow stripes are best defined both pairs are regularly beaded, enlarged on *b* 6 and *b* 1 and constricted on *b* 2, *a* 2 and *b* 5. The inner pair lies in the middle of the paramedian field and the outer pair in the intermediate line, including the sensillæ in its narrow parts. All of these stripes become more or less broken and ill-defined at both ends. Dorsum of sucker marked with paired, irregular dark blotches and pale radial lines, indicating the position of the sensillæ. The venter is usually immaculate, but may bear a few small black spots, and the submarginal stripes may be solid black, blackish-olive, lead-colour or dusky with small black spots, or occasionally they may be entirely absent.

Harding has the following excellent manuscript note on the variations in colour-pattern of this species (including *H. manillensis*). Describing the black lines bordering the two pairs of yellow stripes as two pairs of chains, he writes: "The four black dorsal chains are subject to several elegant varieties of form. The black spots, median line and dorsal chains may be absent or inconspicuous in certain individuals, but they are never all absent at the same time. Individuals seem to occur which, in life, are devoid of orange dorsal stripes, and in which the black dorsal pattern is superimposed upon a uniform dark green or brown ground-colour."

Digestive tract similar to that of *H. javanica*, but differing in several respects (fig. 38, p. 98). Jaws similarly formed and of large size, the median frequently larger or at least more prominent, shorter and more strongly convex than the others. Salivary papillæ numerous (more than forty on each side), arranged

in irregular rows over the entire sides of the jaws; low, rounded, of two sizes, most of them being about 0.1 mm. in diameter, those near the denticular ridge smaller, about 0.06 mm. in diameter. Teeth stouter, shorter, blunter cones (0.03 × 0.01 mm.) and more widely separated than in *H. javanica* and *H. manillensis*. The number is also less, the median jaws bearing from 103 to 128 and the paired from 86 to 113 on examples of ordinary size, the long series of very small teeth of *H. manillensis* being absent in this species. Pharynx as in *H. javanica*, but the six longitudinal folds not uniting in pairs at the anterior end. Principal gastric cæca in each somite more extended than in *H. javanica*, reaching slightly into the succeeding somite, somewhat curved or bent caudad and usually provided with three lateral lobes better developed than in that species. Accessory cæca little developed, being mere sacculations. Large posterior pair of cæca arising in XIX and reaching to XXVI, slender, with a small lateral lobe in each somite corresponding to the principal cæcum of complete somites. Intestine slightly sacculated, in XX to XXIII.

Reproductive Organs (figs. 38, 54, 55, 56).—Testes normally twelve pairs, XIII/XIV to XXIV/XXV inclusive. Vas deferens as usual, but in some individuals, at least, the glandular layer continues forward nearly to the epididymis. Epididymis in mature worms usually equalling or exceeding in size the entire atrium, consisting of an intricately folded tube of irregular diameter, and folded on itself in a U-shaped pattern with the open end forward, the vas deferens opening into the anterior end of the ventral limb, and the ductus ejaculatorius leaving the anterior end of the dorsal limb. Ductus ejaculatorius, while somewhat enlarged and having its walls muscularly thickened, lacks a definite ejaculatory bulb, even in fully mature and sexually active individuals. Atrium somewhat smaller than vagina but approximating it in size, roughly retort-shaped, the large ovoid prostate bent sharply forward on the cylindrical penis-sac, which somewhat exceeds it in length but is only one-third or one-fourth its diameter, and may be straight or folded. Prostate covered with a thick glandular layer which is solid and not of diffuse, open texture, as in *H. manillensis*. *Ovisacs* generally of large size, ovoidal or ellipsoidal, with short, slender ducts that enter a prominent, solid, ovoidal or pyriform albumin gland and unite to form a short, wide, somewhat folded common oviduct, joining the vagina at about the middle of its length. Vagina divided into a stalk and a cæcum (fig. 56) distinguished by the point of entrance of the common oviduct, the stalk being common to both oviduct and vagina. Including the external bursa the stalk is approximately equal in length to the cæcum, but in cases in which the latter is much enlarged may be as little as two-thirds its length, or, in others, and especially in young individuals, may exceed it somewhat. These ratios in length remain nearly constant in a large number of examples of all sizes and conditions of maturity, but the diameter of the

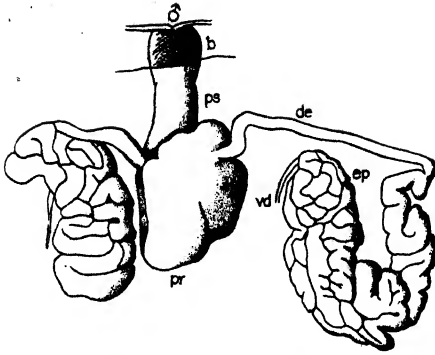

Fig. 54.—*Hirudinaria granulosa*. Antero-dorsal view of removed atrium. $\times 6$. Lettering as in preceding figures. The bursa is shown as though straightened out.



Fig. 55.—*Hirudinaria granulosa*. Atrium of a smaller specimen as seen from the right. $\times 6$.

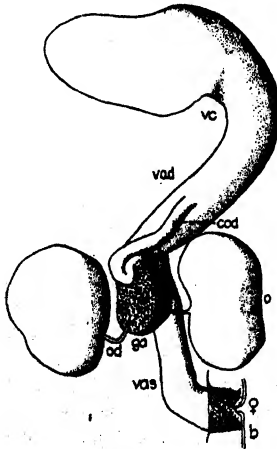

Fig. 56.—*Hirudinaria granulosa*. Dorsal view of female organs, removed, the bursa turned to show in profile. $\times 6$. *va.s.*, vaginal stalk; *v.c.*, vaginal caecum. Other lettering as before.

saccular portion of the vagina increases at maturity. The stalk is muscular and cylindrical and of smaller diameter than the vaginal duct. Typically the vaginal cæcum is divided into an inflated thin-walled sac or pouch and a cylindrical, thicker-walled duct of about equal length and one-half the diameter, but in some individuals the sac may be more inflated and even so encroach upon the duct that the latter nearly or quite disappears as a sharply defined region. Both male and female organs may pass to either the right or the left of the nerve-cord.

Geographical Distribution and Binomics.—The distribution of this species within India, as shown by the large number of specimens in the collection of the Indian Museum, is fairly clear. It is the common medicinal leech of the interior districts of most of India, inhabiting especially the upper plains of the great river valleys of the Indus, Ganges, Irrawaddy and to a more limited extent the Brahmaputra. In the lower parts of these same valleys, and especially in the broad reaches of the Brahmaputra plains of Burma and in a wide coastal zone extending throughout Ceylon, Hindustan and Burma, the evidence indicates that it is replaced by *Hirudinaria manillensis*. The only province in which it approaches the coast is Madras, in which it appears to be the dominant species, not only in the interior but near both the east coast and the west, the collection including examples from the City of Madras and from the Karduan River and at Etakuré, both of the latter points being in Malabar at an elevation of about 100 ft.* The species is especially abundant in the Punjab, along the Baluchistan border, in Rajputana outside of the Indian Desert, in Agra, Oudh, Sind and the Central Provinces. It occurs also at Almahabad in Bombay, in Kashmir, Nepal and Assam, in North and East Burma, and in the Amherst District of Lower Burma and at many other interior localities. Nevertheless it is not a mountain species, the only considerable altitude recorded, 10,000 ft. at Muth in Nepal, probably being a mistake for Muttra in N.W. Agra at about 1000 ft., where it is common or, as Sir A. Shipley kindly suggests, for Muth in the Punjab. Rather it is characteristic of the higher plains and foot-hills between about 500 and 2000 ft. above sea-level. It appears only rarely below 500 ft., and there are only three specific records above 2000 ft., namely on the Wardha River in Berar, Central Provinces, at 2400 ft. in the Simla Hills in Eastern Punjab, and at 4450 ft. in Kumaon, W. Himalayas. In Assam it is recorded from north of the Naga Hills and in Lower Burma from the west slopes of the Dawna Hills. The species does not occur among a large number of paddy-field leeches from Ceylon, Rangoon and the region about Calcutta. (See Appendix, p. 297.)

Throughout this range it occurs in marshes, swamps, ponds, tanks, ditches and the smaller streams, but seldom in rivers.

* See, however, footnote, p. 210.

Whereas collectors of the lowland leeches frequently mention them as attacking cattle and buffaloes, this is not the case with the present species. On the other hand, its attacks on Man are more often referred to. To workmen engaged in building roads or similar work in swamps it is sometimes very troublesome. The bite of the wild leeches is said to be quite irritating, for which reason they are not favoured for medicinal use. In the collections this species and *Hirudo birmanica* are very commonly associated, and the collectors do not discriminate between them.

While the practice of blood-letting by means of leeches is very ancient and formerly was very extensive among the natives of India, there are no government or trade statistics that give a definite idea of its extent. Lt.-Col. J. L. Graham, writing from Simla on behalf of the Director-General of the Indian Medical Service, states: "The use of leeches in medical practice has largely disappeared among European doctors and from the hospitals of the British and Indian Army. The old regulation requiring the senior ward sweeper to make provision for a supply was abolished in 1902. On the other hand, Mr. Prashad and others write that among the native hakims and doctors, leeches are still widely employed to avoid the use of the surgeon's knife. Watt ('Dictionary of the Economic Products of India') states: "At the present time [1890] the leeches employed in Bengal are chiefly caught in tanks in the neighborhood of Baraset [Barisat], by persons who collect them by entering the water and allowing the leeches to catch hold of their legs. They are chiefly gathered in May as the tanks begin to dry up. But the best leeches are said to be obtained from the North-Western Provinces, chiefly from Shekoabad [United Provinces of Agra and Oudh]. Large numbers are, however, also caught at Patiala in the Punjab." The first-mentioned locality is within the range of *H. manillensis*, the second and third of *H. granulosa*. Many of the leeches thus collected are kept in confinement and domesticated before being employed medicinally, the irritating effects of the saliva being thereby mitigated. Mr. D. V. Mamtora writes that a considerable industry in the domestication of leeches exists in the neighbourhood of Ahmadabad, Bombay, and Kahn (1912) describes rather fully the cultural methods employed in Bara Banki, United Provinces. Specimens of the domesticated leeches from the latter two localities prove to be typical examples of the upland species. From the above and similar testimony it is evident that, with the exception of the neighbourhood of Calcutta, where *H. manillensis* is largely used, the favored medicinal leech of Indian commerce is *H. granulosa*. Even in the time of Sushruta the inland leeches were preferred.

The cultural methods have been long in vogue, modern practice being founded on that indicated by Sushruta. In a letter Mr. Kahn summarizes the account given in his published paper. Breeding leeches for medicinal purposes is the sole means of

livelihood of a certain class of people (Chohra). Breeding begins in April or May just before the rains. A few selected adults are placed in a new earthen water-pot with some moistened black clay. The pot is covered with cloth and clay, and put away in a part of the house free from disturbance, for it is believed that the leeches will not breed if disturbed. To gain the same end, breeders in some places bury the pots in the ground. After a few weeks the cocoons or egg-cases are formed. These are at first soft and white, but in two or three days become firm, and in the best practice are removed then and placed in small cups of the same clay and replaced in the jar. This is repeated until the cocoon formation ceases. The cups are changed frequently and the whole kept moistened for about a fortnight, when the cocoons showing active young are broken open by the breeder and the young released. The young are placed in fresh water changed morning and evening. They grow rapidly, and when sufficiently large and disposed to feed, which is indicated by their attacks on a hand placed in the water, they are removed and allowed to take a light meal on the body of the breeder. Care must be taken not to allow them to suck to repletion, which often proves fatal. Feeding in moderation is repeated about every two weeks until they are old enough for use, which may be at two years. The mature leeches are then divided into two lots, the one to be sold for medicinal purposes, the other, called "seed leeches," being reserved for breeding. The latter are kept in water changed at intervals and are fed on blood until the next breeding season. Leeches used for blood-letting and fed with large quantities of blood lose their power of reproduction and are useless for breeding purposes. This is interesting and confirmatory of the conclusion arrived at from a study of *Dinobdella ferox* that the reproductive organs have become abortive in parasitic individuals (p. 183). Those leeches reserved for breeding and not employed medicinally will live for ten years or more.

Susruta (for a copy of a complete translation of the chapter on leeches by Kaviraj Kunja Tal Bhishagratna I am indebted to Major Seymour Sewell) gives many quaint directions for use of leeches in the treatment of various disorders and many popular beliefs concerning them. But the methods and precautions laid down with ancient authority are essentially those now employed. Only those leeches that have not been used for two or three weeks are applied to the part to be treated. If these have been well selected they begin at once to suck blood with avidity and continue until they fall down filled, the amount of blood taken being three or four times the weight of the leech. Such leeches become very dull and inactive. They are rendered again serviceable by stripping with the fingers from tail to head, usually after first pricking with a needle on the middle line of the back behind the head. Thus they are emptied of blood, and after rubbing thoroughly and replacing in water usually recover and after a rest.

of two or three weeks may be used again. Leeches thus regularly employed seldom live more than a year.

The Chohra find that wild leeches do not breed in captivity until long accustomed to it, and are difficult to confine. Their bite is often unbearable to the patient, and, according to Sushruta, causes intense itching and sometimes swelling and fever. As a result the place of the bite is scratched. The probability is that the abscesses, blood-poisoning and occasional death which sometimes follow are more frequently the result of infection introduced into the wound by scratching rather than of the direct poisoning or infection of the bite. The bite of domesticated leeches is far less painful.

Further details relating to breeding are given by Matthal (1920). Twenty-two leeches under observation from May 23 to June 23 formed forty egg-capsules or cocoons, each leech producing from one to four. Drying of the clay stimulates cocoon formation, but may kill some of the leeches, while too much moisture retards it. On one warm day (32° C.) eleven cocoons were formed and four leeches died. Cocoons first appear as a white frothy girdle about the clitellum. The body is slowly withdrawn tailward by rhythmic alternate contractions of the two sides, a process requiring about six hours for its completion. After the cocoon has slipped over the head its ends contract, the anterior end being pointed and the posterior broad and bilobate. It gradually assumes an ellipsoidal form, 18-20 mm. long by 11-13 mm. wide, becomes yellowish in colour and of a stiff, firm texture. The walls consist of an inner membranous layer and an outer spongy or cellular layer filled with air which cause it to float in water. The contents are a greyish jelly in which a number of eggs are suspended. Development proceeds rapidly if the cocoons lie on damp earth, but if they are covered by earth or immersed in water it is retarded or stopped. In about a fortnight three to fourteen (five or six according to Khan) young emerge from each cocoon. They are about 20 mm. long and 2 mm. wide, swim rapidly, attach by the posterior sucker, and in a few days attain the characteristic colour-pattern. By the time of hatching, the grey contents of the cocoon have been entirely used up as food by the young.

Whether or not these leeches actually transmit diseases from person to person or between domestic animals is not certainly known, but the use of the same leech repeatedly, as practised by native doctors offers perfect conditions for the transmission of infective agents. That infections do sometimes follow the use of leeches is evident enough, but the unsanitary customs attendant upon their use and the scratching of the wound due to itching, especially following the application of wild leeches, probably explains many of the cases of ulcers, toxæmia, etc.

41. *Hirudinaria* (*Pœcilobdella*) *viridis*, new species. (Plate VIII, figs. 31, 32, 33).

Diagnosis.—Largest extended specimen 114 × 18 mm. Form as in *H. granulosa*. Colour in general similar to that species but probably more inclined to the greens, and the pattern certainly disintegrated earlier and more completely. The black pattern is limited chiefly to transverse rows of mid-metameric spots. Bright olive-green of dorsum and greyish-green of venter sharply defined by clear bright orange marginal stripes; dorsum usually with supra-marginal black spots on *b* 2 and *b* 5 and often with paramedian spots on *b* 6 and *b* 1, and more or less of a median dorsal line; no definite submarginal black stripes. External morphology in general closely similar to *H. granulosa*. Jaws as in *H. granulosa*. Atrium with penis-sac three or four times as long as prostate, which is covered with a compact layer of glands; ejaculatory duct little enlarged. Female organs similar to those of *H. granulosa*, but vaginal stalk at least twice as long as cæcum at all ages. Type-locality, Shasthancottah, Travancore, Madras State. Type, Indian Museum, ZEV ³⁶⁵⁵/₇.

Description.—None of the specimens is very well preserved, most of them being strongly contracted and the others distorted and softened. Most of them are of small size, the largest 114 × 18 mm. A moderately extended one measures: length, 102 mm.; length to male pore, 22·5 mm.; buccal width, 8 mm.; width at male pore, 12·5 mm.; maximum width (XVII), 14·5 mm.; depth, buccal, 4 mm.; at male pore, 5·2 mm.; at XVII, 6 mm.; diameter caudal sucker, 8 mm. Form about as in *H. granulosa*, but apparently with the head even broader. Oral chamber spacious, the lip marked on the venter by a median furrow ending caudally in the dorsal triangular niche, and two pairs of lateral longitudinal furrows, and on the dorsum by quadrate areas. Eyes, sense-organs and annulations as in *H. granulosa*.

Clitellum as in other species of the genus, a thick, glandular layer extending from X *b* 5 to XIII *a* 2 inclusive, but little evident externally. Gonopores typically at XI *b* 5/*b* 6 and XII *b* 5/*b* 6, but one or both may be more or less within *b* 6. They are larger than on specimens of equal size of the other species of *Hirudinaria*, and the penis much more frequently protrudes as a coarse filament 12–15 mm. long, increasing in diameter to near the tip, which is about 1·6 mm., wrinkled but not spirally twisted or papillated near the end. Nephropores 17 pairs, on the caudal border of *b* 2 from VIII to XXIV inclusive, exactly in line with the ventral intermediate sensillæ, on some specimens very conspicuous, both because of their whiteness and their large size. Anus as in *H. granulosa*. Caudal sucker probably smaller than in *H. granulosa*, as it in no case exceeds two-thirds of the body-width and in most cases is considerably less. Integumental furrows regularly and strongly developed.

Integuments nearly smooth on some, very rough on other individuals, in which the areas stand out as papillæ roughened by the protruding sense-organs, which on still other specimens may be retracted to form minute pits. Each area bears a central larger sense-organ with smaller ones clustered about it. These areas are rather more numerous than on *H. granulosa*, there being from forty-four to fifty-six on each annulus of the middle region. Sensillæ disposed as in *H. granulosa*, but, though appearing conspicuously on the dark background, they are smaller and less elongated, generally white spots on a clear elliptical area; dorsal intermediate largest.

Annulation differs in no obvious respect from that of *H. granulosa* and *H. manillensis* and exhibits much the same variations, though it is probable that they differ in frequency, as was shown for the two other species. VII *a* 3 and VIII *a* 1 are constantly enlarged, and the former commonly has the secondary furrow (*b* 1/*b* 2) more or less evident on the dorsum, and in contracted specimens occasionally on the venter. On complete somites the middle annulus (*a* 2) is usually slightly shorter than the others. XXIV *a* 3 is much longer than the other annuli, and the furrow *b* 5/*b* 6 may be more or less developed or entirely absent. XXVII is uniannulate or biannulate. On many, especially of the smaller and contracted specimens, the intermetameric furrows are much deeper than the others, and the annuli of each somite are separated by a next deepest furrow into an anterior group of three (*b* 1 + *b* 2 + *a* 2) and a posterior group of two (*b* 5 + *b* 6), most evident on the venter.

Colour.—There is no direct information concerning the living coloration of this species, but five specimens preserved in formalin have retained much of its character. In life the green must have been much brighter and the orange richer and redder. The dorsum is of a very uniform rich olive-green, on which the white or colourless sensillæ stand out with exceptional distinctness and the black pattern is obscured, requiring high lighting under water to bring it out. The median line, paramedian spots and supra-marginal spots are usually present but faint, exhibit the usual variations, and any or all may be absent. There are also faint traces of metameric portions of the narrow black lines.

The venter is a uniform dark greenish-grey, without spots and with definite submarginal stripes, though the submarginal field may be more dusky. Apparently the pigment has become diffused over the entire surface, which is probably dusky green in life. The margins have a very clearly defined narrow strip of orange-yellow, continuous for the entire length.

Small examples from which the green and red have faded exhibit the typical generic pigment pattern with some modifications, chiefly in the direction of deficiencies. Most striking is the constant absence of definite submarginal black stripes from every one of forty-eight specimens. Next is the obscurity or frequent absence (in nearly one-half of the cases) of the median dorsal

line, which, however, may be complete and continuous on full-grown individuals or, as is more frequent, be broken into short mid-segmental lines. Next is the early age at which the definitive pattern becomes established. As compared with the other species, this is characterized, in addition to the two deficiencies just mentioned, by slight or no development of the intersegmental parts (on *b* 6 and *b* 1) of the narrow black lines, which thereby become intensified as metameric spots on *b* 2, *a* 2 and *b* 5, and by the frequent absence of the most medial and the most lateral of these lines. This pattern, exhibited by most of the specimens, is established in its losses as fully on one 17 mm. long (contracted) as on the largest, but is subject to the usual variations. As in the other species, the loss of one element of the pattern is unusually correlated with the intensification of another. Two individuals of medium size lack the pattern totally.

Digestive tract as in *H. granulosa*, but presents a few minor differences. Jaws prominent, bearing on each side about sixty outstanding rounded papillæ 0.05 to 0.095 mm. in diameter; the median jaw somewhat larger, with 100-105 teeth, the paired with 90-92 teeth (counted on four specimens). Teeth, as in *H. granulosa*, well spaced and without the long series of very small ones, pointed, conical, the largest 0.027×0.009 mm. No trace of teeth could be found on the specimens in formalin. Pharynx of two dissected, with six broad longitudinal folds not united in pairs anteriorly, but instead three end at the jaws and three alternate with these. Gastric cæca as in *H. granulosa*, the principal pair of each somite rather slender and elongated, with definite lateral and terminal lobes, secondary cæca, nearly one-half as long as the principal ones; last pair arising in XIX, reach to XXVI.

Reproductive organs very distinctive. Testes, in the one fully dissected, eleven pairs, probably varying from ten to twelve, of the usual form and position, first pair always at XIII/XIV. Nothing distinctive about vas deferens. Epididymis (fig. 57) spheroidal, the tortuously folded sperm-duct partly arranged into two limbs, the lateral entered by the vas deferens, the medial giving rise to the ductus ejaculatorius. Ejaculatory duct, while somewhat enlarged, in no case possesses a large bulb, as in *H. manillensis*; it penetrates the glandular layer on the latero-ventral aspect of the prostate and enters the prostate cornus. Atrium of constant form in specimens of all sizes, at maturity very large, much folded and extending throughout most of the length of XI and XII; of elongated, clavate form, the penis-sac gradually increasing in diameter from the external bursa and passing into the spheroid prostate without sharp external differentiation other than the solid glandular layer covering the latter. Female organs (fig. 58) in all essentials quite constant in ten specimens of all sizes dissected. Like the atrium at maturity the vagina is very large, much folded and extends through two somites or more, and by comparison, the ovisacs and oviducts, which are in no way peculiar, appear small. Vagina shaped much like the

atrium, but even longer and more slender, consisting of a vaginal cæcum and a stalk of twice or more its length, at the union of which the common oviduct terminates. Stalk a long cylindrical tube about half the diameter of the penis-sac and exceeding it in length. Cæcum composed of a more or less inflated sac or pouch and a narrower duct that tapers into the stalk and which may be abruptly differentiated from the sac or taper gradually from it.

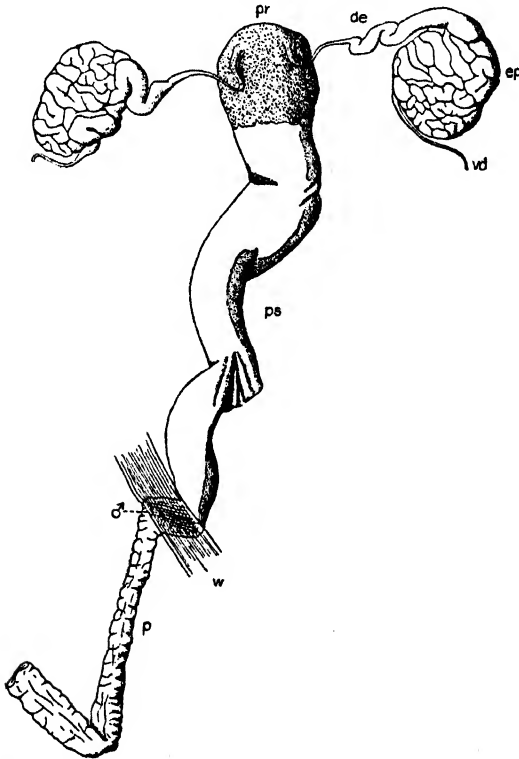

Fig. 57.—*Hirudinaria viridis*. Terminal male organs removed, and straightened out, as seen from in front, with penis protruded. $\times 3\frac{1}{2}$. *p.*, penis. Other lettering as before.

Brown botryoidal tissue is developed to about the same extent as in *H. granulosa*, but much less than in *H. manillensis*.

Geographical Distribution and Bionomics.—Under this head practically nothing is known. Although three lots were sent from the Indian Museum, the label of one has become illegible, and Coviloar, the locality given on another, cannot be found in the

atlases. The remaining lot, including the type, comes from Shas-thancottah, 12 miles N.N.E. of Quilon, Travancore, and was collected by Dr. Annandale. This place is in the southern part of Madras State near the west coast, and the altitude is about 300 ft.

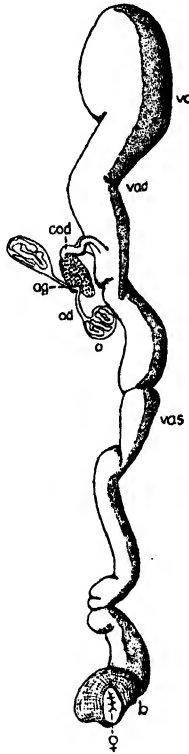

Fig. 58.—*Hirudinaria viridis*. Female organs from dorsum, removed and bursa turned in face view. $\times 3\frac{1}{2}$. *Vas.*, vaginal stalk; *v.c.*, vaginal cæcum. Other lettering as before.

Another specimen, received later, was taken from a small pond in a rice-field at Etakare, Malabar Dist., Madras, at an altitude of 100 ft.

The stomachs of several specimens contain blood and one a small quantity of a greenish flocculent material.

Subfamily HÆMADIPSINÆ.

Synonymy :

- Hæmadipsidæ*, Blanchard, 1893, 1894.
Hæmadipsinæ, Blanchard, 1896, 1899, 1917.
Hæmadipsinæ, Perrier, 1897.
Repantiæ, Brandes (in Leuckart), 1901.
Hæmadipsinæ, Weber, 1915.
Hæmadipsinæ, Harding, 1913.
Hæmadipsinæ, Pinto, 1923.

Type-genus, *Hæmadipsa*, Tennent, 1859 (1861).

General Characteristics.—These are the land-leeches *par excellence*, little annelids that have solved the problem of terrestrial and even of arboreal life far more completely and successfully than have the burrowing and cryptozoic distichodont and Erpobdelline leeches. While, as pointed out before (p. 158), the Aryhyncho-bdellid leeches, for the most part, are not to be regarded as aquatic in any extreme sense, nevertheless water is the dominant element of their physical environment, and the step taken by these land-leeches in the direction of emancipation from dependence upon it in masses is a long one. They have reached nearly or quite the same stage of ecological evolution as, for example, have most of the toads and tree-toads as compared with the aquatic and amphibious salamanders and frogs. That they have not yet completely freed themselves from the shackles of their ancestral habitat is shown by their present geographical and seasonal limitation to places and times of great humidity. As compared with most insects, snakes and lizards, they are as far from being completely adapted to life on dry land as are leeches like *Hirudo* and *Hirudinaria* from the absolute aquatic requirements of such types as sponges, hydroids and echinoderms.

That the land-leeches have been successful in their new habitat is sufficiently shown by their teeming abundance and by their dispersal over a wide range centering round the Indian region and extending through the island groups of the Western Pacific from Japan to Madagascar and Australia. In the dank tropical jungles, the misty ravines and the showery, forested mountain-sides of this extensive region they are among the most dominant and self-assertive elements of the animal life. A volume could be filled with the tales of naturalists, travellers, missionaries, engineers and soldiers, all attesting, from their varied viewpoints, to the invincible and often overwhelming onslaughts of these myriad vampires of the jungles upon such men and beasts as venture to trespass upon their well-guarded domains. A very few quotations will suffice.

Hooker (1854, p. 157), writing of his experience in the Teesta Valley, in Sikkim, states:—"Leeches swarmed in incredible profusion in the streams and damp grass and even among the bushes ;

they got into my hair, hung on my eyelids, and crawled up my back. I repeatedly took upwards of a hundred from my legs, where the small ones used to collect in clusters on the instep; the sores which they produced were not healed for five months afterwards."

Hæckel (1883, pp. 138-139) thus describes them in Ceylon:—"Excepting near the sea and in the highest mountains they swarm in myriads in every wood and bush; and in some of the forests, particularly near the river banks and in the marshy jungles of the highlands and lower hills, it is impossible to take a single step without being attacked by them. Not only do they creep along the ground seeking what they may devour—they are on every bush and tree, from which they frequently drop on the head and neck of the passer-by; while they always creep up his legs, nay, they can even spring to reach their victim."

Semper (1863, p. 559) recounts:—"I once passed through a leech forest where, in less than twenty minutes, such an extraordinary number of these blood-thirsty creatures fastened themselves to my feet that they formed on both sides of the ankles bunches as large as the fist. For the most part they keep on the ground; but there are some that live on trees, and attach themselves to the bodies of animals passing by, generally seeking the eye."

Many stories are told of persons sleeping out in the forest or lost in the jungle, or of soldiers wounded in battle, who were found literally covered with leeches, and who either lost their lives or barely escaped and were crippled for life. Large bodies of soldiers have been driven out of the jungle by them.

These hæmadipsines are so distinctive in appearance that they may be recognized at once. A careful study makes it evident that their external characteristics have been modified chiefly in relation to the changed mode of life, whereas the internal organs, and especially the nervous, vascular, digestive and reproductive systems, are more conservative and show less divergence from the aquatic Indian forms to which they are most closely related. It is evident that the changed habitat has affected principally three sets of conditions: namely, first, water relations; second, conditions of locomotion; and third, conditions of sense reception.

The first involves a change from normal immersion in water to continuous exposure to an atmosphere more or less completely saturated with water vapour and to surroundings frequently drenched by tropical rains. These conditions have been vividly depicted in numerous descriptions of their abodes. Thus Hooker ('Himalayan Journals', I, p. 98) writes:—"In the rank luxuriance of the vegetation and the saturated vapours blown by the S.E. winds from the Indian Ocean 400 miles distant and condensing on the cooler southern slopes of the foot-hills of the Himalayas of Terral, in the dense jungles of stream-cut ravines, legions of leeches occur." Sibree (1915, p. 157) describes their habitat as "deep ravines with rushing water, luxuriant foliage, ferns and

mosses." Semper (1863, p. 186) refers to their living in the open on trees in Ceylon in forests constantly saturated with moisture quite as well as European leeches do in water. While most species of these leeches do not normally enter water even when living in the vicinity of streams, they sometimes do, as will be pointed out later. That they are not injured by immersion in water for a long period was proved by Whitman (1886, p. 528), who thus kept one of the Ceylon species without injury for thirty days. It was, necessary, however, to confine them forcibly, as when free to do so they immediately left the water. It is evident that the land-leeches are physiologically aquatic, and that their preference for a damp climate is in response to the necessity of maintaining the body moisture. Probably the first importance of this is to support respiration. This takes place through a superficial network of capillaries, loops of which penetrate the epidermis, and the skin fails as a respiratory organ unless kept moist.

But it is evident that much more than the selection of an appropriate habitat is involved. There is abundant evidence on the labels and in my correspondence, and there is some little in the literature that these leeches do not everywhere and at all times enjoy the ideal conditions of the saturated jungles of Ceylon and the Philippines. They have extended their range on to the comparatively dry grass-lands where cattle are pastured, as, for example, near Ritani, Naini Tal, where they are very abundant at 7000 ft. (*A. N. Gulati*), and "among moderately dry herbage" (*Annandale*) near Calcutta. There is evidence also that year by year they are pushing to higher altitudes on the mountains (Petch, 1919, p. 79). Furthermore, many of the habitats, and especially the mountain habitats, are subject to the influence of the north-east monsoons, and consequently have a dry winter season. During the progress of the dry season the leeches disappear, as they are reputed to do also in certain districts between rains. These and other similar facts indicate that in spite of having found a terrestrial habitat with abundant resources of moisture, these leeches are nevertheless placed at a great disadvantage as compared with their aquatic relations. Obviously any adaptations for the conservation of water would tend toward the extension of their range and of the yearly period of their activity.

There are several such adaptations. The compactness of the body resulting from its cylindrical form, and the reduction of annuli in the cephalic and anal regions, reduces the surface for evaporation. The small size, of course, is a disadvantage from this point of view. The integuments of the land-leeches are harder than those of other leeches, which may retard evaporation. Mucous glands are also more numerous, and their secretion helps to maintain the skin moisture. But the most important and interesting adaptation is the use made of the nephridial excretion, as Whitman (1886) has already pointed out. In aquatic leeches the nephropores are situated on the ventral surface, and the excreted fluid passes rapidly into the water. In the land-leeches

the nephropores are at the margins of the body, the terminal duct of the vesicle being directed upward to that point. From the point of exit the fluid may be evenly distributed over both dorsal and ventral surfaces by means of the furrows and connecting wrinkles, which act like a system of irrigation channels to equalize its flow. By this means every particle of the fluid may be utilized for moistening the surface of the body. As the rate of flow of the fluid is controlled by a sphincter muscle, no more need be passed out than is needed to maintain the proper physiological conditions, and as the nephridial vesicles are very large, water may be stored in them against a time of need. When medicinal leeches are sucking blood, drops of fluid may be seen to gather at the nephropores and run away (Gratiolet, Moquin-Tandon, et al.). This is supposed to come in part from the blood plasma which is rapidly absorbed and excreted, thus concentrating the solid part of the imbibed blood in the stomach (Bialaszewicz, 1924). Whitman (1886, p. 327) describes drops of clear fluid as flowing from them, and states that the same occurs in the Japanese land-leeches. This, then, offers a means by which the leech may be protected from drying during the critical and important period of feeding, when it is most exposed. After feeding, the leeches seek shelter and darkness, and crawl beneath stones or logs, or bury themselves in the earth, where they are protected against rapid evaporation.

Concerning locomotion, it is evident that the suckers which leeches use as adhesive disks in their ordinary looping movements can function as vacuum cups only so long as the margins are pliable, and form a close air-tight union with the surface of contact. This may be observed in any aquatic leech allowed to crawl over a dry surface. In a brief time the sucker dries, air leaks in at the margins, and it fails to hold. The leech becomes helpless. The land-leeches are especially protected against this imminent danger of their mode of life. In many of them the first pair of nephridia are carried forward, and the external openings are situated at the sides of the buccal ring, whence the secretion is conducted around a large part of the sucker rim by the buccal frill, a thin membranous fold continuing the lateral buccal lobes, thus keeping the margins of the head-sucker moistened.

A similar but more perfect device is attached to the caudal sucker. Here, projecting towards the sides of the sucker, is the so-called *auricle*, the function of which has remained unknown. It is a tri-lobed, flange-like appendage to the margins of somites XXIV, XXV and XXVI, probably derived from the marginal papillæ of their sensory annuli ($\alpha 2$), as is indicated by its structure, position and colour. Usually the middle lobe is small and triangular, the first and third larger with thin membranous margins, the angles of which are somewhat prolonged. The interlobular sinuses are rounded. The whole fits closely to the tessellated surface of the sucker, the angles dipping into its grooves. The last pair of nephropores is situated beneath the first

lobe or between this and the second. When the leech, with sucker attached, holds the body erect, turning and swinging about on its pedicel, as it is described as doing when a victim approaches, the auricles must necessarily sweep back and forth over the sucker. If, now, the nephridial secretion be flowing, the auricle would act as a brush or spreader to distribute it over the surface and margins of the sucker, maintaining their moisture.

While a vacuum disk or cup is no doubt an exceedingly powerful and versatile organ of attachment, when employed in locomotion it seems hardly suited to promote rapid progress. This is for the reason that the disk must first be closely applied to the surface of attachment to force out any foreign particles, and especially any air; the rim must then be sealed, and finally the disk cupped and the space beneath it largely exhausted. Evidently this requires an appreciable length of time, and explains the deliberation with which leeches ordinarily perform their looping locomotion, and especially the slowness with which they fix the sucker. Probably it is for this reason that aquatic leeches swim when rapid movement becomes necessary.

Land-leeches, denied the latter method of progression, have evidently perfected the looping mode, for all observers are a unit in describing the remarkable swiftness with which they advance. Indeed, it is stated that they actually leap. Whitman, discussing especially the old account of Schmarda, expresses the belief that jumping in the strict sense of the word is a physical impossibility for these leeches. However, there is so much testimony to the truth of the assertion, including that of such trained observers as Haeckel (1883), Schmarda (1861) and Meyer (corres.), and several of my recent correspondents, that the fact can scarcely be doubted. Jumping leeches they are sometimes called, so patent is this habit. Both of these facts, the celerity with which the leeches move and their ability to jump, seem incompatible with the use of the sucker solely as a vacuum disk. Another statement that has been difficult to harmonise with the use of the sucker in this manner is that these leeches move with great facility along slender twigs and leaves, and even perch on the trembling edges of the latter. How can a sucker be operated effectively under such conditions?

A study of the structure of the sucker solves this problem, for it becomes quite evident that it differs from that of other leeches, and has been modified in such a manner as to serve as a prehensile organ to a far greater degree than in any other, except possibly some of the fish-leeches. The pedicel is very massive, and its musculature and that of the sucker unusually well developed. While most leeches exhibit slight marginal crenulations of the sucker and faint and irregular radial wrinkles passing to them, in only a few cases do these have any constancy and definiteness. In the land-leeches, however, these structures become fixed as definite radial and subradial ridges or ribs, each ending in a small rounded marginal papillæ. Their number is quite large, varying from

about sixty to ninety and sufficiently constant to characterise certain species. These rays are better developed in the land-leeches than in any others, except the Ichthyobdellid *Actinobdella*. They are admirably adapted to serve as friction ridges to assist in the grasping function of the margin of the disk. The anterior median portion of the margin of the sucker is specially and more highly developed for the same purpose. Some of the more accurate figures and descriptions of the suckers of land-leeches indicate very clearly that they are not exactly circular, but somewhat oval with a slight projecting anterior angle. This point or angle is formed of a median pair of the rays, and the muscles here are thickened. Its length and form differ considerably on different individuals; on some it is barely perceptible, on others it forms a conspicuous, tapering projection which may be straight or hooked. While discernible on all species, it appears to be best developed in the *zeylanica* type, which has the fewest radial ribs. It is evident that this is a functional papilla that may be protruded and extended or contracted or bent ventrad as a hook through the activity of its own and adjacent musculature. Finally, this structure reaches its highest development on the small, mottled race (*cochiniana*) of *H. zeylanica*, which is so abundant in the rain-soaked forests of Cochin State. Every one of a large number of this race possesses a prominent pointed triangular lobe projecting from the anterior rim of the sucker. This is so large and so constant in form that it appears to be a definitive and no longer a facultative structure, as in the other races and species, but, of course, this can be definitely determined only by the study of living leeches. In any event it is certain that it is a well-developed prehensile papilla admirably fitted, with its musculature, to give the animal a firm toe-hold on loose or soft soil, or to enable it to grasp, as with a little apposible finger, the edge of a leaf or a thin twig. In the rapidity and precision with which it can take hold or let go, this prehensile organ is a great improvement over the vacuum disk, and in large part explains the remarkable agility of these animals. It is hoped that a naturalist favourably situated within the geographical range of these leeches will study their behaviour with sufficient care to determine whether they, as a matter of fact, actually do move as here surmised.

Concerning their sensations little can be stated at the present time. So far as actually known, the sense-organs of the land-leeches do not differ materially from those of aquatic leeches. The eyes are relatively larger, the number of series of sensillæ is smaller and some of the individual sensillæ are more prominent, but that is about all that is known. There has been no experimental work on their sensations. Here is another most interesting opportunity for careful studies on behaviour. Whitman notes that some of his leeches manifested very great excitement when a light breath was blown into the bottle in which they were confined. All observers are agreed concerning their great alertness and keen senses, and it is stated that as one passes through their haunts

they may be seen coming to the attack from all directions and from as far as thirty feet, but no one has made it clear through which sense they detect the approach of their victims.

In the substitution of air for water as a circumambient medium certain changes in the sense-organs might be assumed. As the refractive index of the medium changes so might the eyes, but as the eyes of leeches are phototactic and not visual organs, no great change would be necessary or expected. The chemical sense might become more of the nature of our smell than of our taste, but as these leeches live in an atmosphere saturated with water vapour a large part of the time, it is probable that little distinction is to be drawn here either. Then one might expect a distinction between the reception of vibrations transmitted through the ground and through the air, but, so far as I know, no one has detected anything resembling an auditory organ in these leeches. Like aquatic leeches, the land-leeches apparently are very sensitive to slow mass vibrations, and one may surmise that it is through the vibrations caused by their foot-falls that the leeches learn of the approach of their victims. But smell also may be an important factor. It is possible also that those leeches only which are in the immediate vicinity receive these sensations. Those farther away may be stimulated by the activity of their nearer fellows.

A problematical structure which may be a sense-organ occurs on certain anterior somites of several species. It is best developed on *H. ornata*, and is referred to in the specific descriptions as the furrow-pit. Unfortunately none of the material sectioned is sufficiently well fixed to make it possible to determine its minute structure and nature. It consists of a slit-like depression of the furrow, the epithelial lining of which is deeper than elsewhere, nearly free from mucous glands and capillaries, and lies in a white or unpigmented field. The furrow-pits may prove to be copulatory areas.

In view of their abundance, ubiquity and assertiveness, it is surprising how little accurate information concerning land-leeches we have. It is well-known that they are most active at night and during rainy weather, that most of them will disappear during a few days of no precipitation, and that during the dry season they totally disappear, but no one appears to know what actually becomes of them during the dry season. This was the answer invariably received from Indian naturalists to whom the question was put. The literature is equally barren. It offers several suggestions but few ascertained facts. Tennent (1861), after referring to their complete disappearance during the dry season and their reappearance immediately with the coming of the rains, queries, "Whence do they reappear? Do they, too, take a 'summer's sleep' like the reptiles, molluscs and tank fishes, or may they, like the Rotifera, be dried up and preserved for an indefinite period, resuming their vital activity on the mere recurrence of moisture?" Landon (1905, p. 49) goes so far as to state that they all die with the advent of the dry season, and that those

which reappear on its conclusion are a new generation. This would limit them to an active life of not more than seven or eight months, at the close of which eggs would be laid. This suggestion is so contrary to what is known of other leeches that in the absence of any evidence it seems most improbable. Whitman inclines to the belief that they merely seek shelter under stones, sticks, etc., as they do at all times when not actively moving about, and, thus protected against complete drying, await favourable conditions of moisture. There is considerable evidence that many of the leeches do survive periods of drought in this state of simple rest. Whitman, however, probably goes too far when he denies completely the possibility of hibernation (drought torpidity) except in the case of those mountain leeches that live above the line of occasional frost and snow. Even aquatic leeches will pass into this state of torpidity. The common American *Macrobdella decora* sometimes lives in small ponds that dry up during unusual summers. They then burrow into the mud, coil into a ball and lie quiescent until the pond is filled again. How long they will live in this state is unknown, but in one instance several were removed after the mud had been air-dry for three weeks. When placed in water they were completely quiescent, but rapidly absorbed water, swelled until they were about twice their former (dry) size and became active. Oka (1922, p. 92) has described a case of a fish-leech (*Ozobranchus*) in which this process goes even farther. It is probable, therefore, that some of these leeches do pass into a condition resembling hibernation. There is still another explanation that accounts for the disappearance of some of the leeches from the drier areas, and that is migration. During the dry season they may concentrate in the vicinity of water-courses, and during the wet season spread more widely over the less well-watered lands. The meagre evidence for this statement is to be found in the seasonal tabulation of the collections. This indicates that these leeches are more often taken attached to frogs and turtles during the dry than the wet season, and in a few cases the labels record that they were found under stones by the sides of bodies of water or in the dry beds of streams.

Some speculations concerning the origin of the land-leeches may be of some interest. Whitman (1886) considered their nearest progenitor to be *Hirudo*, by which I think we may assume that he meant any genus of the *Hirudo* type with similar annulation. My own inference is that the Indian genus *Hirudinaria* may be more closely related. It is not only the dominant aquatic leech in the region most affected by land-leeches but is, more prone to leave the water completely than is *Hirudo*, and in several respects (characters of reproductive organs, external sculpture, etc.) it resembles the land-leeches more closely, though in others (jaw papillæ and form of sensillæ) it diverges more widely. In an unpublished note Whitman speculates on the place and conditions of their origin, in part as follows:—

“In the younger tertiary periods a belt of freshwater lakes

skirted the southern base of the Himalayas, extending, with some breaks, across the entire peninsula of India, from the Indus and its tributaries to the Brahmaputra. Prior to the Glacial Epoch this long basin was drained by the elevation of its beds to considerable heights above the level of the sea.

"It would seem then that this upheaval which gave rise to the sub-Himalayan hills must have been attended by conditions that would be favourable to the gradual transmutation of freshwater leeches into land-leeches.

"The gradual escape of the water, resulting from the elevation of its beds, would inevitably lead to a struggle for existence on land, with some prospect of success in localities where the loss of water was best compensated for by frequent rains and a constantly humid atmosphere. Smaller individuals would evidently have some advantages over larger ones, under such conditions. Allowing that the climatic conditions were no more favourable than they now are in some parts of these mountains, there are evidently grounds for the conjecture that some portion of the Sivalik basin was the cradle of the immediate ancestors of the land-leeches. The fact that these leeches are now found in profusion in the lower Himalayan and sub-Himalayan regions under conditions which, according to all accounts, are as favourable to their mode of life as any that occur anywhere in the world; the probability that they have all had a common birth-place on the continent to which these mountains belong; and the fact that geological changes on a grand scale have here taken place, of a kind that would be eminently favourable to the introduction and perpetuation of land-leeches, all tend to justify the same conclusion."

Such information concerning the geographical distribution and relationships of the land-leeches as has accumulated in the forty years since this note was written points to the southern slopes of the Himalayas as the probable centre of their dispersal, and I know of no facts that controvert Whitman's main contention. As the land-leeches frequently attach themselves to birds, their dissemination to islands is easily accounted for.

That the land-leeches must exert a considerable influence upon human welfare is undoubted. There are districts so dominated by them as to be nearly uninhabitable for Man. They have a deleterious effect upon agriculture and stock-raising through attacks on domestic animals. As they repeatedly bite in the same place the continued irritation results in persistent open sores, as is attested by many observers. Attacks on the eye sometimes cause temporary or even permanent blindness (Blanchard, 1917; Semper). Whether they actually transmit blood parasites or other infections has not been definitely established. They are reputed to be vectors of the flagellate (*Herpetomonas*) causing gangrenous ulcer (Prowazek, 1904, p. 28) and of the germ of tetanus (Kribs, in letter). That their bites are followed frequently by suppuration is well known; Davy (1821, pp. 102-105)

attributes frequent death to this cause, and Tytler (1826, p. 373) describes in detail three cases met in his practice of soldiers bitten on the feet and ankles who contracted deep-seated and persistent ulcers from which they became permanently crippled. No doubt many of these cases are due to secondary infection from scratching of the wound or otherwise. It is especially advised not to remove the leeches too forcibly because of the danger of leaving some of the teeth in the wound.

In the arrangement of the genera of the subfamily, Harding (1913) has proposed the two series of *Trignathoferæ* for those having three jaws, as typical of the Hirudidæ, and *Duognathoferæ*, in which the dorso-median jaw is absent, leaving the paired jaws only. Blanchard (1917) ignores this important distinction and defines the genera solely by the number of annuli in complete somites, leaving out of consideration all factors of internal anatomy, a practice that Johansson (1924) justly criticises in its application to the genus *Philæmon*.

All known Indian species belong to the type-genus *Hæmadipsa*.

Genus HÆMADIPSA, Tennent.

Synonymy :

Hæmadipsa, Tennent, 1859 (1861), p. 302.

Hæmadipsa, Whitman, 1886, p. 322.

Hæmadipsa, Blanchard, 1917, pp. 656, 657 (in part).

Type-species, *Sanguisuga zeylanica* Moquin-Tandon, 1826. Ceylon.

Diagnosis.—Size small, form slender, subcylindrical, tapering to head from near caudal end, which is massive. Both size and form much altered when distended with blood. Colour varied, usually longitudinally striped or mottled. Lip more or less triangular. Eyes large, the first four pairs usually on contiguous annuli, but the third and fourth may be separated by a partial or complete annulus. Gonopores usually separated by five annuli (XI *b* 5/*b* 6 and XII *b* 5/*b* 6), but in a few species by more. Furrow-pits often present on some or all of the somites from VIII to XII. Integument tessellated, the areas especially prominent on the head and caudal sucker. Caudal sucker with numerous prominent radiating ribs on ventral surface and a more or less well-developed anterior marginal prehensile papilla. Auricles well developed, trilobate. Nephropores marginal, the last pair beneath the auricles, the first usually on the buccal margins. Jaws three, very high and prominent, without papillæ. Teeth acute, conical, slightly curved, in moderate number. Pharynx with three or six longitudinal folds. Stomach bearing simple, unbranched cæca, one pair in each somite, the last pair elongated. Atrium small, pyriform, covered with loose glands; ejaculatory bulb little developed and epididymis an open convoluted loop. Vagina divided into a narrow tabular duct and large cylindrical

cæcal sac, into the outer end of which the oviduct opens dorsad to the duct.

Speciation.—A final and satisfactory determination of the species of this genus is yet to be accomplished. Earlier writers based species largely upon geographical separation or upon colour-differences. Blanchard's (1917) extensive studies show a great individual variation and intergradation in colour-pattern, and led him to unite nominal species (including *japonica*, Whitman) having a very wide distribution over Japan, China, all parts of India, Burma and Ceylon, and neighbouring parts of the continent, the Philippine Islands, Malay Archipelago, Sunda Islands, etc., under *H. zeylanica*. Kaburaki (1921) went, perhaps, even farther, for, while he follows Oka in omitting *H. japonica* from his synonymy, he includes *H. sylvestris*, which Blanchard described as distinct. The material studied by the writer makes it quite clear that the land-leeches of the Indian region are extremely variable externally, and that they fall into a number of geographical races distinguished by size, colour-pattern, arrangement of head-plates, number of sucker rays, etc. Lots from particular localities are very much more constant in all of these respects, but grade into those from neighbouring and more distant districts, with the result that a number of subspecies are recognizable. In addition, there are several forms which differ so decidedly and constantly that they can hardly be discussed except as full species. These conditions differ from those generally appertaining to aquatic leeches, and remind one more of those found among terrestrial pulmonates, small rodents, etc. What the exact nature of these forms will ultimately prove to be remains to be determined. They may include ecological varieties, Mendelian segregates, localized mutations and true morphological species, so far as present evidence goes, or they may be something else. Present evidence is insufficient for a decision, and these questions can be adequately discussed only by someone in a position to study the leeches in life and familiar with the complex topographical and climatic conditions prevailing in their habitats.

An interesting fact is that several of the colour-varieties are associated with land-planarians having a nearly identical colour-pattern, a resemblance that might be described as mimetic. Here are several interesting problems for resident naturalists.

Key to Species and Subspecies of Indian Hamadipsæ.

- A. Gonopores separated by five annuli; auricles present.
 - a. Somite VII 3-annulate and VIII 4-annulate.
 - b. Furrow-pits obscure, when present on IX to XII; prehensile papilla well developed; size small.
 - 1. Eyes 3 and 4 on contiguous annuli; sucker rays usually 71-73 (66-74);

- colour-pattern usually mottled, with a median dorsal light or dark stripe, but other patterns occur *H. zeylanica*, p. 225.
2. Eyes 3 and 4 separated by a complete or partial annulus; sucker rays usually 69-71 (66-74); colour-pattern usually more or less reticulated or longitudinally chain-striped *H. montana*, p. 269.
- bb. Furrow-pits evident, on VIII to XI or some of them; prehensile papilla little developed.
3. Eyes 3 and 4 separated by a complete (rarely incomplete) annulus; furrow-pits present but not conspicuous, on VIII, IX and X, rarely on XI; sucker rays usually 74-76 (69-80), prehensile papilla little or not developed; colour brown with usually 3 black dorsal stripes, size larger *H. sylvestris*, p. 276.
4. Eyes 3 and 4 separated by a usually incomplete, rarely complete, annulus; furrow-pits very conspicuous on IX and X in white areas; sucker rays 86-94, prehensile papilla little developed; colour very showy velvety-black alternating with cream or pale yellow stripes, the venter red and the suckers pale blue *H. ornata*, p. 284.
- aa. Somite VII 4-annulate and VIII 5-annulate *H. dussumieri*, p. 291.

42. *Hæmadipsa zeylanica* Moquin-Tandon. (Plate V, fig. 7.)

Synonymy :

Sanguisuga zeylanica Moquin-Tandon, 1826, p. 120.

Hirudo zeylanica, Moquin-Tandon, 1846, p. 346.

Hirudo (*Hæmopsis*?) *ceylanica*, Schmarda, 1861, p. 3, Taf. xvi, fig. 143 (colour-varieties: *unicolor*, *punctata*, *vittata* and *brunnea*). (Ceylon.)

Hæmadipsa ceylanica, Tennent, 1859 (1861), pp. 301-304 (text-figures of movements, head and teeth). (Ceylon.)

Hæmadipsa ceylanica, Whitman, 1866, pp. 319-349 (in account of *H. japonica*. Pl. xviii, figs. 8 and 9 (colour).

Hæmadipsa ceylanica, Blanchard, 1887, p. 156.

Hæmadipsa zeylanica (Moquin-Tandon), Blanchard, 1894 a, p. 5, figs. 3-7; 1894 c, p. 113; 1897 a, p. 86; 1897 b, p. 335.

Hæmadipsa ceylanica, Brandes, in Leuckart, 1901, pp. 886-889 (includes as colour-varieties those of Schmarda and *japonica*, Whitman).

Hæmadipsa zeylanica (Moquin-Tandon), Blanchard, 1917 (in part), pp. 657-661, text-figs. 2-6 and pl. vii (external morphology and variations in colour-pattern, some of which are probably not

of this species. Gives synonymy, distribution, variations and bionomics).

Hæmadipsa zeylanica (Moquin-Tandon), Kaburaki (in part), 1921, pp. 715, 716. (Includes all Indian *Hæmadipsæ*, of which several colour-varieties are recognized. Darjeeling, East Himalays, Assam, Central Provinces, Lower Burma, etc.)

Hæmadipsa zeylanica (Moquin-Tandon), Moore, 1924, pp. 363, 384. (Assam, Naini Tal and Simla Hills.)

Other synonymy is omitted.

Diagnosis.—Size small, the largest in full extension about 40 mm. long, usually not exceeding 20 mm., very slender, cylindrical, tapering from the broad sucker pedicel to the head; when contracted more depressed and with the maximum width further forward. Colour variable; in the typical subspecies with the ground reddish-brown, mottled or flecked with black, with narrow median dorsal and marginal pale yellow stripes, the former sometimes greenish; other races with a ground of various shades of yellow and brown to chocolate or even almost black, plain or variously mottled or reticulated with black, with or without a paler dorsal median field, and very constantly with a narrow median dorsal black or dark brown stripe and yellow marginal stripes and sometimes with intermediate blotches, reticulations or longitudinal stripes of black or brown. Head areas variable, but third and fourth pairs of eyes typically on contiguous somites, at most and only rarely, separated by a few small areas; median areas on head segments absent in typical subspecies but frequent in others. Furrow pits rarely discernible, when present weakly developed in furrows $a2/u3$, of IX to XII. Caudal sucker with prehensile papilla usually well defined, variable in size and degree of extension and retraction, frequently very prominent and in the subspecies *cochiniana* possibly permanently of large size; sucker rays usually 71–73.

Type unknown. Type-locality, Ceylon.

Description.—A relatively small and very slender leech, very rarely reaching 50 mm. in length in full extension in life. A fully extended preserved specimen of the largest size measures: length, 40 mm.; length to male pore, 11.3 mm.; buccal width, 1.6 mm.; width at male pore, 3 mm.; maximum width (XXIV), 4 mm.; buccal depth, 1.5 mm.; depth at male pore, 2.7 mm.; maximum depth (at XXI), 3.6 mm.; caudal sucker, 5×5.4 mm. A large specimen in contraction measures: length, 23.8 mm.; length to male pore, 6.5 mm.; buccal width, 8.4 mm.; width at male pore, 9 mm., maximum width (XX), 11 mm.; depth at male pore, 2.7 mm.; depth at XX, 3.4 mm.; sucker, 5×5.5 mm. The great majority of preserved specimens are less than 15 mm. long. These have very little or no blood in the stomach.

Form in life and when extended round and very slender, "thread-like," or, at most, of the "diameter of a knitting needle," tapering very regularly from the caudal sucker to the buccal ring, beyond which the head may be somewhat expanded or not;

caudal sucker usually exceeding the body diameter somewhat. Contracted specimens much more depressed, with the greatest width further forward at about XX, the venter flat or slightly concave and the dorsum strongly convex, both cephalic and caudal suckers much less than body-width. When fully gorged with blood they are very much larger, both in length and diameter, and flask-shaped, the cæcal region being distended and stretched to the utmost, the preclitellar region forming a narrow neck.

Head (fig. 59) distinctly triangular, the lip prominently pointed in extension, broader and more rounded in contraction, the sides convex; unsegmented margin of lip well developed, divided into numerous granule-like areas. Dorsum of head usually rougher than on *H. montana*, the tessellæ being more prominently elevated.

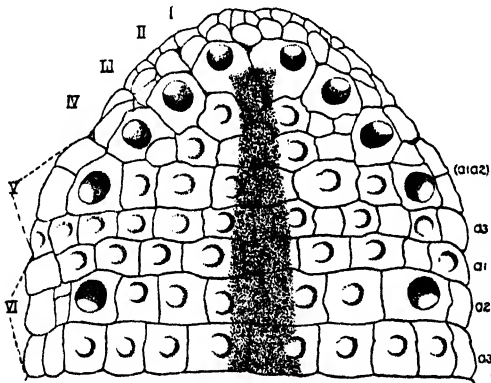

Fig. 59.—*Hæmadipsa zeylanica*. Somites I-VI, from dorsum. $\times 25$. Somite notation on left, annuli on right; stippled band is median yellow stripe, circles eyes, and crescents other sense-organs.

Ventral face finely granular, sometimes unfurrowed, but usually with a pair of longitudinal furrows bounding a pair of lateral lobes; a deeper median fissure extending from the dorsal angle of the mouth to the tip of the lip, or more commonly fading out in the anterior half, leaving a broad undivided anterior median area. Lateral labial lobes broad, rounded ridges extending from the margins of the head to the sides of the mouth. Caudad and laterad of these are the lateral buccal lobes ending just within the sides of the lip in two fleshy sub-lobes and with a membranous frill along the buccal ring, but less developed than on *H. montana*. Mouth triangular, bounded by the three triangular lobes constituting the velum. Buccal ring constituted of all of somite V, the furrow $a2/a3$, while continued on to the latero-ventral face, becoming obsolete in the mid-ventral field. Eyes large and conspicuous, on annuli 2, 3, 4, 5 and 8, arranged in the usual manner,

the second pair largest, the others following in the order of 1, 3, 4 and 5.

Clitellum indicated externally only by a greyish or yellow coloration extending over the fifteen annuli, X *b* 5 to XIII *a* 2 inclusive. Gonopores both small, round orifices strictly in the furrows, the male at XI *b* 5/*b* 6, the female at XII *b* 5/*b* 6. Nephropores seventeen pairs, on the margins immediately anterior to the marginal papillæ, the first pair stated by Whitman (1886) to be on the caudal border of VIII *a* 1, the last on XXIV *a* 2, beneath the anterior lobe of the auricle, and the others as usual on *b* 2. Anus on XXVII, small, often partly concealed between two rather large projecting areas of XXVII. Auricles of medium size, fitting closely to the dorsal face of the sucker, trilobate, the lobes representing the marginal papillæ of XXIV, XXV and XXVI *a* 2, each bearing a translucent, membranous appendage, the first largest and projecting forward, the second a mere point, and the third a truncated triangle.

Furrow-pits in this species require further study. They are rarely discernible, and it is doubtful if they represent anything more than a deeper retraction of the furrows by dorso-ventral muscles attached at these points. They appeared on only one-fifth of several hundred examined, in the dorso-intermediate field of furrow *b* 2/*a* 2 of somites IX, X, XI and XII.

Caudal sucker broadly ovate, slightly longer than wide, the cephalic border slightly pointed by the prolongation of the median pair of rays as a papilla, often slightly hooked ventrad and varying greatly in size. This papilla is capable of extension and ventral flexion, and varies much in size in different specimens. In every one of forty-five specimens from Cochin State it is a very prominent triangular process, usually strongly bent ventrad, and is almost as well developed in the same race from other localities. Dorsal surface strongly and roughly areolated, the polygonal areas arranged in four and part of a fifth irregular circular rows. Ventral surface with a central depressed areolated region, and a strongly ribbed peripheral zone, with from 66-74 (usually 71-73) ribs ending in small marginal papillæ. These ribs are not strictly radial in arrangement, but form a series of nearly symmetrical pairs, most of which pass anterior or posterior of the centre.

Annulation.—Somites I to IV, weakly annulated owing to the irregularities of the areoli (fig. 59). Beginning with V *a* 3, the annuli are clearly defined by deeper furrows and each is divided by shallow longitudinal furrows into small more or less quadrate areas bearing small sense-organs, the number in the circumference of annuli of complete somites varying between forty-five and fifty. The following is the usual arrangement: Somite I consists of two or three pairs of small subcircular areas which may be asymmetrical, but rarely include a strictly median area. II, a pair of large ocular areas bearing the first pair of eyes and usually a small

post-ocular sense-organ, and one or two small marginal areas on each side; a common variation is the separation of this post-ocular sensory part as a distinct small area on one or both sides. Of one hundred examined for this character twelve showed it in greater or less degree. In cases where these supplementary areas are largest they have the effect of displacing the succeeding interocular areas caudad, resulting in various irregularities, the most noteworthy being an apparent incipient biannulation of somite IV, the observation of which condition is probably what led Kaburaki to fail to discriminate between this species and *H. sylvestris*. III consists of the second pair of oculars, larger than the first pair, a marginal or two on each side and one or two pairs of interoculars which present frequent variations and irregularities. IV, third pair oculars, usually two pairs marginals and two or three pairs of interoculars, the latter being disposed typically in a transverse row, but presenting many variations, among them a rare median area. V is biannulate, the first annulus consisting of the fourth pair of oculars, a variable number (up to eight) of small marginals, more or less in two rows, and usually three pairs of interoculars in a regular transverse row. $V a 3$ is a complete annulus divided into quadrate areas perfectly aligned and uniting with ($a 1$, $a 2$) only in the mid-ventral field. Of more than two hundred specimens from Ceylon studied, not a single one exhibited any areas intercalated between the third and fourth pairs of eyes, and only seven had median areas, usually a single one on II or III, or between the median pairs of both of these, and in one case one in each. In two cases one and in one case both of the paramedian areas of IV and V are coalesced into a large area extending across both annuli. In only three cases is there any indication, and this very incomplete, of the subdivision transversely of the interocular areas of the first annulus of V. All of these areas bear either segmental sensillæ or non-segmental sense-organs, which, on the interocular areas, are nearly as large as the sensillæ.

VI is triannulate ($a 1 = a 2 = a 3$) all around, except for a slight reduction of $a 1$ and $a 2$ and the furrow $a 1/a 2$ in the mid-ventral field; fifth pair of eyes on $a 2$. VII is quite similar except for the absence of eyes and of reduction in the mid-venter. VIII quadrannulate ($a 1 > a 2 > b 5 = b 6$). IX quinquannulate ($b 1 = b 2 = b 5 = b 6 < a 2$). X-XXII quinquannulate ($b 1 = b 2 = b 5 = b 6 < a 2$). On these complete somites the neural annuli are not only slightly longer than, but project beyond, the other annuli. On the ventral surface the intersegmental furrows are deeper than the others, and the 3-2 ($b 1 + b 2 + a 2$) ($b 5 + b 6$) grouping of the annuli is often obvious. XXIII is also quinquannulate, but $b 5$ and $b 6$ are reduced ($a 2 > b 1 = b 2 > b 5 = b 6$). XXIV is triannulate ($b 1 = b 2 > a 2$); $b 1$ and $b 2$ are somewhat shortened and united at the margins, $a 2$ bears the first auricular lobe and the last pair of nephropores, and $a 3$ is suppressed. XXV and XXVI

are uniannulate, each bearing an auricular lobe and the dorsal sensillæ. XXVII is uniannulate, very small, includes the anus, and may unite with XXVI at the margins.

The areas on the complete somites are less elevated than on the head and caudal region, but appear rougher than on the corresponding region of *H. montana*. Sensillæ are six dorsal and six ventral pairs, the marginals being absent. The dorsal paramedians and intermediates, though well developed, are less elevated on papillæ and less prominent on the Ceylon subspecies than on some of the others. During life the white or pale colour makes them conspicuous.

Colour.—Living colour (Pl. IV, fig. 7) of the typical Ceylon pattern a rich reddish-brown both dorsally and ventrally, finely or coarsely spotted with black, generally more profusely towards the margins and on the borders of the median line. Narrow median and paired marginal stripes of pale bright lemon or yellow both continuous for entire length and flanked more or less by black flecks. Auricles nearly colourless and ventral faces of suckers dusky. Sensillæ appear as whitish or colourless points. Schmarða has described uniform brownish and yellowish-grey varieties from Ceylon, and Blanchard, Kaburaki, et al., other varieties from elsewhere. Of about eight hundred specimens from Ceylon examined by me all but one are of the typical pattern. The black mottling is sometimes so heavy that collectors have described the living colour as black or chocolate. Preserved specimens more or less faded buff or reddish-yellow, the warmth of the shade differing individually, generally slightly less reddish on the venter and in preclitellar region. A narrow median dorsal field, slightly paler, free from spots and on all of these specimens lacking a median dark stripe. Marginal stripes clear pale yellow. Elsewhere on the dorsum a pair of broad lateral fields, and on the venter the entire surface, marked more or less thickly with irregular, sprawly, black, dusky or dark-brown spots, sometimes confluent, and without any obvious plan, usually somewhat less numerous on the venter, and on both surfaces variable in size. On the dorsum the spotted areas usually extend from the third pair of eyes to the sucker; on the venter from the post-buccal to the sucker. Nephridial auricles and immediately surrounding area pale and unspotted. Ventral faces of both suckers greyish, unspotted. This is the typical *zeylanica* pattern which appears to be absent or rare on the Asiatic continent, where it is replaced by closely related forms tentatively designated as local races and subspecies described beyond.

Digestive System.—Jaws three, short, high, very strongly convex, narrowly compressed, without papillæ. Teeth 71 to 76 on median jaw, 68 to 72 on paired; the largest about 0.0235 mm. by 0.0053 mm., slender, acutely conical, slightly curved with small bilobed bases; the others tapering, by the gradual reduction of the point, until nothing is left but the basal pieces in distichous series. Pharynx occupies the full length of VIII and IX, and is

broadly fusiform or subcylindrical, with six broad, thick, longitudinal folds, which in some specimens are much larger than in *H. montana*. Stomach with a single pair of cæca in each somite from X to XIX inclusive, the first nine pairs confined within their somites, simple, unbranched, and scarcely lobate, the last reflexed by the side of the intestine and reaching to XXIV, more or less sacculated.

Reproductive System.—Testes ten pairs, XIII/XIV to XXII/XXIII, inclusive, situated as usual, spheroidal, about 0.5 mm. in diameter in mature examples, each with a brown botryoidal spot. Vas deferens much folded and irregular with glandular covering, extending forward to ganglion XII, becoming very slender and arching medio-caudad to join the anterior end of the lateral limb of the epididymis. Epididymis a loosely folded, widened, U-shaped mass of the sperm-duct extending through part of somites XI and XII by the sides of the atrium and vaginal sac. The lateral limb receives the vas deferens, and the medial limb ends anteriorly in the highly lustrous ductus ejaculatorius, which includes a small fusiform bulb and opens by a short, narrow duct into the enlarged prostate region of the atrium. Atrium as usual in the genus, small, pyriform, scarcely rising above level of the nerve-cord, deeply buried along with the atrial cornua and ducti ejaculatorii in a loose mass of unicellular glands. Penis-sac short, narrow and tapered; prostate spheroidal and smooth. Ovisacs on each side of nerve-cord in caudad end of somite XII. As is the case with the ducti ejaculatorii, either oviduct may pass beneath the nerve-cord. No distinct albumin gland. Common oviduct slightly tortuous, on dorsum of vaginal duct, and opening close to it into the anterior or distal end of the vaginal sac, a prominent papilla on the inner surface of the latter marking the point of entrance. Owing to this relation the vaginal sac approaches the cæcal form of *Hirudinaria*. Its size and proportions vary considerably, but generally it is short, subcylindrical, or sausage-shaped, about twice as long as wide and reaches to the caudad end of XVI. Vaginal duct narrow and perfectly straight, passing from the end of the sac ventral to the entrance of the oviduct, directly to the external bursa; diameter about one-tenth length, which is about one-third length of sac.

Geographical Distribution and Bionomics.—As comprehensively understood by Blanchard (1917), Kaburaki (1921) and others, this species has an extensive range throughout south-eastern continental Asia and the Oriental islands from Japan on the north throughout the Philippines to the Malay Archipelago and neighbouring island groups. This range covers 60° of longitude and 50° of latitude, and reaches from sea-level on Ceylon to above 12,000 feet in the Himalayas. Obviously many of the references included by these authors are to forms other than the species as here understood, but I am not prepared to discuss them critically at the present time.

Within the geographical limits of the present book the typical

subspecies appears to be confined to the island of Ceylon, not a single example occurring in the extensive collection of land-leeches from most parts of the Indian mainland. On the other hand, every one of upwards of eight hundred Ceylonese specimens conforms to the diagnosis of this subspecies. Both Tennent and Schmarida refer to a second species, the occurrence of which Whitman denies, and of which I find no evidence whatever. Land-leeches are abundant over a large part of the island and especially so in the low, moist hill-country. Tennent (1860, p. 302) states they are not frequent in the plains, which are too hot and dry for them; but amongst the rank vegetation in the lower ranges of the hill-country, which are kept damp by frequent showers, they are found in tormenting profusion.

Schmarida (1861, p. 3) reports them as found in all parts of Ceylon both on the plains and in the mountains to 3000 feet, rarely above. Hæckel's statement, already quoted (p. 245), is in accord with this. Whitman has a MS. note to the effect that in Ceylon their range does not much exceed 4000 feet, and there is much other testimony to the same effect. If these statements are entirely reliable, it is probable that these leeches have recently extended their vertical range, for not only are there many specimens from Galle and Colombo, near the coast, and from moderate elevations at Kandy and Peradeniya, but there are also two lots from higher altitudes: Pattiola, 6200 feet, and Horton Plains, 7000 feet, both collected by S. W. Kemp in December 1913 and both taken from frogs. In addition there is the following direct statement of Petch (1919, pp. 79, 80):—"While leeches drive one from the jungles of (say) the Ratnapura District, the up-country jungles are generally free from them. But a close acquaintance with the country around Hakgala during nine years leads to the conclusion that they are gradually migrating upward. In 1906 the first leech in the Hakgala was found at the bottom of the valley below. In 1909 they had gradually extended their range until they were abundant in the last ravine bounding the gardens, and remained abundant at that point. In 1912 they were common below the laboratory in grass, but not at the Bungalow (elevation 6500 ft.). In 1913 one was found above the Bungalow."

While numerous accounts of the intolerable pests that these leeches are in Ceylon have been given by visitors to that island, and while far more is known of this than of any other land-leech, our knowledge is still very far from complete. Nothing has been published concerning its breeding habits, and we are almost as ignorant of its seasonal changes in habits, its precise method of locomotion, its informing senses and various other aspects of its behaviour and natural history. Among the best of these accounts are those of Knox (1681, pp. 48, 49), Davy (1821, pp. 102-105), Tennent (1859-1861, pp. 301-305 and 479-483) and Hæckel (1883, pp. 138, 139). Excellent compilations from these and other sources are given by Whitman (1886, pp. 319-349), Shipley

(1916, pp. 176-181), and Blanchard (1917, pp. 657-661), in addition to much new matter relating to *H. japonica*, which Blanchard considered identical with the present species. Whitman, in the best account of the structure and activities of a land-leech ever given, adds some personal observations made during a visit to Ceylon.

As Haeckel's account is far less known than the others a few additional extracts may be quoted:—"When they have sucked their fill they are about as large as an ordinary leech; but when fasting they are no thicker than a thread and scarcely more than half an inch long. They wriggle through the elastic texture of a stocking with the greatest rapidity. Often the bite is felt at the time, but as often it is not. . . . To deter the leeches from biting and to cure the wounds lemon juice, carbolic acid and alcohol are recommended. The result of the bite is very different with different persons. Those who have a tender skin—and I am unfortunately one of them—feel a painful throbbing in the wound for some days, and a more or less disagreeable inflammation of the surrounding skin. As the leeches by preference attack these inflamed and irritated spots with fresh bites, the wound by constant aggravation often becomes so serious as to be even dangerous. When the English seized Kandy in 1815 they had to toil for weeks through the dense jungle of the damp hill-country, and they lost a great many men from the incessant attacks of swarms of leeches. In neighbourhoods which are most infested by them the Europeans wear leech-garters, as they are called, as a protection—high overalls of India rubber, or of some very thick material which cover the shoes and are secured above the knees. I protected myself in the jungle by painting a ring of carbolic acid round above very high hunting boots, and this line the leeches never crossed. In some parts of the island, however, the swarms of leeches make any long stay almost impossible."

To most persons the bite is quite painless, and often they become aware of the attacks of the leeches only by seeing the blood flowing or, as Tennent states, actually welling over the tops of the victims' boots. Others mention a slight or even a severe and prolonged itching and others a sharp pain. There is much testimony concerning the frequent infection of the wounds. For example, Tytler (1826, pp. 375-377) describes cases of deep-seated ulcers resulting in permanent crippling as a consequence of bites. Shipley (1916, p. 181) quotes Dr. R. J. Drummond as stating that "the bite is often septic, and that it often leads to a serious abscess which is long in healing. He recommends pushing a match, which has been dipped in carbolic acid, well home into the sinus made by the leech's head." And many writers and physicians practicing on the island mention similar cases. How far the infection is primary and how far the result of scratching or other later contamination, seems never to have been investigated.

All observers are a unit in describing the ability of these leeches to penetrate the most closely-woven fabrics. This is attributed to their slenderness, pointed heads and great muscularity, which enables them to insinuate themselves through the finest interstices or minutest openings. Probably an important additional factor is their ability to sever obstructing threads with the jaws. Their prowess in this respect is attested by Green (1907, p. 191), who writes:—"I happened to imprison a full-grown leech in one of the glass-topped cardboard boxes commonly employed by entomologists. Twenty-four hours later, the leech was found to have escaped through a hole perforating the double stout card (fully a millimetre in thickness). The hole measured 10 mm. in longest diameter and was cleanly cut, the excised portion having apparently been reduced to powder."

Besides Man and the domestic animals the Ceylon leech is reported as attacking frogs, but doubtless they stop at no vertebrate that offers a meal of blood. Prof. Arthur Willey writes that they enter the nares of dogs. Several observers report that a considerable length of time (Whitman says thirty or forty minutes for the Japanese leech) is required to feed. They swell up like ticks to the form of a grape, fall off, seek shelter, and become sluggish and quiescent. Miss Robertson (1909, p. 679) states that all land-leeches found abroad in the jungle are empty. Those containing blood are never met with. This indicates that, like other leeches after feeding, they become negatively phototactic and retire to places providing darkness and shelter. Only hungry leeches range and rage abroad. Whitman states that after feeding they enter water more readily, and that a Ceylon leech was kept immersed in water for thirty days without injury. Their dependence upon moisture and their disappearance in dry weather are well known. Thus Knox (1681, p. 48) states: "In dry weather none of them appear; but immediately upon the fall of rain the grass and woods are full of them." It may be that the change in range indicated above is related to increasing humidity in the area invaded.

The above account is based upon the examination of over eight hundred examples of the typical subspecies received from Ceylon through various sources. This subspecies very rarely, if ever, occurs on the Asiatic mainland, but it is abundant in the Philippines. *H. japonica* is probably a subspecies only, unless Prof. Whitman's original material included specimens of *H. sylvestris*, as his account of the number of teeth, the colour-pattern, etc., indicates may have been the case. In this case there would be some uncertainty concerning the application of the name. In any event, some examples of the common Japanese mountain leech sent by Prof. Oka certainly differ from *H. zeylanica* only sub-specifically.

The distinct forms recognized as occurring within the scope of this book are as follows:—

Key to Subspecies of Hæmadipsa zeylanica.

These characters will serve to distinguish at least 95 per cent. of the individuals taken within the typical areas; the others may be intermediate in one or more respects.

- a. Prehensile sucker papilla large and prominent, apparently a permanent structure.
1. Head tessellæ irregular and variable, median ones frequently present and more rarely traces of areas between eyes 3 and 4; colour-pattern mottled with black above and below, no paler median dorsal field, but constantly a black or dark stripe. Cochin State and vicinity. *cochiniana.*
 - aa. Prehensile sucker papilla constantly present, but varying greatly in size and prominence, apparently with functional activity. No areas intercalated between eyes 3 and 4, except as a rare variation.
 - b. A median dorsal yellow or greenish-yellow line.
 2. Head tessellæ very regular, median areas nearly constantly absent and areas intercalated between eyes 3 and 4 very rare; colour usually reddish-brown or orange but variable, very constantly mottled with black. Ceylon *zeylanica.*
 - bb. A median dorsal black or dark line very constant, in a paler median field.
 3. Median head tessellæ very frequently present, but no areas between eyes 3 and 4; ground-colour variable, but dark-blotched pattern constant. Western Himalayas (Naini Tal) *agilis.*
 4. No tessellæ on median line of head or between eyes 3 and 4; ground-colour variable and dark spots or blotches absent or obscure. Eastern Himalayas (Darjeeling) *montivindicis.*

H. zeylanica cochiniensis, new subspecies. (Plate IX, fig. 36.)

Diagnosis.—Size and form, general external morphology and, when rarely present, furrow-pits as in *zeylanica*. Colour mottled on both faces, no paler median dorsal field or line, but constantly a median dorsal dark stripe. Tessellæ on head commonly irregular, median areas much more frequent than in *zeylanica*, occurring on one or more somites of twenty-two specimens and forming a complete series on one. Some traces of areas intercalated between the third and fourth pairs of eyes occur on more than fifty. Usually these are faint and little developed, and in many cases it is impossible to decide whether they should be assigned to IV or to V, but in three cases there is a nearly or quite complete transverse row approaching the condition characteristic of *H. montana* and *H. sylvestris*, but obviously representing IV a 3. The most striking characteristic is the large size of the prehensile papilla. It is prominent in every one of seventy-four specimens

and very prominent on nearly all, being a large, triangular, sharp-pointed process strongly hooked or bent ventrad and having every appearance of being a permanent structure and not in large part a facultative one as in other subspecies. Sucker rays 66-74.

Type in Indian Museum. Kavalai, Cochin State (*F. N. Gravely*), Sept. 24, 1914.

Common in extreme southern portion of India, Cochin State, Nilgiris Hills, Madras, N. Kanara, Bombay, and a few specimens have a locality named Tenmalai, which I have been unable to locate. Taken from near sea-level to 3500 feet. Nothing specifically is known of its habits and œcology, which probably do not differ from those of the Ceylon form. It would be interesting to learn whether the highly developed prehensile papilla is correlated with greater facility in climbing trees or similar activity.

H. zeylanica agilis, new subspecies. (Plate IV, fig. 6.)

Diagnosis.—Size, form, annulation and general morphology like *zeylanica*. Colour in life light olive, yellowish-olive, or brown with a broad, dorsal, paler and usually immaculate field and a continuous median black or dark-brown line; elsewhere irregularly maculated as in *cochiniana* but the spots, usually coarser and more variable both in number and size; venter similar but paler, marginal stripes pale yellow, white or even silvery. Head tessellæ as in *zeylanica*, except that median areas are more frequent in some lots; thus, one lot of 153 specimens exhibits a median area on either III or IV or both of 72 specimens, or very nearly one-half, but not a single one has intercalated areas between the third and fourth eyes. Furrow-pits rarely apparent, but small depressions occasionally on IX to XII as in *zeylanica*; pale spots, however, frequently appear at these points. Prehensile papilla variable, about as in *zeylanica*. Sucker rays 66-76. Dorsal intermediate and paramedian, segmental papillæ very prominent and pale-coloured, as in *montivindicis* and *japonica*, larger than in *zeylanica* and *cochiniana*.

Type in Indian Museum (ZEV 4034). Shigadh, Naini Tal, 5500 feet.

This subspecies is the common land-leech of the Western Himalayas, very abundant in Naini Tal and Almora. 426 specimens come from these two districts at altitudes of 4500-7000 feet, only four specimens from the Nepal Valley at 4500-6500 feet, and none whatever were found among a large number of land-leeches from the Darjeeling District. Mr. B. Prashad notes their abundance about the Kumaon Lakes at 5500 feet, and Mr. A. N. Gulati writes that "grass leeches" abound in the cattle pastures and jungles near Muktesar, their upper limit being about 7100 feet. They attack the grazing cattle but do not enter their nostrils, and he refers to them as "jumping" on his boots

and leggings. All of the specimens in the collection were taken in August, September, and October, and very little of their activities is recorded.

H. zeylanica montivindicis, new subspecies. (Plate V, fig. 8; IX, fig. 37.)

Diagnosis.—Size, form, annulation and general morphology like *zeylanica*. Colour in life olive-brown, reddish-brown or yellowish-brown, occasionally very dark; mid-dorsal field paler, with a continuous dark brown or black median line; black spots usually absent, but a few obscure ones sometimes present; rounded, pale yellow or cream-coloured spots include the paramedian and intermediate sensillæ; marginal stripes pale yellow, cream-coloured or nearly white. Head tessellæ as in *zeylanica*, median areas very rarely present and areas between third and fourth eyes in one of 178 specimens. Furrow-pits as in last. Prehensile papilla more or less developed as in *zeylanica*; sucker rays 69 to 76 or rarely 79. Paramedian and intermediate segmental papillæ very prominent and pale-coloured.

Type in Indian Museum (ZEV 2268). Sureil, Darjeeling, 5000 ft. (*A. Alcock*).

Geographical Distribution and Bionomics.—This is the small dark-coloured land-leech that so abounds in the damp ravines and dripping forests of moderately high levels in the Darjeeling District, Sikkim and Assam, and which is referred to resentfully by so many harrassed travellers who have invaded its domains. Numerous small lots from many localities in this region attest to its abundance and general distribution. The lowest elevation definitely represented is 1800 feet at Ghumti, the highest 9500 feet in the Rongshar Valley, where it was taken by Major Hingston on the 1924 Mt. Everest Expedition. Hooker traced it still higher to 11,500 feet in the Zemu Valley. It appears to be most abundant between 4500 and 7000 feet. In the Dawna Hills it is common between 2100 and 2500 feet. At the higher altitudes it is associated with *H. montana* and with similarly coloured land-planarians and at the lower levels in Assam with *H. sylvestris*.

So far as the labels indicate, the collections were made from the latter part of March to early November. In three different cases those taken in March are referred to as "under stones in dry bed of stream" or "under stones by side of spring." Of one lot taken April 4th it is recorded that they were under stones on damp ground. No similar records are made for any other months. Of one lot taken at Kurseong, Darjeeling, on April 20th, Dr. Annandale notes: "From men's legs in jungle. This is the common land-leech at Kurseong. In dry weather it remains concealed under stones in damp places, but during the rains it swarms

among the herbage in the jungle, attacking the feet and legs of persons as they pass by."

Three egg-capsules taken along with mature examples (having well-marked clitella) of this subspecies are the only cocoons of any of the forms of this species that have come to light. They were collected at Pashok, Darjeeling, at an elevation of 5000 feet between May 26th and June 14th by F. H. Gravely. They are nearly spherical with an external diameter of 8-9.5 mm., the inner capsule being about 6 mm. and with a continuous wall, the outer layer composed of about thirty-five coarse, irregular polyhedral "cells" open at the outer ends; colour pale brown or amber (Pl. IX, fig. 37).

It is to this subspecies that Hooker refers in the passage quoted on p. 244, and of which he further writes: "I cannot but think that the extraordinary abundance of these *Auelides* in Sikkim may cause the death of many animals. Some marked murrains have followed very wet seasons, when the leeches appear in incredible numbers; and the disease in the cattle, described to me by the Lepchas as in the stomach, in no way differs from what leeches would produce. . . . I have seen cattle feeding in places where the leeches so abounded that fifty or sixty were frequently together on my ankles, and ponies were almost maddened by their biting the fetlocks" (1854, i, p. 167, footnote). At Tanglo he reports a small black species of land-leech as swarming between 3000 and 7000 feet. "The bite of these blood-suckers gives no pain, but is followed by a considerable effusion of blood. They puncture through thick worsted stockings and even trousers, and, when full, roll in the form of a little soft ball into the bottom of the shoe" (p. 107). Landon (1905, p. 49) attributes the absence of game from parts of Sikkim to the abundance of land-leeches and also accuses them (possibly erroneously in confusion with the cattle-leech) of habitually entering the nares of the cattle. He writes: "To remove them a bowl of warm milk at the cow's nose, a little slip-knot, and a quick hand are all that is required. Fourteen or fifteen successively have been thus taken from the nostrils of one unfortunate heifer." Hooker recommends snuff and tobacco leaves as a protection against them.

These four subspecies are well defined and characteristic of their geographical areas. Practically all of my material falls under them. Very few land-leeches are available from the adjacent areas, but the few *H. zeylanica* collected in them mostly prove to be intermediates, thus supporting the view that the four forms described are subspecies. This question, however, requires much further study. In addition there are three single specimens from Simla Hill States, Darjeeling and Dawna Hills that differ from any of these and from one another, the status of which must be left open for the present.

43. *Hæmadipsa montana*, new species. (Plate IX, figs. 38, 39, 40.)

Synonymy :

Hæmadipsa sylvestris, Moore, 1924, pp. 384, 385, pl. xx, fig. 19 (Palni Hills, Madras). Not *Hæmadipsa sylvestris*, Blanchard, 1894.

Hæmadipsa zeylanica, Blanchard, 1917 (in part).

Hæmadipsa zeylanica, Kaburaki, 1921, et al. (in part).

Diagnosis.—Size and form about as in *H. zeylanica*, but sucker relatively somewhat larger. Living colour unknown, but probably differing from the preserved colour chiefly in being redder. Colour of preserved specimens yellow to rich buff, rarely with a paler median dorsal field and sometimes varying to a golden-brown, chocolate or even almost black. Markings variable, consisting chiefly of bold longitudinal stripes. Median dorsal black stripe and pale yellow or white marginal stripes, enlarged ventrally on a2 of every complete somite, constant. One or two pairs of black or nearly black intermediate chain-stripes or a black reticulum, and a black submarginal stripe usually present. Third and fourth pairs of eyes separated by a nearly or quite complete transverse row of areas representing $V a 1^*$. Caudal sucker with prehensile papilla slightly developed and 68–74 rays. Other characters as in the mountain forms of *H. zeylanica*.

Type in Indian Museum. Near Kukkal, Palni Hills, Madras, 5500–6500 ft. (*S. Kemp*), Aug. 31, 1922.

Description.—Mature, partly extended, individuals vary from 14 mm. long by 1·8 mm. wide and 1·5 mm. deep to 30 mm. by 3·4 mm. by 2·9 mm. Contracted specimens are much wider and more depressed, one such measuring 14·7 by 4·8 by 3·6 mm. Complete measurements of a medium-sized specimen in a state of moderate contraction are: length, 19 mm.; length to male pore, 4·8 mm.; buccal width, 2·2 mm.; width at male pore, 4 mm.; maximum width (at XXII), 4·6 mm.; depth at male pore, 2·8 mm.; depth at XX, 3·1 mm.; caudal sucker, 4·6 by 4·9 mm. A specimen of the same size as the latter, but fully distended with blood, measures 35 by 11 by 6 mm., the sucker being 4·6 by 5 mm. Others filled with blood measure up to 42 by 15 by 11 mm.

Form in extension slender, subcylindrical, little depressed, tapering regularly near caudal end, or in life even linear and thread-like; in the latter condition both suckers often expanded. In contraction much more depressed, with the maximum width further forward. Texture very firm and hard, far less plastic than most jawed-leeches, owing to the great development of the muscles and the reduction of botryoidal and connective tissues.

* In a recent paper (1924, p. 384) I designated this annulus as IV a3, following Blanchard in assigning it to the preceding somite, and it is possible that this is the correct interpretation, as it conforms to the general rule of somite elaboration.

When filled with blood they are bottle- or flask-shaped, somites I-VIII forming the unenlarged neck and the cœciferous segments the distended body

The *head* (fig. 60) is ordinarily triangular and pointed, but on contracted specimens is broadly rounded into the lateral outlines of the body. The unsegmented margin is unusually wide and apparently very mobile, granular, and bears numerous labial sense-organs. Dorsum of cephalic region very strongly areolated of rounded tessellæ, much more prominent than those on the body generally, and arranged in transverse rows representing the annuli and somites. Eyes five pairs, similar to those of *H. zeylanica* but apparently not quite so prominent, borne on areas much larger than those not eye-bearing. The first three pairs of eyes on the contiguous annuli 2, 3, 4, the fourth on 6 and separated from the third pair by a nearly or quite complete row of annuli constituting the fifth annulus (V a 1), and the fifth pair on annulus 9.

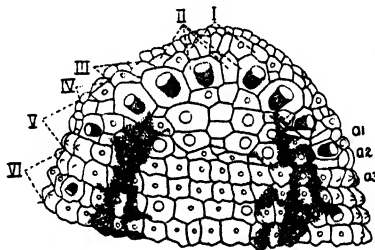

Fig. 60.—*Hamadipsa montana*. Somites I-VI, from dorsum. $\times 12$. Irregular stippled areas are the beginning of the paired chain-stripes; stippled cylinders, eyes and small circles, other sense-organs.

Ventral face of lip and roof of oral chamber either smooth or finely granular, with only very shallow, longitudinal furrows, the median fissure limited to the caudal half, becoming deeper and wider as it merges with the median jaw recess. Lateral buccal lobes within the buccal margins of the cephalic sucker, but sometimes projecting prominently. Specimens with the mouth-parts more relaxed present the following conditions:—There is an anterior medial trapezoidal or keystone-shaped, finely granular or wrinkled area, separated laterally and caudally by a pair of shallow furrows, from smooth, elongated lateral areas which extend obliquely from the border of the lip at somite III, where they are very narrow but gradually become broader, to the median fissure and paired lobes of the velum. A pair of deeper furrows bounds these areas latero-caudally and separates them from the lateral buccal lobes formed by somite IV. Lateral buccal lobes triangular, with the apex at the lateral angle of the mouth and

the base projecting as two fleshy lobes just within the sides of the buccal ring; divided into two lobes by a furrow and continued along the buccal ring by a free fold or frill. Ventral or basal side of velum a small, tumid lobe enclosed within the buccal ring.

Clitellum visible externally only as a greyish or yellowish coloration extending over the fifteen annuli from X *b* 5 to XIII *a* 2 inclusive. Gonopores separated by five annuli, the male at XI *b* 5/*b* 6, the female at XII *b* 5/*b* 6, both strictly in the furrows and simple, small, round orifices. Nephropores mostly concealed in the furrows, but situated, as in *H. zeylanica*, on the marginal line of the caudal border of annulus *b* 2 or its homolog, of somites XI to XXIV, the last pair beneath the anterior lobe of the nephridial auricle. Nephridial auricles conspicuous both on account of large size and pale colour, trilobate, supported on XXIV *a* 2 XXV, and XXVI, the first and last being broad and truncate, the middle one much smaller, narrow and pointed. All three are thin and flat and fit closely to the sucker, leaving between them two small rounded openings. Anus a minute opening between the last annulus and the sucker. Caudal sucker relatively slightly larger than on *H. zeylanica*, little exposed behind the body, roughly areolated above, the area in 4 or 5 rows, slightly longer than wide, with a slightly pointed projection (prehensile papilla) anteriorly, the venter with strongly marked radiating ribs, 69-71 (in two individuals 74, in one 68) not extending into the areolated area caudad of the centre.

Annulation in general closely similar to that of *H. zeylanica*, the furrows deep and the rings prominent and outstanding; areolated but less prominently and roughly than *H. zeylanica*, the areas being marked out by short longitudinal furrows, but except on the head and caudal sucker not prominently elevated. On middle somites there are about fifty of these areas on the entire circumference of each annulus, equally dorsal and ventral, and each bears a small, white, simple sense-organ. On sensory annuli the metameric sensillæ stand out conspicuously, both because of the larger size and conspicuous white or pale colour of the papillæ and because of the size and contrasting translucency of the sensillæ themselves. They are of the same number and arrangement as in *H. zeylanica*, both dorsally and ventrally, and the dorsal paramedian and intermediate papillæ are of especially large size and prominence. Not infrequently on the venter of contracted specimens the inter-segmental furrows are obviously deeper than the others, and the annuli fall into the primary 2-1-2 groups or even the 3-2 groups, as indicated by the depth of the furrows. On complete somites the sensory annuli (*a* 2) are not only longer than the other annuli, but project above them, and this, combined with the large size and pale colour of the segmental papillæ, gives to these annuli a striking prominence, less marked, however, than in *H. zeylanica montivindicis*.

Somites, with the exception of V, are constituted essentially as in *H. zeylanica*, as follows:—

I consists of a preocular row of four to six small areas and presumably the apical portion of the wide unsegmented margin of the cephalic sucker. II consists chiefly of a pair of enlarged areas bearing the first pair of eyes, which are usually in contact medially but sometimes separated by a small interocular area or two, as in the one figured; also an indefinite group of one or more small areas laterad of the eyes. III has a pair of still larger oculiferous areas in agreement with the larger size of the eyes, a small lateral group similar to that of II, and an interocular group (rarely incomplete) consisting of a pair of areas of moderate size bearing the paramedian sensillæ, and in most cases one or two small areas variously arranged in tandem between the latter, all of these forming an irregular transverse row. IV consists of a pair of oculiferous areas somewhat smaller than those of III and bearing the third pair of eyes, a scarcely inferior pair bearing the paramedian sensillæ and, alternating with these, smaller, median, intermediate and marginal areas, the first two nearly always consisting of two in tandem, the last of two transverse rows of varying number. One of the lateral group bears supra-marginal sensillæ. In this arrangement somite IV exhibits an incipient biannulate constitution. V is definitely biannulate and incipiently triannulate on the dorsum, and forms the buccal ring ventrally; $a\ 3$ is the first definitely distinct annulus, and the furrow separating it from the larger anterior annulus continues well on to the venter, but disappears in the median field. Throughout it is divided into very regular squarish areas, less convex than those on preceding annuli, and each bearing a small sense-organ. The first annulus of V consists of a pair of oculiferous and a pair of paramedian sensilliferous areas occupying the entire length of the annulus. The remainder of the annulus consists of a complete transverse row of small irregular areas of various sizes extending across the entire width of the posterior part of the annulus, which, with the oculiferous and paramedian areas, may be considered to represent $a\ 2$, and an anterior and still more irregular and variable row representing $a\ 1$. The most constant element of this latter row is the portion laterad of the paramedian area and extending between the third and fourth pairs of eyes and laterad of the latter to the sides of the buccal ring. Almost equally constant is a median group, often sharply distinct from the posterior row, and consisting of a pair of rather large areas bearing sense-organs approaching the paramedian sensillæ in size and usually separated by one or even two much smaller areas. There is much variation in the exact arrangement and number of these, and in some cases there is uncertainty whether a given area should be attributed to IV $a\ 3$ or V $a\ 1$. Somite VI is triannulate ($a\ 1 = a\ 2 < a\ 3$), the furrow $a\ 1/a\ 2$ continuing on to the ventral side, but becoming very shallow in the median field; fifth pair of eyes and a full set of dorsal and ventral sensillæ on $a\ 2$. VII similarly triannulate. VIII quadrannulate ($a\ 1 > a\ 2 > b\ 5 = b\ 6$); full number of areolæ developed on this

somite. IX-XXIII quinquannulate ($b\ 1 = b\ 2 < a\ 2 > b\ 5 = b\ 6$). On XXIII, $b\ 5$ and $b\ 6$ are somewhat reduced in size and the furrow is shallower than on preceding somites. XXIV triannulate ($b\ 1 = b\ 2 < a\ 2$), $a\ 3$ apparently being entirely suppressed, as is indicated by the position of the sensillæ on $a\ 2$, the seventeenth pair of nephropores on the caudal margin of $b\ 2$ beneath the first lobe of the nephridial auricle, which is borne on $a\ 2$, and the distribution of pigment. XXV, XXVI and XXVII each uniannulate, all bearing sensillæ and the first two the second and third lobes, respectively, of the nephridial auricle, which may have arisen out of the marginal sensilliferous papillæ. XXVII is much reduced and precedes the very small anus.

Colour.—Living colour unknown, but probably differing chiefly in being redder. Colour of preserved specimens variable, partly blotched, partly striped and partly a combination of these patterns. One lot of specimens from the Palmi Hills presents a very heavily blotched or reticulate pattern of brown and yellow, the general effect being darker or lighter according to which predominates. When dark the ground-colour is a rich medium golden-brown, chocolate or almost black, when pale it is buff or yellow, the spots being the reverse, and in no case is there a paler median field. Pigmentation is usually heavier toward the caudal end and lighter on the venter. Marginal stripes are very pale yellow or white and widen irregularly on the sensory annuli to include the submarginal and sometimes the supra-marginal sensillæ, invariably ceasing at the end of XXIII, but represented by a white or pale yellow spot on XXIV $a\ 2$, XXV and XXVI, which includes the greater part of the nephridial auricle. On some specimens a more or less well-defined, median dorsal, dark brown stripe extends from II to XXVI inclusive, and in others there is a marked tendency for the pale spots to coalesce into larger areas in the intermediate field of alternate segments.

A more frequent pattern, represented by the examples collected by Major Hingston in the Himalayas, combines the reticular with the longitudinally striped pattern. In these the ground varies from a yellow to a rich buff, often distinctly reddish, especially on the venter, and in all cases continuing uniformly across the median dorsal field. When the linear pattern is most clearly defined there are seven dorsal dark stripes, a narrow, sharply-defined, brown, dark-brown, or black median stripe continuous for the entire length from the first pair of eyes to the anus, a pair of narrow, sharply defined dark brown or black supra-marginal stripes continuous from about somite VI to the nephridial auricle, and two pairs (paramedian and intermediate) of broader and less definite, chain-like or reticular, brown or dusky stripes which usually coalesce at the anterior end and break into irregular spots at the caudal end. The venter is nearly uniform yellow or buff and immaculate, usually more reddish or more dusky than the dorsal ground-colour, with well-defined dusky or black submarginal stripes which become wider and

more intense as a series of quadrate spots alternating with the segmental enlargements of the marginal stripe. The latter being white, or nearly so, stand out very conspicuously in contrast to the dark supra-marginal and submarginal bordering stripes. They begin at the buccal region and end abruptly on XXIII *a* 2, and are more or less enlarged on *a* 2 and *b* 2 of each somite by ventral extensions to or including the submarginal sensillæ, and in some cases by dorsal extensions to include the supra-marginal sensillæ also. Caudally they are sharply limited by a black or dark spot at the point where the supra-marginal and submarginal stripes unite across the margin between them and the white auricular areas, which are the morphological continuation of the marginal fields. The buccal and marginal portions of the head and a spot including all but the base of the auricle are white or nearly so, and the dorsum of the caudal sucker is usually white or pale, with a few small dark spots or none. Metameric sensory papillæ also white. Ventral face of both suckers grey.

The pattern varies as follows:—The median stripe may be intense, or become faint almost to invisibility, without being interrupted, or it may become broken segmentally into a series of dashes which may shrink to mere dots, or it may be restricted in length by reduction at both ends. The paramedian and intermediate stripes may vary in extent or be more or less broken into spots at the ends, and they may be distinct, or more or less united, beginning intersegmentally on *b* 6 or *b* 1 and extending until they form one pair of broad reticulated areas. The marginal stripes may be interrupted at the caudal end between the enlargements for a few segments, resulting in the formation of detached white spots.

Alimentary Canal.—Oral chamber described above. Jaws three, placed as usual, very strongly compressed, thin, high, with strongly convex margin and no papillæ. Teeth strictly monostichodont, varying in number from 61 to 72, the larger number on the median jaw. They are curved, conical and acute, those at the central end being high and slender, about three and one-half times as high as the basal diameter, 0.0196×0.0052 mm., rapidly diminishing until, at about the twentieth, the height and basal diameter are equal, and becoming continually lower and smaller until those at the peripheral end become almost invisible and subside into the cuticle.

Pharynx short, compact, subcylindrical, extending through VIII and part of IX, with three sets of mucous folds, dorsal and ventro-lateral, each set consisting of an anterior short, thick fold continuing the jaw-fold which fades out about the middle of the pharynx, and a pair of more slender flanking folds which arise from the anterior end of the latter and, diverging slightly from it, continue to the caudal end of the pharynx, which is provided with an annular fold or valve.

Stomach (Pl. VIII, fig. 40) thin-walled, reaching from somite IX to XIX inclusive, and provided with eleven pairs of gastric cæca,

one pair in each somite. The first two or pre-genital pairs are small and crowded, the next four increase in size, the sixth to the tenth remaining uniform. All of these are simple and unbranched and scarcely lobed, but are usually bent or sloped caudad into the succeeding somite. The eleventh pair arises in the caudal part of XIX or anterior part of XX and reaches to XXIV, being tubular, slightly sacculated, at least in contracted specimens, and lying on each side of the intestine. Between the cæca the stomach may be slightly bulbous, but there are no definite secondary cæca. Intestine simple, straight.

Reproductive Organs (Pl. VIII, fig. 40).—Testes ten pairs, situated in the usual position intersegmentally from XIII/XIV to XXII/XXIII inclusive, spheroidal, each with a short vas efferens extending laterally to the vas deferens, which forms a series of metameric loops and in some specimens extends a short distance caudad of the last testes. Both vasa efferentia and vasa deferentia are unusually coarse, being covered with a thick glandular layer and much folded. Vasa deferentia unchanged to level of ganglion XII, where they emerge from the glandular covering as very fine, hair-like ducts extending into XI, in which they pass into the enlarged tubes of the epididymes, entering the latter on the ventral face. Epididymes rather massive, occupying the greater part of XI and XII anterior to the vaginal sac and concealing the ejaculatory ducts and atrium from above. They consist of a soft, smooth tube distorted by pressure, intricately and loosely folded into a long loop, which is again folded and the ends tucked into the mass. The whole is loosely held together by a connective tissue investment. The ductus ejaculatorius leaves the anterior end of the epididymis and consists of a small fusiform enlargement (1.2×5 mm.) with thick muscular walls and a slender duct, either the right or the left one of which may pass beneath the nerve-cord to enter the mass of prostate glands. In the case of one distended with blood the epididymes embrace the enlarged vaginal sac, the right one covering the cephalic half to ganglion XV, the left one the caudal half to the end of XVI. Atrium very small, scarcely rising above the level of the nerve-cord, pyriform, about 1.5 mm. long and about half that in diameter at the large or prostate end, the whole enveloped and concealed in a loose mass of small unicellular glands which appear to open partly on the body-floor and partly into the prostate end of the atrium.

Ovaries small, spheroidal or pyriform sacs in line with the testes and immediately behind ganglion XII. Oviducts slender, nearly straight, varying in length from a little less than the diameter to one and one-third times the diameter of the ovisac; either the right or left passes beneath the nerve-cord. They unite without an enlarged albumin gland in a common oviduct which is of about the same diameter and two and one-half to three times as long as the paired oviduct, slightly widening, and which opens into the anterior end of the vaginal sac immediately dorsad of its

duct. Vagina sharply differentiated into duct and sac, the former slender, straight, cylindrical, about 0.2 mm. in diameter and 2-2.3 mm. long, leading from the end of the sac. Sac massive, cylindo-ellipsoidal, sometimes slightly constricted, when mature measuring 6.2 × 2.3 mm. to 7.3 × 3.5 mm., generally disposed longitudinally, in which case it will reach from immediately behind the atrium to end of somite XVI, or sometimes transversely, in which case it is usually confined to XII and XIII.

Geographical Distribution and Bionomics.—This species, which was originally (Moore, 1924) mistaken for *H. sylvestris*, Blanchard, because of the presence of a partial annulus separating the third and fourth eyes, is less known than the subspecies of *H. zeylanica*, in all forty specimens only appearing in the collections.

So far as this material indicates, it is a strictly mountain species, the several lots occurring at widely separated points: namely, Kukkal, in the Palni Hills, Madras State, at 5500-6500 feet elevation; near Darjeeling, at 7000-8000 ft.; in the collections made by Major Hingston on the 1924 Mount Everest Expedition at Phadma Chen at 7000 ft., and Gantok, 5000 and 9000 ft.; and at Sukli, on the east side of the Dawna Hills in Burma, at 2100 ft. The last is a solitary specimen collected by F. H. Graveley during the last week of November; the others, so far as noted on the labels, were collected in July and August. There is no specific information regarding the habits of this species, but there is no present evidence that they differ from *H. zeylanica montivindicis*, with which it is associated in the Himalayas. It is quite probable that some of the land-leeches met with by Hooker and others in the Darjeeling District were of this species, and it is also quite probable that it differs in habitat from the apparently far more abundant *montivindicis*.

The capacity of these leeches for imbibing blood is illustrated by one of the Gantok lots, nine of which were empty and six gorged with blood (Pl. VIII, figs. 38, 39). The six latter weigh 13.86 grams., and an equal number of the former of the same size 1.2 grams. The fed leeches, therefore, are eleven and one-half times as heavy as the unfed.

44. *Hæmadipsa sylvestris* Blanchard. (Plate V, figs. 9, 10; IX, fig. 41.)

Synonymy:

Hæmadipsa sylvestris Blanchard, 1894, pp. 114, 115. (Carin Mts., Burma, 1000 m.)

Hæmadipsa sylvestris, Blanchard, 1897 a, p. 88, pl. v, figs. 9-11 (diagram of external organization); Blanchard, 1897 b, p. 386. (Sumatra.)

Hæmadipsa sylvestris, Blanchard, Brandes, 1901, p. 889.

Hæmadipsa sylvestris, Blanchard, 1917, pp. 661, 662, fig. 11 (annulation). (Java, Sumatra, Burma and Tonkin.)

Hæmadipsa zeylanica, Kaburaki, 1921 c, pp. 715, 716 (in part).
Not *Hæmadipsa sylvestris*, Moore, 1924, pp. 384, 385.

Diagnosis.—Largest and most robust of the Indian *Hæmadipsæ*, full-grown examples exceeding two inches in length. Colour plain yellow or brown of varied shades, the mid-dorsal field sometimes paler, with three dorsal black or dark brown stripes, the median typically narrower, broken or even obsolete. Sucker rays most frequently 74–76, but varying between 69 and 80; prehensile papilla little developed. Head tessellæ largely irregular; median areas constantly present; annulus V a 1 more or less developed as areas separating the third and fourth eyes, and sometimes forming a complete transverse row. Furrow-pits four or five pairs on VIII to XI or XII, often indicated by pale spots. First pair of nephropores on buccal margin.

Type-locality, Carin (Karenni) Mountains, Burma, 1000 m.

Description.—Size large for the genus, ordinary specimens not fully extended, often attaining a length of 50 mm. and larger and more extended ones as much as 70 mm. It is possible that in life

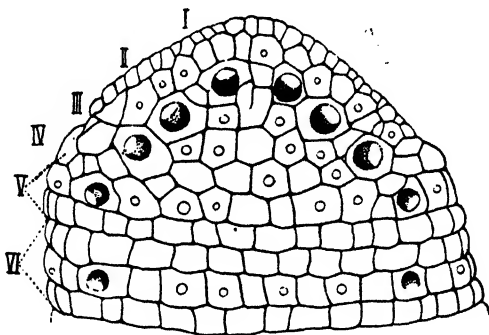

Fig. 61.—*Hamadipsa sylvestris*. Somites I–VI, from dorsum, showing areolation and other head characters as in preceding figures. $\times 12$.

and in the tenuous state of extension some of these leeches may attain a length of four inches. Compared with the ordinary *H. zeylanica* they are giants. A typical specimen of moderate size measures: length, 42 mm.; length to male pore, 8.5 mm.; buccal width, 3 mm.; width at male pore, 4.9 mm.; maximum width (XXI), 8.5 mm.; depth at buccal ring, 2.1 mm., at male pore, 2.8 mm., at somite XXI, 4.3 mm.; caudal sucker, 6.3 \times 7 mm.

Form of preserved specimens more robust and more depressed than other species, tending strongly to a clavate outline with the greatest width at XXI or farther caudad, tapering to a comparatively slender preclitellar region. Distinctly depressed with venter flattened and dorsum strongly convex.

Head (fig. 61) broadly rounded, seldom distinctly triangular as in other species. Dorsally there is a very distinct but narrow

granulated margin, each area bearing a labial sense-organ, and the annuli strongly but irregularly areolated, each area with an eye, sensilla or non-segmental sense-organ. A typical arrangement of the first five somites is as follows:—I, four preocular areas; II, two pairs of marginals, one pair of large oculars bearing the first pair of eyes, and one small interocular wedged between the anterior ends of the oculars; III, two pairs of marginals, one pair of large oculars bearing the second pair of eyes, and three interoculars, the median one triangular, with its apex separating the paired areas anteriorly and its base forward against the oculars of II; IV, two pairs of marginals in tandem, a pair of large oculars bearing the third pair of eyes, and two rows of interoculars of five areas each, forming a biconvex group converging on the oculars. All of these pass into the margin of the lip laterally, IV contributing somewhat to the buccal ring. Somite V consists dorsally of two complete and a third incomplete ring, all united ventrally into the buccal, with its single row of tessellæ. Dorsally $a3$ is distinct as a typical, fully differentiated annulus. The larger anterior annulus consists of a well-developed $a2$ bearing the fourth pair of eyes on large ocular areas, and a partially separated $a1$, which consists of a row of small areas on each side beginning a little laterad of the oculars, passing between the third and fourth eyes and reaching interocularly to the paramedians, thus leaving a median gap which is bridged by three large areas in $a2$. It is possible that middle areas of the second row attributed to IV $a3$ may have been detached from V $a1$, but this could be determined only by a most exhaustive study of the nerve distribution. The irregularities and variations in this region are numerous, but practically all specimens possess median areas, and also a row of areas between somites IV and V, most frequently connected with the latter, sometimes with the former, occasionally in part with both. Of 156 specimens examined with reference to this character, 131, or 84 per cent., had these areas definitely intercalated between the 3rd and 4th pairs of eyes. They are often absent from young specimens and become more evident with increase in size. On the other hand, a perfectly regular continuous row of areas extending across the entire width of the head is unusual. The eyes are large and prominent, and have the direction and arrangement usual in the genus.

Ventral surface of lip finely granulated, with the median furrow shallow or absent, but a pair of deeper lateral furrows cutting off the lateral buccal lobes. On all of the specimens examined these lobes are rather thick and fleshy, and, although continued along the inner face of the buccal ring, do not form a membranous frill as in *H. ornata*.

Clitellum extending as usual over fifteen annuli (X $b5$ to XIII $a2$ inclusive), but even in mature specimens not apparent on the exterior as a definite zone, but only as a slight deepening of the colour. Internally it forms a thick, loose, glandular layer. Gonopores both small openings exactly in the furrows, the male XI

b 5/b 6, the female XII *b 5/b 6*. Furrow-pits four (or five) pairs in the intermediate line of IX *b 2/a 2* to XII *b 2/a 2* (or occasionally on XIII), the last sometimes inconspicuous or wanting, all much less conspicuous than in *H. ornata*. The furrows VIII/IX to XI/XII may be much deeper than the others. Owing to the pale ground-colour these depressed areas are not indicated in preserved specimens by white or pale spots, though these appear to be present on the living leeches, as shown in colour-sketches.

Caudal sucker moderately large, about three-fourths maximum width of contracted, exceeding that of extended, specimens, generally broadly ovate with the longitudinal diameter exceeding the transverse, the anterior marginal process little developed. Radiating ribs most frequently 74 to 76, the mean of a large number being 75, but varying from 69 to 81. Dorsum coarsely areolated, the polygonal areas in at least five rows.

Nephridial auricles large and well-developed, trilobate, the lobes on the margins of XXIV *a 2*, XXV and XXVI, the middle small and triangular, sometimes obsolete, the first and last with thin, membranous, irregularly subquadrate margins with produced angles.

Nephropores are usually obvious, opening dorsad from short canals just ventrad of the line of marginal sensillæ in the caudal border of *b 2* of somites IX to XXIII inclusive, the seventeenth pair on the ventral surface of the first lobe of the auricle, the first on the sides between the buccal ring and buccal frill. The latter are rarely visible in surface views, but must be demonstrated by sections.

Annuli very distinct except on the areolated region of the head, separated by deep furrows, the intersegmental and the *a 1/a 2* furrows being regularly deeper than the others. They are divided into the usual quadrate areas especially well-defined on caudal somites. On the dorsum of complete somites nine or ten of these are included between the two paramedian black stripes and eleven or twelve between each of these and the margins, making thirty-one to thirty-four in all. Each bears a central larger sensory papilla and about it a cluster of smaller sense-organs, which may be nearly flush with the surface or somewhat elevated. On the venter the areas are smaller and less clearly defined. *Sensillæ* are arranged as in *H. zeylanica*, but differ strikingly from those of that species, and especially of the mountain subspecies, in their small size and lack of elevation upon papillæ. They are therefore inconspicuous, and upon many specimens indistinguishable. Only upon a few unusually rough examples from Lower Burma are they as conspicuous as Blanchard indicates in the types.

Annulation.—Except for the characteristics of the head segments, already fully described, the constitution of the somites is exactly the same as in *H. zeylanica* and as described by Whitman for *H. japonica*.

Coloration closely resembles that figured and described by Whitman for *H. japonica*, but differs very constantly in that the

median dorsal stripe, which is the best-developed and commonly the only one in the latter, is in this species narrower and more imperfect than the paired stripes, and frequently broken or obsolete. As described by Blanchard and figured from life by A. C. Chowdhary (Pl. V, figs. 9 and 10), the living colour is rich reddish- or yellowish-brown, olive-brown or pale olive, uniform over the entire dorsum, or the median field is a paler shade of the same colour, or in some cases yellowish. The venter may be the same colour or somewhat paler, or more reddish. Dark spots are entirely absent from both surfaces, but ill-defined pale spots may occur in the position of the furrow-pits. The dorsum is marked with a median and a pair of paramedian black or dark brown lines, both extending for nearly the entire length. The latter are placed at the boundary of the paler and darker fields when present, and are broader and more continuous, though often shorter than the median line. Marginal stripes bright orange or yellow.

Preserved specimens rarely exhibit the paler median dorsal field, but this may be due to the fading which obviously has taken place on most of the specimens. The ground-colour, both above and below, is nearly white, grey, pale yellow, buff or light brown, in all cases nearly or quite uniform and quite free from dark spotting, but with the marginal stripes faintly indicated. The dorsal stripes are very constant, usually as narrow lines which may be deep black or dark brown. The median line is invariably narrower and fainter than the paired stripes, but when best developed is longer, beginning between the first or second pair of eyes, whereas the paired stripes usually begin on somite VIII. Both extend caudad to XXV or XXIV. The paired stripes are quite continuous and unbroken and the median may be continuous, but usually is best developed in the furrows and often very narrow or interrupted on the annuli, resulting in a series of small spots. The type described by Blanchard in which the median stripe is broken into a series of short metameric dashes is rare. Much more commonly the median stripes become reduced or disappear completely, resulting in a true bilineate pattern, which is in sharp contrast to the condition of these stripes in *H. japonica*. Nor do any of these have the small, pale yellow spots at the dorsal sensillæ which are so conspicuous on *H. japonica* and most of the subspecies of *H. zeylanica*.

Digestive System.—Jaws are more elongated than in *H. zeylanica* and bear more numerous teeth, 72 to 87, the largest of which measure 0.025×0.0053 mm. Pharynx and stomach as in *H. zeylanica*. Gastric cæca eleven pairs, one pair in each somite from IX to XIX inclusive, alternating with small bulbous enlargements of the stomach. The pre-genital pairs are small, the next four pairs increasing in size. All are simple, unbranched, spacious, and the sixth to tenth are bent somewhat caudad and have bulbous ends. The last pair arises in XIX, and extends at the sides of the intestine to XXIV, having four lateral lobes.

Reproductive organs (fig. 62) differ in no important respect from those of *H. zeylanica*. Testes 10 pairs, at XIII/XIV to XXII/XXIII inclusive. Epididymes large, open, folded, U-shaped loops extending through XII and XIII, receiving the vasa deferentia into the anterior end of their lateral limbs and continuing at their anterior medial ends into the ducti ejaculatorii, which are slightly fusiform, transversely arched, very firm, and of a yellow colour and satiny sheen, opening into the prostate head of the atrium. Atrium very small, rising but little above the

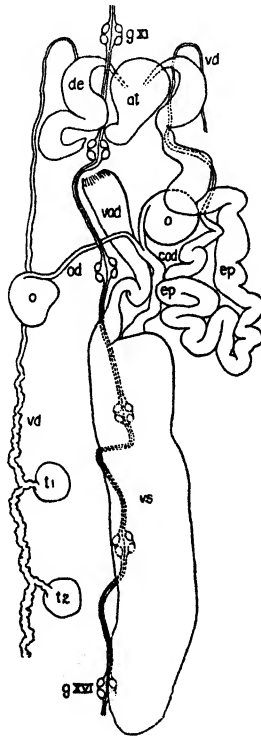

Fig. 62.—*Hamadipsa sylvestris*. Outline of anterior part of reproductive organs *in situ*, left epididymis removed. $\times 12$. *at.*, atrium. Other lettering as before.

nerve-cord, the penis-sac and prostate little differentiated externally, and the atrial cornua not sharply differentiated from the ducti ejaculatorii, which are asymmetrical to accommodate the nerve-cord. The whole is partly concealed by a loose glandular investiture. Ovarian sacs one pair, ellipsoidal, about twice the size of the small anterior testes and lying at a higher level at

XII/XIII. Oviducts simple, straight tubes, the one about as long as the diameter of the ovisac, the other, which passes beneath the nerve-cord, about fifty per cent. longer. Common oviduct about twice the length of the longer and about twice its diameter, bent into a sigmoid curve and opening into the anterior end of the vaginal sac. Vaginal sac in fully mature worms a thin-walled, sausage-shaped cæcum about three or four times as long as wide and reaching from XII to the caudal end of XV. The vaginal duct arises from the sac or cæcum at its anterior end ventral to the point of entrance of the oviduct, and passes with a sharp curve beneath the nerve-cord to the small female bursa. It is a hard muscular tube, about as long as the oviduct and twice its diameter.

Geographical Distribution and Bionomics.—The type-locality of this species is the Karenni Mts. of Lower Burma at about 3000 feet. Blanchard later reported it from the mountains of Java and Sumatra and from near sea-level in Tonkin. So far as the numerous specimens studied testify, the distribution in India conforms with this vertical range and indicates that the species is chiefly confined to the north-eastern provinces. From the highlands of the Chinese border and Darjeeling it ranges throughout Burma and part of Bengal south through the plains of the lower Ganges and Brahmaputra to the environs of Calcutta and through the Irrawaddy swamps to Pegu and Rangoon to Lower Burma. With the exception of a single isolated specimen from Naini Tal, in the Western Himalayas of the United Provinces, not one has appeared among many hundreds of land-leeches from other parts of India and Ceylon. Clearly the stronghold of this species is in the hills of Assam, especially in the neighbourhood of Shillong and Cherripungi and in Cachar (fifty comprising one lot from the latter), and at elevations between 3000 and 4000 feet. There it attains its largest size and evidently is the dominant land-leech, and so conspicuous as to attract the attention of all collectors. The known vertical range is from near sea-level at Calcutta and Rangoon to about 5000 feet near Shillong. It is quite probable that this species has at times been confused with the trilineate variety of *H. japonica*, as, except that the latter never reaches so large a size, there is little to distinguish them without a critical study.

Concerning seasonal distribution, specimens are recorded as having been taken in every month of the year, a fact which, so far as this species at least is concerned, effectually disposes of the statement sometimes made that land-leeches all die upon the approach of winter and the dry season. From Assam alone specimens collected in every month but January and July were examined, but spring and autumn collections were by far the most numerous. But this may have been the result merely of the accidents of collecting and the omission of dates from many of the labels. On the other hand, the Calcutta dates, so far as recorded on the labels, are limited to November, December and January. Another fact of interest is that specimens collected during the

winter months, both in the vicinity of Calcutta and elsewhere, as in the Khasi Hills, are sometimes recorded as having been taken in a semi-torpid condition under bricks and stones or buried in soil, sometimes in stream-beds, in mud by the side of ponds or in moist earth. Thus, R. G. Uradin states that specimens taken November 27th at Tribene were buried a few inches below the surface of the soil on the bank of the Hoogly River, and were lying in a sluggish condition when turned over. R. Hodgard writes thus of specimens collected on December 21st in the neighbourhood of Tollygunge, near Calcutta:—"I found the adults almost entirely buried in the mud under bricks, only the upper surface being seen. They were also in contracted condition and lay quite still as though dead. The young ones, however, always crawled out and moved about quickly when the bricks under which they were hidden were removed."

It appears also that this species is found in the vicinity of and enters water voluntarily during other seasons, and, contrary to what Whitman, Tennent and others have stated for other species, that it swims well. Mr. G. Mackrell, writing of examples encountered at Sylhet, Assam, on June 14th, states that "they swim actively in water, but one finds them on damp grass as well." Hooker (1848, ii, p. 42) mentions leeches in incredible profusion in the streams and damp grass in the Teesta River Valley at 2000 ft., and (i, p. 157) "leeches swarm below 7000 ft.; a small black species [*H. zeylanica montivindicis*] above 3000 ft. and a large yellow-brown one below that elevation" at Tonglo. These references are undoubtedly to the present species. The Indian Museum collection includes specimens taken along with *Hirudinaria javanica* and *Hirudinaria manillensis*, and therefore presumably in or close to water. Annandale, on the other hand, mentions specimens collected at Tollygunge in moderately dry herbage.

Besides the general statements that it attacks man and domestic animals, the only record of specific hosts that I find are the bullock and fresh-water crab (*Potamon atkinsonianum*), both on the northern hills.

Unlike the smaller land-leeches this species rarely occurs in great swarms, and, although it may be plentiful, it is referred to several times as solitary. This is confirmed by a record of the collections, for, notwithstanding that the number of lots exceeds that of any other form, the total number of individuals amounts to only 177, a number exceeded by several single lots of *H. zeylanica* and its subspecies *agilis*.

Several correspondents designate this the "stinging" leech, and state that its bite, unlike that of the common land-leech, is very painful. Whether this statement is warranted or is based upon a confusion of this species with the true "stinging" leech (*H. ornata*) remains to be determined. It is not improbable that both may possess this characteristic.

This is the only species of land-leech which has been taken in actual contact with its egg-capsules. They were taken twice, on

August 20th and September 2nd, at Katihar, Punaeh District, North Burma, by C. Paiva, and on both occasions under boxes in a garden. Once the leech was found with the "egg" beside it, and in the other case was actually coiled about the capsule. Three capsules each measure about 8×11 mm., and are broadly ellipsoidal in shape, with a densely opaque central capsule slightly exceeding one-half of those measurements. This inner capsule, which contains the eggs or embryos and the "albumin" in which they are embedded, is formed of a stout and continuous envelope with a short tube for exit at each end. This is further encased in an outer spongy layer composed of a single thickness of large and coarse polyhedral cells numbering about forty-five, and in all of these specimens closed externally, not open as in the capsules of *H. zeylanica montivindicis*.

45. *Hæmadipsa ornata*, new species. The Stinging Land-Leech. (Plate V, fig. 11; IX, fig. 42).

Diagnosis.—Size medium; form probably most slender and terete of the Indian representatives of the genus. Colour in life a brilliantly contrasting pattern of velvety black and light yellow or cream-coloured stripes, the black stripes a median and a pair of intermediate, much broader than the yellow; venter a rich ferruginous; suckers pale blue. Annulus *V a 1* well developed between third and fourth eyes, but not forming a complete row of areas; median areas little developed. First pair of nephridia opening on buccal rim. Furrow-pits exceptionally well developed at IX and X *b 2/a 2*, a less conspicuous pair on VIII, each in an unpigmented white or pale yellow spot. Sucker nearly circular, the functional prehensile papilla slightly developed; rays unusually numerous, 86-94. Dorsal sensillæ raised prominently on rounded papillæ.

Type in Indian Museum collection No. 4875. Ghumti, Darjeeling District, about 3000 ft. (*G. W. O'Brian*, collector).

Description.—The size is between that of *H. zeylanica* and *H. sylvestris*. The largest specimen is 42.5 mm. by 4.5 mm. The type, a well-extended specimen, measures: length, 39.5 mm.; length to male pore, 11.5 mm.; width at buccal ring, 2.4 mm.; at male pore, 2.9 mm.; maximum width (XXIII), 4.2 mm.; depth at male pore, 2.7 mm., at XXIII, 3.7 mm.; caudal sucker, 5.3 by 5.7 mm. The usual length is around 30 mm.

Form habitually more slender and elongated than other species, very little depressed but nearly circular in cross-section, the maximum diameter far back, close to the sucker at XXIII.

Head (fig. 63) usually somewhat widened at the buccal ring, bluntly triangular. When fully expanded, as when the leech is engaged in sucking, it forms a repand, circular disk. Ventral surface granulated and in the resting state with a shallow median, and two pairs of furrows, laterad of which are the large lateral buccal lobes continued as distinct buccal frills. On the dorsum the

tessellæ are relatively smaller and more regular than in *H. sylvestris*, but resemble that species in their general arrangement. Their typical disposition is shown in fig. 63, which also shows well the broad unsegmented margin of the head. Eyes five pairs, arranged as in the other species but appearing to be somewhat smaller, the third and fourth pairs constantly separated by well-developed areas which, however, do not form a complete transverse row. Median areas little developed. Buccal ring formed by

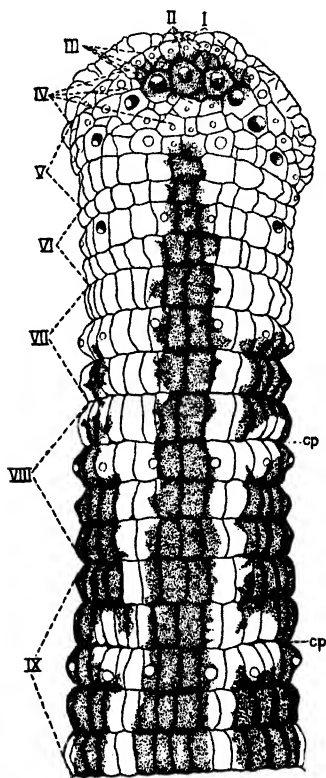

Fig 63.—*Hæmadipsa ornata*. Somites I–IX, from dorsum, showing eyes, sensillæ and on head other sense-organs, somites, annuli, areolæ and furrow-pits (cp). $\times 7\frac{1}{2}$.

somite V, the furrow *a 2/a 3* continuing almost to the mid-venter. Post-buccal ring divided, as the furrows on somite VI may be traced entirely across the venter.

Otitellum seldom discernible externally even by a distinctive colour, but dissection demonstrates the loose glandular layer,

extending over the usual fifteen annuli (X b 5 to XIII a 2 inclusive). Gonopores in the furrows XI b 5/b 6 and XII b 5/b 6, in no case appearing otherwise than as small pores in the furrows. In no case is a penis protruded. Nephropores appear just ventrad of the marginal line on the caudal border of b 2 of somites IX to XXIII inclusive, as conspicuous pores directed upward, the exact position of which is indicated in most cases by a small spot of deep brown pigment. A similar spot often occurs at the corresponding point on VIII a 1, but in no case has it been possible to demonstrate the actual opening of the first pair of nephridia either here or on the buccal margins. In two specimens openings appeared to be in the latter position, but unfortunately adequate material for sectioning is lacking. The opening of the seventeenth pair is clearly on the ventral surface of the base of the first lobe (XXIV a 2) of the nephridial auricle.

Auricles large, consisting of three lobes derived from the marginal papillæ and integuments of a 2 of XXIV, XXV and XXVI. The lobes are separated by broad, nearly circular sinuses, and all are relatively large, with thin membranous margins, the first and third squarish or even with the angles prolonged, the middle lobe smaller or rarely nearly as large, triangular or truncate, with the margin rounded. The whole is admirably adapted to fit closely to the irregular dorsal surface of the sucker. The dorsal surface is conspicuously white, the ventral pigmented, thus in agreement with the marginal and submarginal stripes.

Caudal sucker relatively large, considerably exceeding the maximum body diameter of extended examples; flat, discoid, slightly longer than wide, with the anterior angle little produced as a prehensile papilla. The dorsal surface is strongly and roughly tessellated, with the areas in five distinct transverse rows besides some less distinct marginal areas. The six series of dorsal and two of ventral sensillæ are well-developed, but seldom more than three appear in any one series. The venter is divided into a middle granular area and a broad marginal zone of radiating ribs which are remarkable both for their prominence and the unusually large number, which varies from 86 to 94, each terminating in a prominent marginal tooth. These ribs are really not strictly radial, as only a few of them would pass through the centre if produced. Both the anterior and posterior ones are arranged in pairs along a median longitudinal axis, and the anterior angle is formed of the first pair, not of a single ray. The sucker, therefore, is bilaterally symmetrical.

Furrow-pits are typically present in IX b 2/a 2 and X b 2/a 2, but a smaller pair occasionally occurs on VIII. They are situated in the intermediate field within the lateral black stripes, and because of their whiteness or pale cream-colour are very conspicuous. They are usually well-developed in this species and extend half-way across the bounding annuli. While none of the

material examined is sufficiently well fixed to make the determination of their exact structure possible, or to decide whether they contain a peculiar organ, several facts are quite clear. The unpigmented area is smooth and translucent, in contrast to the rough, black surrounding area; it is slightly depressed; the furrow at this point is much deeper; and the epithelium in the deeper part of the depression, at least, is thicker and lacks capillaries and most of the mucous glands, so abundantly present in the surrounding area. These areas are clearly modified, but their minute structure and significance is unknown. They have much of the appearance of the copulatory or fertilization areas of the *Erpobdellidæ*.

The *integumental areas* are more prominent in this than in any species of Indian land-leech, the papillæ project prominently and the surface (of preserved leeches) is harsher and rougher to the touch. In the post-clitellar middle region the number of areas is about forty to forty-two, arranged about as follows: A 4, B 2 or 3, C 3, D and E each 0 or 1, F 3, G 5 and H 7 or 8; adding the twelve sensillæ to these, the total number of areas on sensory annuli is about 50 to 54. Sensillæ are borne on rather large but low, rounded papillæ which, because of their white colour contrasting with the black background, are very conspicuous. They have the usual number and arrangement, six dorsal and six ventral, the marginals being absent, or occasionally present and very small. On the head each area bears a single sense-organ similar in appearance but smaller than true sensillæ. On the body the non-metameric organs are much smaller.

Annulation.—The typical constitution of the somites is as follows:—I consists of five small preocular areas, each bearing a labial sense-organ. II includes a pair of large oculars bearing the first pair of eyes and in contact medially, and a pair of marginals, each of which may be divided transversely into two. III consists of the second pair of large oculars, one or two pairs of marginals bearing one pair of sensillæ and three interoculars, of which the median is very small, and the paired large, and bearing the paramedian sensillæ. Variations occur, as in the figure. IV is constituted of the third pair of oculars, a large marginal bearing the supra-marginal sensilla, and usually one or two smaller marginals, about three pairs or two pairs and a median group of interoculars, forming a regular transverse row. Additional small areas may occur, and in one the median and next pair laterad are divided by a faint transverse furrow with two incipient rows, the beginning of IV α 3. V is biannulate, the furrow α 2/ α 3 nearly complete all round, fading out only close to the ventral mid-line, the tessellæ forming two rows clear across the venter. The first or longer annulus is regularly divided into two rows of areas representing α 1 and α 2. The latter consists of the large oculars bearing the fourth pair of eyes, usually two or three marginals on each side reaching the buccal rim, and three

or four pairs of interoculars, the pair bearing the paramedian sensillæ being much the largest. a_1 is usually deficient medially between the paramedians, but from these laterad consists of a complete row extending between the third and fourth pair of eyes to the margins of the head. Occasionally it extends clear across the middle in a regular row of as many as seven interoculars. VI is triannulate all round, $a_1 < a_2 < a_3$ on dorsum, while on the venter a_1/a_2 becomes shallower and a_1 , especially, shorter, and bears the fifth pair of eyes and a full set of sensillæ on a_2 . VII triannulate, approximately equally so all round ($a_1 > a_2 < a_3$). VIII quadrannulate ($a_1 > a_2 = b_5 = b_6$). IX-XXIII are all complete and quinquannulate ($b_1 = b_2 = b_5 = b_6 > a_2$), except that on XXIII b_5 and b_6 are somewhat reduced. The sensory annuli of complete somites, although slightly shorter than the others, are more elevated and project slightly above the general level. XXIV triannulate ($b_1 = b_2 = a_2$), the fate of a_3 being doubtful as in other species. XXV, XXVI and XXVII each uniannulate.

Colour.—The living colours (Pl. V, fig. 11) of this leech are very striking and handsome, and Susruta's appellation of "rainbow-striped" applies well to it. It is noteworthy also that they are retained after preservation with remarkable fidelity. The condition in life is depicted in the figure after A. C. Chowdhary, and the following description based upon the type is in close agreement both with this and with other specimens. On the dorsum a broad velvety black solid stripe occupies the entire width of the median field from the fourth pair of eyes to the anus (V to XXVII). Bordering this is a pair of cream-coloured stripes about one-third as wide and occupying the paramedian lines from VIII to XXIV a_2 . Caudad of the latter they merge into the blue colour of the caudal region, and on VIII they broaden and similarly merge with the blue colour of the head. On b_2 and a_2 of IX and X, and on some specimens less obviously on the same part of VIII, they spread laterad as pairs of ovate cream-coloured spots, including the intermediate sensillæ and the furrow-pits anterior and laterad of them. Laterad of the paramedian pale stripes is a pair of dark stripes wider than the median, beginning at about VII a_2 or a_3 as a warm smoky-brown, becoming darker, first along the medial border and finally for the entire width, a rich purplish-black, and ending abruptly on XXIV. As these stripes embrace the entire width of the intermediate field, about half of the paramedian and about one-third of the supra-marginal, the cream-coloured or whitish intermediate and supra-marginal sensillæ appear on them as conspicuous small spots. Marginal stripes are the narrowest of them all, pale cream-colour or nearly white, beginning indefinitely at about VIII, becoming sharply defined and continuing to XXIV. Venter reddish-buff, becoming paler anteriorly and smoky-brown at the margins, the latter colour especially concentrated in spots about the submarginal sensillæ

and nephropores on annuli $b\ 2$ and $a\ 2$. Cephalic end anterior to VIII, dorsum of caudal sucker, bases of nephridial auricles and the segments bearing them pale blue. Venter of both suckers and gonoporal regions grey. A dusky spot on the head includes the first two pairs of eyes.

Other specimens are exactly like the types, but several which have probably faded have the black stripes replaced by purplish-brown or even lavender-brown with deep concentrations on $b\ 2$ and $a\ 2$. Specimens from Pashok are very dark with a strongly ferruginous tinge, especially on the venter, the intermediate black stripes narrower than the median, and all reaching farther forward. The pale intermediate spots on IX and X are present on all specimens. Three specimens from Sarawan somewhat doubtfully referred to this species have the paired black stripes each divided into two, making five in all.

Geographical Distribution and Bionomics.—Except for three somewhat doubtful examples from Bihar and one from the Hill Tracts in East Bengal, all of the thirty-two specimens of this species were collected in Darjeeling and Assam from elevations between 1500 feet in the Khasi Hills to 3000 feet at Ghumti, at which point it is reputed to be common below that elevation. Most of the lots consist of single specimens, but two of eight and twelve were taken at Kamrup, Assam. In this district Mr. L. W. Middleton reports them as inhabiting the small hills on the edge of the low country along the Brahmaputra. In agreement with other collectors he designates them as “stinging leeches,” and states that “these leeches attack man, and their bite, unlike that of other land-leeches, is very painful.” This peculiarity is of interest in connection with their showy “warning” colours. So far as recorded, the dates of collection fall entirely within the months of May, June, July and August, and one in October. That they climb trees is attested by S. W. Kemp, who refers to one that fell upon him from a tree in a jungle in North Assam.

Two egg-capsules collected by C. W. Beebe at Jorpokri, Darjeeling, may belong to this species. They measure 13×10 and 11×9 mm. respectively, are similar in structure and colour to those of *H. zeylanica montivindicis* (Pl. VIII, fig. 37), but the outer layer is composed of about sixty polyhedral cells, part of which are open, part closed.

A land-planarian similar in size, form, and colour-pattern occurs with the leeches in Darjeeling.

46. *Hæmadipsa dussumieri* Blanchard.

Synonymy :

Hæmadipsa dussumieri Blanchard, 1917, p. 668.

Somites I to IV uniannulate; V biannulate; VI triannulate; VII quadrannulate ($a\ 1 + a\ 2 + b\ 5 + b\ 6$); VIII quinquannulate ($b\ 1 + b\ 2 + a\ 2 + b\ 5 + b\ 6$); IX–XXIII complete, quinquannulate;

XXIV quadrannulate ($b1 + b2 + a2 + a3$)?; XXV, XXVI and XXVII each uniannulate. Total number of annuli 100. Male gonopore XI $b5/b6$, female XII $b5$. Length 36 mm., width 5 mm.

Type in Paris Museum, No. 195, collected by Dussumier. Locality unknown, but supposed by Blanchard to be southern Hindustan, inasmuch as the collection of the Paris Museum includes other leeches collected by Dussumier in 1830 from the Malabar and Coromandel coasts.

No *Hæmadipsa* exhibiting such constitution of somites VII, VIII and XXIV has been seen by me.

BIBLIOGRAPHY.

The following publications are cited in the section on annulation, the general account of the Arhynchobdellæ and the systematic account of species of the latter:—

- AGASSIZ, L. 1846. *Nomenclator Zoologicus*.
- ATCHINSON, J. E. S. 1889. *Zoology of the Afghan Delimitation Commission*. Trans. Linn. Soc. London, (2) v, pp. 53-142. Leeches, p. 105.
- ANNANDALE, N. 1913. The Leeches of the Lake of Tiberias. *Journ. & Proc. Asiatic Society of Bengal*, (n. s.) ix, 6, pp. 211-214.
- ANNANDALE, N., and AMIN-UD-DIN. 1920. Note on the Occurrence of a Leech (*Limnatis nilotica*) in Seitan and the Afghan-Beluch Desert. *Records of the Indian Museum*, xvii, pp. 135, 136.
- APÁTHY, S. 1888 a. Analyse der äusseren Körperform der Hirudineen. *Mitth. Zool. Sta. Neapel*, viii, pp. 153-232. Taf. 8 u. 9.
- 1881 b. Süswasser-Hirudineen. *Zool. Jahrb. Abth. f. Sys. etc.*, iii, pp. 725-794.
- BAIRD, W. 1869. Descriptions of some new Suctorial Annelides in the Collection of the British Museum. *Proc. Zool. Soc. London*, 1869, pp. 310-318.
- BIALASZEWICZ, K. 1924. Influence de la Nutrition sur le Metabolisme chimique et energetique chez les Sanguées. *Arch. Internat. de Physiologie*, xxiii, Fasc. 3, pp. 218-234.
- BLANCHARD, R. 1887. *Dictionnaire encyclopédique sci. med. Art. Hirudinées*. Paris.
- 1892 a. Description de la *Nephele atomaria*. *Bull. Soc. Zool. France*, xviii, pp. 165-172.
- 1892 b. Sur la présence de la *Trocheta subviridis* en Ligurie et description de cette Hirudinee. *Atti della Soc. ligustica di sci. nat. e geog.*, iii, no. 4, pp. 31, 8 text-figs. Also separate, Genes, 1893.
- 1893 a. Revision des Hirudinées du Musée de Turin. *Boll. Mus. Zool. ed. Anat. Comp. Univ. di Torino*, viii, no. 145, pp. 32, 13 text-figs.
- 1893 b. Sur quelques Hirudinées du Piémont. *Idem*, viii, no. 146, pp. 12, 5 text-figs.
- 1894 a. Revision des Hirudinées du Musée de Dresde. *Abhandl. u. Ber. d. K. Mus. Zool. Anthr.-Eth. du Dresden*, 1892-3, no. 4, p. 8, pl. i.
- 1894 b. Hirudinées de l'Italie continentale et insulaire. *Boll. Mus. di Zool. et Anat. Comp. di Torino*, ix, no. 192, pp. 84, 30 text-figs.
- 1894 c. Viaggio di Leonardo Fea in Birmanica e regioni vicine.—LVII. Hirudinées. *Ann. Mus. civico di Storia Naturale, Genova*, (2) xiv, pp. 113-118.
- 1896. Description des quelques Hirudinées Asiatiques. *Mém. Soc. Zool. de France*, ix, pp. 316-330, 7 text-figs.
- 1897 a. Hirudinées des Indes Néerlandaises. *Zool. Ergeb. Reise in Neiderländisch Ost-Indien*, iv, pp. 332-355, 11 text-figs.
- 1897 b. Hirudinées du Musée de Leyde. Notes from the Leyden Museum, xix, pp. 73-133, pls. iv-vi, text-figs. 7-20.
- 1897 c. Hirudineen Ost-Afrikas. *Die Thierwelt Ost-Afrikas*. Berlin, iv, 8 pp., 1 pl., 3 text-figs.

- BLANCHARD, R. 1917. Monographie des Hémadipsines (Sangsues terrestres). Bull. de la Soc. Pathologie Exotique, x, pp. 640-675, pl. vii, 16 text-figs.
- BLAINVILLE, H. M. D. DE. 1818. In Lamarck, Histoire Naturelle des Animaux sans Vertèbres, v.
- 1827. Dict. des Sci. Nat. Paris, xvii, Art. Sangsue.
- 1828. Id. lvii, Art. Vers.
- BOLLES-LEE, A. 1821. Microscopists' Vade-Mecum, 8th ed. Philadelphia.
- BOLSIVS, H. 1895. L'Anatomie des Hirudinées terrestres. C. R. Troisième Cong. Internat. d. Catholiques, Bruxelles, pp. 3-9, 10 text-figs.
- BOYNTON, W. II. 1913. Duration of the Infectiveness of Virulent Rinderpest Blood in the Water-Leech (*Hirudo boyntoni*, Wharton). Philippine Journ. of Sci., Sec. B., viii, pp. 509-521.
- BRANDES, G. 1901. In Leuckart. Die Parasiten des Menschen, 2nd ed. vol. i, pt. 2, Appendix. Leipzig.
- CARENA, H. 1820. Monographie du genre *Hirudo*, etc. Mem. Real. Accad. Sci. de Torino, xxv, no. 272, 2 plates.
- CASTLE, W. E. 1900. The Metamerism of the Hirudinea. Proc. Amer. Acad. Arts and Sci. xxxv, pp. 285-303, 8 figs.
- CLAUS, C. 1885. Lehrbuch der Zoologie. (Eng. trans. by Sedgwick.)
- DAVY, J. 1821. An account of the interior of Ceylon. London. Land-Leech, pp. 102-103, pl. ii, fig. 4.
- DE QUAL, L. 1917. Nuovi Irudinei esotici del Museo Zoologico di Torino. Boll. Mus. Zool. ed Anat. comp., xxxii, no. 724, p. 20, 1 text-fig.
- DUTROCHET, II. 1817. Note sur une Annelide d'un genre nouveau. Bull. des Sciences Soc. Philomatique, Paris, p. 130.
- DUTT, U. C. 1877. Materia Medica of the Hindus, p. 275.
- EDWARDS, J. F. 1924. Rinderpest in India. Ann. Rep. Board of Scientific Advice for India for 1922-23, p. 63.
- GRATIOLET, P. 1862. Recherches sur l'organisation du système vasculaire dans le sangsue médicinale et l'aulastome vorace. Ann. Sci. Nat. (4) xvii, Zool. pp. 174-231, 1 plate.
- GRUBE, E. 1850 (1851). Die Familien der Anneliden. Berlin.
- 1866. Ueber Landblutegel. Schles. Gesellsch. f. Vaterl. Cultur, pp. 59, 60.
- 1868. Novara Reise, Zool. Bd. ii, Abth. 3. Anneliden. Wien. Leeches, pp. 37-43, Taf. iv.
- GREEN, P. E. 1907. Boring Power of Land-Leeches. Spolia Zeylanica, iv, p. 181.
- HARDING, W. A. 1910. A Revision of the British Leeches. Parasitology, iii, no. 2, pp. 130-201, pls. xiii-xv, 16 text-figs.
- 1913. On a New Land-Leech from the Seychelles. Trans. Linn. Soc. London, (2) xvi, pp. 39-43, pl. vi.
- 1920. Fauna of the Chilka Lake. Mem. Indian Mus. v, no. 7, pp. 509-517, text-figs.
- HAECKEL, E. 1883. A Visit to Ceylon. Eng. trans. Boston. Land-Leeches, pp. 188, 189.
- HARVEY, Dr. 1869. Land-Leeches of Ceylon. Ann. & Mag. Nat. Hist. (4) iii, p. 324.
- HOCKER, J. D. 1854 (1855). Himalayan Journals. London. 1st ed., 1854, Leeches, i, pp. 107, 167; ii, pp. 17, 54. 2nd ed., 1855, omits footnote on p. 54 and is differently paged.
- HORNADAY, W. T. 1886. Two Years in the Jungle. New York. Land-leeches, p. 426.

- JOHANSSON, L. 1910. Zur Kenntnis der Herpobdelliden Deutschlands. *Zool. Anz.* xxxv, pp. 705-714; xxxvi, pp. 367-380, 2 text-figs.
- 1913. Hirudineen aus dem Sudan. Results of the Swedish Zoological Expedition to Egypt and the White Nile, 1907. No. 24, pp. 42, pl. i, 13 text-figs.
- 1914. Ueber den Bau von *Trematobdella perspicax*. *Id.*, no. 24 A, pp. 33, 21 text-figs.
- 1918. Hirudineen von Neu-Caledonien und den neuen Hebriden. In Sarasin u. Roux, *Nova Caledonia, Zoologie*, vol. ii, no. 13, pp. 373-396, pl. xii and 6 text-figs.
- 1924. Ein neuer Landblutegel aus den Juan Fernandez Inseln. In the 'Natural History of Juan Fernandez and Easter Island,' vol. iii, no. 48, pp. 439-460, pl. xiv, 2 text-figs.
- KABURAKI, T. 1921 a. On some Leeches from the Chilka Lake. *Mem. Indian Mus.* v, pp. 662-675, 5 text-figs.
- 1921 b. Note on the Leech *Limnatis nilotica*. *Records Indian Museum*, xviii, pp. 213, 214, pl. v.
- 1921 c. Notes on some Leeches in the Indian Museum. *Id.*, pp. 689-719, 7 text-figs.
- KHAN, M. M. 1912. Notes on Rearing Leeches in Bara Banki District, United Provinces. *Records of Indian Mus.*, vii, pp. 206, 207.
- KINBERG, J. G. H. 1866. *Annulata nova*. *Ofver. K ngl. Vet.-Akad. F rh.* 1865, no. 9; *Hirudinacea*, pp. 256-257.
- KINLOCK, A. P. 1922. Leech attacking a Snake. *Journ. Bombay Nat. Hist. Soc.* xxviii, p. 557.
- KNOX, R. 1681. *Historical Relations of the Island of Ceylon. Leeches*, pp. 48, 49.
- LAMARCK, J. P. B. 1818. *Histoire Naturelle des Animaux sans Vertebres*. Paris. Vol. v.
- LANDON, P. 1905. *The Opening of Tibet*. New York. *Leeches*, p. 49.
- LAYARD, E. 1853. *Mag. Nat. Hist.* p. 225.
- LESSON, J. P. 1842. Description d'une nouvelle esp ce de Sangsue. *Revue Zoologique Soci t  Ouvri re*, p. 8.
- LEUCKART, R. 1863. *Die Menschlichen Parasiten*. Leipzig. *Hirudinei*, Bd. i, pp. 634-739.
- LINNEUS, C. 1758. *Systema Natur *. 10th ed.
- LIVANOW, N. 1903. Untersuchungen zur Morphologie der Hirudineen. *Zool. Jahrb. Abth. Anat.* xix, pp. 29-90, Taf. 2-6.
- 1904. *Id.* xx, pp. 153-226, Taf. 9-11.
- MATTHAL, G. 1920. Preliminary Observations on Cocoon-formation by the Common Lahore Leech, *Limnatis (Pacilobdella) granulosa* (Sav.). *Journ. & Proc. Asiatic Soc. of Bengal*, n. s. xvi, no. 8, pp. 341-346, text-figs. and pl. xviii.
- MASTERMAN, E. W. G. 1908. *Hirudinea as Human Parasites in Palestine*. *Parasitology*, i, no. 2, pp. 182-185.
- MOORE, J. P. 1898. The Leeches of the U.S. National Museum. *Proc. U.S. Nat. Mus.* xxi, pp. 543-563, pl. xl.
- 1900. A Description of *Microbdella biannulata*, with especial regard to the Constitution of the Leech Somite. *Proc. Acad. Nat. Sci. Philad.* pp. 50-70, pl. vi.
- 1901 a. *Hirudinea of Illinois*. *Bull. Illinois State Lab'y Nat. Hist.* pp. 479-547, pls. xlii-xlvii.
- 1901 b. Descriptions of Two New Leeches from Porto Rico. *Bull. U.S. Fish Comm. for 1900*, ii, pp. 211-222, pls. xii & xiii.

- MOORE, J. P. 1912. The Leeches of Minnesota. Geol. and Nat. Hist. Survey of Minnesota. Zool. Ser. no. 5, pt. 3, pp. 65-150. Frontispiece and pls. i-vi.
- 1924. Notes on some Asiatic Leeches (Hirudinea), principally from China, Kashmir and British India. Proc. Acad. Nat. Sci. Philad. lxxx, pp. 343-388, pls. xix-xxi.
- MOQUIN-TANDON, A. 1826. Monographie de la famille des Hirudinées. Montpellier.
- 1846. Id., 2nd ed. Paris.
- MÜLLER, O. F. 1774. Vermium Terrestrium et Fluviatilium. Havnæ et Lipsiæ, 1773-1774. i, pt. 2.
- MURIE, J. 1865. On a Leech in the Viscera of a Moluccan Deer. Proc. Zool. Soc. London, pp. 659-662.
- OKA, A. 1895. On some New Japanese Land-Leeches. Journ. Coll. Science Imp. Univ. viii, pp. 275-306, pls. xxviii-xxx.
- 1910. Synopsis der Japanischen Hirudineen, mit Diagnosen der neuen Species. Annot. Zool. Jap. vii, pt. 3, pp. 165-183.
- 1917. Zoological Results of a Tour in the Far East. Pt. iii, Hirudinea. Mem. Asiat. Soc. Bengal, vi, pp. 159-176, pl. vii.
- 1922 a. Vertrockung w. Wiederbelebung bei einer Süßwasser-Hirudinie. Zool. Anz. liv, pp. 91-93, text-fig.
- 1922 b. Hirudinea from Inlé Lake, S. Shan States. Records Indian Mus. xxiv, pp. 521-524, 7 text-figs.
- 1923. Sur les genres *Mimobdella* Blanchard et *Odontobdella* nov. gen. Anat. Zool. Jap. x, pp. 243-253, 15 text-figs.
- 1925 a. Notice sur les Hirudinées d'Extreme Orient. I-IV. Id., x, pp. 311-326, 10 text-figs.
- 1925 b. Id., v-vii, pp. 237-335, 7 text-figs.
- PERRIER, E. 1897. Traité de Zoologie.
- PETCH, T. 1919. Extension of the Range of the Common Leech. Spolia Zeylanica, xx, pp. 79-80.
- PINTO, C. 1923. Ensaio Monographico dos Hirudineos. Revista de Museum Paulista, xiii, pp. 266.
- PLOTNIKOFF, V. 1907. Glossosiphonidæ, Hirudinidæ and Herpobdellidæ du Musée Zoologique de l'Academie Imp. des Sci. Ann. Zool. Acad. Sci. (1905), x, pp. 133-158. (In Russian.)
- PROWAZEK. 1904. Die Entwicklung von *Herpetomonas*. Arbeiten Kaiserlichen Gesundheitsamte, xx, pp. 440.
- ROBERTSON, M. 1909. Studies on Ceylon Hæmatozoa. Quart. Journ. Micr. Sci. n. s. liii, pp. 665-695, plates xvi & xvii and 4 text-figs.
- SAVIGNY, J. C. 1920 (1922). Système des Annelides. Paris.
- SCHEGOLEFF, J. 1916. Leech fauna of the Amur Region. Revue Zool. Russ. i, pp. 250-252. (In Russian; English resumé.)
- SCHMAYDA, L. F. 1861. Neue Turbellarien, Rotatorien und Anneliden. Leipzig. 2te Hälfte. Leeches, pp. 2-7, Taf. xvi, text-figs.
- SHIPLEY, A. E. 1916. The Minor Horrors of War. London. Leeches, pp. 143-181.
- SIBREE. 1915. A Naturalist in Madagascar. London.
- SUSRUTA. 1835 (1836). The Suśruta or System of Medicine taught by Dhanwantari and composed by his Disciple Suśruta. Ed. by S. M. Gupta. Calcutta. 2 vols. Leeches, i, Chap. xiii, pp. 98-105.
- SEMPER, C. 1863. Zeitsch. f. wiss. Zool. xiii, p. 559.
- 1873. Die Palau-Inseln in stillen Ocean, p. 372. Leipzig.

- TENNENT, J. E. 1859 (1860). Ceylon. An Account of the Island, etc. 2 vols. London. 4th. ed., 1860. Leeches, i, pp. 301-307, text-figs. Prefatory notices indicate that the first, second and third editions were published in 1859.
- 1861. Natural History of Ceylon. London. Leeches, pp. 479-485. Same account as above.
- THUNBERG, C. P. 1796. Voyages au Japan etc., with notes on Natural History by J. B. Lamarck. Paris. Leeches, iv, p. 287.
- TYTLER, J. The Bite of the Ceylon Leech. Edinburgh New Philosophical Journal, i, pp. 375-377.
- WAHLBERG, R. F. 1842. Trenne nya Blodigel-arten. Skand. Naturf. Förhandl. iii, pp. 131-8, 665-668.
- 1856. Ofversigt Köngl. Vet.-Akad. Förh. 1855, pp. 233, 234.
- WALL, F. 1914. A Popular Treatise on the Common Indian Snakes. Journ. Bombay Nat. Hist. Soc. xxii, pp. 206-215. (Leech attacking snake, p. 208.)
- 1920. Snakes and Leeches. Id., xxix, p. 302.
- WATTS, G. 1890. Dictionary of the Economic Products of India. Calcutta. Leeches, p. 619.
- WEBER, M. 1915. Monographie des Hirudinées Sud-Americaines. Neuchatel. pp. 1-134, pls. i-vi.
- WHARTON, L. D. 1913. *Hirudo boyntoni*, a new Philippine Leech. Philip. Journ. Sci., D. viii, pp. 369-371.
- WHITMAN, C. O. 1884. The External Morphology of the Leech. Proc. Amer. Acad. Arts & Sci. xx, pp. 76-87, 1 plate.
- 1886. The Leeches of Japan. Quart. Journ. Micr. Sci. xxvi, pp. 317-416, pls. xvii-xxi and text-figs.
- 1892. The Metamerism of Clepsine. Festschr. 70sten Geburtstage R. Leuckarts, pp. 285-295, plates xxxix, lx.
- WISE, T. A. 1845. Commentary on the Hindu System of Medicine. Calcutta. Leeches, pp. 177, 178.

APPENDIX
TO THE
ARHYNCHOBDELLÆ.

Several small collections received after the completion of the manuscript make possible some important additions to localities and other data, as well as some corrections relating to the following species:—

***Herpobdelloidea indica* (Kaburaki).**

Dr. H. G. Kribs has sent several specimens taken from pools at the junction of the Jumna and Ganges Rivers near Allahabad at an elevation of five hundred and thirty feet. Dried egg-cocoons attached to stones are similar to those of *Erpobdella* and measure 7×2.5 to 3 mm.

***Myxobdella annandalei*, Oka.**

Additional synonymy:

? *Hæmopsis concolor* Kaburaki, 1921 c, pp. 713, 714, fig. 7 (annulation). (Kasauli, W. Himalayas.)

There is little doubt of the correctness of this determination as the types agree in every determined feature of external morphology, anatomy and colour.

***Dinobdella notata*, Moore.**

The collection of the Madras Museum includes three specimens kindly forwarded for study by Mr. F. H. Gravely. All were taken in the Nilgiris Hills at altitudes between 6500 and 8000 feet, one at Ootanamund and two at Keti, May 20–30, 1921. They are fully mature and much better preserved than the types, with which they agree both internally and externally except in the following important respect. The jaws are much better preserved and larger, and the teeth, which are totally absent in the types, probably having been lost through maceration, are well preserved and perfectly obvious on all three of these. They have the form, size and arrangement characteristic of *Hirudo* and related genera and number from 57 to 63. This observation again throws doubt upon the generic position of this species, and draws it closer to *Hirudo birmanica*.

***Hirudo birmanica* (Blanchard).**

Dr. H. G. Kribs reports this species as common in pools along the banks of the Jumna River near Allahabad. Other collections received from the Indian Museum, the Madras Museum and the British Museum represent additional localities, mostly in Madras and Ceylon, especial interest attaching to the following: Kilakaria, on the south-east coast of Madras in the latitude of north Ceylon, and Udayagira, in the northern Eastern Ghats, at 3000 feet. This species is an almost universal inhabitant of village tanks and is common in rice fields.

***Hirudinaria manillensis* (Lesson).**

Additional specimens received from the Indian Museum include some from the Dara Ismail Kahn District, and prove that this species penetrates at least 500 miles up the valley of the Indus River to a point in close proximity to the highlands, though itself approximately on the 500 foot contour line. In the far south, on the contrary, its range extends into the hills, not only in the interior of Ceylon, as already stated, but also in the Mysore District of central Madras, from which there are examples in the British Museum.

***Hirudinaria granulosa* (Savigny).**

Further collections submitted by the Director of the Indian Museum confirm the discovery of the abundance of this species on the west coast in Malabar District and Cochin State, where it appears to be far more plentiful than the lowland *H. manillensis*. It is abundant also throughout the North-West Frontier Provinces.

That the reported entrance of this species and the last into the nose passages of mammals is not entirely a matter of mistaken identity, as the writer has been inclined to believe, is proved by an example contributed by Dr. H. G. Kribs, which was taken from the nasal chamber of a dog at Landour, United Provinces.

***Hæmadipsa sylvestris* (Blanchard).**

A typical small example reported to have been taken in Madras (exact locality unknown) is included in the collection of the British Museum.

***Hæmadipsa zeylanica* (Savigny).**

A study of sections of the several subspecies makes it possible to correct the statement of Whitman and others that the first pair of nephridia differ from those of other species of the genus and agree with the condition typical of aquatic leeches in opening on somite VIII. As a matter of fact, they are carried forward to the lateral rim of the oral sucker as usual in the genus, and as first demonstrated by Bolsius (1895).

***H. zeylanica agilis*, Moore.**

Additional localities are Landour, United Provinces, 7500 feet, July, H. G. Kribs; Palni Hills, Madras, 4500 feet, June, F. H. Gravely; and Dhoni Forest, S. Malabar, 1500-4000 feet, E. Barnes.

***H. zeylanica montivindicis*, Moore.**

Specimens in the Madras Museum taken in June at Kalimpong, Darjeeling, have the positions of the nephropores, beginning with the second pair on IX, very conspicuously indicated by intensely dark pigment spots, as already described for *H. ornata*.

GENERAL INDEX.

[All names printed in italics are synonyms.]

- aculeata* (*Pontobdella*), 41.
agilis (*Hæmadipsa zeylanica*, subsp.), 266, 298.
Albione, 39.
Alqëtlã (=leech), vi.
Alukah (=leech), xvii.
amara (*Pterobdella*), 54.
Āmir, vi.
Annandale, acknowledgements to Dr., xxix, 30, 121.
annandalei (*Glossiphonia*), 65.
annandalei (*Myxobdella*), 161, 296.
Arabs, use of leeches by, vi.
Arhynchobdellæ, Introduction to, 97; diagnosis, 97; external characteristics, 97; body-regions, 99; clitellum, 100; gonopores, 100; nephropores, 101; complete somite, 101; sensillæ, 102; reproductive organs, 107; coloration, 110; geographical distribution, 111; economic relations, 113; relations to human interests, 114; study and preservation, methods, 117; classification, 120, 125; Appendix to, 296.
Asolepiades of Bithynia, xxiv.
asiatica (*Hæmopsis*), 190.
asiatica (*Hemiclepsis marginata* subsp.), 87.
asiatica (*Hirudo*), 189, 190.
atomaria (*Herpobdella*), 131.
atomaria (*Herpobdella octoculata* var.), 131.
atomaria (*Hirudo*), 130.
atomaria (*Nephelis*), 130.
Avicenna, the Canon of, xxiv.
Barbronia, 135.
Bdella, 194.
bioculata (*Clepsine*), 68.
birmanica (*Hæmopsis*), 176.
birmanica (*Hæmopsis*), 192.
birmanica (*Hirudo*), 192, 297.
Bleeding by means of leeches; vii, ix et seq., 236, 237.
boynstoni (*Hirudo*), 219.
Branchellion, 93.
Breul, Dr., xxvi.
Brightwell, xxx.
Bugs (*Cimex lectularius*) expel leeches, xxiv.
cæca (*Piscicola*), 52.
carena (*Clepsine*), 60.
Carp (*Capœta fratercula*) preys on leeches, xv.
Celsus, xix.
ceylanica (*Glossiphonia*), 73.
ceylanica (*Glossosiphonia*), 73.
ceylanica (*Hæmadipsa*), 255.
ceylanica (*Hirudo* (*Hæmopsis*?)), 255.
ceylanica (*Placobdella*), 73.
Ceylon colonised by Aryans, viii.
Chalmers, Lord, xiv.
cimiformis (*Glossiphonia*), 57.
Clepsina, 57.
Clepsine, 57, 81.
Clepsinidæ, 57.
cochiniana (*Hæmadipsa zeylanica* subsp.), 265.
complanata (*Clepsine*), 57.
complanata (*Glossiphonia*), 57.
complanata (*Glossosiphonia*), 57.
complanata (*Hirudo*), 57.
concolor (*Hæmopsis*), 296.
Cook, J. M., xviii.
Crocodile, xvii, xviii, 14.
Damiri's Zoological lexicon, vi.
decora (*Macrobdella*), xxix.
depressa (*Pontobdella*), 45.
Dina, 135.
Dinobdella, 175.
dussumieri (*Hæmadipsa*), 289.

- Ébrard, xxix.
elegans (*Clepsine*), 57.
elegans (*Glossiphonia*), 57.
 Elephants, xxi.
 emyda (Placobdella), 74.
 Epidaurus, xxvi.
 Erh Ya, the, v.
 Erpobdella, 130.
Erpobdella, 57.
Erpobdellidæ, 126; Key to genera and subgenera, 129.
Eubranchella, 36.
- ferox* (*Dinobdella*), 175.
ferox (*Whitmania*), 175.
fmbrata (*Clepsine* (*Glossiphonia*)), xviii.
 Foraminobdella, 149.
fulva (*Placobdella*), 78.
fuscolineata nipponica (*Hirudo*), 192.
- Galen, De Hirudinibus, xxii.
 Galilee, leeches in, xv.
 Gaster, Dr., xvii.
Geobdella, 151.
 Giles, Prof. H. A., vi.
Glossiphonia, 57.
Glossiphoniidæ, 57, 93.
Glossobdella, 57.
Glossopora, 57.
Glossosiphonia, 57.
Gnathobdellæ, 97.
Gnathobdella, 154.
Gnathobdellidæ, 154.
gracilis (*Placobdella*), 93.
grandis (*Limnobdella*), 201.
granulosa (*Hirudinaria* (*Pacilobdella*)), 226, 297.
granulosa (*Hirudo*), 226.
granulosa (*Limnatis*), 226.
granulosa (*Limnatis*), 218.
granulosa (*Limnatis* (*Pacilobdella*)), 226.
granulosa (*Limnatis* (*Pacilobdella*)), xxix, 218.
 Green, Mr. F. W., v.
gulo (*Autostomum*), 190.
- Hæmadipsa*, 253.
Hæmadipsidæ, 244.
Hæmadipsinæ, 244.
Hæmopsis, 199.
 "Hairy" leeches, 229.
 Hebrews, use of leeches by, xvii.
Helluo, Oken, 130.
Helobdella, 68.
Hemiclepsis, 83.
heptamerata (*Foraminobdella*), 149.
 Herodotus, xvii.
Herpobdella, 130.
Herpobdellidæ, 126.
Herpobdelloidea, 140.
heteroclita (*Clepsine*), 60.
heteroclita (*Glossiphonia*), 60.
heteroclita (*Glossosiphonia*), 60.
heteroclita (*Hirudo*), 60.
hexoculata (*Herpobdella*), 135.
 Hippocrates, xxiv.
 Hirudidæ, 154.
 Hirudinæ, 158; Key to Indian Genera and Subgenera, 159-160.
Hirudinina, 158.
 Hirudinaria, 207.
 Hirudinea, Segmentation (metamerism and annulation) of, 1; diagnosis, 35.
Hirudinidæ, 154.
Hirudinides, 154.
 Hirudo, 189.
 Horse-leech, xiv, xvii, xx, xxii, 200.
hyalina (*Hirudo*), 60.
- Iatrobella*, 189.
Ichthyobdellidæ, 35, 93.
 ilqitu (= leech), vi.
indica (*Albionc*), 45.
indica (*Herpobdelloidea*), 144, 296.
indica (*Hirudo*), 45.
indica (*Nematobdella*), 144.
indica (*Pontobdella*), 45.
 Indo-Aryan Research, Encyclopedia of, vii.
inleana (*Placobdella*), 76.
- jantseanus* (*Ozobranchus*), 36.
javanica (*Hirudinaria*), 210.
javanica (*Limnatis*), 210.
javanica (*Limnatis* (*Pacilobdella*)), 210.
javanica (*Sanguisuga*), 210.
 Johnson, J. R., xxviii, xxix.
lævis (*Hirudo*), 169.
lævis (*Whitmania*), 169.
 Lap-wing, Egyptian Spur-wing (*Hoplopterus armatus*), xviii.
lateroculata (*Herpobdelloidea*), 141.
 Lebanon, leeches in, xv.
 Leeches in Anglo-Saxon literature, xxvii; in Assyrian, vi; in Chinese, v; in Egyptian, v; in French, xxvii; in German, xxvi; in Greek, xvii; in Latin, xvii; in Pali, xiv; in Sanskrit, vii; in commerce, five classes of, xxx; artificial ponds for, xxviii; cultural methods, 236-238.
Leptostoma, 168.
 Limnatis, 199.
lineata (*Herpobdella*), 131.
Lophobdella, 36.
loricata (*Pontobdella*), 39.
 Lun Hêng, the, v.
luzoniæ (*Hirudo*), 218.
- macrothela* (*Pontobdella* (subgen. *Pontobdellina*)), 45.
maculata (*Hirudo*), 218.
maculosa (*Hirudo*), 218.
maculosa (*Limnatis*), 218.
 Mahābhārata, leech first mentioned in the, viii.
manillensis (*Hirudinaria*), 218, 297.
manillensis (*Hirudo*), 218.
manillensis (*Limnatis* (*Pacilobdella*)), 219.
 Marcellus, xvii.
marginata (*Glossiphonia*), 83.

- marginata (Hemiclepsis), 83.
marginata (Hemiclepsis marginata subsp.), 83.
marginata (*Hirudo*), 83.
Masterman, Mr., xv.
medicinalis (*Hirudo*), xxviii, xxix, xxx.
Messalinus, xix.
meyeri (*Protolepsis*), 82.
Microstoma, 168.
montana (*Hæmadipsa*), 269.
montivindicis (*Hæmadipsa zeylanica* subsp.), 267, 298.
multistriata (*Hirudo*), 218.
Myxobdella, 161.
- Natantia*, 158.
Nematobdella, 140.
Nepālī juko, viii.
Nephelidæ, 126.
Nephelides, 126.
Nicholson, Prof. R. A., vii.
nigriscens (*Aulostomum*), 190.
nilotica (*Bdella*), 200.
nilotica (*Limnatis*), xiv, xv, 200.
nilotica (*Palæobdella*), 200.
nipponia (*Hirudo*), xxix.
nociva (*Helobdella*), 70.
notata (*Dinobdella*), 185, 296.
- octoculata (*Eropbdella*), 130.
octoculata, *Herpobdella*, 131.
octoculata (*Hirudo*), 130.
officialis (*Liostoma*), xxix.
olivacea (*Piscicola*), 48.
ornata (*Hæmadipsa*), 284.
Ozobranchus, 36.
- Palæobdella*, 199.
pallida (*Clepsine*), 57.
paludum (*Hæmopsis*), 201.
paludum (*Limnatis*), 201.
- papillatus* (*Ozobranchus*), 36.
papillosa (*Hirudo*), 60.
Paraclepsis, 88.
parasitica (*Placobdella*), 93.
Peck, A. L., xxvi.
Persians, use of leeches by the, vi.
Pharyngobdellæ, 126.
pigna (*Whitmania*), 169.
pigrum (*Leptostoma*), 169.
pigrum (*Microstoma*), 169.
Piscicola, 48.
Placobdella, 72.
Pliny, xix.
Plover (*Pluvianus ægypticus*), xviii.
Pontobdella, 39.
Pontobdellina, 44.
Po wu chih, the, v.
prædatrix (*Paraclepsis*), 88.
Prior, Prof., xxvii.
Protolepsine, 81.
Protolepsis, 81.
Proverbs, Book of, xiv, xvii.
Pseudobranchellion, 36.
Pterobdella, 54.
- quadrioculata (*Trocheta*), 151.
quatre-fagesi (*Lophobdella*), xviii.
- Rapson, Prof., vii.
Repantia, 244.
reticulata (*Glossiphonia*), 65.
Rhynchobdellæ, Introduction to, 13; diagnosis, 13, 35; families of, 13; suckers, 13; body-form, 14; hosts, 14; external characters, 15; œlom, 17; vascular system, 21; alimentary tract, 23; generative organs, 24; spermatophore, 25; copulatory area, 26; ooductive tissue, 26; eggs and cocoons, 28; nephridia, 29; methods of preservation, 30; bibliography, 94.
- rouzi*, *Barbronia*, 135.
Savifa, 140.
Sandpiper (*trochilos*) of Herodotus, xvii.
sanguisorba (*Hirudo*), 218.
Sanguisuga, 189.
sanguisuga (*Hæmopsis*), 200.
Sanskrit names for leech : raktapā, jalauka, jala-sarpinī, jalūka Sindī jaru, etc., vii, viii.
Scaptobdella, 151.
sexoculata (*Clepsine*), 57.
sexoculata (*Glossiphonia*), 57.
sexoculata (*Protolepsine*), 82.
sexoculata (*Theromyzon*), 82.
shipleyi (*Ozobranchus*), 36.
Sornatius, xx.
stagnalis (*Glossiphonia*), 68.
stagnalis (*Helobdella*), 68.
stagnalis (*Hirudo*), 68.
subviridis, Murie (*Trocheta*), 175.
Sushruta Samhita, viii, ix, xiii note, xxiv, 116, 236, 237.
sylvestris (*Hæmadipsa*), 276, 297.
- Talmud, xiv, xvii.
Themison, leeches first used by, xxiv.
Theromyzon, 81.
Thompson, R. Campbell, vi.
Trachelobdella, 93.
trioculata (*Hirudo*), 60.
Trocheta, 151.
Trocheta, 151.
troctina (*Hirudo*), xxix.
tuberculata (*Glossiphonia*), 57.
turkestanica (*Limnatis*), 200, 201.
Turner, Prof. R. L., vii, viii.
undulata (*Placobdella*), 78.

- viridis* (*Hirudinaria*
 (*Pæcilobdella*)), 239.
vulnifera (*Paraolepsis*),
 91.
 Wang Chung, v.
weberi (*Barbronia*), 135.
- weberi* (*Dina*), 135.
weberi (*Glossiphonia*),
 62.
Whitmania, 168.
Whitmania sp., 185.
 Winckworth, Mr. C. P.
 T., vi.
- zeylanica* (*Hæmadipsa*),
 255, 297.
zeylanica (*Hirudo*),
 255.
zeylanica (*Sanguisuga*),
 253, 255.

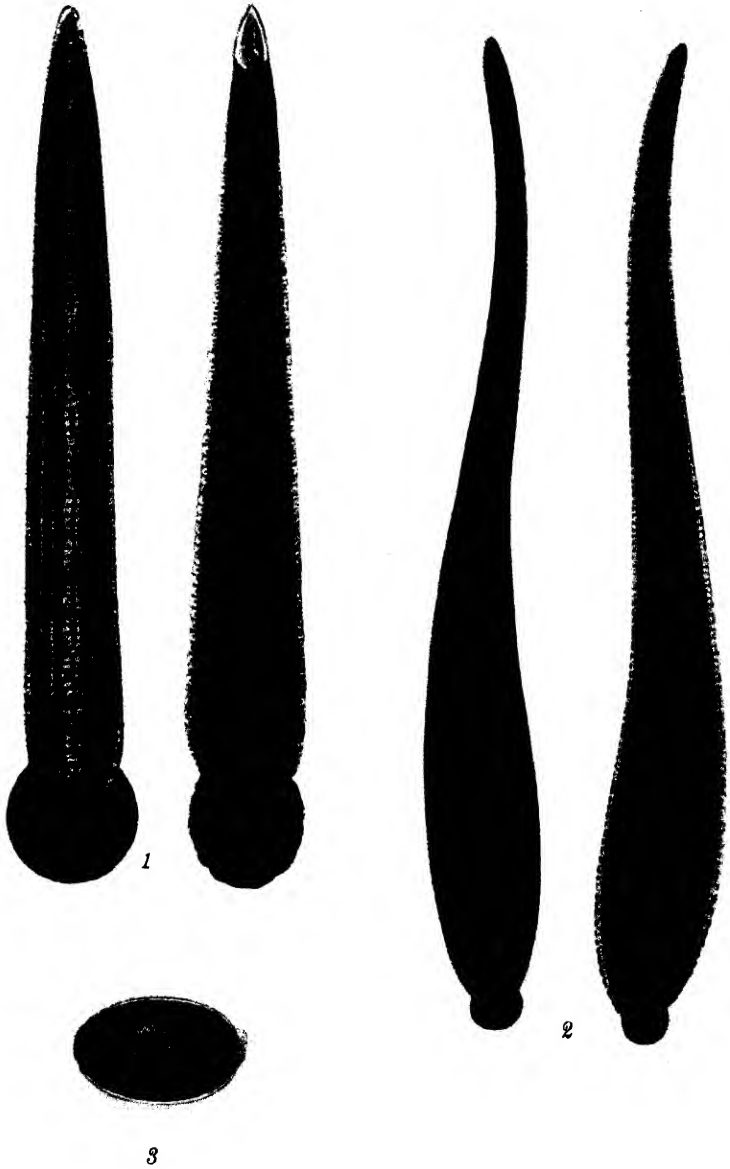

INDIAN ARHYNCHOBDELLÆ.
(For detailed Explanation, see p. xxxiv.)

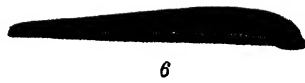
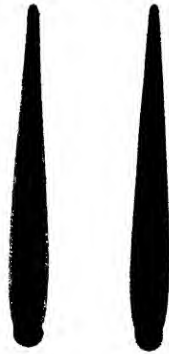

INDIAN ARHYNCHOBDELLÆ.
(For detailed Explanation, see p. xxxiv.)



INDIAN ARHYNCHOBDELLÆ.
(For detailed Explanation, see p. xxxv.)

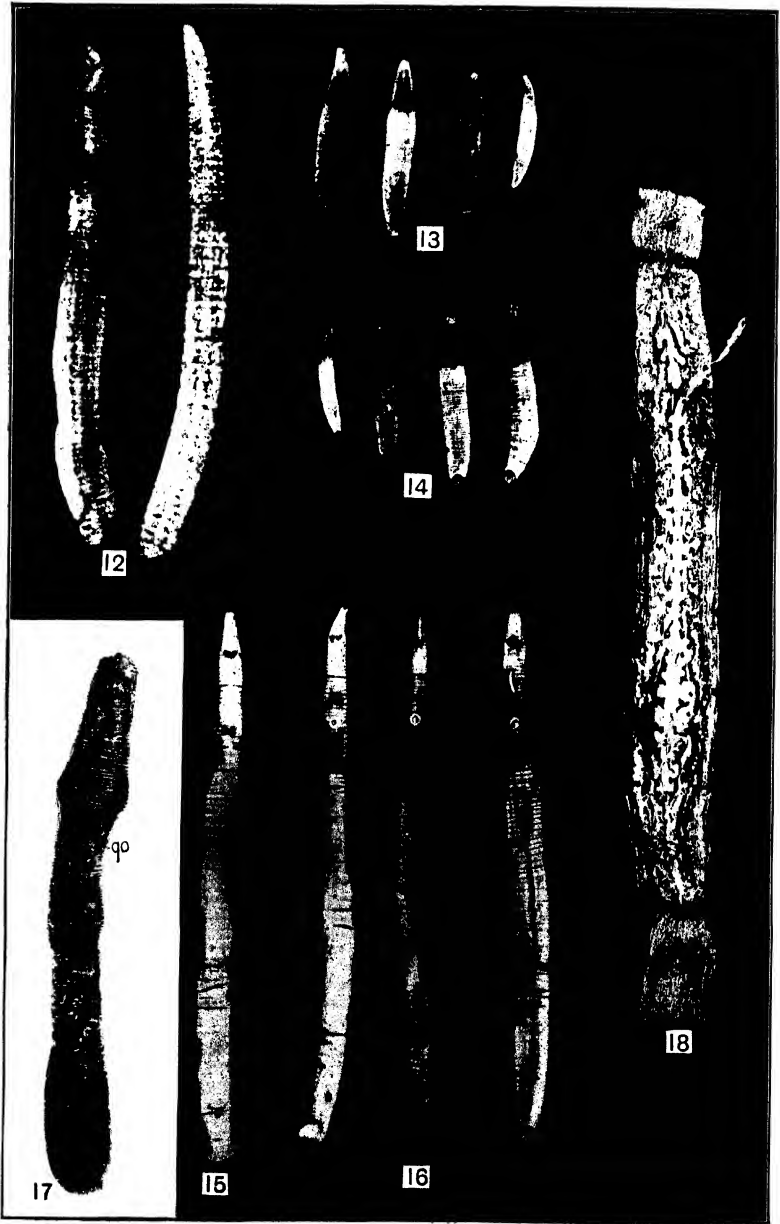

INDIAN ARHYNCHOBDELLÆ.
(For detailed Explanation, see p. xxxv.)

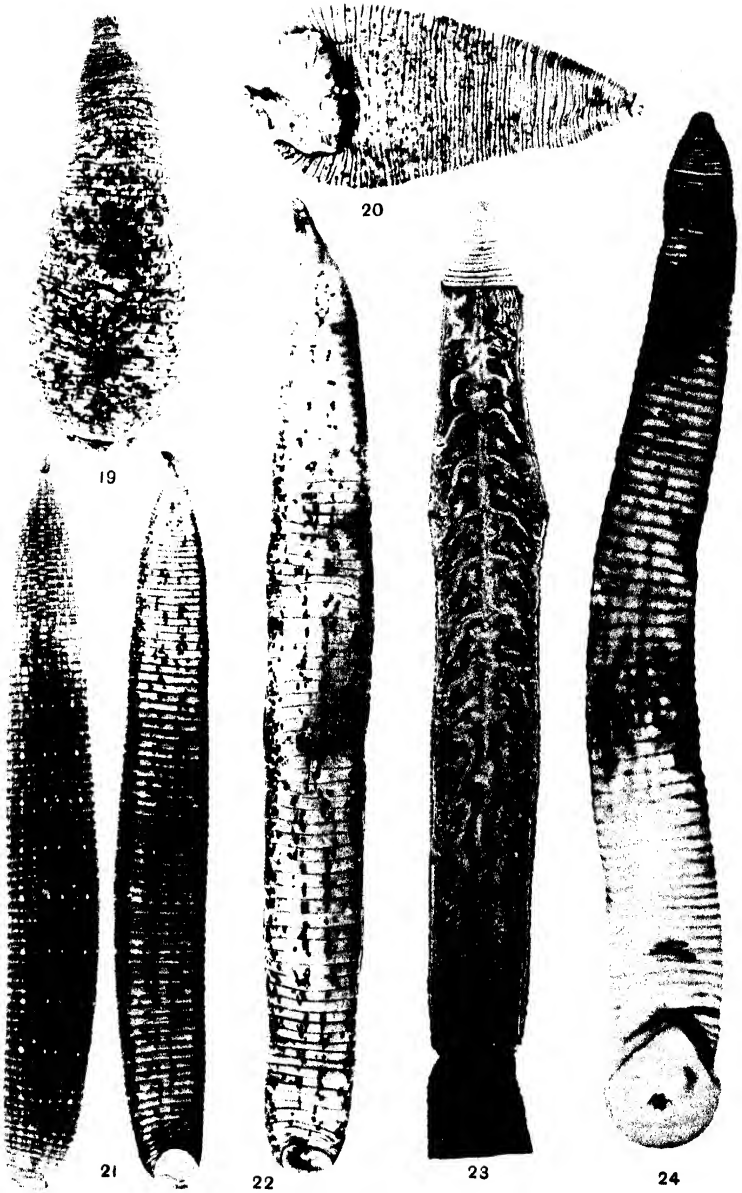

INDIAN ARHYNCHOBDELLÆ.
(For detailed Explanation, see p. xxxv.)



INDIAN ARYNCHOBDELLÆ.
(For detailed Explanation, see p. xxxvi.)

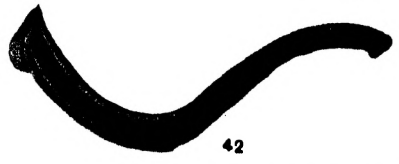
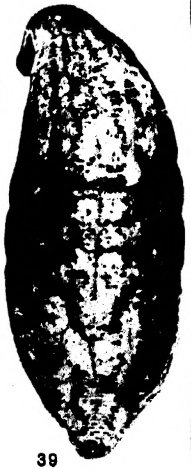
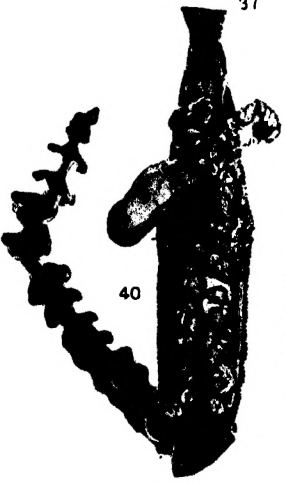
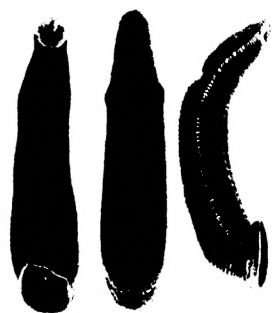
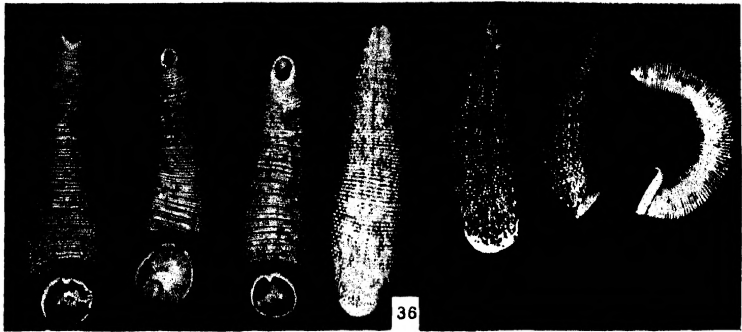

INDIAN ARHYNCHOBDELLÆ.
(For detailed Explanation, see p. xxxvi.)

