

# Birla Central Library

PILANI (Jaipur State)

Class No :- 549

Book No. :- D146 FM

Accession No - 33858





# DANA'S MANUAL OF MINERALOGY

FOR THE STUDENT OF ELEMENTARY MINER-  
ALOGY, THE MINING ENGINEER, THE  
GEOLOGIST, THE PROSPECTOR,  
THE COLLECTOR, ETC.

BY

WILLIAM E. FORD

Assistant Professor of Mineralogy in the Sheffield Scientific  
School of Yale University

*THIRTEENTH EDITION*

ENTIRELY REVISED AND REWRITTEN

TOTAL ISSUE, THIRTY-FIVE THOUSAND

NEW YORK  
JOHN WILEY & SONS, INC.  
LONDON: CHAPMAN & HALL, LIMITED

COPYRIGHT, 1912,  
BY  
EDWARD S. DANA AND WILLIAM E. FORD

—————  
COPYRIGHT, 1912, IN GREAT BRITAIN

**Stanbope Press**  
F. H. GILSON COMPANY  
BOSTON, U.S.A.

10-20

## PREFACE.

---

THE "Manual of Mineralogy" was first published by James Dwight Dana in 1848. A second edition was printed in 1850 and a "New Edition," which had been revised and enlarged, was published in 1857. The book was rearranged and rewritten for the third edition which appeared in 1878. This edition included an extensive chapter on rocks, and the title of the book was changed to "Manual of Mineralogy and Petrography." The fourth and last revision was published in 1887. Since that time the book has been frequently reprinted, so that the last edition was the twelfth. But it is now twenty-five years since the last revision of the text. Believing that the Manual has amply proved its usefulness, and with the desire of keeping the series of the Dana Mineralogies complete, Professor Edward S. Dana asked the author to prepare a new and revised edition. .

It was found that it was desirable to rewrite the book, and consequently, as far as the text and figures are concerned, this present edition is almost wholly new. The scope and character of the book, however, have been kept as nearly as possible the same. The book has been primarily designed to fill the ordinary needs of the elementary student of Mineralogy, the mining engineer, the geologist and the practical man who may be interested in the subject. It has been made brief and direct and the treatment has been as untechnical as possible.

The chapter on Petrography has been omitted and only a brief and general description of the various important rock types given. This change was made in view of the fact that since 1887 the subject of Petrography has had so large a development as to render impossible its adequate treatment in a single chapter. Moreover, several elementary books on the subject,

notably "Rocks and Rock Minerals" by L. V. Pirsson, are now available. Because of this, the title has been changed again to its original form and the book is to be known in the future as "Dana's Manual of Mineralogy."

The order adopted in the description of species has been changed to that of the chemical classification as used in the System of Mineralogy. It was felt that this was, on the whole, the most logical and useful arrangement. Following the description of the individual species, however, various tables are given, among them one in which the minerals are grouped according to their chief element. After each such list a general description of the association and occurrence of the minerals which it contains is given. Statistics of mineral production, etc., are given in Appendix II. It is intended by frequent revision of this portion of the book to keep the figures reasonably up to date.

The author has made free use of many sources in the preparation of the book. He is especially indebted to the sixth edition of "Dana's System of Mineralogy" and the "Text Book of Mineralogy" by E. S. Dana, to the "Brush-Penfield Determinative Mineralogy and Blowpipe Analysis" and to "Rocks and Rock Minerals" by L. V. Pirsson. He acknowledges gratefully the constant advice and criticism of Professor Edward S. Dana.

SHEFFIELD SCIENTIFIC SCHOOL OF YALE UNIVERSITY,  
NEW HAVEN, CONN., *June*, 1912.

## INTRODUCTION.

---

MINERALS are the materials of which the earth's crust consists and are therefore among the most common objects of daily observation. A mineral may be defined as a naturally occurring substance having a definite and uniform chemical composition with corresponding characteristic physical properties. This eliminates all artificial products of the laboratory which may conform to the last part of the definition. It also eliminates all natural products of organic agencies, since they will not show the uniform chemical and physical characters demanded of a mineral.

In the form of rocks, minerals make up the solid matter of the earth's crust. But in the great majority of cases a rock is not made up of a single mineral, but is a more or less heterogeneous aggregate of several different species. A few rocks, like limestone and quartzite, consist of but one mineral in a more or less pure state. In addition to occurring as essential and integral parts of rocks, minerals are found distributed through them in a scattered way, or in veins and cavities. Water is a mineral, but generally in an impure state from the presence of other minerals in solution. The atmosphere and all gaseous materials set free in volcanic and other regions are mineral in nature.

### Characters of Minerals.

1. Minerals, as previously stated, have a definite chemical composition. This composition, as determined by chemical analysis, serves to define and distinguish the species, and indicates their profoundest relations. Owing to difference in composition, minerals exhibit great differences when subjected to the action of various chemical reagents, and these peculiarities are a means of determining the kind of mineral under examination



in any case. The department of the science treating of the composition of minerals and their chemical reactions is termed *Chemical Mineralogy*.

2. Each mineral, with few exceptions, has its definite form, by which, when in good specimens, it may be known. These forms are cubes, prisms, pyramids, etc. They are included under plane surfaces arranged in symmetrical order, according to mathematical law. These forms are called crystals. Besides these outward forms there is also a distinctive internal structure for each species. The facts of this branch of the science come under the head of *Crystallographic Mineralogy*.

3. Minerals differ in hardness, from talc at one end of the scale to the diamond at the other. Minerals differ in specific gravity, and this character, like hardness, is a most important means of distinguishing species. Minerals differ in color, transparency, luster and other optical properties. The facts and principles relating to the above characters and others of a similar nature are included in the department of *Physical Mineralogy*.

4. The detailed descriptions of individual mineral species, including their chemical, crystallographic and general physical characters, together with their occurrence, associations, uses, etc., are included under the division known as *Descriptive Mineralogy*.

5. Lastly, the discussion of the methods that are used for identifying minerals forms the division known as *Determinative Mineralogy*.

These different branches of the subject are taken up in this book in the following order: **I. Crystallographic Mineralogy; II. Physical Mineralogy; III. Chemical Mineralogy; IV. Descriptive Mineralogy; V. Determinative Mineralogy.**

# TABLE OF CONTENTS.

	PAGE
INTRODUCTION.....	V
<b>I. CRYSTALLOGRAPHY.</b>	
INTRODUCTION.....	1
SYMMETRY .....	7
CRYSTAL NOTATION.....	9
DEFINITION OF VARIOUS TERMS.....	12
ISOMETRIC SYSTEM.....	16
TETRAGONAL SYSTEM.....	31
HEXAGONAL SYSTEM.....	37
ORTHORHOMBIC SYSTEM.....	47
MONOCLINIC SYSTEM.....	50
TRICLINIC SYSTEM.....	54
<b>II. GENERAL PHYSICAL PROPERTIES OF MINERALS.</b>	
STRUCTURE OF MINERALS.....	57
CLEAVAGE, PARTING AND FRACTURE.....	59
HARDNESS OF MINERALS.....	60
TENACITY OF MINERALS .....	62
SPECIFIC GRAVITY OF MINERALS .....	62
PROPERTIES DEPENDING UPON LIGHT	
Luster.....	65
Color of Minerals.....	67
Refraction of Light in Minerals .....	68
Double Refraction in Minerals.....	71
PYROELECTRICITY.....	72
<b>III. CHEMICAL MINERALOGY.</b>	
CHEMICAL GROUPS.....	74
DERIVATION OF A CHEMICAL FORMULA.....	75
CALCULATION OF PERCENTAGE COMPOSITION.....	76
ISOMORPHISM.....	77
ISOMORPHOUS GROUPS.....	79
DIMORPHISM, TRIMORPHISM, ETC.....	80
INSTRUMENTS, REAGENTS AND METHODS OF TESTING.....	80
TESTS FOR THE ELEMENTS.....	93

	PAGE
<b>IV. DESCRIPTIVE MINERALOGY.</b>	
DESCRIPTION OF SPECIES.....	115
LISTS OF MINERALS ARRANGED ACCORDING TO ELEMENTS..	309
OCCURRENCE AND ASSOCIATION OF MINERALS	
Rocks and Rock-making Minerals.....	328
Pegmatite Dikes and Veins.....	345
Contact Metamorphic Minerals.....	347
Veins and Vein Minerals.....	349
LISTS OF MINERALS ARRANGED ACCORDING TO SYSTEMS OF CRYSTALLIZATION.....	354
<b>V. DETERMINATIVE MINERALOGY.</b>	
INTRODUCTION.....	364
DETERMINATIVE TABLES.....	369
INDEX TO DETERMINATIVE TABLES.....	434
APPENDIX I. LIST OF MINERALS FOR A COLLECTION.....	436
APPENDIX II. MINERAL STATISTICS.....	437
INDEX.....	451

# MANUAL OF MINERALOGY.

---

## I. CRYSTALLOGRAPHY.

### I. INTRODUCTION.

THE great majority of our minerals, when the conditions of formation are favorable, occur in definite and characteristic geometrical forms which are known as crystals. To gain a comprehensive knowledge of the laws which govern the shape and character of crystals is a very important part of the study of mineralogy. This division of the subject is called crystallography. It forms almost a separate science in itself, and to adequately and exhaustively discuss it would require a volume much larger than the present one. In the following section, however, the attempt will be made to present the elements of crystallography in a brief and simple manner and at least to introduce the reader to the more essential facts and principles of the subject.

A crystal has been defined as follows: *A crystal is a body which by the operation of molecular affinity has assumed a definite internal structure with the form of a regular solid inclosed by a certain number of plane surfaces arranged according to the laws of symmetry.\** This is a very compact definition and several pages will be devoted to its discussion.

A better idea of the fundamental laws of crystallography will be obtained by first considering the three prominent modes of crystallization. Crystals are formed by crystallization either (1) from a solution, (2) from fusion, or (3) from a vapor. The first case, that of crystallization from solution, is the most familiar to our ordinary experience. Take for example a water solution

\* Century Dictionary.

containing sodium chloride (common salt). Suppose that by evaporation the water is slowly driven off. The solution will, under these conditions, gradually contain more and more salt per unit volume, and ultimately the point will be reached where the amount of water present can no longer hold all of the salt in solution, and this must begin to precipitate out. In other words, part of the sodium chloride, which has up to this point been held in a state of solution by the water, now assumes a solid form. If the conditions are so arranged that the evaporation of the water goes on very slowly, the separation of the salt in solid form will progress equally slowly and definite crystals will result. The particles of sodium chloride as they separate from the solution will by the laws of molecular attraction group themselves together and gradually build up a definitely shaped solid which we call a crystal. Crystals can also be formed from solution by lowering the temperature or pressure of the solution. Hot water will dissolve much more salt, for instance, than cold, and if a hot solution is allowed to cool, a point will be reached where the solution becomes supersaturated for its temperature and salt will crystallize out. Again, the higher the pressure to which water is subjected the more salt it can hold in solution. So with the lowering of the pressure of a saturated solution supersaturation will result and crystals form. Therefore, in general, crystals may form from a solution by the evaporation of the solvent, by the lowering of the temperature or by a decrease in pressure.

A crystal is formed from a fused mass in much the same way as from a solution. The most familiar example of crystallization from fusion is the formation of ice crystals when water freezes. While we do not ordinarily consider it in this way, water is fused ice. When the temperature is sufficiently lowered the water can no longer remain liquid, and it becomes solid by crystallization into ice. The particles of water which were free to move in any direction in the liquid now become fixed in their position, and by the laws of molecular attraction arrange themselves in a definite order and build up a solid crystalline mass. The formation of igneous rocks from molten lavas, while more

complicated, is similar to the freezing of water. In the fluid lava we have many elements in a dissociated state. As the lava cools these elements gradually group themselves into different mineral molecules, which gather together and slowly crystallize to form the mineral particles of the resulting solid rock.

The third mode of crystal formation, that in which the crystals are produced from a vapor, is less common than the other two described above. The principles that underlie the crystallization are much the same. The dissociated chemical atoms through the cooling of the gas are brought closer together until they at last form a solid with a definite crystal structure. An example of this mode of crystal formation is seen in the formation of sulphur crystals about the mouths of fumeroles in volcanic regions, where they have been crystallized from sulphur-bearing vapors.

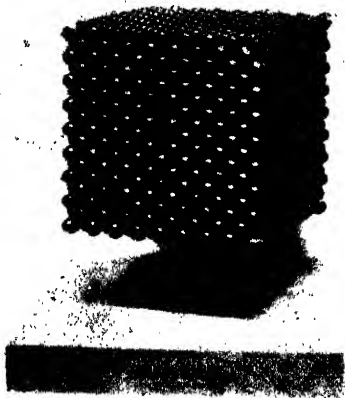
The most fundamental and important fact concerning crystals is that they possess a definite internal structure. A crystal is to be conceived as made up of an almost infinite number of excessively minute mineral particles which have a regular arrangement and relation to each other and form, as it were, a crystal network. Little is definitely known as to the character or size of these mineral particles. They may be the same as the chemical molecule, but more probably consist in definite groups of that molecule. There are many proofs that a crystal does possess a definite internal arrangement of its mineral particles, but the following three are the most important.

**Cleavage.** Many minerals when fractured break with definite and smooth flat surfaces which are known as cleavage planes. Common salt, halite, for instance, cleaves in three different planes which are at right angles to each other. It is said, therefore, to have a cubic cleavage. When it crystallizes it usually shows cubic forms also. The planes of cleavage are found to be always parallel to the natural cubic crystal faces. If the internal structure of halite was heterogeneous, the fact that it always shows this cubical cleavage would be inexplicable. It can only be explained by assuming some definite internal arrangement which permits and controls such a cleavage.

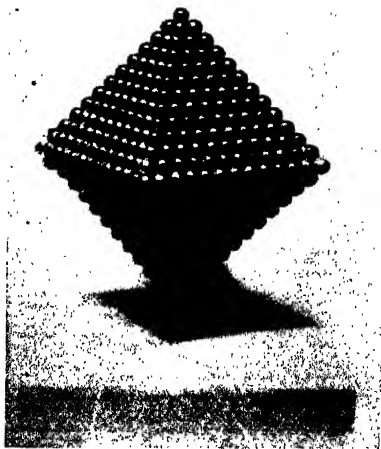
**Optical Properties.** All transparent crystals have definite effects upon the light which passes through them. Many of them further produce changes in the character of the light which cannot be accounted for except through the constraining influence of the internal structure of the mineral. Take the case of calcite as an example. In general, if you look at an object through a clear block of calcite you will observe a double image. The mineral, in other words, has the power of doubly refracting light. Further, it can be proved that each of the two rays into which calcite breaks up light has a definite plane of vibration, i.e., each ray is polarized. A piece of glass similar in shape to the calcite block would not have produced these effects, because the internal structure of glass is heterogeneous, while that of calcite is definite and regular.

**Regular and Constant Outward Form.** If a series of objects all having the same shape and size are grouped together according to some regular arrangement, the resulting mass will have a definite form which will bear a strict relationship to the character of the individual objects and the law which was followed in assembling them. As a simple illustration, consider an ordinary pile of bricks. If each individual brick is exactly like every other in size and all of them are piled together according to a regular plan, the shape of the resulting mass will depend directly upon the shape of the individual bricks and the law which governed their arrangement. Figs. A and B, Plate I, are reproductions from photographs of models which are built up solidly of small steel balls. All of the constituent particles of each model are exactly alike in shape and size, and they have been piled together according to a regular arrangement. The result has been, as is shown in the figures, to produce regularly and definitely shaped solids. If therefore a regular arrangement of uniform particles produces a solid with a definite shape, the converse proposition must be true. If we have a mineral which occurs in certain characteristic and uniformly shaped crystals (halite, for example, in cubes), it must follow that this could only be accomplished through the mineral possessing a regular internal structure.

PLATE I.



A. Cube.



B. Octahedron.  
Models made of Steel Balls.





**The Outward Crystal Form May Be Varied with the Same Internal Crystalline Structure.** There may be several different limiting forms possible upon crystals of the same mineral. Galena, PbS, for example, usually crystallizes in the form of a cube, but it also at times shows octahedral crystals. The internal structure of galena is constant, but both the cube and octahedron are forms that conform to that structure. The models shown on Plate I illustrate this point. Both are built up of similar particles and their arrangement is the same in each case. In one, however, (Fig. A), the planes of a cube, and in the other (Fig. B) the planes of an octahedron, limit the figure.

With the same internal structure there are, however, only a certain number of possible planes which can serve to limit a crystal. And it is to be noted, moreover, that of these possible planes there are only a comparatively few which commonly occur. The positions of the faces of a crystal are determined by those directions in which on account of the internal structure a large number of the individual mineral particles lie. And those planes which include the greater number of particles are the ones

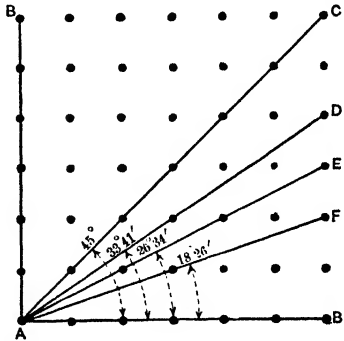


Fig. 1.

most commonly found as faces upon the crystals. Consider Fig. 1, which might represent one layer of particles in a certain crystal network. The particles are equally spaced from each other and have a rectilinear arrangement. It will be observed that there are several possible lines through this network that include a greater or less number of the particles. These lines would represent the cutting direction through this network of certain possible crystal planes; and it would be found that of these possible planes those which include the larger number of particles, like those cutting along the lines A-B and A-C, would be the more common in occurrence.

**Law of the Constancy of Interfacial Angles.** Since the internal structure of any mineral is always constant, and since the possible crystal faces of that mineral have a definite relationship to that structure, it follows that the faces must have also a definite relationship to each other. This fact may be stated as follows: *The angles between two similar faces on the same substance are always the same.* Fig. 1 will also illustrate this point. The face which cuts the network along the line  $A-C$  must make an angle of 45 degrees with the face which cuts along the line  $A-B$ , etc. This law is the most fundamental and important in the science of crystallography. It frequently enables one to identify a mineral by the measurement of the interfacial angles on its crystals. A mineral may be found in crystals of widely varying shapes and sizes, but the angle between two similar faces will always be the same.

An important part of the study of crystallography consists in the measuring and classifying of the interfacial angles on the crystals of all minerals. These measurements are accomplished by means of instruments known as goniometers. For accurate work, particularly in the case of small crystals, a type of instrument known as a reflection goniometer is used. This is an instrument upon which the crystal to be measured is mounted so as to reflect beams of light from its faces through a telescope to the eye. The size of the angle through which a crystal has to be turned in order to throw successive beams of light from two adjacent faces into the telescope determines the angle existing between the faces. A simpler instrument used for approximate work and with larger crystals is known as a contact goniometer. Its character and use are illustrated by Fig. 2.

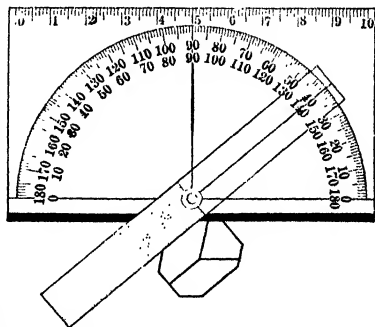


Fig. 2. Contact Goniometer.

The regular internal structure of crystals requires that the ultimate individual mineral particles must be at least physically alike. A physical likeness between these particles necessitates that they should also be the same chemically, or at least closely similar. Consequently we can state that in general a crystal must be made up of a regular assemblage of particles which are chemically the same, and therefore that a crystallized mineral must have a definite and uniform chemical composition. This statement is a general one and will suffice for the present; certain modifications will be found stated on page 77 under isomorphism. A crystal is a guarantee of the chemical homogeneity of a mineral. From this it follows that only definite chemical compounds are capable of crystallization.

To sum up the conclusions of the preceding paragraphs: *A crystal is a solid with definite chemical composition which possesses a definite internal arrangement of its mineral particles. These internal characteristics are expressed outwardly in a definite external form. And since the internal structure of the same substance is always constant, the angles between the similar bounding planes of the crystals of that substance are also constant.*

## II. SYMMETRY.

Crystals are grouped together into different classes according to the symmetry which they show. The symmetry of crystals is of three kinds, namely: 1. Symmetry in respect to a plane; 2. Symmetry in respect to a line; 3. Symmetry in respect to a point.

**Symmetry Plane.** A symmetry plane is an imaginary plane which divides a crystal into halves, each of which is the mirror image of the other. Fig. 3 will illustrate the character of such a plane. The shaded portion of the figure shows the position of the one plane of symmetry that a crystal of this sort possesses. For each face, edge or point on one side of the plane there is a corresponding face, edge or point in a similar position on the other side of the plane.

**Symmetry Axis.** A symmetry axis is an imaginary line through a crystal about which the crystal may be revolved as

upon an axis and repeat itself in appearance two or more times during the revolution. In Fig. 4 the line  $C-C'$  is an axis of symmetry, for when the crystal represented is revolved upon it, it will have, after a revolution of  $180^\circ$ , the same appearance as at first; or in other words, similar planes, edges, etc., will appear in the places of the corresponding planes and edges of the original position. Point  $A'$  will occupy the original position of  $A$ ,  $B'$  that of  $B$ , etc. Since the crystal is repeated twice in appearance during a complete revolution, this axis is said to be one of binary or twofold symmetry. In addition to axes of binary symmetry, we have axes of trigonal (threefold), tetragonal (fourfold) and hexagonal (sixfold) symmetry.

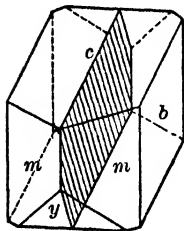


Fig. 3.  
Symmetry Plane.

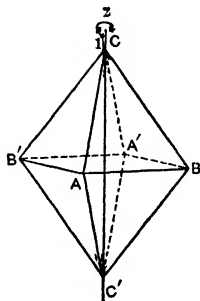


Fig. 4.  
Symmetry Axis.

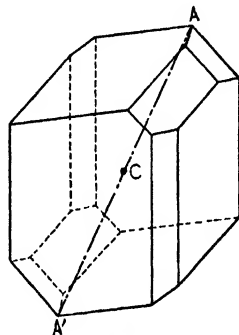


Fig. 5.  
Symmetry Center.

**Center of Symmetry.** A crystal has a center of symmetry if an imaginary line is passed from some point on its surface through its center, and a similar point is found on the line at an equal distance beyond the center. The crystal represented in Fig. 5 has a center of symmetry, for the point  $A$  is repeated at  $A'$  on a line passing from  $A$  through the center,  $C$ , of the crystal, the distances  $AC$  and  $A'C$  being equal.

All possible crystal forms can be grouped into thirty-two classes depending upon the different degrees of symmetry which they show. These thirty-two classes may be further grouped into six systems, the classes of each system having certain close

relations to each other. These systems are known as the Isometric, Tetragonal, Hexagonal, Orthorhombic, Monoclinic and Triclinic Systems. All crystals will be found to belong to one or the other of these systems. As stated above, there are thirty-two possible subdivisions of these six systems, but the majority of them are only of theoretical interest, since practically all known species can be placed in one or the other of some ten or twelve classes.

### III. CRYSTAL NOTATION.

A system of notation has been developed by which we can describe the different crystal classes and the crystal forms found in each. One of the important conceptions to this end is that of *crystallographic axes*.

**Crystallographic Axes.** Crystallographic axes are imaginary lines or directions within a crystal to which the crystal faces are referred and in terms of which they are described. In the different systems the axes vary in number (three or four), in their relative lengths and in the angles of inclination to each other. As a general case we will consider the crystallographic axes of the Orthorhombic System. They are three in number, at right angles to each other, and each has a characteristic relative length. Fig. 6 represents such axes for the orthorhombic mineral sulphur. When placed in the proper position for description, or "oriented" as it is termed, one axis called  $a$  is horizontal and perpendicular to the observer, another axis, called  $b$ , is horizontal and parallel to the observer, while the third axis, called  $c$ , is vertical. The ends of each axis are designated by either a plus or a minus sign, the front end of  $a$ , the right-hand end of  $b$  and the upper end of  $c$  being positive, while in each case the opposite end is negative. When, as in the Orthorhombic System, the three axes have different relative lengths, these values have to be determined experimentally by making the necessary measurements on crystals of each mineral. Fig. 7 would represent a crystal of sulphur in which each face of the crystal form, known as a pyramid, intercepts each axis at what is considered as its unit length. From the values obtained by measuring the angles

between the different faces of this crystal an expression of the relative lengths of the three axes can be obtained by calculation. The length of the  $b$  axis is taken as unity and the lengths of the  $a$  and  $c$  axes are expressed in terms of it. The axial ratio for sulphur is  $a : b : c = 0.813 : 1.00 : 1.903$ . It must be borne in mind that these lengths are only relative in their value. They do not represent any actual distances. A sulphur crystal may be of microscopic size or several inches in diameter, but in either case the above ratio would hold true.

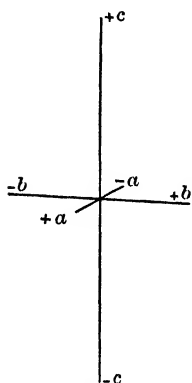


Fig. 6.  
Orthorhombic  
Crystal Axes.

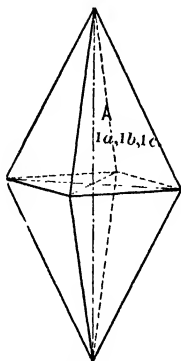


Fig. 7.  
Orthorhombic  
Pyramid.

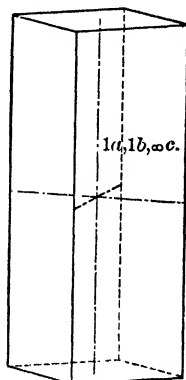


Fig. 8.  
Orthorhombic  
Prism.

**Parameters.** Crystal faces are described according to their relations to the crystallographic axes. A series of numbers which indicate the relative distances by which a face intersects the different axes are called its parameters. A face which cuts all three axes at distances from the point of their intersection which are relatively the same as the unit lengths of the axes is said to have the following parameters:  $1a, 1b, 1c$  (see Fig. 7). A face which cuts the two horizontal axes at distances which are relatively to each other as the unit lengths of those axes but is parallel to the vertical axis would have for parameters  $1a, 1b, \infty c$  (see Fig. 8). If a face cuts the two horizontal axes at distances proportional to their unit lengths and cuts the vertical axis at

a distance twice its relative unit length, it will have for parameters  $1a, 1b, 2c$ . It is to be emphasized that these parameters are strictly relative in their values and do not indicate any actual cutting lengths. To further illustrate this, consider Fig. 9, which represents a possible sulphur crystal. The forms present upon it are two pyramids of different slope but each intersecting all three of the crystal axes when properly extended. The lower pyramid intersects the two horizontal axes at distances which are proportional to their unit lengths and if it was extended as shown by the dotted lines would also cut the vertical axis at a distance proportional to its unit length. The parameters of the face of this form which cuts the positive ends of the three axes would be  $1a, 1b, 1c$ . The upper pyramid would cut the two horizontal axes, as shown by the dotted lines, also at distances which, although greater than in the case of the lower pyramid, are still proportional to their unit lengths. It cuts the vertical axis, however, at a distance which, when considered in respect to its intersections with the horizontal axes, is proportional to one-half of the unit length of  $c$ . The parameters of a face of this form would therefore be  $1a, 1b, \frac{1}{2}c$ . From this example it will be seen that the parameters  $1a, 1b$ , do not in the two cases represent the same actual cutting distances but express only relative values. The parameters of a face do not in any way determine its size, for a face may be moved parallel to itself for any distance without changing the relative values of its intersections with the crystallographic axes.

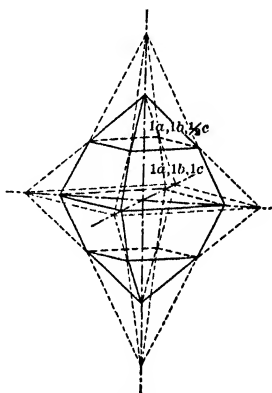


Fig. 9.

The upper pyramid would cut the two horizontal axes, as shown by the dotted lines, also at distances which, although greater than in the case of the lower pyramid, are still proportional to their unit lengths. It cuts the vertical axis, however, at a distance which, when considered in respect to its intersections with the horizontal axes, is proportional to one-half of the unit length of  $c$ . The parameters of a face of this form would therefore be  $1a, 1b, \frac{1}{2}c$ . From this example it will be seen that the parameters  $1a, 1b$ , do not in the two cases represent the same actual cutting distances but express only relative values. The parameters of a face do not in any way determine its size, for a face may be moved parallel to itself for any distance without changing the relative values of its intersections with the crystallographic axes.

**Law of Definite Mathematical Ratio.** It is to be noted that in general the ratio of the intercepts of a crystal face upon the crystallographic axes can be expressed by whole numbers or definite fractions. These numbers, or fractions, are commonly



simple, such as 1, 2, 3,  $\frac{1}{2}$ ,  $\frac{1}{3}$ ,  $\frac{2}{3}$ , etc., and in the great majority of cases are 1 or  $\infty$ . This law, that the axial intercepts of all crystal faces form a definite mathematical ratio, is an extremely important one. It is a necessary corollary to the theoretical considerations given on page 5 and following.

**Indices.** Various methods of notation have been devised to express the intercepts of any crystal face upon the crystal axes, and several different ones are in common use. The most universally employed is the system of indices of Miller. While not as simple for a beginner, perhaps, as some one of the systems in which the parameters of the crystal faces are used, it adapts itself so much more readily to crystallographic calculations and consequently has so wide a use that it seems wise to introduce it here.

The indices of a face consist of a series of whole numbers which have been derived from its parameters by their inversion and, if necessary, the subsequent clearing of fractions. The indices of a face are always given, so that the three numbers refer to the  $a$ ,  $b$  and  $c$  axes respectively, and therefore ordinarily the letters which indicate the different axes are omitted. The pyramid illustrated in Fig. 7, which has  $1a$ ,  $1b$ ,  $1c$  for parameters, would have 111 for indices. The face, Fig. 8, which has  $1a$ ,  $1b$ ,  $\infty c$  for parameters, would have 110 for indices. The face, Fig. 9, which has  $1a$ ,  $1b$ ,  $\frac{1}{2}c$  for parameters, would have 112 for indices. A face which has  $1a$ ,  $1b$ ,  $2c$  for parameters would have 221 for indices.

Common use is made of what is known as the *symbol* of a form. A symbol of any form consists of the indices of the face having the simplest relations to the axes. This is used when it is desired to refer to some particular crystal form, and the symbol then stands for the whole form and not simply for the single face whose indices it is.

#### IV. DEFINITIONS OF VARIOUS TERMS.

**Crystal Form.** By the expression "crystal form" is meant the assemblage of all similar faces which are possible with a certain degree of symmetry. In Fig. 7 is represented a crystal form known as a pyramid. In the particular symmetry class

to which it belongs the three crystal axes are axes of binary symmetry and the axial planes are planes of symmetry. Under these conditions, if we assume the presence of the face *A* we must have the other seven faces also in order to satisfy the demands of the symmetry. In this case the assemblage of the eight pyramidal faces constitutes the crystal form. A crystal form does not necessarily make a solid figure. Consider Fig. 10, which is of a crystal of the Monoclinic System. In this system the *b* axis is an axis of binary symmetry and the plane of the *a* and *c* axes is a symmetry plane. Under these conditions, if we assume the presence of the plane *b*, the symmetry demands only the parallel face *b'*. So these two faces, being all the possible similar planes with this particular symmetry, constitute a crystal form. There are three crystal forms present on the crystal represented in Fig. 10.

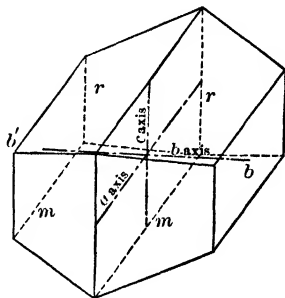


Fig. 10.

There are three crystal forms present on the crystal represented in Fig. 10.

**Crystal Habit.** By the crystal habit of any mineral is meant the common and characteristic form or combination of forms in which that mineral crystallizes. Galena, for example, has a cubic, magnetite an octahedral and garnet a dodecahedral habit. By this is meant that, although these minerals are found in crystals which show other forms, such occurrences are comparatively rare, and their "*habit*" is to crystallize as indicated.

**Crystal Combinations.** In the great majority of cases, a crystal will show a combination of two or more crystal forms rather than one single form. In fact, many crystal forms, since they do not make a solid figure by themselves, must occur in combination with other forms. The combination in which it occurs may quite change the appearance of a form, and its recognition will depend upon the position and relation of its faces rather than upon their shape. Fig. 11 is of a simple form known as a cube, and Fig. 12 is of a simple form known as an octahedron. Fig. 13 shows a combination of the two, in which the corners of

the cube are truncated by the faces of the octahedron, while Fig. 14 shows the same two forms in a combination in which the points of the octahedron are truncated by the faces of the cube. When a corner or an edge of one form is replaced by a face of another form, the first is said to be *truncated* by the second. If an edge is replaced by two similar faces it is said to be *beveled*.

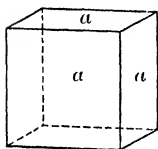


Fig. 11.  
Cube.

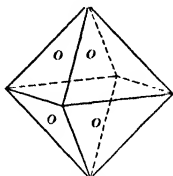


Fig. 12.  
Octahedron.

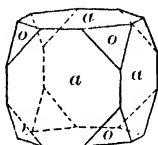


Fig. 13.  
Cube Truncated  
by Octahedron.

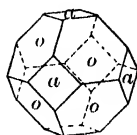


Fig. 14.  
Octahedron Trun-  
cated by Cube.

**Crystal Distortion.** It seldom happens that the conditions for crystal growth are such as to permit the development of crystals of ideal symmetry. The crystal may have grown more rapidly in one direction than in another; other surrounding minerals may have interfered, and in various ways its symmetrical growth been prevented. Such a crystal is said to show distortion.

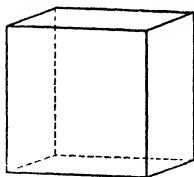


Fig. 15. Cube.

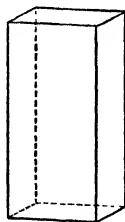


Fig. 16. Distorted Cube.

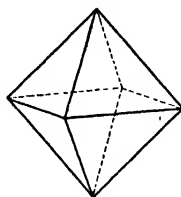


Fig. 17. Octahedron.

Ordinarily the amount of distortion is not so great as to prevent one from readily imagining what the ideally developed crystal would be like and so determining its symmetry and character. It is to be noted that the real symmetry of a crystal does not depend upon the symmetrical shape and size of its faces, but rather upon the symmetrical arrangement of its interfacial

angles. In the Figs. 15 and 16, 17 and 18, 19 and 20, are given various crystal forms, first ideally developed and then distorted.

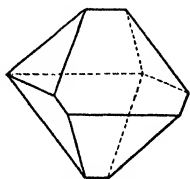


Fig. 18.  
Distorted Octahedron.

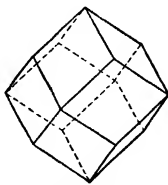


Fig. 19.  
Dodecahedron.

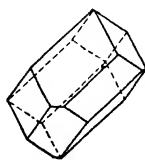


Fig. 20.  
Distorted Dodecahedron.

**Crystal Pseudomorphs.** At times we find a mineral occurring in crystals which prove to be not the characteristic forms for that mineral, but are rather the typical forms of some other species. Such crystals are said to be *pseudomorphs*, or *false forms*. They originate in various ways. The mineral may have changed in its composition without, however, changing its crystal form. We find, for example, that cuprite,  $\text{Cu}_2\text{O}$ , frequently alters to malachite,  $\text{CuCO}_3 \cdot \text{Cu}(\text{OH})_2$ , but without a change in the crystal shape. The resulting crystals would have the composition of malachite but the crystal form of cuprite. Another mode of origin is to have one mineral deposited on the crystals of another and so form, as it were, a cast of the second. Smithsonite,  $\text{ZnCO}_3$ , is at times found in pseudomorphic crystals whose forms are those of calcite. In this case the smithsonite has been deposited in a thin layer over the crystal of calcite, which may have subsequently been removed. The resulting crystal is a pseudomorph of smithsonite after calcite. Pseudomorphs cannot be regarded as true crystals, since their internal structure does not correspond to the outward crystal form.

**Twin Crystals.** When two or more crystals intergrow according to some definite law, the resulting group is said to be a twin crystal. The different members, ordinarily two, of a twin crystal have usually a plane, known as a twinning plane, or an axis, known as a twinning axis, which is common to both. In Fig. 21, which represents a twin crystal of fluorite, we have two cubes intergrown in such a way that the diagonal axis  $A-A'$  is

common to the two individuals. The individual, the faces of which are shaded in the figure, lies as if it had been turned about this axis from the position occupied by the other individual through an angle of 60 degrees. The line  $A-A'$  is known as the twinning axis. In Fig. 22 is represented a twinned octahedron. The two individuals here are grown together with an octahedral

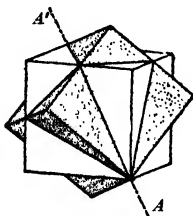


Fig. 21. Twinned Cubes.

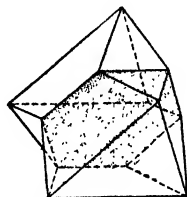


Fig. 22. Twinned Octahedron.

face in common. It will be noted that the composition plane, which is shaded, is parallel to one face of each individual. This plane is known as the twinning plane. The twin of Fig. 21 is known as a penetration twin, since the two individuals interpenetrate each other; while the twin of Fig. 22 is a contact twin, since the two individuals lie simply in contact with each other upon a certain plane.

## V. ISOMETRIC SYSTEM.

**Crystallographic Axes.** The crystallographic axes of the Isometric System are three in number, of equal lengths, and make right angles with each other. When properly orientated one axis is vertical and the other two are horizontal, one being parallel and the other perpendicular to the observer, as is shown in Fig. 23. Since the three axes are identical in character, they are interchangeable, and any one of them may serve as the vertical axis, etc. In giving the indices

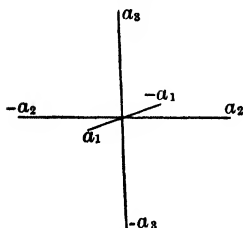


Fig. 23. Isometric Axes.

of a face of an isometric form, the order of the axes, etc., is the same as described in a previous paragraph, page 9.

## Normal Class.

**Symmetry and Forms.** The symmetry shown by the crystals of the Normal Class of the Isometric System is as follows. The three crystallographic axes are axes of tetragonal symmetry (see Fig. 24). There are also four diagonal axes of trigonal symmetry. These axes emerge in the middle of each of the octants formed by the intersection of the crystallographic axes (see Fig. 25). Further, there are six diagonal axes of binary symmetry, each of which bisects one of the angles between two of the crystallographic axes, as illustrated in Fig. 26.

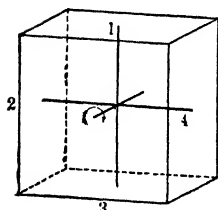


Fig. 24.

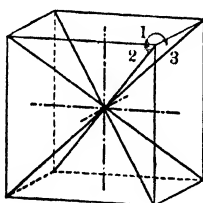


Fig. 25.

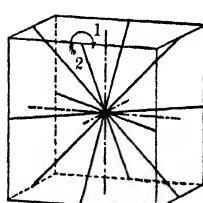


Fig. 26.

Axes of Symmetry, Isometric System, Normal Class.

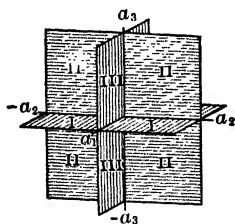


Fig. 27.

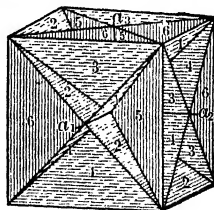


Fig. 28.

Planes of Symmetry, Isometric System, Normal Class.

This class shows nine planes of symmetry, three of them being known as the axial planes, since each includes two crystallographic axes (see Fig. 27), and six being called diagonal planes, since each bisects the angle between two of the axial planes (see Fig. 28).

To summarize the symmetry of this class:

3 crystallographic axes of tetragonal symmetry;

4 diagonal axes of trigonal symmetry;

6 diagonal axes of binary symmetry;

3 axial planes of symmetry;

6 diagonal planes of symmetry.

This symmetry, which is of the highest degree possible in solids with plane surfaces, defines the Normal Class of the Isometric System. Every crystal form and every combination of forms that belongs to this class must show its complete symmetry. It is important to remember that in this class the three crystallographic axes are axes of tetragonal symmetry, since this fact distinguishes the class from all others and by means of it the crystallographic axes can be easily located and a crystal properly orientated.

The forms of the Isometric System, Normal Class, are as follows:

1. *Cube or Hexahedron.* The cube is a form composed of six square faces which make  $90^\circ$  angles with each other. Each face intersects one of the crystallographic axes and is parallel to the other two. Its symbol is (100). Fig. 29 represents a simple cube.

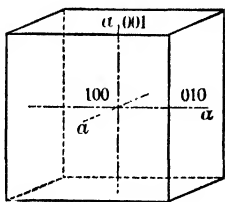


Fig. 29. Cube.

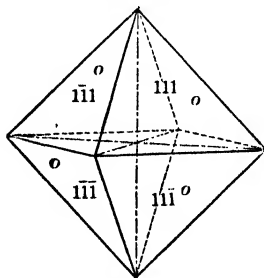


Fig. 30. Octahedron.

2. *Octahedron.* The octahedron is a form composed of eight equilateral triangular faces, each of which intersects all three of the crystallographic axes equally. Its symbol is (111). Fig. 30 represents a simple octahedron and Figs. 31 and 32 show combinations of a cube and an octahedron. When in combination

the octahedron is to be recognized by its eight similar faces, each of which is equally inclined to the three crystallographic axes. It is to be noted that the faces of an octahedron truncate symmetrically the corners of a cube.

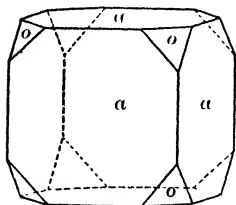


Fig. 31.  
Cube and Octahedron.

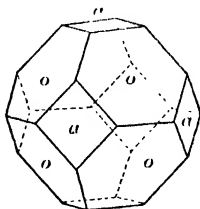


Fig. 32.  
Octahedron and Cube.

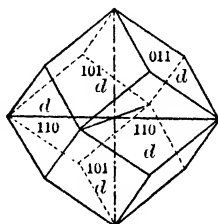


Fig. 33.  
Dodecahedron.

3. *Dodecahedron.* The dodecahedron is a form composed of twelve rhombic-shaped faces. Each face intersects two of the crystallographic axes equally and is parallel to the third. Its symbol is (110). Fig. 33 shows a simple dodecahedron, Fig. 34 shows a combination of dodecahedron and cube, Figs. 35 and 36 combinations of dodecahedron and octahedron, and Fig. 37 a combination of cube, octahedron and dodecahedron. It is to be noted that the faces of a dodecahedron truncate the edges of both the cube and the octahedron.

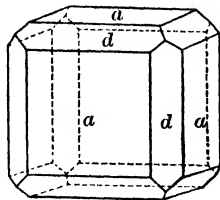


Fig. 34.  
Cube and Dodecahedron.

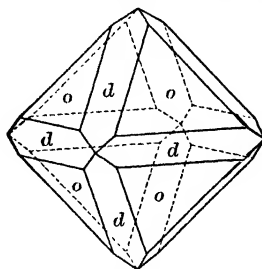


Fig. 35.  
Octahedron and Dodecahedron.

4. *Tetrahexahedron.* The tetrahexahedron is a form composed of twenty-four isosceles triangular faces, each of which intersects one axis at unity, the second at some multiple, and is



parallel to the third. There are a number of tetrahexahedrons which differ from each other in respect to the inclination of their faces. Perhaps the one most common in occurrence has the parameter relations  $1a, 2b, \infty c$ , the symbol of which would be (210). The symbols of other forms are (310), (410), (320), etc. It is helpful to note that the tetrahexahedron, as its name indicates, is like a cube, the faces of which have been replaced by four others. Fig. 38 shows a simple tetrahexahedron and Fig. 39 a cube with its edges beveled by the faces of a tetrahexahedron.

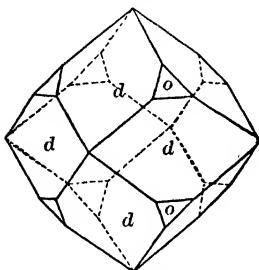


Fig. 36.  
Dodecahedron and Octahedron.

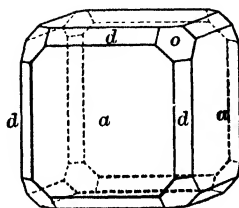


Fig. 37.  
Cube, Octahedron and Dodecahedron.

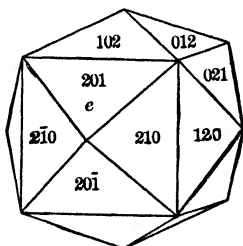


Fig. 38.  
Tetrahexahedron.

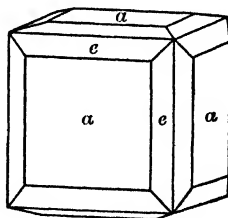


Fig. 39.  
Cube and Tetrahexahedron.

5. *Trapezohedron or Tetragonal Trisoctahedron.* The trapezohedron is a form composed of twenty-four trapezium-shaped faces, each of which intersects one of the crystallographic axes at unity and the other two at equal multiples. There are various trapezohedrons with their faces having different angles of inclination. A common trapezohedron has for its parameters

1*a*, 2*b*, 2*c*, the symbol for which would be (211). The symbols for other trapezohedrons are (311), (411), (322), etc. It will be noted that a trapezohedron is an octahedral-like form and may be conceived of as an octahedron, each of the planes of which has been replaced by three faces. Consequently it is sometimes called a tetragonal trisoctahedron. The qualifying word, tetragonal, is used to indicate that each of its faces has four edges and to distinguish it from the other trisoctahedral form, the

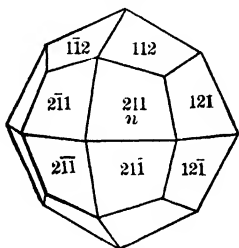


Fig. 40.  
Trapezohedron.

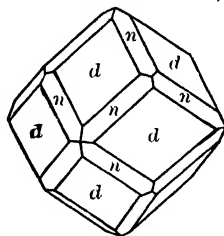


Fig. 41.  
Dodecahedron and Trapezohedron.

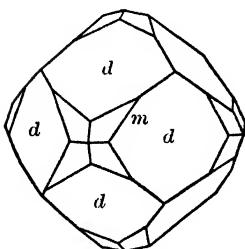


Fig. 42.  
Dodecahedron and Trapezohedron.

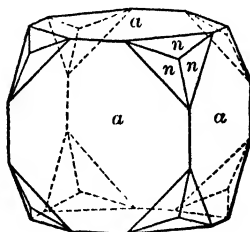


Fig. 43.  
Cube and Trapezohedron.

description of which follows. Trapezohedron is the name, however, most commonly used. The following are aids to the recognition of the form when it occurs in combinations: the three similar faces to be found in each octant; the relations of each face to the axes; and the fact that the middle edges between the three faces in any one octant go toward points which are equidistant from the ends of the two adjacent crystallographic axes. Fig. 40 shows a simple trapezohedron, and Figs. 41 and 42 show

each a trapezohedron in combination with a dodecahedron. It is to be noted that the faces of the common trapezohedron (211) (Fig. 41) truncate the edges of the dodecahedron. Fig. 43 shows a combination of cube and trapezohedron.

6. *Trisoctahedron or Trigonal Trisoctahedron.* The trisoctahedron is a form composed of twenty-four isosceles triangular faces, each of which intersects two of the crystallographic axes at unity and the third axis at some multiple. There are various trisoctahedrons the faces of which have different inclinations. A common trisoctahedron has for its parameters  $1a, 1b, 2c$ , its symbol being (221). Other trisoctahedrons have the symbols (331), (441), (332), etc. It is to be noted that the trisoctahedron, like the trapezohedron, is a form that may be conceived of as an octahedron, each face of which has been replaced by three others. Frequently it is spoken of as the trigonal trisoctahedron, the modifying word indicating that its faces have each three edges and so differ from those of the trapezohedron. But when the word "trisoctahedron" is used alone it refers to this form. The following points would aid in its identification when it is found occurring in combinations: the three similar faces in each octant; their relations to the axes; and the fact that the middle edges between them go toward the ends of the crystallographic axes.

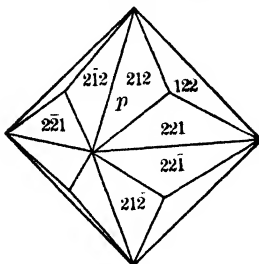


Fig. 44.  
Trisoctahedron.

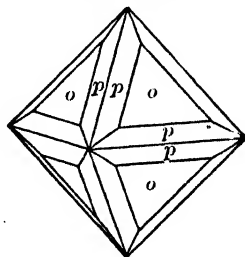


Fig. 45.  
Octahedron and Trisoctahedron.

Fig. 44 shows the simple trisoctahedron and Fig. 45 a combination of a trisoctahedron and an octahedron. It will be noted that the faces of the trisoctahedron bevel the edges of the octahedron.

7. *Hexoctahedron.* The hexoctahedron is a form composed of forty-eight triangular faces, each of which cuts differently on all three crystallographic axes. There are several hexoctahedrons, which have varying ratios of intersection with the axes. A common hexoctahedron has for its parameter relations  $1a$ ,  $\frac{2}{3}b$ ,  $3c$ , its symbol being  $(321)$ . Other hexoctahedrons have the symbols  $(421)$ ,  $(531)$ ,  $(432)$ , etc. It is to be noted that the hex-

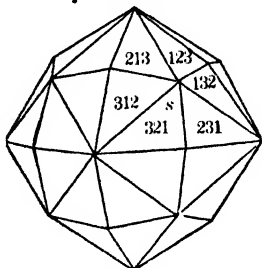


Fig. 46.  
Hexoctahedron.

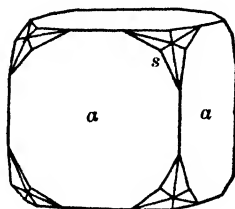


Fig. 47.  
Cube and Hexoctahedron.

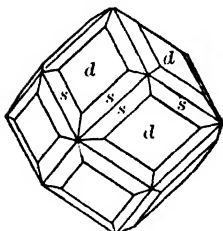


Fig. 48.  
Dodecahedron and Hexoctahedron.

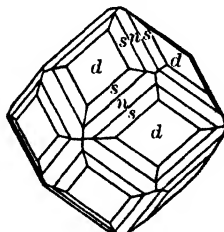


Fig. 49.  
Dodecahedron, Trapezohedron and  
Hexoctahedron.

octahedron is a form that may be considered as an octahedron, each face of which has been replaced by six others. It is to be recognized when in combination by the facts that there are six similar faces in each octant and that each face intercepts the three axes differently. Fig. 46 shows a simple hexoctahedron, Fig. 47 a combination of cube and hexoctahedron, Fig. 48 a combination of dodecahedron and hexoctahedron, and Fig. 49 a combination of dodecahedron, trapezohedron and hexoctahedron.

*Occurrence of the Above Forms.* The cube, octahedron and dodecahedron are the most common of the isometric forms. The trapezohedron is also frequently observed on a few minerals. The other forms, the tetrahexahedron, trisoctahedron and hexoctahedron, are rare and are ordinarily to be observed only as small truncations in combinations.

The following is a list of the commoner minerals upon the crystals of which each form is prominent:

Cube: Galena, halite, sylvite, fluorite, cuprite.

Octahedron: Spinel, magnetite, franklinite, chromite.

Dodecahedron: Magnetite, garnet.

Trapezohedron: Leucite, garnet, analcite.

### Pyritohedral Class.

The Pyritohedral Class is one of the subordinate divisions of the Isometric System. It differs from the Normal Class, since its crystals commonly show forms that do not possess as high a symmetry as those of that class. The name of the class is derived from that of its chief member, pyrite.

**Symmetry and Forms.** The symmetry of the Pyritohedral Class is as follows: The three crystal axes are axes of binary

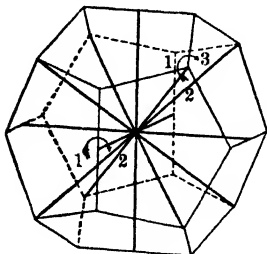


Fig. 50.  
Symmetry of Pyritohedral Class, Isometric System.

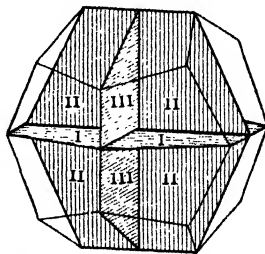


Fig. 51.

symmetry; the four diagonal axes, each of which emerges in the middle of an octant, are axes of trigonal symmetry; the three axial planes are planes of symmetry (see Figs. 50 and 51).

The characteristic forms of the Pyritohedral Class are as follows:

1. *Pyritohedron or Pentagonal Dodecahedron.* This form consists of twelve pentagonal-shaped faces, each of which intersects one crystallographic axis at unity, the second axis at some multiple, and is parallel to the third. There are a number of pyritohedrons which differ from each other in respect to the inclination of their faces. Perhaps the most common in occurrence has the parameter relations  $1a, 2b, \infty c$ , the symbol of which would be (210) (see Fig. 52). It is to be noted that the parameter relations of the pyritohedron are the same as those of the tetrahexahedron (see page 19). A pyritohedron may be considered as derived from a corresponding tetrahexahedron by the omission of alternate faces and the extension of those remaining. Fig. 53

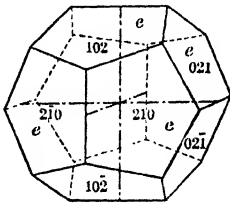


Fig. 52.  
Pyritohedron.

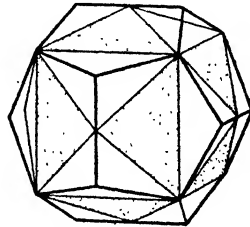


Fig. 53.  
Showing Relation between Pyritohedron and Tetrahexahedron.

shows the relations of the two forms, the shaded faces of the tetrahexahedron being those which when extended would form the faces of the pyritohedron.

2. *Diploid.* The diploid is a rare form found only in this class. It is composed of twenty-four faces which correspond to one-half the faces of a hexoctahedron. Fig. 54 represents a diploid.

In addition to the two forms described above, minerals of this class show also the cube, octahedron, dodecahedron, trapezohedron and trisoctahedron. Sometimes these forms may appear alone and so perfectly developed that they cannot be told from the forms of the Normal Class. This is often true of octahedrons of pyrite. Usually, however, they will show by the presence of striation lines or etching figures that they do not possess the

high symmetry of the Normal Class but conform rather to the symmetry of the Pyritohedral Class. This is shown in Fig. 55, which represents a cube of pyrite with characteristic striations, which are so disposed that the crystal shows the lower symmetry.

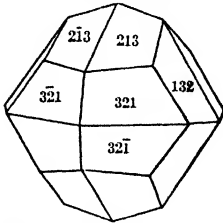


Fig. 54. Diploid.

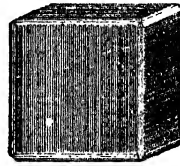


Fig. 55. Striated Cube.

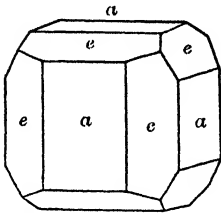


Fig. 56. Cube and Pyritohedron.

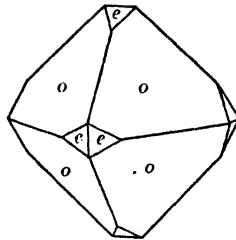


Fig. 57. Octahedron and Pyritohedron.

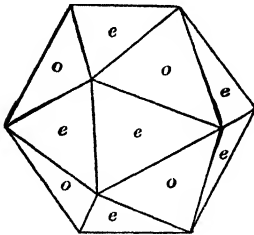
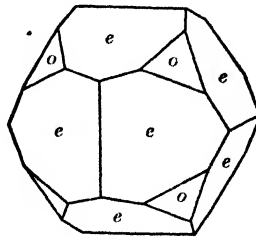
Fig. 58.  
Octahedron and Pyritohedron.Fig. 59.  
Pyritohedron and Octahedron.

Fig. 56 represents a combination of cube and pyritohedron, in which it will be noted that the faces of the pyritohedron truncate unsymmetrically the edges of the cube. Figs. 57, 58 and 59 represent combinations of pyritohedron and octahedron with

various developments. Fig. 60 shows a cube truncated with pyritohedron and octahedron. Fig. 61 represents a combination of cube and the diploid  $f$  (421). These figures should be studied in order to impress upon one's mind the characteristic symmetry of the class.

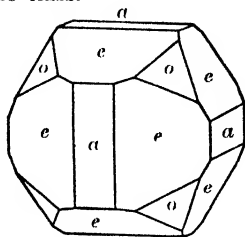


Fig. 60.  
Pyritohedron, Cube and Octahedron.

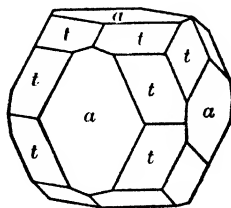


Fig. 61.  
Diploid and Cube.

The chief mineral of the Pyritohedral Class is pyrite; other much rarer members are smaltite, chloanthite, cobaltite, gersdorffite and sperrylite.

### Tetrahedral Class.

Another subordinate division of the Isometric System is known as the Tetrahedral Class, deriving its name from its chief form, the tetrahedron.

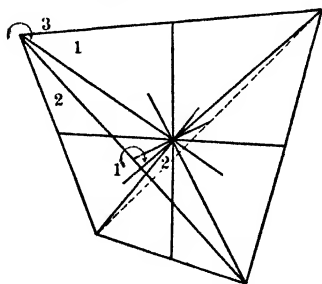


Fig. 62.  
Symmetry of Tetrahedral Class, Isometric System.

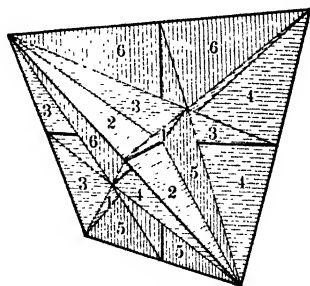


Fig. 63.

**Symmetry and Forms.** The symmetry of this class is as follows: The three crystallographic axes are axes of binary symmetry; the four diagonal axes are axes of trigonal symmetry; there are six diagonal planes of symmetry (see Figs. 62 and 63).



The characteristic forms of the Tetrahedral Class are as follows:

1. *Tetrahedron*. The tetrahedron is a form composed of four equilateral triangular faces, each of which intersects all of

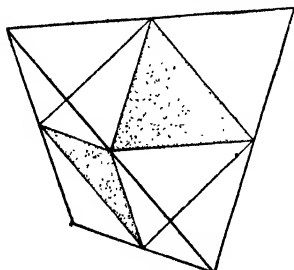


Fig. 64.  
Showing Relation between Octahedron and Tetrahedron.

the crystallographic axes at equal lengths. It can be considered as derived from the octahedron of the Normal Class by the omission of the alternate faces and the extension of the others, as shown in Fig. 64. This form, shown also in Fig. 65, is known as the positive tetrahedron and has for its symbol  $(111)$ . If the other four faces of the octahedron had been extended, the tetrahedron resulting would have

had a different orientation, as shown in Fig. 66. This is known as the negative tetrahedron and has for its symbol  $(\bar{1}\bar{1}\bar{1})$ . The

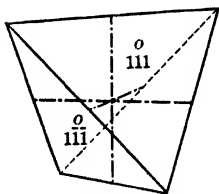


Fig. 65.  
Positive Tetrahedron.

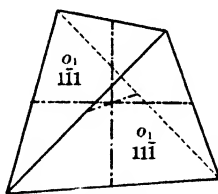


Fig. 66.  
Negative Tetrahedron.

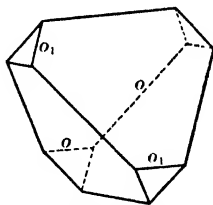


Fig. 67.  
Positive and Negative Tetrahedrons.

positive and negative tetrahedrons when occurring alone are geometrically identical, and the only reason for recognizing the possibility of the existence of two different orientations lies in the fact that at times they may occur truncating each other, as shown in Fig. 67. If a positive and negative tetrahedron occurred together with equal development, the resulting crystal could not be distinguished from an octahedron, unless, as is usually the case, the faces of the two forms showed different lustres, etchings or striations that would serve to differentiate them.

Other possible but rare tetrahedral forms are the following: The tristetrahedron (Fig. 68), the faces of which correspond to one-half the faces of a trapezohedron; the deltoïd dodecahedron (Fig. 69), the faces of which correspond to one-half those of the trisoctahedron; the hexakistetrahedron (Fig. 70), the faces of which correspond to one-half the faces of the hexooctahedron.

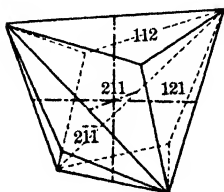


Fig. 68.  
Tristetrahedron.

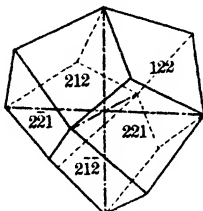


Fig. 69.  
Deltoïd Dodecahedron.

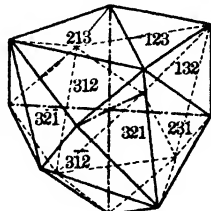


Fig. 70.  
Hexakistetrahedron.

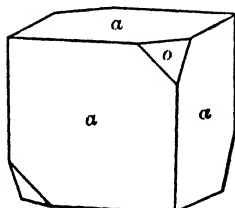


Fig. 71.  
Cube and Tetrahedron.

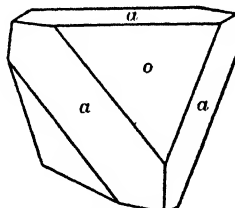


Fig. 72.  
Tetrahedron and Cube.

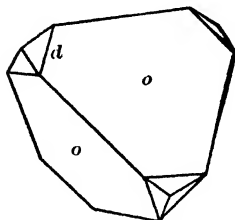


Fig. 73.  
Tetrahedron and Dodecahedron.

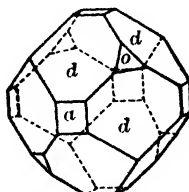


Fig. 74.  
Dodecahedron, Cube and Tetrahedron.

The cube and dodecahedron are also found on minerals of the Tetrahedral Class. Figs. 71 and 72 show combinations of cube

and tetrahedron. It will be noted that the tetrahedron faces truncate the alternate corners of the cube, or that the cube faces truncate the edges of a tetrahedron. Fig. 73 shows the combination of tetrahedron and dodecahedron. Fig. 74 represents a combination of cube, dodecahedron and tetrahedron. Fig. 75 shows a combination of tetrahedron and tristetrahedron.

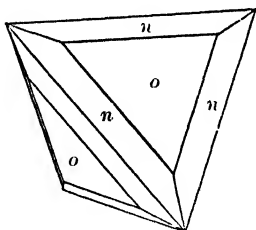


Fig. 75. Tetrahedron and Tristetrahedron.

Tetrahedrite and the related tennantite are the only common minerals that ordinarily show distinct tetrahedral forms. Sphalerite occasionally exhibits them, but commonly its crystals are quite complex and distorted.

### Characteristics of Isometric Crystals.

The striking characteristics of isometric crystals which would aid in their recognition may be summarized as follows:

The crystals are equidimensional in three directions at right angles to each other. These three directions in crystals of the Normal Class are axes of tetragonal symmetry. The crystals commonly show faces that are squares or equilateral triangles or these figures with truncated corners. They are characterized by the large number of similar faces, the smallest number on any form of the Normal Class being six. Every form by itself would make a solid.

*Important Isometric Angles.* Below are given various interfacial angles which may assist in the recognition of the commoner isometric forms:

$$\text{Cube (100)} \wedge \text{cube (010)} = 90^\circ 0' 0''.$$

$$\text{Octahedron (111)} \wedge \text{octahedron } (\bar{1}\bar{1}\bar{1}) = 70^\circ 31' 44''.$$

$$\text{Dodecahedron (110)} \wedge \text{dodecahedron (101)} = 60^\circ 0' 0''.$$

$$\text{Cube (100)} \wedge \text{octahedron (111)} = 54^\circ 44' 8''.$$

$$\text{Cube (100)} \wedge \text{dodecahedron (110)} = 45^\circ 0' 0''.$$

$$\text{Octahedron (111)} \wedge \text{dodecahedron (110)} = 35^\circ 15' 52''.$$

## VI. TETRAGONAL SYSTEM.

**Crystallographic Axes.** The crystallographic axes of the Tetragonal System are three in number and make right angles with each other. The two horizontal axes are equal in length and interchangeable, but the vertical axis is of some different length which varies with each tetragonal mineral. Fig. 76 represents the crystallographic axes for the tetragonal mineral zircon. The length of the horizontal axes is taken as unity, and the relative length of the vertical axis is expressed in terms of the horizontal. This length has to be determined for each tetragonal mineral by measuring the interfacial angles on a crystal and making the proper calculations. For zircon the length of the vertical axis is expressed as  $c = 0.640$ . The proper orientation of the crystallographic axes and the method of their notation is like that of the Isometric System and is shown in Fig. 76.

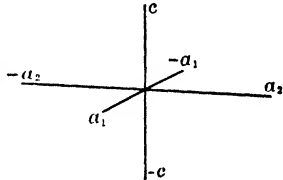


Fig. 76. Tetragonal Axes.

## Normal Class.

**Symmetry and Forms.** The symmetry of the Normal Class of the Tetragonal System is as follows: The vertical crystallographic axis is an axis of tetragonal symmetry. There are

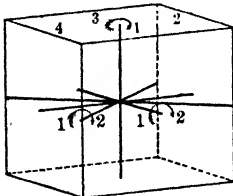


Fig. 77.

Symmetry of Normal Class, Tetragonal System.

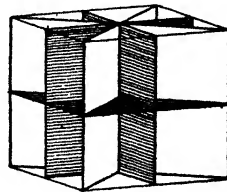


Fig. 78.

four horizontal axes of binary symmetry, two of which are coincident with the crystallographic axes, while the other two bisect the angles between these. Fig. 77 shows the axes of symmetry.

There are four vertical and one horizontal planes of symmetry. Each vertical plane of symmetry passes through one of the horizontal axes of symmetry. The position of the planes of symmetry is shown in Fig. 78.

The forms of the Normal Class, Tetragonal System, are as follows:

1. *Prism of First Order.* The prism of the first order consists of four rectangular vertical faces, each of which intersects the two horizontal crystallographic axes equally. Its symbol is  $(110)$ . The form is represented in Fig. 79.

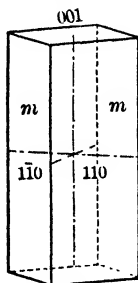


Fig. 79.  
First Order Prism.

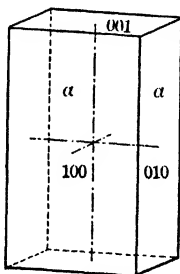


Fig. 80.  
Second Order Prism.

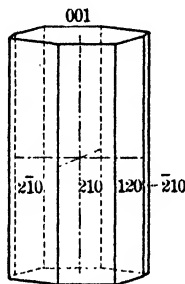


Fig. 81.  
Ditetragonal Prism.

2. *Prism of Second Order.* The prism of the second order consists of four rectangular vertical faces, each of which intersects one horizontal crystallographic axis and is parallel to the other two axes. Its symbol is  $(100)$ . The form is represented in Fig. 80.

3. *Ditetragonal Prism.* The ditetragonal prism is a form consisting of eight rectangular vertical faces, each of which intersects the two horizontal crystallographic axes unequally. There are various ditetragonal prisms, depending upon their differing relations to the horizontal axes. The symbol of a common form is  $(210)$ , which is represented in Fig. 81.

4. *Pyramid of First Order.* The pyramid of the first order is a form consisting of eight isosceles triangular faces, each of which intersects all three crystallographic axes, the intercepts upon the two horizontal axes being equal. There are various pyramids

of the first order, depending upon the inclination of their faces. The unit pyramid which intersects all the axes at their unit lengths is the most common, its symbol being (111). Symbols for other pyramids of the first order are (221), (331), (112), (113), etc. Fig. 82 represents the unit pyramid on zircon.

5. *Pyramid of Second Order.* The pyramid of the second order is a form composed of eight isosceles triangular faces, each of which intersects one horizontal axis and the vertical axis and is parallel to the second horizontal axis. There are various pyramids of the second order, with different intersections upon the vertical axis. The most common form is the unit pyramid,

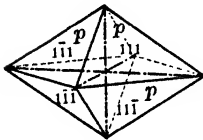


Fig. 82.  
First Order Pyramid.

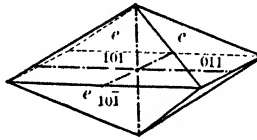


Fig. 83.  
Second Order Pyramid.

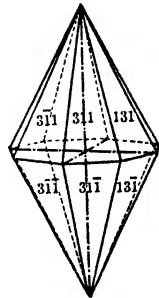


Fig. 84.  
Ditetragonal Pyramid.

which has (101) for its symbol. Other pyramids of the second order would have the symbols (201), (301), (102), (103), etc. Fig. 83 represents a unit pyramid of the second order upon zircon.

6. *Ditetragonal Pyramid.* The ditetragonal pyramid is a form composed of sixteen isosceles triangular faces, each of which intersects all three of the crystallographic axes, cutting the two horizontal axes at different lengths. There are various ditetragonal pyramids, depending upon the different axial intersections possible. One of the most common is the pyramid having (311) for its symbol. This is shown as it would appear upon zircon in Fig. 84.

7. *Basal Pinacoid*. The basal pinacoid, basal plane, or base, as it is variously called, is a form composed of two horizontal faces. Its symbol is (001). It is shown in combination with a prism in Figs. 79, 80 and 81.

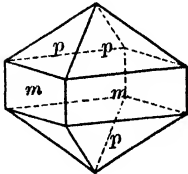


Fig. 85. Zircon.

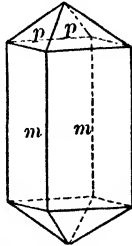


Fig. 86. Zircon.

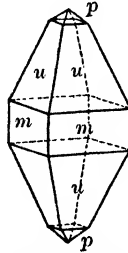


Fig. 87. Zircon.

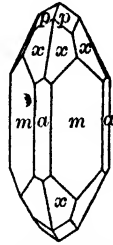


Fig. 88. Zircon.

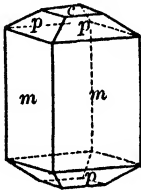


Fig. 89. Vesuvianite.

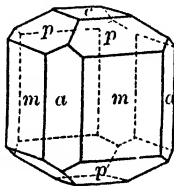


Fig. 90. Vesuvianite.

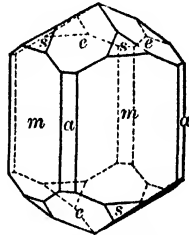


Fig. 91. Rutile.

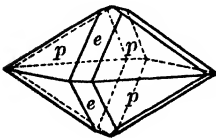


Fig. 92. Cassiterite.

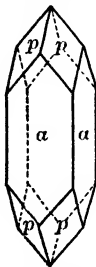


Fig. 93. Apophyllite.

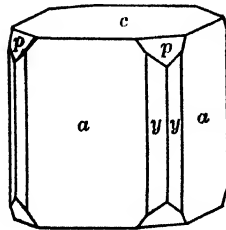


Fig. 94. Apophyllite.

*Tetragonal Combinations*. The different pyramids are the only tetragonal forms that can occur alone, and even they are ordinarily found in combination with other forms. Characteristic combinations are represented in Figs. 85-94.

## Sphenoidal Class.

The Sphenoidal Class corresponds in the Tetragonal System to the Tetrahedral Class in the Isometric System. It is characterized by the following symmetry: The three crystallographic axes are axes of binary symmetry (see Fig. 95), and there are two vertical diagonal planes of symmetry (see Fig. 96).

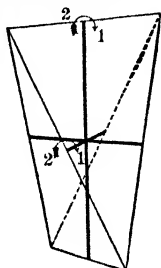


Fig. 95.

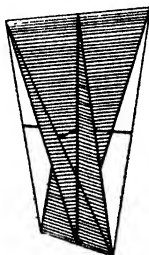
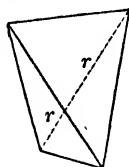
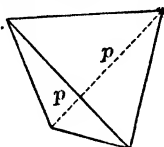
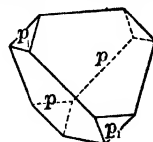


Fig. 96.

Symmetry of Sphenoidal Class, Tetragonal System.

*Sphenoid.* The characteristic form of the class is known as a sphenoid (from a Greek word meaning *axlike*). It consists of four isosceles triangular faces which intersect all three of the crystallographic axes, the intercepts on the two horizontal axes being equal. The faces correspond in their position to the alter-

Fig. 97.  
Sphenoid.Fig. 98.  
Sphenoid.Fig. 99.  
Positive and Negative Sphenoids.

nating faces of the tetragonal pyramid of the first order. There may be different sphenoids, depending upon their varying intersections with the vertical axes. Two different sphenoids are shown in Figs. 97 and 98. There may also be a positive and a negative sphenoid, the combination of the two being represented in Fig. 99.



The sphenoid differs from the tetrahedron in the fact that its vertical crystallographic axis is not of the same length as the horizontal axes. The only common sphenoidal mineral is chalcopyrite. The length of the vertical axis in chalcopyrite is very close to that of the horizontal axes,  $c = 0.985$ . In the case of the unit sphenoid, therefore, it would require accurate measurements in order to differentiate it from an isometric tetrahedron. Chalcopyrite crystals ordinarily show only the unit sphenoid (Fig. 98), but at times show a steeper sphenoid (Fig. 97).

### Tri-Pyramidal Class.

Another division of lower symmetry of the Tetragonal System is known as the Tri-pyramidal Class. It is characterized by a form known as the pyramid of the third order. This form consists of eight faces which correspond in their position to one-half of the faces of a ditetragonal pyramid. The minerals found in this class are few and rare. Moreover, their crystals seldom show the faces of the pyramid of the third order, and when these do occur they are usually quite small. Therefore it seems hardly necessary in this place to consider this class in greater detail. Fig. 100 is of a crystal of scapolite, upon which the faces of the third-order pyramid  $z$  are shown.

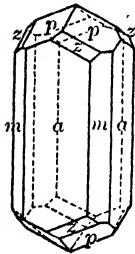


Fig. 100.  
Scapolite.

### Characteristics of Tetragonal Crystals.

Since the only common tetragonal mineral that does not belong to the Normal Class is chalcopyrite, which, moreover, is to be easily recognized by its general physical characteristics, we may confine ourselves here to the consideration only of the crystals of the Normal Class.

The striking characteristics of tetragonal crystals may be summarized as follows: One axis of tetragonal symmetry; the length of the crystal parallel to this axis is usually greater or less than its other dimensions; the cross section of a crystal when viewed in the direction of the axis of tetragonal symmetry consists usually of a square or a truncated square.

VII. HEXAGONAL SYSTEM.

**Crystallographic Axes.** The crystallographic axes of the hexagonal system are four in number. Three of these lie in the horizontal plane, while the fourth is vertical. The three horizontal axes are of equal length and interchangeable. They make angles of  $60^\circ$  and  $120^\circ$  with each other. The vertical axis varies in its relative length for each hexagonal mineral, and this is expressed in terms of the length of the horizontal axes, which is taken as unity. Thus in the case of beryl, the vertical axis, designated as  $c$ , has a length which in relation to the length of the horizontal axes can be expressed as  $c = 0.499$ .

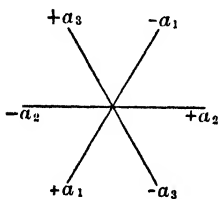


Fig. 101.

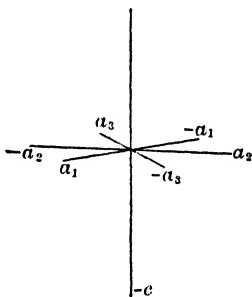


Fig. 102.

Hexagonal Axes.

When properly orientated, one of the horizontal crystallographic axes is parallel to the observer, and the other two make  $30^\circ$  angles on either side of a line perpendicular to him. Fig. 101 shows the proper position of the horizontal axes when viewed in the direction of the vertical axis. As the three horizontal axes are interchangeable with each other, they are usually designated  $a_1$ ,  $a_2$  and  $a_3$ . Note that  $a_1$  is to the left of the observer with its positive end at the front, that  $a_2$  is parallel to the observer and its positive end is at the right, while  $a_3$  is to the right of the observer and its positive end is at the back. Fig. 102 shows the four axes in clinographic projection. In giving the indices of any face upon a hexagonal crystal four numbers must

be given, since there are four axes. The numbers referring to the intercepts of the face with the three horizontal axes are given first in their proper order, while the number referring to the intercept on the vertical axis is given last.

### Normal Class.

**Symmetry and Forms.** The symmetry of the Normal Class of the Hexagonal System is as follows: The vertical crystallographic axis is an axis of hexagonal symmetry. There are six horizontal axes of binary symmetry, three of them being coincident with the crystallographic axes and the other three lying midway between them (see Fig. 103). There is a horizontal

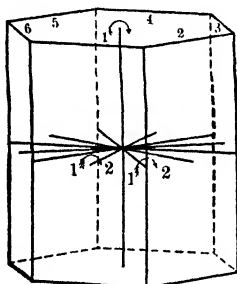


Fig. 103.

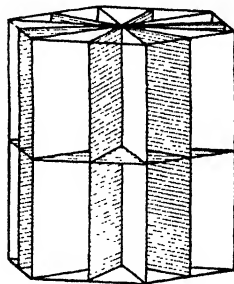


Fig. 104.

Symmetry of Normal Class, Hexagonal System.

plane of symmetry and six vertical planes of symmetry (see Fig. 104). The forms of the Normal Class are as follows:

1. *Prism of First Order.* This is a form consisting of six rectangular vertical faces each of which intersects two of the horizontal crystallographic axes equally and is parallel to the third. Fig. 105 shows the prism of the first order. The symbol for the form is  $(10\bar{1}0)$ .

2. *Prism of Second Order.* This is a form consisting of six rectangular vertical faces, each of which intersects two of the horizontal axes equally and the intermediate horizontal axis at one-half this distance. Fig. 106 shows the prism of the second order. The symbol for the form is  $(11\bar{2}0)$ .

3. *Dihexagonal Prism.* The dihexagonal prism has twelve rectangular vertical faces, each of which intersects all three of the

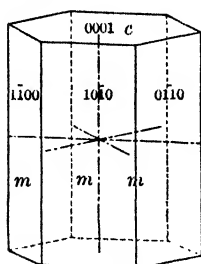


Fig. 105.

Prism of First Order.

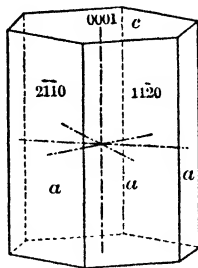


Fig. 106.

Prism of Second Order.

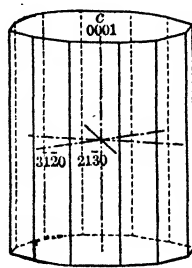


Fig. 107.

Dihexagonal Prism.

horizontal crystallographic axes at different lengths. There are various dihexagonal prisms, depending upon their differing relations to the horizontal axes. The symbol of a common dihexagonal prism is (2130) (see Fig. 107).

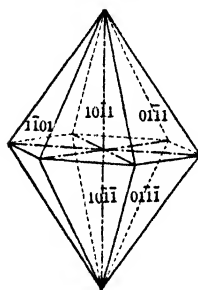


Fig. 108.

Pyramid of First Order.

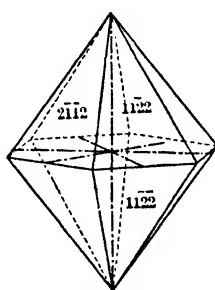


Fig. 109.

Pyramid of Second Order.

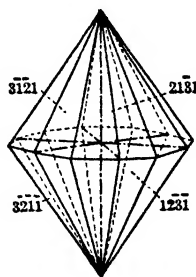


Fig. 110.

Dihexagonal Pyramid.

4. *Pyramid of First Order.* This form consists of twelve isosceles triangular faces, each of which intersects two of the horizontal crystallographic axes equally, is parallel to the third horizontal axis and intersects the vertical axis (see Fig. 108). There are various pyramids of the first order possible, depending upon the inclination of their faces. The unit form would have the symbol (1011).

5. *Pyramid of the Second Order.* This is a form composed of twelve isosceles triangular faces, each of which intersects two of the horizontal axes equally, the third and intermediate horizontal axis at one-half this distance, and also intersects the vertical axis (see Fig. 109). There are various pyramids of the second order possible, depending upon the inclination of their faces. A common form would have for its symbol  $(11\bar{2}2)$ .

6. *Dihexagonal Pyramid.* The dihexagonal pyramid is a form of twenty-four isosceles triangular faces, each of which intersects all three of the horizontal axes differently and intersects also the vertical axis. This form is shown in Fig. 110. There are different dihexagonal pyramids which vary in their intercepts, one of the most common having for its symbol  $(21\bar{3}1)$ .

7. *Basal Pinacoid.* The basal pinacoid is a form composed of two horizontal faces. It is shown in combination with the different prisms in Figs. 105, 106 and 107. Its symbol is  $(0001)$ .

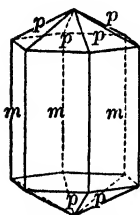


Fig. 111.

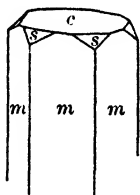


Fig. 112.

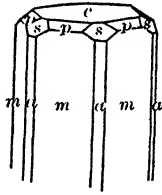


Fig. 113.

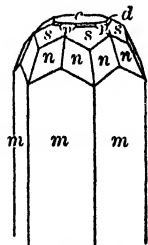


Fig. 114.

Beryl Crystals.

Figs. 111-114 show various combinations of the forms of this class.

### Tri-Pyramidal Class.

A division of the Hexagonal System showing lower symmetry than that of the Normal Class is known as the Tri-pyramidal Class. It has a vertical axis of hexagonal symmetry and a horizontal plane of symmetry. It is characterized by the form known as the pyramid of the third order. This form consists of twelve faces, which correspond in their position to one-half of the faces of a dihexagonal pyramid. The minerals of the

Apatite Group are the only ones of importance in this class, and upon their crystals the pyramid of the third order is rarely to be seen. When it is observed it shows usually only small faces. Fig. 115 represents a complex crystal of apatite with the faces of a third-order pyramid ( $\mu$ ) upon it.

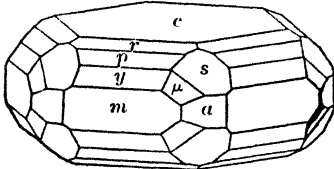


Fig. 115. Apatite.

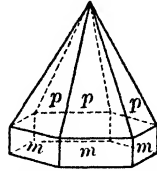


Fig. 116. Zincite.

### Hemimorphic Class.

The crystals of certain rare minerals show the forms of the Normal Class but with hemimorphic development. A hemimorphic crystal is one that shows different forms or combinations of forms at the opposite ends of a symmetry axis. Fig. 116 represents a crystal of zincite with a prism terminated by a pyramid above and a basal pinacoid below.

### Rhombohedral Class. Normal Division.

The forms of this class are to be referred to the hexagonal crystallographic axes, but show a lower symmetry than those of the Normal Class.

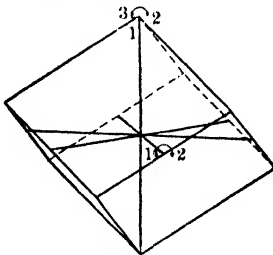


Fig. 117.

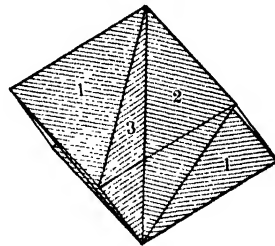


Fig. 118.

Symmetry of Rhombohedral Class, Hexagonal System.

**Symmetry and Forms.** The vertical crystallographic axis is one of trigonal symmetry, and the three horizontal crystallo-

graphic axes are axes of binary symmetry (see Fig. 117). There are three vertical planes of symmetry bisecting the angles between the horizontal axes (see Fig. 118).

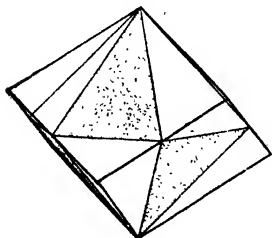


Fig. 119. Showing Relation between First Order Pyramid and Rhombohedron.

1. *Rhombohedron*. The rhombohedron is a form consisting of six rhombic-shaped faces, which correspond in their position to the alternate faces of a hexagonal pyramid of the first order. The relation of these two forms to each other is shown in Fig. 119. There may be two different orientations of the rhombohedron. A *positive* rhombohedron is shown in Fig. 120 and a *negative* rhombohedron in Fig. 121. It is to be noted that when properly orientated the

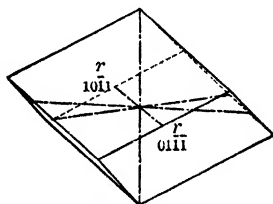


Fig. 120. Positive Rhombohedron.

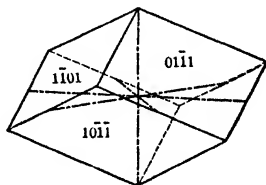


Fig. 121. Negative Rhombohedron.

positive rhombohedron has one of its faces, and the negative rhombohedron one of its edges, toward the observer. There are various rhombohedrons, which differ from each other in the inclination of their faces. The symbol of the unit positive rhombohedron is  $(10\bar{1}1)$  and of the unit negative rhombohedron  $(0\bar{1}\bar{1}1)$ . Characteristic combinations of positive and negative rhombohedrons with each other and with other hexagonal forms are shown in Figs. 122-130.

2. *Scalenoedron*. This form consists of twelve scalene triangular faces. These faces correspond in their position to the alternate *pairs* of faces of a dihexagonal pyramid. The relation of the two forms to each other is shown in Fig. 131. The striking characteristics of the scalenoedron are the **zigzag middle edges**

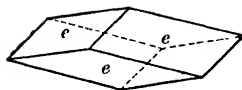


Fig. 122. Calcite.

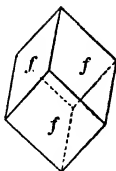


Fig. 123. Calcite.

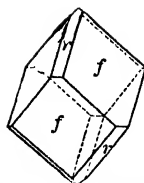


Fig. 124. Calcite.

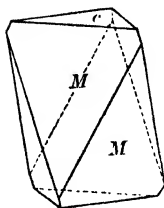


Fig. 125. Calcite.

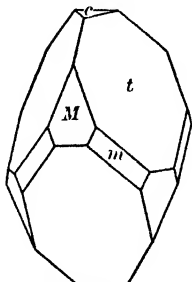


Fig. 126. Calcite.

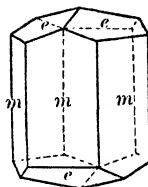


Fig. 127. Calcite.

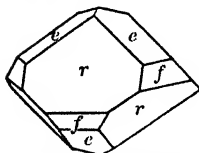


Fig. 128. Chabazite.

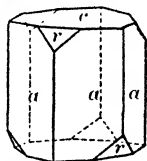


Fig. 129. Corundum.

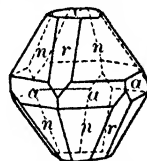


Fig. 130. Corundum.

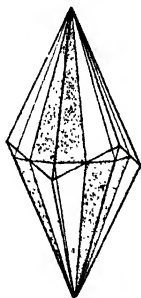


Fig. 131. Showing Relation between Dihexagonal Pyramid and Scalenohedron.

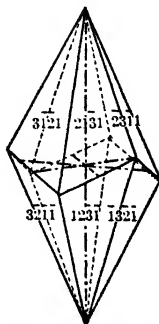


Fig. 132. Scalenohedron.



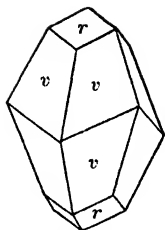


Fig. 133. Calcite.

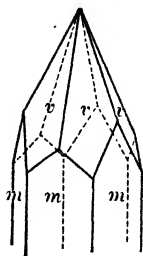


Fig. 134. Calcite.

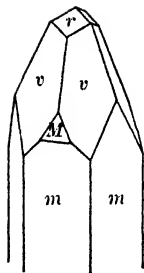


Fig. 135. Calcite.

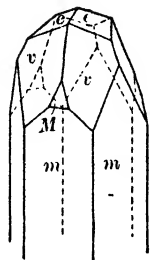


Fig. 136. Calcite.

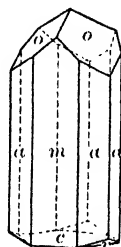


Fig. 137. Tourmaline.

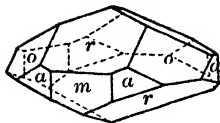


Fig. 138. Tourmaline.

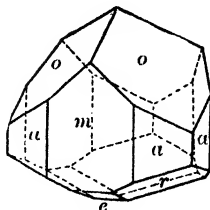


Fig. 139. Tourmaline.

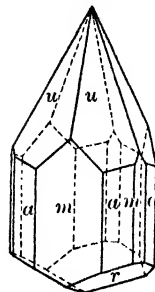


Fig. 140. Tourmaline.

which differentiate it from an ordinary pyramid and the alternating, relatively obtuse and acute angles over the edges that meet at the vertices of the form. There are many different possible scalenohedrons, depending upon the varying slope of their faces. A common scalenohedron having the symbol  $(21\bar{3}1)$  is represented in Fig. 132. Characteristic combinations of scalenohedrons with other forms are shown in Figs. 133-136.

### **Rhombohedral Class. Hemimorphic Division.**

Tourmaline crystals show the forms of the Rhombohedral Class but with hemimorphic development. They are also commonly characterized by the presence of three faces of a triangular prism. Figs. 137-140 represent characteristic hemimorphic tourmaline crystals.

### **Rhombohedral Class. Tri-Rhombohedral Division.**

This is a subdivision of the Rhombohedral Class, which contains only a few and rare minerals. It is characterized by the forms known as the rhombohedrons of the second and third orders. The faces of a second-order rhombohedron correspond in position to one-half the faces of the second-order hexagonal pyramid, and those of the third order to one-quarter of the faces of the dihexagonal pyramid.

### **Rhombohedral Class. Trapezohedral Division.**

The only important mineral of this class that is commonly found in crystals is quartz, and its crystals as a rule do not show forms other than those of the Rhombohedral Class, Normal Division. At times, however, small faces may occur of a form known as a trapezohedron, which shows a lower symmetry. This form has six faces, which correspond in their position to one-quarter of the faces of a dihexagonal pyramid. The quartz crystals are said to be right- or left-handed, depending upon whether these faces are to be observed truncating the edges between prism and rhombohedron faces at the right or at the left. Figs. 141 and 142 represent these two types.

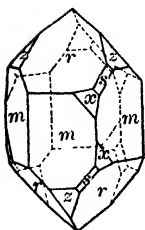


Fig. 141.  
Right-handed Quartz.

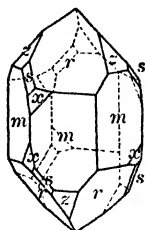


Fig. 142.  
Left-handed Quartz.

### Characteristics of Hexagonal Crystals.

Hexagonal crystals are most readily recognized by the following facts: The vertical crystallographic axis is one of either hexagonal or trigonal symmetry. The crystals are commonly prismatic in habit. When viewed in the direction of the vertical axis, they usually show a hexagonal cross section.

## VIII. ORTHORHOMBIC SYSTEM.

**Crystallographic Axes.** The crystallographic axes of the orthorhombic system are three in number. They make  $90^\circ$  angles with each other and are of unequal lengths. The rela-

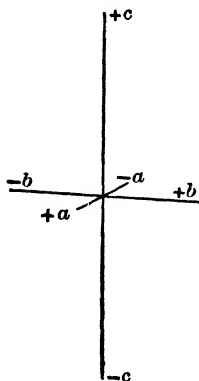


Fig. 143.  
Orthorhombic Axes.

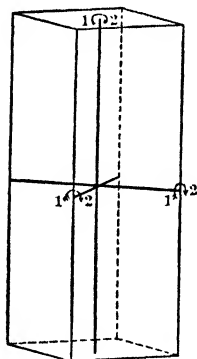


Fig. 144.  
Axes of Symmetry.  
Orthorhombic System.

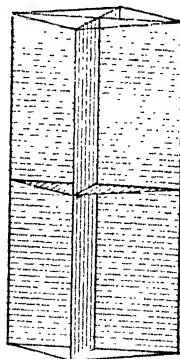


Fig. 145.  
Planes of Symmetry.  
Orthorhombic System.

tive lengths of the axes, or the axial ratio, has to be determined for each orthorhombic mineral. Any one of the three axes may be chosen as the vertical or *c* axis. The longer of the other two is taken as the *b* axis and is called the *macro-axis*. The shorter of the horizontal axes is taken as the *a* axis and is called the *brachy-axis*. The length of the *b* axis is taken as unity and the relative lengths of the *a* and *c* axes are given in terms of it. Fig. 143 represents the crystallographic axes for the orthorhombic mineral sulphur, whose axial ratio would be as follows:  $a : b : c = 0.813 : 1 : 1.903$ .

### Normal Class.

**Symmetry and Forms.** The symmetry of the Normal Class, Orthorhombic System, is as follows: The three crystallographic axes are axes of binary symmetry and the three axial planes are planes of symmetry (see Figs. 144 and 145).

1. *Pyramid*. An orthorhombic pyramid has eight triangular faces, each of which intersects all three of the crystallographic axes. There are various different pyramids with varying intercepts on the axes. A unit pyramid (see Fig. 146) would have for its symbol (111).

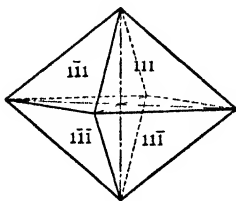


Fig. 146. Pyramid.

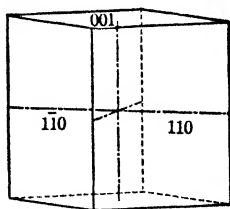


Fig. 147. Prism and Base.

2. *Prism*. An orthorhombic prism has four vertical rectangular faces, each of which intersects the two horizontal axes. There are various prisms, depending upon their differing relations to the horizontal axes. A unit prism (see Fig. 147) would have for its symbol (110).

3. *Macrodome*. A macrodome is a form consisting of four rectangular faces, each of which intersects the  $a$  and  $c$  axes and is parallel to the  $b$  or macro-axis. It is named from the axis to which it is parallel. There are various macrodomes with different axial intercepts. A unit form (see Fig. 148) would have for its symbol  $(101)$ .

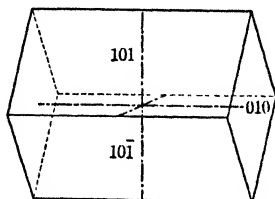


Fig. 148.  
Macrodome and Brachypinacoid.

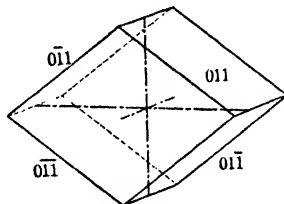


Fig. 149.  
Brachydome and Macropinacoid.

4. *Brachydome*. The brachydome consists of four rectangular faces, each of which intersects the  $b$  and  $c$  axes and is parallel to the  $a$  or brachy-axis. There are various brachydomes with different axial intercepts. A unit form (see Fig. 149) would have for its symbol  $(011)$ .

5. *Macropinacoid*. The macropinacoid has two parallel faces, each of which intersects the  $a$  axis and is parallel to the  $b$  and  $c$  axes. It derives its name from the fact that it is parallel to the  $b$  or macro-axis. It is represented in Fig. 150 and its symbol is  $(100)$ .

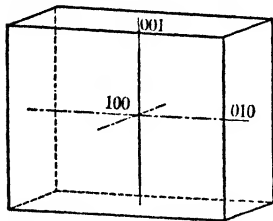


Fig. 150.  
Macropinacoid, Brachypinacoid,  
and Basal Pinacoid.

6. *Brachypinacoid*. This is a form consisting of two parallel faces, each of which intersects the  $b$  axis and is parallel to the  $a$  (brachy) and the  $c$  axes. It is represented in Fig. 150 and its symbol is  $(010)$ .

7. *Basal Pinacoid*. The basal pinacoid is a form consisting of two horizontal faces. It is represented in Fig. 150 and its symbol is  $(001)$ .

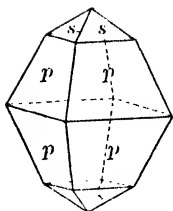


Fig. 151. Sulphur.

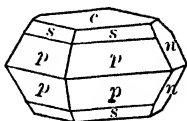


Fig. 152. Sulphur.

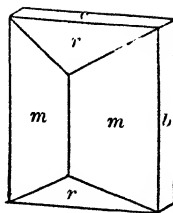


Fig. 153. Staurolite.

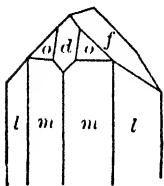


Fig. 154. Topaz.

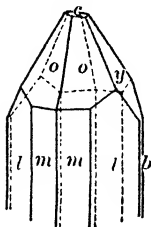


Fig. 155. Topaz

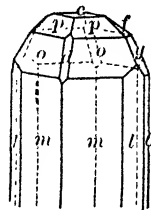


Fig. 156. Topaz.

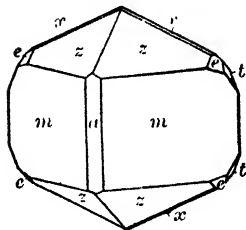


Fig. 157. Brookite.

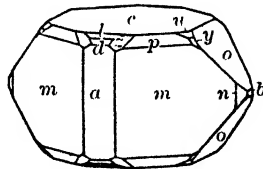


Fig. 158. Anglesite.

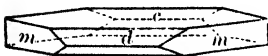


Fig. 159. Barite.

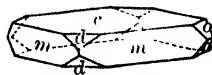


Fig. 160. Barite.

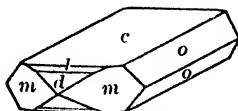


Fig. 161. Celestite.

**Combinations.** Practically all orthorhombic crystals consist of combinations of two or more forms. Characteristic combinations of the various forms are given in Figs. 151-161.

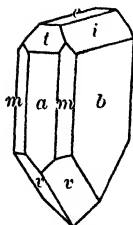


Fig. 162.  
Calamine.

### Hemimorphic Class.

The only orthorhombic mineral of importance belonging to this class is calamine. When its crystals are doubly terminated they show different forms at either end of the vertical axis. Fig. 162 represents a characteristic crystal.

### Characteristics of Orthorhombic Crystals.

The most distinguishing characteristics of orthorhombic crystals are as follows: The three chief directions at right angles to each other are of different lengths. These three directions are axes of binary symmetry. The crystals are commonly prismatic in their development and show usually cross sections that are either rectangles or truncated rectangles.

## IX. MONOCLINIC SYSTEM.

**Crystallographic Axes.** The crystallographic axes of the Monoclinic System are three in number. They are of unequal lengths. The axes  $a$  and  $b$ , and  $b$  and  $c$ , make  $90^\circ$  angles with each other, but  $a$  and  $c$  make some oblique angle with each other. The relative lengths of the axes and the angle between the  $a$  and  $c$  axes vary for each monoclinic mineral and have to be determined in each case from appropriate measurements. The  $a$  axis is known as the *clino-axis*, while the  $b$  axis is known as the *ortho-axis*. The length of the  $b$  axis is taken as unity and the lengths of the  $a$  and  $c$  axes are expressed in terms of it. When properly orientated the  $c$  axis is vertical, the  $b$  axis is horizontal and parallel to the observer, and the  $a$  axis is inclined downward toward him. The smaller of the two supplementary angles that  $a$  and  $c$  make with each other is designated as  $\beta$ .

Fig. 163 represents the crystallographic axes of the monoclinic mineral orthoclase, the axial constants of which are expressed as follows:  $a : b : c = 0.658; 1 : 0.555; \beta = 63^\circ 57'$ .

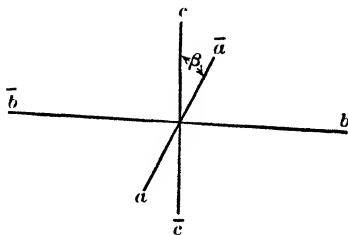


Fig. 163. Monoclinic Axes.

### Normal Class.

**Symmetry and Forms.** The symmetry of the Normal Class of the Monoclinic System is as follows: The crystallographic axis  $b$  is an axis of binary symmetry and the plane of the  $a$  and

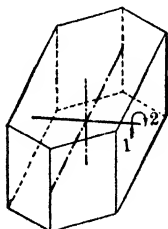


Fig. 164.

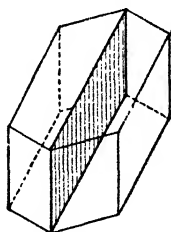


Fig. 165.

Symmetry of Monoclinic System.

$c$  axes is a plane of symmetry (see Figs. 164 and 165). The forms are as follows:

1. *Pyramid.* A monoclinic pyramid is a form consisting of four triangular faces, each of which intersects all three of the crystallographic axes. There are different pyramids, depending upon varying axial intercepts. There are, further, two independent types of monoclinic pyramids, depending upon whether the two faces on the upper half of the crystal intersect the



positive or the negative end of the  $a$  axis. A unit pyramid of the first of these types is shown in Fig. 166 and has for its symbol  $(111)$ . A unit pyramid of the second of these types is represented in Fig. 167 and has for its symbol  $(\bar{1}11)$ . Fig. 168 shows these two types in combination with each other. It should be emphasized that a monoclinic pyramid consists of only four faces, two of which are to be found intersecting the upper end of the  $c$  axis and the other two intersecting its lower end. The two types described above are entirely independent of each other.

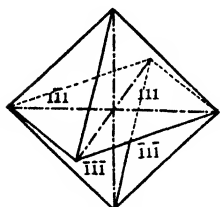


Fig. 166.

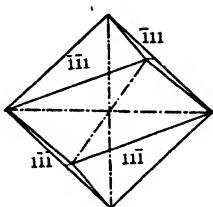


Fig. 167.

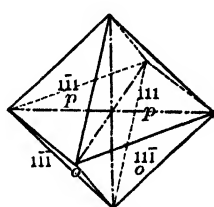


Fig. 168.

Monoclinic Pyramids.

2. *Prism*. The monoclinic prism has four vertical rectangular faces, each of which intersects the  $a$  and  $b$  axes. There are various prisms with different axial intercepts. A unit prism is represented in Fig. 169 and has for its symbol  $(110)$ .

3. *Orthodome*. An orthodome consists of two parallel faces, each of which intersects the  $a$  and  $c$  axes and is parallel to the  $b$  or ortho-axis. Its name is derived from that of the axis to which it is parallel. There are different orthodomes with different axial intercepts. There are also two distinct and independent types of orthodomes, depending upon whether the face upon the upper end of the crystal intersects the positive or negative end of the  $a$  axis. These two types of orthodomes are represented in combination in Fig. 170, but it should be emphasized that they are entirely independent of each other. The symbol of the unit orthodome in front is  $(101)$  and that of the one behind is  $(\bar{1}01)$ .

4. *Clinodome*. The clinodome is a form having four faces, each of which intersects the  $b$  and  $c$  axes and is parallel to the  $a$  or clino-axis. There are various clinodomes with differing axial

intercepts. A unit form is represented in Fig. 171 and would have for its symbol (011).

5. *Orthopinacoid*. The orthopinacoid has two parallel faces, each of which intersects the  $a$  axis and is parallel to the  $b$  and  $c$  axes. It derives its name from the fact that it is parallel to the  $b$  or ortho-axis. It is represented in Fig. 171 and its symbol is (100).

6. *Clinopinacoid*. The clinopinacoid consists of two parallel faces, each of which intersects the  $b$  axis and is parallel to the  $a$  (clino) and the  $c$  axes. It is represented in Fig. 170 and its symbol is (010).

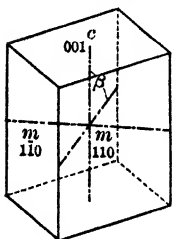


Fig. 169.  
Prism and Base.

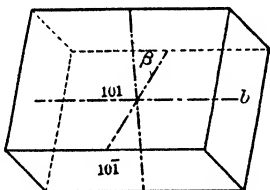


Fig. 170.  
Orthodomes and Clinopinacoid.

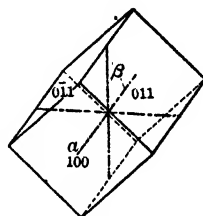


Fig. 171.  
Clinodome and  
Orthopinacoid.

7. *Basal Pinacoid*. The basal pinacoid is a form consisting of two parallel faces, each of which intersects the vertical axis and is parallel to the  $a$  and  $b$  axes. It is represented in Fig. 169 and its symbol is (001).

*Monoclinic Combinations*. Characteristic combinations of the forms described above are given in Figs. 172-179.

### Characteristics of Monoclinic Crystals.

Monoclinic crystals are to be distinguished chiefly by their low symmetry. The fact that they possess but one plane of symmetry and one axis of binary symmetry at right angles to it would serve to differentiate them from the crystals of all other systems and classes. Usually the inclination of the crystal faces which are parallel to the clino-axis is marked.

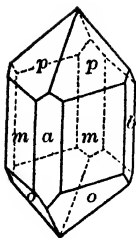


Fig. 172.

Pyroxene.

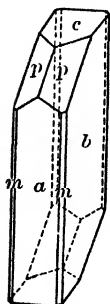


Fig. 173.

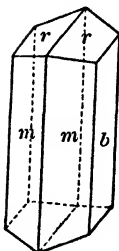


Fig. 174.

Amphibole.

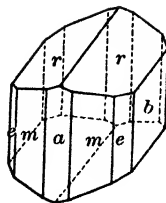


Fig. 175.

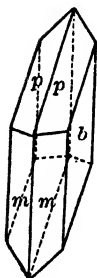
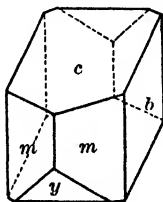
Fig. 176.  
Gypsum.

Fig. 177.

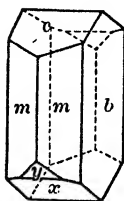
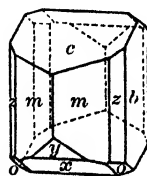
Fig. 178.  
Orthoclase.

Fig. 179.

## X. TRICLINIC SYSTEM.

**Crystallographic Axes.** The crystallographic axes of the Triclinic System are three in number. They are of unequal lengths and make oblique angles with each other. The axial directions for each triclinic mineral are chosen arbitrarily, but in such a way as to yield the simplest relations. Any one of them may be taken as *c*, the vertical axis. The longer of the other two is designated as the *b* or macro-axis, while the shorter is called *a* or the brachy-axis. The relative lengths of the three axes and the angles which they make with each other have to be calculated for each mineral from appropriate measurements. The angles which the different axes make with each other are

designated respectively as  $\alpha$ ,  $\beta$  and  $\gamma$  (see Fig. 180). For example, the crystal constants of the triclinic mineral axinite are as follows:  $a : b : c = 0.482 : 1 : 0.480$ ;  $\alpha = 82^\circ 54'$ ;  $\beta = 91^\circ 52'$ ;  $\gamma = 131^\circ 32'$ .

### Normal Class.

**Symmetry and Forms.** The symmetry of the Normal Class of the Triclinic System consists only in a center of symmetry (see Fig. 5, page 8). It has no axes or planes of symmetry. All forms of the Triclinic System consist of two similar and parallel faces. In this respect all triclinic forms might be spoken of as pinacoids. They are, however, usually designated as pyramids when their faces intersect all three axes, as prisms or domes when they intersect two axes and as pinacoids when they intersect but one axis.

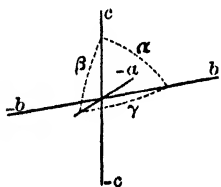


Fig. 180.  
Triclinic Axes.

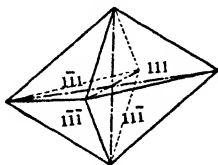


Fig. 181.  
Pyramids.

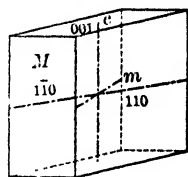


Fig. 182.  
Prisms and Basal Pinacoid.

1. *Pyramid.* A triclinic pyramid consists of two parallel faces, each of which intersects all three crystallographic axes. There are four possible types, depending upon the octants in which the faces lie. Fig. 181 shows a combination of four unit pyramids.

2. *Prisms.* A triclinic prism consists of two parallel faces, each of which intersects the  $a$  and  $b$  axes and is parallel to the  $c$  axis. There are two possible types, a combination of which is shown in Fig. 182.

3. *Domes.* A triclinic dome consists of two similar parallel faces, each of which intersects the  $c$  axis and either the  $a$  or  $b$  axes and is parallel to the other. They are spoken of as either macro- or brachydomes, depending upon the axis to which they are parallel. There are two types of each. Fig. 183 represents

a combination of the two types of macrodomc and Fig. 184 a combination of the two brachydomes.

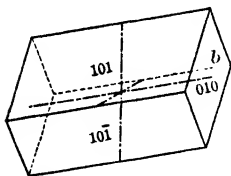


Fig. 183.  
Macrodomes and  
Brachypinacoid.

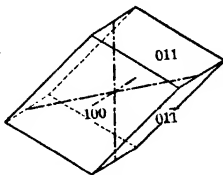


Fig. 184.  
Brachydomes and  
Macropinacoid.

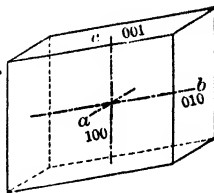


Fig. 185.  
Macropinacoid, Brachypinacoid, and Basal Pinacoid.

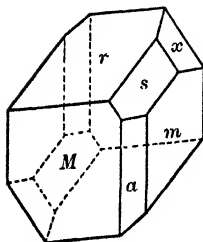


Fig. 186.  
Axinite.

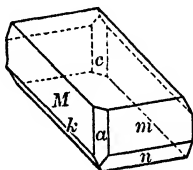


Fig. 187.  
Rhodonite.

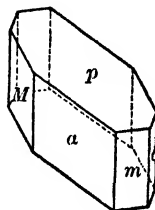


Fig. 188.  
Chalcantite.

4. *Pinacoids*. A triclinic pinacoid is a form consisting of two parallel faces, each of which intersects one crystallographic axis and is parallel to the other two. They are designated as the macropinacoid with the symbol (100), as the brachypinacoid with the symbol (010), and as the basal pinacoid with the symbol (001). A combination of the three forms is shown in Fig. 185.

*Triclinic Combinations*. Figs. 186-188 represent characteristic triclinic crystals.

### Characteristics of Triclinic Crystals.

There are only a few triclinic minerals and they seldom show distinct and well-developed crystals. When such crystals do occur they are to be recognized by the fact that they have no plane or axis of symmetry and by the fact that each form consists of only two similar and parallel faces.

## II. GENERAL PHYSICAL PROPERTIES OF MINERALS.

### I. STRUCTURE OF MINERALS.

IF by the phrase "*structure of minerals*" is meant their **internal** or molecular structure, all minerals may be included in one of two classes: (1) *Crystalline*; (2) *Amorphous*. With only a few exceptions, minerals are crystalline in their structure. This does not signify, however, that these minerals necessarily occur in distinct crystals, but only that their internal structure is such that they may under favorable circumstances definitely crystallize. The few mineral species that are classified as amorphous possess no regular internal structure and therefore cannot crystallize.

Commonly, however, the expression "structure of minerals" refers to their outward shape and form. Various descriptive terms are used in this connection that will need short definitions.

**1. When a mineral consists of distinct crystals the following terms may be used:**

- a. *Crystallized*. In definite crystals (see A, pl. II).
- b. *Acicular*. In slender needlelike crystals.
- c. *Capillary*. In hairlike crystals.
- d. *Filiform*. In threadlike crystals.
- e. *Dendritic*. Arborescent, in slender divergent branches, somewhat plantlike, made up of more or less distinct crystals.
- f. *Reticulated*. Latticelike groups of slender crystals.
- g. *Divergent or Radiated*. Radiating crystal groups (see C, pl. II).
- h. *Drusy*. A surface is drusy when covered with a layer of very small crystals.

**2. When a mineral consists of columnar individuals the following terms may be used:**

- a. *Columnar*. In stout columnlike individuals.
- b. *Fibrous*. In slender columnar individuals. The fibers may be parallel or radiated (see D, pl. II).
- c. *Stellated*. When the radiating individuals form starlike or circular groups.
- d. *Globular*. When the radiating individuals form spherical or hemispherical groups.
- e. *Botryoidal*. When the globular forms are in groups. The word is derived from the Greek for a "bunch of grapes" (see B, pl. III).
- f. *Reniform or Mammillary*. When a mineral is in broad rounded masses resembling in shape either a kidney or mammæ (see A, pl. III).

**3. When a mineral consists of scales or lamellæ.**

- a. *Foliated*. When a mineral separates easily into plates or leaves.
- b. *Micaceous*. Similar to foliated but the mineral can be split into exceedingly thin sheets, as in the micas.
- c. *Lamellar or tabular*. When a mineral consists of flat plate-like individuals superimposed upon and adhering to each other.
- d. *Plumose*. Consisting of fine scales with divergent or featherlike structure.

**4. When a mineral consists of grains.**

*Coarse to fine granular*. When a mineral consists of an aggregate of large or small grains.

**5. Miscellaneous.**

- a. *Compact — Earthy*. A uniform aggregate of exceedingly minute particles.
- b. *Stalactitic*. When a mineral has the shape of cylinders or cones which have been formed by deposition from mineral-bearing waters dripping from the roof of some cavity (see B, pl. II).
- c. *Concentric*. Consisting of more or less circular layers superimposed upon one another about a common center (see C, pl. III).

PLATE II.



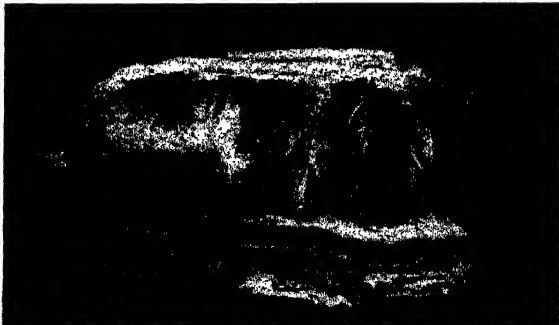
A.



B.



C.



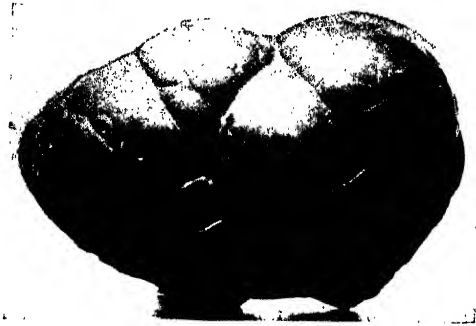
D.

A. Crystallized — Quartz.  
B. Stalactitic — Limonite.

C. Radiated — Natrolite.  
D. Fibrous — Serpentine.



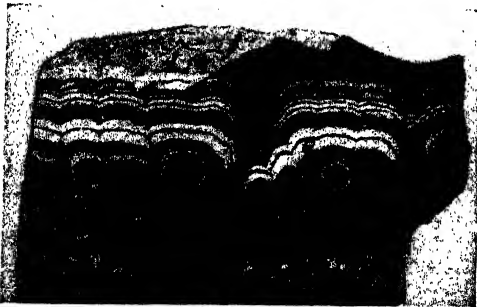
PLATE III.



A.



B.



C.

A. Mammillary or Reniform — Hematite. B. Botryoidal — Chalcedony.  
C. Concentric — Malachite.

d. *Banded*. When a mineral occurs in narrow parallel bands of different color or texture.

e. *Geodes*. When a cavity has been lined by the deposition of mineral material but not wholly filled, the more or less spherical mineral shell is called a geode. The mineral is often banded owing to successive depositions of the material, and the inner surface is frequently covered with projecting crystals.

f. *Massive*. When a mineral is composed of compact material with an irregular form and does not show any peculiar structure like those described above, it is said to be massive.

## II. CLEAVAGE, PARTING AND FRACTURE.

1. **Cleavage**. If a mineral, when the proper force is applied, breaks so that it shows definite plane surfaces, it is said to possess a cleavage. These cleavage surfaces resemble natural crystal faces. They are always parallel to some possible crystal face, and usually to one having simple relations to the crystallographic axes. They may be perfect, as in the cases of the micas, calcite, gypsum, etc., or they may be more or less obscure. Cleavage is due to the fact that in the mineral structure there is a certain plane or planes along which the molecular cohesion is weaker than in other directions. All minerals do not show cleavage, and only a comparatively few show it in an eminent degree. The quality of the cleavage and its crystallographic direction are often important aids in the identification of a mineral. The cleavage of a mineral

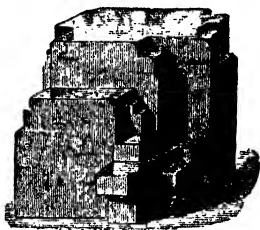


Fig. 189. Cubic Cleavage — Galena.

is described according to the crystal face to which it is parallel, as cubic cleavage (galena, halite) (see Fig. 189), octahedral cleavage (fluorite), dodecahedral cleavage (sphalerite), rhombohedral cleavage (calcite), prismatic cleavage (amphibole), basal cleavage (topaz), pinacoidal cleavage (stibnite), etc.

2. **Parting**. Certain minerals when subjected to a strain or pressure develop planes of molecular weakness along which they

may subsequently be broken. When plane surfaces are produced on a mineral in this way it is said to have a parting. This phenomenon resembles cleavage, but is to be distinguished from it by the facts that not every specimen of a certain mineral will exhibit it, but only those specimens which have been subjected to the proper pressure, and that even in these specimens there are only certain planes in the given direction along which the mineral will break. In the case of cleavage, every specimen of the mineral will in general show it, and it can be produced in a given direction in all parts of a crystal. Familiar examples of parting are the cases of the octahedral parting of magnetite, the basal parting of pyroxene and the rhombohedral parting of corundum.

3. **Fracture.** By the fracture of a mineral is meant the way in which it breaks when it does not show plane surfaces as in cleavage or parting. The following terms are commonly used to designate different sorts of fracture:

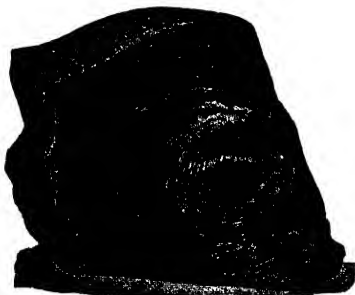


Fig. 190. Conchoidal Fracture—Volcanic Glass.

a. *Conchoidal.* When the fracture has smooth, curved surfaces like the interior surface of a shell it is said to be conchoidal (see Fig. 190). This is most commonly observed in such substances as glass, quartz, etc.

b. *Fibrous or Splintery.* When the mineral breaks showing splinters or fibers.

c. *Hackly.* When the mineral breaks with a jagged, irregular surface with sharp edges.

d. *Uneven or Irregular.* When the mineral breaks into rough and irregular surfaces.

### III. HARDNESS OF MINERALS.

Minerals vary quite widely in their hardness, and a determination of their degree of hardness is often an important aid to their identification. A series of minerals has been chosen as a

scale by comparison with which the relative hardness of any mineral may be told. The scale consists of crystallized varieties of the following minerals, each species being harder than those preceding it in the scale.

*Scale of Hardness.*

- |             |                |              |
|-------------|----------------|--------------|
| 1. Talc.    | 4. Fluorite.   | 8. Topaz.    |
| 2. Gypsum.  | 5. Apatite.    | 9. Corundum. |
| 3. Calcite. | 6. Orthoclase. | 10. Diamond. |
|             | 7. Quartz.     |              |

In order to determine the relative hardness of any mineral in terms of this scale, it is necessary to find which ones of these minerals it can and which it cannot scratch. In making the determination the following precautions should be observed: Sometimes when a mineral is softer than another, portions of the first will leave a mark on the second which may be mistaken for a scratch. It can be rubbed off, however, while a true scratch will be permanent. Some minerals are frequently altered on the surface to material which is much softer than the original mineral. A fresh surface of the specimen to be tested should therefore be used. Sometimes the physical structure of a mineral may prevent a correct determination of its hardness. For instance, if a mineral is pulverulent, granular or splintery in its structure, it may be broken down and apparently scratched by a mineral much softer than itself. It is always advisable when making the hardness test to confirm it by reversing the order of procedure.

The following materials may serve in addition to the above scale: The finger nail is a little over 2 in hardness, since it can scratch gypsum and not calcite. A cent is about 3 in hardness, since it can just scratch calcite. The steel of an ordinary pocket-knife is just over 5, and ordinary window glass has a hardness of 5.5.

Crystals frequently show different degrees of hardness, depending upon the direction in which they are scratched. Ordinarily the difference is so small that it can be detected only by the use of delicate instruments.

#### IV. TENACITY OF MINERALS.

The following terms are used to describe various kinds of tenacity in minerals:

1. **Brittle.** When a mineral breaks or powders easily.
2. **Malleable.** When a mineral can be hammered out into thin sheets.
3.  **Sectile.** When a mineral can be cut into thin shavings with a knife.
4. **Flexible.** When a mineral bends but does not resume its original shape when the pressure is released.
5. **Elastic.** When, after being bent, the mineral will resume its original position upon the release of the pressure.

#### V. SPECIFIC GRAVITY OF MINERALS.

The specific gravity of a mineral is a number which expresses the ratio existing between its weight and the weight of an equivalent volume of water. If a mineral has a specific gravity of 2, it means that a given specimen of that mineral weighs twice as much as the same volume of water. The specific gravity of a mineral which does not vary in its composition is a constant factor, the determination of which is frequently an important aid to its identification.

After a little experience one can frequently judge quite accurately the specific gravity of a mineral by weighing it in the hand. Minerals containing the heavy metals like lead, copper, iron, etc., can be at once differentiated from those containing lighter elements by this means. And by practice one can become expert enough to be able to distinguish from each other minerals that have comparatively small differences in specific gravity; for instance, topaz (sp. gr. = 3.52) from orthoclase (sp. gr. = 2.57), and fluorite (sp. gr. = 3.18) from quartz (sp. gr. = 2.6).

In order to accurately determine the specific gravity of a mineral, the following conditions must be observed: The mineral must be pure. It must also be solid, with no cracks or cavities

within which bubbles or films of air could be imprisoned. The fragment used should be reasonably large, about one cubic inch being a convenient size. If these conditions cannot be met, it is of little use to attempt a specific gravity determination by any rapid and simple method.

The necessary steps in making an ordinary specific gravity determination are briefly as follows: The mineral is first weighed in air. Let this weight be represented by  $x$ . It is then immersed in water and weighed again. Under these conditions it weighs less, since any object immersed in water is buoyed up by a force equivalent to the weight of the water displaced. Let the weight in water be represented by  $y$ . Then  $x - y$  equals the loss of weight caused by immersion in water, or the weight of an equal volume of water. The expression  $\frac{x}{x - y}$  will therefore yield a number which is the specific gravity of the mineral.

The specific gravity of a mineral may be determined in various ways, those most commonly used being described below.

**1. By Means of a Chemical Balance.** The most accurate method of determining the specific gravity of a mineral is by the use of a chemical balance. To one beam of the balance is suspended a wire basket which is so arranged that it can be immersed in a beaker of water (see Fig. 191). The basket is hung in the water and then counterbalanced by weights on the opposite pan of the balance. The mineral specimen to be tested, having been first weighed on the balance in the ordinary fashion, is now placed in the basket under the water and weighed again. These two weights are the necessary data for calculating the specific gravity as explained above.

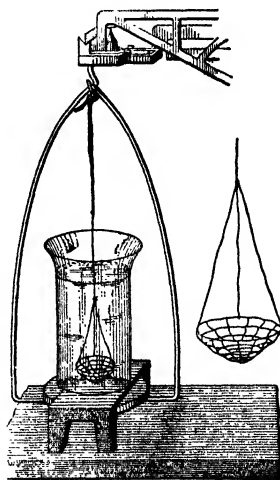


Fig. 191.

2. **By Means of a Jolly Balance.** Fig. 192 represents the balance of Jolly, by which the specific gravity is measured through the stretching of a spiral wire spring. From the spring is suspended two small metal pans (*c* and *d*), one above the other. The apparatus is so arranged that the lower pan (*d*) is always immersed in a beaker of water which, resting upon the adjustable platform *B*, can be placed at any required height. On the side of the upright *A*, which faces the spiral wire, there is a mirror with a graduated scale engraved upon it. The position of the balance is determined by means of a small bead (*m*) which is strung on the wire above the upper pan and which serves as an indicator. The eye is brought into such a position that the bead exactly covers its image in the mirror, and its position is then determined by means of the scale.

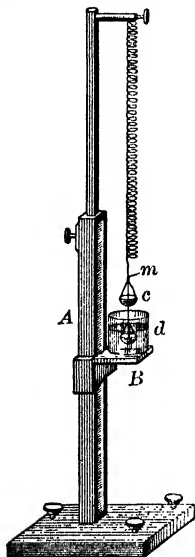


Fig. 192.

Three readings must be taken: first, simply the position of the balance with the lower pan in the water,  $x$ ; second, its position when the mineral is placed in the upper pan,  $y$ ; and third, its position when the mineral is in the lower pan and covered with water,  $z$ . The platform *B* with the beaker of water must be properly adjusted for each of these readings so as to always have the lower pan immersed in the water. The expression  $x - y$  will give a number representing the weight of the mineral in air, while  $x - z$  will yield a number corresponding to its weight in water. From these values the specific gravity of the mineral can be calculated as described above.

3. **By Means of a Beam Balance.** This is a very convenient and quite accurate method of determining specific gravity. The balance illustrated in Fig. 193 was devised by S. L. Penfield, who describes its operation as follows:

“The beam of wood is supported on a fine wire, or needle, at *b* and must swing freely. The long arm *bc* is divided into a

decimal scale, commencing at the fulcrum *b*; the short arm carries a double arrangement of pans so suspended that one of them is in the air and the other in water. A piece of lead on the short arm serves to almost balance the long arm, and, the pans being empty, the beam is brought to a horizontal position, marked upon the upright, near *c*, by means of a rider *d*. A number of counterpoises are needed, which do not have to be of any specific

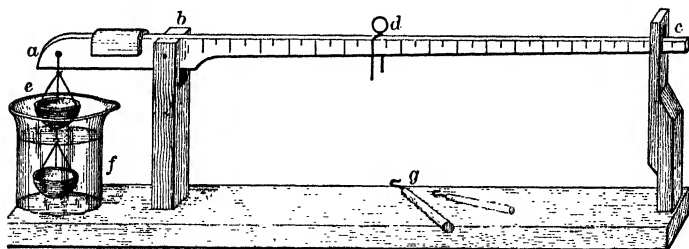


Fig. 193.

denomination, as it is their position on the beam and not their actual weight which is recorded. The beam being adjusted by means of the rider *d*, a fragment of the mineral is placed in the upper pan and a counterpoise is chosen, which, when placed near the end of the long arm, will bring it into a horizontal position. The weight of the mineral in air is given by the position of the counterpoise on the scale. The mineral is next transferred to the lower pan, and the same counterpoise is brought nearer the fulcrum *b* until the beam becomes again horizontal, when its position gives the weight of the mineral in water." From these two values the specific gravity of the mineral can be calculated.

## VI. PROPERTIES DEPENDING UPON LIGHT.

### A. Luster.

The luster of a mineral is its appearance due to the effect of light upon it. In general we divide minerals into three classes depending upon their luster, namely, metallic luster, submetallic



luster and nonmetallic luster. A mineral having the appearance of a metal like lead or copper is said to have a metallic luster. The term is further defined by saying that a mineral with a metallic luster is strictly opaque to light when examined on its thinnest edges. The metallic luster of a mineral can be proved by observing the color of its powder. If the powder is black or very dark in color, it means that each little particle of the mineral is still opaque to light, and therefore the mineral has a metallic luster. This test is made usually by the aid of what is called a streak plate. This consists of a piece of unglazed white porcelain upon which the mineral is rubbed so that a streak of its powder is formed upon the plate. The color of this "streak" of the mineral, as it is called, will determine its luster and also frequently will materially help in its identification. Examples of minerals with metallic luster would be, galena,  $PbS$ , with a bluish gray streak; pyrite,  $FeS_2$ , with a black streak; chalcopyrite,  $CuFeS_4$ , with a greenish black streak; and hematite,  $Fe_2O_3$ , with a dark reddish brown streak.

**Nonmetallic Luster.** Minerals with a nonmetallic luster are transparent to light on their thin edges. In general they are light colored, but not necessarily so. When a streak is obtained from a nonmetallic mineral, it is either colorless or very light in color. Various descriptive terms are used to further describe the appearance of nonmetallic minerals, the more common being as follows:

*Vitreous.* Having the luster of glass. Example, quartz.

*Resinous.* Having the appearance of resin. Example, sphalerite.

*Pearly.* Having the appearance of pearl. This is usually observed in minerals on surfaces that are parallel to cleavage planes. Example, basal plane on apophyllite.

*Greasy.* Looking as if covered with a thin layer of oil. Examples, some specimens of sphalerite and massive quartz.

*Silky.* Like silk. It is the result of a fine fibrous structure. Examples, fibrous malachite, serpentine, etc.

*Adamantine.* Having a hard, brilliant luster like that of a diamond. It is due to the mineral's high index of refraction

(see p. 71). The transparent lead minerals, like cerussite and anglesite, show it.

**Submetallic Luster.** There is no sharp divisional line between minerals with metallic and those with nonmetallic luster, and the group of minerals lying between is said to have a submetallic luster. They show a colored streak, but one which is not black or very dark in color. Examples of minerals with submetallic luster are limonite and some of the darker varieties of sphalerite.

## B. Color of Minerals.

The color of minerals is one of their most important physical properties. In the case of many minerals, especially those showing a metallic luster, color is a definite and constant property and will serve as an important means of identification. For example, the brass-yellow color of chalcopyrite, the blue-gray of galena, the black of magnetite, the green of malachite, etc., is in each case a striking property of the mineral. It is to be noted, however, that surface alterations may change the color even in minerals whose color is otherwise constant. This is shown in the yellow tarnish frequently observed on pyrite and marcasite, the purple tarnish on bornite, etc. In noting the color of a mineral, therefore, a fresh surface should be examined. Many minerals, however, do not show a constant color in their different specimens. This variation in color in the same species may be due to different causes. A change in color is often produced by a change in composition. The progressive isomorphous replacement of zinc by iron in sphalerite (see page 77) will change its color from white through yellow and brown to black. The minerals of the Amphibole Group show a similar variation in color. The amphibole tremolite, which is a silicate with only calcium and magnesium as bases, is very light in color, at times almost white; while actinolite and hornblende, which are amphiboles that contain increasing amounts of iron, range in color from green to black. Again, a mineral may show a wide range of color without any apparent change in composition. Fluorite is a striking example of this, since it is found in crystals that are colorless, white, pink, yellow, blue, green, etc. Such

extreme cases are, however, rare. Minerals are also frequently colored by various impurities. The red variety of quartz, known as jasper, is colored by small amounts of hematite. From the above it is seen that, while the color of a mineral is one of its important physical properties, it is not always constant, and must therefore often be used with some caution in the identification of a species.

**Play of Colors. Iridescence, Opalescence, etc.** A mineral is said to show a *play of colors* when on turning it several prismatic colors are seen in rapid succession. This is to be seen especially in the diamond and precious opal. A mineral is said to show a *change of color* when on turning it the colors change slowly, being different for varying positions. This is observed in labradorite. A mineral is *iridescent* when it shows a series of prismatic colors in the interior of the crystal or on the surface. It is usually caused by the presence of small fractures or cleavage planes which serve to break up the light into the prismatic colors. *Opalescence* is a milky or pearly reflection from the interior of a specimen. It is observed at times in opal and cat's-eye. A mineral is said to show a *tarnish* when the color of the surface differs from that of the interior.

**Asterism.** Some crystals, especially those of the Hexagonal System, when viewed in the direction of the vertical axis, present starlike rays of light. This arises from peculiarities of texture along the axial directions, or from some inclusions. A remarkable example is the star sapphire.

**Phosphorescence.** Several minerals when rubbed or heated give out light. This property is known as phosphorescence. Fluorite often shows phosphorescence when fragments are gently heated. The color of the emitted light may be green, purple, rose, yellow, etc.

### C. Refraction of Light in Minerals.

When light comes into contact with a transparent mineral, part of it is reflected from the surface of the mineral and part enters the mineral. The light which enters the mineral is in general refracted. When light passes from a rarer into a denser

medium, as in the case of passing from air into a mineral, its velocity is retarded. This change in velocity is accompanied by a corresponding change in the direction in which the light travels, and it is this change in direction of propagation that is known as refraction of light. The amount of refraction of a given light ray is directly proportional to the ratio existing between the velocity of light in air and in the mineral. The ratio between these two velocities is known as the index of refraction of the mineral and is designated by  $n$ . That is, if the index of refraction, or  $n$ , of a mineral is 2, light will travel in it with one-half the velocity it has in air.

In Fig. 194 let  $M-M$  represent the surface of a crystal of flu-  
orite. Let  $N-O$  be normal to that surface. Let  $A-O$  be one of  
a number of parallel light rays striking the surface  $M-M$  in such  
a way as to make the angle  $i$  (angle of incidence) with the normal

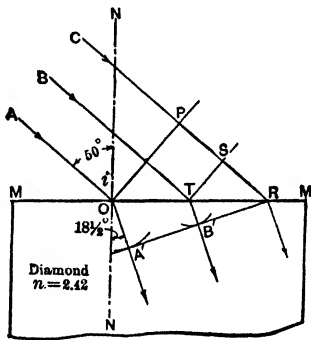
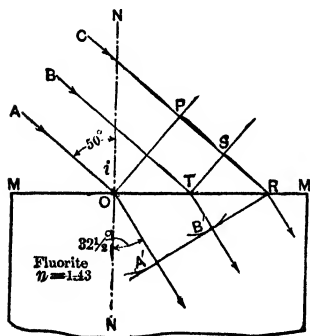


Fig. 194.

Fig. 195.

Refraction of Light.

$N-O$ . Let  $O-P$  be at right angles to the rays and representing the wave front of the light in air. As the crystal is the denser medium the light will travel in it more slowly. Therefore, as each ray in turn strikes the surface  $M-M$ , it will be retarded and the direction of its path be changed proportionately. In going from a rarer into a denser medium, the direction of the ray will be bent toward the normal  $N-O$ . To find the direction of the rays and line of wave front in the crystal, proceed as follows: Since the

index of refraction of fluorite is 1.43, ray *A* will travel in the crystal, in the time it takes ray *C* to travel from *P* to *R*,  $\frac{1}{1.43}$  of that distance, or to some point on the circular arc the length of whose radius *OA'* is  $\frac{1}{1.43}$  the distance *P-R*. Similarly, ray *B* will travel in the mineral during the period of time in which ray *C* travels from *S* to *R* a distance equal to  $\frac{1}{1.43}$  of the distance *S-R*, or the radius *TB'*. The same reasoning will hold true for all other rays. The wave front in the crystal can then be determined by drawing a tangent — the line *A'B'R* — to these various circular arcs; and lines perpendicular to this wave front will represent the direction in which the light travels in the mineral, and the angle *NOA'* or *r* will be the angle of refraction. Fig. 195 shows the same construction as that of Fig. 194, only in this case the mineral in question is assumed to be diamond. Since the index of refraction of diamond ( $n = 2.42$ ) is much greater than that of fluorite, light will travel in it with a still slower velocity. Consequently in diamond the amount of refraction will be greater. This is shown in the two figures, in both of which the angle of incidence is the same.

The refractive power toward light which a mineral possesses has often a distinct effect upon the appearance of the mineral. For example, a mass of cryolite may almost always be told at sight, though, as is generally the case, there is no crystal shape to aid in the identification. The mass has a peculiar appearance, something like that of wet snow, and quite different from that of ordinary white substances; and this is due to the fact that the index of refraction of cryolite is unusually low for a mineral. An instructive experiment may be tried by finely pulverizing some pure white cryolite and throwing the powder into water, when it will apparently disappear, as if it had instantly gone into solution. The powder, however, is insoluble, and may be seen indistinctly as it settles to the bottom of the vessel. The reason for this disappearance of the cryolite is that its index of refraction (about 1.34) is near that of water (1.335), hence the light travels almost as readily through the mineral as through water, and consequently it undergoes little reflection or refraction.

Substances having an unusually high index of refraction have an appearance which it is hard to define, and which is generally spoken of as adamantine luster. This kind of luster may be comprehended best by examining specimens of diamond ( $n = 2.419$ ) or of cerussite ( $n =$  about 3.2). They have a flash and quality, some diamonds almost a steel-like appearance, which is not possessed by minerals of low index of refraction; compare, for example, cerussite and fluorite ( $n = 1.434$ ). It is their high index of refraction that gives to many gem minerals their great brilliancy and charm.

In the majority of cases the index of refraction of a mineral is not far from 1.5, and gives to minerals a luster which is designated as vitreous. Quartz ( $n = 1.55$ ), feldspar ( $n = 1.52$ ) and calcite ( $n = 1.57$ ) are good examples.

#### D. Double Refraction in Minerals.

All minerals except those belonging to the Isometric System show in general a double refraction of light. That is, when a ray of light enters such a mineral it is broken up into two rays, each of which travels with a different velocity through the mineral. Since each ray has its own characteristic velocity, it follows that the angle of refraction will be different in each case and the paths of the two rays will be divergent. In other words, the light has undergone double refraction. In the majority of cases the amount of this double refraction is small, and the fact that it exists can only be demonstrated by special and delicate instruments. Calcite, however, shows such a strong double refraction that it can be easily observed. Take a cleavage block of clear calcite (Iceland spar), for instance, and place it over an

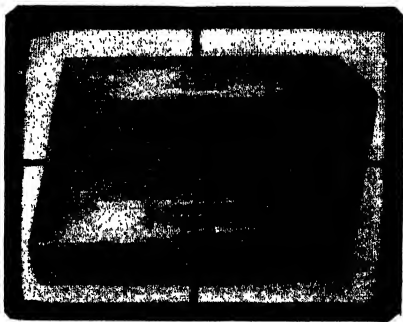


Fig. 196. Double Refraction in Calcite.

Fig. 196. Double Refraction in Calcite.

image marked on paper. The image will appear double (see Fig. 196).

The amount of double refraction, or in other words the amount of divergence of the two rays, shown by any mineral depends, first, upon the refracting power of the mineral, or its strength of birefringence, as it is called; second, upon the thickness of the block of the mineral; and lastly, upon the crystallographic direction in which the light is traveling in the mineral. In the case of tetragonal and hexagonal minerals, there is one direction (that of the vertical crystallographic axis) in which no double refraction takes place. As soon as a ray of light in the mineral diverges from this direction it is doubly refracted, and the amount of double refraction increases as the path of the light becomes more oblique, and attains its maximum when it is at right angles to the vertical axis. Such minerals belong to the optical class known as uniaxial. In the case of orthorhombic, monoclinic and triclinic minerals, there are two directions similar to the one described above, in which no double refraction takes place, and the minerals of these systems are therefore spoken of as optically biaxial.

In addition to doubly refracting light, all minerals except those of the Isometric System polarize it as well. Ordinary light is conceived as made up of vibrations taking place in all planes. Light is polarized when it vibrates in a single plane. In the case of both uniaxial and biaxial crystals, each of the two rays into which a beam of light is refracted is polarized and in planes which are perpendicular to each other. For a fuller consideration of the optical properties of minerals, the reader must be referred to books of a more detailed character.

## VII. PYROELECTRICITY.

Crystals of certain minerals, on cooling after being heated to about 100° C., will develop upon different portions a positive and a negative electric charge. This can be proved by the power that such minerals show under these conditions to attract and hold to themselves small pieces of paper, etc. Minerals which are hemimorphic in their crystallographic character, like calamine, tourmaline, etc., exhibit this property.

### III. CHEMICAL MINERALOGY.

A MINERAL may be defined as a naturally occurring substance having a definite chemical composition. The chemical composition of a mineral is the most fundamentally important fact about it, for upon this all its other properties must in great measure be dependent. The physical characteristics of a mineral may sometimes serve as means of its positive identification, and in the great majority of cases they will be of material assistance; but the final proof of its identity will more often lie in the determination of its chemical character by means of chemical tests. Consequently the study of the chemistry of minerals is the most important single division of the subject. This section will, therefore, be devoted to a brief and elementary discussion of chemical mineralogy. First some general aspects of the subject will be presented, followed by a short description of the methods of testing for the different elements most commonly observed. The scope and size of this book necessitate the assumption that the reader is familiar with at least the essentials of chemical fact and nomenclature.

Scientists up to the present time have established the occurrence of more than eighty different elements. The greater part of these, however, are extremely rare and are only of scientific interest. Some forty-four elements are found in sufficient amount, or because of their properties are of sufficient importance, to warrant a discussion of them here. A considerable proportion of this list also must be considered as rare in occurrence. The following table gives the names and symbols of the eighteen most common elements arranged in the approximate order of their importance as constituents of the earth's crust:



Oxygen	O.	Sodium	Na.	Phosphorus	P.
Silicon	Si.	Potassium	K.	Sulphur	S.
Aluminium	Al.	Hydrogen	H.	Barium	Ba.
Iron	Fe.	Titanium	Ti.	Manganese	Mn
Calcium	Ca.	Carbon	C.	Strontium	Sr.
Magnesium	Mg.	Chlorine	Cl.	Fluorine	F.

It is to be noted that the above list fails to include such important elements as copper, lead, zinc, silver, gold, tin, mercury, nickel, antimony, arsenic, etc., all of which form much less than one-hundredth of one per cent of the rocks of the earth's crust.

These elements occur alone or in various chemical combinations in the form of minerals. Below is given a brief discussion of the various classes of chemical compounds in which the majority of minerals occur.

### Chemical Groups.

**Elements.** There are a few minerals that consist of single elements alone. For example, gold, Au.

**Sulphides.** A very important group of minerals, consisting of combinations of the various metals with the element sulphur, are known as sulphides. They include the majority of the metallic ore minerals. For example, pyrite,  $\text{FeS}_2$ .

**Sulpho-salts.** This group of minerals includes a series which mostly contain lead, copper or silver in combination with sulphur and either antimony or arsenic. For example, tetrahedrite,  $\text{Cu}_9\text{Sb}_2\text{S}_7$ .

**Haloids.** This group includes minerals that are salts of the halogen acids, chiefly hydrochloric or hydrofluoric acids. Examples are halite, NaCl, and fluorite,  $\text{CaF}_2$ .

**Oxides.** The minerals of this group contain a metal in combination with oxygen. For example, hematite,  $\text{Fe}_2\text{O}_3$ .

**Hydroxides.** An hydroxide is a mineral that contains the hydroxyl group, OH, as an important radical. For example, limonite,  $\text{Fe}_2\text{O}_3(\text{OH})_2$ .

**Carbonates.** The carbonates are salts of carbonic acid,  $\text{H}_2\text{CO}_3$ . For example, calcite,  $\text{CaCO}_3$ .

**Silicates.** The silicates form the largest chemical group among minerals. They contain various elements as bases, the most common of which are sodium, potassium, calcium, magnesium, aluminium and ferrous and ferric iron. They are frequently very complex in their chemical structure. They are salts of a number of different silicic acids, the most important of which are as follows:

Orthosilicate acid =  $H_4SiO_4$ , which is represented by almandite,  $Fe_2Al_2(SiO_4)_3$ .

Metasilicic acid =  $H_4Si_2O_6$  or  $H_2SiO_3$ , represented by leucite,  $KAl(SiO_3)_2$ .

Polysilicic acid =  $H_4Si_3O_8$ , represented by orthoclase,  $KAlSi_3O_8$ .

**Niobates and Tantalates.** These are combinations of various metals with the rare niobic and tantallic acids. For example, columbite,  $FeNb_2O_6$ , and tantalite,  $FeTa_2O_6$ .

**Phosphates.** The phosphates are salts of some phosphoric acid. The most common member of the group is the mineral apatite,  $Ca_4(CaF)(PO_4)_3$ .

**Sulphates.** The sulphates are salts of sulphuric acid,  $H_2SO_4$ . For example, gypsum,  $CaSO_4 \cdot 2H_2O$ .

**Tungstates.** These are salts of the rare tungstic acid  $H_2WO_4$ . For example, scheelite,  $CaWO_4$ .

### Derivation of a Chemical Formula from the Analysis of a Mineral.

The chemical formulas which are assigned to minerals have in every case been calculated from chemical analyses. An analysis gives the percentage composition of a mineral, or, in other words, the parts by weight in one hundred of the different elements or radicals present. Consider the following analysis of chalcopyrite:

Percentages.	Atomic weights.	Ratio.
S = 34.82 ÷	32.06	= 1.086 = 2.00
Cu = 34.30 ÷	63.6	= 0.539 = 0.99 or 1.00
Fe = 30.59 ÷	55.9	= 0.547 = 1.00
99.71		

The percentage numbers given indicate the proportions by weight of the different elements in the mineral. But as these

elements have different atomic weights, the numbers do not represent the ratio of the different atoms to each other in the chemical molecule. In order to derive the relative proportions of the atoms of the different elements to each other, the percentages as given are divided in each case by the atomic weight of the element. This gives a series of numbers which does represent the ratio of the atoms to each other in the molecule. In the analysis of chalcopyrite this ratio becomes  $S : Cu : Fe = 2 : 1 : 1$ . Consequently  $CuFeS_2$  will constitute the chemical formula for the mineral.

If the mineral is an oxygen compound the results of the analysis are given as percentages of the oxides present, and by a calculation similar to that outlined above the ratio of these oxide radicals to each other in the molecule is determined; the only difference in the process being that in this case the percentage numbers are divided by the sum of the atomic weights of the elements present in the different radicals. As an example consider the following analysis of gypsum:

Percentages.	Molecular weights.	Ratio.
$SO_3 = 46.61 \div$	83.06	$= 0.583 = 1.00$
$CaO = 32.44 \div$	56.1	$= 0.578 = 0.99 \text{ or } 1.00$
$H_2O = 20.74 \div$	18.0	$= 1.152 = 1.98 \text{ or } 2.00$
<u>99.79</u>		

From this it is seen that the ratio of the radicals to each other in the molecule is  $SO_3 : CaO : H_2O = 1 : 1 : 2$ , and consequently the composition of gypsum can be represented by the formula  $CaO.SO_3.2H_2O$  or  $CaSO_4.2H_2O$ .

### Calculation of the Percentage Composition of a Mineral from Its Chemical Formula.

It frequently happens that it is desirable to determine what the theoretical composition of a mineral is, having given its formula. The process of calculation is the reverse of that described in the preceding division. Take, for example, the mineral chalcopyrite,  $CuFeS_2$ ; what are the proportions by weight of the different elements in one hundred parts of the mineral? The process consists in first adding up the atomic

weights of the different elements present and so obtaining the molecular weight of the compound, as follows:

	Atomic weights.
Cu	= 63.6
Fe	= 55.9
S = 32.06 × 2	= 64.12
Molecular weight CuFeS <sub>2</sub>	= 183.62

It is obvious from the above that in 183.62 parts by weight of chalcopyrite there are 63.6 parts of copper, etc. In order to find the parts of copper in 100 parts of the mineral, or in other words, its percentage, the following proportion is made:

$$183.62 : 63.6 = 100 : x.$$

When this equation is solved,  $x$  becomes 34.64, or the percentage of copper in chalcopyrite. The percentages of the iron and sulphur are to be obtained in a similar manner.

### Isomorphism.

It is to be noted frequently that the results of a mineral analysis do not agree with the theoretical composition of the mineral as calculated from its formula. Further, it often happens that the analyses of different specimens of the same mineral will show marked variations in the proportions of the different elements present. If the material analyzed was pure and the analysis accurately made, these variations are commonly to be explained by the principle of isomorphism. To make clear what is meant by this term, it will be best to consider some illustrative examples. Sphalerite, for instance, is a mineral which shows in its different specimens a wide range in color, from white through

I.	At. wt.	Ra- tio.	II.	At. wt.	Ra- tio.	III.	At. wt.	Ra- tio.
S = 32.22	32.06	=1.00	33.36	32.06	=1.04	33.25	32.06	=1.037
Zn = 67.46	65.4	=1.03	63.36	65.4	=0.96	50.02	65.4	=0.764
Fe = .....	.....	.....	3.60	55.9	=0.06	15.44	55.9	=0.276
Cd = .....	.....	.....	.....	.....	.....	0.30	112.4	=0.002
Pb = .....	.....	.....	.....	.....	.....	1.01	206.9	=0.004
<b>Total.....99.68</b>	.....	.....	<b>100.32</b>	.....	.....	<b>100.02</b>	.....	.....

brown to black, with a corresponding variation in composition. In column I is given an analysis of white sphalerite from Franklin Furnace, N. J., in column II is given an analysis of a brown sphalerite from Roxbury, Conn., and in column III that of a black sphalerite from Felsöbánya.

It will be noted that in the three analyses there is a progressive increase in the percentages of iron present and a corresponding decrease in the amount of zinc. It would appear as if the iron had replaced a portion of the zinc in the mineral and was playing the same part as the zinc in the molecule. Further, if the atomic ratios are derived from each analysis by the method described in the preceding division, it will be found that in analyses II and III the series of numbers do not show any rational relations to each other. But, if the numbers derived in each case from the percentages of the different metals present are combined, their sum will equal the number derived from the percentage of the sulphur. In other words, the number of atoms of zinc plus those of iron, lead and cadmium equals the number of atoms of sulphur. The formula of sphalerite could therefore be written  $R''S$ , where  $R''$  equals chiefly zinc, with smaller amounts of iron and other metals. Another way of expressing the same thing would be  $(Zn,Fe)S$ . In this case the iron is said to be isomorphous with the zinc, since it has the power to replace the zinc in the mineral in varying proportions without changing its molecular structure or crystal form.

The garnets form a series of minerals with the same crystallization and general physical properties, but show quite a wide variation in chemical composition. Consider the following analysis of an almandine garnet:

Percentages.	Molecular weights.	Ratio.	
$SiO_2 = 35.92$	$\div 60.4$	$= 0.594$	$= 3.00$
$Al_2O_3 = 19.18$	$\div 102.2$	$= 0.187$	} $0.217 = 1.09$
$Fe_2O_3 = 4.92$	$\div 159.8$	$= 0.030$	
$FeO = 29.47$	$\div 71.9$	$= 0.409$	
$MnO = 4.80$	$\div 71.0$	$= 0.067$	} $0.609 = 3.02$
$MgO = 3.70$	$\div 40.36$	$= 0.091$	
$CaO = 2.38$	$\div 56.1$	$= 0.042$	
<u>100.37</u>			

It is a silicate containing chiefly ferrous and aluminium oxides but with smaller amounts of manganese, magnesium, calcium and ferric oxides. If the ratio of the series of oxides to each other in the molecule is obtained, it is seen that it is not a rational one. But if the ratio numbers of the similar oxides are combined, — that is, the number from the  $\text{Al}_2\text{O}_3$  with that from the  $\text{Fe}_2\text{O}_3$ , and that from the  $\text{FeO}$  with those from the  $\text{MnO}$ ,  $\text{MgO}$  and  $\text{CaO}$ , — it will be found that the relationship of the different groups of radicals can be expressed as  $\text{SiO}_2 : \text{Al}_2\text{O}_3 + \text{Fe}_2\text{O}_3 : \text{FeO} + \text{MnO} + \text{MgO} + \text{CaO} = 3 : 1 : 3$ . From this it is seen that some of the possible  $\text{Al}_2\text{O}_3$  has been replaced by isomorphous  $\text{Fe}_2\text{O}_3$ , and that a part of the  $\text{FeO}$  has been replaced by the isomorphous oxides of  $\text{MnO}$ ,  $\text{MgO}$  and  $\text{CaO}$ . The formula for this garnet might be written, therefore, as  $3\text{R}''\text{O} \cdot 1\text{R}_2'''\text{O}_3 \cdot 3\text{SiO}_2$  or  $\text{R}_3''\text{R}_2'''\text{(SiO}_4)_3$ , in which  $\text{R}'' = \text{Fe, Mn, Mg and Ca}$ , and  $\text{R}''' = \text{Al and Fe}$ .

**Isomorphous Groups.** A series of compounds which have analogous chemical compositions and closely similar crystal forms are said to make an isomorphous group. The artificial compounds known as the alums form a striking example. They are double salts of sulphuric acid, similar to the following,  $\text{KAl(SO}_4)_2 \cdot 12\text{H}_2\text{O}$ , which is known as potash alum. They may vary in their composition by the substitution of  $\text{Na}$ ,  $\text{Li}$ ,  $\text{NH}_4$ , etc., for the potassium and of  $\text{Fe}'''$  and  $\text{Cr}$  for the aluminium. All these compounds have, therefore, different but analogous compositions, and it is found also that they all crystallize in the Isometric System with an octahedral habit. Further, if a crystal of one alum is suspended in a saturated solution of another member of the series, the crystal will continue to grow. From this it is proved that the molecules of the different alums are physically so closely alike that they can be substituted for each other in any proportion. Therefore this series of compounds is said to be an *Isomorphous Group*.

Many such groups are to be found in minerals, and attention is called to them in various places in Section IV. Reference might be made to one of the most prominent of these in the case of the Calcite Group (see page 203). This is a series of minerals

all of which are carbonates of similar bivalent metals, and therefore they can be said to have analogous chemical compositions. Further, they all crystallize in the same crystal system and class, and have closely agreeing angles between similar crystal faces. Consequently they conform to the second requirement for an Isomorphous Group, namely, that the minerals of it should show similar crystal forms.

### Dimorphism, Trimorphism, Etc.

A number of cases are well known among minerals in which two or three different species have the same chemical composition but distinctly different physical properties. When one compound appears in two different forms, it is said to be dimorphous; when in three different forms, trimorphous. Carbon in the forms of graphite and diamond, calcium carbonate as calcite and aragonite, iron sulphide as pyrite and marcasite, are familiar examples of dimorphism. The two minerals in each case differ from each other in such physical properties as crystallization, hardness, specific gravity, color, reactions with acids, etc. Titanium oxide,  $TiO_2$ , is trimorphous, since it occurs in the three distinct minerals, rutile, octahedrite and brookite.

### Instruments, Reagents and Methods of Testing.

**The Blowpipe and Its Use.** Many of the chemical tests made on minerals are performed by aid of an instrument known as a blowpipe. The blowpipe consists essentially of a tapering tube ending in a small and symmetrical opening through which air can be forced in a thin stream at high pressure. This current of air, when directed into a luminous flame, converts it into a small and very hot flame, by means of which many important tests can be made.

Fig. 197 represents a common type of blowpipe. The air is forced from the lungs into the mouthpiece, *c*, which fits into the upper end of the tube and issues from the small opening at the other end. The tip of the blowpipe, *b*, is placed just within a

flat flame which is rich in carbon, such as is obtained from a candle or ordinary illuminating gas. A convenient method of producing a blowpipe flame is to use illuminating gas in a Bunsen burner, in which an inner tube, *c* (Fig. 198), has been placed so as to shut off the supply of air at the base of the burner and thus convert the flame into a luminous one. The upper end of this tube is flattened and cut at an angle, as is shown in Fig. 198. The

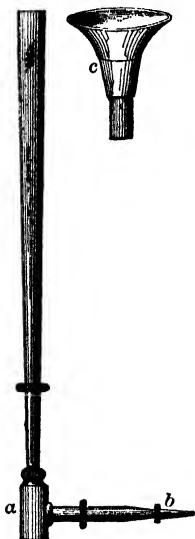


Fig. 197.

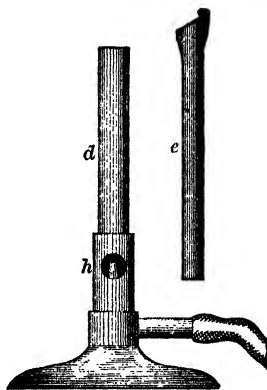


Fig. 198.

gas flame is ordinarily adjusted so that it measures about 1 inch in height and  $\frac{1}{2}$  inch in breadth. The blowpipe is introduced into this flame as shown in Fig. 199. The resulting blowpipe flame should be nonluminous, narrow, sharp-pointed and clean-cut. If illuminating gas is not available, a candle with a flat wick or even an ordinary candle can be used. The latter require, however, more skill in manipulation.

**The Art of Blowpiping.** It usually requires some practice before one can produce a steady and continuous blowpipe flame.



Many tests can be made by means of a flame produced by exhausting the supply of air in the lungs simply once. But frequently an operation takes a longer time than this would give, and the interruption necessary in order to fill the lungs afresh would materially interfere with the success of the experiment. Consequently it often becomes important to be able to maintain a steady stream of air from the blowpipe for a considerable time. This is accomplished by distending the cheeks so as to form a reservoir of air in the mouth. When the supply of air in the lungs is exhausted, the passage from the mouth into the throat

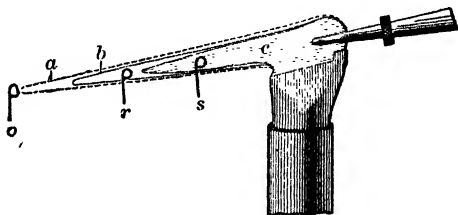


Fig. 199.

is closed by lifting the root of the tongue and while a new supply is being obtained by breathing in through the nose a steady stream of air is also being forced out of the reservoir in the mouth. In this way a constant flame may be obtained. It requires, however, considerable practice to do this skillfully.

**The Character of the Blowpipe Flame.** Fig. 199 represents a typical blowpipe flame. The inner cone, *c*, which is light blue in color and the most distinct part of the flame, is composed of unburned gas mixed with air from the blowpipe. There is no combustion taking place in this part of the flame. Around this cone is a narrow pale-violet cone, *b*, which is almost invisible and in which the combustion does take place. Any gas that is used for the production of the flame will consist of some combination of carbon and hydrogen. These elements when the gas is burned are converted into their respective oxides. The hydrogen burns directly to water vapor,  $H_2O$ . The carbon

burns first to its lower oxide, CO, known as carbon monoxide. Later this oxide will be changed by the addition of another atom of oxygen to the higher oxide, CO<sub>2</sub>, carbon dioxide. The final products of the combustion will, therefore, be the gases H<sub>2</sub>O and CO<sub>2</sub>. In cone *b*, where combustion is taking place, there will necessarily be considerable amounts of the lower oxide of carbon, CO. Surrounding cone *b* there will be an invisible cone, *a*, consisting of the final products of combustion, CO<sub>2</sub> and H<sub>2</sub>O.

**Fusion by Means of Blowpipe Flame.** A good blowpipe flame may reach a temperature as high as 2000° C. When skillfully handled small pieces of fine platinum wire may be melted in it. The determination of the degree of fusibility of a mineral

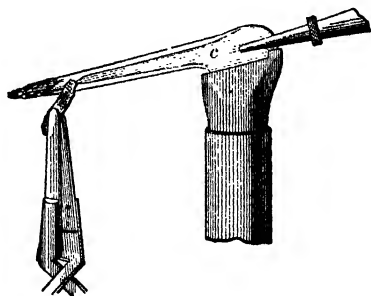


Fig. 200.

is an important aid to its identification. In order to make the test, a small and if possible a sharply pointed fragment of the mineral should be inserted into the blowpipe flame just beyond the tip of the inner cone, where the combustion is most rapid and the temperature the highest. The fragment should be held as illustrated in Fig. 200, so that it projects beyond the end of the forceps by which it is held in such a manner that the entire heat of the flame can be concentrated upon it. If it melts and rounds over, losing its sharp outline, it is said to be fusible in the blowpipe flame. Minerals can therefore be divided into two classes, as to whether they are fusible or infusible in this flame. The minerals which are fusible can be further classified according to

the degree of ease with which they fuse. To assist in this classification, a series of six minerals which show different degrees of fusibility has been chosen as a scale to which all fusible minerals may be approximately referred. For instance, when a mineral is said to have a fusibility of 3, it means that it will fuse with the same degree of ease as the mineral which is listed as 3 in the scale. In making such comparative tests, it is necessary to use fragments of the same size and to have the conditions of the experiments uniform. The minerals of the scale of fusibility are as follows:

1. *Stibnite*. Very easily fusible. A small splinter will readily melt in a candle flame.

2. *Chalcopyrite*. Easily fusible. A small fragment will fuse in the Bunsen burner flame.

3. *Almandine Garnet*. Infusible in the Bunsen burner flame but fuses easily in the blowpipe flame.

4. *Actinolite*. A sharp-pointed splinter fuses without much difficulty in the blowpipe flame.

5. *Orthoclase*. The edges of a fragment are rounded at the highest heat of the blowpipe flame.

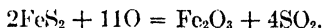
6. *Enstatite*. Practically infusible in blowpipe flame, only the fine ends of sharp-pointed fragments being rounded.

**Reducing and Oxidizing Flames.** Reduction consists essentially in taking oxygen away from a chemical compound, and oxidation consists in adding oxygen to it. These two opposite chemical reactions can be accomplished by means of a blowpipe flame. Cone *b*, Fig. 199, as explained above, contains CO, or carbon monoxide. This is what is known as a reducing agent, since, because of its strong tendency to take up oxygen in order to become CO<sub>2</sub>, or carbon dioxide, it will, if possible, take oxygen away from another substance in contact with it. For instance, if a small fragment of the ferric oxide of iron, hematite, Fe<sub>2</sub>O<sub>3</sub>, is held in this part of the blowpipe flame, it will be reduced by the removal of one atom of oxygen to the ferrous oxide, FeO, according to the following equation:



This change can be proved by noting that the ferric oxide is red in color and nonmagnetic, while the ferrous oxide is black and strongly magnetic. This cone *b* is therefore known as the reducing part of the blowpipe flame, and when it is wished to perform a reduction test the mineral fragment is placed at *r*, as shown in Fig. 199.

On the other hand, if oxidation is to be accomplished, the mineral must be placed entirely outside of the flame, where the oxygen of the air can have free access to it, but where it can still get in large degree the heat of the flame. Under these conditions, if the reaction is possible, oxygen will be added to the mineral and the substance will be oxidized. The oxidizing part of the blowpipe flame is at *o* (Fig. 199). Pyrite,  $\text{FeS}_2$ , for instance, if placed in the oxidizing flame, would be converted into ferric oxide,  $\text{Fe}_2\text{O}_3$ , and sulphur dioxide,  $\text{SO}_2$ , according to the following equation:



The ferric oxide would form a dark-red residue, while the sulphur dioxide would come off as a pungent-smelling gas.

**Use of Charcoal in Blowpiping.** Small charcoal blocks, that should best be about 4 inches long, 1 inch wide and  $\frac{1}{2}$  inch thick,



Fig. 201. An Oxide Coating on Charcoal.

are employed in a number of blowpipe tests. They are used as a support upon which various reactions are accomplished. For instance, metals like lead, silver, copper, etc., may be reduced from their minerals by means of the blowpipe flame, the experiment being performed upon charcoal. Characteristic oxide coatings also may be obtained upon the surface of a charcoal block (see Fig. 201). The charcoal should be of a fine and uniform grain. It should not be so soft as to readily soil the fingers, nor should it be so hard as not to be easily cut and scraped by a knife. The following table gives a list of the elements which yield

characteristic oxide coatings when their minerals are heated in the oxidizing flame on charcoal:

Oxide.	Color and character of coating.	Remarks.
<i>Arsenious Oxide.</i> $As_2O_3$ .	White and volatile, depositing at some distance from the mineral.	Usually accompanied by garlic odor.
<i>Antimony Oxides.</i> $Sb_2O_3$ , $Sb_2O_5$ .	White and volatile, depositing close to the mineral.	Heavier than arsenic oxide.
<i>Zinc Oxide.</i> $ZnO$ .	Yellow when hot, white when cold. Nonvolatile in the oxidizing flame. Deposits very close to mineral.	If coating is moistened with cobalt nitrate and heated intensely, it turns green.
<i>Tin Oxide.</i> $SnO_2$ .	Faint yellow when hot, white when cold. Nonvolatile in the oxidizing flame.	
<i>Molybdenum Oxide.</i> $MoO_3$ .	Pale yellow when hot, white when cold. Sometimes crystalline. Volatile in the oxidizing flame.	If the coating is touched for a moment by a reducing flame, it becomes dark blue.
<i>Lead Oxide.</i> $PbO$	Yellow near the mineral and white farther away.	Coating at times is composed of white sulphite and sulphate of lead in addition to the oxide.
<i>Bismuth Oxide.</i> $Bi_2O_3$ .	Yellow near the mineral and white farther away.	To be told from the lead-oxide coating by iodine tests (see p. 97).

**Open Tube Test.** Glass tubing of hard glass is used in making what are known as open tube tests. The tubing should be cut into approximately 8-inch lengths and have an internal diameter of  $\frac{1}{4}$  inch. An open tube is used ordinarily for making oxidation tests. A small amount of the mineral to be tested is commonly powdered and placed in the tube at a point about one-third of its length from one end. A narrow strip of paper folded into a shallow trough will serve as a boat to introduce the powder into the tube. The tube is then inclined at as sharp an angle as possible, with the mineral lying nearer the lower end. The tube is then held over a Bunsen burner flame in such a way that the flame plays on the upper part of the tube. This serves to convert the inclined tube into a chimney, up which a current of air flows. After a moment the tube is shifted so that the flame

heats it at a point just above the mineral, or in some cases the flame may be directly beneath the mineral. The mineral is being heated under these conditions in a steady current of air, and it will be oxidized if such a reaction is possible. Various oxides may come off as gases and either escape at the end of the tube or be condensed as sublimates upon its walls. The following table gives a list of those elements which yield characteristic reactions when heated in open tubes:

<b>Element.</b>	<b>Description of Test.</b>
<i>Sulphur.</i>	Sulphur dioxide, $\text{SO}_2$ , comes out of upper end of tube as a gas with a pungent and irritating odor. If a moistened strip of blue litmus paper is placed at the upper end of the tube, it becomes red, due to the acid reaction caused by the sulphurous acid.
<i>Arsenic.</i>	Arsenious oxide, $\text{As}_2\text{O}_3$ , condenses at a considerable distance above the heated portion as a volatile coating of small colorless octahedral crystals.
<i>Antimony.</i>	Antimonious oxide, $\text{Sb}_2\text{O}_3$ , deposits as a volatile white ring closer to the heated portion of the tube than the arsenious oxide. Antimony sulphides yield also a dense nonvolatile white sublimate of antimonate of antimony, $\text{Sb}_2\text{O}_4$ , which collects along the bottom of the tube.
<i>Molybdenum.</i>	Molybdenum trioxide, $\text{MoO}_3$ , collects near the heated portion as a network of pale yellow to white crystals.
<i>Mercury.</i>	Collects in minute gray globules which can be rubbed together.

*Note.* Other reactions may be obtained from some of the above elements if the mineral is heated too rapidly or without the establishment of a strong current of air flowing through the tube.

**Closed Tube Test.** Frequently a small glass tube which has been closed at one end is useful in testing minerals. The tube

is made out of soft glass and should have a length of about  $3\frac{1}{2}$  inches and an internal diameter from  $\frac{1}{8}$  to  $\frac{3}{16}$  of an inch. Two closed tubes can easily be made by fusing the center of a piece of tubing 7 inches in length and pulling it apart. The closed tube test is used to determine what takes place when a mineral is subjected to heat practically out of contact with the air. Ordinarily there is no chemical reaction involved. In general, in the closed tube the mineral will break down into simpler parts if that is possible, but otherwise nothing will take place except possibly a fusion of the mineral. The following table gives a list and brief description of the important closed tube tests:

**Substance.****Description of Test.**

*Water, H<sub>2</sub>O.* All minerals containing water of crystallization or the hydroxyl radical will give on moderate heating a deposit of drops of water on the cold upper walls of the tube.

*Sulphur, S.* All sulphides which contain an *excess* of sulphur will give a sublimate of sulphur, which is red when hot and yellow when cold.

*Arsenic, As.* Native arsenic and some arsenides will give a deposit of metallic arsenic. This consists of two rings, one being composed of a black and amorphous material, the other lying nearer the bottom of the tube, of a silver-gray and crystalline material.

*Oxysulphide of antimony, Sb<sub>2</sub>S<sub>2</sub>O.* Sulphide of antimony and some sulphantimonites give this sublimate in the form of a slight coating which deposits close to the bottom of the tube. It is black when hot and red when cold. It is accompanied by a faint deposit of sulphur further up the tube.

*Sulphide of mercury, HgS.* A black amorphous sublimate which forms when cinnabar is heated.

*Mercury*, Hg. Gray metallic globules of metallic mercury are obtained when native mercury or amalgams are heated or when the sulphide is mixed with dry sodium carbonate and heated.

**Flame Test.** Certain elements may be volatilized when minerals containing them are heated intensely before the blow-pipe and so impart characteristic colors to the flame. The flame color to be obtained from a mineral will often serve as an important means of its identification. A flame test may be made by heating a small fragment of the mineral held in the forceps, but a more decisive test is usually obtained when the fine powder of the mineral is introduced into the Bunsen burner flame on a piece of fine platinum wire. The following table gives a list of the important elements which yield flame colors. It is to be noted that a mineral may contain one of these elements, but because of the nonvolatile character of the chemical combination will fail to give a flame color.

<b>Element.</b>	<b>Color of Flame.</b>	<b>Remarks.</b>
<i>Strontium.</i>	Crimson.	Strontium minerals which give the flame color also give alkaline residues after being heated.
<i>Lithium.</i>	Crimson.	Lithium minerals which give the flame color do not give alkaline residues after being heated.
<i>Calcium.</i>	Orange.	In the majority of cases a distinct calcium flame will be obtained only after the mineral has been moistened with HCl.
<i>Sodium.</i>	Intense yellow.	A very delicate reaction. The flame should be very strong and persistent to indicate the presence of sodium in the mineral as an essential constituent.



Element.	Color of Flame.	Remarks.
<i>Barium.</i>	Yellow green.	Minerals which give the barium flame also give alkaline residues after ignition.
<i>Molybdenum.</i>	Yellow green.	Obtained from the oxide or sulphide of molybdenum.
<i>Boron.</i>	Yellow green.	Minerals giving a boron flame rarely give alkaline residues after ignition.
<i>Copper.</i>	{ Emerald-green.	Obtained from the oxide of copper.
	{ Azure-blue.	Obtained from the chloride of copper.
<i>Zinc.</i>	Bluish green.	Appears usually as bright streaks and threads in the flame.
<i>Lead.</i>	Pale azure-blue.	Tinged with green in the outer parts.

**Color Reactions with the Fluxes.** Some elements, when dissolved in certain fluxes, give a characteristic color to the fused mass. The fluxes that are most commonly used are borax,  $\text{Na}_2\text{B}_4\text{O}_7 \cdot 10\text{H}_2\text{O}$ , sodium carbonate,  $\text{Na}_2\text{CO}_3$ , and salt of phosphorus,  $\text{HNaNH}_4\text{PO}_4 \cdot 4\text{H}_2\text{O}$ . The operation is best performed by first fusing the flux on a small loop of platinum wire into the form of a lens-shaped bead. The loop on the wire should best have the shape and size shown in Fig. 202. After the flux has been fused into a bead on the wire, a small amount of the powdered mineral is introduced into it and is dissolved by further heating. The color of the resulting bead may depend upon whether it was heated in the oxidizing or reducing flame and



Fig. 202. Loop of Platinum Wire for Bead Tests.

whether the bead is hot or cold. The following table gives a list of the important bead tests:

Table of Color Reactions with the Fluxes.

Oxides of		Borax Bead.		Phosphorus Salt Bead.	
		Oxidizing flame.	Reducing flame.	Oxidizing flame.	Reducing flame.
<i>Chromium.</i>	Hot.	Yellow.	Green.	Dirty green.	Dirty green.
	Cold.	Yellowish green.	Green.	Fine green.	Fine green.
<i>Vanadium.</i>	Hot.	Yellow.	Dirty green.	Yellow.	Dirty green.
	Cold.	Yellowish green almost colorless.	Fine green.	Yellow.	Fine green.
<i>Uranium.</i>	Hot.	Deep yellow to orange-red.	Pale green.	Yellow.	Pale dirty green.
	Cold.	Yellow.	Pale green to nearly colorless.	Pale greenish yellow.	Fine green.
<i>Iron.</i>	Hot.	Deep yellow to orange-red.	Bottle-green.	Deep yellow to brownish red.	Red-yellow to yellow-green.
	Cold.	Yellow.	Pale bottle-green.	Yellow to almost colorless.	Almost colorless.
<i>Copper.</i>	Hot.	Green.	Colorless to green.	Green.	Brownish green.
	Cold.	Blue.	Opaque red with much oxide.	Blue.	Opaque red.
<i>Cobalt.</i>	Hot.	Blue.	Blue.	Blue.	Blue.
	Cold.	Blue.	Blue.	Blue.	Blue.
<i>Nickel.</i>	Hot.	Violet.	Opaque gray.	Reddish to brownish red.	Reddish to brownish red.
	Cold.	Reddish brown.	Opaque gray.	Yellow to reddish yellow.	Yellow to reddish yellow.
<i>Manganese.</i>	Hot.	Violet.	Colorless.	Grayish violet.	Colorless.
	Cold.	Reddish violet.	Colorless.	Violet.	Colorless.

Sodium carbonate with oxide of manganese gives when heated in the oxidizing flame an opaque bead, green when hot, bluish

green when cold. When heated in the reducing flame the bead is colorless.

### Dry Reagents.

The following paragraphs give a brief description of the more important dry reagents used in testing minerals:

**Sodium Carbonate**,  $\text{Na}_2\text{CO}_3$ , is a white salt that is used chiefly as a flux to decompose minerals by fusion on charcoal and more rarely as a flux in a bead test.

**Borax**,  $\text{Na}_2\text{B}_4\text{O}_7 \cdot 10\text{H}_2\text{O}$ , is a white salt that is used chiefly in making bead tests and more rarely as a flux on charcoal.

**Microcosmic Salt** or **Salt of Phosphorus**,  $\text{HNaNH}_4\text{PO}_4 \cdot 4\text{H}_2\text{O}$ , is a white salt used in making bead tests.

**Acid Potassium Sulphate**,  $\text{HKSO}_4$ , is a white salt that is used in making a test for fluorine (see page 100).

**Acid Potassium Sulphate and Fluorite Mixture** is a mixture of three parts of the former and one part of the latter. It is used in making a test for boron (see page 97).

**Potassium Iodide and Sulphur Mixture**. A mixture of equal parts of these two materials is used in making a test for bismuth (see page 97).

**Tin** and **Zinc** are used in granulated form to make certain reduction tests in hydrochloric acid solutions.

**Test Papers**. Blue litmus paper is a test paper which changes in color from blue to red when exposed to the action of an acid. It is most commonly used in the open tube test for sulphur (see page 109). Yellow turmeric paper is a test paper that turns brown when exposed to the action of an alkali. It is most commonly used in making a test for the presence of an alkali or alkaline earth in a mineral (see under sodium, page 109; calcium, page 98, etc.). Red litmus paper can be substituted for the yellow turmeric. It turns blue when exposed to the action of an alkali.

### Wet Reagents.

The following paragraphs give a brief description of the more important wet reagents used in testing minerals:

**Hydrochloric Acid, Muriatic Acid, HCl**, is an acid which is commonly used for the solution of minerals, etc. It is a non-oxidizing acid. The ordinary laboratory acid is diluted with three parts of water.

**Nitric Acid, HNO<sub>3</sub>**, is a strong solvent and oxidizing agent. It is commonly used in its concentrated form.

**Sulphuric Acid, H<sub>2</sub>SO<sub>4</sub>**, is less commonly used than the others as a solvent. It may be used in its concentrated form, but usually is diluted with four parts of water. When water is added to the acid a large amount of heat is generated. Water should never be added to the hot acid. The acid boils at 337° C.

**Ammonium Hydroxide, NH<sub>4</sub>OH**, is a strong alkali used chiefly to neutralize acid solutions and as a precipitant for aluminium and ferric hydroxides (see pages 95 and 101). For laboratory use it is commonly diluted with three parts of water.

**Ammonium Carbonate, (NH<sub>4</sub>)<sub>2</sub>CO<sub>3</sub>**, and **Ammonium Oxalate, (NH<sub>4</sub>)<sub>2</sub>C<sub>2</sub>O<sub>4</sub>**, are chiefly used in the form of aqueous solutions to precipitate the alkaline earths, calcium, strontium and barium, from their solutions (see page 98).

**Hydrogen Sodium Phosphate, HN<sub>2</sub>PO<sub>4</sub>**, is used in the form of an aqueous solution to test for the presence of magnesium (see page 103); **Barium Hydroxide, Ba(OH)<sub>2</sub>**, in testing for carbon dioxide (see page 98); **Barium Chloride, BaCl<sub>2</sub>**, for sulphuric acid (see page 110); **Ammonium Molybdate, (NH<sub>4</sub>)<sub>2</sub>MoO<sub>4</sub>**, for phosphoric acid (see page 106); **Silver Nitrate, AgNO<sub>3</sub>**, for chlorine (see page 99).

**Potassium Ferrocyanide, K<sub>4</sub>Fe(CN)<sub>6</sub>·3H<sub>2</sub>O**, and **Potassium Ferricyanide, K<sub>3</sub>Fe<sub>2</sub>(CN)<sub>12</sub>**, are used in dilute solutions to test for ferric and ferrous iron respectively (see page 102). **Ammonium Sulphocyanate, NH<sub>4</sub>CNS**, is also used to test for ferric iron. **Cobalt Nitrate, Co(NO<sub>3</sub>)<sub>2</sub>**, is used in the form of a dilute solution in blowpipe tests for aluminium and zinc (see pages 95 and 112).

### Tests for the Elements.

On the following pages will be given brief descriptions of the more important blowpipe and chemical tests for the elements as they occur in minerals. In order to facilitate reference to

this section, the different elements will be treated in alphabetical order. Under each element the tests will be given in the approximate order of their importance. For a fuller discussion of this part of the subject reference must necessarily be made to the textbooks that treat of it alone. Below is a list of the elements whose tests are discussed, with their chemical symbols, valence and atomic weights.

Element.	Sym- bol.	Valence.	Atomic Weight.
Aluminium	Al	Trivalent	27
Antimony	Sb	Trivalent and pentavalent	120
Arsenic	As	Trivalent and pentavalent	75
Barium	Ba	Bivalent	137
Beryllium	Be	Bivalent	9
Bismuth	Bi	Trivalent	208
Boron	B	Trivalent	11
Calcium	Ca	Bivalent	40
Carbon	C	Tetravalent	12
Chlorine	Cl	Univalent	35.5
Chromium	Cr	Trivalent and sexivalent	52.5
Cobalt	Co	Bivalent	59
Columbium, <i>see</i> Niobium.			
Copper	Cu	Univalent and bivalent	63.4
Fluorine	F	Univalent	19
Glucinum, <i>see</i> Beryllium.			
Gold	Au	Univalent and trivalent	197.3
Hydrogen	H	Univalent	1
Iron	Fe	Bivalent and trivalent	56
Lead	Pb	Bivalent and tetravalent	207
Lithium	Li	Univalent	7
Magnesium	Mg	Bivalent	24
Manganese	Mn	Bivalent, trivalent and tetravalent	55
Mercury	Hg	Univalent and bivalent	200
Molybdenum	Mo	Tetravalent and sexivalent	96
Nickel	Ni	Bivalent	59
Niobium	Nb	Pentavalent	94
Oxygen	O	Bivalent	16
Phosphorus	P	Pentavalent	31
Platinum	Pt	Bivalent and tetravalent	195
Potassium	K	Univalent	39.1
Silicon	Si	Tetravalent	28
Silver	Ag	Univalent	108
Sodium	Na	Univalent	23
Strontium	Sr	Bivalent	87.5
Sulphur	S	Bivalent and sexivalent	32
Tantalum	Ta	Pentavalent	182.6
Tellurium	Te	Bivalent	125
Tin	Sn	Tetravalent	119
Titanium	Ti	Trivalent and tetravalent	48
Tungsten	W	Sexivalent	185
Uranium	U	Tetravalent and sexivalent	240
Vanadium	V	Pentavalent	51.4
Zinc	Zn	Bivalent	65.4

### Aluminium.

1. **Precipitation by Ammonium Hydroxide.** Aluminium is precipitated in the form of aluminium hydroxide,  $\text{Al}(\text{OH})_3$ , when an excess of ammonium hydroxide is added to an acid solution. The precipitate is flocculent in form and colorless or white. It is precipitated under the same conditions as ferric hydroxide (see page 101), and since the latter has a dark color a small amount of aluminium hydroxide might be overlooked in a mixture of the two. To make a further test under these conditions, filter off the precipitate and treat it with a hot solution of sodium hydroxide, which will dissolve any aluminium hydroxide present but will not affect the ferric hydroxide. Filter, and to the filtrate add hydrochloric acid in slight excess, and then make alkaline with ammonium hydroxide again. This will precipitate any aluminium that may be present as pure aluminium hydroxide.

2. **Blowpipe Test with Cobalt Nitrate.** Light colored and infusible aluminium minerals when moistened with a drop of cobalt nitrate and heated intensely before the blowpipe assume a dark blue color.

### Antimony.

1. **Oxide Coating on Charcoal.** When an antimony mineral is heated in the oxidizing flame on charcoal, a heavy white coating of antimony oxide settles on the charcoal at a short distance from the mineral. The coating is readily volatile when heated.

2. **Open Tube Test.** When metallic antimony or a compound of antimony with sulphur is heated in the open tube, a white powdery sublimate of antimony oxide,  $\text{Sb}_2\text{O}_3$ , forms in a ring on the inner wall of the tube, a short distance above the mineral. It is a volatile coating. If the mineral contains sulphur, as is usually the case, a second coating will form as a white powder along the bottom of the tube. It is another oxide of antimony,  $\text{Sb}_2\text{O}_4$ . It is nonvolatile and is usually more conspicuous than the first.

### Arsenic.

The test to be used for arsenic depends upon whether the mineral contains oxygen. In the majority of cases an arsenic compound does not contain oxygen, and then tests 1, 2 and 3 will serve. If, on the other hand, the mineral is an oxygen compound, test 4 must be used.

1. **Oxide Coating on Charcoal.** When an arsenic mineral is heated in the oxidizing flame on charcoal, a white coating of arsenious oxide,  $\text{As}_2\text{O}_3$ , is deposited on the charcoal at some distance from the mineral. The coating is very volatile. Its formation is usually accompanied by a characteristic odor of garlic.

2. **Open Tube Test.** When an arsenic mineral is carefully heated in the open tube a colorless or white crystalline sublimate of arsenious oxide,  $\text{As}_2\text{O}_3$ , forms in a ring on the inner wall of the tube at a considerable distance above the mineral. It is very volatile. When examined with a lens the coating will usually show well-defined octahedral crystals. If the mineral is heated too rapidly, metallic arsenic may sublime instead of the oxide (see the next test).

3. **Closed Tube Test.** Many arsenic minerals when heated in a closed tube yield a sublimate of metallic arsenic, known as the arsenic mirror. This sublimate shows an amorphous black band above and a silver-gray crystalline band below. If the bottom of the tube be broken off and the metallic arsenic volatilized by heat, the characteristic garlic odor will be obtained.

4. **Closed Tube Test for an Arsenate.** When arsenic occurs in a mineral in the form of an arsenate, i.e., an oxidized compound, none of the above tests will serve. In this case place the mineral in a closed tube with a splinter of charcoal and then heat. The charcoal will act as a reducing agent and set metallic arsenic free, which will condense on the wall of the tube as an arsenical mirror similar to that described under test 3.

### Barium.

1. **Flame Test.** Barium minerals when heated intensely give a yellowish green flame color.

2. **Precipitation as Barium Sulphate.** Barium is precipitated as barium sulphate,  $\text{BaSO}_4$ , from an acid solution by the addition of dilute sulphuric acid. The precipitate is white and finely divided and being very insoluble will form in a quite dilute solution (distinction from calcium and strontium).

3. **Alkaline Reaction.** Barium is an alkaline earth metal. When a mineral contains barium in combination with a volatile acid, it will give, after ignition, a residue which will react alkaline on a piece of moistened turmeric paper.

### Beryllium or Glucinum.

Beryllium is a rare element which has no simple blowpipe or chemical test.

### Bismuth.

1. **Charcoal Tests.** When heated with sodium carbonate on charcoal in the reducing flame, a bismuth mineral will yield a metallic globule and an oxide coating. The metal is easily fusible, lead-gray when hot, but becomes covered with an oxide coating on cooling. It is only imperfectly malleable, for when hammered out it flattens at first but later breaks into small grains. The oxide coating,  $\text{Bi}_2\text{O}_3$ , is white with a yellow ring next the mineral. These bismuth reactions are quite similar to those for lead (see page 102), consequently the following modification is useful. If the bismuth mineral is fused on charcoal with a mixture of potassium iodide, KI, and sulphur (see page 92), a characteristic and distinctive coating is obtained. This sublimate is yellow next to the mineral and brilliant red on the outside. Under similar conditions with lead a solid yellow coating would be obtained.

### Boron.

1. **Flame Test.** Some boron minerals give a yellow-green flame when heated alone. Most boron minerals, however, will only yield the flame color when their powder is mixed with acid potassium sulphate and fluorite mixture (see page 92) and then



introduced on a platinum wire into a Bunsen burner flame. As the mixture fuses, a momentary but distinct green flame is obtained.

### Calcium.

1. **Flame Test.** When calcium occurs in a mineral in such a state that it can be volatilized by heat, it will yield a characteristic orange flame color. Frequently the mineral has to be moistened by hydrochloric acid before heating. The flame should not be confused with the crimson and more persistent flame of strontium or lithium.

2. **Alkaline Reaction.** Calcium is an alkali-earth metal. When a mineral contains calcium in a combination with a volatile acid, it will give, after ignition, a residue which will react alkaline on a piece of moistened turmeric paper.

3. **Precipitation as Calcium Oxalate or Carbonate.** Calcium is readily and completely precipitated from alkaline solutions as calcium oxalate,  $\text{CaC}_2\text{O}_4$ , or calcium carbonate,  $\text{CaCO}_3$ , by the addition of ammonium oxalate,  $(\text{NH}_4)_2\text{C}_2\text{O}_4$ , or ammonium carbonate,  $(\text{NH}_4)_2\text{CO}_3$ . Both precipitates are white and finely divided.

4. **Precipitation as Calcium Sulphate.** Calcium is precipitated from a concentrated hydrochloric acid solution as calcium sulphate on the addition of a little dilute sulphuric acid. The precipitate is quite readily soluble in water and therefore will not form in a dilute solution (distinction from barium and strontium).

### Carbon.

Carbon exists in minerals chiefly in the form of carbonic acid in the carbonates.

1. **Test for Carbon Dioxide with an Acid.** All carbonates when treated with a strong acid (best hydrochloric) dissolve with a vigorous effervescence of carbon dioxide gas. In some cases (for example, dolomite,  $\text{CaMg}(\text{CO}_3)_2$ ) the acid needs to be heated to start the reaction, and in others (for example, cerussite,  $\text{PbCO}_3$ ) a dilute acid is necessary. Carbon dioxide gas is colorless and odorless. It will not support combustion, as is shown when

a lighted match is placed in a test tube that contains it. The gas is heavier than air and can be poured from the test tube in which it has been generated into another in which some barium hydroxide solution has been placed. When the contents of the latter tube are shaken together, the carbon dioxide reacts with the barium hydroxide to form a white precipitate of barium carbonate,  $\text{BaCO}_3$ .

### Chlorine.

1. **Precipitation as Silver Chloride.** Chlorine is precipitated from a dilute nitric acid solution as silver chloride,  $\text{AgCl}$ , by the addition of a small amount of silver nitrate,  $\text{AgNO}_3$ . The test is very delicate, traces of chlorine being shown by a milky appearance of the solution. When in any quantity the precipitate is curdy in form. It is white on precipitation but darkens on exposure to light. It is soluble in ammonium hydroxide.

### Chromium.

1. **Bead Tests.** Chromium is usually tested for by the color it gives to the fluxes (see page 91). The salt of phosphorus bead when fused in the oxidizing flame yields a fine green color. This is the most characteristic chromium bead.

### Cobalt.

1. **Bead Tests.** A cobalt mineral when fused in either a borax or salt of phosphorus bead yields a distinctive dark blue color. The test is very delicate.

**Columbium, see Niobium.**

### Copper.

1. **Flame Tests.** An oxidized compound of copper when introduced into the flame gives it a vivid green flame color due to the copper oxide volatilized. When the mineral is moistened with hydrochloric acid and then heated, the flame color is an intense blue. If the mineral is a sulphide, it must be roasted in the oxidizing flame before moistening with hydrochloric acid.

2. **Blue Solution with Ammonium Hydroxide.** If an acid solution containing copper is made alkaline with ammonium hydroxide, it will assume a deep blue color.

3. **Reduction to Metal on Charcoal.** When a small amount of a copper mineral is mixed with a flux (best equal parts of sodium carbonate and borax), placed on charcoal and heated intensely in the reducing flame, metallic globules of copper will be formed. They are difficultly fusible, bright when hot, but become coated with an oxide coating on cooling. They are malleable and show the characteristic copper color. Sulphides of copper must first be roasted in the oxidizing flame in order to remove the sulphur before mixing with the flux.

### Fluorine.

1. **Etching Tests.** The ordinary test for fluorine consists in converting it into hydrofluoric acid and observing the latter's etching effect upon glass. A watch glass or other piece of glass may be covered with paraffin and then the coating removed in spots. Upon this is placed the powdered mineral with a few drops of concentrated sulphuric acid. The action of the acid upon the fluoride will serve to liberate hydrofluoric acid, which will in turn etch the glass where it has been exposed. The action should be allowed to continue for some time, when on cleaning the glass the etched spots will be visible.

A modification of the above test can be made in a closed tube. Take a closed tube of about  $\frac{1}{4}$  inch diameter and made preferably of hard glass. Into this introduce a powdered mixture of the mineral, glass and acid potassium sulphate, and then heat in the Bunsen burner flame. When heated, acid potassium sulphate is converted into the normal potassium sulphate with the liberation of sulphuric acid. The acid attacks the fluoride and sets free hydrofluoric acid. This in turn acts upon the glass present and etches it. The etching, however, is not readily apparent on account of the conditions of the experiment. As a secondary reaction, however, there will be formed in the upper part of the tube a white sublimate of silicon dioxide. This sublimate is volatile because of the presence with it of small

amounts of hydrofluosilicic acid. If the bottom of the tube is broken off and its interior gently washed with water, this acid will be dissolved and removed. If the tube is now dried again, the white coating will prove to be no longer volatile. This silicon dioxide coating is a proof of the action of hydrofluoric acid in the bottom of the tube and therefore of the presence of fluorine in the mineral.

**Glucinum, see Beryllium.**

### Gold.

There is no simple blowpipe or chemical test for gold. Ordinarily its physical characteristics are sufficient to identify it. For a discussion of the occurrence and tests for gold see page 126.

### Hydrogen.

1. **Closed Tube Test for Water.** Hydrogen exists in minerals either as water of crystallization (for example, gypsum,  $\text{CaSO}_4 \cdot 2\text{H}_2\text{O}$ ) or as the hydroxyl radical (for example, brucite,  $\text{Mg}(\text{OH})_2$ ). In either case its presence may be detected by heating a fragment of the mineral in a closed tube and observing the water which condenses upon the upper cold wall of the tube. Water of crystallization is driven off more readily than water of hydroxyl, but the test is easily obtained in either case.

### Iron.

1. **Magnetic Test.** Any mineral that contains a sufficient amount of iron to permit it to be classified as an iron mineral will readily become magnetic when heated in the reducing part of the blowpipe flame. A comparatively small fragment should be used and the test made with a magnet after it has cooled.

2. **Precipitation with Ammonium Hydroxide.** Ferric iron is readily and completely precipitated as ferric hydroxide,  $\text{Fe}(\text{OH})_3$ , from an acid solution by adding an excess of ammonium hydroxide. It is a flocculent precipitate with a reddish

brown color. If there is any doubt as to the state of oxidation of the iron in the original solution, a few drops of nitric acid should be added and the solution heated in order to make certain that the iron is ferric.

**3. Cyanide Tests for Ferrous and Ferric Iron.** Occasionally it may be important to determine whether the iron in a mineral is ferrous or ferric in its valence. This can be done only when the mineral is soluble in a nonoxidizing acid like hydrochloric and when it is not a sulphide. If these conditions can be fulfilled, then divide the solution into two parts. To one add a few drops of a dilute solution of potassium *ferri*cyanide, and if the solution contains any *ferrous* iron a heavy dark blue precipitate will form. If, on the other hand, it contained only ferric iron, there would be no precipitate but only a darkening of the color of the solution. To the second portion of the solution add a few drops of a dilute solution of potassium *ferro*-cyanide, and if there is any *ferric* iron present a heavy dark blue precipitate similar to the one in the previous case will form. But if the solution contained only ferrous iron, a light blue precipitate would be formed. The characteristic dark blue precipitate must contain both valences of iron and will only form when a cyanide is added containing the opposite kind of iron to that already in the solution.

Ammonium or potassium sulphocyanate is also used in making the ferric test. A few drops of one of these reagents added to a ferric iron solution will give it a deep red color. All of these tests are extremely delicate and will give good results if only a trace of iron is present. They should never be used to determine the presence of iron in a mineral but only to differentiate ferrous from ferric iron.

### Lead.

**1. Charcoal Test.** Any lead mineral when powdered and mixed with sodium carbonate will yield a metallic globule when the mixture is heated on charcoal in the reducing flame. The globule is bright lead color when hot, but becomes covered with a dull oxide coating on cooling. It is very malleable and can

be hammered out into a thin sheet. A coating on the charcoal of lead oxide,  $PbO$ , will also form, which varies in color from yellow next to the fused mass to white at a distance. It will be best obtained by removing the lead globule to a fresh piece of charcoal and heating it in the oxidizing flame.

2. **Acid Tests.** Lead minerals as a rule are only slowly attacked by acids. Dilute nitric acid is the best solvent to use. If to a nitric acid solution a few drops of hydrochloric or sulphuric acid are added, white precipitates will form, which are respectively lead chloride,  $PbCl_2$ , and lead sulphate,  $PbSO_4$ . The latter is quite insoluble.

### Lithium.

1. **Flame Test.** Lithium is a rare element which is to be distinguished by the persistent and strong crimson color which it gives to the flame.

### Magnesium.

1. **Precipitation as Ammonium Magnesium Phosphate.** The only common test for magnesium is to precipitate it in the form of ammonium magnesium phosphate,  $NH_4MgPO_4$ , by the addition of hydrogen sodium phosphate,  $HNa_2PO_4$ , to a strongly ammoniacal solution. The precipitate usually forms somewhat slowly, is white in color and frequently is granular in texture. In order to make a decisive test certain precautions are necessary. As the precipitation is made in an ammoniacal solution, any precipitates formed by an excess of ammonium hydroxide must be first filtered off. It may be necessary before adding the ammonium hydroxide to add a few drops of nitric acid so as to make certain that any iron in the solution is in the ferric state. Also, before making the final test, any elements, such as calcium, strontium and barium, that are precipitated in ammoniacal solution by means of ammonium oxalate, must be removed. In any case their presence must be tested for before adding the hydrogen sodium phosphate, because, if present, they would be precipitated by that reagent along with the magnesium.

### Manganese.

1. **Bead Tests.** a. Manganese gives to the sodium carbonate bead when heated in the oxidizing flame a characteristic bluish green color. The bead is opaque when cold.

b. With the borax bead, when heated in the oxidizing flame manganese gives a purple or amethystine color. The bead is transparent when cold.

Both tests are very delicate.

### Mercury.

1. **Closed Tube Tests.** The powdered mineral is thoroughly mixed with dry sodium carbonate and placed in a closed tube and then heated. The sodium carbonate will decompose the mineral and liberate metallic mercury, which will volatilize and condense in the upper part of the tube.

2. **Precipitation on Copper.** Boil the powdered mineral with hydrochloric acid, into which some powdered pyrolusite,  $MnO_2$ , has been placed. The chlorine evolved by the action of the acid on the manganese dioxide will serve to dissolve the mercury mineral. If into this solution a clean strip of copper is placed (a cent which has been cleaned with a little nitric acid will serve), it will become covered by a thin coating of metallic mercury.

The chief and only common mineral of mercury is cinnabar,  $HgS$ , and for its distinctive physical and chemical tests see page 145.

### Molybdenum.

The tests for the rare element molybdenum depend upon whether it is in combination with sulphur or in an oxygen compound. See under molybdenite, page 137, and under wulfenite, page 308, for descriptions of the various tests.

### Nickel.

1. **Borax Bead Test.** When dissolved in a borax bead in the oxidizing flame, nickel will give it a brownish color. If the bead is heated in the reducing flame for some time, it will become

opaque because of the separation in it of metallic nickel. The brown color due to nickel is often masked by the deep blue color due to the presence of cobalt, which is frequently associated with nickel in its occurrence. In this case there is no simple test for nickel.

2. **In Ammoniacal Solution.** A comparatively strong acid solution of nickel will on the addition of an excess of ammonium hydroxide become light blue in color. The test should not be confused with the similar but stronger test for copper.

### Niobium.

Niobium, or columbium, as it is sometimes called, is a rare acid element that is associated with tantalum in the niobates and tantalates.

1. **Reduction Test with Tin.** The best test for niobium is to fuse some of the powdered mineral with several parts of sodium carbonate. The resulting mass is dissolved in a few cubic centimeters of dilute hydrochloric acid and then a few grains of metallic tin are added. The solution is boiled and the hydrogen set free by the action of the acid on the tin serves as a reducing agent. The result is to form a compound of niobium which is dark blue in color. This color does not readily change to brown on continued boiling, and disappears on addition of water. This distinguishes the niobium test from a similar one for tungsten (see page 111).

### Oxygen.

While oxygen is one of the most common elements in minerals, its presence is ordinarily determined indirectly by testing for the different oxygen acids. In the case of a few oxides in which there is an excess of oxygen, a direct test may be made.

1. **Closed Tube Test.** The powdered oxide is placed in a closed tube with a small splinter of charcoal resting just above it. The tube is heated and if free oxygen is evolved the charcoal will at first glow and then burn with a bright light. It is to be noted that only a few oxides which contain an excess of oxygen will give this test.



### Phosphorus.

1. **Precipitation with Ammonium Molybdate.** Phosphorus exists in minerals in the form of phosphoric acid in the phosphates. It is best tested for by forming a dilute nitric acid solution of the mineral and adding a few cubic centimeters of this to an excess of ammonium molybdate solution. A canary-yellow precipitate of ammonium phosphomolybdate will be formed. The precipitate forms slowly at first and comes down best in a warm solution.

2. **Flame Test.** Many phosphates when heated before the blowpipe give a pale bluish green flame color. This may frequently be obtained better when the mineral has previously been moistened with a drop of concentrated sulphuric acid.

### Platinum.

There are no simple blowpipe or chemical tests for platinum. The physical characteristics of the metal are usually sufficient for its identification (see page 132).

### Potassium.

1. **Flame Test.** Volatile potassium salts give a characteristic pale violet flame color. The potassium flame will, however, commonly be obscured by the stronger yellow flame of sodium. This difficulty can be overcome by filtering the flame through a piece of blue glass. The sodium flame, being a monochromatic light, cannot pass through the blue glass, while the violet flame of potassium will be visible.

When the potassium does not exist in the mineral in a volatile state, as in the case with potassium silicates, the powdered mineral must be first thoroughly mixed with gypsum ( $\text{CaSO}_4 \cdot 2\text{H}_2\text{O}$ ) and the mixture introduced into the Bunsen burner flame on a platinum wire. There will be a reaction between the two, and the potassium will be liberated in the form of a sulphate, which, being a volatile salt, will give the flame color. It will be momentary in duration and must be viewed through the blue glass.

### Silicon.

Silicon exists as the acid element in the large group of minerals known as the silicates. Some of these are readily soluble in acids, but the greater part are quite insoluble. The tests employed differ somewhat in the two cases.

1. **Test for a Soluble Silicate.** If the silicate is soluble, it should be powdered and dissolved in boiling hydrochloric acid. When this solution is evaporated a jellylike material will separate out just before dryness is reached. This silica jelly, as it is called, is a form of silicic acid and proves the presence of silicon in the mineral. On continued evaporation it will be dehydrated and converted into a sandy and insoluble substance having the composition of silicon dioxide,  $\text{SiO}_2$ .

2. **Test for an Insoluble Silicate.** In the case of an insoluble silicate, the mineral must be decomposed by fusion with sodium carbonate before treating it with an acid. Make a mixture of one part of the powdered mineral to three parts of sodium carbonate and fuse thoroughly before the blowpipe on a loop of platinum wire. It is best to make two or three such beads. The fusion serves to decompose the silicate and to render the resulting mass wholly soluble in acids. The beads are powdered and dissolved in boiling dilute nitric acid. The evaporation is conducted as explained in experiment 1 and a similar silica jelly is obtained.

Frequently it is desirable to make tests for the bases which are present in the silicate. In this case, after the formation of the jelly, continue the evaporation to complete dryness. This converts the silicon into the insoluble oxide but leaves the bases in the form of various soluble salts. Treat the residue in the test tube with a little water and hydrochloric acid, warm and filter from the insoluble silica. Add an excess of ammonium hydroxide to the filtrate to precipitate any aluminium or ferric iron as their respective hydroxides. Filter if necessary, and to the filtrate add a little ammonium oxalate to precipitate any calcium as calcium oxalate. Filter again, and to the filtrate add more ammonium hydroxide if necessary and then a little hydro-

gen sodium phosphate, which will precipitate any magnesium present as ammonium magnesium phosphate.

**3. Decomposition of Silicates by Acids.** Certain silicates, when their powder is treated with boiling hydrochloric acid, are decomposed, the bases going into solution and the silicon separating as the dioxide,  $\text{SiO}_2$ . In this case there would be no jelly formed when the solution is evaporated. The mineral powder in such cases disappears, but the solution never becomes perfectly clear owing to the silica, which remains in suspension in the solution. It gives the solution a translucent appearance. The surest proof that the mineral has been decomposed is to filter the solution and test for various bases in the filtrate in a similar manner to that described under test 2.

**4. Test with the Salt of Phosphorus Bead.** When the powder of a silicate is heated in a salt of phosphorus bead, the bases are dissolved, leaving the silica present as an insoluble translucent skeleton.

## Silver.

**1. Reduction to the Metal on Charcoal.** Silver can frequently be reduced to a metallic globule from its compounds by heating the powdered mineral on charcoal with sodium carbonate. The resulting globule is bright both when hot and cold. It is malleable. No accompanying coating is formed on the charcoal. This test for silver is frequently complicated by the presence of lead, arsenic or antimony in the mineral. Usually the mineral should be carefully roasted on charcoal in the oxidizing flame before attempting the reduction in order to remove the last two; otherwise a brittle globule will result. In many cases the only satisfactory test for silver is the fire assay.

**2. Precipitation as Silver Chloride.** When a silver mineral is dissolved in nitric acid and to the solution a few drops of hydrochloric acid is added, a white curdy precipitate of silver chloride,  $\text{AgCl}$ , is formed. The test is quite delicate, and if there is only a trace of silver in the solution its presence will be indicated by a milky-blue coloration. The precipitate is white

at first but darkens on exposure to light. It is soluble in ammonium hydroxide. Frequently when a silver mineral is treated with nitric acid a precipitate will result at once. This may be metantimonic acid, lead sulphate, etc., and should be filtered off before making the silver test.

### Sodium.

1. **Flame Test.** Sodium compounds when heated give a strong and persistent yellow flame. The test is very delicate and must be used with care, for only a trace of sodium may yield a distinct flame. If the mineral contains sodium in any notable amount, it should give an intense and continuous flame color.

### Strontium.

1. **Flame Color.** Strontium compounds give a very strong and persistent crimson flame. The only other flame which is similar is that obtained from lithium. Strontium can be positively determined from lithium by the following tests.

2. **Alkaline Reaction.** When a mineral contains strontium in combination with a volatile acid, it will give, after ignition, a residu which will react alkaline on a piece of moistened turmeric paper.

3. **Precipitation as Strontium Sulphate.** Strontium is precipitated from a mediumly dilute solution as strontium sulphate,  $\text{SrSO}_4$ , on the addition of a little dilute sulphuric acid. The precipitate is somewhat soluble and will not form in very dilute solutions (distinction from calcium and barium, which see).

### Sulphur.

Sulphur exists in minerals either without oxygen, as in the sulphides, or with oxygen, as in the sulphates. These two types of sulphur compounds require different tests.

#### *Tests for Sulphur in Sulphides.*

1. **Open Tube Test.** Sulphides when heated in the open tube give off sulphur dioxide gas, which escapes with the current

of air from the upper end of the tube. Its presence can be detected by its pungent and irritating odor. A piece of moistened blue litmus paper inserted into the upper end of the tube will turn red on account of the sulphurous acid formed.

2. **Charcoal Test.** The odor of sulphur dioxide may be obtained when a sulphide is roasted on charcoal.

3. **Fusion with Sodium Carbonate.** When a sulphide is fused on charcoal with sodium carbonate, the residue, unless the heating has been too prolonged, will contain sodium sulphide. If the slag is removed and placed with a drop of water on a clean silver surface (a coin will serve), there will result a dark brown stain due to the formation of silver sulphide.

#### *Tests for Sulphur in Sulphates.*

The test for sulphuric acid depends upon whether the sulphate is soluble or insoluble in acids.

1. **Test for a Soluble Sulphate.** If the sulphate is soluble, treat it with hydrochloric acid, and to the resulting solution add a little barium chloride. A heavy white precipitate of barium sulphate will result.

2. **Test for an Insoluble Sulphate.** Powder the mineral, mix with sodium carbonate and charcoal dust and fuse on charcoal in the reducing flame. The charcoal serves to reduce the sulphate to a sulphide, so that the resulting slag contains sodium sulphide. When the fused mass is placed with a drop of water on a clean silver surface, a dark brown stain of silver sulphide will form. It is to be noted that a sulphide would yield the same test (see above), so that it is necessary to make certain that the mineral being tested does not belong to that chemical group.

### **Tantalum.**

There is no simple test for tantalum. It is usually associated, however, with niobium (see page 105).

### **Tellurium.**

1. **Test with Sulphuric Acid.** When a telluride is heated in concentrated sulphuric acid, it gives a deep crimson color to

the solution. The color will disappear if the acid is heated too hot, or if after cooling it is diluted with water.

2. **Charcoal Test.** When heated on charcoal a white sublimate of  $TcO_2$  is formed which somewhat resembles antimony oxide. It is volatile and when touched with the reducing flame gives a pale greenish color to it.

### Tin.

1. **Reduction to Metallic Globule.** Take a small amount of the finely powdered mineral and mix it with five or six volumes of sodium carbonate and considerable charcoal dust and fuse intensely on charcoal in the reducing flame. Small bright globules of metallic tin will result. They become covered with an oxide coating on cooling. A white and difficultly volatile tin oxide coating will form on the charcoal. If the tin globule is treated with a little concentrated nitric acid, it will be converted into a white powder, which is metastannic acid.

### Titanium.

1. **Reduction Test in Hydrochloric Acid.** A comparatively concentrated hydrochloric acid solution containing titanium will become pale violet in color when it is boiled with a few grains of metallic tin. The hydrogen liberated by the action of the acid on the tin is a reducing agent and forms  $TiCl_3$  in the solution which gives this color. The color is not a strong one, and the solution may have to be evaporated nearly to dryness in order to show it distinctly. Most titanium minerals are insoluble in hydrochloric acid and must first be thoroughly fused with sodium carbonate in order to bring the titanium into soluble form. The fusion is best done by introducing the finely powdered mineral into a sodium carbonate bead made on a platinum wire. Several such beads should be used.

### Tungsten.

1. **Reduction Test in Hydrochloric Acid.** Treat a tungsten mineral with hydrochloric acid. If it is decomposed by the acid a yellow precipitate of tungstic oxide,  $WO_3$ , will result. Add

to the acid a few grains of metallic tin and boil. The hydrogen set free by the action of the hydrochloric acid on the tin serves as a reducing agent and converts the yellow  $WO_3$  to a blue precipitate which is a mixture of the two oxides  $WO_3$  and  $WO_2$ . On continued reduction the oxide becomes all  $WO_2$  and is brown in color. The test is similar to the one for niobium, but is to be distinguished from that, since the blue color in the tungsten test does not disappear on dilution of the solution; and further, it turns to brown on continued reduction. If the tungsten mineral is not attacked by hydrochloric acid, its powder must first be thoroughly fused with sodium carbonate. The resulting mass is powdered and digested with water, which will dissolve the sodium tungstate formed during the fusion. After filtering the reduction test is made as described above.

### Uranium.

1. **Bead Tests.** The tests for uranium consist in the colors it imparts to the fluxes (see page 91). The yellowish green color given to the salt of phosphorus bead when heated in the oxidizing flame is the most characteristic.

### Vanadium.

1. **Bead Tests.** The tests for vanadium consist in the colors it imparts to the fluxes (see page 91). The amber color given to the salt of phosphorus bead when heated in the oxidizing flame is the most characteristic.

### Zinc.

1. **Oxide Coating on Charcoal.** Metallic zinc is easily obtained from the zinc minerals by fusing them with sodium carbonate on charcoal in the reducing flame. But, since the metal is volatilized at a temperature considerably below that of the blowpipe flame, no metallic globule can be formed. The metallic zinc is therefore all volatilized, and, meeting the oxygen of the surrounding air, is converted into the oxide,  $ZnO$ , which drops upon the charcoal as a nonvolatile coating, which is yellow when

hot but white when cold. The coating deposits very close to the fusion. It may frequently be obtained in more distinct form by making the fusion on a loop of platinum wire, which is held about one-quarter of an inch from the surface of a charcoal block and the blowpipe flame so directed that the oxide coating is deposited upon the charcoal behind the bead. If the coating is moistened with a drop of cobalt nitrate and then heated intensely by the blowpipe flame, it will become dark green in color.

2. **Flame Color.** Some zinc minerals, when a fragment is held in the forceps and heated in the reducing flame, will show a characteristic flame color. This is due to the burning in the flame of the metallic zinc which has been volatilized. It takes the form of momentary streaks or threads in the flame and has a pale greenish blue color.



## IV. DESCRIPTIVE MINERALOGY.

### INTRODUCTION.

DESCRIPTIVE Mineralogy should include first of all a description of the crystallographic, general physical and chemical characters of each mineral species, and should further give an account of its mode of occurrence and characteristic associations. The localities at which a mineral occurs in notable amount or quality should also be mentioned. In the case of minerals possessing an economic value, a brief statement of their uses is of interest. The order in which these various items are given under each mineral in this Section is as follows:

1. *Chemical Composition.*
2. *Crystallization.*
3. *Structure.*
4. *General Physical Properties.*
5. *Tests.*
6. *Occurrence.*
7. *Use.*

Descriptive Mineralogy should also point out the chemical and physical relationships existing between the different mineral species. It will be noted that many minerals fall into definite groups the members of which have chemical and crystallographic features in common. The most scientific classification of minerals recognizes these facts and places the minerals having analogous chemical compositions together, and further groups them according to crystallographic and physical similarities. Short paragraphs will be found in various parts of this Section which explain more fully these relationships. The prominent chemical

groups of this classification and the order in which they are treated are given below:

1. *Native Elements.*
2. *Sulphides, etc.*
3. *Sulpharsenites, etc.*
4. *Chlorides, etc.*
5. *Oxides.*
6. *Carbonates.*
7. *Silicates, Titanates.*
8. *Niobates, Tantalates.*
9. *Phosphates, etc.*
10. *Borates.*
11. *Uranates.*
12. *Sulphates, etc.*
13. *Tungstates, Molybdates.*

At the end of the matter descriptive of individual species will be found small sections devoted to (a) Minerals of economic importance arranged according to the chief elements they contain; (b) Occurrence and association of minerals; (c) Table of minerals arranged according to the systems of crystallization.

## ELEMENTS.

Comparatively few of the elements are found in the native state, and moreover, these are in general rare in occurrence. The elements occurring as minerals may be divided into three classes: (1) *Nonmetals*, (2) *Semimetals* and (3) *Metals*. The important minerals among the nonmetals are diamond, graphite and sulphur. The semimetals — tellurium, arsenic, antimony and bismuth — belong together in a crystal group, all of them showing rhombohedral crystals with closely agreeing fundamental angles. The Gold Group is the most important one among the metals, including the isometric minerals, — gold, silver and copper. Another group contains the rare metals platinum and iron.

## I. NONMETALS.

**Diamond.**

**Composition.** Pure carbon.

**Crystallization.** Isometric; tetrahedral. Crystals are usually octahedral in habit, but the faces are commonly curved or pitted

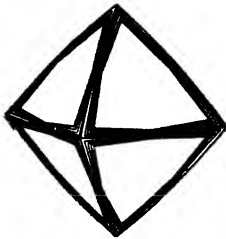


Fig. 203.

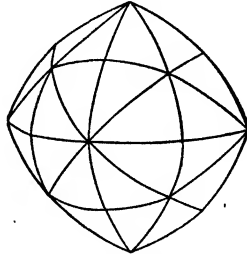


Fig. 204.

(Fig. 203). Curved faces of the hexoctahedron are frequently observed (Fig. 204). Cubic and dodecahedral planes rare.



Fig. 205.

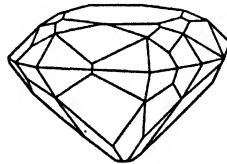


Fig. 206.

Twins, with the octahedron as twinning plane (Fig. 205); often flattened.

**Structure.** Usually in crystals, but commonly distorted into elongated and irregular forms. At times in spherical forms with radiating structure. Rarely massive.

**Physical Properties.** Perfect cleavage parallel to the octahedral faces.  $H. = 10$  (hardest substance known).  $G. = 3.5$ . Luster adamantine or greasy. Usually colorless or pale yellow.

Also pale shades of red, orange, green, blue and brown. Rarely in deep shades of blue, red or green; at times black. Usually transparent but may be translucent or opaque. Very high index of refraction (diamond = 2.42, quartz = 1.55). Strong dispersion of light. Electrified by friction and becomes phosphorescent when rubbed with a cloth. Some stones after exposure to sunlight give off a phosphorescent glow in the dark.

**Varieties.** *Ordinary.* In rounded crystals, some of which are perfectly transparent and colorless (first water). Others are faintly colored in various shades and frequently contain inclusions and are flawed. *Bort.* In rounded spherical forms with radiating structure or made up of confused crystalline aggregates; usually gray, brown or black in color and translucent to opaque. Fragments of crystals that are unavailable for cutting are also frequently called bort. *Carbonado* or *black diamond.* Massive with crystalline structure or granular to compact without cleavage. Black or grayish black; opaque.

**Tests.** To be distinguished by its great hardness, its adamantine luster and its octahedral cleavage. Burns at a high temperature to  $\text{CO}_2$  gas, leaving no ash. Will burn readily in oxygen gas, giving off a brilliant light.

**Occurrence.** The diamond is a rare mineral. It has been found in many different localities, but only a few have furnished the mineral in notable amount. Most commonly the diamond is found in the sands and gravels of stream beds, where it has been preserved by its great hardness and fairly high specific gravity. In South Africa and recently in Arkansas it has been found embedded in masses of an igneous rock, known as peridotite. Three countries have up to the present furnished practically the entire world's output of diamonds, namely, India, Brazil, and South Africa.

The important diamond fields of India are located in the eastern and southern portions of the peninsula. Many of the famous old diamond fields in this region are now abandoned, but work is still carried on by the natives in the mines in a district lying to the south of Allahabad and Benares. Many of the world's famous diamonds were found in India, but at present the yield is small.

Diamonds were discovered in Brazil in the first half of the eighteenth century, and have been mined there ever since. At present, however, the production is comparatively small. They are found in the stream gravels in several different districts, the two most im-

portant being located in the provinces of Minas Geraes and Bahia. The city of Diamantina, Minas Geraes, is situated in the center of the most productive field, the diamonds being found chiefly in the gravels of the Rio Jequitinhonha and Rio Doce. Extensive upland deposits of diamond-bearing gravels and clays are also worked.

About 96 per cent of the world's output of diamonds comes at present from South Africa. The first diamonds were discovered in the gravels of the Vaal River in 1867. The diamond-bearing gravels covered a considerable area but were not very thick. Later the diamonds were discovered embedded in the rock of several volcanic necks located near the present town of Kimberly in Griqualand-West, south of the Vaal River, near the boundary of the Orange Free State. The diamonds in this district were first discovered in the soil resulting from the disintegration of the underlying diamond-bearing rock. This soil was colored yellow by iron oxides, and was known as the "yellow ground." The underlying, undecomposed peridotite rock from which the diamonds are obtained at present is called the "blue ground." The principal mines are the Kimberly, Du Toitspan, De Beers and Bultfontein, near Kimberly, the Jagersfontein in the Orange Free State, and the Premier in the Transvaal. The mines were originally worked as open pits, but, as they have increased in depth, underground methods have been adopted. The blue rock containing the diamonds is brought to the surface, crushed into coarse fragments and spread out on platforms to gradually disintegrate under atmospheric influences. The resulting gravel is washed over and concentrated, the diamonds being finally separated on shaking tables that have been coated with grease, to which the diamond crystals stick, while the rest of the material is washed away. Diamonds have also recently been discovered in alluvial deposits near Lüderitzbuchte, German Southwest Africa.

Diamonds have been found sparingly in various parts of the United States. Small stones have occasionally been discovered in the stream sands along the eastern slope of the Appalachian Mountains from Virginia south to Georgia. Diamonds have also been reported from the gold sands of northern California and southern Oregon. Sporadic occurrences of diamonds have been noted in the glacial drift in Wisconsin, Michigan and Ohio. In 1906 the first diamond was found at a new locality situated near Murfreesboro, Pike County, Arkansas. The stones are found here not only in the detrital soil but also embedded in the underlying peridotite rock in a manner quite similar to that of the South African occurrence.

**General.** The diamond is the most important of the gem stones. Its value depends upon its hardness, its brilliancy, which is due to its high index of refraction, and to its "fire," which is due to its strong dispersion of light into the prismatic colors. In general the most

valuable stones are those which are flawless and colorless or possess a "blue-white" color. A faint straw-yellow color, which diamond often shows, detracts much from its value. Deep shades of yellow, red, green or blue are greatly prized, and fine stones of these colors bring very high values.

The diamond is cut by first cleaving off any undesirable or flawed portions of the crystal and then grinding facets upon it by use of diamond powder. The crystal is fixed at the end of a stick by means of soft solder, leaving the part projecting which is to be cut. A circular plate of soft iron is then charged with diamond dust, and this by its revolution grinds and polishes the stone. Most diamonds are cut into the form known as the *brilliant* (see Fig. 206). This is a stone cut with a large eight-sided facet on top and a series of small inclined faces around it. The lower half consists of steeply inclined faces giving the stone on this side a pyramidal shape. The depth of a brilliant is nearly equal to its breadth, and it, therefore, can only be cut from a thick stone. Thinner stones, in proportion to the breadth, are cut into what is known as the *rose diamond*. This is a stone which has its upper surface covered with small triangular facets. Its lower surface may be one plane face, or the cutting of the upper half may be duplicated. With exceptional-shaped stones other cuttings are used.

The value of a cut diamond depends upon its color and purity, upon the skill with which it has been cut and upon its size. A one-carat stone weighs 205 milligrams, and if cut in the form of a brilliant would be 6.25 millimeters in diameter and 4 millimeters in depth, and if of good color would be valued from \$150 to \$175. A two-carat stone of the same quality would have a value three or four times as great.

**Famous Stones.** The older famous diamonds include the following: the *Kohinoor*, weighing 106 carats, is one of the crown jewels of Great Britain; the *Regent or Pitt*, weighing 136 carats, belonging to France; the *Orloff*, which is mounted in the Russian imperial scepter, weighs 193 carats; Austria owns the *Florentine* yellow diamond, which weighs 139 carats; the *Star of the South*, weighing 125 carats, is said to be in India.

Large stones found more recently in South Africa include the following: The *Victoria* or *Imperial*, which weighed 457 carats when found, and 230 when cut. It was, however, later recut, its present weight being 180 carats. The *Stewart* weighed before and after cutting 288 and 120 carats respectively. The *Tiffany* diamond, which is of a brilliant yellow color, weighs 125 carats. The *Colenso* diamond, presented to the British Museum in 1887 by John Ruskin, weighs 129 $\frac{1}{4}$  carats. The *Excelsior* diamond, found at Jagersfontein in 1903, is now known as the *Jubilee*, and weighs 239 carats. The

*Cullinan* or *Premier* diamond was found at the Premier Mine, Transvaal, and was the largest stone ever found, weighing 3024 carats or 1.7 pounds troy, and measured 4 by  $2\frac{1}{2}$  by 2 inches. This stone was presented to King Edward VII by the Transvaal Government and has been cut into 9 large stones, the larger ones weighing 516, 309, 92 and 62 carats respectively, and into 96 smaller brilliants.

**Name.** The name diamond comes from the Greek word *adamas*, meaning "invincible."

**Use.** In addition to its wide use as a gem, the diamond is extensively used as an abrasive. Crystal fragments are used to cut glass. The fine powder is employed in grinding and polishing diamonds and other stones. The noncrystalline, opaque varieties, especially that known as carbonado, are used in the bits of diamond drills. These drills are frequently employed in mining operations to explore the rocks and to determine the position and size of ore bodies. Recently the diamond has been used in wiredrawing and in the making of tungsten filaments for electric lights.

### Graphite.

**Composition.** Carbon, like the diamond. Sometimes impure with iron oxide, clay, etc.

**Crystallization.** Hexagonal-rhombohedral. In tabular crystals with hexagonal outline. Prominent basal plane. Distinct planes of other forms very rare. Rhombohedral symmetry sometimes shown by triangular markings on base.

**Structure.** In foliated masses; scaly; granular to compact; earthy. Sometimes in globular forms with radiated structure.

**Physical Properties.** Perfect basal cleavage.  $H. = 1-2$  (readily marks paper and soils the fingers).  $G. = 2.2$ . Luster metallic, sometimes dull earthy. Black color with brownish tinge. Black streak. Greasy feel. Folia flexible but not elastic.

**Tests.** Infusible. Very refractory in its chemical nature. Recognized by its color, foliated structure and softness. Distinguished from molybdenite by the brownish tinge to its black color (molybdenite has a blue tone) and the lack of chemical tests.

**Occurrence.** Graphite most commonly occurs in metamorphic rocks, such as crystalline limestones, schists and gneisses. It may occur as large crystalline plates inclosed in the rock or disseminated in small flakes in sufficient amount to form a considerable proportion of the rock. In these cases, it has probably been derived from carbon material of organic origin which has been converted into graphite during the metamorphism of the rock. Instances are known in which coal beds, under influence of strong metamorphic action, such as the intrusion into them of an igneous rock, have in a greater or less degree been converted into graphite. Examples of such an occurrence are to be found in the graphitic coals of Rhode Island, and in the coal fields of Sonora, Mexico. Graphite also occurs in fissure veins associated with calcite, quartz, orthoclase, pyroxene, etc. An example of such veins is to be found in the deposits at Ticonderoga, New York. Here the veins traverse a gneiss and besides the graphite contain quartz, biotite, orthoclase, tourmaline, apatite, pyrite, titanite, etc. The graphite may have been formed in these veins from hydrocarbons introduced into them during the metamorphism of the region and derived from the surrounding carbon-bearing rocks. Graphite occurs occasionally as an original constituent in igneous rocks. It has been observed in the basalts of Ovifak, Greenland, in an *elæolite* syenite from India, in a granite pegmatite from Maine, in meteorites, etc.

The most productive deposits of graphite at present are on the island of Ceylon, where it occurs in coarsely foliated masses in veins in gneiss. It occurs in large amounts in various localities in Austria, Italy, India, Mexico, etc. The chief deposits in the United States are in the Adirondack region of New York, in Essex, Warren, Washington and Saratoga counties.

**Artificial.** Artificial graphite is manufactured on a large scale in the electrical furnaces at Niagara Falls. Anthracite coal with a small amount of evenly distributed ash is subjected to the intense heat of the electrical current and converted into graphite. The output of artificial graphite is considerably in excess of that of the natural mineral.

**Name.** Derived from the Greek word "*to write.*"

**Use.** Used in the manufacture of refractory crucibles for the steel, brass and bronze industries. Most of the graphite used in this way is imported from Ceylon. Used widely, when mixed with oil, as a lubricant. Mixed with fine clay, it forms the "lead" of pencils. Much of the graphite used in the United States for this purpose comes from Sonora, Mexico. Used in the manufacture of a protective paint for structural iron and



steel works. Used in the coating of foundry facings, for electrodes, stove polishes, in electrotyping, etc.

### Sulphur.

**Composition.** Sulphur; often impure with clay, bitumen, etc.

**Crystallization.** Orthorhombic. Pyramidal in habit (Fig. 207). Often with two pyramids, brachydome and base in combination (Figs. 208 and 209).

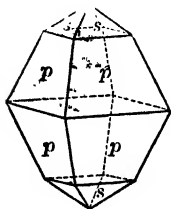


Fig. 207.

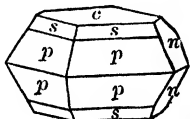


Fig. 208.

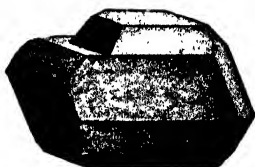


Fig. 209.

**Structure.** Often in irregular masses imperfectly crystallized. Massive, reniform, stalactitic, as incrustations, earthy.

**Physical Properties.** H. = 1.5-2.5. G. = 2.05-2.09. Resinous luster. Color sulphur-yellow, varying with impurities to yellow shades of green, gray and red. Transparent to opaque. Imperfect conductor of heat. When a fragment is held in the hand close to the ear it will be heard to crack. This is due to the expansion of the surface layers because of the heat from the hand, while the interior, on account of the slow heat conductivity, is unaffected. Crystals of sulphur should, therefore, be handled with care.

**Tests.** Fusible at 1 and burns with a blue flame giving strong odor of sulphur dioxide. Sublimes in C. T. giving a red to dark yellow liquid when hot, yellow solid when cold. Told by its yellow color and the ease with which it burns.

**Occurrence.** Found either associated with beds of gypsum, as an alteration product of a sulphate, or in connection with active or extinct volcanoes, as a result of fumerole action. Sometimes in connection with sulphides in metallic veins and derived from their

oxidation. Found in large deposits and in fine crystals near Girgenti, Sicily, associated with celestite, gypsum, calcite, aragonite, etc.; also in connection with the volcanoes of Mexico, Hawaii, Japan, Iceland, etc. In the United States is mined in Calsasieu Parish, Louisiana, and in Wyoming and Utah.

**Use.** Used in the manufacture of sulphuric acid, in the manufacture of matches, gunpowder, fireworks, insecticides, for vulcanizing rubber and in medicine.

## II. SEMIMETALS.

### Tellurium.

Native tellurium with sometimes a small amount of selenium, gold, iron, etc. Hexagonal-rhombohedral. Crystals rare; usually minute hexagonal prisms with rhombohedral terminations. Commonly massive, columnar to fine granular. Perfect prismatic cleavage.  $H. = 2-2.5$ .  $G. = 6.1-6.3$ . Metallic luster. Tin-white color. Gray streak. Wholly volatile B. B. Fusible at 1. On charcoal tinges reducing flame green and gives a white oxide coating. Heated with concentrated sulphuric acid gives deep red color to solution. A rare species, found usually associated with the rare tellurides of gold and silver. Occurs with sylvanite near Zalathna, Transylvania, at the Good Hope Mine, Vulcan, Colorado, and in other districts in that state. Tellurium has little commercial value.

### Arsenic.

**Composition.** Arsenic, often with some antimony and traces of iron, silver, gold, bismuth, etc.

**Crystallization.** Hexagonal-rhombohedral. Crystals rare.

**Structure.** Usually granular massive, sometimes reniform and stalactitic.

**Physical Properties.** Perfect basal cleavage.  $H. = 3.5$ .  $G. = 5.7$ . Metallic luster. Color tin-white on fresh fracture, tarnishes on exposure to dark gray. Gray streak.

**Tests.** Volatile without fusion. B. B. on charcoal gives white volatile coating of arsenious oxide and odor of garlic. In O. T. gives volatile crystalline deposit of arsenious oxide. In C. T. gives arsenic mirror.

**Occurrence.** A comparatively rare species found in veins in crystalline rocks associated with antimony minerals, the ruby silvers, realgar, orpiment, sphalerite, etc. Found in the silver mines of Saxony, in Bohemia, Norway, Zmeov in Siberia, Chile, Mexico. Sparingly in the United States.

**Name.** The name arsenic is derived from a Greek word meaning *masculine*, a term first applied to the sulphide of arsenic on account of its potent properties.

**Use.** Very minor ore of arsenic.

### Antimony.

**Composition.** Antimony, with (at times) small amounts of arsenic, iron or silver.

**Crystallization.** Hexagonal-rhombohedral. Distinct crystals rare.

**Structure.** Usually in granular masses showing distinct cleavage; radiated; botryoidal.

**Physical Properties.** Perfect basal cleavage.  $H. = 3-3.5$ .  $G. = 6.6-6.7$ . Metallic luster. Tin-white color. Gray streak.

**Tests.** Easily and completely volatile. Fusibility 1. When heated on charcoal gives a dense white coating of antimony trioxide. Heated in O. T. gives a white, slowly volatile sublimate of antimony trioxide.

**Occurrence.** A rare species, found usually in connection with silver veins and associated with arsenic and antimony compounds. Occurs at Sala, Sweden; Andreasberg, Harz Mountains; at Příbram, Bohemia; Allemont, France; Chile; South Ham, Canada; York County, New Brunswick, etc.

**Use.** Minor ore of antimony.

### Bismuth.

**Composition.** Bismuth, with sometimes small amounts of arsenic, sulphur, tellurium.

**Crystallization.** Hexagonal-rhombohedral. Distinct crystals rare.

**Structure.** Usually laminated and granular; sometimes reticulated or arborescent.

**Physical Properties.** Basal and rhombohedral cleavage. H. = 2–2.5. G. = 9.8. Sectile. Brittle. Metallic luster. Color silver-white with decided reddish tone. Streak silver-white, shining.

**Tests.** Fusible at 1. B. B. on charcoal gives metallic globule and yellow to white coating of bismuth oxide. The globule is somewhat malleable but cannot be hammered into as thin a sheet as in the case of lead. Mixed with potassium iodide and sulphur and heated on charcoal gives a brilliant yellow to red coating. Recognized chiefly by its laminated structure, its reddish silver color and its sectility.

**Occurrence.** A comparatively rare mineral, occurring usually in connection with ores of silver, cobalt, lead and zinc. Found in the silver veins of Saxony; in Norway and Sweden; Cornwall, England; with the silver and cobalt minerals at Cobalt, Ontario, Canada; only sparingly in the United States.

**Use.** Ore of bismuth. The greater part of the bismuth of commerce is produced from the sulphide, bismuthinite, or from other ores that contain a small per cent of the metal. It is chiefly employed in the manufacture of low-fusing alloys which are used as safety plugs in boilers and in automatic fire sprinklers, etc. Its salts are used in medicine.

### III. METALS.

#### GOLD GROUP. ISOMETRIC.

##### Gold.

**Composition.** Gold, commonly alloyed with small amounts of silver and at times with traces of copper and iron. Ordinarily, native gold contains varying amounts of alloyed silver up to 16 per cent. California gold contains between 10 and 15 per cent of silver. The greater part of native gold is about 90 per cent "fine" or contains 10 per cent of other metals. Gold containing unusually high percentages of silver (25 to 40 per cent) is known as *electrum*.

**Crystallization.** Isometric. Crystals are commonly octahedral in habit, showing also at times the faces of the dodeca-

hedron, cube, etc. (see Figs. 210, 211 and 212). Often in arborescent crystal groups with crystals elongated in the direction of an

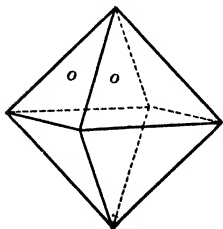


Fig. 210.  
Octahedron.

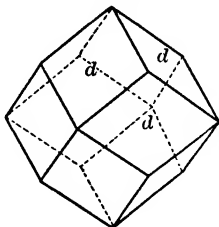


Fig. 211.  
Dodecahedron.

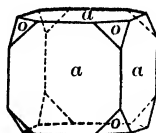


Fig. 212.  
Cube and Octahedron.

octahedral axis. Crystals irregularly distorted and passing into filiform, reticulated and dendritic shapes.

**Structure.** Usually in irregular plates, scales or masses. Seldom definitely crystallized.

**Physical Properties.** H. = 2.5-3. G. = 15.6-19.3 (becomes greater as the percentages of the other metals present decrease). Very malleable and ductile. Color various shades of yellow, depending upon purity, becoming paler with increase in the percentage of silver present.

**Tests.** Easily fusible at 2.5-3. Insoluble in ordinary acids but soluble in a mixture of hydrochloric and nitric acids. To be distinguished from certain yellow sulphides (particularly pyrite and chalcopyrite) and from yellow flakes of altered micas by its malleability, its insolubility and its great weight.

**Occurrence.** Although gold is a rare element, it is to be found widely distributed in nature, occurring in small amounts. Its presence as a primary constituent of igneous rocks, more particularly of the acidic type, has been abundantly proved. It is to be found most commonly in quartz veins. It occurs in detrital sands and gravels in what are known as placer deposits. It is present in small amounts in sea water. It is important to note that gold occurs almost wholly as the native metal, the only class of compounds which it forms in nature being the tellurides.

The chief source of gold is the gold-quartz veins. It occurs in these veins usually as very small specks scattered uniformly throughout the quartz gangue. The contents of these veins are in general

considered to have been deposited from ascending mineral-bearing solutions. That gold is capable of solution and subsequent precipitation by means of underground waters has been repeatedly demonstrated. In the majority of veins the gold is so finely divided and uniformly distributed that its presence in the ore cannot be detected with the eye. It is interesting to note that with the value of gold at \$20.67 a troy ounce, ore which contains one per cent of gold by weight would be worth \$6028 to the ton, while an ore containing only 0.01 per cent of gold would still be a rich ore, having a value of \$60 per ton. Ores are mined at a profit sometimes which contain only 0.001 per cent of gold and yield but \$6 to the ton. So it might be quite impossible to detect the presence of gold in a valuable ore by any ordinary tests. A definite estimation of the amount of gold present by means of a careful assay is the only way usually to determine the value of an ore. But occasionally, under favorable conditions, the gold may collect in larger amounts, in nests and pockets in the veins, occurring usually as irregular plates and masses between the crystals of quartz. In the quartz veins the gold is frequently associated with sulphides, particularly with pyrite. It is thought that the gold does not exist in any chemical combination with the pyrite, but has the same mechanical relation to it that it has to the quartz. The upper portions of the **gold-quartz veins** as a rule have been enriched in their values. The gold present in this upper zone was in part deposited contemporaneously with the formation of the vein, but frequently the greater part has been transported, either in solution or by mechanical settling, from that upper portion of the vein which has been gradually eroded away. And so the gold in this part of the vein represents the concentration in a small space of the original gold content of a much greater length of vein. By the oxidation of the gold-bearing sulphides originally deposited in this portion of the vein the gold embedded in them has been set free, rendering the gold easy of extraction. Ores that contain the gold free from intimate association with sulphides are known as "free-milling" because their gold content can be recovered by amalgamation with the mercury of the plates over which the finely crushed ore runs from the stamp mill. Where sulphides are present in any quantity all of the gold cannot be recovered by amalgamation and a chemical process, either the cyanide or chlorination process, must be used, either alone, or in addition to the amalgamation.

In addition to occurring with quartz and pyrite, gold has been found associated with chalcopyrite, sphalerite, galena, stibnite, cinnabar, arsenopyrite, limonite, calcite, etc.

Gold, on account of its great weight, is mechanically sorted in running water from the lighter material of the sands and gravels in which it may occur. In this way a concentration frequently takes

place in stream beds and gold placer deposits are formed. In general these deposits will be found where the current of the water has been suddenly checked and the heaviest particles of its load dropped in the bottom of the stream. Sand bars, etc., formed in this way may contain rich placer deposits. Irregularities in the bottom of a stream frequently act as natural riffles and catch behind them the heavier gold traveling along the bottom of the stream. In general, also, such deposits will be richer as the stream is ascended and the original veins from which the gold has been derived are approached. The larger masses of gold which have been rolled together by the action of the stream are called *nuggets*. These sometimes attain considerable size. The very fine gold which is known as *float gold* may be carried by the streams for long distances.

In California, at the close of the glacial epoch, large amounts of gold-bearing gravels were deposited in the stream beds. Subsequent changes in the elevation of the country and extensive lava flows have caused a rearrangement of the drainage, and in places these old gravel beds are to be found to-day upon the hillsides and are known as the hill gravels. In places they have been covered over with lava flows and so preserved from erosion. At Cape Nome, Alaska, the beach sands contained gold, where by the action of the waves the gold has been concentrated to form placer deposits.

The important gold-producing states and territories of the United States, in their approximate order of importance, are Colorado, Alaska, California, Nevada, South Dakota, Utah, Montana, Arizona and Idaho. There are several other states that also produce the metal, but in comparatively small amounts. The most important gold-producing districts of California are those of the series of gold-quartz veins known as the Mother Lode which lie along the western slope of the Sierras in Nevada, Amador, Calaveras, Eldorado, Tuolumne and Mariposa counties. Between one-third and one-half of California's gold production comes from placer deposits, mostly worked by dredging operations in Butte and Yuba counties. The gold of Alaska has been derived chiefly from placer deposits, but recently the vein deposits have been of increasing importance. The chief producing districts are the Yukon Basin, the Fairbanks District and the Seward Peninsula, including Nome. Although Colorado is one of the first states in the production of gold, about one-half of its output comes from the Cripple Creek District in Teller County, where the gold occurs only sparingly native, but chiefly in the form of the tellurides, sylvanite and calaverite. The other chief producing counties are San Miguel and Ouray in the San Juan District, and Lake County, containing the Leadville District, and Gilpin, Clear Creek and Boulder counties in the Clear Creek District. The chief gold districts of Nevada are Goldfield and Tonopah and

other smaller camps in Nye and Esmeralda counties. The gold from South Dakota comes from the Black Hills, the Homestake Mine at Lead being the largest producer. The gold-producing districts of Utah are the Tintic and Bingham districts in Juab and Salt Lake counties respectively, and the Mercur District in Tooele County.

Important foreign gold-producing countries are as follows: South Africa, Australia, Russia, Mexico and Canada. The region known as the Rand, near Johannesburg in the Transvaal, South Africa, is the most productive gold district in the world. The gold occurs here scattered throughout inclined beds or "reefs" of a quartzose conglomerate, which has been mined in enormous amounts and to great depths. Australia has the following chief gold districts: Kalgoorlie in western Australia (largely tellurides), Ballarat and Bendigo in Victoria, Mount Morgan in Queensland and various fields in New South Wales. In Russia gold is mined in western Siberia and the Urals, in the Irkutsk Province, in Transbaikalia and Amur. The production of Mexico comes chiefly from the districts of Guanajuato, El Oro and Dolores.

## Silver.

**Composition.** Silver, frequently containing small amounts of alloyed copper and gold, more rarely traces of platinum, antimony, bismuth, mercury.

**Crystallization.** Isometric. Crystals commonly distorted and in branching, arborescent or reticulated groups.

**Structure.** Commonly in irregular masses, plates, scales, etc.; at times as coarse or fine wire.

**Physical Properties.** H. = 2.5-3. G. = 10.1-11.1, pure 10.5. Malleable and ductile. Color silver-white, often tarnished to brown or gray-black.

**Tests.** Easily fusible at 2 to bright globule. No oxide coating on charcoal. Easily soluble in nitric acid, giving on addition of hydrochloric acid a curdy white precipitate of silver chloride, which turns dark on exposure to light. Deposited from its solution by action of a clean copper plate.

**Occurrence.** Occurs usually as small irregular flakes and masses disseminated through various vein minerals, often invisible. Found associated with native copper, galena, argentite, chalcocite, the ruby silvers, tetrahedrite, calcite, barite, etc. While native silver is not



an uncommon mineral, the larger part of the world's output of the metal is obtained from its various compounds with sulphur, antimony, arsenic, etc. Most of the native silver occurring in nature is probably secondary in its origin, having been derived by reduction from some of its compounds.

Native silver has been found in the United States with native copper in the copper mines of Lake Superior; in crystal groups at the Elkhorn Mine, Montana; in large masses in the silver mines at Aspen, Colorado. Is found, at present, in large quantities as platy masses, associated with various cobalt and nickel minerals, at Cobalt, Ontario, Canada. An important silver ore in the mines of Chihuahua, Guanajuato, Durango, Sinaloa and Sonora, Mexico. Occurs commonly in the mines of Peru. Was found in large masses, one of which weighed 500 pounds, in the mines at Kongsberg, Norway. One of the ores of the silver mines of Saxony and Bohemia.

**Use.** Silver is used for ornamental purposes, for coinage, plating, etc. It is usually alloyed with copper. The standard silver coin in the United States contains one part of copper to nine parts of silver.

## Copper.

**Composition.** Copper, often containing small amounts of silver, bismuth, mercury, etc.

**Crystallization.** Isometric. Tetrahexahedron faces common on crystals, (see Fig. 213). Also cube and dodecahedron. Crystals usually distorted and in branching and arborescent groups, (see Pl. IV).

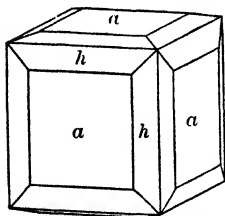


Fig. 213. Cube and Tetrahexahedron.

**Structure.** Usually in irregular masses, plates, scales, etc. In twisted and wire-like forms.

**Physical Properties.** H. = 2.5-3. G. = 8.8-8.9. Highly ductile and malleable. Color copper-red, usually dark and with a dull luster on account of tarnish.

**Tests.** Fuses at 3 to a globule, which becomes covered with an oxide coating on cooling. Dissolves readily in nitric acid, and the solution is colored a deep blue on addition of ammonium hydroxide in excess.

PLATE IV.



Arborescent Copper, Lake Superior.



**Occurrence.** A mineral found widely distributed in copper veins, but usually in small amount. Associated with various copper minerals, most commonly with the oxidized ores, cuprite, malachite and azurite. Ordinarily is strictly a secondary mineral and is to be found only in the upper parts of copper veins.

The most notable deposit of native copper known in the world is on Keweenaw Peninsula in northern Michigan, on the southern shore of Lake Superior. The region is occupied by a series of igneous flows of trap rock interbedded with sandstone conglomerates. The whole series dips toward the north. The copper is found in veins intersecting this rock series; in the amygdaloidal belts at the top of the various trap flows; and as a cementing material in the sandstone conglomerate. This last type has furnished the most important ore deposits, some of which have been worked for considerably over a mile in vertical depth. Not only does the copper act as a cement to bind the conglomerate together, but it has often penetrated the quartz boulders of the rock to a depth of a foot or more. It is associated with such minerals as epidote, datolite, calcite and various zeolites. The mines were worked superficially by the Indians, and have been actively developed since the middle of the eighteenth century. Most of the copper of the district occurs in very small irregular specks, but notable large masses have been found, one weighing 420 tons being discovered in 1857.

Sporadic occurrences of copper similar to that of the Lake Superior District have been found in the sandstone areas of the eastern United States, notably in New Jersey, and in the glacial drift overlying a similar area in Connecticut. Native copper occurs in small amounts, associated with the oxidized ores of Arizona, New Mexico and northern Mexico.

**Use.** The most important uses to which the metal is put are as an electrical conductor; in the manufacture of brass (an alloy of copper and zinc), of bronze (an alloy of copper and tin with frequently zinc); for sheet copper; and as copper sulphate, which is used in calico printing, in galvanic cells, etc.

*Mercury, Amalgam (Ag,Hg) and Lead* are rare metals.

## PLATINUM-IRON GROUP.

### Platinum.

**Composition.** Platinum, usually alloyed with several per cent of iron and with smaller amounts of iridium, osmium, etc. The amount of metallic platinum present seldom exceeds 80 per cent.

**Crystallization.** Isometric. Crystals very rare. Commonly distorted.

**Structure.** Usually in small grains or scales. Sometimes in irregular masses and nuggets of larger size.

**Physical Properties.** H. = 4–4.5 (unusually high for a metal). G. = 14–19 native; 21–22 when chemically pure. Malleable and ductile. Color steel-gray, with bright luster.

**Tests.** B. B. infusible. Unattacked by ordinary reagents; soluble in a mixture of hydrochloric and nitric acids. Determined by its high specific gravity, infusibility and insolubility.

**Occurrence.** Platinum is a rare metal which occurs almost exclusively native (only one rare compound, sperrylite, PtAs<sub>2</sub>, being known). It is found in quantity in only a few localities, and then only in the stream sands, as placer deposits, where it has been preserved on account of its great weight and hardness. Occurs in the alluvial deposits associated with the rarer metals of the Platinum Group, gold, iron-nickel alloys, chromite, etc. Its original source is probably usually in peridotite rocks or the serpentine rocks resulting from their metamorphism. It occurs so sparingly disseminated through such rocks, however, that it is only after their disintegration and the subsequent concentration of the platinum in the resulting sands that workable deposits of the metal are formed. Placer deposits of platinum are therefore to be looked for in the vicinity of masses of such peridotite rocks.

Practically the entire world's supply of platinum at present comes from the Ural Mountains in Russia. The central and northern end of this range has large masses of altered peridotite rocks, and in the sands of the streams descending from it, chiefly on the eastern slope in Siberia, platinum is found in considerable quantity. The chief districts are Nizhni Tagilsk, Bissersk and Goroblagodat, and farther to the north, Bogoslowsk.

Platinum was first discovered in the United States of Colombia, South America, where it received its name *platina* from *plata* (silver). It is to be found there in two districts near the Pacific coast. The chief district covers the greater part of the intendencia of Choco, while the second, that of Barbacoas, is in the department of Cauca. The platinum occurs here with gold in placer deposits, and, while the fields are not largely productive at present, they may become so.

The only platinum found in the United States comes from the gold placer deposits of Oregon and California, but the yearly yield amounts to only a few thousand dollars in value.

**Use.** The uses of the metal depend chiefly upon its insolubility, infusibility and superior hardness. It is used for various scientific instruments such as crucibles, dishes, etc., in the chemical laboratory; to line the distilling apparatus in the manufacture of sulphuric acid; in the electrical industry for contacts, etc.; in jewelry, chiefly as the setting for diamonds; as anodes in the electrolytic chemical industry; for electric heating apparatus; for the measurement of high temperatures by the use of thermoelectricity; for sparking plugs in explosive motors; in incandescent electric lights; in the manufacture of false teeth and in fillings for teeth; and in various chemical reactions which are facilitated by the use of finely divided platinum.

### Iron.

Native iron, with always some nickel and usually small amounts of cobalt and frequently traces of copper, manganese, sulphur, carbon, phosphorus, etc. Isometric. Practically always massive. H. = 4-5. G. = 7.3-7.8. Malleable. Metallic luster. Color steel-gray to black. Strongly magnetic. Occurs very sparingly as terrestrial iron, and in the form of meteorites. Found, included in basalt, on the west coast of Greenland, varying in size from small disseminated grains to large masses. Has been noted in a few other localities with a similar association. Nickel-iron alloys have been found in the gold sands of New Zealand (*awaruile*), from Josephine County, Oregon (*josephinite*), and from the Fraser River, British Columbia (*souesile*). Most meteorites contain native iron. The metal sometimes forms practically the entire body of the meteorite, while at other times it forms a cellular mass, inclosing grains of chrysolite, etc. In the stony meteorites, iron is found disseminated through them in the shape of small grains. Meteorites are to be recognized usually by their fused and pitted exterior. At first they are coated with a film of iron oxide, which disappears, however, on continued exposure to the weather.

*Iridium*, *Iridosmine*, an alloy of iridium and osmium, and *Palladium* are rare metals in the Platinum-Iron Group.

### SULPHIDES.

The sulphides form an important group of minerals which includes the majority of the ore minerals. With them are classed the similar but rarer selenides, tellurides, arsenides and anti-

monides. The sulphides may be divided into two groups depending upon the character of the metal present: (1) *Sulphides of the Semimetals*, (2) *Sulphides of the Metals*.

## SULPHIDES OF THE SEMIMETALS.

### Realgar.

**Composition.** Arsenic monosulphide,  $\text{AsS}$  = Sulphur 19.9, arsenic 70.1.

**Crystallization.** Monoclinic. Short prismatic crystals, vertically striated. (See Fig. 214.)

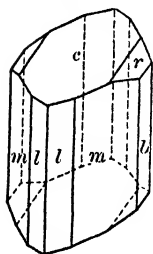


Fig. 214.

**Structure.** In crystals, coarse to fine granular, often earthy and as an incrustation.

**Physical Properties.** Cleavage parallel to clinopinacoid.  $H. = 1.5-2$ .  $G. = 3.55$ . Resinous luster. Color and streak red to orange. Transparent to opaque.

**Tests.** Fusible at 1. Easily volatile. Heated on charcoal yields a volatile white sublimate of arsenious oxide with characteristic garlic odor. Roasted in O. T. gives volatile crystalline sublimate of arsenious oxide and odor of sulphur dioxide. Characterized chiefly by deep red color and resinous luster.

**Occurrence.** A rare mineral, occurring usually with orpiment,  $\text{As}_2\text{S}_3$ . Found associated with silver and lead ores in Hungary, Bohemia, Saxony, etc. Found in good crystals at Nagyág, Transylvania; Binnenthal, Switzerland; Allchar, Macedonia. Occurs in Iron County, Utah. Found deposited from the geyser waters in Yellowstone Park.

**Name.** The name is derived from the Arabic, *Rahj al ghar*, *powder of the mine*.

**Use.** Was used in fireworks to give a brilliant white light when mixed with saltpeter and ignited. Artificial arsenic sulphide is at present used for this purpose.

### Orpiment.

**Composition.** Arsenic trisulphide,  $\text{As}_2\text{S}_3$  = Sulphur 39, arsenic 61.

**Crystallization.** Monoclinic. Crystals small and rarely distinct.

**Structure.** Usually foliated.

**Physical Properties.** Very perfect cleavage parallel to clinopinacoid. Folia flexible but not elastic. Sectile.  $H. = 1.5-2$ .  $G. = 3.4-3.5$ . Resinous luster, pearly on cleavage face. Color lemon-yellow. Translucent.

**Tests.** Same as for realgar (which see). Characterized by its yellow color, perfect cleavage and foliated structure.

**Occurrence.** A rare mineral, associated usually with realgar. Found in various places in Hungary; in Kurdistan; in Peru, etc. Occurs at Mercur, Utah. Deposited from geyser waters in the Yellowstone Park.

**Name.** Derived from the Latin, *auripigmentum*, "golden paint."

**Use.** For a pigment, in dyeing and in a preparation for the removal of hair from skins. Artificial arsenic sulphide is largely used in place of the mineral.

### Stibnite.

**Composition.** Antimony trisulphide,  $Sb_2S_3$  = Sulphur 28.6, antimony 71.4. Sometimes carries gold or silver.

**Crystallization.** Orthorhombic. Slender prismatic habit, prism zone vertically striated. Crystals often steeply terminated. (See Fig. 216.) Often in radiating groups. Crystals sometimes curved or bent (Fig. 215).

**Structure.** In radiating crystal groups or in bladed forms with prominent cleavage. Massive, coarse to fine columnar.

**Physical Properties.** Perfect cleavage parallel to brachypinacoid.  $H. = 2$ .  $G. = 4.55$ . Metallic luster, splendid on cleavage surfaces. Color and streak lead-gray.

**Tests.** Very easily fusible at 1. B. B. on charcoal gives dense white coating of antimony trioxide and odor of sulphur dioxide. When roasted in O. T. gives nonvolatile white sublimate on bottom of tube and a white volatile sublimate as ring around tube. Heated in C. T. gives a faint ring of sulphur and below a red (when cold) deposit of oxysulphide of antimony. Char-



acterized by its bladed structure, perfect cleavage in one direction, its lead-gray color and soft black streak.



Fig. 215.

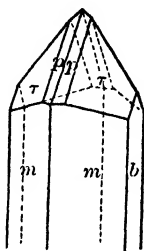


Fig. 216.

**Occurrence.** Deposited by alkaline waters in connection usually with quartz. Found in quartz veins or beds in granite and gneiss. Associated with other antimony minerals, as the products of its decomposition, and with galena, cinnabar, sphalerite, barite and sometimes gold. Found in various mining districts in Saxony, and Bohemia, Mexico, New South Wales, China, etc. Occurs in magnificent crystals in Province of Iyo, island of Shikoku, Japan. Found in quantity only sparingly in the United States, the chief deposits being in California, Nevada and Idaho.

**Use.** Used in various alloys, as type metal, pewter and anti-friction metal. The sulphide is employed in the manufacture of fireworks, matches, percussion caps, etc. Used in vulcanizing rubber. Used in medicine as tartar emetic and other compounds. Antimony trioxide is used as a pigment and for making glass.

### Bismuthinite.

**Composition.** Bismuth trisulphide,  $\text{Bi}_2\text{S}_3$  = Sulphur 18.8, bismuth 81.2.

**Crystallization.** Orthorhombic. In acicular crystals.

**Structure.** Usually massive, foliated or bladed.

**Physical Properties.** Perfect cleavage parallel to brachypinacoid.  $H. = 2$ .  $G. = 6.4-6.5$ . Metallic luster. Color and streak lead-gray.

**Tests.** Easily fusible (1). Roasted in O. T. or B. B. on charcoal gives odor of sulphur dioxide. Mixed with potassium iodide and sulphur and heated on charcoal gives characteristic yellow to red coating. Resembles stibnite; recognized by the test for bismuth.

**Occurrence.** A rare mineral, found in Cumberland, England; in Saxony, Sweden, Bolivia, Beaver County in Utah, etc.

**Use.** An ore of bismuth. See under native bismuth.

### Molybdenite.

**Composition.** Molybdenum disulphide,  $MoS_2 =$  Sulphur 40, molybdenum 60.

**Crystallization.** Hexagonal. Crystals in hexagonal-shaped plates or short, slightly tapering prisms.

**Structure.** Commonly foliated massive or in scales.

**Physical Properties.** Perfect basal cleavage. Laminae flexible but not elastic. Sectile.  $H = 1$ .  $G. = 4.75$ . Greasy feel. Metallic luster. Color lead-gray. Grayish black streak.

**Tests.** Infusible. Heated B. B. gives yellowish green flame. Roasted in O. T. gives odor of sulphur dioxide and deposit of thin plates of molybdenum oxide, crossing the tube above the mineral. Heated on charcoal in O. F. gives a white coating of molybdenum oxide; when this coating is touched with R. F. turns to deep blue color. Resembles graphite but is distinguished from it by having a blue tone to color, while graphite has a brown tinge, and by its reactions for sulphur and molybdenum.

**Occurrence.** Occurs in granite, gneiss and granular limestone, either as nests or disseminated through the rock. Found in the United States in many localities, but usually not in commercial quantity. Found at Blue Hill and Cooper, Maine; Westmoreland, New Hampshire; Pitkin, Colorado; in Okanogan County, Washington.

**Use.** An ore of molybdenum. See under wulfenite.

## SULPHIDES, ETC., OF THE METALS.

The sulphides of the metals are divided into the following groups: A. *Basic Division*; B. *Monosulphide Division*; C. *Intermediate Division*; D. *Disulphide Division*.

### A. BASIC DIVISION.

This division includes several rare compounds of silver or copper with antimony or arsenic such as dyscrasite,  $\text{Ag}_3\text{Sb}$  to  $\text{Ag}_6\text{Sb}$ ; domeykite,  $\text{Cu}_3\text{As}$ ; algodonite,  $\text{Cu}_6\text{As}$ ; whitneyite,  $\text{Cu}_9\text{As}$ .

### B. MONOSULPHIDE DIVISION.

#### 1. GALENA GROUP. ISOMETRIC.

##### **Argentite.** Silver Glance.

**Composition.** Silver sulphide,  $\text{Ag}_2\text{S}$  = Sulphur 12.9, silver 87.1.

**Crystallization.** Isometric. Cube, dodecahedron and octahedron the most common forms. Crystals often distorted and arranged in branching or reticulated groups.

**Structure.** Commonly massive, platy, earthy or as a coating. More rarely in crystals.

**Physical Properties.** H. = 2-2.5. G. = 7.3. Easily sectile, can be cut with a knife like lead. Metallic luster. Color and streak blackish lead-gray. Streak shining. Bright on fresh surface but on exposure becomes dull black, due to the formation of an earthy sulphide.

**Tests.** Easily fusible at 1.5 with intumescence. When fused alone on charcoal in O. F. gives off odor of sulphur dioxide and yields a globule of pure silver. Distinguished by these tests and by its color, sectility and high specific gravity.

**Occurrence.** A fairly common ore of silver. Usually found in silver veins as small masses, often earthy or as a coating. Associated with native silver, the ruby silvers, stephanite and other silver minerals; also galena. In the United States it was an important ore in the mines of the Comstock Lode, Nevada; at present found in Nevada at Tonopah and elsewhere. Found also in some of the silver

districts of Arizona. An important ore in the silver mines of Guanajuato and elsewhere in Mexico; in Peru, Chile and Bolivia. Important European localities for its occurrence are Freiberg in Saxony, Annaberg in Austria, Joachimsthal in Bohemia, Schemnitz and Kremnitz in Hungary, Kongsberg in Norway.

**Use.** An important ore of silver.

### Galena. Galenite.

**Composition.** Lead sulphide,  $PbS$  = Sulphur 13.4, lead 86.6. Almost always carries traces of silver sulphide, frequently enough to make it a valuable silver ore. At times also contains small amounts of selenium, zinc, cadmium, antimony, bismuth and copper.

**Crystallization.** Isometric. Most common form is the cube, octahedron sometimes as truncations to cube, more rarely as the

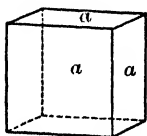


Fig. 217.  
Cube.

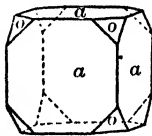


Fig. 218.  
Cube and Octahedron.

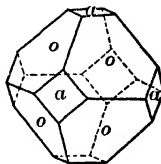


Fig. 219.  
Octahedron and Cube.

simple form (Figs. 217, 218 and 219; see also A, pl.V.). Dodecahedron and trisoctahedron rare.

**Structure.** Commonly crystallized or massive cleavable; coarse or fine granular.

**Physical Properties.** Perfect cubic cleavage.  $H. = 2.5-2.75$ .  $G. = 7.4-7.6$ . Bright metallic luster. Color and streak lead-gray.

**Tests.** Easily fusible at 2. Reduced on charcoal to lead globule with formation of yellow to white coating of lead oxide. When heated rapidly in the O. F. the coating is heavier and consists chiefly of a white volatile combination of oxides of lead and sulphur, which resembles the antimony oxide coating. Odor of sulphur dioxide when roasted on charcoal or in O. T. When

treated with strong nitric acid is oxidized to white lead sulphate. Determined chiefly by its high specific gravity, softness, black streak and cubic cleavage.

**Alteration.** By oxidation it is converted into the sulphate, anglesite, the carbonate, cerussite, or other compounds.

**Occurrence.** A very common metallic sulphide, associated with sphalerite, pyrite, marcasite, chalcopyrite, cerussite, anglesite, dolomite, calcite, quartz, barite, fluorite, etc. Frequently found with silver minerals, often containing that metal itself and so becoming an important silver ore. A large part of the supply of lead comes as a secondary production from ores mined chiefly for their silver. Occurs most commonly in connection with limestones, either as veins or irregular deposits, or as replacement deposits.

The following are the important lead producing localities in the United States: Southeastern Missouri, in which the ore occurs in the form of beds with the mineral disseminated through the limestone; southwestern Missouri, where it is associated with zinc ores, and is found in irregular veins and pockets in limestone and chert; Idaho, where the lead is derived chiefly from lead-silver deposits, the greater part of which come from near Wallace in Shoshone County; Utah, in connection with the silver deposits of the Tintic and Park City districts; Colorado, chiefly from the lead-silver ores of the Leadville District.

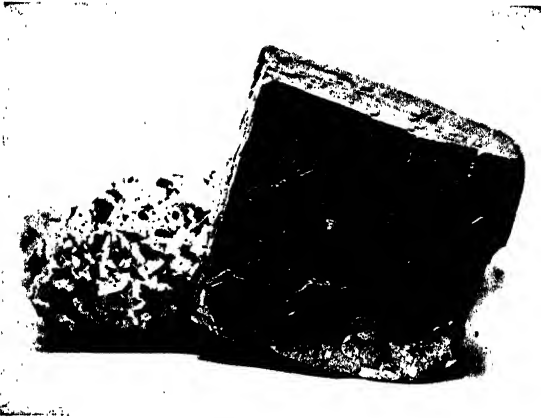
The most famous foreign localities are, Freiberg, Saxony; the Harz Mountains; Příbram, Bohemia; Cornwall, Derbyshire and Cumberland, England.

**Name.** The name galena is derived from the Latin *galena*, a name originally given to lead ore.

**Use.** Practically the only source of lead and an important ore of silver. Metallic lead is used chiefly as follows: for conversion into white lead (a basic lead carbonate), which is the principal ingredient of the best white paints, or into the oxides used in making glass and in giving a glaze to earthenware; as pipe and sheets; for shot; it is one of the ingredients of solder (an alloy of lead and tin), of type metal (an alloy of lead and antimony) and of low-fusion alloys consisting of lead, bismuth and tin.

The following rare tellurides belong in this group; *hessite*,  $\text{Ag}_2\text{Te}$ ; *petzite*  $(\text{Ag,Au})_2\text{Te}$ ; *altaite*,  $\text{PbTe}$ .

PLATE V.



A. Galena with Dolomite, Joplin, Missouri.



B. Fluorite, Cumberland, England.



## 2. CHALCOCITE GROUP. ORTHORHOMBIC.

## Chalcocite. Copper Glance.

**Composition.** Cuprous sulphide,  $\text{Cu}_2\text{S}$  = Sulphur 20.2, copper 79.8.

**Crystallization.** Orthorhombic. Usually in small tabular crystals with hexagonal outline. Striated parallel to the brachy-

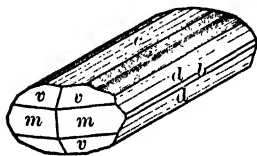


Fig. 220.

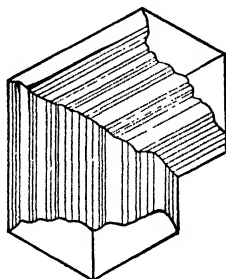


Fig. 221.

axis (Fig. 220). Often twinned in pseudo-hexagonal forms (Fig. 221).

**Structure.** Massive. Crystals very rare.

**Physical Properties.** Conchoidal fracture.  $H. = 2.5-3$ .  $G. = 5.5-5.8$ . Metallic luster. Color shining lead-gray, tarnishing on exposure to dull black. Streak grayish black.

**Tests.** Easily fusible at 2-2.5. In O. T. or B. B. on charcoal gives odor of sulphur dioxide. Roasted mineral, moistened with hydrochloric acid, gives azure-blue flame. Soluble in nitric acid; and the solution with an excess of ammonia turns dark blue. Recognized by its massive structure, its high specific gravity, its color, softness and black streak.

**Occurrence.** Found in crystals in Cornwall, England, and Bristol, Connecticut. Occurs as a mineral of secondary origin in the enriched zone of copper veins associated with bornite, chalcopyrite, enargite, malachite, pyrite, etc. Found as an ore at Monte Catini, Tuscany; Mexico, Peru, Bolivia, Chile, etc. Occurs in immense



deposits at Butte, Montana. Found in Alaska at Kennecott, Copper River District.

**Use.** An important copper ore.

### Stromeyerite.

A sulphide of silver and copper  $(Ag,Cu)_2S$  or  $Ag_2S.Cu_2S$ . Orthorhombic. Commonly massive.  $H. = 2.5-3$ .  $G. = 6.15-6.3$ . Metallic luster. Color and streak grayish black. Fusible at 1.5. In O. T. gives odor of sulphur dioxide. Roasted mineral with hydrochloric acid gives azure-blue flame. Nitric acid solution with hydrochloric acid gives precipitate of silver chloride. A rare silver mineral found with other silver ores.

### 3. SPHALERITE GROUP. ISOMETRIC, TETRAHEDRAL.

#### Sphalerite. Zinc Blende, Black Jack.

**Composition.** Zinc sulphide,  $ZnS =$  Sulphur 33, zinc 67. Almost always contains at least a small percentage of iron replacing the zinc, but the amount of iron may rise as high as 15 to 18 per cent. Also frequently contains small amounts of manganese, cadmium, mercury, etc.

**Crystallization.** Isometric; tetrahedral. Tetrahedron (Fig. 222), dodecahedron and cube common forms, but the crystals

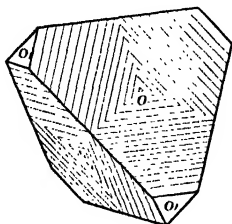


Fig. 222.

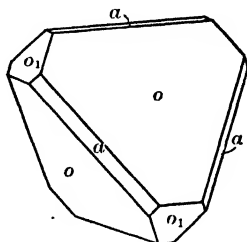


Fig. 223.

frequently highly complex and usually distorted or in rounded forms. Often twinned.

**Structure.** Usually massive cleavable, coarse to fine granular. Compact, botryoidal. Also in rounded crystal masses.

**Physical Properties.** Perfect dodecahedral cleavage.  $H. = 3.5-4$ .  $G. = 4-4.1$ . Nonmetallic and resinous to submetallic luster; also adamantine. Color white when pure, and green when nearly so. Commonly yellow, brown to black, darkening with increase in the amount of iron present. Transparent to translucent. Streak white to yellow and brown.

**Tests.** Infusible with pure zinc sulphide to difficultly fusible with increase in amount of iron. Gives odor of sulphur dioxide when heated on charcoal or in O. T. Decomposed in powder by warm hydrochloric acid with evolution of hydrogen sulphide gas, which may be detected by its disagreeable odor. When heated on charcoal gives a coating of zinc oxide (yellow when hot, white when cold) which is nonvolatile in oxidizing flame. Recognized usually by its striking resinous luster and perfect cleavage. The dark varieties (black jack) can be told by noting that a knife scratch leaves a reddish brown streak.

**Occurrence.** Sphalerite, the most important ore of zinc, is an extremely common mineral, especially as a constituent of metallic veins. Found widely distributed, but chiefly in veins and irregular bodies in limestone rocks. Associated with galena, pyrite, marcasite, chalcopyrite, smithsonite, calcite, dolomite, siderite, etc. May carry silver or gold. Large deposits are found in the United States in Missouri, Kansas, Arkansas, Wisconsin, Iowa, Illinois, Colorado. The chief locality for its production is the Joplin District in southwestern Missouri. Found in large quantities in connection with the lead-silver deposits of Leadville, Colorado. Noteworthy European localities are at Alston Moor and other places in the lead-mining districts of northern England; Binnenthal, Switzerland, in fine crystals; at Schemnitz and other localities in the gold and silver-mining districts of Hungary.

**Name.** The name *blende* is from the German, blind or deceptive, because while often resembling galena it yielded no lead. *Sphalerite*, for the same reason, is derived from a Greek word meaning *treacherous*.

**Use.** The most important ore of zinc. The chief uses for metallic zinc, or *spelter*, are in galvanizing iron, making brass, an alloy of copper and zinc, in electric batteries, and as sheet zinc. Zinc oxide, or zinc white, is used extensively for making

paint. Zinc chloride is used as a preservative for wood. Zinc sulphate is used in dyeing and in medicine. Sphalerite also serves as the most important source of cadmium.

### Alabandite.

Manganese sulphide,  $MnS$ . Isometric; tetrahedral. Usually granular massive. Cubic cleavage.  $H. = 3.5-4$ .  $G. = 3.95$ . Submetallic luster. Color iron-black, tarnished to brown on exposure. Streak olive-green. Fusible at 3. Gives odor of sulphur dioxide when roasted in O.T. Soluble in hydrochloric acid with evolution of hydrogen sulphide gas. With sodium carbonate in O. F. gives opaque greenish blue bead (manganese). A rare mineral, occurring usually with gold or silver ores.

### Pentlandite.

A sulphide of iron and nickel  $(Ni,Fe)S$ . Isometric. Massive granular. Octahedral cleavage.  $H. = 3.5-4$ .  $G. = 4.55-5$ . Metallic luster. Yellowish bronze color. Black streak. Fusible at 1.5-2. Gives odor of sulphur dioxide in O. T. Magnetic on heating in R. F. Roasted mineral in O. F. colors borax bead reddish brown (nickel). Closely resembles pyrrhotite in appearance but to be distinguished by the octahedral cleavage. A rare mineral, found with chalcopyrite near Lillehammer, Norway, and with pyrrhotite and chalcopyrite in the nickel deposits at Sudbury, Canada.

Other minerals which are rare in occurrence that belong in this group are, *metacinnabarite*,  $HgS$ ; *tiemannite*,  $HgSc$ ; *onofrite*,  $Hg(S,Se)$ ; *coloradoite*,  $HgTe$ .

## 4. CINNABAR-MILLERITE GROUP. HEXAGONAL.

### Cinnabar.

**Composition.** Mercuric sulphide,  $HgS =$  Sulphur 13.8, mercury 86.2. Usually impure from admixture of clay, iron oxide, etc.

**Crystallization.** Hexagonal-rhombohedral; trapezohedral. Crystals usually rhombodral, often in penetration twins. Trapezohedral faces rare.

**Structure.** Usually fine granular massive; also earthy and as incrustations. Crystals rare.

**Physical Properties.** H. = 2-2.5. G. = 8.10. Adamantine luster when pure, to dull and earthy when impure. Color vermilion-red when pure, to brownish red when impure. Scarlet streak. Transparent to opaque.

**Tests.** Wholly volatile when free from gangue. Gives black sublimate of mercury sulphide when heated alone in C. T. When carefully heated in C. T. with dry sodium carbonate gives globules of metallic mercury. Carefully roasted in O. T. gives odor of sulphur dioxide and sublimate of metallic mercury. Recognized usually by color, streak and high specific gravity.

**Occurrence.** The most important ore of mercury, but found in quantity at comparatively few localities. Occurs filling fissures, cavities, etc., usually in sedimentary rocks; frequently as impregnations in sandstone or limestone. Associated with pyrite, marcasite, sulphur, calcite, barite, gypsum, opal, quartz, etc. Always found in the neighborhood of igneous rock masses from which it is thought that the mercury was derived. Deposited probably through the agency of ascending hot waters. Deposits of mercuric sulphide are being formed to-day by the hot springs at Steamboat Springs, Nevada, and at Ohaiawai, New Zealand. The important localities for the occurrence of cinnabar are at Almaden, Spain; Idria in Carniola; Huancavelica in southern Peru; Kwei Chaw, China; New Idria in San Benito County, Napa County, and New Almaden in Santa Clara County, California; Terlingua, Brewster County, Texas. *Hepatic cinnabar* is an inflammable variety with liver-brown color and sometimes a brownish streak, usually granular or compact.

**Name.** The name cinnabar is supposed to have come from India, where it is applied to a red resin.

**Use.** The only important source of mercury.

### Covellite.

Cupric sulphide,  $\text{CuS}$ . Hexagonal. Rarely in tabular hexagonal crystals with prominent basal plane. Usually massive. Perfect basal cleavage. H. = 1.5-2. G. = 4.59. Metallic luster. Color indigo-blue. Fusible at 2.5. Gives odor of sulphur dioxide in O. T. and much sulphur in C. T. The roasted mineral, moistened with hydrochloric acid and ignited, gives a blue flame (copper). When moistened with water shows a strong purple color. A rare mineral, found only in the enriched sulphide zone of copper deposits, associated with chalcocite, bornite, etc.

**Greenockite.**

**Composition.** Cadmium sulphide,  $CdS = \text{Sulphur } 22.3, \text{ cadmium } 77.7.$

**Crystallization.** Hexagonal; hemimorphic. Crystals hemimorphic, showing prism faces and terminated usually below with base and above with pyramids.

**Structure.** Usually pulverulent, as thin powdery incrustations. Crystals small and rare.

**Physical Properties.**  $H. = 3-3.5. G. = 4.9-5.$  Luster adamantine to resinous, earthy. Color yellow.

**Tests.** Infusible. Yields odor of sulphur dioxide when heated B. B. or in O. T. Decomposed by hydrochloric acid with the evolution of hydrogen sulphide gas, which may be detected by its disagreeable odor. Gives a reddish brown coating of cadmium oxide when heated with sodium carbonate on charcoal. Characterized by its yellow color and pulverulent form.

**Occurrence.** Most common mineral containing cadmium but found only in a few localities and in small amount. Associated usually with zinc ores, often as a coating on sphalerite and smithsonite. Found in crystals at Bishopton, Renfrewshire, Scotland; with the zinc ores of southwestern Missouri and in Arkansas, also in various localities in Bohemia and Greece.

**Use.** A source of cadmium. Cadmium-bearing zinc ores furnish the greater part of the metal produced. Cadmium is used in alloys for dental and other purposes. The sulphide serves as a yellow pigment.

**Millerite. Capillary Pyrites.**

**Composition.** Nickel sulphide,  $NiS = \text{Sulphur } 35.3, \text{ nickel } 64.7.$

**Crystallization.** Hexagonal-rhombohedral.

**Structure.** Usually in hairlike tufts and radiating groups of slender to capillary crystals. Sometimes in velvety incrustations.

**Physical Properties.** Cleavage rhombohedral.  $H. = 3-3.5. G. = 5.65.$  Metallic luster. Pale brass-yellow; with a green-

ish tinge when in fine hairlike masses. Streak black, somewhat greenish.

**Tests.** Fusible at 1.5-2 to magnetic globules. Gives odor of sulphur dioxide when heated on charcoal or in O. T. The roasted mineral colors the borax bead reddish brown in O. F.

**Occurrence.** Occurs in various localities in Saxony and Bohemia; in Cornwall; with hematite and siderite at Antwerp, N. Y.; with pyrrhotite at the Gap Mine, Lancaster County, Pennsylvania; in calcite at St. Louis, Missouri, Keokuk, Iowa, etc.

**Use.** A subordinate ore of nickel.

### Niccolite. Copper Nickel.

**Composition.** Nickel arsenide, NiAs = Arsenic 56.1, nickel 43.9. Usually with a little iron, cobalt and sulphur. Arsenic frequently replaced in part by antimony.

**Crystallization.** Hexagonal; hemimorphic (?).

**Structure.** Usually massive. Crystals rare.

**Physical Properties.** H. = 5-5.5. G. = 7.5. Metallic luster. Color pale copper-red, (hence called *copper-nickel*) with gray to blackish tarnish. Brownish black streak.

**Tests.** Fusible (2). When heated B. B. on charcoal a white volatile deposit of arsenious oxide forms and a garlic-like odor is given off. Gives to borax bead a reddish brown color (nickel). Characterized chiefly by its color.

**Occurrence.** Associated usually with cobalt, silver and copper minerals. Not very common. Found in the silver mines of Saxony, in Sweden, at Cobalt, Canada, etc.

**Use.** A minor ore of nickel.

### Pyrrhotite. Magnetic Pyrites.

**Composition.** A sulphide of iron, varying in composition from  $Fe_9S_8$  up to  $Fe_{10}S_{17}$ .  $Fe_{11}S_{12}$  is the usually accepted formula. Often carries a small amount of nickel.

**Crystallization.** Hexagonal. Crystals usually tabular, or sometimes pyramidal.

**Structure.** Practically always massive with granular or lamellar structure.

**Physical Properties.** H. = 4. G. = 4.65. Metallic luster. Brownish bronze color. Black streak. Usually slightly magnetic, but sometimes scarcely at all so.

**Tests.** Easily fusible. Strongly magnetic after heating. B. B. or in O. T. gives odor of sulphur dioxide. Little or no sulphur in C. T. Decomposed by hydrochloric acid, giving off hydrogen sulphide gas. Recognized usually by its massive structure and bronze color.

**Occurrence.** A common minor constituent of igneous rocks. Occurs in large masses in intimate association with basic igneous rocks and is thought by many to have been formed through magmatic differentiation. This view is doubted by many and is still open to question. Associated with the ferromagnesian minerals of the rocks in which it occurs, and also with chalcopyrite, and nickel minerals, as pentlandite, millerite, etc. Found in large quantities in Norway and Sweden, at Sudbury, Ontario, Canada; at Stafford and Ely, Vermont; at Ducktown, Tennessee. Was found at the Gap Mine, Lancaster County, Pennsylvania.

**Name.** Derived from a Greek word meaning *reddish*.

**Use.** Serves as an important ore of nickel, particularly at Sudbury, Ontario.

In this group belongs also the rare mineral, *wurtzite*, ZnS, which differs from sphalerite, since it is Hexagonal in crystallization.

## C. INTERMEDIATE DIVISION.

**Bornite.** Purple Copper Ore, etc.

**Composition.**  $\text{Cu}_3\text{FeS}_4$  = Sulphur 25.5, copper 63.3, iron 11.2. Analyses of different specimens show quite a wide variation in the percentages of the elements present, copper ranging from 55 to 71 per cent. Analyses of the purest material, however, agree with the above formula.

**Crystallization.** Isometric. Crystals rare. Usually in rough cubes, sometimes in penetration twins. Dodecahedron and octahedron at times.

**Structure.** Commonly massive.

**Physical Properties.** H. = 3. G. = 4.9-5.4. Metallic luster. Color brownish bronze on fresh fracture but quickly tarnishing on exposure to variegated purple and blue and finally to almost black. Streak grayish black.

**Tests.** Easily fusible at 2.5. Gives odor of sulphur dioxide on charcoal or in O. T. Yields only a very little sulphur in C. T. Becomes magnetic in R. F. If, after roasting, it is moistened with hydrochloric acid and heated, it gives an azure-blue flame (copper). Easily soluble in nitric acid with separation of sulphur; solution neutralized with ammonia gives red-brown precipitate of ferric hydroxide and blue color to filtrate. Characterized chiefly by its purple tarnish.

**Occurrence.** An important and widely occurring ore of copper, but usually with other copper minerals and in subordinate amount. It has been found as a primary constituent in igneous rocks and in pegmatite veins. Bornite and chalcopyrite are the two common original copper minerals, from which other copper minerals have been derived through secondary action. It is also frequently, itself, a secondary mineral, formed in the upper, enriched zone of copper veins through the action of descending copper-bearing solutions, upon chalcopyrite. The minerals with which it is commonly associated are chalcopyrite, chalcocite, enargite, malachite, azurite, pyrite, etc. It frequently occurs in intimate mixture with chalcopyrite and chalcocite. Found in the United States at Butte, Montana; in the copper mines of Virginia and North Carolina. It was found in unusual crystals, associated with crystallized chalcocite at Bristol, Connecticut. Occurs at Acton, Canada. Found in Cornwall; Monte Catini, Tuscany, and in various other European countries. An important ore in Chile, Peru, Bolivia and Mexico.

**Name.** Bornite was named after the mineralogist von Born (1742-1791). Sometimes called *horseflesh ore* in reference to the color on the fresh fracture, or *variegated copper ore* or *peacock ore* because of its purple tarnish. Called for the latter reason *erubescite* by English mineralogists.

**Use.** An important ore of copper.

### Linnæite.

A sulphide of cobalt,  $\text{Co}_3\text{S}_4$  or  $\text{CoS}\cdot\text{Co}_2\text{S}_3$ , with the cobalt replaced in varying amount by nickel. Isometric. In small octahedral



crystals or granular massive.  $H. = 5.5$ .  $G. = 4.9$ . Metallic luster. Color pale steel-gray. Grayish black streak. Fusible at 2. Gives odor of sulphur dioxide in O. T. Fuses in R. F. to a magnetic globule. Roasted mineral colors the borax bead blue (cobalt). A rare mineral, found with chalcopyrite near Riddarhyttan, Sweden; with barite and siderite at Müsen, Prussia; with lead ores at Mine La Motte, Missouri.

### Chalcopyrite. Copper Pyrites. Yellow Copper Ore.

**Composition.** A sulphide of copper and iron,  $CuFeS_2 =$  Sulphur 35, copper 34.5, iron 30.5.

**Crystallization.** Tetragonal; sphenoidal. Crystals usually in unit sphenoids (Fig. 224), which because the vertical axis is close to unity ( $c = 0.985$ ) are very near to the isometric tetrahedron

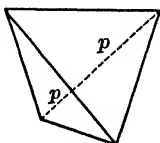


Fig. 224.

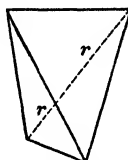


Fig. 225.

in angles. Steeper sphenoids (Fig. 225), and other more complex forms occasionally observed.

**Structure.** Usually massive, compact; at times in crystals.

**Physical Properties.**  $H. = 3.5$ .  $G. = 4.2-4.3$ . Metallic luster. Color brass-yellow; often tarnished to bronze or iridescent. Streak greenish black.

**Tests.** Easily fusible to a magnetic globule. Gives odor of sulphur dioxide when heated B. B. or in O. T. Gives sulphur in C. T. After roasting, and moistening with hydrochloric acid, gives an azure-blue flame. Readily decomposed by nitric acid, giving separated sulphur; solution made ammoniacal gives red-brown precipitate of ferric hydroxide and blue filtrate (copper). Recognized by its brass-yellow color, greenish black streak and its softness. Distinguished from pyrite by its being softer than

steel and from gold by its being brittle. Known sometimes as "fool's gold," a term which is also applied at times to pyrite.

**Occurrence.** The most common ore of copper. Occurs widely distributed in metallic veins associated with pyrite, pyrrhotite, bornite, chalcocite, tetrahedrite, malachite, azurite, sphalerite, galena, quartz, calcite, dolomite, siderite, etc. May carry gold or silver and become an ore of those metals. Often in subordinate amount with large bodies of pyrite, making them serve as low-grade copper ores. Chief ore of copper mines at Cornwall, England; Falun, Sweden; Rio Tinto, Spain; Sudbury, Canada; in South Africa, Chile, etc. Found widely in the United States but usually in connection with other copper minerals in equal or greater amount; found at Butte, Montana; Bingham, Utah; various districts in California, Colorado, Arizona, etc.

**Name.** Derived from Greek word meaning *brass* and from *pyrites*.

**Use.** Most important ore of copper.

### Stannite.

A sulphide of copper, tin and iron,  $\text{Cu}_2\text{S.FeS.SnS}_2$ . Zinc at times also present. Tetragonal, sphenoidal, but pseudo-isometric through twinning. Practically always massive. H. = 4. G. = 4.4. Metallic luster. Color steel-gray. Streak black. Fusible at 1.5. Slightly magnetic after heating in R. F. After roasting, and moistening with hydrochloric acid, gives when ignited a blue flame (copper). Fused alone on charcoal gives a nonvolatile white coating of tin oxide. A rare mineral, found in various places in Cornwall and with the tin ores of Bolivia.

## D. DISULPHIDE DIVISION.

### 1. PYRITE GROUP. ISOMETRIC; PYRITOHEDRAL.

#### Pyrite. Iron Pyrites.

**Composition.** Iron disulphide,  $\text{FeS}_2$  = Sulphur 53.4, iron 46.6. Sometimes contains small amounts of nickel, cobalt and copper. Frequently carries minute quantities of gold (auriferous pyrite).

**Crystallization.** Isometric; pyritohedral. Most common crystal forms are the cube, the faces of which are usually striated, the striæ on adjacent faces being perpendicular to each other

(Fig. 226); the octahedron, and the pentagonal dodecahedron, known commonly as the pyritohedron (Fig. 227). Figs. 228 to

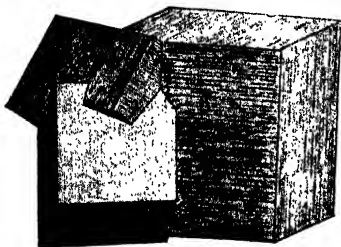


Fig. 226. Striated Cubes.

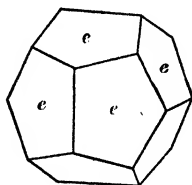


Fig. 227. Pyritohedron

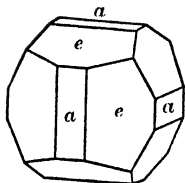


Fig. 228.  
Cube  
and Pyritohedron.

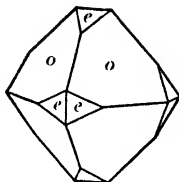


Fig. 229.  
Octahedron  
and Pyritohedron.

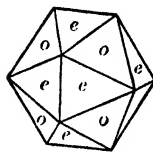


Fig. 230.  
Octahedron  
and Pyritohedron.

230 show characteristic combinations of these forms. Fig. 231 shows a penetration twin that is at times observed.

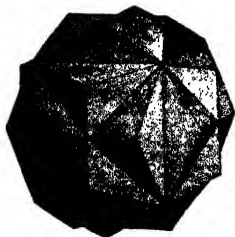


Fig. 231. Twinned  
Pyritohedrons.

**Structure.** Often in crystals. Also massive, granular, reniform, globular and stalactitic.

**Physical Properties.** Brittle. H. = 6-6.5 (unusually hard for a sulphide). G. = 4.95-5.10. Luster metallic, splendent. Color pale brass-yellow, becoming darker at times on

account of tarnish. Streak greenish or brownish black.

**Tests.** Easily fusible (2.5–3) to a magnetic globule. Yields much sulphur in C. T. Gives off sulphur dioxide in O. T. or B. B. on charcoal. Insoluble in hydrochloric acid. Fine powder completely soluble in nitric acid, but may yield separated sulphur when too rapidly decomposed. Distinguished from chalcopyrite by its paler color and the fact that it cannot be scratched by steel; from gold by its being brittle.

**Occurrence.** Pyrite is the most common of the sulphides. It is a common vein mineral, occurring in rocks of all ages and associated with many different minerals. Found frequently with chalcopyrite, sphalerite, galena, etc. Is widely distributed as an accessory rock mineral in both igneous and sedimentary rocks. Important deposits of pyrite in the United States are in Prince William, Louisa and Pulaski counties, Virginia, where it occurs in large lenticular masses which conform in position to the foliation of the inclosing schists; in St. Lawrence County, New York; at the Davis Mine, near Charlemont, Massachusetts; in various places in California. Large deposits occur at Rio Tinto and other mines in Spain, also in Portugal.

**Alteration.** Pyrite is easily altered to oxides of iron, usually limonite. It is, however, in general much more stable than marcasite. Pseudomorphic crystals of limonite after pyrite are common. Pyrite veins are usually capped by a cellular deposit of limonite, termed *gossan*. Rocks that contain pyrite are unsuitable for structural purposes because the ready oxidation of the pyrite in them would serve both to disintegrate the rock and to stain it with iron oxide.

**Name.** The name *pyrite* is from a Greek word meaning *fire*, in allusion to the fact that when struck with steel it gives off brilliant sparks.

**Use.** Pyrite is often mined for the gold or copper associated with it. Because of the large amount of sulphur present in the mineral it is never used as an iron ore. It is chiefly used to furnish sulphuric acid and copperas (ferrous sulphate). Sulphuric acid is perhaps the most important of all chemicals, being used for many different purposes, some of the more important being in the purification of kerosene and in the preparation of mineral fertilizers. The gas  $\text{SO}_2$  derived either through burning sulphur

or by roasting pyrite is used extensively in the preparation of wood pulp for manufacture into paper. Copperas is used in dyeing, in the manufacture of inks, as a preservative of wood, and for a disinfectant.

### Smaltite-Chloanthite.

Smaltite is cobalt arsenide,  $\text{CoAs}_2$ ; chloanthite, nickel arsenide,  $\text{NiAs}_2$ . The two molecules are isomorphous and all gradations between the two species occur. Isometric; pyritohedral. Usually massive, granular. Octahedral cleavage.  $H. = 5.5-6$ .  $G. = 6.3-6.8$ . Metallic luster. Color tin-white. Streak black. Fusible at 2-2.5. Roasted on charcoal give a volatile coating of arsenious oxide with characteristic garlic odor. In borax bead in O. F. give blue color (cobalt). Rare species, occurring with other cobalt and nickel minerals, often associated with silver and copper ores.

### Cobaltite-Gersdorffite.

Cobaltite is a sulpharsenide of cobalt,  $\text{CoAsS}$ ; gersdorffite a sulpharsenide of nickel,  $\text{NiAsS}$ . The two molecules are isomorphous with each other, and may occur together in varying amounts. Usually, however, any specimen will be found to be near one or the other ends of the series. Iron is frequently present, replacing the cobalt or the nickel, and sometimes in considerable amount. Isometric; pyritohedral. Cobaltite commonly in cubes, pyritohedrons and octahedrons, also massive. Gersdorffite usually massive. Cubic cleavage.  $H. = 5.5-6$ .  $G. = 5.8-6.2$ . Metallic luster. Color, tin-white, in cobaltite inclining to reddish tone. Streak black. Fusible 2-3. On charcoal give a volatile white sublimate of arsenious oxide with characteristic garlic odor. In O. T. give volatile crystalline sublimate of arsenious oxide with odor of sulphur dioxide. In O. F. in borax bead give deep blue color (cobalt); if gersdorffite contains no cobalt, gives brown bead (nickel). Rare minerals, cobaltite being the commoner. Found associated with other cobalt and nickel minerals and with silver and copper ores. Notable occurrences of cobaltite are at Tunaberg, Sweden, and Cobalt, Ontario, Canada.

### Sperrylite.

A platinum arsenide,  $\text{PtAs}_2$ . Isometric; pyritohedral. Usually in small grains, or in almost microscopic crystal fragments.  $H. = 6-7$ .  $G. = 10.6$ . Metallic luster. Tin-white color. Black streak. Fusible at 2. Roasted on charcoal gives volatile white coating of

arsenious oxide with characteristic garlic odor. Roasted in O. T., at first very gently, a platinum sponge is left, which is insoluble in any single acid. A very rare mineral and the only known compound of platinum occurring in nature. Found with chalcopyrite in a gold-quartz vein near Sudbury, Canada, and with covellite at the Rambler Mine, Encampment, Wyoming.

## 2. MARCASITE GROUP. ORTHORHOMBIC.

**Marcasite.** White Iron Pyrites.

**Composition.** Iron disulphide, like pyrite,  $\text{FeS}_2 =$  Sulphur 53.4, iron 46.6.

**Crystallization.** Orthorhombic. Crystals commonly tabular parallel to basal plane, showing also short prisms and low brachydomes (Fig. 232). The brachydomes usually striated parallel

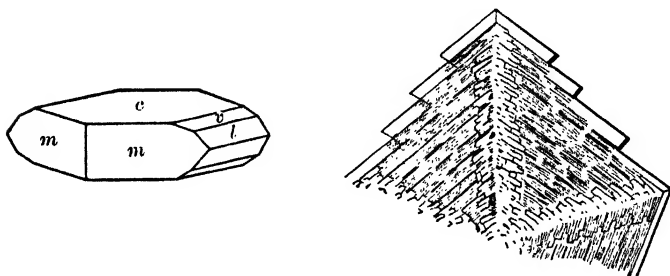


Fig. 233.

to the brachy-axis. Often twinned, giving coxcomb and spear-shaped groups (Fig. 233). Closely related in crystal forms and habit to arsenopyrite.

**Structure.** Usually in radiating forms. Often stalactitic, having an inner core with radiating structure and covered on the outside with irregular crystal groups. Also globular, reniform, etc. More rarely in crystals.

**Physical Properties.** H. = 6–6.5. G. = 4.85–4.9. Metallic luster. Color pale yellow to almost white, yellow to brown tarnish. Streak grayish black.

**Tests.** Fusible (2.5–3) to a magnetic globule. B. B. on charcoal or in O. T. gives odor of sulphur dioxide. Much sulphur in

C. T. When fine powder is treated by cold nitric acid, and the solution allowed to stand until vigorous action ceases and then boiled, the mineral is decomposed with separation of sulphur. Pyrite treated in the same manner would have been completely dissolved. Recognized usually by its pale yellow color, its crystals or its fibrous structure.

**Occurrence.** Marcasite is found in metalliferous veins, frequently with lead and zinc ores. Also at times in sedimentary rocks. It is more unstable than pyrite, being easily decomposed, and is not nearly as common in its occurrence. Found abundantly in clay near Carlsbad and elsewhere in Bohemia; in various places in Saxony; in the chalk marl of Folkestone and Dover, England; with zinc and lead deposits of Joplin, Missouri, and of Mineral Point, Wisconsin.

**Name.** Derived from an Arabic word, at one time applied generally to pyrite.

**Use.** To a slight extent as a source of sulphuric acid, etc.

### Arsenopyrite. Mispickel.

**Composition.** Sulpharsenide of iron,  $\text{FeAsS}$  = Arsenic 46, sulphur 19.7, iron 34.3. Sometimes cobalt replaces a part of the iron (*danaite*).

**Crystallization.** Orthorhombic. Usually in tabular diamond-shaped crystals, formed by a short prism terminated by low brachydomes. The brachydomes are usually striated parallel

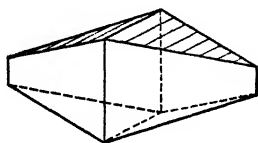


Fig. 234.

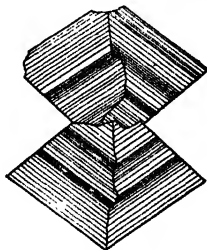


Fig. 235.

to the brachy-axis (Fig. 234). Twinned at times, giving stellate groups; the different individuals of the twin groups being dis-

tinguished from each other by the direction of the striations upon them (Fig. 235). Agrees closely in angles and crystal habit with marcasite.

**Structure.** In crystals. Massive, granular to compact.

**Physical Properties.** H. = 5.5-6. G. = 6-6.2. Metallic luster. Silver-white color. Black streak.

**Tests.** Fusible at 2 to a magnetic globule. B. B. on charcoal gives a volatile coating of arsenious oxide and a characteristic garlic odor. In O. T. gives odor of sulphur dioxide and a volatile ring of arsenious oxide. In C. T. gives arsenic mirror. Recognized usually by its silver-white color, its crystals and a test for arsenic.

**Occurrence.** Arsenopyrite is the most common mineral containing arsenic. Found in veins in crystalline rocks, associated with ores of tin, silver, lead and with pyrite, chalcopyrite, sphalerite, etc. Sometimes it is auriferous and serves as a gold ore. Occurs in quantity at Freiberg and Munzig, Saxony; in the Harz Mountains; with tin ores in Cornwall, England; in various places in Bolivia; New South Wales; Deloro, Canada, where it is mined as a gold ore; Roxbury, Connecticut, etc.

**Use.** An ore of arsenic. Arsenious oxide is used in the manufacture of glass, as a poison and a preservative. Paris green, an arsenate and acetate of copper, is used as a poison and a pigment. Sulphides of arsenic are used for paints and fireworks.

### 3. SYLVANITE GROUP.

#### Sylvanite.

**Composition.** Telluride of gold and silver (Au,Ag)Te<sub>2</sub>. The ratio of the amounts of gold and silver varies somewhat; when Au : Ag = 1 : 1 = Tellurium 62.1, gold 24.5, silver 13.4.

**Crystallization.** Monoclinic. Distinct crystals rare.

**Structure.** Usually bladed or granular. Often in skeleton forms deposited on rock surfaces and resembling writing in appearance.

**Physical Properties.** Perfect cleavage parallel to clinopinacoid. H. = 1.5-2. G. = 8-8.2. Brilliant metallic luster. Color silver-white. Streak gray.



**Tests.** Easily fusible (1). If a little of the powdered mineral is heated in concentrated sulphuric acid the solution assumes a deep red color (tellurium). When decomposed in nitric acid leaves a rusty-colored, spongy mass of gold, and the solution with hydrochloric acid gives white precipitate of silver chloride. With sodium carbonate on charcoal gives a globule of gold and silver. Determined, by above tests, by its silver color and good cleavage.

**Occurrence.** A rare mineral, found with gold ores at Offenbánya and Nagyág in Transylvania; Kalgoorlie, West Australia; Cripple Creek, Colorado.

**Name.** Derived from Transylvania, where it was first found.

**Use.** An ore of gold.

### Calaverite.

**Composition.** Gold telluride,  $\text{AuTe}_2$  = Tellurium 55.97, gold 44.03. Silver usually present isomorphous with the gold, to a small extent.

**Crystallization.** Monoclinic. Crystals usually developed parallel to the ortho-axis and the faces of the orthodome zone deeply striated. Terminated at the ends of the ortho-axis with a large number of faces. Crystallization complicated. Twinning frequent.

**Structure.** Usually granular. Distinct crystals rare.

**Physical Properties.** H. = 2.5. G. = 9.35. Metallic luster. Silver-white color, sometimes with yellowish tarnish. Streak gray.

**Tests.** Easily fusible (1). If a little of the powdered mineral is heated in concentrated sulphuric acid the solution assumes a deep red color (tellurium). When decomposed by nitric acid leaves a rusty-colored, spongy mass of gold, and on addition of hydrochloric acid gives only a slight precipitate of silver chloride. Distinguished from sylvanite by small amount of silver present and by its lack of a cleavage.

**Occurrence.** Found with sylvanite and other tellurides in the Cripple Creek District, Colorado, and at Kalgoorlie, West Australia.

**Name.** Found originally at the Stanislaus Mine, Calaveras County, California, whence name.

**Use.** An ore of gold.

Other rare tellurides belonging to this group are, *krennerite*,  $\text{AuTe}_2$ , and *nagyagite*, a sulpho-telluride of lead and gold.

## SULPHARSENITES, ETC.

The minerals in this division are considered to be salts of the sulpho-acids of trivalent arsenic, antimony and bismuth. Various types of these acids are found, such as  $\text{H}_3\text{AsS}_3$ ,  $\text{H}_2\text{AsS}_2$ ,  $\text{H}_4\text{As}_2\text{S}_5$ , etc. A subdivision includes the sulpharsenates, etc., being chiefly salts of the acid  $\text{H}_3\text{AsS}_4$ . The metals observed are most commonly copper, silver and lead; also at times iron, zinc and mercury.

### Jamesonite. Feather Ore.

**Composition.** Sulphantimonite of lead,  $\text{Pb}_3\text{Sb}_2\text{S}_6$  or  $3\text{PbS} \cdot \text{Sb}_2\text{S}_3$  = Sulphur 19.7, antimony 29.5, lead 50.8.

**Crystallization.** Orthorhombic.

**Structure.** Usually in acicular crystals or in capillary forms. Also fibrous to compact massive.

**Physical Properties.** Basal cleavage. Brittle. H. = 2-3. G. = 5.5-6. Metallic luster. Color and streak steel-gray to grayish black.

**Tests.** Fusible at 1. On charcoal gives a combination coating of lead and antimony oxides. Roasted in O. T. gives sublimate of antimony oxides. Heated on charcoal with a mixture of potassium iodide and sulphur gives a chrome-yellow coating of lead iodide. Recognized by above tests and characteristic fibrous structure. Difficult to distinguish from similar species (see below).

**Occurrence.** Found in Cornwall, England, and from various localities in Hungary, Saxony, etc.; from Bolivia. Noted in the United States from Sevier County, Arkansas, and the Montezuma Mine, Nevada.

**Similar Species.** There are a number of minerals similar to jamesonite in composition and general physical characteristics whose relations to each other in many cases are not thoroughly understood. These include such minerals as *zinkenite*,  $\text{PbS.Sb}_2\text{S}_3$ ; *plagionite*,  $5\text{PbS.4Sb}_2\text{S}_3$ ; *warrenite*,  $3\text{PbS.2Sb}_2\text{S}_3$ ; *boulangerite*,  $3\text{PbS.Sb}_2\text{S}_3$ ; *meneghinite*,  $4\text{PbS.Sb}_2\text{S}_3$ ; *geocronite*,  $5\text{PbS.Sb}_2\text{S}_3$ .

### Bournonite.

**Composition.** Sulphantimonite of lead and copper ( $\text{Pb,Cu}_2$ ) $_3\text{Sb}_2\text{S}_6$  or  $3(\text{Pb,Cu}_2)\text{S.Sb}_2\text{S}_3$ . The relative amounts of the lead and copper present vary, but in general correspond closely to the ratio,  $\text{Pb} : \text{Cu}_2 = 2 : 1$ .

**Crystallization.** Orthorhombic. Crystals usually short prismatic to tabular. Sometimes quite complex with many prism,

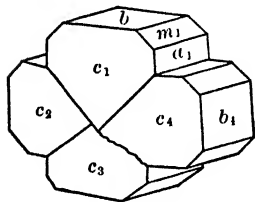


Fig. 236.

pyramid and dome faces. Frequently twinned, giving tabular crystals with recurring reëntrant angles in the prism zone (Fig. 236), whence the common name of *cogwheel ore*.

**Structure.** Massive; granular to compact; in crystals.

**Physical Properties.** H. = 2.5–3. G. = 5.7–5.9. Metallic luster. Color and streak steel-gray to black.

**Tests.** Fusible at 1. B. B. on charcoal gives a combination coating of antimony and lead oxides. Roasted in O. T. gives sublimes of antimony oxides. Heated on charcoal with a mixture of potassium iodide and sulphur gives a chrome-yellow coating of lead iodide. Decomposed with nitric acid, solution turns blue with excess of ammonia (copper). Recognized either by characteristic crystals or above tests.

**Occurrence.** A rare mineral. Found at Neudorf and other localities in the Harz Mountains; Kapnik in Hungary; Liskeard in Cornwall, etc. Has been found, also, in various places in the United States, but not in notable amount or quality.

**Pyrargyrite.** Dark Ruby Silver.

**Composition.** Sulphantimonite of silver,  $\text{Ag}_3\text{SbS}_3$  or  $3\text{Ag}_2\text{S.Sb}_2\text{S}_3 =$  Sulphur 17.8, antimony 22.3, silver 59.8. Sometimes contains a small amount of arsenic. Compare proustite.

**Crystallization.** Hexagonal-rhombohedral; hemimorphic. Crystals prismatic with rhombohedral and scalenohedral terminations. Usually distorted and often with complex development. Frequently twinned.

**Structure.** In crystals or massive; compact; in disseminated grains.

**Physical Properties.** Rhombohedral cleavage.  $H. = 2.5$ .  $G. = 5.85$ . Luster adamantine. Color usually dark red to black, in thin splinters deep ruby-red. Indian-red streak.

**Tests.** Fusible at 1. On charcoal gives dense white coating of antimony trioxide. After prolonged heating, coating becomes tinged with a reddish color near assay due to a small amount of volatilized silver. Odor of sulphur dioxide and coatings of antimony oxides when heated in O. T. Decomposed by nitric acid and solution with hydrochloric acid gives white precipitate of silver chloride. Characterized chiefly by its dark red color and streak.

**Occurrence.** A rare silver mineral associated with proustite, argentite, galena, calcite, etc. Found in the silver mines at Andreasberg, Harz Mountains; at Freiberg, Saxony; Příbram, Bohemia; in Hungary; Transylvania; Norway; in Guanajuato, Mexico; at Chañarcillo, Chile. Found in various silver veins in the San Juan Mountains and elsewhere in Colorado; in the silver districts of Nevada, New Mexico, etc.

**Name.** Derived from two Greek words meaning *fire-silver*.

**Use.** An ore of silver.

**Proustite.** Light Ruby Silver.

**Composition.** Sulpharsenite of silver,  $\text{Ag}_3\text{AsS}_3$  or  $3\text{Ag}_2\text{S.As}_2\text{S}_3 =$  Sulphur 19.4, arsenic 15.2, silver 65.4. May contain a small amount of antimony. Compare pyrargyrite.

**Crystallization.** Hexagonal-rhombohedral; hemimorphic. Crystals commonly with prominent steep rhombohedrons and scalenohedrons. Often distorted and frequently complex in development.

**Structure.** Commonly massive, compact, in disseminated grains.

**Physical Properties.** Rhombohedral cleavage.  $H. = 2-2.5$ .  $G. = 5.55$ . Adamantine luster. Color ruby-red. Transparent to translucent. Red streak. High index of refraction.

**Tests.** Fusible at 1. Heated on charcoal gives volatile sublimate of arsenious oxide with characteristic garlic odor. In O.T. gives odor of sulphur dioxide and volatile crystalline sublimate of arsenious oxide. In C. T. gives abundant sublimate of arsenic sulphide, reddish black when hot, reddish yellow when cold. With sodium carbonate on charcoal gives a globule of silver. Characterized chiefly by its ruby-red color and streak and its brilliant luster.

**Occurrence.** A rare mineral, occurring in silver veins associated with various other sulpharsenites and sulphantimonites. Found in the silver mines of Saxony; Bohemia; at Chañarcillo, Chile, in fine crystals; common in the silver mines of Peru and Mexico. Found in Colorado in the silver mines of the San Juan Mountains and elsewhere; in various silver districts in Nevada, etc.

**Use.** An ore of silver.

**Tetrahedrite-Tennantite.** Gray Copper. Fahlore.

**Composition.** *Tetrahedrite*,  $Cu_9Sb_2S_7$  or  $4Cu_2S.Sb_2S_3 =$  Sulphur 23.1, antimony 24.8, copper 52.1. *Tennantite*,  $Cu_8As_2S_7$  or  $4Cu_2S.As_2S_3 =$  Sulphur 25.5, arsenic 17.0, copper 57.5. Antimony and arsenic are usually both present and the two species graduate into each other, so that no sharp line can be drawn between them. The copper is often replaced in varying amounts by iron, zinc, silver, mercury, lead, etc.

**Crystallization.** Isometric; tetrahedral. Habit tetrahedral. Tetrahedron (Fig. 237), tristetrahedron, dodecahedron and cube the common forms.

**Structure.** Frequently in crystals. Also massive, coarse or fine granular.

**Physical Properties.** H. = 3-4. G. = 4.7-5. Metallic luster, often splendent. Color grayish black to black. Streak black.

**Tests.** Easily fusible at 1.5. On charcoal or in O. T. gives tests for antimony or arsenic, or both. After roasting, and moistening with hydrochloric acid, gives azure-blue flame. Decomposed by nitric acid with separation of sulphur and antimony trioxide; solution made alkaline with ammonia turns blue. The two species are only to be told apart by testing for the presence of antimony and arsenic, and as both are often present in the same specimen a quantitative analysis may be necessary in order to positively determine to which end of the series it belongs. Recognized by its tetrahedral crystals, or when massive by its fine-grained structure and by its gray color.

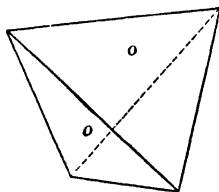


Fig. 237.

**Occurrence.** Found in metallic veins usually associated with chalcopyrite, pyrite, sphalerite, galena and various other silver, lead and copper ores. May carry sufficient silver to become an important ore of that metal (the highly argentiferous variety is known as *freibergite*). Is found in the United States in various silver and copper mines in Colorado, Nevada, Arizona, etc. Found in Cornwall, England; the Harz Mountains, Germany; Freiberg, Saxony; Příbram in Bohemia; various places in Hungary; in the silver mines of Mexico, Chile, Peru and Bolivia.

**Use.** An ore of silver and copper.

### Stephanite.

**Composition.** Sulphantimonite of silver,  $\text{Ag}_5\text{SbS}_4$  or  $5\text{Ag}_2\text{S}\cdot\text{Sb}_2\text{S}_3$  = Sulphur 16.3, antimony 15.2, silver 68.5.

**Crystallization.** Orthorhombic. Crystals usually short prismatic and tabular parallel to the base. Edges of crystals truncated by various pyramids. Prism zone usually shows the four prism faces and the two of the brachypinacoid, all making

nearly  $60^\circ$  angles with each other and so giving the crystals a hexagonal aspect. Also twinned in pseudohexagonal crystals. Crystals usually small.

**Structure.** Massive, in disseminated grains; crystallized.

**Physical Properties.** H. = 2–2.5. G. = 6.2–6.3. Metallic luster. Color and streak iron-black.

**Tests.** Fusible at 1. B. B. on charcoal gives dense white sublimate of antimony trioxide and odor of sulphur dioxide. Decomposed by nitric acid, and if after filtering a little hydrochloric acid is added to filtrate, it gives a white precipitate of silver chloride. Recognized by its stout hexagonal crystals and the above tests.

**Occurrence.** A rare silver mineral. Found associated with other sulphantimonites of silver, etc. Occurs at Freiberg and other localities in Saxony; in Bohemia and Hungary; at Guanajuato and Arizpe, Sonora, etc., Mexico; in Peru and Chile. In the United States was an abundant ore at the Comstock Lode and other silver deposits in Nevada.

**Use.** An ore of silver.

### Polybasite.

**Composition.** Sulphantimonite of silver,  $\text{Ag}_9\text{SbS}_6$  or  $9\text{Ag}_2\text{S}\cdot\text{Sb}_2\text{S}_3$  = Sulphur 15, antimony 9.4, silver 75.6. Copper replaces a part of the silver and arsenic replaces the antimony.

**Crystallization.** Monoclinic. Crystals are pseudorhomboidal in symmetry, occurring in short hexagonal prisms, often thin tabular. Basal planes show triangular markings.

**Structure.** In crystals. Granular.

**Physical Properties.** H. = 2–3. G. = 6–6.2. Metallic luster. Color steel-gray to iron-black. Streak black.

**Tests.** Fusible at 1. B. B. on charcoal gives dense white coating of antimony trioxide with odor of sulphur dioxide. After decomposition by nitric acid, the filtrate with hydrochloric acid gives white precipitate of silver chloride. To be distinguished from other similar species chiefly by its crystals.

**Occurrence.** A comparatively rare silver mineral, associated with other sulphantimonides of silver and with silver ores in general.

Found in the silver mines of Mexico, Chile, Saxony and Bohemia. Found in the United States at the Comstock Lode, Nevada; near Ouray, Colorado, etc.

**Name.** Name is in allusion to the *many bases* contained in the mineral.

**Use.** An ore of silver.

### Enargite.

**Composition.** Sulpharsenate of copper,  $\text{Cu}_3\text{As}_4$  or  $3\text{Cu}_2\text{S} \cdot \text{As}_2\text{S}_5 =$  Sulphur 32.6, arsenic 19.1, copper 48.3. Antimony may replace in part the arsenic, and the species graduate toward *famatinite* ( $3\text{Cu}_2\text{S} \cdot \text{Sb}_2\text{S}_5$ ).

**Crystallization.** Orthorhombic. Prismatic crystals with prism zone vertically striated.

**Structure.** Columnar, bladed, massive.

**Physical Properties.** Perfect prismatic cleavage. H. = 3. G. = 4.43–4.45. Metallic luster. Color and streak grayish black to iron-black.

**Tests.** Easily fusible (1). B. B. on charcoal gives volatile white sublimate of arsenious oxide and characteristic garlic odor. In O. T. gives white crystalline sublimate of arsenious oxide and odor of sulphur dioxide. Roasted on charcoal, then moistened with hydrochloric acid and again ignited, gives azure-blue flame. Characterized by its color, its cleavage and the above tests.

**Occurrence.** A comparatively rare mineral, found associated with other copper minerals, as chalcocite, bornite, tennantite, etc. Found abundantly at Morococha, Peru; also in the United States of Colombia; Argentine Republic; island of Luzon, Philippines. Found in considerable quantity with the copper ores at Butte, Montana. Occurs in the silver mines of the San Juan Mountains, Colorado.

**Use.** An ore of copper. Arsenic oxide also obtained from it at Butte, Mont.

## CHLORIDES, ETC.

The chlorides with the related bromides, iodides and fluorides are grouped into the following divisions: (1) *Anhydrous Chlorides*, etc.; (2) *Oxychlorides*, etc.; (3) *Hydrous Chlorides*, etc.



## 1. ANHYDROUS CHLORIDES, ETC.

**HALITE GROUP.**

The *Halite Group* includes the isometric minerals *halite*, NaCl; *sylvite*, KCl; *cerargyrite*, AgCl; *embolite*, Ag(Cl,Br); *bromyrite*, AgBr.

**Halite. Common Salt.**

**Composition.** Sodium chloride, NaCl = Chlorine 60.6, sodium 39.4. Commonly contains impurities, such as calcium sulphate and calcium and magnesium chlorides.

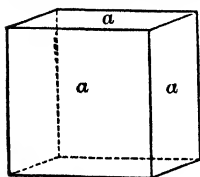


Fig. 238.

**Crystallization.** Isometric. Habit cubic (Fig. 238). Other forms very rare.

**Structure.** In crystals or granular crystalline, in masses showing cubical cleavage, known as *rock salt*. Also massive, granular to compact.

**Physical Properties.** Perfect cubic cleavage. H. = 2.5. G. = 2.1–2.6. Transparent to translucent. Colorless or white, or when impure may have shades of yellow, red, blue, purple. Readily soluble in water. Salty taste. Diathermous.

**Tests.** Easily fusible at 1.5, giving strong yellow flame of sodium. After intense ignition B. B. residue gives alkaline reaction to moistened test paper. Readily soluble in water; solution made acid with nitric acid gives with silver nitrate a heavy white precipitate of silver chloride. Salty taste. Distinguished from sylvite (KCl) by its yellow flame color and by the latter having a somewhat more bitter taste.

**Occurrence.** A common and widely disseminated mineral, occurring often in extensive beds and irregular masses, interstratified in rocks of all ages, in such a manner as to form a true rock mass. Associated with gypsum, sylvite, anhydrite, calcite, clay, sand, etc. Occurs also dissolved in the waters of salt springs, salt seas and the ocean.

The deposits of salt have been formed by the gradual evaporation and ultimate drying up of inclosed bodies of salt water. The salt

beds formed in this way have subsequently been covered by other sedimentary deposits and gradually buried beneath the rock strata formed from them. The salt beds range from a few feet up to one hundred in thickness and have been found at depths of two thousand feet and more from the surface. The history of the formation of these salt beds is as follows: River waters contain a small but appreciable amount of various soluble salts. When these waters are collected in a sea which has no outlet, or in other words, a sea where the evaporation equals or exceeds the amount of water flowing in, there is a gradual concentration in the sea of the salts brought into it by the rivers. The sea water, therefore, in time becomes heavily charged with soluble salts, particularly sodium chloride. When the points of concentration of the various salts held in solution are reached, they will be deposited progressively upon the sea bottom, commencing with the most insoluble. This process may continue for a long period of time and ultimately a thick layer of salt and other soluble minerals be formed on the bottom. The process may be interrupted by seasons of flood in which the sea water becomes freshened beyond the concentration point. Silt materials may be brought in at such times and deposited upon the bottom and so form beds of clay alternating with those of salt. Such deposits of salt have been formed whenever favorable conditions occurred, and are now to be found buried in rock strata of all ages. At the present time similar deposits are being formed in the Great Salt Lake and the Dead Sea.

In the United States salt is produced, on a commercial scale, in some fifteen states, either from rock-salt deposits, or by evaporation of salt lake or sea waters. Beds of rock salt are found in New York State from the Outka Valley in Wyoming County east to Morrisville, Madison County, and south of this line wherever wells have been driven deep enough to reach the beds. The important producing localities are near Syracuse, Ithaca, Watkins and Ludlowville, and at various places in Wyoming, Genesee and Livingston counties. Extensive deposits of salt occur in Michigan, chiefly in Saginaw, Bay, Midland, Isabella, Detroit, Wayne, Manistee, and Mason counties. Notable deposits are also found in Ohio, Kansas, Louisiana. Salt is obtained by the evaporation of saline waters in California, Utah and Texas.

Important foreign localities for the production of salt are to be found in Austrian Poland, Hungary, Bavaria, Prussia, Spain and Great Britain.

**Use.** The chief uses of salt are for culinary and preservative purposes. It is used also in the manufacture of soda ash (sodium carbonate), which is used in glass making, soap making,

bleaching, etc., and in the preparation of sodium salts in general. Salt is used also in the extraction of gold by the chlorination process.

### Sylvite.

**Composition.** Potassium chloride,  $KCl =$  Chlorine 47.6, potassium 52.4. Sometimes contains sodium chloride.

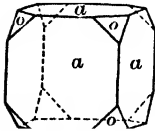


Fig. 239.

**Crystallization.** Isometric. Cube and octahedron frequently in combination (Fig. 239).

**Structure.** Usually in granular crystalline masses showing cubic cleavage; compact.

**Physical Properties.** Perfect cubical cleavage.  $H. = 2.$   $G. = 1.9.$  Transparent when pure. Colorless or white; also shades of blue, yellow or red from impurities. Readily soluble in water. Salty taste but more bitter than in the case of halite.

**Tests.** Easily fusible at 1.5, giving violet flame of potassium, which may be obscured by yellow flame due to sodium present. The yellow sodium flame may be filtered out by use of a blue glass, and the violet of the potassium rendered visible. After intense ignition, residue gives alkaline reaction on moistened test paper. Readily soluble in water; solution made acid with nitric acid gives with silver nitrate a heavy precipitate of silver chloride. Distinguished from halite by the violet flame color of potassium and its slightly bitter taste.

**Occurrence.** Has the same origin, mode of occurrence and associations as halite (which see) but is much more rare. Found in some quantity and at times well crystallized in connection with the salt deposits at Stassfurt, Prussia.

**Name.** Potassium chloride is the *sal digestivus Sylvii* of early chemistry, whence the name for the species.

**Use.** One source of potassium compounds which are extensively used as fertilizers. Other potassium minerals that are found in Germany in sufficient amount to make them valuable as sources of potassium salts are, *carnallite*,  $KCl.MgCl_2.6H_2O$  (see page 173); *kainite*,  $MgSO_4.KCl.3H_2O$ ; *polyhalite*,  $K_2SO_4.MgSO_4.2CaSO_4.2H_2O$ .

### Cerargyrite. Horn Silver.

**Composition.** Silver chloride,  $\text{AgCl}$  = Silver 75.3, chlorine 24.7. Some varieties contain mercury.

**Crystallization.** Isometric. Habit cubic.

**Structure.** Usually massive, resembling wax; often in plates and crusts.

**Physical Properties.**  $H. = 2-3$ .  $G. = 5.8-6$ . Sectile, can be cut with a knife like horn. Transparent to translucent. Color pearl-gray to colorless. Rapidly darkens to violet-brown on exposure to light.

**Tests.** Very easily fusible at 1. B. B. on charcoal gives a globule of silver. Insoluble in nitric acid, but slowly soluble in ammonium hydroxide. When heated with galena in C. T. gives a white sublimate of lead chloride. Distinguished chiefly by its horny or waxlike appearance and its sectility.

**Occurrence.** Cerargyrite is an important secondary ore of silver. It is only to be found in the upper, enriched zone of silver veins where descending waters containing small amounts of chlorine have acted upon the oxidized products of the primary silver ores of the vein. Found associated with other silver ores, galena, etc.; with native silver, cerussite and secondary minerals in general. Was an important mineral in the mines at Leadville and elsewhere in Colorado, at the Comstock Lode in Nevada, in crystals at the Poorman's Lode in Idaho. Notable amounts have been found in Peru, Chile and Mexico, and in the silver mines of Saxony.

**Name.** Cerargyrite is derived from two Greek words meaning *horn* and *silver*, in allusion to its hornlike appearance and characteristics.

**Use.** Silver ore.

### Embolite.

**Composition,  $\text{Ag}(\text{Cl},\text{Br})$ .** Crystallization, structure and physical properties, like those of cerargyrite (which see). Tests, same as for cerargyrite, except that, when heated in C. T. with galena, it gives a lead bromide sublimate, which is yellow when hot and white when cold. Occurrence, same as for cerargyrite, with which it is usually found, but much rarer.

Other similar silver compounds which are still rarer in their occurrence are, *bromyrite*,  $\text{AgBr}$ ; *iodobromite*,  $\text{Ag}(\text{Cl}, \text{Br}, \text{I})$ ; *iodyrite*,  $\text{AgI}$ .

### Fluorite. Fluor Spar.

**Composition.** Calcium fluoride,  $\text{CaF}_2$  = Fluorine 48.9, calcium 51.1.

**Crystallization.** Isometric. Habit cubic (Fig. 240) often in twinned cubes (Figs. 241 and 242). Other forms are rare, but examples of all the forms of the Normal Class have been observed; the tetrahedron (Fig. 243) and hexoctahedron (Fig. 244) are characteristic.

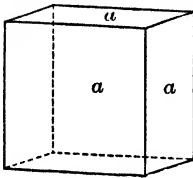


Fig. 240.

**Structure.** Usually crystallized. Also massive; coarse or fine granular, columnar.

**Physical Properties.** Perfect octahedral cleavage.  $H. = 4$ .  $G. = 3.18$ . Transparent to subtranslucent. Vitreous luster. Color widely various; most commonly light green, yellow, bluish green or purple, also

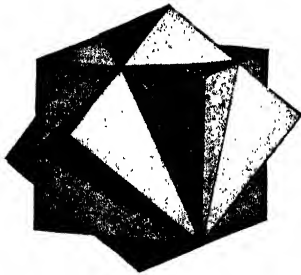


Fig. 241.

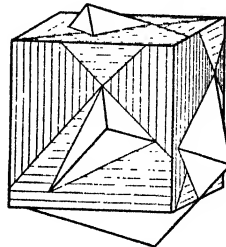


Fig. 242.

colorless, white, rose, blue, brown. A single crystal may show varying bands of color; the massive variety is also often banded in color. The bluish green varieties often show fluorescence (green by transmitted light, blue by reflected light). Some varieties phosphoresce when heated, giving off variously colored

lights which are independent of the actual color of the specimen. The variety affording a green light is known as *chlorophane*.

**Tests.** Fusible at 3, and residue gives alkaline reaction to moistened test paper. Gives a reddish flame (calcium). When mixed with potassium bisulphate and heated in C. T., hydro-

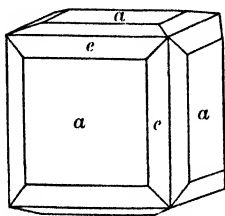


Fig. 243.

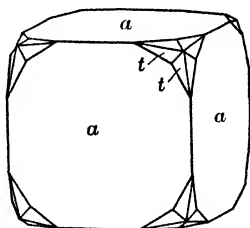


Fig. 244.

fluoric acid is evolved which etches the glass, and a white deposit of silica forms upon the walls of the tube. Determined usually by its cubic crystals and octahedral cleavage, also vitreous luster and usually fine coloring, and by the fact that it can be scratched with a knife.

**Occurrence.** A common and widely distributed mineral. Usually found either in veins in which it is the chief mineral or as a gangue mineral with metallic ores, especially those of lead and tin. Common in dolomites and limestone and has been observed also as a minor accessory mineral in various igneous rocks. Associated with many different minerals, as calcite, dolomite, gypsum, celestite, barite, quartz, galena, sphalerite, cassiterite, topaz, tourmaline, apatite.

The more important deposits in the United States are in southern Illinois near Rosiclare, and in the adjacent part of Kentucky. The fluorite occurs here in limestone, in fissure veins which at times become 40 feet in width. Fluorite is found in quantity in England, chiefly from Cumberland, Derbyshire and Durham; the first two localities being famous for their magnificent crystallized specimens. Found commonly in the mines of Saxony.

**Use.** Fluorite is used mainly as a flux in the making of steel, in the manufacture of opalescent glass, in enameling cooking utensils, for the preparation of hydrofluoric acid, and occasionally as an ornamental material in the form of vases, dishes, etc.

**Cryolite.**

**Composition.** A fluoride of sodium and aluminium,  $\text{Na}_3\text{AlF}_6$ , = Fluorine 54.4, aluminium 12.8, sodium 32.8.

**Crystallization.** Monoclinic. Prominent forms are prism and base. Crystals rare, usually cubic in aspect, and in parallel groupings growing out of massive material.

**Structure.** Usually massive.

**Physical Properties.** H. = 2.5. G. = 2.95-3. Vitreous to greasy luster. Colorless to snow-white. Transparent to translucent. A low index of refraction, giving the mineral an appearance of watery snow or of paraffin. Powdered mineral almost disappears when immersed in water.

**Tests.** Easily fusible (1.5), with strong yellow sodium flame. After intense ignition, residue gives alkaline reaction on moistened test paper. Fused in C. T. with potassium bisulphate, evolves hydrofluoric acid and gives a volatile white ring of silica. Characterized by its massive structure, white color and peculiar luster.

**Occurrence.** Occurs in a large vein lying in granite at Arksukfiord on the west coast of Greenland. The following minerals are found in small amounts associated with the cryolite: quartz, siderite, galena, sphalerite, pyrite, chalcopyrite, wolframite, fluorite, cassiterite, molybdenite, arsenopyrite, columbite. Found also in very small amounts at Miask, Ilmen Mountains, Siberia, and at foot of Pike's Peak, Colorado.

**Name.** Name is derived from two Greek words meaning *frost* and *stone*, in allusion to its icy appearance.

**Use.** It is used for the manufacture of sodium salts, of certain kinds of glass and porcelain, and as a flux in the electrolytic process for the production of aluminium.

**2. OXYCHLORIDES, ETC.****Atacamite.**

**Composition.** Copper chloride with copper hydroxide,  $\text{CuCl}_2 \cdot 3\text{Cu}(\text{OH})_2$ , = Chlorine 16.6, copper 14.9, cupric oxide 55.8, water 12.7.

**Crystallization.** Orthorhombic. Commonly slender prismatic in habit, with vertical striations. Also tabular parallel to brachypinacoid.

**Structure.** In confused crystalline aggregates; fibrous; granular. As sand.

**Physical Properties.** Cleavage perfect parallel to brachypinacoid.  $H. = 3-3.5$ .  $G. = 3.75-3.77$ . Adamantine to vitreous luster. Color various shades of green. Transparent to translucent.

**Tests.** Fusible (3-4), giving an azure-blue flame of copper chloride. B. B. on charcoal with sodium carbonate gives globule of copper. Nitric acid solution with silver nitrate gives white precipitate of silver chloride; with ammonia in excess gives blue solution. Gives acid water in C. T. Characterized by its green color and granular crystalline structure. Distinguished from malachite by its lack of effervescence in acids.

**Occurrence.** A comparatively rare copper mineral. Found originally as sand in the province of Atacama in Chile. Occurs with other copper ores in various localities in Chile and Bolivia. Found in some of the copper districts of Australia; occurs sparingly in the copper districts of Arizona.

**Use.** A minor ore of copper.

### 3. HYDROUS CHLORIDES, ETC

#### Carnallite.

A hydrous chloride of potassium and magnesium,  $KCl.MgCl_2.6H_2O$ . Orthorhombic. Massive, granular. Crystals rare. Luster nonmetallic, shining, greasy. Color milk-white, often reddish, due to included hematite. Transparent to translucent.  $H. = 1$ .  $G. = 1.6$ . Bitter taste. Deliquescent. Fusible at 1-1.5 with violet flame. After ignition gives an alkaline reaction on moistened test paper. Easily and completely soluble in water; on addition of nitric acid and silver nitrate gives a white precipitate of silver chloride. Acid solution neutralized with ammonia and sodium phosphate added gives a white precipitate of ammonium magnesium phosphate. Found associated with halite, sylvite, etc., in the salt deposits at Stassfurt, Prussia. Used as a source of potassium compounds.



## OXIDES.

The oxides are subdivided into three sections: (1) *Oxides of Silicon*; (2) *Oxides of the Semimetals*; (3) *Oxides of the Metals*.

## 1. OXIDES OF SILICON.

## Quartz.

**Composition.** Silicon dioxide,  $\text{SiO}_2$  = Oxygen 53.3, silicon 46.7. Often with various impurities.

**Crystallization.** Hexagonal-rhombohedral; trapezohedral. Crystals commonly prismatic, with prism faces horizontally striated. Terminated usually by a combination of a positive and negative rhombohedron, which often are so equally developed as to give the effect of a hexagonal pyramid (Fig. 245).

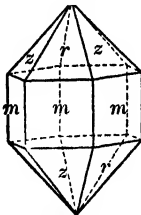


Fig. 245.

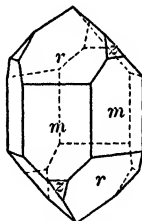


Fig. 246.

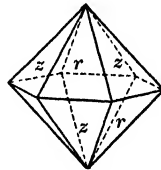


Fig. 247.

Sometimes one rhombohedron predominates or occurs alone (Fig. 246). At times the prism faces are wanting, and the combination of the two rhombohedrons gives what appears to be a doubly terminated hexagonal pyramid (known as a quartzoid) (Fig. 247). Crystals at times very much distorted, when the recognition of the prism faces by their horizontal striations will assist in the orientation of the crystal. The trapezohedral faces are to be occasionally observed as small truncations between a prism face and that of an adjoining rhombohedron either to the right or left, forming what are known as right- or left-handed crystals (Figs. 248 and 249). Crystals are often elongated in tapering and sharply pointed forms, due to an oscillatory combination between the faces of the different rhombohedrons and

those of the prism (A, Pl. VI). Sometimes twisted and bent. Crystals frequently twinned. The twins at times are so inti-

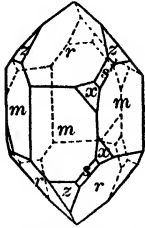


Fig. 248. Right-handed Crystal.

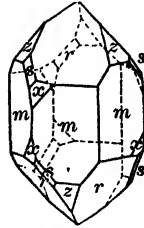


Fig. 249. Left-handed Crystal.

mately intergrown that they can only be determined by the irregular position of the trapezohedral faces, by etching the crystal or by the pyroelectric phenomena that they show.

**Structure.** Commonly in crystals. From large crystals usually attached at one end, to finely crystalline coatings, forming "drusy" surfaces. Also common in massive forms of great variety. From coarse- to fine-grained crystalline to flintlike or cryptocrystalline varieties. Sometimes in concretionary forms, mammillary, etc. As sand.

**Physical Properties.** H. = 7. G. = 2.65-2.66. Vitreous luster, sometimes greasy, splendent to nearly dull. Color widely various. Usually colorless or white, but frequently colored by various impurities, yellow, red, pink, amethyst, green, blue, brown, black. Transparent to opaque. Conchoidal fracture.

**Tests.** Infusible. Insoluble. Yields a clear glass when the finely powdered mineral is fused with an equal volume of sodium carbonate. Usually told by its glassy luster, conchoidal fracture, hardness (7) and crystal form.

**Varieties.** A great many different forms of quartz exist to which varietal names have been given. The more important varieties with a brief description of each follow.

#### A. CRYSTALLINE VARIETIES.

1. *Rock Crystal.* Colorless quartz, commonly in distinct crystals.

2. *Amethyst*. Quartz colored purple or violet, often crystallized.

3. *Rose Quartz*. Usually massive, color a rose-red or pink. Often fades somewhat on exposure to light.

4. *Smoky Quartz; Cairngorm Stone*. Crystallized quartz of a smoky yellow to brown and almost black color. Named cairngorm from the locality of Cairngorm in Scotland.

5. *Milky Quartz*. Milky white in color and nearly opaque. Sometimes with greasy luster.

6. *Cat's-eye*. A stone, which when cut in a round shape (*en cabochon*) exhibits an opalescent or chatoyant effect, as it is termed, is called a cat's-eye. Quartz among other minerals gives at times this effect, which is due either to fibrous inclusions or to a fibrous structure of the quartz itself. The latter is seen in the *tiger's-eye*, a yellow fibrous quartz from South Africa, which is pseudomorphic after another fibrous mineral, crocidolite.

7. *With Inclusions*. Many other minerals occur at times as inclusions in quartz. *Rutilated quartz* has fine needles of rutile penetrating it. Tourmaline and other minerals are found in quartz in the same way. *Aventurine* is quartz including brilliant scales of hematite or mica. Liquids and gases at times occur as inclusions; both liquid and gaseous carbon dioxide exist in some quartz.

## B. CRYPTOCRYSTALLINE VARIETIES.

1. *Chalcedony*. An amorphous quartz material, translucent with a waxy luster. White, yellowish brown to dark-brown in color. Often mammillary, stalactitic, etc., in structure. Deposited from aqueous solutions and found lining or filling cavities in rocks (see Fig. B, pl. III).

2. *Carnelian*. A red chalcedony.

3. *Chrysoprase*. An apple-green chalcedony.

4. *Agate*. A variegated chalcedony. The different colors usually in delicate, fine parallel bands which are commonly curved, sometimes concentric (Fig. B, pl. VI). The color is sometimes strengthened or even changed by artificial means. Some agates have the different colors arranged not in bands but

PLATE VI.



*A.* Smoky Quartz, Pike's Peak, Colorado.



*B.* Agate, Oberstein, Germany.



irregularly distributed. Moss agate is a variety in which the variation in color is due to visible impurities, often manganese oxide.

5. *Onyx*. A banded chalcedony like agate, except the bands are arranged in straight parallel lines.

6. *Flint*. Something like chalcedony but of dull, often dark color. It breaks with a prominent conchoidal fracture and gives a sharp edge. Used for various implements by early man.

7. *Jasper*. Opaque quartz, usually colored red from hematite inclusions.

**Occurrence.** Quartz is the most common of minerals. Occurs as an important constituent of the acid igneous rocks, such as granite, rhyolite, pegmatite, etc. It is a common mineral of sedimentary rocks, forming the chief mineral in sandstone. Occurs largely also in metamorphic rocks, as gneisses and schists, while it forms practically the only mineral of quartzites. Deposited often from solution and forms the most common vein and gangue mineral. In rocks it is associated chiefly with feldspar and muscovite; in veins with practically the entire range of vein minerals. Often carries gold and becomes an important ore of that metal. Occurs in large amount as sand in stream beds and upon the seashore and as a constituent of soils.

Rock crystal is found widely distributed, some of the more notable localities being: the Alps; Minas Geraes and Goyoz, Brazil; on the island of Madagascar; in Japan. The best quartz crystals from the United States are found at Hot Springs, Arkansas, and Little Falls, New York. Important occurrences of amethyst are located in the Ural Mountains and in Brazil. Found at Thunder Bay on the north shore of Lake Superior and in the United States in Oxford County, Maine; Delaware and Chester counties, Pennsylvania; Black Hills, South Dakota, etc. Smoky quartz is found in large and fine crystals in Canton Uri, Switzerland; at Pike's Peak, Colorado; Alexander County, North Carolina; at Auburn, Maine, etc. The chief source of agates at present is a district in southern Brazil and northern Uruguay. They are mostly cut at Oberstein, Germany, itself a famous agate locality. Found in Laramie County, Wyoming, and numerous other places in the United States. Massive quartz, occurring in quartz veins or with feldspar in pegmatite veins, is mined for its various commercial uses in Connecticut, New York, Maryland, Wisconsin, etc.

**Use.** Widely used in its various colored forms as ornamental material, as amethyst, rose quartz, cairngorm, cat's-eye, tiger's-

eye, aventurine, carnelian, agate, onyx, etc. Used for abrading purposes either as quartz sand or as sandpaper. Used in the manufacture of porcelain, of glass, as a wood filler, in paints, scouring soaps, etc. As sand is used in mortars and cements: As quartzite, sandstone, and in its various other rock forms as a building stone, for paving purposes, etc. Large amounts of quartz sand are used as an acid flux in certain smelting operations.

### Opal.

**Composition.** Silicon dioxide, like quartz, with a varying amount of water,  $\text{SiO}_2 \cdot n\text{H}_2\text{O}$ .

**Crystallization.** Amorphous.

**Structure.** Massive; often botryoidal, stalactitic, etc.

**Physical Properties.** H. = 5.5-6.5. G. = 1.9-2.3. Vitreous luster; often somewhat resinous. Colorless, white, pale shades of yellow, red, brown, green, gray and blue. With darker colors, which are due to various impurities. Often has a milky or "opalescent" effect and sometimes shows a fine play of colors. Transparent to opaque.

**Tests.** Infusible. Insoluble. Reacts like quartz. Gives a little water upon intense ignition in C. T.

**Varieties.** *Precious Opal.* White, milky blue, yellow. Sometimes dark, as in so-called *black opal*. Translucent, with an internal play of colors. This phenomenon is said to be due to thin curved laminæ which refract the light differently from the mass of the material, and so serve to break it up into the various prismatic colors. *Fire opal* is a variety with intense orange to red reflections.

*Common Opal.* Milk-white, yellow, green, red, etc., without internal reflections.

*Hyalite.* Clear and colorless opal with a globular or botryoidal structure.

*Geyserite.* Opal deposited by hot springs and geysers. Found about the geysers in the Yellowstone Park.

*Wood Opal.* Fossil wood with opal as the petrifying material.

*Tripolite, or Infusorial earth.* Fine-grained deposits, resem-

bling chalk in appearance. Formed by the accumulation of the siliceous shells of small sea organisms.

**Occurrence.** Opal is found lining and filling cavities in igneous and sedimentary rocks, where it has evidently been deposited through the agency of hot waters. In its ordinary variety it is of widespread occurrence. Precious opals are found at Czernowitza, Hungary; in Queretaro and other states in Mexico; in Honduras; and from various localities in Australia, the chief district being White Cliffs, New South Wales. Recently black opal has been found in Idaho.

**Use.** As a gem. The stones are usually cut in round shapes, *en cabochon*, and gems of one-carat size are valued up to \$20. Stones of large size and exceptional quality are very highly prized.

## 2. OXIDES OF THE SEMIMETALS.

The minerals of this division are all rare in occurrence. Some of the more important species are, *arsenolite*,  $As_2O_3$ ; *senarmonite*,  $Sb_2O_3$ ; *valentinite*,  $Sb_2O_3$ ; *tellurite*,  $TeO_2$ ; *tungstite*,  $WO_3$ ; *cervantite*,  $Sb_2O_4$ .

## 3. OXIDES OF THE METALS.

The oxides of the metals are grouped into two main divisions: A. *Anhydrous Oxides*; B. *Hydrous Oxides*. Further, the Anhydrous Oxides are further subdivided into: (1) *Protoxides*; (2) *Sesquioxides*; (3) *Intermediate Oxides*; (4) *Dioxides*.

### A. ANHYDROUS OXIDES.

#### 1. PROTOXIDES.

**Cuprite.** Ruby Copper. Red Copper Ore.

**Composition.** Cuprous oxide,  $Cu_2O$  = Oxygen 11.2, copper 88.8.

**Crystallization.** Isometric. Common forms are cube, octahedron and dodecahedron, frequently in combination (Fig. 250). Sometimes in much elongated cubic crystals, capillary in size; known as "plush copper" or *chalcotrichite*.

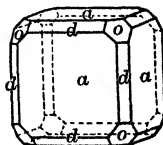


Fig. 250.



**Structure.** Usually massive, more rarely in crystals or capillary forms.

**Physical Properties.** H. = 3.5-4. G. = 6. Luster adamantine in clear crystallized varieties to submetallic and earthy in massive varieties. Color red of various shades. Ruby-red in transparent crystals. Streak brownish red, Indian-red. High index of refraction, giving brilliant luster to transparent variety.

**Tests.** Easily fusible at 3, giving emerald-green flame, or, if moistened with hydrochloric acid and then heated, flame is azure-blue. Gives globule of copper on charcoal in R. F. When dissolved in small amount of concentrated hydrochloric acid and solution diluted with cold water gives a white precipitate of cuprous chloride (test for cuprous copper). Usually to be determined by its color and streak.

**Occurrence.** An important ore of copper of secondary origin. Found in the upper, oxidized portions of copper veins, associated with the other secondary copper minerals, native copper, malachite, azurite, chrysocolla, etc. Found in the United States in connection with the copper deposits at Bisbee, Morenci, etc., Arizona. Found in small amount with the native copper from Lake Superior. An important ore in Chile, Peru and Bolivia. Fine crystals come from Bisbee, Arizona; Cornwall, England; Chessy, France; the Urals.

**Name.** Derived from the Latin, *cuprum*, *copper*.

**Use.** Ore of copper.

### Zincite.

**Composition.** Zinc oxide,  $ZnO$  = Oxygen 19.7, zinc 80.3. Manganese protoxide often present.

**Crystallization.** Hexagonal; hemimorphic. Terminated above by faces of a steep pyramid and below with a basal plane. Sometimes shows short prism.

**Structure.** Usually massive with platy or granular structure.

**Physical Properties.** Perfect basal cleavage. H. = 4-4.5. G. = 5.5. Luster subadamantine. Color deep red to orange-yellow. Streak orange-yellow. Translucent to almost opaque.

**Tests.** Infusible. Soluble in hydrochloric acid. When the finely powdered mineral is mixed with sodium carbonate and charcoal dust and intensely heated B. B., gives a nonvolatile

coating of zinc oxide, yellow when hot, white when cold. Usually with borax bead in O. F. gives a reddish violet color (manganese). Told chiefly by its color and streak.

**Occurrence.** Found in the zinc deposits at Franklin Furnace, New Jersey, associated with franklinite and willemite, often in an intimate mixture. Sometimes embedded in pink calcite.

**Use.** An ore of zinc, particularly used for the production of zinc white (zinc oxide).

In this division also belong *water, ice*,  $H_2O$ , which is hexagonal in crystallization, and *tenorite* or *melaconite*,  $CuO$ .

## 2. SESQUIOXIDES.

### HEMATITE GROUP.

The Hematite Group includes the closely related rhombohedral minerals, *corundum*,  $Al_2O_3$ , *hematite*,  $Fe_2O_3$ , and *ilmenite*  $(Fe,Ti)_2O_3$ .

#### Corundum.

**Composition.** Aluminium oxide,  $Al_2O_3$  = Oxygen 47.1, aluminium 52.9.

**Crystallization.** Hexagonal-rhombohedral. Crystals usually prismatic in habit or tapering hexagonal pyramids (Figs. 251 and

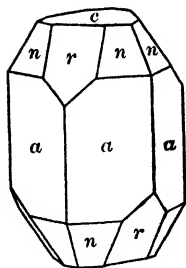


Fig. 251.

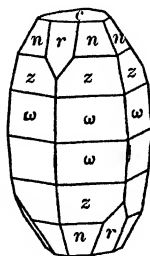


Fig. 252.



Fig. 253.

252). Often rounded into barrel shapes (Fig. 253). Frequently with deep horizontal striations. At times shows rhombohedral and pyramidal faces.

**Structure.** Rudely crystallized or massive with parting planes nearly cubic in angle; coarse or fine granular.

**Physical Properties.** Parting basal and rhombohedral, the latter giving nearly cubic blocks. H. = 9 (next to the diamond in hardness). G. = 3.95–4.1 (unusually high for a nonmetallic mineral). Adamantine to vitreous luster. Color various. Usually some shade of brown, pink or blue. May be white, gray, green, ruby-red or sapphire-blue. Transparent to opaque.

**Tests.** Infusible. Insoluble. Finely pulverized material moistened with cobalt nitrate and intensely ignited assumes a blue color (aluminium). Characterized chiefly by its great hardness, adamantine luster and high specific gravity.

**Varieties.** *Ordinary Corundum.* In translucent to opaque masses, showing often the nearly cubical parting; also granular to compact.

*Gem Corundum.* When transparent and finely colored, corundum furnishes various gem stones. The *ruby* is deep red corundum; *sapphire* is blue corundum. Stones of other colors are sometimes spoken of as yellow, violet, etc., sapphires or are designated by prefixing the word oriental to the name of some other mineral similar in color; thus, *oriental topaz* is a brownish yellow corundum; *oriental amethyst*, a reddish violet corundum, etc.

*Emery.* Is a fine-grained corundum mixed with other minerals, chiefly magnetite.

**Occurrence.** Common in the metamorphic rocks, such as crystalline limestone, mica-schist, gneiss, etc. Found also as an original constituent of certain igneous rocks, usually those deficient in silica. Found sometimes in large masses, evidently the product of magmatic differentiation. Found frequently in crystals and rolled pebbles in detrital soil and stream sands, where it has been preserved through its hardness. Associated minerals are commonly chlorite micas, chrysolite, serpentine, magnetite, spinel, cyanite, diaspore, etc.

Rubies are found chiefly in Burmah, Siam and Ceylon. The most important locality in Burmah is near Mogok, 90 miles north of Mandalay. The stones are found here chiefly in the soil resulting from the decay of a metamorphosed limestone. They have also been found *in situ* in the limestone. The rubies of Siam are found near Bangkok, on the Gulf of Siam, where they occur in a clay,

derived from the decomposition of a basalt. The rubies of Ceylon are found with other gem stones in the stream gravels. A few rubies have been found in the gravels and in connection with the larger corundum deposits of North Carolina.

Sapphires are found associated with the rubies of Siam and Ceylon. They occur also at Banskar in Cashmere, India. In the United States small sapphires of fine color are found in various localities in Montana. They were first found in the river sands east of Helena when washing them for gold. They have since been found embedded in the rock of lamprophyre dikes. The rock is quarried and after exposure to the air for a time it gradually decomposes, setting the sapphires free. Sapphires are also found over an extensive area in central Queensland, Australia.

Massive corundum is found in the United States in various localities along the eastern edge of the Appalachian Mountains from North Carolina south. It has been extensively mined in southwestern North Carolina. It occurs here in large masses lying at the edges of intruded masses of a chrysolite rock (dunite) and is thought to have been a separation from the original magma. Found as an original constituent of a nepheline syenite in the Province of Ontario, Canada. At times the corundum is so abundant as to form more than 10 per cent of the rock mass.

The impure corundum, known as emery, is found in large quantities on Cape Emiri on the island of Naxos and in various localities in Asia Minor. In the United States emery has been extensively mined at Chester, Massachusetts.

**Artificial.** Artificial corundum is now being made in the electrical furnaces at Niagara. Small synthetic rubies and sapphires, colored with minute amounts of chromium, have been successfully made. Also small grains of the natural stone have been fused together into larger masses, from which stones of two or three carats in size can be cut. These are known as reconstructed rubies and sapphires.

**Use.** As a gem stone. The ruby at times yields the most valuable of gems; a stone of the deep red known as "pigeon's blood" may bring \$1500 to \$2000 a carat. The blue sapphire is less valuable, ranging at times, however, as high as \$125 a carat. Corundum stones of various other color are valued up to \$30 a carat.

Used also as an abrasive, either ground from the pure massive material, or in its impure form as emery. Artificial corundum

and *carborundum*, which in composition is a carbide of silicon, are now manufactured on a large scale in electric furnaces and are being used in considerable amount as abrasives instead of the naturally occurring corundum.

### Hematite.

**Composition.** Iron sesquioxide,  $\text{Fe}_2\text{O}_3$  = Oxygen 30, iron 70. Sometimes with titanium and magnesium, passing into ilmenite.

**Crystallization.** Hexagonal-rhombohedral. Crystals usually thick to thin tabular. Basal planes prominent, often showing

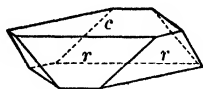


Fig. 254.

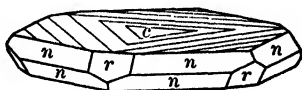


Fig. 255.

triangular markings (Figs. 254 and 255). Edges of plates sometimes beveled with rhombohedral and pyramidal forms (Fig.

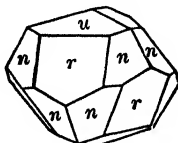


Fig. 256.



Fig. 257.

256). Thin plates at times grouped in rosette forms (iron roses) (Fig. 257). More rarely crystals are distinctly rhombohedral, often with nearly cubic angles.

**Structure.** Usually earthy or in botryoidal to reniform shapes with radiating structure. At times micaceous; crystallized.

**Physical Properties.** Rhombohedral parting with nearly cubic angles.  $H. = 5.5-6.5$ .  $G. = 4.8-5.3$ . Metallic luster. Color reddish brown to black. Streak light to dark Indian-red.

**Tests.** Infusible. Becomes strongly magnetic on heating in R. F. Slowly soluble in hydrochloric acid; solution with potassium ferrocyanide gives dark blue precipitate (test for ferric iron). Told chiefly by its characteristic Indian-red streak.

**Varieties.** *Specular Hematite.* Black hematite with brilliant splendent luster (whence name, *specular*, mirrorlike), in crystals or in foliated masses with micaceous structure.

*Columnar to Reniform Hematite, Kidney Ore.* Brownish black color, in columnar to reniform shapes with radiating structure, having fibrous appearance (A, pl. III).

*Oolitic and Fossil Ore.* Impure hematite in small globular or lenticular concretions. At times with fossils.

*Earthy Hematite.* In pulverulent, earthy form of various shades of reddish brown. Often somewhat hydrated and passing into limonite.

**Occurrence.** Hematite is a widely distributed mineral in rocks of all ages and forms the most abundant ore of iron. Occurs as an accessory mineral in feldspathic igneous rocks, such as granite. Found from microscopic scales to enormous masses in connection with metamorphic rocks. It is found in red sandstones as the cementing material that binds the quartz grains together.

The crystallized variety is found at many places, more particularly from the island of Elba; St. Gothard, Switzerland, in "iron roses"; in the lavas of Vesuvius; at Cleator Moor, Cumberland, etc. In the United States the columnar and earthy varieties are found in enormous beds that furnish a large proportion of the iron ore of the world. The chief iron-ore districts of the United States are grouped around the southern and northwestern shores of Lake Superior in Michigan, Wisconsin and Minnesota. The chief districts, which are spoken of as iron-ore ranges, are, from east to west, the Marquette Range in northern Michigan; the Menominee Range in Michigan to the southwest of the Marquette; the Penokee-Gogebic Range in northern Wisconsin; the Mesabi Range, north of Duluth in Minnesota; and the Vermillion Range farther north in Minnesota, near the Canadian boundary. The iron ore of these different ranges varies from the hard black micaceous specular variety to the soft red earthy type. All of the ore bodies lie in rock troughs which furnish impervious underlying basements to the deposits. In all of the districts, except the Mesabi, these underlying rocks are in the nature of altered igneous dikes, known as soapstone dikes. The ore bodies lie in more or less broken quartz material, frequently colored red by inclusions of hematite and called jasper. The origin of these deposits is attributed to the slow concentration of the iron content of a siliceous carbonate rock by downward moving waters. These waters were at last collected in the impervious rock troughs and there deposited their iron content by

a replacement of the quartz of the overlying rock. The ores are mined in part by underground methods, and in part, where the ore is soft and lies sufficiently near the surface, by the use of steam shovels.

Hematite is also found in the United States in various places in connection with the outcrop of rocks of the Clinton formation, from central New York south along the line of the Appalachian Mountains to central Alabama. The most important deposits of the series lie in eastern Tennessee and northern Alabama, near Birmingham. Hematite has been found at Iron Mountain and Pilot Knob in southeastern Missouri. Deposits of considerable importance are located in Wyoming, in Laramie and Carbon counties.

**Name.** Derived from a Greek word meaning *blood*, in allusion to the color of the powdered mineral.

### **Ilmenite.** Menaccanite. Titanic Iron Ore.

**Composition.** Ferrous titanate,  $\text{FeTiO}_3$  = Oxygen 31.6, titanium 31.6, iron 36.8. By the introduction of ferric oxide, the ratio between the titanium and iron often varies widely. Sometimes contains magnesium replacing the ferrous iron.

**Crystallization.** Hexagonal-rhombohedral; tri-rhombohedral. Crystals usually thick tabular with prominent basal planes and small rhombohedral truncations. Faces of the third order rhombohedron rare. Crystal angles, etc., close to those for hematite.

**Structure.** Usually massive, compact; also in grains or as sand. Often in thin plates.

**Physical Properties.** H. = 5.5-6. G. = 4.7. Metallic to submetallic luster. Color iron-black. Streak black to brownish red. Sometimes magnetic without heating.

**Tests.** Infusible. May be magnetic without heating. Fine powder fused in R. F. with sodium carbonate yields a magnetic mass. After fusion with sodium carbonate the fusion can be dissolved in hydrochloric acid, and when the solution is boiled with tin it assumes a violet color (titanium).

**Occurrence.** Occurs as beds and lenticular bodies enveloped in gneiss and other crystalline metamorphic rocks. Often associated with magnetite. Also as an accessory mineral in eruptive rocks. Found in large quantities at Krägerö and other localities in Norway;

at Miask in the Ilmen Mountains; at Bay St. Paul in Quebec, Canada. Found at Washington, Connecticut; in Orange County, New York, etc.

**Use.** Has practically no commercial use. A little of it present in a body of magnetite iron ore makes the ore so difficult to smelt as to render it of little value.

### 3. INTERMEDIATE OXIDES.

#### SPINEL GROUP.

A group of oxides which in composition are combinations of a bivalent oxide with a trivalent oxide, the general formula being,  $R''O.R_2'''O_3$ .  $R''O$  may be  $MgO$ ,  $ZnO$ ,  $FeO$ ,  $MnO$ , while  $R_2'''O_3$  may be  $Al_2O_3$ ,  $Fe_2O_3$ ,  $Mn_2O_3$ ,  $Cr_2O_3$ . The chief members of the group are as follows:

*Spinel*,  $MgO.Al_2O_3$  or  $MgAl_2O_4$ .

*Gahnite*,  $ZnO.Al_2O_3$  or  $ZnAl_2O_4$ .

*Magnetite*,  $FeO.Fe_2O_3$  or  $FeFe_2O_4$ .

*Franklinite*,  $(Fe,Mn,Zn)O.(Fe,Mn)_2O_3$

or  $(Fe,Mn,Zn)(Fe,Mn)_2O_4$ .

*Chromite*,  $(Fe,Mg)O.Cr_2O_3$  or  $(Fe,Mg)Cr_2O_4$ .

The crystalline habit of all the members of the group is octahedral. The dodecahedron is sometimes present, but other forms are rare.

#### Spinel.

**Composition.**  $MgAl_2O_4$  or  $MgO.Al_2O_3 =$  Alumina 71.8, magnesia 28.2. The magnesium may be, in part, replaced by ferrous iron or manganese and the aluminium by ferric iron and chromium.

**Crystallization.** Isometric. Habit strongly octahedral (Fig. 258). Sometimes in twinned octahedrons (spinel twins) (Fig. 259). Dodecahedron at times as small truncations (Fig. 260). Other forms rare.

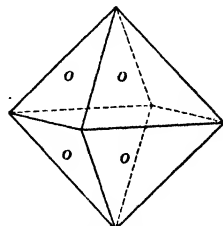


Fig. 258.



**Structure.** Usually crystallized.

**Physical Properties.** H. = 8. G. = 3.5–4.1. Nonmetallic. Vitreous luster. Color various, — red, lavender, blue, green, brown, black, sometimes almost white. Streak white. Usually translucent to opaque, at times clear and transparent.



Fig. 259.

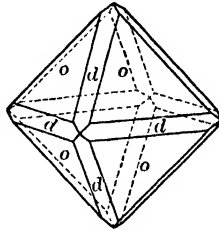


Fig. 260.

**Tests.** Infusible. The finely powdered mineral dissolves completely B. B. in the salt of phosphorus bead (proving the absence of silica). Recognized chiefly by its hardness (8), its octahedral crystals and vitreous luster.

**Varieties.** 1. *Ruby Spinel*. Nearly pure magnesian spinel. Clear red; transparent to translucent. When rose-red known as *balas ruby*; yellow or orange-red, *rubicelle*; violet-red, *almandine ruby*.

2. *Pleonaste*. Iron-magnesia spinel. Color dark green, brown to black. Opaque or nearly so.

3. *Chlorospinel*. Magnesia-iron spinel. Color grass-green owing to the presence of copper.

4. *Picotite, or Chrome Spinel*. Contains chromium and has iron replacing magnesium. Color yellowish or greenish brown. Translucent to opaque.

**Occurrence.** A common metamorphic mineral occurring embedded in granular limestone, associated with calcite, serpentine, etc. Occurs also as an accessory mineral in many basic igneous rocks, as peridotites, etc. Found frequently as rolled pebbles in stream sands, where it has been preserved on account of its hardness. The ruby spinels are found in this way, often associated with

the corundum ruby, in the sands of Ceylon, Siam, Upper Burmah, Australia and Brazil. Ordinary spinel is found in various localities in New York, New Jersey and Massachusetts.

**Use.** When transparent and finely colored is used as a gem. Usually red in color and known as the spinel ruby, balas ruby, etc. Some stones are blue in color. The largest cut stone known weighs in the neighborhood of 80 carats. The stones usually are comparatively inexpensive, although a stone of exceptionally fine color may bring as high as \$100 per carat.

### Gahnite.

A zinc spinel,  $ZnAl_2O_4$  or  $ZnO.Al_2O_3$ , with ferrous iron and manganese isomorphous with the zinc and ferric iron with the aluminium. Isometric. Commonly octahedral, also rarely showing dodecahedrons and cubes.  $H. = 7.5-8$ .  $G. = 4.55$ . Vitreous luster. Dark green color. Infusible. The fine powder fused with sodium carbonate on charcoal gives a white nonvolatile coating of zinc oxide. A rare mineral. Found in the United States in notable crystals at Franklin, New Jersey, and Rowe, Massachusetts.

### Magnetite.

**Composition.**  $Fe_3O_4$  or  $FeO.Fe_2O_3 =$  Iron sesquioxide 69.0, iron protoxide 31.0 or oxygen 27.6, iron 72.4. The ferrous iron is sometimes replaced by magnesium, rarely nickel; also at times titaniferous.

**Crystallization.** Isometric. Octahedral habit (Fig. 261), sometimes twinned octahedrons. Dodecahedron at times (Fig. 262) either alone or with octahedron (Fig. 263). Other forms rare.

**Structure.** Usually granular massive, coarse or fine; sometimes as sand; also frequently crystallized.

**Physical Properties.** Often under pressure develops octahedral parting.  $H. = 6$ .  $G. = 5.18$ . Metallic luster. Color iron-black. Streak black. Strongly magnetic; sometimes a natural magnet, known as lodestone.

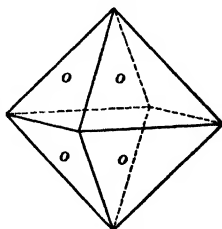


Fig. 261.

**Tests.** Infusible. Slowly soluble in HCl and solution reacts for both ferrous and ferric iron. Distinguished chiefly by its strong magnetism, its black color and streak, and its hardness (6).

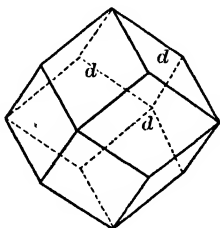


Fig. 262.

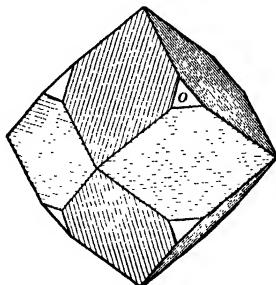


Fig. 263.

**Occurrence.** A common ore of iron. It is found as an accessory mineral in rocks of all classes and sometimes becomes their chief constituent. Most commonly associated with crystalline metamorphic rocks, also frequently in rocks that are rich in ferromagnesium minerals, such as diabase, gabbro, peridotite. In many cases forms large ore bodies that are thought to be the result of magmatic differentiation; such bodies are often highly titaniferous. Occurs at times in immense beds and lenses, inclosed in old metamorphic rocks. Found in the black sands of the seashore. Occurs as thin plates and dendritic growths between plates of mica. Often intimately associated with corundum, forming the material known as emery.

In the United States, found in large beds with the Archæan rocks of the Adirondacks in Warren, Essex and Clinton counties of northern New York; in various places in New Jersey; at Cornwall, Pennsylvania. Important foreign localities are in Norway and Sweden, where it is the chief iron ore. Natural magnets or lodestones are found in Siberia; in the Harz Mountains, Germany; at Magnet Cove, Arkansas.

**Name.** Probably derived from the locality Magnesia, bordering on Macedonia. A fable, told by Pliny, ascribes its name to a shepherd named Magnes, who first discovered the mineral on Mount Ida by noting that the nails of his shoes and the iron ferrule of his staff adhered to the ground.

**Use.** An important iron ore.

### Franklinite.

**Composition.**  $(\text{Fe}, \text{Zn}, \text{Mn})\text{O} \cdot (\text{Fe}, \text{Mn})_2\text{O}_3$ . Shows wide variation in the proportions of the different elements present, but conforms to the general formula,  $\text{RO} \cdot \text{R}_2\text{O}_3$ .

**Crystallization.** Isometric. Habit strongly octahedral. Dodecahedron sometimes as truncations. Other forms rare. Crystals often rounded.

**Structure.** Massive, coarse or fine granular, in rounded grains or crystallized.

**Physical Properties.**  $H. = 6$ .  $G. = 5.15$ . Metallic luster. Color iron-black. Streak dark brown. Not magnetic.

**Tests.** Infusible. Becomes strongly magnetic on heating in R. F. Gives a bluish green color to sodium carbonate bead in O. F. (manganese). When very fine powder is mixed with sodium carbonate and heated intensely on charcoal gives a coating of zinc oxide. Distinguished by above tests and its black color and brown streak.

**Occurrence.** Found practically only in the zinc deposits at Franklin Furnace, New Jersey, which are in the form of large beds, enclosed in granular limestone. Associated chiefly with zincite and willemite, with which it is often intimately intergrown.

**Use.** As an ore of zinc and manganese. The zinc is converted into zinc white and the residue is smelted to form an alloy of iron and manganese, *spiegeleisen*, which is used in the manufacture of steel.

### Chromite.

**Composition.**  $\text{FeCr}_2\text{O}_4$  or  $\text{FeO} \cdot \text{Cr}_2\text{O}_3 =$  Chromium sesquioxide 68.0, iron protoxide 32.0. The iron may be replaced by magnesium and the chromium by aluminium and ferric iron.

**Crystallization.** Isometric. Habit octahedral. Crystals small and rare.

**Structure.** Commonly massive, granular to compact.

**Physical Properties.**  $H. = 5.5$ .  $G. = 4.6$ . Metallic to sub-metallic luster. Color iron-black to brownish black. Streak dark brown.

**Tests.** Infusible. When finely powdered and fused on charcoal with sodium carbonate gives a magnetic residue. Imparts a green color to the borax and salt of phosphorus beads (chromium).

**Occurrence.** A common constituent of peridotite rocks and the serpentines derived from them. One of the first minerals to separate from a cooling rock magma, and its large ore deposits are thought to have been derived by such magmatic differentiation. Associated with chrysolite, serpentine, corundum, etc.

Found only sparingly in the United States. Pennsylvania, Maryland, North Carolina and Wyoming have produced it in the past. California is the only producing state at present (1910). The important countries for its production are New Caledonia, Greece and Canada.

**Uses.** Chromium is used with various other metals to give hardness to steel. Chromite bricks are used to a considerable extent as linings for metallurgical furnaces, on account of their neutral and refractory character. The bricks are usually made of crude chromite and coal tar but sometimes of chromite with kaolin, bauxite, milk of lime or with other materials. Chromium is a constituent of certain green, yellow, orange and red pigments and of similarly colored dyes.

---

### Chrysoberyl.

**Composition.** Beryllium aluminate,  $\text{BeAl}_2\text{O}_4$ , = Alumina 80.2, beryllium oxide 19.8.

**Crystallization.** Orthorhombic. Crystals usually tabular parallel to macropinacoid, which face is vertically striated. Commonly twinned, often in pseudo-hexagonal forms.

**Structure.** Usually in crystals.

**Physical Properties.** Prismatic cleavage.  $H. = 8.5$  (unusually high).  $G. = 3.65-3.8$ . Vitreous luster. Color various shades of green, brown, yellow, sometimes red by transmitted light.

**Tests.** Infusible. Insoluble. The finely powdered mineral is wholly soluble in the salt of phosphorus bead (absence of silica). Mineral, moistened with cobalt nitrate and ignited, turns blue

(aluminium). Characterized by its extreme hardness, its yellowish to emerald-green color and its twin crystals.

**Varieties.** 1. *Ordinary*. Color pale green, yellow; sometimes transparent.

2. *Alexandrite*. Emerald-green variety, but red by transmitted light and generally also by artificial light.

3. *Cat's-eye, or Cymophane*. A variety which when polished shows an opalescent luster, and across whose surface plays a long narrow beam of light, changing its position with every movement of the stone. This effect is known as chatoyancy, and is best obtained when the stone is cut in an oval or round form (*en cabochon*). This property of the mineral is thought to be due to numerous minute tubelike cavities, arranged in a parallel position. Chrysoberyl is the true cat's-eye, and is not to be confused with various other minerals possessing similar properties (e.g., quartz).

**Occurrence.** A rare mineral. Found in the alluvial gem deposits of Brazil and Ceylon; the alexandrite variety comes from the Ural Mountains. In the United States it has been found at Norway and Stoneham, Maine; Haddam, Connecticut; and in North Carolina.

**Name.** *Chrysoberyl* means *golden beryl*. *Cymophane* is derived from two Greek words meaning *wave* and *to appear*, in allusion to the chatoyant effect of some of the stones. *Alexandrite* was named in honor of Alexander II of Russia.

**Use.** Serves as a gem stone. The ordinary yellowish green stones are valued up to \$5 a carat. Alexandrite brings as high as \$60 for a one-carat stone. A one-carat cat's-eye may have a value up to \$50.

Two rare manganese minerals belong in the section of Intermediate Oxides: *hausmannite*,  $MnO.Mn_2O_3$ , and *braunite*,  $3Mn_2O_3.MnSiO_3$ .

#### 4. DIOXIDES.

##### Cassiterite. Tin Stone.

**Composition.** Tin dioxide,  $SnO_2$  = Oxygen 21.4, tin 78.6.

**Crystallization.** Tetragonal. Common forms are prisms and pyramids of first and second orders (Fig. 264). Frequently in

elbow-shaped twins; twinning plane being a pyramid of the second order (Fig. 265).

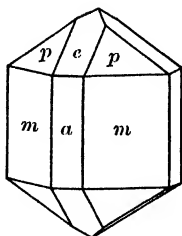


Fig. 264.

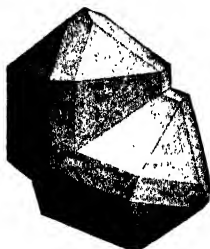


Fig. 265.

**Structure.** Usually massive granular; often in reniform shapes with radiating fibrous-like structure (*wood tin*); crystallized.

**Physical Properties.** H. = 6-7. G. = 6.8-7.1 (unusually high for a mineral with nonmetallic luster). Nonmetallic, adamantine luster to submetallic and dull. Color usually brown or black; rarely yellow or white. Streak white.

**Tests.** Infusible. Gives globule of tin with coating of white tin oxide when finely powdered mineral is fused on charcoal with a mixture of sodium carbonate and charcoal powder. Insoluble. Recognized by its high specific gravity, its color and light streak.

**Occurrence.** Cassiterite is widely distributed in small amounts but is only produced on a commercial scale in a few localities. Cassiterite has been noted as an original constituent of igneous rocks, but it is more commonly to be found in veins associated with quartz. As a rule tin-bearing veins are found in or near pegmatites or granitic rocks. Tin veins usually have minerals which contain fluorine and boron, such as tourmaline, topaz, fluorite, apatite, etc., and the minerals of the wall rocks are commonly much altered. It is thought, therefore, that the tin veins have been formed through the agency of vapors which carried tin with boron and fluorine. Cassiterite is at times a minor constituent of pegmatite veins. Also it is found in the form of rolled pebbles in placer deposits.

Cassiterite is not found in large quantities in the United States, the only productive locality at present being on the Seward Peninsula, Alaska. Found also in the pegmatites of North and South

Carolina; in the Black Hills, South Dakota; near El Paso, Texas. The world's supply of tin ore comes from Tasmania, from New South Wales, Queensland and other states of Australia, from Bolivia and from the Malay States. Cornwall, England, has produced large amounts of tin ore in the past.

**Use.** Only ore of tin. Chief use of tin is in coating or "tinning" metals, particularly iron, to form what is known as sheet tin. Tin is also used in various alloys: solder, containing tin and lead; bell-metal and bronze, containing copper and tin.

### Rutile.

**Composition.** Titanium dioxide,  $TiO_2$  = Oxygen 40, titanium 60. A little iron is usually present and may amount to 10 per cent.

**Crystallization.** Tetragonal. Usually prismatic with pyramidal terminations (Fig. 266). Vertically striated. Frequently

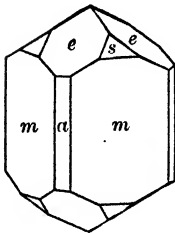


Fig. 266.

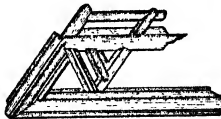


Fig. 267.



Fig. 268.

in elbow twins, often repeated (Figs. 267 and 268). Twinning plane is pyramid of second order. Crystals sometimes slender acicular.

**Structure.** Usually crystallized. Sometimes compact massive.

**Physical Properties.** H. = 6-6.5. G. = 4.18-4.25. Luster adamantine to submetallic. Color red, reddish brown to black. Usually nearly opaque, may be transparent.



**Tests.** Infusible. Insoluble. Fused with sodium carbonate, then fused mass dissolved in hydrochloric acid and boiled with tin, the solution assumes a violet color.

**Occurrence.** Rutile is found in granite, gneiss, mica schist, metamorphic limestone and dolomite, sometimes as an accessory mineral in the rock, sometimes in quartz veins traversing it. Often occurs as slender crystals penetrating quartz. Remarkable crystals come from Graves Mountain, Lincoln County, Georgia. Also found in Alexander County, North Carolina, in Randolph County, Alabama, and at Magnet Cove, Arkansas. Has been mined near Roseland, Nelson County, Virginia. Notable European localities are Krägerö, Norway; Yrieux, near Limoges, France; in the Ural Mountains.

**Use.** Source of titanium. Titanium is used to a small extent in steel and cast iron; for electrodes in arc lights; to give a yellow color to porcelain and false teeth.

### Octahedrite. Anatase.

Titanium dioxide,  $TiO_2$ , same as rutile and brookite. Tetragonal. Usually in pyramidal crystals, also tabular parallel to base.  $H. = 5.5-6$ .  $G. = 3.8-3.95$ . Adamantine luster. Color yellow, brown, blue, black, transparent to opaque. Tests same as for rutile (which see). A comparatively rare mineral, found usually as an accessory mineral in metamorphic rocks.

### Brookite.

Titanium dioxide,  $TiO_2$ , like rutile and octahedrite. Orthorhombic. Habit varied. Tabular parallel to macropinacoid, square prismatic and at times by an equal development of 4 prism and 8 pyramid faces resembles a hexagonal pyramid. Occurs only in crystals.  $H. = 6$ .  $G. = 4-4.07$ . Luster adamantine to submetallic.

Color hair-brown to black. Translucent to opaque. Tests, same as for rutile. A rare mineral, occurring with one of the other forms of titanium dioxide, rutile or octahedrite. Occurs in good crystals at St. Gothard, Switzerland; in the Tyrol; Trenadoc, Wales; Ellen-ville, New York; Magnet Cove, Arkansas.

### Pyrolusite.

**Composition.** Manganese dioxide,  $MnO_2$ . Commonly contains a little water.

**Crystallization.** Crystals probably always pseudomorphous after manganite.

**Structure.** Radiating columnar to fibrous (Fig. A, pl. VII); also granular massive; often in reniform coats.

**Physical Properties.** H. = 2-2.5 (often soiling the fingers). G. = 4.75. Metallic luster. Iron-black color and streak. Splintery fracture.

**Tests.** Infusible. A small amount of powdered mineral gives in O. F. a reddish violet bead with borax or a bluish green opaque bead with sodium carbonate. Gives oxygen in C. T., which will cause a splinter of charcoal to ignite when placed in tube above the mineral and heated. Only a small amount of water in C. T. In hydrochloric acid, chlorine gas evolved.

**Occurrence.** A secondary mineral. Manganese is dissolved out of the crystalline rocks, in which it is almost always present in small amounts, and redeposited under various conditions, chiefly as pyrolusite. Dendritic coatings of pyrolusite are frequently observed on rock surfaces, coating pebbles, etc. Nodular deposits of pyrolusite are found on the sea bottom. Nests and beds of manganese ores are found inclosed in residual clays, derived from the decay of manganeseiferous limestones. As the rock has weathered and its soluble constituents been taken away, the manganese content has been concentrated in nodules and masses composed chiefly of pyrolusite. Also found in veins with quartz and various metallic minerals.

Mined in Thuringia, Moravia, Transylvania, Bohemia, Westphalia, Australia, Japan, India, New Brunswick, Nova Scotia. In the United States, manganese ores are found in Virginia, Georgia, Arkansas and California.

**Name.** *Pyrolusite* is derived from two Greek words meaning *fire* and *to wash*, because it is used to free glass through its oxidizing effect of the colors due to iron.

**Uses.** Most important manganese ore. Manganese is used in the manufacture of the alloys with iron, *spiegeleisen* and *ferromanganese*, employed in making steel; also in various alloys with copper, zinc, aluminium, tin, lead, etc. Pyrolusite is used as an oxidizer in the manufacture of chlorine, bromine and oxygen; as a disinfectant in potassium permanganate; as a drier in paints, a decolorizer of glass, and in electric cells and batteries. Manganese is also used as a coloring material in bricks, pottery, glass, etc.

*Polianite*,  $MnO_2$ , is a rare mineral, occurring in minute tetragonal crystals.

## B. HYDROUS OXIDES.

### Turgite. Hydrohematite.

Composition is  $Fe_4O_3(OH)_2$  or  $2Fe_2O_3 \cdot 1H_2O$ . Compare limonite and goethite. Reniform and stalactitic, with radiating fibrous structure. Sometimes earthy. H. = 5.5-6. G. = 4.14. Submetallic luster. Color black to reddish black. Streak Indian-red. Difficultly fusible at 5-5.5. Strongly magnetic after heating in R. F. In C. T. gives 5 per cent of water and generally decrepitates. Distinguished from limonite by red streak and from hematite by giving water in C. T. Found usually associated with limonite. Occurred in considerable amount at Salisbury, Conn., where it often formed an outer layer an inch or more in thickness on the masses of limonite.

### Diaspore.

**Composition.**  $AlO(OH)$  or  $Al_2O_3 \cdot H_2O$  = Alumina 85, water 15.

**Crystallization.** Orthorhombic. Usually in thin crystals, tabular parallel to the brachypinacoid.

**Structure.** Bladed; foliated massive.

**Physical Properties.** Perfect cleavage parallel to brachypinacoid. H. = 6.5-7. G. = 3.35-3.45. Vitreous luster except on cleavage face, where it is pearly. Color white, gray, yellowish, greenish.

**Tests.** Infusible. Insoluble. Fine powder wholly soluble in salt of phosphorus bead (absence of silica). Ignited with cobalt nitrate turns blue (aluminium). Gives water in C. T. Characterized by its good cleavage, scaly structure and its hardness (6.5-7).

**Occurrence.** Usually a decomposition product of corundum and found associated with that mineral in dolomite, chlorite-schist, etc. Found in the Urals; at Schemnitz, Hungary; Campolongo in Switzerland. In the United States in Chester County, Pennsylvania; at Chester, Massachusetts; near Franklin, North Carolina, etc.

**Name.** Derived from a Greek word meaning *to scatter*, in allusion to its decrepitation when heated.

PLATE VII.



A. Pyrolusite, Negaunee, Michigan.



B. Manganite, Ilfeld, Harz Mts.



### Goethite.

**Composition.**  $\text{FeO}(\text{OH})$  or  $\text{Fe}_2\text{O}_3 \cdot \text{H}_2\text{O}$  = Oxygen 26, iron 62.9, water 10.1.

**Crystallization.** Orthorhombic. Prismatic, vertically striated. Often flattened parallel to brachypinacoid. In acicular crystals at times.

**Structure.** Massive, reniform, stalactitic, with radiating fibrous structure. Foliated. Rarely in distinct crystals.

**Physical Properties.** Perfect cleavage parallel to brachypinacoid.  $H. = 5-5.5$ .  $G. = 4.37$ . Adamantine to dull luster. Silky luster in certain fine scaly or fibrous varieties. Color yellowish brown to dark brown. Streak yellowish brown (same as for limonite).

**Tests.** Difficultly fusible (5-5.5). Becomes magnetic in R. F. Water in C. T. Told chiefly by the color of its streak and distinguished from limonite by its tendency to crystallize and the smaller amount of water which it contains.

**Occurrence.** Occurs with the other oxides of iron, hematite and limonite. Found at Eisenfeld in Nassau; near Bristol, England; at Lostwithiel, Cornwall. In the United States in connection with the Lake Superior hematite deposits, particularly at Negaunee, Michigan.

**Use.** A minor ore of iron.

### Manganite.

**Composition.**  $\text{MnO}(\text{OH})$  or  $\text{Mn}_2\text{O}_3 \cdot \text{H}_2\text{O}$  = Oxygen 27.3, manganese 62.4, water 10.3.

**Crystallization.** Orthorhombic. Crystals usually long prismatic with obtuse terminations, deeply striated vertically (Fig. B, pl. VII). Often twinned.

**Structure.** Usually in radiating masses; crystals often grouped in bundles. Also columnar.

**Physical Properties.** Perfect cleavage parallel to brachypinacoid.  $H. = 4$ .  $G. = 4.3$ . Metallic luster. Steel-gray to iron-black color. Dark brown streak.

**Tests.** Infusible. A small amount of the powdered mineral gives in O. F. a reddish-violet bead with borax or a bluish green opaque bead with sodium carbonate. Much water when heated in C. T. Told chiefly by its black color, prismatic crystals, hardness (4) and brown streak. The last two will serve to distinguish it from pyrolusite.

**Occurrence.** Found in connection with pyrolusite and other manganese minerals and with iron oxides. Occurs at Ilfeld, Harz Mountains, in fine crystals; also at Ilmenau, Thuringia; Cornwall, England; Negaunee, Michigan, etc.

**Use.** A minor ore of manganese.

**Limonite.** Brown Hematite. Bog-iron Ore.

**Composition.**  $\text{Fe}_2\text{O}_3(\text{OH})_6$  or  $2\text{Fe}_2\text{O}_3 \cdot 3\text{H}_2\text{O}$  = Oxygen 25.7, iron 59.8, water 14.5. Often impure. Compare turgite and goethite.

**Crystallization.** Noncrystalline.

**Structure.** In mammillary to stalactitic forms with radiating fibrous structure (Fig. B, pl. II); also concretionary; sometimes earthy.

**Physical Properties.** H. = 5-5.5. G. = 3.6-4. Submetallic luster. Color dark brown to nearly black. Streak yellowish brown.

**Tests.** Difficultly fusible (5-5.5). Strongly magnetic after heating in R. F. Much water in C. T. (15 per cent). Characterized chiefly by its structure and yellow-brown streak.

**Occurrence.** Limonite is a common ore of iron and is always secondary in its origin, formed through the alteration or solution of previously existing iron minerals. Pyrite is often found altered to limonite, the crystal form being at times preserved, giving limonite pseudomorphs. Sulphide veins are often capped near the surface, where oxidation has taken place, by a mass of cellular limonite, which is known as *gossan*, or an *iron hat*. Iron minerals existing in the rocks are among the first to undergo decomposition, and their iron content is often dissolved by percolating waters through the agency of the small amounts of carbonic acid which they contain. The iron is transported as a carbonate by the waters to the surface and then often carried by the streams finally into marshes and stagnant pools. There, under the effect of the evaporation of the

water and its consequent loss of the carbonic acid, which served to keep the iron carbonate in solution, and through the agency of the reducing action of carbonaceous matter present, the iron carbonate is changed to an oxide, which separates from the water and collects first as an iridescent scum on the surface of the water, and then later sinks to the bottom. In this way, under favorable conditions, beds of impure limonite can be formed in the bottom of marshes and bogs. Such deposits are very common and are known as *bog-iron ores*, but, because of the foreign materials deposited along with the limonite, are seldom of sufficient purity to be worked.

Limonite deposits are also to be found in connection with iron-bearing limestones. The iron content of the limestone is gradually dissolved out by circulating waters and transported by them to some favorable spot, and there the iron is slowly redeposited as limonite, gradually replacing the calcium carbonate of the rock. Or, by the gradual weathering and solution of the limestone, its iron content may be left in the form of residual masses of limonite, lying in clay above the limestone formation.

Such deposits are often of considerable size, and because of their greater purity are much more often mined than the bog-iron ores. Deposits of this type are to be found chiefly along the Appalachian Mountains, from western Massachusetts as far south as Alabama. These ores have been of considerable importance in western Massachusetts, northwestern Connecticut, southeastern New York, and in New Jersey. To-day they are chiefly mined in Alabama, Virginia, Tennessee and Georgia. Limonite deposits of various kinds are found throughout the western country, but as yet they have not been extensively developed.

Limonite is the coloring material of yellow clays and soils, and mixed with fine clay makes what is known as yellow ocher. Limonite is commonly associated in its occurrence with hematite, turgite, pyrolusite, calcite, siderite, etc.

**Name.** Derived from the Greek word meaning *meadow*, in allusion to its occurrence in bogs.

**Use.** As an iron ore. As a pigment, in yellow ocher.

### Bauxite.

**Composition.**  $\text{Al}_2\text{O}(\text{OH})_4$  or  $\text{Al}_2\text{O}_3 \cdot 2\text{H}_2\text{O}$  = Alumina 73.9, water 26.1. Often impure.

**Crystallization.** Noncrystalline.

**Structure.** In round concretionary grains; also massive, earthy, claylike.



**Physical Properties.** G. = 2-2.55. Dull to earthy luster. Color white, gray, yellow, red.

**Tests.** Infusible. Insoluble. Assumes a blue color when moistened with cobalt nitrate and then ignited (aluminium). Gives water in C. T.

**Occurrence.** Probably usually a secondary mineral derived from the decomposition of rocks containing aluminium silicates. Sometimes as a residual deposit, preserving evidences of the original rock structure; sometimes oölitic and concretionary in character and evidently deposited from water. May, perhaps, at times, be deposited by waters from hot springs. Occurs at Baux, near Arles, France, in disseminated grains in limestone; at Allauch, near Marseilles, France, in oölitic form with calcite as cement. In the United States the chief deposits are found in Georgia, Alabama and Arkansas.

**Use.** As an ore of aluminium, in the manufacture of aluminium salts; artificial abrasives and bauxite brick.

### Brucite.

**Composition.** Magnesium hydroxide,  $Mg(OH)_2$  = Magnesia 69.0, water 31.0. Iron and manganese sometimes present.

**Crystallization.** Hexagonal-rhombohedral. Crystals usually tabular with prominent basal planes, showing at times small rhombohedral truncations.

**Structure.** Commonly foliated, massive.

**Physical Properties.** Perfect basal cleavage. Folia flexible but not elastic. Sectile. H. = 2.5. G. = 2.39. Luster on base pearly, elsewhere vitreous to waxy. Color white, gray, light green. Transparent to translucent.

**Tests.** Infusible. B. B. glows. Gives water in C. T. Easily soluble in hydrochloric acid, and after solution has been made ammoniacal an addition of sodium phosphate gives a white granular precipitate of ammonium magnesium phosphate (test for magnesium). Recognized by its foliated structure, light color and pearly luster on cleavage face. Distinguished from talc by its greater hardness and lack of greasy feel.

**Occurrence.** Found associated with serpentine, dolomite, magnesite, chromite, etc., as a decomposition product of magnesium

silicates. Notable localities for its occurrence are at Unst, one of the Shetland Islands; Aosta, Italy; at Tilly Foster Iron Mine, Brewster, New York; at Wood's Mine, Texas, Pennsylvania.

### Gibbsite. Hydrargillite.

Aluminium hydroxide,  $\text{Al}(\text{OH})_3$ . Monoclinic. Rarely in hexagonal-shaped tabular crystals. Stalactitic or botryoidal. Basal cleavage. H. = 2-3.5. G. = 2.3-2.4. Luster pearly, vitreous or dull. Color white. Infusible. Insoluble in hydrochloric acid. Moistened with cobalt nitrate and ignited assumes a blue color. Water in C. T. A rare species, most commonly found with corundum.

### Psilomelane.

Of uncertain composition, chiefly manganese oxides,  $\text{MnO}_2$  with  $\text{MnO}$  and  $\text{H}_2\text{O}$ , also small amounts of barium oxide, cobalt oxide, etc. Noncrystalline. Massive, botryoidal, stalactitic. H. = 5-6. G. = 3.7-4.7. Submetallic luster. Black color. Brownish black streak. Infusible. A small amount of mineral fused in O. F. with sodium carbonate gives an opaque bluish green bead. Gives much water in C. T. Distinguished from the other manganese oxides by its greater hardness. An ore of manganese, occurring usually with pyrolusite.

## CARBONATES.

The carbonates are grouped into two divisions: (1) *Anhydrous Carbonates*; (2) *Acid, Basic and Hydrrous Carbonates*.

### 1. ANHYDROUS CARBONATES.

#### CALCITE GROUP.

The *Calcite Group* consists of a series of carbonates of the bivalent metals, calcium, magnesium, ferrous iron, manganese and zinc. They all crystallize in the rhombohedral class of the Hexagonal System with closely agreeing crystal constants. They all show a perfect rhombohedral cleavage, with the angle between the cleavage faces varying from  $105^\circ$  to  $108^\circ$ . The *Calcite Group* forms one of the most marked and important groups of isomorphous minerals, its chief members being as follows:

*Calcite*,  $\text{CaCO}_3$ .

*Dolomite*,  $(\text{Ca}, \text{Mg})\text{CO}_3$ .

*Magnesite*,  $MgCO_3$ .

*Siderite*,  $FeCO_3$ .

*Rhodochrosite*,  $MnCO_3$ .

*Smithsonite*,  $ZnCO_3$ .

### Calcite.

**Composition.** Calcium carbonate,  $CaCO_3$  = Carbon dioxide 44.0, lime 56.0. Small amounts of magnesium, ferrous iron, manganese and zinc may replace the calcium.

**Crystallization.** Hexagonal-rhombohedral. Crystals are very varied in habit, often highly complex. Over 300 different forms have been described. Three important habits: (1) Prismatic, in which the prism faces are prominent, in long or short prisms with

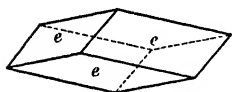


Fig. 269.

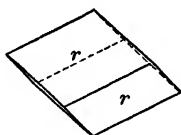


Fig. 270.

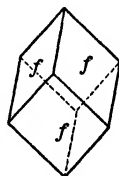


Fig. 271.

basal plane or rhombohedral terminations (Figs. 273 and 274); (2) Rhombohedral, in which rhombohedral forms predominate,

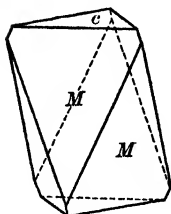


Fig. 272.

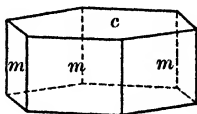


Fig. 273.

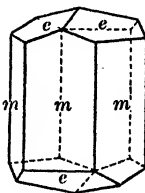


Fig. 274.

both low and steep rhombohedrons, the unit (cleavage) form is not common (Figs. 269, 270, 271 and 272); (3) Scalenohedral, in which the scalenohedrons predominate, often with prism faces

and rhombohedral truncations (Figs. 275, 276, 277, 278 and A, pl. VIII). All possible combinations and variations of these

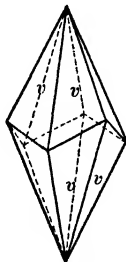


Fig. 275.

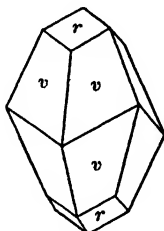


Fig. 276.

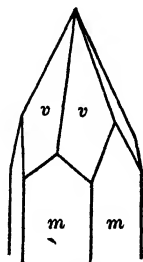


Fig. 277.

types. Twinning according to several different laws frequent. Fig. 279 represents one type of twinning in which the basal plane is the twinning plane.

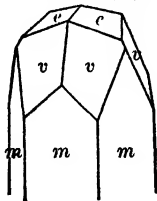


Fig. 278.



Fig. 279.

**Structure.** Crystallized or crystalline granular, coarse to fine. Also fine-grained to compact, earthy. In stalactitic forms, etc.

**Physical Properties.** Perfect cleavage parallel to unit rhombohedron (angle of rhombohedron =  $105^\circ$  and  $75^\circ$ ).  $H. = 3$ .  $G. = 2.72$ . Luster vitreous to earthy. Color usually white or colorless. May be variously tinted, gray, red, green, blue, yellow, etc. Also, when impure, brown to black. Usually transparent to translucent. Opaque when impure. Strong double refraction, hence the name *doubly-refracting spar*.

**Tests.** Infusible. After intense ignition, residue gives alkaline reaction to moistened test paper. Fragment moistened with

hydrochloric acid and heated gives orange-red flame. Fragments effervesce freely in cold dilute hydrochloric acid. Concentrated solution gives precipitate of calcium sulphate when a few drops of sulphuric acid are added; no precipitate will form if solution is dilute. Distinguished by its softness (3), its perfect cleavage, light color, vitreous luster, etc. Distinguished from dolomite by the fact that fragments of calcite effervesce freely in cold hydrochloric acid, while those of dolomite do not.

**Varieties.** 1. *Ordinary.* Calcite in cleavable or crystalline masses. When transparent and colorless known as *Iceland spar*, because of its occurrence in quantity in Iceland.

2. *Limestone, Marble, Chalk.* Calcite exists in enormous quantities in the form of limestone rocks, which form a large part of the sedimentary strata of the earth. When these rock masses have been subjected to great heat and pressure they develop a crystalline structure, usually showing cleavage faces of greater or less size. Crystalline limestones are known as marble. On account of various impurities and through the presence in them of other minerals, they assume a wide range of colors, and form a long series of ornamental stones to which various names are given. Chalk is a very fine-grained, pulverulent deposit of calcium carbonate, occurring at times in large beds. It has been formed through the slow accumulation on the sea bottom of fragments of shells and of the skeletons of minute sea animals.

3. *Cave Deposits, etc.* Calcareous waters often deposit calcite in the form of stalactites, concretions, incrustations, etc. It is usually semitranslucent, of light-yellow colors. Many caves in limestone regions are lined with such deposits. Hot calcareous spring waters may form a deposit of calcite, known as *travertine*, around their mouths. Such a deposit is being formed at the Mammoth Hot Springs, Yellowstone Park.

4. *Siliceous Calcites.* Calcite crystals may inclose considerable amounts of quartz sand (up to 60 per cent) and form what are known as sandstone crystals. Such occurrences are found at Fontainebleau, France (Fontainebleau limestone), and in the Bad Lands, South Dakota.

**Occurrence.** Calcite is one of the most common and widely diffused of minerals. It occurs as enormous and widespread sedimentary rock masses, in which it is the predominant, at times practically the only mineral present. Such rocks are the limestones, marbles (metamorphosed limestones), chalks, calcareous marls, calcareous sandstones, etc. The limestone rocks have, in great part, been formed by the deposition on a sea bottom of great thicknesses of calcareous material in the form of shells, skeletons of sea animals, etc. A smaller proportion of these rocks have been formed directly by precipitation of calcium carbonate. It occurs as a secondary mineral in igneous rocks as a product of decomposition of lime silicates. It is found lining the amygdaloidal cavities in lavas. It occurs in many sedimentary and metamorphic rocks in greater or less proportion. It is the cementing material in the light-colored sandstones. Calcite is also one of the most common of vein minerals, occurring as a gangue material, with all sorts of metallic ores.

It would be quite impossible to specify all of the important districts for the occurrence of calcite in its various forms. Some of the more notable localities in which finely crystallized calcite is found are as follows: Andreasberg in the Harz Mountains; various places in Saxony; in Cumberland, Derbyshire, Devonshire, Cornwall, Lancashire, England; Iceland; Guanajuato, Mexico; Joplin, Missouri; Lake Superior copper district; Rossie, New York, etc.

**Use.** The most important use for calcite is for the manufacture of lime for mortars and cements. Limestone when heated to about 1000° F. loses its carbonic acid, and is converted into quicklime, CaO. This, when mixed with water (slaked lime), swells, gives off much heat, and finally by absorption of carbon dioxide from the air hardens, or, as commonly termed, "sets." Quicklime when mixed with sand forms the common mortar used in building. Certain limestones contain various clayey materials as impurities. Cements made from these limestones have the valuable property of hardening under water, and are known as hydraulic cements. Many hydraulic cements are made up artificially by combining their ingredients in experimentally determined proportions. The chemistry of the process of their hardening is not fully understood, but various silicates of calcium and aluminium are probably formed. Portland cement, used so largely in concrete construction, is a mixture of about 6 parts of lime, 2 parts of silica, and 1 part of alumina.

Chalk is used as a fertilizer, for whiting and whitewash, for crayons, etc. It is found in many places in Europe, the chalk cliffs of Dover being famous.

Limestone is largely used as a building material, and is obtained in the United States chiefly from Pennsylvania, Indiana, Ohio, Illinois, New York, Missouri, Wisconsin. Limestone is largely used as a flux for smelting various metallic ores. A fine-grained limestone is used in lithographing.

Marbles are used very extensively as ornamental and building material. The most important marble quarries in the United States are found in Vermont, New York, Georgia, Tennessee, etc.

Iceland spar is valuable for optical instruments, being used in the form of the Nicol prism to produce polarized light. Obtained at present only from Iceland.

### Dolomite.

**Composition.** Carbonate of calcium and magnesium,  $\text{CaMg}(\text{CO}_3)_2$  = Carbon dioxide 47.8, lime 30.4, magnesia 21.7. Varieties occur in which the proportion of  $\text{CaCO}_3$  to  $\text{MgCO}_3$  is not as 1 : 1. Small amounts of ferrous carbonate frequently replace some of the magnesium carbonate. Manganese is also present at times.

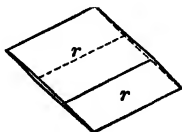


Fig. 280.

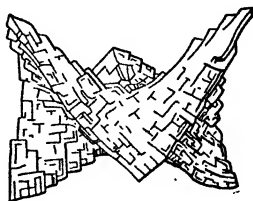


Fig. 281.

**Crystallization.** Hexagonal-rhombohedral. Crystals are usually the unit rhombohedron (cleavage rhombohedron) (Fig. 280). Faces often curved, and sometimes so acutely as to form "saddle-shaped" crystals (Fig. 281). Other forms rare.

**Structure.** In coarse, granular, cleavable masses to fine-grained and compact and in crystals.

PLATE VIII.



*A.* Calcite, Joplin, Missouri.



*B.* Aragonite, Cleator Moor, England.





**Physical Properties.** Perfect rhombohedral cleavage (cleavage angle =  $106^{\circ} 15'$ ). H. = 3.5–4. G. = 2.85. Vitreous luster; pearly in some varieties (pearl spar). Color usually some shade of pink, flesh color; may be colorless, white, gray, green, brown and black. Transparent to translucent.

**Tests.** Infusible. After intense ignition a fragment will give an alkaline reaction to moistened test paper. Readily soluble, with effervescence in hot hydrochloric acid; fragment only slowly attacked by cold dilute acid (difference from calcite). Solution oxidized by nitric acid and then made ammoniacal (may precipitate ferric hydroxide) will with ammonium oxalate give a white precipitate of calcium oxalate; filtrate with sodium phosphate gives granular white precipitate of ammonium magnesium phosphate. Crystallized variety told by its curved rhombohedral crystals and usually by its flesh-pink color.

**Occurrence.** Dolomite occurs chiefly in widely extended rock masses as dolomite limestone and marble. Occurrence same as for calcite rocks. The two varieties can only be told apart by tests, the simplest being to see if a drop of cold hydrochloric acid placed on the rock will produce effervescence (if so, rock is calcite; if not, dolomite). Often intimately mixed with calcite. Occurs also as a vein mineral, chiefly in the lead and zinc veins that traverse limestone. Found in large rock strata in the dolomite region of southern Tyrol; Binnenthal, Switzerland; northern England; Joplin, Missouri, etc.

**Use.** As a building and ornamental stone. For the manufacture of certain cements. For the manufacture of magnesia used in the preparation of refractory linings of the converters in the basic steel process.

*Ankerite*,  $\text{CaCO}_3 \cdot (\text{Mg}, \text{Fe}, \text{Mn})\text{CO}_3$ , is a subspecies intermediate between calcite, dolomite and siderite.

### Magnesite.

**Composition.** Magnesium carbonate,  $\text{MgCO}_3$ , = Carbon dioxide 52.4, magnesia 47.6. Iron carbonate also often present.

**Crystallization.** Hexagonal-rhombohedral. In rhombohedral crystals.

**Structure.** Compact earthy forms common, also less frequently in cleavable granular masses, coarse to fine. Also compact. Crystals rare.

**Physical Properties.** Perfect rhombohedral cleavage, sometimes distinct. H. = 3.5–4.5. G. = 3–3.1. Vitreous luster. Color white, gray, yellow, brown. Transparent to opaque.

**Tests.** Infusible. After intense ignition gives a faint alkaline reaction on moistened test paper. Scarcely acted upon by cold but dissolves with effervescence in hot hydrochloric acid. Solution, after the precipitation of any iron and calcium, gives in the presence of an excess of ammonia, with sodium phosphate, a white granular precipitate of ammonium magnesium phosphate.

**Occurrence.** Found associated with serpentine rocks as a product of their alteration, with dolomite, brucite, etc. Magnesite is mined to a small extent in Tulare County, California. Most of the magnesite used in the United States is imported, coming chiefly from Styria in Austria-Hungary and from Greece.

**Use.** Magnesite is chiefly used in the preparation of magnesite bricks for refractory linings in metallurgical furnaces. Also used in the preparation of magnesium salts (Epsom salts, magnesia, etc.).

### Siderite. Spathic Iron. Chalybite.

**Composition.** Ferrous carbonate,  $\text{FeCO}_3$  = Carbon dioxide 37.9, iron protoxide 62.1, iron = 48.2. Manganese, magnesium and calcium may be present in small amounts.

**Crystallization.** Hexagonal-rhombohedral. Crystals usually unit rhombohedrons (same as cleavage form), frequently with curved faces.

**Structure.** Usually cleavable granular. At times botryoidal, compact and earthy. More rarely in crystals.

**Physical Properties.** Perfect rhombohedral cleavage (cleavage angle =  $107^\circ$ ). H. = 3.5–4. G. = 4.5–5. Vitreous luster. Color usually light to dark brown. Transparent to opaque.

**Tests.** Difficultly fusible (4.5–5). Becomes strongly magnetic on heating. Heated in C. T. decomposes and gives a black magnetic residue. Soluble in hydrochloric acid with

effervescence; solution gives with potassium ferricyanide a dark blue precipitate (test for ferrous iron). Recognized usually by its color and cleavage.

**Varieties.** 1. *Crystallized.* In crystals or granular cleavable masses.

2. *Concretionary.* In globular concretions.

3. *Clay Ironstone.* Impure by admixture with clay materials. Sometimes in concentric layers. Forms stratified bodies with coal formations, etc.

4. *Black-band Ore.* An impure stratified deposit of siderite, containing considerable carbonaceous matter. Associated with coal beds.

**Occurrence.** Found in the form of clay ironstone and black-band ore in extensive stratified formations associated with coal measures. These ores are the chief source of iron in Great Britain and are found in Staffordshire, Yorkshire and Wales. Clay ironstone is also abundant in the coal measures of western Pennsylvania and eastern Ohio, but it is not used to any great extent as an ore. Siderite, in its crystallized form, is a common vein mineral associated with various metallic ores, as silver minerals, pyrite, chalcopyrite, tetrahedrite, galena, etc.

**Name.** The original name for the mineral was *spherosiderite*, given to the concretionary variety and subsequently shortened to siderite to apply to the entire species. *Spathic ore* is a common name. *Chalybite*, used by some mineralogists, was derived from the Chalybes, who lived on the Black Sea, and were in ancient times workers in iron.

**Use.** An ore of iron. Important in Great Britain, but of very subordinate value in the United States.

### Rhodochrosite.

**Composition.** Manganese protocarbonate,  $\text{MnCO}_3$ , = Carbon dioxide 38.3, manganese protoxide 61.7. Iron is usually present, replacing a part of the manganese and sometimes calcium, magnesium, zinc, etc.

**Crystallization.** Hexagonal-rhombohedral. Crystals unit rhombohedrons (same as cleavage rhombohedron), frequently with curved faces.

**Structure.** Usually cleavable massive; granular to compact. Rarely in crystals.

**Physical Properties.** Perfect rhombohedral cleavage (cleavage angle =  $107^\circ$ ). H. = 3.5–4.5. G. = 3.45–3.6. Vitreous luster. Color usually some shade of rose-red; may be light pink to dark brown. Transparent to translucent.

**Tests.** Infusible. Soluble in hot hydrochloric acid with effervescence. Gives reddish violet color to borax bead when heated in O. F. Told usually by its pink color, rhombohedral cleavage and hardness (4). Distinguished by its hardness from rhodonite ( $\text{MnSiO}_3$ ) (H. = 5.5–6.5).

**Occurrence.** A comparatively rare mineral, occurring in veins with ores of silver, lead and copper, and with other manganese minerals. Found in the silver mines of Hungary and Saxony. In the United States at Branchville, Connecticut; Franklin, New Jersey; in good crystals at Alicante, Colorado, etc.

**Name.** Derived from two Greek words meaning *rose* and *color*, in allusion to its rose-pink color.

**Use.** A minor ore of manganese.

### Smithsonite.

**Composition.** Zinc carbonate,  $\text{ZnCO}_3$  = Carbon dioxide 35.2, zinc protoxide 64.8. Iron and manganese often replace a part of the zinc; also at times calcium and magnesium.

**Crystallization.** Hexagonal-rhombohedral. Rarely in small rhombohedral or scalenohedral crystals.

**Structure.** Usually reniform, botryoidal or stalactitic and in crystalline incrustations or in honeycombed masses known as *dry-bone ore*. Also granular to earthy. Distinct crystals rare.

**Physical Properties.** Perfect rhombohedral cleavage, which, on account of the usual structure, is seldom observed. H. = 5 (unusually high for a carbonate). G. = 4.30–4.35. Vitreous luster. Color usually dirty brown. May be white, green, blue, pink, etc. Translucent to opaque.

**Tests.** Infusible. Soluble in hydrochloric acid with effervescence. A fragment heated B. B. in R. F. gives bluish green

streaks in the flame, due to the burning of the volatilized zinc. Heated in R. F. on charcoal gives a nonvolatile coating of zinc oxide, yellow when hot, white when cold; if coating is moistened with cobalt nitrate and again heated it turns green. Distinguished by its effervescence in acids, its tests for zinc, its hardness (5) and its high specific gravity.

**Occurrence.** It is a zinc ore of secondary origin. Found in connection with zinc deposits near the surface, and where the oxidized ores have been acted upon by carbonated waters. Common in connection with zinc deposits lying in limestone rocks. Associated with sphalerite, galena, calamine, cerussite, calcite, limonite, etc. Often found in pseudomorphs after calcite. "*Dry-bone ore*" is a honeycombed mass, with the appearance of dried bone, whose structure has resulted from the manner of deposition of the mineral. Some calamine, the silicate of zinc, is included under the term. Occurs, as an ore, in the zinc deposits of Missouri, Arkansas, Wisconsin, Virginia, etc. Found at times in translucent green or greenish blue material which is available for ornamental uses. Such smithsonite is found at Laurium, Greece, and at Kelly, New Mexico.

**Name.** Named in honor of James Smithson (1754-1829), who founded the Smithsonian Institution at Washington. English mineralogists call the mineral calamine, using either electric calamine or hemimorphite as the name for the silicate.

**Use.** An ore of zinc.

### ARAGONITE GROUP.

The *Aragonite Group* consists of a series of carbonates of the bivalent metals, calcium, strontium, barium and lead, which crystallize in the Orthorhombic System with closely related crystal constants and similar habits of crystallization. All of them appear at times in twin crystals which are pseudohexagonal in character. The members of the group are:

*Aragonite*,  $\text{CaCO}_3$ .

*Strontianite*,  $\text{SrCO}_3$ .

*Witherite*,  $\text{BaCO}_3$ .

*Cerussite*,  $\text{PbCO}_3$ .

### Aragonite.

**Composition.** Calcium carbonate, like calcite,  $\text{CaCO}_3$  = Carbon dioxide 44, lime 56. May contain a little strontium or lead, rarely zinc.

**Crystallization.** Orthorhombic. Three prominent habits of crystallization: (1) Acicular pyramidal; consisting of a prism terminated by a combination of a very steep pyramid and brachydome (see Fig. 282; and B, pl. VIII). Usually in radiating groups of large to very small crystals. (2) Tabular; consisting of prominent brachypinacoid faces modified by a prism

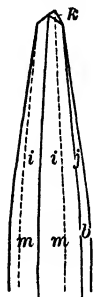


Fig. 282.

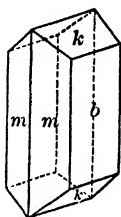


Fig. 283.



Fig. 284.

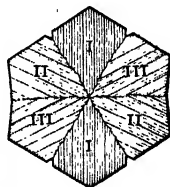


Fig. 285.

and a low brachydome (Fig. 283). Often twinned with a prism face as a twinning plane (Fig. 284). (3) In pseudo-hexagonal twins (Fig. 285). This type shows a hexagonal-like prism terminated by a basal plane, and is formed by an intergrowth of three individuals with basal planes in common and their prism faces falling partly in the same plane, and partly with only slightly different positions. The crystals are distinguished from true hexagonal forms by noting that the basal plane is striated in three different directions, and also by the fact that, because the prism angle of the simple crystals is not exactly  $60^\circ$ , the composite prism faces for the twin will often show slight re-entrant angles.

**Structure.** In crystals. Also reniform, columnar, stalactitic, etc.

**Physical Properties.** Vitreous luster. Colorless, white, pale yellow and variously tinted. Transparent to translucent.  $H. = 3.5-4$ .  $G. = 2.95$  (harder and heavier than calcite).

**Tests.** Infusible. Decrepitates. After intense ignition the powder gives an alkaline reaction on moistened test paper. Fragments fall to powder (change to calcite) when heated at low redness in C. T. Chemical tests same as for calcite (page 205). Distinguished from calcite by its lack of cleavage, and the fact that fragments fall to powder when heated in C. T.

**Occurrence.** Less stable than calcite and much less common in its occurrence. Usually found as a vein mineral. Experiments have shown that carbonated waters containing calcium more often deposit aragonite when they are hot and calcite when they are cold. Some sea shells are composed entirely or in part of aragonite. The pearly layer of many shells is aragonite. It has been noted that the aragonite shells are not readily preserved as fossils, being easily dissolved or disintegrated, or at times apparently slowly changing to calcite. Aragonite is most commonly found associated with beds of gypsum and deposits of iron ore (where it sometimes occurs in forms resembling coral, and is called *flos ferri*, flower of iron). At times found lining amygdaloidal cavities in basalt. Found frequently with pyrite, chalcopyrite, galena, malachite, etc. Notable localities for the various crystalline types are as follows: Pseudohexagonal twin crystals are found at Aragon, Spain; Bastennes, in the south of France; and at Girgenti, Sicily. The tabular type of crystals is found near Bilin, Bohemia. The acicular type is found at Alston Moor and Cleator, Cumberland, England. *Flos ferri* is found in the Stryian iron mines. Stalactitic forms occur in Buckinghamshire and Devonshire, England, and Lanarkshire, Scotland. A fibrous banded form of a delicate blue color comes from Chile.

### Witherite.

**Composition.** Barium carbonate,  $BaCO_3 =$  Carbon dioxide 22.3, barium oxide 77.7.

**Crystallization.** Orthorhombic. Crystals always twinned, forming pseudohexagonal pyramids by the intergrowth of three individuals terminated by brachydomes (Fig. 286). Crystals sometimes doubly terminated; often deeply striated horizontally and by a series of re-



Fig. 286.



entrant angles have the appearance of one pyramid capping another.

**Structure.** In twin crystals, also botryoidal to globular; columnar or granular.

**Physical Properties.** H. = 3.5. G. = 4.3. Vitreous luster. Colorless, white, gray. Translucent.

**Tests.** Easily fusible at 2.5–3, giving a yellowish green flame (barium). After intense ignition gives an alkaline reaction on moistened test paper. Soluble in hydrochloric acid with effervescence. All solutions, even the very dilute, give precipitate of barium sulphate with sulphuric acid (difference from calcium and strontium). Heavy.

**Occurrence.** A comparatively rare mineral. Found in fine crystals at Hexham in Northumberland and Alston Moor in Cumberland. Occurs at Tarnowitz in Silesia; Leogang in Salzburg; near Lexington, Kentucky; Thunder Bay, Lake Superior.

**Use.** A minor source of barium compounds.

### Strontianite.

**Composition.** Strontium carbonate,  $\text{SrCO}_3$  = Carbon dioxide 29.9, strontia 70.1. A little calcium sometimes present.

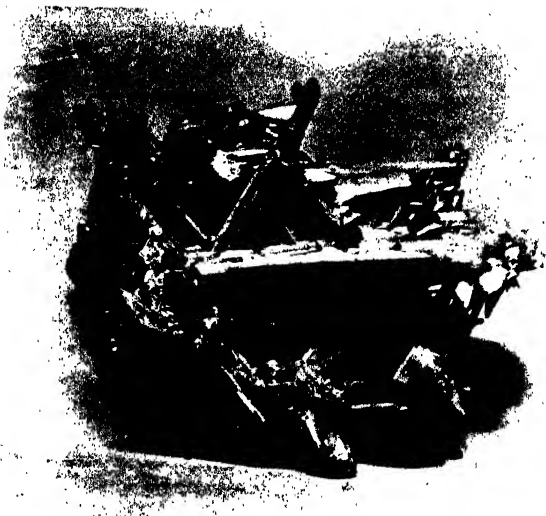
**Crystallization.** Orthorhombic. Crystals usually acicular, like type (1) under aragonite. Twinning also frequent, giving at times pseudo-hexagonal forms.

**Structure.** Radiating crystallized, also columnar; fibrous and granular.

**Physical Properties.** H. = 3.5–4. G. = 3.7. Vitreous luster. White, gray, yellow, green. Transparent to translucent.

**Tests.** Infusible. On intense ignition throws out fine branches and gives a crimson flame (strontium) and residue gives alkaline reaction on moistened test paper. Effervescence in hydrochloric acid, and the mediumly dilute solution will give precipitate of strontium sulphate on addition of a few drops of sulphuric acid; no precipitate will form in the very dilute solution (difference from calcium and barium). Usually necessary to make the above tests to determine the mineral.

PLATE IX.



Cerussite, Broken Hill, New South Wales.



**Occurrence.** A comparatively rare mineral. Originally found at Strontian in Argyllshire. Occurs also with lead ores at Pateley Bridge Yorkshire; at Hamm and Münster, Westphalia; at Schoharie, New York, etc.

**Use.** Has no great commercial use. A minor source of strontium compounds, used in fireworks and in the separation of sugar from molasses.

### Cerussite.

**Composition.** Lead carbonate,  $\text{PbCO}_3$  = Carbon dioxide 16.5, lead oxide 83.5.

**Crystallization.** Habit varied and crystals show many forms. Crystals often tabular parallel to brachypinacoid (Fig. 287). Frequently twinned, forming lattice-like groups with the plates crossing each other at  $60^\circ$  angles (pl. IX). Sometimes pyramidal in habit; also twinned in pseudo-hexagonal pyramids, frequently with deep reentrant angles in the prism zone.

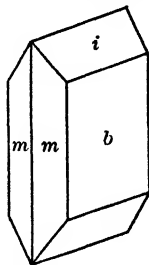


Fig. 287.

**Structure.** In crystals or in granular crystalline aggregates; fibrous; granular massive; compact; earthy.

**Physical Properties.**  $H. = 3-3.5$ .  $G. = 6.55$  (high for a mineral with nonmetallic luster). Adamantine luster. Colorless, white or gray. Transparent to almost opaque.

**Tests.** Easily fusible (1.5). With sodium carbonate B. B. on charcoal gives globule of lead and yellow to white coating of lead oxide. Soluble in warm dilute nitric acid with effervescence. In C. T. usually decrepitates and is changed to lead oxide, which is dark yellow when hot. Recognized by its high specific gravity, white color and adamantine luster.

**Occurrence.** An important and widely distributed lead ore of secondary origin, formed by the oxidation of galena in the presence of carbonated waters. Found in the upper and oxidized zone of lead veins, associated with galena, anglesite, sphalerite, smithsonite, silver ores, etc. Notable localities for its occurrence are Ems in Nassau; Mies, Bohemia; Nerchinsk, Siberia; Broken Hill, New

South Wales; Phoenixville, Pennsylvania; Leadville, Colorado, various districts in Arizona, etc.

**Use.** An important ore of lead.

---

*Phosgenite*, a chlorocarbonate of lead  $(PbCl)_2CO_3$ , tetragonal in crystallization, is a rare member of the Anhydrous Carbonate Division.

## 2. ACID, BASIC AND HYDROUS CARBONATES.

### **Malachite.** Green Copper Carbonate.

**Composition.** Basic carbonate of copper,  $(Cu.OH)_2CO_3$  or  $CuCO_3.Cu(OH)_2$  = Carbon dioxide 19.9, cupric oxide 71.9, water 8.2. Copper = 57.4.

**Crystallization.** Monoclinic. Crystals usually slender prismatic but seldom distinct.

**Structure.** Usually radiating fibrous with botryoidal or stalactitic structure (see Fig. C, pl. III). Often granular or earthy.

**Physical Properties.** Perfect basal cleavage. H. = 3.5-4. G. = 3.9-4.03. Adamantine to vitreous luster in crystals; often silky in fibrous varieties; dull in earthy type. Color bright green. Translucent to opaque.

**Tests.** Fusible (3), giving a green flame. With fluxes in R. F. on charcoal gives copper globule. Soluble in hydrochloric acid with effervescence. Solution turns deep blue with excess of ammonia. Much water in C. T. Recognized by its bright green color and radiating fibrous structure.

**Occurrence.** An important and widely distributed copper ore of secondary origin. Found in the oxidized portions of copper veins associated with azurite, cuprite, native copper, iron oxides and the various sulphides of copper and iron. Usually occurs in copper veins that lie in limestones. Notable localities for its occurrence are at Nizhni Tagilsk in the Ural Mountains; at Bembe on west coast of Africa; in the copper mines in Chile; in New South Wales. In the United States, an important copper ore in the southwestern copper districts; at Bisbee, Morenci, and other localities in Arizona; in New Mexico; at Cannanea, in northern Mexico.

**Name.** Derived from the Greek word for *mallows*, in allusion to its green color.

**Use.** An important ore of copper. Has been used to some extent as an ornamental material for vases, veneer for table tops, etc.

**Azurite.** Chessylite. Blue Copper Carbonate.

**Composition.** A basic carbonate of copper,  $\text{Cu}(\text{Cu.OH})_2(\text{CO}_3)_2$  or  $2\text{CuCO}_3.\text{Cu}(\text{OH})_2 =$  Carbon dioxide 25.6, cupric oxide 69.2, water 5.2. Copper = 55.3.

**Crystallization.** Monoclinic. Habit varied. Crystals frequently complex and distorted in development, sometimes in radiating spherical groups.

**Structure.** Crystallized. In radiating botryoidal structure. Earthy.

**Physical Properties.** H. = 3.5-4. G. = 3.77. Vitreous luster. Intense azure-blue color. Transparent to opaque.

**Tests.** Same as for malachite (which see). Characterized chiefly by its azure-blue color.

**Occurrence.** Origin and associations same as for malachite. Found in fine crystals at Chessy, France; in Siberia; at Copper Queen Mine, Bisbee, Arizona. Widely distributed with copper ores. Not so common as malachite.

**Name.** Named in allusion to its color.

**Use.** An important ore of copper.

### Aurichalcite.

A basic carbonate of zinc and copper,  $2(\text{Zn,Cu})\text{CO}_3.3(\text{Zn,Cu})\text{OH}_2$ . In acicular crystals, forming drusy incrustations. H = 2. G. = 3.6. Pearly luster. Color pale green to blue. Infusible. Soluble in hydrochloric acid with effervescence. Solution turns blue with ammonia in excess. Fused in R. F. on charcoal with sodium carbonate gives a nonvolatile coating of zinc oxide (yellow when hot, white when cold). Water in C. T. A rare mineral, found in the oxidized zones of copper veins.

### Gay-Lussite.

A hydrous carbonate of calcium and sodium,  $\text{CaCO}_3.\text{Na}_2\text{CO}_3.5\text{H}_2\text{O}$ . Monoclinic. In rude crystals with uneven surfaces. Often wedge-

shaped. Prismatic cleavage.  $H. = 2-3$ .  $G. = 1.99$ . Vitreous luster. Colorless, white, gray. Fusible at 1.5, giving yellow flame of sodium. Gives alkaline reaction after ignition. Effervesces in acids. Concentrated hydrochloric acid solution gives precipitate of calcium sulphate with sulphuric acid. A rare species, found in salt-lake deposits at Merida, Venezuela, and near Ragtown, Nevada.

Other rarer species in this division include *hydrozincite*,  $ZnCO_3 \cdot 2Zn(OH)_2$ ; *trona*,  $Na_2CO_3 \cdot HNaCO_3 \cdot 2H_2O$ ; *hydromagnesite*,  $3MgCO_3 \cdot Mg(OH)_2 \cdot 3H_2O$ .

## SILICATES.

The silicates form the largest single section of the Chemical Classification of Minerals. They may be divided into (1) *Anhydrous Silicates*, (2) *Hydrous Silicates*.

### ANHYDROUS SILICATES.

This section may be subdivided into (1) *Disilicates*, *Polysilicates*, being salts of disilicic acid,  $H_2Si_2O_6$ , or polysilicic acid,  $H_4Si_3O_8$ ; (2) *Metasilicates*, being salts of metasilicic acid,  $H_2SiO_3$ ; (3) *Orthosilicates*, being salts of orthosilicic acid,  $H_4SiO_4$ ; (4) *Subsilicates*, including various basic species.

#### 1. DISILICATES, POLYSILICATES.

The only representative of the disilicates of sufficient importance to warrant mention here is the rare lithium mineral, *petalite*,  $LiAl(Si_2O_6)_2$ .

### THE FELDSPAR GROUP.

The feldspars form one of the most important of mineral groups. They are polysilicates of aluminium with either potassium, sodium and calcium and rarely barium. They may belong to either the monoclinic or the triclinic systems but with the crystals of the different species resembling each other closely in angles, habits of crystallization, and methods of twinning. They all show cleavages in two directions which make an angle of  $90^\circ$ , or closely  $90^\circ$ , with each other. Hardness is about 6 and specific gravity 2.6.

## MONOCLINIC SECTION.

## Orthoclase. Potash Feldspar.

**Composition.** Potassium-aluminium silicate,  $\text{KAlSi}_3\text{O}_8 =$  Silica 64.7, alumina 18.4, potash 16.9. Soda sometimes replaces a portion of the potash.

**Crystallization.** Monoclinic. Crystals are usually prismatic in habit and have as prominent forms, clinopinacoid, base, prism, with often smaller orthodomcs (Figs. 288, 289 and 290). Fre-

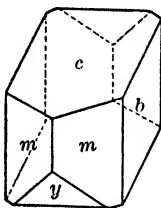


Fig. 288.

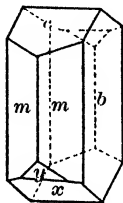


Fig. 289.

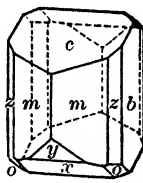


Fig. 290.

quently twinned; Carlsbad with clinopinacoid as twinning plane (Fig. 291); Baveno with clinodome as twinning plane (Fig. 292); Manebach with base as twinning plane (Fig. 293).



Fig. 291.  
Carlsbad Twin.



Fig. 292.  
Baveno Twin.

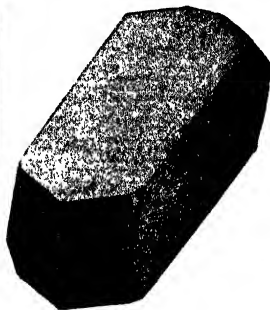


Fig. 293.  
Manebach Twin.

**Structure.** Usually crystallized or coarsely cleavable to granular; more rarely fine-grained, massive and cryptocrystalline.



**Physical Properties.** Two prominent cleavages (one parallel to base, perfect: the other parallel to clinopinacoid, good), making an angle of  $90^\circ$  with each other. H. = 6-6.5. G. = 2.5-2.6. Luster vitreous. Colorless, white, gray, flesh-red, more rarely green. Streak white.

**Varieties.** *Common feldspar* is the usual opaque variety. *Adularia* is white or colorless and translucent to transparent. Some adularia shows an opalescent play of colors, and is called *moonstone*. Most of the moonstones, however, belong to the members of the plagioclase feldspar series. *Sanidine*, or *glassy feldspar*, is a variety occurring in glassy, often transparent, phenocrysts in eruptive rocks.

**Tests.** Difficultly fusible (5). Insoluble in acids. When mixed with powdered gypsum and heated on platinum wire gives the violet flame of potassium. Usually to be recognized by its color, hardness and cleavage. Distinguished from the other feldspars by its right-angle cleavage and the lack of striations on the best cleavage surface.

**Alteration.** When acted upon by waters carrying carbon dioxide in solution, orthoclase alters, forming a soluble carbonate of potassium and leaving as a residue either a mixture of kaolin ( $H_4Al_2Si_2O_9$ ) and quartz ( $SiO_2$ ), or of muscovite ( $H_4K(AlSiO_4)_2$ ) and quartz. Kaolin forms the chief constituent of clays and has been derived in this manner.

**Occurrence.** One of the most common of minerals. Widely distributed as a prominent rock constituent, occurring in all types of rocks; igneous, in granites, syenites, porphyries, etc.; sedimentary, in certain sandstones and conglomerates; metamorphic, in gneisses. Also in large crystals and cleavable masses in pegmatite veins, associated chiefly with quartz, muscovite and albite. These veins are to be found where granite rocks abound. Large veins of this character from which feldspar is quarried in considerable amounts occur in the New England and Middle Atlantic states, chiefly in Maine, Connecticut, New York, Pennsylvania and Maryland.

**Name.** The name *orthoclase* refers to the right-angle cleavage possessed by the mineral. *Feldspar* is derived from the German word *feld*, field.

**Use.** Orthoclase is chiefly used in the manufacture of porcelain. It is ground very fine and mixed with kaolin, or clay, and quartz. When heated to high temperature the feldspar fuses and acts as a cement to bind the material together. Fused feldspar also furnishes the major part of the glaze on porcelain ware.

A rare barium feldspar, *hyalophane*  $(K_2, Ba)Al_2Si_4O_{12}$ , belongs here.

### TRICLINIC SECTION.

#### Microcline.

**Composition.** Like orthoclase,  $KAlSi_3O_8$  = Silica 64.7, alumina 18.4, potash 16.9.

**Crystallization.** Triclinic. Axial lengths and angles only slightly different from those of orthoclase. Ordinarily the crystals of the two species cannot be told apart except by very accurate measurements or a microscopical examination. Microcline crystals are usually twinned according to the same laws as orthoclase. Also microscopically twinned according to the albite and pericline laws, characteristic of the triclinic feldspars. A thin section of microcline under the microscope in polarized light usually shows a characteristic grating structure, caused by the crossing at nearly right angles of the twin lamellæ formed according to these triclinic twinning laws. Orthoclase, being monoclinic, could not show such twinning.

**Structure.** In cleavable masses or in crystals.

**Physical Properties.** Cleavage parallel to base and brachypinacoid, with angle of  $89^\circ 30'$  (orthoclase would have  $90^\circ$ ).  $H. = 6-6.5$ .  $G. = 2.54-2.57$ . Vitreous luster. Color white to pale yellow. Also sometimes green (*Amazon stone*) or red. Transparent to translucent.

**Tests.** Same as for orthoclase. The two species only to be distinguished from each other by careful examination (see above).

**Occurrence.** Same as for orthoclase. Much that passes as orthoclase in reality is microcline. Occurs with a green color in the Ural Mts. and at Pike's Peak, Colorado, and is known as *Amazon stone*.

**Name.** *Microcline* is derived from two Greek words meaning *little* and *inclined*, referring to the slight variation of the cleavage angle from  $90^\circ$ .

**Use.** Same as for orthoclase. Amazon stone is at times polished and used as an ornamental material.

### THE PLAGIOCLASE FELDSPARS. ALBITE-ANORTHITE SERIES.

The triclinic soda-lime feldspars embrace a series of isomorphous minerals varying in composition from albite,  $\text{NaAlSi}_3\text{O}_8$ , to anorthite,  $\text{CaAl}_2\text{Si}_2\text{O}_8$ . These two molecules can replace each other in any proportion, and as a consequence a practically complete series may be found from the pure soda feldspar, and then with gradually increasing amounts of the anorthite molecule, to the pure lime feldspar. Definite names have been given to various mixtures of these two molecules, the more important being listed below:

<i>Albite</i> ,	$\text{NaAlSi}_3\text{O}_8$ .
<i>Oligoclase</i> ,	$3\text{NaAlSi}_3\text{O}_8.1\text{CaAl}_2\text{Si}_2\text{O}_8$ .
<i>Andesine</i> ,	$1\text{NaAlSi}_3\text{O}_8.1\text{CaAl}_2\text{Si}_2\text{O}_8$ .
<i>Labradorite</i> ,	$1\text{NaAlSi}_3\text{O}_8.3\text{CaAl}_2\text{Si}_2\text{O}_8$ .
<i>Anorthite</i> ,	$\text{CaAl}_2\text{Si}_2\text{O}_8$ .

These triclinic feldspars crystallize in forms closely resembling those of the monoclinic orthoclase, and the axial lengths and inclinations are also closely the same. This similarity in the crystal structure between the monoclinic and triclinic feldspars is best shown by a comparison of the cleavage angles of the different species, that of orthoclase being  $90^\circ$ , of albite  $86^\circ 24'$ , and of anorthite  $85^\circ 50'$ . The triclinic feldspars are often known as the *plagioclase* feldspars, because of their *oblique cleavage*.

The crystals of the plagioclase feldspars are frequently twinned according to the various laws governing the twins of orthoclase, i.e., the Carlsbad, Baveno and Manebach laws. They are also practically always twinned according to one or both of two laws, known as the albite and pericline laws. The twinning plane in the albite law is the brachypinacoid, which corresponds to the clinopinacoid in orthoclase. The angle between the basal

plane and this twinning plane is not  $90^\circ$ , but about  $86^\circ$ ; so that if one imagines a triclinic feldspar crystal cut in two along this plane and one-half revolved  $180^\circ$  from its original position upon an axis perpendicular to the plane, there would then be formed a shallow trough along the upper surface of the crystal, because the basal planes of the two adjacent halves would not lie in the same plane, but rather slope at a slight angle toward each other. This sort of twinning is commonly repeated many times in a single crystal, and gives rise to thin lamellæ, each one in twin position in respect to those on either side (see Figs. 296 and 297). Consequently a basal plane or cleavage surface of such a twinned crystal will be crossed by a number of parallel groovings or striations (Fig. 298). Many times these striations are so fine as not to be visible to the unaided eye, but also at times they are coarse and easily seen. The presence of these striation lines upon the better cleavage surface of a feldspar is one of the best proofs that it belongs to the plagioclase series. In the pericline law the twinning axis is the  $b$  crystallographic axis, and when this results in polysynthetic twins the consequent striations are to be seen on the brachypinacoid.

### Albite. Soda-feldspar.

**Composition.** Sodium-aluminium silicate,  $\text{NaAlSi}_3\text{O}_8$  = Silica 68.7, alumina 19.5, soda 11.8. Calcium is usually present in small amount in the form of the anorthite molecule,  $\text{CaAl}_2\text{Si}_2\text{O}_8$ .

**Crystallization.** Triclinic. Usually in tabular crystals paral-

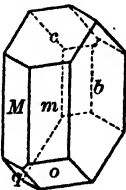


Fig. 294.

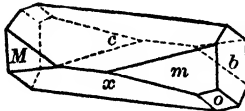


Fig. 295.



Fig. 296. Albite Twin.

lel to brachypinacoid (Fig. 294). Sometimes elongated parallel to  $b$  crystal axis (Fig. 295). Twinning very common, according

to the albite law (see above) and evidenced by fine striation lines on the better cleavage surface (Figs. 297 and 298). Twinning according to the other laws frequent.

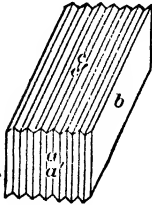


Fig. 297.

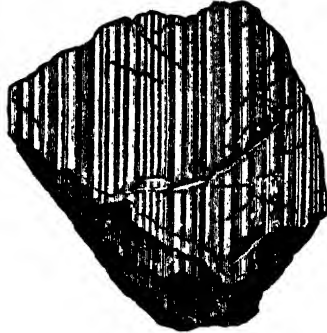


Fig. 298. Albite Twinning.

**Structure.** Commonly massive, either lamellar with lamellæ often curved or in cleavable masses. Distinct crystals rare.

**Physical Properties.** Perfect cleavage parallel to base; good cleavage parallel to brachypinacoid. Cleavage angle  $86^{\circ} 24'$ . H. = 6. G. = 2.62. Vitreous luster; sometimes pearly on cleavage surface. Colorless, white, gray. Transparent to opaque.

**Tests.** Fusible at 4–4.5, giving yellow flame (sodium). Insoluble in acids. Characterized by its hardness, white color, cleavage, frequently curved lamellar structure, striations on better cleavage surface, etc.

**Occurrence.** Like orthoclase, a widely distributed and important rock-making mineral. It occurs in all classes of rocks, but particularly in those of igneous origin, such as granites, syenites, porphyries and felsite lavas. Found commonly, also, in pegmatite veins. Notable localities for albite are to be found in Switzerland and the Tyrol; in the United States at Paris, Maine; Chesterfield, Massachusetts; Haddam and Branchville, Connecticut; Amelia Court House, Virginia, etc.

**Name.** From the Latin *albus*, white, in allusion to its color.

**Use.** Has the same uses as orthoclase, but not so commonly employed. Some varieties, when polished, show an opalescent play of colors and are known as *moonstones*. Other members

of the plagioclase series and orthoclase show at times this same effect. The stones are usually cut in round or oval shapes and are valued up to \$3 a carat. The finest moonstones come from Ceylon, but they are chiefly orthoclase.

### Oligoclase.

**Composition.** Intermediate between albite and anorthite, chiefly near  $3\text{NaAlSi}_3\text{O}_8 \cdot 1\text{CaAl}_2\text{Si}_2\text{O}_8$ .

**Crystallization.** Triclinic. Like albite.

**Structure.** Usually massive, cleavable to compact. Crystals rare.

**Physical Properties.** Cleavage in two directions at  $86^\circ 32'$ . One cleavage (parallel to base) is better than the other, and on this parallel striation lines due to twinning are commonly to be seen.  $H. = 6$ .  $G. = 2.66$ . Vitreous to pearly luster. Color usually whitish with faint tinge of grayish green, also reddish white, etc. Translucent to opaque.

**Tests.** Fusible at 4-4.5. Insoluble in hydrochloric acid. To be told from albite only by a test for calcium. Briefly, the test is made as follows: Fuse powdered mineral with sodium carbonate; dissolve fusion in hydrochloric acid and evaporate to dryness, moisten residue with water and a little nitric acid, boil and then filter off insoluble silica; to filtrate add ammonium hydroxide in excess, filter off precipitate of aluminium hydroxide; in filtrate get precipitate of calcium oxalate upon addition of ammonium oxalate. To be positively distinguished from andesine and labradorite only by a chemical analysis or an optical examination.

**Occurrence.** Like albite, but not so common. Found in various localities in Norway, notably at Tvedestrand, where it contains inclusions of hematite, which give the mineral a golden shimmer and sparkle. Such feldspar is called aventurine oligoclase, or *sunstone*. Occurs in the United States at Fine and Macomb, St. Lawrence County, New York; Danbury and Haddam, Connecticut; Bakersville, North Carolina, etc.

**Name.** Derived from two Greek words meaning *little* and *fracture*.

**Use.** Occasionally used as an ornamental material; in the varieties sunstone and moonstone.

### Andesine.

**Composition.** Intermediate between albite and anorthite, corresponding chiefly to  $1\text{NaAlSi}_3\text{O}_8 \cdot 1\text{CaAl}_2\text{Si}_2\text{O}_8$ .

**Crystallization.** Triclinic. Like albite.

**Structure.** In cleavable masses. Crystals rare.

**Physical Properties.** Cleavage in two directions at  $86^\circ 14'$ . One cleavage (parallel to base) better than the other, and on this parallel striation lines due to twinning are commonly to be seen.  $H. = 6$ .  $G. = 2.69$ . Vitreous to pearly luster. Color white, gray, greenish, yellowish, flesh-red. Often exhibits a beautiful play of colors, due partly to the intimate twinning and partly to inclusions.

**Tests.** Same as for oligoclase. To be positively distinguished from oligoclase and labradorite only by a chemical analysis or an optical examination.

**Occurrence.** Same as for albite, but less common. More frequently found in somewhat more basic igneous rocks, i.e., those containing less silica and more lime and magnesia.

**Name.** Occurs in a rock called andesite, found in the Andes Mountains.

### Labradorite.

**Composition.** Intermediate between albite and anorthite, corresponding chiefly to  $1\text{NaAlSi}_3\text{O}_8 \cdot 3\text{CaAl}_2\text{Si}_2\text{O}_8$ .

**Crystallization.** Triclinic. Like albite.

**Structure.** In cleavable masses. Crystals rare.

**Physical Properties.** Cleavage in two directions at  $86^\circ 5'$ . One cleavage (parallel to base) better than the other, and on this parallel striation lines due to twinning are commonly shown.  $H. = 6$ .  $G. = 2.73$ . Vitreous luster. Usually gray, brown or greenish; sometimes colorless or white. Often shows a beautiful play of colors, due in part to the intimate twinning structure, in part to inclusions. Transparent to opaque.

**Tests.** Same as for oligoclase.

**Occurrence.** Like albite, but more commonly in the darker colored basic igneous rocks, and usually associated with pyroxene or amphibole: Found on the coast of Labrador in large amounts, associated with hypersthene and magnetite, and when polished showing a fine iridescent play of colors.

**Use.** As an ornamental stone.

### Anorthite.

**Composition.** Calcium-aluminium silicate,  $\text{CaAl}_2\text{Si}_2\text{O}_8$  = Silica 43.2, alumina 36.7, lime 20.1. Soda is usually present, in small amount, in the albite molecule,  $\text{NaAlSi}_3\text{O}_8$ .

**Crystallization.** Triclinic. Crystals usually prismatic parallel to vertical axis. Twinning common according to albite and pericline laws (see above).

**Structure.** Massive cleavable. Crystals rare.

**Physical Properties.** Cleavage in two directions at  $85^\circ 50'$ . One cleavage (parallel to base) better than the other.  $H. = 6$ .  $G. = 2.75$ . Vitreous to pearly luster. Color white, grayish, reddish. Transparent to opaque.

**Tests.** Fusible at 4.5. Dissolves slowly in hydrochloric acid and yields a silica jelly upon evaporation. Gives a strong test for calcium (see under oligoclase) and only a slight yellow flame (sodium).

**Occurrence.** A rock-making mineral, particularly in the dark-colored basic igneous rocks. Associated with various calcium and magnesium silicates. Found in the lavas of Mount Vesuvius; of Japan, etc.

**Name.** Derived from the Greek word meaning *oblique*, because of its triclinic crystallization.

## 2. METASILICATES.

### Leucite.

**Composition.** A metasilicate of aluminium and potassium,  $\text{KAl}(\text{SiO}_3)_2$  = Silica 55.0, alumina 23.5, potash 21.5.

**Crystallization.** Isometric. Trapezohedral habit (Fig. 299). Other forms rare. Strictly isometric only at temperatures of



500° C. or over. On cooling below this temperature it undergoes an internal molecular rearrangement to that of some other crystal system, but the external form does not change. It is formed in lavas at high temperatures and is then isometric in internal structure as well as outward form.

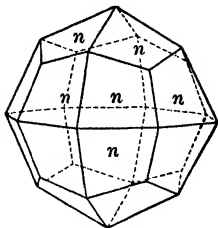


Fig. 209.

**Tests.** Infusible. Decomposed by hydrochloric acid with the separation of silica but without the formation of a jelly. Addition of ammonia to the solution gives precipitate of aluminium hydroxide. When mixed with powdered gypsum and fused gives violet potassium flame (best observed through a blue glass).

**Occurrence.** A rather rare mineral, occurring almost wholly in lavas. Found in rocks in which the amount of potassium in the magma was in excess of the amount necessary to form feldspar. Is not observed, therefore, in rocks that show quartz. Chiefly found in the rocks of central Italy; notably as phenocrysts in the lavas of Vesuvius. Pseudomorphs after leucite are found in syenites of Arkansas, Montana, Brazil, etc.

**Name.** From a Greek word meaning *white*.

*Pollucite*,  $H_2Cs_2Al_2(SiO_3)_6$ , is a rare mineral that belongs in the same group as leucite.

### PYROXENE GROUP.

The *Pyroxene Group* includes a series of related metasilicates which have calcium, magnesium and ferrous iron as the important bases, also manganese and zinc. Further certain molecules contain the alkalis and aluminium and ferric iron. They may belong to either the orthorhombic, monoclinic or triclinic systems, but the crystals of the different species are closely similar in many respects.

## ORTHORHOMBIC SECTION.

## Enstatite, Bronzite, Hypersthene.

A group of orthorhombic members of the pyroxene group, *enstatite* being magnesium metasilicate,  $\text{MgSiO}_3$ ; *bronzite*, the same as enstatite, with small amounts of iron replacing the magnesium; *hypersthene*, an iron-magnesium metasilicate,  $(\text{Mg,Fe})\text{SiO}_3$ . Distinct crystals rare. Usually foliated massive with good cleavage; fibrous, etc. Color from white in enstatite to green and brown with increase in iron. Rock-making minerals, occurring like the monoclinic pyroxenes but much rarer. Found in basic igneous rocks, such as peridotite, gabbro, etc.

## Pyroxene.

**Composition.** Pyroxene is a metasilicate, varying in its composition. It contains as bases chiefly calcium and magnesium, with smaller amounts of ferrous iron. In some varieties, however, molecules are introduced in which are the alkalis (chiefly sodium), aluminium and ferric iron. The more important varieties of pyroxene with the formulas assigned to them follow.

*Diopside*,  $\text{CaMg}(\text{SiO}_3)_2$ .

*Common pyroxene*,  $\text{Ca}(\text{Mg,Fe})(\text{SiO}_3)_2$ .

*Augite*,  $\text{CaMg}(\text{SiO}_3)_2$  with  $\text{MgAl}_2\text{SiO}_6$  and  $\text{NaAlSi}_2\text{O}_6$ ; with iron isomorphous with both the magnesium and the aluminium.

These varieties form an isomorphous series, and all gradations between them appear. Other varieties of less common occurrence are *hedenbergite*,  $\text{CaFe}(\text{SiO}_3)_2$ ; *schefferite*, a manganese pyroxene; *jeffersonite*, a manganese-zinc pyroxene.

**Crystallization.** Monoclinic. Crystals prismatic in habit; prism faces make angles of  $87^\circ$  and  $93^\circ$  with each other. The prism zone commonly shows the prism faces truncated by the faces of both vertical pinacoids, so that the crystals show, when viewed parallel to the vertical axis, a rectangular cross section with truncated corners. The interfacial angles in the prism zone are either exactly or very closely  $90^\circ$  and  $45^\circ$ . The terminations vary, being made up frequently of a combination of

the basal plane with pyramids both in front and behind (Figs. 300-302).

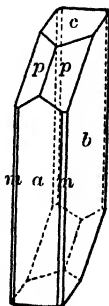


Fig. 300.

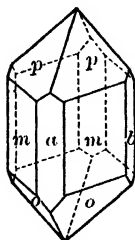


Fig. 301.

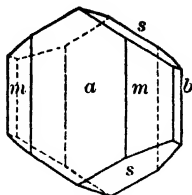


Fig. 302.

**Structure.** In crystals. Often lamellar. Coarse to fine granular.

**Physical Properties.** Prismatic cleavage sometimes good, often interrupted. Sometimes basal parting observed, often shown by twinning lamellæ (see Fig. A, pl. X).  $H. = 5-6$ .  $G. = 3.2-3.6$ . Vitreous luster. Color varying from white and light green in diopside, to green in pyroxene, through dark green to black in augite. Color deepens with increase in the amount of iron present. Transparent to opaque.

**Tests.** Fusible from 4 to 4.5. Insoluble in hydrochloric acid. To test for bases: fuse with sodium carbonate; dissolve in nitric acid; evaporate to dryness; notice the formation of silica jelly; moisten residue with water and hydrochloric acid; boil and filter from insoluble silica; add ammonium hydroxide in excess, precipitate of aluminium and ferric hydroxide; to boiling filtrate add ammonium oxalate, precipitate of calcium oxalate; to filtrate add sodium phosphate, precipitate of ammonium magnesium phosphate. Recognized usually by its characteristic crystals.

**Occurrence.** The pyroxenes are common and important rock-making minerals, being found chiefly in the dark colored igneous rocks, especially those whose magmas were rich in iron, calcium and magnesium. They are seldom to be found in rocks that contain much quartz. Augite is found in basaltic lavas, and in the dark

PLATE X.



A.



B.



C.

- A. Pyroxene showing Twinning Lamellæ due to Basal Parting.  
B Spodumene Crystal from Huntington, Massachusetts  
C Garnet Crystals in Mica-Schist.



colored intrusions known generally as trap, in gabbros and peridotites. Diopside and common pyroxene are found sometimes in syenites and similar rocks; also as metamorphic minerals in impure recrystallized dolomitic limestones. Common pyroxene also occurs in some gneisses. In the limestones, pyroxene is often associated with tremolite, scapolite, vesuvianite, garnet, titanite, phlogopite, etc. In igneous rocks it is found with orthoclase, the plagioclase feldspars, nephelite, chrysolite, leucite, amphibole, magnetite, etc. Some of the notable localities, particularly for fine crystals, are the following: For diopside, Ala, Piedmont; Traversella; Nordmark, Sweden; in various localities in Orange County, New York; for augite, in the lavas of Vesuvius; at Fassathal, Tyrol; Bilin, Bohemia; hedenbergite from Sweden and Norway; schefferite from Sweden; jeffersonite from Franklin, New Jersey.

**Names.** The name *pyroxene*, *stranger to fire*, is a misnomer, and was given to the mineral because it was thought that it did not occur in igneous rocks. *Diopside* comes from two Greek words meaning *double appearance*. *Augite* comes from a Greek word meaning *luster*.

**Use.** Clear green diopside or common pyroxene is occasionally used as a gem material.

### Ægirite or Acmite.

A soda-ferric iron pyroxene,  $\text{NaFe}''(\text{SiO}_3)_2$ . Monoclinic. Slender prismatic crystals, often with steep terminations. Faces often imperfect. Imperfect prismatic cleavage with  $93^\circ$  angle. H. = 6–6.5. G. = 3.5–3.55. Vitreous luster. Color brown or green. Translucent to opaque. Fusible at 3.5, giving yellow sodium flame. Fused globule slightly magnetic. A comparatively rare rock-making mineral found chiefly in nephelite-syenite and phonolite.

### Spodumene.

**Composition.** Lithium-aluminium metasilicate,  $\text{LiAl}(\text{SiO}_3)_2 =$  Silica 64.5, alumina 27.4, lithia 8.4. Usually has a small amount of sodium replacing the lithium.

**Crystallization.** Monoclinic. Prismatic crystals, flattened frequently parallel to the orthopinacoid. Deeply striated vertically (see Fig. B, pl. X). Crystals usually coarse and with roughened faces. Sometimes very large.

**Structure.** In crystals or cleavable masses.

**Physical Properties.** Perfect prismatic cleavage.  $H. = 6.5-7$ .  $G. = 3.18$ . Vitreous luster. Color white, gray, pink, yellow, green. Transparent to translucent when unaltered.

**Tests.** Fusible at 3.5, throwing out fine branches at first, and then fusing to a clear glass. Gives a crimson flame (lithium). Insoluble in acids.

**Varieties.** *Ordinary.* Color white or gray, sometimes pink. Commonly in flattened prismatic crystals, often very large. Frequently altered to other minerals.

*Hiddenite.* A clear, transparent variety ranging in color from yellow-green to deep emerald. Found in small striated and etched crystals.

*Kunzite.* A transparent variety ranging from pale pink to deep amethystine purple. Has been found in flattened crystals 8 to 10 inches in length, 5 to 6 in breadth.

**Alteration.** Spodumene very easily alters to other species, becoming dull and opaque. The alteration products include albite, eucryptite ( $LiAlSiO_4$ ), muscovite, microcline.

**Occurrence.** A comparatively rare species, but found occasionally in very large crystals in pegmatite veins. Occurs at Goshen, Chesterfield, Chester, Huntington and Sterling, Massachusetts; Branchville, Connecticut; Etta tin mine, Pennington County, South Dakota, in crystals measuring many feet in length. Hiddenite occurs with emerald beryl at Stony Point, Alexander County, North Carolina. Kunzite is found with pink beryl in San Diego County, California.

**Names.** *Spodumene* comes from a Greek word meaning *ash colored*. *Hiddenite* is named for Mr. W. E. Hidden; *kunzite* for Dr. G. F. Kunz.

**Use.** The varieties hiddenite and kunzite furnish very beautiful gem stones but are limited in their occurrence.

### Jadeite.

A sodium-aluminium metasilicate,  $NaAl(SiO_3)_2$ . Massive, granular to closely compact.  $H. = 6.5-7$ .  $G. = 3.33-3.35$ . Vitreous luster. Color white, gray to light green. Translucent to opaque. Very tough. Fuses at 2.5, coloring the flame yellow (sodium). Forms in part the material known as jade and highly prized by oriental peoples as an ornamental material. Made into finely carved

ornaments and utensils, and when of fine color and translucent commands a high price. Found chiefly in Upper Burmah, in southern China and in Thibet.

### Wollastonite.

**Composition.** Calcium metasilicate,  $\text{CaSiO}_3$  = Silica 51.7, lime 48.3.

**Crystallization.** Monoclinic. Usually in tabular crystals, with either base or orthopinacoid prominent.

**Structure.** Commonly massive, cleavable to fibrous; also compact.

**Physical Properties.** Perfect cleavage parallel to orthopinacoid.  $H. = 5-5.5$ .  $G. = 2.8-2.9$ . Vitreous luster, pearly on cleavage surfaces. Sometimes silky when fibrous. Colorless, white or gray. Translucent to opaque.

**Tests.** Fusible at 4 to a white, almost glassy globule. Decomposed by hydrochloric acid, with the separation of silica but without the formation of a jelly. Filtered solution with ammonium hydroxide and ammonium carbonate gives white precipitate of calcium carbonate.

**Occurrence.** Commonly found in crystalline limestones which have been metamorphosed either through the heat and pressure attendant upon the intrusion into them of igneous rocks or upon movements of the earth's crust. An impure limestone, containing quartz for instance, under these conditions will become crystalline, and new minerals, such as wollastonite, be formed. Associated with calcite, diopside, lime garnet, tremolite, lime feldspars, vesuvianite, epidote, etc. May at times be so plentiful as to constitute the chief mineral of the rock mass. Such wollastonite rocks are found in California, the Black Forest, Brittany, etc. More rarely found in feldspathic schists.

### Pectolite.

**Composition.**  $\text{HN a C a}_2(\text{Si O}_3)_3$  = Silica 54.1, lime 33.8, soda 9.3, water 2.7.

**Crystallization.** Monoclinic. Crystals usually elongated parallel to the ortho-axis.

**Structure.** Usually in aggregates of acicular crystals. Frequently radiating, with fibrous appearance. Sometimes compact.



**Physical Properties.** Perfect cleavage parallel to the orthopinacoid.  $H. = 5$ .  $G. = 2.7-2.8$ . Vitreous to pearly luster. Colorless, white or gray.

**Tests.** Fuses quietly at 2.5-3 to a glass; colors flame yellow (sodium). Decomposed by hydrochloric acid, with the separation of silica but without the formation of a jelly. Filtered solution with ammonium hydroxide and ammonium carbonate gives white precipitate of calcium carbonate. Water in C. T.

**Occurrence.** A mineral of secondary origin similar in its occurrence to the zeolites. Found lining amygdaloidal cavities in basalt, associated with various zeolites, phrenite, calcite, etc. Found at Bergen Hill and West Paterson, New Jersey.

### TRICLINIC SECTION.

#### Rhodonite.

**Composition.** Manganese metasilicate,  $MnSiO_3 =$  Silica 45.9, manganese protoxide 54.1. Iron, calcium and sometimes zinc replace a part of the manganese.

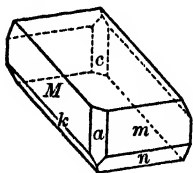


Fig. 303. Franklin Furnace, New Jersey.

**Crystallization.** Triclinic. Crystals commonly tabular parallel to base (Fig. 303). Crystals often rough with rounded edges.

**Structure.** Commonly massive, cleavable to compact; in embedded grains.

**Physical Properties.** Prismatic cleavage at about  $92^\circ$ .  $H. = 6-6.5$ .  $G. = 3.63$ . Vitreous luster. Color rose-red, pink, brown. Translucent to opaque.

**Tests.** Fusible (3-3.5) to a nearly black glass. Insoluble in hydrochloric acid. In O. F. gives clear reddish violet color to borax bead.

**Occurrence.** Found at Langbän, Sweden, with iron ore; found in large masses near Ekaterinburg, Urals; from Broken Hill, New South Wales. A zinciferous variety, known as *fowlerite*, occurs in good-sized crystals in limestone with franklinite, willemite, zincite, etc., at Franklin Furnace, New Jersey.

**Name.** Derived from the Greek word for a *rose*, in allusion to the color.

**Use.** Sometimes polished for use as an ornamental stone. Obtained chiefly from the Urals.

### AMPHIBOLE GROUP.

The minerals of the Amphibole Group crystallize in either the orthorhombic, monoclinic or triclinic systems, but the crystals of the different species are closely similar in many respects. Chemically they form a series parallel to that of the Pyroxene Group (page 230), being metasilicates with calcium, magnesium and ferrous iron as important bases, and also with manganese and the alkalis. Certain molecules that are present in some varieties contain aluminium and ferric iron.

### ORTHORHOMBIC SECTION.

#### Anthophyllite.

An orthorhombic amphibole, corresponding to the orthorhombic pyroxene group, enstatite—bronzite—hypersthene. An iron-magnesium metasilicate,  $(\text{Mg,Fe})\text{SiO}_3$ . Rarely in distinct crystals. Commonly lamellar or fibrous. Perfect prismatic cleavage. Color gray to various shades of green and brown. A comparatively rare mineral, occurring in mica-schist, etc.

#### Amphibole.

**Composition.** The amphiboles consist of a series of minerals analogous in many ways to the pyroxenes. They are chiefly metasilicates of calcium and magnesium with ferrous iron replacing the magnesium. Other molecules are at times introduced, in which are the alkalis, aluminium and ferric iron. The more important varieties of amphibole with the formulas assigned to them follow.

*Tremolite*,  $\text{CaMg}_3(\text{SiO}_3)_4$ .

*Actinolite*,  $\text{Ca}(\text{Mg,Fe})_3(\text{SiO}_3)_4$ .

*Hornblende*,  $\text{CaMg}_2(\text{SiO}_3)_4$  with  $\text{Na}_2\text{Al}_2(\text{SiO}_3)_2$  and  $\text{Mg}_2\text{Al}_2(\text{SiO}_3)_2$ . Ferrous iron is isomorphous with the magnesium and ferric iron with the aluminium.

These varieties form an isomorphous series and all gradations between them occur.

**Crystallization.** Monoclinic. Crystals prismatic in habit; the prism faces make angles of  $55^\circ$  and  $125^\circ$  with each other (compare the  $87^\circ$  and  $93^\circ$  angles of pyroxene). The prism zone shows, in addition to the prism faces, usually those of the clinopinacoid and sometimes also those of the orthopinacoid.

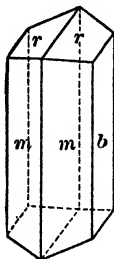


Fig. 304.

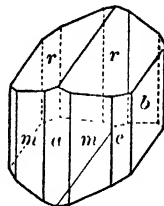


Fig. 305.

Prism zone frequently vertically striated and imperfectly developed. When the prism faces are distinct, the cross section of the crystal, when viewed in a direction parallel to the vertical axis, does not have the rectangular shape shown by the crystals of pyroxene. The termination of the crystals is almost always formed by the two faces of a low clinodome (Figs. 304 and 305).

**Structure.** In crystals. Often bladed and frequently in radiating columnar aggregates. Sometimes in silky fibers. Coarse to fine granular. Compact.

**Physical Properties.** Perfect prismatic cleavage at angle of  $125^\circ$ , often yielding a splintery surface.  $H. = 5-6$ .  $G. = 3-3.3$ . Vitreous luster. Often with silky sheen in the prism zone. Color varying from white and light green in tremolite, to green in actinolite, through dark green to black in hornblende. Color deepens with increase in the amount of iron present. Transparent to opaque.

**Tests.** Fusible 3-4. Chemical tests same as for pyroxene, which see. Told from pyroxene by its better prismatic cleavage,

by the difference in the prismatic angle and by the characteristic presence on the crystals of the low clinodome.

**Occurrence.** Amphibole is an important and widely distributed rock-making mineral, occurring both in igneous and metamorphic rocks, being particularly characteristic, however, of the latter. The fact that amphibole frequently contains hydroxyl and fluorine indicates that, in some degree, it is often of pneumatolytic origin. Tremolite is most frequently found in impure, crystalline, dolomitic limestones, where it has been formed during the crystallization of the rock, while undergoing metamorphism. Actinolite commonly occurs in the crystalline schists, being often the chief constituent of green-colored hornblende-schists and greenstones. Frequently the amphibole of such rocks has had its origin in the pyroxene contained in the igneous rock from which the metamorphic type has been derived. Common hornblende is found in igneous rocks, such as granites, syenites, diorites, gabbros, and in some peridotites; it rarely occurs in the dark traps and basalts. It also occurs in the metamorphic rocks, such as gneisses and hornblende schists.

Notable localities for the occurrence of crystals are: tremolite from Campolongo, Tessin; from Russell, Gouverneur, Amity, Pierrepont, De Kalb, etc., New York; actinolite from Greiner, Zillertal, Tyrol; hornblende from Bilin, Bohemia; Monte Somma, Italy. Actinolite frequently comes fibrous, and is the material to which the name *asbestos* was originally given. Has been found in the metamorphic rocks in various states along the Appalachian Mountains. *Nephrite* is a tough, compact variety of actinolite which supplies much of the material known as *jade* (see also under jadeite). A famous locality for its occurrence is in the Kuen Lun Mountains, on the southern border of Turkestan.

**Names.** *Tremolite* is derived from the Tremola Valley near St. Gothard. *Actinolite* comes from two Greek words meaning *a ray* and *stone*, in allusion to its frequently somewhat radiated structure.

**Uses.** The fibrous variety is used to some extent as asbestos material. The fibrous variety of serpentine furnishes more and usually a better grade of asbestos. The compact variety, nephrite, is used largely for ornamental material by oriental peoples and is called jade.

Among the other rarer monoclinic members of the *Amphibole Group* are *glaucofane*,  $\text{NaAl}(\text{SiO}_3)_2(\text{Fe,Mg})\text{SiO}_3$ ;

*riebeckite*,  $2\text{NaFe}(\text{SiO}_3)_2 \cdot \text{FeSiO}_3$ ; *crocidolite*,  $\text{NaFe}(\text{SiO}_3)_2 \cdot \text{FeSiO}_3$ ;  
*arfvedsonite*,  $\text{Na}_3(\text{Ca, Mg})_3(\text{Fe, Mn})_{14}(\text{Al, Fe})_2\text{Si}_{21}\text{O}_{48}$ .

### TRICLINIC SECTION.

The only member of the *Triclinic Section* of the *Amphibole Group* is the rare mineral *enigmatite*,  $\text{Na}_4\text{Fe}_2\text{AlFe}''(\text{Si, Ti})_{12}\text{O}_{38}$ .

### Beryl.

**Composition.**  $\text{Be}_3\text{Al}_2\text{Si}_6\text{O}_{18}$ . Analyses show a small amount of water. Small amounts of the alkali oxides, often in part consisting of caesium oxide, frequently replace the beryllium oxide.

**Crystallization.** Hexagonal. Strong prismatic habit. Frequently vertically striated and grooved. Forms usually present

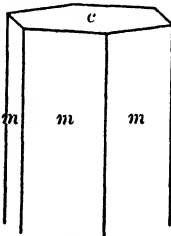


Fig. 306.

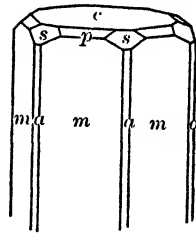


Fig. 307.

consist only of prism of first order and base (Fig. 306). Small pyramid faces of both the first and second orders sometimes occur, but the pyramid faces are rarely prominent (Fig. 307). Dihexagonal forms quite rare. Crystals frequently of considerable size with rough faces.

**Structure.** In crystals. Also massive, with indistinct columnar structure or granular.

**Physical Properties.** H. = 7.5–8. G. = 2.75–2.8. Vitreous luster. Color commonly bluish green or light yellow; may be deep emerald-green, golden yellow, pink, white or colorless. Transparent to subtranslucent. Frequently the larger, coarser

crystals show a mottled appearance due to the alternation of clear transparent spots with cloudy, almost opaque portions.

**Tests.** B. B. whitens and fuses with difficulty at 5-5.5 to an enamel. Yields a little water on intense ignition. Insoluble in acids. Recognized usually by its hexagonal crystals, its hardness, color, etc.

**Varieties.** *Ordinary Beryl.* In coarse translucent to opaque crystals or masses, usually of a pale greenish blue or yellow color. Sometimes in very large crystals; one from Grafton, New Hampshire, measured over 4 feet in length with a diameter between 20 and 30 inches, weight 2900 pounds.

*Aquamarine.* Name given to the pale greenish blue transparent stone. Used as a gem.

*Golden Beryl.* A deep golden yellow variety, which, when clear, is used as a gem.

*Rose Beryl.* A variety varying in color from pale pink to deep rose. Beautiful gem material from Madagascar has been named *morganite*.

*Emerald.* The true emerald is the deep green transparent beryl and is among the most highly prized of gems. The color is due to small amounts of chromium.

**Occurrence.** Beryl, although containing the rare element beryllium, is a rather common and widely distributed mineral. It occurs usually as an accessory mineral in pegmatite veins. It is also found in clay-slate and mica-schist. Emeralds of gem quality occur in a dark bituminous limestone at Musa, 75 miles northwest of Bogota, United States of Colombia. This locality has been worked almost continually since the middle of the sixteenth century, and has furnished the greater part of the emeralds of the world. Another famous locality for emeralds is in Siberia on the river Takovaya, 45 miles east of Ekaterinburg. They occur in a mica-schist associated with phenacite, chrysoberyl, rutile, etc. Rather pale emeralds have been found in small amount from Alexander County, North Carolina, associated with the green variety of spodumene, hiddenite. Beryl of the lighter aquamarine color is much more common, and is found in gem quality in Brazil, Siberia, and many other localities. In the United States they have been found in various places in Maine, New Hampshire, Massachusetts, Connecticut, North Carolina, Colorado, etc. The golden beryl has been found in Maine, Connecticut, North Carolina and Pennsylvania; also in Siberia and Ceylon.

The rose-colored beryl has been found in San Diego County, California, associated with pink tourmaline and the pink spodumene, kunzite. A similar occurrence in Madagascar has furnished magnificent rose-colored stones (morganite).

**Use.** Used as a gem stone of various colors. The emerald ranks as one of the most valuable of stones, at times being of much greater value than the diamond. Perfect and deeply colored stones have been sold as high as \$1000 per carat. Aquamarines range in value from \$1 to \$15 a carat. Golden beryls bring from \$1 to \$10 a carat. The rose beryl is valued from \$5 to \$20 a carat.

### Iolite. Cordierite.

A complex silicate of magnesium, ferrous iron and aluminium. Orthorhombic. Usually in short pseudo-hexagonal twinned crystals; as embedded grains; massive. Vitreous luster. Color different shades of blue. Most commonly altered into some form of mica, becoming opaque and of various shades of grayish green. Found as an accessory mineral in granite, gneiss (cordierite gneiss), schists, etc.

## 3. ORTHOSILICATES.

### Nephelite.

**Composition.** Sodium-aluminium silicate, approximately  $\text{NaAlSi}_3\text{O}_8$ . There is always a few per cent of potash present, sometimes also lime, replacing the soda.

**Crystallization.** Hexagonal. Rarely in small prismatic crystals with basal plane; sometimes shows pyramidal planes.

**Structure.** Almost invariably massive, compact, and in embedded grains. Massive variety often called *elæolite*.

**Physical Properties.** Distinct cleavage parallel to prism.  $H. = 5.5-6$ .  $G. = 2.55-2.65$ . Vitreous luster in the clear crystals to greasy luster in the massive variety. Colorless, white or yellowish. In the massive variety gray, greenish and reddish. Transparent to opaque.

**Tests.** Fusible at 4 to a colorless glass. B. B. gives strong yellow flame of sodium. Readily soluble in hydrochloric acid and on evaporation yields a silica jelly.

**Alteration.** Easily alters into various other minerals, such as the zeolites, natrolite, analcite, hydronephelite, thomsonite; also sodalite, muscovite, kaolin, etc.

**Occurrence.** Nephelite is rarely found except in igneous rocks. It occurs in some recent lavas as glassy crystals, such as are found in the lavas of Vesuvius. The opaque, massive or coarsely crystalline variety is found in the older rocks and is called *elæolite*. Phonolite, *elæolite-syenite* and nephelite-basalt are important rocks in which nephelite is an essential constituent. It is only to be found in rocks whose magmas contained an excess of soda over the amount required to form feldspar. It is therefore seldom found in rocks that contain free quartz. Extensive masses of nephelite rocks, *elæolite-syenites*, are found in Norway. Massive and crystallized nephelite is found at Litchfield, Maine, associated with cancrinite. Found at Magnet Cove, Arkansas.

**Name.** *Nephelite* is derived from a Greek work meaning a *cloud*, because when immersed in acid the mineral becomes cloudy. *Elæolite* is derived from the Greek word for *oil*, in allusion to its greasy luster.

*Cancrinite*,  $H_6Na_6Ca(NaCO_3)_2Al_8(SiO_4)_9$ , is a rare mineral similar to nephelite in occurrence and associations.

## SODALITE GROUP.

### Sodalite.

Composition,  $Na_4(AlCl)Al_2(SiO_4)_3$ . Isometric. Crystals rare, usually dodecahedrons. Commonly massive, in embedded grains. Dodecahedral cleavage. H. = 5.5-6. G. = 2.15-2.3. Vitreous luster. Color usually blue, also white, gray, green. Transparent to opaque. Fusible at 3.5-4, to a colorless glass, giving a strong yellow flame (sodium). Soluble in hydrochloric acid and gives gelatinous silica upon evaporation. Nitric acid solution with silver nitrate gives white precipitate of silver chloride. A comparatively rare rock-making mineral associated with nephelite, cancrinite, etc., in nephelite-syenites, trachytes, phonolites, etc. Found in transparent crystals in the lavas of Vesuvius. Similar minerals, but rarer in their occurrence, are *haiynite*,  $(Na_2.Ca)_2(Al.NaSO_4)Al_2(SiO_4)_3$ , and *noselite*,  $Na_4(NaSO_4.Al)Al_2(SiO_4)_3$ .

### Lazurite. Lapis-lazuli.

Composition,  $Na_4(Al.NaS_3)Al_2(SiO_4)_3$ , with small amounts of the sodalite and haiynite molecules in isomorphous replacement. Iso-



metric. Crystals rare, usually dodecahedral. Commonly massive, compact. H. = 5-5.5. G. = 2.4-2.45. Vitreous luster. Color deep azure-blue, greenish blue. Translucent. Fusible at 3.5, giving strong yellow flame (sodium). Soluble in hydrochloric acid with slight evolution of hydrogen sulphide gas, and gives gelatinous silica upon evaporation. A rare mineral, occurring usually in crystalline limestones as a product of contact metamorphism. Lapis-lazuli is usually a mixture of lazurite with small amounts of calcite, pyroxene, etc. It commonly contains small disseminate particles of pyrite. It is used as an ornamental stone, for carvings, etc. The best quality of lapis-lazuli comes from northeastern Afghanistan. Also found at Lake Baikal, Siberia, and in Chile.

### GARNET GROUP.

**Composition.** The garnets are orthosilicates which conform to the general formula  $R_3''R_2'''(\text{SiO}_4)_3$ .  $R''$  may be calcium, magnesium, ferrous iron and manganese;  $R'''$  may be aluminium, ferric iron and chromium. The formulas of the chief varieties are given below; many of them, however, grade more or less into each other.

<i>Grossularite</i> ,	$\text{Ca}_3\text{Al}_2(\text{SiO}_4)_3$ .
<i>Pyrope</i> ,	$\text{Mg}_3\text{Al}_2(\text{SiO}_4)_3$ .
<i>Almandite</i> ,	$\text{Fe}_3\text{Al}_2(\text{SiO}_4)_3$ .
<i>Spessartite</i> ,	$\text{Mn}_3\text{Al}_2(\text{SiO}_4)_3$ .
<i>Andradite</i> ,	$\text{Ca}_3\text{Fe}_2(\text{SiO}_4)_3$ .
<i>Uvarovite</i> ,	$\text{Ca}_3(\text{Cr},\text{Al})_2(\text{SiO}_4)_3$ .

**Crystallization.** Isometric. Common forms dodecahedron (Fig. 308) and trapezohedron (Fig. 309), often in combination (Figs. 310 and 311). Hexoctahedron observed at times (Fig. 312). Other forms rare.

**Structure.** Usually distinctly crystallized; also in rounded grains; massive granular, coarse or fine.

**Physical Properties.** H. = 6.5-7.5. G. = 3.15-4.3, varying with the composition. Luster vitreous to resinous. Color varying with composition; most commonly red, also brown, yellow, white, green, black. White streak. Transparent to almost opaque.

**Tests.** With the exception of uvarovite, all garnets fuse at 3 to 3.5; uvarovite is almost infusible. The iron garnets, alman-

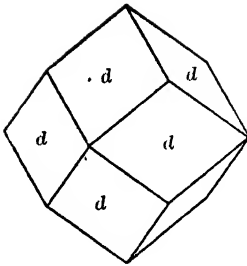


Fig. 308.

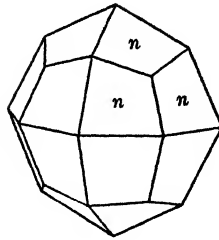


Fig. 309.

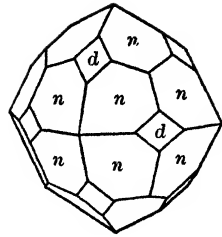


Fig. 310.

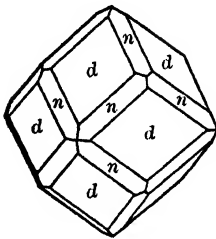


Fig. 311.

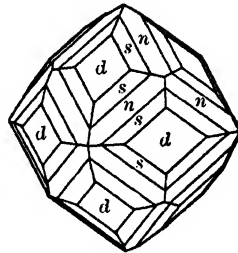


Fig. 312.

dite and andradite, fuse to magnetic globules. Spessartite when fused with sodium carbonate gives a bluish green bead (manganese). Uvarovite gives a green color to salt of phosphorus bead (chromium). Andradite is somewhat difficultly soluble in hydrochloric acid and gelatinizes imperfectly on evaporation. All the other garnets are practically insoluble in acids. All of them, with the exception of uvarovite, may be dissolved in hydrochloric acid after simple fusion and the solutions will gelatinize on evaporation. Garnets are usually recognized by their characteristic isometric crystals, their hardness, color, etc. It frequently requires an analysis to positively distinguish between the different members of the group.

**Varieties.** *Grossularite, Essonite, Cinnamon Stone.* Calcium-aluminium garnet. Often contains ferrous iron replacing calcium and ferric iron replacing aluminium. Color white, green,

yellow, cinnamon-brown, pale red. Name derived from the botanical name for gooseberry, in allusion to the light green color of the original grossularite.

*Pyrope.* Precious garnet in part. Magnesium-aluminium garnet. Calcium and iron also present. Color deep red to nearly black. Often transparent and then used as a gem. Name derived from Greek, meaning *firelike*. *Rhodolite* is name given to a pale rose-red or purple garnet, corresponding in composition to two parts of pyrope and one of almandite.

*Almandite.* Precious garnet in part. Common garnet in part. Iron-aluminium garnet. Ferric iron replaces aluminium and magnesium replaces ferrous iron. Color fine deep red, transparent in precious garnet; brownish red, translucent to opaque in common garnet. Name derived from Alabanda, where in ancient times garnets were cut and polished.

*Spessartite.* Manganese-aluminium garnet. Ferrous iron replaces the manganese and ferric iron the aluminium. Color brownish to garnet-red.

*Andradite.* Common garnet in part. Calcium-iron garnet. Aluminium replaces the ferric iron; ferrous iron, manganese and sometimes magnesium replace the calcium. Color various shades of yellow, green, brown to black. Named after the Portuguese mineralogist, d'Andrada.

*Uvarovite.* Calcium-chromium garnet. Color emerald-green. Named after Count Uvarov.

**Occurrence.** Garnet is a common and widely distributed mineral, occurring as an accessory constituent of metamorphic and sometimes of igneous rocks. Its most characteristic occurrence is in mica-schists (see Fig. C, pl. X), hornblende-schists and gneisses. Found in pegmatite veins, more rarely in granite rocks. Grossularite is found chiefly as a product of contact or regional metamorphism in crystalline limestones. Pyrope is often found in peridotite rocks and the serpentines derived from them. Spessartite occurs in the igneous rock, rhyolite. *Melanite*, a black variety of andradite, occurs mostly in certain eruptive rocks. Uvarovite is found in serpentine associated with chromite. Garnet frequently occurs as rounded grains in stream- and sea-sands.

Almandite, of gem quality, is found in northern India, Brazil, Australia, and in several localities in the Alps. Fine crystals, al-

though for the most part too opaque for cutting, are found in a mica-schist on the Stickeen River, Alaska. Pyrope of gem quality is found associated with clear grains of chrysolite (peridot) in the surface sands near Fort Defiance, close to the Utah-Arizona state line. Famous localities for pyrope gems are near Teplitz and Bilin, Bohemia. Grossularite is only a little used in jewelry, but essonite or cinnamon stones of good size and color are found in Ceylon. A green andradite, known as *demantoid*, comes from the Urals and yields fine gems known as *Uralian emeralds*.

**Alteration.** Garnet often alters to other minerals, particularly talc, serpentine and chlorite.

**Name.** *Garnet* is derived from the Latin *granatus*, meaning like a grain. *Carbuncle*, an old name for garnet and other red stones, was derived from the Latin word *carbo*, *coal*, and is used at present to designate garnets cut in oval form.

**Use.** Chiefly as a rather inexpensive gem stone. Sometimes ground and used on account of its hardness for abrading purposes, as sand for sawing and grinding stone, or for making sand-paper.

## CHRYSLITE GROUP.

### Chrysolite or Olivine. Peridot.

**Composition.** Orthosilicate of magnesium, with varying amounts of ferrous iron,  $(Mg,Fe)_2SiO_4$ . The ratio between the magnesium and iron varies widely.

**Crystallization.** Orthorhombic. Crystals usually a combination of prism, macro- and brachypinacoids and domes, pyramid and base. Often flattened parallel to either the macro- or brachypinacoid.

**Structure.** Usually in embedded grains or in granular masses.

**Physical Properties.** H. = 6.5-7. G. = 3.27-3.37. Vitreous luster. Olive to grayish green, brown. Transparent to translucent.

**Tests.** Infusible. Rather slowly soluble in hydrochloric acid and yields gelatinous silica upon evaporation. After evaporation to dryness, take up residue in water with nitric acid, filter

off silica, add ammonia in excess to precipitate ferric hydroxide, filter, add ammonium oxalate to prove absence of calcium, add sodium phosphate and obtain precipitate of ammonium-magnesium phosphate (test for magnesium). Distinguished usually by its glassy luster, green color and granular structure.

**Occurrence.** A rather common rock-making mineral, varying from an accessory character to that of a main constituent of the rock. It is found principally in the dark colored ferro-magnesium igneous rocks such as gabbro, peridotite and basalt. A rock, known as dunite, is made up almost wholly of chrysolite. Found also at times as glassy grains in meteorites. Occasionally in crystalline dolomitic limestones. Associated often with pyroxene, the plagioclase feldspars, magnetite, corundum, chromite, serpentine, etc. The transparent green variety, known as *peridot*, and used as a gem material, was found in ancient times in the East, the exact locality for the stones not being known. At present peridot is found in Upper Egypt, near the Red Sea, and in rounded grains associated with pyrope garnet in the surface gravels of Arizona and New Mexico. Crystals of chrysolite are found in the lavas of Vesuvius. Larger crystals, altered to serpentine, come from Snarum, Norway. Chrysolite occurs in granular masses in the volcanic bombs in the Eifel. Dunite rocks are found at Dun Mountain, New Zealand, and with the corundum deposits of North Carolina.

**Alteration.** Very readily altered to serpentine; magnesium carbonate, iron ore, etc., may form at the same time.

**Name.** Chrysolite means *golden stone*. Olivine derives its name from the usual olive-green color of the mineral, and is the term usually given to the species when speaking of it as a rock-making mineral. *Peridot* is an old name for the species.

**Use.** As the clear green variety, known usually as peridot, it has some use as a gem. A one-carat stone may be valued up to \$5.

Other members of the *Chrysolite Group* which are rarer in occurrence are *Monticellite*,  $\text{CaMgSiO}_4$ ; *fosterite*,  $\text{Mg}_2\text{SiO}_4$ ; and *fayalite*,  $\text{Fe}_2\text{SiO}_4$ . Ordinary chrysolite is intermediate in composition between the last two. Another member which has been found in the zinc deposits at Franklin Furnace, New Jersey, is *tephroite*,  $\text{Mn}_2\text{SiO}_4$ .

**PHENACITE GROUP.****Willemite.**

**Composition.** Zinc orthosilicate,  $Zn_2SiO_4$  = Silica 27, zinc oxide 73, zinc 58.6. Manganese often replaces a considerable part of the zinc (manganiferous variety called *troostite*), iron also present at times in small amount.

**Crystallization.** Hexagonal-rhombohedral; tri-rhombohedral. In hexagonal prisms with rhombohedral terminations. Faces of third-order rhombohedrons rare.

**Structure.** Usually massive to granular. Rarely crystallized except in variety *troostite*.

**Physical Properties.** H. = 5.5. G. = 3.89–4.18. Vitreous to resinous luster. Color white, yellow-green, blue, when pure; with increase of manganese becomes apple-green, flesh-red and brown. Transparent to opaque.

**Tests.** Willemite infusible, *troostite* difficultly fusible (4.5–5). Soluble in hydrochloric acid and yields gelatinous silica on evaporation. Gives a coating of zinc oxide when heated with sodium carbonate on charcoal; coating yellow when hot, white when cold; if coating is moistened with cobalt nitrate and heated again it turns green. *Troostite* will give reddish violet color to the borax bead in O. F. (manganese).

**Varieties.** *Ordinary.* White or light colored.

*Troostite.* Apple-green, flesh-red or gray color. Contains a considerable amount of manganese. Found at Franklin Furnace, New Jersey, in quite large crystals.

**Occurrence.** Found at Altenberg, near Moresnet, Belgium, and at Franklin Furnace, New Jersey. At the latter locality it is associated with franklinite and zincite, often in an intimate mixture; also embedded in calcite. Occurs sparingly at Merritt Mine, New Mexico.

**Use.** A valuable zinc ore.

**Phenacite.**

Beryllium orthosilicate,  $Be_2SiO_4$ . Hexagonal-rhombohedral; tri-rhombohedral. Crystals usually rhombohedral in form, sometimes with short prisms. Often with complex development and fre-

quently showing the faces of the third-order rhombohedron. Prismatic cleavage.  $H. = 7.5-8$ .  $G. = 2.96$ . Vitreous luster. Colorless, white. Transparent to translucent. Infusible and insoluble. A rare mineral, found associated usually with topaz, chrysoberyl, beryl, apatite, etc. Fine crystals are found at the emerald mines in the Urals, at Pike's Peak and Mount Antero, Colorado, and in Minas Geraes, Brazil. Occasionally cut as a gem stone.

*Dioptase*,  $H_2CuSiO_4$ , is a rare mineral belonging in this group.

### SCAPOLITE GROUP.

A group of minerals varying in composition by the isomorphous mixture in different amounts of the two molecules,  $Ca_4Al_6Si_6O_{25}(Me)$  and  $Na_4Al_3Si_3O_{24}Cl(Ma)$ . When the first molecule (*Me*) alone is present, the subname of *meionite* is used; when the second molecule (*Ma*) represents the composition, the name *marialite* is used. *Wernerite*, or *common scapolite*, shows a combination of the two molecules according to the ratios of *Me* : *Ma* as 3 : 1 to 1 : 2; while *mizzonite* corresponds to the ratios of *Me* : *Ma* as 1 : 2 to 1 : 3. Mixtures in all proportions may exist.

#### Wernerite. Common Scapolite.

**Composition.** See above.

**Crystallization.** Tetragonal; tripyramidal. Crystals usually prismatic. Prominent forms are prisms of the first and second

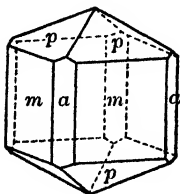


Fig. 313.

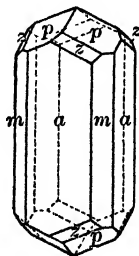


Fig. 314.

orders, pyramid of first (Fig. 313). Rarely shows the faces of the pyramid of the third order (Fig. 314).

**Structure.** Crystals are usually coarse, with rough faces and often large. Also massive, granular, or with faint fibrous appearance.

**Physical Properties.** Imperfect prismatic cleavage.  $H.=5-6$ .  $G.=2.68$ . Vitreous luster when fresh and unaltered. Color white, gray or pale green. Transparent to opaque.

**Tests.** Fusible. Varieties containing sodium give yellow flame on ignition. Imperfectly decomposed by hydrochloric acid, yielding separated silica but without the formation of a jelly.

**Alteration.** Easily altered into various other minerals, such as mica, epidote, talc, kaolin, etc.

**Occurrence.** The scapolites occur in the crystalline schists, gneisses and amphibolites, and in many cases have probably been derived by alteration from plagioclase feldspars. They also characteristically occur in crystalline limestones formed through the contact metamorphic action of an intruded igneous rock. Associated with light colored pyroxene, amphibole, garnet, apatite, titanite, zircon, etc. Found in various places in Massachusetts; Orange, Essex, Lewis, Jefferson and St. Lawrence counties, New York; at Grenville, Templeton, Algona, etc., Canada.

The other members of the group, *meionite*, *mizzonite* and *marialite*, are much rarer in occurrence. Their crystals are usually smaller and of better quality than those of wernerite. Meionite and missonite are found in limestone blocks on Monte Somma.

---

### Vesuvianite.

**Composition.** A basic silicate of calcium and aluminium. Contains usually also iron oxides, magnesia and fluorine. Formula uncertain.

**Crystallization.** Tetragonal. Prismatic in habit. Often vertically striated. Common forms are prisms of first and second orders, pyramid of first order and base (Figs. 315 and 316). Some crystals show a more complex development with other prisms, pyramids, ditetragonal forms, etc.



**Structure.** In crystals, also massive, columnar, granular.

**Physical Properties.** H. = 6.5. G. = 3.35–4.45. Vitreous to resinous luster. Usually green or brown in color; also yellow, blue, red. Commonly subtransparent to translucent. Streak white.

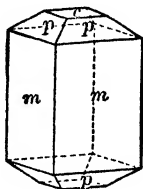


Fig. 315.

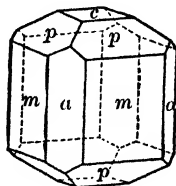


Fig. 316.

**Tests.** Fuses with intumescence to a greenish or brownish glass. Only slightly soluble in acids but gelatinizes in hydrochloric acid after simple fusion.

**Occurrence.** Usually to be found in crystalline limestones where they have been metamorphosed by the contact action of igneous rocks. Formed probably by the action upon impure limestone of hot vapors containing water and fluorine given off by the igneous rock. Associated with other contact minerals, such as garnet, pyroxene, tourmaline, chondrodite, etc. Was originally discovered in the ancient ejections of Vesuvius and in the dolomitic blocks of Monte Somma. Important localities are, Ala, Piedmont; Monzoni, Tyrol; Vesuvius; Christiansand, Norway; Achmatook, Urals; River Wilui, Siberia; in the United States, at Phippsburg and Rumford, Maine; near Amity, New York; Inyo County, California; in Canada at Litchfield, Pontiac County; at Grenville, Ontario; at Templeton, Quebec.

## ZIRCON GROUP.

### Zircon.

**Composition.**  $ZrSiO_4$  = Silica 32.8, zirconia 67.2.

**Crystallization.** Tetragonal. Crystals usually show a simple combination of prism and pyramid of the first order (Figs. 317

and 318). The prism of the second order and a ditetragonal pyramid also at times observed (Fig. 319). Base very rare.

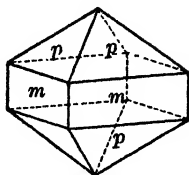


Fig. 317.

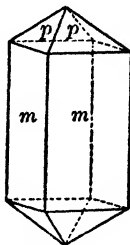


Fig. 318.

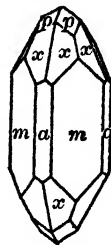


Fig. 319.

Crystal forms and axial ratio prove a close relationship between zircon and cassiterite and rutile.

**Structure.** Usually crystallized; also in irregular grains.

**Physical Properties.** H.=7.5. G.=4.68. Luster adamantine. Usually nearly opaque, sometimes transparent. Color commonly some shade of brown; also colorless, gray, green, red. Streak uncolored. High refractive index.

**Tests.** Infusible. A small fragment when intensely ignited glows and gives off a white light. When fused with sodium carbonate and fusion then dissolved in dilute hydrochloric acid, the solution will turn a piece of turmeric paper to an orange color (zirconium). Recognized usually by its characteristic crystals, color, luster, hardness and high specific gravity.

**Occurrence.** Zircon is a common and widely distributed accessory mineral in all classes of igneous rocks. It is especially frequent in the more acid types such as granite, syenite, diorite, etc. Very common in nephelite-syenite. It is the first one among the silicates to crystallize out from a cooling magma. Found also commonly in crystalline limestone, in gneiss, schist, etc. Found frequently as rounded pebbles in stream sands; often with gold. Gem zircons are found in the stream sands at Matura, Ceylon. Occurs in the gold gravels in the Urals, Australia, etc. Found in the nephelite-syenites of Norway and of Litchfield, Maine. In considerable quantity in the sands of Henderson and Buncombe counties, North Carolina.

**Use.** When transparent serves as a gem stone, valued usually at \$10 or less per carat. It is sometimes colorless, but more often of a brownish and red-orange color, called *hyacinth* or *jacinth*. The colorless, yellowish or smoky stones are called *jar-gon*, because while resembling the diamond they have little value; and thence the name *zircon*. Serves as the source of zirconium oxide, which with other rare oxides is used in the manufacture of the Welsbach incandescent mantle.

### Thorite.

Thorium silicate,  $\text{ThSiO}_4$ , always with some water, probably from alteration, and sometimes uranium. Tetragonal. Crystal forms resemble those of zircon. Also massive. Resinous to greasy luster.  $H. = 4.5-5$ .  $G. = 4.8-5.2$ . Color orange-yellow, brown, black. Transparent to opaque. Infusible. Soluble in hydrochloric acid and gives gelatinous silica upon evaporation. A rare mineral, found chiefly in Norway, commonly altered. For uses of thorium see under monazite.

## DANBURITE-TOPAZ GROUP.

### Danburite.

**Composition.** Calcium-boron silicate,  $\text{CaB}_2(\text{SiO}_4)_2$ .

**Crystallization.** Orthorhombic. Prismatic crystals, closely related to those of topaz in habit.

**Structure.** Commonly in crystals.

**Physical Properties.**  $H. = 7-7.25$ .  $G. = 2.97-3.02$ . Vitreous luster. Colorless or pale yellow. Transparent to translucent.

**Tests.** Fusible (3.5-4), giving a green flame. Insoluble in acids.

**Occurrence.** Found in crystals at Danbury, Conn.; Russell, New York; eastern Switzerland; Japan.

### Topaz.

**Composition.**  $(\text{Al.F})_2\text{SiO}_4$  with isomorphous  $(\text{Al.OH})_2\text{SiO}_4$ .

**Crystallization.** Orthorhombic. In prismatic crystals terminated by pyramids, domes and basal plane (Figs. 320, 321 and

322). Often highly modified (Fig. 323). Prism faces often vertically striated.

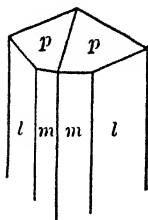


Fig. 320.

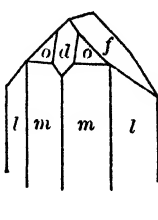


Fig. 321.

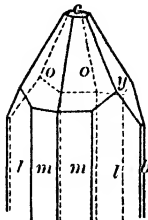


Fig. 322.

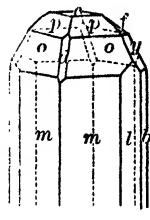


Fig. 323.

**Structure.** In crystalline masses; also granular, coarse or fine.

**Physical Properties.** Perfect basal cleavage.  $H. = 8$  (unusually high).  $G. = 3.52-3.57$ . Vitreous luster. Colorless, yellow, yellow-brown, pink, bluish, greenish. Transparent to translucent.

**Tests.** Infusible. Insoluble. Recognized chiefly by its crystals, its basal cleavage, its hardness (8) and high specific gravity.

**Occurrence.** A mineral formed through the agency of fluorine-bearing vapors given off during the last stages of the solidification of igneous rocks. Found in cavities in rhyolite lavas and granite; a characteristic mineral in pegmatite veins. Associated with other pneumatolytic minerals, as tourmaline, cassiterite, apatite, fluorite, etc.; also with quartz, mica, feldspar. Found at times as rolled pebbles in stream sands. Notable localities for its occurrence are the Nerchinsk district in Siberia in large wine-yellow crystals; from Adunchilon and Mursinka, Siberia, in pale blue crystals; from various tin localities in Saxony; from Minas Geraes, Brazil; Mino Province, Japan; San Luis Potosi, Mexico; Pike's Peak and Nathrop, Colorado; Thomas Range, Utah; Stoneham, Maine.

**Name.** Derived from the name of an island in the Red Sea but originally probably applied to some other species.

**Use.** As a gem stone. A number of other inferior stones are also frequently called topaz. The color of the stones varies, being colorless, wine-yellow, golden brown, pale blue and pink. The pink color is usually artificial, being produced by gently

heating the dark yellow stones; it is permanent, however. The value of topaz ranges up to \$10 for a one-carat stone.

### Andalusite. Chialstolite.

**Composition.** Aluminium silicate,  $\text{Al}_2\text{SiO}_5$  = Silica 36.8, alumina 63.2.

**Crystallization.** Orthorhombic. Usually in coarse, nearly square prisms. Closely related crystallographically to topaz.

**Structure.** In crystals; massive.

**Physical Properties.** H. = 7.5. G. = 3.16–3.20. Vitreous luster. Flesh-red, reddish brown, olive-green. Often with dark colored carbonaceous inclusions forming a cruciform design, lying parallel to the axial directions (variety *chialstolite* or *macle*) (see Fig. 324). Transparent to opaque. At times strongly dichroic, appearing, in transmitted light, green in one direction and red in another.

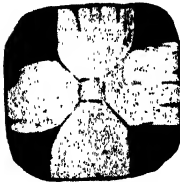


Fig. 324.  
Cross Section of Chialstolite Crystal.

**Tests.** Infusible. Insoluble. When fine powder is made into a paste with cobalt nitrate and intensely ignited it turns blue (aluminium).

**Occurrence.** Found in schists. Often impure and commonly, at least partly altered. Notable localities are in Andalusia, Spain; the Tyrol; in water-worn pebbles from Minas Geraes, Brazil. In the United States at Standish, Maine; Westford, Lancaster and Sterling, Massachusetts; Litchfield and Washington, Connecticut; Delaware County, Pennsylvania. Chialstolite is found in Morihan, Brittany; Bimbowrie, South Australia; and Massachusetts.

**Use.** When clear and transparent may serve as a gem stone.

### Sillimanite. Fibrolite.

An aluminium silicate like andalusite,  $\text{Al}_2\text{SiO}_5$ . An orthorhombic mineral, occurring in long slender crystals without distinct terminations; often in parallel groups; frequently fibrous. Perfect pinacoidal cleavage. H. = 6–7. G. = 3.23. Color hair-brown to pale green. Transparent to translucent. Infusible. Insoluble. A comparatively rare mineral, found as an accessory constituent of metamorphic rocks; gneiss, mica-schist, etc.

### Cyanite.

**Composition.** Aluminium silicate, like andalusite and sillimanite,  $Al_2SiO_5$ .

**Crystallization.** Triclinic. Usually in long tabular crystals; terminations rare.

**Structure.** In bladed forms.

**Physical Properties.** Perfect pinacoidal cleavage.  $H. = 5$  parallel to length of crystals, 7 at right angles to this direction.  $G. = 3.56-3.66$ . Vitreous to pearly luster. Color usually blue, often of darker shade toward the center of the crystal. Also at times white, gray or green.

**Tests.** Infusible. Insoluble. A fragment moistened with cobalt nitrate and ignited assumes a blue color (aluminium). Characterized by its bladed crystals, good cleavage, blue color and the fact that it is softer than a knife in the direction parallel to the length of the crystals but harder than a knife in the direction at right angles to this.

**Occurrence.** An accessory mineral in gneiss and mica-schist, often associated with garnet, staurolite, corundum, etc. Notable localities for its occurrence are St. Gothard, Switzerland; in the Tyrol; Litchfield, Connecticut; Chester and Delaware counties, Pennsylvania; Gaston, Rutherford and Yancey counties, North Carolina.

**Name.** Derived from a Greek word meaning *blue*.

### Datolite.

**Composition.** A basic orthosilicate of calcium and boron,  $Ca(B.OH)SiO_4 =$  Silica 37.6, boron trioxide 21.8, lime 35, water 5.6.

**Crystallization.** Monoclinic. Habit varied. Crystals usually nearly equidimensional in the three axial directions and often complex in development (Fig. 325).

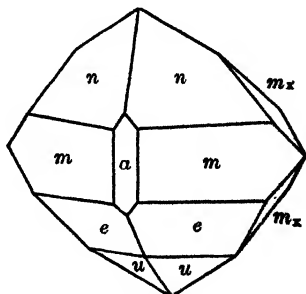


Fig. 325.

**Structure.** In crystals. Coarse to fine granular. Sometimes compact.

**Physical Properties.** H. = 5-5.5. G. = 2.8-3. Vitreous luster. Colorless, white, yellow. Often with faint greenish tinge. Transparent to translucent, rarely opaque.

**Tests.** Fuses at 2-2.5 to a clear glass and colors the flame green (boron). Soluble in hydrochloric acid and yields gelatinous silica on evaporation. Gives a little water in C. T. Characterized by its glassy luster, pale green color, and its crystals with many and usually irregularly developed faces.

**Occurrence.** A mineral of secondary origin, found usually in cavities in basalt lavas and similar rocks. Associated with various zeolites, with calcite, prehnite, etc. Occurs associated with the trap rocks of Massachusetts, Connecticut and New Jersey, particularly at Westfield, Massachusetts, and Bergen Hill, New Jersey. Found associated with the copper deposits of Lake Superior.

**Name.** Derived from a Greek work meaning *to divide*, alluding to the granular structure of a massive variety.

A rare mineral belonging to the Datolite Group is *gadolinite*,  $\text{Be}_2\text{FeY}_2\text{Si}_2\text{O}_{10}$ .

## EPIDOTE GROUP.

### Zoisite.

**Composition.**  $\text{HCa}_2\text{Al}_2\text{Si}_2\text{O}_{12}$  = Silica 39.7, alumina 33.7, lime 24.6, water 2.0.

**Crystallization.** Orthorhombic. Prismatic crystals usually without distinct terminations. Vertically striated.

**Structure.** In crystals; also massive.

**Physical Properties.** H. = 6-6.5. G. = 3.25-3.37. Vitreous luster. Color grayish white, green, pink. Transparent to almost opaque.

**Tests.** Fuses at 3-4 with intumescence to a light colored slag. Yields a little water on intense ignition in C. T.

**Occurrence.** Usually in crystalline schists with one of the amphiboles. *Thulite* is a rose-pink variety.

### Epidote.

**Composition.**  $\text{Ca}_2(\text{Al.OH})(\text{Al,Fe})_2(\text{SiO}_4)_3$ . Iron occurs in varying amounts isomorphous with both the aluminium and calcium.

**Crystallization.** Monoclinic. Crystals are often much elongated parallel to the ortho-axis with a prominent development of the faces of the orthodome zone, giving them a prismatic aspect. Striated parallel to the ortho-axis. Terminated usually only at one end of the ortho-axis and most commonly by the two faces of a pyramid (Fig. 326). Twinning shown at times.

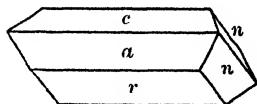


Fig. 326.

**Structure.** Usually coarse to fine granular. In crystals. At times fibrous.

**Physical Properties.** Perfect basal cleavage.  $H. = 6-7$ .  $G. = 3.37-3.45$ . Vitreous luster. Color usually pistachio-green or yellowish to blackish green, sometimes gray. Transparent to opaque. Transparent varieties often show strong dichroism, appearing dark green in one direction, and brown in a direction at right angles to the first.

**Tests.** Fuses at 3-4 with intumescence to a black slag. On intense ignition in C. T. yields a little water.

**Occurrence.** Epidote occurs commonly in the crystalline metamorphic rocks; as gneiss, amphibolite and various schists. Is formed frequently also during the metamorphism of an impure limestone. Is the product of alteration of such minerals as feldspar, pyroxene, amphibole, biotite, scapolite, etc. Often associated with chlorite. Notable localities for its occurrence in fine crystals are Knappenwand, Unterzulzbachthal, Tyrol; Bourg d'Oisans, Dauphiné, the Ala Valley and Traversella, Piedmont; Prince William Island, Alaska; Haddam, Connecticut; Riverside, California.

### Allanite.

A mineral similar to epidote in composition, but containing considerable amounts of the cerium metals, cerium, lanthanum and didymium, and sometimes with smaller amounts of yttrium and erbium. Composition complex and widely varying. Monoclinic,



habit of crystals often similar to epidote. Commonly massive and in embedded grains.  $H.$  = 5.5–6.  $G.$  = 3.5–4.2. Submetallic to pitchy and resinous luster. Brown to pitch-black color. Fuses at 2.5 with intumescence. Sometimes magnetic after heating. Gelatinizes in acids. Occurs as a minor accessory constituent in many igneous rocks. Frequently associated with epidote.

### Axinite.

**Composition.**  $\text{Ca}_7\text{Al}_4\text{B}_2(\text{SiO}_4)_8$ ; with varying amounts of ferrous iron, manganese, magnesium and hydrogen isomorphous with the calcium, and ferric iron with the aluminium.

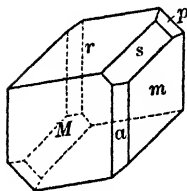


Fig. 327.

**Crystallization.** Triclinic. Crystals usually thin with sharp edges but varied in habit (Fig. 327).

**Structure.** In crystals. Massive, lamellar to granular.

**Physical Properties.** Pinacoidal cleavage.  $H.$  = 6.5–7.  $G.$  = 3.27–3.35. Vitreous luster. Color clove-brown, gray, green, yellow. Transparent to opaque.

**Tests.** Fusible at 2.5–3 with intumescence. When mixed with potassium bisulphate and fluorite and the mixture heated on platinum wire gives a green flame (boron).

**Occurrence.** Notable localities for its occurrence are Bourg d'Oisans in Dauphiné; St. Just, Cornwall; Obira, Japan; Franklin Furnace, New Jersey, etc.

**Name.** Derived from a Greek word meaning *ax*, in allusion to the wedgelike shape of the crystals.

### Prehnite.

**Composition.**  $\text{H}_2\text{Ca}_2\text{Al}_2\text{Si}_3\text{O}_{12}$  = Silica 43.7, alumina 24.8, lime 27.1, water 4.4.

**Crystallization.** Orthorhombic. Distinct crystals rare.

**Structure.** Reniform, stalactitic. In rounded groups of tabular crystals.

**Physical Properties.**  $H.$  = 6–6.5.  $G.$  = 2.8–2.95. Vitreous luster. Color usually light green, passing into white. Translucent.

**Tests.** Fuses at 2.5 with intumescence to an enamel. Heated in C. T. yields water. Slowly acted upon by hydrochloric acid but gelatinizes after simple fusion.

**Occurrence.** As a mineral of secondary origin lining amygdaloidal cavities in basalt, etc. Associated with zeolites, datolite, pectolite, calcite, etc. Occurs in the United States at Farmington, Connecticut; Paterson and Bergen Hill, New Jersey; Somerville, Massachusetts; Lake Superior copper district. Found also in various European localities.

#### 4. SUBSILICATES.

##### HUMITE GROUP.

The three minerals, *humite*,  $Mg_3[Mg(F,OH)]_2[SiO_4]_2$ , *chondrodite*,  $Mg_5[Mg(F,OH)]_2[SiO_4]_3$ , and *clinohumite*,  $Mg_7[Mg(F,OH)]_2[SiO_4]_4$ , are closely related chemically and crystallographically. They are characteristically found in crystalline limestones. Chondrodite is the most common in occurrence.

Ilvaite, or lievrite,  $HCaFe_2''Fe'''Si_2O_6$ , is a rare mineral belonging in this section.

##### Calamine.

**Composition.** Silicate of zinc,  $H_2(Zn_2O)SiO_4 =$  Silica 25, zinc oxide 67.5, water 7.5.

**Crystallization.** Orthorhombic; hemimorphic. Crystals usually tabular parallel to the brachypinacoid. They show prism faces and are terminated above usually by a combination of macrodomes and brachydomes and base, and below by a pyramid (Fig. 328).

**Structure.** Usually in crystal groups with the individuals attached at their lower (pyramidal) ends and lying with their brachypinacoid faces in common. Crystals often divergent, giving rounded groups with slight reëntrant notches between the individual crystals, forming knuckle or coxcomb masses. Also mammillary, stalactitic, massive and granular.

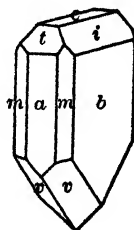


Fig. 328.

**Physical Properties.** Prismatic cleavage.  $H.=4.5-5$ .  $G.=3.4-3.5$ . Vitreous luster. Color white, sometimes with faint bluish or greenish shade; also yellow to brown. Transparent to translucent. Strongly pyroelectric.

**Tests.** Fusible with difficulty at 5. Soluble in hydrochloric acid and yields gelatinous silica on evaporation. Fused on charcoal with sodium carbonate gives a nonvolatile coating of zinc oxide (yellow when hot, white when cold). Gives water in C. T. Recognized usually by the characteristic grouping of its crystals, but may be obscure and to be determined only by above tests.

**Occurrence.** A mineral of secondary origin, found in the oxidized portion of zinc deposits, associated with smithsonite, sphalerite, cerussite, anglesite, galena, etc. Usually with limestone rocks. Occurs at Altenberg and Moresnet, Belgium; Aix-la-Chapelle, Germany; in Carinthia; Hungary; Cumberland, England; Sterling Hill, near Ogdensburg, New Jersey; Friedensville, Pennsylvania; Wythe County, Virginia; with the zinc deposits of southwestern Missouri.

**Name.** Supposed to be derived from *cadmia*, a name given by the ancients to the silicate and carbonate of zinc. The mineral is called by English mineralogists *hemimorphite* or *electric calamine*.

**Use.** An ore of zinc.

### Tourmaline.

**Composition.** A complex silicate of boron and aluminium, containing varying amounts of ferrous iron, magnesium, manganese, calcium, sodium, potassium, lithium, hydroxyl and fluorine.

**Crystallization.** Hexagonal-rhombohedral; hemimorphic. Crystals usually prismatic, vertically striated. A triangular prism, with three faces, prominent, which with the tendency of the prism faces to be vertically striated and to round into each other gives the crystals usually a cross section like a spherical triangle (Fig. 329). Crystals are commonly terminated by base and low positive and negative rhombohedrons; sometimes scalenohedrons are present. When the crystals are doubly ter-

minated they usually show different forms at the opposite ends of the vertical axis (hemimorphism) (Figs. 330 and 331).

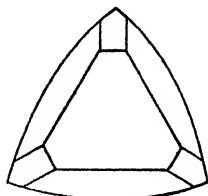


Fig. 329.

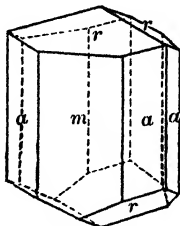


Fig. 330.

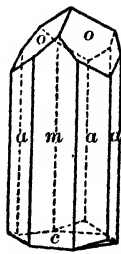


Fig. 331.

**Structure.** Usually in crystals. Sometimes massive compact; also coarse to fine columnar, either radiating or parallel.

**Physical Properties.** Vitreous to resinous luster. Color varied, depending upon the composition. Common tourmaline with much iron is black, sometimes brown. More rarely light colored in fine shades of red, pink, green, blue, yellow, etc. Rarely white or colorless. A single crystal may show several different colors either arranged in concentric bands about the center of the crystal or in transverse layers along its length. Strongly pyroelectric; i.e., when cooling from being heated to about  $100^{\circ}\text{C}$ . it develops positive electricity at one end of the crystal and negative at the other, which enables the crystal to attract and hold bits of paper, etc. Strongly dichroic; i.e., light traversing the crystal in one direction may be of quite a different color or shade of color from that traversing the crystal in a direction at right angles to the first.  $H. = 7-7.5$ ;  $G. = 2.98-3.2$ .

**Tests.** To be recognized usually by the characteristic rounded triangular cross section of the crystals; absence of prismatic cleavage, coal-like fracture of black variety.

**Occurrence.** Tourmaline is one of the most common and characteristic minerals formed by pneumatolytic action. That is, it is a mineral that has been formed at high temperatures and pressures through the agency of vapors carrying boron, fluorine, etc. It is found, therefore, commonly as an accessory mineral in pegmatite

veins, or dikes, occurring with granite intrusions. Associated with the ordinary minerals of granite pegmatite, orthoclase, albite, quartz and muscovite; also with lepidolite, beryl, apatite, fluorite, etc. Found also as an accessory mineral in metamorphic rocks, such as gneisses, schists and crystalline limestones.

The black tourmaline is of widespread occurrence as an accessory mineral in metamorphic rocks. The light colored gem varieties are found in the pegmatite dikes. Famous localities for the occurrence of the gem tourmalines are the island of Elba; in the state of Minas Geraes, Brazil; Ural Mountains near Ekaterinburg; Madagascar; Paris and Auburn, Maine; Haddam Neck, Connecticut; Mesa Grande, Pala, Rincon and Ramona in San Diego County, California.

**Name.** The name *tourmaline* comes from *turamali*, a name given to the early gems from Ceylon.

**Use.** Tourmaline forms one of the most beautiful of the semi-precious gem stones. The color of the stones varies, the principal shades being olive-green, pink to red and blue. Sometimes a stone is so cut as to show different colors in different parts. The green-colored stones are usually known by the mineral name, tourmaline, or as *Brazilian emeralds*. The red or pink stones are known as *rubellite*, while the rarer dark blue stones are called *indicolite*.

### Staurolite.

**Composition.** A ferrous iron-aluminium silicate,  $\text{HA}_2\text{FeSi}_2\text{O}_{13}$ .

**Crystallization.** Orthorhombic. Habit prismatic, showing usually a combination of prism with large angle ( $130^\circ$ ), brachy-

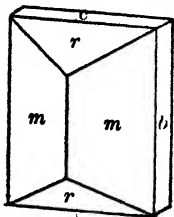


Fig. 332.

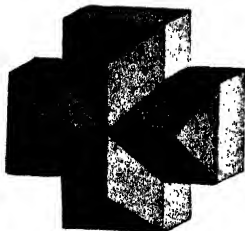


Fig. 333.



Fig. 334.

pinacoid, base and macrodome (Fig. 332). Cruciform twins very common; of two types, (1) in which the two individuals

cross at nearly  $90^\circ$  (Fig. 333), (2) in which they cross at nearly  $60^\circ$  (Fig. 334). Sometimes both types are combined in one crystal.

**Structure.** Usually in crystals.

**Physical Properties.** H. = 7-7.5. G. = 3.65-3.75. Resinous to vitreous luster, for pure and fresh material; often dull to earthy when altered or impure. Color red-brown to brownish black. Translucent to opaque.

**Tests.** Infusible. Insoluble. On intense ignition in C. T. yields a little water. Often very impure. Recognized by its characteristic crystals and twins.

**Occurrence.** Staurolite is an accessory mineral in metamorphic rocks; in crystalline schists, slates, and sometimes in gneisses. Often associated with garnet, cyanite, sillimanite, tourmaline. Notable localities for its occurrence are Monte Campini, Switzerland; in Brittany; Minas Geraes, Brazil; Windham, Maine; Franconia and Lisbon, New Hampshire; Chesterfield, Massachusetts; Fannin County, Georgia.

**Name.** Derived from a Greek word meaning *cross*, in allusion to its cruciform twins.

**Use.** Occasionally a transparent stone from Brazil is cut as a gem.

## HYDROUS SILICATES.

### ZEOLITE DIVISION.

#### INTRODUCTORY SUBDIVISION.

##### Apophyllite.

**Composition.**  $H_7KCa_4(SiO_3)_8 \cdot 4\frac{1}{2}H_2O$ . Usually contains a small amount of fluorine.

**Crystallization.** Tetragonal. Usually shows a combination of prism of second order, pyramid of first and basal plane (Figs. 335 and 336). Small faces of a ditetragonal prism sometimes observed (Fig. 337). Prism faces show vertical striations and have a vitreous luster, while base shows pearly luster. Crystals may resemble an isometric combination of cube and octa-

hedron, but are shown to be tetragonal by difference in luster between faces of prism and base.

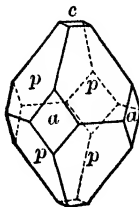


Fig. 335.

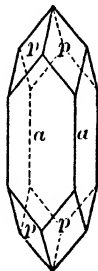


Fig. 336.

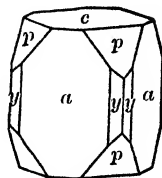


Fig. 337.

**Structure.** In crystals; also massive and lamellar.

**Physical Properties.** Perfect basal cleavage.  $H. = 4.5-5$ .  $G. = 2.3-3.4$ . Luster of base pearly, other faces vitreous. Color usually colorless, white or grayish; may show pale shades of green, yellow, rose. Usually transparent, rarely nearly opaque.

**Tests.** Fuses easily with swelling to a white vesicular enamel. Colors the flame pale violet (potassium). Yields 16 per cent of water in C. T. Decomposed by hydrochloric acid with separation of silica but without the formation of a jelly. Solution gives little or no precipitate with ammonia but gives an abundant white precipitate with ammonium carbonate (calcium carbonate). Recognized usually by its crystals, color, luster and basal cleavage.

**Occurrence.** Occurs commonly as a secondary mineral lining cavities in basalt and related rocks. Associated with various zeolites, with calcite, datolite, pectolite, etc. Found in fine crystals at Bergen Hill, New Jersey; Cliff Mine, Lake Superior copper district; Table Mountain, near Golden, Colorado; mercury mines, New Almaden, California; Nova Scotia; Guanajuato, Mexico; near Bombay, India; Andreasberg, Harz Mountains; Färöer Islands; Iceland; Greenland, etc.

**Name.** *Apophyllite*, named from two Greek words meaning to get leaves, because of its tendency to exfoliate when ignited.

**ZEOLITES.**

The zeolites form a large family of hydrous silicates which show close similarities in composition and in their associations and mode of occurrence. They are silicates of aluminium with sodium and calcium as the important bases. They average from 3.5 to 5.5 in hardness and from 2 to 2.4 in specific gravity. Many of them fuse readily with marked intumescence, hence the name *zeolite*, from two Greek words meaning to *boil* and *stone*. They are secondary minerals found characteristically in cavities and veins in basic igneous rocks.

**Heulandite.**

Composition,  $H_4CaAl_2(SiO_2)_6 \cdot 3H_2O$ . Monoclinic, but crystals often simulate orthorhombic symmetry. Clinopinacoid prominent, having often a diamond shape. Perfect cleavage parallel to clinopinacoid. H. = 3.5-4. G. = 2.15-2.2. Vitreous luster, except on clinopinacoid, which is pearly. Color white, yellow, red. Transparent to almost opaque. Fusible (3) with intumescence. Decomposed by hydrochloric acid with separation of silica. Water in C. T. A mineral of secondary origin found in cavities of basic igneous rocks associated with other zeolites, calcite, etc. Found in notable quality in Iceland; the Färöer Islands; British India; Nova Scotia.

**Phillipsite.**

Composition,  $(K_2, Ca)Al_2Si_4O_{12} \cdot 4\frac{1}{2}H_2O$ . Monoclinic. Crystals are uniformly penetration twins but often appearing to be tetragonal or orthorhombic in form. Cleavage parallel to base and clinopinacoid. H. = 4-4.5. G. = 2.2. Vitreous luster. White or reddish in color. Translucent to opaque. Fuses at 3 to a white enamel. Gelatinizes with hydrochloric acid. Water in C. T. A secondary mineral found in cavities of igneous rocks associated with other zeolites, etc.

**Harmotone.**

A barium zeolite having the composition  $(K_2, Ba)Al_2Si_4O_{12} \cdot 3H_2O$ . Monoclinic. Crystals are uniformly cruciform penetration twins. Perfect cleavage parallel to clinopinacoid. H. = 4.5. G. = 2.4-2.5. Vitreous luster. Colorless or white. Translucent. Fuses at 3. Decomposed by hydrochloric acid with separation of silica. Addition of sulphuric acid to hydrochloric acid solution gives a



white precipitate of barium sulphate. Water in C. T. A mineral of secondary origin, occurring in cavities of basic igneous rocks, associated with other zeolites, calcite, etc.

### Stilbite. Desmine.

**Composition.**  $(\text{Na}_2, \text{Ca})\text{Al}_2\text{Si}_6\text{O}_{16} \cdot 6\text{H}_2\text{O}$ .

**Crystallization.** Monoclinic. Uniformly in cruciform twins.



Fig. 338.

Commonly tabular parallel to clinopinacoid. Crystals usually in sheaflike aggregates (Fig. 338).

**Structure.** In crystal groups, divergent or radiated.

**Physical Properties.** Perfect cleavage parallel to clinopinacoid.  $H. = 3.5-4$ .  $G. = 2.1-2.2$ . Vitreous luster; pearly on clinopinacoid. Color white, yellow, brown, red. Translucent.

**Tests.** Fuses with intumescence at 3. Decomposed by hydrochloric acid with separation of silica but without the formation of a jelly. Water in C. T. Characterized chiefly by its cleavage, pearly luster on the cleavage face and common sheaflike groups of crystals.

**Occurrence.** A mineral of secondary origin found in amygdaloidal cavities in basalts and related rocks. Found associated with other zeolites, calcite, etc. Notable localities for its occurrence are Poonah, India; Isle of Skye; Färöer Islands; Kilpatrick, Scotland; Iceland; Nova Scotia.

**Name.** Derived from a Greek word meaning *luster*.

### Laumontite.

A zeolite with composition  $\text{H}_4\text{CaAl}_2\text{Si}_4\text{O}_{14} \cdot 2\text{H}_2\text{O}$ . Monoclinic. In prismatic crystals with oblique terminations; columnar. Cleavage parallel to prism and clinopinacoid.  $H. = 3.5-4$ .  $G. = 2.25-2.35$ . Vitreous to pearly luster. Color white or gray. Alters on exposure, becoming opaque and pulverulent. Fusible (2.5). Gelatinizes in acids. Water in C. T. Found as a mineral of secondary origin in cavities of basic igneous rocks, associated with other zeolites, etc.

### Chabazite.

**Composition.** Usually corresponds to  $(Ca, Na_2)Al_2Si_4O_{12} \cdot 6H_2O$  but different analyses show considerable variation from this formula, so that the composition is still uncertain.

**Crystallization.** Hexagonal-rhombohedral. Common form is the simple rhombohedron *r*, having nearly cubic angles. May show several different rhombohedrons (Fig. 339). Often in penetration twins.

**Structure.** Usually in crystals.

**Physical Properties.** H. = 4-5. G. = 2.05-2.15. Vitreous luster. Color white, yellow, flesh-red. Transparent to translucent.

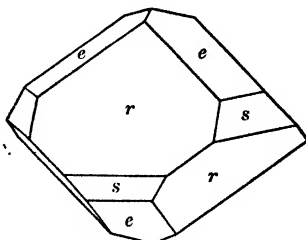


Fig. 339.

**Tests.** Fuses with swelling at 3. Decomposed by hydrochloric acid with the separation of silica but without the formation of a jelly. Solution after filtering off silica gives precipitate of aluminium hydroxide with ammonia, and in filtrate ammonium carbonate gives white precipitate of calcium carbonate. Gives much water in C. T. Recognized usually by its crystals.

**Occurrence.** A mineral of secondary origin found usually with other zeolites, lining amygdaloidal cavities in basalt. Notable localities for its occurrence are the Färöer Islands; Greenland and Iceland; the Giant's Causeway, Ireland; at Aussig, Bohemia; in Nova Scotia, etc.

**Name.** Chabazite is derived from a Greek word which was an ancient name for a stone.

*Gmelinite*,  $(Na_2, Ca)Al_2Si_4O_{12} \cdot 6H_2O$ , is closely related to chabazite but rarer in occurrence.

### Analcite.

**Composition.** Hydrous sodium-aluminium metasilicate,  $NaAlSi_3O_8 \cdot H_2O$  = Silica 54.5, alumina 23.2, soda 14.1, water 8.2. Note similarity in composition to leucite,  $KAlSi_3O_8$ .

**Crystallization.** Isometric. Usually in trapezohedrons (Fig. 340). Cubes with trapezohedral truncations also known (Fig. 341).

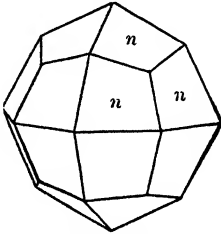


Fig. 340.

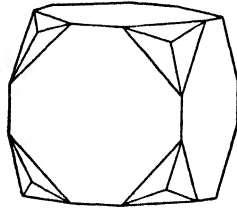


Fig. 341.

**Structure.** Usually in crystals, also massive granular.

**Physical Properties.** H. = 5-5.5. G. = 2.27. Vitreous luster. Colorless or white. Transparent to nearly opaque.

**Tests.** Fusible at 3.5, becoming first opaque and then a clear glass. Colors the flame yellow (sodium). Decomposed by hydrochloric acid with the separation of silica without the formation of a jelly. Gives water in C. T. Usually recognized by its crystals and its vitreous luster.

**Occurrence.** Commonly a secondary mineral, formed by the action of hot circulating waters, and is to be found deposited in the cavities of igneous and especially volcanic rocks. Associated with calcite, and various zeolites and related minerals. Fine crystals found at Bergen Hill, New Jersey; in the Lake Superior copper district; at Table Mountain, near Golden, Colorado; at Cape Blomidon, Nova Scotia; in the Cyclopean Islands near Sicily; in the Fassathal, Tyrol; on the Färöer Islands; in Iceland.

**Name.** Derived from a Greek word meaning *weak*, in allusion to its weak electric power when heated or rubbed.

### Natrolite.

**Composition.**  $\text{Na}_2\text{Al}_2\text{Si}_3\text{O}_{10}\cdot 2\text{H}_2\text{O}$ . A zeolite.

**Crystallization.** Orthorhombic. Crystals usually slender prismatic, often acicular. Prism zone vertically striated. Sometimes terminated by low pyramid. Crystals often appear to be tetragonal in symmetry. Sometimes in cruciform twins.

**Structure.** Usually in radiating crystal groups (see Fig. C, pl. II); also fibrous, massive, granular or compact.

**Physical Properties.** Perfect prismatic cleavage.  $H. = 5-5.5$ .  $G. = 2.25$ . Vitreous luster. Colorless or white. Sometimes tinted yellow to red. Transparent to translucent.

**Tests.** Easily fusible (2.5) to a clear, transparent glass giving a yellow (sodium) flame. Water in C. T. Soluble in hydrochloric acid and gelatinizes upon evaporation. Recognized chiefly by its radiating crystals.

**Occurrence.** A mineral of secondary origin, found lining amygdaloidal cavities in basalt, etc. Associated with other zeolites, calcite, etc. Notable localities for its occurrence are Aussig and Teplitz, Bohemia; Puy de Dome, France; Fassathal, Tyrol; Kapnik, Hungary; in various places in Nova Scotia; Bergen Hill, New Jersey; copper district, Lake Superior.

### Scolecite.

A zeolite with composition  $\text{CaAl}_2\text{Si}_3\text{O}_{10}\cdot 3\text{H}_2\text{O}$ . Monoclinic. In slender prismatic, twinned crystals. In radiating groups. Sometimes fibrous. Prismatic cleavage.  $H. = 5-5.5$ .  $G. = 2.16-2.4$ . Vitreous luster; silky when fibrous. Colorless or white. Transparent to almost opaque. Fuses at 2.5 to a voluminous frothy slag. Gelatinizes in acids. Water in C. T. A mineral of secondary origin, found lining cavities in basic igneous rocks, associated with other zeolites, etc.

### Thomsonite.

A zeolite, having the composition  $(\text{Na}_2\text{Ca})\text{Al}_2(\text{SiO}_4)_2\cdot 2\frac{1}{2}\text{H}_2\text{O}$ . Orthorhombic but distinct crystals rare. Commonly columnar with radiated structure. Perfect pinacoidal cleavage.  $H. = 5-5.5$ .  $G. = 2.3-2.4$ . Vitreous luster. Colorless, white, gray. Transparent to translucent. Fuses with intumescence at 2-2.5. Soluble and gelatinizes in acids. Much water in C. T. Occurs in amygdaloidal cavities in basalt, etc., associated with other zeolites.

## MICA DIVISION.

### MICA GROUP.

The micas form a series of complex silicates of aluminium with potassium and hydrogen, also often magnesium, ferrous iron, and in some varieties, sodium, lithium, ferric iron. More rarely manganese, chromium, barium, fluorine and titanium are present

in small amounts. The composition of many of the micas is not definitely understood and the formulas assigned to them are only approximate.

They crystallize in the monoclinic system but with an axial inclination of practically  $90^\circ$ , so that their monoclinic symmetry is not clearly seen. The crystals are usually tabular with prominent basal planes, and have either a diamond- or hexagonal-shaped outline with angles of  $60^\circ$  and  $120^\circ$ . The crystals, as a rule, therefore, appear to be either orthorhombic or hexagonal in their symmetry. They are all characterized by a very perfect basal cleavage.

They form an isomorphous series, and various gradations between the different members occur. Their isomorphism is further indicated by two members of the group frequently crystallizing together, with a parallel position, in the same crystal plate. Biotite occurs crystallizing in this way with muscovite, and muscovite with lepidolite, etc.

The important members of the group follow:

<i>Muscovite</i> ,	$H_2KAl_3(SiO_4)_3$ .
<i>Lepidolite</i> ,	$KLi[Al_2(OH,F)]Al(SiO_3)_3$ .
<i>Biotite</i> ,	$(H,K)_2(Mg,Fe)_2Al_2(SiO_4)_3$ .
<i>Phlogopite</i> ,	$H_2KMg_3Al(SiO_4)_3?$
<i>Lepidomelane</i> ,	$(H,K)_2Fe_3(Fe,Al)_4(SiO_4)_5?$

### **Muscovite.** Common Mica.

**Composition.**  $H_2KAl_3(SiO_4)_3$ . Contains also frequently small amounts of ferrous and ferric iron, magnesium, calcium, sodium, lithium, fluorine, titanium, etc.

**Crystallization.** Monoclinic with axial angle nearly  $90^\circ$ . Occurs in tabular crystals with prominent base. The presence of prism faces having angles of  $60^\circ$  and  $120^\circ$  with each other gives the plates a diamond-shaped outline, making them simulate orthorhombic symmetry. If the clinopinacoid faces are also present, the crystals become hexagonal in outline with apparently hexagonal symmetry. The prism faces are roughened by horizontal striations and frequently taper.

**Structure.** Foliated in large to small sheets; in scales which are sometimes aggregated into plumose or globular forms. Distinct crystals comparatively rare.

**Physical Properties.** Extremely perfect cleavage parallel to base, allowing the mineral to be split into excessively thin sheets. Folia flexible and elastic.  $H. = 2-2.5$ .  $G. = 2.76-3$ . Vitreous to silky or pearly luster. Transparent and almost colorless in thin sheets. In thicker blocks, opaque with light shades of brown and green. May be yellow to white. Some crystals are translucent when viewed perpendicular to the prism zone but opaque in a direction perpendicular to the base.

**Tests.** Fusible at 4.5-5. Unattacked by boiling hydrochloric or sulphuric acids. Characterized by its micaceous structure and light color. Told from phlogopite by its not being decomposed in sulphuric acid and from lepidolite by not giving a crimson flame B. B.

**Occurrence.** A widespread and very common rock-making mineral. Found in such igneous rocks as granite and syenite. Especially characteristic of pegmatite veins, and found lining cavities in granites, where it has evidently been formed by the action of mineralizing vapors during the last stages of the formation of the rock. Muscovite is chiefly characteristic of the deep-seated igneous rocks, and is not found in the recent eruptive rocks. Also very common in metamorphic rocks, as gneiss and schist, forming the chief constituent in certain mica-schists. In some schistose rocks it occurs in the form of fibrous aggregates of minute scales having a silky luster, but which do not show so plainly the characters of the mineral. This variety is known as *sericite*, and is usually the product of alteration of feldspar. Muscovite also originates, as the alteration product of several other minerals, as topaz, cyanite, spodumene, adalosite, scapolite, etc. *Pinite* is a name given to the micaceous alteration product of various minerals, and which corresponds in composition more or less closely to muscovite.

In the pegmatite veins, muscovite occurs associated with quartz and feldspar, with tourmaline, beryl, garnet, apatite, fluorite, etc. It is found often in these veins in large blocks, which are at times several feet across.

Muscovite is found in the United States in commercial deposits chiefly in the Appalachian and Rocky Mountain regions. The most productive pegmatite veins occur in North Carolina, mostly in Mitchell, Yancey, Haywood, Jackson and Macon counties, and

in the Black Hills of South Dakota. Of less importance are the deposits in Colorado, Alabama and Virginia. Muscovite has been mined in New Hampshire, Maine and Connecticut. Large deposits are found in Canada in the township of Grenville, east of Ottawa, and in a district to the east of Quebec. Large and important deposits occur in India.

**Name.** *Muscovite* was so called from the popular name of the mineral, *Muscovy-glass*, because of its use as a substitute for glass in Russia. *Mica* was probably derived from the Latin *micare*, meaning *to shine*.

**Use.** Used chiefly as an insulating material in the manufacture of electrical apparatus. Used as a transparent material (isinglass) for stove doors, lanterns, etc. Scrap mica, or the waste material in the manufacture of sheet mica, is used in many ways, as in the manufacture of wall papers to give them a shiny luster; as a lubricant when mixed with oils; as a nonconductor of heat and as a fireproofing material.

### Lepidolite.

**Composition.** Lithia mica,  $\text{KLi}[\text{Al}_2(\text{OH.F})]\text{Al}(\text{SiO}_3)_3$ .

**Crystallization.** Monoclinic. Crystals usually in small plates or prisms with hexagonal outline.

**Structure.** Commonly in coarse- to fine-grained scaly aggregates.

**Physical Properties.** Perfect basal cleavage.  $H. = 2.5-4$ .  $G. = 2.8$ . Pearly luster. Color pink and lilac to grayish white. Translucent.

**Tests.** Easily fusible (2), giving a crimson flame (lithium). Insoluble in acids. Characterized chiefly by its micaceous structure and lilac to pink color.

**Occurrence.** A comparatively rare mineral, found in pegmatitic veins, usually associated with pink and green tourmaline, cassiterite, amblygonite, spodumene, etc. Often intergrown with muscovite in parallel position. Notable localities for its occurrence are at Roznau, Moravia; St. Michael's Mount, Cornwall; western Maine at Hebron, Auburn, Norway, Paris, Rumford; Chesterfield, Massachusetts; San Diego County, California.

**Name.** Derived from a Greek word meaning *scale*.

**Use.** A source of lithium compounds.

### Biotite.

**Composition.**  $(\text{H}, \text{K})_2(\text{Mg}, \text{Fe})_2\text{Al}_2(\text{SiO}_4)_3$ .

**Crystallization.** Monoclinic. In tabular or short prismatic crystals with prominent basal planes. Crystals rare, frequently pseudorhombohedral.

**Structure.** Usually in irregular foliated masses; often in disseminated scales or in scaly aggregates.

**Physical Properties.** Perfect basal cleavage. Folia flexible and elastic.  $H. = 2.5-3$ .  $G. = 2.95-3$ . Splendent luster. Color usually dark green and brown to black. More rarely lighter yellow. Thin sheets usually have a smoky color (differing from the almost colorless muscovite).

**Tests.** Difficultly fusible at 5. Unattacked by hydrochloric acid. Decomposed by boiling concentrated sulphuric acid, giving a milky solution. Characterized by its micaceous structure, cleavage and dark color.

**Occurrence.** An important and widely distributed rock-making mineral, but not as common as muscovite. Occurs in igneous rocks, especially those in which feldspar is prominent, such as granite and syenite. Found also in many felsite lavas and porphyries. Less common in the ferromagnesium rocks. Is also present in some metamorphosed rocks, as gneiss and schist. Occurs in fine crystals in the lavas of Vesuvius.

### Phlogopite.

**Composition.** A magnesium mica, near biotite, but containing no iron,  $\text{H}_2\text{KMg}_3\text{Al}(\text{SiO}_4)_3(?)$ . Usually contains about 3 per cent of fluorine.

**Crystallization.** Monoclinic. Usually in six-sided plates or in tapering prismatic crystals. Crystals frequently large and coarse.

**Structure.** In crystals or foliated masses.

**Physical Properties.** Perfect basal cleavage. Folia flexible and elastic.  $H. = 2.5-3$ .  $G. = 2.86$ . Luster vitreous to



pearly. Color yellowish brown, green, white, often with copper-like reflections from the cleavage surface. Transparent in thin sheets to opaque in the mass.

**Tests.** Fusible at 4.5-5. Insoluble in hydrochloric acid. Decomposed by boiling concentrated sulphuric acid, giving a milky solution. Characterized by its micaceous structure, cleavage and yellowish brown color. Told from muscovite by its decomposition in sulphuric acid and from biotite by its lighter color. But it is impossible to draw a sharp distinction between biotite and phlogopite.

**Occurrence.** Occurs as a product of metamorphism in crystalline magnesium limestones or dolomitic marbles. Rarely found in igneous rocks. Notable localities are in Finland; Sweden; Campo-longo, Switzerland; Ceylon, etc. In North America, found chiefly in Jefferson and St. Lawrence counties, New York; at North and South Burgess, Ontario, and in various localities in Quebec, Canada.

**Name.** Named from a Greek word meaning *firelike*, in allusion to its color.

**Use.** Same as for muscovite.

### Lepidomelane.

A mica, that may be regarded as a variety of biotite, characterized by the large amount of ferric iron that it contains,  $(H,K)_2Fe_3(Fe,Al)_4(SiO_4)_6(?)$ . Monoclinic. In small hexagonal-shaped tables, or as an aggregate of minute scales. Perfect basal cleavage. H. = 3. G. = 3-3.2. Adamantine to pearly luster. Color black to greenish black. Opaque or translucent in very thin laminae. Fuses at 4.5-5 to a magnetic globule. Decomposed by hydrochloric acid. A comparatively rare mineral, found chiefly in pegmatitic granites and syenites.

### CLINTONITE GROUP.

The minerals of this group are rare species that lie between the true micas and the chlorites. They resemble the micas in crystal forms, cleavage, etc., but differ physically in that their folia are brittle, and chemically in that they are basic in character. The only species in the group that warrants description is margarite.

### Margarite.

A micaceous mineral with the composition  $H_2CaAl_4Si_2O_{12}$ . Monoclinic but seldom in distinct crystals. Usually in foliated aggregates. Perfect basal cleavage. H. = 3.5-4.5 (harder than the true micas). G. = 3.05. Luster vitreous to pearly. Color pink, white and gray. Translucent. Folia somewhat brittle. Fuses at 4-4.5. Unattacked by acids. Occurs usually with corundum and apparently as one of its alteration products. Found in this way with the emery deposits of Asia Minor; on the islands of the Greek archipelago; at Chester, Massachusetts; Chester County, Pennsylvania; with corundum deposits in North Carolina, etc.

### CHLORITE GROUP.

A somewhat ill-defined group of closely related micaceous minerals is known as the *Chlorite Group* or as the *chlorites*. They are so named on account of the characteristic green color that they show. They are silicates of aluminium with magnesium, ferrous iron and hydroxyl. Ferric iron may replace the aluminium in small amount. Chromium and manganese may occur. Calcium and the alkalis, which are characteristic of the micas proper, are practically absent. The composition of these minerals is not fully understood. Their crystal forms are similar to those of the micas and they show a perfect basal cleavage. Their laminæ, however, are tough and inelastic. Clinocllore is the most common member of the group.

### Clinocllore. Penninite.

**Composition.**  $H_3Mg_5Al_2Si_3O_{18}$ . See above.

**Crystallization.** Monoclinic. In six-sided tabular crystals, with prominent basal planes. Similar in habit to the crystals of the mica group, but distinct crystals rare. Penninite is pseudorhomboidal in symmetry, otherwise it is identical with clinocllore.

**Structure.** Usually foliated massive or in aggregates of minute scales; in finely disseminated particles; earthy.

**Physical Properties.** Perfect basal cleavage. Folia flexible but not elastic. H. = 2-2.5. G. = 2.65-2.75. Vitreous to

pearly luster. Color green of various shades. Rarely pale green, yellow, white, rose-red. Transparent to opaque.

**Tests.** Difficultly fusible, 5-5.5. Unattacked by hydrochloric acid. Decomposed by boiling concentrated sulphuric acid, giving a milky solution. Characterized by its green color, micaceous structure and cleavage and by the fact that the folia are not elastic.

**Occurrence.** A common and widespread mineral, always of secondary origin. It results from the alteration of silicates containing aluminium, ferrous iron and magnesium, such as pyroxene, amphibole, biotite, garnet, vesuvianite, etc. To be found where rocks, containing such minerals, are undergoing metamorphic change. The green color of many igneous rocks is due to the chlorite into which the ferromagnesian silicates have altered. The green color of many schists and slates is due to finely disseminated particles of the mineral.

**Name.** *Chlorite* is derived from a Greek word meaning *green*, in allusion to the common color of the mineral.

### Serpentine.

**Composition.** A magnesium silicate,  $H_4Mg_3Si_2O_{10}$ , = Silica 44.1, magnesia 43.0, water 12.9. Ferrous iron and nickel may be present in small amount.

**Crystallization.** Monoclinic (optically). Occurs, however, only in pseudomorphic crystals.

**Structure.** Often in delicate fibers, which can be separated from each other (see Fig. D, pl. II). Usually massive, but microscopically fibrous and felted.

**Physical Properties.** H. = 2.5-5, usually 4. G. = 2.5-2.65. Luster greasy, waxlike in the massive varieties, silky when fibrous. Color olive to blackish green, yellowish green, white. Color often variegated, showing mottling in lighter and darker shades of green. Translucent to opaque.

**Tests.** Infusible. Decomposed by hydrochloric acid with the separation of silica but without the formation of a jelly. Filtered solution, after being oxidized with nitric acid and having any iron precipitated by ammonium hydroxide, and the absence

of calcium proved by addition of ammonium oxalate, gives a precipitate of ammonium-magnesium phosphate with sodium phosphate. Water in C. T. Recognized by its variegated green color and its greasy luster or by its fibrous structure.

**Varieties.** *In Crystals.* Occurs in crystals as pseudomorphs after various magnesian silicates, principally chrysolite, pyroxene, amphibole.

*Precious Serpentine.* Massive, translucent, of light to dark green color. Often mixed with white marble and shows beautiful variegated coloring. Frequently called *verd antique* marble.

*Ordinary Serpentine.* Massive, opaque, of various shades of green.

*Chrysotile.* The fibrous asbestiform variety, which is to be found in veins traversing the massive serpentine. This is the asbestos of commerce for the most part.

**Occurrence.** A common mineral and widely distributed. Always as an alteration product of some magnesian silicate, especially chrysolite, also pyroxene, amphibole, etc. Frequently associated with magnesite, chrysolite, chromite, etc. Found in both igneous and metamorphic rocks, sometimes in disseminated particles, sometimes in such quantity as to make up practically the entire rock-mass. Precious serpentine is found at Falun and Gulsjö, Sweden; Isle of Man; Cornwall, etc. The fibrous variety, chrysotile, comes from the Province of Quebec, Canada, just north of the Vermont line; from Vermont; New York; New Jersey; Grand Canyon, Arizona, etc.

**Name.** The name refers to the green serpentlike cloudings of the massive variety.

**Use.** The variety *chrysotile* is the chief source of asbestos. Fibrous amphibole (which see) is also used for the same purposes. The uses of asbestos depend upon its fibrous, flexible structure, which allows it to be woven into cloth, felt, etc., and upon its incombustibility and slow conductivity of heat. Asbestos products, therefore, are used for fireproofing and as an insulating material against heat and electricity. The massive mineral is often used as an ornamental stone and may at times be valuable as building material.

**Genthite. Garnierite.**

Nickel silicates of uncertain composition. *Genthite* contains magnesium,  $\text{Ni}_2\text{Mg}_2\text{Si}_3\text{O}_{10}\cdot 6\text{H}_2\text{O}(?)$ ; *Garnierite*,  $\text{H}_2\text{NiSiO}_4(?)$ . Amorphous, earthy to slightly botryoidal structure. As incrustations. H. = 3-4. G. = 2.2-2.8. Earthy and dull luster. Color apple-green to white. Infusible. Difficultly decomposed by hydrochloric acid, giving separated silica. In O. F. color the borax bead brown. In C. T. blacken and give water. Genthite found with chromite at Texas, Lancaster County, Pennsylvania. Garnierite occurs in considerable amount, associated with serpentine and chromite, near Noumea, New Caledonia, and serves as an important ore of nickel.

**Talc. Steatite. Soapstone.**

**Composition.** A magnesium silicate,  $\text{H}_2\text{Mg}_3(\text{SiO}_3)_4 = \text{Silica } 63.5, \text{ magnesia } 31.7, \text{ water } 4.8$ .

**Crystallization.** Monoclinic. Crystals rare. Usually tabular with rhombic or hexagonal outline.

**Structure.** Foliated massive; sometimes in radiating foliated groups. Also compact.

**Physical Properties.** Perfect basal cleavage. Thin folia somewhat flexible but not elastic. Sectile. H. = 1 (will make a mark on cloth). G. = 2.8. Pearly to greasy luster. Color apple-green, gray, white; in soapstone often dark gray or green. Translucent to opaque. Greasy feel.

**Tests.** Difficultly fusible (5). Unattacked by acids. Characterized by its micaceous structure and cleavage, by its softness and greasy feel. To be distinguished from pyrophyllite by moistening a fragment with cobalt nitrate and heating intensely; talc will assume a pale violet color, pyrophyllite a blue color.

**Varieties.** *Foliated Talc.* Light green or white, foliated, with a greasy feel.

*Steatite or Soapstone.* Massive, with fine granular to cryptocrystalline structure. Gray to dark green colors; often impure, through the presence of such minerals as chlorite, tremolite, mica, etc.

*Pseudomorphous.* Is frequently pseudomorphous after such minerals as enstatite, pyroxene, amphibole, chrysolite, etc.

**Occurrence.** Talc is a mineral of secondary origin formed by the alteration of magnesium silicates, such as chrysolite, enstatite, pyroxene, amphibole, etc. Found at times in the igneous rocks, because of the alteration of such silicates, especially in peridotites and pyroxenites. Most characteristically found, however, in the metamorphic rocks, where it may form as soapstone, practically the entire rock-mass, or occur as a prominent constituent in the schistose rocks, as in talc-schist. In the United States, talc or soapstone quarries are to be found chiefly along the line of the Appalachian Mountains, the mineral being produced in Vermont, Massachusetts, Rhode Island, New York, New Jersey, Pennsylvania, Maryland, Virginia, North Carolina, and Georgia. Important deposits are located in St. Lawrence County, New York, where the talc occurs in the form of beds of schist interstratified with limestones. It is associated here with tremolite and enstatite, from masses of which it has evidently been derived. Large deposits of soapstone occur in Virginia in a narrow belt running from Nelson County northeast into Albemarle County. It occurs here in sheets sometimes 100 or more feet in thickness. There is a long series of talc and soapstone deposits in Vermont, located along the east side of the Green Mountains. Talc has been mined in considerable quantity in Swain County, North Carolina.

**Use.** In the form of slabs, soapstone is used extensively for wash tubs, sinks, table tops, electrical switchboards, hearthstones, furnace linings, etc. An especially compact variety is used for the tips of gas burners, for tailors' chalk, slate pencils, by the Chinese for carvings, etc. Talc is also used in a finely powdered form as a filler to give weight to paper, as a lubricant, for toilet powders, in paints, as a heat insulator, etc.

### **Kaolin or Kaolinite.**

**Composition.** An aluminium silicate,  $H_4Al_2Si_2O_9$ , = Silica 46.5, alumina 39.5, water 14.

**Crystallization.** Monoclinic. In very minute, thin, rhombic or hexagonal-shaped plates.

**Structure.** Usually in claylike masses, either compact or friable.

**Physical Properties.** Perfect basal cleavage.  $H. = 2-2.5$ .  $G. = 2.6-2.63$ . Luster usually dull earthy; crystal plates

pearly. Color white. Often variously colored by impurities. Usually unctuous and plastic.

**Tests.** Infusible. Insoluble. Assumes a blue color when moistened with cobalt nitrate and ignited (aluminium). Recognized usually by its claylike character.

**Occurrence.** Of widespread occurrence. The chief constituent of clay. Always a mineral of secondary origin, being derived by the alteration of aluminium silicates, particularly feldspar. It is found mixed with feldspar in rocks that are undergoing alteration; at times it forms entire beds where such alteration has been carried to completion. As one of the common products of the decomposition of rocks it gets into soils and being transported by water is deposited, mixed with quartz and other materials in lakes, etc., in the form of beds of clay.

**Name.** *Kaolin* is a corruption of the Chinese, *Kauling*, a locality from which material was obtained for the manufacture of porcelain and which was thought to be the same as kaolin.

**Use.** Used in the form of clay in making all kinds of pottery, stoneware, bricks, etc. The finer, purer grades of kaolin are used in the manufacture of porcelain, china, etc.

### Pyrophyllite.

**Composition.**  $\text{H}_2\text{Al}_2(\text{SiO}_3)_4$  = Silica 66.7, alumina 28.3, water 5.0.

**Crystallization.** Monoclinic (?). Not observed in crystals.

**Structure.** Foliated, sometimes in radiating lamellar aggregates. Also granular to compact. Identical with talc in structure and appearance.

**Physical Properties.** Perfect basal cleavage. Folia somewhat flexible but not elastic. H. = 1-2 (will make a mark on cloth). G. = 2.8-2.9. Pearly to greasy luster. Color white, apple-green, gray, brown. Usually opaque. Greasy feel.

**Tests.** Infusible. Unattacked by acids. Characterized chiefly by its micaceous structure and cleavage, its softness and greasy feel. Only to be easily distinguished from talc by moistening a small fragment with cobalt nitrate and igniting, when it assumes a blue color (aluminium). Talc under the same conditions would become pale violet.

**Occurrence.** A comparatively rare species. Found in metamorphic rocks; frequently with cyanite. Occurs in considerable amount in Moore and Chatham counties, North Carolina.

**Use.** Quarried in North Carolina and used for the same purposes as talc. It does not command, however, as high a price as the best grades of talc. A considerable part of the so-called *agalmatolite*, from which the Chinese carve small images, is this species.

### Chrysocolla.

**Composition.** Hydrus copper silicate,  $\text{CuSiO}_3 \cdot 2\text{H}_2\text{O}$  = Silica 34.3, copper oxide 45.2, water 20.5. Varies considerably in composition and often impure.

**Structure.** Noncrystalline. Massive compact. Sometimes earthy.

**Physical Properties.** H. = 2-4. G. = 2.0-2.4. Luster vitreous to earthy. Color green to greenish blue; brown to black when impure.

**Tests.** Infusible. Decomposed by hydrochloric acid with the separation of silica but without the formation of a jelly. Gives a copper globule when fused with sodium carbonate on charcoal. In C. T. darkens and gives water.

**Occurrence.** A comparatively rare mineral occurring in the oxidized zones of copper veins. Associated with malachite, azurite, cuprite, native copper, etc. Found in the copper districts of Arizona and New Mexico.

**Name.** Chrysocolla, derived from two Greek words meaning *gold* and *glue*, which was the name of a similar appearing material used to solder gold.

**Use.** A minor ore of copper.

### Titanite. Sphene.

**Composition.** Calcium titano-silicate,  $\text{CaTiSiO}_5$  = Silica 30.6, titanium oxide 40.8, lime 28.6. Iron is usually present in small amounts.

**Crystallization.** Monoclinic. Crystals varied in habit. Often with prominent basal plane which is steeply inclined and



which in combination with short prism and pyramid faces gives a thin wedge-shaped crystal (Figs. 342 and 343).

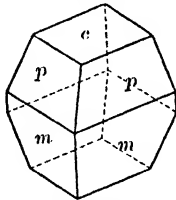


Fig. 342.

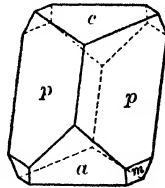


Fig. 343.

**Structure.** Usually crystallized or lamellar.

**Physical Properties.** Prismatic cleavage.  $H. = 5-5.5$ .  $G. = 3.4-3.55$ . Resinous to adamantine luster. Color gray, brown, green, yellow, black. Transparent to opaque.

**Tests.** Fusible at 4 with slight intumescence to a dark mass. Only slightly attacked by hydrochloric acid. Fused with sodium carbonate; fusion dissolved in hydrochloric acid; the solution when boiled with tin gives a violet color (titanium).

**Occurrence.** A rather common accessory mineral in igneous rocks, being found as small crystals in granites, diorites, syenites, trachytes, phonolites, etc. Also found often in crystals of considerable size embedded in the metamorphic rocks, gneiss, chlorite-schist and crystalline limestone. Very commonly associated with chlorite. Also found with iron ores, pyroxene, amphibole, scapolite, zircon, apatite, feldspar, quartz, etc. Notable localities for its occurrence in crystals are Tavetsch, St. Gothard, etc., Switzerland; Ala, Piedmont; Sandford, Maine; Gouverneur, Diana, Rossie, Fine, Pitcairn, Edenville, Brewster, etc., in New York; in various places in Ontario, Canada.

**Name.** *Sphene* comes from a Greek word meaning *wedge* in allusion to a characteristic development of the crystals.

*Perovskite*,  $\text{CaTiO}_3$ , is a rare isometric titanate.

## NIOBATES — TANTALATES.

### Columbite — Tantalite.

**Composition.** A niobate and tantalate of ferrous iron and manganese  $(\text{Fe}, \text{Mn})(\text{Nb}, \text{Ta})_2\text{O}_6$ , which varies in composition from the niobate, *columbite*  $(\text{Fe}, \text{Mn})\text{Nb}_2\text{O}_6$ , to the tantalate, *tantalite*

(Fe,Mn)Ta<sub>2</sub>O<sub>6</sub>. Often contains small amounts of tin, tungsten, etc. A variety, known as *manganotantalite*, is essentially a tantalite with most of the iron replaced by manganese.

**Crystallization.** Orthorhombic. Habit of crystals is short prismatic; often in square prisms because of prominent development of the vertical pinacoids. Terminated by basal plane, pyramids and domes; frequently complex (Fig. 344). At times in heart-shaped contact twins.

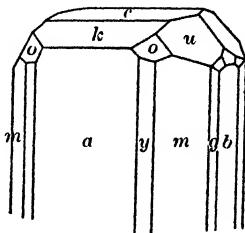


Fig. 344.

**Structure.** Crystallized and in parallel crystal groups. Also frequently granular massive.

**Physical Properties.** H. = 6. G. = 5.3-7.3, varying with the composition, increasing with rise in percentage of tantalum oxide present. Submetallic luster. Color iron-black, frequently iridescent. Streak dark red to black.

**Tests.** Difficultly fusible (5-5.5). Fused with borax; the bead dissolved in hydrochloric acid; the solution boiled with tin gives a blue color (niobium). There is no simple test for tantalum. Generally when fused in O. F. with sodium carbonate gives an opaque bluish green bead. Fused with sodium carbonate on charcoal in R. F. yields a magnetic mass. Recognized usually by its black color, submetallic streak and high specific gravity.

**Occurrence.** Occurs in granite rocks and in pegmatite veins, associated with quartz, feldspar, mica, tourmaline, beryl, spodumene, cassiterite, samarskite, wolframite, microlite, monazite, etc. Notable localities for its occurrence are the west coast of Greenland; Bodenmais, Bavaria; Ilmen Mountains, Siberia; Western Australia (*manganotantalite*); Standish, Maine; Haddam, Middletown and Branchville, Connecticut; in Amelia County, Virginia; Mitchell County, North Carolina; Black Hills, South Dakota; near Cañon City, Colorado.

**Name.** The two names are derived from the acid elements that the minerals contain. Niobium is often called columbium.

**Use.** Source of tantalum, which is used in making filaments for incandescent electric lamps. It is said that more than 20,000 20-candle-power electric-light filaments can be made from one pound of tantalum. The tantalum, used for this purpose in the United States, is imported and is derived, chiefly, from the manganotantalite deposits of western Australia.

There are a number of other niobates and tantalates, all of which are rare in occurrence. The following, however, might be mentioned: *pyrochlore*, chiefly a niobate of the cerium metals and calcium; *microlite*, essentially  $\text{Ca}_2\text{Ta}_2\text{O}_7$ ; *fergusonite*, a niobate of yttrium, erbium, cerium, uranium, etc.; *samaraskite*, a niobate and tantalate of ferrous iron, uranium and the cerium metals.

## PHOSPHATES, ETC.

The phosphates and the related arsenates, vanadates and antimonates may be divided into three classes: (1) *Anhydrous Phosphates, etc.*; (2) *Acid and Basic Phosphates, etc.*; (3) *Hydrous Phosphates, etc.*

### 1. ANHYDROUS PHOSPHATES, ETC.

#### Xenotime.

Yttrium phosphate,  $\text{YPO}_4$ . Erbium may be present in considerable amount, also small amounts of cerium, silicon and thorium. Tetragonal. Crystal forms resemble those of zircon. In rolled grains. Prismatic cleavage.  $H. = 4-5$ .  $G. = 4.55-5.1$ . Vitreous to resinous luster. Color yellowish to reddish brown. Opaque. Infusible. Tests as in monazite, which see. A rare mineral which occurs, like monazite, as an accessory constituent in granite, gneiss and pegmatite veins. Found as rolled grains in the stream sands, particularly in Brazil.

#### Monazite.

**Composition.** A phosphate of the cerium metals  $(\text{Ce}, \text{La}, \text{Di})\text{PO}_4$  with usually some thorium silicate,  $\text{ThSiO}_4$ .

**Crystallization.** Monoclinic. Crystals usually small, often flattened parallel to the orthopinacoid.

**Structure.** Usually in granular masses, frequently as sand. Crystals rare.

**Physical Properties.** H. = 5-5.5. G. = 5.2-5.3. Resinous luster. Color yellowish to reddish brown. Translucent to opaque.

**Tests.** Infusible. Insoluble in hydrochloric acid. After fusion with sodium carbonate, dissolve in nitric acid and add solution to excess of ammonium molybdate solution. A yellow precipitate forms (test for a phosphate). Decomposed by heating with concentrated sulphuric acid; solution after dilution with water and filtering gives with ammonium oxalate a precipitate of the oxalates of the rare earths.

**Occurrence.** A comparatively rare mineral occurring as an accessory mineral in gneissoid rocks, and as rolled grains in the sands derived from the decomposition of such rocks, where it has been preserved because of its hardness and high specific gravity. Found in the United States, chiefly in North and South Carolina, both in gneiss and in the stream sands. The bulk of the world's supply of monazite sand comes from the provinces of Minas Geraes, Rio de Janeiro, Bahia, and São Paulo, Brazil.

**Name.** The name *monazite* is derived from a Greek word meaning *to be solitary*, in allusion to the rarity of the mineral.

**Use.** Monazite is the chief source of thorium oxide, which it contains in amounts varying from 1 to 20 per cent; commercial monazite usually containing between 3 and 9 per cent. Thorium oxide is used in the manufacture of mantles for incandescent gas lights.

### Triphylite — Lithiophilite.

Phosphates of lithium with ferrous iron and manganese. *Triphylite* corresponds to  $\text{LiFePO}_4$ , *Lithiophilite* to  $\text{LiMnPO}_4$ . The two molecules are isomorphous and replace each other in varying amounts. Orthorhombic, crystals rare. Commonly massive, cleavable to compact. Cleavage parallel to base and brachypinacoid. H. = 4.5-5. G. = 3.42-3.56. Luster vitreous to resinous. Color bluish gray in triphylite to salmon-pink or clove-brown in lithiophilite. Translucent. Fusible at 2.5, giving red lithium flame. Triphylite becomes magnetic on heating in R. F. Lithiophilite gives in O. F. an opaque bluish green bead with sodium carbonate. Soluble in nitric acid and when the solution is added to an excess of a solution of ammonium molybdate gives yellow precipitate (test for phosphoric acid). Rare minerals occurring in pegmatite veins associated with other phosphates, etc. Triphylite found at Huntington,

Massachusetts; Peru, Maine; Grafton, New Hampshire; Rabenstein, Bavaria; Keityo, Finland. Lithiophilite found at Branchville, Connecticut.

### THE APATITE GROUP.

The *Apatite Group* consists of a closely related series of minerals crystallizing in the pyramidal group of the hexagonal system. They are:

<i>Apatite</i> ,	$\text{Ca}_4(\text{CaF})(\text{PO}_4)_3$ .
<i>Pyromorphite</i> ,	$\text{Pb}_4(\text{PbCl})(\text{PO}_4)_3$ .
<i>Mimetite</i> ,	$\text{Pb}_4(\text{PbCl})(\text{AsO}_4)_3$ .
<i>Vanadinite</i> ,	$\text{Pb}_4(\text{PbCl})(\text{VO}_4)_3$ .

#### Apatite.

**Composition.** *Fluor-apatite*,  $\text{Ca}_4(\text{CaF})(\text{PO}_4)_3$ ; more rarely *chlor-apatite*,  $\text{Ca}_4(\text{CaCl})(\text{PO}_4)_3$ .

**Crystallization.** Hexagonal; tri-pyramidal. Crystals usually long prismatic in habit; sometimes short prismatic or tabular.

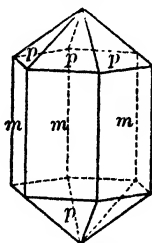


Fig. 345.

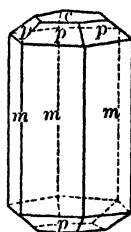


Fig. 346.

Usually terminated by prominent pyramid of first order and frequently a basal plane (Figs. 345 and 346). Some crystals show faces of the third order pyramid and have at times a very complex development.

**Structure.** Usually crystallized; also granular massive to compact.

**Physical Properties.** H. = 5 (can just be scratched by a knife). G. = 3.15. Vitreous to subresinous luster. Color usually some shade of green or brown; also blue, violet, colorless. Transparent to opaque.

**Tests.** Difficultly fusible (5-5.5). Soluble in acids. Gives a yellow precipitate of ammonium phosphomolybdate when dilute nitric acid solution is added to large excess of ammonium molybdate solution. Concentrated hydrochloric acid solution gives white precipitate of calcium sulphate when a few drops of sulphuric acid are added. Recognized usually by its crystals, color and hardness. Distinguished from beryl by the prominent pyramidal terminations of its crystals and by its being softer than a knife.

**Variety.** *Phosphorite.* An impure variety of apatite is known as phosphorite. It occurs in a compact or earthy form or in concretionary and nodular masses in fossiliferous rocks of different ages. Probably of organic origin.

**Occurrence.** Apatite is widely disseminated as an accessory constituent in all classes of rocks; igneous, metamorphic and sedimentary. It is also found in pegmatite and other veins, probably of pneumatolytic origin. Found in titaniferous magnetites. Occasionally concentrated into large deposits or veins. In the form of phosphorite or phosphate rock occurs extensively as a rock strata.

Apatite, as it exists scattered in small crystals throughout the rocks, slowly undergoes alteration and is gradually dissolved by percolating carbonated waters. Some of the phosphoric acid thus brought into solution goes into the sea where it is absorbed by living organisms; some remains in the soil, where its presence is a necessary condition for fertility and from which it is absorbed by plants and through them goes into the bodies of animals. The large bodies of phosphorite are derived from organic sources, such as animal remains. Bone is calcium phosphate in composition.

Apatite occurs in commercial amount in Ontario and Quebec, Canada. It is found there in crystals and masses enclosed in crystalline calcite and in veins and irregular nests along the contact of the limestone with eruptive rocks. The chief deposits lie in Ottawa County, Quebec. Crystalline apatite occurs in large amounts along the southern coast of Norway, between Langesund and Arendal. It is found there in veins and pockets associated with a mass of gabbro. Nodular deposits of phosphate rock are found at intervals all along the Atlantic coast from North Carolina to Florida, the chief deposits being in the latter state. High grade phosphate deposits are found in western middle Tennessee. Commercial deposits of phosphorite are to be found in northern Wales, in northern France, northern Germany, Belgium, Spain, etc.

Finely crystallized apatite occurs at various localities in the Alps; in Alexander County, North Carolina; at Auburn, Maine, etc.

**Use.** Apatite and phosphate rock are chiefly used for fertilizer purposes. They are usually ground and treated with sulphuric acid to render the phosphoric acid more soluble. Transparent varieties of apatite of fine color are occasionally used for gem material. The mineral is too soft, however, to allow of its very extensive use for this purpose.

### Pyromorphite.

**Composition.**  $Pb_4(PbCl)(PO_4)_3$  = Phosphorus pentoxide 15.7, lead protoxide 82.2, chlorine 2.6. The phosphorus is often replaced by arsenic and the species graduates into mimetite.

**Crystallization.** Hexagonal; tri-pyramidal. Prismatic crystals with basal plane. Rarely shows pyramid truncations. Often in rounded barrel-shaped forms. Sometimes cavernous, the crystals being hollow prisms (Fig. 328). Frequently in parallel groups.

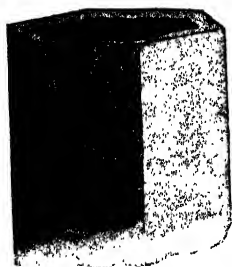


Fig. 347.

**Structure.** Crystallized, globular, reniform, fibrous and granular.

**Physical Properties.** H. = 3.5-4. G. = 6.5-7.1. Resinous luster. Color usually various shades of green, brown, yellow; more rarely orange-yellow, gray, white. Subtransparent to nearly opaque.

**Tests.** Easily fusible (2). Gives a lead globule when fused on charcoal with sodium carbonate. When fused alone on charcoal gives a globule which on cooling shows crystalline structure. Faint white sublimate of lead chloride when heated in C. T. A few drops of the nitric acid solution added to ammonium molybdate solution gives a yellow precipitate of ammonium phosphomolybdate.

**Occurrence.** A mineral formed by secondary action and found in the upper oxidized portions of lead veins, associated with other lead minerals. Notable localities for its occurrence are the lead mines of Poullaouen, Brittany; at Ems in Nassau; in the Nerchinsk

district, Siberia; Cornwall; Phoenixville, Pennsylvania; Davidson County, North Carolina, etc.

**Name.** Derived from two Greek words meaning *fire* and *form* in allusion to the crystalline form it assumes on cooling from fusion.

**Use.** A subordinate ore of lead.

### Mimetite.

**Composition.**  $Pb_4(PbCl)(AsO_4)_3$  = Arsenic pentoxide 23.2, lead protoxide 74.9, chlorine 2.4. Phosphorus replaces the arsenic in part and calcium, the lead. *Endlichite* is a variety intermediate between mimetite and vanadinite.

**Crystallization.** Hexagonal; tri-pyramidal. Crystals prismatic, showing basal plane and at times pyramids. Usually in rounded barrel- to globular-shaped forms.

**Structure.** In rounded crystals, mamillary crusts.

**Physical Properties.** H. = 3.5. G. = 7-7.2. Resinous luster. Colorless, yellow, orange, brown. Subtransparent to almost opaque.

**Tests.** Easily fusible (1.5). Gives globule of lead when fused with sodium carbonate on charcoal. A fragment placed in C. T. and heated in contact with a splinter of charcoal gives deposit of metallic arsenic on walls of tube.

**Occurrence.** A comparatively rare mineral of secondary origin, occurring in the upper, oxidized portion of lead veins. Notable localities for its occurrence are in Cornwall, Devonshire, and Cumberland, England; Johannegeorgenstadt, Saxony; Nerchinsk, Siberia; Phoenixville, Pennsylvania; Cerro Gordo, California, etc.

**Name.** Derived from the Greek for *imitator* in allusion to its resemblance to pyromorphite.

**Use.** A minor ore of lead.

### Vanadinite.

**Composition.**  $Pb_4(PbCl)(VO_4)_3$  = Vanadium pentoxide 19.4, lead protoxide 78.7, chlorine 2.5. Phosphorus and arsenic sometimes present in small amount replacing vanadium. In the variety *endlichite* the proportion of  $V_2O_5$  to  $As_2O_5$  is nearly as 1: 1.



**Crystallization.** Hexagonal; tri-pyramidal. Prism with base. Sometimes small pyramidal faces, rarely the pyramid of the third order. In rounded crystals; sometimes cavernous.

**Structure.** In crystals and globular forms. As incrustations.

**Physical Properties.** H. = 3. G. = 6.9–7.1. Adamantine to resinous luster. Color ruby-red, brown, yellow. Transparent to opaque.

**Tests.** Easily fusible (1.5). Gives globule of lead on charcoal when fused with sodium carbonate. Gives an amber color in O. F. to salt of phosphorus bead (vanadium). Dilute nitric acid solution gives with silver nitrate a white precipitate of silver chloride. Endlichite would give in C. T. the reaction for arsenic (see under mimetite).

**Occurrence.** A rare mineral of secondary origin found in the upper oxidized portion of lead veins. Occurs in various districts in Arizona and New Mexico.

**Use.** Source of vanadium and minor ore of lead. Vanadium is obtained chiefly from other ores, such as the sulphide, patronite; the vanadate, carnotite; and a vanadium mica, roscoelite. Vanadium is used chiefly as a steel hardening metal. Meta-vanadic acid,  $HVO_3$ , is used as a yellow pigment, known as vanadium bronze. Vanadium oxide is used as a mordant in dyeing.

---

### Amblygonite.

A phosphate of lithium and aluminium,  $Li(AlF)PO_4$ , having hydroxyl isomorphous with the fluorine and often sodium in small amount replacing the lithium. Triclinic. Usually massive, cleavable to compact. Perfect basal cleavage. H. = 6. G. = 3.08. Luster vitreous, pearly on cleavage face. Color white to pale green or blue. Translucent. Easily fusible (2) giving a red flame (lithium). Insoluble in acids. After fusion with sodium carbonate and dissolving in nitric acid, solution with excess of ammonium molybdate solution gives yellow precipitate (test for phosphate). A rare mineral found in pegmatite veins with tourmaline, lepidolite, apatite, etc. Found at Montebas, France; Hebron, Paris, Auburn, and Peru, Maine, etc.

## 2. ACID AND BASIC PHOSPHATES, ETC.

**Olivenite.**

An arsenate and hydroxide of copper,  $\text{Cu}_3\text{As}_2\text{O}_8 \cdot \text{Cu}(\text{OH})_2$ . Orthorhombic. Prismatic, often in acicular crystals. Also reniform, fibrous, granular.  $H. = 3$ .  $G. = 4.1-4.4$ . Fusible at 2-2.5. Adamantine to vitreous luster. Color olive-green to blackish green; also shades of brown and yellow to white. Translucent to opaque. With sodium carbonate on charcoal gives a copper globule. When ignited in C. T. with splinter of charcoal gives arsenical mirror. A little water when heated in C. T. Found rarely in oxidized portions of copper veins.

**Lazulite.**

A phosphate of magnesium and aluminium,  $\text{Mg}(\text{Al.OH})_2(\text{PO}_4)_2$ , with varying amounts of ferrous iron, replacing the magnesium. Monoclinic, usually in steep pyramids. Also massive, granular to compact.  $H. = 5-5.5$ .  $G. = 3.05-3.1$ . Vitreous luster. Azure-blue color. Translucent to opaque. Infusible. B. B. swells, loses its color and falls to pieces. Insoluble. A rare mineral.

## 3. HYDROUS PHOSPHATES, ETC.

**Vivianite.**

Hydrous ferrous phosphate,  $\text{Fe}_3\text{P}_2\text{O}_8 \cdot 8\text{H}_2\text{O}$ . Monoclinic. Prismatic crystals, vertically striated; often in radiating groups; at times fibrous or earthy. Perfect pinacoidal cleavage.  $H. = 1.5-2$ .  $G. = 2.58-2.68$ . Vitreous to pearly luster. Colorless when unaltered. Blue to green when altered. Transparent when fresh to opaque on exposure. Fusible at 2-2.5 to a magnetic globule. Nitric acid solution added to an excess of ammonium molybdate solution gives yellow precipitate (test for phosphate). Water in C. T. A rare mineral of secondary origin, associated with pyrrhotite, pyrite, limonite and other iron minerals.

*Erythrite* or *Cobalt Bloom*,  $\text{Co}_3\text{As}_2\text{O}_8 \cdot 8\text{H}_2\text{O}$ , is a rare secondary mineral which occurs as an alteration product of cobalt arsenides. It is usually pulverulent in structure and crimson to pink in color. *Annabergite* or *Nickel Bloom*,  $\text{Ni}_3\text{As}_2\text{O}_8 \cdot 8\text{H}_2\text{O}$ , is a similar nickel compound. It is light green in color.

**Scorodite.**

A hydrous ferric arsenate,  $\text{FeAsO}_4 \cdot 2\text{H}_2\text{O}$ . Orthorhombic, usually in pyramidal crystals, resembling octahedrons; also prismatic. Crystals in irregular groups. Also earthy.  $H. = 3.5-4$ .

G. = 3.1-3.3. Vitreous luster. Pale green to liver-brown in color. Translucent. Fusible at 2-2.5. Magnetic when heated in R. F. Heated intensely with splinter of charcoal in C. T. gives arsenical mirror. Water in C. T. In hydrochloric acid reacts for ferric iron. Occurs in oxidized portions of metallic veins with arsenopyrite and other iron minerals

### Wavellite.

A hydrous aluminium phosphate,  $(\text{AlOH})_3(\text{PO}_4)_2 \cdot 5\text{H}_2\text{O}$ . Orthorhombic, crystals rare. Usually in radiating globular aggregates. Good cleavage. H. = 3-4. G. = 2.33. Vitreous luster. Color white, yellow, green and brown. Translucent. Infusible. Insoluble. Decomposed by fusion with sodium carbonate and dissolved in nitric acid gives yellow precipitate (test for phosphoric acid) when solution is added to excess of ammonium molybdate. Moistened with cobalt nitrate, and then ignited assumes a blue color (aluminium). A rare mineral.

### Turquoise.

**Composition.** A hydrous phosphate of aluminium, colored by small amounts of a copper phosphate,  $\text{H}(\text{Al}_2\text{OH})_2\text{PO}_4$  with isomorphous  $\text{H}(\text{Cu.OH})_2\text{PO}_4$ .

**Structure.** Noncrystalline. Massive compact, reniform, stalactitic, encrusting. In thin seams and disseminated grains.

**Physical Properties.** H. = 6. G. = 2.6-2.8. Waxlike luster. Color blue, bluish green, green. Translucent to opaque.

**Tests.** Infusible. Insoluble. After fusion with sodium carbonate and dissolving in nitric acid, gives a yellow precipitate with an excess of ammonium molybdate solution (test for a phosphate). Gives a momentary green flame. In C. T. turns dark and gives water.

**Occurrence.** Turquoise is usually found in the form of small veins and stringers traversing more or less decomposed igneous rocks. The famous Persian deposits are found in trachyte near Nishapur in the province of Khorassan. In the United States it is found in much altered granite or granite porphyry in Mohave County, Arizona, and in Grant and Santa Fe counties, New Mexico. Turquoise has also been found in Nevada, California and Colorado.

**Name.** Is French and means *Turkish*, the original stones having come into Europe through Turkey.

**Use.** As a gem stone. It is always cut in round or oval forms and a one-carat stone may be valued as high as \$10. Much turquoise is cut which is veined with the various gangue materials and such stones are sold under the name of *turquoise matrix*.

## NITRATES.

## Soda Niter.

**Composition.** Sodium nitrate,  $\text{NaNO}_3$  = Nitrogen pentoxide 63.5, soda 36.5.

**Crystallization.** Hexagonal-rhombohedral. Homœomorphous with calcite. Has closely the same crystal constants, cleavage, optical properties, etc., as calcite. If a cleavage block of calcite is placed in a crystallizing solution of sodium nitrate, small rhombohedrons of the latter will form with parallel orientation on the calcite.

**Structure.** Usually massive, as an incrustation or in beds.

**Physical Properties.** Perfect rhombohedral cleavage.  $H. = 1.5-2$ .  $G. = 2.29$ . Vitreous luster. Colorless or white, also reddish brown, gray, yellow, etc. Transparent to opaque. Cooling taste.

**Tests.** Very easily fusible (1), giving a strong yellow sodium flame. After intense ignition gives an alkaline reaction on moistened test paper. Easily and completely soluble in water. Heated in C. T. with potassium bisulphate gives off red vapors of nitrous oxide.

**Occurrence.** Because of its solubility in water it is only to be found in arid and desert regions. Found in large quantities in the district of Tarapacá, northern Chile and the neighboring parts of Bolivia. Occurs over immense areas as a salt (caliche) bed interstratified with sand, beds of common salt, gypsum, etc. Has been noted in Humboldt County, Nevada, and in San Bernardino County, California.

**Use.** In Chile it is quarried, purified and used as a source of nitrates.

## Niter.

Potassium nitrate,  $\text{KNO}_3$ . Orthorhombic. Usually as thin encrustations or as silky acicular crystals. Perfect cleavage.  $H. = 2$ .  $G. = 2.09-2.14$ . Vitreous luster. Color white. Translucent.

Easily fusible (1) giving violet flame (potassium). After ignition gives alkaline reaction on moistened test paper. Heated in C. T. with potassium bisulphate gives red fumes of nitrous oxide. Easily soluble in water. Saline and cooling taste. Found as delicate crusts, as an efflorescence, on surfaces of earth, walls, rocks, etc. Found as a constituent of certain soils. Also in the loose soil of limestone caves. Not as common as soda niter, but produced from soils in France, Germany, Sweden. Obtained in India. Used as a source of nitrogen compounds.

## BORATES.

### Boracite.

Composition,  $Mg_7Cl_2B_{10}O_{30}$ . Isometric; tetrahedral. Crystals usually show cube, tetrahedron and dodecahedron in some combination. Crystals usually isolated and disseminated in other minerals. Also massive. Vitreous luster. Colorless, white, gray, green. Transparent to translucent. H. = 7. G. = 2.9-3.0. Fusible at 3 with green flame color (boron). Soluble in hydrochloric acid. Turmeric paper moistened with a solution of the mineral and then dried at 100° C. turns reddish brown (boron). Occurs associated with halite, anhydrite, gypsum, etc., as one of the products formed by the evaporation of bodies of salt water.

### Colemanite.

Hydrous borate of calcium,  $Ca_2B_6O_{11} \cdot 5H_2O$ . Monoclinic, in short prismatic crystals, highly modified. Cleavable massive to granular and compact. Perfect pinacoidal cleavage. H. = 4-4.5. G. = 2.42. Vitreous to adamantine luster. Colorless to white. Transparent to translucent. Fusible at 1.5. B. B. exfoliates, crumbles and gives green flame (boron). Water in C. T. A rare mineral, but occurring in considerable quantity in the salt lake deposits, in the arid regions of southeastern California, in Death Valley, Inyo County, and in San Bernardino and Los Angeles counties.

### Borax.

**Composition.** Hydrous sodium borate,  $Na_2B_4O_7 \cdot 10H_2O$  = Boron trioxide 36.6, soda 16.2, water 47.2.

**Crystallization.** Monoclinic. Prismatic crystals, sometimes quite large.

**Structure.** In crystals and as massive cellular material or encrustations.

**Physical Properties.** Perfect cleavage parallel to orthopinacoid.  $H. = 2-2.5$ .  $G. = 1.75$ . Vitreous luster. Colorless or white. Translucent to opaque. Sweetish-alkaline taste.

**Tests.** Easily fusible (1-1.5) with much swelling and gives strong yellow flame (sodium). Readily soluble in water. Turmeric paper, moistened with a dilute hydrochloric acid solution of the mineral, turns reddish brown when dried at  $100^{\circ}C$ . Much water in C. T.

**Occurrence.** Formed as a deposit from the evaporation of salt lakes, and as an efflorescence on the surface of the ground in arid regions. The deposits in Thibet have furnished large amounts of borax, which has been exported to Europe in the crude state, under the name of tincal. Found in quantity in the United States in the desert region of southeastern California, in Death Valley, Inyo County and in San Bernardino County. Occurs also in the adjacent parts of Nevada. Borax is associated with the other minerals deposited in similar manner, such as halite, gypsum, colemanite, and various rare borates.

**Name.** Borax comes from an Arabic name for the substance.

**Use.** Borax is used for washing and cleansing; as an antiseptic, preservative, etc., in medicine; as a solvent for metallic oxides in soldering and welding; and as a flux in various smelting and laboratory operations.

## URANATES.

### Uraninite. Pitch Blende.

**Composition.** An uncertain combination of the oxides of uranium,  $UO_2$  and  $UO_3$ . With small amounts of lead and the rare elements, thorium, yttrium, cerium, nitrogen, helium, argon, radium. It is the mineral in which the gas helium was first discovered on the earth, having been previously noted in the gases surrounding the sun by means of the sun's spectrum. In it, also, was first discovered the rare and strange substance, radium.

**Crystallization.** Isometric. In octahedrons, also with dodecahedrons. Less often showing cube faces. Crystals rare.

**Structure.** Usually massive and botryoidal; also in grains.

**Physical Properties.** H. = 5.5. G. = 9-9.7 (unusually high). Luster submetallic to pitchlike, dull. Color black. Streak brownish black.

**Tests.** Infusible. Imparts to the salt of phosphorus bead in O. F. a yellowish green and in R. F. a green color. Soluble in dilute sulphuric acid with the slight evolution of helium gas. Characterized chiefly by its pitchy luster, its high specific gravity, its color and streak.

**Occurrence.** Occurs either as a primary constituent of granite rocks or as a secondary mineral with ores of silver, lead, copper, etc. Found under the latter condition at Johannegeorgenstadt, Marienberg and Schneeberg in Saxony, at Joachimsthal and Příbram in Bohemia, and Rezbánya in Hungary. Occurs also in connection with the tin deposits of Cornwall, England. In the United States found in isolated crystals in pegmatite veins at Middletown, Glastonbury and Branchville, Connecticut. In the mica mines of Mitchell County, North Carolina. A narrow vein of it has been mined near Central City, Gilpin County, Colorado.

**Use.** The chief interest in the mineral lies in the fact that it is the principal source of radium. This element exists in it in extremely small percentages and it is necessary to subject a large amount of the mineral to a chemical concentration in order to produce a few grains of a radium salt. Uranium, itself, has only a limited use. Experiments have been made looking toward its use in steel. In the form of various compounds it has a limited use in coloring glass and porcelain, in photography and as chemical reagents.

## SULPHATES.

The sulphates and the related chromates may be divided into three divisions: (1) *Anhydrous Sulphates*; (2) *Acid and Basic Sulphates*; (3) *Hydrous Sulphates*.

### 1. ANHYDROUS SULPHATES.

#### Glauberite.

A sulphate of sodium and calcium,  $\text{Na}_2\text{Ca}(\text{SO}_4)_2$ . Monoclinic. Crystals thin, tabular parallel to base. Basal cleavage. H. = 2.5-3. G. = 2.7-2.85. Vitreous luster. Color pale yellow or gray.

Slightly saline taste. Fusible (1.5-2), giving yellow flame (sodium). After ignition, gives an alkaline reaction on moistened test paper. Soluble in hydrochloric acid and solution with barium chloride gives white precipitate of barium sulphate. A rare mineral occurring in the saline deposits, formed by the evaporation of salt lakes.

**BARITE GROUP.**

The Barite Group consists of the sulphates of barium, strontium, lead and calcium. They crystallize in the orthorhombic system with closely related crystal constants and similar habits. The members of the group are as follows:

- Barite*,  $BaSO_4$ .
- Celestite*,  $SrSO_4$ .
- Anglesite*,  $PbSO_4$ .
- Anhydrite*,  $CaSO_4$ .

**Barite. Barytes. Heavy Spar.**

**Composition.** Barium sulphate,  $BaSO_4$  = Sulphur trioxide 34.3, baryta 65.7. Strontium and calcium sulphates present at times.

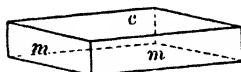


Fig. 348.

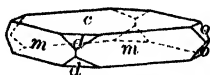


Fig. 349.

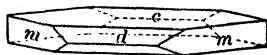


Fig. 350.

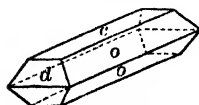


Fig. 351.

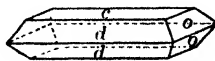


Fig. 352.

**Crystallization.** Orthorhombic. Crystals usually tabular parallel to base; often diamond shaped because of the presence of a short prism (Fig. 348). Both macro- and brachydomes



usually present, either beveling the corners of the diamond-shaped crystals (Figs. 349 and 350), or if the prism faces are wanting, beveling the edges of the tables and forming rectangular prismatic-shaped crystals elongated parallel to either the brachy- or macro-axis (Figs. 351 and 352). Crystals sometimes quite complex.

**Structure.** In crystals. In divergent groups of tabular crystals forming "crested barite." Also coarsely laminated; granular, earthy.

**Physical Properties.** Perfect cleavage parallel to base and prism faces. H. = 3-3.5. G. = 4.5 (heavy for a nonmetallic mineral). Vitreous luster; pearly at times on base. Colorless, white, and light shades of blue, yellow, red. Transparent to opaque.

**Tests.** Fusible at 4, giving yellowish green barium flame. After ignition gives an alkaline reaction on moistened test paper. Fused with sodium carbonate and charcoal dust gives a residue, which, when moistened, produces a dark stain of silver sulphide on a clean silver surface. Recognized by its white color, high specific gravity, characteristic cleavage and crystals.

**Occurrence.** Barite is a common mineral of wide distribution. It occurs usually as a gangue mineral in metallic veins, associated especially with ores of silver, lead, copper, cobalt, manganese and antimony. Sometimes in veins in limestone with calcite and celestite or in sandstone with copper ores. At times acts as a cement in sandstone. Deposited occasionally as a sinter by waters from hot springs. Notable localities for the occurrence of crystalline barite are in Westmorland, Cornwall, Cumberland, Derbyshire, and Surrey, England; Felsöbanya and other localities, Hungary; in Saxony and Bohemia. In the United States at Cheshire, Connecticut; De Kalb, New York; Fort Wallace, New Mexico. Massive barite, occurring usually as veins, nests and irregular bodies in limestones, has been quarried in the United States in Connecticut, Virginia, North Carolina, Georgia, Tennessee, Kentucky and Missouri.

**Use.** Barite is used chiefly for the production of barium hydroxide, employed in the refining of sugar. It is ground and used as a white pigment, to give weight to cloth and paper, etc.

### Celestite.

**Composition.** Strontium sulphate,  $\text{SrSO}_4$  = Sulphur trioxide 43.6, strontia 56.4.

**Crystallization.** Orthorhombic. Crystals resemble closely those of barite (which see). Commonly tabular parallel to the base or prismatic parallel to the brachy- or macro-axis with prominent development of the domes (Fig. 353). Crystals which are elongated parallel to the brachy-axis are frequently terminated in front by four faces in nearly equal development, consisting of 2 prism faces and 2 of the macrodome (Fig. 354).

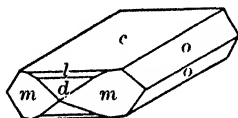


Fig. 353.

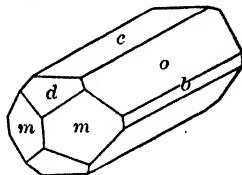


Fig. 354.

**Structure.** Crystallized. Also radiating fibrous; sometimes granular.

**Physical Properties.** Perfect cleavage parallel to base and prism.  $H. = 3-3.5$ .  $G. = 3.95-3.97$ . Luster vitreous to pearly. Colorless, white, often faintly blue or red. Transparent to translucent.

**Tests.** Fuses at 3.5-4 and colors the flame crimson (strontium). After ignition gives an alkaline reaction on moistened test paper. Fused with sodium carbonate and charcoal dust gives a residue, which, when moistened, produces on a clean silver surface a dark stain of silver sulphide. Closely resembles barite and it will usually need a flame test to positively differentiate the two species.

**Occurrence.** Celestite is found usually disseminated through limestone or in nests and lining cavities in such a rock. Associated with calcite, dolomite, gypsum, halite, sulphur, etc. Notable localities for its occurrence are with the sulphur deposits of Sicily; at Bex, Switzerland; Yate, Gloucestershire, England; Herregrund, Hungary; Strontian Island, Put-in-Bay, Lake Erie, Mineral

County, West Virginia; San Bernardino County, California. Found disseminated in limestones near Syracuse, New York, and in Monroe County, Michigan.

**Name.** Derived from *cælestis* in allusion to the faint blue color often present.

**Use.** Used in the preparation of nitrate of strontium for fireworks. Other strontium salts used in the refining of sugar.

### Anglesite.

**Composition.** Lead sulphate,  $\text{PbSO}_4$  = Sulphur trioxide 26.4, lead oxide 73.6.

**Crystallization.** Orthorhombic. Crystal habit often similar to that of barite (which see) but much more varied. Crystals may be prismatic parallel to all three of the crystal axes and frequently show many forms, with a complex development.

**Structure.** Crystallized. Also massive, granular to compact. Frequently earthy, in concentric layers about a nucleus of galena.

**Physical Properties.** Perfect cleavage parallel to base and prism.  $H. = 2.75-3$ .  $G. = 6.12-6.39$  (unusually high). Adamantine luster when pure and crystalline, dull when earthy. Colorless, white, pale shades of yellow, green and blue. May be colored dark gray, etc., by impurities. Transparent to opaque.

**Tests.** Easily fusible at 2.5. On charcoal with sodium carbonate reduced to a lead globule with yellow to white coating of lead oxide. Fused with sodium carbonate and charcoal dust gives a residue, which, when moistened, produces on a clean silver surface a dark stain of silver sulphide. Recognized by its high specific gravity, its adamantine luster and frequently by its association with galena.

**Occurrence.** Anglesite is a common lead mineral of secondary origin. It is formed through the oxidation of galena, sometimes directly to the sulphate as is shown by the concentric layers of anglesite found at times surrounding a core of unaltered galena, or sometimes by an intermediate solution and subsequent recrystallization. Found in the upper, oxidized portions of lead veins, associated with galena, cerussite, sphalerite, smithsonite, calamine, iron oxides, etc

Notable localities for its occurrence are Monte Poni, Sardinia; Island of Anglesea, England; at Leadhills, Scotland; various localities in Hungary, etc. Found in large amounts in Australia. Occurs in the United States at Phoenixville, Pennsylvania; Carroll County, Maryland; Colorado; Cerro Gordo, California.

**Name.** Named from the original locality on Island of Anglesea.

**Use.** An ore of lead.

### Anhydrite.

**Composition.** Anhydrous calcium sulphate,  $\text{CaSO}_4$  = Sulphur trioxide 58.8, lime 41.2.

**Crystallization.** Orthorhombic. Crystals rare; when observed are thick tabular, also prismatic parallel to the macro-axis.

**Structure.** Usually in crystalline masses, with rectangular cleavage. Fibrous, granular.

**Physical Properties.** Cleavage parallel to the three pinacoids, so yielding rectangular blocks.  $H. = 3-3.5$ .  $G. = 2.89-2.98$ . Luster vitreous to pearly. Color white with sometimes a faint gray, blue or red tinge. Transparent to translucent.

**Tests.** Fusible at 3-3.5. After ignition gives an alkaline reaction on moistened test paper. Moistened with hydrochloric acid and ignited gives orange-red flame of calcium. Soluble in hot hydrochloric acid and dilute solution with barium chloride gives white precipitate of barium sulphate.

**Occurrence.** Occurs in much the same manner as gypsum, and often associated with that mineral but is not nearly as common. Found in beds associated with salt deposits and in limestone rocks. Found at times in amygdaloidal cavities in basalt. Occurs at Aussee in Styria; at Stassfurt, Prussia; Bavaria; Hall in Tyrol; Bex, Switzerland; in the United States at Lockport, New York; Nashville, Tennessee. Found in large beds in Nova Scotia.

---

### Crocoite.

Lead chromate,  $\text{PbCrO}_4$ . Monoclinic. In slender prismatic crystals, vertically striated. Also granular.  $H. = 2.5-3$ .  $G. = 5.9-6.1$ . Adamantine luster. Color bright red. Orange-yellow streak. Fusible at 1.5. Fused with sodium carbonate on charcoal gives a lead globule. With borax gives a green bead in O. F. A rare mineral found in the oxidized zones of lead veins. Fine crystals come from Mount Dundas, Tasmania.

## 2. ACID AND BASIC SULPHATES.

**Brochantite.**

A basic sulphate of copper,  $\text{CuSO}_4 \cdot 3\text{Cu}(\text{OH})_2$ . Orthorhombic. Slender prismatic crystals, vertically striated, often acicular. Sometimes massive reniform. Perfect pinacoidal cleavage.  $H. = 3.5-4$ .  $G. = 3.9$ . Vitreous luster. Emerald to blackish green in color. Transparent to translucent. Fusible (3.5). Copper globule when fused with sodium carbonate on charcoal. Hydrochloric acid solution with barium chloride gives white precipitate of barium sulphate. Water in C. T. A rare mineral found in the oxidized portions of copper veins.

## 3. HYDROUS SULPHATES.

**Gypsum. Selenite.**

**Composition.** Hydrus calcium sulphate,  $\text{CaSO}_4 \cdot 2\text{H}_2\text{O} =$  Sulphur trioxide 46.6, lime 32.5, water 20.9.

**Crystallization.** Monoclinic. Crystals usually tabular parallel to clinopinacoid; in diamond-shaped crystals with edges beveled by prism and pyramid faces (Fig. 355). Other forms rare. Sometimes twinned (Fig. 356).

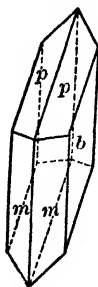


Fig. 355.



Fig. 356.

**Structure.** Cleavable massive; foliated; granular massive; sometimes with fibrous appearance.

**Physical Properties.** Cleavage in three directions; perfect parallel to clinopinacoid, yielding easily thin folia; with conchoidal surface parallel to orthopinacoid; with fibrous fracture

parallel to a pyramid. H. = 2 (can be scratched by the finger nail). G. = 2.32. Usually with vitreous luster; sometimes silky. Colorless, white, gray; sometimes various shades of yellow, red, brown, etc., from impurities. Transparent to opaque.

**Tests.** Fusible at 3-3.5. After intense ignition, residue gives alkaline reaction on moistened test paper. Soluble in hot dilute hydrochloric acid and solution with barium chloride gives white precipitate of barium sulphate. Much water in C. T. Characterized by its softness and its perfect pinacoidal cleavage.

**Varieties.** *Crystalline.* In crystals or foliated masses.

*Fibrous.* With coarse to fine fibrous appearance. *Satin spar* is fine fibrous with silky luster.

*Massive.* *Alabaster*, a fine-grained variety. *Rock gypsum*, massive granular or earthy; often impure.

**Occurrence.** Gypsum is a common mineral which is widely distributed in sedimentary rocks, often as thick beds. It frequently occurs interstratified with limestones and shales. Usually to be found as a layer underlying beds of rock salt and has been deposited there as one of the first minerals to crystallize because of the concentration of salt waters. Occurs also as lenticular bodies or scattered crystals in clays and shales. Found at times in volcanic regions, especially where limestones have been acted upon by sulphur vapors. Also, is common as a gangue mineral in metallic veins. Associated with many different minerals, the more common ones being salt, anhydrite, dolomite, calcite, sulphur, pyrite, quartz. Deposits of gypsum of commercial importance are found in many localities in the United States, but the chief producers are located in New York, Oklahoma, Texas, Iowa, Michigan, Ohio, Virginia and Kansas. Gypsum is found in large deposits in Arizona and New Mexico in the form of wind-blown sand.

**Name.** Derived from the Greek name for the species. At times the crystalline variety is called *selenite*, which comes from a Greek word meaning *moon*, probably in allusion to the moon-like white reflections from some varieties.

**Use.** Gypsum is chiefly used for the production of plaster of Paris. In the manufacture of this material, the gypsum is ground and then heated, until a large proportion of the water has been driven off. This plaster, when mixed with water, slowly absorbs the water and so hardens or "sets." Plaster of

Paris is used extensively for "staff," the material from which temporary exposition buildings are built, and for molds and casts of all kinds. Gypsum is employed in making adamant plaster for interior use. Serves as land plaster, for a fertilizer. Satin spar and alabaster are cut and polished for various ornamental purposes but are restricted in their uses on account of their softness.

### Chalcanthite. Blue Vitriol.

**Composition.** Hydrus copper sulphate,  $\text{CuSO}_4 \cdot 5\text{H}_2\text{O}$  = Sulphur trioxide 32.1, cupric oxide 31.8, water 36.1.

**Crystallization.** Triclinic. Crystals commonly tabular parallel to a pyramid face.

**Structure.** Crystallized, also massive in stalactitic and reniform structure, sometimes with fibrous appearance.

**Physical Properties.** H. = 2.5. G. = 2.12-2.30. Vitreous luster. Color deep azure-blue. Transparent to translucent. Metallic taste.

**Tests.** Fusible at 3. Gives copper globule when fused with sodium carbonate on charcoal. Soluble in water. Dilute hydrochloric acid solution gives with barium chloride precipitate of barium sulphate. Much water in C. T. Characterized by its blue color and its solubility in water.

**Occurrence.** A rare mineral, found at times in arid regions as a secondary mineral, occurring near the surface in copper veins, and derived from the original copper sulphides by oxidation. Often deposited from the waters in copper mines.

**Use.** A minor ore of copper. The artificial blue vitriol is used in calico printing, in galvanic cells, and in various manufacturing industries.

### Kalinite. Potash Alum.

A hydrus sulphate of aluminium and potassium,  $\text{K}_2\text{SO}_4 \cdot \text{Al}_2(\text{SO}_4)_3 \cdot 24\text{H}_2\text{O}$ . Isometric; pyritohedral. Usually fibrous or massive. H. = 2-2.5. G. = 1.75. Vitreous luster. Colorless to white. Transparent to translucent. Fuses at 1 with swelling and gives a violet flame (potassium). Easily soluble in water. Astringent taste. Hydrochloric acid solution with barium chloride gives a white precipitate of barium sulphate, and with ammonium hydroxide in

excess gives white precipitate of aluminium hydroxide. A comparatively rare mineral, which usually occurs as efflorescence on clays and slates, particularly those containing disseminated pyrite. Also at times in connection with sublimation products from volcanoes.

## TUNGSTATES, MOLYBDATES.

### Wolframite-Hübnerite.

**Composition.** Tungstates of ferrous iron and manganese. *Wolframite*  $(Fe,Mn)WO_4$ , in which the ratio of the iron to the manganese varies from 9 : 1 to 2 : 3. *Hübnerite*, nearly pure  $MnWO_4$ .

**Crystallization.** Monoclinic. Crystals commonly tabular parallel to the orthopinacoid, giving bladed forms. Prism zone vertically striated.

**Structure.** In bladed, lamellar or columnar forms. Massive granular.

**Physical Properties.** Perfect cleavage parallel to clinopinacoid.  $H. = 5-5.5$ .  $G. = 7.2-7.5$ . Submetallic to resinous luster. Color black in wolframite to brown in hübnerite. Streak from nearly black to brown.

**Tests.** Fusible (3-4). Insoluble in acids. Fused with sodium carbonate, fusion then dissolved in hydrochloric acid, tin added and solution boiled gives a blue color (tungsten). In O. F. with sodium carbonate gives bluish green bead (manganese). Wolframite when fused with sodium carbonate in R. F. on charcoal gives a magnetic mass.

**Occurrence.** Comparatively rare minerals, found usually with cassiterite and associated also with scheelite, bismuth, quartz, pyrite, galena, sphalerite, etc. Found in fine crystals from Schlaggenwald, Bohemia, and in the various tin districts of Saxony and Cornwall. Wolframite occurs in the United States in the Black Hills, South Dakota; Boulder County, Colorado; Seward Peninsula, Alaska. Hübnerite is found near Butte, Montana; in various localities in Nevada and Arizona.

**Use.** Chief ores of tungsten. Tungsten is used as a hardening metal in the manufacture of tool steel. Also as a filament in incandescent electric lights. Sodium tungstate is used in fire-proofing cloth and as a mordant in dyeing.



### Scheelite.

**Composition.** Calcium tungstate,  $\text{CaWO}_4$  = Tungsten trioxide 80.6, lime 19.4. Molybdenum is usually present, replacing a part of the tungsten.

**Crystallization.** Tetragonal; tri-pyramidal. Crystals usually simple pyramids of first order. Closely resemble isometric octahedrons in angles (Fig. 357). Faces of the pyramid of third order are small and rare.

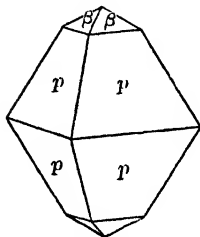


Fig. 357.

**Structure.** Massive granular; in crystals.

**Physical Properties.** Cleavage parallel to pyramid of first order.  $H. = 4.5-5$ .  $G. = 6.05$  (unusually high for a mineral with nonmetallic luster). Vitreous to adamantine luster. Color white, yellow, green,

brown. Usually translucent to opaque, sometimes transparent.

**Tests.** Difficultly fusible (5). Decomposed by boiling hydrochloric acid leaving a yellow residue of tungstic oxide, which, when tin is added to the solution and boiling continued, turns first blue then brown. Recognized by its high specific gravity and the test for tungsten.

**Occurrence.** Occurs usually with quartz in crystalline rocks associated with cassiterite, topaz, fluorite, apatite, molybdenite, wolframite, etc. Found at times with gold. Occurs in connection with the tin deposits of Bohemia, Saxony and Cornwall; in quantity in New South Wales and Queensland. Found in the United States at Trumbull, Connecticut; near Randsburg, San Bernardino County, California; near Browns, Humboldt County, Nevada; near Dragoon, Cochise County, Arizona.

**Use.** A subordinate ore of tungsten, wolframite (which see) furnishing the greater amount. Tungsten is used chiefly as a steel-hardening metal.

### Wulfenite.

**Composition.** Lead molybdate,  $\text{PbMoO}_4$  = Molybdenum trioxide 39.3, lead oxide 60.7. Calcium sometimes replaces the lead.

**Crystallization.** Tetragonal; tri-pyramidal. Crystals usually square tabular in habit with prominent base. Sometimes very thin. Edges of tables beveled with faces of low second order pyramid. More rarely pyramidal in habit. Pyramid of third order in small faces and very rare.

**Structure.** In crystals; also massive granular, coarse to fine.

**Physical Properties.** H. = 4.5-5. G. = 6.05. Vitreous to adamantine luster. Color yellow, orange, red, gray, white. White streak. Transparent to subtranslucent.

**Tests.** Easily fusible at 2. Gives a lead globule when fused with sodium carbonate on charcoal. With salt of phosphorus in R. F. gives green bead; in O. F. yellowish green when hot to almost colorless when cold. If powdered mineral is moistened with concentrated sulphuric acid and evaporated almost to dryness in a porcelain crucible the residue will show a deep blue color on cooling (molybdenum).

**Occurrence.** Found in the oxidized portion of lead veins with other ores of that metal, especially vanadinite and pyromorphite. Found in the United States in a number of places in Utah, Nevada, Arizona and New Mexico.

**Use.** An ore of molybdenum. Molybdenum is used as a steel-hardening metal. In the form of ammonium molybdate it is used as a chemical reagent, as a fireproofing material and as a disinfectant. Molybdenum used also to color leather and rubber.

## LISTS OF MINERALS ARRANGED ACCORDING TO ELEMENTS.

In the following section are given lists of the minerals that are of commercial importance because of some element which they contain. All of the minerals that could serve as a source of any particular element are grouped together, their relative importance being indicated by the type used in printing their names. The order in which the minerals are given in each list is the same as that in which they are described in the previous section of this book. The different elements have been treated in alphabetical sequence in order to facilitate ready reference

to them. Each table will be followed by a brief general discussion of the occurrence of the minerals given in it and by a short statement as to the uses of the element derived from them.

### Aluminium.

**Cryolite**,  $\text{Na}_3\text{AlF}_6$ .

**Bauxite**,  $\text{Al}_2\text{O}(\text{OH})_4$ .

**Corundum**,  $\text{Al}_2\text{O}_3$ .

**The Feldspars**,  $\text{KAlSi}_3\text{O}_8$ ,  $\text{NaAlSi}_3\text{O}_8$ ,  
 $\text{CaAl}_2\text{Si}_2\text{O}_8$ , etc.

Gibbsite,  $\text{Al}(\text{OH})_3$ .

**Kaolin**,  $\text{H}_4\text{Al}_2\text{Si}_2\text{O}_9$ .

Aluminium is the most common of all the metals. Unlike other metals, however, its occurrence, with the exception of the fluorides, is restricted to minerals containing oxygen. It is most abundantly found in the rock-making silicates, in the majority of which it is an essential constituent. It also occurs in large amount in the clays. The minerals which can be used as ores of the metal are, however, few in number, the only one at present of importance being bauxite. The enormous amounts of aluminium contained in the various silicates are not yet available because of the difficulty and expense of extraction.

Bauxite is produced in the United States chiefly from Arkansas, Alabama, Georgia and Tennessee. The deposits in Arkansas are found in Pulaski and Saline counties. They have an average thickness of 10 to 15 feet. In one district the beds lie directly upon a body of kaolin, which in turn rests upon a syenite rock-mass and it is probable that both minerals have been derived from its decomposition. The Alabama-Georgia district extends from Jacksonville, Alabama, to Cartersville, Georgia. The ore occurs as pockets or lenses in a clay which has been derived by weathering processes from a dolomite limestone. The bauxite is either pisolitic or clay-like in structure.

Cryolite, imported from Greenland, has been used as an ore of aluminium and at present is used as a flux in the electrolytic process by which most of the metal is obtained.

The usual process at present by which aluminium is extracted from the bauxite ores is briefly as follows: The ore is heated to low redness with sodium carbonate forming sodium aluminate. This compound is leached out by water and by passing  $\text{CO}_2$  gas

into the solution the aluminium is precipitated as the hydroxide. The latter on being heated is converted into the oxide of the metal. The pure metal is prepared from this oxide by an electrolytic process which takes place in a bath of fused cryolite. The tank in which the reaction takes place is lined with carbon and forms the cathode, while graphite rods suspended in the bath serve as the anode. The metal collects in the bottom of the tank.

Aluminium is valuable because of its low density and because it is not easily oxidized or corroded. It is a good electrical conductor and to some extent is replacing copper used for that purpose. It is used in many alloys, particularly with zinc, copper and nickel. It is used in small amounts in casting steel in order to take up any oxygen in the melt and also to prevent porosity in the metal. Aluminium and iron oxide are mixed in a finely divided state to form the material known as thermit. When this mixture is ignited the heat of the combustion of the aluminium is so great that it can be used in welding iron and steel. Sheets and tubes and castings of aluminium are used wherever a light weight metal is desired, for instance in the manufacture of certain parts of automobiles. Aluminium is used in the manufacture of cooking utensils, as a substitute for lithographic stones and zinc plates, as powder in the manufacture of metallic paints, etc. It is used also in the form of salts, chiefly alum and aluminium sulphate, to harden paper, in the purification of water, as mordants in dyeing, in baking powders, in medicine, etc.

### Antimony.

Native Antimony, Sb.

**Stibnite,  $Sb_2S_3$ .**

Antimony occurs in a considerable number of minerals, especially those belonging to the series known as the sulpho-salts, which are largely combinations of copper, lead or silver with antimony and sulphur. These minerals are mined, however, for the other metals that they contain and any antimony that is produced from them is in the nature of a by-product. Stibnite is practically the only mineral which is mined for its antimony. This mineral has been found in the United States in a

comparatively few deposits. It has been mined on a small scale in California, Nevada and Idaho. The greater part of the antimony produced in the United States is derived from antimonial lead which is an alloy of the two metals derived from the smelting of lead ores that contain small amounts of antimony minerals. Considerable amounts of antimony and antimony ores are imported, chiefly from China, France, Italy, Mexico and Japan.

Antimony is used in alloys, such as type metal (lead, antimony and bismuth), babbitt or anti-friction metal (antimony, tin, etc.), britannia metal (tin with antimony and copper), etc. Antimony oxide is used as a pigment and in the glazing of enameled ware. The sulphide is used in fireworks, in safety matches and in percussion caps. Other compounds are used in medicine and for various purposes in the arts.

### Arsenic.

Native Arsenic, As.

Realgar, AsS.

Orpiment, As<sub>2</sub>S<sub>3</sub>.

**Arsenopyrite**, FeAsS.

Arsenic in minerals ordinarily plays the part of a nonmetallic element, similar to sulphur in its chemical relations. It forms three classes of compounds, the arsenides, the sulpharsenites and the arsenates. The number of minerals which contain arsenic is considerable but only a few can be considered as distinctively arsenic minerals. Arsenopyrite is the only one which at present serves as an ore. Most of the arsenic oxide produced comes as a by-product in the smelting of arsenical ores for copper, gold, lead, etc. Large amounts of the oxide are obtained from the smelting of the copper ores at Butte, Mont., the mineral enargite, Cu<sub>3</sub>AsS<sub>4</sub>, being its chief source. The oxide is also produced at smelting plants in Washington and Utah. Arsenopyrite has been mined at Brinton, Virginia.

Metallic arsenic is used in some alloys, particularly with lead in shot metal. Arsenic is chiefly used, however, in the form of white arsenic, or arsenious oxide. This is employed in medicine, as a poison, as a preservative, in making Paris green (an arsenate and acetate of copper), as a pigment, in glass manufacture, etc.

**Barium.**Witherite,  $\text{BaCO}_3$ .**Barite**,  $\text{BaSO}_4$ .

Barite is the chief source of barium compounds. It has been mined in the United States in Missouri, North Carolina, Georgia, Kentucky and Tennessee. The mineral is ground and sometimes purified by washing and then used as a partial substitute for white lead in paint, to give weight to paper and cloth, etc. Barium hydroxide is used extensively in sugar refining.

**Bismuth.**

Native Bismuth, Bi.

Bismuthinite,  $\text{Bi}_2\text{S}_3$ .

The most important bismuth mineral is the native metal. Bismuth is produced, however, mostly as a by-product in the smelting of gold and silver ores. Only a comparatively small amount is obtained in the United States, chiefly from Colorado and Utah.

Bismuth is used in the alloys which it forms with lead, tin and cadmium. These fuse at low temperatures and are used for safety fuses, safety plugs, etc. Various compounds of bismuth are used in medicine and in the arts.

**Cadmium.**Greenockite,  $\text{CdS}$ .

Greenockite is the only cadmium mineral of importance and this is very rare in occurrence. The cadmium of commerce is obtained from zinc ores that carry a small amount of the metal. Practically the entire output of cadmium in the United States comes from the zinc ores of the Joplin district, Missouri, which frequently contain some 0.3 per cent of the metal. The zinc ores of Silesia have for a long time been a prominent source of cadmium.

Cadmium is used in various alloys, such as low-fusing alloys, dental amalgam, metal for stereotype plates, etc. The metal is used with silver in electroplating. The sulphide,  $\text{CdS}$ , is known as cadmium-yellow and is used extensively as a pigment. Various salts of cadmium find uses in the arts.

**Chromium.**

**Chromite**,  $\text{FeCrO}_4$  with  $\text{MgCrO}_4$ .      **Crocoite**,  $\text{PbCrO}_4$ .

Chromite, or chromic iron ore, is the chief source of chromium. Its production in the United States is very small, coming mostly from Shasta County, California. It has also been found in workable deposits in Pennsylvania, Maryland, North Carolina and Wyoming. Large amounts of the ore are imported from New Caledonia, Greece and Canada.

Chromium is used as a steel-hardening metal. It gives to steel a superior hardness and if added in the proper proportion does not produce brittleness. The mineral chromite is made into bricks that are used as linings for metallurgical furnaces. Various red, orange and green pigments and dyes are made from chromium compounds. Chromium salts are used as mordants in the dyeing and printing of cloth. Chromium compounds are useful in tanning leather.

**Cobalt.**

**Linnæite**,  $\text{Co}_3\text{S}_4$ .      **Cobaltite**,  $\text{CoSAs}$ .  
**Smaltite**,  $\text{CoAs}_2$ .

Cobalt is a rare element which is usually found in small amounts associated with nickel minerals. Much of the cobalt of commerce is produced from other ores as a by-product. The only source of cobalt at present in the United States is from the lead ores of southeastern Missouri, where it occurs sparingly as the mineral linnæite. The metal is produced from a cobaltiferous manganese ore found in New Caledonia, and also from the silver ores of Cobalt, Canada.

Cobalt is chiefly used in the form of the oxide as a blue pigment in making glass and pottery.

**Copper.**

**Native Copper**,  $\text{Cu}$ .      **Bornite**,  $\text{Cu}_5\text{FeS}_4$ .  
**Chalcocite**,  $\text{Cu}_2\text{S}$ .      **Chalcopyrite**,  $\text{CuFeS}_2$ .  
**Stromeyerite**,  $\text{CuAgS}$ .      **Tetrahedrite**,  $\text{Cu}_9\text{Sb}_2\text{S}_7$ .  
**Covellite**,  $\text{CuS}$ .      **Tennantite**,  $\text{Cu}_3\text{As}_2\text{S}_7$ .

**Enargite**,  $\text{Cu}_3\text{AsS}_4$ .

**Atacamite**,  $\text{Cu}_2\text{Cl}(\text{OH})_3$ .

**Cuprite**,  $\text{Cu}_2\text{O}$ .

**Malachite**,  $\text{Cu}(\text{OH})_2 \cdot \text{CuCO}_3$ .

**Azurite**,  $\text{Cu}(\text{OH})_2 \cdot 2\text{CuCO}_3$ .

**Chrysocolla**,  $\text{CuSiO}_3 \cdot 2\text{H}_2\text{O}$ .

**Olivenite**,  $\text{Cu}(\text{CuOH})\text{AsO}_4$ .

**Brochantite**,  $\text{Cu}_4(\text{OH})_6\text{SO}_4$ .

**Chalcanthite**,  $\text{CuSO}_4 \cdot 5\text{H}_2\text{O}$ .

Copper is a common and widely distributed element. It is found in a number of important minerals which usually occur in veins. Chalcopyrite is the most important ore, and in most cases is the only primary copper mineral in a deposit. The other important sulphides, bornite and chalcocite, are usually, although not always, the results of secondary enrichment. Solutions that have leached out the copper content of the upper portion of a copper vein will react with the unoxidized chalcopyrite farther down to enrich it in respect to the amount of copper it contains and convert it into bornite and chalcocite. In this way copper veins often show in the upper part, just below the oxidized zone, a body of enriched sulphides. The veins at Butte, Montana, are notable examples of this. This enriched sulphide zone is to be observed in general when the copper veins traverse igneous rocks. When they lie in limestones the upper portion of the vein is more liable to be characterized by the presence of the oxidized copper ores, native copper, cuprite, malachite, azurite, chrysocolla, etc. Pyrite often contains small amounts of copper and when it occurs in large bodies becomes an important ore of the metal.

Copper is produced in from fifteen to twenty of the states and territories of the United States. A brief description of the chief districts in the more productive states follows. *Alaska*: Three districts of importance have been developed; the Ketchikan district where the ores are contact bodies, and are composed chiefly of pyrrhotite, magnetite, pyrite and chalcopyrite; Prince William Sound district including several mines on Latouche Island; Copper River district where immense bodies of chalcocite and azurite occur in limestone. *Arizona*: The most productive district is that of Bisbee where the ore bodies replace limestone and are closely associated with intrusive rocks. The original ores were chiefly cupriferous pyrite, but secondary en-



richment has extended to great depths. Near the surface large bodies of oxidized ores were found. The Jerome district has large bodies of ore lying in an igneous rock which through shearing has been rendered almost schistose in structure. The ores at present are largely sulphides. Clifton-Morenci district has its ores occurring as contact deposits lying in limestone and shales into which dikes of porphyry have been intruded, and as disseminated bodies lying in the porphyry itself. The workable ores are those which have undergone secondary enrichment, and consist of both carbonates and sulphides. Globe district has deposits that occur as lenticular replacement bodies in limestone and as deposits in fissures in diabase. Disseminated bodies also occur. *California*: The chief districts lie in Shasta County, where the ores occur as replacement bodies along shear zones in a granite porphyry. *Colorado*: Most of the copper from this state comes as a by-product in the smelting of gold and silver ores and is derived chiefly from Lake, San Juan, Gilpin, Chaffee and Clear Creek counties. *Idaho*: The greater part of the output comes from the Cœur d'Alene district. The deposit consists of disseminated bornite, chalcocite and chalcopyrite in beds of quartzite. *Michigan*: This state was for a long period the most important producer in the country, and still ranks with the leading three. The ores are unique in that they consist wholly of native copper. They occur on Keweenaw Peninsula, the rocks of which consist of a series of alternating sandstone conglomerate beds and basic lava flows, all inclined at a steep angle to the northwest. The copper is found disseminated through and acting as a cement in the conglomerates, and in less important deposits in the amygdaloidal layers of the lavas. *Montana*: The one important district, and for a number of years the most important copper district in the world, is at Butte. The ores occur as replacement veins in a granitic rock. The ores have been very greatly enriched by secondary action forming at times very large sulphide bodies. The important ore minerals are chalcopyrite, chalcocite and enargite. *Nevada*: The important district is at Ely, where the sulphide ores occur as disseminations in highly altered porphyry. *New Mexico*:

The Santa Rita-Hanover and the Burro Mountain districts are the chief producers. *Tennessee*: The chief district is that of Ducktown. The ores occur as steeply dipping lenses in a schist and contain chiefly pyrrhotite, pyrite and chalcopyrite. *Utah*: The Bingham district has ores which are closely associated with a granitelike rock called monzonite which is intruded into a series of quartzites, limestones and shales. The bodies are either contact deposits in limestone or in large disseminated deposits in the monzonite. The Tintic district has ore bodies occurring as contact deposits, replacements in limestone and filling fissures, the last being the most important. The Frisco district has ores which consist of pyrite and chalcopyrite occurring disseminated in a monzonite.

Important copper deposits outside of the United States are at Rio Tinto in Spain; in Australasia, at Mount Lyell in Tasmania, at Wallaroo and Moontain, South Australia, at Mount Morgan in Queensland and at different localities in New South Wales; in Mexico at Cananea and at various districts in Sonora, etc.; in Canada at the Boundary district in British Columbia and the Sudbury district in Ontario. Chile, Japan and Germany also produce notable amounts of copper.

Copper is extensively used in the form of wire, sheet and nails. A large amount, chiefly as wire, is used as an electrical conductor. It has important uses in various alloys, as brass (copper and zinc), bronze and bell metal (copper and tin, at times zinc also), German silver (copper, zinc and nickel), etc. Copper sulphate, or blue vitriol, is used in calico printing and in galvanic cells.

## Gold.

**Native Gold**, Au, with small amounts of Ag.

Petzite, (Ag,Au)<sub>2</sub>Te.

Sylvanite, AuAgTe<sub>4</sub>.

Krennerite, AuTe<sub>2</sub>.

Calaverite, AuTe<sub>2</sub>.

By far the greater part of gold occurs as the native metal. It enters into only one series of compounds, the tellurides, and these minerals, while at times forming rich ore deposits, as at Cripple Creek, Colorado, are found in only a few districts. For

the occurrence and associations of the gold ores see under gold, page 125; under calaverite, page 158; and sylvanite, page 157.

The uses of gold for jewelry, plating and coins are well known. The standard gold for United States coin is composed of 9 parts gold and 1 part copper. The gold used in jewelry is alloyed with copper and silver in order to harden it. The purity of gold is given in carats; 24 carats being the pure metal. Most of the gold used is 18 carats fine or  $\frac{3}{4}$  gold and  $\frac{1}{4}$  other metals. Gold is used as the standard of international exchange and one troy ounce is worth \$20.67.

### Iron.

**Hematite**,  $\text{Fe}_2\text{O}_3$ .

Goethite,  $\text{Fe}_2\text{O}_3(\text{OH})_2$ .

**Magnetite**,  $\text{Fe}_3\text{O}_4$ .

**Limonite**  $\text{Fe}_4\text{O}_3(\text{OH})_6$ .

Turgite,  $\text{Fe}_4\text{O}_5(\text{OH})_2$ .

**Siderite**,  $\text{FeCO}_3$ .

Iron, next to aluminium, is the most abundant metal in the crust of the earth. It very rarely occurs native, being found chiefly in the form of oxides, sulphides and silicates. It is found in greater or less amount in many rocks, especially in those that contain the amphiboles, pyroxenes, micas or olivine. The mineral species that contain iron are very numerous but the minerals of importance as ores number only three or four. Iron occurs in large amounts in the sulphides, pyrite,  $\text{FeS}_2$ , being the most common of all sulphides. These, however, never serve as ores of the metal because of the injurious effects of the presence of sulphur upon the iron. The minerals used as ores are the various oxides or the carbonate.

The various iron ores are formed under different conditions, and as a rule occur alone or in association with only small amounts of any one of the others. For discussion of the occurrence of the iron ores see, therefore, under hematite, page 184; magnetite, page 189; limonite, page 200; and siderite, page 210.

Hematite is by far the most important ore of iron, forming in the United States about nine-tenths of the ore produced. Limonite and magnetite form each about one-twentieth of the total, while the amount of siderite produced is almost negligible. Hematite ore comes chiefly from the various Lake Superior dis-

tricts and to a much less extent from Alabama. Limonite is found in the Appalachian states, and magnetite in New York, New Jersey and Pennsylvania. Siderite is obtained from Ohio.

Nearly one-half of the world's production of iron ore comes from the United States; the amount produced from Minnesota alone nearly if not quite equals that produced in any other country. Germany and Great Britain, Spain and France, are notable producers of iron.

The uses of iron and steel are too well known to need discussion. Copperas, or green vitriol,  $\text{FeSO}_4 \cdot 7\text{H}_2\text{O}$ , is the most important salt of iron, being used in dyeing, in making inks, Prussian blue, rouge, and as a disinfectant. Rouge,  $\text{Fe}_2\text{O}_3$ , is used as a polishing powder and as a red paint. Considerable amounts of soft iron ore, known as paint ore, are ground for mineral paints, such as ocher, umber, sienna, etc.

### Lead.

<b>Galena</b> , $\text{PbS}$ .	Vanadinite, $\text{Pb}_4(\text{PbCl})(\text{VO}_4)_3$ .
<b>Cerussite</b> , $\text{PbCO}_3$ .	<b>Anglesite</b> , $\text{PbSO}_4$ .
Phosgenite, $(\text{PbCl})\text{CO}_3$ .	Crocoite, $\text{PrCrO}_4$ .
Pyromorphite, $\text{Pb}_4(\text{PbCl})(\text{PO}_4)_3$ .	
Mimetite, $\text{Pb}_4(\text{PbCl})(\text{AsO}_4)_3$ .	Wulfenite, $\text{PbMoO}_4$ .

Galena is the usual primary ore of lead and furnishes by far the greater part of the metal. Cerussite and anglesite are secondary minerals which occur in smaller amounts in the oxidized zone of lead deposits. Galena occurs most commonly associated with zinc ores, especially sphalerite, or in connection with silver ores. Lead, which is derived from ores that are free from silver, is known as "soft lead," while "desilverized" lead, which is obtained from silver ores, is known as "hard lead." Lead ores are most commonly found as replacement deposits in limestone rocks, either in the form of beds or irregular bodies, or as small masses disseminated through a stratum of the rock. For the associations and distribution of lead ores see under galena, page 139.

Metallic lead is used in the form of sheet, pipe, etc. It is used to make weights, bullets and shot. It is a constituent of various

alloys such as solder (lead and tin), type metal (lead and antimony), low-fusing alloys (lead, bismuth and tin). A large amount of lead is used in the form of the basic carbonate,  $(\text{Pb.OH})_2\text{Pb}(\text{CO}_3)_2$ , which is known as white lead, and is very valuable as a paint. The oxides of lead, litharge,  $\text{PbO}$ , and minium,  $\text{Pb}_3\text{O}_4$ , are used in making fine grades of glass, in glazing earthenware and as pigments. Lead chromates are used as yellow and red paints. Lead acetate, known as sugar of lead, has important uses in various industries.

### Manganese.

Alabandite, $\text{MnS}$ .	<b>Psilomelane</b> , $\text{MnO}_2$ , $\text{MnO}$ , etc.
Franklinite, $(\text{Fe,Mn,Zn})(\text{Fe,Mn})_2\text{O}_4$ .	
Braunite, $\text{Mn}(\text{Mn,Si})\text{O}_3$ .	Wad, mixture of oxides.
<b>Manganite</b> , $\text{Mn}_2(\text{OH})_2\text{O}_2$ .	Rhodochrosite, $\text{MnCO}_3$ .
<b>Pyrolusite</b> , $\text{MnO}_2$ .	Rhodonite, $\text{MnSiO}_3$ .

Manganese is an element that is widely distributed in small amounts. Traces of it at least are to be found in most rocks. It most commonly occurs in silicates, oxides and carbonates. The oxides are the most abundant, and practically all of the metal is derived from them.

The ore deposits of manganese are ordinarily of secondary origin. The manganese existing in the rock-making silicates, through the agency of weathering processes, is changed to an oxide. By some process of concentration these minerals are often gathered together into irregular bodies lying in residual clays. At times the manganese oxides occur associated with iron oxides, and when this is the case the two are smelted together to form directly an iron-manganese alloy used in making steel. Manganese minerals also frequently occur as gangue minerals in connection with silver ores. A manganese ore to be of commercial value should contain at least 40 per cent of metallic manganese and be low in percentages of phosphorus and silica.

Manganese is obtained in the United States from the following materials: manganese ores, manganiferous iron ores, manganif-

erous silver ores, and from the residuum left from smelting the zinc ores of Franklin Furnace, New Jersey. Manganese ores are found in commercial deposits in Virginia, Georgia, Arkansas and California. Manganiferous iron ores are found in Virginia, and at various places in the Lake Superior iron-ore districts. Manganiferous silver ores are found in the Rocky Mountain and Great Basin regions, the principal locality being Leadville, Colorado. The zinc ores of Franklin Furnace, New Jersey, contain small percentages of manganese, chiefly in the mineral franklinite, and in the smelting of them the manganese remains in the residuum from which it is later obtained. This is the most important source of manganese at present in the United States. Because of the small domestic production of manganese ores large amounts have to be imported. These come largely from India and Brazil.

Manganese is chiefly used in the form of alloys, those with iron being the most important. Spiegeleisen is an alloy of iron and manganese containing below 20 per cent of manganese, while ferromanganese contains manganese ranging in amount from 20 to 90 per cent. These alloys are extensively used in the manufacture of steel. They serve to take away any oxygen that might be in the iron, the oxygen uniting with the manganese and going into the slag. They serve also to introduce carbon into the steel and to prevent its oxidation, and also to counteract the bad effects of sulphur and phosphorus. Manganese has also of itself a hardening influence on steel. For these reasons manganese steels have a wide use.

Chemical uses of manganese compounds include the use of the oxide, pyrolusite,  $MnO_2$ , as an oxidizer in the manufacture of chlorine, bromine and oxygen, as a drier in paints and varnishes, as a decolorizer of glass, and in the dry-cell battery. Potassium permanganate is used as a disinfectant. Manganese is used in printing calico and for coloring bricks, pottery and glass.

## Mercury.

### Cinnabar, $HgS$ .

Mercury, or quicksilver, is neither abundant nor widespread in its occurrence. The native metal is sometimes found and

other rare minerals of mercury are occasionally noted, but practically the only ore of the metal is the sulphide, cinnabar. For the occurrence and distribution of mercury, therefore, see under cinnabar, page 144.

The most important use of mercury is in the amalgamation process for recovering gold and silver from their ores. It is used in the form of an amalgam with tin in "silvering" mirrors. It is used in thermometers, barometers, etc. Mercury salts, especially calomel, are used in medicine. The sulphide is used as the pigment called vermilion.

### Molybdenum.

**Molybdenite**,  $\text{MoS}_2$ .

**Wulfenite**,  $\text{PbMoO}_4$ .

Molybdenum is a rare element occurring chiefly as the sulphide, molybdenite. More rarely wulfenite may serve as an ore. See under molybdenite, page 137, and under wulfenite, page 308, for their occurrence and distribution. Only a small amount of molybdenum is produced in the United States.

Molybdenum is used to a small extent as a steel-hardening metal. In the form of ammonium molybdate it is used as a chemical reagent, as a fireproofing material, and as a disinfectant. Molybdenum compounds are also used to color leather and rubber.

### Nickel.

**Pentlandite**,  $(\text{Ni,Fe})\text{S}$ .

**Chloanthite**,  $\text{NiAs}_2$ .

**Millerite**,  $\text{NiS}$ .

**Gersdorffite**,  $\text{NiAsS}$ .

**Niccolite**,  $\text{NiAs}$ .

**Genthite**,  $\text{Ni}_2\text{Mg}_2\text{Si}_2\text{O}_{10} \cdot 6\text{H}_2\text{O}(?)$ .

**Nickeliferous Pyrrhotite**. **Garnierite**, noumeaite,  $\text{H}_2\text{NiSiO}_4(?)$ .

**Linnæite**,  $(\text{Co,Ni,Fe})_3\text{S}_4$ .

Nickel is a comparatively rare element, found often associated with cobalt. Its minerals are frequently found in small amounts in connection with magnesian igneous rocks, where it is commonly associated with chromite. Only a few localities produce the metal in commercial quantities, the world's output coming mostly from the nickeliferous pyrrhotite ores of Sudbury, On-

tario, Canada, or from the silicate (garnierite) ores of New Caledonia. The production of nickel from ores mined in the United States is very small.

The chief use of nickel is in various alloys. Nickel steel, containing about 3.5 per cent of nickel, has a wide use because of its great strength and toughness. Other alloys are German silver (nickel, zinc and copper); metal for coinage (nickel and copper). Large amounts of nickel are used in nickel plating.

### Platinum.

**Native Platinum**, Pt, with some iron and traces of the rare platinum metals. Sperrylite,  $\text{PtAs}_2$ .

Platinum is a rare element which usually occurs native. Its only known compound occurring as a mineral is the arsenide, sperrylite, which has been found very sparingly in two or three localities in association with copper and nickel ores. Platinum is characteristically found associated with the magnesian rocks called peridotites and often with chromite. The only commercial deposits of platinum so far known are placer deposits, the materials of which have been derived from the weathering of the rocks that contained the platinum in disseminated particles. For the occurrence and distribution of platinum see page 131.

The uses of platinum chiefly depend upon its high fusing point ( $1700^\circ$  to  $1800^\circ$  C.) and its resistance to chemical reagents. It is valuable for all sorts of laboratory apparatus, such as crucibles, dishes, spoons, etc. It is used in the sulphuric acid industry for concentrating kettles and also in the contact process for the manufacture of the acid in the form of finely divided platinum, in contact with which the acid is formed. It is largely used as wire to form the electrical connections with the filaments of incandescent electric lights. It is used in jewelry, particularly as the setting for diamonds, in dentistry in the making of false teeth, in electrical heating apparatus, for sparking plugs in explosion motors, in the measuring of high temperatures, in electrical contacts, etc. Potassium chloro-platinate,  $2\text{KCl.PtCl}_2$ , is employed in photography.



## Silver.

<b>Native Silver</b> , Ag.	Proustite, $3\text{Ag}_2\text{S} \cdot \text{As}_2\text{S}_3$ .
<b>Argentite</b> , $\text{As}_2\text{S}$ .	Stephanite, $5\text{Ag}_2\text{S} \cdot \text{Sb}_2\text{S}_3$ .
Stromeyerite, $\text{Ag}_2\text{S} \cdot \text{Cu}_2\text{S}$ .	Polybasite, $9\text{Ag}_2\text{S} \cdot \text{Sb}_2\text{S}_3$ .
Sylvanite, $\text{AgAuTe}_4$ .	<b>Cerargyrite</b> , AgCl.
Pyrargyrite, $3\text{Ag}_2\text{S} \cdot \text{Sb}_2\text{S}_3$ .	Embolite, $\text{Ag}(\text{Cl}, \text{Br})$ .

It is to be noted that none of the silver minerals contain oxygen, the most important series being included in the sulphide and sulpho-salt groups. Besides the distinctively silver minerals listed above, several minerals of other metals contain at times sufficient silver to make them valuable ores of the metal. Most important among these are the argentiferous varieties of galena, chalcocite, bornite, chalcopyrite and tetrahedrite. These minerals form the most common ores of silver, either because of the small amounts of silver which they contain, or the small amounts of silver minerals associated with them.

The important ores of silver can be divided into three main classes, namely, the siliceous ores, copper ores and lead ores. The siliceous ores are those ores which contain large proportions of quartz with small amounts of gold and silver minerals and are comparatively free from other metals. Most of them contain both gold and silver, the gold value being often in excess of the silver value. The chief districts in which this type of silver ore is produced are Tonopah in Nevada; the San Juan, Leadville and Aspen districts in Colorado; Granite, Jefferson and Silverbow counties in Montana; and in various districts in Idaho, Arizona, California, South Dakota and Utah. The important deposits of copper ores which contain a notable amount of silver are found at Butte in Montana; at the Bingham and Tintic districts in Utah; at the Bisbee, United Verde and Silver Bell districts in Arizona; in Shasta County, California; and at various places in Idaho, Michigan and Colorado. The important deposits of lead ore that produce silver are to be found at the Cœur d'Alene district in Idaho; at the Bingham and Tintic districts in Utah; at the Creede, San Juan and Leadville districts in Colorado; and at various districts in Nevada,

Montana and Arizona. For the production of these different classes of silver ores see Appendix II.

The important foreign countries for the production of silver are Mexico, Canada and Australia. In Mexico the chief districts are Guanajuato, Pachuca, El Oro, Parral and Santa Eulalia; in Canada in the Boundary and Kootenai districts in British Columbia and the Cobalt district in Ontario; in Australia chiefly from the Broken Hill district in New South Wales.

In connection with silver ores the following facts are of interest. Owing to the high value of silver, only a small percentage of the metal in an ore is sufficient to make it valuable. For instance, an ore that contained only 0.34 per cent of silver would yield 100 ounces to the ton, which is an amount much larger than usual. In giving the assay value of an ore, the amount of silver is usually stated in ounces per ton of ore. Lead-silver ores are of value because in the smelting the silver will be taken up by the lead. Ores containing calcium carbonate and iron and manganese minerals are of value because of the service of these materials in fluxing the ore. Zinc minerals detract from the value of an ore because of the added difficulty in smelting caused by their presence.

The uses of silver for coinage, for various useful and ornamental objects and for plating are too well known to need discussion. The standard silver coin for the United States contains nine parts of silver to one of copper. Silver salts are used in photography and caustic silver ( $\text{AgNO}_3$ ) is employed in medicine.

### Tin.

Stannite,  $\text{Cu}_2\text{S}\cdot\text{FeS}\cdot\text{SnS}$ .

Cassiterite,  $\text{SnO}_2$ .

The only ore of tin of importance is the oxide, cassiterite. This is a mineral which, while occurring in small quantities in many localities, is found only in a comparatively few commercial deposits. For the occurrence and distribution of the mineral see page 193. The United States at present produces only a small amount of tin ore.

Tin is chiefly used in the coating or "tinning" of metals, especially iron. The tin plate thus formed is used in roofing, in

various utensils, etc. An amalgam of tin and mercury is used in "silvering" mirrors. Various alloys are valuable, such as solder (tin and lead), bronze and bell metal (copper and tin). The artificial oxide of tin is used as a polishing powder. Stannic chloride is employed as a mordant in dyeing.

### Titanium.

<b>Ilmenite</b> , titanite iron, $\text{FeTiO}_3$	Octahedrite, $\text{TiO}_2$ .
with $\text{MgTiO}_3$ and $\text{Fe}_2\text{O}_3$ .	Brookite, $\text{TiO}_2$ .
<b>Rutile</b> , $\text{TiO}_2$ .	Titanite, $\text{CaTiSiO}_5$ .

Titanium is a rare element, but is quite widely distributed in small quantities. In the form of the minerals rutile and titanite it is present in most igneous rocks. Ilmenite is commonly found in the basic igneous rocks, and is often associated with magnetic iron ores.

Very little titanium ore is produced in the United States. Rutile deposits occur in Virginia, and some of the Adirondack magnetite deposits contain considerable ilmenite.

The present uses of titanium are rather limited. It has been used in steel and cast iron, in which it serves to eliminate the oxygen and nitrogen. It is also said to give a high tensile strength and great ductility to the steel. It is being used to some extent in the manufacture of electrodes for arc lights. The oxide is used to give a yellow color to porcelain, and to give a natural color to false teeth.

### Tungsten.

<b>Wolframite</b> , $(\text{Fe}, \text{Mn})\text{WO}_4$ .	<b>Scheelite</b> , $\text{CaWO}_4$ .
Hübnerite, $\text{MnWO}_4$ .	

Tungsten is a rare acid-forming heavy metal found chiefly in the tungstates of iron and calcium, wolframite and scheelite. For the occurrence and distribution of these minerals see under wolframite, page 307, and scheelite, page 308.

The most important use to which tungsten is put is as a steel-hardening metal. Tungsten steels hold their temper at high temperatures and are therefore valuable for the making of high-

speed tools, etc. Because of its high fusing point metallic tungsten is used as a filament in incandescent electric lights. Sodium tungstate is used in fireproofing cloth and as a mordant in dyeing. Calcium tungstate is used as the luminous screen in X-ray apparatus.

### Vanadium.

Roscoelite,  $H_8K_2(Mg,Fe)(Al,V)_4(SiO_3)_2(?)$ .

Vanadinite,  $Pb_4(PbCl)(VO_4)_3$ . Carnotite,  $K(UO_2)_2(VO_4)_2 \cdot 3H_2O(?)$ .

Vanadium is an acid-forming metal which is known in a number of very rare minerals. The three listed above are the only ones which occur in sufficient quantities in the United States to be available for ores. Roscoelite is a green micaceous mineral containing about 2 per cent of metallic vanadium. It is found in a soft sandstone near Placerville, Col. Carnotite is a sulphur-yellow pulverulent mineral of doubtful composition which is found in sandstones in several districts in Colorado and Utah, near the boundary line between the two states. Vanadinite is a secondary lead mineral which is found sparingly in the oxidized zones of certain lead deposits in Arizona and New Mexico. All of these ores are low grade, and are worked only in a small way and at intervals. The chief supply of vanadium ores at present comes from Peru, where there are large deposits of an impure carbonaceous sulphide of vanadium, known as patronite.

Vanadium is used chiefly in steel, and is said to give it great tensile and elastic strength. Metavanadic acid,  $HVO_3$ , is used as a yellow pigment, known as vanadium bronze. Vanadium oxide serves as a mordant in dyeing.

### Zinc.

**Sphalerite**,  $ZnS$ .

Zincite,  $ZnO$ .

Franklinite,  $(Fe,Zn,Mn)(Fe,Mn)_2O_3$ .

**Smithsonite**,  $ZnCO_3$ .

Willemite,  $Zn_2SiO_4$ .

**Calamine**,  $(ZnOH)_2SiO_3$ .

The sulphide, sphalerite, is the one common primary ore of zinc. The carbonate, smithsonite, and the silicate, calamine, are usually associated with sphalerite deposits as secondary

minerals. The three minerals, zincite, franklinite and willemite, are found in unique deposits at Franklin Furnace, New Jersey. Together with a large number of rare and unusual minerals they form anticlinal beds lying intercalated in a limestone series. In general sphalerite, the chief ore of zinc, is found in irregular replacement deposits in limestone. It is very frequently intimately associated with lead minerals. For its occurrence and distribution see page 142.

Metallic zinc, or spelter, as it is called, is chiefly used for galvanizing iron, as an alloy with copper in brass, and in storage and telegraph batteries. Zinc dust or zinc shavings are used to precipitate gold from its solution in the cyanide process. Large amounts of zinc oxide, or zinc white, are used as a white paint which is even more permanent than lead paints. Zinc chloride is used as a wood preservative.

## **OCCURRENCE AND ASSOCIATION OF MINERALS.**

Although minerals are found in many modes of occurrence, and in an almost endless variety of associations, there are, however, certain frequent and important ways in which they occur that should be pointed out. An understanding of the conditions under which a particular mineral is usually formed, together with a knowledge of what other minerals are characteristically associated with it, is of the greatest value. On the following pages is given, therefore, a brief discussion of the more important modes of mineral occurrence, and of the more common associations observed.

### **Rocks and Rock-making Minerals.**

Since by far the greater part of minerals occur as rock constituents a short description of the more important rock types and of the common rock-making minerals will be given first. Only the barest outline of the subject can be given here and for more detailed information the reader is referred to one of the textbooks which treat more particularly of petrology.

Rocks may be divided into three main divisions, namely:

- I. *Igneous.*
- II. *Sedimentary.*
- III. *Metamorphic.*

### I. Igneous Rocks.

*Igneous Rocks*, as the name indicates, are those which have been formed by the cooling and consequent solidification of a once hot and fluid mass of rock material. This liquid mass is known as a rock magma. A magma, in a measure, is like a solution containing in a dissociated condition the elements which, when the mass cools sufficiently, unite to form the various minerals that go to make up the resulting rock. The elements which form the chief constituents of the magmas of igneous rocks are oxygen, silicon, aluminium, iron, calcium, magnesium, sodium and potassium, named in the order of their abundance. When a magma cools these elements unite to form various mineral molecules, which, when the point of supersaturation is reached, crystallize out to form the minerals of the rock. Certain compounds under similar conditions crystallize out of the fluid mass earlier than do others. In most igneous rocks a more or less definite order of crystallization for their mineral constituents can be determined. In general the more basic minerals or those which contain the smaller amounts of silica, which is the acid element in igneous rocks, are observed to crystallize first and the more acid minerals last. Among the commoner rock-making minerals the following would be the usual order of crystallization; iron oxides like magnetite first, then the ferro-magnesian minerals like pyroxene, next the plagioclase feldspars, then orthoclase and lastly quartz.

The type of minerals to be found in any igneous rock would depend chiefly upon the chemical composition of the original magma. If the magma was acid in character, i.e., had a high percentage of silica, the resulting rock would contain the more acid minerals and an abundance of free quartz. It would usually be light in color. If, on the other hand, the magma had

a low percentage of silica, or in other words was basic in character, the resulting rock would contain the more basic minerals and would not show free quartz. It would also in general be dark in color.

In addition to the wide variation in chemical and mineral composition shown by igneous rocks there is also a variation in their physical structure. This is dependent upon the mode of origin of the rock. If a rock has been formed from a magma buried at a considerable depth in the crust of the earth it must have cooled very slowly and taken a long period of time for its gradual crystallization and solidification. Under these conditions the mineral particles have had the opportunity, because of the slowness of crystallization, to grow to considerable size. A rock having such a deep-seated origin has, therefore, a coarse-grained structure and the various minerals that go to form the rock can in general be differentiated and recognized by the unaided eye. Such rocks are commonly termed *plutonic*.

On the other hand, if, by volcanic forces, the magma, has been extruded upon the surface of the earth or intruded in the form of dikes into the rocks lying close to the surface, its subsequent cooling and solidification go on quite rapidly. Under these conditions the mineral particles have little chance to grow to any size and the resulting rock is fine-grained in character. In some cases, indeed, the cooling has been too rapid to allow the separation of any minerals and the resulting rock is like a glass. Ordinarily the mineral constituents of such a rock are only to be definitely recognized by a microscopic examination of a thin section of the rock. Such igneous rocks are known as *volcanic* rocks.

An igneous rock, because of the mode of its formation, consists of crystalline particles which may be said to interlock with each other. In other words, it is a solid mass, and each mineral particle is intimately and firmly embedded in the surrounding particles. This structure will enable one ordinarily to distinguish an igneous from a sedimentary rock, the latter being composed of grains which do not interlock with each other but stand out, more or less, by themselves. A sedimentary rock is not

so firm and coherent as an igneous rock. Further the texture of an igneous rock is the same in all directions and it forms a fairly uniform and homogeneous mass. This characteristic will enable one to distinguish an igneous from a metamorphic rock, since the latter shows a more or less definite parallel arrangement of its minerals and a banded structure.

Because of the almost infinite variation possible in the chemical composition of their magmas, and because of the various conditions under which they may form, igneous rocks show likewise a wide variation in character. The more common and important types, however, are very briefly described below.

### Plutonic, Coarse-grained Rocks.

1. **Granite.** A granite is a medium- to coarse-grained, light-colored rock having an even texture and consisting chiefly of quartz and a feldspar. Frequently both orthoclase and a plagioclase feldspar, and usually also small amounts of mica or hornblende are present. The feldspars can be recognized by their color and cleavage. Frequently the orthoclase is colored flesh-color or red, while the soda-lime feldspar is usually white. The quartz is recognized by its glassy luster and conchoidal fracture. It is usually white or smoky-gray in color and is found in irregular grains filling up the interstices between the other minerals. The mica, which may be either muscovite or biotite, is to be recognized by its cleavage. Granite is a common rock type.

2. **Syenite.** A syenite is a medium- to coarse-grained light-colored rock with an even texture and much like a granite in appearance. It is to be distinguished from granite, however, by the fact that it contains little or no quartz. Its chief minerals are the feldspars, with more or less hornblende, mica or pyroxene. A variety, known as nephelite-syenite, is characterized by the presence of considerable amounts of nephelite. Another variety, called anorthosite, is composed chiefly of labradorite. The feldspars, mica and hornblende may be distinguished as described under granite. The pyroxene resembles hornblende in appearance, but does not show as good a prismatic cleavage.



Nephelite is recognized by its lack of a distinct cleavage and its oily and greasy luster. Syenites are not very common.

3. **Diorite.** Diorite is a medium- to coarse-grained dark gray or greenish colored rock having an even texture and consisting chiefly of hornblende and a feldspar, in which the hornblende predominates. Often fine grains of iron ore may be observed, and frequently considerable amounts of biotite. It is a common rock type.

4. **Gabbro.** Gabbro is a medium- to coarse-grained dark gray to greenish black rock with an even texture composed chiefly of pyroxene and a feldspar. It is closely similar to diorite, the distinction lying in the fact that it contains pyroxene instead of amphibole. These two minerals, as they occur in these rocks, cannot always be told apart by a megascopic examination. The pyroxene is usually in small crystal grains with rather poor prismatic cleavages which are at nearly right angles to each other. Hornblende is more liable to be in longer prismatic crystals and shows better cleavages, the angle of which is about  $125^\circ$ . It is a common rock.

5. **Dolerite.** This is a name given to those varieties of diorite and gabbro which are too fine-grained in character to enable one to tell megascopically whether the dark-colored mineral which they contain is hornblende or pyroxene.

6. **Peridotite.** A peridotite is a medium- to coarse-grained dark green to black rock with an even texture which consists wholly of ferromagnesian minerals. These are chiefly olivine, pyroxene and hornblende. As one or the other of these minerals predominates, various variety names are used, such as *dunite* for an olivine rock and *pyroxenite* and *hornblendite* for respectively pyroxene and hornblende rocks. Common accessory minerals found in these rocks are ilmenite, chromite and garnet. The peridotites are not very common in their occurrence.

### Volcanic, Fine-grained Igneous Rocks.

Because of their very fine-grained structure volcanic rocks cannot in general be readily told apart. A number of different types are recognized, the distinction between them being based,

however, chiefly upon microscopic study. In the field only an approximate classification, depending upon whether the rock is light or dark in color, can be made. A brief description of these two types of volcanic rocks follows.

1. **Felsite.** This is a dense fine-grained rock type with a stony texture and includes all colors except dark gray, dark green or black. These rocks may, by the aid of a lens, still show a very fine-grained structure or their mineral constituents may occur in such small particles as to give them a dense and homogeneous, often a flinty, appearance. By microscopic study the felsites have been divided into the following groups; *rhyolite*, consisting chiefly of alkaline feldspars and quartz; *darite*, lime-soda feldspars and quartz; *trachyte*, alkaline feldspars with little or no quartz; *andesite*, soda-lime feldspars with little or no quartz; *phonolite*, alkaline feldspars and nephelite. As a rule these varieties are not to be distinguished from each other in the field. The felsites are widespread in their occurrence, being found as dikes and sheets intruded into the upper part of the earth's crust or as lava flows which have been poured out upon the earth's surface.

2. **Basalt.** The basalts are dense fine-grained rocks that are of very dark color, green or black. They are composed of microscopic grains of a soda-lime feldspar with pyroxene, iron ore, often more or less olivine and at times biotite or hornblende. These rocks are formed under the same conditions as the felsites and are to be found occurring in the same ways.

3. **Glassy Rocks.** Some of the volcanic rocks have cooled so rapidly that they are wholly or in part made up of a glassy material in which the different elements have not had the necessary opportunity to group themselves into definite minerals. If the entire rock is composed of glass it is called *obsidian*, when it has a bright and vitreous luster; *pitchstone* when its luster is dull and pitchy; *perlite* if it is made up of small spheroids; and *pumice* if it has a distinctly cellular structure. These rocks may also have distinct crystals of various minerals embedded in the glass, in which case they are known as *glass porphyries* (see below for a definition of a porphyry) or *vitrophyres*.

**Porphyries.** Igneous rocks at times show distinct crystals of certain minerals which lie embedded in a much finer-grained material. These larger crystals are known as *phenocrysts*, and the finer-grained material as the *groundmass* of the rock. Rocks exhibiting such a structure are known as porphyries. The phenocrysts may vary in size from crystals an inch or more across down to quite small individuals. The groundmass may also be composed of fairly coarse-grained material or its grains may be microscopic in size. It is the distinct difference in size existing between the phenocrysts and the particles of the groundmass that is the distinguishing feature of a porphyry. This peculiar structure is due to certain conditions prevailing during the formation of the rock which permitted some crystals to grow to considerable size before the main mass of the rock consolidated into a finer- and uniform-grained material. The explanation of the reasons why a certain rock should assume a porphyritic structure would involve a more detailed discussion than it is expedient to give in this place. Any one of the above described types of igneous rocks may have a porphyritic variety, such as *granite-porphyry*, *diorite-porphyry*, *felsite-porphyry*, etc. Porphyritic varieties are more liable to occur in connection with volcanic rocks, and they are also found most frequently in the case of the more acid types.

## II. Sedimentary Rocks.

Sedimentary rocks are secondary in their origin, the materials of which they are composed having been derived from the decay and disintegration of some previously existing rock mass. They have been formed by a deposition of sediments in a body of water. They may be divided into two classes, depending upon whether their origin has been mechanical or chemical in its nature. In the case of the sedimentary rocks of a mechanical origin, their constituent particles have been derived from the disintegration of some rock mass, and have been transported by streams into a large body of quiet water, where they have been deposited in practically horizontal layers. Sedimentary

rocks of chemical origin have had the materials of which they are composed dissolved by waters circulating through the rocks and brought ultimately by these waters into a sea, where through some chemical change they are precipitated upon its floor, also in horizontal layers. These horizontal beds of sediments are ultimately consolidated into the masses known as sedimentary rocks.

Sedimentary rocks are therefore characterized by a parallel arrangement of their constituent particles into layers and beds which are to be distinguished from each other by differences in thickness, size of grain and often in color. It is to be noted, further, that sedimentary rocks in general are composed of an aggregate of individual mineral particles, each of which stands out in a way by itself and does not have that intimate interlocking relation with the surrounding particles which is to be seen in the minerals of an igneous rock. In all the coarser-grained sedimentary rocks there is some material which, acting as a cement, surrounds the individual mineral particles and binds them together. This cement is usually either silica, calcium carbonate or iron oxide. The chief minerals to be found in sedimentary rocks are quartz and a carbonate, calcite or dolomite. These give rise to the two chief types of sedimentary rocks, the sandstones and the limestones. A brief description of these rocks follows.

**1. Sandstone.** Sandstones are mechanical in their origin, being formed by the consolidation into rock masses of beds of sand and gravel. Usually the constituent grains are rounded and water-worn, but at times they may be more or less angular in shape. With the variation in the size of the mineral particles the rocks themselves vary in their grain. Coarse-grained sandstones formed from gravels are known as *conglomerates*. The cement which serves to bind the sand grains together may be deposited silica, a carbonate, usually calcite, an iron oxide, hematite or limonite, or fine-grained argillaceous or claylike material. The color of the rock will depend in large measure upon the character of the cement. The rocks which have silica or calcite as their binding material are light in color, usually pale

yellow, buff, white to gray, while those that contain an iron oxide are red to reddish brown. It is to be noted that when a sandstone breaks it is usually the cement that is fractured, while the individual grains remain unbroken, so that the fresh surfaces of the rock have a granular appearance and feeling. The chief mineral of sandstones is quartz, but at times a rock may contain notable amounts of feldspar and is then termed an *arkose*. *Graywacke* is a sandstone, usually of a gray color, which in addition to quartz and feldspar contains particles of other rocks and minerals.

2. **Shale.** The shales are very fine-grained sedimentary rocks which have been formed by the consolidation of beds of mud, clay or silt. They have usually a thinly laminated structure. Their color is commonly some tone of gray, although they may be white, yellow, brown, green to black. They are composed chiefly of kaolin, mica, etc., but are too fine-grained to permit the recognition of their mineral constituents by the eye alone. By the introduction of quartz and an increase in the size of grain they grade into the sandstones.

3. **Limestone.** The limestones are carbonate rocks composed usually chiefly of calcite, although dolomite may also be at times an important constituent. The carbonate has in the great majority of cases been extracted from the sea water by the agency of minute organisms and then deposited in beds which ultimately are consolidated into rock. These rocks are usually fine- and even-grained in structure and sometimes quite dense. Some limestones are quite pure calcite, while others contain claylike materials and various oxides as impurities. The color of a limestone is usually gray, although it may be white, yellow, brown to almost black. It is a soft rock, to be easily scratched by a knife. It will effervesce readily in any common acid. In the case of limestones composed of dolomite, however, the acid needs to be heated. *Oolite*, or *oolitic limestone*, is a variety which consists of an aggregate of small spherical concretions. *Chalk* is a very fine-grained friable limestone composed of shells of minute sea animals known as foraminifera. *Travertine* is a deposit of calcium carbonate formed by springs. A fine example

exists in the deposits formed by the Mammoth Hot Springs, Yellowstone Park. *Marl* is a loose, earthly material composed of a carbonate mixed with clay in variable amount.

### III. Metamorphic Rocks.

Metamorphic rocks are rocks which have undergone some chemical or physical change subsequent to their original formation. This change has been brought about by means of high temperature and pressure aided by the action of water and other chemical agents. The changes involve the formation of new minerals, the adding or subtracting of chemical constituents and a physical readjustment of the mineral particles to conform to the existing pressure. The original rock from which a metamorphic rock has been derived may be either igneous or sedimentary. As these rocks become involved in movements of the earth's crust, they are subjected to extreme pressures accompanied usually by high temperatures. The result will be frequently to transform the existing minerals into others more stable under the new conditions. The physical structure of the rock will also ordinarily be changed during the process. Because of the pressure to which the rock is subjected the mineral particles will be more or less broken and flattened and rearranged in parallel layers. This banded or laminated character given by the parallel arrangement of its minerals is the most striking peculiarity of a metamorphic rock. Because of this structure a metamorphic rock can be distinguished from an igneous rock. Further, in the great majority of cases a metamorphic rock has a crystalline structure which distinguishes it from a sedimentary rock. There are, of course, all gradations from a typical metamorphic rock into an unaltered sedimentary rock on the one hand and into an unaltered igneous rock on the other. The most common types of metamorphic rocks are briefly described below.

1. **Gneiss.** When the word gneiss is used alone it usually refers to a metamorphic rock composed essentially of quartz, feldspar and a mica. The quartz and feldspar occur together in layers which are separated from each other by thin drawn-out

bands of mica. A gneiss has usually a light color, although this is not necessarily so. Various varieties of gneiss have received distinctive names, most of which are self-explanatory, like *banded-gneiss*, *lenticular-gneiss*, *biotite-gneiss*, *hornblende-gneiss*, *granite-gneiss*, *diorite-gneiss*, etc. Gneiss is a very common rock type, especially in regions in which the oldest rocks, those of the Archæan age, are found. Gneisses have been more commonly derived by the metamorphism of igneous rocks, mostly granites, but may have been formed from sedimentary rocks as well.

2. **Mica-schist.** Mica-schist is a rock composed essentially of quartz and a mica, usually either muscovite or biotite. The mica is the prominent mineral, occurring in irregular leaves and in foliated masses. The mica plates all lie with their cleavage planes parallel to each other and give to the rock a striking laminated or "schistose" structure. The mica-schists frequently carry characteristic accessory minerals, such as garnet, staurolite, cyanite, epidote, hornblende, etc. They may have been derived from either an igneous or a sedimentary rock. Next to the gneisses, they are the most common metamorphic rocks.

3. **Quartzite.** As its name indicates, a quartzite is a rock composed essentially of quartz. It is a firm, compact rock which breaks with an uneven, splintery or conchoidal fracture. It is usually light in color. Quartzite has been derived from a sandstone by intense metamorphism. It is a common and widely distributed rock.

4. **Slate.** Slates are exceedingly fine-grained rocks which have a remarkable cleavage which permits them to be split into thin and broad sheets. Their color is commonly gray to black, but may be green, yellow, brown, red, etc. They have been formed commonly by the metamorphism of shales. Their characteristic slaty cleavage may or may not be parallel to the bedding planes of the original shales. They are quite common in occurrence.

5. **Various Schists.** There are various other kinds of schistose rocks, which are chiefly derived by the metamorphism of the ferromagnesian igneous rocks. The most important types are

*talcschist, chlorite-schist, amphibolite or hornblende-schist.* They each are characterized, as their names indicate, by the preponderance of some metamorphic ferromagnesian mineral.

**6. Marble.** A marble is a metamorphosed limestone. It is a crystalline rock composed of grains of calcite, or more rarely dolomite. At times the individual grains are so small that they cannot be distinguished by the eye, and again they may be quite coarse and show clearly the characteristic cleavage of the mineral. Like limestone, a marble is characterized by its softness and its effervescence with acids. When pure, marble is white in color, but it may show a wide range of color, due to various impurities that it contains. It is a rock which is found in many localities and at times in thick and extensive beds.

### The Common Rock-making Minerals.

Although many minerals are found as rock constituents, those which can be termed common and characteristic rock-making minerals are comparatively few in number. The following list gives the names of these minerals, with a brief statement in each case of the types of rocks in which they most commonly occur.

**1. Quartz.** Quartz,  $\text{SiO}_2$ , is a very common and widely distributed rock-making mineral. It is found in all the light-colored, acid, igneous and metamorphic rocks. It is the chief constituent of sandstones and quartzites. It is to be recognized by its hardness (7), its vitreous luster, lack of cleavage and conchoidal fracture. When it occurs in igneous rocks it often has a gray or smoky color.

**2. The Feldspars.** The feldspars include orthoclase and microcline,  $\text{KAlSi}_3\text{O}_8$ , albite,  $\text{NaAlSi}_3\text{O}_8$ , anorthite,  $\text{CaAl}_2\text{Si}_2\text{O}_8$ , and various mixtures of these last two as oligoclase (3 albite to 1 anorthite), andesite (1 albite to 1 anorthite) and labradorite (1 albite to 3 anorthite). They are very common rock-making minerals and are found in a great variety of rock types. They are characteristic of most igneous rocks, and frequently constitute a large proportion of them. They are found in the gneisses and to a less extent in some sandstones. They are to



be distinguished by their two cleavages at right angles or nearly so, their vitreous luster and their hardness (6). It frequently is difficult, if not impossible, to tell the kind of feldspar present in a rock by inspection alone. Under favorable conditions twinning striations may be observed on the best cleavage face, which would indicate that the feldspar belonged to the plagioclase group (see page 225) and could not be orthoclase.

**3. Nephelite.** Nephelite is a silicate whose composition is essentially  $\text{NaAlSiO}_4$ . It is restricted in its occurrence, being found only in certain igneous rocks, such as the nephelite syenites, which are low in percentages of silica. It is often mistaken for quartz, but the two minerals are practically never found together. It is best determined by a chemical test. Unlike most rock-making minerals, it is readily soluble in hydrochloric acid and the solution gelatinizes on evaporation.

**4. Sodalite.** Sodalite,  $\text{Na}_4(\text{AlCl})\text{Al}_2(\text{SiO}_4)_3$ , is similar in its occurrence to nephelite, with which it is commonly associated. It may be greenish gray or white in color, but is usually blue. Häüynite and noselite are similar but rare species which occur in the same way.

**5. Leucite.** Leucite has the composition  $\text{KAl}(\text{SiO}_3)_2$ . It is a rare rock-making mineral found chiefly in rather basic lavas. It is commonly in the form of phenocrysts which show trapezohedral forms. It is white to gray in color with a dull vitreous luster.

**6. The Micas.** The micas are common rock-making minerals. They may be divided into two classes: the light colored micas which are chiefly muscovite, and the dark colored micas consisting mostly of biotite. They are to be determined by their micaceous structure, eminent cleavage and the elasticity of their leaves. Muscovite is found in granites and syenites and other igneous rocks. It is especially common in the metamorphic rocks, particularly the gneisses and schists. Biotite is found in many igneous rocks such as the granites, syenites and felsites. It occurs also in the gneisses and schists.

**7. The Pyroxenes.** The pyroxenes form an important series of rock-making minerals which, although the different members

vary considerably in composition, are closely related crystallographically. The important types are hypersthene,  $(\text{Mg,Fe})\text{SiO}_3$ , diopside,  $\text{CaMg}(\text{SiO}_3)_2$ , common pyroxene,  $\text{Ca}(\text{Mg,Fe})(\text{SiO}_3)_2$ , augite,  $\text{Ca}(\text{Mg,Fe})(\text{SiO}_3)_2$  with  $(\text{Mg,Fe})(\text{Al,Fe})_2\text{SiO}_6$  as well, and ægirite,  $\text{NaFe}(\text{SiO}_3)_2$ . The pyroxenes are characteristically found in igneous rocks, particularly those that contain large amounts of lime, iron and magnesia, such as basalt, gabbro, peridotite, etc. Diopside and common pyroxene are at times found in metamorphic limestones. The pyroxenes vary in color from white through green to black. They occur usually in small grains or in short prisms. If they show distinct crystal outlines, they can be told by the square cross section of their prisms. They have a rather poor cleavage.

**8. The Amphiboles.** The amphiboles or hornblendes are calcium, magnesium, iron metasilicates which closely resemble the pyroxenes in their chemical composition. The most important members of the group are tremolite,  $\text{CaMg}_3(\text{SiO}_3)_4$ , actinolite,  $\text{Ca}(\text{Mg,Fe})_3(\text{SiO}_3)_4$ , common hornblende,  $\text{Ca}(\text{Mg,Fe})_3(\text{SiO}_3)_4$ , with a molecule containing aluminium and ferric iron besides, and arfvedsonite, which contains chiefly soda, lime and iron protoxide. The amphiboles are particularly characteristic of the metamorphic rocks, but are found in the igneous rocks as well. Tremolite is most commonly found in crystalline metamorphosed limestones, actinolite in schists, hornblende in granites, syenites and diorites, and also in gneisses and hornblende schists. The amphiboles commonly occur in bladed prismatic crystals with a good prismatic cleavage. The cleavage angle is broad, having a value of about  $125^\circ$ . They vary in color from white through green to black, but are most commonly green.

**9. Chrysolite, or Olivine.** Chrysolite, or olivine, as it is more commonly termed when spoken of as a rock constituent, is an orthosilicate of magnesium and ferrous iron  $(\text{Mg,Fe})_2\text{SiO}_4$ . It is a characteristic constituent of the ferromagnesian igneous rocks such as gabbros, peridotites and basalts. It is almost the only mineral present in the igneous rock known as dunite. It is usually green in color, with a vitreous luster and granular structure.

10. **Kaolin.** Kaolin is a silicate of aluminium,  $H_4Al_2Si_2O_9$ , which is always secondary in its origin. It is formed by the weathering of some aluminium silicate, usually a feldspar. It may occur in quite pure masses where feldspathic rocks have been entirely altered, but is most commonly found, however, in an impure state in clay, and in the rocks formed from claylike materials such as shales, slates, etc. When pure it is often friable or mealy in structure, although at times it is compact. It varies in color from white to yellow, brown, red, etc., depending upon the amount and character of the foreign material mixed with it.

11. **Chlorites.** The chlorites are a group of green-colored micaceous minerals of which clinocllore is the most common member. In composition they are hydrous silicates of aluminium and magnesium. They are always secondary in their origin. They are frequently formed by the alteration of the ferromagnesian minerals occurring in igneous rocks. The green color of such rocks is usually due to the presence of chlorite. They are also common in the chlorite-schists, in green slates, etc. They are to be recognized by their green color, micaceous structure, perfect cleavage, and by the fact that their leaves are not elastic.

12. **Serpentine.** Serpentine,  $H_4Mg_3Si_2O_9$ , is also a secondary mineral formed by the alteration of some original ferromagnesian mineral, such as pyroxene, amphibole, and especially olivine. It occurs, therefore, in altered igneous rocks and in metamorphic rocks. It may occur in disseminated particles or in rock masses, of which it is the chief mineral. It is usually of some shade of green in color and has an oily or waxy luster. It is usually massive in structure, but may become coarsely fibrous in the variety known as chrysotile.

13. **Talc.** Talc,  $H_2Mg_3(SiO_3)_4$ , is similar in its origin and occurrence to serpentine. It is found at times in altered igneous rocks, but is more characteristic of metamorphic rocks where it may occur in large beds as soapstone. It is characterized by its extreme softness (1), greasy feel and also frequently by its foliated structure.

14. **Calcite.** Calcite,  $CaCO_3$ , is a common and widely distributed rock-making mineral found chiefly in the sedimentary

and metamorphic rocks. Such rocks as the limestones, marbles and chalks are composed almost entirely of the mineral. It is to be told by its softness (3), its rhombohedral cleavage and its ready effervescence in cold acids.

15. **Dolomite.** Dolomite,  $\text{CaMg}(\text{CO}_3)_2$ , is found in the same way as calcite but less commonly. The two minerals are usually associated with each other and form dolomite marbles and dolomitic limestones. Its physical properties are practically the same as those of calcite. It will only effervesce, however, in hot acids.

### Accessory Rock-making Minerals.

In addition to the more important and common rock-making minerals that have been described in the preceding pages, there is a group of minerals which are characteristically found as rock constituents but in a minor way. They occur usually only as small and scattered crystals in the rock and seldom become one of its prime constituents. These minerals are known as accessory rock-making minerals. The occurrences of the more important of them are briefly described below.

1. **Garnet.** Garnet is a common accessory mineral, being particularly characteristic of the metamorphic rocks. It is found frequently in mica-schists, hornblende-schists, gneisses and metamorphosed limestones. More rarely it is found in igneous rocks. It occurs in small irregular grains or frequently in fair-sized definitely shaped crystals. It is usually red or brown in color. For the different varieties of garnets and their distinguishing features, see p. 245.

2. **Epidote.** Epidote is formed by the alteration of silicates containing lime, iron and aluminium. It is also characteristic of metamorphosed limestones. It may be associated with chlorite, calcite, etc. It is usually found in bladed crystalline masses and has a characteristic yellow-green color, is hard and has one good cleavage.

3. **Staurolite.** Staurolite is found in metamorphic rocks, such as the mica-schists and slates. Sometimes it is a constituent of gneiss. It is associated with mica, quartz, garnet, cyanite, etc

It is characterized by a brown color, hardness (7) and prismatic orthorhombic crystals which may show cross-shaped twins.

4. **Cyanite.** Cyanite,  $\text{Al}_2\text{SiO}_5$ , is a rather rare accessory mineral which is found in gneisses and mica-schists. It is associated with muscovite, quartz, garnet, staurolite, etc. It is to be distinguished by its bladed structure, one good cleavage, blue color and by the fact that it is distinctly harder in the direction parallel to the length of the crystals than in the direction at right angles to this.

5. **Zircon.** Zircon,  $\text{ZrSiO}_4$ , is a rather rare mineral which usually occurs in minute crystals scattered throughout a rock mass. It is found in granites, syenites, crystalline limestones, chloritic schists, etc. It is to be distinguished by its usually brown color, hardness (7.5) and tetragonal crystallization.

6. **Titanite.** Titanite or sphene,  $\text{CaTiSiO}_5$ , is a comparatively rare mineral found as an accessory constituent in granite, syenites, gneiss, mica- and chlorite-schists and crystalline limestones. It occurs as microscopical crystals in many igneous rocks.

7. **Magnetite.** Magnetite,  $\text{Fe}_3\text{O}_4$ , is widespread in its occurrence as a rock constituent. It is found in all kinds of igneous rocks, usually in small disseminated grains. It is also characteristic of the crystalline schists and gneisses. Ordinarily it occurs in comparatively small amounts and would be classed as an accessory mineral but at times it becomes a prime constituent of the rock and may be segregated into almost pure bodies of the mineral. It is characterized by its metallic luster, black color and streak and its strong magnetic properties.

8. **Ilmenite.** Ilmenite or titanite iron,  $\text{FeTiO}_3$ , is a common accessory mineral occurring in the same way as magnetite and frequently found associated with it. It is most commonly found in the gabbros and related rocks. It is difficult to tell it from magnetite by simple inspection.

9. **Hematite.** Hematite,  $\text{Fe}_2\text{O}_3$ , is found as an accessory mineral in the feldspathic igneous rocks such as granite. It occurs also in the crystalline schists. It is common in the sedimentary and metamorphic rocks and at times forms large bodies of almost

pure mineral. It is the red pigment in many rocks and soils and forms the cementing material in many sandstones. It is to be recognized by its red streak.

10. **Pyrite.** Pyrite,  $\text{FeS}_2$ , is found in small disseminated crystals in all classes of rocks. It is characterized by its pale brass color, metallic luster, hardness (6), black streak and frequently also by its isometric crystal forms.

11. **Apatite.** Apatite,  $\text{Ca}_4(\text{CaF})(\text{PO}_4)_3$ , is found in crystals of considerable size in metamorphosed limestones. It is also common in microscopic crystals in all varieties of igneous rocks, and in many metamorphic ones.

In addition to the minerals listed above, the following, more rare in their occurrence, are at times found as accessory rock constituents; rutile, iolite, scapolite, andalusite and sillimanite.

### Pegmatite Dikes and Veins.

In connection with the deep-seated, coarse-grained igneous rocks, especially the granites, we frequently find mineral deposits which are known as pegmatite dikes or veins. These bodies have the general shape and character of an igneous dike or a broad mineral vein although in certain respects they differ markedly from either of these. They are to be found running through the main mass of the igneous rock or filling fissures in the other surrounding rocks. They are composed chiefly of the same minerals as occur in the igneous rock, but usually in very coarse crystallizations. A granite pegmatite is therefore made up principally of quartz, feldspar and mica. The quartz and feldspar crystals may be several feet in length and the mica plates are at times more than a foot across. In addition to the coarseness of the crystallization of the minerals, these veins possess other peculiar features. The minerals of a pegmatite vein, for instance, have not apparently been deposited in the definite order that prevailed in the igneous rock mass, but their crystals have grown more nearly simultaneously. These veins will also at times show a ribboned or banded structure where the different minerals occur in distinct layers which lie parallel

to the walls of the deposit. Their minerals are also commonly quite irregularly distributed through the mass, so that at times the vein is composed chiefly of feldspar and again becomes nearly pure quartz. Frequently, along the central portion of the dike, cavities and openings will be observed into which crystals of the different minerals project. These characteristics point to a somewhat different origin for the pegmatite veins from that of the igneous rock with which they are associated.

No extended and detailed discussion of the theory of the origin of pegmatite veins can be given here, but it may be briefly summarized as follows. Pegmatite veins are formed during the last stages of the cooling and solidification of a plutonic igneous rock. As an igneous magma cools and slowly solidifies, it shrinks somewhat in volume and various cracks and fissures open up throughout the mass. The pressure due to the weight of the rock forces any still fluid material from the interior of the mass up through these cracks and also into any fissures that may exist in the surrounding rocks. The filling up of these fissures both in the igneous rock itself and in the neighboring rocks constitutes a pegmatite vein. As a magma cools and its minerals crystallize, large amounts of water vapor are frequently set free so that the residue of the still fused rock material must contain much higher percentages of water than the original magma. Consequently it becomes in its character and behavior more like a solution than a fused mass. This would account for the peculiar features observed in pegmatite veins which differentiate them from ordinary igneous deposits.

The minerals found in pegmatite veins may be divided into three general divisions. First come those minerals which form the main mass of the deposit and which, as stated above, are the same as the prominent minerals of the igneous rock with which the pegmatite dike is associated. These are commonly *quartz*, a feldspar which is usually either *orthoclase* or *microcline*, but may be *albite*, and a mica which may be either *muscovite* or *biotite*. *Garnet* is also at times in a smaller way a characteristic constituent. Second comes a series of rare minerals which are, however, quite commonly observed in pegmatite deposits, and

which are characterized by the presence in them of fluorine, boron or hydroxyl. Their presence in the veins indicates also that gases under high pressures have been instrumental in their formation. The minerals of this type include *beryl*, *tourmaline*, *apatite* and *fluorite*. A third class of minerals found in pegmatite veins includes species containing rare elements such as lithium, molybdenum, tin, niobium and tantalum, the rare earths, etc. These are minerals which are rarer still in their occurrence, but when they do occur are usually to be found in pegmatite deposits. The most important members of this group are *molybdenite*, *lepidolite*, *spodumene*, *triphylite*, *columbite*, *cassiterite* and *monazite*.

Because of the frequent occurrence in pegmatite veins of the rare minerals mentioned above, some of which are often found finely colored and well crystallized, these deposits are of particular interest to students of mineralogy. Pegmatite veins are also of commercial importance, for it is from them that most of the feldspar and mica used in the arts are obtained. Many beautiful gem stones, such as beryl and tourmaline, are also found in them. Pegmatite veins are widely distributed in their occurrence, being almost universally found wherever plutonic igneous rocks are exposed. Important districts for pegmatite veins in the United States include the New England states, the Black Hills in South Dakota and Southern California.

### Contact Metamorphic Minerals.

When an igneous rock magma is intruded into the earth's crust, it causes through the attendant heat and pressure a greater or less alteration in the surrounding rock. This alteration, or metamorphism, of the rocks lying next to an igneous intrusion usually consists partly in the development of new and characteristic mineral species. The minerals that are formed under these conditions are known as *contact metamorphic minerals*, since they are produced by a metamorphic change and are to be found at or near the contact line between the rock in which they lie and an igneous rock. Any rock into which an igneous mass is intruded will be affected in a greater or less degree, the



amount and character of the change depending chiefly upon the size of the intruded mass and upon the chemical and physical character of the surrounding rock. The most striking and important contact metamorphic changes take place when the igneous rock is intruded into impure limestones. When a pure limestone is affected, it is recrystallized and converted into a marble, but without any development of new species. But, on the other hand, in the case of an impure limestone the heat and pressure caused by the igneous intrusion will serve to develop new and characteristic minerals in the rock. An impure limestone will ordinarily contain, besides the calcium carbonate of the rock, varying amounts of quartz, clay, iron oxide, etc. Under the influence of the heat and pressure these materials will combine with the calcium carbonate to form new minerals. For instance, the calcite and quartz may react together to form wollastonite,  $\text{CaSiO}_3$ . If the limestone contains dolomite, the reaction of this mineral with quartz may produce pyroxene,  $(\text{Ca},\text{Mg})\text{SiO}_3$ . If clay is present, aluminium will enter into the reaction and such minerals as spinel,  $\text{MgAl}_2\text{O}_4$ , and grossularite,  $\text{Ca}_3\text{Al}_2\text{Si}_3\text{O}_{12}$ , may result. If any carbonaceous materials are present, the effect of the metamorphism may convert them into graphite. The common contact metamorphic minerals found in limestone are as follows: *graphite*, *spinel*, *corundum*, *wollastonite*, *tremolite*, *pyroxene* and the lime garnets, *grossularite* and *andradite*.

As mentioned in a preceding paragraph, an igneous rock in cooling often gives off large amounts of mineralizing vapors. These consist largely of water vapor, but often include boron and fluorine gases. Under the influence of these vapors, other minerals are often formed in the contact zone of a limestone. These particular minerals are commonly spoken of as *pneumatolytic minerals*, since they are formed, partly at least, through the agency of mineral gases. They consist chiefly of calcium and aluminium silicates which contain hydroxyl, fluorine or boron. The most common of the pneumatolytic contact minerals are *chondrodite*, *vesuvianite*, *scapolite*, *phlogopite*, *tourmaline* and *fluorite*.

### Veins and Vein Minerals.

Most of the important mineral deposits, especially those that furnish the valuable metals, are found in what are known as veins. A brief discussion of veins and vein minerals follows.

The rocks of the earth's crust have many openings existing within them. These openings vary in size from microscopic cracks to cavities of considerable extent. The openings may be irregular and discontinuous or they may be in the form of fissures which are continuous for greater or less distances. Below a certain inconsiderable depth, these openings are largely filled by water. This underground water, as it is termed, slowly circulates through the rocks by means of the openings in them. Through a large part of its circulation, the water must exist at a high temperature and pressure, and under these circumstances becomes a strong solvent and active chemical agent. Underground water in general descends slowly through the smaller openings in the rocks, and then gradually finding its way into the bigger openings will at last enter some larger fissure and changing its course will begin to ascend. On its passage through the rocks, it will have dissolved their more soluble constituents, and when it ultimately enters the larger fissures and commences to rise will be carrying considerable amounts of dissolved mineral material. The igneous rocks in particular are important factors in furnishing underground waters with mineral constituents partly because of the effect of their heat upon its activity, and partly because they give off in the form of vapors a large amount of mineral material which ultimately gets into the underground circulation. When these mineral laden waters commence to rise in the larger fissures, they slowly come into regions of lower pressure and temperature. Under these changing conditions, the water will not be able to retain all its mineral constituents in solution, and their points of saturation being reached various minerals will begin to crystallize out and be deposited on the walls of the fissure. In time, if the process continues, the fissure may be completely filled from wall to wall with minerals deposited in this way. Such a filled fissure is known as a mineral vein.

Evidence that the minerals of a vein have been deposited from solution is given by the following facts. Often a mineral vein shows a distinctly banded or ribboned structure. That is, the different minerals occur in more or less regular layers which lie parallel to the walls. This shows that the various minerals have not been deposited simultaneously, but in a definite order of succession. Again, frequently it will be observed that the vein material has not completely filled the fissure, but that there are openings left along its central line. These openings are termed *vugs* and are often lined with crystallized minerals. These conditions cannot be easily explained except on the assumption that the contents of a mineral vein have been deposited from solution.

The shape and general physical character of a vein depends upon the type of fissure its minerals have been deposited in, and the type of fissure in turn depends upon the character of the rock in which it lies and the kind of force which originally caused its formation. In a firm homogeneous rock, like a granite, a fissure will be fairly regular and clean cut in character. It is liable to be comparatively narrow in respect to its horizontal and vertical extent and reasonably straight in its course. On the other hand, if a rock that is easily fractured and splintered, like a slate or a schist, is subjected to a breaking strain, we are more liable to have formed a zone of narrow and interlacing fissures, rather than one straight crack. In an easily soluble rock like a limestone, a fissure will often be extremely irregular in its shape and size due more or less to a solution of its walls by the waters that have flowed through it.

A typical vein consists of a mineral deposit which has filled a fissure solidly from wall to wall, and shows sharply defined boundaries. There are, however, many variations from this type. Frequently, as observed above, irregular openings termed *vugs* may occur among the vein minerals. It is from these *vugs* that we obtain many of our crystallized mineral specimens. Again, the walls of a vein may not be sharply defined. The mineralizing waters that filled the fissure may have acted upon the wall rocks and partially dissolving them may have replaced them with the vein minerals. Consequently we may have almost a

complete gradation from the unaltered rock to the pure vein filling, and with no sharp line of division between. Some deposits have been largely formed by the deposition of vein minerals in the wall rocks. Such deposits are known as *replacement deposits*. They are more liable to be found in the soluble rocks like limestones. There is every gradation possible from a true vein with sharply defined walls to a replacement deposit with indefinite boundaries.

The mineral contents of a vein depend chiefly upon the chemical composition of the waters from which its minerals have crystallized. There are many different sorts of veins, and many different mineral associations are observed in them. There are, however, certain minerals and associations that are more frequent in their occurrence to which attention should be drawn. The sulphides form perhaps the most characteristic chemical group of minerals to be found in veins. The following minerals are very common vein minerals, *pyrite*,  $\text{FeS}_2$ , *chalcopyrite*,  $\text{CuFeS}_2$ , *galena*,  $\text{PbS}$ , *sphalerite*,  $\text{ZnS}$ , *chalcocite*,  $\text{Cu}_2\text{S}$ , *bornite*,  $\text{Cu}_5\text{FeS}_4$ , *marcasite*,  $\text{FeS}_2$ , *arsenopyrite*,  $\text{FeAsS}$ , *stibnite*,  $\text{Sb}_2\text{S}_3$ , *tetrahedrite*,  $\text{Cu}_9\text{Sb}_2\text{S}_7$ , etc. In addition to these, which in large part comprise our ore minerals, certain nonmetallic minerals are also commonly to be observed. These being of no particular commercial value are called *gangue minerals* (*gangue* is from *gang*, a vein). They include the following: *quartz*,  $\text{SiO}_2$ , *calcite*,  $\text{CaCO}_3$ , *dolomite*,  $\text{CaMg}(\text{CO}_3)_2$ , *siderite*,  $\text{FeCO}_3$ , *barite*,  $\text{BaSO}_4$ , *fluorite*,  $\text{CaF}_2$ , *rhodochrosite*,  $\text{MnCO}_3$ , etc.

While comparatively few positive statements concerning the associations of vein minerals can be made, the following points are of interest.

**1. Gold-bearing Quartz Veins.** Native gold is most commonly found in quartz veins. It may occur alone in the quartz either in nests or in finely disseminated particles, or it may occur in connection with certain sulphides in the veins. The most common sulphides found in such connections are pyrite, chalcopyrite and arsenopyrite.

**2. Gold- and Silver-bearing Copper Veins.** The gold and silver content of these veins is associated with the various copper

sulphides. Frequently the amount of the precious metals is quite small. The chief minerals are chalcopyrite, tetrahedrite, bornite, chalcocite, pyrite and various rarer silver minerals.

3. **Silver-bearing Lead Veins.** Silver and lead minerals are very commonly associated with each other. These veins contain such minerals as galena, argentite, tetrahedrite, sphalerite, pyrite, calcite, dolomite, rhodochrosite, etc.

4. **Lead-zinc Veins.** Lead and zinc minerals often occur together particularly in deposits that lie in limestones. The chief minerals of such deposits are galena, sphalerite, marcasite, chalcopyrite, smithsonite, calamine, cerussite, calcite, dolomite.

5. **Copper-iron Veins.** Copper and iron sulphides are quite commonly associated with each other, the prominent minerals of such veins being pyrite, chalcopyrite, chalcocite, bornite, tetrahedrite, enargite, etc.

### **Primary and Secondary Vein Minerals. Secondary Enrichment.**

In many mineral veins, it is obvious that certain minerals belong to the original vein deposit while certain others have been formed subsequently. These two classes of minerals are known respectively as *Primary* and *Secondary Minerals*. The primary vein minerals are those which were originally deposited by the ascending waters in the vein fissure. The primary metallic vein minerals are comparatively few in number, the more important being pyrite, chalcopyrite, galena and sphalerite. The secondary vein minerals have been formed from the primary minerals by some subsequent chemical reaction. This change is ordinarily brought about through the influence of oxidizing waters which coming from the surface of the earth descend through the upper portions of the vein. Under these conditions, various new minerals are formed, many of them being oxidized compounds. As the descending waters lose their oxygen content within a comparatively short distance of the earth's surface, the secondary minerals are only to be found in the upper part of a vein. Together with the formation of these secondary minerals, there is

frequently a downward migration of the valuable metals in the vein. This is brought about by the solution of the minerals in the uppermost portion of the vein and a subsequent reprecipitation a little farther down. As the surface of the earth is gradually lowered by erosion, the upper part of a vein is continually being worn away. But the metallic content of the uppermost part of the vein is always being carried downward by the descending oxidizing waters. In this way, the metallic content of the upper part of many veins has been notably enriched since there is concentrated in this short space most of the original contents of hundreds, perhaps thousands, of feet of the vein which have been slowly worn away by the general erosion of the country. Consequently the zone of the secondary vein minerals is also frequently a zone of secondary enrichment. This is an important fact to be borne in mind since, because of it, the upper two or three hundred feet of a vein are ordinarily the richest portion of a deposit. The ore below that depth gradually reverts to its original unaltered and unenriched character and may frequently prove too low in value to warrant its being mined. The prevalent idea that the ore of a vein must increase in value with increasing depth is not true in the great majority of cases.

It will be of interest to consider the more important primary vein minerals and the secondary minerals that are commonly formed from them.

**1. Iron Minerals.** The common primary vein iron mineral is pyrite,  $\text{FeS}_2$ . Marcasite,  $\text{FeS}_2$ , while not so common in occurrence is also a primary mineral. When oxidized, these minerals yield ordinarily the hydrated oxide limonite,  $\text{Fe}_2\text{O}_3[\text{OH}]_2$ . The upper portion of a vein that was originally rich in pyrite will often show a cellular and rusty mass of limonite. This limonite deposit near the surface is commonly termed *gossan*. The yellow rusty character of the outcrop of many veins enables one frequently to locate them and to trace them across the country.

**2. Copper Minerals.** The one common primary copper mineral is chalcopyrite,  $\text{CuFeS}_2$ . At times, some of the other sulphides may be primary in their origin, but this is not generally

the case. The secondary formation of bornite and chalcocite may be explained as follows. The copper sulphide existing in the original chalcopyrite is oxidized by the descending waters at the surface to copper sulphate which is then dissolved and carried farther down the vein. Here it comes in contact with unaltered chalcopyrite and a reaction takes place which enriches the sulphide, changing it to bornite,  $\text{Cu}_5\text{FeS}_4$ . Later, more copper sulphate in solution comes in contact with the bornite and a further enrichment takes place with the formation of chalcocite,  $\text{Cu}_2\text{S}$ . In each case, there is an interchange of metals, the iron in the original sulphide going into solution as a sulphate thus taking the place of the copper which has been precipitated. If the copper deposit lies in limestone rocks, we commonly find the various carbonates and oxides of copper also formed in the upper parts of the deposit. The secondary copper minerals therefore include *chalcocite*,  $\text{Cu}_2\text{S}$ , *bornite*,  $\text{Cu}_5\text{FeS}_4$ , *native copper*,  $\text{Cu}$ , *cuprite*,  $\text{Cu}_2\text{O}$ , *malachite*,  $(\text{Cu.OH})_2\text{CO}_3$ , *azurite*,  $\text{Cu}(\text{Cu.OH})_2(\text{CO}_3)_2$ , *chrysocolla*,  $\text{CuSiO}_3 \cdot 2\text{H}_2\text{O}$ , *chalcanthite*,  $\text{CuSO}_4 \cdot 5\text{H}_2\text{O}$ .

3. **Lead Minerals.** The one primary lead mineral is galena,  $\text{PbS}$ . The secondary minerals of lead are all oxidized compounds and include the following: *cerussite*,  $\text{PbCO}_3$ , *anglesite*,  $\text{PbSO}_4$ , *pyromorphite*,  $\text{Pb}_4(\text{PbCl})(\text{PO}_4)_3$ , *wulfenite*,  $\text{PbMoO}_4$ .

4. **Zinc Minerals.** Sphalerite,  $\text{ZnS}$ , is the only common primary zinc mineral. The chief secondary minerals are *smithsonite*,  $\text{ZnCO}_3$ , and *calamine*,  $\text{H}_2(\text{Zn}_2\text{O})\text{SiO}_4$ .

5. **Silver Minerals.** Probably most of the sulphide minerals of silver are primary in their origin. The following minerals are usually secondary, although native silver at times appears primary; *native silver*,  $\text{Ag}$ , *cerargyrite*,  $\text{AgCl}$ , *embolite*,  $\text{Ag}(\text{Cl}, \text{Br})$ , etc.

### Lists of Minerals Arranged According to Systems of Crystallization.

In the following tables the minerals which are described in this book are listed according to the system of crystallization to which they belong. The order in which they are given is according to the chemical classification adopted in this book.

## ISOMETRIC SYSTEM: NORMAL CLASS.

## Elements.

- |                        |                        |
|------------------------|------------------------|
| 1. <b>Diamond</b> , C. | 4. <b>Copper</b> , Cu. |
| 2. <b>Gold</b> , Au.   | 5. Platinum, Pt.       |
| 3. <b>Silver</b> , Ag. | 6. Iron, Fe.           |

## Sulphides.

- |                                       |   |
|---------------------------------------|---|
| 1. <b>Galena</b> , PbS.               | 4. <b>Bornite</b> , $\text{Cu}_5\text{FeS}_4$ . |
| 2. Argentite, $\text{Ag}_2\text{S}$ . | 5. Linnarite, $\text{Co}_3\text{S}_4$ .         |
| 3. Pentlandite, (Ni,Fe)S.             |   |

## Chlorides, etc.

- |                          |                                       |
|--------------------------|---------------------------------------|
| 1. <b>Halite</b> , NaCl. | 4. Embolite, Ag(Cl,Br).               |
| 2. Sylvite, KCl.         | 5. <b>Fluorite</b> , $\text{CaF}_2$ . |
| 3. Cerargyrite, AgCl.    |                                       |

## Oxides.

- |   |  |
|---|--|
| 1. Senarmontite, $\text{Sb}_2\text{O}_3$ .              | 4. Gahnite, $\text{ZnAl}_2\text{O}_4$ .                      |
| 2. <b>Cuprite</b> , $\text{Cu}_2\text{O}$ .             | 5. <b>Magnetite</b> , $\text{Fe}_3\text{O}_4$ .              |
| <i>Spinel Group</i> , $\text{R}''\text{R}'''\text{O}_4$ | 6. Franklinite, (Fe,Mn,Zn)                                   |
| or $\text{R}''\text{O.R}'''\text{O}_3$ .                | (Fe, Mn) $_2\text{O}_4$ .                                    |
| 3. <b>Spinel</b> , $\text{MgAl}_2\text{O}_4$ .          | 7. <b>Chromite</b> , $(\text{Fe,Mg})\text{Cr}_2\text{O}_4$ . |

## Silicates.

- |   |   |
|---|---|
| 1. <b>Leucite</b> , $\text{KAl}(\text{SiO}_3)_2$ .                            | 5. <b>Garnet Group</b> , $\text{R}_3\text{R}_2(\text{SiO}_4)_3$ . |
| 2. <b>Analcite</b> , $\text{NaAl}(\text{SiO}_3)_2 \cdot \text{H}_2\text{O}$ . | Grossularite, $\text{Ca}_3\text{Al}_2(\text{SiO}_4)_3$ .          |
| 3. Sodalite,  | Pyrope, $\text{Mg}_3\text{Al}_2(\text{SiO}_4)_3$ .                |
| $\text{Na}_4(\text{AlCl})\text{Al}_2(\text{SiO}_4)_3$ .                       | Almandite, $\text{Fe}_3\text{Al}_2(\text{SiO}_4)_3$ .             |
| 4. <b>Lazurite</b> ,  | Spessartite, $\text{Mn}_3\text{Al}_2(\text{SiO}_4)_3$ .           |
| $\text{Na}_4(\text{Al.NaS}_3)\text{Al}_2(\text{SiO}_4)_3$ .                   | Andradite, $\text{Ca}_3\text{Fe}_2(\text{SiO}_4)_3$ .             |
|   | Uvarovite,  |
|   | $\text{Ca}_3(\text{Cr,Al})_2(\text{SiO}_4)_3$ .                   |

## Uranate.

1. Uraninite,  $\text{UO}_3$  and  $\text{UO}_2$  with Th, Y, Ce, Pb, He, Ra.



## ISOMETRIC SYSTEM: PYRITOHEDRAL CLASS.

**Sulphides, etc.**

- |                                     |  |                                   |
|-------------------------------------|--|-----------------------------------|
| 1. <b>Pyrite</b> , $\text{FeS}_2$ . |  | 4. Cobaltite, $\text{CoAsS}$ .    |
| 2. Smaltite, $\text{CoAs}_2$ .      |  | 5. Gersdorffite, $\text{NiAsS}$ . |
| 3. Chloanthite, $\text{NiAs}_2$ .   |  | 6. Sperryllite, $\text{PtAs}_2$ . |

**Sulphate.**

1. Kalinite, Alum,  $\text{KAl}(\text{SO}_4)_2 \cdot 12\text{H}_2\text{O}$ .

## ISOMETRIC SYSTEM: TETRAHEDRAL CLASS.

**Sulphides, etc.**

- |                                       |  |                               |
|---------------------------------------|--|-------------------------------|
| 1. <b>Sphalerite</b> , $\text{ZnS}$ . |  | 3. Alabandite, $\text{MnS}$ . |
| 2. Tiemannite, $\text{HgSe}$ .        |  |                               |

**Sulphantimonites, Sulpharsenites.**

- |   |  |   |
|---|--|---|
| 1. <b>Tetrahedrite</b> ,<br>$\text{Cu}_9\text{Sb}_3\text{S}_7 = 4\text{Cu}_2\text{S} \cdot \text{Sb}_2\text{S}_3$ . |  | 2. <b>Tennantite</b> ,<br>$\text{Cu}_3\text{As}_2\text{S}_7 = 4\text{Cu}_2\text{S} \cdot \text{As}_2\text{S}_3$ . |
|---|--|---|

**Borate.**

1. Boracite,  $\text{Mg}_7\text{Cl}_2\text{B}_{10}\text{O}_{30}$ .

## TETRAGONAL SYSTEM: NORMAL CLASS.

**Sulphide.**

1. Stannite,  $\text{Cu}_2\text{FeSnS}_4$ .

**Oxides and Closely Related Silicates and Phosphates.**

- |  |  |                                       |
|--|--|---------------------------------------|
| 1. Octahedrite, $\text{TiO}_2$ .                             |  | 4. <b>Zircon</b> , $\text{ZrSiO}_4$ . |
| 2. <b>Cassiterite</b> , $\text{SnO}_2$ or $\text{SnSnO}_4$ . |  | 5. Thorite, $\text{ThSiO}_4$ .        |
| 3. <b>Rutile</b> , $\text{TiO}_2$ or $\text{TiTiO}_4$ .      |  | 6. Xenotime, $\text{YPO}_4$ .         |

**Carbonate.**

1. Phosgenite,  $(\text{PbCl})_2\text{CO}_3$ .

**Silicates.**

- |  |  |  |
|--|--|--|
| 1. <b>Vesuvianite</b> , Complex<br>$\text{Ca}, \text{Mg}, \text{Na}, \text{Al}, \text{Fe}$ silicate. |  | 2. Apophyllite,<br>$\text{H}_7\text{KCa}_4(\text{SiO}_3)_8 \cdot 4\frac{1}{2}\text{H}_2\text{O}$ . |
|--|--|--|

## TETRAGONAL SYSTEM: TRI-PYRAMIDAL CLASS.

## Silicate.

1. **Wernerite** or **Scapolite**,  $\text{Ca}_4\text{Al}_6\text{Si}_6\text{O}_{25}$  with  $\text{Na}_4\text{Al}_3\text{Si}_9\text{O}_{24}\text{Cl}$ .

## Tungstate and Molybdate.

1. Scheelite,  $\text{CaWO}_4$ . | 2. Wulfenite,  $\text{PbMoO}_4$ .

## TETRAGONAL SYSTEM: SPHENOIDAL CLASS.

## Sulphide.

1. **Chalcopyrite**,  $\text{CuFeS}_2$ .

## HEXAGONAL SYSTEM: NORMAL CLASS.

## Sulphides.

1. Molybdenite,  $\text{MoS}_2$ . | 3. **Pyrrhotite**,  $\text{Fe}_{11}\text{S}_{12}$ .  
2. Covellite,  $\text{CuS}$ .

## Silicates.

1. **Beryl**,  $\text{Be}_3\text{Al}_2(\text{SiO}_3)_6$  with | 2. **Nephelite**,  $\text{NaAlSiO}_4$ .  
some  $[\text{OH}]?$  (Approx.)

## HEXAGONAL SYSTEM: HEMIMORPHIC CLASS.

## Sulphides, etc.

1. Greenockite,  $\text{CdS}$ . | 2. Niccolite,  $\text{NiAs}$ .

## Oxide.

1. Zincite,  $\text{ZnO}$  with  $\text{MnO}$ .

## HEXAGONAL SYSTEM: TRI-PYRAMIDAL CLASS.

## Phosphates, etc.

## Apatite Group.

1. **Apatite**,  $\text{Ca}_4(\text{CaF})(\text{PO}_4)_3$ . | 3. **Mimetite**,  
2. **Pyromorphite**, |  $\text{Pb}_4(\text{PbCl})(\text{AsO}_4)_3$ .  
 $\text{Pb}_4(\text{PbCl})(\text{PO}_4)_3$ . | 4. **Vanadinite**,  
 $\text{Pb}_4(\text{PbCl})(\text{VO}_4)_3$ .

HEXAGONAL SYSTEM: RHOMBOHEDRAL CLASS.  
NORMAL DIVISION.

Elements.

- |                         |  |                   |
|-------------------------|--|-------------------|
| 1. <b>Graphite</b> , C. |  | 4. Bismuth, Bi.   |
| 2. Arsenic, As.         |  | 5. Tellurium, Te. |
| 3. Antimony, Sb.        |  |                   |

Sulphides, Sulphantimonites, Sulpharsenites.

- |   |  |   |
|---|--|---|
| 1. Millerite, NiS.  |  | 3. Proustite,   |
| 2. Pyrargyrite,   |  | Ag <sub>3</sub> AsS <sub>3</sub> or 3Ag <sub>2</sub> S.As <sub>2</sub> S <sub>3</sub> . |
| Ag <sub>3</sub> SbS <sub>3</sub> or 3Ag <sub>2</sub> S.Sb <sub>2</sub> S <sub>3</sub> . |  |   |

Oxides, Hydroxides.

- |   |  |                                   |
|---|--|-----------------------------------|
| 1. <b>Corundum</b> , Al <sub>2</sub> O <sub>3</sub> . |  | 3. Brucite, Mg(OH) <sub>2</sub> . |
| 2. <b>Hematite</b> , Fe <sub>2</sub> O <sub>3</sub> . |  |                                   |

Carbonates.

Calcite Group.

- |  |  |   |
|--|--|---|
| 1. <b>Calcite</b> , CaCO <sub>3</sub> .                  |  | 4. <b>Siderite</b> , FeCO <sub>3</sub> .      |
| 2. <b>Dolomite</b> , CaMg(CO <sub>3</sub> ) <sub>2</sub> |  | 5. <b>Rhodochrosite</b> , MnCO <sub>3</sub> . |
| (tri-rhombohedral).                                      |  | 6. <b>Smithsonite</b> , ZnCO <sub>3</sub> .   |
| 3. <b>Magnesite</b> , MgCO <sub>3</sub> .                |  |   |

Silicates.

- |  |  |   |
|--|--|---|
| 1. <b>Tourmaline</b> ,   |  | 2. Chabazite,   |
| R <sub>3</sub> Al <sub>3</sub> (B.OH) <sub>2</sub> Si <sub>4</sub> O <sub>19</sub> |  | (Ca,Na <sub>2</sub> )Al <sub>2</sub> Si <sub>4</sub> O <sub>12</sub> .6H <sub>2</sub> O?. |
| (hemimorphic).   |  |   |

Nitrate.

1. **Soda-niter**, NaNO<sub>3</sub>.

HEXAGONAL SYSTEM: RHOMBOHEDRAL CLASS.  
TRI-RHOMBOHEDRAL DIVISION.

Titanate.

1. Ilmenite, FeTiO<sub>3</sub>.

Silicates.

- |  |  |  |
|--|--|--|
| 1. Willemite, Zn <sub>2</sub> SiO <sub>4</sub> . |  | 2. Phenacite, Be <sub>2</sub> SiO <sub>4</sub> . |
|--|--|--|

HEXAGONAL SYSTEM: RHOMBOHEDRAL CLASS.  
TRAPEZOHEDRAL DIVISION.

## Sulphide.

1. **Cinnabar**,  $\text{HgS}$ .

## Oxide.

1. **Quartz**,  $\text{SiO}_2$ .

## ORTHORHOMBIC SYSTEM.

## Element.

1. **Sulphur**, S.

## Sulphides, etc.

- |  |   |
|--|---|
| 1. <b>Stibnite</b> , $\text{Sb}_2\text{S}_3$ .     | 4. <b>Stromeyerite</b> , $\text{CuAgS}$ . |
| 2. <b>Bismuthinite</b> , $\text{Bi}_2\text{S}_3$ . | 5. <b>Marcasite</b> , $\text{FeS}_2$ .    |
| 3. <b>Chalcocite</b> , $\text{Cu}_2\text{S}$ .     | 6. <b>Arsenopyrite</b> , $\text{FeAsS}$ . |

## sulphantimonites, etc.

- |   |  |
|---|--|
| 1. <b>Bournonite</b> , $(\text{Pb,Cu}_2)_3\text{Sb}_2\text{S}_6$<br>or $3(\text{Pb,Cu}_2)\text{S.Sb}_2\text{S}_3$ . | 2. <b>Stephanite</b> , $\text{Ag}_5\text{SbS}_4$ or<br>$5\text{Ag}_2\text{S.Sb}_2\text{S}_3$ . |
|---|--|

## Sulpharsenate.

1. **Enargite**,  $\text{Cu}_3\text{AsS}_4$  or  $3\text{Cu}_2\text{S.As}_2\text{S}_5$ .

## Chlorides.

- |   |   |
|---|---|
| 1. <b>Atacamite</b> , $\text{Cu}_2\text{Cl}(\text{OH})_2$ . | 2. <b>Carnallite</b> , $\text{KMgCl}_3 \cdot 6\text{H}_2\text{O}$ . |
|---|---|

## Oxides, Hydroxides.

- |   |  |
|---|--|
| 1. <b>Chrysoberyl</b> , $\text{BeAl}_2\text{O}_4$ .         | 5. <b>Manganite</b> , $\text{Mn}_2\text{O}_3(\text{OH})_2$ .   |
| 2. <b>Brookite</b> , $\text{TiO}_2$ .                       | 6. <b>Pyrolusite</b> , $\text{MnO}_2$ with<br>about 2% $\text{H}_2\text{O}$ . (Pseudo-<br>morphous.) |
| 3. <b>Diaspore</b> , $\text{Al}_2\text{O}_3(\text{OH})_3$ . |  |
| 4. <b>Goethite</b> , $\text{Fe}_2\text{O}_3(\text{OH})_3$ . |  |

## Carbonates.

## Aragonite Group.

- |  |   |
|--|---|
| 1. <b>Aragonite</b> , $\text{CaCO}_3$ .    | 3. <b>Witherite</b> , $\text{BaCO}_3$ . |
| 2. <b>Strontianite</b> , $\text{SrCO}_3$ . | 4. <b>Cerussite</b> , $\text{PbCO}_3$ . |

## Silicates.

- |   |   |
|---|---|
| 1. Enstatite, Bronzite,<br>Hypersthene,<br>$MgSiO_3, (Mg, Fe)SiO_3$ .<br>2. Anthophyllite, $(Mg, Fe)SiO_3$ .<br>3. Iolite,<br>$(Mg, Fe)_4Al_6(Al.OH)_2(Si_2O_7)_3$ .<br>4. <b>Chrysolite</b> , $(Mg, Fe)_2SiO_4$ .<br>5. Danburite, $CaB_2(SiO_4)_2$ .<br>6. <b>Topaz</b> , $(Al(F.OH))_2SiO_4$ .<br>7. Andalusite, $(AlO)AlSiO_4$ .<br>8. Zoisite,<br>$Ca(Al.OH)Al_2(SiO_4)_2$ | 9. Prehnite, $H_2Ca_2Al_2(SiO_4)_3$ .<br>10. <b>Calamine</b> ,<br>$H_2(Zr_{12}O)SiO_4$ (hemimorphic).<br>11. <b>Staurolite</b> ,<br>$(Mg, Fe)(Al.OH)(AlO)_4(SiO_4)_2$ .<br>12. Sillimanite, $Al_2SiO_5$ .<br>13. <b>Natrolite</b> ,<br>$Na_2Al_2Si_3O_{10}.2H_2O$ .<br>14. Thomsonite<br>$(Na_2, Ca)Al_2(SiO_4)_2.2\frac{1}{2}H_2O$ . |
|---|---|

## Niobate, Tantalate.

1. **Columbite-tantalite**,  $(Fe, Mn)(Nb, Ta)_2O_6$ .

## Phosphates, etc.

- |   |   |
|---|---|
| 1. Triphylite-lithiophillite,<br>$Li(Fe, Mn)PO_4$ .<br>2. Olivenite, $Cu(Cu.OH)AsO_4$ . | 3. Scorodite, $FeAsO_4.2H_2O$ .<br>4. Wavellite,<br>$(Al.OH)_3(PO_4)_2.5H_2O$ . |
|---|---|

## Nitrate.

1. Niter,  $KNO_3$ .

## Sulphates.

- |   |  |
|---|--|
| 1. <b>Barite</b> , $BaSO_4$ .<br>2. <b>Celestite</b> , $SrSO_4$ .<br>3. <b>Anglesite</b> , $PbSO_4$ . | 4. <b>Anhydrite</b> , $CaSO_4$ .<br>5. Brochantite, $Cu_4(OH)_6SO_4$ . |
|---|--|

## MONOCLINIC SYSTEM.

## Sulphides, Tellurides.

- |   |   |
|---|---|
| 1. Realgar, $AsS$ .<br>2. Orpiment, $As_2S_3$ . | 3. Sylvanite, $AuAgTe_4$ .<br>4. Calaverite, $AuTe_2$ . |
|---|---|

**Sulphantimonite.**

1. Polybasite,  $\text{Ag}_3\text{SbS}_6$ .

**Fluoride.**

1. Cryolite,  $\text{Na}_3\text{AlF}_6$ .

**Hydroxide.**

1. Gibbsite,  $\text{Al}(\text{OH})_3$ .

**Carbonates.**

- |   |  |
|---|--|
| <ol style="list-style-type: none"> <li>1. Malachite, <math>(\text{Cu.OH})_2\text{CO}_3</math>.</li> <li>2. Azurite, <math>\text{Cu}(\text{Cu.OH})_2(\text{CO}_3)_2</math>.</li> <li>3. Aurichalcite,<br/><math>2(\text{Zn,Cu})\text{CO}_3.3(\text{Zn,Cu})(\text{OH})_2</math>.</li> </ol> | <ol style="list-style-type: none"> <li>4. Gay-Lussite,<br/><math>\text{Na}_2\text{CO}_3.\text{CaCO}_3.5\text{H}_2\text{O}</math>.</li> </ol> |
|---|--|

**Silicates.**

- |  |  |
|--|--|
| <ol style="list-style-type: none"> <li>1. Orthoclase, <math>\text{KAlSi}_3\text{O}_8</math>.</li> <li>2. Pyroxene Group, <math>\text{R}''\text{SiO}_3</math><br/>(<math>\text{R} = \text{Ca, Mg, Fe}</math>).</li> <li>3. Ægirite, <math>\text{NaFe}(\text{SiO}_3)_2</math>.</li> <li>4. Jadeite, <math>\text{NaAl}(\text{SiO}_3)_2</math>.</li> <li>5. Spodumene, <math>\text{LiAl}(\text{SiO}_3)_2</math>.</li> <li>6. Wollastonite, <math>\text{CaSiO}_3</math>.</li> <li>7. Pectolite, <math>\text{HNaCa}_2(\text{SiO}_3)_3</math>.</li> </ol> | <ol style="list-style-type: none"> <li>8. Amphibole Group,<br/><math>\text{R}''\text{SiO}_3</math> (<math>\text{R} = \text{Ca, Mg, Fe}</math>).</li> <li>9. Datolite, <math>\text{Ca}(\text{B.OH})\text{SiO}_4</math>.</li> <li>10. Epidote,<br/><math>\text{Ca}_2(\text{Al.OH})\text{Al}_2(\text{SiO}_4)_3</math>.</li> <li>11. Allanite,<br/><math>\text{Ca}_2(\text{Al.OH})(\text{Al, Fe, Ce, La, Di})_2</math><br/><math>(\text{SiO}_4)_3</math>.</li> </ol> |
|--|--|

**Hydrated Silicates.**

- |  |   |
|--|---|
| <ol style="list-style-type: none"> <li>1. Heulandite,<br/><math>\text{H}_4\text{CaAl}_2(\text{SiO}_3)_6.3\text{H}_2\text{O}</math>.</li> <li>2. Harmotome,<br/><math>(\text{K}_2, \text{Ba})\text{Al}_2\text{Si}_4\text{O}_{14}.5\text{H}_2\text{O}</math>.</li> <li>3. Stilbite,<br/><math>(\text{Na}_2, \text{Ca})\text{Al}_2\text{Si}_5\text{O}_{16}.6\text{H}_2\text{O}</math>.</li> </ol> | <ol style="list-style-type: none"> <li>4. Laumontite,<br/><math>\text{H}_4\text{CaAl}_2\text{Si}_4\text{O}_{14}.2\text{H}_2\text{O}</math>.</li> <li>5. Scolecite,<br/><math>\text{CaAl}_2\text{Si}_3\text{O}_{10}.3\text{H}_2\text{O}</math>.</li> </ol> |
|--|---|

**Foliated, Micaceous Silicates.**

- |   |   |
|---|---|
| 1. <b>Muscovite</b> , $H_2KAl_3(SiO_4)_3$ .<br>2. <b>Lepidolite</b> ,<br>$KLi(Al_2(OH,F))Al(SiO_3)_3$ .<br>3. <b>Biotite</b> ,<br>$(H,K)_2(Mg,Fe)_2Al_2(SiO_4)_3$ .<br>4. <b>Phlogopite</b> ,<br>$H_2KMg_3Al(SiO_4)_3?$ .<br>5. <b>Lepidomelane</b> ,<br>$(H,K)_2Fe_3(Fe,Al)_4(SiO_4)_5?$ . | 6. <b>Margarite</b> , $H_2CaAl_4Si_2O_{12}$ .<br>7. <b>Clinocllore</b> , Chlorite,<br>$H_3Mg_5Al_2Si_3O_{18}$ .<br>8. <b>Serpentine</b> , $H_4Mg_3Si_2O_9$ .<br>9. <b>Kaolin</b> , $H_4Al_2Si_2O_9$ .<br>10. <b>Talc</b> , $H_2Mg_3(SiO_3)_4$ .<br>11. <b>Pyrophyllite</b> , $H_2Al_2(SiO_3)_4$ . |
|---|---|

**Titanosilicate.**

1. **Titanite**,  $CaTiSiO_5$ .

**Phosphates.**

- |  |   |
|--|---|
| 1. <b>Monazite</b> , $(Ce,La,Di)PO_4$<br>with $ThSiO_4$ .<br>2. <b>Lazulite</b> ,<br>$Mg(Al.OH)_2(PO_4)_2$ . | 3. <b>Vivianite</b> ,<br>$Fe_3(PO_4)_2.8H_2O$ . |
|--|---|

**Borates.**

- |   |   |
|---|---|
| 1. <b>Colemanite</b> ,<br>$Ca_2B_3O_{11}.5H_2O$ . | 2. <b>Borax</b> , $Na_2B_4O_7.10H_2O$ . |
|---|---|

**Sulphates, Chromates.**

- |   |                                     |
|---|-------------------------------------|
| 1. <b>Glauberite</b> , $Na_2Ca[SO_4]_2$ .<br>2. <b>Crocoite</b> , $PbCrO_4$ . | 3. <b>Gypsum</b> , $CaSO_4.2H_2O$ . |
|---|-------------------------------------|

**Tungstates.**

- |                                   |                                  |
|-----------------------------------|----------------------------------|
| 1. <b>Wolframite</b> , $FeWO_4$ . | 2. <b>Hübnerite</b> , $MnWO_4$ . |
|-----------------------------------|----------------------------------|

## TRICLINIC SYSTEM.

## Silicates.

- |  |  |
|--|--|
| 1. <b>Microcline</b> , $\text{KAlSi}_3\text{O}_8$ .<br><i>Plagioclase Feldspars.</i> | 5. <b>Labradorite</b> , 1 Albite, 3 Anorthite.                           |
| 2. <b>Albite</b> , $\text{NaAlSi}_3\text{O}_8$ .                                     | 6. <b>Anorthite</b> , $\text{CaAl}_2\text{Si}_2\text{O}_8$ .             |
| 3. <b>Oligoclase</b> , 3 Albite, 1 Anorthite.  | 7. <b>Rhodonite</b> , $\text{MnSiO}_3$ .                                 |
| 4. <b>Andesine</b> , 1 Albite, 1 Anorthite.  | 8. <b>Cyanite</b> , $\text{Al}_2\text{SiO}_5$ .                          |
|  | 9. <b>Axinite</b> , $\text{Ca}_7\text{Al}_4\text{B}_2(\text{SiO}_4)_6$ . |

## Phosphate.

1. **Amblygonite**,  $\text{Li}(\text{AlF})\text{PO}_4$ .

## Sulphate.

1. **Chalcanthite**,  $\text{CuSO}_4 \cdot 5\text{H}_2\text{O}$ .

## AMORPHOUS OR MASSIVE MINERALS.

## Oxides, Hydroxides.

- |   |  |
|---|--|
| 1. <b>Opal</b> , $\text{SiO}_2$ , generally with 3 to 9% $\text{H}_2\text{O}$ . | 4. <b>Bauxite</b> , $\text{Al}_2\text{O}(\text{OH})_3$ .   |
| 2. <b>Turgite</b> , $\text{Fe}_4\text{O}_5(\text{OH})_2$ .                      | 5. <b>Psilomelane</b> , $\text{MnO}_2$ with $\text{MnO}$ , $\text{BaO}$ , $\text{CoO}$ , $\text{H}_2\text{O}$ , etc. |
| 3. <b>Limonite</b> , $\text{Fe}_2\text{O}_3(\text{OH})_2$ .                     |  |

## Silicates.

- |   |  |
|---|--|
| 1. <b>Genthite</b> , <b>Garnierite</b> ,<br><i>Ni, Mg, silicates.</i> | 2. <b>Chrysocolla</b> , $\text{CuSiO}_3 \cdot 2\text{H}_2\text{O}$ . |
|---|--|

## Phosphate.

1. **Turquoise**,  $\text{H}(\text{Al} \cdot 2\text{OH})_2\text{PO}_4$  with  $\text{H}(\text{Cu} \cdot \text{OH})_2\text{PO}_4$ .



## V. DETERMINATIVE MINERALOGY.

### INTRODUCTION.

Determinative Tables for minerals are of two kinds: (1) those which rely chiefly upon chemical tests, and (2) those which make use solely of physical tests. Obviously, since the chemical composition of a mineral is its most fundamental property, those tables which emphasize chemical tests are much the more satisfactory. On the other hand, the tables which depend wholly upon physical tests have distinct limitations beyond which it is impossible to use them. These latter tables have, however, the important advantages that their tests are simpler, more readily and quickly performed, and do not require the equipment of a laboratory. For these reasons physical determinative tables probably have a wider use, in spite of their limitations, than those that involve chemical tests.

The character and purpose of this book forbid the inclusion of elaborate chemical tables and require instead the introduction of physical tables of as simple a form as possible. Such tables must, however, be used with a thorough understanding of their nature and their inherent disadvantages. Many of the physical properties of minerals are not entirely fixed in their character. Color, for instance, is frequently an extremely variable property. Hardness, while more definite, may vary to a slight extent, and by a change in the structure of a mineral may appear to vary much more widely. Cleavage is a property which may often be obscured by the physical condition of the mineral. Consequently in making a determination of a mineral by means of its physical properties alone, it is necessary to have a fairly typical specimen and one which is of sufficient size to enable its characters to be definitely seen. Often, moreover, it will be impossible by the aid of such tables to positively differentiate between two

or three similar species. Frequently, however, in such cases the descriptions of these possible minerals given in Section IV will enable one to make a definite decision. Moreover, the tables that follow, used in connection with the chemical tests given under the description of minerals in Section IV, together with the more detailed explanations of the various tests to be found in Section III, may serve as a substitute for more elaborate chemical tables.

The Determinative Tables given beyond have been made as brief and simple as possible. Only the common species or those which, while rarer in occurrence, are of economic importance have been included. The chances of having a mineral to determine that is not included in these tables are small, but it must be borne in mind that there is such a possibility. The names of the minerals have been printed in three different styles of type, as (see page 373) **CHALCOCITE**, **ARGENTITE** and *Stephanite*, in order to indicate their relative importance and frequency of occurrence. Whenever it was felt that difficulty might be experienced in correctly placing a mineral, it has been included in the two or more possible divisions. Usually, however, for the sake of brevity, the detailed description of such a mineral has been printed in full only upon one page.

On page 369 will be found a General Classification of the tables. The proper division in which to look for a mineral is to be determined by means of the tests indicated there. The tables are divided into two main sections depending upon the luster of the minerals in them. The first division includes those minerals which have a Metallic or Submetallic Luster. By that is meant those minerals which on their thinnest edges remain opaque and which consequently will give black or dark-colored "streaks" when they are rubbed across a piece of unglazed porcelain, the so-called streak plate. Nonmetallic minerals are those which are transparent upon their thinnest edges, and which therefore give either a colorless or a light-colored streak. It is to be noted that the color of the streak cannot always be foretold from the color of the mineral itself. Frequently a dark-colored mineral will be found to give a light-colored streak.

The tables are next subdivided according to hardness. The tests used in the General Classification are: (1) minerals that are soft enough to leave a mark when rubbed across a piece of paper; (2) minerals that can be scratched by the finger nail; (3) those that can be cut by a cent; (4) minerals that are softer than the steel of the blade of an ordinary pocket knife; (5) and (6) minerals that are harder than a knife but can or cannot be scratched by quartz. In applying the tests for hardness, certain precautions should be observed. Before deciding upon the relative hardness of a mineral, it is well to try the test if possible in two ways. For instance, if a mineral is apparently scratched by the edge of a cent make sure on the other hand that the cent cannot be scratched by the mineral. Further, the cent and the knife blade used in making the tests should be bright and clean, otherwise the rubbing off of a layer of dirt or tarnish might be mistaken for a scratch. In the tables themselves, the hardness of the minerals is given in terms of the Scale of Hardness, see page 61. The possession of specimens of the minerals of this scale, so that the hardness of a mineral could be closely determined, would frequently be of great assistance in the use of the tables. Lastly, it is to be remembered that the physical condition of a mineral may apparently change its hardness. For instance, minerals that occur at times in pulverulent or fibrous forms will under these conditions appear to be much softer than when in their more usual form. Also the chemical alteration of a mineral will commonly change its hardness.

The minerals with nonmetallic luster are, in general, further subdivided according to whether they show a prominent cleavage or not. This will frequently be a difficult decision to make. It will require some practice and experience before one can always make the determination rapidly and accurately. Note that the minerals are divided according to whether they show a *prominent* cleavage or not. Minerals in which the cleavage is imperfect or ordinarily obscure are included with those that have no cleavage. It will always be best, if it is possible, to actually try to produce a cleavage upon the specimen rather than to judge from its appearance alone. If a mineral shows a cleavage, the num-

ber of the cleavage planes, their relations to each other and to any crystal forms present, etc., are to be noted. As far as possible, the minerals in which the cleavage may become obscure, because of certain conditions of structure, have been included in both divisions.

The minerals which fall in any one of the different divisions of the tables have been arranged according to various methods. In some cases, those that possess similar cleavages have been grouped together; frequently color determines their order, etc. The column farthest to the left will indicate the method of arrangement used in each section. Most of the different properties listed and the more general facts included under the headings, Crystallization and Structure and Remarks, need no especial explanation. A few words, however, may be said concerning the column headed Specific Gravity. For a discussion of specific gravity and the methods for its accurate determination, see page 62. If the specimen to be determined is of sufficient size and is pure, its approximate specific gravity can be determined by simply weighing it in the hand. In order to do this, however, will require some experience. Below is given a list of common minerals which show a wide range of specific gravity. By experimenting with specimens of these, one can become quite expert in the approximate determination of the specific gravity of any mineral.

Halite, 2.14	Limonite, 3.80	Cerussite, 6.51
Gypsum, 2.32	Corundum, 4.03	Cassiterite, 6.95
Orthoclase, 2.56	Chalcopyrite, 4.20	Galena, 7.50
Calcite, 2.72	Barite, 4.48	Cinnabar, 8.10
Fluorite, 3.18	Pyrite, 5.03	Copper, 8.84
Topaz, 3.53	Chalcocite, 5.75	Silver, 10.60

When the subdivisions of the tables are studied, the following interesting and important facts are to be noted. The majority of the minerals with metallic luster are sulphides. Most of them are softer than a knife. The only sulphides that are harder than a knife are Pyrite, Marcasite and Arsenopyrite. The greater part of minerals with metallic or submetallic luster that are

harder than a knife are oxygen compounds of iron. Among the minerals with nonmetallic luster, it is to be noted that those which are harder than a knife are, with very few exceptions, either silicates or oxides. Comparatively few silicates are to be found among the minerals of nonmetallic luster which are softer than a knife. It is to be further noted that the majority of such silicates contain water in some form. On the other hand, the greater part of the carbonates, sulphates, phosphates, etc., are to be found in these sections.

## GENERAL CLASSIFICATION OF THE TABLES.

### A. METALLIC OR SUBMETALLIC LUSTER.

- I. Very Soft. Will Readily Leave a Mark on Paper, p. 370.
- II. Can be Scratched by a Knife, but Will not Readily Leave a Mark on Paper, p. 372.
- III. Cannot be Scratched by a Knife, p. 382.

### B. NONMETALLIC LUSTER.

- I. Minerals which Give a Definitely Colored Streak, p. 386.
- II. Minerals which Give a Colorless Streak.
  - 1. Can be scratched by the finger nail, p. 392.
  - 2. Cannot be scratched by the finger nail, but can be scratched by a cent.
    - a. Show a prominent cleavage, p. 396.
    - b. Do not show a prominent cleavage.
      - 1. A small splinter is fusible in the candle flame.
        - a. Readily soluble in water; yield a taste, p. 398.
        - b. Insoluble in water, p. 400.
      - 2. Infusible in the candle flame, p. 400.
  - 3. Cannot be scratched by a cent, but can be scratched by a knife.
    - a. Show a prominent cleavage, p. 402.
    - b. Do not show a prominent cleavage, p. 410.
  - 4. Cannot be scratched by a knife, but can be scratched by quartz.
    - a. Show a prominent cleavage, p. 414.
    - b. Do not show a prominent cleavage, p. 420.
  - 5. Cannot be scratched by quartz.
    - a. Show a prominent cleavage, p. 426.
    - b. Do not show a prominent cleavage, p. 428.

## METALLIC OR

### I. Very soft. Will readily

Streak.	Color.	Hardness.	Cleavage and Fracture.	Spec. Grav.
Black.	Iron-black.	2-2 5. Marks paper easily.	F. Splintery.	4.7
	Steel-gray to iron-black	1-1 5. Marks paper easily.	One perfect C.	2.2
Gray-black.	Blue-black or lead-gray.	1-1 5. Marks paper easily.	One perfect C.	4.7
		2. Marks paper easily.	One perfect C.	4.5
		2 5. Marks paper with difficulty.	Perfect cubic C.	7.6
Bright red.	Red to vermilion.	Marks paper with difficulty.		8.1
Red-brown.	Red-brown.	Marks paper easily.		5.2
Yellow-brown	Yellow-brown.	Marks paper easily.		3.6-4.0

See also covellite, p. 377, and argentite, p. 373,

## SUBMETALLIC LUSTER.

leave a mark on paper.

Crystallization and Structure.	Remarks.	Name and Composition.
Usually radiating fibrous or splintery.	Distinguished from other minerals of this group by its structure.	<b>PYROLUSITE.</b> MnO <sub>2</sub> .
Rhombohedral. Micaceous.	May be in hexagonal-shaped leaves. Told from molybdenite by the brown tinge to its black color. Greasy feel.	<b>GRAPHITE.</b> C.
Hexagonal. Micaceous.	May be in hexagonal-shaped leaves. Told from graphite by the blue tinge to its black color and its higher specific gravity. Greasy feel.	Molybdenite. MoS <sub>2</sub> .
Orthorhombic. Bladed structure or in slender radiating crystals.	Characterized by its long and bright cleavage faces. Fuses in the candle flame.	<b>STIBNITE.</b> Sb <sub>2</sub> S <sub>3</sub> .
In cubic crystals or cleavage masses.	See p. 375.	<b>GALENA.</b> PbS.
Earthy.	The earthy form of cinnabar is not common.	<b>CINNABAR.</b> HgS.
Earthy.	The earthy form of hematite is often known as red ochre or paint ore.	<b>HEMATITE.</b> Fe <sub>2</sub> O <sub>3</sub> .
Earthy.	The earthy form of limonite is often known as yellow ochre.	<b>LIMONITE.</b> Fe <sub>2</sub> O <sub>3</sub> (OH) <sub>3</sub> .

which may leave a slight mark on paper.



METALLIC OR

II. Can be scratched by a knife,

Streak.	Color.	Hardness.	Cleavage and Fracture.	Spec. Grav.
Soft black.	Iron-black.	2-2.5. Very soft. Will mark paper.	F. Splintery.	4.7
Black, with sometimes a brown tinge.	Iron-black.	5-6. U. harder than knife.	F. Irregular.	4.3
Gray-black.	Steel-gray on fresh surface, tarnishing to dead black on exposure.	2.5-3.	F. Irregular.	5.7
Black, with sometimes a brown tinge	Steel-gray, sometimes tarnishes to dead black on exposure.	3-4.	F. Irregular.	4.7-5.0
Black.	Gray-black.	3.	C. Perfect prismatic. F. Uneven.	4.4
		2-2.5.	F. Uneven.	7.3
		2-2.5.	F. Uneven.	6.2
		2-3.	F. Uneven.	6-6.2
		2.5-3.	F. Uneven.	6.2-6.3
		2-3.	F. Fibrous	5.5-6

## SUBMETALLIC LUSTER.

but will not readily leave a mark on paper.

Crystallization and Structure.	Remarks.	Name and Composition.
Usually radiating fibrous or splintery.	Usually to be told by its structure and soft black streak.	<b>PYROLUSITE.</b> MnO <sub>2</sub> .
	See p. 385.	Psilomelane. MnO <sub>2</sub> with MnO, etc.
Orthorhombic. Compact massive.	Often associated with other copper ores, such as bornite, chalcopyrite, malachite, etc.	<b>CHALCOCITE</b> (Copper Glance). Cu <sub>2</sub> S.
Isometric, tetrahedral. Massive or in tetrahedral crystals.	Often associated with chalcopyrite, pyrite, silver ores, etc.	<b>TETRAHEDRITE</b> (Gray Copper). 4Cu <sub>2</sub> S.Sb <sub>2</sub> S <sub>3</sub> .
Orthorhombic. In bladed masses, showing long cleavage faces. More rarely in stout prismatic crystals.	A rare mineral, found usually with other copper minerals.	Enargite. 3Cu <sub>2</sub> S.AS <sub>2</sub> S <sub>3</sub> .
Isometric. Usually irregular massive or earthy. At times in small isometric crystals, commonly cubes.	Distinguished by being easily sectile, i.e., it can be cut with a knife, like lead. Bright steel-gray on fresh surface but tarnishing to a dull gray-black on exposure.	Argentite. Ag <sub>2</sub> S.
Orthorhombic. In small irregular masses, often earthy. At times in stout six-sided prismatic crystals.	A rare mineral. Bright steel-gray on a fresh surface but tarnishing to a dull gray-black on exposure.	Stephanite. 5Ag <sub>2</sub> S.Sb <sub>2</sub> S <sub>3</sub> .
Monoclinic. Often in thin six-sided crystal plates with triangular markings on top. Also massive and earthy.	A rare mineral.	Polybasite. 9(Ag, Cu) <sub>2</sub> S.Sb <sub>2</sub> S <sub>3</sub> .
Irregular massive.	A rare mineral. To be positively told only by chemical tests.	Stromeyerite. CuAgS.
In fibrous, feather-like masses.	Characterized usually by its fibrous structure.	Jamesonite (Feather ore). 2PbS.Sb <sub>2</sub> S <sub>3</sub> .

Fuse quietly and easily in the candle flame.

**METALLIC OR**

**II. Can be scratched by a knife, but will**

<b>Streak.</b>	<b>Color.</b>	<b>Hardness.</b>	<b>Cleavage and Fracture.</b>	<b>Spec. Grav.</b>
<b>Black.</b>	<b>Gray-black.</b>	2.5-3.	F. Uneven.	5.8
		4.	F. Uneven.	4.4
<b>Gray-black.</b>	<b>Blue-black or lead-gray.</b>			4.5
		Will leave a mark on paper.	One perfect cleavage.	6.4
		2.5. Marks paper with difficulty.	Perfect cubic cleavage.	7.6
	<b>Tin-white, tarnishing to dark gray.</b>	3.5.	One good cleavage but seldom seen.	5.7
	<b>Tin-white.</b>	3-3.5.	One good cleavage seen in the more coarsely crystallized type.	6.6
2-2.5.		Perfect prismatic cleavage in 3 directions.	6.1-6.3	

## SUBMETALLIC LUSTER.

not readily leave a mark on paper. (Continued.)

Crystallization and Structure.	Remarks.	Name and Composition.
Orthorhombic. In stout six-sided prismatic crystals. Often twinned with reentrant angles, giving a "cog-wheel" effect. Also massive granular.	Commonly called "cog-wheel ore" because of the characteristic grouping of its crystals. Easily fusible in the candle flame. Not to be positively identified when massive except by chemical tests.	Bournonite. $2PbS.Cu_2S.Sb_2S_3$ .
Tetragonal. Irregular massive.	Decrepitates violently in the candle flame. Sometimes shows a bluish tarnish.	Stannite (Tin Pyrites). $Cu_2S.FeS.SnS_2$ .
Orthorhombic. Bladed structure or in slender radiating crystals.	Characterized by its long bright cleavage faces. Fuses easily in the candle flame.	<b>STIBNITE.</b> $Sb_2S_3$ .
Orthorhombic. In long slender crystals, often radiating. Frequently bladed.	Fuses in candle flame. A rare mineral. To be positively told from stibnite only by a test for bismuth.	Bismuthinite. $Bi_2S_3$ .
Isometric. Crystallized or (cleavable) granular.	If a small fragment is held in a candle flame it does not fuse but is slowly reduced and small globules of metallic lead collect upon the surfaces.	<b>GALENA.</b> $PbS$ .
Rhombohedral. Usually fine granular, often with botryoidal structure.	Tarnishes more readily than the other similar minerals. Heated in the candle flame does not fuse but gives off a white smoke and yields a strong garlic odor. A rare mineral.	Arsenic. As.
Rhombohedral. Usually fine granular.	Usually bright in luster. Heated in candle flame does not fuse readily, gives off a white smoke but no odor. A rare mineral.	Antimony. Sb.
Rhombohedral. In cleavable masses.	Characterized by bright luster and prominent cleavage. Heated in candle flame fuses very easily. A rare mineral, often associated with the gold and silver tellurides. See under sylvanite, below.	Tellurium. Te.

METALLIC OR

II. Can be scratched by a knife, but will

Streak.	Color.	Hardness.	Cleavage and Fracture.	Spec. Grav.
Gray-black.	Tin-white.	1.5-2.	One perfect C.	8-8.7
		2.5.	F. Uneven.	9.3
Black.	Usually pale copper-red. See p. 382.	5-5.5.	F. Uneven.	7.5
	Brownish bronze but when exposed to the air rapidly takes on a purple tarnish.	3.	F. Uneven.	4.9-5.4
	Brownish bronze.	4.	F. Uneven.	4.6
		3.5-4.	C. Octahedral.	4.9
	Brass-yellow.	3.5.	F. Uneven.	4.2
	Brass-yellow, almost greenish when in very slender crystals.	3-3.5.	F. Uneven. C. Rhombohedral but seldom seen.	5.6
	Indigo-blue, may tarnish to blue-black.	1.5-2.	Perfect basal C.	4.6

See also wolframite, p. 379, which may give nearly a black streak.

## SUBMETALLIC LUSTER.

not readily leave a mark on paper. (Continued.)

Crystallization and Structure.	Remarks.	Name and Composition.
Monoclinic. In thin lath-shaped crystals. Often as thin coatings on surfaces of the rock arranged like ancient forms of writing.	Fuses very easily in candle flame. A rare mineral. Often to be positively told from tellurium and the other similar tellurides only by chemical tests (see p. 157).	Sylvanite. AuAgTe.
Monoclinic. In irregular small masses or in thin, deeply striated lath-shaped crystals.	Easily fusible in candle flame. Takes on at times a faint yellow color. A very rare mineral. Told from tellurium and sylvanite by its lack of cleavage, but for positive identification may need chemical tests.	Calaverite. AuTe <sub>2</sub> .
Hexagonal, hemimorphic. Massive.	See p. 363.	Nicolite. NiAs.
Isometric. Massive.	Recognized usually by its prominent purple tarnish. Associated with other copper ores, chiefly chalcocite and chalcopyrite.	<b>BORNITE.</b> Cu <sub>5</sub> FeS <sub>4</sub> .
Hexagonal. Massive.	Recognized usually by its characteristic color. Small fragments often magnetic. Often associated with chalcopyrite and pyrite. Frequently carries nickel.	<b>PYRRHOTITE.</b> Fe <sub>11</sub> S <sub>12</sub> .
Isometric. Granular.	A rare mineral resembling closely pyrrhotite, with which it is intimately associated. Distinguished from pyrrhotite by its cleavage.	Pentlandite. (Ni,Fe)S.
Tetragonal, sphenoidal. Usually massive. Sometimes in small tetrahedral-shaped crystals.	Usually recognized by its color and softness. Associated with pyrite, chalcocite, bornite, etc.	<b>CHALCOPYRITE</b> (Copper Pyrites). CuFeS <sub>2</sub> .
Rhombohedral. In radiating groups of hairlike crystals.	Commonly called capillary pyrites	Millerite. NiS.
Hexagonal. In platy masses or in thin six-sided platy crystals.	A rare mineral. Characterized chiefly by its color. Tarnishes to blue-black on exposure. Moistened with a drop of water turns purple.	Covellite. CuS.

**METALLIC OR**

**II. Can be scratched by a knife, but will**

<b>Streak.</b>	<b>Color.</b>	<b>Hardness.</b>	<b>Cleavage and Fracture.</b>	<b>Spec. Grav.</b>
Dark-brown to black.	Steel-gray to iron-black.	4.	One good C. F. Splintery.	4.3
	Iron-black to brownish black.	5.5. Scratched by knife with difficulty if at all.	F. Uneven.	4.3
			One good C. F. Uneven.	7.2-7.5
See also psilomelane and tetrahedrite, p. 373, which may give brown-black streaks.				
Light to dark brown.	Dark brown to coal-black.	3.5-4.	Perfect C. in six directions (dodecahedral).	4.1
Red-brown. Indian-red.	Dark brown to steel-gray to black.	5.5-6.5. Softer in some earthy varieties but usually harder than a knife.	F. Uneven or fibrous.	5.2
			F. Splintery.	4.1
	Deep red to black.	2.5.	C. Rhombohedral. F. Conchoidal.	5.8
	Red-brown to deep red. Ruby-red in transparent variety.	3.5-4.	F. Uneven.	6.0

## SUBMETALLIC LUSTER.

not readily leave a mark on paper. (Continued.)

Crystallization and Structure.	Remarks.	Name and Composition.
Orthorhombic. In radiating fibrous or crystalline masses. Sometimes in distinct prismatic crystals, often grouped in bundles.	Often closely resembles pyrolusite, with which it is frequently associated, but is to be distinguished from the latter by its greater hardness and dark-brown streak.	<b>MANGANITE.</b> $\text{MnO}(\text{OH}) = \text{Mn}_2\text{O}_3 \cdot \text{H}_2\text{O}.$
Usually in granular masses.	See p. 385.	<b>CHROMITE</b> (Chromic Iron). $\text{FeCr}_2\text{O}_4 = \text{FeO} \cdot \text{Cr}_2\text{O}_3.$
Monoclinic. In bladed masses. Granular to massive.	Characterized by bladed structure showing good cleavage parallel to length of crystal. As the amount of manganese contained in the mineral increases it becomes browner in color and streak and graduates toward hübnerite, $\text{MnWO}_4$ .	Wolframite. $(\text{Fe}, \text{Mn})\text{WO}_4.$
Isometric, tetrahedral. Usually cleavable granular.	Most sphalerite is nonmetallic and strongly resinous in its luster. With increase in the amount of iron present it becomes dark brown to black. The darker varieties can often be told by scratching a cleavage surface with a knife and noting the reddish mark left. The color of the streak is always much lighter than the color of the specimen.	<b>SPHALERITE</b> (Zinc Blende, Black Jack, etc.). $(\text{Zn}, \text{Fe})\text{S}.$
	See p. 385.	<b>HEMATITE.</b> $\text{Fe}_2\text{O}_3.$
	See p. 385.	<b>Turgite.</b> $\text{Fe}_3\text{O}_5(\text{OH})_2 = 2\text{Fe}_2\text{O}_3 \cdot \text{H}_2\text{O}.$
Rhombohedral. Irregular massive.	The dark Ruby Silver, showing dark ruby color in thin splinters. See p. 387.	<b>Pyrrargyrite.</b> $3\text{Ag}_2\text{S} \cdot \text{Sb}_2\text{S}_3.$
Isometric. Massive or rarely in isometric crystals, cubes or octahedrons. Sometimes in very slender crystals (chalcotrichite or plush copper).	Characterized by its submetallic luster and red streak. Associated with other copper minerals, especially malachite and native copper.	<b>CUPRITE.</b> $\text{Cu}_2\text{O}.$



## METALLIC OR

### II. Can be scratched by a knife, but will

Streak.	Color.	Hardness.	Cleavage and Fracture.	Spec. Grav.
Yellow-brown. Yellow ochre.	Dark brown to black.	5-5.5. Softer in some varieties but usually harder than a knife.	F. Splintery.	3.6-4.0
			One good C. F. Splintery.	4.3
Dark red.	Dark red to vermilion.	2-2.5. Some earthy varieties are soft enough to mark paper.	F. Uneven. Prismatic C., seldom seen.	8.1
Copper-red, shiny.	Copper-red, black tarnish.	2.5-3.	F. Hackly.	8.8
Silver-white, shiny.	Silver-white, gray to black tarnish.	2.5-3.	F. Hackly.	10.5
Gray, shiny.	Whitish, or steel-gray.	4-4.5.	F. Hackly.	14-19
Silver-white, shiny.	Silver-white with a reddish tone.	2-2.5.	Perfect basal and rhombohedral C.	9.8
Gold-yellow, shiny.	Gold-yellow.	2.5-3.	F. Hackly.	19
Olive-green.	Iron-black with a brown tarnish.	3.5-4.	C. Cubical.	3.9

## SUBMETALLIC LUSTER.

not readily leave a mark on paper. (Continued.)

Crystallization and Structure.	Remarks.	Name and Composition.
	See p. 387.	<b>LIMONITE</b> (Bog Iron Ore). $\text{Fe}_2\text{O}_3(\text{OH})_2 = 2\text{Fe}_2\text{O}_3 \cdot 3\text{H}_2\text{O}$ .
	See p. 387.	Goethite. $\text{FeO}(\text{OH}) = \text{Fe}_2\text{O}_3 \cdot \text{H}_2\text{O}$ .
Rhombohedral. Usually fine granular or earthy.	Usually impure and of a dark-red or brown color. When pure is translucent to transparent and of a bright red color. Very heavy.	<b>CINNABAR.</b> HgS.
Isometric. Usually in irregular grains. May be in branching crystal groups or in rude isometric crystals.	A metal. Malleable. Very heavy.	<b>COPPER.</b> Cu.
	A metal. Malleable. Very heavy.	<b>SILVER.</b> Ag.
Isometric. Irregular grains or nuggets.	A metal. Malleable. Very heavy. Unusually hard for a metal. Very rare.	Platinum. Pt.
Rhombohedral. In cleavable granular masses.	A metal. Sectile. When hammered out is at first malleable but soon breaks up into small pieces. Easily fusible in the candle flame. A rare mineral.	Bismuth. Bi.
Isometric. In irregular grains, nuggets, leaves, etc.	A metal. Malleable. Very heavy.	<b>GOLD.</b> Au.
Isometric, tetrahedral. In granular cleavable masses.	A rare mineral. Characterized by its brown tarnish, olive-green streak and cubical cleavage.	Alabandite. MnS.

·METALLIC OR  
III. Cannot be scratched

Streak.	Color.	Hardness.	Cleavage and Fracture.	Spec. Grav.
		5.5-6.	F. Uneven.	6-6.2
		5.5-6.	F. Uneven.	5.5-6
	Silver or tin white.	5.5.	F. Uneven.	5.5
		5.5.	F. Uneven.	4.9
lack.	Usually pale copper-red. Sometimes almost silver-white with pink tone.	5-5.5.	F. Uneven.	7.5
	Pale brass-yellow.	6-6.5	F. Uneven.	5.0.
	Pale yellow to almost white. Yellowish tarnish.	6-6.5	F. Uneven.	4.9
	Black.	6.	F. Uneven. At times shows octahedral parting.	5.18

## SUBMETALLIC LUSTER.

by a knife.

Crystallization and Structure.	Remarks.	Name and Composition.
Orthorhombic. Massive granular. Sometimes in crystals.	When crystallized is commonly found in diamond-shaped tabular crystals with striations running parallel to the shorter diagonal of the diamond. Sometimes in fan-shaped twins.	<b>ARSENOPYRITE</b> (Mispickel). FeAsS.
Isometric, pyritohedral. Massive.	Rare minerals found with other cobalt and nickel species.	Smaltite-Chloanthite. CoAs <sub>2</sub> -NiAs <sub>2</sub> .
Isometric, pyritohedral. Usually massive.	Rare minerals found with other cobalt and nickel species. Cobaltite shows a faint reddish tone to its silver color.	Cobaltite-Gersdorffite. CoAsS-NiAsS.
Isometric. In fine granular masses or in small octahedral crystals.	A rare mineral.	Linnæite. (Co,Ni) <sub>2</sub> S <sub>4</sub> .
Hexagonal, hemimorphic. Massive.	Recognized chiefly by its color and streak. A rare mineral found with other nickel and cobalt ores.	Nicolite. NiAs.
Isometric, pyritohedral. Massive granular. Often in striated cubes, octahedrons, pyritohedrons, etc.	Most common sulphide. Will strike fire with steel.	<b>PYRITE</b> (Iron Pyrites). FeS <sub>2</sub> .
Orthorhombic. Often in radiating fibrous masses. In crystal groups.	Found in nodules and stalactites. Not nearly so common as pyrite. Usually distinguished from pyrite by its lighter color and characteristic crystals, but it may require a chemical test to positively differentiate them (see p. 156).	<b>MARCASITE</b> (White Iron Pyrites). FeS <sub>2</sub> .
Isometric. Usually coarse to fine granular. At times in crystals, usually octahedrons.	Strongly magnetic. No other mineral exhibits this property as strongly.	<b>MAGNETITE.</b> Fe <sub>3</sub> O <sub>4</sub> .

**METALLIC OR**  
**III. Cannot be scratched**

<b>Streak.</b>	<b>Color.</b>	<b>Hardness.</b>	<b>Cleavage and Fracture.</b>	<b>Spec. Grav.</b>
Very dark brown to black.	Black.	5.5.	F. Uneven.	9-9.7
		5.5-6	F. Uneven.	4.3
	Black.	5-6.	F. Uneven.	4.3
		6.	F. Uneven.	5.3-7.0
Dark brown.	Iron-black to brownish black.	5.5-6.	One good C. F. Uneven.	7.2-7.5
			F. Uneven.	4.6
			F. Uneven.	5.1
Red-brown. Indian-red.	Dark brown to steel-gray to black.	5.5-6.5. Softer in some earthy varieties.	F. Uneven or fibrous.	5.2
			F. Splintery.	4.1

## SUBMETALLIC LUSTER.

by a knife. (Continued.)

Crystallization and Structure.	Remarks.	Name and Composition.
Isometric. Massive granular. Small botryoidal. Rarely in octahedral crystals.	Characterized by its black color and pitchy luster. Rare. The mineral in which the rare elements, helium and radium have been found.	Uraninite (Pitch Blende). Uncertain composition. Chiefly oxides of uranium.
Rhombohedral. In grains as sand; massive granular; platy crystals.	Sometimes slightly magnetic. Often associated with magnetite.	ILMENITE (Titanic Iron). $\text{FeTiO}_3$ with $\text{Fe}_2\text{O}_3$ . Sometimes much Mg.
Compact massive, sometimes stalactitic or botryoidal.	Dull-black luster. Often associated with other manganese ores from which it is told by its greater hardness.	Psilomelane. Uncertain composition. $\text{MnO}_2$ with $\text{MnO}$ , $\text{H}_2\text{O}$ , $\text{BaO}$ , $\text{K}_2\text{O}$ , etc.
Orthorhombic. Granular or in stout prismatic crystals.	Black shiny luster on fresh surface. Sometimes takes on a slight bluish tarnish.	Columbite-Tantalite. (Fe,Mn) $\text{Nb}_2\text{O}_6$ with (Fe,Mn) $\text{Ta}_2\text{O}_6$ .
In bladed masses.	See p. 379.	Wolframite. (Fe,Mn) $\text{WO}_4$ .
Isometric. Usually in granular masses. Rarely in small octahedral crystals.	Characterized often by a pitchy luster and accompanied frequently by traces of a yellow oxidation product.	CHROMITE. (Chromic Iron). $\text{FeCr}_2\text{O}_4$ .
Isometric. Granular or in octahedral crystals.	Occurs at Franklin Furnace, N. J., usually in intimate association with sincite (red) and willemite (green).	FRANKLINITE. (Fe,Zn,Mn) $\text{O}$ (Fe,Mn) $_2\text{O}_3$ .
Rhombohedral. Radiating, reniform, crystallized, micaceous.	Recognized usually by its red-brown streak. When in fibrous mammillary forms cannot be positively told from the rare mineral turgite except by proving the absence of water in its composition by heating in a closed tube.	HEMATITE. $\text{Fe}_2\text{O}_3$ .
Radiating reniform and stalactitic.	A rare mineral usually associated with limonite. For positive identification see above.	Turgite (Hydro-hematite). $\text{Fe}_2\text{O}_3(\text{OH})_2 = 2\text{Fe}_2\text{O}_3 \cdot \text{H}_2\text{O}$ .

**METALLIC OR**  
**III. Cannot be scratched**

Streak.	Color.	Hardness.	Cleavage and Fracture.	Spec. Grav.
Yellow-brown.	Dark brown to black.	5-5.5. Softer in some earthy varieties.	F. Splintery.	3.6-4.0
			One good C. F. Splintery.	4.3

**NONMETALLIC**  
**I. Give a definitely**

Streak.	Color.	Hardness.	Cleavage and Fracture.	Spec. Grav.
Dark red.	Dark red to vermillion.	2-2.5.	F. Uneven.	8.1
	Red-brown. Ruby-red when transparent.	3.5-4.	F. Uneven.	6.0
Red-brown. Indian-red.	Dark brown to steel-gray, to black.	5.5-6.5.	F. Splintery.	5.2
				4.1
	Deep red to black.	2.5.	F. Conchoidal.	5.8
Bright red.	Ruby-red.	2-2.5.	F. Conchoidal.	5.5

## SUBMETALLIC LUSTER.

by a knife. (Continued.)

Crystallization and Structure.	Remarks.	Name and Composition.
Radiating fibrous in mammillary or stalactitic forms.	Characterized by its streak and structure. Not always to be positively told from the rarer mineral goethite, except by an estimation of the water present. Limonite contains 15% goethite 10% of water.	<b>LIMONITE</b> (Bog Iron Ore). $\text{Fe}_2\text{O}_3(\text{OH})_2 = 2\text{Fe}_2\text{O}_3 \cdot 3\text{H}_2\text{O}$ .
Orthorhombic. Radiating fibrous in mammillary or stalactitic forms. Sometimes in groups of slender radiating crystals. More rarely in distinct prismatic crystals.	Told definitely from limonite if it shows cleavage or any crystal structure. Otherwise to be distinguished only as described above.	Goethite. $\text{FeO}(\text{OH}) = \text{Fe}_2\text{O}_3 \cdot \text{H}_2\text{O}$ .

## LUSTER.

colored streak.

Crystallization and Structure.	Remarks.	Name and Composition.
Rhombohedral. Usually fine granular or earthy.	See p. 381.	<b>CINNABAR.</b> $\text{HgS}$ .
Usually massive.	See p. 379.	<b>CUPRITE</b> (Ruby Copper). $\text{Cu}_2\text{O}$ .
Reniform, crystalline, micaceous, earthy.	See p. 385.	<b>HEMATITE.</b> $\text{Fe}_2\text{O}_3$ .
Reniform and stalactitic.	See p. 385.	Turgite. $\text{Fe}_3\text{O}_5(\text{OH})_2 = 2\text{Fe}_2\text{O}_3 \cdot \text{H}_2\text{O}$ .
Rhombohedral. Irregular massive. Rarely in crystals.	The dark "ruby silver" showing dark ruby-red color in thin splinters. A rare mineral associated with proustite, stephanite, polybasite, argentite, etc. Easily fusible in the candle flame.	<b>Pyrrargyrite.</b> $3\text{Ag}_2\text{S} \cdot \text{Sb}_2\text{S}_3$ .
Rhombohedral. Irregular massive. Rarely in crystals.	The light "ruby silver." Characterized by its color and adamantine luster. Rare, with associations like those of pyrrargyrite. Easily fusible in the candle flame.	<b>Proustite.</b> $3\text{Ag}_2\text{S} \cdot \text{As}_2\text{S}_3$ .



## NONMETALLIC

### I. Give a definitely

Streak.	Color.	Hardness.	Cleavage and Fracture.	Spec. Grav.
Yellow-brown.	Dark brown to black.	5-5.5. Softer in some varieties but usually harder than a knife.	F. Splintery.	3.6-4.0
			One good C. F. Splintery.	4.3
Brown.	Dark brown.	5.5.	One good C. F. Uneven.	7.2-7.5
Light brown.	Light to dark brown.	3.5	Perfect C. In 6 directions (dodecahedral).	4.0
Light orange to dark brown.	Orange-yellow, brown, black.	4.5-5.	Prismatic C.	4.8-5.2
Light brown.	Brown to black.	6-7.	F. Uneven.	6.8-7.1
Light brown.	Reddish brown to black.	6-6.5.	F. Uneven. C. Not prominent.	4.2
Orange-yellow.	Deep red to orange-yellow.	4-4.5.	C. Basal.	5.5
	Bright red.	2.5-3.	F. Uneven.	5.9-6.1
	Deep red.	1.5-2. Can be scratched by finger nail.	F. Conchoidal. One C., not prominent.	3.5

# LUSTER.

colored streak. (Continued.)

Crystallization and Structure.	Remarks.	Name and Composition.
Mammillary or stalactitic.	See p. 387.	<b>LIMONITE</b> (Bog Iron Ore). $\text{Fe}_2\text{O}_3(\text{OH})_x = 2\text{Fe}_2\text{O}_3 \cdot 3\text{H}_2\text{O}$ .
Mammillary or stalactitic. Radiating groups of slender crystals.	See p. 387.	Goethite. $\text{FeO}(\text{OH}) = \text{Fe}_2\text{O}_3 \cdot \text{H}_2\text{O}$ .
Monoclinic. In bladed masses.	See p. 379.	Wolframite. $(\text{Fe}, \text{Mn})\text{WO}_4$ .
Isometric; tetrahedral. In granular cleavable masses or in rounded crystals.	Characterized by its resinous luster and perfect cleavage. See p. 379.	<b>SPHALERITE.</b> $\text{ZnS}$ .
Tetragonal. In prismatic crystals; also massive, compact.	A rare mineral.	Thorite. $\text{ThSiO}_4$ .
Tetragonal. In irregular masses; in compact fibrous reniform structure; in rolled grains. Rarely in prismatic crystals. Commonly twinned.	Very heavy. Usually opaque to translucent. Occurs as rolled grains in sand; in pegmatite veins and in granite rocks.	<b>CASSITERITE</b> (Tin Stone). $\text{SnO}_2$ .
Tetragonal. In prismatic crystals vertically striated; often slender acicular. Frequently twinned.		<b>RUTILE.</b> $\text{TiO}_2$ .
Hexagonal; hemimorphic. Granular cleavable.	Characterized by its color, streak and cleavage. Found at Franklin Furnace, N. J., often intimately associated with franklinite (black) and willemite (green).	<b>ZINCITE.</b> $(\text{Zn}, \text{Mn})\text{O}$ .
Monoclinic. In long slender crystals, often in interlacing groups.	Characterized by its color and high luster. Decrepitates in the candle flame.	Crocoite. $\text{PbCrO}_4$ .
Monoclinic. Crystallised or earthy.	Easily fusible in the candle flame. Characterized by its color and when in crystals by its resinous luster.	Realgar. $\text{AsS}$ .

## NONMETALLIC

### I. Give a definitely

Streak.	Color.	Hardness.	Cleavage and Fracture.	Spec. Grav.
Pale yellow.	Lemon-yellow.	1.5-2. Can be scratched by finger nail.	One prominent C.	3.5
	Pale yellow.	1.5-2.5.	F. Conchoidal or uneven.	2.0
Light yellow-green.	Blackish, olive-green, brown.	3.	F. Uneven.	4.4
Light green.		3-3.5.	One good C.	3.7
		3.5-4.	One good C., not commonly seen.	3.9
	Bright green.	3.5-4	One good C., rarely seen.	3.9-4.0
Light blue.	Intense azure-blue.	3.5-4.	F. Conchoidal or uneven.	3.7
		2.5.	F. Conchoidal.	2.2
Very light blue.	Light green to turquoise blue.	2-4.	F. Uneven.	2.0-2.4
Grayish blue.	Very dark blue. Bluish green.	1.5-2.	One good C.	2.6-2.7

See also lazurite, p. 415, which may give a very light blue streak.

# LUSTER.

colored streak. (Continued.)

Crystallization and Structure.	Remarks.	Name and Composition.
Monoclinic. In cleavable masses.	Easily fusible in the candle flame. Characterized by its cleavage, color and resinous luster.	Orpiment. $As_2S_3$ .
Orthorhombic. In crystals. Granular crystalline. Earthy.	Burns with a blue flame giving a strong odor of sulphur dioxide. A poor conductor of heat. A mass held in the hand close to the ear will be heard to crackle on account of the irregular expansion due to the heat of the hand. Often earthy and impure.	<b>SULPHUR.</b> S.
Orthorhombic. In aggregates of small crystals.	Characterized by its color and small prismatic crystals.	Olivenite. $Cu(Cu.OH)AsO_4$ .
Orthorhombic. In granular cleavable masses or in small prismatic crystals.	Characterized by its dark green color and good cleavage.	Acatamite. $Cu_2Cl(OH)_2 =$ $CuCl_2.3Cu(OH)_2$ .
Orthorhombic. In small prismatic crystals or in granular masses.	Characterized by its green color and slender prismatic crystals.	Brochantite. $CuSO_4.3Cu(OH)_2$ .
Monoclinic. Radiating fibrous, mammillary.	Characterized by its bright green color and radiating fibrous structure. Effervesces when a drop of cold acid is placed on the specimen.	<b>MALACHITE.</b> $CuCO_3.Cu(OH)_2$ .
Monoclinic. In small crystals, often in groups. Radiating fibrous, mammillary.	Characterized by its intense blue color. Effervesces when a drop of cold acid is placed on the specimen.	<b>AZURITE.</b> $2CuCO_3.Cu(OH)_2$ .
Triclinic. In crystals. Massive, stalactitic. Sometimes with fibrous appearance.	Soluble in water. Metallic taste. Characterized by color. Product of oxidation of copper sulphides.	Chalcanthite. (Blue Vitriol). $CuSO_4.5H_2O$ .
Massive and amorphous.	Characterized by its structure and color. Associated with other copper minerals.	<b>CHRYSOCOLLA.</b> $CuSiO_3.2H_2O$ .
Monoclinic. Usually in prismatic crystals.	Characterized by its color and streak.	Vivianite. $Fe_3(PO_4)_2.8H_2O$ .

and lepidomelane, p. 393, which may give a light green streak.

# NONMETALLIC

## II. Give a

### 1. Can be scratched

Cleavage and Fracture.	Color.	Luster.	Hardness.	Spec. Grav.
<p><b>Perfect cleavage in one plane.</b> The Micas or related micaceous minerals, which possess such a perfect cleavage that they can be split into exceedingly thin sheets. Sometimes they occur as aggregates of minute scales when the micaceous structure may not be readily apparent.</p>	Pale brown, green, yellow, white.	Vitreous, pearly.	2-2.5.	2.8
	Usually dark brown, green to black. May be yellow.	Vitreous.	2.5-3.	3.0
	Yellowish brown, green, white.	Vitreous, pearly.	2.5-3.	2.8
	Black, greenish black.	Adamantine to pearly.	3.	3-3.2
	Green of various shades.	Vitreous, pearly.	2-2.5.	2.7
	White apple-green, gray. When impure as in soapstone, dark gray, dark green to almost black.	Pearly, greasy.	Very soft. Will leave a mark on cloth.	2.8
	White, gray green.	Pearly, vitreous.	2.5.	2.4

## LUSTER.

colorless streak.

by the finger nail.

Crystallization and Structure.	Remarks.	Name and Composition.
Monoclinic. In foliated masses; in tabular crystals with hexagonal or diamond-shaped outlines: in scales.	The common mica or ising-glass. Characterized by its micaceous structure, its perfect cleavage, the elasticity of its leaves and its light color. While in the mass it may be brown or green, the thin sheets are colorless.	<b>MUSCOVITE</b> (Potash Mica). $H_2KAl_3(SiO_4)_3$ .
Monoclinic. In irregular foliated masses. Six-sided tabular crystals rare.	The common dark green or black mica. Even in thin sheets it shows a smoky color. Sheets are flexible and elastic.	<b>BIOTITE.</b> $(H, K)_2(Mg, Fe)_3$ $(Al, Fe)(SiO_4)_3$ .
Monoclinic. In irregular foliated masses. Often in six-sided tabular crystals, frequently large.	Usually a light- though sometimes a dark-colored mica. Often shows a coppery-like reflection from the cleavage surface. Occurs in crystalline limestone.	<b>PHLOGOPITE.</b> $(H, K)_2(Mg, Fe)_3$ $(Al, Fe)(SiO_4)_3$ .
Monoclinic. Usually in masses of small irregular scales.	Characterized by its micaceous structure and its shining black color.	Lepidomelane. $(H, K)_2Fe_2(Fe, Al)_3$ $(SiO_4)_3?$ .
Monoclinic. Usually in irregular foliated masses, at times in compact masses of minute scales.	Characterized by its green color and by the fact that thin sheets are flexible but not elastic.	<b>CLINOCHLORE,</b> Penninite (Ripidolite, Chlorite). $H_3Mg_5Al_2Si_2O_{11}$ .
Monoclinic. Foliated or compact.	Characterized by their greasy feel, softness, frequently distinctly foliated or micaceous structure. Cannot be positively told apart by physical tests. See p. 280.	<b>TALC</b> (Steatite, Soapstone). $H_2Mg_3(SiO_4)_4$ .
		<b>PYROPHYLLITE</b> $H_2Al_3(SiO_4)_4$ .
Rhombohedral. Commonly foliated massive. At times in broad tabular crystals.	Luster on cleavage surface pearly, elsewhere vitreous. Sectile. Transparent to translucent. Can be split with some difficulty into thin sheets which are somewhat flexible but not elastic.	<b>Brucite.</b> $Mg(OH)_2$ .

## NONMETALLIC

### II. Give a

#### 1. Can be scratched

Cleavage and Fracture.	Color.	Luster.	Hardness.	Spec. Grav.
Perfect pinacoidal C. Two other cleavages not so prominent.	Colorless, white, gray. Sometimes colored by impurities.	Vitreous.	2.	2 3
One perfect C.	Blue, bluish green to colorless.	Pearly to vitreous.	2-3.	2.6-2 7
Cubical C.	Colorless or white.	Vitreous.	2-2.5.	2.0
F. Uneven.	Pearl-gray or colorless. Turns to pale brown on exposure to light.	Adamantine.	2-3. Highly sectile.	5.8-6.0
F. Uneven.	Green or yellow.	Adamantine.	2-3. Highly sectile.	5.8
F. Uneven.	Pale yellow.	Resinous.	1.5-2.5.	2.0
F. Uneven. Rhombohedral C. Seldom seen.	Colorless or white.	Vitreous.	1.5-2.	2.3
F. Conchoidal. C. Prismatic, seldom seen.				2.1

See also kaolinite, bauxite, and greenockite p 401, which on account

## LUSTER.

colorless streak.

by the finger nail. (Continued.)

Crystallization and Structure.	Remarks.	Name and Composition.
Monoclinic. In granular masses or cleavable crystalline.	Characterized by its one perfect cleavage, and two others, one giving a conchoidal surface and the other a silky surface, and by its softness.	<b>GYPSUM</b> (Alabaster). $\text{CaSO}_4 \cdot 2\text{H}_2\text{O}$ .
Monoclinic.	See p. 391.	Vivianite. $\text{Fe}_3(\text{PO}_4)_2 \cdot 8\text{H}_2\text{O}$ .
Isometric.	See p. 397.	Sylvite KCl.
Isometric. In irregular masses. Rarely in rude crystals.	Commonly known as horn-silver, because it can be cut with a knife like horn and because in thin plates it is translucent. More common than the other halogen salts of silver but to be distinguished from them only by chemical tests.	<b>CERARGYRITE</b> (Horn Silver). AgCl.
Isometric. In irregular masses. Rarely in rude crystals.	Like cerargyrite. To be distinguished from it only by chemical tests.	Embolite. $\text{Ag}(\text{Cl}, \text{Br})$ .
Orthorhombic. Crystallized. Granular. Earthy.	Burns with a blue flame giving a strong odor of sulphur dioxide. Often earthy and impure. See also p. 391.	<b>SULPHUR.</b> S.
Saline crusts.		<b>SODA NITER.</b> $\text{NaNO}_3$ .
	Rare minerals. Readily soluble in water; cooling and salty tastes. Readily fusible in the candle flame.	
Usually in thin crusts, silky tufts and delicate acicular crystals.		Niter. $\text{KNO}_3$ .

of their earthy structure may appear to be softer than the finger nail.



# NONMETALLIC

## II. Give a

### 2. Cannot be scratched by the finger nail,

*a. Show a*

Cleavage.	Color.	Luster.	Hardness.	Spec. Grav.
<p>Cleavage in one plane. See also the minerals of the mica group, p. 393, which may at times be harder than the finger nail.</p>	Lilac, grayish, white.	Pearly.	2.5-4	2.8-2.9
	Pink, gray, white.	Pearly.	3.5-4.5	3.0
	Blue, bluish green to colorless.	Pearly to vitreous.	3	2.6-2.7
	Colorless or white.	Vitreous to resinous.	3.5	4.3
<p>Cubic.</p>	Colorless, white, red, blue.	Vitreous.	2.5	2.1
	Colorless or white.	Vitreous.	2-2.5	2.0
<p>In 3 directions at right angles to each other but with varying degrees of ease.</p>	Colorless, white, blue, gray, red.	Vitreous, pearly.	3-3.5	2.9
<p>Cleavage in more than one plane. In 3 directions not at right angles to each other, giving rhombohedrons.</p>	Colorless, white and variously tinted.	Vitreous.	3	2.7
	Colorless, white, pink, etc.	Vitreous, pearly.	3.5-4	2.8

# LUSTER.

colorless streak.

but can be scratched by a cent.

*prominent cleavage.*

Crystallization and Structure.	Remarks.	Name and Composition.
Monoclinic. In masses of small irregular scales. Rarely in six-sided prismatic crystals.	Characterized by its lilac color. Always in very small sheets or scales. A rare mineral often associated with colored tourmalines.	Lepidolite (Lithia Mica). $\text{LiK}(\text{Al}(\text{OH},\text{F})_2)\text{Al}(\text{SiO}_3)_2$ .
Monoclinic. Usually in irregular foliated masses.	Folia somewhat brittle. Characterized by its color. A rare mineral.	Margarite. $\text{H}_2\text{CaAl}_2\text{Si}_2\text{O}_{12}$ .
Monoclinic. Prismatic crystals, often in stellate groups. At times divergent, fibrous or earthy.	A rare mineral.	Vivianite. $\text{Fe}_3(\text{PO}_4)_2 \cdot 8\text{H}_2\text{O}$ .
Usually massive with radiating structure.	Cleavage rarely prominent. See p. 411.	WITHERITE. $\text{BaCO}_3$ .
Isometric. In granular cleavable masses or in cubic crystals.	Common salt. Characterized by its salty taste. Fusible in the candle flame. Highly diathermous. Compare sylvite, below.	HALITE (Common Salt). $\text{NaCl}$ .
Isometric. Same as for halite. Crystals frequently show octahedral truncations.	A rare mineral closely resembling halite. To be distinguished from it by its more bitter taste and its greater softness (can usually be scratched by the finger nail).	Sylvite. $\text{KCl}$ .
Orthorhombic. In granular cleavable masses.	Characterized chiefly by its cleavage. If in a form where this does not show it will require chemical tests to determine it.	ANHYDRITE. $\text{CaSO}_4$ .
Rhombohedral. In fine- to coarse-grained cleavable masses. When crystallized shows prismatic, rhombohedral and scalenohedral forms.	Effervesces readily when a drop of cold acid is placed upon it. Characterized by its perfect rhombohedral cleavage and crystal forms. Clear varieties show strong double refraction. Occurs in large masses as limestone and marble. Crystal faces may be harder than a cent.	CALCITE. $\text{CaCO}_3$ .
Rhombohedral	See p. 407.	DOLOMITE. $\text{CaMg}(\text{CO}_3)_2$ .

## NONMETALLIC

### II. Give a

#### 2. Cannot be scratched by the finger nail,

*a. Show a*

Cleavage and Fracture.	Color.	Luster.	Hardness.	Spec. Grav.
In 3 directions giving tabular diamond-shaped cleavage blocks.	Colorless, white, blue, yellow, red.	Vitreous, pearly.	3-3.5	4.5
	Colorless, white, blue, red.	Vitreous, pearly.	3-3.5	3.9
	Colorless or white. Gray and brown when impure.	Adamantine.	3	6.3

*b. Do not show a*

#### 1. A small splinter is

*a. Readily soluble in water;*

F. Conchoidal.	Colorless, white, red.	Vitreous, greasy.	2.5	1.6
F. Conchoidal. One good C. seldom seen.	Colorless or white.	Vitreous.	2-2.5	1.7
F. Conchoidal.	Colorless or white.	Vitreous.	2-2.5	1.7

See also halite, p. 397, which may exist in forms in which its cleavage is

## LUSTER.

colorless streak.

but can be scratched by a cent.

*prominent cleavage. (Continued.)*

Crystallization and Structure.	Remarks.	Name and Composition.
Orthorhombic. In aggregates of platy crystals or in tabular orthorhombic crystals with rectangular or diamond-shaped outlines. Crystal edges frequently beveled by other faces. At times granular.	Characterized by its unusual weight for a nonmetallic mineral, its platy structure, cleavage and pearly luster on basal cleavage. At times to be told from celestite and anglesite only getting a green flame (test for barium).	<b>BARITE,</b> Barytes. (Heavy Spar). $BaSO_4$ .
Orthorhombic. In granular platy masses or in tabular crystals like those of barite. At times in long prismatic-like crystals with blunt terminations.	Very similar in appearance to barite. Frequently can only be told from barite and anglesite by getting a crimson flame color (test for strontium).	<b>CELESTITE.</b> $SrSO_4$ .
Orthorhombic. Usually earthy and impure. At times in small crystals resembling those of barite and celestite.	Characterized by its weight. Usually associated with galena as an alteration product in concentric layers around an unaltered core of galena. Will often need a test for lead for its positive identification.	<b>ANGLESITE.</b> $PbSO_4$ .

*prominent cleavage.*

fusible in the candle flame.

yield a taste.

Orthorhombic. Commonly massive, granular.	A rare mineral. In the candle flame swells, then fuses. Bitter salty taste.	Carnallite. $MgCl_2 \cdot KCl \cdot 6H_2O$ .
Monoclinic. In crusts, often impure. Rarely in prismatic crystals.	A comparatively rare mineral. Found only in dry countries. In candle flame swells and then fuses. Sweetish-alkaline taste.	<b>BORAX.</b> $Na_2B_4O_7 \cdot 10H_2O$ .
Usually fibrous or massive or in mealy or solid crusts.	Easily fusible with frothing in candle flame. A rare mineral. Astringent taste.	Kalinite (Potash Alum). $KAl(SO_4)_2 \cdot 12H_2O$ .

obscure, and chalcantite, p. 390, which may give a nearly colorless streak.

## NONMETALLIC

### II. Give a

**2. Cannot be scratched by finger nail,**

*b. Do not show a*

1. A small splinter is fusible

*b. Insoluble in*

Color.	Luster.	Cleavage and Fracture.	Hardness.	Spec. Grav.
Colorless or white.	Vitreous to greasy.	F. Uneven. C. In one direction, seldom seen.	3-3.5	2.9
	Adamantine.	F. Conchoidal.	3-3.5	6.5
Colorless, yellow, orange, brown.	Resinous.	F. Uneven.	3-3.5	7.0-7.2

See also vanadinite below.

### 2. Infusible

Colorless or white. See also bauxite, wavellite and serpentine below, which may be nearly white.	Vitreous to resinous.	F. Uneven.	3-3.5	4.3
	Pearly, dull.	F. Earthy.	2-2.5	2.6
Honey-, citron- or orange-yellow.	Adamantine, resinous, earthy.	F. Uneven.	3-3.5	4.9-5.2
Yellow, brown, gray, white.	Dull, earthy.	F. Uneven.	3	2.5
Ruby-red, brown, yellow.	Resinous.	F. Uneven.	3	6.9-7.1

## LUSTER.

colorless streak.

but can be scratched by a cent.

*prominent cleavage.*

in the candle flame.

water.

Crystallization and Structure.	Remarks.	Name and Composition.
Monoclinic. Massive.	Characterized by its peculiar translucent appearance, like that of paraffine. Its fine powder practically disappears when placed in water but is insoluble.	CRYOLITE. $\text{Na}_3\text{AlF}_6$ .
Orthorhombic. In granular masses; platy crystals often crossing each other to form a lattice-like effect.	When fused in the candle flame is slowly reduced showing globules of lead on surface of fragment. Heavy. Effervesces when a drop of cold acid is placed upon it. Associated usually with galena.	CERUSSITE. $\text{PbCO}_3$ .
	See p. 413.	Mimetite. $\text{Pb}_4(\text{PbCl})(\text{AsO}_4)_3$ .

which may fuse slightly.

in the candle flame.

Often massive with radiating structure.	See p. 411.	WITHERITE. $\text{BaCO}_3$ .
Generally clay-like, compact or mealy.	Often impure. When breathed upon gives an argillaceous odor. Will adhere to a dry tongue. The basis of most clays.	KAOLINITE. $\text{H}_4\text{Al}_2\text{Si}_2\text{O}_9$ .
Hexagonal, hemimorphic. Usually in form of powder. Rarely in crystals.	A rare mineral. Characterized by its color and pulverulent form. Often as a coating on sphalerite.	Greenockite. $\text{CdS}$ .
In rounded grains. Also earthy, clay-like.	A rare mineral. Often impure.	Bauxite. $\text{Al}_2\text{O}(\text{OH})_3$ .
Hexagonal, pyramidal. In slender prisms. Sometimes in cavernous crystals and also in rounded barrel-shaped forms.	Characterized by its color and crystals. Compare mimetite, above and pyromorphite, p. 413.	Vanadinite. $\text{Pb}_4(\text{PbCl})(\text{VO}_4)_3$ .

## NONMETALLIC

### II. Give a

#### 2. Cannot be scratched by the finger nail,

*b. Do not show a*

#### 2. Infusible

Color.	Luster.	Cleavage and Fracture.	Hardness.	Spec. Grav.
Yellow, green, white, brown.	Vitreous, pearly.	F. Uneven. One C., not prominent.	3-4	2.3
Olive to blackish-green, yellow-green, white.	Greasy-, wax-like.	F. Uneven.	3.5-5	2.6
Pale to deep green.	Dull to resinous.	F. Uneven.	3-4	2.2-2.8

Some varieties of anglesite, p. 399, anhydrite, p. 397, and vivianite, p. 397, do not show

#### 3. Cannot be scratched by a cent

*a. Show a*

	Cleavage.	Color.	Luster.	Hardness.	Spec. Grav.
Prominent Cleavage in One Plane Only	C. Pinacoidal.	Blue, usually darker at center of crystal. At times white, gray or green.	Vitreous, pearly.	5-7	3.6
	C. Basal.	Light blue, green, gray, salmon to clove-brown.	Resinous.	4.5-5	3.5
	C. Pinacoidal.	White, yellow, brown, red.	Pearly, vitreous.	3.5-4	2.1-2.2

## LUSTER.

colorless streak.

but can be scratched by a cent.

*prominent cleavage.*

in the candle flame. (Continued.)

Crystallization and Structure.	Remarks.	Name and Composition.
Usually in radiating hemispherical, globular forms.	Characterized by its structure.	Wavellite. $(\text{Al}(\text{OH})_3(\text{PO}_4)_2 \cdot 5\text{H}_2\text{O}$ .
Massive. Fibrous.	See p. 415.	<b>SERPENTINE.</b> $\text{H}_4\text{Mg}_3\text{Si}_2\text{O}_{10}$ .
Massive and amorphous, at times as an incrustation with botryoidal or stalactitic surface; earthy.	A rare mineral. Characterized chiefly by its color.	Genthite (Garnierite). Nickel, magnesium silicate.

a distinct cleavage and might be expected to be included in the above group.

but can be scratched by a knife.

*prominent cleavage.*

Crystallization and Structure.	Remarks.	Name and Composition.
Triclinic. In bladed structure with prominent cleavage plane.	Characterized by its color and the fact that it can be scratched by a knife in a direction parallel to length of crystal but not in a direction at right angles to this.	<b>CYANITE.</b> $\text{Al}_2\text{SiO}_5$ .
Commonly massive cleavable.	Rare species. Triphylite is essentially $\text{LiFePO}_4$ and lithiophyllite $\text{LiMnPO}_4$ .	Triphylite. Lithiophyllite. $\text{Li}(\text{Fe}, \text{Mn})\text{PO}_4$ .
Monoclinic. Commonly in sheaf-like aggregates of crystals or in flat tabular crystals.	Characterized by the grouping of its crystals into a radiating sheaf-like aggregate and by the pearly luster of the cleavage face.	<b>STILBITE.</b> $\text{H}_2(\text{Ca}, \text{Na})_2\text{Al}_2(\text{SiO}_3)_6 \cdot 4\text{H}_2\text{O}$ .



# NONMETALLIC

## II. Give a

### 3. Cannot be scratched by a cent,

*a. Show a*

Cleavage.	Color.	Luster.	Hardness.	Spec. Grav.
C. Basal.	Colorless, white, pale green, yellow, rose.	Pearly, vitreous.	4.5-5	2.3-2.4
C. Pinacoidal.	White, yellow, red.	Pearly, vitreous.	3.5-4	2.2
C. Pinacoidal, often not prominent.	White, colorless.	Vitreous.	4.5	2.4-2.5
C. Pinacoidal.	Colorless, white.	Vitreous.	4-4.5	2.4
C. Pinacoidal, seldom seen.	Colorless, white.	Vitreous to resinous.	3.5	4.3
C. Pinacoidal.	Colorless, white, gray.	Vitreous, pearly.	5-5.5	2.8-2.9
C. Pinacoidal, also basal but seldom seen.	Colorless, white, gray.	Vitreous, pearly.	4.5-5	2.7-2.8
C. In two directions. C. Prismatic.	Colorless, white.	Vitreous.	5-5.5	2.2

Prominent Cleavage in One Plane Only.  
 See also willemite, p. 415.

Usually colorless or White.

## LUSTER.

colorless streak.

but can be scratched by a knife.

*prominent cleavage. (Continued.)*

Crystallization and Structure.	Remarks.	Name and Composition.
Tetragonal. In prismatic crystals with square cross-section. Often resemble a combination of cube and octahedron.	Pearly luster on basal plane (cleavage face), vitreous luster on other faces. Prism faces usually vertically striated. A zeolite found lining cavities in igneous rocks.	APOPHYLLITE. $H_7KCa_4(SiO_3)_3$ $4\frac{1}{2}H_2O$ .
Monoclinic. Crystals often tabular parallel to cleavage plane (surface of pearly luster).	Pearly luster on cleavage face, elsewhere vitreous. A rare zeolite found lining cavities in igneous rocks.	Heulandite. $H_4(Ca, Na_2)Al_2$ $(SiO_7)_6 \cdot 3H_2O$ .
Monoclinic. Crystals usually like square prisms terminated by 4 pyramid faces, the latter faces striated. At times in cruciform penetration twins.	Characterized by its crystals, see p. 267. A rare zeolite found lining cavities in igneous rocks.	Harmotome. $(Ba, K_2)Al_2Si_6O_{14}$ $5H_2O$ .
Monoclinic. In crystalline or granular crystalline masses.	Decrepitates violently in the candle flame. A rare mineral.	Colemanite. $Ca_2B_6O_{11} \cdot 5H_2O$ .
Usually massive with radiating structure.	See p. 411.	WITHERITE. $BaCO_3$ .
Monoclinic. Usually cleavable massive to fibrous. Also compact. Rarely in tabular crystals.	Associated with crystalline limestone.	WOLLASTONITE. $CaSiO_3$ .
Monoclinic. Commonly in close radiating aggregates of acicular crystals. Fibrous massive.	Characterized by its radiating structure. A rare mineral.	Pectolite. $HN_2Ca_2(SiO_3)_2$ .
Orthorhombic. In slender to acicular prismatic crystals terminated by 4 low pyramid faces. Prism faces vertically striated. Often in radiating groups.	Characterized chiefly by its structure. A zeolite found lining cavities in igneous rocks.	NATROLITE. $N_2Al(AIO)$ $(SiO_3)_3 \cdot 2H_2O$ .

# NONMETALLIC

## II. Give a

### 3. Cannot be scratched by a cent,

*a. Show a*

	Cleavage.	Color.	Luster.	Hardness.	Spec. Grav.
Cleavage in Two Directions. See also Calamine and Scapolite, p. 411.	C. Prismatic making angles of 55° and 125°.	White, green, black.	Vitreous, pearly.	5-6	3.0-3.3
	C. Prismatic making angles of 54° and 126°.	Gray, clove-brown, green.	Vitreous, pearly.	5-6	3.1
	C. Prismatic, rather poor at 90° angles.	White, green, black.	Vitreous.	5-6	3.1-3.5
Cleavage in Three Directions.	C. Prismatic with nearly 90° angles.	Rose-red, pink, brown.	Vitreous.	5-6	3.6
		Colorless, white and variously tinted.	Vitreous.	3	2.7
	In 3 directions not at right angles to each other, giving rhombohedrons.	Colorless, white, pink, etc.	Vitreous, pearly.	3.5-4	2.8

## LUSTER.

colorless streak.

but can be scratched by a knife.

*prominent cleavage. (Continued.)*

Crystallization and Structure.	Remarks.	Name and Composition.
Monoclinic. In slender prismatic crystals, showing prominent cleavage, giving frequently a bladed appearance. When terminated the crystals usually show 2 low dome faces. Sometimes fibrous, asbestiform.	Tremolite, $\text{CaMg}_3\text{Si}_4\text{O}_{12}$ , is white, gray, violet; Actinolite, $\text{Ca}(\text{Mg},\text{Fe})_4\text{Si}_4\text{O}_{12}$ , green of various shades; Amphibole or Hornblende, $\text{CaMg}_2\text{Si}_4\text{O}_{12}$ with $\text{Na}_2\text{Al}_2\text{Si}_4\text{O}_{12}$ and $\text{Mg}_2\text{Al}_2\text{Si}_4\text{O}_{12}$ , is green to black. The group is characterized chiefly by its broad angle cleavage. Found in metamorphic rocks.	<b>AMPHIBOLE GROUP.</b> Essentially calcium, magnesium metasilicates.
Orthorhombic. Lamellar or fibrous.	See p. 419.	Anthophyllite. $(\text{Mg},\text{Fe})\text{SiO}_3$ .
Monoclinic. In stout prismatic crystals with rectangular cross-section. When terminated they usually show more than 2 faces at ends. Often in granular crystalline masses.	Diopside, $\text{CaMgSi}_2\text{O}_6$ , is colorless, white, pale green; Pyroxene, $\text{Ca}(\text{Mg},\text{Fe})\text{Si}_2\text{O}_6$ , light to dark green; Augite, $\text{CaMgSi}_2\text{O}_6$ with $\text{MgAl}_2\text{Si}_2\text{O}_6$ and $\text{NaAlSi}_3\text{O}_8$ , is greenish black to black. Characterized by the rectangular cross-section of its crystals and the rather poor prismatic cleavage at right angles. Shows at times a basal parting. Found in igneous rocks.	<b>PYROXENE GROUP.</b> Essentially calcium, magnesium metasilicates.
Triclinic. Usually massive, cleavable to compact, in embedded grains; in large rough crystals with rounded edges.	Characterized by its color.	Rhodonite. $\text{MnSiO}_3$ .
Rhombohedral. In granular cleavage masses or crystallized.	See p. 397.	<b>CALCITE.</b> $\text{CaCO}_3$ .
Rhombohedral. In fine to coarse-grained cleavable masses. Often in strongly curved rhombohedral crystals.	Will not effervesce when a drop of cold hydrochloric acid is placed upon it. Characterized by its rhombohedral cleavage, by its rounded rhombohedral crystals and its frequently pink or flesh color. Pearly luster on curved crystal faces. Occurs in large masses as dolomite limestone and marble. Frequently associated with lead and zinc minerals.	<b>DOLOMITE.</b> $\text{CaMg}(\text{CO}_3)_2$ .

# NONMETALLIC

## II. Give a

### 3. Cannot be scratched by a cent,

*a. Show a*

Cleavage.	Color.	Luster.	Hardness.	Spec. Grav.
In 3 directions not at right angles to each other, giving rhombohedrons.	White, yellow, gray, brown.	Vitreous.	3.5-4	3.0-3.1
	Light to dark brown.	Vitreous, pearly.	3.5-4	3.8
	Pink, rose-red, dark red, brown.	Vitreous, pearly.	3.5-4.5	3.5-3.6
	Brown, green, blue, pink, white.	Vitreous.	5	4.3
	White, yellow, flesh-red.	Vitreous.	4-5	2.1
In 3 directions at right angles to each other but with varying degrees of ease.	Colorless, white, blue, gray, red.	Vitreous, pearly.	3-3.5	2.9
In 3 directions giving tabular diamond-shaped cleavage blocks.	Colorless, white, blue, yellow, red.	Vitreous, pearly.	3-3.5	4.5
C. Octahedral.	Colorless, violet, green, yellow, pink. Usually has a fine color.	Vitreous.	4	3.1
C. Perfect in 6 directions, dodecahedral.	Yellow, brown, white.	Strongly resinous.	3.5-4	4.0
Dodecahedral C., more or less distinct.	White, gray, blue, green.	Greasy, vitreous.	5.5-6	2.1-2.3

*Note.* — Apatite, p. 413, may show somewhat imperfect cleavage.

## LUSTER.

colorless streak.

but can be scratched by a knife.

*prominent cleavage. (Continued.)*

Crystallization and Structure.	Remarks.	Name and Composition.
Rhombohedral. In granular cleavable masses.	A rare mineral.	Magnesite. $MgCO_3$ .
Rhombohedral. In cleavable masses or in small rhombohedral crystals.	After being heated in the candle flame a fragment is attracted by a magnet.	SIDERITE. $FeCO_3$ .
Rhombohedral. In cleavable masses or in small rounded rhombohedral crystals.	Characterized by its color, cleavage and softness.	RHODOCHRO-SITE. $MnCO_3$ .
Rhombohedral. Usually in botryoidal or honey-combed masses.	See p. 411.	SMITHSONITE. $ZnCO_3$ .
Rhombohedral. In small rhombohedral crystals with nearly cubic angles.	A zeolite found lining cavities in igneous rocks.	CHABAZITE. $(Ca, Na_2)Al_2(SiO_3)_4 \cdot 6H_2O$ .
Orthorhombic. In granular cleavable masses.	See p. 397.	Anhydrite. $CaSO_4$ .
Orthorhombic. In tabular crystals and lamellar masses.	See p. 399.	BARITE, Barytes (Heavy Spar). $BaSO_4$ .
Isometric. In cubic crystals, often in interpenetration twins.	Characterized by its crystals, color and cleavage. The bluish green variety shows fluorescence, i.e. appears green by transmitted and blue by reflected light.	FLUORITE. $CaF_2$ .
Isometric, tetrahedral. In cleavable masses or small rounded crystals.	Characterized by its color, luster and cleavage.	SPHALERITE. $ZnS$ .
Isometric. Massive or in embedded grains.	Frequently blue in color. A rock-making mineral, never associated with quartz. Usually opaque to translucent.	Sodalite. $Na_4(AlCl)Al_3(SiO_4)_3$ .

# NONMETALLIC

## II. Give a

### 3. Cannot be scratched by a cent,

*b. Do not show a*

	Color.	Luster.	Cleavage and Fracture.	Hardness.	Spec. Grav.
Usually Colorless or White. See also below, pyroxene, apatite, scheelite, which may occur in colorless or white varieties.	Colorless, pale green, yellow.	Vitreous.	F. Uneven.	5-5.5	2.9-3.0
	White, pale green, blue.	Vitreous.	F. Uneven. C. prismatic, seldom seen.	4.5-5	3.4
	White, gray, light green, darker green or brown.	Vitreous to dull.	F. Uneven. C. prismatic, seldom seen.	5-6	2.7
	Colorless or white.	Vitreous.	F. Uneven.	3.5-4	2.9
	Colorless or white.	Vitreous.	F. Uneven.	5-5.5	2.3
	Colorless or white.	Vitreous to resinous.	F. Uneven.	3.5	4.3
	Colorless or white.	Vitreous, pearly.	Pinacoidal C., may be obscure.	4.5-5	2.7-2.8
	Colorless or white.	Vitreous.	Prismatic C., may be obscure.	5-5.5	2.2
Usually Brown.	Brown, green, blue, pink, white.	Vitreous.	F. Uneven. Rarely shows rhombohedral C.	5	4.3
	Gray, brown green, yellow.	Resinous, adamantine.	F. Uneven. Prismatic C., seldom prominent.	5-5.5	3.4-3.5

# LUSTER.

colorless streak.

but can be scratched by a knife.

*prominent cleavage.*

Crystallization and Structure.	Remarks.	Name and Composition.
Monoclinic. Usually in crystals developed with nearly equal dimensions in all directions and many faces.	Characterized by its luster and crystals. Usually transparent. Occurs with the zeolites, lining cavities in igneous rocks.	DATOLITE. $\text{Ca}(\text{B.OH})\text{SiO}_4$ .
Orthorhombic. Often in radiating crystal groups. Also stalactitic, mammillary.	Characterized by its structure. Pyroelectric.	CALAMINE. $(\text{Zn.OH})_2\text{SiO}_3$ .
Tetragonal. In prismatic crystals, granular or massive.	Often altered.	SCAPOLITE. $\text{Ca}_4\text{Al}_6\text{Si}_6\text{O}_{18}$ with $\text{Na}_4\text{Al}_3\text{Si}_3\text{O}_{24}\text{Cl}$ .
Orthorhombic. Frequently in radiating groups of acicular crystals.	Effervesces in cold acids. Falls to powder in candle flame.	ARAGONITE. $\text{CaCO}_3$ .
Isometric. In crystals, usually trapezohedrons.	Characterized by its crystals and its glassy luster. A zeolite found lining cavities in igneous rocks.	ANALCITE. $\text{NaAl}(\text{SiO}_3)_2\text{H}_2\text{O}$ .
Orthorhombic. Often in masses with radiating structure; granular; rarely in hexagonal pyramidal crystals.	Heavy. When a fragment is placed in cold hydrochloric acid there is a brisk effervescence for a moment and then the action ceases.	WITHERITE. $\text{BaCO}_3$ .
In radiating acicular crystals.	See p. 405.	Pectolite. $\text{HNaCa}_2(\text{SiO}_3)_3$ .
Radiating prismatic.	See p. 405.	Natrolite. $\text{Na}_2\text{Al}(\text{AlO})(\text{SiO}_3)_3 \cdot 2\text{H}_2\text{O}$ .
Rhombohedral. In rounded botryoidal forms. Often in honey-combed masses.	Harder than most carbonates. A fragment effervesces when placed in cold hydrochloric acid.	SMITHSONITE. $\text{ZnCO}_3$ .
Monoclinic. In thin crystals with sharp edges, wedge-shaped.	Characterized by its crystals.	TITANITE (Sphene). $\text{CaTiSiO}_5$ .



# NONMETALLIC

## II. Give a

### 3. Cannot be scratched by a cent,

*b. Do not show a*

	Color.	Luster.	Cleavage and Fracture.	Hardness.	Spec. Grav.
Usually Yellow, Reddish Yellow or Brown. See also scapolite above and apatite and pyromorphite below.	Yellowish to reddish brown.	Resinous, vitreous.	F. Uneven. Prismatic C., seldom prominent.	4-5	5.0
	Yellowish to reddish brown.	Resinous.	F. Uneven.	5-5.5	5.2-5.3
	White, yellow, green, brown.	Vitreous, adamantine.	F. Uneven.	4 5-5	6.0
	Usually a brilliant shade of yellow or orange. Also red, gray, green.	Vitreous to adamantine.	F. Uneven.	4.5-5	6.0
	Colorless, yellow, orange, brown.	Resinous.	F. Uneven.	3.5	7.0-7.2
Usually green.	Yellow, brown, gray, white.	Dull, earthy.	F. Uneven.	3	2.5
	White, green, black.	Vitreous.	F. Uneven. Rather poor prismatic C., at 90° angles.	5-6	3.1-3.5
	Green, blue, violet, brown, colorless.	Vitreous, greasy.	F. Uneven.	5	3.1
	Green, brown, yellow, gray.	Resinous.	F. Uneven.	3.5-4	6.5-7.1

## LUSTER.

colorless streak.

but can be scratched by a knife.

*prominent cleavage. (Continued.)*

Crystallization and Structure.	Remarks.	Name and Composition.
Tetragonal. In prismatic or pyramidal crystals. In rolled grains.	A rare mineral. Heavy.	Xenotime. YPO <sub>4</sub> .
Monoclinic. In small crystals or as rolled grains.	A rare mineral. Heavy.	MONAZITE. (Ce,La,Di)PO <sub>4</sub> often with ThSiO <sub>4</sub> .
Tetragonal. In octahedral-like crystals. Massive, granular.	A rare mineral. Heavy.	Scheelite. CaWO <sub>4</sub> .
Tetragonal. Usually in very thin square tabular crystals. Less frequently octahedral in habit. Also granular massive.	Characterized by its crystals and color. Heavy.	Wulfenite. PbMoO <sub>4</sub> .
Hexagonal. In small prismatic crystals. Prism faces often curved, giving barrel shapes. In granular masses.	A rare mineral. Heavy. Fuses slowly in candle flame.	Mimetite. Pb <sub>4</sub> (PbCl)(AsO <sub>4</sub> ) <sub>4</sub> .
	See p. 401.	Bauxite. Al <sub>2</sub> O(OH) <sub>3</sub> .
Monoclinic. In stout rectangular crystals with rectangular cross-section.	See p. 407.	<b>PYROXENE GROUP.</b> Essentially calcium and magnesium silicates.
Hexagonal. In prismatic crystals, often large, usually with prominent pyramid planes. Also massive.	Characterized by its crystals.	<b>APATITE.</b> Ca <sub>4</sub> (CaF)(PO <sub>4</sub> ) <sub>3</sub> .
Hexagonal. In small crystals. Often in rounded barrel-shaped forms. Crystals at times cavernous. Often globular and botryoidal.	Characterized chiefly by its structure and color. Heavy.	<b>PYROMORPHITE.</b> Pb <sub>4</sub> (PbCl)(PO <sub>4</sub> ) <sub>3</sub> .

## NONMETALLIC

### II. Give a

Cannot be scratched by a cent,

*b. Do not show a*

	Color.	Luster.	Cleavage and Fracture.	Hardness.	Spec. Grav.
Usually Green. See also smithsonite, scapolite and calamine above.	Yellow, green, white, brown.	Vitreous, pearly.	F. Uneven. One C., not prominent.	3-4	2.3
	Olive to blackish green, yellow-green, white.	Greasy, waxlike.	F. Uneven.	3.5-5	2.6
	Yellow-green, white, colorless, blue, gray, brown.	Vitreous.	F. Uneven. May show fairly good C.	5.5	4.0-4.1
	White, gray, blue, green.	Greasy, vitreous.	F. Conchoidal. Dodecahedral C., seldom seen.	5.5-6	2.1-2.3
	Deep azure-blue, greenish blue.	Vitreous.	F. Uneven.	5-5.5	2.4

## NONMETALLIC

### II. Give a

4. Cannot be scratched by a knife,

*a. Show a*

	Cleavage.	Color.	Luster.	Hardness.	Spec. Grav.
One cleavage.	C. Basal.	White to pale green or blue.	Vitreous to greasy.	6	3.0
	C. Pinacoidal.	Colorless, white, gray.	Vitreous, pearly.	5-5.5	2.8-2.9

**LUSTER.**

colorless streak.

but can be scratched by a knife.

*prominent cleavage.* (Continued.)

<b>Crystallization and Structure.</b>	<b>Remarks.</b>	<b>Name and Composition.</b>
Usually in radiating hemispherical, globular forms.	Characterized by its structure.	Wavellite. $(\text{Al.OH})_2(\text{PO}_4)_2$ $5\text{H}_2\text{O}$ .
Massive. Fibrous in the asbestos variety.	Characterized by its massive structure, mottled green color and frequently by the presence of veins of finely fibrous material, known as chrysotile or asbestos.	<b>SERPENTINE.</b> $\text{H}_4\text{Mg}_3\text{Si}_2\text{O}_{10}$ .
Massive and in disseminated grains.	See p. 423.	<b>WILLEMITE.</b> $\text{Zn}_2\text{SiO}_4$ . Troostite. $(\text{Zn}, \text{Mn})_2\text{SiO}_4$ .
Massive or in embedded grains.	See p. 409.	Sodalite. $\text{Na}_4(\text{AlCl})\text{Al}_2$ $(\text{SiO}_4)_3$ .
Usually massive.	Characterized by its color.	Lazurite (Lapis-Lazuli). $(\text{Na}_2, \text{Ca})_2(\text{Al.NaS}_7)$ $\text{Al}_2(\text{SiO}_4)_3$ .

**LUSTER.**

colorless streak.

but can be scratched by quartz.

*prominent cleavage.*

<b>Crystallization and Structure.</b>	<b>Remarks.</b>	<b>Name and Composition.</b>
Usually cleavable to compact massive.	A rare mineral. Usually found with lepidolite, tourmaline, etc.	Amblygonite. $\text{Li}(\text{AlF})\text{PO}_4$ .
Usually cleavable massive to fibrous.	See p. 405.	<b>WOLLASTONITE.</b> $\text{CaSiO}_3$ .

## NONMETALLIC

### II. Give a

#### 4. Cannot be scratched by a knife,

##### a. Show a prominent

	Cleavage.	Color.	Luster.	Hardness.	Spec. Grav.
Cleavage in one plane only. See also hypersthene and willemite below.	C. Pinacoidal.	White, gray, pale lavender, yellowish, greenish.	Pearly, vitreous.	6.5-7	3.4
	C. Pinacoidal.	Grayish white, green, pink.	Vitreous, pearly.	6-6.5	3.3
	C. Pinacoidal.	Hair-brown, gray, grayish green.	Vitreous.	6-7	3.2
	C. Basal.	Yellowish to blackish green to gray.	Vitreous.	6-7	3.4
	C. Pinacoidal.	Blue, usually darker at center of crystal. At times gray or green.	Vitreous, pearly.	5-7	3.6
	Cleavage in two directions. C. Prismatic.	Colorless, white.	Vitreous.	5-5.5	2.2
Cleavage in two planes.	C. Basal and pinacoidal making a 90° angle.	Colorless, white, gray, cream, red, green.	Vitreous, pearly.	6	2.6

## LUSTER.

colorless streak.

but can be scratched by quartz.

cleavage. (Continued.)

Crystallization and Structure.	Remarks.	Name and Composition.
Orthorhombic. In thin tabular crystals or scales. Bladed or foliated structure.	Pearly luster on cleavage face, elsewhere vitreous. Often associated with corundum, chlorite, margarite, etc.	Diaspore. $\text{AlO}(\text{OH})$ .
Orthorhombic. In prismatic crystals, deeply striated vertically and seldom distinctly terminated. Also massive, columnar to compact.	Pearly luster on cleavage face, elsewhere vitreous.	Zoisite. $\text{Ca}_2(\text{Al.OH})\text{Al}_2(\text{SiO}_4)_3$ .
Orthorhombic. Commonly in long slender unterminated crystals. Often in close parallel groups. Fibrous, columnar.	In schistose rocks.	Sillimanite (Fibrolite). $\text{Al}_2\text{SiO}_5$ .
Monoclinic. In slender prismatic crystals, striated parallel to length of crystal. Also fibrous, granular.	Characterized by its olive-green color. When transparent shows dichroism; i.e., in transmitted light appears green in one position and brown in another. In metamorphic rocks; often in crystalline limestones.	<b>EPIDOTE.</b> $\text{Ca}_2(\text{Al.OH})(\text{Al,Fe})_2(\text{SiO}_4)_3$ .
Bladed.	See p. 403.	<b>CYANITE.</b> $\text{Al}_2\text{SiO}_5$ .
Radiating prismatic.	See p. 405.	<b>NATROLITE.</b> $\text{Na}_2\text{Al}(\text{AlO})(\text{SiO}_3)_3 \cdot 2\text{H}_2\text{O}$ .
Monoclinic. In cleavable masses or in irregular grains as a rock constituent. May be in crystals, see Figs. 269-271, p. 221.	Orthoclase is monoclinic while microcline is triclinic. Ordinarily they can only be told apart by a microscopic examination. The green amazon stone is usually microcline. Characterized by its 2 cleavage planes at right angles; the basal cleavage is the better. Found as a prominent constituent of granite rocks and pegmatite veins, associated with quartz and mica.	<b>ORTHOCLASE,</b> Microcline (Potash Feldspar). <b>KAISi<sub>3</sub>O<sub>8</sub>.</b>

# NONMETALLIC

## II. Give a

### 4. Cannot be scratched by a knife,

*a. Show a prominent*

	Cleavage.	Color.	Luster.	Hardness.	Spec. Grav.
Cleavage in two planes.	C. Basal perfect. C. Pinacoidal not so distinct. The two make angles with each other varying from 85° 50' to 86° 24'.	Colorless, white, gray, greenish, bluish, reddish. Often exhibit a beautiful play of color on the cleavage surfaces.	Vitreous, pearly.	6	2.6-2.7
	C. Prismatic.	White, gray, pink, emerald-green	Vitreous.	6.5	3.2
	C. Prismatic making angles of 55° and 125°.	White to green to black.	Vitreous, pearly.	5-6	3.0-3.3
	C. Prismatic. Perfect at angles of 54° and 126°.	Gray, clove-brown, green.	Vitreous, pearly.	5.5-6	3.1
	C. Prismatic. Not very perfect at angles nearly 90°.	Greenish to brownish black.	Vitreous.	6-6.5	3.5
	C. Prismatic. Rather poor at 90° angles.	White to green to black.	Vitreous.	5-6	3.1-3.5

**LUSTER.**

colorless streak.

but can be scratched by quartz.

*cleavage.* (Continued.)

<b>Crystallization and Structure.</b>	<b>Remarks.</b>	<b>Name and Composition.</b>
Triclinic. In cleavable masses or in irregular grains as a rock constituent. Albite may be in thin tabular crystals or with a curved lamellar structure.	Albite = $\text{NaAlSi}_3\text{O}_8$ ; Oligoclase = $3\text{NaAlSi}_3\text{O}_8$ , $1\text{CaAl}_2\text{Si}_2\text{O}_8$ ; Andesine = $1\text{NaAlSi}_3\text{O}_8$ , $1\text{CaAl}_2\text{Si}_2\text{O}_8$ ; Labradorite = $1\text{NaAlSi}_3\text{O}_8$ , $3\text{CaAl}_2\text{Si}_2\text{O}_8$ ; Anorthite = $\text{CaAl}_2\text{Si}_2\text{O}_8$ . Characterized by a perfect basal cleavage and a pinacoidal cleavage not so distinct; the two making an angle with each other of nearly $90^\circ$ . Often on the best cleavage surface will be seen a series of fine parallel striation lines due to intimate twinning. Often they show a fine play of colors on cleavage surfaces, pale blue in albite and oligoclase; bright blue, green, gold, etc., in andesine and labradorite. Rock constituents; albite and oligoclase in the light colored granitic rocks; the others in the darker colored, more basic igneous rocks.	<b>THE PLAGIOCLASE FELDSPARS.</b> Combinations in varying amounts of $\text{NaAlSi}_3\text{O}_8$ , the Albite molecule, and of $\text{CaAl}_2\text{Si}_2\text{O}_8$ , the Anorthite molecule.
Monoclinic. In flattened prismatic crystals, vertically striated; sometimes very large. Also massive, cleavable.	Lilac to pink called kunzite. Green is called hiddenite. Often alters to other minerals with a dull gray color. Not common.	<b>SPODUMENE.</b> (Li,Na)Al(SiO <sub>3</sub> ) <sub>2</sub> .
Monoclinic. In slender prismatic crystals, showing prominent cleavage.	See p. 407.	<b>AMPHIBOLE GROUP.</b>
Orthorhombic. Commonly lamellar or fibrous massive; fibers often very slender. Also in aggregates of prisms. Distinct crystals rare.	Characterized by its cleavage angle. Sometimes fibrous (asbestiform). Not common. An orthorhombic amphibole.	<b>Anthophyllite.</b> (Mg,Fe)SiO <sub>3</sub> .
Monoclinic. Long prismatic crystals, vertically striated. Acute terminations characteristic. Also in groups of acicular crystals. Fibrous.	A rare mineral.	<b>Acmite</b> (Egirite). $\text{NaFe}(\text{SiO}_3)_2$ .
Monoclinic. In stout prismatic crystals with rectangular cross-section.	See p. 407.	<b>PYROXENE GROUP.</b>



## NONMETALLIC

### II. Give a

#### 4. Cannot be scratched by a knife,

*a. Show a prominent*

Cleavage.	Color.	Luster.	Hardness.	Spec. Grav.
Cleavage in two planes. Enstatite has fair prismatic C., at 90°. Hypersthene has perfect pinacoidal C.	Gray-brown, green, bronze-brown, black.	Pearly, bronze-like.	5.5-6.5	3.2-3.3
C. Prismatic at nearly 90°.	Rose-red, pink, brown.	Vitreous.	5-6	3.6
C. Basal and pyramidal.	Yellow, brown, blue, black.	Adamantine.	5.5-6	3.8-3.9
Dodecahedral C., seldom seen.	White, gray, blue, green.	Greasy, vitreous.	5.5-6	2.1-2.3

*b. Do not show a*

Color.	Luster.	Cleavage and Fracture.	Hardness.	Spec. Grav.
Colorless or white.	Vitreous.	F. Uneven.	5-5.5	2.3
Gray, white, colorless.	Vitreous to dull.	F. Uneven.	5.5-6	2.5
Colorless, pale green, yellow.	Vitreous.	F. Uneven.	5-5.5	2.9-3.0
Colorless, white, to pale yellow.	Vitreous.	F. Uneven.	7	3.0
White, gray, light to dark green, brown.	Vitreous to dull.	F. Uneven. Prismatic C., seldom seen.	5-6	2.7

Chiefly colorless, white or gray. See also Pyroxene and Sodalite below.

## LUSTER.

colorless streak.

but can be scratched by quartz.

*cleavage.* (Continued.)

Crystallization and Structure.	Remarks.	Name and Composition.
Orthorhombic. Crystals usually prismatic but rare. Commonly massive, fibrous or lamellar.	Enstatite is light colored; with increase of iron, bronzius, is olive-green to brown, often with bronze-like reflections; hypersthene, rich in iron, is dark green to almost black. An orthorhombic pyroxene.	ENSTATITE (Bronzite). $MgSiO_3$ . Hypersthene. $(Fe,Mg)SiO_3$ .
Triclinic. Usually massive, cleavable to compact.	See p. 407.	RHODONITE. $MnSiO_3$ .
Tetragonal. In pyramidal crystals. At times tabular with prominent basal plane.	A rare mineral.	Octahedrite (Anatase). $TiO_2$ .
Isometric. Massive or in embedded grains. Rarely in dodecahedral crystals.	Frequently blue. A rock-making mineral, never associated with quartz. Opaque to translucent.	Sodalite. $Na_4(AlCl)Al_2(SiO_4)_3$ .

*prominent cleavage.*

Crystallization and Structure.	Remarks.	Name and Composition.
In trapezohedrons.	See p. 411.	ANALCITE. $NaAl(SiO_3)_2 \cdot H_2O$ .
Isometric. In trapezohedrons.	Characterized by its crystals. Usually gray in color and with a dull luster. Translucent to opaque. Found as phenocrysts in basic igneous rocks, never with quartz.	LEUCITE. $KAl(SiO_3)_2$ .
Monoclinic. Usually crystallized.	See p. 411.	DATOLITE. $Ca(BOH)SiO_4$ .
Orthorhombic. In prismatic crystals.	See p. 429.	Danburite. $CaB_2(SiO_4)_2$ .
Tetragonal. Prismatic crystals, granular or massive.	Often altered. Opaque to translucent.	SCAPOLITE. $Ca_4Al_2Si_6O_{28}$ with $Na_4Al_2Si_4O_{24}Cl$ .

# NONMETALLIC

## II. Give a

### 4. Cannot be scratched by a knife,

*b. Do not show a*

Color.	Luster.	Cleavage and Fracture.	Hardness.	Spec. Grav.
Colorless, gray, greenish, reddish.	Greasy, vitreous.	F. Uneven. Prismatic C., seldom seen.	5.5-6	2.6
Apple-green, gray, white.	Vitreous.	F. Uneven.	6-6.5	2.9
Yellow-green, white, colorless, blue, gray, brown.	Vitreous.	F. Uneven. May show fairly good C.	5.5	4-4.1
Olive to grayish-green, brown.	Vitreous.	F. Uneven. C., rarely seen.	6.5-7	3.3
Green, brown, blue, red, pink, white, black.	Vitreous.	F. Uneven.	7-7.5	3-3.1
Green, brown, yellow, blue, red.	Vitreous, resinous.	F. Uneven.	6.5	3.4
White to green to black.	Vitreous.	F. Uneven. Rather poor prismatic C., at 90° angles.	5-6	3.1-3.4
Clove-brown, gray, green, yellow.	Vitreous.	F. Conchoidal. Pinacoidal C., not prominent.	6.5-7	3.3

Chiefly light to dark green.  
 See also scapolite, p. 421, and andalusite and titanite, p. 425.

## LUSTER.

colorless streak.

but can be scratched by quartz.

*prominent cleavage.* (Continued.)

Crystallization and Structure.	Remarks.	Name and Composition.
Hexagonal. Usually massive. Rarely in small prisms.	A rock-making mineral. Commonly found in igneous rocks which do not contain quartz. Usually opaque to translucent with a greasy luster.	NEPHELITE. $\text{NaAlSiO}_4$ .
Orthorhombic. Reniform, globular and stalactitic with crystalline surface. In groups of tabular crystals, often barrel-shaped. Distinct crystals rare.	Characterized by its structure and pale green color. Translucent.	PREHNITE. $\text{H}_2\text{Ca}_2\text{Al}_2(\text{SiO}_4)_2$ .
Massive and in disseminated grains. Rarely in hexagonal prismatic crystals.	Characterized by its color and granular structure. Associated at Franklin with red zincite and black franklinite. Troostite is brown or gray in color.	WILLEMITE. $\text{Zn}_2\text{SiO}_4$ Troostite. $(\text{Zn},\text{Mn})_2\text{SiO}_4$ .
Orthorhombic. Usually granular either in masses or disseminated.	Characterized usually by its green color, glassy luster and granular structure. Occurs in basic igneous rocks.	CHRYSOLITE (Olivine, Peridot). $(\text{Mg},\text{Fe})_2\text{SiO}_4$ .
Hexagonal, rhombohedral. Usually in slender prismatic crystals.	See p. 431.	TOURMALINE. A complex boron silicate containing chiefly Al, Fe, Mg, Mn, alkalis, F and OH.
Tetragonal. In square prismatic crystals terminated usually by base and pyramid. Often columnar. Granular massive.	Usually green or brown in color. Transparent to translucent. Often occurs in crystalline limestones.	VESUVIANITE (Idocrase) $\text{Ca}_3(\text{Al}(\text{OH},\text{F}))$ $(\text{Al},\text{Fe})_2(\text{SiO}_4)_2$ .
Monoclinic. In stout prismatic crystals with rectangular cross-section.	See p 407.	PYROXENE GROUP.
Triclinic. Crystals with acute edges, wedge-shaped. Also lamellar, lamellae often curved.	Characterized by its crystal habit. Transparent to translucent. Not common.	Axinite. $\text{Ca}_3\text{Al}_4\text{B}_3(\text{SiO}_4)_3$ .

# NONMETALLIC

## II. Give a

### 4. Cannot be scratched by a knife,

*b. Do not show a*

Color.	Luster.	Cleavage and Fracture.	Hardness.	Spec. Grav.
Red-brown to brownish black.	Resinous, vitreous, dull when altered.	F. Uneven.	7-7.5	3.8
Reddish brown, flesh-red, olive-green.	Vitreous, dull when altered.	F. Uneven. C. seldom prominent.	7.5 Softer when altered.	3.2
Brown, gray, green, yellow.	Resinous, adamantine.	F. Uneven. Prismatic C. seldom prominent.	5-5.5	3.4-3.5
Yellowish to reddish brown.	Resinous.	F. Uneven.	5-5.5	5.2-5.3
Brown to black.	Adamantine.	F. Uneven.	6-7	6.8-7.1
Reddish brown to black.	Adamantine.	F. Uneven. C. not prominent.	6-6.5	4.2
Hair-brown to black.	Adamantine.	F. Uneven.	6.	4.0
Brown to pitch-black.	Pitchy or resinous.	F. Uneven to conchoidal.	5.5-6	3.5-4.2
Blue, rarely colorless.	Vitreous.	F. Conchoidal. C. Pinacoidal not prominent.	7-7.5	2.6

Chiefly various shades of brown.



## NONMETALLIC

### II. Give a

#### 4. Cannot be scratched by a knife,

*b. Do not show a*

	Color.	Luster.	Cleavage and Fracture.	Hardness.	Spec. Grav.
Blue.	Deep azure-blue, greenish blue.	Vitreous.	F. Uneven.	5-5.5	3.0-3.1
	Azure-blue.	Vitreous.	F. Uneven.	5-5.5	2.4
	Blue, green, white, gray.	Greasy, vitreous.	F. Conchoidal. Dodecahedral C. seldom seen.	5.5-6	2.1-2.3

Pink to red. See tourmaline, p. 423.

Black. The following minerals may be almost or quite black; cassiterite,

## NONMETALLIC

### II. Give a

#### 5. Cannot be scratched

*a. Show a*

Cleavage	Color.	Luster.	Hardness.	Spec. Grav.
Perfect basal C.	Colorless, yellow, pink, bluish, greenish.	Vitreous.	8	3.5
C. Pinacoidal.	Hair-brown, gray, grayish green.	Vitreous.	6-7	3.2
C. Prismatic.	White, gray, pink, emerald-green.	Vitreous.	6.5-7	3.2
C. Octahedral.	Colorless, yellow, red, blue, gray, black.	Adamantine.	10	3.5

See also corundum, p. 429, which may show a parting resembling cleavage.

**LUSTER.**

colorless streak.

but can be scratched by quartz.

*prominent cleavage.* (Continued.)

<b>Crystallization and Structure.</b>	<b>Remarks.</b>	<b>Name and Composition.</b>
Usually massive.	Characterized by its color.	Lazurite (Lapis-Lazuli). $(\text{Na}_2, \text{Ca})_2(\text{Al}, \text{NaS}_3)$ $\text{Al}_2(\text{SiO}_4)_3$ .
Usually in pyramidal crystals.	A rare mineral. Characterized by its color. Told from lazurite by its crystals. Opaque.	Lazulite. $(\text{Mg}, \text{Fe})(\text{Al}, \text{OH})_2$ $(\text{PO}_4)_2$ .
Massive.	See p. 421.	SODALITE. $\text{Na}_4(\text{AlCl})\text{Al}_2$ , $(\text{SiO}_4)_3$ .

rutile, brookite, allanite, p. 425; pyroxene and tourmaline, p. 423.

**LUSTER.**

colorless streak.

by quartz.

*prominent cleavage.*

<b>Crystallization and Structure.</b>	<b>Remarks.</b>	<b>Name and Composition.</b>
Orthorhombic. In prismatic crystals, terminated by base, pyramids and domes. Also coarse to fine granular.	Characterized by its crystals, hardness and cleavage.	TOPAZ. $(\text{AlF})_2\text{SiO}_4$ (OH) iso. with F.
Orthorhombic. Commonly in long slender crystals.	See p. 417.	Sillimanite (Fibrolite). $\text{Al}_2\text{SiO}_5$ .
Monoclinic.	See p. 419.	SPODUMENE. $(\text{Li}, \text{Na})\text{Al}(\text{SiO}_3)_2$ .
Isometric. In octahedral crystals, faces usually rough and curved. In irregular rounded pieces.	Characterized by its extreme hardness. Rare.	Diamond. C.



# NONMETALLIC

## II. Give a

### 5. Cannot be scratched

*b. Do not show a*

	Color.	Luster.	Cleavage and Fracture.	Hardness.	Spec. Grav.
Chiefly colorless or white. See also jadedite, p. 431.	Colorless, white, smoky, amethyst. Various colored when impure.	Vitreous, greasy.	F. Conchoidal	7	2.6
	Colorless, white to pale yellow.	Vitreous.	F. Uneven.	7	3.0
	White, colorless.	Vitreous.	F. Conchoidal.	7.5-8	2.9
	White, gray, blue, yellow, brown, green, pink, red.	Adamantine to vitreous.	F. Uneven.	9	4.0
Chiefly light to dark green.	Lavender, blue, green, brown, red, black.	Vitreous.	F. Conchoidal.	8	3.5-3.8
	Bluish green, green, yellow, pink, colorless.	Vitreous.	F. Conchoidal, uneven.	7-7.5	2.7
	Yellowish to emerald-green.	Vitreous.	F. Conchoidal, uneven. C. not prominent.	8.5	3.6-3.8

## LUSTER.

colorless streak.

by quartz.

*prominent cleavage.*

Crystallization and Structure.	Remarks.	Name and Composition.
Rhombohedral, trapezohedral. Irregular massive; in embedded grains; as pebbles, sand. Crystals usually show hexagonal prism terminated by what appears to be a hexagonal pyramid. Prism faces are striated horizontally. Crystals frequently tapering.	Characterized by its crystals; its conchoidal fracture and vitreous luster. For description of varieties see pp. 175-177. Transparent to translucent. Most common mineral.	<b>QUARTZ.</b> $\text{SiO}_2$ .
Orthorhombic. In prismatic crystals, resembling those of topaz. Also disseminated in indistinct crystals and irregular masses.	Characterized by its crystals. Distinguished from topaz by its lack of cleavage. Transparent to translucent. A rare mineral.	Danburite. $\text{CaB}_2(\text{SiO}_4)_2$ .
Rhombohedral. In small rhombohedral crystals.	A rare mineral.	Phenacite. $\text{Be}_2\text{SiO}_4$ .
Hexagonal, rhombohedral. In irregular masses showing at times an almost cubic structure owing to a rhombohedral parting. In rude prisms, often barrel-shaped.	Characterized by its extreme hardness. Ruby = red; sapphire = blue; various other colors. Emery is impure corundum usually with magnetite. May show rhombohedral parting with nearly $90^\circ$ angles.	<b>CORUNDUM.</b> $\text{Al}_2\text{O}_3$ .
Isometric. In octahedrons; sometimes twinned.	Characterized by its crystals and its hardness. Ruby spinel when red.	<b>SPINEL.</b> $\text{MgAl}_2\text{O}_4$ .
Hexagonal. Usually in prismatic crystals with basal plane; pyramid faces rare. Sometimes deeply furrowed vertically. Crystals at times large. Also irregular, massive.	Often shows a mottling of color due to alternation of transparent and opaque spots. Crystals very characteristic. Most common color = blue-green, known as aqua-marine; also deep green as emerald; yellow as golden beryl; pink as morganite. Found in pegmatite veins.	<b>BERYL.</b> $\text{Be}_3\text{Al}_2(\text{SiO}_3)_3 \cdot \frac{1}{2}\text{H}_2\text{O}$ .
Orthorhombic. In tabular crystals which are frequently twinned giving hexagonal shapes.	A rare mineral. Characterized by its hardness.	Chrysoberyl (Alexandrite). $\text{BeAl}_2\text{O}_4$ .

## NONMETALLIC

### II. Give a Cannot be scratched

*b. Do not show a*

	Color.	Luster.	Cleavage and Fracture.	Hardness.	Spec. Grav.
Chiefly light to dark green.  See also andalusite, below, and axinite, zircon, garnet, p. 433.	Green, brown, blue, red, pink, white, black.	Vitreous.	F. Uneven.	7-7.5	3.0-3.1
	Green, gray, white.	Vitreous.	F. Splintery. C., prismatic at nearly 90° angles, not prominent.	7	3.3
	Olive to grayish green, brown.	Vitreous.	F. Uneven. C. rarely seen.	6.5-7	3.3
	Green, brown, yellow, blue, red.	Vitreous, resinous.	F. Uneven.	6.5	3.4
	Dark green.	Vitreous.	F. Conchoidal, uneven.	7.5-8	4.5
Chiefly brown.	Reddish brown to black.	Adamantine.	F. Uneven. C. not prominent.	6-7	6.8-7.1
	Reddish brown, flesh-red, olive-green.	Vitreous, dull when altered.	F. Uneven. C. seldom prominent.	7.5	3.2

## LUSTER.

colorless streak.

by quartz.

*prominent cleavage.* (Continued.)

Crystallization and Structure.	Remarks.	Name and Composition.
Rhombohedral. Usually in slender prismatic crystals, striated vertically. Cross-section usually resembles a spherical triangle. When terminated usually shows base and rhombohedrons. Often in slender radiating crystals.	Widely various in color. Most commonly black. Of the lighter colors green is most frequent. Characterized by its crystal structure. Crystals exhibit pyro-electricity; i.e., after being heated they will attract and hold small pieces of tissue paper, etc., A candle flame may be used. Found in pegmatite veins and metamorphic rocks.	<b>TOURMALINE.</b> A complex boron silicate containing chiefly Al, Fe, Mg, Mn, alkalies F and (OH).
Always massive, usually closely compact.	Translucent. A rare mineral.	Jadeite (Jade). $\text{NaAlSi}_2\text{O}_6$ .
Orthorhombic. Usually granular.	See p. 423.	<b>CHRYSOLITE</b> (Olivine, Peridot). $(\text{Mg, Fe})_2\text{SiO}_4$ .
Tetragonal.	See p. 423.	Vesuvianite (Idocrase). $\text{Ca}_3(\text{Al}(\text{OH}, \text{F}))(\text{Al, Fe})_2(\text{SiO}_4)_5$ .
Isometric. Usually in octahedrons. Sometimes twinned.	Characterized by its crystals and hardness. A variety of spinel; see p. 429.	Gahnite (Zinc Spinel). $\text{ZnAl}_2\text{O}_4$ .
Tetragonal. In irregular masses; in compact fibrous, reniform structure; in rolled grains. Rarely in prismatic crystals, twins.	Very heavy. Usually opaque to translucent. Often gives a light-brown streak. Usually to be scratched by quartz with difficulty. Occurs as rolled grains in sand, in pegmatite veins and in granite rocks.	<b>CASSITERITE</b> (Tin Stone). $\text{SnO}_2$ .
Orthorhombic. In coarse prismatic crystals with nearly square cross-section.	Often soft on surface due to alteration. Frequently a cross-section of a crystal will show a dark-colored cross due to a regular arrangement of impurities in the interior of crystal. Occurs in metamorphic rocks, usually clay slates.	Andalusite (Chiastolite). $\text{Al}_2\text{SiO}_5$ .

## NONMETALLIC

### II. Give a

#### 5. Cannot be scratched

*b. Do not show a*

	Color.	Luster.	Cleavage and Fracture.	Hardness.	Spec. Grav.
Chiefly various shades of brown. See also vesuvianite, p. 431.	Clove-brown, green, yellow, gray.	Vitreous.	F. Conchoidal. C. Pinacoidal, not prominent.	6.5-7	3.3
	Red-brown to brownish black.	Resinous, vitreous. Dull when altered.	F. Uneven.	7-7.5	3.7
	Brown, red, gray, green, colorless.	Adamantine.	F. Conchoidal. C. prismatic not prominent.	7.5	4.7
	Usually brown to red. Also various shades of yellow, green, pink, etc.	Vitreous.	F. Uneven.	6.5-7.5	3.1-4.3

Yellow minerals, see corundum, beryl, p. 429, axinite and garnet above.  
 Pink to red minerals, see corundum, spinel, beryl, p. 429, tourmaline, p. 431, and garnet above.

Black mineral, see tourmaline, p. 431.

# LUSTER.

colorless streak.

by quartz.

*prominent cleavage.* (Continued.)

Crystallization and Structure.	Remarks.	Name and Composition.
Triclinic.	See p. 423.	Axinite. $\text{Ca}_7\text{Al}_4\text{B}_2(\text{SiO}_4)_3$ .
Orthorhombic. In prismatic crystals; very commonly in cruciform penetration twins.	Characterized by its crystals. May be altered to earthy material in which case it can be softer than a knife. Opaque to translucent. Occurs in mica schist.	STAUROLITE. $(\text{AlO})_4(\text{Al.OH})\text{Fe}(\text{SiO}_4)_2$ .
Tetragonal. Usually in small prisms terminated by pyramid of the same order. As rolled grains in sand.	Characterized by its crystals. Usually opaque.	ZIRCON. $\text{ZrSiO}_4$ .
Isometric. Commonly as dodecahedrons, trapezohedrons or a combination of the two. In rolled grains.	Grossularite = $\text{Ca}_3\text{Al}_2(\text{SiO}_4)_3$ , usually light yellow or green. Pyrope = $\text{Mg}_3\text{Al}_2(\text{SiO}_4)_3$ , deep red. Almandite = $\text{Fe}_3\text{Al}_2(\text{SiO}_4)_3$ , brown to red. Spessartite = $\text{Mn}_3\text{Al}_2(\text{SiO}_4)_3$ , red. Andradite = $\text{Ca}_3\text{Fe}_2(\text{SiO}_4)_3$ , green, yellow, brown, to black. Uvarovite = $\text{Ca}_3\text{Cr}_2(\text{SiO}_4)_3$ , emerald-green. Characterized by crystal shape and commonly its red color. An accessory rock mineral. Commonly in metamorphic rocks. As sand.	GARNET. $\text{R}''_3\text{R}'''_2(\text{SiO}_4)_3$ . $\text{R}'' = \text{Ca, Mg, Fe, Mn}$ $\text{R}''' = \text{Al, Fe, Cr}$ .

## INDEX TO DETERMINATIVE TABLES.

- |                      |                        |                     |
|----------------------|------------------------|---------------------|
| Aemite, 419          | Brookite, 425          | Diopside, 407       |
| Actinolite, 407      | Brucite, 393           | Dolomite, 397, 407  |
| Alabandite, 381      |                        |                     |
| Albite, 419          | Calamine, 411          | Embolite, 395       |
| Allanite, 425        | Calaverite, 377        | Enargite, 373       |
| Amblygonite, 415     | Calcite, 397, 407      | Enstatite, 421      |
| Amphibole, 407, 419  | Carnallite, 399        | Epidote, 417        |
| Analcite, 411, 421   | Cassiterite, 389, 425, |                     |
| Anatase, 421         | 431                    | Fluorite, 409       |
| Andalusite, 425, 431 | Celestite, 399         | Franklinite, 385    |
| Andesine, 419        | Cerargyrite, 395       |                     |
| Anglesite, 399       | Cerussite, 401         | Gahnite, 431        |
| Anhydrite, 397, 409  | Chabazite, 409         | Galena, 371, 375    |
| Anorthite, 419       | Chalcanthite, 391      | Garnet, 423         |
| Anthophyllite, 407,  | Chalcocite, 373        | Garnierite, 403     |
| 419                  | Chalcopyrite, 377      | Genthiite, 403      |
| Antimony, 375        | Chloanthite, 383       | Gersdorffite, 383   |
| Apatite, 413         | Chromite, 379, 385     | Goethite, 381, 387, |
| Apophyllite, 405     | Chrysoberyl, 429       | 389                 |
| Aragonite, 411       | Chrysocolla, 391       | Gold, 381           |
| Argentite, 373       | Chrysolite, 423, 431   | Graphite, 371       |
| Arsenic, 375         | Cinnabar, 371, 381,    | Greenockite, 401    |
| Arsenopyrite, 383    | 387                    | Gypsum, 395         |
| Atacamite, 391       | Clinocllore, 393       |                     |
| Augite, 407          | Cobaltite, 383         | Halite, 397         |
| Axinite, 423, 433    | Colemanite, 405        | Harmotome, 405      |
| Azurite, 391         | Columbite, 385         | Hematite, 371, 379, |
|                      | Copper, 381            | 385, 387            |
| Barite, 399, 409     | Corundum, 429          | Heulandite, 405     |
| Bauxite, 401, 413    | Covellite, 377         | Hornblende, 407     |
| Beryl, 429           | Crocoite, 389          | Hypersthene, 421    |
| Biotite, 393         | Cryolite, 401          |                     |
| Bismuth, 381         | Cuprite, 379, 387      | Ilmenite, 385       |
| Bismuthinite, 375    | Cyanite, 403, 417      | Iolite, 425         |
| Borax, 399           |                        |                     |
| Bornite, 377         | Danburite, 421, 429    | Jadeite, 431        |
| Bournonite, 375      | Datolite, 411, 421     | Jamesonite, 323     |
| Brochantite, 391     | Diamond, 427           |                     |
| Bronzite, 421        | Diaspore, 417          | Kaolinite, 401      |

- Kalinite, 399**  
**Labradorite, 419**  
**Lazulite, 427**  
**Lazurite, 415, 427**  
**Lepidolite, 397**  
**Lepidomelane, 393**  
**Leucite, 421**  
**Limonite, 371, 381, 387, 389**  
**Linnæite, 383**  
**Lithiophyllite, 403**  
**Magnetite, 383**  
**Magnesite, 409**  
**Malachite, 391**  
**Manganite, 379**  
**Marcasite, 383**  
**Margarite, 397**  
**Microcline, 417**  
**Millerite, 377**  
**Mimetite, 401, 413**  
**Molybdenite, 371**  
**Monazite, 413, 425**  
**Muscovite, 393**  
**Natrolite, 405, 411, 417**  
**Nephelite, 423**  
**Niccolite, 377, 383**  
**Niter, 395**  
**Octahedrite, 421**  
**Oligoclase, 419**  
**Olivinite, 391**  
**Olivine, 423, 431**  
**Orpiment, 391**  
**Orthoclase, 417**  
**Pectolite, 405, 411**  
**Pentlandite, 377**  
**Phenacite, 429**  
**Phlogopite, 393**  
**Platinum, 381**  
**Plagioclase Feldspars, 419**  
**Polybasite, 373**  
**Prehnite, 423**  
**Proustite, 387**  
**Psilomelane, 373, 385**  
**Pyrargyrite, 379, 387**  
**Pyrite, 383**  
**Pyrolusite, 371, 373**  
**Pyromorphite, 413**  
**Pyrophyllite, 393**  
**Pyrrhotite, 377**  
**Pyroxene, 407, 413, 419, 423**  
**Quartz, 429**  
**Realgar, 389**  
**Rhodochrosite, 409**  
**Rhodonite, 407, 421**  
**Rutile, 389, 425**  
**Scapolite, 411, 421**  
**Scheelite, 413**  
**Serpentine, 403, 415**  
**Siderite, 409**  
**Sillimanite, 417, 427**  
**Silver, 381**  
**Smallite, 383**  
**Smithsonite, 409, 411**  
**Sodalite, 409, 415, 421, 427**  
**Soda Niter, 395**  
**Sphalerite, 379, 389, 409**  
**Spinel, 429**  
**Spodumene, 419, 427**  
**Stannite, 375**  
**Staurolite, 425, 433**  
**Stephanite, 373**  
**Stibnite, 371, 375**  
**Stilbite, 403**  
**Stromeyerite, 373**  
**Sulphur, 391, 395**  
**Sylvanite, 377**  
**Sylvite, 395, 397**  
**Talc, 393**  
**Tantalite, 385**  
**Tellurium, 375**  
**Tetrahedrite, 373**  
**Thorite, 389**  
**Titanite, 411, 425**  
**Topaz, 427**  
**Tourmaline, 423, 431**  
**Tremolite, 407**  
**Triphyllite, 403**  
**Turgite, 379, 385, 387**  
**Uraninite, 385**  
**Vanadinite, 401**  
**Vesuvianite, 423, 431**  
**Vivianite, 391, 395, 397**  
**Wavellite, 403, 415**  
**Willemite, 415, 423**  
**Witherite, 397, 401, 405, 411**  
**Wolframite, 379, 385, 389**  
**Wollastonite, 405, 415**  
**Wulfenite, 413**  
**Xenotime, 413**  
**Zincite, 389**  
**Zircon, 433**  
**Zoisite, 417**



## APPENDIX I.

### LIST OF MINERALS SUITABLE FOR A SMALL MINERAL COLLECTION.

For the convenience of those who desire to possess a small but representative mineral collection the following list is given. The names of the more important species are printed in black-face type, and the names of other desirable but less important minerals in ordinary type. The first list includes 59 names, while the complete list numbers 109.

<b>Graphite</b>	<b>Pyrolusite</b>	<b>Epidote</b>
<b>Sulphur</b>	Manganite	<b>Prehnite</b>
<b>Gold in quartz</b>	<b>Limonite</b>	<b>Calamine</b>
<b>Silver</b>	Brucite	<b>Tourmaline</b>
<b>Copper</b>	<b>Calcite</b>	<b>Staurolite</b>
Orpiment	<b>Dolomite</b>	<b>Apophyllite</b>
<b>Stibnite</b>	<b>Siderite</b>	Heulandite
Molybdenite	Rhodochrosite	<b>Stilbite</b>
<b>Galena</b>	<b>Smithsonite</b>	Chabazite
Argentite	<b>Aragonite</b>	Analcite
<b>Chalcocite</b>	Witherite	<b>Natrolite</b>
<b>Sphalerite</b>	Strontianite	<b>Muscovite</b>
<b>Cinnabar</b>	<b>Cerussite</b>	Lepidolite
Millerite	<b>Malachite</b>	<b>Biotite</b>
Niccolite	Azurite	Phlogopite
<b>Pyrrhotite</b>	<b>Orthoclase</b>	<b>Clinoclhore</b>
<b>Bornite</b>	<b>Albite</b>	<b>Serpentine</b>
<b>Chalcopyrite</b>	Oligoclase	<b>Talc</b>
<b>Pyrite</b>	Labradorite	<b>Kaolinite</b>
<b>Marcasite</b>	Leucite	Chrysocolla
<b>Arsenopyrite</b>	<b>Pyroxenes</b> (several	Titanite
<b>Tetrahedrite</b>	varieties)	Columbite
<b>Halite</b>	Spodumene	Monazite
<b>Fluorite</b>	Pectolite	<b>Apatite</b>
Cryolite	Rhodonite	Pyromorphite
<b>Quartz</b> (several	<b>Amphibole</b> (sev-	Mimetite
varieties)	eral varieties)	Vanadinite
<b>Opal</b>	<b>Beryl</b>	Turquoise
<b>Cuprite</b>	<b>Garnet</b>	Uraninite
Zincite	Chrysolite	<b>Barite</b>
<b>Corundum</b>	Willemite	<b>Celestite</b>
<b>Hematite</b>	Scapolite	<b>Anglesite</b>
Spinel	Vesuvianite	Anhydrite
<b>Magnetite</b>	Zircon	Wolframite
Franklinite	Topaz	Scheelite
Chromite	Andalusite	Wulfenite
<b>Cassiterite</b>	Cyanite	
Rutile	Datolite	

## APPENDIX II. MINERAL STATISTICS.

### INTRODUCTION.

Brief statistics relative to the amount and value of the production of the different economic minerals and metals are presented below. The figures have been taken from the bulletin of the United States Geological Survey entitled Mineral Resources of the United States for 1915. Unless otherwise stated all statistics refer to productions from the United States. It should be noted that because of the European war the conditions affecting mineral production during 1915 were abnormal in several respects. In the case of many metals there was a marked increase in the amounts produced and the prices obtained were exceptionally high.

### SUMMARY OF THE MINERAL PRODUCTION OF THE UNITED STATES FOR 1915.

#### Metals.

Pig Iron.....	\$401,409,604	Zinc.....	\$113,617,000
Silver.....	37,397,300	Mercury.....	1,826,912
Gold.....	101,035,700	Aluminum.....	17,985,500
Copper.....	242,902,000		
Lead.....	47,660,000	Total.....	\$993,000,000

#### Nonmetals.

Bituminous Coal.	\$502,037,688	Sand (Molding, etc.)	\$21,514,977
Anthracite Coal..	184,653,498	Slate.....	4,958,915
Natural Gas.....	101,312,381	Stone.....	74,595,352
Petroleum.....	179,462,890	Borax.....	1,677,099
Clay Products..	163,120,232	Gypsum.....	6,596,893
Cement.....	75,155,102	Phosphate Rock...	5,413,449
Lime.....	14,336,756	Pyrite.....	1,674,933

**Nonmetals (Continued)**

Sulphur . . . . .	\$5,954,236*	Glass Sand . . . . .	\$1,606,640
Salt . . . . .	11,747,686	Graphite . . . . .	429,631
Mineral Paints . .	15,514,059	Mica . . . . .	428,769
Asphalt . . . . .	5,242,073	Mineral Waters . . . .	5,138,794
Bauxite . . . . .	1,514,834	Quartz . . . . .	273,553
Feldspar . . . . .	629,356	Talc . . . . .	1,891,582
Gems . . . . .	170,431	Tungsten Ores . . . . .	4,100,000
		Total . . . . .	\$1,393,565,098

Total value of all mineral products = \$2,393,831,951.

\* 1914.

**Aluminium.**

The production of bauxite, the ore of aluminium, in 1915 had a value of \$1,514,834. The consumption of the metal totaled 99,806,000 pounds. Its price varied from 19 to 60 cents per pound.

**Antimony.**

Only a small amount of antimony ore is mined in the United States. The domestic source of the metal is largely confined to the smelting of antimonial lead ores where it is obtained in the nature of a by-product. The total value of the antimony produced during 1915, was \$2,100,000.

**Apatite**, see Phosphate Rock.

**Arsenic.**

Arsenic, chiefly in the form of the oxide, is produced by only a few companies in the United States and the total production is comparatively small. It is practically all obtained as a by-product from the smelting of ores that contain small amounts of the metal. A large part of the production comes from the smelting of the copper ores at Butte, Montana, which contain arsenic in the form of the mineral enargite. The amount of arsenic oxide, or white arsenic, produced in 1915 was 5,498 tons with a value of \$302,116.

**Asbestos.**

The amount of asbestos produced is small, amounting to \$76,952 worth in 1915. Imports for the same year had a value of \$1,981,483.

**Barite.**

The value of the barite produced in 1915 was \$381,032. The largest amount came from Missouri.

**Bauxite**, see Aluminum.

**Bismuth.**

Little bismuth was produced in 1915. Imports of the metal reached the value of \$108,288.

**Borax.**

A considerable amount of the borates produced in the United States comes from the mineral colemanite. All the borates mined are grouped together, however, under the title borax. The value of the production for 1915 was \$1,677,099.

**Calcite.**

Following are the statistics for the production of Portland Cement for 1915.

	Quantity in Barrels.	Value of Shipments.
Pennsylvania.....	28,648,941	\$20,252,961
Indiana.....	8,145,401	7,336,821
Kansas.....	3,580,287	2,826,443
California.....	4,503,306	6,338,918
Illinois.....	5,156,869	4,884,026
Missouri.....	4,626,771	4,007,679
New Jersey.....	1,579,173	1,473,499
Michigan.....	4,765,294	4,454,608
New York.....	5,043,889	4,039,215
Iowa.....	4,559,630	4,119,952
Ohio.....	1,948,826	1,917,920
Texas.....	1,939,363	2,518,233
Washington.....	1,496,216	1,790,499
12 other states.....	9,920,941	8,795,900
<b>Total.....</b>	<b>85,914,907</b>	<b>\$74,756,674</b>

Total production of cement of all classes for 1915 had a value of \$74,285,248.

The value of the production of limestone for the year 1915 follows:

Illinois.....	\$2,864,103	Ohio.....	\$4,405,590
Indiana.....	4,204,092	Pennsylvania.....	6,367,446
Missouri.....	1,927,534	Virginia.....	1,534,545
New York.....	3,018,871	Other states.....	9,078,919
Michigan.....	1,828,766	Total.....	\$35,229,866

**Cement**, see above.

### Chromite.

The production and imports of chromite for the year 1915 follow. Chromite wholly from California, 3,281 tons; value \$36,744. Imported, chiefly from New Caledonia, British South Africa, Portuguese Africa and Canada, 76,455 tons; value \$780,061.

### Clay.

The total value of the various kinds of clay produced in 1915 was \$3,971,941. The value of kaolin produced was \$241,520. The value of kaolin imported during 1915 was \$1,152,778. The total value of all brick and tile products was \$125,794,844; that of pottery products was \$37,325,388.

### Copper.

The amounts of copper produced in the years 1905, 1910 and 1915 follow:

	1905.	1910.	1915.
	Pounds.	Pounds.	Pounds.
Alaska.....	4,900,866	4,311,026	70,695,286
Arizona.....	235,908,150	297,250,538	432,467,690
California.....	16,697,489	45,760,200	37,658,444
Colorado.....	9,404,830	9,307,497	7,272,178
Idaho.....	7,321,585	6,877,515	6,217,728
Michigan.....	230,287,992	221,462,984	238,956,410
Montana.....	314,750,582	283,078,473	268,263,040
Nevada.....	413,292	64,494,640	67,757,322
New Mexico.....	5,334,192	3,784,609	62,817,234
Tennessee.....	?	16,691,777	18,205,308
Utah.....	58,153,393	125,185,455	175,177,695
Other states.....	18,735,472	2,944,795	2,521,192
<b>Total.....</b>	<b>901,907,843</b>	<b>1,080,159,509</b>	<b>1,388,009,527</b>

Note. — Practically the entire production of Michigan is from native copper; that of the other states is from various other ores.

The value of copper varies quite widely from year to year. One pound was worth about 16.75 c. in 1900; 15.63 c. in 1905; 13 c. in 1910; 17.47 c. in 1915.

The United States furnished in 1913 approximately one-half of the total world's production. Statistics are not available for subsequent years. Other countries that have produced notable amounts of copper are Mexico, Spain, Portugal, Japan, Australasia, Chile, Canada, Germany.

### Corundum.

The production of corundum for abrasive purposes is practically negligible. Since 1898, when the production was valued at \$275,064, it has rapidly fallen until in 1915 the only corundum produced was in the form of emery with a total value for the year of \$31,131. Considerable amounts of emery are imported, the value for 1915 being \$271,649. The decline in the domestic production of corundum is due in large part to the manufacture of the artificial abrasives, carborundum and alundum. The value of such materials produced in 1915 was \$2,248,778. For the production of corundum as sapphire, see under gem stones.

### Feldspar.

The amount of feldspar sold in 1915 was as follows:

	Quantity.	Value.
	Tons.	
Connecticut.....	13,510	\$73,124
Maine.....	27,878	191,456
Maryland.....	12,485	36,861
New York.....	17,375	65,988
Pennsylvania.....	15,830	120,984
Other states.....	26,691	140,943
<b>Total.....</b>	<b>113,769</b>	<b>\$629,356</b>

**Fluorite, Fluorspar.**

The production of fluorite during 1915 was as follows: Colorado, New Hampshire and New Mexico, \$10,562; Illinois, and Kentucky, \$753,913.

**Garnet.**

The value of garnet produced for an abrasive during 1915 was \$139,584.

**Gem Stones.**

The value of the gems and ornamental stones produced in the United States for 1915 was \$170,431. More than 20 different minerals contributed to this total, the majority of them being found in small amounts, however. The values of the production of the more important stones follow: Sapphire, \$88,214; Tourmaline, \$10,969; Turquoise and turquoise matrix, \$11,691.

**Gold.**

The values of the gold production in the years 1905, 1910 and 1915 are given below.

	1905.	1910.	1915.
Alaska.....	\$15,630,000	\$16,126,749	\$16,710,000
Arizona.....	2,799,214	3,149,366	4,555,900
California.....	18,898,545	19,715,440	22,547,400
Colorado.....	25,023,973	20,507,058	22,530,800
Idaho.....	1,075,618	1,096,842	1,170,600
Montana.....	4,794,083	3,730,486	4,978,300
Nevada.....	5,269,819	18,878,864	11,883,700
Oregon.....	1,405,235	679,488	1,867,100
South Dakota.....	6,989,492	5,402,257	7,403,500
Utah.....	.....	.....	3,907,900
Other states.....	6,274,102	5,647,228	3,483,500
<b>Total.....</b>	<b>\$88,159,881</b>	<b>\$94,933,778</b>	<b>\$101,035,700</b>

The gold production of the leading countries for the year 1915 follows:

United States....	\$101,035,700	Africa.....	\$217,639,599
Canada.....	18,936,971	Japan.....	5,385,917
Mexico.....	6,559,275	China.....	2,804,692
Russia.....	28,586,392	India.....	11,522,457
		Australasia.....	49,397,797
Total including all other countries.....			\$470,466,214

### Graphite.

The production of natural graphite in 1915 was as follows:

	Quantity.	Value.
	Pounds.	
Alabama.....	3,474,800	\$204,572
6 other states.....	5,961,200	225,059
Total.....	9,436,000	\$429,631

Artificial graphite produced in 1915 amounted to 2,542 tons; value, \$99,633.

Ceylon produced graphite in 1913 with a value of \$2,935,529.

### Gypsum.

The value of the gypsum produced in the various states for 1915 follows:

California.....	\$113,863	Oklahoma and Texas	\$814,109
Iowa.....	1,278,128	Utah.....	75,835
Kansas.....	250,014	Wyoming.....	103,110
Michigan.....	686,309	Other states.....	1,235,299
New York.....	1,267,706		
Ohio.....	772,520	Total.....	\$6,596,893



## Iron.

The production in long tons of the different iron ores by states is given in the following table for 1915.

	Hematite.	Limonite.	Magnetite.
Alabama.....	4,374,309	935,045	.....
Michigan.....	12,514,516	.....	.....
Minnesota.....	33,464,660	.....	.....
New Jersey.....	.....	.....	415,234
New York.....	71,207	.....	927,638
Pennsylvania.....	.....	22,552	340,757
Tennessee.....	181,509	100,469	2,207
Virginia.....	38,506	309,536	.....
Wisconsin.....	1,095,388	.....	.....
Other states.....	486,163	142,291	101,048
Total.....	52,227,324	1,488,700	1,807,002

Total of all ores = 55,526,490 tons.

## Production of Lake Superior District by ranges in long tons.

	Marquette.	Menominee.	Gogebic.	Vermilion.	Mesabi.*
1880	1,384,010	524,735	.....	.....	.....
1885	1,430,862	690,435	119,590	227,075	.....
1890	2,863,848	2,274,192	2,914,081	891,910	.....
1895	1,982,080	1,794,970	2,625,475	1,027,103	2,839,350
1900	3,945,068	3,680,738	3,104,033	1,675,949	8,158,450
1905	3,772,645	4,472,630	3,344,551	1,578,626	20,156,566
1910	4,631,427	4,983,729	4,746,818	1,390,360	30,576,409
1915	3,817,892	4,665,465	4,996,237	1,541,645	30,802,409
Total to end of 1915	116,266,083	98,253,341	87,900,570	37,942,442	369,658,988

\* The Mesabi District first shipped ore in 1892.

Total for Lake Superior District to end of 1915 = 713,213,051 tons.

**Kaolin, see Clay.****Lead.**

The production of lead in 1915 follows:

	Short Tons.
Colorado.....	32,352
Idaho.....	160,680
Missouri.....	195,634
Utah.....	106,105
Other states.....	42,241
Total.....	<u>537,012</u>

Its various uses were divided in 1909 as follows:

	Short Tons.
White lead and oxides.....	134,138
Pipe.....	52,914
Sheet.....	23,421
Shot.....	36,433
Other purposes.....	104,094

The average price of lead for 1915 was 4.7 cents per pound.

**Limestone, see Calcite.****Magnesite.**

The production of magnesite for 1915 amounted to 30,499 tons, valued at \$274,491. The imports of the mineral were valued at \$487,211.

**Manganese.**

The United States produces only small amounts of manganese ores. The output comes from Georgia, California, Virginia, Arkansas, etc., and was valued in 1915 at \$113,309. A larger amount of manganese ores, in which the manganese is saved as a by-product, was produced. The imports of manganese ores were valued at \$2,655,980.

**Mercury.**

The production of mercury (quicksilver) for 1915 was as follows:

California, 14,283 flasks (75 lbs. each); value, \$1,174,881		
Arizona, Oregon, Texas, 4,423 flasks	“	442,120
Nevada, 2,327	“	209,911

**Mica.**

The total value of the mica produced during 1915 was \$428,769. Importations during the same year were valued at \$692,269.

**Monazite.**

There has been no domestic production of monazite since 1910. The importations of monazite, thorium oxide and thorium nitrate for 1915 had a value of \$332,073.

**Nickel.**

No nickel ores are known to have been mined in the United States in recent years. The value of the nickel ore and matte imported during 1915 was \$7,629,686.

**Phosphate Rock.**

The production of phosphate rock during 1915 was as follows:

	Value.
Florida.....	\$3,762,239
Tennessee.....	1,327,747
South Carolina.....	310,850
Other states.....	12,613
Total.....	<u>\$5,413,449</u>

**Platinum.**

The value of the platinum produced in the United States is small, being \$23,500 in 1915. Russia produced 200,450 ounces in 1905, 275,000 ounces in 1910, and 124,000 ounces in 1915. Other sources at present are negligible. The value of importa-

tions into the United States of unmanufactured and manufactured platinum in 1915 amounted to more than \$2,412,008. The price of platinum has been steadily rising. Platinum in ingots at New York during 1915 varied from \$38.00 to \$85.50 per ounce.

### Potash Salts.

The value of potash salts produced in the United States in 1915 was \$342,000. The value of the various salts imported during 1915 was \$3,765,224.

### Pyrite.

The production of pyrite by states for 1915 follows:

	Long Tons.	Value.
California.....	132,270	\$496,111
Illinois and Indiana.....	15,821	25,556
Ohio.....	10,857	27,404
Virginia.....	145,050	729,644
Wisconsin.....	13,985	43,354
Other states.....	76,141	352,864
Total.....	394,124	\$1,674,933

Average price per ton = \$4.25.

### Quartz.

Pure crystalline quartz, used for pottery, scouring soaps, paints, etc., brings about \$2.00 to \$3.50 per ton in its crude form. The purer varieties of quartzite and sandstone, used for the same purposes, are worth from \$1.00 to \$2.00 a ton. The total production of quartz for these purposes, and including that used as a flux or for abrading purposes for 1915, had a value of \$273,553. The value of the sandstone production in the United States for the same year was \$6,095,800. Sand, used for glass, moulding, building, etc., was produced from a great number of states, Pennsylvania, Ohio, New York, Illinois, New Jersey, Indiana and Michigan leading in the order named and had a total value, in 1915, of \$23,121,617.

## Rutile, see Titanium.

## Salt.

The production of salt in the different important states for 1915 follows:

	Quantity.	Value.
	(In barrels of 280 lbs.)	
California.....	1,048,457	\$694,070
Kansas.....	3,765,164	1,035,879
Michigan.....	12,588,788	4,304,731
New York.....	11,217,471	2,976,405
Ohio.....	5,880,243	1,462,192
Texas.....	444,978	345,944
Utah.....	394,850	266,334
West Virginia.....	232,239	115,143
Other states.....	2,659,306	546,988
<b>Total.....</b>	<b>38,231,496</b>	<b>\$11,747,686</b>

## Silver.

The amounts and values of the silver production for the years 1905, 1910 and 1915, are given below:

	1905.		1910.		1915.	
	Ounces.	Commer- cial Value.	Ounces.	Commer- cial Value.	Ounces.	Commer- cial Value.
Arizona.....	2,605,712	\$1,573,850	2,566,528	\$1,385,925	5,665,672	\$2,826,500
Colorado.....	11,499,307	6,945,581	8,509,598	4,595,183	7,199,745	3,591,900
Idaho.....	8,679,093	5,242,172	7,369,742	3,979,661	13,042,466	6,506,800
Montana.....	13,231,300	7,991,705	12,162,857	6,567,942	14,423,173	7,195,600
Nevada.....	6,482,081	3,915,177	12,479,871	6,739,130	14,453,085	7,210,500
Utah.....	11,036,471	6,666,028	10,466,971	5,652,164	13,073,471	6,522,200
Other states..	2,738,522	1,543,926	3,847,942	2,183,190	7,103,463	3,543,800
<b>Total.....</b>	<b>56,272,496</b>	<b>\$33,988,587</b>	<b>57,598,509</b>	<b>\$31,103,195</b>	<b>74,961,075</b>	<b>\$37,397,300</b>

Two thirds of the world's total production of silver comes from Mexico, United States and Canada, arranged in the order of their importance.

The commercial value of silver varies quite widely from year to year. An ounce was valued in 1900 at 61.6 c., in 1905 at 60.4 c., in 1910 at 49.3 c., and in 1915 at 51.9 c.

**Soapstone**, see Talc.

### Sulphur.

The value of the sulphur produced in 1914, chiefly from Louisiana and Texas was \$5,954,236. The value of the imports for the same year was \$477,937.

### Talc and Soapstone.

The production of talc and soapstone for 1915 follows.

New Jersey and		Vermont.....	\$409,652
Pennsylvania.....	\$56,466	Virginia.....	504,742
New York.....	864,843	Other states.....	<u>34,758</u>
North Carolina.....	21,501	Total.....	\$1,891,582

### Tin.

The domestic production of tin is negligible. The value of the imports of the metal for 1915 was \$38,854,597.

### Titanium.

Very little rutile is produced in the United States. The localities in Nelson County, Virginia, are the only ones that have been worked recently. The value of the rutile produced from them in 1915 was \$27,500. The value of the mineral varies according to purity from \$40 to \$150 per ton.

**Tourmaline**, see Gem Stones.

### Tungsten.

The total value of tungsten concentrates produced during 1915 was \$4,100,000. These come chiefly from California and Colorado.

**Turquoise**, see Gem Stones.

**Zinc.**

The production of zinc in the United States for 1915 is given below.

	Short Tons.
Colorado.....	52,297
Kansas.....	14,365
Missouri.....	136,300
Montana.....	93,573
New Jersey.....	116,618
Wisconsin.....	41,403
Other states.....	<u>231,935</u>
Total.....	586,491

The world's production of spelter by countries for 1913 follows:

	Short Tons.
Belgium.....	217,928
France and Spain.....	78,289
Germany.....	312,075
Great Britain.....	65,197
United States.....	<u>346,676</u>
Total.....	1,093,635

## INDEX.

---

*Note.* — Names of mineral species are printed in heavy-faced type; synonyms and variety names in italics; general matter in light-faced type.

- A.
- Accessory rock-making minerals, 343.
- Acicular structure, 57.
- Acid potassium sulphate, 92
- Acmite**, 233.
- Actinolite*, 237.
- Adamantine luster, 66.
- Adularia*, 222.
- Ægirite**, 233.
- Ænigmatite**, 240.
- Agalmatolite*, 283.
- Agate*, 176.
- Alabandite**, 144.
- Alabaster*, 305.
- Albite**, 225.
- Alexandrite*, 193.
- Allanite**, 259.
- Almandite*, 244.
- Altaite**, 140.
- Aluminium, tests for, 95.
- Aluminium minerals, 310.
- Amalgam**, 131.
- Amazon stone*, 223.
- Amblygonite**, 292.
- Amethyst*, 176.
- Ammonium carbonate, 93.
- Ammonium hydroxide, 93.
- Ammonium molybdate, 93.
- Ammonium oxalate, 93.
- Ammonium sulphocyanite, 93.
- Amorphous minerals, 363.
- Amphibole**, 237.
- Amphibole Group*, 237.
- Analcite**, 269.
- Anatase**, 196.
- Andalusite**, 256.
- Andesine**, 228.
- Andesite, 333.
- Andradite*, 244.
- Anglesite**, 302.
- Anhydrite**, 303.
- Ankerite**, 209.
- Annabergite**, 293.
- Anorthite**, 229.
- Anthophyllite**, 237.
- Antimony**, 124.
- Antimony minerals, 311.
- Antimony, tests for, 95.
- Apatite**, 288.
- Apatite Group*, 288.
- Apophyllite**, 265.
- Aquamarine*, 241.
- Aragonite**, 214.
- Aragonite Group*, 213.
- Arfvedsonite**, 246.
- Argentite**, 138.
- Arkose, 336.
- Arsenic**, 123.
- Arsenic minerals, 312.
- Arsenic, tests for, 96.
- Arsenopyrite**, 156.
- Asbestos, 279.
- Asterism, 68.
- Atacamite**, 172.
- Augite**, 231.
- Aurichalcite**, 219.
- Aventurine*, 176.
- Axinite**, 260.
- Azurite**, 219.



## B.

*Balas ruby*, 188.  
 Banded structure, 59.  
**Barite**, 299.  
*Barite Group*, 299.  
 Barium chloride, 93.  
 Barium hydroxide, 93.  
 Barium minerals, 313.  
 Barium, tests for, 96.  
*Barytes*, 299.  
 Basalt, 333.  
**Bauxite**, 201.  
 Bead tests, 90.  
 Beam balance, 64.  
**Beryl**, 240.  
**Biotite**, 275.  
**Bismuth**, 124.  
**Bismuthinite**, 136.  
 Bismuth minerals, 313.  
 Bismuth, tests for, 97.  
*Black-band ore*, 211.  
*Black jack*, 142.  
 Blowpipe, 80.  
 Blowpipe flame, 82.  
*Blue vitriol*, 306.  
*Bog-iron ore*, 200.  
**Boracite**, 296.  
**Borax**, 296.  
 Borax, 92.  
**Bornite**, 148.  
 Boron, tests for, 97.  
*Bort*, 117.  
 Botryoidal structure, 58.  
**Boulangerite**, 160.  
**Bournonite**, 160.  
 Brachy-axis, 47.  
 Brachydome, 48.  
 Brachypinacoid, 48.  
**Braunite**, 193.  
*Brazilian emerald*, 264.  
 Brittle, 62.  
**Brochantite**, 304.  
**Bromyrite**, 170.  
*Bronzite*, 231.

**Brookite**, 196.  
*Brown hematite*, 200.  
**Brucite**, 202.

## C.

Cadmium minerals, 313.  
*Cairngorm stone*, 176.  
**Calamine**, 261.  
**Calaverite**, 158.  
**Calcite**, 204.  
*Calcite Group*, 203.  
 Calcium, tests for, 98.  
**Cancrinite**, 243.  
*Capillary pyrites*, 146.  
 Capillary structure, 57.  
*Carbonado*, 117.  
 Carbon, tests for, 99.  
 Carborundum, 184.  
*Carbuncle*, 247.  
**Carnallite**, 173.  
*Carnelian*, 176.  
**Cassiterite**, 193.  
*Cat's eye*, 176, 193.  
**Celestite**, 301.  
**Cerargyrite**, 169.  
**Cerussite**, 217.  
**Chabazite**, 269.  
**Chalcanthite**, 306.  
*Chalcedony*, 176.  
**Chalcocite**, 141.  
**Chalcopyrite**, 150.  
*Chalcotrichite*, 179.  
 Chalk, 206, 336.  
*Chalybite*, 210.  
 Chemical formula, 75.  
 Chemical groups, 74.  
*Chessylite*, 219.  
*Chiastolite*, 256.  
**Chloanthite**, 154.  
 Chlorine, tests for, 99.  
*Chlorite Group*, 277.  
*Chlorophane*, 171.  
*Chlorospinel*, 188.  
**Chondrodite**, 261.

- Chromite**, 191.  
 Chromium minerals, 314.  
 Chromium, tests for, 99.  
**Chrysoberyl**, 192.  
**Chrysocolla**, 283.  
**Chrysolite**, 247.  
*Chrysoprase*, 176.  
*Chrysotile*, 279.  
**Cinnabar**, 144.  
*Cinnamon stone*, 245.  
 Classification of minerals, 114.  
*Clay ironstone*, 211.  
 Cleavage, 3, 59.  
 Clino-axis, 50.  
**Clinocllore**, 277.  
 Clinodome, 52.  
**Clinohumite**, 261.  
 Clinopinacoid, 53.  
*Clintonite Group*, 276.  
 Closed tube test, 87.  
 Coatings on charcoal, 86.  
*Cobalt bloom*, 293.  
**Cobaltite**, 154.  
 Cobalt minerals, 314.  
 Cobalt nitrate, 93.  
 Cobalt, tests for, 99.  
*Cogwheel ore*, 160.  
**Colemanite**, 296.  
**Coloradorite**, 144.  
 Color of minerals, 67.  
**Columbite**, 284.  
 Columnar structure, 58.  
 Compact structure, 58.  
 Concentric structure, 58.  
 Conchoidal fracture, 60.  
 Conglomerate, 335.  
 Constancy of interfacial angles, 5.  
 Contact metamorphic minerals, 347.  
**Copper**, 130.  
*Copper glance*, 141.  
 Copper minerals, 314.  
*Copper nickel*, 147.  
*Copper pyrites*, 150.  
 Copper, tests for, 99.  
*Cordierite*, 242.  
**Corundum**, 181.  
**Covellite**, 145.  
*Crocidolite*, 240.  
**Crocoite**, 303.  
**Cryolite**, 172.  
 Crystal combinations, 13.  
 Crystal, defined, 1.  
 Crystal distortion, 14.  
 Crystal form, 12.  
 Crystal habit, 13.  
 Crystallized structure, 57.  
 Crystallographic axes, 9.  
 Cube, 18.  
**Cuprite**, 179.  
**Cyanite**, 257.  
*Cymophane*, 193.
- D.**
- Dacite, 333.  
**Danburite**, 254.  
**Datolite**, 257.  
 Deltoid dodecahedron, 29.  
*Demantoid*, 247.  
 Dendritic structure, 57.  
*Desmine*, 268.  
 Determinative Mineralogy, 364.  
 Determinative Tables, 369.  
**Diamond**, 116.  
**Diaspore**, 198.  
 Dimorphism, 80.  
**Diopside**, 231.  
**Dioptase**, 250.  
 Diorite, 332.  
 Diploid, 25.  
 Divergent structure, 57.  
 Dodecahedron, 19.  
 Dolerite, 332.  
**Dolomite**, 208.  
 Double refraction, 71.  
 Drusy structure, 57.  
*Dry-bone ore*, 212.  
 Dry reagents, 92.  
 Dunite, 332.

## E.

Earthy structure, 58.  
*Elcolite*, 242.  
 Elastic, 62.  
*Electric calamine*, 262.  
*Electrum*, 125.  
 Elements, 115.  
 Elements, list of, 94.  
**Embolite**, 169.  
*Emerald*, 241.  
*Emery*, 182.  
**Enargite**, 165.  
*Endlichite*, 291.  
**Enstatite**, 231.  
**Epidote**, 259.  
*Erubescite*, 149.  
**Erythrite**, 293.  
*Essonite*, 245.  
**Eucryptite**, 234.

## F.

*Fahlöre*, 162.  
**Famatinite**, 165.  
**Fayalite**, 248.  
*Feather ore*, 159.  
*Feldspar Group*, 220.  
 Felsite, 333.  
**Fergusonite**, 286.  
*Fibrolite*, 256.  
 Fibrous fracture, 60.  
 Fibrous structure, 58.  
 Filiform structure, 57.  
 Flame tests, 88.  
 Flexible, 62.  
*Flint*, 177.  
*Flos ferri*, 215.  
 Fluorine, tests for, 100.  
**Fluorite**, 170.  
*Fluor spar*, 170.  
 Foliated structure, 58.  
**Fosterite**, 248.  
 Fracture, 60.  
**Franklinite**, 191.  
 Fusion, 83.

## G.

Gabbro, 332.  
**Gadolinite**, 258.  
**Gahnite**, 189.  
**Galena**, 139.  
*Galenite*, 139.  
 Gangue minerals, 351.  
**Garnet**, 244.  
**Garnierite**, 280.  
**Gay Lussite**, 219.  
**Genthite**, 280.  
**Geocronite**, 160.  
 Geode, 59.  
**Gersdorffite**, 154.  
*Geyselite*, 178.  
**Gibbsite**, 203.  
**Glauberite**, 298.  
**Glaucophane**, 239.  
 Globular structure, 58.  
**Gmelinite**, 269.  
 Gneiss, 337.  
**Goethite**, 199.  
**Gold**, 125.  
*Golden beryl*, 241.  
 Gold minerals, 317.  
 Gold, tests for, 101.  
 Goniometers, 6.  
 Gossan, 153.  
 Granite, 331.  
 Granular structure, 58.  
**Graphite**, 120.  
*Gray copper*, 162.  
 Graywacke, 336.  
 Greasy luster, 66.  
**Greenockite**, 146.  
*Grossularite*, 244.  
 Groundmass, 334.  
**Gypsum**, 304.

## H.

Hackly fracture, 60.  
**Halite**, 166.  
 Hardness of minerals, 60.

**Harmotone**, 267.  
**Hausmannite**, 193.  
**Häüynite**, 243.  
*Heavy spar*, 299.  
**Hedenbergite**, 231.  
**Hematite**, 184.  
*Hemimorphite*, 262.  
**Hessite**, 140.  
**Heulandite**, 267.  
 Hexahedron, 18.  
 Hexagonal axes, 37.  
 Hexagonal minerals, 357.  
 Hexagonal prisms, 38.  
 Hexagonal pyramids, 39, 40.  
 Hexagonal symmetry, 38.  
 Hexagonal system, 37.  
 Hexakistetrahedron, 29.  
 Hexoctahedron, 23.  
*Hiddenite*, 234.  
*Hornblende*, 237.  
 Hornblendite, 332.  
*Horn silver*, 169.  
*Horseflesh ore*, 149.  
**Hübnerite**, 307.  
**Humite**, 261.  
*Hyacinth*, 254.  
*Hyalite*, 178.  
**Hyalophane**, 223.  
*Hydrargillite*, 203.  
 Hydrochloric acid, 93.  
 Hydrogen sodium phosphate, 93.  
*Hydrohematite*, 198.  
**Hydromagnesite**, 220.  
**Hydrozincite**, 220.  
**Hypersthene**, 231.

## I.

**Ice**, 181.  
*Iceland spar*, 206.  
 Igneous rocks, 329.  
**Ilmenite**, 186.  
**Ivaite**, 261.  
 Index of refraction, 69.  
 Indices, 12.

*Indicolite*, 264.  
*Infusorial earth*, 178.  
**Iodyrite**, 170.  
**Iolite**, 242.  
 Iridescence, 68.  
**Iridium**, 133.  
**Iridosmine**, 133.  
**Iron**, 133.  
 Iron minerals, 318.  
*Iron pyrites*, 151.  
 Iron, tests for, 101.  
 Irregular fracture, 60.  
 Isometric angles, 30.  
 Isometric axes, 16.  
 Isometric minerals, 355.  
 Isometric symmetry, 17.  
 Isometric system, 16.  
 Isomorphism, 77.  
 Isomorphous groups, 79.

## J.

*Jacinth*, 254.  
**Jadeite**, 234.  
**Jamesonite**, 159.  
*Jargon*, 254.  
*Jasper*, 177.  
*Jeffersonite*, 231.  
 Jolly balance, 64.

## K.

**Kainite**, 168.  
**Kalinite**, 306.  
*Kaolin*, 281.  
**Kaolinite**, 281.  
*Kidney ore*, 185.  
**Krennerite**, 159.  
*Kunzite*, 234.

## L.

**Labradorite**, 228.  
 Lamellar structure, 58.  
*Lapis-lazuli*, 243.  
**Laumontite**, 268.

**Lazulite**, 293.  
**Lazurite**, 243.  
**Lead**, 131.  
 Lead minerals, 319.  
 Lead, tests for, 102.  
**Lepidolite**, 274.  
**Lepidomelane**, 276.  
**Leucite**, 229.  
*Lievrite*, 261.  
 Limestone, 206, 336.  
**Limonite**, 200.  
**Linnæite**, 149.  
**Lithiophilite**, 287.  
 Lithium, test for, 103.  
 Litmus paper, 92.  
 Lodestone, 189.  
 Luster, 65.

## M.

Macro-axis, 47.  
 Macrodome, 48.  
 Macropinacoid, 48.  
**Magnesite**, 209.  
 Magnesium, tests for, 103.  
*Magnetic pyrites*, 147.  
**Magnetite**, 189.  
**Malachite**, 218.  
 Malleable, 62.  
 Mammillary structure, 58.  
 Manganese minerals, 320.  
 Manganese, tests for, 104.  
**Manganite**, 199.  
*Manganotantalite*, 285.  
 Marble, 206, 339.  
**Marcasite**, 155.  
**Margarite**, 277.  
**Marialite**, 250, 251.  
 Marl, 337.  
 Massive minerals, 363.  
 Massive structure, 59.  
**Meionite**, 250, 251.  
**Melaconite**, 181.  
*Melanite*, 246.  
*Menaccanite*, 186.

*Meneghinite*, 160.  
**Mercury**, 131.  
 Mercury minerals, 321.  
 Mercury, tests for, 104.  
**Metacinnabarite**, 144.  
 Metallic luster, 66.  
 Metamorphic rocks, 337.  
*Mica Group*, 271.  
 Mica-schist, 338.  
 Micaceous structure, 58.  
**Microcline**, 223.  
 Microcosmic salt, 92.  
**Microlite**, 286.  
*Milky quartz*, 176.  
**Millerite**, 146.  
**Mimetite**, 291.  
*Mispickel*, 156.  
**Mizzonite**, 250, 251.  
**Molybdenite**, 137.  
 Molybdenum minerals, 322.  
 Molybdenum, tests for, 104.  
**Monazite**, 286.  
 Monoclinic axes, 50.  
 Monoclinic minerals, 360.  
 Monoclinic prism, 52.  
 Monoclinic pyramid, 51.  
 Monoclinic symmetry, 51.  
 Monoclinic system, 50.  
**Monticellite**, 248.  
*Moonstone*, 222, 226.  
*Morganite*, 241.  
 Muriatic acid, 93.  
**Muscovite**, 272.

## N.

**Nagyagite**, 159.  
**Natrolite**, 270.  
**Nephelite**, 242.  
**Niccolite**, 147.  
*Nickel bloom*, 293.  
 Nickel minerals, 322.  
 Nickel, tests for, 104.  
 Niobium, tests for, 105.  
**Niter**, 295.

Nitric acid, 93.  
 Nonmetallic luster, 66.  
**Noselite**, 243.

## O.

Obsidian, 333.  
**Octahedrite**, 196.  
 Octahedron, 18.  
**Oligoclase**, 227.  
**Olivenite**, 293.  
**Olivine**, 247.  
**Onofrita**, 144.  
*Onyx*, 177.  
 Öölite, 336.  
**Opal**, 178.  
 Opalescence, 68.  
 Open tube test, 86.  
**Orpiment**, 134.  
 Ortho-axis, 50.  
**Orthoclase**, 221.  
 Orthodome, 52.  
 Orthopinacoid, 53.  
 Orthorhombic axes, 46.  
 Orthorhombic minerals, 359.  
 Orthorhombic prism, 47.  
 Orthorhombic pyramid, 47.  
 Orthorhombic symmetry, 46.  
 Orthorhombic system, 47.  
 Oxidizing flame, 84.  
 Oxygen, tests for, 105.

## P.

**Palladium**, 133.  
 Parameters, 10.  
 Parting, 59.  
*Peacock ore*, 149.  
*Pearl spar*, 209.  
 Pearly luster, 66.  
**Pectolite**, 235.  
 Pegmatite dike, 345.  
**Penninite**, 277.  
 Pentagonal dodecahedron, 25.  
**Pentlandite**, 144.

Percentage composition, 76.  
*Peridot*, 247.  
 Peridotite, 332.  
 Perlite, 333.  
**Perovskite**, 284.  
**Petalite**, 220.  
**Petzite**, 140.  
**Phenacite**, 249.  
 Phenocryst, 334.  
**Phillipsite**, 267.  
**Phlogopite**, 275.  
 Phonolite, 333.  
**Phosgenite**, 218.  
 Phosphorescence, 68.  
*Phosphorite*, 289.  
 Phosphorus, tests for, 106.  
*Picotite*, 188.  
*Pitch blende*, 297.  
 Pitchstone, 333.  
*Plagioclase feldspars*, 224.  
**Plagionite**, 160.  
**Platinum**, 131.  
 Platinum minerals, 323.  
 Platinum, tests for, 106.  
 Play of colors, 68.  
*Pleonaste*, 188.  
 Plumose structure, 58.  
 Plutonic rocks, 330, 331.  
 Pneumatolytic minerals, 348.  
 Polarized light, 72.  
**Polianite**, 198.  
**Pollucite**, 230.  
**Polybasite**, 164.  
**Polyhalite**, 168.  
 Porphyry, 334.  
*Potash alum*, 306.  
*Potash feldspar*, 221.  
 Potassium iodide and sulphur mixture, 92.  
 Potassium ferricyanide, 93.  
 Potassium ferrocyanide, 93.  
 Potassium, tests for, 106.  
**Prehnite**, 260.  
 Primary vein minerals, 352.  
**Proustite**, 161.

- Pseudomorphs, 15.  
**Psilomelane**, 203.  
 Pumice, 333.  
*Purple copper ore*, 148.  
**Pyrrargyrite**, 161.  
**Pyrite**, 151.  
 Pyritohedral class, 24.  
 Pyritohedron, 25.  
**Pyrochlore**, 286.  
 Pyroelectricity, 72.  
**Pyrolusite**, 196.  
**Pyromorphite**, 290.  
*Pyrope*, 244.  
**Pyrophyllite**, 282.  
**Pyroxene**, 231.  
*Pyroxene Group*, 230.  
 Pyroxenite, 332.  
**Pyrrhotite**, 147.
- Q.
- Quartz**, 174.  
 Quartzite, 338.  
*Quicksilver*, see Mercury.
- R.
- Radiated structure, 57.  
**Realgar**, 134.  
*Red copper ore*, 179.  
 Reducing flame, 84.  
 Refraction of light, 68.  
 Reniform structure, 58.  
 Replacement deposits, 351.  
 Resinous luster, 66.  
 Reticulated structure, 57.  
**Rhodochrosite**, 211.  
*Rhodolite*, 246.  
**Rhodonite**, 236.  
 Rhombohedral class, 41.  
 Rhombohedral minerals, 358.  
 Rhombohedron, 42.  
 Rhyolite, 333.  
**Riebeckite**, 239.  
*Rock crystal*, 175.  
 Rock-making minerals, 339.  
*Rock salt*, 166.  
*Rose beryl*, 241.  
*Rose quartz*, 176.  
*Rubellite*, 264.  
*Rubicelle*, 188.  
*Ruby*, 182.  
*Ruby copper*, 179.  
*Ruby silvers*, 161.  
**Rutile**, 195.
- S.
- Salt*, 166.  
 Salt of phosphorus, 92.  
**Samarskite**, 286.  
 Sandstone, 335.  
*Sanidine*, 222.  
*Sapphire*, 182.  
*Salin spar*, 305.  
 Scalenohedron, 42.  
 Scale of fusibility, 84.  
 Scale of hardness, 61.  
*Scapolite Group*, 250.  
**Schoelite**, 308.  
*Schefferite*, 231.  
 Schist, 338.  
**Scolecite**, 271.  
**Scorodite**, 293.  
 Secondary enrichment, 352.  
 Secondary vein minerals, 352.  
 Sectile, 62.  
 Sedimentary rocks, 334.  
*Selenite*, 304.  
**Serpentine**, 278.  
 Shale, 336.  
**Siderite**, 210.  
 Silicon, tests for, 107.  
 Silky luster, 66.  
**Sillimanite**, 256.  
**Silver**, 129.  
*Silver glance*, 138.  
 Silver minerals, 324.  
 Silver nitrate, 93.  
 Silver, tests for, 108.

- Slate, 338.  
**Smaltite**, 154.  
**Smithsonite**, 212.  
*Smoky quartz*, 176.  
*Soapstone*, 280.  
*Soda-feldspar*, 225.  
**Sodalite**, 243.  
**Soda niter**, 295.  
 Sodium carbonate, 92.  
 Sodium, tests for, 109.  
*Spathic iron*, 210.  
 Specific gravity, 62.  
*Specular hematite*, 185.  
**Sperrylite**, 154.  
*Spessartite*, 244.  
**Sphalerite**, 142.  
**Sphene**, 283.  
 Sphenoid, 35.  
 Sphenoidal class, 35.  
**Spinel**, 187.  
*Spinel Group*, 187.  
**Spodumene**, 233.  
 Stalactitic structure, 58.  
**Stannite**, 151.  
**Staurolite**, 264.  
*Steatite*, 280.  
 Stellated structure, 58.  
**Stephanite**, 163.  
**Stilbite**, 135.  
**Stilbite**, 268.  
**Stromeyerite**, 142.  
**Strontianite**, 216.  
 Strontium, tests for, 109.  
 Structure of minerals, 57.  
 Sublimates in closed tube, 88.  
 Sublimates in open tube, 87.  
 Sublimates on charcoal, 86.  
 Submetallic luster, 67.  
 Sulphides, 133.  
**Sulphur**, 122.  
 Sulphuric acid, 93.  
 Sulphur, tests for, 109.  
 Syenite, 331.  
**Sylvanite**, 157.  
**Sylvite**, 168.  
 Symmetry, 7.  
 Symmetry axis, 7.  
 Symmetry center, 8.  
 Symmetry plane, 7.
- T.
- Tabular structure, 58.  
**Talc**, 280.  
**Tantalite**, 284.  
 Tarnish, 68.  
**Tellurium**, 123.  
 Tellurium, tests for, 110.  
 Tenacity of minerals, 62.  
**Tennantite**, 162.  
**Tenorite**, 181.  
**Tephroite**, 248.  
 Test papers, 92.  
 Tetragonal axes, 31.  
 Tetragonal combinations, 34.  
 Tetragonal minerals, 356.  
 Tetragonal prisms, 32.  
 Tetragonal pyramids, 32, 33.  
 Tetragonal system, 31.  
 Tetragonal symmetry, 31.  
 Tetragonal trisoctahedron, 20.  
 Tetrahedral class, 27.  
**Tetrahedrite**, 162.  
 Tetrahedron, 28.  
 Tetrahexahedron, 19.  
**Thomsonite**, 271.  
**Thorite**, 254.  
*Thulite*, 258.  
**Tiemannite**, 144.  
*Tiger's eye*, 176.  
 Tin minerals, 325.  
*Tin stone*, 193.  
 Tin, tests for, 111.  
*Titanic iron ore*, 186.  
**Titanite**, 283.  
 Titanium minerals, 326.  
 Titanium, tests for, 111.  
**Topaz**, 254.  
**Tourmaline**, 262.  
 Trachyte, 333.



- Trapezohedral class, 45.  
 Trapezohedron, 20.  
 Travertine, 206, 336.  
*Tremolite*, 237.  
 Triclinic axes, 54.  
 Triclinic domes, 55.  
 Triclinic minerals, 363.  
 Triclinic pinacoids, 56.  
 Triclinic prisms, 55.  
 Triclinic pyramids, 55.  
 Triclinic symmetry, 55.  
 Triclinic system, 54.  
 Trigonal trisoctahedron, 22.  
 Trimorphism, 80.  
**Triphylite**, 287.  
*Tripolite*, 178.  
 Tri-rhombohedral class, 45.  
 Trisoctahedron, 22.  
 Tristetrahedron, 29.  
**Trona**, 220.  
*Troostite*, 249.  
 Tungsten minerals, 326.  
 Tungsten, tests for, 111.  
**Turgite**, 198.  
 Turmeric paper, 92.  
**Turquoise**, 294.  
 Twin crystals, 15.
- U.
- Uneven fracture, 60.  
*Uralian emeralds*, 247.  
**Uraninite**, 297.  
 Uranium, tests for, 112.  
*Uvarovite*, 244.
- V.
- Vanadinite**, 291.  
 Vanadium minerals, 327.  
 Vanadium, tests for, 112.  
*Variiegated copper ore*, 149.  
 Veins and vein minerals, 349.  
 Verd antique marble, 279.  
**Vesuvianite**, 251.  
 Vitreous luster, 66.  
 Vitrophyre, 333.  
**Vivianite**, 293.  
 Volcanic rocks, 330, 332.
- W.
- Warrenite**, 160.  
 Water, tests for, 101.  
**Wavellite**, 294.  
**Wernerite**, 250.  
 Wet reagents, 92.  
*White iron pyrites*, 155.  
**Willemite**, 249.  
**Witherite**, 215.  
**Wolframite**, 307.  
**Wollastonite**, 235.  
**Wulfenite**, 308.  
**Wurtzite**, 148.
- X.
- Xenotime**, 286.
- Y.
- Yellow copper ore*, 150.
- Z.
- Zeolites*, 267.  
*Zinc blende*, 142.  
**Zincite**, 180.  
 Zinc minerals, 327.  
 Zinc, tests for, 112.  
**Zinkenite**, 160.  
**Zircon**, 252.  
**Zoisite**, 258.



## DATE OF ISSUE

This book must be returned  
within 3, 7, 14 days of its issue. A  
fine of ONE ANNA per day will  
be charged if the book is overdue.

---

1

1

# PHARMACEUTICS