

BIRLA CENTRAL LIBRARY

PILANI (RAJASTHAN)

Class No 720.956

Book No H29I

Acc 4007





# INDIAN ARCHITECTURE

**ALL RIGHTS RESERVED**





FIR SINGH DEVA'S PALACE, DAHIYA

*Frontispice*

# INDIAN ARCHITECTURE

ITS PSYCHOLOGY, STRUCTURE, AND HISTORY  
FROM THE FIRST MUHAMMADAN INVASION TO  
THE PRESENT DAY

BY E. B. HAVELL

AUTHOR OF

"INDIAN SCULPTURE AND PAINTING," "THE IDEALS OF INDIAN ART," ETC.

WITH ILLUSTRATIONS

LONDON  
JOHN MURRAY, ALBEMARLE STREET, W.



FIRST EDITION . . . *June* 1913  
SECOND EDITION . . . 1927

## PREFACE TO THE SECOND EDITION

THE first publication of this book, fourteen years ago, brought about a lively discussion in Parliament and the Press of the architectural principles which should be observed in the construction of public buildings in India. Since then the New Delhi has been planned and built, and the question may be asked whether the modern Western system of building adopted has been fully justified by results, and how far Indian craftsmanship has benefited by a project which is one of the most costly, if not the greatest, ever attempted in India. This point is fully discussed in the new chapter added to this edition. The appendix has been enlarged by documents relating to the petition presented to the Secretary of State for India in 1913.

Architectural practice in this country is again engaging the attention of Parliament, and the Prime Minister in his recent appeal for the preservation of old English cottages declares that it is a public duty to see whether we cannot "once again tap the springs of craftsmanship which have not flowed in this country for so long." This raises the question whether it is beyond the capacity of our architects to tap the still flowing springs of Indian craftsmanship for India's benefit, and whether it is necessary, or desirable, for our prestige as rulers, to continue the present system which has been pumping

vi      PREFACE TO THE SECOND EDITION

those springs dry ever since our Public Works Department was organised in India.

The wider issues involved in this question, which are beyond the scope of an architectural work, were discussed by me in an article in the *Nineteenth Century and After*, December 1912.

E. B. H.

OXFORD.

*April 1927.*

## P R E F A C E

IN two previous works I have endeavoured to lay down a sound critical basis for the study of Indian sculpture and painting: the present one deals with Indian architecture on the same lines. The history of architecture is not, as Fergusson thought, the classification of buildings in archæological water-tight compartments according to arbitrary academic ideas of style, but a history of national life and thought. The first duty of an historian of Indian architecture is to realise for himself the distinctive qualities which constitute its Indianness, or its value in the synthesis of Indian life. Fergusson only read into Indian architecture the values he attached to it from his knowledge of Western archæology, and consequently the only result of his magnificent pioneer work has been to give the subject an honourable place in the Western architect's library among the books which are never read. At the same time Fergusson's authority among archæologists has been so great that, except on minor points of classification, his views of Indian history have never been seriously disputed; and the ever-increasing quantity of most valuable material collected by the Archæological Survey of India year by year is still religiously docketed and labelled according to the scheme laid down by him forty years ago.

Indian architecture covers a field as wide as the whole architecture of Europe, and therefore in this first attempt to turn the study of it off the side-track in which Fergusson left it I have limited myself to those chapters of it which have

most practical interest for the modern architect. And as historical studies miss their aim unless they can make clear the bearing of the experience of the past upon the actualities of the present day, I have planned this work so as to make evident to expert and layman alike the relation between Indian architectural history and a great problem which is exercising the public mind at the present moment—the building of the new Delhi—and a question of much more vital importance—the preservation of Indian handicraft.

For fifty years Indian departmentalism has followed a system of building, demoralising alike to the architect and the craftsman, which has been as injurious to the true interests of the British Raj as it has been fatal to the development of art and craft in India. Great Britain, like every other European country, has slowly come to realise how prodigal she has been in the last two centuries with her own handicrafts and all other forms of artistic wealth which belong to national well-being and are the true expression of it. What finer opportunity can there be than the building of the new Delhi for inaugurating a new architectural and educational policy which will remove the incubus now pressing so hardly upon Indian craft and industry, and at the same time give a great impulse to the new movement for the revival of architecture in this country?

The ethics of the present departmental system will not be raised to a higher plane by removing the official architect's office from Simla to London ; the fineness of the architectural effect of the new Delhi, academically considered, will not justify methods which are ruinous to Indian handicraft. We shall be more British by giving Indian craftsmen their due.

When all sincere architects in Europe are doing their best to revive the principle of collaboration between architect and craftsman which has been and will be the foundation of

the true art of building in all ages, it would be a calamity both for India and for this country if the only result of the building of the new Delhi is the establishment of another departmental school for teaching Indians modern pseudo-scientific methods by which architecture, so far as concerns themselves, ceases to be an art.

In working out the principal historical sequences I have relied chiefly upon the documents which the buildings themselves provide : they are by far the most reliable, and the deductions I have drawn from them can easily be checked by the architectural student. Those who wish to enter into further detail can follow up the various clues I have given, either by investigations on the spot or by consulting the finely illustrated works published by the Archæological Survey of India ; especially the reports of the Survey of Western India by Dr. Burgess and Mr. Cousins, Mr. Edmund Smith's four volumes on Fatehpur-Sikrî, and the more recent reports presented by Mr. Marshall.

Fergusson and Dr. Burgess are my chief authorities for chronological facts and measurements of buildings. I am greatly indebted to the Secretary of State for India for permission to use material from various reports of the Archæological Survey, and also to Mr. Murray for the use of some blocks from Fergusson's "History." Mr. J. H. Marshall, C.I.E., Director-General of the Archæological Survey of India, has given me invaluable help with the illustrations. Dr. F. W. Thomas, Librarian, and Mr. A. G. Ellis, Assistant Librarian, India Office, have given me much assistance in etymological questions. I have also to thank Professor Rhys Davids and Mr. Abanindro Tagore for the information they have very kindly furnished. For the loan of photographs I am much indebted to Dr. A. K. Coomaraswamy, Colonel T. H.

Hendley, C.I.E., Mr. H. V. Lanchester, F.R.I.B.A., and Mr. W. Rothenstein. Similar assistance in the illustrations has been very kindly given me by Sir David Prain, Director of the Royal Botanic Gardens, Kew, Mr. and Mrs. Carl Melchior, and by Mrs. Villiers Stuart. Messrs. Bourne & Shepherd; Messrs. Johnston & Hoffmann, Calcutta; and Messrs. R. C. Mazumdar, Benares, have kindly allowed me to reproduce some of their copyright photographs.

LONDON

*March 1913*

# CONTENTS

	PAGES
PREFACE TO THE SECOND EDITION . . . . .	v
PREFACE . . . . .	vii
CHAPTER I	
Hindu and Saracenic Art—The Pointed Arch—The Migrations of Craftsmen—The First Muhammadan Invasion of India . . . . .	1-14
CHAPTER II	
Hindu Symbolism—The Design and Building of the Tâj Mahall . . . . .	15-40
CHAPTER III	
THE THIRTEENTH CENTURY	
Mosques at Delhi and Ajmîr—The Qutb Minâr . . . . .	41-52
CHAPTER IV	
THE FOURTEENTH CENTURY	
Gujerat—Gaur—The Arch in Indian Architecture—Kulbarga—Muhammadan Tombs . . . . .	53-65
CHAPTER V	
THE FIFTEENTH CENTURY	
Mandû : The Jâmi' Masjid ; Mulik Mughî's Mosque—Jaunpur : The Atâla and Jâmi' Masjids—Ahmadâbâd : The Jâmi' Masjid ; Muhâfiz Khan's Masjid—Alif Khan's Masjid—Mosque and Tombs at Sarkhej—Sayyid Usmân's Tomb—Sayyid Mubârak's Tomb—Gaur : Dakhil Gate and Eklâkhi Masjid . . . . .	66-81



## CHAPTER VI

	PAGES
Indian Arches, Brackets, Capitals, and Domes—The Hindu Temple <i>Sikhara</i> . . . . .	82-120

## CHAPTER VII

## THE SIXTEENTH CENTURY IN BENGAL

Husain Shah and the Cult of Satya Pîr—The Influence of Bengali Craftsmanship upon Indo-Muhammadan Architecture—The Buildings at Gaur: The Qadam-i-Rasûl Masjid; The Sonâ Masjid; The Chota Sonâ Masjid; The Jâmi' Masjid of Akhi Serâj-ud-Dîn . . . . .	121-133
---	---------

## CHAPTER VIII

## GUJERAT ARCHITECTURE IN THE SIXTEENTH CENTURY

The Champanîr Mosques—Buildings in Ahmadâbâd: Rânî Rupâvatî's Masjid; Sidi Sayyid's Masjid; Mosque and Tomb of Rânî Sîparî; Dâdâ Harir's Well—Hindu Buildings in Rajputana—The Palace of Mân Singh of Gwalior . . . . .	134-152
---	---------

## CHAPTER IX

## THE ADVENT OF THE MOGULS

Shêr Shah's Mosque and Tomb—Humâyûn's Tomb . . . . .	153-164
--	---------

## CHAPTER X

## THE SIXTEENTH CENTURY

Akbar—The Buildings at Fatehpur-Sikrî—Akbar's Palace at Agra . . . . .	165-181
--	---------

## CHAPTER XI

## VIJAYANAGAR AND BIJÂPÛR

The Architectural Relationship of Vijayanagar and Bijâpûr—The Vitthala-swâmi Temple and other Buildings at Vijayanagar—The Jâmi' Masjid, Bijâpûr—Ibrâhîm's Mosque and Tomb—The Mehtar Mahall—Mahmûd's Tomb—Indian Stucco . . . . .	182-199
--	---------

# CONTENTS

xiii

## CHAPTER XII

### HINDU BUILDINGS IN THE SIXTEENTH CENTURY

PAGES

Govind Deva's Temple at Brindâban—Hinduism and Idolatry—Jaina Temples—Mân Singh's Observatory, Benares . . . . .	200-204
---	---------

## CHAPTER XIII

### THE SEVENTEENTH CENTURY

Bîr Singh Deva's Palace, Dativâ—Palaces at Jodhpur—Mogul Buildings at Agra and Delhi—Tirumalai Nayyak's Palace and Chaultri, Madurai —Chandragiri Palace . . . . .	205-220
--	---------

## CHAPTER XIV

### THE EIGHTEENTH CENTURY TO THE PRESENT DAY

The Decay of the Mogul Empire—Tomb of Safdar Jang, Delhi— Eighteenth-century Buildings at Lucknow.—The Sikandara Bagh, Agra—Modern Rajput Architecture: The City of Jaipur; Palaces at Dîg and Udairpur, Domestic Buildings—Anglo-Indian Architecture— Indian Architecture in the Victorian Period—Modern Buildings.	221-249
--	---------

## CHAPTER XV

The Future of Architecture in India—The Building of the New Delhi . . . . .	250-257
---	---------

## CHAPTER XVI

FOURTEEN YEARS AFTER—AN IMPERIAL OBJECT-LESSON . . . . .	258-269
--	---------

APPENDIX . . . . .	271-276
--------------------	---------

INDEX . . . . .	277-282
-----------------	---------



# LIST OF PLATES

xvii

✓ <small>PLATE</small>		<small>FACING PAGE</small>
✓ XXXV.	DOORWAY OF 'ALĪ SHĀHĪ PĪR-KI MASJID, BIJĀPŪR . <i>(I.O. List)</i>	94
XXXVI.	MONOLITH TEMPLE, KALUGUMALI (ELEVENTH CENTURY ?) <i>(I.O. List)</i>	98
XXXVII.	DECORATION OF DOMES . . . . .	100
XXXVIII.	A RUINED TEMPLE, KHAJURĀHO . . . . . <i>(A.S.I. Photo)</i>	102
XXXIX.	TEMPLES AT SIBSAGAR . . . . . <i>(A.S.I. Photo)</i>	102
✓ XL.	TOMB OF SIKANDAR LODI . . . . . <i>(A.S.I. Photo)</i>	108
XLI.	HINDU TEMPLE AT VISHNUPUR . . . . . <i>(I.O. List)</i>	126
✓ XLII.	SONĀ MASJID, GAUR: SOUTH-EAST CORNER OF 'ĪWĀN . . . . . <i>(A.S.I. Photo)</i>	128
XLIII.	INTERIOR OF SONĀ MASJID, GAUR . . . . . <i>(A.S.I. Photos)</i>	130
XLIV.	INTERIOR OF SAT GUMPĀZ MOSQUE, KHULNA . . . . . <i>(A.S.I. Photo)</i>	130
✓ XLV.	JĀMĪ' MASJID OF AKHI SERĀJ-'UD-DĪN, GAUR . . . . . <i>(A.S.I. Photo)</i>	132
✓ XLVI.	JĀMĪ' MASJID, CHAMPANĪR: NORTH SIDE . . . . . <i>(I.O. List)</i>	134
✓ XLVII.	JĀMĪ' MASJID, CHAMPANĪR: MAIN ENTRANCE PORCH . . . . . <i>(I.O. List)</i>	134
✓ XLVIII.	JĀMĪ' MASJID, CHAMPANĪR: FAÇADE OF LĪWĀN . . . . . <i>(I.O. List)</i>	136
✓ XLIX.	JĀMĪ' MASJID, CHAMPANĪR: LONGITUDINAL SECTION . . . . .	136
✓ L.	JĀMĪ' MASJID, CHAMPANĪR: INTERIOR OF CENTRAL DOME . . . . . <i>(I.O. List)</i>	138
✓ LI.	JĀMĪ' MASJID, CHAMPANĪR: BACK OF LĪWĀN . . . . . <i>(I.O. List)</i>	138
✓ LII.	NAGĪNA MASJID, CHAMPANĪR . . . . . <i>(I.O. List)</i>	140
✓ LIII.	NAGĪNA MASJID, CHAMPANĪR: DETAIL OF MINARET . . . . . <i>(I.O. List)</i>	140
✓ LIV.	RĀNĪ RUPĀVATĪ'S MOSQUE, AHMADĀBĀD . . . . . <i>(I.O. List)</i>	142

PLATE	FACING PAGE
LV. RĀNĪ RUPĀVĀTĪ'S TOMB, AHMADĀBĀD . . . . . ( <i>I.O. List</i> )	142
LVI. SIDI SAYYID'S MOSQUE, AHMADĀBĀD : CROSS SECTION OF LĪWĀN	144
LVII. SIDI SAYYID'S MOSQUE, AHMADĀBĀD : INTERIOR OF LĪWĀN . . . . . ( <i>A.S.I. Photo</i> )	144
LVIII. SIDI SAYYID'S MOSQUE, AHMADĀBĀD : PERFORATED STONE WINDOW ( <i>I.O. List</i> )	146
LIX. RĀNĪ SĪPARĪ'S MOSQUE, AHMADĀBĀD . . . . . ( <i>I.O. List</i> )	146
LX. DĀDĀ HARIR'S WELL, NEAR AHMADĀBĀD : PLAN AND PART SECTION	148
LXI. DĀDĀ HARIR'S WELL, NEAR AHMADĀBĀD . PART SECTION . . . . .	148
LXII. DĀDĀ HARIR'S WELL, NEAR AHMADĀBĀD : CENTRAL SHAFT . . . . . ( <i>I.O. List</i> )	148
LXIII. MĀN SINGH'S PALACE, GWALIOR . . . . . ( <i>I.O. List</i> )	152
LXIV. COURTYARD OF MĀN SINGH'S PALACE, GWALIOR . . . . . ( <i>I.O. List</i> )	152
LXV. MĀN SINGH'S PALACE, GWALIOR : APARTMENT ADJOINING COURT- YARD . . . . . ( <i>I.O. List</i> )	152
LXVI. MOSQUE OF SHĒR SHAH, DELHI . . . . .	160
LXVII. TOMB OF SHĒR SHAH, SAHSARĀM . . . . . ( <i>A.S.I. Photo</i> )	162
LXVIII. TOMB OF HUMĀYŪN, DELHI . . . . . ( <i>I.O. List</i> )	164
LXIX. JĀMĪ' MASJID, FATEHPUR-SĪKRĪ : INTERIOR OF CHAPEL . . . . . ( <i>I.O. List</i> )	166
LXX. JĀMĪ' MASJID, FATEHPUR-SĪKRĪ : FAÇADE OF LĪWĀN . . . . . ( <i>I.O. List</i> )	168
LXXI. THE BULAND DARWĀZA, FATEHPUR-SĪKRĪ . . . . . ( <i>I.O. List</i> )	170
LXXII. AKBAR'S OFFICE, FATEHPUR-SĪKRĪ . . . . . ( <i>I.O. List</i> )	172
LXXIII. DĪWĀN-I-KHĀS, FATEHPUR-SĪKRĪ . . . . . ( <i>I.O. List</i> )	174
LXXIV. PILLAR SUPPORTING AKBAR'S THRONE, FATEHPUR-SĪKRĪ . . . . .	174

# LIST OF PLATES

xix

PLATE	FACING PAGE
LXXV. RAJAH BĪRBAL'S HOUSE, FATEHPUR-SĪKRĪ <i>(I.O. List)</i>	176
LXXVI. ENTRANCE TO JODH BĀI'S PALACE, FATEHPUR-SĪKRĪ	176
LXXVII. PANCH MAHALL, FATEHPUR-SĪKRĪ <i>(I.O. List)</i>	178
LXXVIII. JAHĀNGĪRĪ MAHALL, AGRA: CORNER OF COURTYARD <i>(A.S.I. Photo)</i>	178
LXXIX. JAHĀNGĪRĪ MAHALL, AGRA: THE COURTYARD BEFORE RESTORATION <i>(I.O. List)</i>	180
LXXX. APARTMENT IN JAHĀNGĪRĪ MAHALL, AGRA <i>(A.S.I. Photo)</i>	180
LXXXI. VITTHALASWĀMI TEMPLE, VIJAYANAGAR <i>(I.O. List)</i>	186
LXXXII. SHRINES ON ROOF OF VITTHALASWĀMI TEMPLE, VIJAYANAGAR <i>(I.O. List)</i>	188
LXXXIII. "ELEPHANT STABLES," VIJAYANAGAR <i>(I.O. List)</i>	190
LXXXIV. JĀMI' MĀ'SJID, BIJĀPŪR: SECTION OF LĪWĀN	190
LXXXV. IBRĀHĪM'S TOMB, BIJĀPŪR	192
LXXXVI. SECTION OF IBRĀHĪM'S TOMB, BIJĀPŪR	192
LXXXVII. CEILING OF IBRĀHĪM'S TOMB, BIJĀPŪR	194
LXXXVIII. CORRIDOR OF IBRĀHĪM'S TOMB, BIJĀPŪR <i>(I.O. List)</i>	194
LXXXIX. MEHTAR MAHALL, BIJĀPŪR <i>(I.O. List)</i>	196
XC. MAHMŪD'S TOMB, BIJĀPŪR <i>(A.S.I. Photo)</i>	196
XCI. JAIN TEMPLE, PALITĀNA <i>(I.O. List)</i>	200
XCII. KANDARYA MAHADEVA TEMPLE, KHAJURĀHO <i>(I.O. List)</i>	200
XCIII. GOVIND DEVA'S TEMPLE, BRINDĀBAN <i>(I.O. List)</i>	202
XCIV. INTERIOR OF GOVIND DEVA'S TEMPLE, BRINDĀBAN <i>(A.S.I. Photo)</i>	202

PLATE	FACING PAGE
<b>XCV.</b> GOVIND DEVA'S TEMPLE : PILLARS IN CROSS AISLES . . . . .	202
<i>(I.O. List)</i>	
<b>XCVI.</b> BALCONY OF MÂN SINGH'S PALACE, BENARES . . . . .	204
<b>XCVII.</b> BÎR SINGH DEVA'S PALACE, DATIYÂ : WATER FRONT . . . . .	208
<b>XCVIII.</b> BÎR SINGH DEVA'S PALACE, DATIYÂ : EASTERN FAÇADE . . . . .	208
<b>XCIX.</b> THE PALACE OF URCHÂ . . . . .	210
<i>(I.O. List)</i>	
C. JODHPUR FORT AND PALACE . . . . .	210
CI. BENGALI ROOFS AND CORNICES . . . . .	212
CII. THE SAMMAN BURJ, AGRA PALACE . . . . .	212
CIII. ITMAD-UD-DAULAH'S TOMB, AGRA . . . . .	214
<i>(A.S.I. Photo)</i>	
CIV. AUDIENCE-HALL OF MADURA PALACE . . . . .	218
CV. TIRUMALAI NAYYAK'S CHAULTRI, MADURA . . . . .	218
CVI. GATEWAY OF THE SIKANDARA BAGH, AGRA . . . . .	222
CVII. THE PALACE OF DÎG : GARDEN FRONT . . . . .	224
<i>(I.O. List)</i>	
CVIII. THE PALACE OF DÎG : WATER FRONT . . . . .	226
<i>(I.O. List)</i>	
CIX. THE PALACE OF UDAIPUR . . . . .	226
CX. A MERCHANT'S HOUSE, BIKANËR . . . . .	228
CXI. BUILDINGS AT JODHPUR . . . . .	230
CXII. A SOUTH INDIAN TEMPLE STAPATHI . . . . .	232
CXIII. INDIAN MASONS AT WORK . . . . .	232
CXIV. A MODERN INDIAN PALACE, MARWAR . . . . .	234
CXV. A MODERN INDIAN PALACE, MUNSHI GHÂT, BENARES . . . . .	236
CXVI. A MODERN INDIAN PALACE, GHUSLÂ GHÂT, BENARES . . . . .	238
CXVII. A MODERN HINDU TEMPLE, BRINDÂBAN . . . . .	240
CXVIII. A MODERN HINDU TEMPLE (DURGÂ TEMPLE, BENARES) . . . . .	240

# LIST OF PLATES

xxi

PLATE	FACING PAGE
CXIX. MODERN INDIAN SCULPTURE (TEMPLE AT RAMNAGAR, BENARES)	242
CXX. MODERN INDIAN SCULPTURE (AHMÉTY TEMPLE, BENARES)	242
CXXI. A MODERN MASTER-BUILDER'S BRIDGE, LASHKAR	244
CXXII. STREET IN A MODERN MASTER-BUILDER'S TOWN (LASHKAR)	246
CXXIII. DETAILS OF BUILDINGS, LASHKAR	246
CXXIV. A MODERN CHHATRI, LASHKAR	248
CXXV. POST OFFICE, LASHKAR	250
CXXVI. A MODERN MASTER-BUILDER'S RAILWAY-STATION (ALWAR)	252
CXXVII. MODERN INDIAN SCULPTURE, PURI	254
CXXVIII. VERANDAH OF A MODERN HOUSE, PURI	254
CXXIX. GATEWAY OF A MODERN TEMPLE, BENARES	256

---

## LIST OF TEXT ILLUSTRATIONS

FIG	PAGE
1. Plan of Tâj Mausoleum	23
2. Roof Plan of Chandi Sewa, Java	23
3. Miniature Votive Buddhist Stûpa	26
4. Dome of the Great Temple at Tanjore (Eleventh Century)	27
5. Plan of the Tâj Garden, as drawn by Colonel Hodgson in 1828	37
6. Plan of Mosque at Ajmîr	44
7. Plan of Âdînah Mosque	55
8. Plan of Mosque at Kulbarga	61
9. View of Mosque at Kulbarga	62
10. Jâmi' Masjid, Jaunpur : Principal Entrance to Liwân	69
11. Jâmi' Masjid, Ahmadâbâd : Plan of Liwân	73
12. Plan of Sayyid Usmân's Tomb	78
13. Plan of Sayyid Mubâarak's Tomb	78
14. Tomb of Sayyid Mubâarak : Longitudinal Section	79
15. Leaf of Pipal Tree ( <i>Ficus religiosa</i> )	84
16. Foiled Arches at Mârtând	86
17. Arch at Fatehpur-Sikrî	89



Fig.	PAGE
18. Diagram of Bell-shaped Dome . . . . .	96
19. Construction of Ribbed Dome . . . . .	97
20. Dome similar to Fig. 19, constructed of Permanent Materials . . . . .	98
21. Seed-capsule of the Lotus . . . . .	101
22. Hindu Capital . . . . .	101
23. Finial from a Mosque in Baghdad . . . . .	103
24. Section of a Hindu Dome . . . . .	106
25. Pendentive from Mosque at Old Delhi . . . . .	110
26. Plan of Daryâ Khan's Tomb . . . . .	112
27. Daryâ Khan's Tomb : Section of Principal Dome . . . . .	113
28. Dholkâ. The Khan's Masjid : Plan of One of the Compartments of the Liwân	114
29. Dholkâ. The Khan's Masjid : Section of One of the Compartments of the Liwân . . . . .	115
30. Plan of Mahmûd's Tomb . . . . .	116
31. Section of Mahmûd's Tomb . . . . .	118
32. Pendentives of Mahmûd's Tomb, looking upwards . . . . .	119
33. Plan of Jâmi' Masjid, Champanîr . . . . .	136
34. Section of Mihrâb, Champanîr . . . . .	140
35. Plan of Mihrâb, Champanîr . . . . .	141
36. Râni Rupâvatî's Masjid : Plan of Liwân . . . . .	142
37. Plan of Tomb, Râni Rupâvatî's Masjid . . . . .	143
38. Plan of Jâmi' Masjid, Fatehpur-Sikrî . . . . .	170
39. Plan of Buland Darwâza . . . . .	171
40. Section of the Dîwân-i-Khâs, Fatehpur-Sikrî . . . . .	175
41. Ground Plan of Rajah Birbal's House . . . . .	176
42. Ground Plan of Jodh Bâi's Palace . . . . .	178
43. Arcade of Râm Râja's Treasury Vijayanagar . . . . .	189
44. Plan of Jâmi' Masjid, Bijâpûr . . . . .	190
45. Plan of Govind Deva's Temple, Brindâban . . . . .	201
46. The Jâmi' Masjid, Delhi . . . . .	217
47. South Elevation of Chandragiri Palace . . . . .	219
48. Ground Plan of Chandragiri Palace . . . . .	219
49. Plan of the City of Jaipur . . . . .	223

# INDIAN ARCHITECTURE

## CHAPTER I

### HINDU AND SARACENIC ART—THE POINTED ARCH—THE MIGRATIONS OF CRAFTSMEN—THE FIRST MUHAMMADAN INVADERS OF INDIA

THE student who tries to thread his way through the somewhat bewildering mazes of Indian art is often confused by the classifications and analysis of European writers. First, by the Græco-Roman or Gandhâran theory of the inspiration of Buddhist sculpture; next by a misunderstanding of the whole theory of Indian art in the mediæval or Puranic period, and by the sectarian classification of Buddhist-Hindu architecture; and thirdly by the attribution of the masterpieces of painting and architecture in the Muhammadan period to the superior creative and constructive genius of Islâm, or, as in one notable instance, the Tâj Mahall, to the art of Europe.

All of these misconceptions have their root in one fixed idea, the belief that true æsthetic feeling has always been wanting in the Hindu mind, and that everything really great in Indian art has been suggested or introduced by foreigners.

Fergusson, though generally far in advance of his time in the appreciation of Indian art, was by no means free from these prejudices, and his analysis of Indian architecture of the Muhammadan period confirms the general belief of the present day that between Hindu and Saracenic ideals there is

a great gulf fixed, and that the zenith of Mogul architecture in the reigns of Jahângîr and Shah Jahân was only reached by throwing off the Hindu influences which affected the so-called "mixed" styles of Indo-Muhammadan art. Fergusson distinctly declares that "there is no trace of Hinduism in the works of Jahângîr and Shah Jahân."<sup>1</sup> Though he does not lend his great authority to the legend I have discussed in detail elsewhere, which makes the Tâj Mahall the creation of an Italian adventurer in Shah Jahân's service, he treats all of Jahângîr's and Shah Jahân's buildings as not being of Indian origin, but as entirely conceived by architects of Western Asia, and suggests Samarkand, rebuilt by Timûr (A.D. 1393-1404), as the locality which would throw light on "the style which the Moguls introduced into India."

This persistent habit of looking outside of India for the origins of Indian art must necessarily lead to false conclusions. One may find primitive types, or any of the forms and symbols which Indian artists moulded to their own desires, and trace them back to their archaic roots in Chaldæa, Babylon, Assyria, Persia, or Greece; but for the vital creative impulse which inspired any period of Indian art, whether it be Buddhist, Jain, Hindu, or Muhammadan, one will only find its source in the traditional Indian culture planted in Indian soil by Aryan philosophy, which reached its highest artistic expression before the Mogul dynasty was established, and influenced the greatest works of the Muhammadan period as much as any others. The Tâj, the Motî Masjid at Agra, the Jâmi' Masjid at Delhi, and the splendid Muhammadan buildings at Bijâpûr were only made possible by the not less splendid monuments of Hindu architecture at Mudherâ, Dabhoi, Khajurâho, Gwalior, and elsewhere, which were built before

<sup>1</sup> "History of Indian Architecture," vol. ii. p. 288 (edit. 1910).

the Mogul Emperors and their Viceroys made use of Hindu genius to glorify the faith of Islâm.

The Anglo-Indian and the tourist have been taught to admire the former and to extol the fine æsthetic taste of the Moguls; but the magnificent architectural works of the preceding Hindu period, when Indian sculpture and painting were at their zenith, but rarely attract their attention, though in massive grandeur and sculpturesque imagination they surpass any of the Mogul buildings. Even the term "Mogul" architecture is misleading, for as a matter of fact there were but few Mogul builders in India. The great majority of the builders employed by the Moguls—including not only the humbler artisans but the master-minds which directed them—were Indians, or of Indian descent. Some were professed Muhammadans, but many were Hindus. Mogul architecture does not bear witness, as we assume, to the finer æsthetic sense of Arab, Persian, or Western builders, but to the extraordinary synthetical power of the Hindu artistic genius.

The truth of this statement can be demonstrated not only from documentary evidence, which may or may not be trustworthy, but from the incontrovertible record of the buildings themselves. Western writers have been so eager to seize upon the divergences between Muhammadan and Hindu civilisation, that the common basis which underlies them both generally fails to impress them. Even the main point of difference which divided Muhammadans and Hindus—the use of anthropomorphic symbols—was not by any means essential to Hinduism; and but for the differences, sectarian and racial, which drove many Hindus into the service of Musulmân states beyond the north-west frontier, the Muhammadan conquest of Hindustan would have been hardly possible.

The fundamental antagonism between Hindu and Musul-

mân religious beliefs which we so often assume, never existed at any time. The basis of Muhammad's idealism was the concept of the Unity of the Godhead—"There is One God"—which is only a condensation of the Hindu concept of the Godhead manifesting Itself in all things animate and inanimate. To the simple-minded Arab, either a mariner on the wide ocean or living in tents in the vast expanse of the lonely desert, the idea of the Divine Unity made an irresistible appeal: it sufficed to explain that infinite vastness of sky and earth and sea which surrounded him everywhere by day and night. His whole instinct of art creation was to draw everything in pure outline silhouetted against the sky, as he saw things in the glare of the open desert by day, or in the mysterious splendour of star- and moon-light, like the rocky coasts of Arabia seen from ships at sea.

All Arab design, whether in architecture, in the forms of domestic utensils, or in surface decoration, was distinguished by this feeling for pure outline and colour, rather than by a plastic treatment of surfaces or the massing of forms for contrast of light and shade in which the Hindu architectural genius especially asserted itself. Practically all Saracenic symbolism in architecture was borrowed directly or indirectly from India, Persia, Byzantium, or Alexandria, though devout Muhammadans put their own reading into the symbols they borrowed, just as the early Christians did with those they borrowed from paganism.

Even the pointed arch only acquired from India the religious significance which eventually led the Saracenic builders to adopt it as their own, through the contact of the Arabs with the Buddhists of Western Asia; and thus the very feature by which all Western writers have distinguished Saracenic architecture from the indigenous architecture of

India was originally Indian. If this proposition is opposed to all architectural authority in Europe at the present day, it is only because Western writers, through treating Indo-Muhammadan architecture as a subdivision of the Saracenic schools of Egypt, Spain, Arabia, and Persia, have left out of account the great mass of historical evidence bearing upon the arts of the West which is afforded by the architectural monuments of India.

It is of course a recognised fact that a certain type of the pointed arch was in use in Egypt and in Asia Minor even before the days of Buddhism, and long before the Hegira. But the *mihhrâb* of Muhammadan mosques—the niche in the wall of the sanctuary—and all its religious associations from which the structural application of Saracenic arches started, was not in any way connected with this early type.

The permanent mosques of the first Arab disciples of the Prophet, like the churches of the early Christians, were in most cases not buildings specially constructed for their own ritual, but those belonging to rival creeds reconsecrated for the worship of Allah. When the Arabs started on their career of conquest the first objects of their iconoclastic zeal were the temples and monasteries of the hated idolaters—the Buddhists of Western Asia. After smashing the images and breaking as much of their sculptured ornamentation as offended against the injunctions of their law, the buildings with the empty niches—the quondam Buddhist shrines—remaining in their solid walls were often converted into mosques.

The hallowed associations of generations of Buddhist worshippers still clung to these desecrated shrines, and the doctors of Islâm found it necessary to explain them in a Muhammadan sense. Hence the *mihhrâb*—the niche of the

principal image of Buddha—came to indicate the direction of the holy city of Mecca ; it was traced in the sand or woven in the prayer-mat as a symbol of the faith. The idea appealed strongly to the Arab race, for every mariner saw the mihrâb in the bow of his ship and every desert nomad in the door of his tent. The sentiment of devotion which the image in the niche formerly inspired in the worshipper was thus transferred to the niche itself, and especially to the arch of the niche. The arrangement of niches in Muhammadan houses and palaces (Plate CII) was a secular adaptation of the shrines of Buddhist monasteries. Here, then, was the psychological germ of the pointed style of architecture—Saracenic and Gothic—or of the idealism which was the motive force behind it.

All the forms of the pointed arch which characterise Saracenic buildings in the West are found in the niches of the temples of the various Brahmanical sects in India which inherited the early Buddhist traditions. Remove the images and the sculptured ornament of the niches, and you will find the ordinary Arab arch, the stilted arch, the foliated arch, etc. The process of adaptation by which Indian arches were converted into Saracenic, begun by the Arabs in Western Asia in the first centuries after the Hegira, were continued in successive centuries by all the Muhammadan invaders of India—Arab, Afghan, Turk, and Mongol.

The contemptuous name which Arabian historians gave to all the temples of the infidel in India—Boud-khâna, or “ Buddha-house ”—is one of the many proofs of the early connections of Buddhism with Islâm. Buddhist influence penetrated much farther west than the borders of Asia and Europe. Professor Flinders Petrie has found evidences of the presence of Asoka’s missionaries at Alexandria ; and

PLATE I

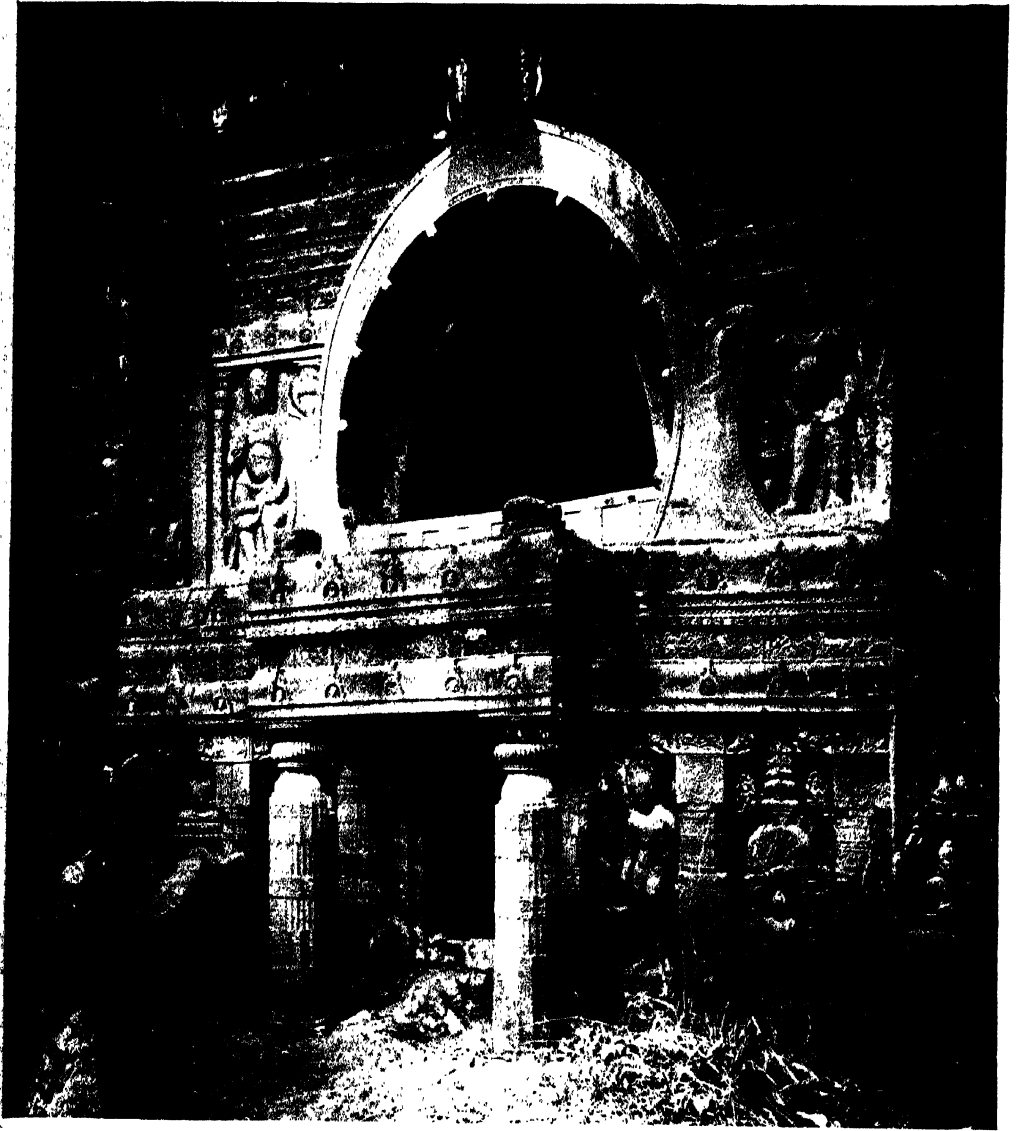

FAÇADE OF CHAPTER-HOUSE AT AJANTĀ (CAVE XIX)





the resemblance of the so-called horse-shoe arch in Moorish palaces and mosques of the eighth century A.D. and later to the lotus-leaf arches of the seventh-century Buddhist chapter-house at Ajantâ (Plate I) can easily be accounted for by the presence of the Indian craftsman in Egypt. Seeing that Indian mariners carried on a regular trade with Egypt even before the third century B.C., it is reasonable to assume that Indian craftsmen often found their way there in later times. No Western structural process by which this form of arch, derived from bent cane or bambu, might have been evolved independently is known to archæologists.

Modern European writers who try to trace the derivation of architectural style entirely from constructive or technical processes would do well to note that the pointed arch in Arab architecture was a purely religious symbol before it became a distinctive structural feature in Saracenic building. The symbolic idea connected with the pointed arch preceded the general use of it as an organic structural feature in place of the round arch and horizontal beam. It appealed to the devout Musulmân not because it was architecturally useful and beautiful, but because it symbolised the two fundamental concepts of his faith—God is One, and Muhammad is His Prophet. It was the architectonic symbol of the hands joined in prayer ; it pointed the way to Mecca and to Paradise, and demonstrated mathematically the divine truth that all things converge towards and meet in the One—the inverse of the Hindu proposition.

M. Prisse d'Avennes, in his work "L'Art Arabe," adopts the ingenious theory put forward by M. Salzmann that the different varieties of the Arab dome and the characteristic "stalactite" pendentives which supported them were originally derived from the form and structure of the water-melon.

He places sections of the latter and details of Arab buildings in Cairo side by side to show the striking similarity between them. We can very well admit the similarity without adopting the conclusion which the author derives from it—a conclusion which ignores entirely the religious idealism which lies behind both Saracenic and Hindu art. If the Arab domes and pendentives were derived from naturalistic motifs only we should see the resemblance more marked in the earlier examples than in the later. As a matter of fact there is no such resemblance in any of the earliest existing examples; the illustrations given by M. Prisse d’Avennes are all of late date, and merely indicate that some Arab builders, struck by the similarity between their traditional architectural forms and the structure of the water-melon, made the resemblance more complete. When a Hindu recognised a resemblance between his sacred symbols and any natural forms he dedicated the latter to the deity represented by the symbol. Thus the *bel* tree and many others became sacred to Siva on account of the resemblance between its compound leaves and the three-pronged trident of Mahâdeva; but the latter symbol was not derived from the natural forms.

There is nothing to show that the Arabs attached any religious significance to the water-melon, either before or after the time of Muhammad. On the other hand, the pointed arch, or mihrâb, was a religious symbol before it was used architecturally by the Arabs. The so-called stalactite pendentive is simply an agglomeration of miniature mihrâb niches<sup>1</sup> geometrically arranged to perform the structural purpose for which it was intended. The pointed domes,

<sup>1</sup> The structure of the stalactite pendentives was in all probability derived from the use of semi-cylindrical tiles, set in mortar, in place of brick corbelling or arches, for the support of light domes.

pendentives, and other characteristic features of pure Saracenic architecture are therefore not to be derived from any natural motifs, but simply from the application of their religious symbolism to all the ancient constructive forms, Roman, Byzantine, Egyptian, Babylonian, Assyrian, Phœnician, Buddhist, and Hindu, used by the builders of the many different races and creeds whom the Arabs employed.

For understanding the development of architecture in different countries it is most important to realise that the conventional nomenclature now given to different styles is apt to be very misleading unless we recognise the very cosmopolitan organisation of the building craft in the Middle Ages as well as in previous periods. No class of society has stood so strongly for religious tolerance and the principle of the universal brotherhood of man as the master-builders, and none have done more for the spread of civilisation, peace, and goodwill among all men. However bitter religious and racial animosities might be, the building fraternity knew none of them. Pagan craftsmen built for Christian, Christian for Musulmân, Buddhist for Jain and Hindu, Hindus for every sect. The same rule applied to craftsmen of different races. In times of peace the master-builders wandered far and wide in search of lucrative employment wherever it might be found. In times of war their lives were often the only ones that were spared by the victors in battle or in the sack of cities, for their services were highly valued by all combatants, even by barbarian marauders like the Huns and Mongols. Every new city that was founded or great monument that was built drew to it builders and craftsmen even from far-distant countries. Thus we read of an architect from Ferghâna in Central Asia building the Nilometer in Egypt, of Chinese craftsmen assisting in the building of Baghdad, of Indian craftsmen in Japan,

and of Persian architects employed in Cairo. If the master-builders of the East had left written records of their travels, we should probably know many Indian Marco Polos who journeyed westwards as well as eastwards when Buddhism was spreading its civilisation all over Asia.

When therefore we speak of Arab architecture and Arab art, it is necessary to remember that few builders and craftsmen were Arab by race ; we simply mean the different phases of art and architecture which were evolved in different countries and by different races under the influence of Arab culture. Dr. Gustave le Bon distinguishes twelve different styles of Arab architecture, of which the only two which can be considered pure—*i.e.* not dominated by Byzantine, Romanesque, Persian, or Hindu influences—are an Egyptian style, represented by the series of mosques dating from the tenth to the fifteenth centuries, and a Spanish style, represented by Saracenic buildings in Seville and Grenada. But even in Egypt and Spain, the sources of inspiration of all that is typical of pure Arab art and architecture were in India, Mesopotamia, Persia, and Central Asia.

Though Saracenic and Indian art had this much in common, it is essential to remember that if India, from the time of Asoka down to the early centuries of the Christian era, had borrowed much artistic material from the countries with which she had had intimate commercial and political relations from time immemorial—Mesopotamia, Persia, and Central Asia—she was at the time of the Muhammadan invasions no longer a borrower, but a lender. Buddhist art had spread all over Western Asia in the previous centuries, and Buddhist Hindu art was at its zenith when India received the first shock of the Muhammadan invasions. As the armies of Islâm, largely recruited from Tartary and Central Asia, came nearer

PLATE II



BARODA GATEWAY, DABHOI (ELEVENTH CENTURY)



to the north-west frontier of India, Saracenic art came into closer contact with Buddhist-Hindu civilisation and became more and more impregnated with Indian influences, until at last Arab, Persian, and Central Asian art lost their own individual identity as creative forces, and merged themselves into different local phases of Indian art of which the æsthetic basis was essentially Hindu, and only Arab, Mogul, and Muslim in a political, ritualistic, and dogmatic sense.

History was, as usual, repeating itself in this ; for exactly similar circumstances had arisen in the early centuries of the Christian era, when the art of Gandhâra, from being a provincial phase of Buddhist art with a strongly developed Græco-Roman dialect, became gradually Indianised and merged itself into the Indian æsthetic synthesis. The Saracenic art which came into India had likewise been Indianised before it crossed the Indus ; for it was upon the basis of Buddhist-Hindu civilisation that the two earliest styles of Indo-Muhammadan architecture which Fergusson calls the Ghaznavide and the Pathân, had been built. It was in the Gandhâra country that Mahmûd of Ghaznî and his successors had the centre of their power, and Indian builders were employed in constructing " the palaces and public buildings, mosques, pavilions, reservoirs, aqueducts, and cisterns " with which Mahmûd's capital was adorned " beyond any city in the East." The builders were not the fighting Afghans, but descendants of the peaceful Buddhist builders adapting their art structurally as well as decoratively to the needs of a militant instead of a monastic community, and to the symbolism of a monotheistic creed.

The Muhammadan invaders of Hindustan certainly did not have the same opinion with regard to the inferiority of Hindu art and architecture, as compared with their own,



which is commonly held by Europeans to-day. The Arabs, before they came to India as conquerors, had drunk deeply at many sources of Hindu culture ; and though they detested Hindu sculpture and painting on religious grounds, they had the highest respect for the skill of Indian architects and artists. Alberuni, the Arab historian who visited India in the beginning of the eleventh century and knowing all the architectural splendour of Baghdad at the height of its glory, before it was laid waste by the Mongols, expressed his astonishment at and admiration for the works of Hindu builders. "Our people," he said, "when they see them, wonder at them and are unable to describe them, much less to construct anything like them."

With this we may compare the admiration of a later Musulmân writer, Abûl Fazl, Akbar's chronicler, for Hindu painting. "It passes our conception of things : few indeed in the whole world can compare with them." Alberuni's contemporary, the great Sultan Mahmûd of Ghaznî, in spite of his detestation of Hindu idolatry, could not refrain from expressing his admiration for Hindu builders. Ferishta tells us that after the sack of Mathurâ he wrote to the Governor of Ghaznî extravagantly extolling the magnificence of the buildings and the city. "There are here," he said, "a thousand edifices as firm as the faith of the faithful ; nor is it likely that this city has attained its present condition but at the expense of many millions of *deenars* nor could such another be constructed under a period of two centuries."<sup>1</sup> When he returned to Ghaznî he brought back 5,300 Hindu captives, doubtless the greater number of them masons and craftsmen, for building the magnificent mosque of marble and granite known by the name of the Celestial Bride, which

<sup>1</sup> Ferishta, Briggs's translation, vol. i. p. 59.

PLATE III



REMAINS OF HINDU BUILDINGS, DABHOI (ELEVENTH CENTURY)



he caused to be built to commemorate his triumphs. Seeing how great the reputation of Hindu craftsmen was, and since we know that Hâroûn-al-Rashîd renewed the ancient intercourse of Mesopotamia with India and had Indian ambassadors at his Court, we may safely assume that Indian builders, artists, and craftsmen were among those of other nations which the great Khalif and his successors employed in the building of Baghdad, just as Timûr, the founder of the Mogul dynasty, used them five centuries later in the building of Samarkand.

When the Muhammadan dynasties—Arab, Turk, or Mongol—established themselves firmly in Hindustan, the reversion of what we may call the pure Saracenic or Arabian characteristics to the old Indian or Buddhist-Hindu types becomes more and more evident. The stern simplicity of the Pathân fortress style, which at first sight seems so very un-Indian in conception, gave way to the luxury and elaboration of Akbar's and Jahângîr's palaces. Of the thirteen local divisions of Indo-Muhammadan architecture enumerated by Fergusson, those of Gujerat, Gaur, and even that of Jaunpur, in spite of its pointed arches, are so conspicuously Hindu in general conception and in detail that it is evident at first glance that the builders and craftsmen must have been almost entirely Indian, and probably many of them Hindus. The Jâmi' Masjid and other mosques of Ahmadâbâd are, as Fergusson says, "Hindu or Jain in every detail," only here and there an arch is inserted, not because it is "wanted constructively, but because it was a symbol of the faith." At first sight the essential Indianness of the remaining Indo-Muhammadan styles, as classified by Fergusson, is not so apparent. In two of the most important, namely the Mogul and Bijâpûr styles, Fergusson and all other writers have ignored the Hindu

element entirely and treated them both as foreign to India. Here, I think, they are as mistaken as the archæological experts who have attributed the inspiration of Indian sculpture to the Græco-Roman craftsmen of Gandhâra. It is Indian art, not Arab, Persian, or European, that we must study to find whence came the inspiration of the Tâj Mahall and great monuments of Bijâpûr. They are more Indian than St. Paul's Cathedral and Westminster Abbey are English.

## CHAPTER II

### HINDU SYMBOLISM—THE DESIGN AND BUILDING OF THE TÂJ MAHALL

WE have already seen that the religious idealism and philosophy of the Arabs were summed up in the pointed arch. What the mihrâb was to the Musulmân, the lotus was to the Buddhist and Hindu. The shining lotus flowers floating on the still dark surface of the lake, their manifold petals opening as the sun's rays touched them at break of day, and closing again at sunset, the roots hidden in the mud beneath, seemed perfect symbols of creation, of divine purity and beauty, of the cosmos evolved from the dark void of chaos and sustained in equilibrium by the cosmic ether, *akâsha*. Their colours, red, white, and blue,<sup>1</sup> were emblems of the Trimûrti, the three Aspects of the One—red for Brahmâ the Creator ; white for Siva, the Divine Spirit ; blue for Vishnu, the Preserver and Upholder of the Universe. The bell-shaped fruit was the mystic Hiranyagarbha, the womb of the Universe, holding the germ of worlds innumerable still unborn. The lotus was the seat and footstool of the Gods, the symbol of the material universe and of the heavenly spheres above it. It was the symbol for all Hinduism, as the mihrâb was for all Islâm.

Closely connected with the symbolism of the lotus was that of the water-pot—the *kalasha* or *kumbhu*—which held the creative element, or the nectar of immortality churned

<sup>1</sup> The lotus in Hindu ritual must be taken to include the water-lily (*Nymphaea*) as well as the sacred lotus of Egypt (*Nelumbium*).

by gods and demons from the cosmic ocean. These two pregnant symbols were employed in Indian architecture and art, both structurally and decoratively, in an infinite variety of ways. The open lotus flower is used as a sun-emblem on the Buddhist rails of Bharhut, Sâncî, and Amarâvatî; the so-called "horse-shoe" arch of early Buddhist gables and windows, derived from bent bambu, suggested the lotus leaf; Buddhist and Hindu domes, constructively derived from the bambu also, were made to imitate the bell-shaped lotus fruit and sculptured with the petals of the flower. The combination of the lotus flower, the bell-shaped fruit, and the water-pot forms the basis of the design of most Hindu temple pillars (fig. 20), the prototypes of which were doubtless the carved wooden posts marking the sacrificial area, in the ancient Vedic rites, to which the victims were bound.

Though the sacrificial element was excluded from Muhammadan symbolism, there was nothing in the latter, either in the abstract or in its concrete artistic applications, which would seem new and strange to the Hindu. A Hindu craftsman would instantly recognise it as part of his own. If the Musulmân preferred to concentrate his thoughts on the Unity of the Godhead rather than on Its infinite manifestations, Hindu philosophy would not dispute with him on that account. The pointed arch was only the familiar lotus petal, the eye of the Gods, used constructively in a way the Hindu craftsman did not usually follow, except in the construction of shrines for his deities, for he preferred the beam and bracket as a structural device; yet he could easily construct it by placing two brackets, or two series of brackets, opposite to each other. The Musulmân dome in construction did not differ materially from the Hindu dome. All varieties of it had their Buddhist or Hindu prototypes, and were classified in the Silpa-sâstras,

the canonical books of Indian craftsmen. Fergusson made a great mistake when, after suggesting Timûr's capital at Samarkand as the place of origin of the style which the Moguls "introduced into India," he states that the "bulbous" dome which appears everywhere at that place was not known in India in the fourteenth century, unless it was in the quasi-Persian province of Sind. The "bulbous" or so-called Tartar dome was common in Indian, Buddhist, and Hindu buildings centuries before it appears in Persia in Saracenic buildings, and that most typical feature of Mogul architecture was certainly not first introduced into India by Muhammadan builders.

The dome which is distinctively Saracenic is not the bulbous one, but the sulted Arab form characteristic of the tombs of the Mameluks at Cairo (fig. A, Plate V). The distinguishing characteristic of this, which we may call the pure Arab dome, is the perfect purity and simplicity of its whole contour; except for surface ornament in low relief, it is quite unbroken; only the springing of it from a circular drum or polygonal base is sometimes marked by a plain band. This type of dome is also sometimes fluted or ribbed. The finial, as in all Arab and true Persian domes, is very inconspicuous, being only a more or less ornamental spike projecting from the crown of the dome, and not, like the Indian one, an important member forming an integral part of the dome itself. We shall see the importance of this for distinguishing the Hindu element in Mogul design later on.

The prototype of this Arab dome is to be found in the mud huts of ancient Mesopotamia, which are sculptured on Assyrian bas-reliefs and are still found in village dwellings of the present day in the neighbourhood of the ruins of Babylon and Nineveh.



The Muslim Arabs perfected the primitive form, used more permanent and costly materials, and lavished ornament in relief and gorgeous colour upon it, but hardly varied the form itself otherwise. The other types of Arab domes in Egypt and elsewhere were borrowed either from Roman, Byzantine, or Persian buildings.

Now, this type of dome, the only one in Saracenic buildings not borrowed from Roman, Byzantine, or Persian architecture, never established itself permanently in India. Indian builders under Muhammadan rule borrowed largely Arab geometric patterns and the splendidly decorative Tughra and Kufic characters; they used also to some extent the Arab stalactite pendentive and the Arab pointed arch, which was also their own; but the structural forms of Muhammadan buildings in India, whenever they can be called Saracenic, were nearly always Hindu adaptations of, and often great improvements upon, the Saracenic types. The greater engineering problems with which they had to deal, notably in dome building, were solved in their own way. Neither the Arabs nor the Persians had previously attempted them.

From this general analysis let us proceed to discuss in detail the marks of their dominating creative genius which Hindu master-builders have left on the great monuments of the Indo-Muhammadan styles. It will make the point clearer if we take first a typical and supreme example of the Mogul period which exhibits the peculiar characteristics of Muhammadan buildings of that epoch in their highest perfection—namely, the Tâj Mahall at Agra. It will better illustrate my thesis because no authority, European or Indian, has yet discovered in it the smallest suggestion of Hindu influence. The whole controversy connected with the building of the Tâj has been concentrated on the story related by the

PLATE IV



THE TAJ MAHAL, FROM THE KIVIR



Augustinian friar, Father Manrique, that its chief architect was an Italian adventurer in Shah Jahân's service, one Geronimo Veroneo. As I have dealt with this question fully elsewhere,<sup>1</sup> I will not discuss it further here.

Fergusson, as noticed above, expressly excludes Hindu influence from any of Jahângîr's or Shah Jahân's buildings. The characteristic Hindu roof of the upper pavilion in Itmad-ud-daulah's tomb and of the Golden Pavilion in the Agra palace are sufficient proof that this statement is not precisely accurate. But the Tâj in its superb simplicity and purity of form seems at first sight so great a contrast to anything that Indian builders have created at any time before the Musulmân conquest that the suggestion of Hindu influence might be ridiculed as absurd. Every one would regard the Tâj as a typical example of pure Muhammadan art

On the other hand when we come to examine it more closely, there is one thing which has struck every writer about the Tâj, and that is its dissimilarity to any other monument in any part of the world. There is only one other building which has been regarded as its prototype, and that is another Indian monument, Humâyûn's tomb at Delhi (Pl. LXVIII). So whether the designer of it was an Italian or of any other nationality, the unique combination of excellences which Western critics find in the Tâj belongs to no Saracenic building outside of India. We may analyse its details archæologically and say this came from Persia, that from Arabia, and here is something which dimly suggests the Italian Renaissance. But when the archæologists have had their say, the fact remains indisputable that whether we regard it as a whole for the perfection of its proportions, the symmetry and just balance of its structural masses, or for the exquisiteness of its

<sup>1</sup> See "Handbook to Agra and the Taj" (Thacker, Spink, Calcutta)

decorative details, we shall find no Saracenic building to compare with it. Whatever it may be it is Indian, for even if its chief architect were an Italian, he discarded European models entirely and took those which India herself had created.

What is the significance of the fact that India is the classic land of Muhammadan architecture? For it can hardly be disputed that there are certain fine qualities in the best Indo-Muhammadan buildings—qualities which are not confined to the Tâj alone, but are characteristic of all the best examples of Muhammadan work in India—which entitle it to be regarded as such.

An enthusiastic admirer of Muhammadan architecture in Egypt and in Spain, Mr. Stanley Lane Poole, is constrained to admit that the mosques of Cairo owe their peculiar charm, not to architectural form or sound constructive principles, but to their decorative beauty, “to tone and air, to association, to delicacy and ingenuity of detail.” He quotes as a criticism which is generally just the following words of another good authority, Franz Pasha, architect to the Khedive’s Government. “While bestowing their full meed of praise on the wonderfully rich ornamentation and other details of Arabian architecture, one cannot help feeling that the style fails to give entire æsthetic satisfaction. Want of symmetry of plan, poverty of articulation, insufficiency of plastic decoration, and an incongruous mingling of wood and stone are the imperfections which strike most northern critics. The architects, in fact, bestowed the whole of their attention on the decoration of surfaces; and down to the present day the Arabian artists have always displayed far greater ability in designing the most complicated ornaments and geometrical figures than in the treatment and proportion of masses. Although we occasionally see difficulties of construction well overcome, as

in the case of the interior of the Bâb-en-Nasr, these instances seem rather to be successful experiments than the result of scientific workmanship.”<sup>1</sup>

Exactly the same criticism may be applied to Saracenic architecture in Persia. Very few of the existing buildings, however magnificent they may be in the decorative use of painted tiles and tile-mosaic, can be compared with Indian for beauty of architectural structure, scientific engineering, skilful planning, and perfect masonic craftsmanship. The one constructive feature of Muhammadan mosques in Persia, the great semi-domed portal, is praised by Fergusson as being “a perfectly satisfactory solution of a problem which exercised the ingenuity of architects in all ages, but was more successfully treated by the Saracenic architects than by any others.”<sup>2</sup> If Persian ingenuity first devised this most admirable structural application of the Arab *mihrâb*, the Indian architects improved greatly upon their use of it, as one can easily see by comparing the entrance of the mausoleum of the Tâj, or the Buland Darwâza of Akbar’s great mosque at Fatehpur-Sîkrî (Pl. LXXI) with any Persian examples. The grandly recessed portals of Indo-Muhammadan buildings never seem out of harmony with structural intentions; they are so finely proportioned and perfectly adjusted to the whole building as never to disturb the balance of the architectural design with their colossal dimensions. In Persian mosques their effect is equally imposing in a decorative sense, but structurally their design is vastly inferior to Indian examples, for the whole façade to which they belong looks more like a temporary screen or hoarding put up to make a display of gorgeous colour than any part of the building itself.

<sup>1</sup> “Art of the Saracens in Egypt,” Stanley Lane Poole, pp. 89-90.

<sup>2</sup> “Indian Architecture,” vol. ii. p. 297 (edit. 1910).

“Stalactite” pendentives and similar structural or ornamental devices were also borrowed frequently by Indian builders; but in this again the superiority of the Hindu to the Saracenic craftsman is conspicuous, for the adaptation is always used in India with perfect taste and structural propriety. In the Alhambra the pendentives and the soffits of arches were overloaded with ornaments in such a way as to destroy entirely the appearance of strength and stability which is essential to good building design. One might imagine that vast swarms of wild bees had built gigantic nests under the arches and domes. Indian builders knew the ethics of their art too well to perpetrate such an outrage.

There can be only one explanation of the manifest architectural superiority of Muhammadan buildings in India to the monuments of Saracenic art in other parts of the world, whether it be in Egypt, Arabia, Persia, or Central Asia. It is that in the eighth and ninth centuries of the Christian era, the time of the first Muhammadan invasions of India, the Hindus were—as both Alberûni and Mahmûd of Ghaznî bore witness later—the master-builders *par excellence* of Asia, and probably of the whole world. The impact of Islâm upon India brought new ideas and stirred Indian builders to new creative efforts, but Hinduism was as superior to Islâm in the arts of peace as Islâm was to Hinduism in the arts of war. The Arabs, Tartars, Mongols, and Persians who came into India had much to learn from Hindu civilisation, and it was from what they learnt and not from what they taught that Muhammadan art in India became great. The Tâj Mahall belongs to India, not to Islâm.

Obviously it is necessary to find something more than general proofs to make such an assertion acceptable. The specific proofs which are necessary the Tâj itself also supplies.

The Indianness of the general impression made by the Tâj is borne out by a detailed examination of its structure. First one may remark that the weakness which is found in most Saracenic monuments, except when they are based upon Roman, Byzantine, or Hindu models, namely that in the massing of structural form they are only completely satisfactory from one point of view—the direction in which the believer turns towards Mecca—is not apparent in the Tâj and is seldom found in Indo-Muhammadan buildings. It has what

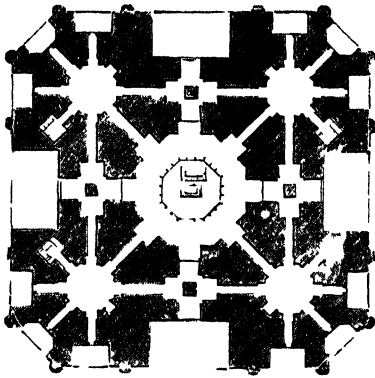

FIG 1 —Plan of Tâj Mausoleum (from Ferguson's "Indian Architecture").

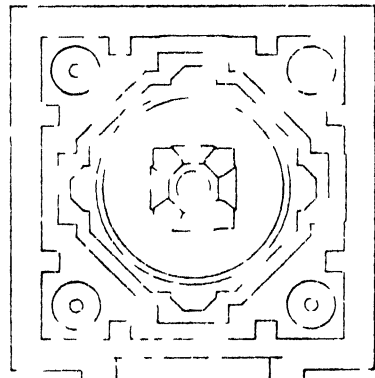

FIG 2 —Roof Plan of Chandī Sewa, Java.

the sculptor calls a good all-round design artistically pleasing from all points of view. This sculpturesque or architectonic quality, which is generally lacking in pure Saracenic buildings, belongs pre-eminently to Hindu architectural design: the Hindu builder was a sculptor as well as a mason, having acquired his skill at Elephanta, Ellora, and Ajantâ in many generations from dealing with great masses of living rock.

Next we can see that the arrangement of the roofing of the mausoleum itself consists of five domes—one large one, and four small cupolas. That this is not an after-thought, as Mr. R. F. Chisholm has suggested, but an integral part of the



whole structural design, will be evident from an examination of the plan of the mausoleum, in which the four chapels, surrounding the central chamber in which the cenotaphs are placed, are shown.

Now, this structural arrangement is not Saracenic, but essentially Hindu. It is known in Hindu architecture as the *pañch-ratna*, the shrine of the five jewels, or the five-headed lingam of Siva, symbolising the five elements, earth, water, air, fire, and ether. A typical example of it is found in one of the small shrines of Chandi Sewa at Prambânâ in Java, which has an arrangement of domes strikingly similar to that of the Tâj. I think it will be obvious that this temple (Plate V, B), and not Humâyûn's tomb, supplies the true prototype of the Tâj mausoleum. The date of the completion of the Chandi Sewa, given by Sir Stamford Raffles and accepted as approximately correct by Mr. Phené Spiers, is A.D. 1098, nearly five and a half centuries before the Tâj was begun and more than a century before any Muhammadan dynasty had established itself in Hindustan. The design of Chandi Sewa was even at that time an old Indian tradition: it was one of the symbolic formulas of temple-building used both by Buddhists and Hindus. The planning and roofing of the Tâj mausoleum were therefore based upon old Indian masonic symbolism, recognised in Buddhist art, adopted by generations of builders throughout the Hindu revival of the Middle Ages, and finally transmitted by them to their descendants in the reign of Shah Jahân. The tradition survives in Hindu temple-building of the present day.

The beauty of the Tâj, so far as the structure is concerned, culminates in the supreme grace of the central dome. The dome of Humâyûn's tomb differs from that of the Tâj in many essential points. The former is of the Saracenic type

PLATE V

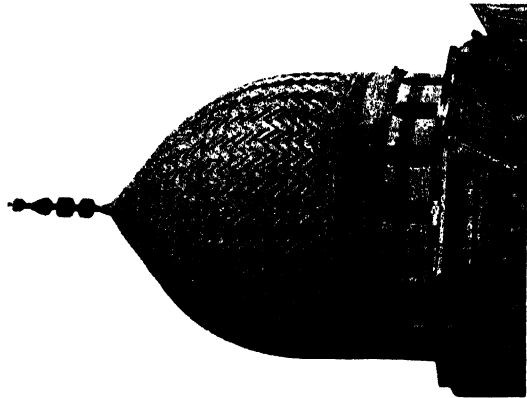

A. ARAB DOME

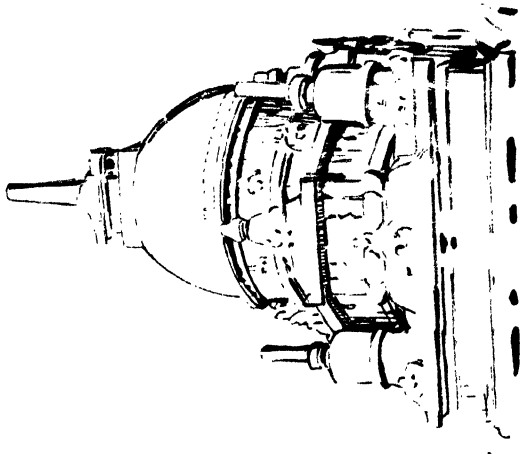

F. DOMES OF CHANDI SEWA

SARACNIC AND HINDU DOMES

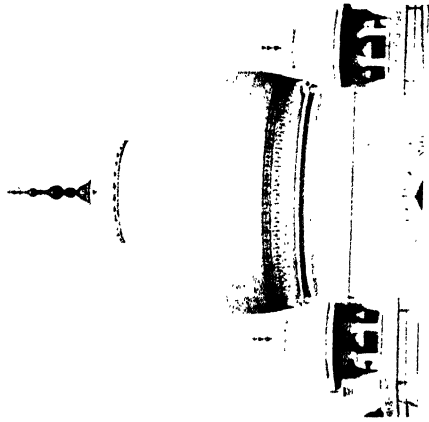

C. DOMES OF THE TAJ MAHALL



of Persia and Central Asia—*i.e.* it is not stilted, like the domes of Arab tombs in Cairo, and instead of springing directly from the drum in which it is built, it is corbelled out so as to overhang the drum slightly at the base. Otherwise it resembles the Arab type of dome in having an unbroken contour from the springing to the crown; the pinnacle or finial being only an insignificant metal spike coming out of the crown.

The dome of the Tâj, on the other hand, is that which is commonly described as a “bulbous” one—not aggressively so, like a typical Tartar dome, but growing up from the base with exquisite tenderness and subtlety, as if the master-craftsman would sum up in its perfect contours all the grace of ideal womanhood. We shall see that the curve is not a single unbroken one, as in the typical Arab dome, but has three marked divisions: first the incurving at the base, where a band of inlaid decoration marks the springing, and suggests a lotus flower holding the dome within its unfolded petals; secondly, the main structure or centre of the dome; and, thirdly, the pinnacle, which does not rise abruptly from the crown, but is connected with the centre of the dome by another lotus-like member which has the petals turned downwards instead of upwards.

Now, these marked characteristics do not belong to the pure Saracenic style of architecture: they are distinctly Indian, and, like the *panch-ratna* grouping of the domes, are based entirely upon Buddhist-Hindu masonic traditions. The dome of the Tâj is not related to that of Humâyûn’s tomb; it is not an Italian, but a Hindu or Indian type.

With regard to “bulbous” domes generally and Fergusson’s statement that they were not known in India until after the Muhammadan invasions, the simple fact is that the “bulbous” form is essentially an Indian one. Many

examples of it exist to this day in the Buddhist rock-cut temples; and for every rock-cut example now extant we may safely assume that, when Buddhism flourished as a State religion, there were a hundred or a thousand built of clay, sun-dried bricks, and other impermanent materials. The *dâgabas* in the interior of the chaityas numbered XIX and XXVI at Ajantâ have "bulbous" domes (Plate VI).

Pl. VI, B shows a domed canopy of "bulbous" form represented in the exterior of Cave

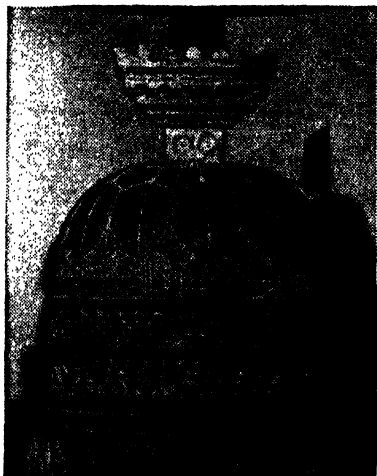

FIG. 3.—Miniature Votive Buddhist Stûpa.

No. XIX. Here one can see plainly the lotus-flower moulding at the springing of the dome: it is found also in the Chandi Sewa dome. The prototype of the lotus member connecting the Hindu pinnacle with the dome can be seen in fig. 3, a Buddhist stûpa with lotus petals springing from the tee and covering the whole dome.

Now, if we refer to the orders of Hindu classic architecture embodied in the Sanskrit technical books as the *Silpa-sâstras*, a summary of which is given in Râm Râz's valuable but fragmentary "Essay on the Architecture of the Hindus," we shall find the connecting links between the dome of the Tâj and its Buddhist prototypes, and see the derivation of its three divisions, or members. The different parts of the dome of a Dravidian temple *vimâna* are there set forth in minute detail.

Above the *ad'histhâna* or base which contains the cell or shrine of the deity there are three main groups of members.

PLATE VI

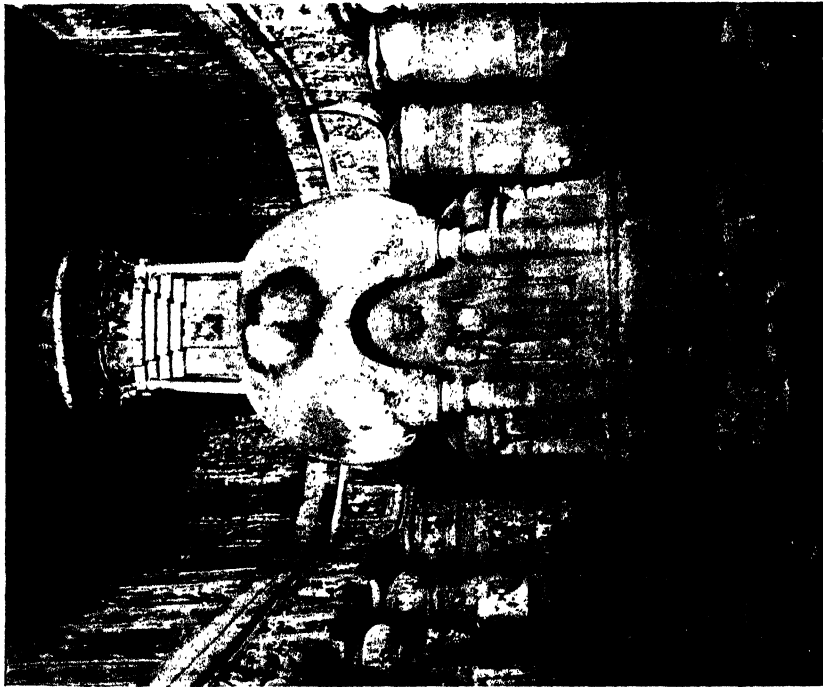

A

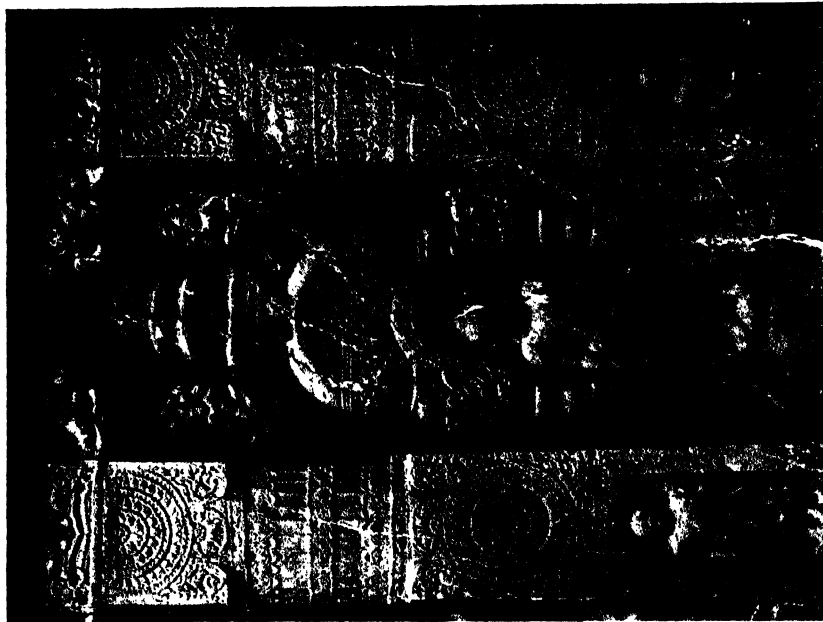

B

DOMES AT AJANTĀ



First there is the *griva*, the neck of the dome, which is the drum or polygonal base on which it rests. The *griva* is crowned by a projecting cornice called the *lupa-mula*. Above this is the *sikhara*, or main portion of the dome itself, which is bulbous-shaped like that of the Buddhist *dâgaba*, and springs from a composite lotus moulding consisting of three parts, two rows of lotus petals connected by a bead-moulding called the *malâbaddha*.

The *sikhara* is surmounted by the *stûpi* or pinnacle, which has two principal members, the *Mahâ-padma*, or great eight-petalled lotus<sup>1</sup> joined to the *sikhara* by a moulding called the *pattica*; and the *kumbha* or *kalasha*, the symbolic water-pot (fig. 4).

This Dravidian type of a Hindu vimâna, early examples of which are found at

Mâmallapuram in Madras, and in the Kailâsa temple at Ellora, is, as Fergusson has shown, only an elaboration of the early Buddhist many-storied monastery, or assembly hall, surmounted by a domed shrine. A reference to the illustrations will show clearly that the constituent elements of the Tâj dome follow exactly in form and in symbolism the old Buddhist-Hindu canon based upon the lotus flower and

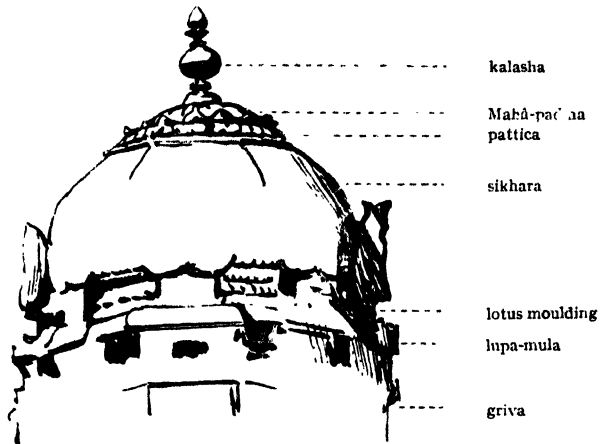

FIG. 4.—Dome of the Great Temple at Tanjore (Eleventh Century).

<sup>1</sup> The divisions between the petals marked the four cardinal and intermediate points.



the water-pot, and have no connection with either Arabian or Italian architectural types.

It may, however, be urged quite reasonably and plausibly that, in spite of this Buddhist-Hindu derivation and resemblances in matters of detail, there is in the whole conception, especially in the purity, simplicity, and subtlety of the contours of the domes, a wide world of difference between the Tâj or the Motî Masjid at Agra and the fantastic elaboration of most Hindu temples. That may be granted, but no one who has entered deeply into the spirit of Buddhist-Hindu art will admit that it excludes the qualities which most appeal to Western taste in Indo-Muhammadan monuments. It will be apparent to every student of Indian painting and sculpture that in their pursuit of the divine ideal and in their treatment of the human figure Buddhist and Hindu artists invariably sought for and realised that same refinement of line and simplification of surfaces which we find so admirable in the Muhammadan monuments of Agra, Delhi, and Bijâpûr. When Indian artists wished to simplify, they simplified as grandly as they elaborated, for they possessed in a high degree both the synthetical and analytical faculty. The vivid imaginative power and consummate executive skill which traced the wonderful outlines of the Ajantâ frescoes, and wrought in stone, bronze, or clay the Indian divine ideal, in which perfect simplicity is joined to sublime strength and dignity, would not find the exquisite tenderness and subtlety of the Tâj beyond its artistic range.

The Tâj has its prototype also in the Ajantâ paintings ; in the Mother and Child before Buddha, in the noble Buddha of the first Cave temple, as well as in the sculptured Buddhas of Anuradhapura and Bôrôbudûr. I have pointed out elsewhere that in several of the great Mogul monuments, notably

PLATE VII

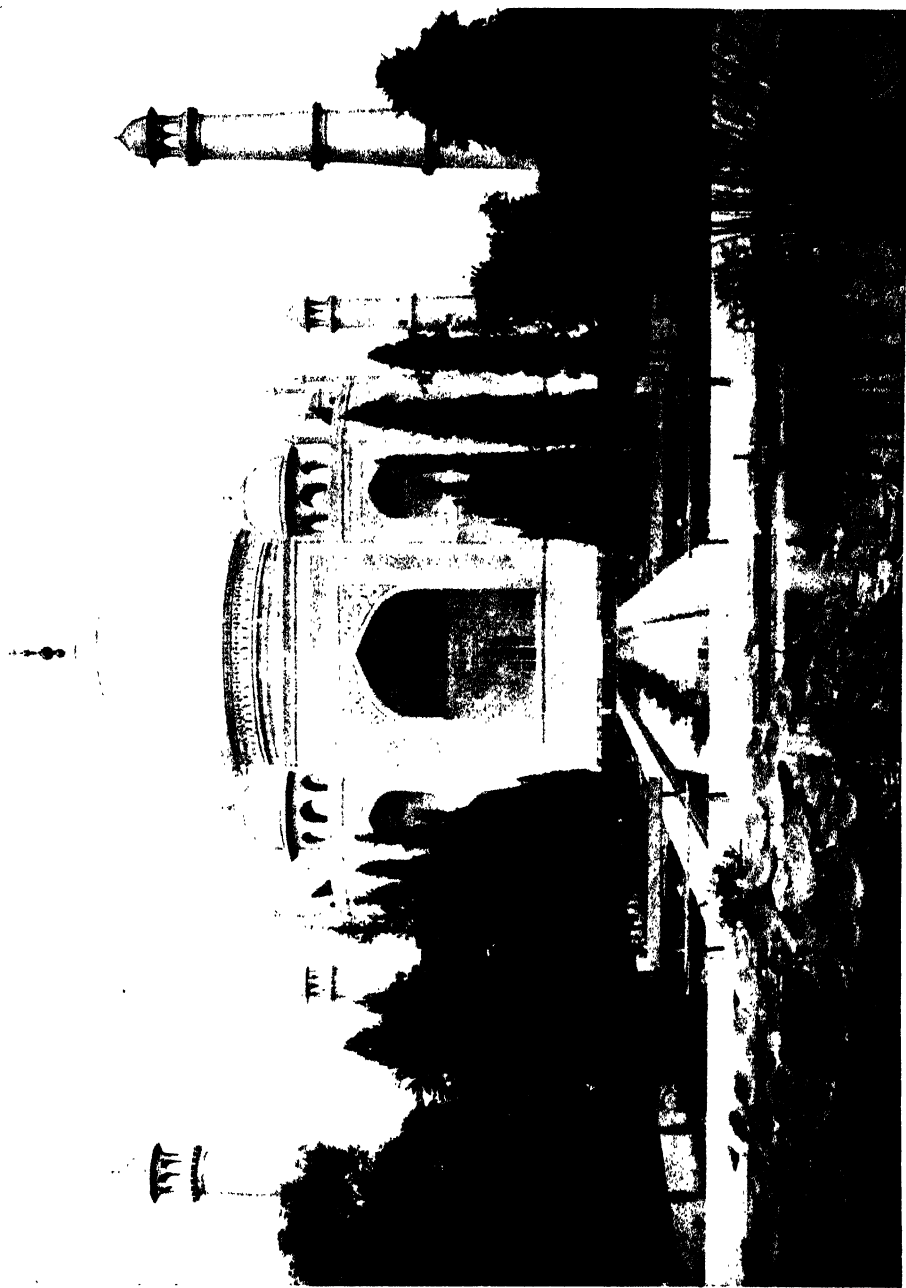

THE TAJ MAUSOLEUM



the Tâj, the tomb of Itmad-ud-daulah and that of Akbar at Sikandra, there is a characteristic personal touch which differentiates them from other monuments of the orthodox Saracenic styles. Neither Akbar nor his son and grandson were strict Muhammadans ; all three had more or less strong Hindu leanings. The tomb of the orthodox Musulmân is always impersonal in its testimony to the glory of God and of the faith of Islâm. But Akbar's tomb is a monument to the great statesman and thinker—one of the few who have tried to harmonise the jarring discords of the world's contending sects and creeds, and to found a universal religion upon a synthesis of all of them. It was a happy idea to plan his monument upon the Indian tradition of a many-storied assembly hall, where the philosophers of old had been wont to meet for debating metaphysical and religious questions—the same plan which Akbar himself had taken for his audience-hall at Fatehpur-Sîkrî, where he met all the doctors of Islâm, of Hinduism, Judaism, and of Christianity, and listened to their disputations. The monument which Nûr Mahall, Jahângîr's favourite wife, raised to the memory of her father, the Itmad-ud-daulah, tells us equally plainly of the refined eclectic tastes of the scholar and polished courtier, the Lord High Treasurer and Prime Minister, and those of his beautiful and accomplished daughter the Empress.

The Tâj itself is still more pregnant with human feeling. It is India's Venus de Milo ; the apotheosis of Indian womanhood. It may be that this personal or human quality is something too vague and intangible to analyse architecturally, though it has been felt by every European who has entered into the spirit of the Tâj. One feels instinctively that the builders tried to rise above the ordinary canons of architectural law : the Tâj is a great ideal conception which belongs

more to sculpture than to architecture ; and in this respect certainly it is more closely related to Hindu than to Saracenic art, for such an idea is altogether repugnant to the puritan sense of Islâm. It is true that the Shia sects did not observe the strict letter of the Qurân, which forbids the representation of animate nature in art, but anything which suggested idolatry in a building of a religious character would not be tolerated by any true believer. We find it in the Tâj just because its builders were inspired by Hindu rather than by Saracenic masonic traditions and symbolism. The Hindu master-builder was both a sculptor and a mason ; his æsthetic vision was more intense, more sensitive, and wider than that of the Musulmân brought up in the dry geometric tradition which kept anthropomorphic idealism beyond the range of artistic expression. The religious prejudices of Islâm prevented the Hindu master-builders from exercising their skill in the usual form of sculpture ; but this tomb of Mumtâz Mahall, whose personal qualities had endeared her to Hindu and Musulmân alike, gave them an unique opportunity. If they could not carve her statue, they could satisfy Shah Jahân's desire for a monument which should be one of the world's wonders by creating an unique architectonic symbol of her loveliness.

We need not suppose that the builders of the Tâj were consciously and deliberately working with this end in view, but only that—consummate artists and craftsmen as they were—being filled with Shah Jahân's passionate desire to create a monument worthy of his beloved consort, the Tâj grew up under their hands a living thing with all the æsthetic attributes of perfect womanhood, more subtle, romantic, and tender in its beauty than any other building of its kind.

From a technical point of view we need only note in the result achieved the careful selection of fine materials, of marble

drawn from the best quarries of Rajputana, contrasted with the rich colour of red sandstone, its surface sometimes delicately carved in low relief, sometimes inlaid with all manner of precious stones as if to simulate a matchless loom-embroidered *sari*. Secondly, the avoidance of all strong, rugged contrasts either in decoration, in the general disposition of masses, or in the rhythmical spacing of architectural details : all heavy mouldings and deep projecting cornices, such as are found in most other Mogul buildings of the time, are omitted, and the contours of the domes are drawn with extraordinary subtlety and fineness. Lastly, exquisitely finished craftsmanship throughout the building.

It might be assumed from my line of argument that I am trying to prove that there is no connection between the design of the Tâj and the building already mentioned, which Fergusson assumes to be its prototype, Humâyûn's tomb at Delhi, commenced by Humâyûn's widow nearly a century before the Tâj was begun, and completed by Akbar in 1565. It would be foolish to make such an attempt, for the connection between the two buildings is obvious. Fergusson's mistake is in not recognising that Humâyûn's tomb is only one link in the evolution of the Tâj, and that the remaining links must be sought for in India, not in Persia or Central Asia. In this monument Indian building tradition, both as regards structure and symbolism, is to a certain extent departed from. Humâyûn had been too little in India to adapt himself to his intellectual environment. His court was a Persian court, and his tomb is only an Indian imitation of a Persian tomb. Humâyûn's architects were trying obsequiously to follow the court traditions of the time, which was entirely a Persian one, just as "progressive" Indian princes of the present day follow European example in building, without considering whether

it may be good or bad. But in the century which had nearly elapsed between the commencement of this building and that of the Tâj, this eclectic Persian influence had been assimilated by Indian builders. The Hindu builders of Akbar, Jahângîr, and Shah Jahân had taken the Persian court tradition and revitalised it by joining it with their own. The link in the chain of the Indian masonic tradition which was weakened in Humâyûn's tomb is forged anew in the Tâj.

The effect of the Persian art tradition as imported into India may be compared with that of the Italian Renaissance in Europe, well described by Professor Lethaby as "the art of scholars, courtiers, and the connoisseurship of middlemen."<sup>1</sup> Akbar made Mogul art great not by setting up a new standard of architectural taste, as Bâbar and Humâyûn did, and as we foolishly do in India to-day, but by allowing the Hindu builders to weld the Persian and Arabian art tradition on to their own. It was because the Hindu craftsmen inherited a strong unbroken tradition, founded upon long centuries of practical experiment and devotion to their art, that they could so easily assimilate all the foreign elements which were imported into India by successive changes of dynasty and religion. Their architecture, whether it was Buddhist, Jain, Hindu, or Musulmân in dogma, was always noble as art, because, like all true architecture, it was "not a thing of will, of design, or of scholarship, but a discovery of the nature of things in building, a continuous development along the same line of direction imposed by needs, desires, and traditions."<sup>2</sup> The Tâj, then, though related in some ways to Humâyûn's mausoleum, was even more closely connected with its Hindu prototype, the Chandi Sewa at Prambânâ, and with the latter's Buddhist

<sup>1</sup> "Architecture," p. 233 (Home University Library).

<sup>2</sup> "Architecture," W. R. Lethaby, p. 207.

prototypes. In architecture it is unique, but neither Arabs, Persians, nor Moguls can claim it as their own, for it is Indian in body and in soul.

The method followed by Shah Jahân in making his arrangements for the building of the Tâj is fully described in the official records of the time, and is very interesting for the light it throws upon the building tradition of the seventeenth century. The Emperor called together a council of all the best master-builders and craftsmen to be found in India and in Central and Western Asia. There were specialists in every branch of building and decorative craft. There was a master-mason from Kandahar, one Muhammad Hanif, with a salary of 1,000 rupees a month; another, Muhammad Sayyid from Multan, who received 500 rupees, and Abu Torah, from the same place, paid 500 rupees. Ismail Khan Rûmi, an expert in dome construction, also received 500 rupees. Two specialists for making the pinnacle surmounting the dome, whose names were Muhammad Sharif of Samarkand and Kazim Khan of Lahore, were paid respectively 500 rupees and 295 rupees a month.

Here we may note in the Persian MS.<sup>1</sup> an interesting etymological proof of Hindu influence in Saracenic masonic traditions. We have seen already that one of the distinctive characteristics of the Arab or Persian dome is that the pinnacle, or finial, is a comparatively insignificant ornamental feature, generally nothing more than a metal spike carrying the ensign of Islâm. In Hindu buildings, on the contrary, it is always treated as an important part of the dome's structure, and as a symbol called in Sanskrit the *kalasha*, or water-pot. Curiously enough, though the water-pot has no symbolic meaning to

<sup>1</sup> The manuscript from which most of these particulars are taken is preserved in the Imperial Library, Calcutta.



the Musūlmân, the technical name for a pinnacle, *kalsa*, in Persian is the Indian word borrowed directly from the Sanskrit. So in this detail of Saracenic architecture it is clear that Persia and not India was the borrower.

Three master-masons from Delhi were paid from 400 to 375 rupees a month. A master-carpenter, probably employed in the erection of the scaffolding and centering of the dome, whose name was Pira, was also a citizen of Delhi. With regard to the decorative work, there were four calligraphists who drew out the inlaid marble inscriptions. The first, Amanat Khan, from Shirâz, a writer of the Tughra character, drew a salary equal to the highest, namely, 1,000 rupees a month. Qader Zaman, "proficient in every branch of Arabic," drew 800 rupees. Muhammad Khan from Baghdad was paid 500 rupees, and Raushan Khan from Syria received 300 rupees. At the Mogul court, as in Persia and Arabia, calligraphists were artists of the highest repute and were paid accordingly. The masons who executed the inlay work, including the so-called *pietra dura*, which is distinctly Persian in character, were Indians and Hindus who came from Kanauj. The chief worker, Chiranji Lal, received one of the highest salaries, 800 rupees—a sufficient proof that he was not a mere artisan working under supervision, but a master-craftsman of high position among Shah Jahân's experts. His chief subordinates were Chhotî Lal, Mannu Lal, and Manuhar Singh, whose salaries ranged from 380 rupees to 200.

Though the extensive use of marble and stone inlaid decoration in Indian buildings was most probably a fashion introduced by the Arabs, who had themselves borrowed it from the Byzantines, it seems that the practice had become a part of the Hindu craft tradition so long before the building of the Tâj as effectually to dispose of the theory that the *pietra*

*dura* of the latter was derived from the Florentine work of the sixteenth century, to which it has no resemblance except in technique. Apparently the Indian *pietra dura* had been practised in Rajputana as early as the beginning of the fifteenth century, for Colonel Tod mentions that Kumbha, the Rânâ of Mewar, in 1438 laid the foundation of a Jain temple costing over a million sterling in the Sadri Pass, in which the interior is inlaid with mosaics "of cornelian and agate. . . . This temple is an additional proof of the early existence of the art of inlaying in India."<sup>1</sup>

Among other decorative craftsmen, two "flower carvers" from Bokhara, Ata Muhammad and Shaker Muhammad, are mentioned as drawing salaries of 500 and 400 rupees respectively. There were three others from Delhi—Banuhâr, Shah Mal, and Zorâwar—whose salaries are not given. Lastly, there was a specialist in garden design, one Ram Lal Kashmiri.

The chief architect who co-ordinated the work of all these master-craftsmen was Ustâd Îsâ, "the best designer of his time." According to one account he was a citizen of Agra, but in another he is said to have come from Shiraz. His salary was 1,000 rupees—it is significant of his position towards the whole work that he received no more than the chief mason, for he was only one among many master-craftsmen carrying on a great living building tradition; not, as would be the case now, a highly paid expert archæological draughtsman of the literate caste in command of an army of workmen skilled in copying paper patterns but with no artistic interest in their work. The different method of working accounts for all the difference between seventeenth-century and modern building.

Tradition, in those days, was not, as is often assumed, a stereotyped line of thought out of touch with the practical

<sup>1</sup> "Annals of Rajasthan," vol. i. p. 289.

needs of the times. These Oriental master-craftsmen were as keenly sensitive to new ideas as any budding architect-draughtsman of the present day, for we are told that before the final design was approved by Shah Jahân they had seen and discussed drawings of all the most famous buildings of the world. When after long consultation the design was settled, a model of it was made in wood. Modern architectural practice has not been able to improve upon this excellent method.

The strong influence which the Indian building tradition exercised over the whole of Western Asia, the tolerant attitude of the Mogul Emperors towards Hinduism, and the wonderful adaptability of Hindu craftsmen are evident in the result arrived at by this remarkable assemblage of experts. A Muhammadan craftsman from Rûm, which may mean Constantinople or any part of Western Asia, is employed to supervise the construction of the dome ; yet the dome itself is not in the slightest degree Byzantine, nor is it Arabian or Persian, but Hindu both in form and in symbolism. The design of the floral mosaic work seems to be inspired by Persian art ; but the master-craftsmen were all Hindus who had probably practised the same craft for many centuries. The plan of the Tâj garden (fig. 5)<sup>1</sup> is according to the Mogul tradition ; yet the garden expert was also a Hindu.

The student of Indian architecture and archæology would do well to remember that Persian or Arabian names do not always indicate Persian or Arabic craftsmen ; on the contrary, the probability is that most craftsmen working on Indian buildings, whether they be Muhammadan or Hindu in religion, are of Indian race. Similarly, a Persian or Arabian motif in

<sup>1</sup> The garden was replanted about ten years ago, but without any regard to Indian symbolism or recognition of the relation of the garden scheme to the design of the buildings.

PLATE VIII

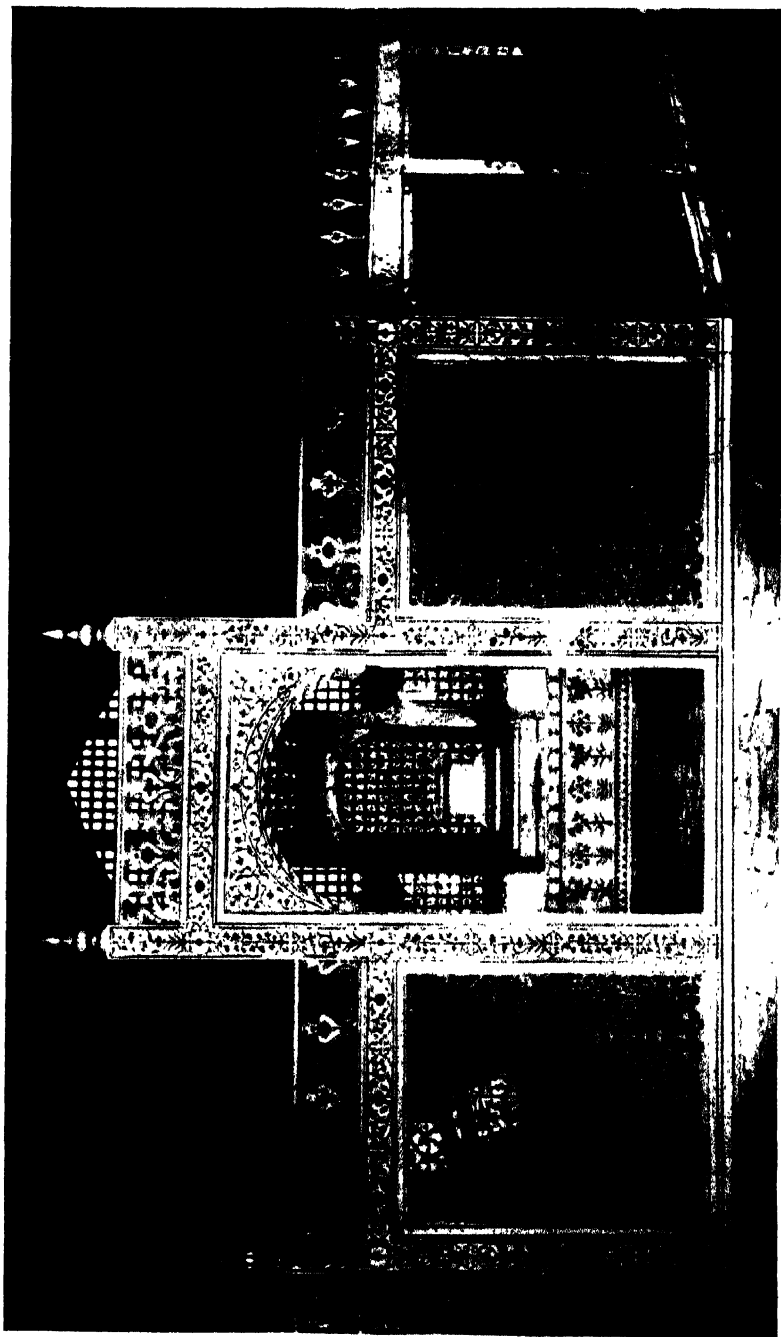

THE SCREEN, TAJ MAUSOLEUM

Photo]

Johnston & Hoffmann



the design or decoration of an Indian building is no more proof that the designers were foreigners than would be the case in an Italian building.

The procedure which Shah Jahân adopted in the design

of the Tâj seems to have been the traditional practice on such occasions. Akbar had done the same at Fatehpur-Sîkrî, and likewise Timûr, the founder of the Mogul dynasty, when he rebuilt Samarkand ; probably Mahmûd of Ghaznî also. It will be instructive to note how different was the architectural aim of these conferences of master-builders to that of an Anglo-Indian departmental committee of the present day. In the first case, although the master-builders

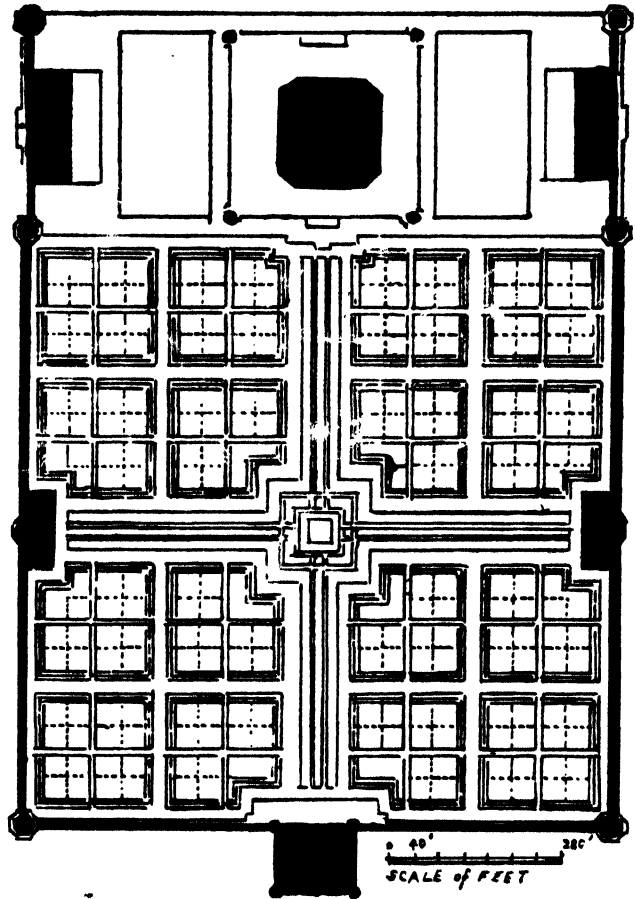

FIG. 5.—Plan of the Tâj Garden, as drawn by Colonel Hodgson in 1828.

represented many different countries and many different styles of building, the question of style did not enter into the discussion at all. Every great monument or new capital city had a proper style of its own, for the traditions which were the

craftsmen's common heritage was a universal craft language understood by all, though every craftsman tried to prove his skill in his own special craft. So, in spite of the cosmopolitan composition of these committees of experts, a city built in Persia naturally became a Persian city, a city in China a Chinese city, and in India an Indian city. Timûr, the Tartar, when he conquered Central Asia, sent to China and to India for expert builders, but he meant Samarkand to be the first city in Asia, not a second-hand Pekin or Delhi. Neither Akbar nor Shah Jahân wasted time in futile archæological discussions which act as a dead weight on the building craft of the present day, both in India and in Europe. The constant interchange of constructive ideas among the master-builders of different countries acted as a real stimulus to creative effort. Architectural style came from the natural organic growth of the art of building instead of being dictated by the caprice of individual taste, by the arbitrary ruling of bureaucratic decrees, or by the sordid impulse of commercial greed.

Incidentally it may be said that the artistic proofs, general and particular, which establish the perfect Indianness of the Tâj, also dispose of the legend regarding its Italian architect more effectually than any judicial decision based upon an examination of Father Manrique's statement of Veroneo's claims. So long as the Tâj could be regarded as an isolated phenomenon in what we call Indo-Saracenic architecture, only distantly related to one other building of the same style and epoch, the assumption might seem plausible—though contrary to all historical precedent—that Veroneo was a genius of extraordinary artistic gifts who, with the aid of Indian craftsmen, had succeeded in improving on the model provided by the mausoleum of Humâyûn by adapting the canons of Western architectural taste to an Oriental building. One

might say that here was an exception to the rule stated by Professor Lethaby that "nothing great or true in building seems to have been invented in the sense of wilfully designed. . . . A whole building, indeed any work of art, is not a product of an act of design by some individual genius ; it is the outcome of ages of experiment." But when it can be shown that the Tāj, though unique in itself, is only one link in a long chain of Indian tradition going back to Buddhist buildings of the sixth and seventh centuries, Veroneo's claim becomes on the face of it absurd. When architecture is a living art, buildings are not "designed"—they grow. The Tāj was not of our modern "architects' architecture." It was of a living organic growth, born of the Indian artistic consciousness.

It will be interesting to observe that soon after the completion of the Tāj, when Shah Jahân's successor, Aurangzĭb, usurped his father's throne, he placed a ban upon the fine arts as being contrary to the injunctions of the Qurân, and dismissed from his court all but orthodox Musulmân craftsmen. The effect upon Mogul buildings was most significant. The chain of the Hindu tradition was thus broken, for only the true believer was considered fit to be employed in designing Muhammadan monuments. Fergusson observes that "there are few things more startling in the history of this style than the rapid decline of taste that set in with the accession of Aurangzĭb." As an example of it he cites the mausoleum which one of the sons of Aurangzĭb caused to be built in memory of his mother, Rabia Daurâni, intended, it is said, to be an exact copy of Shah Jahân's famous monument to Mumtâz Mahall. "The difference between the two monuments," says Fergusson, "even in so short an interval [about thirty years] is startling. The first stands alone in the world for certain qualities that all can appreciate ; the second is by no means remarkable for



any qualities of elegance or design, and narrowly escapes vulgarity and bad taste."

As Fergusson failed to observe any Hindu influence in the buildings of Jahângîr and Shah Jahân, it is not surprising that he should overlook the fact that the difference in two buildings was not due to decline in taste at the Imperial court, but to the break in the Mogul building tradition caused by AurangzÏb's dismissal of Shah Jahân's Hindu artists and craftsmen. The effect of this break affords yet another strong proof of the commanding influence of Hindu tradition in the creation of the great monuments of the Mogul dynasty in India. Neither the inferiority of AurangzÏb's buildings nor the superiority of Akbar's, Jahângîr's, and Shah Jahân's had anything to do with a decline or improvement in the taste of the Mogul court ; it was merely a question of bad or good government. In the latter case the best builders and craftsmen in Asia were employed, without distinction of race or creed ; in the former the best were excluded by the arrogant bigotry of AurangzÏb, who may have been well aware that his buildings were badly designed, but was satisfied by the knowledge that they were not polluted by the hands of the idolatrous infidel.

After AurangzÏb's accession the Hindu master-builders had no choice but to seek patronage from the princes of their own religion, and nothing can be more significant than the fact mentioned by Fergusson that the only Indian buildings which kept up the great tradition of the reigns of Akbar, Jahângîr, and Shah Jahân were the fine palaces of Central India and Rajputana, built for Hindu princes, like those of Datiyâ and Urchâ in Bundelkund (Plates XCVII-XCIX), and that of Dîg at Bharatpur described by Fergusson as a " fairy creation " (Plates CVII-CVIII). All of these were erected in the eighteenth century by Hindu builders for Hindu princes.

## CHAPTER III

### THE THIRTEENTH CENTURY

#### MOSQUES AT DELHI AND AJMÎR—THE QUTB MINÂR

HAVING now considered the Tâj Mahall as a typical example of Indian design produced under Muhammadan auspices, let us go back to the beginnings of Musulmân rule in India and attempt to realise the peculiar conditions which led to the development of the different styles of architecture usually described as Indo-Saracenic. The classification adopted by Fergusson in his history is most misleading to the student, because, for the purpose of an academic analysis, he has detached all Muhammadan architecture from its historical context, and treated it as an importation into India of a new order of architecture by an artistically superior race, rather than as a continuous development of Indian building traditions proceeding from altered conditions of social and political life, changes in religious ritual and symbolism, and in the structural requirements evolved therefrom.

The oft-quoted phrase that "the Pathâns built like Titans and finished like goldsmiths" conveys an historical fallacy. The Pathâns were fighting men, not builders; the building traditions they brought with them into India, called Pathân by Fergusson, were those which Mahmûd of Ghaznî and his descendants had borrowed from India. These traditions in the course of two centuries had been adapted to the needs of a militant race. Western writers exalt the simple dignity and grandeur of the Pathân tombs in Northern

India, to the disparagement of Hindu temple architecture, without pausing to consider that both belong to the Indian building tradition, and that to draw comparisons between their respective architectural merits is like discussing together the different styles of a Norman keep and a Gothic cathedral. Among the fighting clans of Afghanistan a saint's or warrior's tomb on a hilltop was more often a fortress than a holy shrine, and for a reasonable architectural analogy one must put the tombs of the Pathâns in India by the side of the stately Hindu fortresses of Chitor or of Gwalior, or the fort of Agra built by Akbar's Hindu architects. It will then be easy to understand that the Pathân tombs are as truly Indian as the military works of the Hindus.

The only satisfactory method of studying the Indian building styles is to adopt a chronological basis for the general classification, in the same way as European styles are usually designated by the centuries to which they belong, using provincial or local names to distinguish different subdivisions. When one thus compares a fourteenth-century Indian mosque in Gujerat with Hindu temples of about the same period and locality, it will be evident at a glance that there is no real connection, from an architectural point of view, between the former and Muhammadan buildings in Egypt, Arabia, or Persia, and that the term Saracenic can only be used in a conventional sense, for the mosque and the temple are both Hindu.

The beginning of the thirteenth century, or nearly two centuries after the death of Mahmûd of Ghaznî, saw one Muhammadan dynasty established on Indian soil at Delhi, and another in Bengal at the old Hindu capital at Gaur. The few monuments of these two dynasties which are now extant are either mosques or tombs, which show very clearly

that the Muhammadan invaders did not trouble themselves with spreading any new architectural propaganda in India.

The armies of Islâm brought few masons and other craftsmen with them, so the Delhi Sultans and their satraps in Bengal did as Mahmûd had done—they impressed the Hindu builders and craftsmen into their service. They wanted mosques for the true believer to be built quickly and magnificently. Mathurâ and other places which had furnished Mahmûd with builders for his capital were in the vicinity of Delhi. The Muhammadans were thoroughly practical in their methods, and, though they hated the idolater, had no scruples against using the splendid materials provided by Hindu temples, and doubtless found a grim satisfaction in compelling thousands of Hindu craftsmen to wreck their own holy shrines and to rebuild them according to the ritual of Islâm.

The building styles of this part of India, which were lithic developments of the early Indian wooden styles, lent themselves easily to the purposes of the Muhammadan iconoclasts. Nothing was easier than to transport piecemeal the splendidly carved columns, with their bracketed capitals and lintels, of the Jain and Hindu temples, and to re-erect them on a plan dictated by the mullahs who superintended the construction of the mosques, which, according to Muslim tradition, consisted of a quadrangle with its two longer walls generally pointing in the direction of Mecca. On the side opposite to the principal entrance was placed the *liwân*, or sanctuary containing the mihrâb and the *mimbar*, or pulpit. The three remaining sides were usually enclosed by narrow colonnades or corridors. The *liwân* was necessarily much more spacious than these corridors, and the roofing of it thus presented many more constructive difficulties.

The domes of the Hindu temple *mandapas*, or porches, supplied ready-made roofs both for the corridors and for the *liwâns* of the mosques. Of course the heavy external masonry of the Hindu domes with its elaborate sculptured symbolism was neither necessary nor desirable for the roofing of the mosques. All that was essential for Muslim practical purposes was to take the constructive parts, or the inner stone shell of

the Hindu domes (Plate IX), cement them on the outside to make them water-tight, and finish them with the wonderfully fine plaster which Indian masons had used from time immemorial as a preservative for brick-work and as a ground for painted decoration.

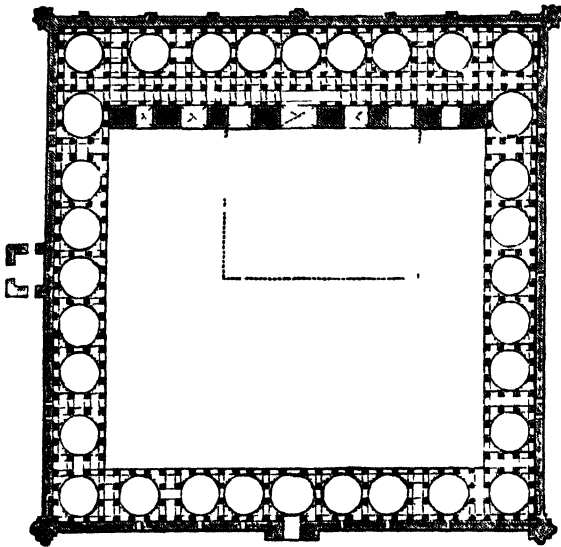

FIG. 6.—Mosque at Ajmir (from Fergusson).  
(Scale, 100 ft. to 1 in.)

No doubt Mahmûd's Indian masons had followed a similar method in roofing the mosques and palaces at Ghaznî,

though in this case they were not reconstructing ancient domes but building new ones. This was the origin of the so-called Pathân or Muhammadan dome in India. It was only a simplified Hindu dome, stripped of its external decoration, but constructed entirely according to Buddhist-Hindu methods. We will discuss these methods later on.

This makeshift mosque, put together by Hindu craftsmen and made decent and proper according to the Puritan sentiment of Islâm by the mutilation of the Hindu figure-sculpture,

PLATE IX

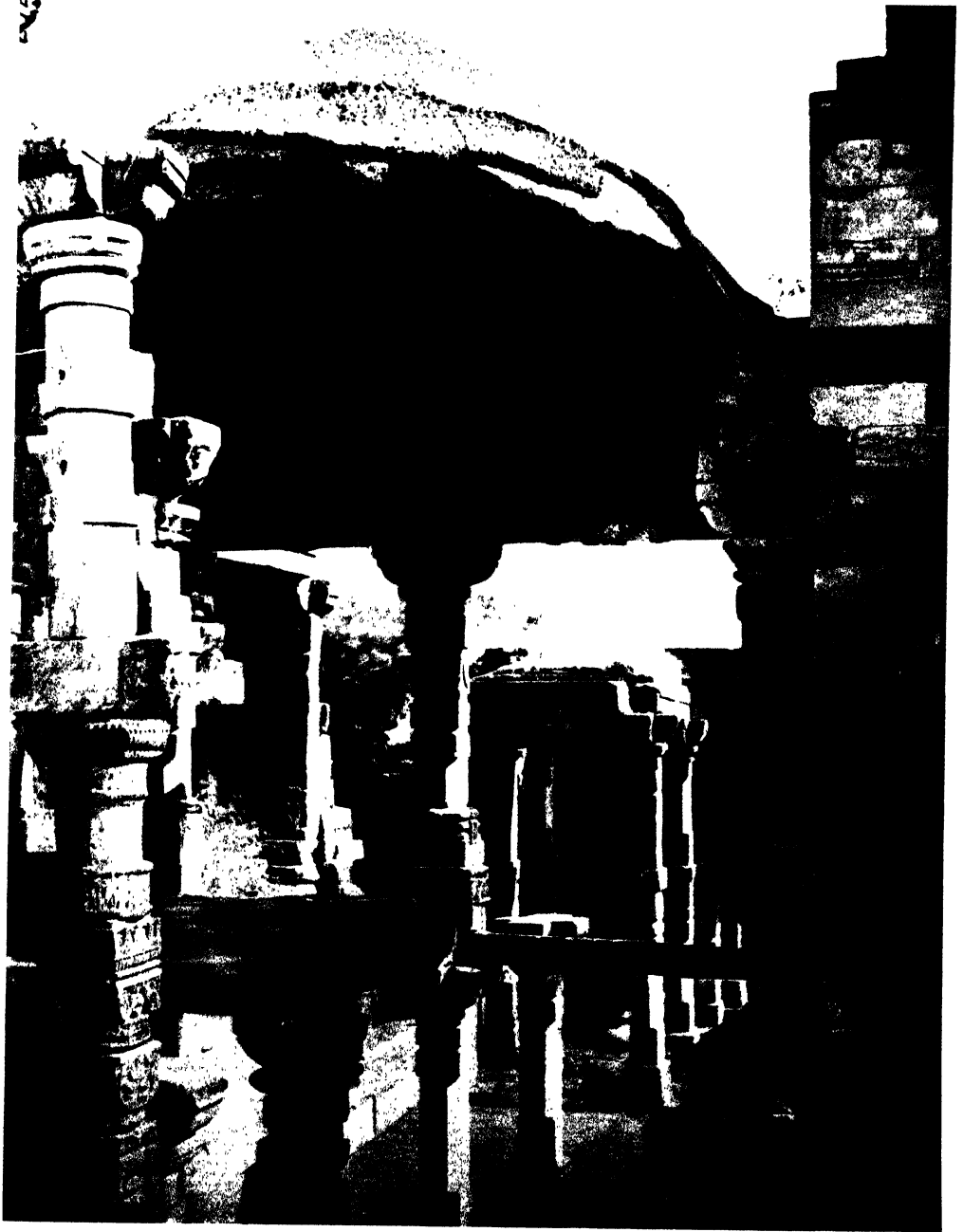

DOME OF QUTBU-D-DIN'S MOSQUE, OLD DELHI



satisfied for a time all the needs of the faithful. The rapidity as well as economy with which official requirements were provided for by these peremptory and drastic measures might well be envied by our Anglo-Indian administrators. According to tradition, the great mosque at Ajmîr, finished in the reign of Altamsh (1211-35), was put together in two and a half days! Due allowance must be made for Oriental hyperbole, but if the walls of the quadrangle and the arches in front of the liwân are left out of account, such a performance, with many thousands of skilled craftsmen at command and finished materials already collected at the spot, would not be altogether incredible. The enclosed quadrangle was probably used for prayer, and thus was regarded as a complete mosque, before the roofing of the colonnades was finished.

The methods of the Delhi Public Works Department in the thirteenth century, if more brutal than those of the present day, were decidedly more practical and efficient, not because the Muhammadan military officers and mullahs were superior in architectural taste to the British subalterns and military chaplains, and their coadjutors the British engineer and bricklayer, who have been deputed in these latter days to instruct the despised Hindu craftsmen, but because the Delhi Sultans did not expect their officials to play the part of amateur builders. They were there to rule and enjoy themselves, and to make the Hindus work for them. Teaching the Hindus Saracenic "orders" of architecture did not enter into their official code; they only required that the heads of the faithful at prayer should be protected from the dripping of rain through a leaking roof. The Hindus were acknowledged to be the best builders that Asia could provide, and Islâm had no professional or commercial interests to promote at the expense of Indian art and craft.



The advantage to the Hindus was that, provided that they did not offend the religious susceptibilities of their masters, they were left free to exercise their wits in the practice of their art and craft, and were not subjected to a slow process of intellectual starvation by being put to copy paper patterns provided by official experts not trained in practical craftsmanship and without knowledge of or sympathy for Oriental art traditions. The advantage to Islâm, from a proselytising point of view, was that very many Hindu craftsmen, some from conviction and some from motives of self-interest, adopted the creed of their masters, and thus in process of time a new style of Indian building more perfectly adapted to Muhammadan needs and taste was evolved.

The mosques constructed in the fashion described from the ruins of Hindu temples became the prototypes of others constructed by Indian Muhammadan builders, but it was soon felt that the open colonnades of the corridors and sanctuary afforded too little protection from sun and rain. To remedy this, a screen of brick, sometimes plastered, sometimes faced with stone, was built in front of them (Plate X), and naturally enough the mullahs insisted that the pointed arch, with its symbolic associations for Islâm, should be used for this screen, the only original constructive work in most early Indian mosques; for even the enclosing walls of the quadrangle were originally the walls of a Hindu or Buddhist temple courtyard. The screen served also a ritualistic purpose: instead of symbolic sculpture, the laws of Islâm or sacred texts were carved upon it for the instruction of the congregation. Now, the Hindu masons were quite familiar with the pointed arch as a symbolical and ornamental feature<sup>1</sup>—from the early days of

<sup>1</sup> When Buddhist or Hindu niches containing the images were large, they were sometimes vaulted, so that the arch became structural as well as decorative.

PLATE X

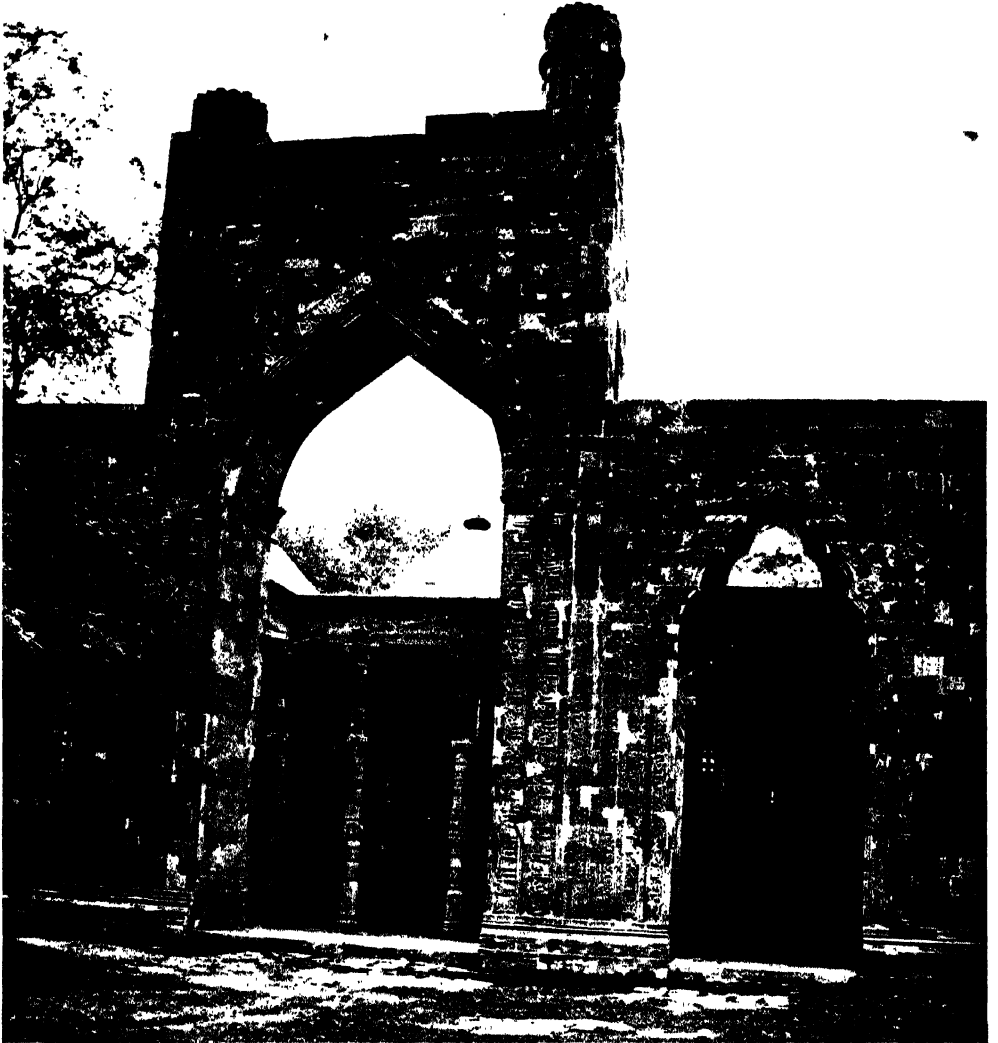

ARCHED SCREEN IN MOSQUE AT AJMÎR



Mahâyâna Buddhism it had been used in Buddhist and Hindu sculpture—but either from experience of earthquakes or for other practical reasons they mistrusted “ the arch which never sleeps ” as a structural device, except for very small spans. And since they had generally at their disposal unlimited quantities of first-rate material, either wood or stone, admirably adapted for their traditional beam-and-bracket system of construction, there was no practical reason for using any other ; so even when put to building arches of wide span for the Muhammadan mullas, they made many attempts to adapt their own system to this innovation.

Fergusson's dictum regarding the great range of arches in the screen-wall of the mosque of Qutbu-d-Dîn—that “ the Afghan conquerors had a tolerably distinct idea that pointed arches were the true form for architectural openings ”—seems to be founded on a complete misconception, both from an historical and an architectural point of view. It is highly improbable that the Musulmâns who directed the building of the mosque—assuming them to have been Afghans, which is not at all likely—were influenced by any æsthetic reflections, intuitive or otherwise, in insisting that arched openings should be put into screen-walls. They wanted arches because they were the symbols of their religion. We may assume that they showed the Hindu craftsmen illuminated copies of the Qurân or paintings of Arabian and Persian mosques as a guide, but otherwise left them to construct the screens as they pleased. The “ Saracenic ” arch is not intrinsically more true for architectural openings, either in a constructive or æsthetic sense, than the round arch or the Hindu beam and bracket. These different constructive methods have each their respective advantages. A true craftsman, guided only by practical considerations, would make the choice of any one of them

depend upon the character of the opening, its size and position in the constructive scheme, and upon the character and quality of the materials he was using. The Hindu craftsman had very good constructive reasons for preferring the beam and bracket for buildings adapted for his own religious ritual. In the buildings he made for Muhammadans the pointed arch may have added to his constructive resources, but it was in no sense scientifically superior to his habitual methods of construction. Indeed, modern developments of building construction, in which iron is so largely employed, reduces the pointed arch to the place it generally held in the Hindu system, namely, to a decorative expedient only, and makes the beam and bracket of the Hindus the scientific form of construction. For this reason, if for no other, the Hindu building craft is worthy of more attention than it has yet received from the Anglo-Indian departmental expert.

The very ruinous state of the mosque at Old Delhi makes it less interesting as an architectural example than the almost contemporary building at Ajmîr, built in the same fashion. The original mosque—in the courtyard of which stands the famous iron pillar,<sup>1</sup> a wonderful monument to the scientific knowledge and skill of Hindu craftsmen many centuries before the Muhammadan invasions—was commenced by the first Delhi Sultan about 1196; the screen of arches in front of the *liwân* were added by his successor Qutbu-d-Dîn about ten years later. Altamsh, the next Sultan, who succeeded in 1210, began to enlarge the mosque by extending the *liwân* with its screen north and south, and by adding a great quadrangle which should have enclosed the original building. The next Sultan, 'Alâu-d-Dîn (1296–1316), built a fine gateway on

<sup>1</sup> It is attributed to the time of the famous Hindu King Vikramaditya, who flourished in the fifth century A.D.

PLATE XI

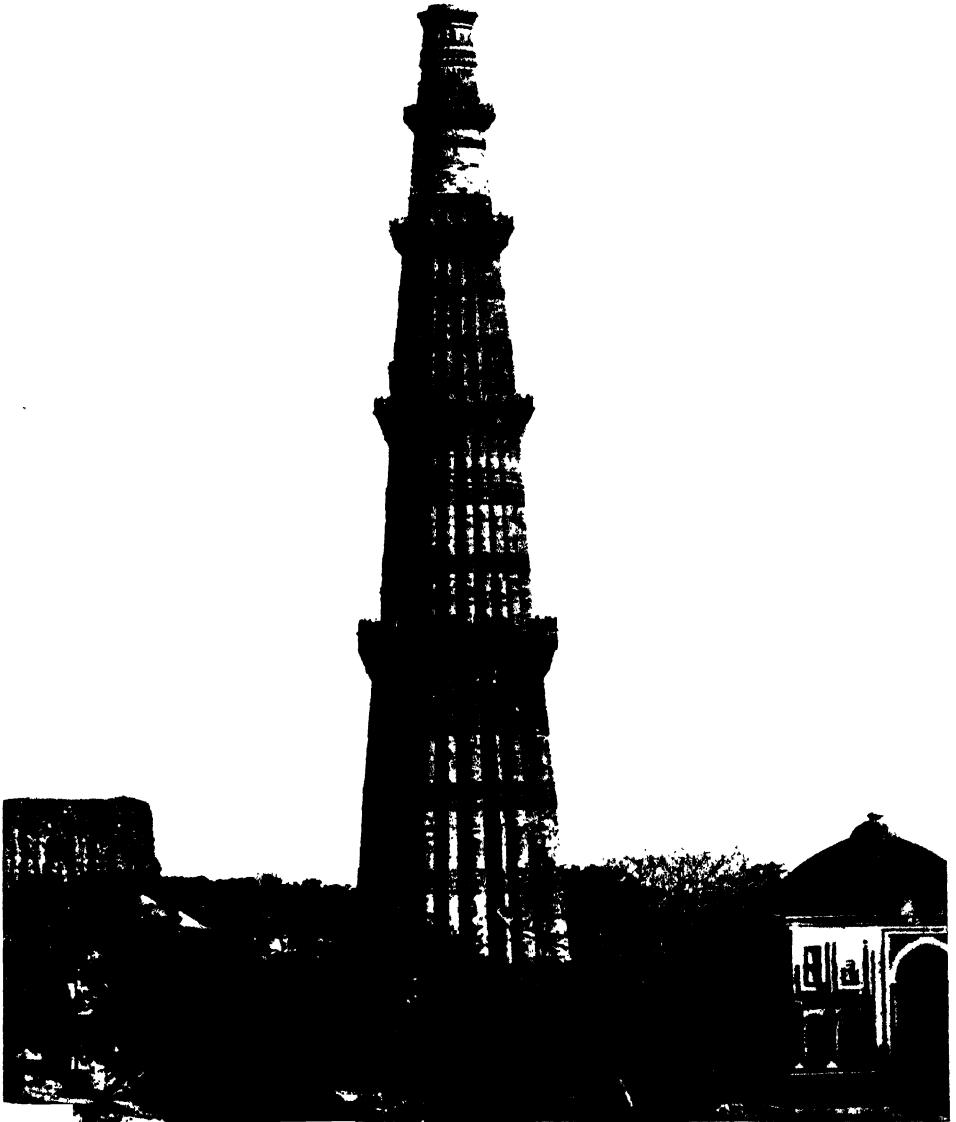

THE QUTB MINAR



the south side of this outer quadrangle, and projected yet further extensions of the building which were never completed, and the present mosque is only a fragment of the original, for nearly the whole of the *lîwân* behind the arches and a considerable part of the corridors surrounding the two quadrangles have disappeared. The great Tower of Victory, in what remains of the outer quadrangle, known as the Qutb Minâr (Plate XI), built about the same time as the original mosque, belongs to a class of monument in which the Hindus excelled ; though this one is a Saracenic modification of the Indian type, of which the two towers at Chitor are the best extant examples. They were no doubt derived from Buddhist structures, which again may have had their prototypes in Babylonia and Assyria. The three finely proportioned lower stories of the Qutb Minâr, which were probably designed by masons from Ghaznî, belong to the original tower ; their exceeding beauty is greatly marred by the upper part, which is a badly conceived restoration and addition of the Sultan Firuz Shah (1351-88). A " classical " cupola added to the summit by a Public Works engineer in the early part of the nineteenth century has fortunately been removed.

Though used as a place from which the *mu-azzin* should summon the faithful to prayer, the tower of Qutbu-d-Dîn<sup>1</sup> has no connection architecturally with the adjacent mosque. The two minarets of the latter were comparatively insignificant and placed on either side of the great central arch of the screen of the *lîwân*, more for ornamental than practical purposes. Only small fragments of the two minarets on the Ajmîr screen now exist. In later buildings, in which they become much

<sup>1</sup> Mr. R. N. Munshi, in his *History of the Kutb Minar* (Bombay, 1911), gives reasons for attributing it to the reign of Qutbu-d-Dîn's son-in-law and successor the Sultan Altamsh, who also built the mosque at Ajmîr.



more important, both structurally and ornamentally, they were frequently removed to the extreme ends of the screen of a mosque, or placed at the four corners of a mausoleum. In the Tâj we find them detached from the building and placed at the four corners of the platform on which it stands.

The most important contribution of Saracenic art to the Indian building craft of the thirteenth century was not constructive but decorative. Some of the Arabian mullahs were past masters in calligraphy, and in the beautiful Kufic and Tughra script the quotations from the Qurân carved on the screens of the mosques (Plate X) made magnificent decoration and admirable sermons in stone. Fergusson admits that in carrying out this work the Indian craftsmen excelled their teachers. "As examples of surface decoration," he justly observes, "these two mosques of Altamsh at Delhi and Ajmîr are probably unrivalled. Nothing in Cairo or in Persia is so exquisite in detail, and nothing in Spain or Syria can approach them for beauty of surface decoration." But when the same high authority proceeds to discriminate between "Muhammadan largeness of conception" and "Hindu delicacy of ornamentation," one must question his judgment in drawing such a distinction between the Musulmân and Hindu artistic genius. The remains of the magnificent Hindu architectural works constructed before and during the time of the first Muhammadan invasions of India prove that largeness of conception was no monopoly of the Saracenic building tradition; and as the earliest Muhammadan buildings in India were undoubtedly built almost entirely by Indians, and mainly according to their own ideas, we should give full credit to the infinite skill and versatility of the Indian builder, who, with an unbroken craft tradition of many centuries behind him, could and did adapt it as perfectly to the formula of the

Muhammadan mullahs as to that of Buddhists, Jains, or Brahmans.

It may seem to the Western eye, trained in the formula of the classical schoolmaster, that the Muhammadan prescription is more pleasing, just because it is more correct according to the canons called classical ; but the creative impulse in the great art produced in India under Muhammadan rule, which seems to us so admirable, belonged to the same Indian races and the same Indian civilisation and culture which had inspired the works of earlier times. If the Indian craftsman of to-day is often a mere copyist, it is chiefly because the methods of our teaching and the principles of our administration have made him so. The whole of Muhammadan architecture in India bears this distinctive impress of the soil to which it belongs—that its structural ideas and symbolism are nearly always essentially Indian, not foreign importations : the foreign suggestions adopted by Indian builders were almost without exception purely decorative ones—*e.g.* the use of Persian and Arabian floral and geometric motifs for surface decoration in place of Hindu sculpture, and the substitution of encaustic and painted tiles for painted plaster or terra-cotta.

These foreign borrowings were never mere copies, but were always given a distinctive Indian character, even when they played an important part in the decorative scheme of building, just as in European art the frequent adaptation of Oriental ideas can generally be recognised as European.

The planning of Muhammadan buildings, the arrangement of the interior, the various forms of the roofing and its supports, whether columns, piers, brackets, pendentives, or arches, were almost invariably derivations from Buddhist or Hindu craft traditions. The screens of pointed arches often make an Indian mosque appear Saracenic from the outside ; but

directly one enters, it is evident that the building is as much Indian as a Hindu temple.

A comparison of Muhammadan buildings of the thirteenth century in India with one which was being constructed in the same century on the Western extremity of the vast territory then under Musulmân rule may be useful for showing how little India really borrowed from Saracenic sources. The Alhambra of Grenada is one of the most typical and famous of Saracenic buildings. Here Arab civilisation, instead of adapting the building traditions of conquered races to its own purposes, was almost for the first time trying to create something which should be wholly after its own ideals. The Moors of Spain tried to cast off the traditions of Rome and Byzantium, of Egypt, Persia, and India, which had hitherto helped them and other Muhammadan races to make magnificent monuments for themselves: they would show what the genius of Islâm could create for itself out of brick and stone. The result may be called magnificent as decoration, but it was not building—rather stage architecture suggestive of gorgeous scenery inspired by illuminated Arab manuscripts, and often made constructively absurd by the painting, gilding, and stucco.

In the thirteenth century mosques of Delhi and Ajmîr it is evident that the Arabian calligraphist and painter had their say with regard to the decoration, but the craftsmanship, both decoratively and constructively, was Indian, and fine because it was Indian. The construction of the arches was according to the Hindu bracket system: the weakness which manifested itself in some of them after many centuries is not due to a faulty system, but to the fact that, like the Egyptians of old, the Muhammadan taskmasters expected their captives to build with unsuitable materials, *i.e.* with stones too small for the Hindu method of bridging over open spaces in walls.

## CHAPTER IV

### THE FOURTEENTH CENTURY

#### GUJERAT—GAUR—THE ARCH IN INDIAN ARCHITECTURE— KULBARGA—MUHAMMADAN TOMBS

AFTER the first century of Muhammadan rule in India, when the ruthless wholesale destruction of Buddhist and Hindu buildings had diminished, the Indian Musulmân builders, with the help of their Hindu brethren, were engaged in grafting a new building tradition upon the old one. Their chief efforts were directed towards giving the arched screens of their mosques a more Indian or Hindu character, though they adopted the Saracenic method of arch construction (with radiating voussoirs) whenever they found it convenient to do so. The screens of Delhi and Ajmîr, beautiful as they are in themselves, are too ill-fitted to the rest of the building and too much of a structural afterthought to satisfy the eye of a good craftsman. The result of these efforts may be seen in some of the fourteenth-century mosques in Gujerat, the rich and fertile Hindu kingdom which was made a viceroyalty to the Delhi Sultanate in 1311, under a converted Rajput, Muzaffar Shah. Gujerat was at that time, as the magnificent remains of Hindu temples at Mudherâ, Dabhoi, and elsewhere testify (see Illustrations), exceptionally rich in architectural material and in craftsmen. The Muhammadans made no attempt to impose any Saracenic ideas upon them. The entrance to the Jâmi' Masjid at Cambay, built about 1325, is almost copied from the porch of the great sun-temple at Mudherâ (Plates XII—

XIII), built in the neighbourhood three centuries before. The arched screen in front of the sanctuary is the only variation on the ordinary structure of Hindu builders. The mosque of Hilâl Khân Qâzi at Dholkâ (Pl. XIV), about twenty-three miles from Ahmadâbâd, and the Tâka or Tanka Masjid at the same place, belong to the same century and style, the former being dated about 1333 and the latter 1361. These mosques have also Hindu entrance porches and ordinary Hindu roofs and colonnades without any further structural development.

In the meantime the Muhammadans who had established themselves at Gaur, the ancient Hindu capital of Eastern Bengal, as early as the end of the twelfth century, were engaged, by the same methods as at Delhi and Gujerat, in forming a local style of architecture of strong characteristics and of very great interest, though the early stages of its development are more difficult to trace on account of the wanton destruction of architectural monuments both by the Afghan iconoclasts and by their successors. When the capital fell into decay on the decline of Muhammadan rule, Gaur was used as a brickfield and quarry by the builders of Dacca, Murshidabad, and Calcutta; the right to dismantle Gaur of its enamelled bricks being farmed out to the landholders of the district in the early days of our revenue administration.<sup>1</sup> It is only quite recently, under Lord Curzon's administration, that the few remains of the splendid monuments of Gaur and the neighbourhood have been adequately conserved and protected.

Enough still remains, however, to show that, owing to the more general use of brick instead of stone in the construction of their mosques and tombs, the builders employed by the Muhammadans at Gaur, as early as the middle of the

<sup>1</sup> Ravenshaw's "Gaur," p. 40, note.

PLATE XII

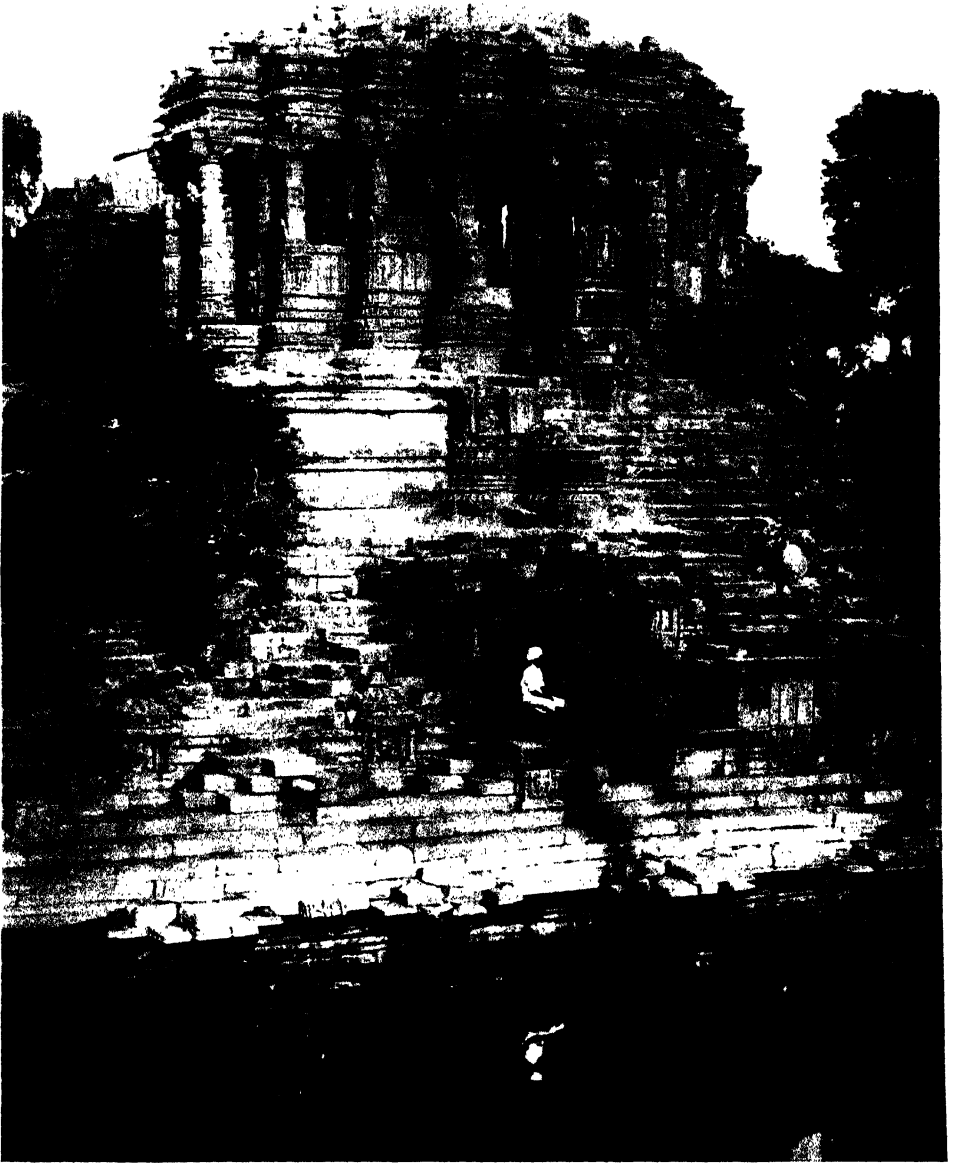

PORCH OF TEMPLE AT MUDHERA (ELEVENTH CENTURY)



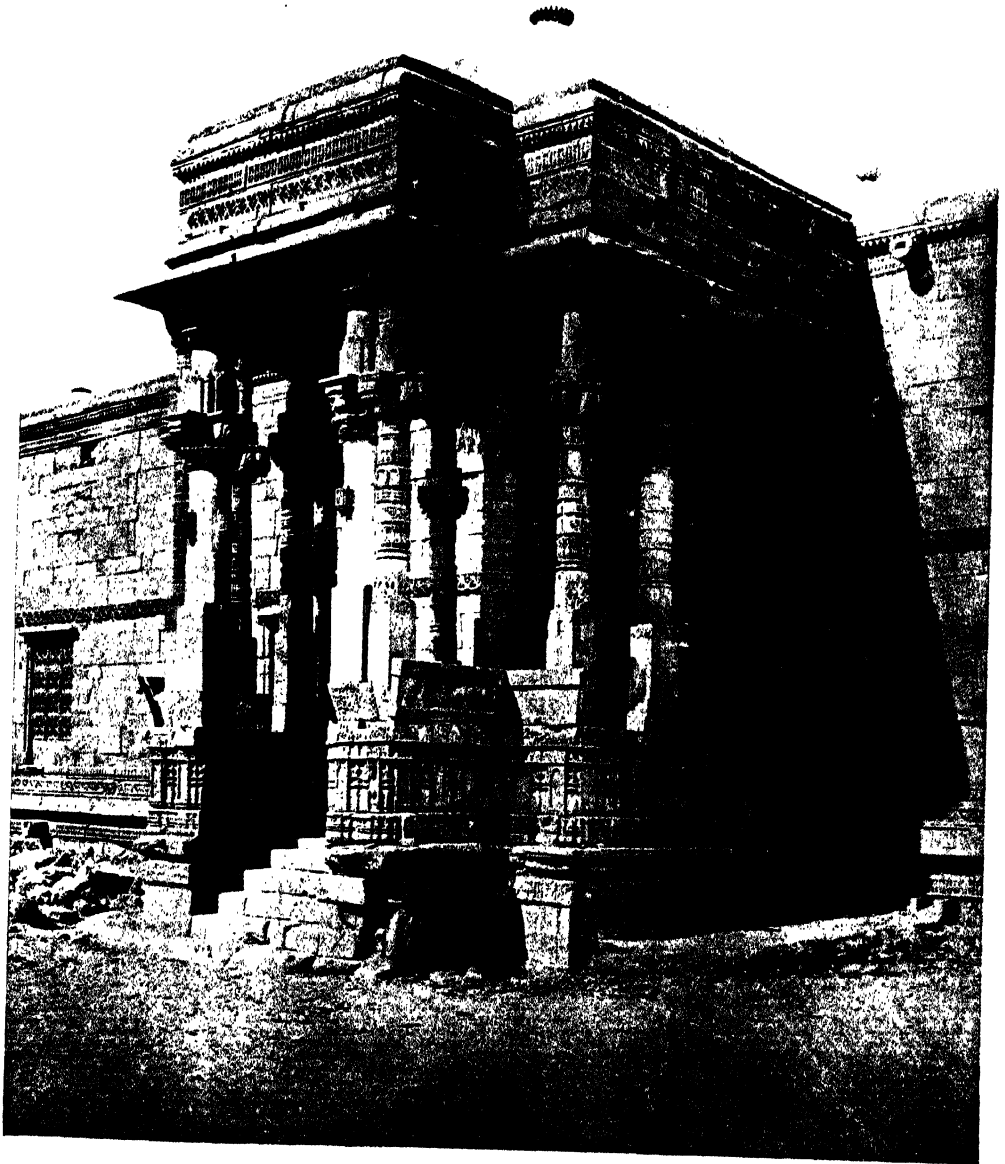

PORCH OF JÁMI' MASJID, CAMBAY





PLATE XIV

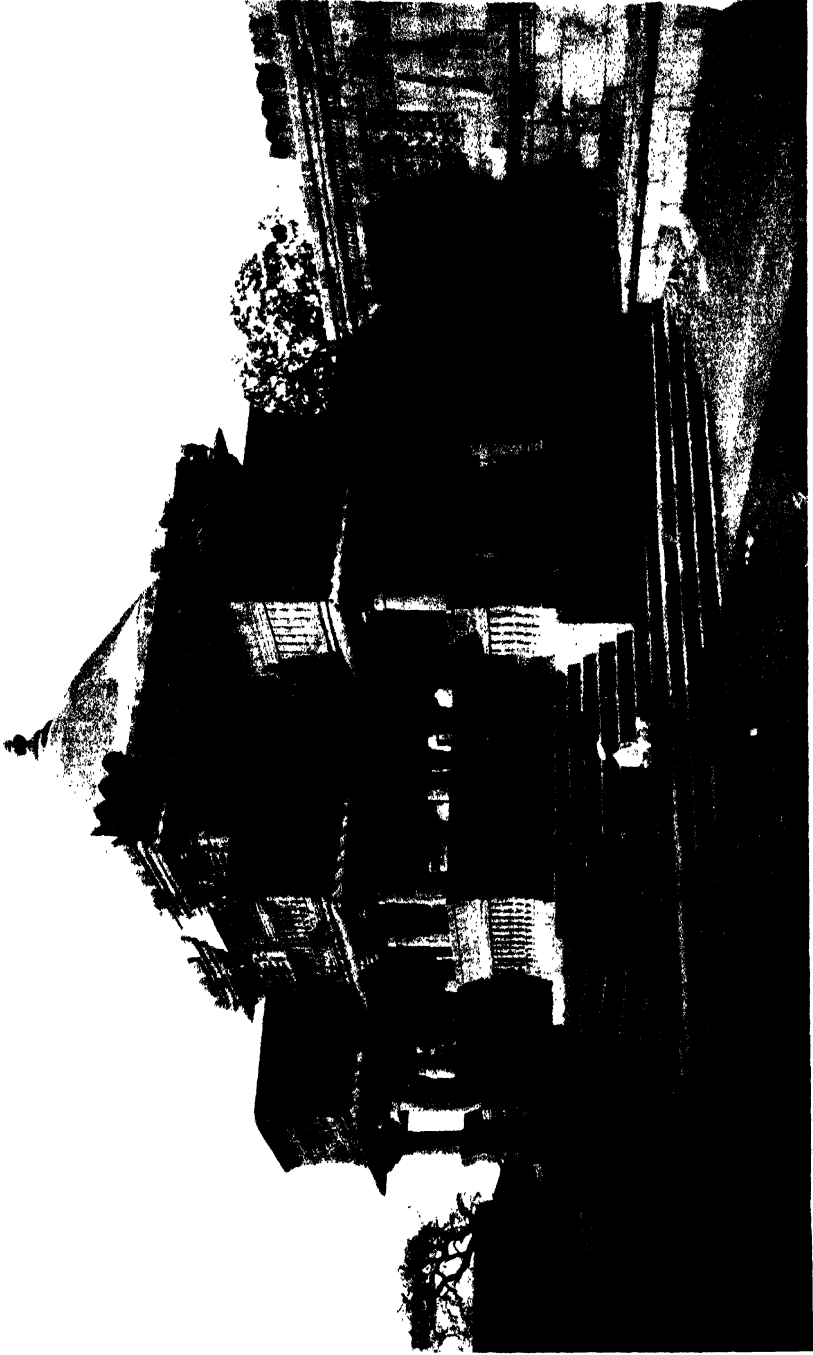

PORCH OF HILĀL KHAN QĀZĪ'S MOSQUE, DHOLKĀ



fourteenth century, were using the pointed arch for constructive purposes much more extensively than they were doing elsewhere in India at that time. This is evident at the Âdīnah mosque, built at Panduâ, near Gaur, during the reign of Sikandar Shah (1358-89): a superficial survey of this building with its Arabic inscriptions and radiating arches might lead one to suppose that the design and construction of it were largely in the hands of foreign architects. But the plan of it (fig. 7) is evidently of Buddhist-Hindu origin; the mihrâbs (Pl. XXXIV) are converted Hindu shrines, and it is much more than probable that in this brick-building country Indian builders were using radiating arches,

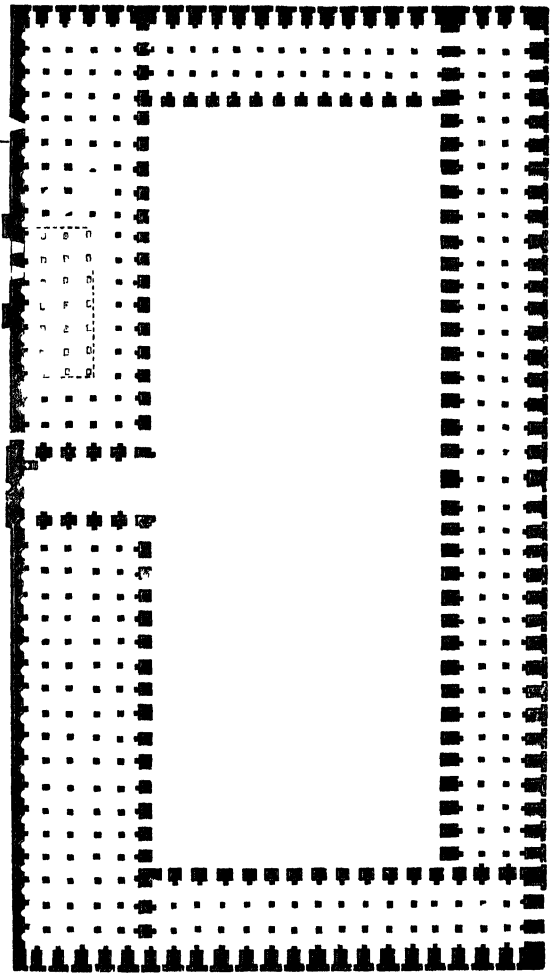

FIG. 7.—Plan of Âdīnah Mosque (from Fergusson's "History").

either round or pointed, for structural purposes before the Muhammadans came. The pointed arch was not an invention of Saracenic builders, and *per se* cannot be taken to prove Saracenic influence in any country. It was used in Egypt,

Syria, and in Asia Minor centuries before the time of Muhammad. India had had intimate relations with these countries from time immemorial, and it is most improbable that Indian builders, skilled craftsmen as they were, remained in total ignorance of the principle of the radiating arch until the time of the Muhammadan invasions. There must have been at one time thousands of Buddhist chapter-houses in Bengal, where their barrel-vaulted roofs and "horse-shoe" windows, frequently built of brick as well as of wood and plaster or thatch, could hardly have been constructed otherwise than by radiating courses.

Fergusson explains why, in some parts of Bengal at least, the trabeate style of building was never in vogue. "The country is practically without stone, or any suitable building material for forming either pillars or beams. Having nothing but brick, it was almost of necessity that they employed arches everywhere, and in every building that had any pretensions to permanency."<sup>1</sup> This being the case, it is difficult to understand why he should have assumed that the radiating arches inside the great temple of Bodh-Gayâ could not have been part of the original structure, but must have been introduced in the course of the Burmese Buddhist restorations of the twelfth and thirteenth centuries. It seems more logical to assume that the Bengali builders, being bricklayers rather than stonemasons, had learnt to use the radiating arch whenever it was useful for constructive purposes long before the Muhammadans came there.

One important fact which leads to this conclusion is stated by Fergusson,<sup>2</sup> though characteristically he tries to explain it away. The arch and vault were systematically used

<sup>1</sup> "Indian Architecture," vol. ii. p. 253 (edit. 1910).

<sup>2</sup> *Ibid.* p. 353.



ÂDÎNAH MOSQUE, CENTRAL CHAMBER IN WESTERN CORRIDOR



by all the Buddhist builders in Burma, who adopted many of the forms of architecture originating in Bengal, together with the religion of Sâkyamuni, at a very early date. Burmese tradition says that many of the oldest temples and monasteries were built by Indian architects; if this is true, they would have come from Bengal. Fergusson says that "Indian" may be taken to mean "foreign," but suggests no reason for rejecting the evidence—such as it is—that the arch and vault were used in Bengal, as they were in Burma, before the Afghans came there. The Afghan invaders were not likely to have brought many builders with them. Gaur was a great Hindu capital, in the heart of the Magadhan country, and its Hindu craftsmen were the direct heirs of the building traditions of the Buddhists. Fergusson, in trying to prove his theory that Hindu builders never under any circumstances used the radiating arch until the Muhammadan builders taught them to do so, seems to ignore the fact that all the Muhammadan buildings at Gaur are just as obviously adaptations of the local Hindu building tradition as are all the mosques in Western India.

Assuming that both the Buddhist and Hindu builders of Bengal were familiar with the structural use of arches in brickwork, it is inconceivable that in the course of many centuries of great building operations they should have refused, from mere prejudice or lack of intelligence, to put bricks on edge instead of laying them flat, whenever a wide span of arch made it expedient to do so. Having adopted that simple expedient, the next would naturally follow—the construction of perfect arches with brick wedges.

Fergusson's theory that the radiating arch is "Saracenic" and the horizontal beam and bracket "Hindu" always seems to imply that the former was a great gift of Western science



to India. It has led archæologists to attribute every Indian building with radiating arches in it to foreign inspiration without further investigation.

From a craftsman's point of view there were good practical reasons why Indian builders should prefer the beam and bracket to the arch when they had plentiful supplies of wood and fine building stone. As these conditions obtained in early times over the greater part of India, it naturally followed that the arch was not so commonly used as it is in countries where wood and stone were less abundant. But in brick-building districts like Bengal one would expect the radiating arch to occur at least occasionally. Since it does occur, there is no reason to attempt to explain it away on archæological grounds. In the absence of any proof to the contrary, therefore, I shall assume that the arches in the Bodh-Gayâ temple were, as they seem to be, part of the original internal structure ; that all the early Muhammadan buildings at Gaur are, as they seem to be, adaptations of the local Hindu-Buddhist building tradition, both structurally and decoratively ; that the brick builders of Bengal, like the brick builders of Persia, used the radiating arch before there was any architecture to be called " Saracenic " ; that the Burmans did use Indian architects, as their traditions say and as might be expected from the relations between the two countries ; and that Fergusson was mistaken in asserting that " up to the time of the first Sultans of Delhi and for some centuries afterwards the Hindus had never built arches." <sup>1</sup>

The general character of the Muhammadan buildings at Gaur differs as widely from the true Saracenic type as any Hindu temple. Moreover, they closely resemble the local Hindu temple architecture. The striking similarity will be

<sup>1</sup> " Indian Architecture," vol. ii. p. 203 (edit. 1910).



QADAM-FIRASUL MOSQUE, GAUR  
(From Rawonshah's "Gaur")



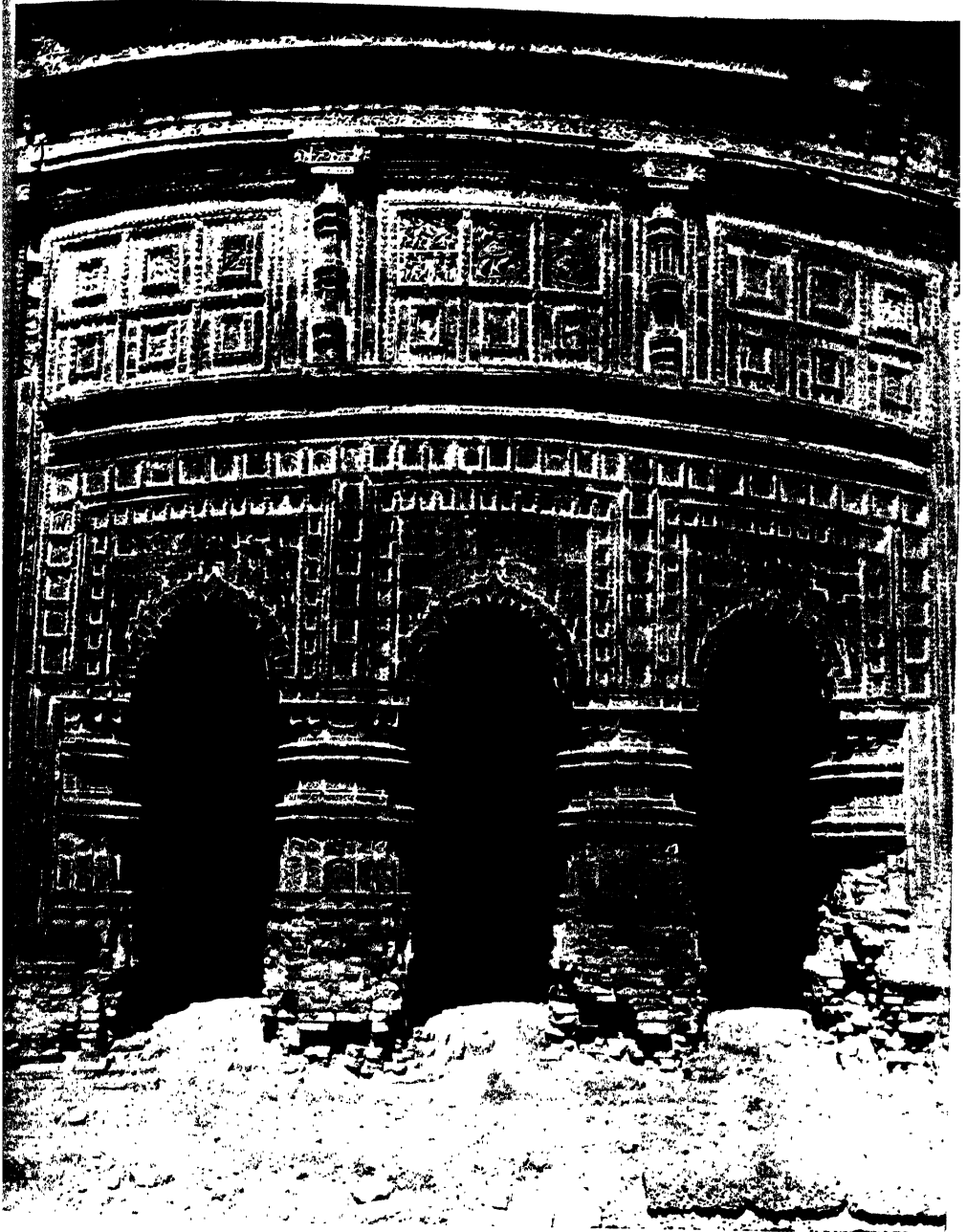

HINDU TEMPLE AT VISHNUPUR



seen by comparing the façade of the Qadam-i-Rasûl mosque with that of the Hindu temple at Vishnupur (Plates XVI-XVII). They are both rather late examples, the former having been built in 1530 and the latter about 1643. But though the Hindu temple is a century later than the other, there can be no mistaking the fact that both belong to the local Hindu tradition of building.

I take it that the real difference between the Muhammadan and Hindu method of construction at Gaur was only this—that the Hindus had used the pointed arch occasionally on a small scale for connecting their massive brick piers and in constructing in brick the curvilinear roofs derived from the earliest Indian roofs of bamboo, thatch, or wood. As the Muhammadans required more spacious buildings for their religious services than the Hindus needed for their individualistic ritual, their craftsmen naturally developed the use of the arch on a larger and bolder scale. But there is no reason to suppose that Indian builders were not capable of doing this for them without any outside assistance, although occasionally, no doubt, the Muhammadan rulers preferred to employ foreign architects. At Gaur there is no more evidence that they did so than there is at Delhi or Ajmîr, for in spite of the decorative elements which betray the influence of Arabic scholars, calligraphists, and illuminators, rather than that of foreign craftsmen, and in spite of the bolder use of radiating arches, the Muhammadan buildings there retain the same strongly marked indigenous character which they have in other places where the usual Hindu constructive methods were employed. The Muhammadan buildings at Gaur, Panduâ, and Maldâ are Bengali, not Arabian or Persian.

The curvilinear cornices and roofs at Gaur undoubtedly belong to the ancient Buddhist-Hindu tradition, and the forms

of the smaller arches, or those which are used decoratively instead of structurally, so far from being Saracenic, are all derived from Buddhist-Hindu prototypes, as will be explained farther on. Though Persian encaustic tile-work shows foreign influence, or rather gives evidence of the mutual exchange of artistic ideas which is natural between two countries so closely connected in race, language, and religion as India and Persia, the beautiful terra-cotta and moulded brickwork is characteristic of Bengal and must have been the work of local craftsmen.

#### KULBARGA

The middle of the fourteenth century saw the armies of Islâm pressing southwards as well as eastwards and westwards, and by 1347 a new Musulmân dynasty had established itself at Kulbarga, another ancient Hindu capital in the Dekhan, not far from the great Hindu city of Vijayanagar, the remains of which still testify to the splendour of the civilisation which Islâm set out to destroy but ended by being brought under its spell, just as Rome in the pride of conquest had been finally led captive by the art and civilisation of Greece.

The great mosque at Kulbarga, built at this time, is, as Fergusson observes, one of the most remarkable of its class in India, and in some respects unique. The Muhammadan builders, dispensing with the use of materials provided by the Hindu temples they despoiled, here began to build for themselves, and by way of experiment they varied the arrangement of the roof and arched screens. Instead of placing the latter in the usual way in front of the *liwân*, or sanctuary, and sometimes in front of the corridors on the side facing the courtyard, they roofed over the whole area of the courtyard, about 126 feet by 100 feet, by a series of 63 small domes of the usual

Hindu construction supported on columns, the corridors on three sides of the quadrangle being covered by a similar series of transverse vaults. To admit light into this covered area the

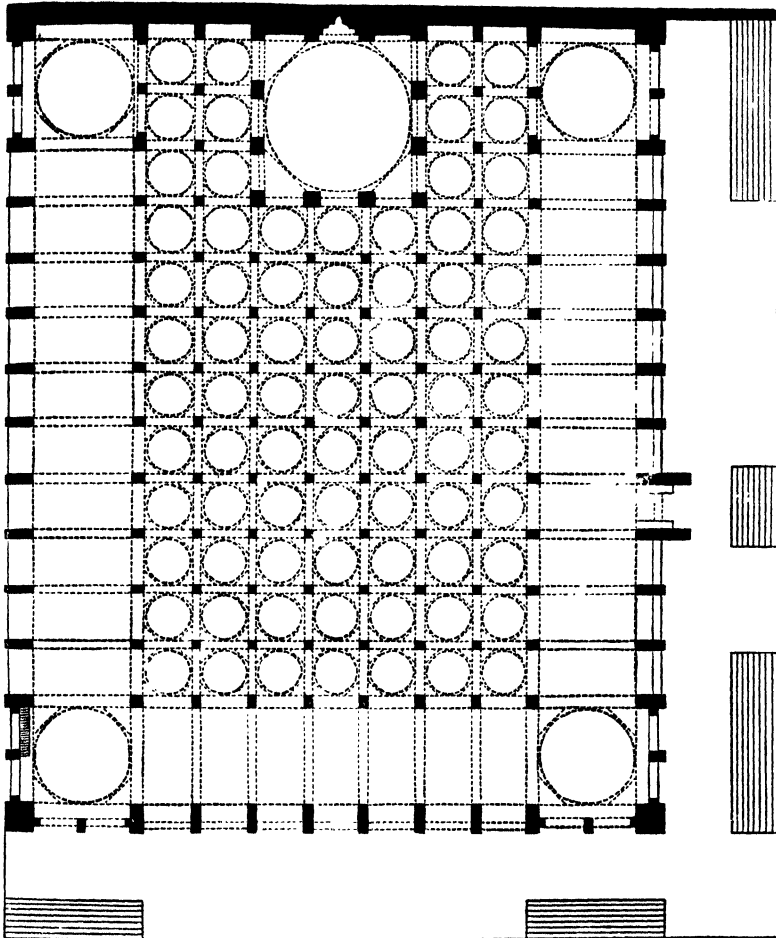

FIG. 8.—Mosque at Kulbarga (from Fergusson's "History").

usual screens of quasi-Saracenic arches had to be placed on the outside of the quadrangle, the four corners of the latter being roofed over by domes of 25 feet in width. The sanctuary was roofed by one large dome of 40 feet, raised on a clerestory,



and flanked on either side by six small domes similar to those which covered the inner courtyard.

The placing of the pointed arches on the exterior of the quadrangle makes this mosque appear to be more Saracenic in its design than usual, but as a matter of fact Saracenic designers had no more to do with the construction of the

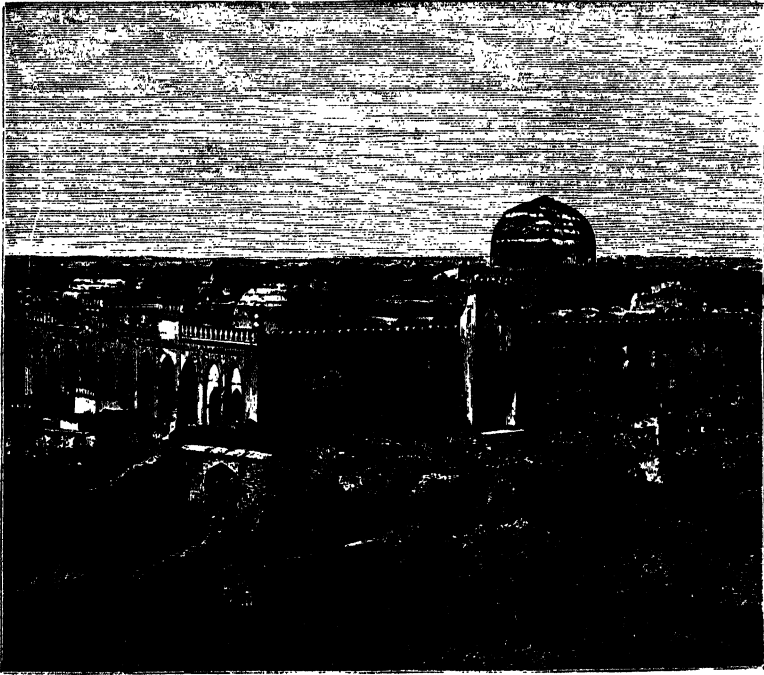

FIG. 9.—View of the Mosque at Kulbarga (from Fergusson's "History").

Kulbarga mosque than they had in other Indian buildings. In the history of Indian craftsmanship this mosque only marks the point where the screen of pointed arches was definitely accepted by Indian builders as a structural device in buildings for Muhammadan use. Although in the case of the Kulbarga mosque the appearance of the exterior was greatly altered by this addition to the resources of the builder, the structure of

the building was not otherwise modified, and the craftsmanship remained Indian throughout.

For some reason or other the experiment here made in the interior arrangement was never repeated in other mosques. From an æsthetic point of view it was successful enough : the placing of the great arches on the outside walls improved the ventilation of the whole building greatly, and the roofing of the whole area afforded much better protection from sun and rain to the congregation. So thorough was the craftsmanship and so excellent the Indian cement used in the roof that in Fergusson's time the mosque " stood in seemingly good repair after four centuries of comparative neglect," though, as he observes, any settlement or crack in the building would have been fatal. With the miserable leaking roofs, designed only for a European climate and often constructed according to the directions of Thomas Atkins or non-commissioned officers acting as amateur builders, most of our modern public buildings in India would, under similar circumstances, fall into ruin in twenty years.

Probably the true reason why this precedent of Kulbarga was not followed afterwards was the conservatism of the mullahs, who objected to a departure from the traditional arrangement of a mosque which exposed the congregation so much to the inquisitive gaze of infidels.

#### MUHAMMADAN TOMBS

So far we have only dealt with the evolution of the Indian mosque from the prototypes at Old Delhi and at Ajmîr. It is necessary now to refer to another type of building which had a very important influence on the development of Indian architecture from the thirteenth century onwards, namely, the

Muhammadan tomb. I have already alluded to the survival of Buddhist-Hindu traditions in the wonderful tomb of Mumtâz Mahall at Agra. In another chapter I will endeavour to trace more exactly the evolution of the domes of Saracenic tombs in Persia from Buddhist dâgabâs, or canopied pavilions in the form of dâgabâs, such as that which is sculptured in the façade of the great chapter-house at Ajantâ (Plate VI, B).

The Hindu builders, who were not relic worshippers and who usually cremated their dead, when they were called upon to construct Muhammadan sepulchral monuments,<sup>1</sup> began by making them in a similar style to their own domed pavilions, or the porches of Hindu temples. These Hindu pavilions were also directly derived from similar Buddhist structures, the domes of which were supported on four, eight, or twelve piers or columns, according to their size, the plan of the pavilions being either square or octagonal. The domes were built in the usual Indian fashion in horizontal layers of stone, brought to an approximately circular plan at the springing of the dome by cutting off the angles of the base of it, in the same way as a square column or pier was changed to a polygonal shape or circular one. Very many old Pathân tombs of this type, built by Indian masons, are to be seen in the neighbourhood of Delhi.

The next step was precisely similar to that which took place in the Indian mosque—the whole structure was enclosed by screens of quasi-Saracenic arches, forming corridors round the sanctuary of the tomb, which served both to protect the pilgrims who resorted thereto and to give more sanctity to

<sup>1</sup> Fergusson assumes that the Rajput custom of building cenotaphs, or *chhatris*, on the site of a chieftain's funeral pyre, was borrowed from the Muhammadans. I do not believe that this was the case; though the magnificence of Muhammadan tombs induced the Rajput princes to make a similar display with their *chhatris*, the custom itself was of much greater antiquity.

it. The dome gradually became larger and higher in proportion to the importance of the saint or other personage it commemorated, and then the roofs of the surrounding corridors were surmounted by four or eight small kiosks or domed pavilions like those which surrounded the upper floors of the many-storied Buddhist monasteries.

In later time the custom which the Moguls had of building tombs for themselves, or for their saints or heroes, in lovely gardens which had served as pleasure-resorts in their owner's lifetime, added a peculiar charm to their monuments which has not quite faded, though the art of the Indian formal garden with its beautiful symbolism is probably now lost.

From a structural point of view the Muhammadan tomb played an important part in the development of the Indian building craft, because the gradual increase in the size and weight of their domes, built of stone and brick and more massive and solid than any which other builders, except the Romans and Byzantines, had before attempted, forced Indian builders to solve the greater engineering problems of dome construction. They did so, as we shall see, in an entirely original way, by an application of constructive principles different to those employed by the Saracenic, Byzantine, or Roman builder. But this was not fully achieved until several centuries later.

## CHAPTER V

### THE FIFTEENTH CENTURY

MANDÛ : THE JÂMI' MASJID ; MULIK MUGHÍ'S MOSQUE—  
JAUNPUR : THE ATÂLA AND JÂMI' MASJIDS—AHMADÂBÂD :  
THE JÂMI' MASJID ; MUHÂFIZ KHAN'S MASJID—ALIF  
KHAN'S MASJID—MOSQUE AND TOMBS AT SARKHEJ—SAYYID  
USMÂN'S TOMB—SAYYID MUBÂRAK'S TOMB—GAUR : DAKHIL  
GATE AND EKLÂKHI MASJID

#### MANDÛ

IN the fifteenth century Muhammadan building activity in India increased in the centres already established, especially at Gaur and Ahmadâbâd, and also extended to others, the chief of which were Dhar and Mandû in the province of Mâlhwâ, and Jaunpur, about 40 miles north-west of Benares. Both in Mâlhwâ and at Jaunpur there were marked developments in Muhammadan building craft, though in different directions. At Mandû the Indian builders began to extend the use of the arch structurally, just as they had done at Gaur in the previous century,<sup>1</sup> so that their buildings assumed a more decidedly Saracenic or Persian appearance internally as well as externally. At Jaunpur they worked in an opposite direction—*i.e.* they took away the typical Arabic or Persian character of the arched screens in front of the *lîwân*, by combining the Hindu beam and bracket with the " Saracenic " arch. This

<sup>1</sup> As there was easy communication by sea between Gaur and the west coast of India, it is extremely probable that craftsmen from Gaur assisted in the building of Mandû and other Muhammadan cities in the neighbouring provinces.

PLATE XVIII

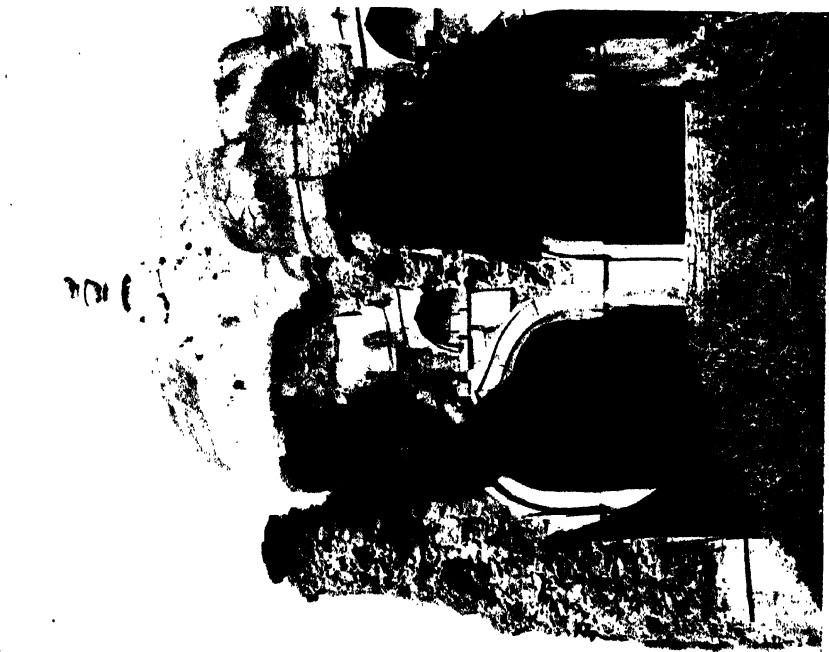

A. DOMES AND ARCHES

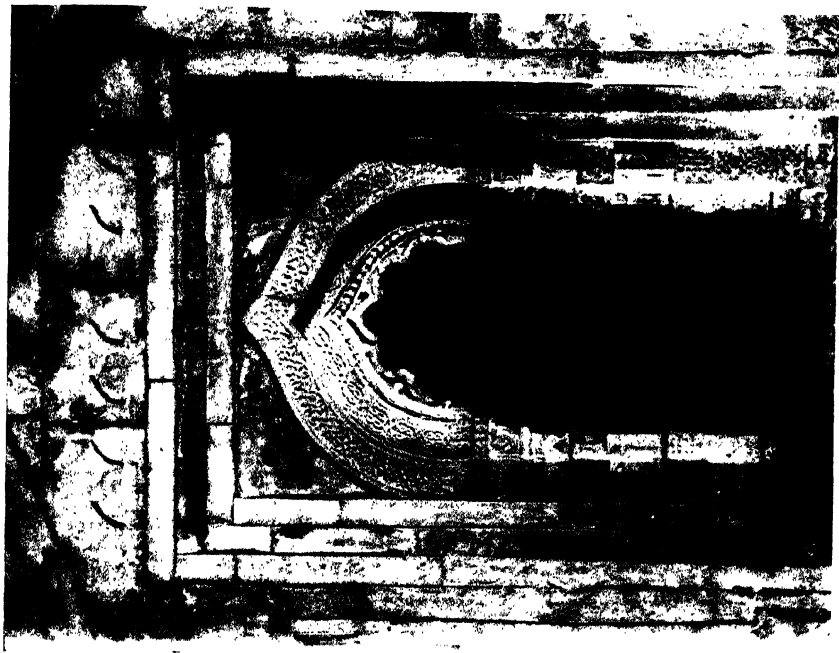

B. MIHRÂB

JÂMI' MASJID, MANDÛ



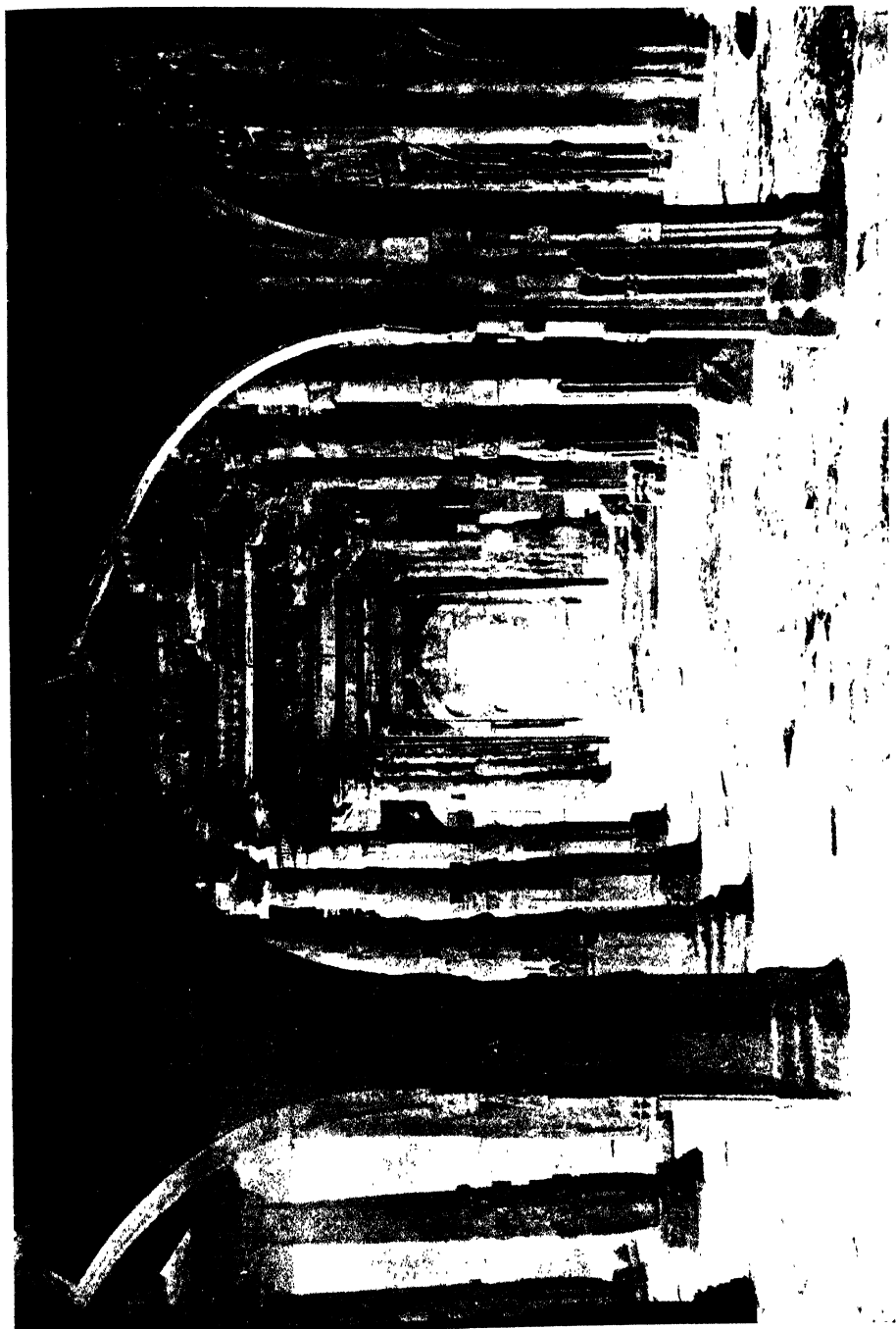

MANDŪ: MALIK MUGHĪ'S MOSQUE, INTERIOR OF LIWĀN





happy combination of the two constructive principles continued to be the most common characteristic of Muhammadan building in India. It was essentially an Indian invention or adaptation—not a foreign one; that is, the Indian craftsmen were not being instructed by foreign builders, but were adapting the structural use of the arch, first forced upon them by their Muhammadan rulers, in the way which pleased themselves.

But in the province of Mâlhwâ, as in Gujerat, the pre-Muhammadan buildings had been for many centuries largely built of stone, and consequently the arch had not been used structurally, even on a small scale, as it had been at Gaur, before the Muhammadan ascendancy. It was, however, inevitable that intelligent craftsmen, as Indians undoubtedly were, once they had accepted the arch as a structural necessity in front of the sanctuary of Muhammadan mosques, and finding it convenient for bridging over wide spans between columns, piers, or walls, should sooner or later begin to experiment with it in the interior of their buildings. This is what happened at Mandû and some other places in Mâlhwâ. Fergusson, classifying Indian buildings as a student of architectural style rather than as a craftsman, assumes that at Mandû, as at Delhi and Ajmîr, Persian, Arabian, or Syrian builders introduced by the Muhammadan rulers were beginning to teach Indians the “true elements of architectural design,” according to Saracenic ideas.

*Prima facie*, the mosques and palaces of Mandû seem to afford strong evidence that this was the case; but the craftsmanship tells a very different tale. There is tile-work which might be Persian or have been imported from Gaur, but no evidence of the Arabian or Persian builder. The stone arches are built by Indian masons experimenting for themselves in

this form of construction. The voussoirs of the arches are not divided with mathematical regularity as they would be by a Persian or Arabian mason skilled in arch construction, but are cut irregularly ; the keystone, which to a skilled arch-builder is the principal one, being the smallest. Moreover, the form of them is not strictly Arabian or Persian, for the crowns are tipped up to give that suggestion of the sacred pîpal leaf which is typical of the arch in Indian-Buddhist and in Hindu shrines. The mihrâbs are only adaptations of local Hindu shrines (Pl. XVIII). The domes are not crowned by the correct Saracenic finial, but by Buddhist-Hindu emblems—a sure sign that the masons were Indians. There are buildings at Mandû which show the transition from the old to the new Indian style, some of the columns in the interior being joined by beam and bracket and others by arches (Pl. XIX). This is an indication that Indian builders, being no longer bound by Hindu ritualistic traditions, were voluntarily adapting their craft to the new structural conditions, for foreign builders imported to instruct Indians would not have used Hindu methods and symbolism.

The difference in point of style between Mâlhwâ architecture and the contemporary Muhammadan styles in Gujerat and Jaunpur is that at Mandû and other places in Mâlhwâ the builders began to obtain the heights they wanted inside the mosques by joining the piers and columns with pointed arches instead of by placing one column on the top of another, or by building two stories, as Hindus would have done. We may agree with Fergusson in appreciating the effect of simple grandeur and expression of power which they obtained in this way, without denying to Indian builders the credit which is their due.

PLATE XX

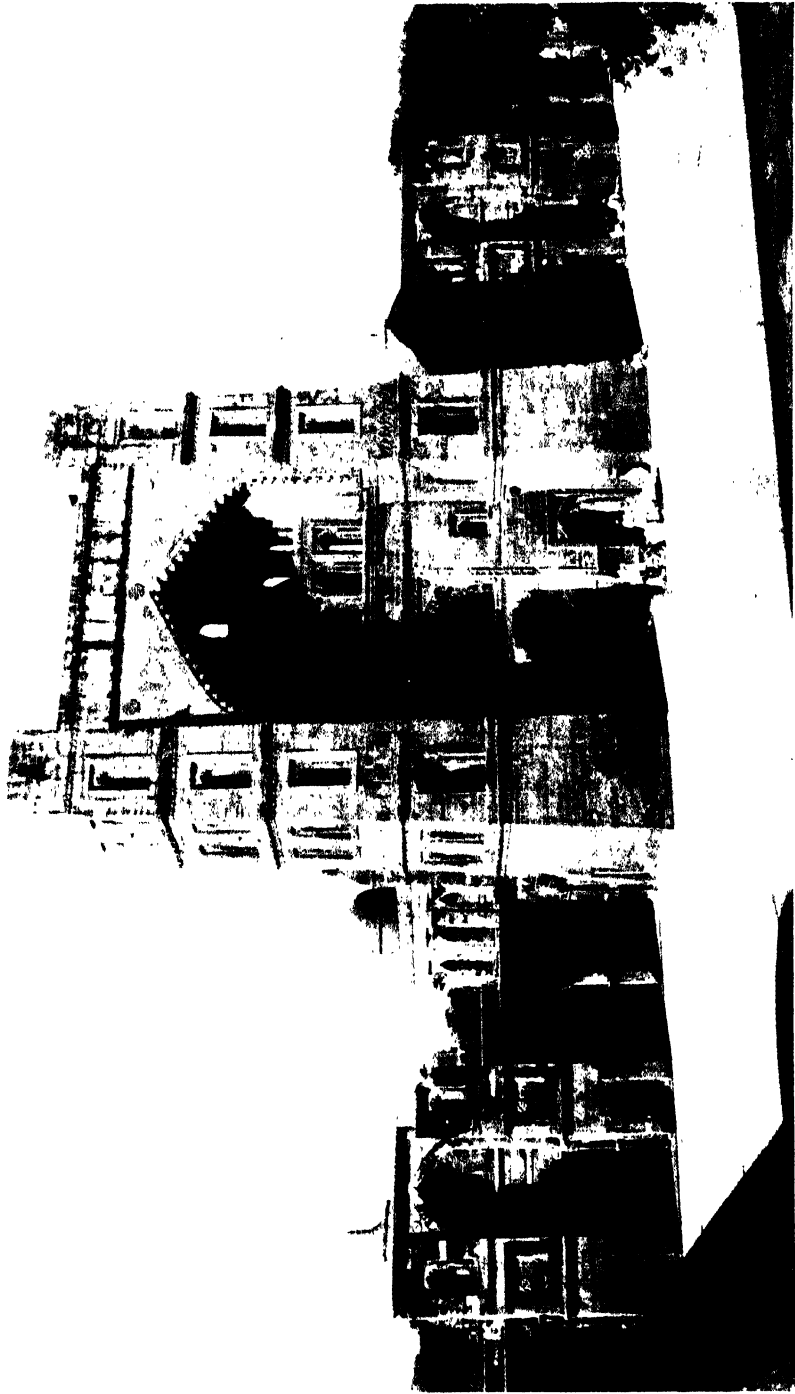

JAUHPUR : ATĀLA MASJID



PLATE XXI



SĀS BAIṬ, OR PAḌMANĀBHA TEMPLE, GWALIOR



## JAUNPUR

At Jaunpur the principal buildings of the fifteenth century are the Atâla Masjid (Pl. XX), completed in 1408 during the Sultanate of Shah Ibrâhîm (1401-39), and the Jâmi' Masjid, commenced in the time of Husain Shah (1452-78)—both noble structures with a strongly marked Hindu character, though the exterior arches are without the pîpal-leaf keystone, and though pointed vaulting with ribs is introduced into some compartments of the interior. A very striking and original effect is produced by the treatment of the screen in front of the liwân, which in these buildings is reduced to a single lofty arch, flanked by turret-like sloping buttresses<sup>1</sup> which serve for minarets, and filled in with

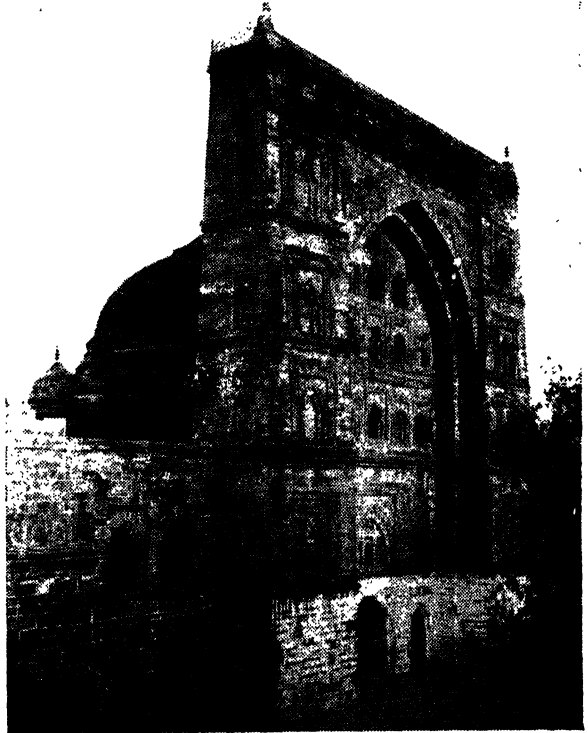

FIG. 10.—Jâmi' Masjid, Jaunpur: Principal Entrance to liwân.

<sup>1</sup> The slope inwards of these buttresses is perhaps the Indian craftsman's reminiscence of early Buddhist methods of construction when the walls of building were sloped inwards to counteract the thrust of vaulted roofs. The sloping architraves sometimes found in the doorways of modern buildings in Sikhim and Tibet are undoubtedly derived from this ancient practice. Some early Pathân tombs in India show the same slope, *e.g.* Tughlaq Khan's tomb at Delhi.



a subsidiary slightly recessed screen in which the "Saracenic" arch and the Hindu lintel are ingeniously combined. An archæologist or purist in style may think the combination strange and hybrid, but as architecture it is finely conceived.

The whole style of the building seems to be a reflection of the massive grandeur of Hindu temples, like the Sâs-Bahû or Padmanâbha temple at Gwalior (Pl. XXI), which resembles these mosques in being built in several stories and in being raised on a platform of masonry. All the domes at Jaunpur are surmounted by Hindu emblems, as in the case with nearly all Muhammadan mosques in India.

#### AHMADÂBÂD

About the same time as the buildings already described were being constructed at Mandû and Jaunpur, Ahmadâbâd—now the capital of an independent Musulmân kingdom, and so called from the name of the second Sultan of the dynasty—was being adorned with a series of splendid buildings which, like other Muhammadan edifices of this period, bear striking testimony to Indian constructive genius. Ahmad Shah, being a Rajput himself, had no foreign prepossessions in architectural style, so that when he set about building a Jâmi' Masjid<sup>1</sup> soon after the commencement of his reign in 1411, his Indian builders were given an entirely free hand in the design of it. It so happened that about the same time, as Fergusson tells us, another independent Rajput chief, Kumbha Rânâ, of Mewar, a Hindu of the Jaina sect, was building a great temple at Rânpur, about sixty miles from Ahmadâbâd. A comparison between these two buildings is particularly useful

<sup>1</sup> A Jâmi' Masjid is the mosque in which the principal or Friday services are celebrated: hence it might be called a "cathedral mosque" to distinguish it from others.

PLATE XXII



JAMI' MASJID, AHMADABAD



PLATE XXIII



TOWER OF VICTORY, CHITOR (A.D. 1440)



as an illustration of my contention that Muhammadan and Hindu architects in India were, with rare exceptions, craftsmen of the same race, imbued with the same craft traditions, and possessing an equal capacity for dealing with any constructive or purely artistic work which their rulers might be pleased to place in their hands.

The few instances in which it can be shown with certainty that Muhammadan rulers in India sent to foreign countries for architects or craftsmen by no means prove that India was unable to supply men of equal or superior capacity, though such cases might logically be taken to prove the ruler's prejudice or ignorance. The only possible way of deciding this question judicially is to examine the buildings themselves for evidence of foreign design and craftsmanship, taking care to discriminate between the two, for a borrowed idea does not necessarily mean foreign brains or handwork.

The term "Saracenic," as applied to Muhammadan architecture in Gujerat, is even more misleading to the student than Fergusson's classification is generally. There is not the least indication in any of these buildings of foreign design or handicraft. No other form of Muhammadan architecture in India, says Fergusson, is so essentially Indian: though generally he represents the Saracenic builder as the inspirer of the Hindu, he is constrained to admire this Indian style as being the most elegant of them all. Comparing the Hindu temple at Rânpur with the contemporary Jâmi' Masjid at Ahmadâbâd, he feels instinctively that there is more poetry in the former, but, fearing that his artistic instinct may offend his academic conscience, he adds, "there is a sobriety about the plan of the mosque which after all may be better taste."

Comparing the façade of the Jâmi' Masjid at Ahmadâbâd (Pl. XXII) with the screens at Delhi and Ajmîr, it is easy to

see how the fifteenth-century builders in Gujerat were trying to modify the thirteenth-century models which had been forced upon Indian master-craftsmen. They clearly felt with the Jaunpur builders, that, however beautiful the Ajmîr and Delhi screens might be in themselves, they were ill-fitted in structure for their purpose and artistically incongruous with the Hindu interior of the mosque. So instead of altering the structure of the interior in order to adapt the latter to the façade, as the Mandû builders tried to do, they Hinduised the design of the façade to make it fit the interior.

Disliking the regularity of the Ajmîr and Delhi screens, they broke up the horizontal lines by dividing the façade into five compartments instead of three; and by increasing the height of each successive compartment from the ends towards the centre of the façade, they gave the whole design the pyramidal lines which are characteristic of Hindu temple-structures. The lofty "Saracenic" arches of the screen were reduced in number to three instead of seven—one on each side of the great central arch—the ten smaller Hindu arches of the adjoining compartments being formed by bringing five of the interior rows of columns on the north and south of the *lîwân* out to the line of the façade and linking them together below the capitals with brackets in Hindu fashion, in the same way as most of the small arches were formed in the buildings at Gaur. The keystones of the three main arches have, as usual, the symbolism of the *pîpal* leaf worked into them.

The beautiful minarets which are so characteristic of this and other mosques in Gujerat have none of the Saracenic feeling of the Qutb Minar at Delhi, but are entirely Hindu in style, being only adaptations of the splendid Rajput Towers of Victory at Chitor (Pl. XXIII). Unfortunately the Jâmi' Masjid lost the upper part of its minarets by an

PLATE XXIV

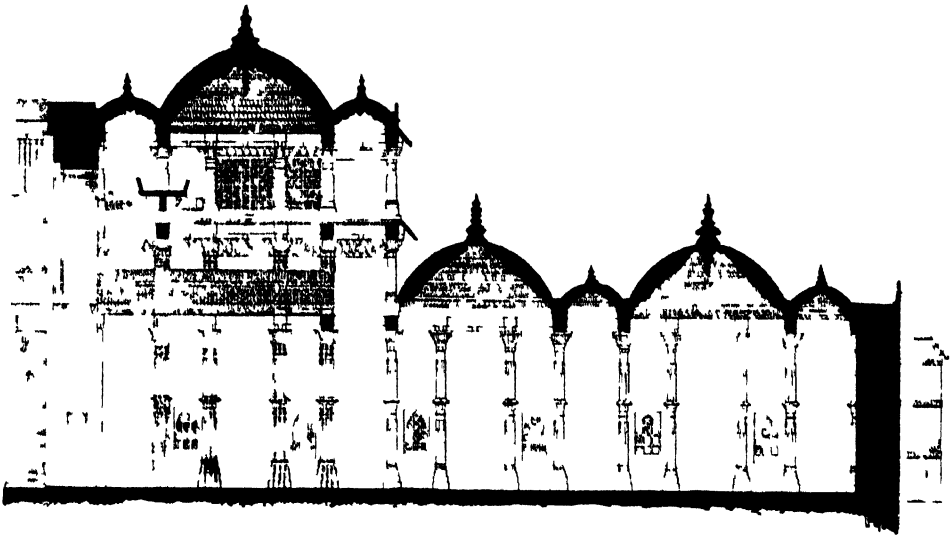

JAMĪ MASJID, AHMADĀBĀD

A HALF-SECTION, LONGITUDINAL SECTION AND CROSS SECTION

(Drawn by the Architectural Survey of India)





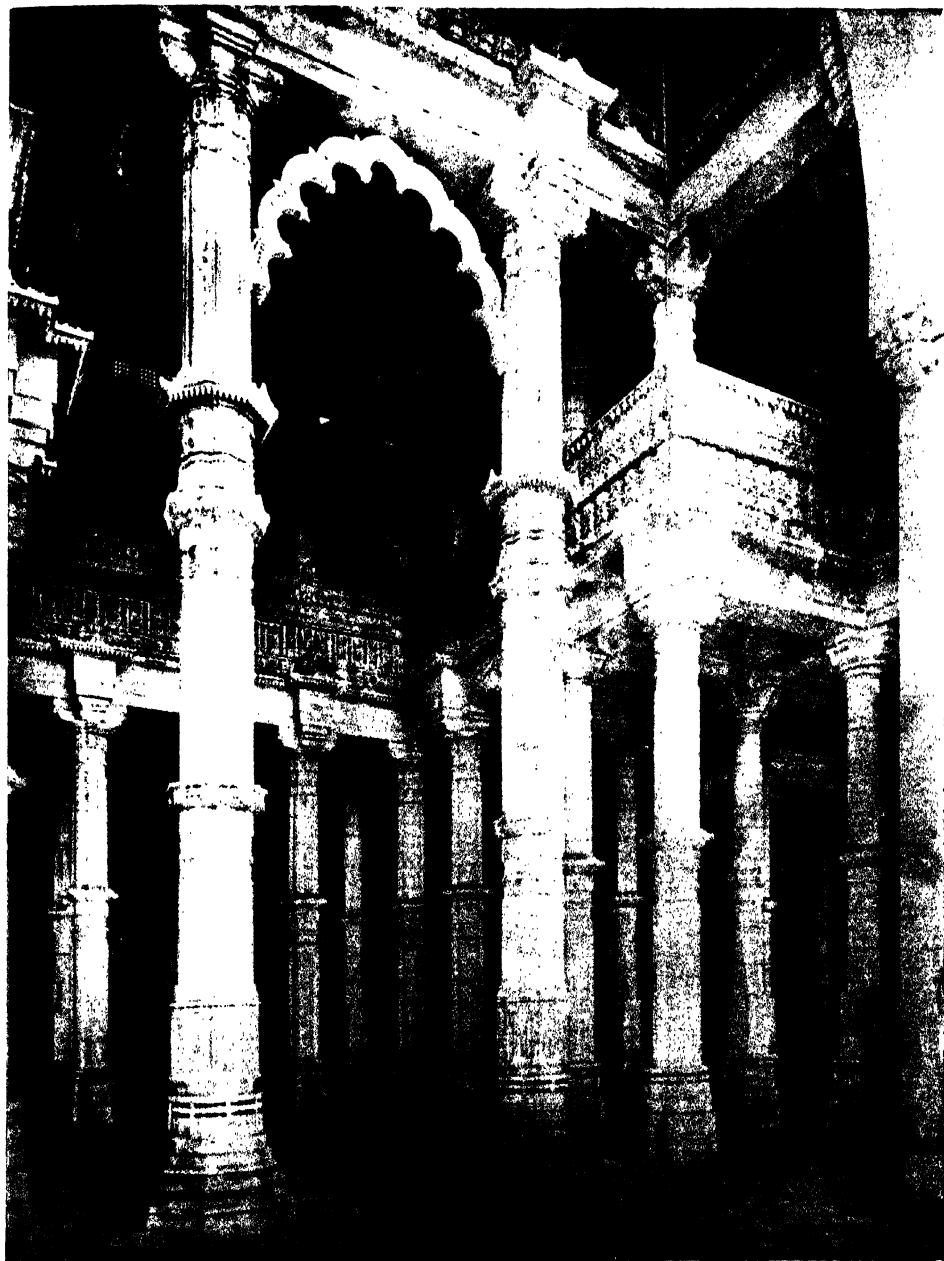

JĀMI' MASJID, AHMADĀBĀD: INTERIOR OF LĪWĀN



earthquake in 1819, and the unity of the whole design of the façade was thus sadly broken. But even when this is taken into consideration one feels that the difficulty of harmonising the Saracenic façade with the Hindu interior was not overcome quite so successfully in the Jâmi' Masjid as in some of the later buildings in Gujerat, particularly the

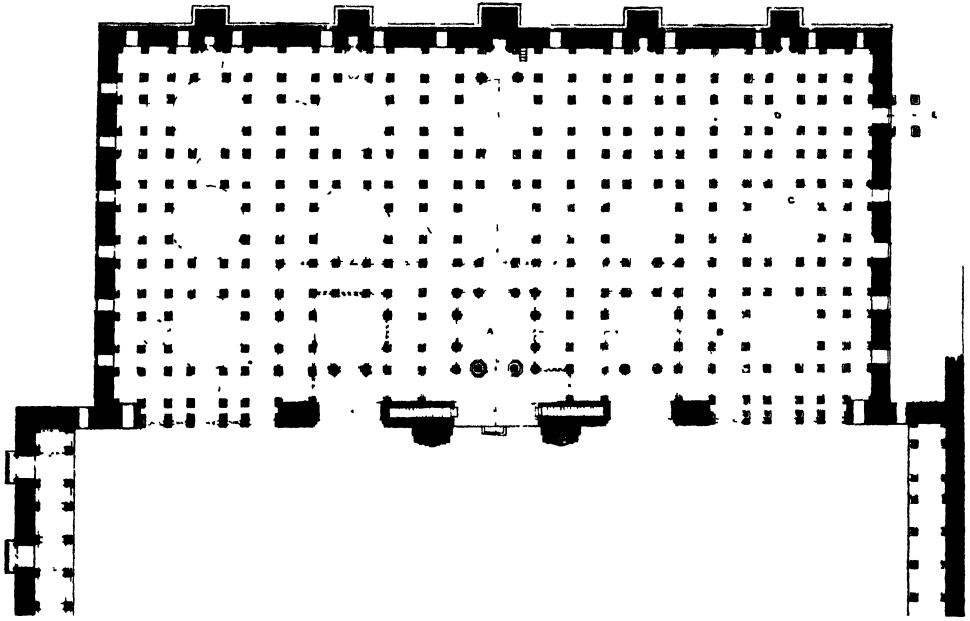

FIG. 11.—Jâmi' Masjid, Ahmadâbâd : Plan of liwân (from a drawing by the Archæological Survey of India).

Rânî Rupâvatî Masjid at Mirzapur (Plate LIV), which has also lost the upper part of its minarets. Fergusson's observation that as the style progressed it became more and more Indian, rather than Saracenic, may be noted in this connection.

The beauty of the Jâmi' Masjid and of most of the Gujerat buildings of this century lies, however, mostly in their interior structure and decoration, into which no trace of the Saracenic

element enters. Even the most sacred symbol of Islâm, the mihrâb, is so completely transformed that, except for a small pointed arch, as much Hindu as Saracenic, it is only a replica of the door of a Hindu shrine.

Plate XXV, the interior of this building, and Plate L, showing the interior of another Gujerat building, the Jâmi' Masjid at Champanîr, will help the reader to realise the decorative richness and noble structural design of these early Gujerat mosques, though the Champanîr mosque is really about half a century later than the Ahmadâbâd building.

The plan of the liwân at Ahmadâbâd (fig. 11) will show the disposition of the columns and arrangement of the domes ; the sections (Pl. XXIV) will explain the structure of the interior. There are fifteen large domes, each supported on eight columns according to the usual Hindu design, and built up in horizontal courses by gradually changing the octagonal base into a circle. The large domes are linked together by a flat roof and by a number of smaller domes of similar construction supported on four columns each. The longitudinal section of the liwân follows the pyramidal lines of the exterior, the great central dome in front of the main entrance, together with its four smaller connecting domes, being raised up above the adjacent ones so as to admit a diffused light through clerestory windows. A similar arrangement obtains in the next adjacent aisles on the longitudinal section. Fergusson observes of this arrangement that " the necessary amount of light is introduced, as in a Byzantine dome, but in a more artistic manner. The sun's rays can never fall on the floor, or even so low as the head of anyone standing there. The light is reflected from the external roof into the dome, and perfect ventilation is obtained, with the most pleasant effect of illumination without glare." He

PLATE XXVI

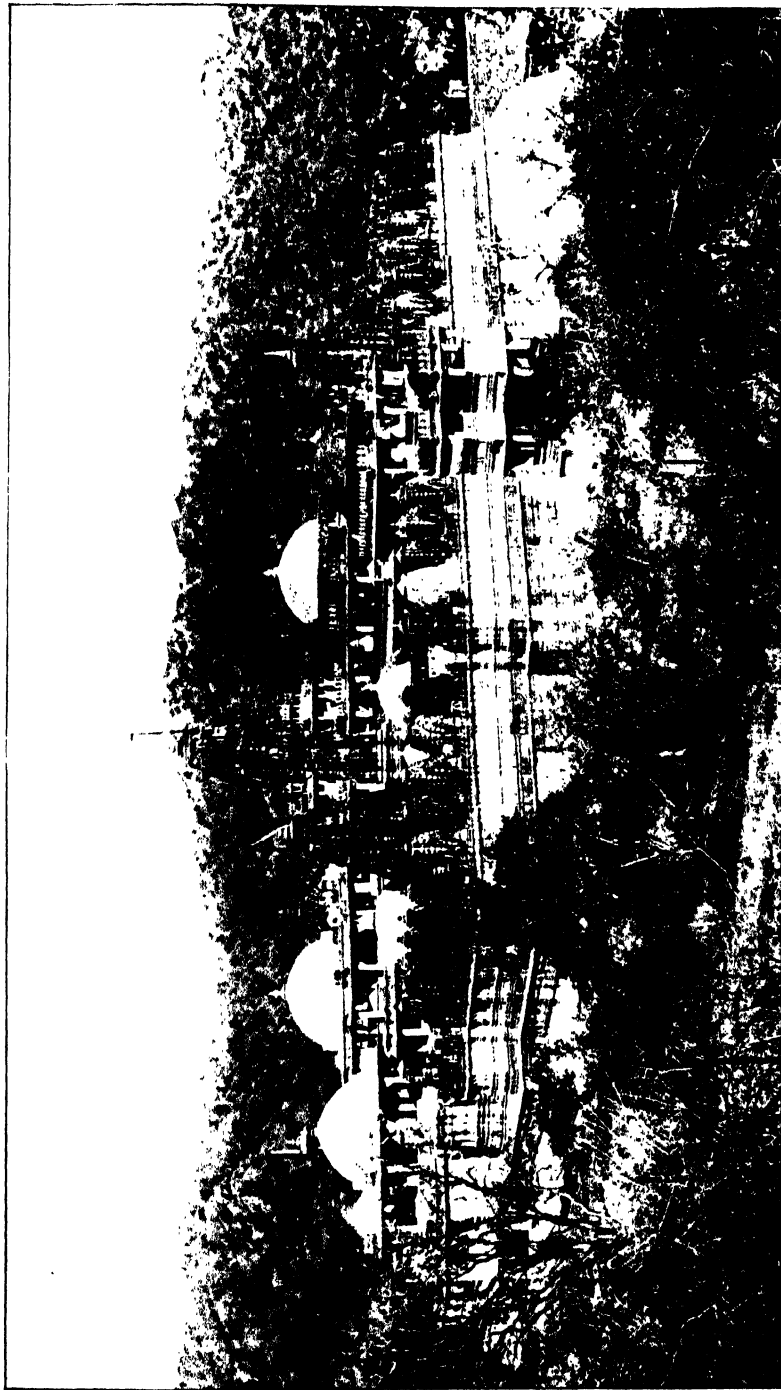

TEMPLE AT RANPUR  
(From Feignson's "History")



might have added that the arrangement was not a Saracenic invention, but a long-standing tradition in Indian temple-building of that part of India; being only a slight modification of the similar idea which is carried out in the lighting of the splendid chapter-house at Ajantâ (Cave XIX). None of the structural Buddhist monasteries of the same period are extant, otherwise we should doubtless have discovered in them the exact prototypes both of the Rânpur temple and of the Jâmi' Masjid at Ahmadâbâd.

As the temple built by Kumbha Rânâ (Pl. XXVI) lies in a sequestered valley in Jodhpur far away from the beaten track, it has not attracted so much attention as the famous shrines of Mount Abû and has not yet been properly photographed, so it is difficult to add to what Fergusson has given for the purpose of showing that Kumbha Rânâ's temple and Ahmad Shah's mosque belong to exactly the same school of architectural design. But one interesting point may be noticed, which might be puzzling to Fergusson's readers—the fact that several of the domes of the Hindu temple are on the exterior "Muhammadan"—*i.e.* they are not sculptured in the Hindu style, but are brought to an even surface by cement and fine plaster in the same way as the domes of Muhammadan mosques. It is possible that in this particular instance the domes may be modern restoration, but it is a fact that soon after the Muhammadan conquests began, the Hindu temple-builders in Northern India began to treat the exterior of their domes in the same way as their craft brethren, the Muhammadan builders, were doing. It would be quite wrong to take this as a proof that the Muhammadans were teaching a superior art to the Hindus; it was simply that the latter sheltered themselves from the fury of their oppressors by observing the same law of protective imitation



by which nature provides for the protection of the weak against the strong. The Brahmans were trying to protect their temples and to make them less offensive to Muhammadan susceptibility by making less conspicuous the anthropomorphic symbolism which Islâm denounced as "idolatry." At the same time the teaching of Islâm was not without its influence upon Hinduism, inasmuch as both Jaina and Saiva teachers began to discountenance the use of images in religious ritual, as the Vedic rishis before the days of Buddhism had done. Idolatry, in the Puritan acceptance of the word, had never been and is not now a part of Brahmanical religious teaching.

The result of this was that in Northern India Hindu and Muhammadan buildings could no longer be distinguished by their domes, for they were often exactly similar. This, however, applies only to the pavilions and to the porch, or *mandapam*, in front of Hindu shrines, for neither the curvilinear spire of the northern styles nor the pyramidal structure which surmounted the shrine containing the image or sacred symbol in Dravidian temples was ever reproduced in Indian mosques. Of course the entire absence of figure sculpture, and generally of animals also, from Muhammadan buildings gave them a distinctive character, quite apart from the more frequent use of arches and differences in planning. What they lost in human interest and in plastic beauty they gained in charm of colour, in fine combinations of geometric and floral patterns, and in rich material. To many Europeans with "classical" predilections they will be more pleasing and correct in taste, owing to the greater restraint in plastic treatment which the law of Islâm imposed upon Indian craftsmen. On the other hand, those who can enter into the spirit of the great Gothic masters will feel no less admiration for the



ALIF KHAN'S MASJID, DHOLKĀ



imaginativeness and wider artistic range which are shown in Hindu temple decoration of the same period.

Throughout the fifteenth century we find the Indian Muhammadan builders pursuing their own aims on these lines, often using foreign models in decorative design, as good craftsmen in all countries use them, not imitatively, but to increase their stock of artistic material. As regards structural design and craftsmanship, it would be difficult to name a single Indian Muhammadan building in this century which could be called foreign to India in the same sense as St. Mark's at Venice was foreign to Italy, or as both Gothic and Renaissance architecture were originally foreign to England.

In several fine mosques at Gujerat and Jaunpur continued experiments were made in the design of the façade, though no important variation was made in the interior: the mosque of Muhâfiz Khan at Ahmadâbâd is one of the most successful in this respect, and one of the few which has its minarets still intact. The Jâmi' Masjid at Dholkâ is another good example which Dr. Burgess supposes to be not later than 1485. The Alif Khan Masjid, otherwise known as the Brick Masjid, is dated by the same authority at about 1450: it is especially interesting in the present day—when one of those many foolish or cynical reasons urged for neglecting the Indian building craft is that it is necessarily extravagant—as showing what beautiful work Indian builders have done in brick and plaster as well as in more precious materials. It is necessary to observe in this connection that comparatively few Indian buildings usually classed as stone are constructed entirely of solid masonry. The main walls are generally of brick faced with stone, sometimes marble. The framing-in of the doorways of Alif Khan's mosque (Pl. XXVII) is an adaptation of the design of the doorways of Hindu shrines.

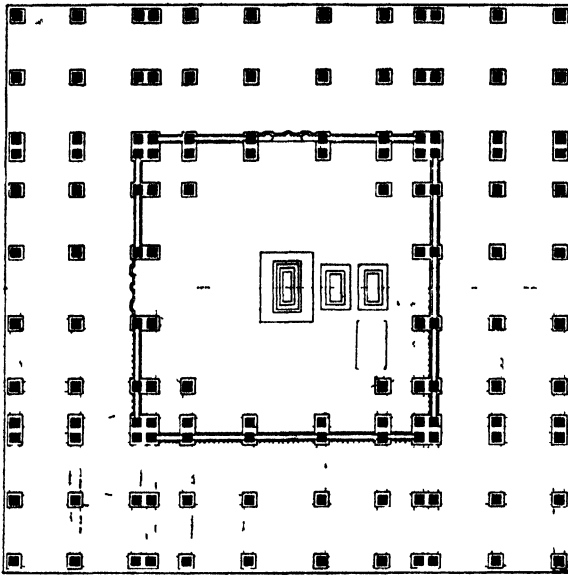

FIG 12 —Plan of Sayyid Usmân's Tomb (from a drawing by Mr H. Cousens).

fine art as exquisite as Persian tile-work, and constituting one of the chief glories of Indian mosques of the sixteenth and seventeenth centuries.

Among the important Muhammadan tombs built in this century, that of Sayyid Usmân, near Ahmadâbâd, is interesting from a structural point of view from a new departure which was made in the supports of the dome; the base of the latter, instead of being octagonal, was transformed into a dodecagon, and greater massiveness was given to the supports by joining

The mosque and tombs at Sarkhej, near Ahmadâbâd, which also belong to the middle of the fifteenth century, are chiefly remarkable for the development they show in the use of pierced stone trellises which had been employed in Hindu temples for many centuries previously. This was an application of indigenous craft which afterwards became a

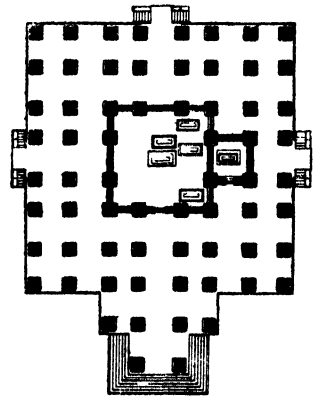
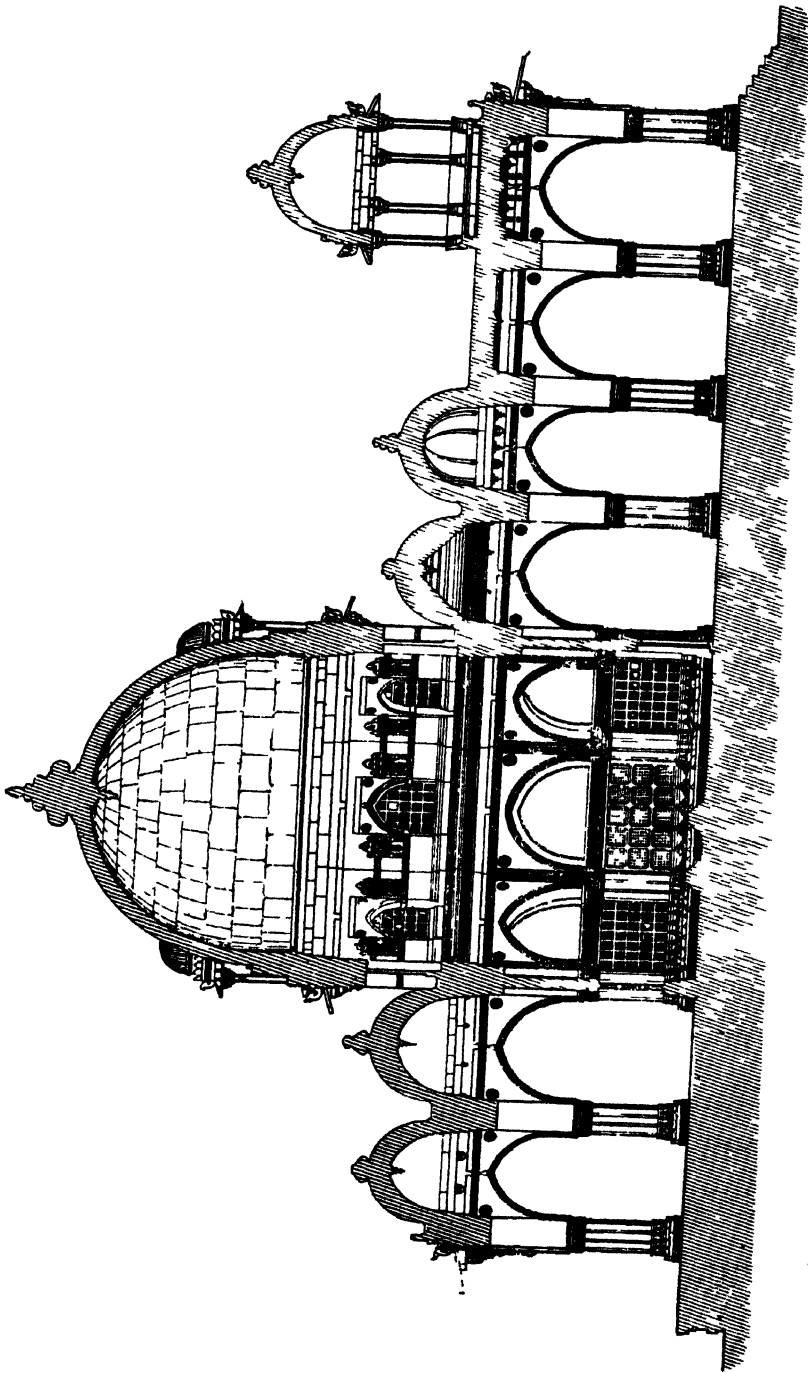

FIG 13 —Plan of Sayyid Mubârak's Tomb.



Scale of 0 10 20 30 40 50 60 70 80 90 100 Feet  
FIG 14 —Tomb of Sayyid Mubarak longitudinal section (from a Drawing by the Archaeological Survey of India)

two or four pillars into single piers—a practice which became common in later Muhammadan buildings and gave them a distinctive character. It was built, according to Fergusson, in 1460.

Another fine tomb of about the same date, that of Sayyid Mubârak, Minister of Mahmûd Begarah, who reigned at Gujerat from 1459 to 1511, is almost unique among the buildings of the province, because the builders, desiring to plan it on a grander scale than usual by increasing the distance between the supports of the roof, took to using arches throughout the building, including the double corridors which surrounded the enclosure of the tomb, as well as in the exterior screens which form the four façades and in the entrance porch. Here, also, for the first time apparently, clerestory windows with pointed arches were introduced into the octagonal base of the dome, giving the structure a distinctly Byzantine appearance. Here, certainly, the casual observer might say, Saracenic builders have been at work. But a careful study will show the Indian masonic tradition carried right through the whole building. The arches are put in by Indian craftsmen,<sup>1</sup> for they have the symbolism of the pîpal leaf in the keystones. The piers are in the form of four square pillars grouped together, a design which a Hindu builder would adopt when a wider spacing than usual necessitated an increase in the traditional size of the roof-supports. A Saracenic master-builder, accustomed to wide spaces between the piers, would not think of a large pier as four small pillars combined. The domes are all of Indian construction and with Indian sym-

<sup>1</sup> It should be noted that Mahmûdâbâd, the place of Sayyid Mubârak's tomb, is close to the old Hindu city of Dabhoi, some of the remains of which are shown in Plates II and III. Doubtless the Muhammadans, as they were wont to do, had drawn many Hindu craftsmen into their service from there.

PLATE XXVIII



TOMB OF SAYYID MUBÁRAK, MAHMÚDÁBÁD





bolism. There is no trace anywhere of foreign suggestion or supervision. All that the Saracenic or Byzantine appearance of the building proves is that, given similar conditions and similar constructive problems, skilled craftsmen in all parts of the world arrive at similar results, though they may choose different ways of working.

At Gaur and at Mandû the buildings of the fifteenth century show little variation on those of the preceding century. The Dakhil Gate and other entrances to the Fort at Gaur and the Eklâkhi Masjid or tomb at Panduâ, ascribed to about the middle of the century, are examples of the beautiful brickwork with moulded and carved decoration which was one of the master-crafts of Bengal until quite recent times.

In Mâlwâ there was great building activity throughout the century, a number of palaces being constructed by the Sultans of that province at Mandû, and a very fine mosque, the Jâmi' Masjid, which was finished by Mahmûd Shah in 1454. The style of these buildings has already been described.

## CHAPTER VI

### INDIAN ARCHES, BRACKETS, CAPITALS, AND DOMES—THE HINDU TEMPLE *SIKHARA*

HAVING discussed the general characteristics of Muhammadan buildings in the first three centuries of their domination in Northern India, I think it will help to explain more fully the previous chapters as well as those which follow if we begin now to analyse the evolution of various important details in Indian architecture, both as regards structure and symbolism. In Indian art the ideal and the practical act and react upon each other to such an extent that it is impossible for the outsider to understand fully the one without knowing the other ; for if in the primitive stages of constructive development we shall find the symbolism growing out of practical craftsmanship, we shall discover later that the symbolism itself often leads to constructive ideas.

We have before noticed that the pointed arch was by no means unfamiliar to Indian craftsmen before the Muhammadan invasion, though structurally they had used it very sparingly and on a small scale. It has not yet been understood by European writers that the trefoil arch originated in Indian Buddhist symbolism many centuries before it appeared in Western art. In India, as in Europe, it was a form which architecture borrowed from the graphic arts, for it originated with the transcendental ideas connected with the Indian conception of the Deity, and with anthropomorphic symbolism. As far as we know, the various forms of Indian religious ritual which were directly derived from Aryan

teaching has this in common with Muhammad's creed, namely, that until the beginning of the Christian era they discountenanced any representation of the Deity in human form. In early Buddhist sculpture the symbols of worship are inanimate memorials of the Master's life on earth; the Bodhi tree underneath which he won Nirvana<sup>1</sup>; his sacred footprints; his begging bowl; but not his own person. Whether Buddhists until the time of Nâgârjuna had the same feelings as Muhammadans regarding the representation of the Deity, or whether it was simply that they had not until that time regarded the Buddha as a divine being, I will not attempt to discuss. The important point in Indian architectural history is that the various forms of foliated arches were associated with the first painted and sculptured representations of the divine Buddha, which began to appear with the rapid spread of Mahâyâna Buddhism in the early centuries of the Christian era.

It has been supposed by Oriental scholars that the earliest sculptures of this kind are those of Græco-Roman craftsmen of the Gandhâra and Mathurâ schools; but I believe that further archæological investigation will show that this assumption is untenable. Sister Nivedita has drawn attention<sup>2</sup> to internal evidence in the Gandhâra sculptures which seems to indicate that they are only Græco-Roman reproductions or imitations of a pre-existing Indian model of the divine Buddha which should be sought for in the Magadha country. It is possible, again, that Indian Buddhist sculptors were borrowing from earlier Jain representations of their quasi-divine

<sup>1</sup> Professor Rhys Davids has shown that according to Buddhist teaching the attainment of Nirvana is a purely spiritual achievement, and does not necessarily imply the dissolution of the physical body.

<sup>2</sup> *Modern Review*, Calcutta, July, August, 1910.

teachers, the Tirthankaras. In any case the symbolism or the ideal from which the trefoil arch is derived was not Greek, or Roman, or Saracenic, but purely Indian.

The trefoil was the shape of the aura, the glory or divine light which shone from the body of the Buddha from the moment when he attained Nirvana under the Bodhi tree at Gayâ. The simplest form of the aura, as drawn by painters and sculptors—and probably the earliest—was the lotus-leaf shape, derived from the gables and windows of the barrel-vaulted roofs of early Indian buildings, which again might have had their prototype in the primitive structures of reeds and thatch which are still found in Mesopotamia.<sup>1</sup>

The term "horse-shoe" arch as applied to these Indian

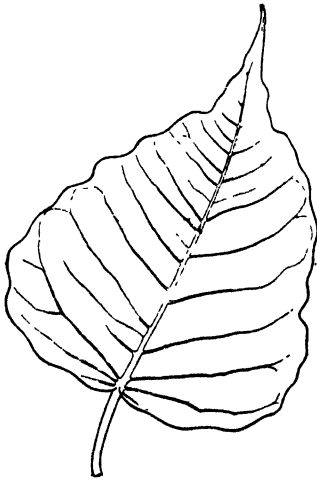

FIG. 15.—Leaf of the Pipal Tree  
(*Ficus religiosa*).

Buddhist buildings by Fergusson and other writers is very inappropriate, for the horse-shoe has no meaning in such a connection, whereas the lotus leaf was a symbol so full of sacred associations for Buddhists that this form of window and gable is found constantly repeated in early Indian buildings as a decorative motif when it was not required structurally. The idea of good luck popularly associated with the horse-shoe is perhaps derived from its resemblance to the lotus leaf. The outer curve of the lotus-leaf arch (Plate XXIX, fig. A) took the form

of the leaf of the sacred pîpal—the Bodhi tree (fig. 14.)

The pîpal tree was associated with the enlightenment of

<sup>1</sup> Dr. Felix Langenegger in "Die Baukunst des Irâq" (Gerhard Kùhtmann: Dresden, 1911) illustrates one of these (fig. 45).

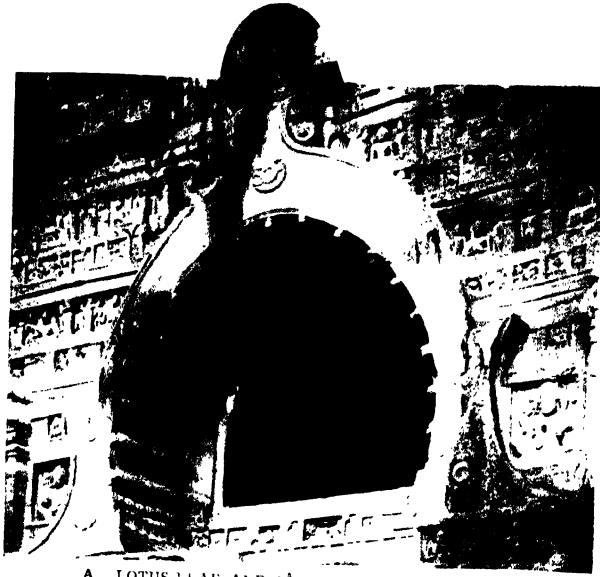

A. LOTUS LEAF AND PIPAL-LEAF ARCH, AJANTA



B. LOTUS LEAF WITH MAKARA (S. INDIAN BRONZE)



C. LOTUS LEAF AND BANYAN LEAF (TIBETAN IMAGE)



Buddha ; but various trees, such as the banyan, were dedicated to other religious teachers, the favourite place for a yogin's meditation being under the shade of a tree. When a Rishi was worshipped as a deity, it was therefore appropriate to make the aureole round the head of the image take the shape of the leaf of his especial tree ; by an easy transition of ideas the leaf was transformed into a flame.

When used to represent the aura in a sculptured or painted figure of Buddha, the lotus leaf was generally associated with the *makara*, a kind of fish-dragon, the fish being an emblem of Kâma, the god of love, and of fertility (Pl. XXIX, fig. B) : here points of flame are added to the edge of the lotus leaf. The fish was also a sign of good luck, for in the Indian legend of Creation it was a fish that saved Manu, the progenitor of the human race, from the flood. This form of aureole with the makara and lotus leaf combined is still a tradition with Saivaite image makers in Southern India.

The trefoil arch was a compound aureole, or nimbus, made up of a combination of the lotus and pîpal or banyan leaf slightly different to that which obtained in the window or gable described above. The pîpal leaf stood for the glory round the head of the Buddha, while the lotus leaf remained as before to indicate the shape of the aura which surrounded the body. The intersection of the two formed the trefoil arch with a pointed crown (Plate XXIX, fig. c). A very common variety of this was made by the *chakra*, or wheel of the Law—which was also the emblem of the sun-gods, Vishnu, Sûrya, and Mitra—taking the place of the pîpal leaf, making the crown of the arch round instead of pointed.

The structural use of these trefoil arches and of their derivations began in Indian buildings about the same time as the painted and sculptured representations of the Buddha



were introduced into Indian art—*i.e.* in the early centuries of the Christian era, when images were placed in niches in the walls of temples, monasteries, or relic shrines, the niche itself taking the form of the aureole. A common form of the niche was the lotus-leaf gable with the pîpal-leaf finial (Pl. XXIX, fig. D). A Græco-Roman adaptation of this with trefoiled arches—showing the round aureole of the cult of Mitra combined with the pointed pîpal leaf of Buddhism—is given in Pl. XXX, A, taken from the 'Alî Masjid stûpa in

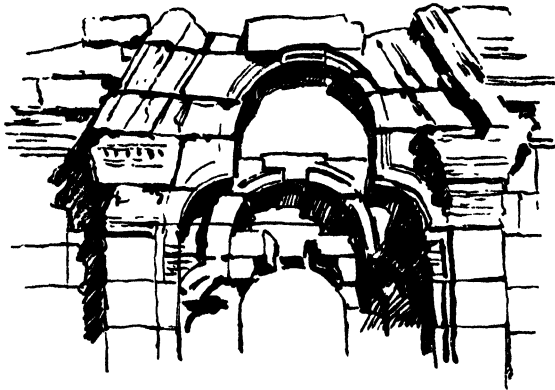

FIG. 16.—Foiled Arches at Mârtând.

the Gandhâra country, a building of about the first century A.D. Several varieties of arched niches of a date long anterior to the Hegira are found in the ruins of the famous Buddhist monastery of Nâlanda (Plate XXX, B), which flourished from the early days of

Buddhism until about the eighth century A.D.

The sun-temple of Mârtând in Kashmir, built in the middle of the eighth century, shows the round trefoil arch used structurally both for doorways and for niches (fig. 16) : this being a stone building, the usual Indian method of constructing arches in horizontal courses is used here, as it was several centuries later in the arched screens of the mosques at Old Delhi and at Ajmîr. The transition from the simple lotus-leaf, or so-called horse-shoe arch, to lobed or cusped arches was all the more easy because the inner curve of the early Indian gable or window was divided into a number of



A. NICHES IN THE 'ALĪ MASJID STŪPA



B. NICHES AT NĀLANDA

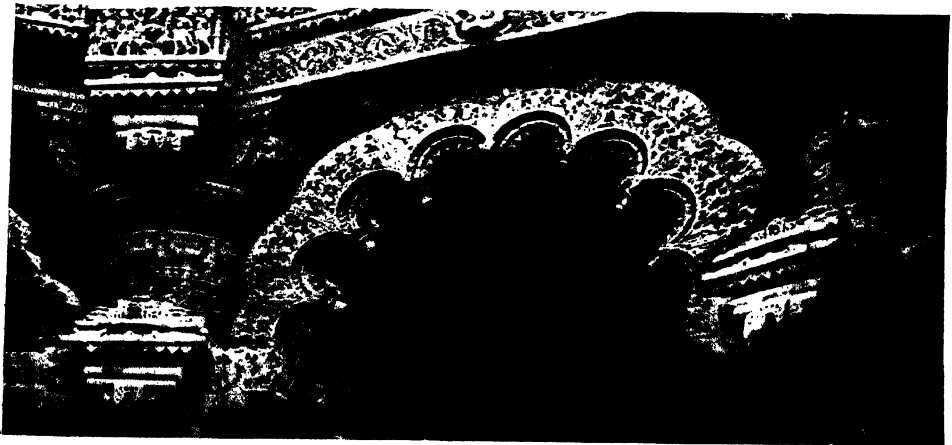

C. ARCHED BRACKET AT MUDHERĀ

DECORATIVE AND STRUCTURAL APPLICATIONS OF THE AURA



equal spaces by the ends of the horizontal wooden purlins which supported the roof (see Pl. XXIX, fig. A). When an image with the wheel nimbus behind the head was placed in one of these gable niches, it would be an obvious elaboration of the niche to continue the half-wheel all round the latter so as to produce the cusped arch shown in fig. C, which is a form of bracket commonly used in Hindu temples of Western India for distributing the weight of the heavy architraves between the columns (Pl. XXX, c). The makara or fish emblem at the springing of the arch shows the derivation of this bracket form from the aureole of images. This bracket, again, was the prototype of the lobed or cusped arches in later Muhammadan buildings. It is used for its original purpose as a bracket in the Jâmi' Masjid at Ahmadâbâd (Pl. XXV).

The Buddhist or Vaishnavite wheel or half-wheel was also a very common decorative motif on ceilings and in the interior of Indian temple domes. The wheel is even found crowning the pinnacle of Saracenic mosques, and it is from the half-wheel, rather than from the Roman scallop, that both Saracenic and Gothic cusplings should be derived, for the examples of sixth- and eighth-century cusplings given by Professor Lethaby<sup>1</sup> as prototypes of the Gothic should, I think, be recognised as vestiges of the Buddhist influence in Western Asia rather than of the Roman.

The arched niches for images which were so numerous in early Buddhist buildings in India, and from India passed into Western Asia with Buddhism, were superseded in later Indian buildings, constructed chiefly of stone, by rectangular niches, not because the symbolism of the aura fell into disuse as Buddhism declined, but because the aura was elaborated ornamentally to such an extent in later Buddhist, Jain, and

<sup>1</sup> "Architecture," p. 145

Brahmanical iconography that it became a part of the sculptor's rather than the builder's craft, and in stonework was usually carved out of the same block as the image to which it belonged. Thus every conceivable variety of pointed and round arches, with or without cusplings, were familiar to all Indian craftsmen for centuries before the Muhammadan invasion, though they were generally recognised as belonging to the design of metal and stone images.

Now, when Muhammadan ritual insisted that arches should be used in Indian mosques, the first impulse of the Indian craftsmen was to adapt these plastic forms, with which they had been familiar for centuries, to structural purposes. They proceeded to Indianise the Persian or Arabian type of pointed arch, originally derived from early Buddhist shrines, first by giving the crown the pointed tip of the pîpal leaf, like the aura of Indian Buddhist images. This we can see in a great many of the thirteenth- and fourteenth-century Indian mosques—the first one at Old Delhi, the next at Ajmîr, and several of those at Jaunpur, Ahmadâbâd, and Mandû. At first it was done tentatively and somewhat crudely, with the effect of weakening the appearance of the arch, though it tells unmistakably that Indian and not foreign masons were at work. The Indian craftsmen themselves evidently saw that the arches thus partially Indianised were not æsthetically satisfactory, for already in Altamsh's mosque at Ajmîr they began to foliate them (Plate X).

Another device used in India in Muhammadan buildings, for relieving what seemed to the Indian craftsman's eye the monotonous line of the Saracenic arch, was an enrichment of the soffit of the arch with a characteristic Indian ornament, used experimentally in many of the earlier buildings and developing later on into the more elegant form of it seen in

fig. 17, which is from one of Akbar's buildings at Fatehpur-Sîkrî (sixteenth century).

But while, on the one hand, there was a tendency in early Muhammadan buildings in India to elaborate upon the little that can be called Saracenic, there was, on the other hand, a marked endeavour to reduce to the simplest form of expression the major part which was Buddhist or Hindu. It was almost as if the Indian craftsmen, under the influence of

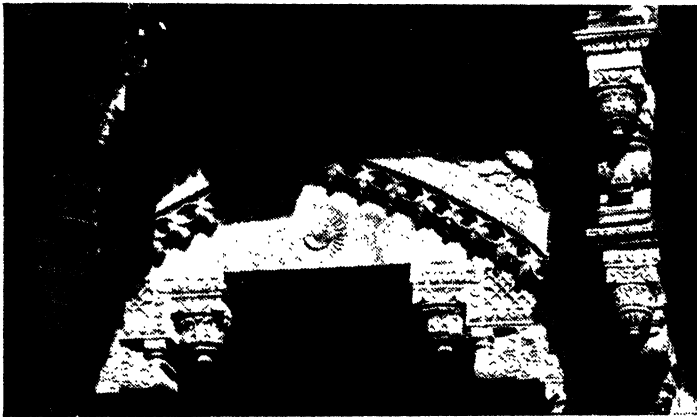

FIG. 17.—Arch at Fatehpur-Sikri.

Islâm, were reverting to the style of early Buddhist art. The masonry and sculpture of the Muhammadan mosques at Gaur are especially interesting for showing the transition of medieval Buddhist-Hindu forms of structure and decoration into the simplified aniconic types which they assumed in Muhammadan buildings. The architraves of the two doorways of the Chota Sonâ Masjid (early sixteenth century) shown in Plate XXXI are clearly derived from Hindu prototypes similar to those which were used by the Gujerat builders as models for a mihrâb (Plate XXXII), though in this case all the details are simplified, all anthropomorphic symbolism is studiously

avoided, and the sculpture is kept in very low relief. The cusped arches of the heads of the doorways are of the same type as those which are used in the more famous Mogul buildings of the seventeenth century, such as the Diwân-i-Khâs at Delhi and the Motî Masjid at Agra. They are obviously only a simplification of the highly ornate foliated brackets, derived from the Buddhist half-wheel as explained above, such as we see in the porch of the Mudherâ temple (Pl. XXX, fig. c). The ogee curve at the springing of the arch—which distinguishes most Indian foliated arches from Saracenic—is the simplified profile of the makara, or fish-dragon emblem, which belongs to the Buddhist-Hindu prototype.<sup>1</sup>

The masonry of the heads of the two doorways shows the transition from the bracket to the arch. In the right-hand doorway (B) the mason has constructed the head of it in Hindu fashion as a bracket pure and simple; using only four blocks of stone, but inserting a small oblong piece above the crown of the false arch, apparently on account of a fault in the two larger blocks, or to correct some mistake in the carving. In the other doorway (A) of the same design the blocks are cut as in the true arch, and a keystone is inserted, probably because the mason had not stone of sufficient size to complete the arch with four blocks, like the other. It will be noticed how frequently the open lotus flower, the sun-emblem, is used as an ornament—a reminiscence of the early Buddhist rails.

The beautiful mihrâb of the fourteenth-century Adînah

<sup>1</sup> The cusped arches of the Chota Sonâ Masjid are not the earliest of their kind in Muhammadan buildings in India, though they are most interesting as revealing clearly the mental process by which the Indian craftsmen worked them out. There are similar arches in the tomb of Altamsh at Old Delhi (c. 1235), and it is quite possible that the Indian masons brought by Mahmûd to Ghazni had arrived at the same form of structural arches by a similar mental process. The main point is that the derivation of this form of cusped arch is Indian, not Saracenic.

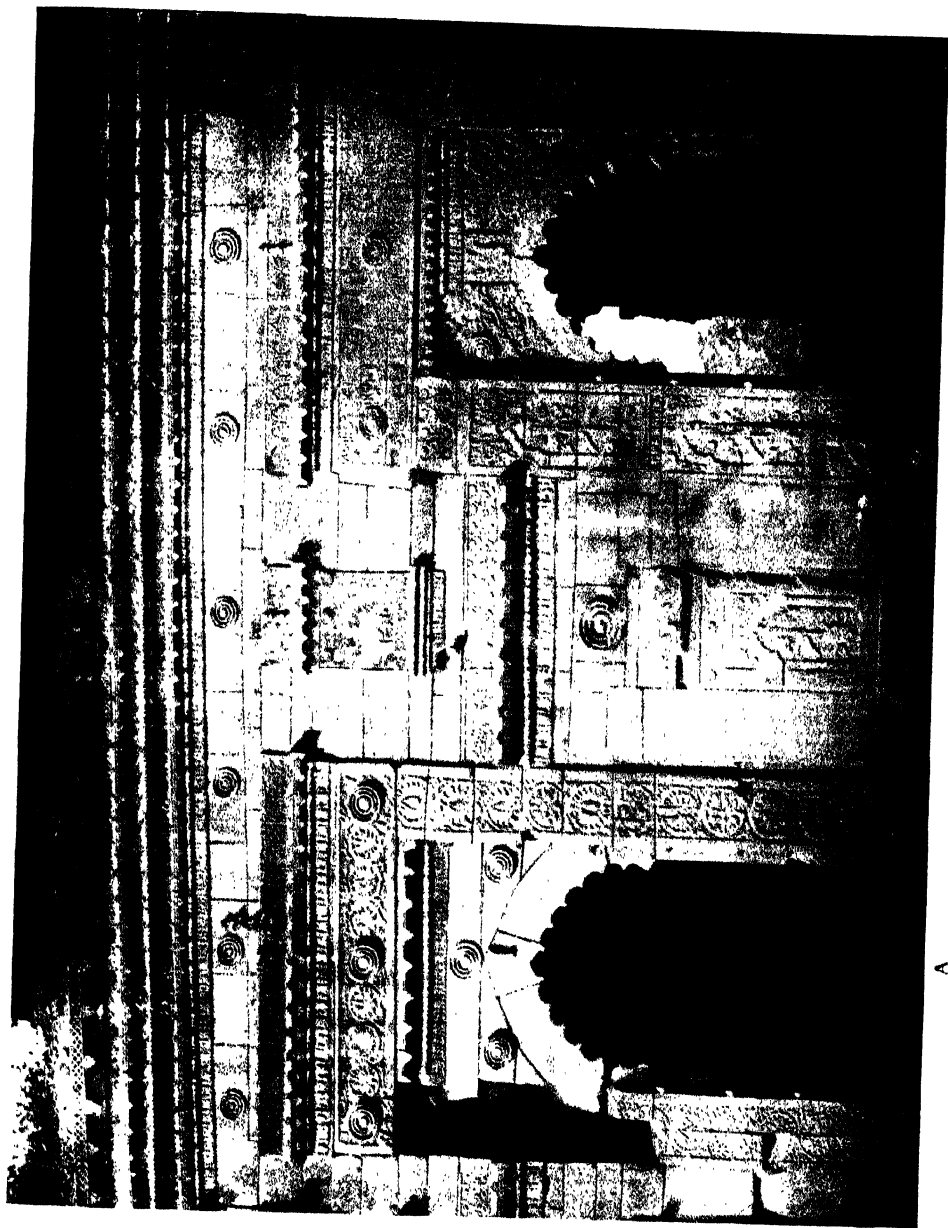

A

B

DOORWAYS OF CHOFA SONÁ MASJID, GAUR





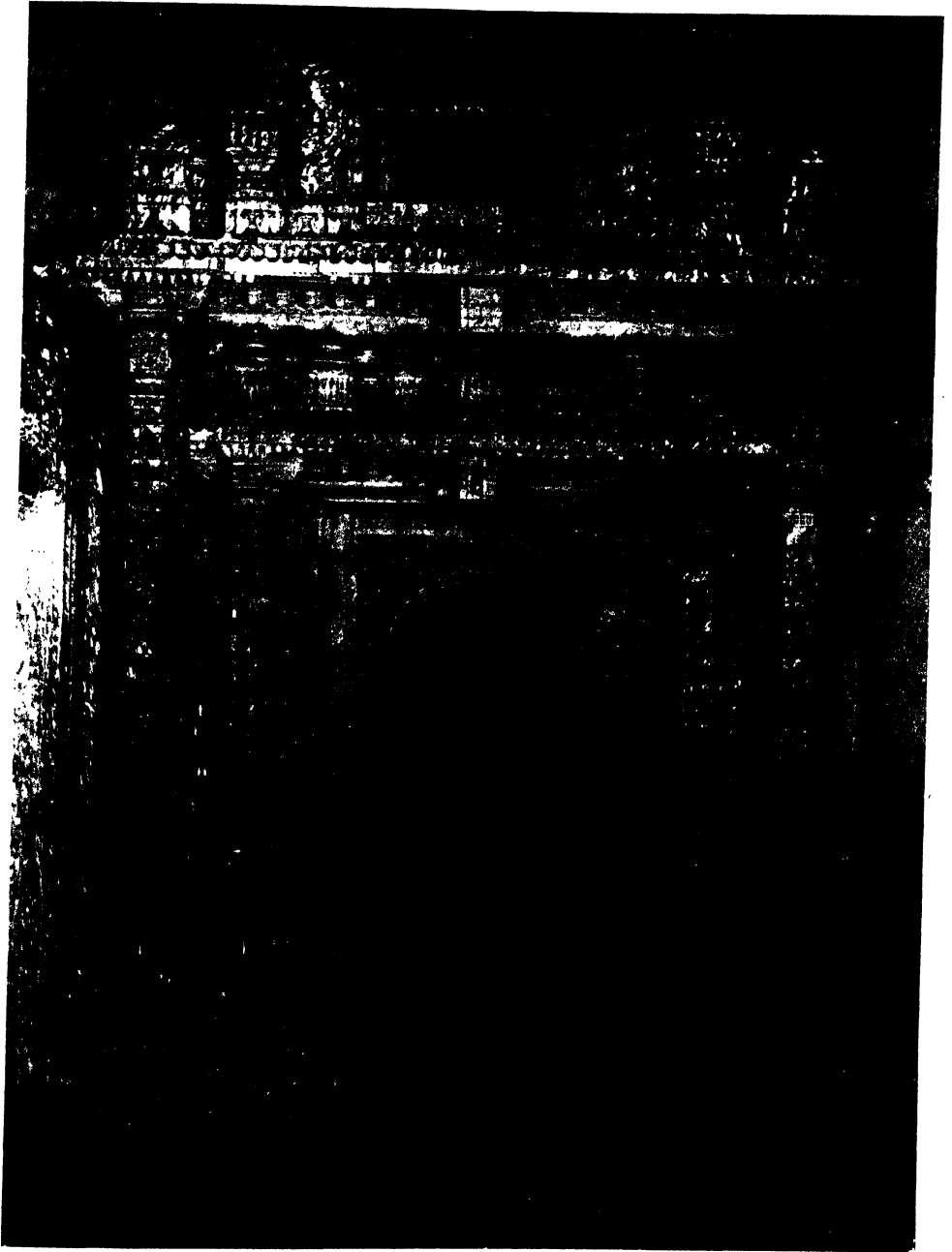

MIHRÂB, JÂMI' MASJID, JUNAGARH



mosque at Gaur (Pl. XXXIII) is so obviously Hindu in design as hardly to require comment. One has only to search among the ancient sculptures which are scattered in profusion about the districts surrounding Gaur to find any number of its Hindu or Buddhist prototypes. The image of Vishnu or Sûrya found lying near a village in the Manbhum district of Bengal has a trefoil arched canopy, symbolising the aura of the god, of exactly the same type as the outer arch of the mihrâb, only the sculptor of the latter has studiously observed the Muhammadan law in converting the *rakshasa's* or demon's head which Hindu tradition placed at the crown of the arch, and all other symbolic ornament derived from animate natural forms into conventional foliage. Except for the absence of such symbols and of the image in the niche, the whole mihrâb is completely Hindu, both in construction and in design.

The only suggestion of Saracenic influence is in the inscriptions and arabesque ornament with which the whole of the plane surfaces of the wall are covered. The technical treatment of these, as a kind of fretwork in two planes of relief, was derived from the Arabian practice of carving quotations from the Qurân on the walls of their mosques. For the sake of clearness the inscriptions had to be treated in this way, without any plastic elaboration, and when they were finished the inventive imagination of the carvers took delight in covering the rest of the surface with geometric and foliated patterns of infinite variety, kept flat like the inscriptions. This was the Musulmân craftsman's substitute for the wider and more human field of interest in which the Hindu sculptor revelled. If the former was less liable to run into extravagance, it was because his range of expression was much more limited; not because his artistic capacity was greater: though it may be that the greater reticence imposed upon him by this

limitation was sometimes a useful discipline for the Oriental imagination.

If the various stages in the evolution of the arch in India are carefully studied, it will not be difficult to trace the Buddhist-Hindu craft tradition in the later Muhammadan buildings which Fergusson and other writers wrongly classify as "Saracenic." Take, for example, the fine recessed doorway of the 'Alî Shâhî Pir-ki Masjid at Bijâpûr (Plate XXXV).

The Bijâpûr buildings are justly commended by Fergusson for their originality, largeness, and grandeur, but as usual he tries to find an explanation for these qualities in the fact that the Âdil Shâhî dynasty under which they were constructed was of foreign (Turkish) descent, and hated everything Hindu. A careful examination of the doorway in the light of the explanation given above will prove that the whole design of it bears not a trace of foreign inspiration; like the vast majority of Muhammadan buildings in India, it shows only a skilful rearrangement of traditional Hindu constructive and decorative ideas within the limitations imposed by the law of Islâm. All the arches have the pîpal-leaf crown. The bracketing under the front arch is unmistakably Hindu, likewise the cusped ornamental arch which goes round it. The conventional device at the crown of the cusping is the Muhammadan aniconic rendering of the Hindu rakshasa's head (*kirtti-mukhi*). The circular ornaments in the spandrils of the arch are flattened-out lotus sun-emblems, which are so conspicuous in the rails of Buddhist stûpas, in Muhammadan disguise. We have seen them already (Pl. XXXI) in an early sixteenth-century mosque at Gaur in their original Indian form. Another very common Hindu motif is the *amalaka* ornament which fills in the angle between the two inner arches. The structural basis of the whole doorway can be seen in the

PLATE XXXIII

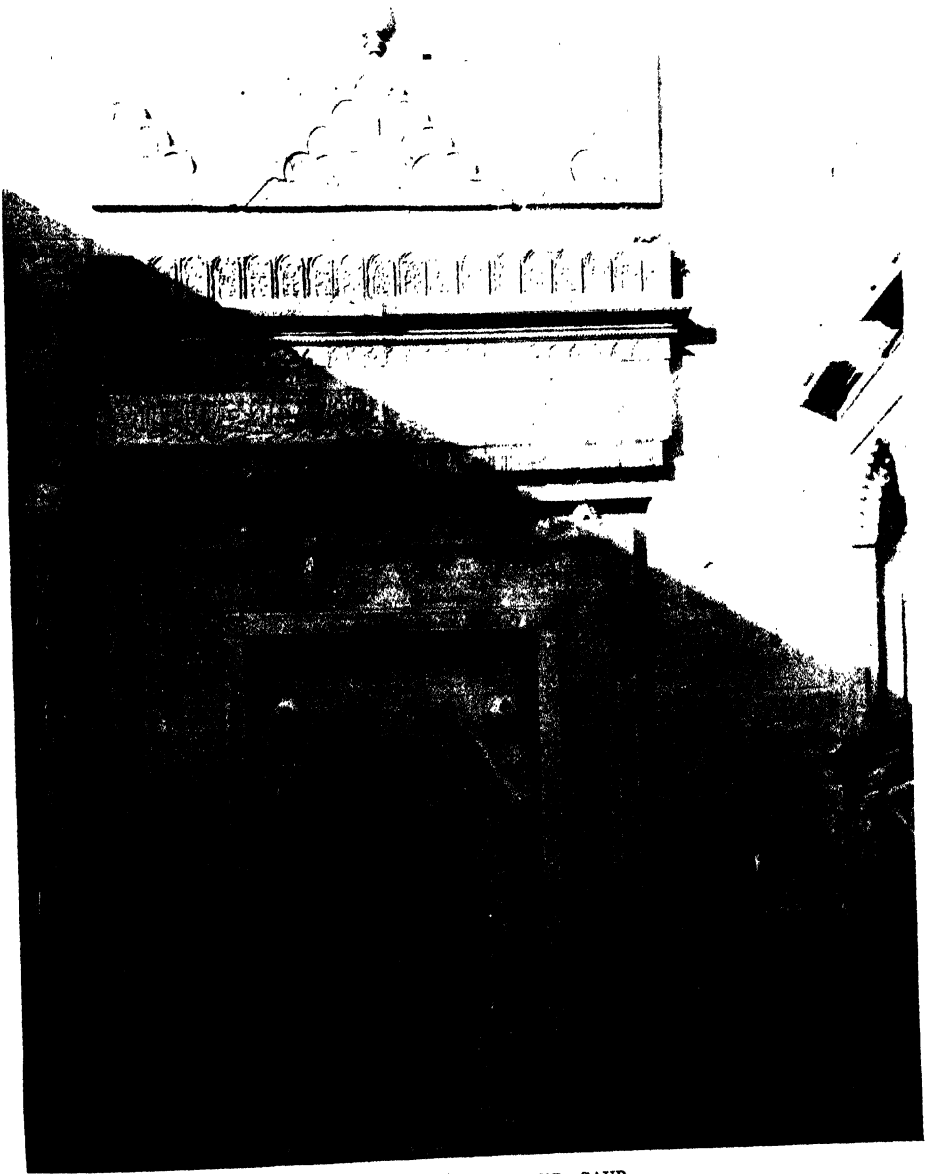

MIHRÂB, ÂDÎNAH MASJID, GAUR



PLATE XXXIV



STONES FROM RUINED TEMPLES : MANBHUM DISTRICT, BENGAL





buildings of the Muhammadan quarter in the neighbouring Hindu city Vijayanagar (fig. 43).

A very characteristic feature of Indian architectural design from the fourteenth century onwards was the combination of the arch with the bracket; the bracket generally playing the constructive part in accordance with Hindu tradition, the arch being used as a symbolic and decorative element. We shall find this combination very frequent in the sixteenth-century Mogul buildings of Akbar's time. The interior of Ibrâhîm's tomb at Bijâpûr (Plate LXXXV) also illustrates it.

The bracket by itself was of course one of the distinctive features of Hindu building construction before Muhammadan times. It would require a lengthy monograph to illustrate all its constructive applications, and to do justice to the infinite skill and fancy which the Indian craftsmen lavished upon the carving of their brackets. The noble gateway at Dabhoi (Plate II) makes one understand the reluctance of Indian builders to use the arch, even for wide openings, when they had plenty of fine material for brackets like these to support the lintels.

The Muhammadans continued to use the bracket throughout most of their buildings, but added nothing to the Hindu craftsman's knowledge in this respect. Their smaller arches were very commonly formed of two brackets joined together. The true arch was generally reserved for wide openings which could not be easily spanned by beam and bracket. The deep bracketed cornices, or dripstones, as well as the balconies supported on brackets, which are so frequent in Indian Muhammadan buildings, are of pure Hindu design without any Saracenic suggestion.

We will now pass on to consider the construction and

symbolism of Indian domes, as found in Muhammadan buildings. Though the dome seems to be so distinctively characteristic of Saracenic architecture, there is not, *pace* Fergusson, a single type of dome in Indian Muhammadan buildings which is not of indigenous origin or derived from early Buddhist prototypes.

It is the case in all countries, but more especially in India, that the great architectural monuments now extant, which seem to us to exhaust all the possibilities of ancient art and science, represent only a very small number of the links in the development of building methods. The missing links are, however, frequently to be found in the humbler dwellings built by craftsmen of the present day who have inherited the traditions of ancient times. In India a few pictorial fragments or rock sculptures are all the indications we now have of many centuries of architectural growth and of thousands of magnificent buildings which in the days of powerful Buddhist and Hindu dynasties were mostly constructed of wood, brick, and plaster—materials which have comparatively little permanence in a tropical climate and offer little resistance to the destructive energies of foreign invaders or the fury of iconoclasts. But the living traditions of Indian craft, the study of which has been so much neglected, will often supply clues for which the archæologist searches in vain among the monuments of the past.

There are two methods of domical construction found in early Muhammadan mosques in India—one, peculiar to India, in which the dome is built up of horizontal courses of stone; the other in which stone ribs resting upon the octagonal base form the structural framework, the intervals between the ribs being filled up with horizontal masonry. The reconstructed Hindu domes used in the Qutb Mosque (Plate IX) are examples

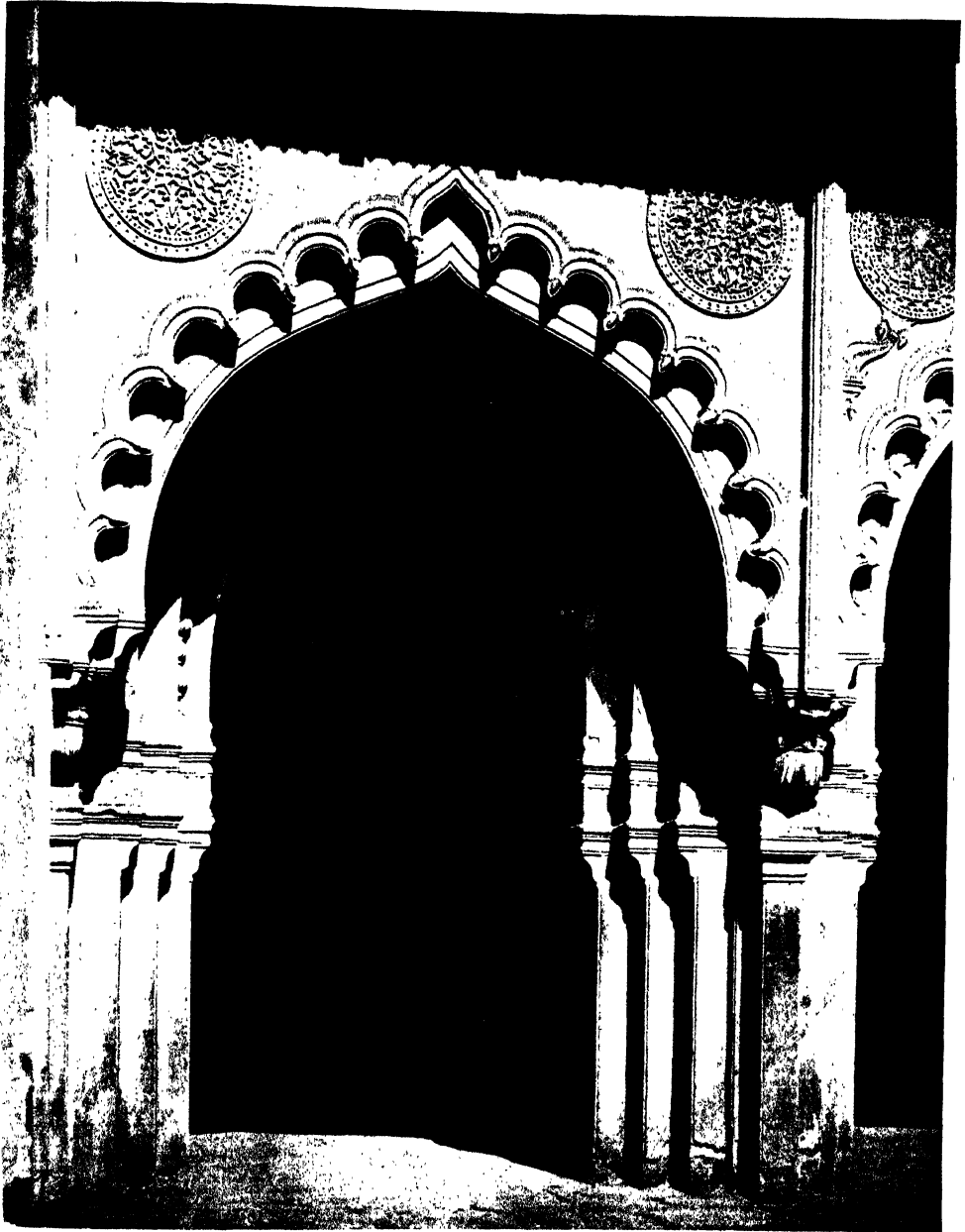

DOORWAY OF 'ALĪ SHĀHĪ PĪR-KI MASJID, BIJĀPŪR



of the first method. The dome of the Champanîr Jâmi' Masjid (Plate L) is an illustration of the other.

Fergusson made a cardinal mistake in supposing that the latter method was not an Indian one.<sup>1</sup> Not only was it Indian but the ribbed dome was certainly the earlier of the two Indian types ; for the method of construction is directly derived from primitive or temporary domes built with a framework of bambu or of wood, whereas the alternative method is distinctly lithic in its technique.

The principal Indian building styles may be roughly divided into three main periods according to roof construction, which is the chief determining factor in the evolution of architectural style. The first period is that in which roofs are built with a framework of bambu , in the second period the bambu construction is reproduced more permanently in timber carpentry ; in the third period the wooden construction is adapted to brick or stone. In all three periods brick and stone were used to some extent in the substructure of the buildings. The same classification will serve to indicate roughly the buildings which belong to three different strata of society—the first one representing the humble dwellings of the ryot and of the lower castes generally ; the second the houses of the well-to-do middle classes ; the third, the palace of the rajah and of the nobility, state buildings, military or civil, and temples or mosques.

The vaulted roofs of Asokan buildings, as sculptured in the Bharut and Sâncîhî reliefs, are all derived from bambu prototypes. The style we see here, which might be called the Early Magadhan style, belongs to Bengal, a country in which the bambu even in the present day determines the structural character of village huts and also that of temple architecture.

<sup>1</sup> " Indian Architecture," vol. ii. p. 57.

The modern Bengali style of temple, so far from belonging to what Fergusson calls an "aberrant type," is the lineal descendant of the early Magadhan style. The form of the lotus-leaf or "horse-shoe" window or gable of the Asokan buildings is that which bent cane or bambu naturally assumes. The elasticity of the latter is a valuable quality in roof construction which Bengali craftsmen were not slow to utilise ; but there were ritualistic as well as technical reasons which

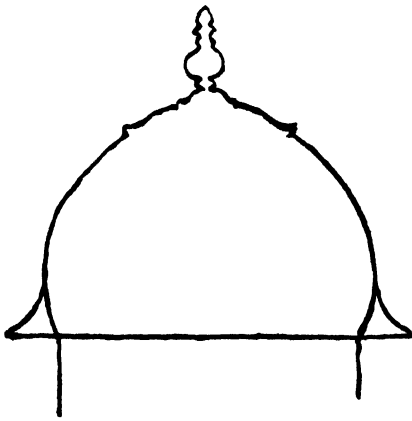

FIG. 18.—Diagram of Bell-shaped Dome.

commended this form to the Asokan builders. The lotus-leaf arch symbolised the sun rising from the sea, or from the banks of the holy Ganges. The adoration of the rising sun has been from time immemorial, and still is, an essential part of all Indian religious ritual, and it agreed well with the joyous spirit of the early Buddhists to let the sun's first rays enter into their houses and shine upon the images in their temples

through these lotus-leaf windows and gables. Their vaulted roofs were first built in bambu ribs of the same form ; in the rock-hewn Buddhist chapter-houses of a later period we can see the bambu ribs imitated in wood (Plate I). When stone began to be used more extensively in building roofs, the difficulty of making such stone ribs for vaults of large size probably led to the trabeate style of building, with terraced roofs, taking the place of the early Magadhan method, except in the country of its origin, Bengal, where brick vaulting and arches came into use.

The principle of ribbed dome construction continued,

however, to be used for domes not built solidly of stone or brick. The lotus-leaf or bent-bambu arch became the structural basis of the dome, known to Western writers as the "bulbous" or "Tartar" dome. The earliest Indian domes—those of stûpas or relic shrines—were approximately hemispherical in shape and built of solid brickwork; but when images of Buddha began to be placed under domed canopies supported by columns, such as we see sculptured on the façade of the great Ajantâ chapter-house (Pl. VI), the dome was necessarily a structural one, and, being so, would be constructed in the Magadha country with ribs of bambu bent into the lotus-leaf or "bulbous" shape. The eight-ribbed Dravidian domes, such as are sculptured at Mâmalla-puram and Kalugumalai (Pl. XXXVI), are all reproductions of structural domes of this type built with bambu or wooden ribs;

the bell-shaped dome being derived from the lotus or bulbous dome by adding eaves with an upward curve (fig. 18), which served the practical purpose of keeping the rain off the walls of the building.

The symbolism which the ancient Hindu craft canons—the Silpa-sâstras—connects with the ornamentation of a dome<sup>1</sup> is directly derived from the principles of bambu or wooden construction. The ornament gave symbolic expression to

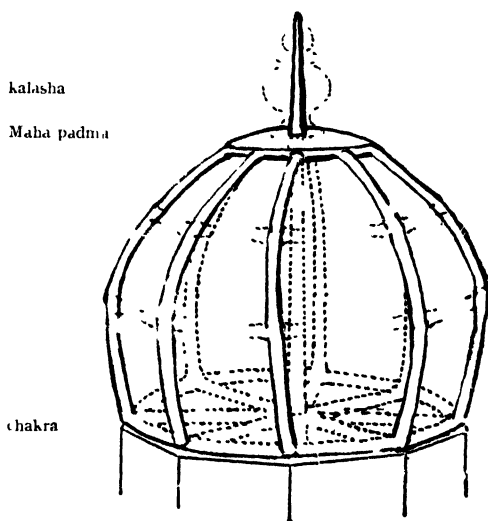
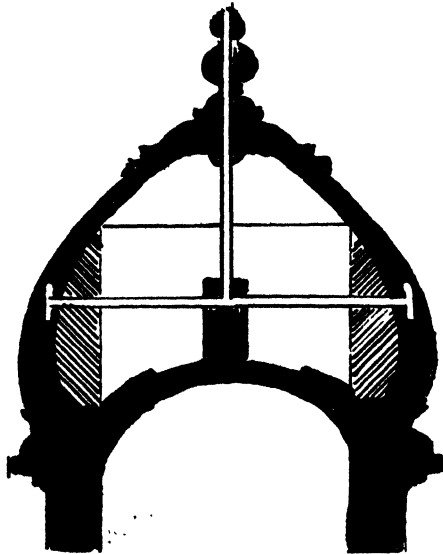

FIG. 19 —Construction of Ribbed Dome.

<sup>1</sup> See pp. 25-6.



the most vital parts in it. In a primitive ribbed dome, made with a bambu or wooden framework, there are four essential parts which ensure the stability of the whole (fig. 19): (1) the pole or axis, which must be firmly fixed either in the ground or upon a stable base, such as an inner roof or dome; (2) the bambu or wooden ribs; (3) the ties by which the ribs are secured to the pole at the springing of the dome; (4) the cap which secures them firmly at the crown of the dome.



Vertical section.

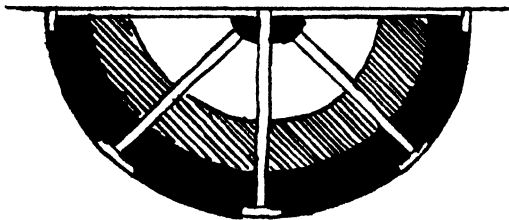

Half-sectional plan.

FIG. 20.—Dome similar to fig. 19, constructed of Permanent Materials.

The lotus petals which invariably decorate the springing of an Indian dome are placed just where the ties—forming a chakra, the wheel of the Law to Buddhists and a symbol of the universe to all Hindus—bind the ribs together at the base. The eight spokes of the wheel would be placed auspiciously by the master-craftsman in the

direction of the four quarters and four intermediate points. The cap at the crown of the dome—decorated by the Mahâpadma, the mystic eight-petalled lotus, or by the amalaka—resembled the nave of a wheel, the most sacred of symbols as

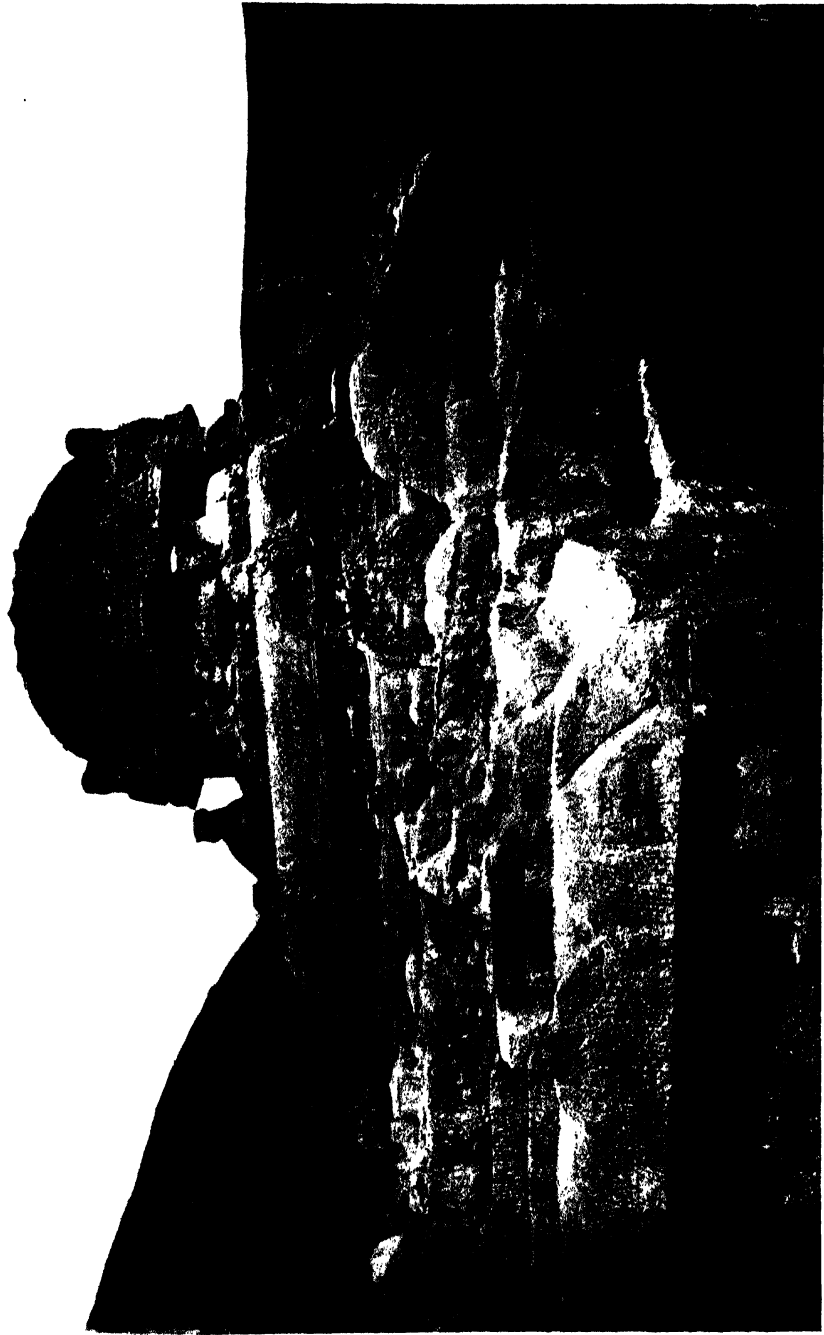

MONOLITHIC TEMPLE, KALUCUMALAI (ELEVENTH CENTURY?)



denoting the central force of the universe, the Cause of all existence. Hence the prominence which was given to this member by all Indian craftsmen, and the veneration with which the amalaka was regarded. The water-pot or kalasha, containing a lotus bud, placed above the Mahâ-padma or the amalaka as a finial was a most appropriate symbol of the creative element and of life itself.

The primitive lotus dome, translated into permanent materials (fig. 20), had many practical recommendations, for the form is one in which the outward thrust is reduced to a minimum. Hence, although in India, when stone began to be largely used in temple building, the system of building massive domes in horizontal courses largely superseded the Buddhist method, the earlier system used by Indian craftsmen continued in vogue in Persia and Central Asia, where stone construction on a large scale never became general.

The tomb of Timur at Samarkand (1405), in which Indian craftsmen assisted, was built on this early Indian principle, with internal ties in the shape of a wheel fixed to the central axis which is supported upon an inner dome.<sup>1</sup> This is precisely the method by which the domed canopies of the Indian Buddhists shown on Plate VI must have been constructed, when built of concrete or of brick. In this case the inner dome takes the place of the principal wheel and acts as a support to the subsidiary one above it. The same methods are used in modern Persian domes,<sup>2</sup> which, like the early Indian structural domes, are always built of light materials.

The construction of the Indian dome with the wheel and ribs explains the origin of the foliated devices, somewhat similar to the stalactite vaulting of the Saracens, and still

<sup>1</sup> See Saladin, "Manuel d'Art Musulman," fig. 276, p. 361.

<sup>2</sup> Langenegger, "Die Baukunst des Irâq," fig. 129, p. 101.

more suggestive of the Roman scallop, which are so often used in the internal decoration of domes and ceilings, both in Hindu temples and Muhammadan mosques.

The whole design (Plate XXXVII) represents the open lotus flower. The circles and semi-circles arranged in foliated patterns which are units of the decoration have nothing to do with the Roman scallop: they are eight-ribbed Indian domes and half-domes in miniature (seen from the inside) cut into the masonry to reduce the weight of it. Each miniature dome also represents a lotus flower enclosed in the wheel (*chakra*) of Vishnu.<sup>1</sup>

Fig. A, Pl. XXXVII, shows the interior of one of the domes of Qutbu-d-Dîn's mosque at Old Delhi, constructed from the material of Hindu temples roughly pieced together. Fig. B in the same plate shows the plan and section of the dome of a Hindu temple at Sunak, in Gujerat, which Dr. Burgess attributes to the tenth century A.D. It is interesting as an example of the transition from the earlier wooden structural methods of the Buddhists to the lithic methods of the Hindus, for here the ribs are reduced to mere ornaments, sculptured with mythological figures, which serve no structural purpose.

I have already shown how the bell-shaped dome was derived from the lotus dome. The bell, as one of the symbols of vibration, the cosmic creative force, played as important a part in early Buddhist ritual as it does in Hindu ritual of the present day. The bell-shaped fruit of the sacred lotus (*Nelumbium speciosum*) (fig. 21) had been from time immemorial a traditional motif for the capitals of Indian temple

<sup>1</sup> It is very probable that this ornamental treatment had its origin in the practice of using earthenware pots to lessen the weight of concrete domes and vaults; and it is quite possible that the practice of using pottery in this way suggested the stalactite pendentive of the Arabs, as it was certainly the earlier of the two methods.

PLATE XXXVII

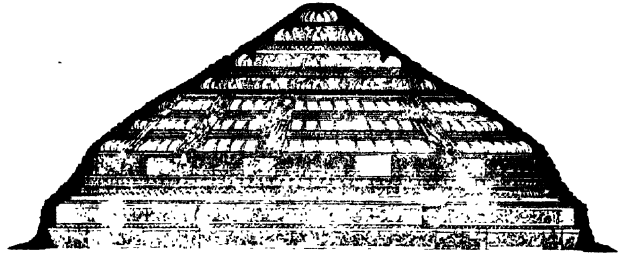
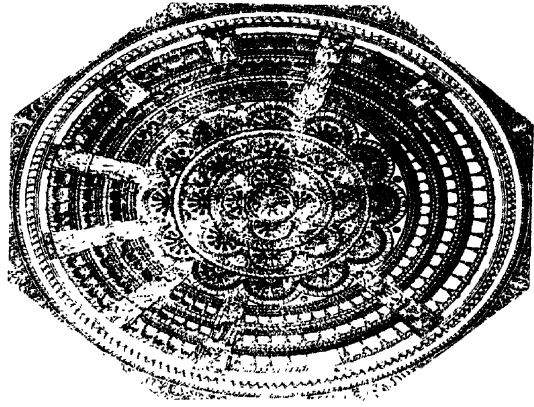

B. HINDU TEMPLE DOME

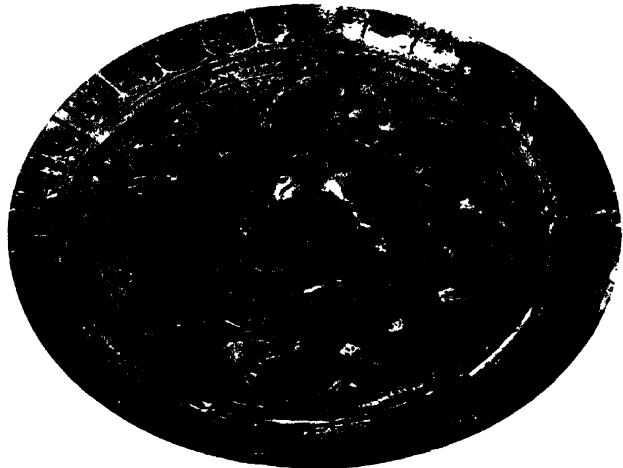

CENTRE OF DOME, QUTBU-D-DIN'S MOSQUE

DECORATION OF DOMES



pillars : the torus (*a*) beneath the seed-capsule to which the petals of the flower are attached formed a strongly emphasised moulding in the design of the capital ; and lotus petals were generally used to decorate the surface of the upper member, which corresponded to the seed-capsule of the real lotus.

The transition from the lotus dome to the bell-shaped dome was thus an easy one for the Indian craftsman to make, whether the starting-point was structural or symbolic. The bell-shaped dome became the usual one for Buddhist stûpas and temples ; but in order that it might be visible from a

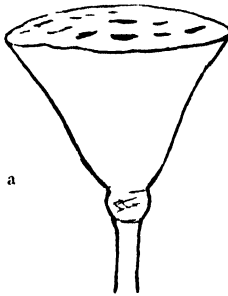

FIG. 21 —Seed-capsule of the Lotus.

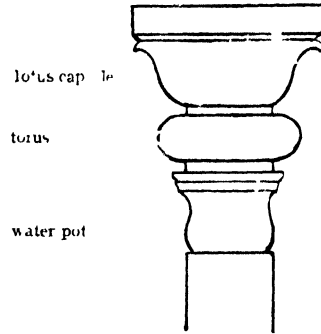

FIG. 22.—Hindu Capital.

greater distance, the height of the bell in proportion to the base was gradually increased. These elongated bell-shaped domes, which are characteristic of Burmese and Siamese architecture, were built of solid brickwork in the more important Buddhist buildings ; but the ribbed principle of construction remained in the Indian craft tradition, for it must have been followed in all the temporary or less important structures built of wood or bambu.

Now when the same kind of structure was made by Indian stonemasons, it became structurally convenient to simplify the form by leaving out four of the eight ribs, and



thus the curvilinear spire, the so-called "sikhara" of northern Hindu temples, was evolved from the Buddhist bell-shaped *dâgaba* or *stûpa*. This has long been a puzzling problem to archæologists, though from a craftsman's point of view the solution of it seems simple. Fergusson only surmised that the sikhara was "invented" principally for æsthetic purposes. Several other archæological writers have connected the sikhara with the Buddhist *stûpa* without explaining the process of its structural evolution—*i.e.* that it is a four-ribbed, bell-shaped dome of abnormal height in proportion to the base.

As in the case of the "horse-shoe" arch, the archæological name given to this spire, or dome, is inappropriate. The modern temple craftsman in Orissa, where the Indian Buddhist traditions are still alive, knows it not as a *sikhara* (a pinnacle or spire), but as a *gandhi* (a bell), a name which connects it definitely with the Buddhist bell-shaped dome.

Pl. XXXVIII, a ruined Hindu temple at Khajurâho, shows the ribbed construction of the sikhara or *gandhi*. The structural modifications of the original wooden prototype which are found in stone-built sikharas are only those which the change of material made necessary. It was impossible to make continuous stone ribs of the length required, so it became usual to build them up in small stone vertebræ, like the human spine. The stability of the structure was secured by building it up in several stories, with through courses of masonry between each. The transition from an octagonal or polygonal sikhara to a four-ribbed one is sometimes to be seen in two adjacent temples (Pl. XXXIX). The *amalaka* which crowned the sikhara performed structural functions similar to those of the cap, or *Mahâ-padma*, of the lotus dome.

From these considerations it will be clear that Indian

PLATE XXXVIII



A RUINED TEMPLE, KHAJURÁHO



PLATE XXXIX



TEMPLES AT SIBSAGAR



masons, when they were employed by their Muhammadan rulers to build domes of greater size than was usual for them, needed no foreign architects to teach them the construction of ribbed domes—it was part of their ancient craft tradition. For understanding the development of Muhammadan architecture in India it is very necessary to realise that many of the forms which Western writers describe as “Saracenic” in Persia, Arabia, and in Egypt were Buddhist and Hindu long before they became Saracenic; so that the Persian influence which flowed into India with the founding of the Mogul Empire was largely a return wave of the Buddhist influences which spread from India into Western Asia, and far beyond, centuries before the Muhammadan supremacy.

Saracenic architecture in Persia shows many indications of Buddhist influence. I have before alluded to the fact that the Persian name for the pinnacle or finial of domes is taken from the Indian word *kalasha*, the water-pot. The combination of forms used in the metal finials of Persian domes also indicates a survival of

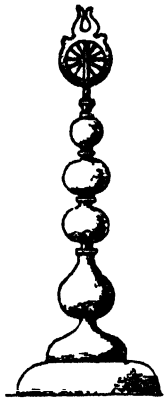

FIG 23—Finial from a Mosque in Baghdad

Buddhist symbolism. The three balls in fig. 23 recall the three umbrellas of the Buddhist tee; the other shape is the Indian water-pot. Still more significant is the fact that several of the finials from Persian and Arabian mosques illustrated by Dr. Langenegger<sup>1</sup> are surmounted, not by the ensign of Islâm, but by the chakra, the wheel of the Law!

It was therefore perfectly easy for any Indian craftsman, whether Buddhist, Hindu, or Muhammadan, to recognise this Saracenic art as his own, in spite of its foreign disguise.

<sup>1</sup> “Die Baukunst des Irâq,” p. 121.

The Indian builders did in fact from the very first treat it frankly as belonging to their own art tradition. Their only endeavour was to divest it of its foreign accretions; and the fact that they consistently did this, unchecked by their Muhammadan employers, so that Muhammadan architecture in India never became more "Saracenic" than the Indian builders wished it to be, is clearly stated in masonic language on all Indian Muhammadan buildings.

A most significant fact, unnoticed by Fergusson, and I believe by all other writers, is that with the rarest exceptions the domes of every Muhammadan building in India, beginning with the mosques at old Delhi and Ajmîr, are crowned not with the symbols of Islâm, as recognised by true believers in Persia, Arabia, Egypt, or Turkey, but by the Indian kalasha, the amalaka, or the lotus-flower—the traditional symbols which surmounted the vimânas and mandapas of Hindu temples.

Nothing could more clearly explain the mental attitude of Hinduism towards the followers of Islâm. "We build these mosques and tombs for you," these Indian masons say, "we set our sacred symbols upon them; for the God whom you know as Allah is Brahmâ and Vishnu and Siva. You may kill us and destroy our temples, but our *bhakti* is not destroyed. Vishnu and Siva are here, even in these stones. Though you only bend your knees to Allah, Brahmâ is immanent in every prayer."

Any student with insight into the philosophic attitude of Hinduism who learns to read the symbolic language of these Indian Muhammadan monuments might well believe that most, if not all, of the craftsmen who built them were Hindus at heart, even though professed followers of the Prophet. In all the Indian-Muhammadan styles of Fergusson's academic

classification—at Delhi, Ajmîr and Agra, Gaur, Mâlwâ, Gujerat, Jaunpur, and Bijâpûr—whether the local rulers were Arab, Pathân, Turk, Persian, Mongol, or Indian, the form and construction of the domes of mosques and tombs and palaces, as well as the Hindu symbols which crown them ; the mihrâbs made to simulate Hindu shrines ; the arches Hinduised often in construction, in form nearly always ; the symbolism which underlies the decorative and structural design,—all these tell us plainly that to the Indian builders the sect of the Prophet of Mecca was only one of the many which made up the synthesis of Hinduism : they could be good Muhammadans but yet remain Hindus.

Let us now proceed to examine further the symbolism and structure of these Muhammadan domes. In spite of a very general uniformity of structure, there is considerable variety in the external form of Indo-Muhammadan domes in the thirteenth, fourteenth, and fifteenth centuries ; but usually they are of three distinct types—first, a conical form following the internal section, secondly, the so-called “ Pathân ” dome with its flattened top and strongly pronounced haunches ; and lastly, the hemispherical or semi-elliptical. The Hindu horizontal system of dome-building could never produce a hemispherical shape internally, and if a Hindu dome of solid masonry were made of the same thickness throughout, the exterior would present the rather ugly conical shape which is seen in many of the early makeshift domes of Muhammadan mosques and tombs (Pl. XIV). The Gujerat builders often tried to meet this æsthetic difficulty by bringing the exterior approximately to a semi-circular section, as in the domes of the side-aisles of the Jâmi’ Masjid at Champanîr (Pl. XLIX). This, of course, meant an increase in the thickness of the domes in the wrong place, and a great



waste of material. The "Pathân" dome was a much better expedient: it was the most scientific, and on that account the most beautiful, curve an Indian craftsman could adopt when he was obliged to puritanise the exterior of the tradi-

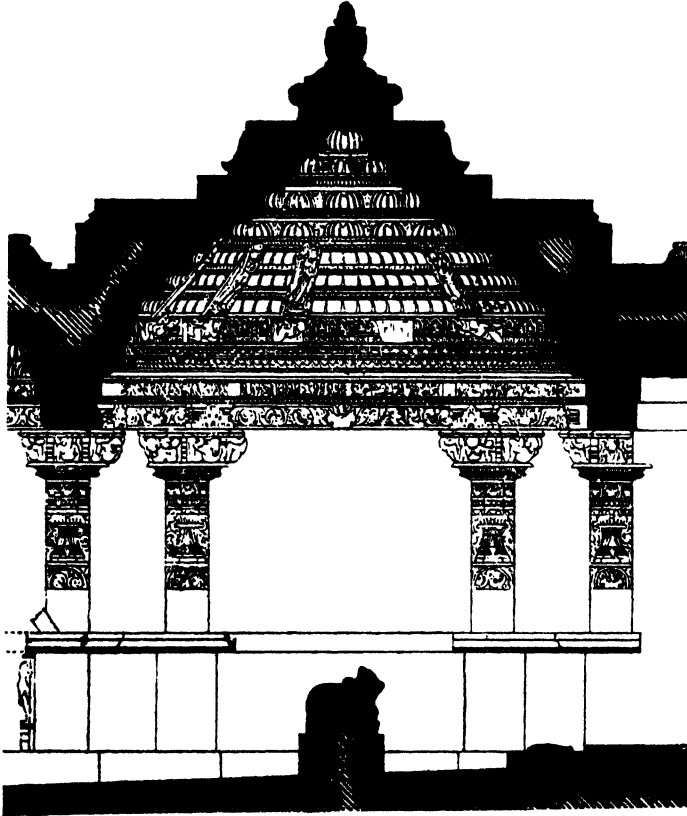

FIG. 24.—Section of a Hindu Dome.

tional Hindu dome by leaving out the sculptured symbolism. The section of the dome of a typical Hindu porch (fig. 24) will show this. If the external excrescences of the sculptured masonry are removed, the dome will be naturally transformed into a "Pathân" dome (Pl. XCI). This was frequently done after the Muhammadan conquest, as I have shown already,

not only in Muhammadan domes, but in the domes of the porches of Hindu temples.

There was, however, another practical alternative. When a hemispherical dome was wanted, the builder could use stone ribs for the structural framework and fill up the interstices with horizontal courses of stone or with rubble masonry. By this means the dome could be made of convenient thickness throughout. There was no need to look to Western models for this ribbed method of construction, for not only were all the wooden and bambu domes of the Buddhist builders constructed on this principle, but the stone-ribbed sikharas of Hindu vimânas and portions of the roof of the mandapas also. The ribbed dome of the Jâmi' Masjîd at Champânâr (Plate L) is, therefore, not a borrowing of a Western fashion, but an intelligent Indian craftsman's expedient for constructing a hemispherical dome scientifically according to the Indian craft tradition. The central dome with its sixteen ribs—two for each petal of the Mahâ-padma. is both in structure and symbolism as much Hindu as are those of the side-aisles which are built entirely in horizontal courses.

Now, according to the Buddhist and Hindu tradition the tee or finial of a dome should rest either upon the amalaka or upon the Mahâ-padma—an eight-petalled lotus with the petals turned downwards—both of which were sun-emblems. The springing of the dome, or the outer rim of the bell, was also ornamented with a row of lotus petals, which suggested that the dome itself grew out of the heart of a lotus flower. Bearing this in mind, we can follow the Indian craftsman's intention in the external decorative treatment of Muhammadan domes. There are three successive stages. The earliest Muhammadan domes had no external ornamentation except the Hindu finial—the bell of the dome was simply

plastered over roughly on the outside. Then the domes are carefully finished externally either with glazed tile-work or with a facing of brick or stone, and the octagonal base is ornamented in the same manner as the parapet of a Hindu fortress wall, sometimes with a suggestion of the lotus leaf or petal, sometimes with the Persian iris worked into it (Pl. XL), but with an obvious intention of reverting to the old Indian masonic tradition, for it was not usual in Arabian or Persian buildings to ornament the external springing of the domes in this manner. Finally, in the Tâj Mahall, and still more distinctly in the domes of the Bijâpûr and Golconda buildings, the Buddhist lotus dome—the “bulbous” one—reappears in a modified form with all its traditional members, according to the Hindu Silpa-sâstras, the base of every “bulbous” dome being enclosed with strongly marked lotus petals (Pl. LXXXV).

This brings us to the further consideration of the interior treatment of Muhammadan domes and of that great triumph of idealistic engineering of the Bijâpûr builders in the tomb of Mahmûd (1638–60), the last but one of the Bijâpûr dynasty, justly described by Fergusson as “a wonder of constructive skill.” For the first few centuries of Muhammadan rule in India the interior decoration and construction of the roofs of mosques and tombs presented no essential difference to those of Hindu temples, except in the absence of anthropomorphic symbolism. The lotus flower and the chakra, either separately or in combination, formed the usual basis of the decorative scheme in both cases. Neither was there any difference in constructive principles until the size and weight of the domes in Muhammadan buildings were so greatly increased that provision had to be made for counteracting the outward thrust of these great masses of masonry or brickwork.

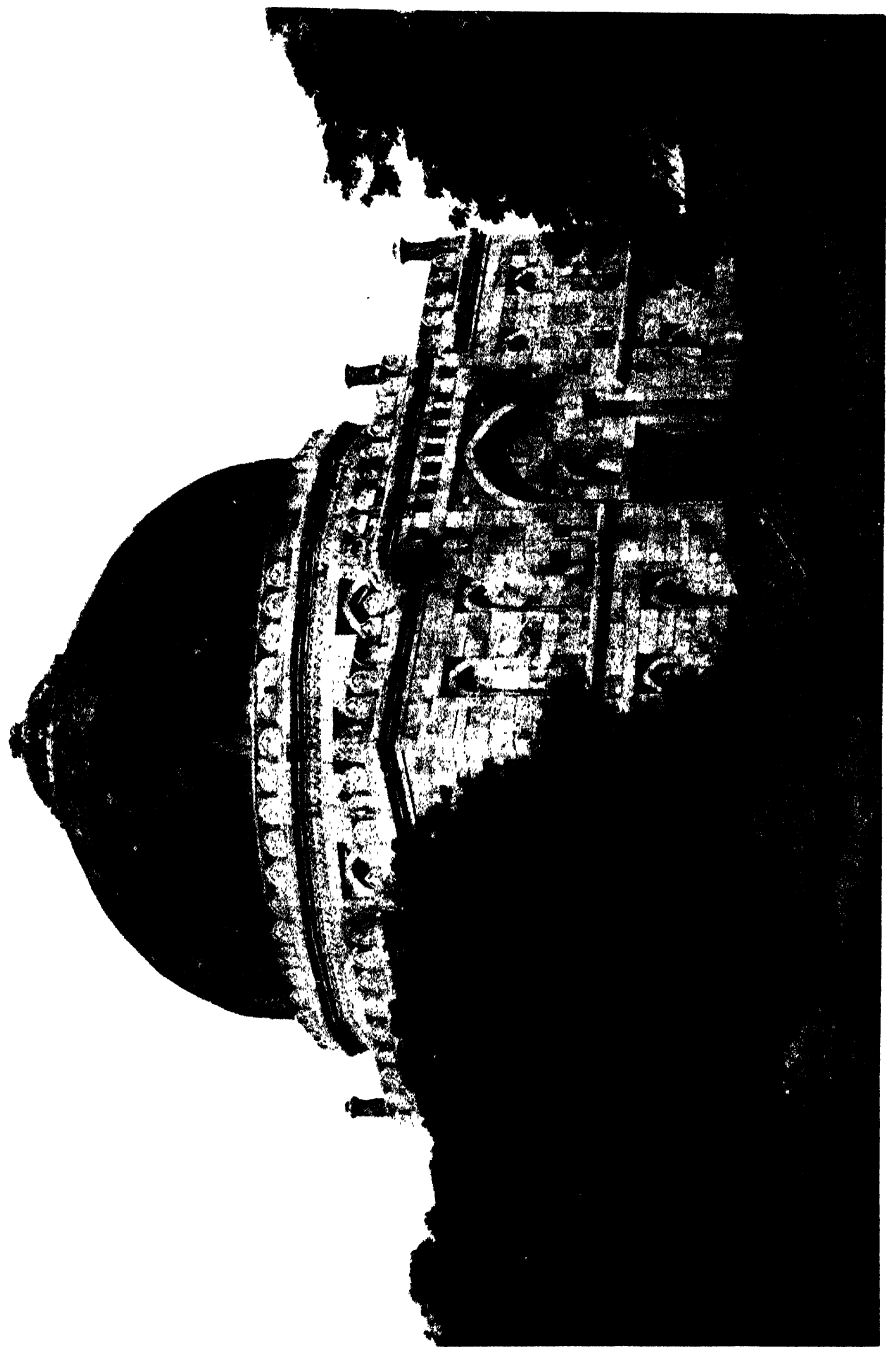

TOMB OF SIKANDAR LODI



The early Indian domed canopy, as I have explained above, must have been constructed on the same principles as modern Persian domes, that is, it had an outer and an inner dome, the outer, or false, dome being merely a shell of mud, plaster, or concrete, of so light a character that nothing more was needed for stability than the inner ties of wood or rope attached to the central post which kept the pinnacle in its place. But in this case, as in so many other, the early practice established a traditional constructive principle which was followed when more permanent materials were used—that is to say, the double roof became a constructive feature in the porches of Hindu temples in Northern India, even when they were built of solid masonry, and Indian builders were accustomed to the idea of counteracting the lateral thrust of a dome from the inside of it. This was the antithesis of the Western idea, which was to build external buttresses and to pile great masses of masonry on the haunches of the dome—as Fergusson says, a very clumsy expedient.

The domes of the porches of Hindu temples in Northern India were usually supported on pillars arranged as in fig. II, the difficulty of supporting the octagonal base of the dome being surmounted, when the latter was of large dimensions, by brackets or stone struts between the pillars. The same principle was followed in all of the early Muhammadan mosques, but the sanctuary of a tomb was often enclosed by walls, like the shrine of a Hindu vimâna, and in this case pendentives would be more convenient to use at the angles whenever the stone beams at the base of the dome required this support.

Pendentives would also become a useful constructive expedient, if not an organic necessity, when, in order to gain more floor-space, the pillars supporting the octagonal base of the dome were dispensed with and the four corner pillars or

piers were joined by arches. In Malik Mughî's mosque at Mandû (Pl. XIX), a very interesting example of the transition from the trabeate to the arched system of building, the capitals of the four corner pillars engaged between the arches are used as brackets to support the base of the dome in the ordinary Hindu method ; but here the dimensions are small

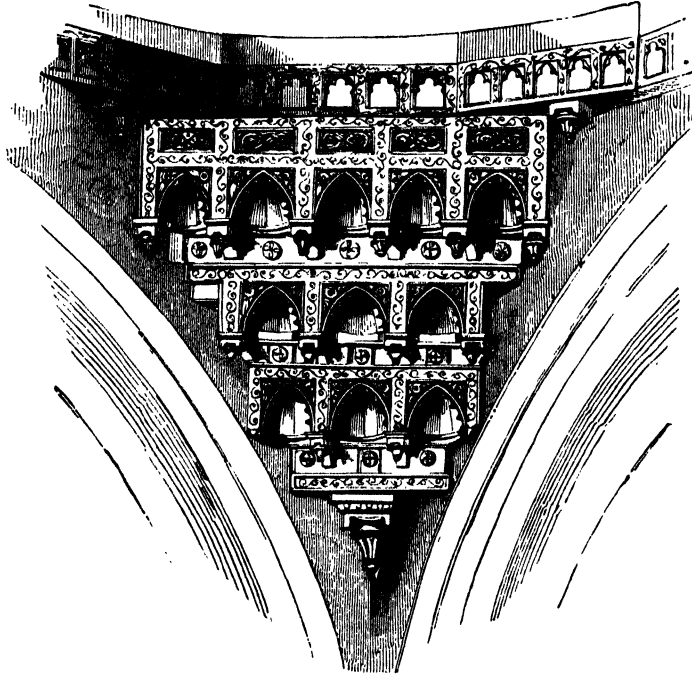

FIG. 25.—Pendentive from Mosque at Old Delhi (from Fergusson's "History").

and the extra eight pillars would not have been necessary if arches had not been used. The usual type of pendentive in early Muhammadan buildings was a solid corner bracket corbelled out of the walls, and often treated decoratively with cusped Hindu arches, as in fig. 25. But when Indian builders got accustomed to using arches of considerable size<sup>1</sup> struc-

<sup>1</sup> I assume that before the Muhammadans came the Buddhists and Hindus had only used arches of small dimensions structurally, in brick-building districts like the Magadha country.

turally instead of pillars and brackets to support the octagonal base of the dome, the arched pendentive naturally came into use also. A rather crude early fifteenth-century application of it can be seen in the Jâmi' Masjid at Mandû (Pl. XVIII). It is important to notice that in this building rubble and brickwork were largely used instead of pure lithic construction, for it was the technique of brick construction which led up to the great engineering achievements of the Bijâpûr builders in the sixteenth and seventeenth centuries.

The germ of the idea of the Bijâpûr dome can be seen in two Muhammadan buildings in Gujerat, which Fergusson has left unnoticed in his history, though structurally they are very important—the tombs of Daryâ Khan and the mosque of Alif Khan, belonging to the middle of the fifteenth century. Both are of brick, both have hemispherical domes, like the Jâmi' Masjid and Mahmûd's tomb at Bijâpûr, and both have some apparent Persian affinities, although on closer examination it is evident that they are the work of Indian builders working out for themselves engineering problems which the Muhammadans in Persia never attempted to solve. Even Fergusson does not deny the originality of Gujerat architecture. "No other form," he says, "is so essentially Indian, and no one tells its tale with the same unmistakable distinctness."<sup>1</sup> The larger Perso-Saracenic domes are thin shells of so light a character that an internal wooden framework often sufficed for their support. Their builders, in an engineering sense, never progressed farther than the domes of the Indian Buddhist builders. Perso-Saracenic buildings on the whole seem hardly to belong to the domain of architecture—they are rather magnificent *chefs-d'œuvre* of painted china or majolica supported by a wooden framework and strengthened with a

<sup>1</sup> "Indian Architecture," vol. ii. p. 229.



core of brick to make them habitable. The Mongolian invasion of Western Asia seems to have swept away in its terrible holocaust the great Sassanian building traditions, so that when the later Persian and Chinese fashions were brought into India by the Muhammadan invaders, it was left to the Indian masons, who since the palmy days of Buddhism had progressed much

farther than the Persians in masonic craftsmanship, to teach their masters what could be done in brick and stone.

The tomb of Daryâ Khan is near Ahma-dâbâd, a mile north of the Delhi gate. Dr. Burgess gives the date ascribed to it, 1453, and the dimensions. The plan is the usual one of Muhammadan tombs in India. The sanctuary containing the tomb is a square

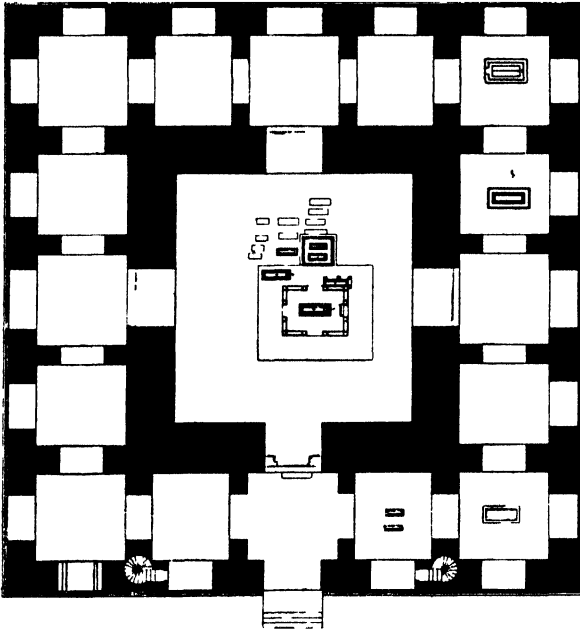

FIG. 26.—Plan of Daryâ Khan's Tomb (drawn by the Archæological Survey of India).

of about 50 feet, covered by a single large dome raised on a circular drum, and surrounded by corridors 19 feet wide, which are enclosed by walls with five arched openings on each side and divided into five corresponding square compartments roofed by small domes. The central dome is built in the following manner: At a height of 17 feet from the floor a small bracket pendentive is corbelled out of each of the four corners of the central hall, the base of

it being shaped in successive courses of brickwork like the arched head of a mihrâb. These corner brackets, or penden-

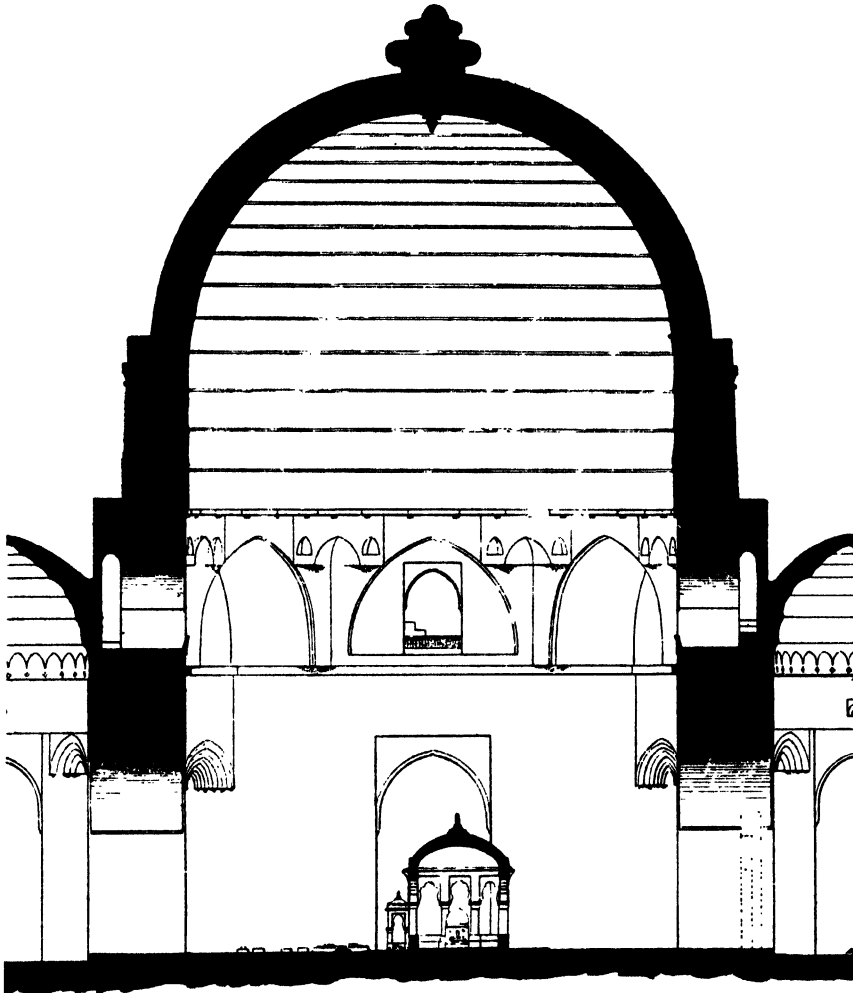

FIG. 27.—Daryâ Khan's Tomb : Section of Principal Dome (drawn by the Archæological Survey of India).

tives, above the arched base are brought to a plane surface of about 7 feet wide reducing the upper part of the hall to an irregular octagon ; and at a height of 29 feet they support a

plain string-course or plinth, carried right round the building, which serves as a base for four larger arches 17 feet wide, built in front of the corner brackets. These larger arches reduce the walls to a regular octagon, according to the usual Hindu practice. Light is admitted into the building by windows placed in the centres of the four main walls just above the string-course. The octagon is reduced to a sixteen-sided polygon by filling

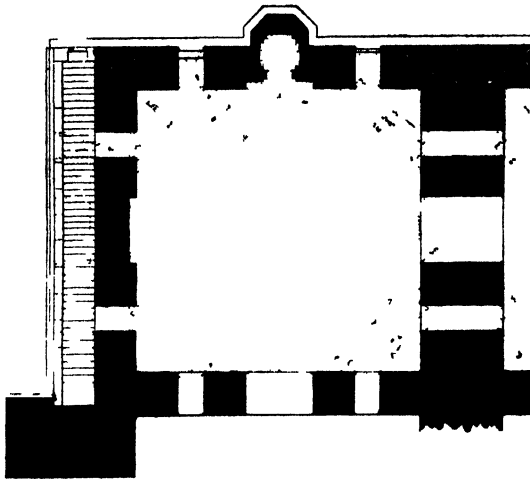

FIG. 28.—Dholkâ The Khan's Masjid Plan of one of the Compartments of the Liwân (drawn by the Archæological Survey of India).

up the angles with eight smaller brackets; and at a height of 45 feet from the floor another string-course or cornice serves as the starting-line of the circular drum of the dome, which is 17 feet in height. The brickwork of the drum and dome is laid in successive horizontal rings about 4 feet in height, as if to simulate the Hindu lithic construction. The total height inside is 86

feet. The usual Hindu finial crowns the top of the dome, and the springing of it is marked outside by the lotus-leaf parapet, which is not found in any Arabian or Persian domes. In fact, the whole building is structurally as characteristically Indian as are all the other Muhammadan tombs and mosques in Gujerat.

Alif Khan's Masjid at Dholkâ, about twenty-three miles to the south-west of Ahmadâbâd, has a liwân, or sanctuary, divided into three compartments, each about 43 feet square, covered by domes approximately hemispherical. It was

built about the same time as Daryâ Khan's tomb, but the arrangement for the support of the domes is more elegant and marks a distinct advance in architectural skill, though the domes are smaller, being about 41 feet in diameter, or 9 feet less than that of the other building. The beautiful stucco

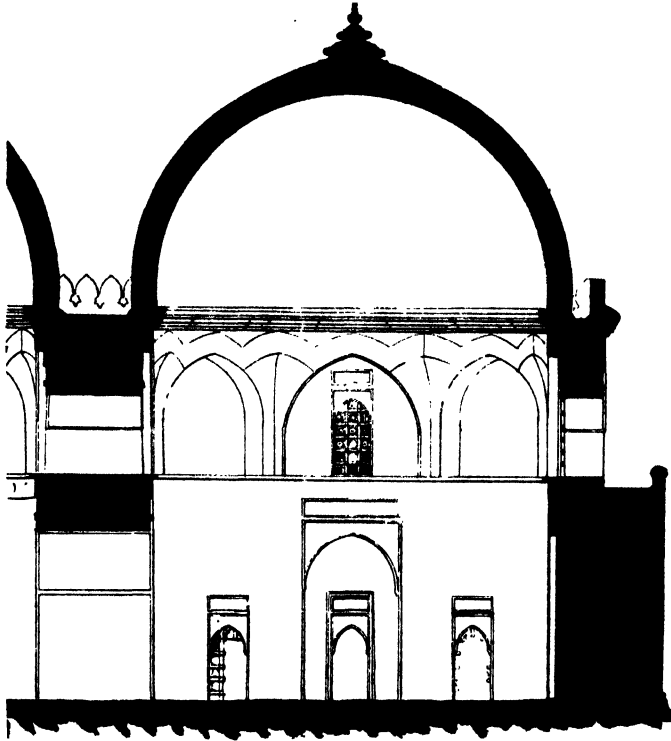

FIG. 29.—Dholkâ. The Khan's Masjid: Section of one of the Compartments of the Liwân (drawn by the Archaeological Survey of India).

work of the entrance doorways is shown in Pl. XXVII. The plan and section drawn by Mr. Cousens (figs. 28 and 29) will explain the construction of the domes. At a height of about 23 feet from the floor, says Dr. Burgess, a plain string-course runs along the walls and is surmounted by eight arches—four of them with groins across the corners, so as to reduce the

square to an octagon—the four on the sides enclosing perforated windows through the outer walls and plain openings through the inner ones. These arches, with groined segments between their haunches, reduce the space, at a height of 38 feet from the floor, to a sixteen-sided polygon, with a plain stepped moulding laid over the cusps to form the base of the dome, which rises to a height of 63 feet from the floor inside.

Now let us compare these two buildings with the two much greater and more famous buildings at Bijâpûr, the Jâmi'

Masjid, begun in the latter half of the sixteenth century, and Mahmûd's tomb, nearly a century later. Fergusson's description of the great dome of the latter, which will serve to explain both, is as follows :

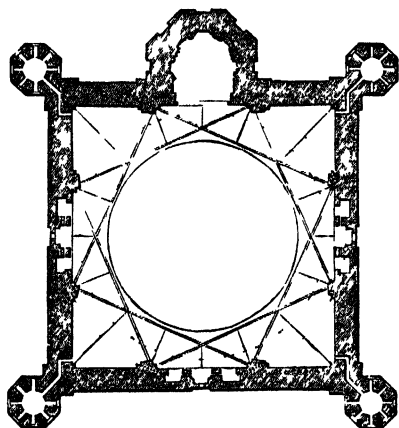

FIG 30 —Plan of Mahmûd's Tomb  
(from Fergusson's "History")

" As will be seen from the plan (fig. 30), it is internally a square apartment 135 ft. 5 in. each way ; its area consequently is 18,337 sq. ft., while that of the Pantheon at Rome is, within the walls, only

15,833 sq. ft. ; and even taking into account all the recesses in the walls of both buildings, this is still the larger of the two.

" At a height of 57 ft. from the floor line the hall begins to contract, by a series of pendentives as ingenious as they are beautiful, to a circular opening 97 ft. in diameter. On the platform of these pendentives at a height of 109 ft. 6 in., the dome is erected 124 ft. 5 in. in diameter, thus leaving a gallery more than 12 ft. wide all round the interior. Internally, the dome is 178 ft. above the floor, and externally 198 ft. from

the outside platform ; its thickness at the springing is about 10 ft., and at the crown 9 ft.

“ The most ingenious and novel part of this dome is the mode in which the lateral or outward thrust is counteracted. This was accomplished by forming the pendentives so that they not only cut off the angles, but that, as shown in the plan, their arches intersect each other, and form a very considerable mass of masonry perfectly stable in itself ; and by its weight acting inwards, counteracting any thrust that can possibly be brought to bear upon it by the pressure of the dome. If the whole edifice thus balanced has any tendency to move, it is to fall inwards, which from its circular form is impossible ; while the action of the weight of the pendentives being in the opposite direction to that of the dome, it acts like a tie, and keeps the whole in equilibrium, without interfering at all with the outline of the dome.

“ In the Pantheon and most European domes a great mass of masonry is thrown on the haunches, which entirely hides the external form, and is a singularly clumsy expedient in every respect, compared with the elegant mode of hanging the weight inside.”

If Fergusson had not been obsessed with the idea that the greatness of Indo-Muhammadan architecture was due to Saracenic inspiration, he would have seen that though much grander on account of their colossal dimensions and finer in architectural treatment, the Bijâpûr domes of the sixteenth and seventeenth centuries established no new principle in engineering, but with a single modification followed exactly that on which the two Gujerat buildings had been constructed in the fifteenth century. In both of the latter the weight of the pendentives at the base of the dome acts as an internal tie, the mechanical principles being similar to that which was

used by the early Buddhist builders, though the lateral thrust of these smaller domes would be insignificant compared with that of Mahmûd's colossal tomb. The only difference, from an engineering point of view, was that on account of the lateral thrust being so much greater, the inner circular string-

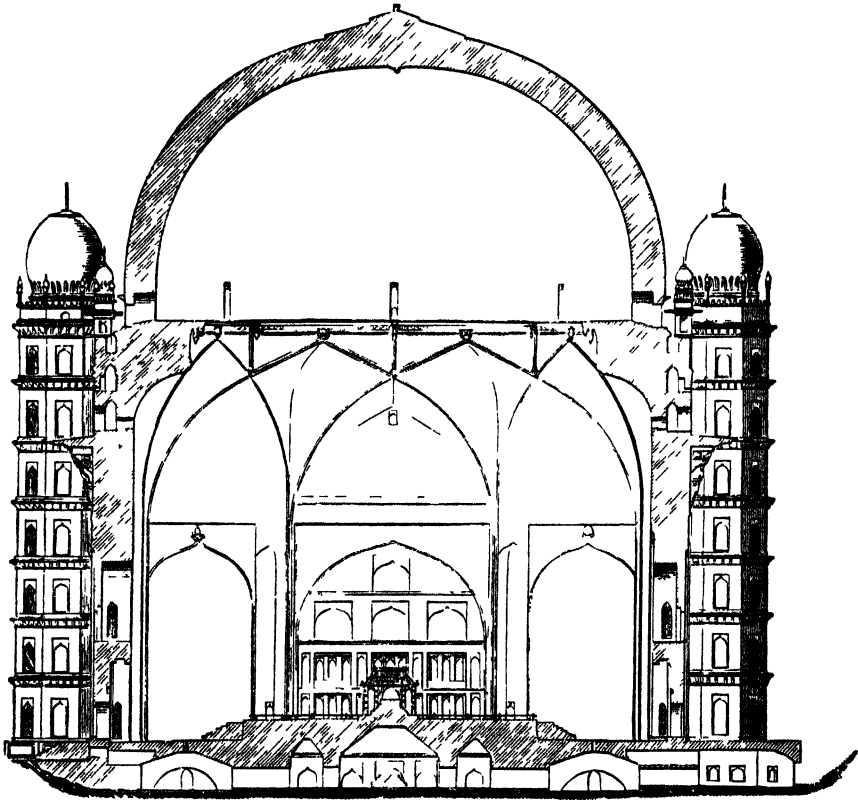

FIG. 31.—Section of Mahmûd's Tomb (from Fergusson's "History").

course, or cornice, at the springing of the dome had to be much heavier and thrown more inwards.

The way the Bijâpûr builders effected this was as ingenious as it was beautiful; but the idea was Indian, not Saracenic. Indian builders in the sixteenth century had become familiar with the Persian pendentive, formed by

intersecting brick arches. The light Persian pendentive, however, would not have served their purpose, so, like good craftsmen, they invented a new way of using it—a combination of the Hindu and Saracenic methods with Hindu idealism behind them.

In the tomb of Daryâ Khan, though arches are used in the pendentives, the pendentives themselves are arranged

on the Hindu bracket system—*i.e.* the square base of the dome is converted into a circle gradually by tier upon tier of bracket pendentives placed in horizontal and vertical planes only. In the Dholkâ mosque the principle is the same, but the upper tier of brackets below the springing of the dome combines with the arches of the lower ones

in forming a decorative scheme like the petals of a half-opened lotus flower—a device characteristically Hindu. The Jâmi' Masjid and Mahmûd's tomb at Bijâpûr show a variation of the same treatment, in which the resemblance to lotus petals is made more complete by the intersection of the arches. This produced not only the mechanical result which was aimed at—that of a sufficient contra-weight to the lateral thrust of the dome—but it achieved also the artistic ideal which the Indian builders had in their mind,

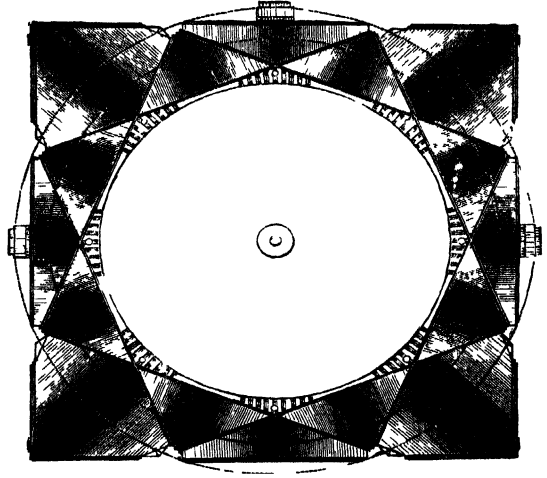

FIG 32.—Pendentives of Mahmûd's Tomb, looking upwards (from Fergusson's "History").



to support the dome on the symbolic lotus flower, the eight-petalled Mahâ-padma formed by the groining of the pendentives, which repeats internally the Mahâ-padma on which the finial of the dome is placed.

Thus we find both the artistic idealism and the practical craftsmanship of the Hindu and Buddhist building traditions inspiring the Muhammadan builders in all their greatest works. Unless the archæologist relies upon examples in which Indian inspiration is conspicuous, he will search in vain in Central Asia, Persia, Arabia, Egypt, or in Europe for Saracenic buildings which explain either the symbolism or the constructive principles of the great Muhammadan buildings in India. The true history of Indian architecture, Buddhist, Hindu, and Muhammadan, is written in the monuments which exist only in India itself.

## CHAPTER VII

### THE SIXTEENTH CENTURY IN BENGAL

HUSAIN SHAH AND THE CULT OF SATYA PIR—THE INFLUENCE OF BENGALI CRAFTSMANSHIP UPON INDO-MUHAMMADAN ARCHITECTURE—THE BUILDINGS AT GAUR: THE QADAM-I-RASÛL MASJID; THE SONÂ MASJID; THE CHOTA SONÂ MASJID; THE JÂMI' MASJID OF AKHI SERÂJ-UD-DÎN.

THE detailed analysis of structure given in the last chapter will, I hope, enable the reader to follow more closely the history of the Indian building craft from the sixteenth century down to modern times. It will enable him to see that the principal structural forms of Indian architecture, in the Mogul period and all other periods of Indian history, as well as the creative inspiration which lay behind these forms, were essentially Indian; that Indian architecture, like Indian sculpture, painting, and music, forms a great original school which worked out its own ideals, borrowing from foreign sources less than any of the great European schools have done. "Indo-Saracenic" as applied to Muhammadan architecture in India is an unscientific classification, based on the fundamental error which vitiates the work of most European historians of Indian civilisation. It is as if a Muhammadan historian of European architecture would describe French Gothic as "Franco-Arabian." With equal justice Italy might claim Shakespeare as an Anglo-Italian poet because the plots of his dramas are frequently based on Italian stories. The cultural basis of Muhammadan architecture in India was essentially Indian,

not Saracenic—the buildings which may be regarded as an exception to this rule are few and unimportant as regards their influence on the history of Indian architecture. Indian craftsmen, like those of all other countries, learnt other languages besides their own, but they remained always true to Indian ideals, whether they were Buddhists, Hindus, or Muhammadans. Persian, Arabian, Central Asian, and Chinese craftsmen came into India in the Mogul period, as Byzantine and other craftsmen came into Italy for the building of St. Mark's at Venice ; but there is no epoch-making Muhammadan monument in India entirely inspired by Saracenic culture in the same way as the Duomo of Venice was entirely inspired by Byzantium.

It is a travesty of Indian history to represent Arabian culture as a great creative force which transformed the ideals of Indian art and taught Indian builders the true principles of architecture. Muhammadanism in India, even as a religion, is essentially different to the creed professed by the Western school of Islâm : as art it belongs almost entirely to Hinduism. The mainspring of the great development of Muhammadan architecture in the sixteenth and seventeenth centuries in India is really to be found in the eagerness with which cultured Muhammadans of Arabian, Persian, Turkish, or Mongolian race, when the passion of warfare and the heat of religious hatred had subsided, applied themselves to the study of the art, literature, and religion of the land of their adoption, establishing a neutral ground on which Hindu and Musulmân might meet fraternally. Though Persian and Arabic were ceremonial languages at the Imperial Court of the Moguls, so that even Hindu rajahs and pandits often found it expedient to become proficient in them, the study of Sanskrit by Muhammadan scholars and poets gave a great impetus to indigenious

literature also. Mr. Dinesh Chandra Sen, in his very valuable "History of Bengali Language and Literature,"<sup>1</sup> tells us how a great Sanskritic revival in Bengal in the seventeenth century was heralded by a Muhammadan writer, Syed Âlâol, "with a mastery of the Sanskrit tongue, the like of which we rarely find among Hindu poets in the Bengali literature." The *rapprochement* between Hindus and Muhammadans on a religious ground was even more remarkable. Akbar was not the only Musulmân monarch who endeavoured to found a religious cult to which both Hindus and Muhammadans could subscribe. Nearly a century before the promulgation of the "Divine Faith" at Fatchpur-Sikrî, Husain Shah of Gaur had either originated or given imperial sanction to the worship of Satya Pîr—a name compounded of a Sanskrit and an Arabic word—as the common God of both communities.<sup>2</sup> The fact mentioned by Mr. Sen that there are many poems in old Bengali in honour of Satya Pîr, both by Muhammadan and Hindu poets, proves that the cult at one time had a strong hold on popular imagination.

The common religious sentiment and ties of nationality which brought the two creeds together manifested their influence in many ways. "Many a Mahomedan offered *pûja* at Hindu temples, as the Hindus offered *sinni* at Mahomedan mosques. In the North-West Provinces the Hindus celebrated the Mahorum festivities with as great enthusiasm as the Mahomedans. Mirza Hosen Âli, a native of the Tippera district who lived a hundred years ago, not only composed songs in praise of the goddess Kâlî, but worshipped her at his house with great *éclat*. . . . Hindus have borne Mahomedan names and the Mahomedans are often called by Hindu names, and such instances are very common in this country even now.

<sup>1</sup> P. 622.

<sup>2</sup> "History of Bengali Language and Literature," pp. 796-7.

. . . The Indian Musalman goes through a long series of festivities and ceremonies, most of which are bodily importations from the Hindus, while others are adapted with slight modifications to give them the colour of Mahomedanism. From birth to death, at every stage of life, says Mr. Mazhalul-Haque, the Mahomedans in India perform ceremonies which are of purely Hindu origin.”<sup>1</sup>

Nothing is more clear to the student of Indian architecture who can read the language of the Indian craftsman, that it was the willingness of the Musulmân rulers to adopt the art and culture of Hindustan—their genius for learning rather than for teaching, which made Indo-Muhammadan architecture great. The willingness to learn may in itself be regarded as a proof of high intelligence and an innate artistic instinct, and undoubtedly many of the Muhammadan sovereigns had great artistic gifts, like many exalted patrons of art in medieval Europe ; but the great architects of India were Indians by birth and instinct.

When the subject is rightly understood, I have no doubt that the sixteenth century, rather than the seventeenth, will be appreciated as the classic epoch of Muhammadan architecture in India. The Tâj Mahall, the Motî Masjid at Agra, and a few other buildings of Shah Jahân's time are unique in themselves and surrounded by a halo of romance which appeals strongly to popular imagination. But exquisite as these are both in art and craftsmanship, they belong to the lyric rather than the epic school of architecture, and many of the buildings contemporary with them betray a weakness of design—a prettiness approaching insipidity—which was a faithful reflection of the approaching decadence of the Mogul Empire. It is unfortunate for Indian art that nearly all Western historians

<sup>1</sup> “ History of Bengali Language and Literature,” pp. 793-4.

have seized upon this later school, tinged with the voluptuousness and extravagance of a dissolute Court life, as the truest and most characteristic expression of Muhammadan art in India, while the robust and virile art of the early pre-Mogul period, which bears the same relation to the later phases as a Sanskrit epic does to a Persian sonnet, is relegated to an inferior place as belonging to a Hindu or "mixed" style.

In the beginning of the sixteenth century Gaur and Gujerat, the former chiefly in brick and the latter mostly in stone, were the great creative centres of the architecture of Northern India; for in the north the Muhammadans had acquired such a firm hold upon the country that there was little activity in Hindu temple-building or in secular public works. Moreover, the Muhammadan rulers showed such a tolerant spirit towards the religious feelings of their Hindu subjects that to assist in the building of a Muhammadan mosque might well have been regarded by the latter as an act of devotion equal to a gift to a Hindu shrine. Husain Shah, the reputed author of the Satya Pîr cult in Bengal, was emperor at Gaur, and Musulmân sovereigns of Rajput descent ruled in Gujerat.

These two localities, far more than any beyond the Indus, were the true formative centres of the early and later Muhammadan styles in India, and of the modern Indian building tradition in the north. Just as the temples of Hindu Gaur had carried on the traditions of early Magadhan architecture, with modifications adapted to the Hindu ritual and symbolism, so the mosques of Musulmân Gaur were modifications of Hindu temples adapted to the ritual of Islâm. And just as a Hindu pandit at the Musulmân Courts became a good Persian and Arabic scholar without ceasing to be a Hindu, so the Indian craftsmen who built Muhammadan mosques, tombs,

palaces, and public works acquired the artistic culture of Persia and Arabia as a second language, without becoming Indo-Persians or Indo-Arabs. The Arabian and Persian element was, as in other parts of India, decorative rather than constructive, for the Arabian and Persian craftsmen who came into India were mostly calligraphists, painters, decorators, and upholsterers—not builders. It was thus that the constructive forms used at Gaur and in Gujerat by Indian builders came to predominate in the Mogul architecture of Fatehpur-Sikri, Agra, and Delhi. The cusped arches of the early sixteenth-century buildings at Gaur (Plate XXXI) are of the same type as those of Shah Jahân's palace at Delhi and many other of his buildings—both derived from Buddhist-Hindu prototypes. The bent cornices and curvilinear roofs of Gaur, derived from the bambu construction of the Buddhists of Bengal, are found in many of the buildings of the Moguls and belong to the building tradition of modern Rajputana. The history of Indian craftsmanship thus repeated itself, for many centuries previously similar features in the early Magadhan style had been carried by the Buddhist craftsmen throughout the greater part of Asoka's empire. The style of the roofs and gables sculptured at Bharhut and Sanchi and painted at Ajanta must have been formed originally on the bambu construction of Bengal.

Some day, possibly, when official architects in India throw aside the narrow professional prejudices which are their stumbling-block, both in an engineering and artistic sense, they may realise that in picking up the threads of this great tradition which survives to this day, they may find many suggestions for the use of modern European building material. Even in the primitive bambu construction, adapted by Buddhist and Hindu builders to wood and stone, which

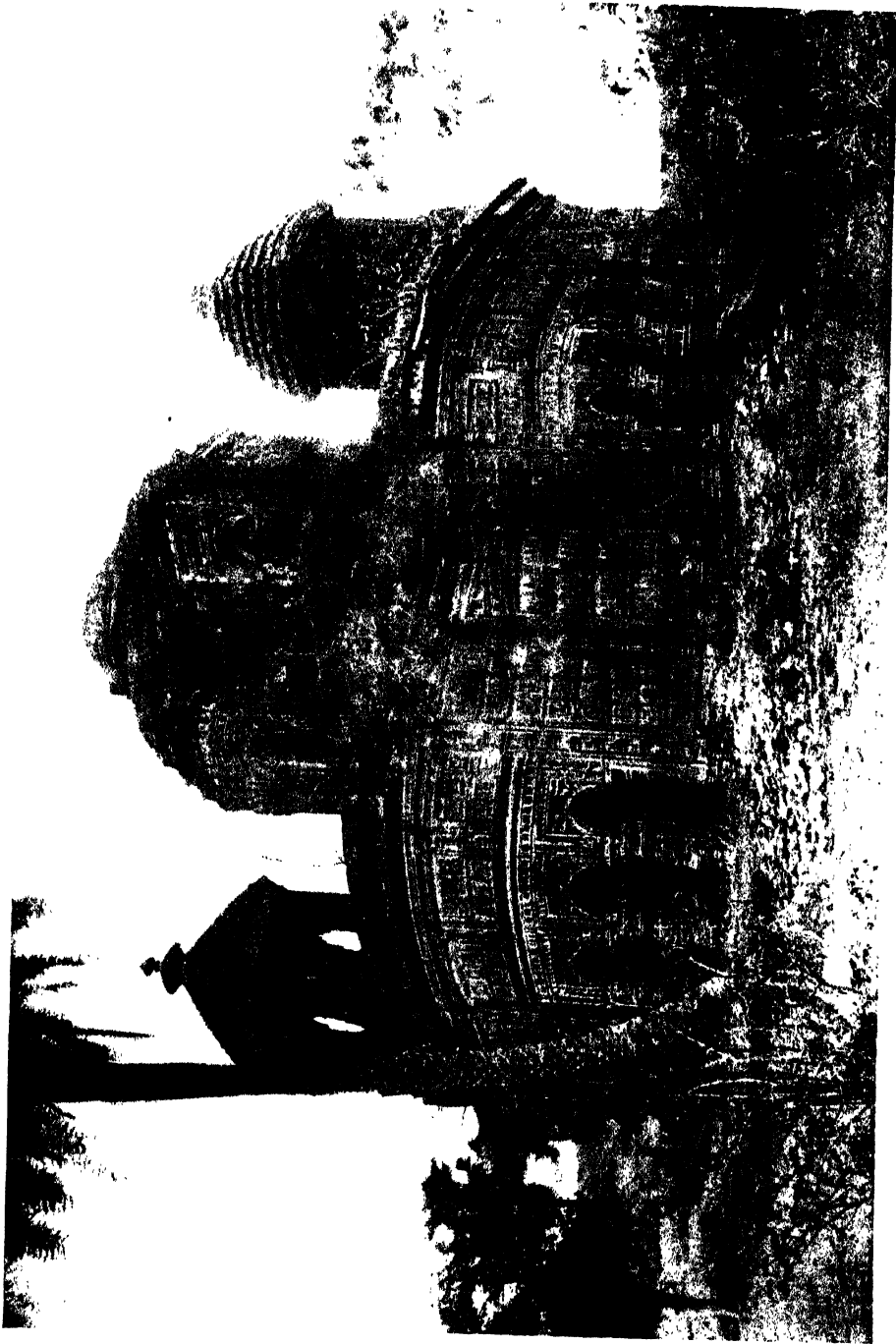

HINDU TEMPLE AT VISHNUPUR





the European expert affects to despise as primitive and unscientific, there is the same principle as in the construction of most modern and up-to-date European building ; for the elasticity of the bambu has its modern analogue in the elasticity of steel—a material in the use of which the Hindu craftsman had no rival until quite modern times.<sup>1</sup>

Though there are no ancient Hindu temples now existing at Gaur itself, there is ample evidence that Husain Shah (1493–1519), and his son Nasrat Shah (1519–32), in whose reigns the finest buildings now remaining at Gaur were erected, employed the local Hindu builders to design their architectural works, and that the development of style which took place there was the natural outcome of the practical requirements of Muhammadan ritual, rather than an improvement in taste or advance in architectural skill due to the importation of foreign builders.

Externally the general characteristics of the Gaur mosques of the sixteenth century, when the style was fully formed, are shown in the façade of the Qadam-i-Rasûl Masjid (Pl. XVI). It is only necessary to compare this with a typical Bengali temple (Pl. XLI)<sup>2</sup> to see that the design of the Muhammadan building is identical with the local Hindu style, which in itself is founded upon the earlier Buddhist tradition. There is not the slightest trace of Saracenic influence in the design of the Hindu temple : the arches are Buddhist-Hindu arches, and technically seem to be as natural

<sup>1</sup> For interesting notes on the use of wrought-iron girders in Orissan temples, see "Orissa and her Remains : Ancient and Mediæval," by Manumohan Ganguly, B.E., M.R.A.S. (Thacker & Co.).

<sup>2</sup> The temple here illustrated is actually a century later in date than the mosque at Gaur, but there is no doubt that it represents a very much older type. It belongs to the old Buddhist *panch-ratna* type of temple, like the Javanese shrine of Chandi Sewa of the eleventh century (Plate V), which was the prototype of the Tâj Mahall.

to the brick construction of Bengal as the horizontal beam and bracket were to the purely lithic construction of Gujerat. They are, in fact, a Hindu modification of the lotus-leaf arches of the Buddhists, which in the lithic Hindu styles were reduced to an ornament on the great curved cornices or dripstones, as the Hindu stonemasons had no structural use for the arch. In Bengal the arch of the Buddhist builders remained in structural use because brick was the material instead of stone. The size of the arches diminished because Hindu worship was individualistic, not communal, and, except when a large crowd of pilgrims congregated at some specially venerated shrine, did not require the same floor-space as the religious services of the Buddhist Sangha demanded.

The same practical reason operated in the interior of Muhammadan mosques at Gaur, as in other places in India, in the contrary direction. The congregation of the faithful, like the Buddhists, required a wide open floor-space in their places of worship, and their Indian builders provided this for them by widening the space between columns and piers and walls, and thereby increased the size and number of the arches and vaults required ; but the essential characteristics of the architectural style remained Indian throughout.

It is difficult to realise from the comparatively few ruined buildings which now remain of the once great city of Gaur that its influence upon the building craft of Northern and Western India, both before and after the Muhammadan conquest, must have been far greater than that of any city of Persia, Arabia, or Mesopotamia. Under the name of Lakshmanavati, or Lakhnauti, it had long been the Hindu capital of Bengal with a tradition going back many centuries before Christ.



SONÁ MASJID, GAUR: SOUTH-EAST CORNER OF LIWÁN



In the sixteenth century it was known to the Portuguese as one of the greatest cities of India, the population being estimated at over a million. The ruins of it now existing cover an extent of country over ten miles in length and between two and three in breadth. Situated, as it was originally, on the banks of the Ganges, it was in easy communication with the greater part of Northern and Western India; and as it was one of the two first centres of Muhammadan rule in India, the permanent school of craftsmen established there must have greatly influenced the building of later Muhammadan cities in India. In studying the development of Muhammadan architecture in Gujerat, Mâlwâ, and in the Dekhan, it will always be more profitable to look to Gaur rather than to Persia for the origin of forms, especially those in brick, which are not accounted for by the local Hindu craft tradition.

The Sonâ Masjid, or the Golden Mosque—so called from the gilding of its domes—was commenced by the Emperor Husain Shah and completed by Nasrat Shah in the early part of the sixteenth century. It is one of the largest buildings now remaining at Gaur. The plan of it resembled that of the older Adînah mosque (fig. 7), but little now remains of the courtyard. The *liwân*, mainly built of brick, was faced in front with a nearly black hornblende stone, finely sculptured in low relief with designs adapted from the local Hindu terra-cotta work. Traces of gilding still remain. The façade, a corner of which is shown in Pl. XLII, has eleven doorways, each 14 feet high and  $8\frac{1}{2}$  feet wide, which have cusped Hindu arches and are framed with carved architraves adapted in design from the doorways of Hindu shrines. Eleven corresponding brick arches inside the *liwân* form an aisle covered by the same number of domes, and behind this

aisle three others are formed by twenty stone pillars of Hindu design (Pl. XLIII, B), connected with brick arches and dividing the remaining area of the *liwân* into thirty-three compartments also covered by domes. The upper part of the minarets at the four corners of the *liwân* have fallen. Their appearance when complete can be seen in Plate XLV.

The curved cornices of the exterior and the vaulting of part of the side aisles with its beautiful stucco decoration shown in Pl. XLIII, A, are reminiscences of the ancient bambu roofing still used in the cottages of Bengal. "To understand this," says Fergusson, "it may be as well to explain that the roofs of the huts in Bengal are formed of two rectangular frames of bambus, perfectly flat and rectangular when formed, but when lifted from the ground and fitted to the substructure they are bent so that the elasticity of the bambu, resisting the flexure, keeps all the fastenings in a state of tension, which makes a singularly firm roof out of very frail materials. It is the only instance I know of elasticity being employed in building, but it is so singularly successful in attaining the desired end, and is so common, that we can hardly wonder when the Bengalis turned their attention to more permanent modes of building they should have copied this one."<sup>1</sup>

The details of the Chota Sonâ Masjid, a smaller version of the Sonâ Masjid, have been described in the previous chapter. Pl. XLIV shows the usual method of building the brick domes of Gaur.

The beautiful moulded brickwork which until recent times was one of the indigenous crafts of Bengal can be seen in Plate XLV, the Jâmi' Masjid of Akhi Serâj-ud-Dîn, one of the latest buildings at Gaur, and one of the most complete, for

<sup>1</sup> "History of Indian Architecture," vol. ii. pp. 159-60.

PLATE XLIII

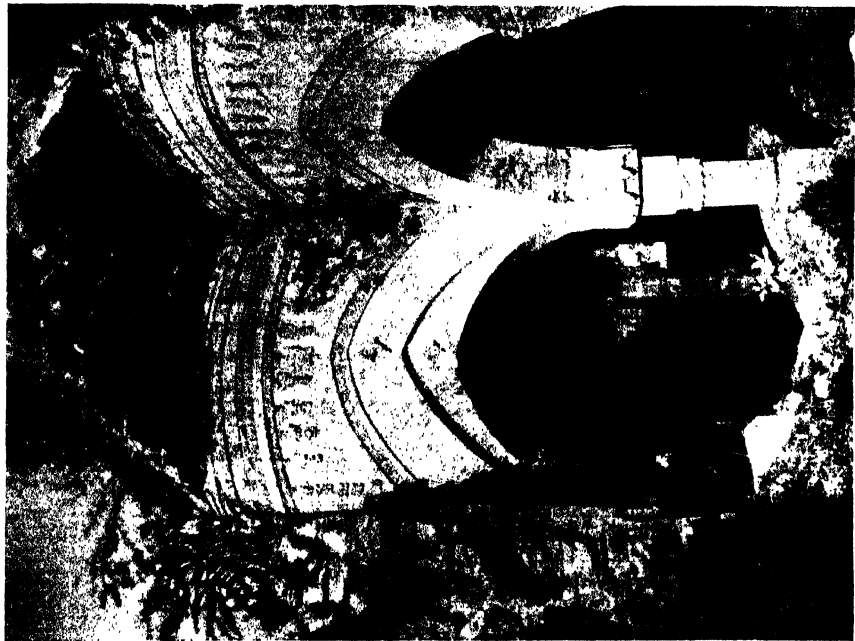

A

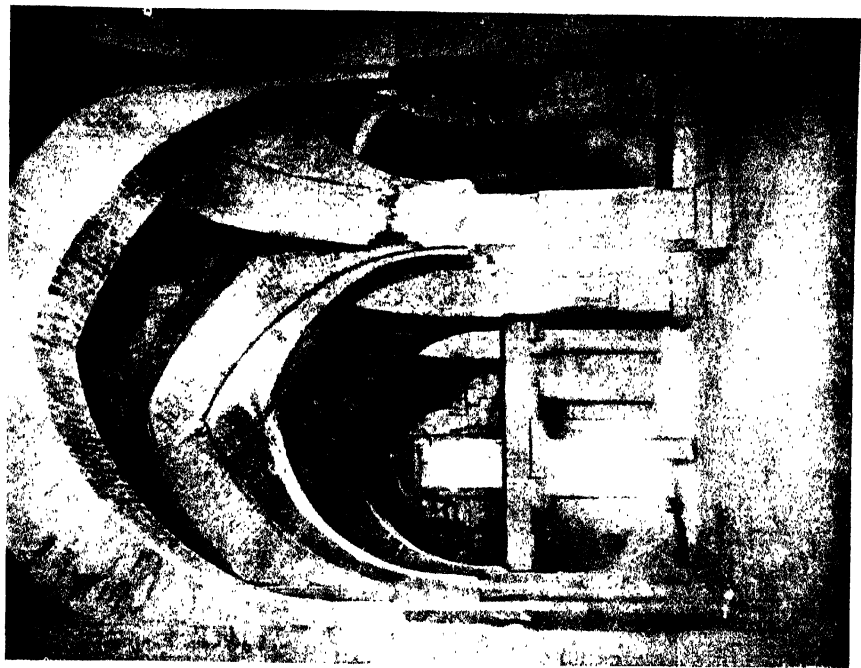

B

INTERIOR OF SONĀ MASJID, GAUR







INTERIOR OF SAT GUMBAZ MOSQUE, KHUJINDA



the minarets remain intact and the domes retain their Hindu finials. It will be useful to compare this building with Alif Khan's Masjid at Dholkâ (Plate XXVII).

Though the motifs of the decoration in Muhammadan buildings at Gaur are, as I have shown, all of Buddhist-Hindu origin and similar to the indigenous terra-cotta work of Bengal, it has a distinction of its own for which due credit must be given to the exquisite taste of the Arabian and Persian calligraphists, who must have directed some at least of the decoration of the early Muhammadan buildings at Gaur. But the fact that Indian craftsmen widened the basis of their art tradition by adding to it the culture of Persia and Arabia proves the greatness of their artistic capacity, but does not reduce Indo-Muhammadan art to a provincial form of Saracenic.

In 1537 Gaur was sacked by the Afghan ruler of Bihâr, Shêr Khan, and in 1576 became part of the empire of the Moguls. About the same time a great plague ravaged the city, so that it was gradually deserted, and its splendid buildings were buried in the jungle. Gaur is important in the history of Indian architecture not so much for the monuments it bequeathed to posterity as for its influence on the living tradition of Indian architecture. It was one of the great brick-building centres of Northern India which carried on the traditions of the Buddhist builders, both under Indian and Musulmân rulers. Such a great local school of craftsmanship would be the natural centre for supplying the demands of other city builders. A country so rich in architectural resources as India was in medieval times had no need to import foreign builders, neither is there any historical evidence that she ever did so to the same extent as Italy imported from Byzantium, England from France, or the Saracens in Egypt from all sides.

When Gaur was absorbed into Akbar's empire, its crafts-

men were dispersed and many, no doubt, migrated to the Mogul capitals, where, in conjunction with the builders of Gujerat, Rajputana, and other Indian craft centres, they assisted in forming the new Indian style adapted to the habits and tastes of their Mogul masters—a style with which certain structural and decorative elements from Persia and Arabia were combined, but yet remained essentially Indian. The argument that there is a common craft tradition, embodying a creative impulse which is wholly Indian, underlying not only Buddhist, Jain, and Hindu architecture, but also the thirteen styles of Muhammadan building classified by Fergusson as “Indo-Saracenic,” each having a marked individuality of its own, may seem absurd to those who regard architectural history merely as a classification of “styles” according to a scheme in which the superiority of West to East is the starting-point. It may be less incomprehensible when it is considered that though India contains a congeries of diverse races speaking several hundred distinct dialects, the whole of its literature and folk-lore belong to a synthesis of thought which can only be described as Indian. The contribution of Islâm to this synthesis made no exception to the rule ; it was a contribution which gave a new impulse to Indian creative imagination without changing the spirit of it or imposing upon it another craft tradition.

The effect of Islâm upon Indian craftsmanship was this : it detached a great number of craftsmen from the service of orthodox Hinduism, and thus set them free from the strict observance of the religious artistic canons—the Silpa-sâstras—which under the domination of a priestly literary caste had become too meticulous and inelastic, invaluable though they were as embodying the practice of a great craft tradition. Islâm preserved the principles of this great tradition for its

PLATE XLV

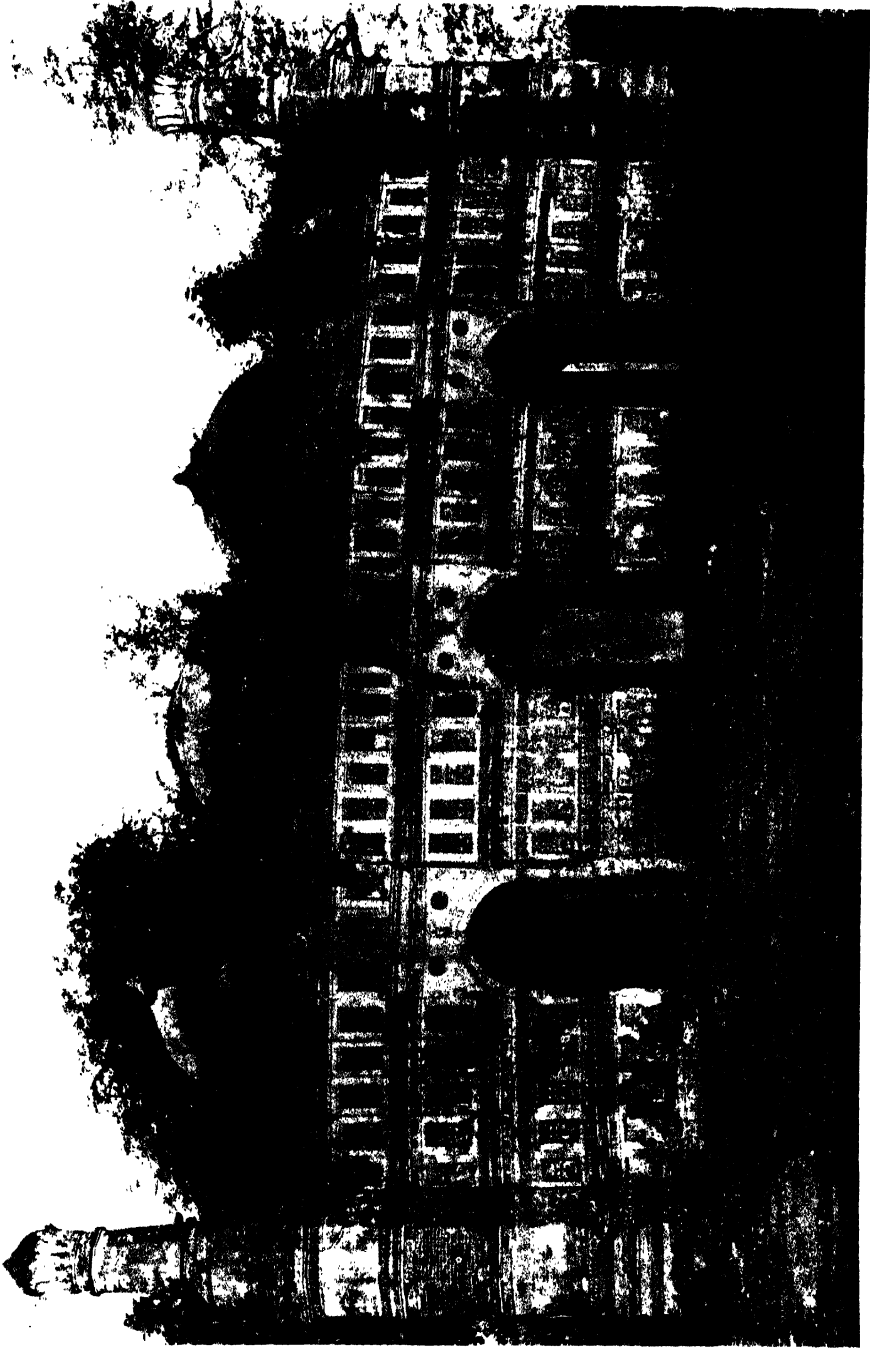

JAMI MASJID OF AKHI SERAJ-UL-DIN, GAUR



own purposes, and except for the restriction regarding anthropomorphic symbolism, allowed free play to Indian creative imagination in the many different centres of Muhammadan rule in India. Each group of city builders made use of the local craft tradition for developing its architectural ideas, creating a true Indian Renaissance on this foundation. There was at the same time an interchange of ideas between the different local centres, and, as in all great art movements in all countries, an inflow of ideas from outside which compensated to some extent for the narrow restriction which the law of Islâm placed upon the sculptor's art. Thus the first three and a half centuries of Muhammadan domination, subject to this important limitation, became a period of wonderful creative activity in Indian art and architecture, but the impulse was always from within.

Though, as I have said, there was an interchange of ideas between these different local centres, we must not expect to find the manifestation of it in the direct imitation of “ style ” which, most disastrously for art and craft, belongs to modern architectural practice in Europe. Such imitation did not exist in Europe until the sixteenth century, when the dilettante architect began to usurp the functions of the master-builder, and never existed in India before the days of the Public Works “ expert.” We shall not be able to find in the buildings of the Moguls any attempt to reproduce those of Gaur or of Gujerat, but we shall see the survival of the Gaur craft tradition in the bent roof of the Golden Pavilion in Shah Jahân's palace at Delhi (Pl. CI) and in the planning of the mausoleum of the Tâj Mahall, which reproduces the panch-ratna grouping of the domes of a contemporary Bengali temple (Pl. XLI). The craftsmanship of brick-built mosques and tombs in India owed far more to Bengal than to Persia.



## CHAPTER VIII

### GUJERAT ARCHITECTURE IN THE SIXTEENTH CENTURY

THE CHAMPANÎR MOSQUES—BUILDINGS IN AHMADÂBÂD : RÂNÎ RUPÂVATÎ'S MASJID ; SIDI SAYYID'S MASJID ; MOSQUE AND TOMB OF RÂNÎ SÎPARÎ ; DÂDÂ HARIR'S WELL—HINDU BUILDINGS IN RAJPUTANA—THE PALACE OF MÂN SINGH OF GWALIOR

“ As the style progressed,” says Fergusson, of the architecture of Gujerat, “ it became more and more Indian.” Not only this, but it produced some of the most stately and beautiful buildings ever consecrated to Muhammadan worship. The fifteenth century in Gujerat had been a time of fierce struggle between the Musulmân sovereigns and the rulers of the neighbouring Hindu states. Ahmad Shah (1441-42), the founder of Ahmadâbâd, and his immediate successors were too busy in destroying Hindu temples and in propagating the faith of Islâm by the sword to become great builders. But in the early part of the sixteenth century, under the most powerful of the Muhammadan rulers of Gujerat, Mahmûd Shah Begarah (1459-1511), Ahmadâbâd had become on the whole, says Ferishta, “ the handsomest city in Hindustan, and perhaps in the whole world.”<sup>1</sup>

Champanîr, a hill-fortress about seventy-eight miles south-east from Ahmadâbâd, was taken by Mahmûd in 1484 after a heroic defence of eight and a half months by the Hindu chieftain, Jay Singh Pâtâi Râwal, who when wounded and

<sup>1</sup> Briggs's translation, vol. iv. p. 14.

PLATE XLVI

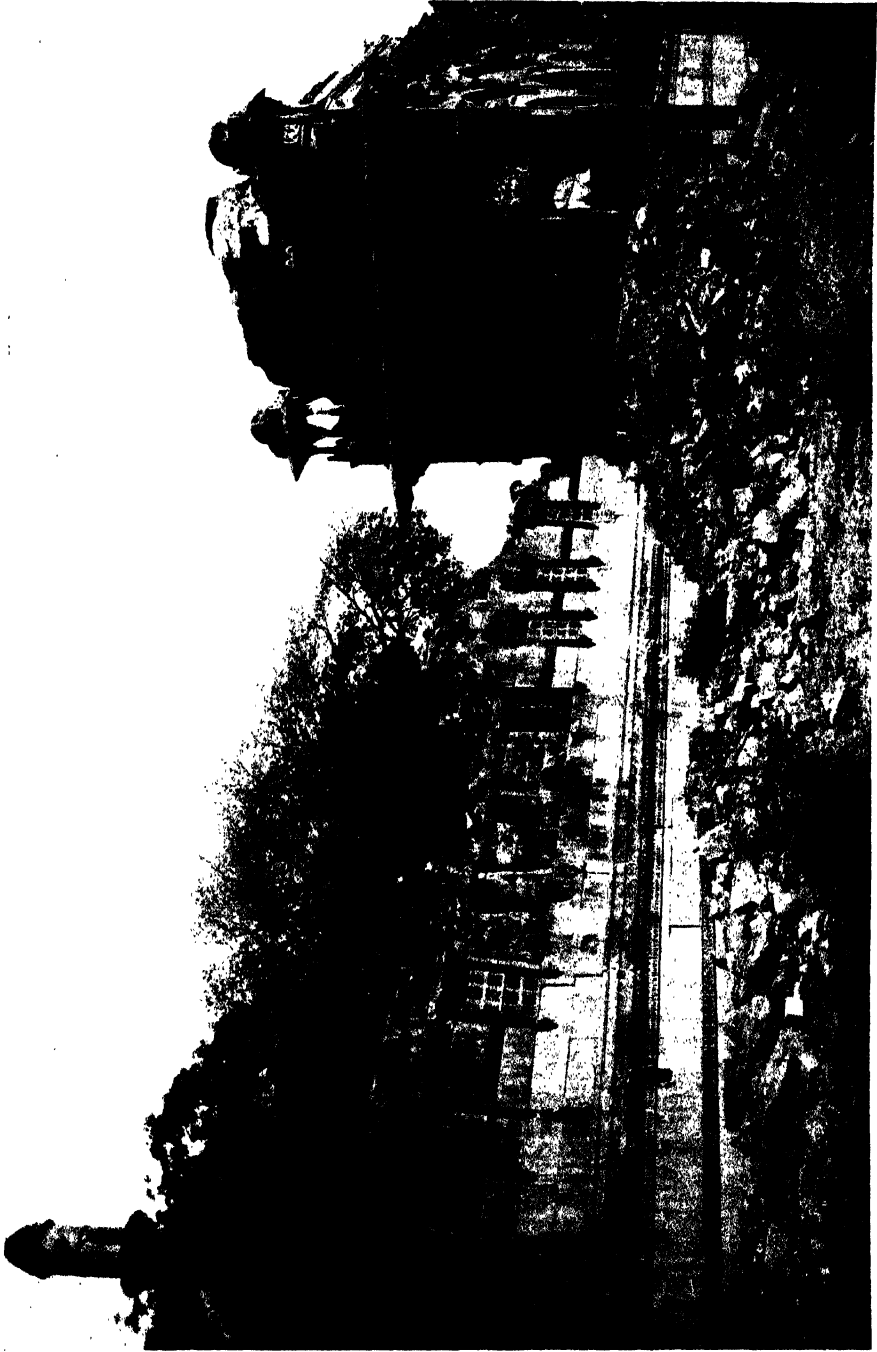

JAMI' MASJID, CHAMPANI'R : NORTH SIDE



PLATE XLVII

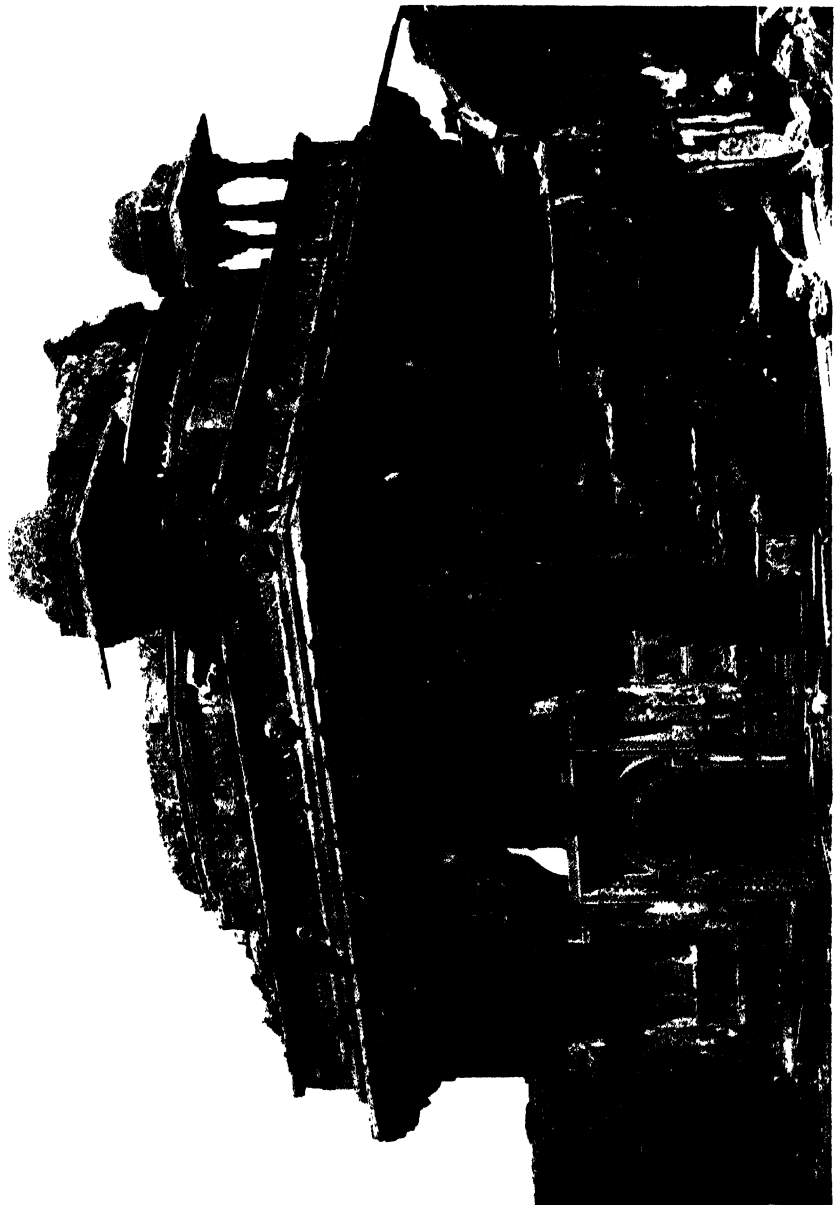

IAMI MASJID, CHAMEPANIR : MAIN ENTRANCE PORCH



taken prisoner preferred death to acceptance of the dogmas of Islâm.<sup>1</sup> Mahmûd made Champanîr his capital, and before his death in 1511 had built there many splendid buildings, including a Jâmi' Masjid which should be regarded not only as the finest in Gujerat, but as one of the noblest buildings of its class anywhere, for in many ways it is far superior to other architectural monuments of the Muhammadans which are better known to the European student.

It has a better architectural *ensemble* than Akbar's mosque at the Fatehpur-Sîkrî, which is overpowered by its magnificent portal, the Buland Darwâza. In dimensions it is little inferior to the great mosques of Ahmadâbâd and Delhi : in certain qualities of design it surpasses them both. The Jâmi' Masjid at Delhi has the advantage in the skill with which it is planned for external effect. It may be more imposing as a silhouette against a glowing sunset, but that borrowed glory disappears on closer approach, for the interior is as cold and expressionless as a modern Renaissance church. The Champanîr mosque needs no help from its surroundings, beautiful as they are ; for every stone of it glows with the warmth of its own expression. It combines consummate craftsmanship with lofty religious idealism ; the exquisite rhythm of Greek construction with the sumptuous richness of Byzantine decoration, though it lacks the human interest of Christian idealistic art.

The designing of the Champanîr mosque shows a great advance from Ahmadâbâd buildings of the preceding century, but no signs whatever of Persian or Arabian suggestion, except in some of the decorative details. The Gujerat builders, after a century of experimenting at Ahmadâbâd and elsewhere, had acquired as much skill in the structural use of the pointed arch as they had in their own traditional style of building, and

<sup>1</sup> Dr. Burgess, " Archæological Survey of Western India," vol. vi. p. 39.

from the habit of thought formed by the religious teaching of Islâm had adopted a mode of artistic expression more in harmony with that religion than with the pantheistic philosophy of Hinduism. But the artistic principles and the craft

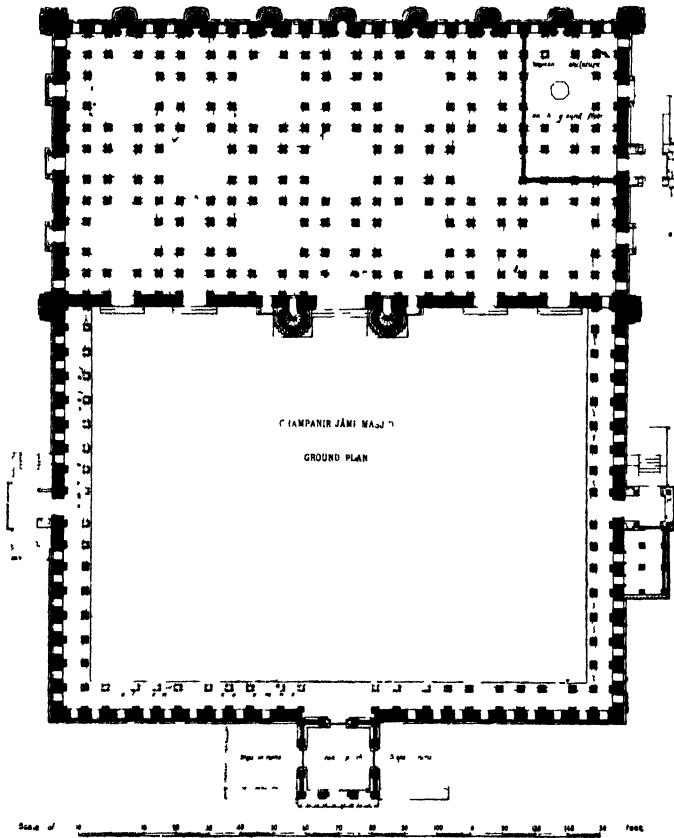
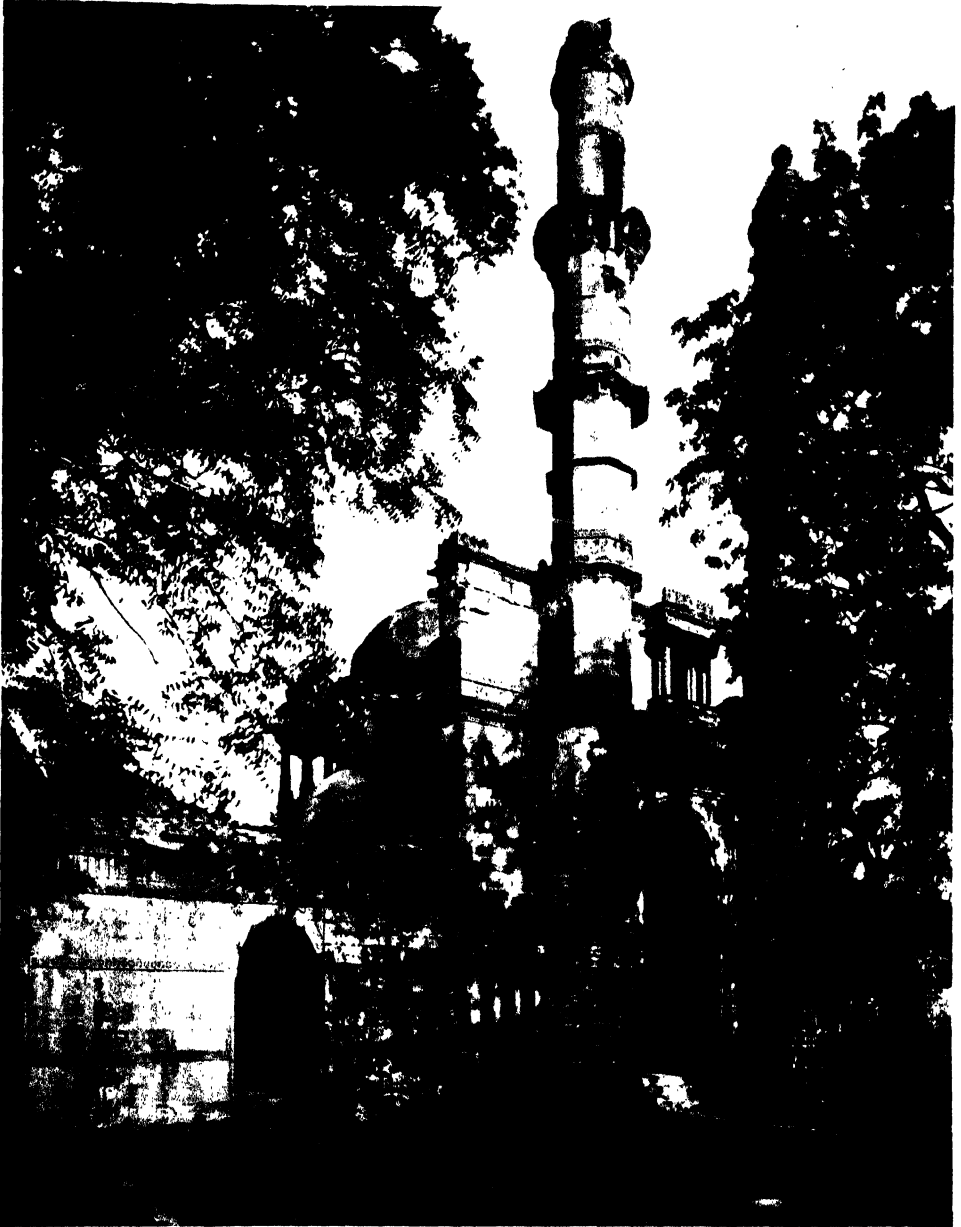

FIG. 33.—Plan of Jâmi' Masjid, Champanîr (drawn by the Archæological Survey of India)

tradition were not otherwise changed: they were only being adapted to the ideals of a particular school of religious thought.

The orientation of the mosque is the same as that which was used for a Hindu temple—*i.e.* the four walls of the enclosure face the four cardinal points, the principal entrance being towards the rising sun. The planning of it is more compact

than that of the Jâmi' Masjid at Ahmadâbâd, the courtyard being smaller in proportion to the size of the *liwân*. In this and in the emphasising of the pyramidal lines of the whole structure it resembles even more closely the Hindu prototype of the Gujerat mosques—the Chaumukh temple at Rânpur (Plate XXVI).



JÂMI' MASJID, CHAMPANÎR : FAÇADE OF LIWÂN





PLATE XLIX

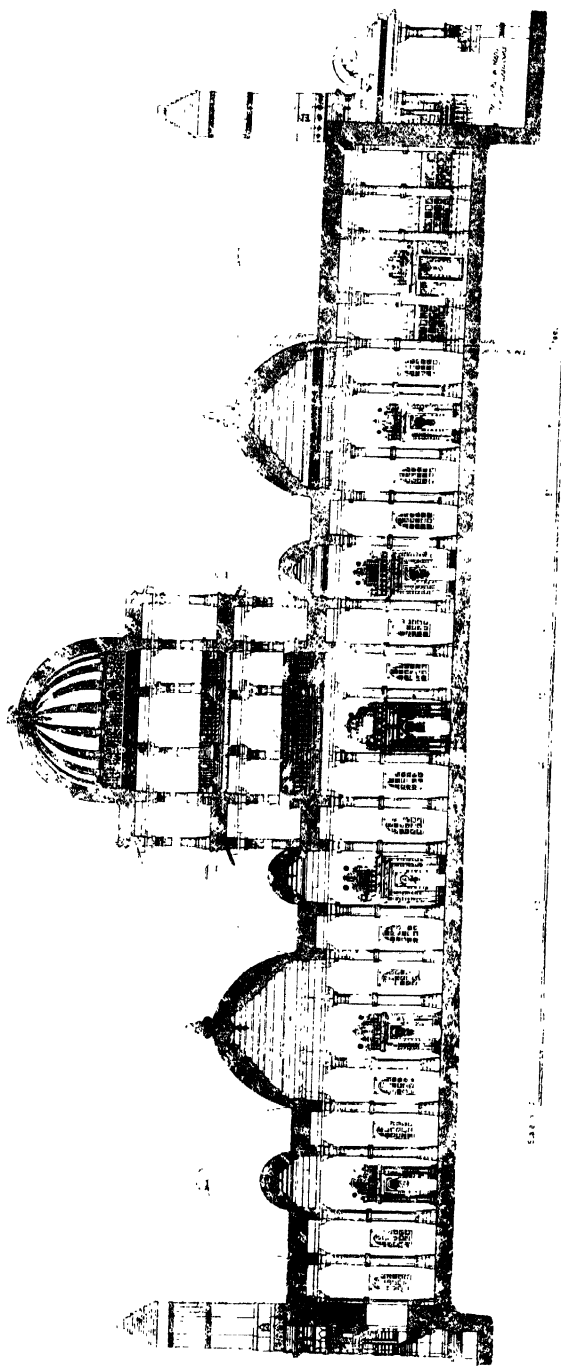

JĀMĪ MASJĪD, CHAMPĀNĪR : LONGITUDINAL SECTION



The enclosing walls of the mosque measure 216 feet from east to west, and 178 feet from north to south. The courtyard is 115 feet from east to west, and is surrounded on three sides by corridors with arcades open to the court, the outer walls being pierced by elegant windows of purely Hindu design, filled with perforated stone lattices (Pl. XLVI). The main entrance on the east is through a noble domed portico (Pl. XLVII). The carving on it betrays the influence of the Arabic calligraphist, but the whole structural basis of it is Hindu. The pilasters on the sides of the doorway repeat those of a Hindu temple; the arches are constructed experimentally in Hindu fashion, sometimes like brackets sometimes with keystones and irregular voussoirs.

The façade of the *lîwân*, the centre of which is shown in Pl. XLVIII,<sup>1</sup> proves how completely the Gujerat builders of the sixteenth century had overcome the difficulties of harmonising the arched screen in front of the *lîwân* with the purely Hindu structure of the interior. There is nothing of the awkwardness which is seen in the arrangement of the façades of the earlier Gujerat mosques. The spacing out is finely balanced and the proportions carefully adjusted as in the best Renaissance buildings of Europe, while there is a subtlety in the rhythm and a fertility of imagination in the co-ordination and design of the detail which only the best Gothic craftsmen have equalled.

There are five entrances to the *lîwân*—a central doorway, 15 feet in width, and two on either side of it of half that size. The main entrance is flanked by two stately minarets, 100 feet in height, of perfect proportions, which are echoed by four

<sup>1</sup> The illustration does not do justice to the beauty of the façade on account of the trees which obstruct the full view of it. A better impression of the whole design will be obtained from the illustration of the Nagîna Masjid (Plate LII).

others, 50 feet in height, at the outer corners of the *lîwân* (Plate LI). The proportion of a double square is also observed in the ground-plan of the *lîwân*. The central part of the façade is a square of 51 feet, or, if the height of the minarets is included, very nearly a double square. The side-wings, the plainness of which contrasts well with the richness of the centre, are also of the same proportion; the height of each being 28 feet and the width 56 feet. The frequent occurrence of the double square, a favourite canon of proportion with the Renaissance architects of Italy, will probably tempt some Western writer to suggest that Mahmûd of Gujerat imported Italians to teach his master-builders the "true principles" of architecture!

The base of the two central minarets, which contain spiral staircases leading up to the upper galleries of the *lîwân* and to a door at the top of each, are richly carved in the style of the Rajput Towers of Victory (Pl. XXIII), up to the level of the crown of the central doorway. Above this they are ornamented at intervals proportioned with unerring skill and taste with a series of exquisitely carved string-courses and bracketed cornices, each one of different design. At a height of about two-thirds from the base, the section of the minarets changes from an octagon to a sixteen-sided polygon, and finally to a circle, as usual in Hindu temple pillars. The summit of each is crowned like the *mandapa* of a Hindu temple.

The plan and section (Pl. XLIX) will show the arrangement of the interior of the *lîwân*, which measures 169½ feet by 81 feet, and is also an adaptation of the design of contemporary Hindu temples in Rajputana. Like the exterior it is simpler than that of the *Jâmi' Masjid* at Ahmadâbâd, and finer in proportion. There are eleven domes of about 20 feet in diameter—four along the front and back and three along the

PLATE L

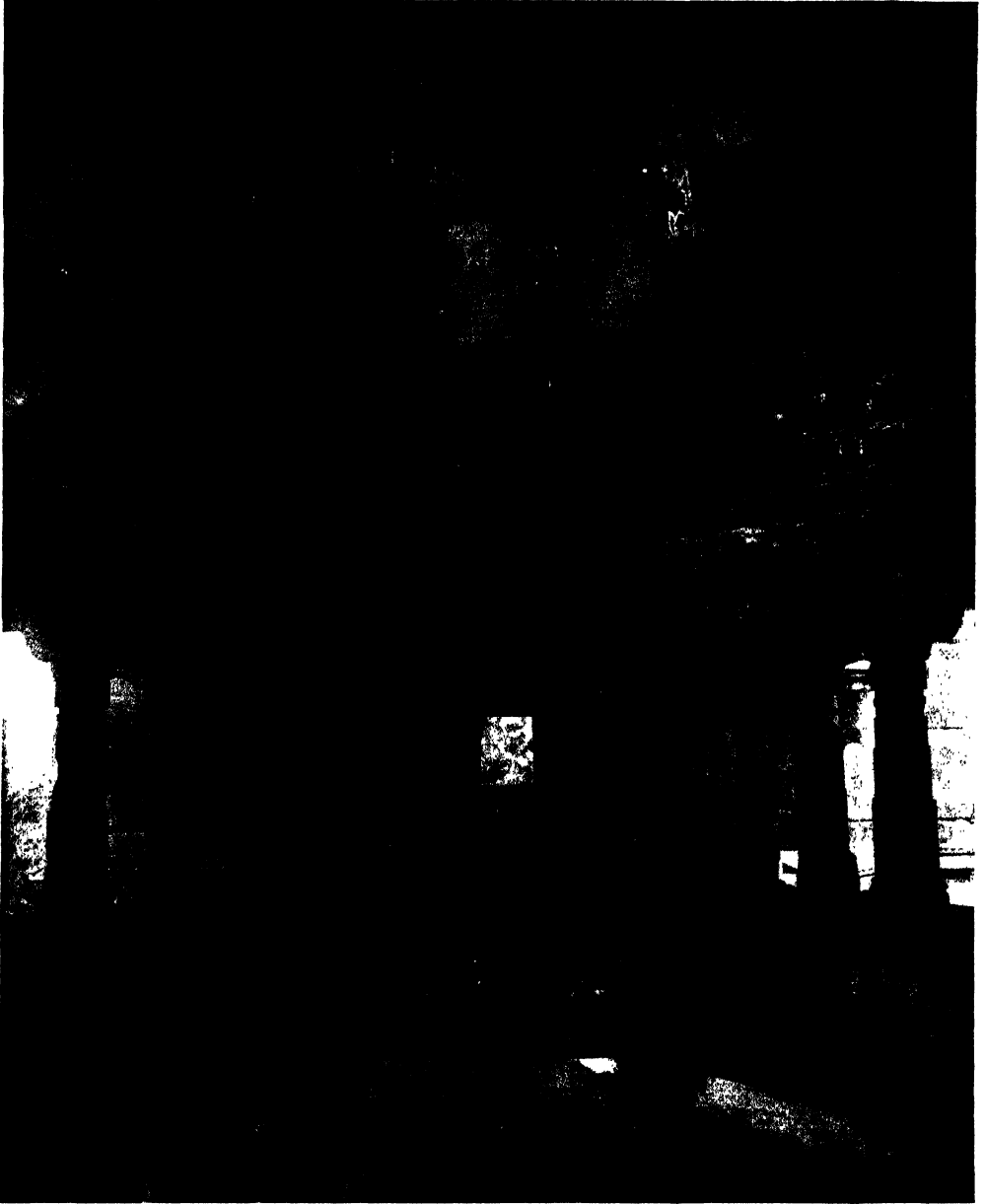

JĀMI<sup>2</sup> MASJID, CHAMPANĪR : INTERIOR OF CENTRAL DOME



PLATE LI



JAMI' MASJID, CHAMPANIR : BACK OF LAWAN





central line from north to south—which are linked together by a flat roof and ten smaller domes. The general level of the roof is only  $17\frac{1}{2}$  feet in height, but the central part of it, corresponding to the transept of a Christian church, is carried up to three stories, the roof of it being brought forward to the façade wall so as to form a lofty entrance porch. Though this transept with its dome (Plate L) is of insignificant size compared with many other buildings in Europe and in India, in nobility of conception, justness of proportion, and in the virile strength of its flawless masonic craftsmanship it can hold its own with any. Shah Jahân ransacked Asia for the most precious materials so that the tomb of his beloved queen might surpass all others in beauty. His craftsmen, indeed, made full use of them ; but the Jâmi' Masjid of Champanîr proves that great architecture can dispense with marble and precious stones. Here the mason's chisel suggests the glow of colour, gold and inlay before they were added to the building.

The central dome is of the same diameter as the ten large domes of the adjacent aisles, but it is several feet higher from the springing to the crown. The desire for a greater height was no doubt the reason for its being constructed with sixteen stone ribs, instead of by concentric horizontal courses of stone like the other domes. In the previous chapter I have shown the error of Fergusson's assumption that the ribbed dome was introduced into India by Saracenic builders from the West. It is significant that the Champanîr dome in which this principle is employed occupies an analogous position in the mosque to the spire of the vimâna in a Rajputana temple. The latter being always constructed with stone ribs, it was natural for the Indian craftsman to apply the same principle to the central dome of a mosque, and to build the subordinate ones in the same way as the domes of a Hindu temple porch, *i.e.* with

horizontal courses of stone. That is exactly what they did at Champanîr.

The exterior of the other domes, which, if the line of the interior structure had been followed, would have had an ugly conical shape like the makeshift domes of early Muhammadan buildings in India, is brought to an approximately semi-circular section by a casing of brickwork, with a final coating of plaster. All the domes are surmounted by the Hindu emblems, the water-pot and the *amalaka*.

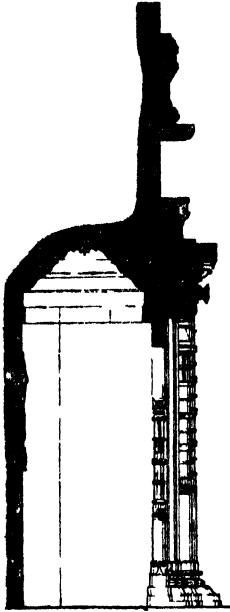
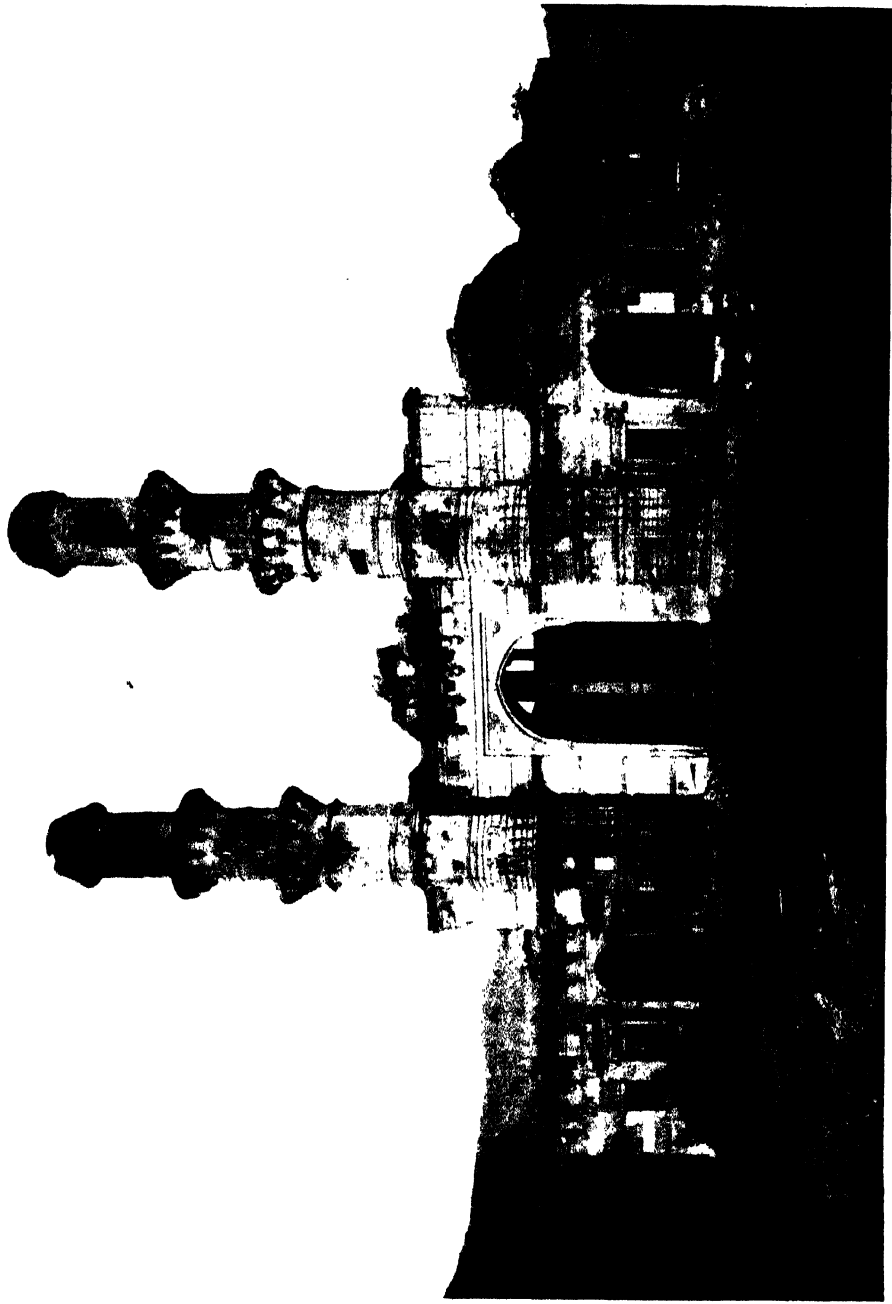

FIG 34 —Section of Mihrâb, Champanîr

Along the west wall of the *liwân* are placed seven beautifully sculptured mihrâbs, three large ones in the centre with two smaller ones on each side of them. With the omission of anthropomorphic symbolism they are exact reproductions of Hindu temple shrines, and are precisely similar in style to the beautiful mihrâb of the Junagarh mosque shown in Pl. XXXII. The spaces between the mihrâbs and the two end spaces are filled by sixteen windows with perforated stone lattices, like those in the corridors of the courtyard.

The south wall is pierced by three windows with very elegant bracketed balconies similar in design to those of the façade. Plate LI shows the whole exterior or back view of the *liwân* as seen from the south-west. The seven buttresses in the west wall are variations of the designs of the sculptured bases of the minarets.

There can be no dispute that the Champanîr mosque, like those of Jaunpur, Mandû, and elsewhere in the preceding century, will convey to the European observer a first impres-



NAGINA MASJID, CHAMPANĪR



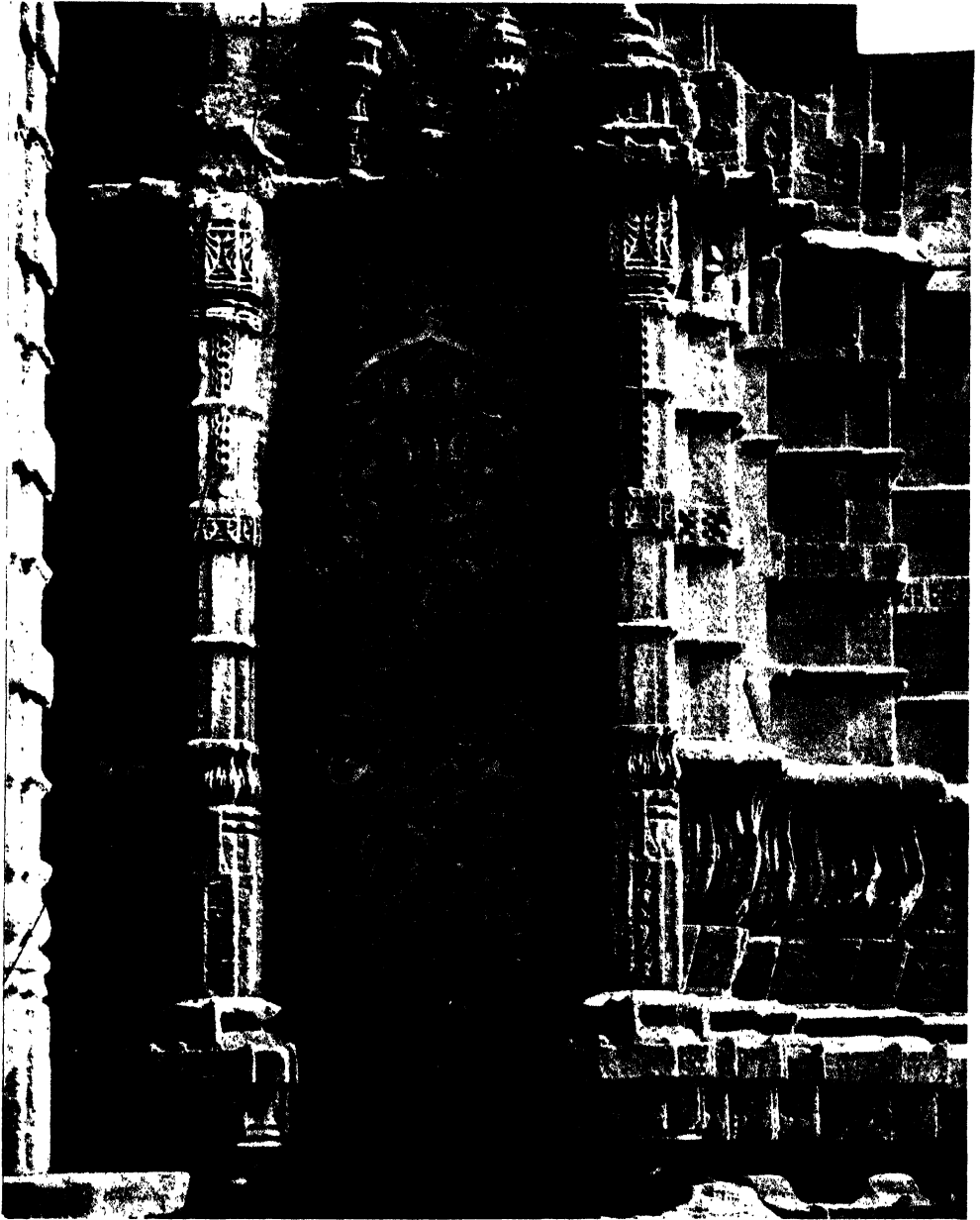

NAGINA MASJID, CHAMPAÑR : DETAIL OF MINARET



sion of belonging to a building tradition very different to that of Hindu temples. He will convince himself that he can trace in the gradual development of Indo-Muhammadan architecture a growing sense of structural rhythm, a fine feeling for proportion and for the just co-ordination of plain and decorated surfaces which he fails to perceive in the Hindu buildings with which he is acquainted.

But that is chiefly because few trained European critics have as yet thought it worth while to apply themselves to a careful study of Hindu art and architecture. In Europe there are no opportunities for doing so, and the usual itinerary of a tourist in India only

enables him to compare some of the finest Muhammadan buildings with the most decadent of Hindu architecture.

A closer investigation, guided by a true

sense of historical analysis, will enable him to see that the difference between the mosque and the temple—when a just comparison is made between them—is only a difference of artistic mood, controlled by ritualistic and practical considerations, not a difference of artistic tradition, knowledge, or skill. The science of Muhammadan art in India, as well as the inspiration of it, came from the Hindu Silpa-sâstras. The outstanding fact in the history of Muhammadan architecture in India is that until the beginning of the seventeenth century, when its decadence was approaching, the development of it was entirely from within. Though they looked to Baghdad and Mecca as their spiritual centres, neither the political nor

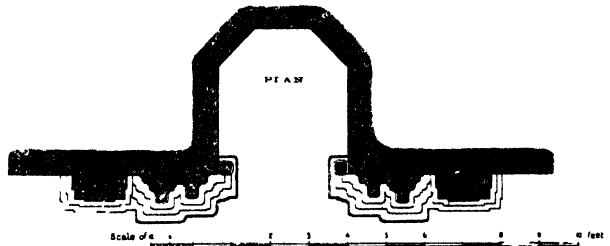

FIG. 35.—Plan of Mihrâb, Champanîr.



religious leaders of Islâm showed any bias towards foreign architectural fashions.

Champanîr, says Dr. Burgess, remained the political capital of Gujerat until 1536. Among the ruins of this splendid city there are still many buildings which deserve detailed description, but I must content myself with a passing reference to the Nagîna Masjîd, a beautiful little building very similar to the Jâmi' Masjîd, though much smaller. It is evidently

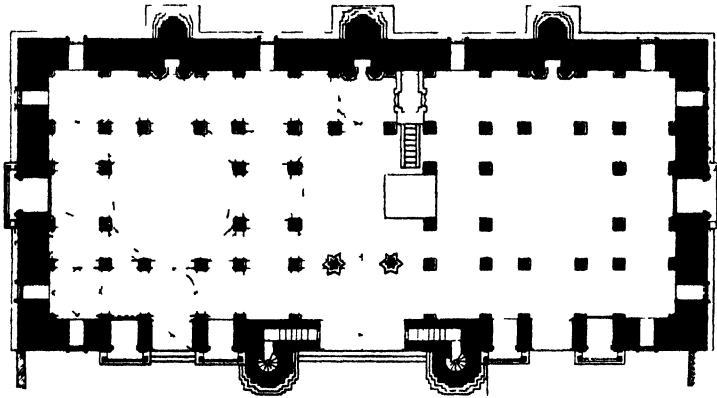
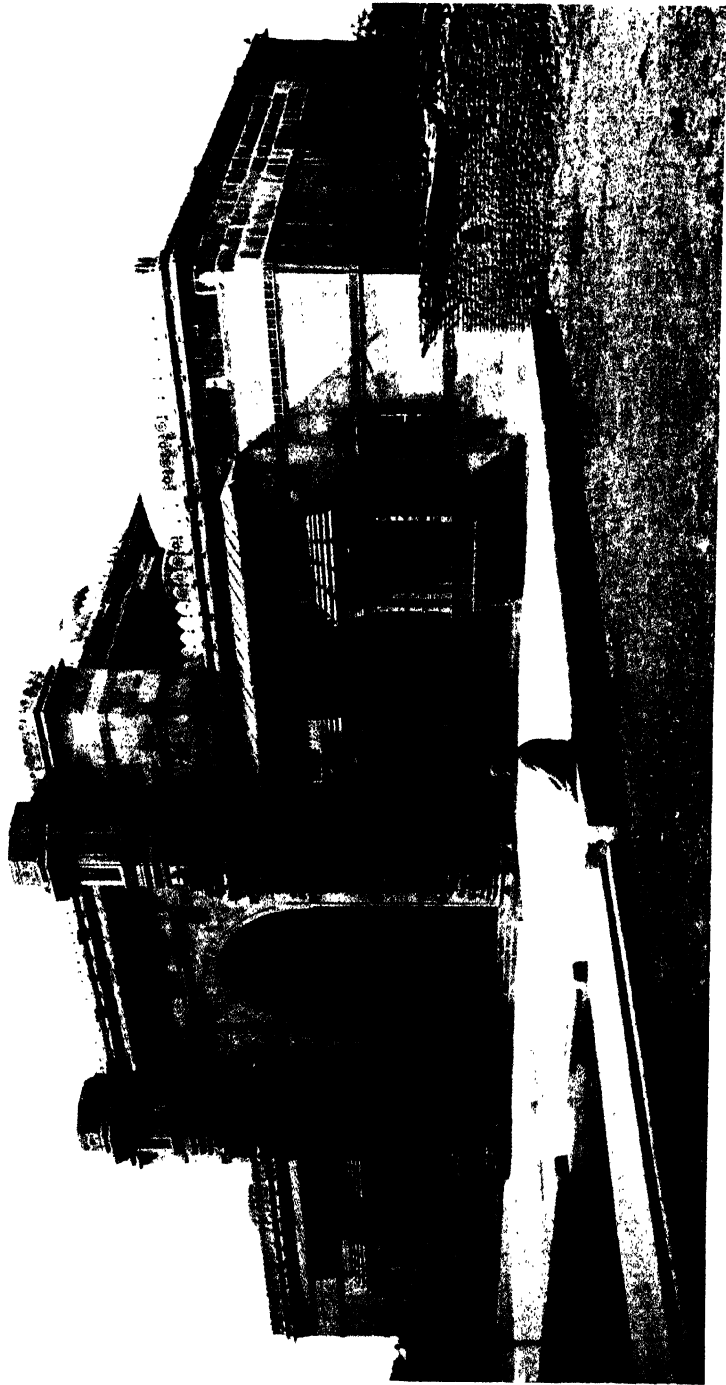

FIG. 36 — Râni Rupâvatî's Masjîd Plan of Liwân (drawn by the Archaeological Survey of India)

of the same period. The façade of the liwân is shown in Plate LII.

The perforated stone windows sculptured in the bases of the minarets (Pl. LIII) show the progressive development of those surpassingly beautiful foliated trellises for which the mosques at Ahmadâbâd are famous. Professor Lethaby is wrong in saying that "all the lattices of the East, Indian and Chinese, must derive from the Arab lattice." The stone lattices in Muhammadan buildings in Gujerat are, like other details, derived directly from the Hindu temples of Western India and Rajputana. Muhammadan social customs made lattices more necessary in the mosque than they were in the

PLATE LIV



RANI RUPAVATI'S MOSQUE, AHMADABAD



PLATE LV

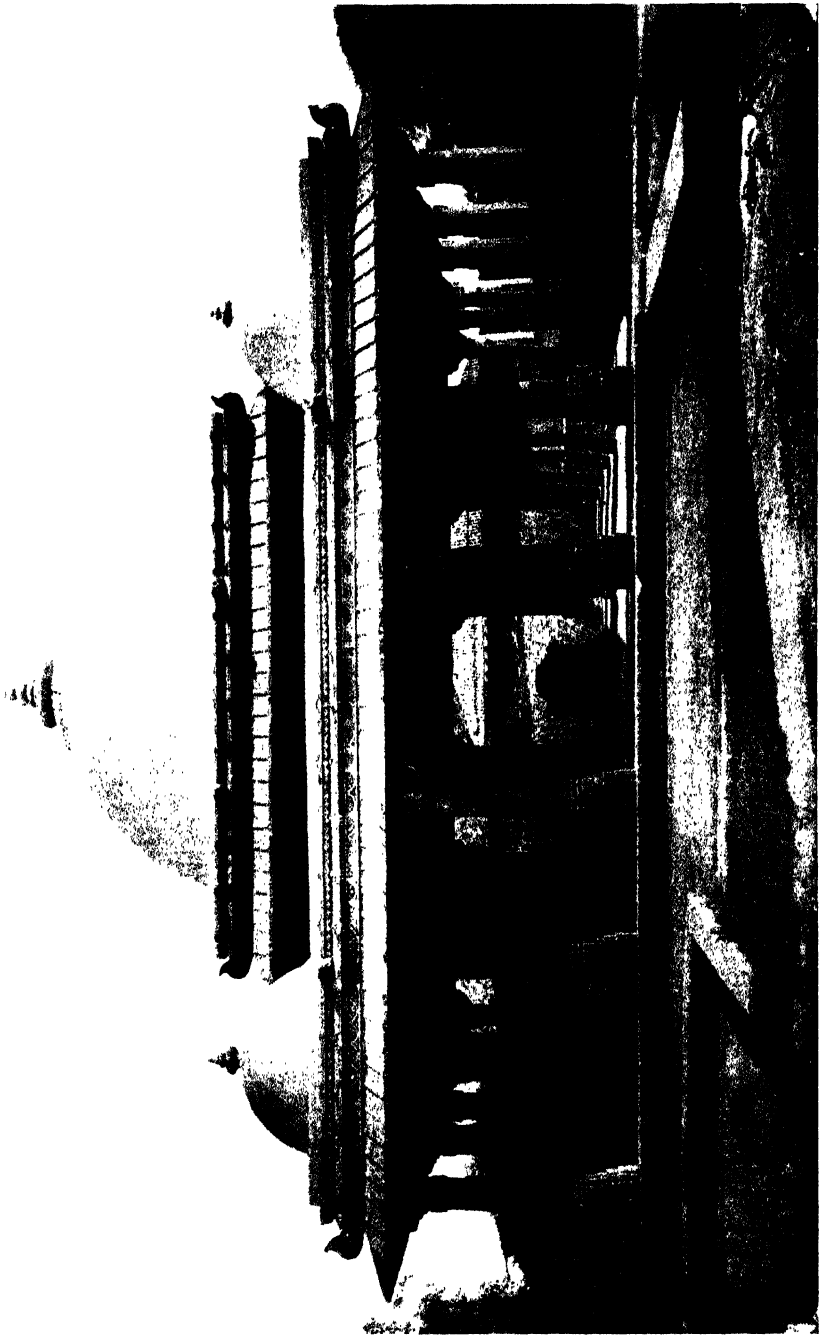

RĀNĪ RUPĀVATĪ'S TOMB, AHMADĀBĀD



temple. The Indian craftsman, following his own tradition, supplied the demand for both.

After the removal of the Court to Champanîr there was still great building activity in the old capital and throughout the kingdom of Gujerat. The Rânî Rupâvatî Masjid, or the Queen's mosque, in the Mîrzapur quarter of the city, is typical of the style of the early sixteenth century. Making allowances for the stunted appearance of the façade of the lîwân, due to the loss of the upper half of the minarets, it is one of the most successful of the Ahmadâbâd mosques, though by no means so finely balanced in design as the two mosques at Champanîr. It is much smaller than the Jâmi' Masjid, and only the lîwân remains intact. The outside dimensions of the latter are 103 feet by 46 feet. It is covered by three domes about 19 feet in diameter linked together by a flat roof and smaller domes, the central dome being raised upon a clerestory to admit light and air according to the usual arrangement of Gujerat mosques.

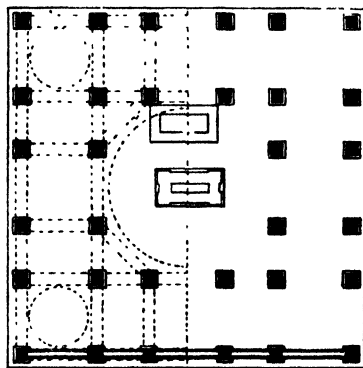

FIG. 37.—Plan of Tomb, Rânî Rupâvatî's Masjid.

The details of the Mîrzapur mosque—the bases of the minarets, the balcony windows, and the perforated stone lattices—are as exuberantly rich as the sculpture of the Hindu temples from which they are derived.

The tomb of the Rânî, said to be one of the ladies of the Royal household, from whom the mosque is named, is in an adjacent courtyard. Like all the early Muhammadan tombs in India, it shows a great contrast to the mosque in its classic severity of design and sobriety of decoration; but

it is nevertheless purely Hindu in general conception and in detail.

Starting from a square or octagonal ground-plan with a single dome supported on columns like the porch of a Hindu temple, the roof-plan of the Muhammadan tomb gradually developed into the *panch-ratna* or "five-jewelled" type of Buddhist and Hindu temple, by the addition of four smaller domes or kiosks at the corner of the square, or into the *nava-ratna* or "nine-jewelled" type when the ground-plan was octagonal. In the former case four minarets or octagonal buttresses sometimes took the place of the smaller domes. In the Tâj Mahall the four detached minarets echo the small kiosks over the four side-chapels of the mausoleum. The great majority of Muhammadan tombs in India are planned upon this scheme, or some slight variation of it.

Another of the most beautiful of the mosques of Ahmadâ-bâd—the so-called mosque of Sidi Sayyid, built within the enclosure of the royal palace—belongs to the early part of the sixteenth century. It has, however, suffered much from vandalism, first from the Marathas who desecrated it, and afterwards under British rule when it was converted into an office for the revenue collection of the district. Its restoration and conservation were part of the splendid work done by the Archæological Survey of India under Lord Curzon's Government.

It is a small mosque, and only the *lîwân*, measuring 68 feet by 36 feet, now remains ; the upper part of the minarets at the two front corners have fallen. Structurally it is interesting as showing one of the first attempts of the Gujerat builders to use the arch in the interior of the *lîwân* for the support of the roof. Here, as elsewhere, it is quite evident that the Indian did it tentatively but quite spontaneously,

PLATE LVI

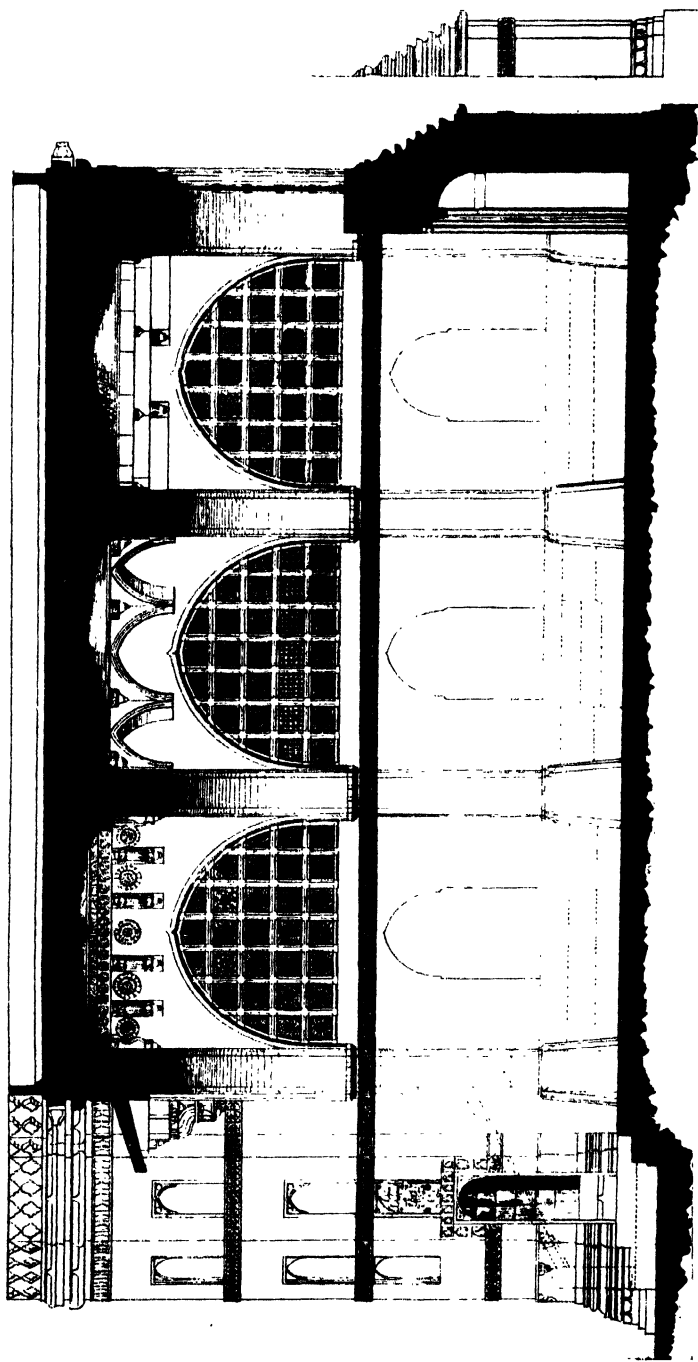

SIDI SAYYID'S MOSQUE, AHMADRABAD: CROSS SECTION OF LIWÂN  
(Drawn by the Archaeological Survey of India)





PLATE LVII

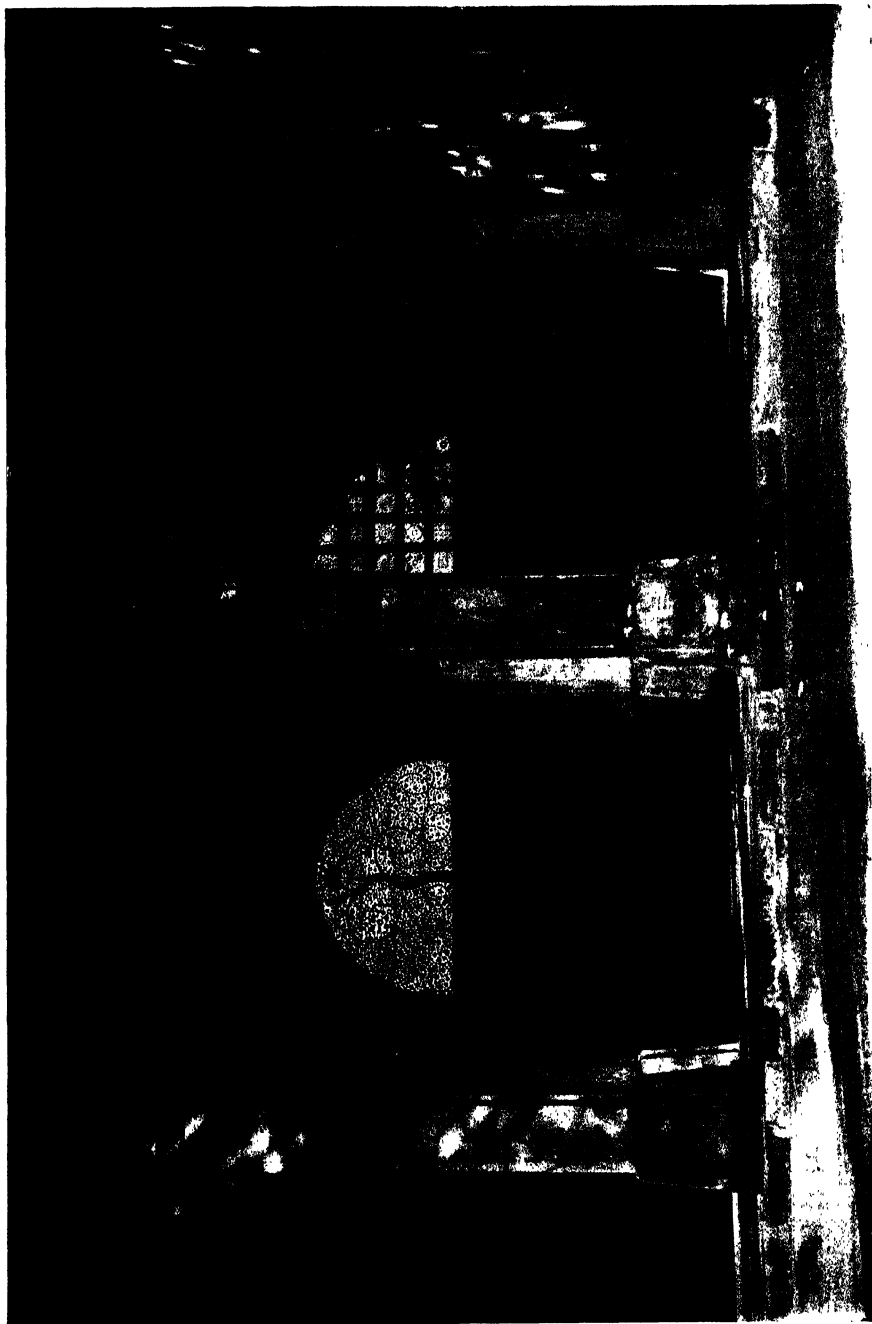

SIDI SAYYID'S MOSQUE, AHMADĀBĀD: INTERIOR OF LIWĀN



without any instruction or suggestion from foreign craftsmen, to whom the arch was familiar as a structural expedient. The pîpal leaf is carefully carved on the keystone of the arches (Pl. LVIII). No Saracenic craftsman would have done this. Neither would a Saracenic builder skilled in arch construction have experimented with Hindu methods of construction as these builders did. It was just because the Indian builders of the fifteenth and sixteenth centuries could and did experiment so freely that they produced such great results. Three different devices, Dr. Burgess points out, were employed in roofing the fifteen compartments into which the plan of the lîwân is divided by its pillars. "Some are contracted in the usual Hindu method by cutting off the corners by three courses of lintels, reducing the square to a thirty-two-sided polygon ; in others pendentive arches are thrown across the corners in the style so common in Northern India ; in others again a Hindu system of brackets support the base of the covering dome."<sup>1</sup> The domes being of small dimensions, they are contained within the thickness of the roof, which is flat outside.

Though skilfully planned and elegant in proportions, as are all the Gujerat buildings of this period, Sidi Sayyid's mosque in its mutilated condition would not be specially remarkable except for the glorious stone tracery of the arched windows in the back of the lîwân, which besides ventilating the interior give it almost as much warmth of colour as the jewelled windows of Western cathedrals. From the outside it is equally beautiful (Pl. LVIII). In this class of window tracery India stands alone : it is a purely Indian development of the sculptor's craft having its origin in the Hindu temple tradition. It owed nothing to Persian art : the best Ahmadâbâd tracery shows no Persian influence. It is stronger in

<sup>1</sup> "Archæological Survey of Western India," vol. vii. p. 41.

design and better suited for its purpose than most of the work of the Mogul period, when the Indian craftsmen adopted the Persian fashions of the court. Persian influence generally was very far from being the great inspiring force in Mogul art which it is commonly assumed to be by Western critics. The court fashions of the later Mogul Emperors had, on the whole, a decidedly weakening effect on the native vigour of Indian architecture, as they certainly had upon the *morale* of Indian social life. Professor Lethaby's oft-quoted characterisation of Indo-Muhammadan architecture as "elasticity, intricacy, and glitter—suggestive of fountain spray and singing birds," is only just if applied to the later decadent phases of it, when Persian influence was strongest and when the demoralising influences of a dissolute court were faithfully reflected in court architecture. Applied to the virile and intensely practical art and architecture of the sixteenth century it is meaningless, as Professor Lethaby himself would, I am sure, be the first to admit.

Perso-Saracenic art on its own soil was superbly great ; but Persian influence brought into India from time to time by courtiers and casual craftsmen could not inspire Indian art with qualities it did not itself possess. The suggestions given to India in this way did not alter Indian art, but were turned by Indian artists and craftsmen in the direction they chose. The inspiration remained Indian always, just as Shakespeare drew his inspiration from his native heath even when he borrowed an idea from Scotland or from Italy.

The mosque and tomb of Rânî Sîparî are among the most elegant of the Ahmadâbâd buildings of this period ; the date of their completion, according to an inscription over the central mihrâb of the mosque, was 1514—three years after the death of Sultan Mahmûd Shah Begarah. They were built by one of his queens in memory of her son, Abu Khan,

PLATE LVIII

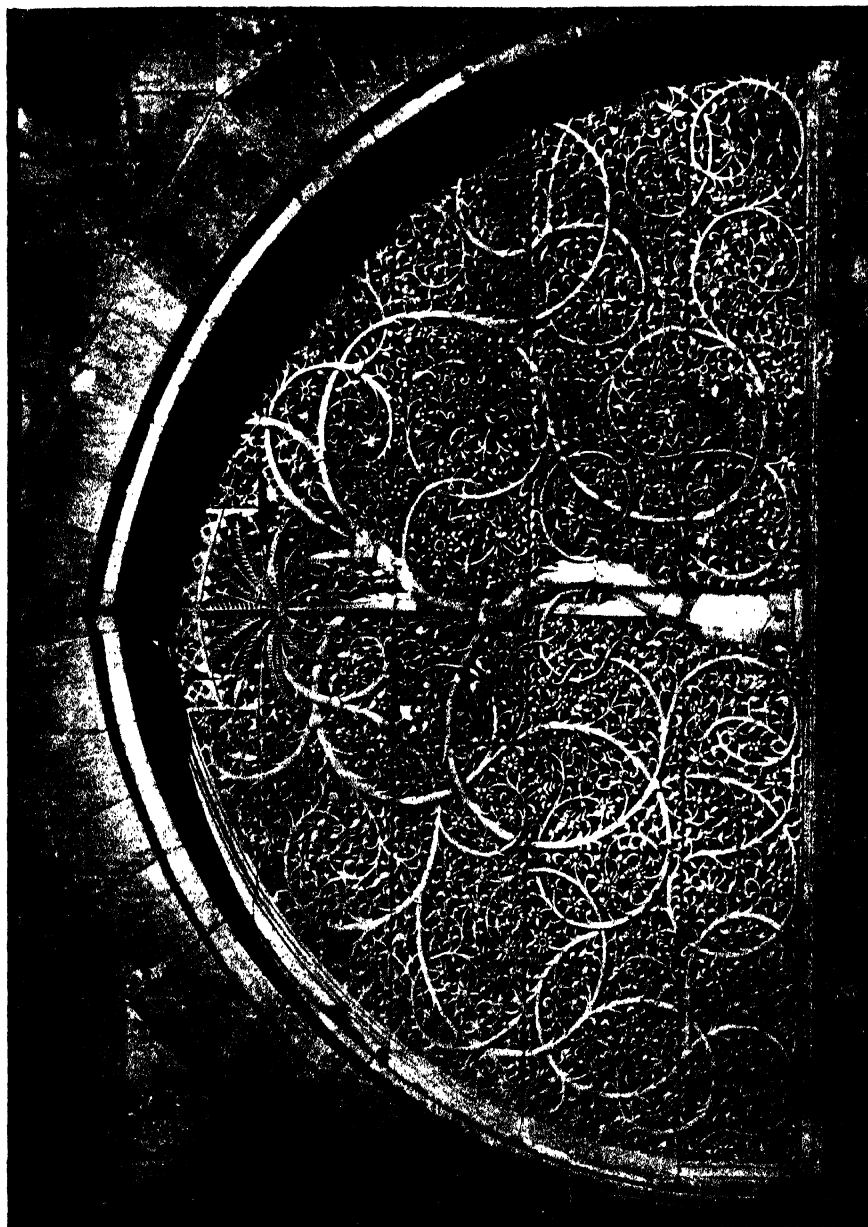

SIDI SAYYID'S MOSQUE, AHMADÁBÁD : PERFORATED STONE WINDOW



PLATE LIX

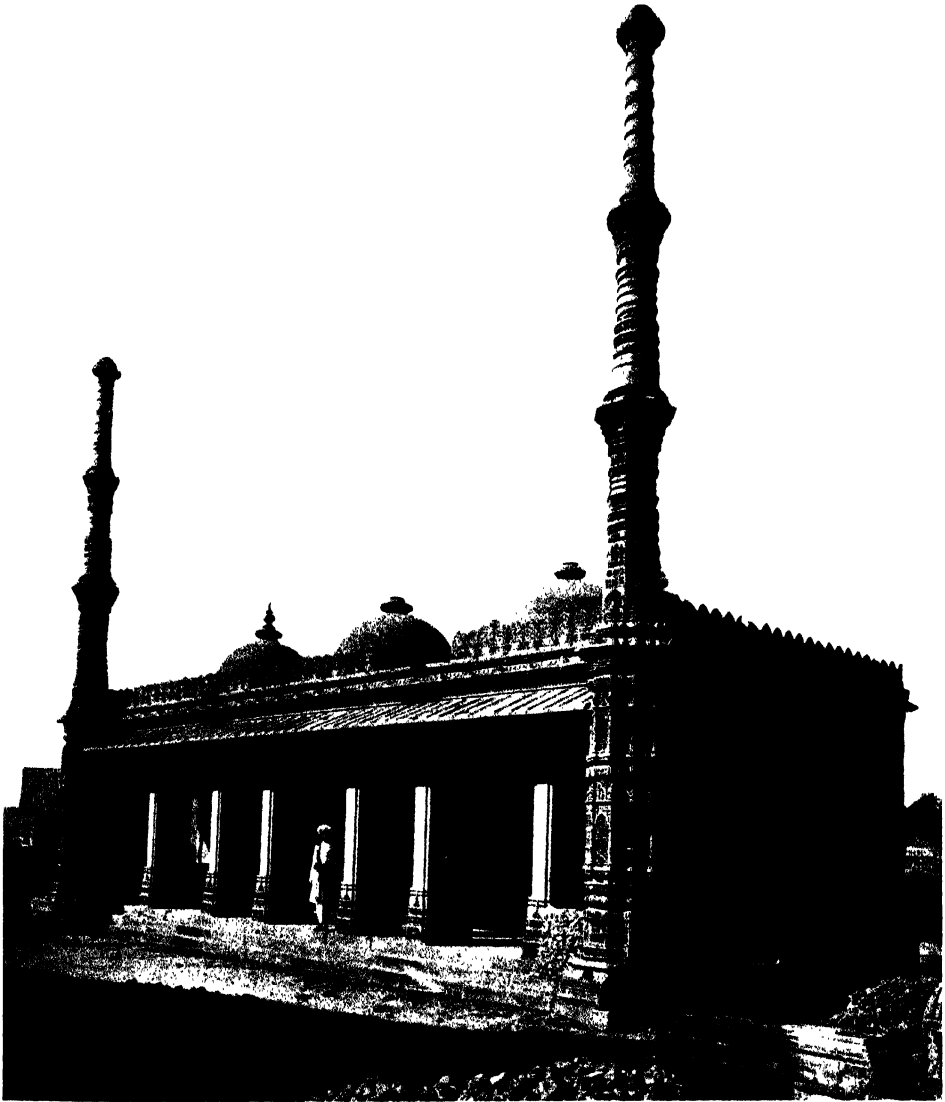

RĀNĪ SĪPARĪ'S MOSQUE, AHMADĀBĀD





the heir-apparent, who was put to death by the Sultan's order for misbehaviour. "He had got into someone's house, *who found him there and thrashed him.*" The report of the prince's disgrace reached the Sultan's ear, who ordered that poison should be put in his wine.<sup>1</sup> Apparently it was not until after the Sultan's death that the unhappy mother was allowed to consecrate her grief for the loss of her son by building the mosque and tomb.

The mosque is of small size, the *lîwân* measuring only 48 feet by 19½ feet, but it is interesting architecturally as being one of the later Gujerat mosques which dispense with arched construction entirely, and revert to the pure Hindu tradition of building. In this respect it is a contrast to the contemporary mosque of Sidi Sayyid just described. Dr. Burgess has observed that, the tomb and mosque being planned and built together, they show the proper co-ordination of the structural arrangements of the two buildings according to the Indian tradition; that is, the spacing between the pillars of the tomb and its outer screen-wall are controlled by the arrangement of the pillars of the mosque. The mosque is praised by Fergusson as being "the most exquisite gem of Ahmadâbâd, both in plan and detail." He admired particularly the minarets, as being more beautiful than those of Muhafîz Khan's mosque, and as "surpassing in beauty of outline and richness of detail those of Cairo." For such comparison it would be wiser to take the minarets of the two Champanîr mosques, which in structural design are much better. The minarets of Rânî Sîparî's mosque are structurally the least satisfactory part of the building, the excessive thinness of the upper part giving them an unpleasant appearance of instability—a grave architectural error. The mosque is

<sup>1</sup> Bayley's "Gujerat," p. 239.

very skilfully planned, and the detail deserves all Fergusson's commendation ; but on the whole the architectural *ensemble* of the tomb is better than that of the mosque.

Mosques, tombs, and palaces are by no means the only architectural monuments of the sixteenth century in India. Domestic architecture would demand a separate volume ; the Muhammadan sovereigns of the time rivalled the fame of their Hindu predecessors for military works and for magnificent irrigation works, bathing-places, and public wells, with spacious subterranean chambers which provided a cool retreat in the hot season.

Gujerat is specially famous for its public wells, many of them being built at the expense of pious Hindus and dedicated to the public service. One of the finest is that known as Dādā Harir's Wāv, at Asârwâ, near Ahmadâbâd, which, according to a Sanskrit inscription placed in one of the galleries, was constructed in the first year of the sixteenth century by Bâi Srî Harîra, one of the ladies of the Mahmûd Shah Begarah's court. It is designed strictly on the lines of the older Hindu step-wells, which supplied water both for irrigation and for domestic use. It was originally surrounded by a public orchard, irrigated from the well by the help of bullocks. The well supplied a reservoir connected with it, from which water-pots for drinking and domestic purposes can be filled. A fine domed pavilion covers the approach to the shaft of the reservoir, the descent to which is made by flights of steps, 18½ feet in width, connected with a series of pillared platforms, the roofs of which serve to strengthen the stone-faced sides of the excavation. The central shaft of the reservoir, which is 24 feet square, has two spiral staircases on the sides of it, to make access easier. Here there are four tiers of pillared galleries supporting the sides of the shaft, and providing cool





PLATE LXI

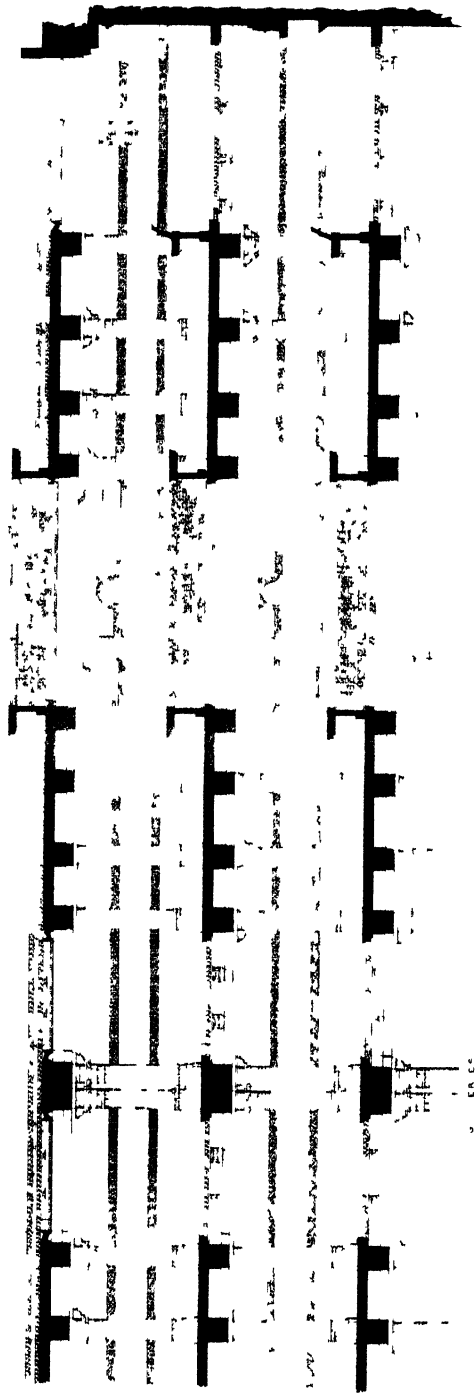

SECTION FIVE

DADA HARIS WELLS

DADA HARIS WELLS, NEAR AHMADABAD PART SECTION

(Drawn to the scale of 1/4 inch = 1 foot)



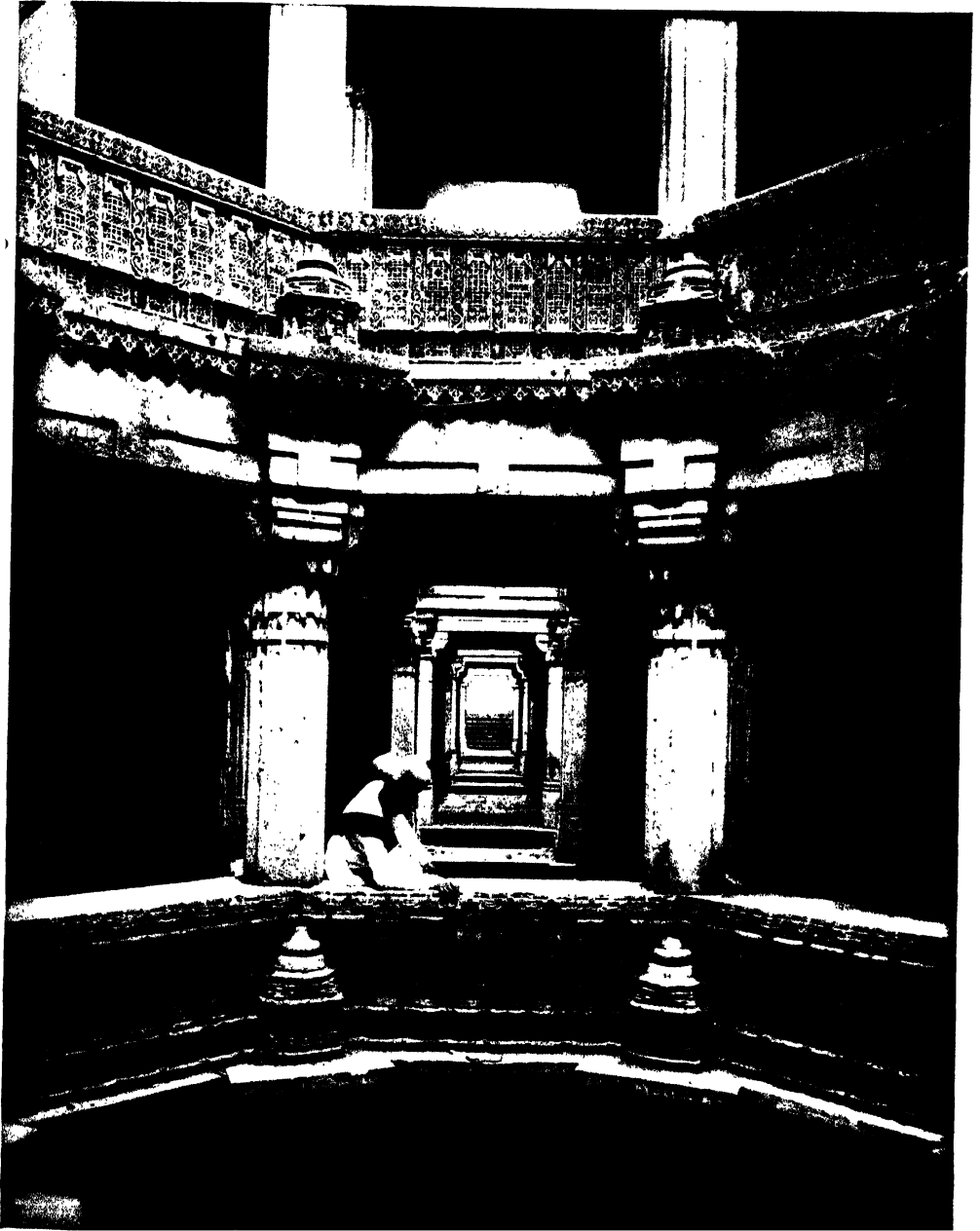

DĀDĀ HARIR'S WELL, NEAR AHMADĀBĀD : CENTRAL SHAFT





resting-places for the people using the well. The water, says Dr. Burgess, is usually high up in the third gallery, the fourth being always submerged. "After the third gallery is reached and the depth exceeds 30 feet, the side walls require more support, and the builders, well aware of this, divided the next opening, over the stair leading down from the third gallery, into two, by lintels 4 feet broad in each storey, supported by two pairs of coupled shafts; and again, after another roof of about 19 feet in length, standing on eight pillars, a second shaft follows, similarly divided by lintels in each storey. By this structural arrangement the side thrusts of the walls were effectively met and overcome."<sup>1</sup>

The plan and sections drawn by Mr. Cousens (Pl. LX-LXI) will give some idea of the fine design of these pillared platforms and galleries, as truly "classic" in feeling as the palaces of the Medici at Florence. The loving labour and skill lavished on the decoration of the parapet walls of the central galleries, only lacking the human interest of the best Hindu architectural sculpture, can be seen in the illustration (Plate LXII). One can easily realise that the builders of this well built it in exactly the same spirit as they built the noble transept of the Champanîr mosque. To the Indian craftsman the construction of a well was as much a religious work as the building of a mosque or temple. What a treasure-house of fine culture for the people who come daily to draw water from this well! What profanity and impertinence for Europeans to transport their modern secular vulgarity to India, under the pretence of teaching principles of design to a school of craftsmanship inheriting such traditions!

In a work of this kind, covering so wide a field, I cannot attempt to give any idea of the extraordinary fertility of

<sup>1</sup> "Archæological Survey of Western India," vol. viii. p. 5.

invention of Indian builders, both Hindu and Musulmân, in the fifteenth and sixteenth centuries. So far from following a strict architectural formulary, indigenous or foreign, it would seem as if the builders of every mosque and tomb were inspired by the ambition to use the old traditions for creating something new. The results were not, as might be expected, equally successful in every case ; but the new stimulus to creative effort led up to some of the noblest achievements in Indian architecture. It was just this relaxation of pedantic rules, allowing free play to the Indian craftsman's inventive genius, which accounts for the imaginative richness of Muhammadan architecture in India, shown not only in the creation within a few centuries of so many different local schools of architecture, but in the variety of types in each local style.

Until the seventeenth century there was no official architectural formulary, like our modern dilettante " style," imposed upon the Indian builders by the Muhammadan courts ; except, perhaps, in the reigns of Bâbar and Humâyûn, which were too brief and stormy to make any permanent impression upon the Indian craft tradition. Herein lies the whole secret of the great architectural achievements of the Muhammadan period. The spirit of Islâm was not in itself a great creative force in art, but it served practically to stir up the intellectual waters in India by giving to Indian craftsmen the finest creative opportunities.

It is important to bear in mind that though Gujerat in the fifteenth and early part of the sixteenth centuries was, owing to the ferment of the new structural ideas, the most important creative centre in India, it was architecturally only a province of Rajputana, and for a complete sketch of the history of the period it would be necessary to review all the magnificent buildings erected at Chitor and elsewhere by the

great champion of Hinduism, Kumbha Râna of Mewar (1418–68), and other Rajput chiefs, who resisted all the assaults of Islâm in that part of India until the middle of the sixteenth century, when they became Akbar's staunchest and most powerful allies. But even if the material for such a review were available, it would not throw more light upon the development of Indian architecture at this period than is given by the Hindu buildings of an earlier date illustrated in this volume, which were the original types from which both Hindu and Musulmân in the fifteenth and sixteenth centuries derived most of their structural and decorative ideas.

The temple of Ranpur, built by Kumbha Râna, which was the prototype of many of the Gujerat mosques, has been already referred to. The most remarkable of the Râna's buildings, however, was the splendid nine-storied tower at Chitor (Plate XXIII), raised to commemorate his victory over the Musulmân of Mâlhwâ in 1440 ; an almost unique monument of the genius of the Hindu master-builder, for the only one now existing comparable with it is a somewhat smaller but equally fine Tower of Victory of an earlier date, built by another Hindu rajah.<sup>1</sup> It stands upon a basement 47 feet square ; the total height is 122 feet ; and the greatest width of the tower at the base is 30 feet. It is a fine example of the skill with which the Hindu craftsman, in the great creative epochs of Indian art, could combine the most extraordinary richness of decoration with a wonderful largeness of architectural conception ; for though the whole surface of the tower above the basement is covered with the most elaborate sculpture, the various planes of plastic relief are most skilfully co-ordinated and kept in their right places by the bold design of the cornices, pilasters, and other details of the structural design. The

<sup>1</sup> See Fergusson, vol. ii. plate 295 (edit. 1910).

sculpture generally shows the decadence of the art which began to set in after the tenth century A.D., but as architecture the tower ranks among the finest of its class anywhere.

Another remarkable Hindu building of the early sixteenth century is the palace of Mân Singh of Gwalior (1486–1518)—a contemporary of Mahmûd Shah Begarah of Gujerat—though, unfortunately, it is one of those which has suffered most from subsequent maltreatment. It was added to by his successor, Vikrama Shâhi, in 1518, and both Jahângîr and Shah Jahân in the seventeenth century built palaces for themselves there. Pl. LXIII–LXV show part of the façade and two of the most interesting parts of the interior of Mân Singh's palace. Fergusson's comments on this building betray his characteristic error in dealing with the history of the Muhammadan period. "Among the apartments of the palace was one called the Bâradarî, supported on twelve columns, and 45 feet square, with a stone roof, which was one of the most beautiful apartments of its class anywhere to be found. It was, besides, singularly interesting from the expedients to which the Hindu architect was forced to resort to imitate the vaults of the Moslims. They had not then learned to copy them, as they did at the end of that century, at Brindâban and elsewhere, under the guidance of the tolerant Akbar."<sup>1</sup>

The reader will have already understood that from the time they entered India nearly all Muhammadan rulers, with the exception of Aurangzîb, were the patrons of Hindu master-builders, for the very practical reason that they had no better ones to employ. The knowledge gained by the Indian builder in the service of his Musulmân employer was not due to the guidance of Akbar or any other of his patrons, but to the exercise of his own intelligence.

<sup>1</sup> Vol. ii. p. 176 (edit. 1910).

PLATE LXIII

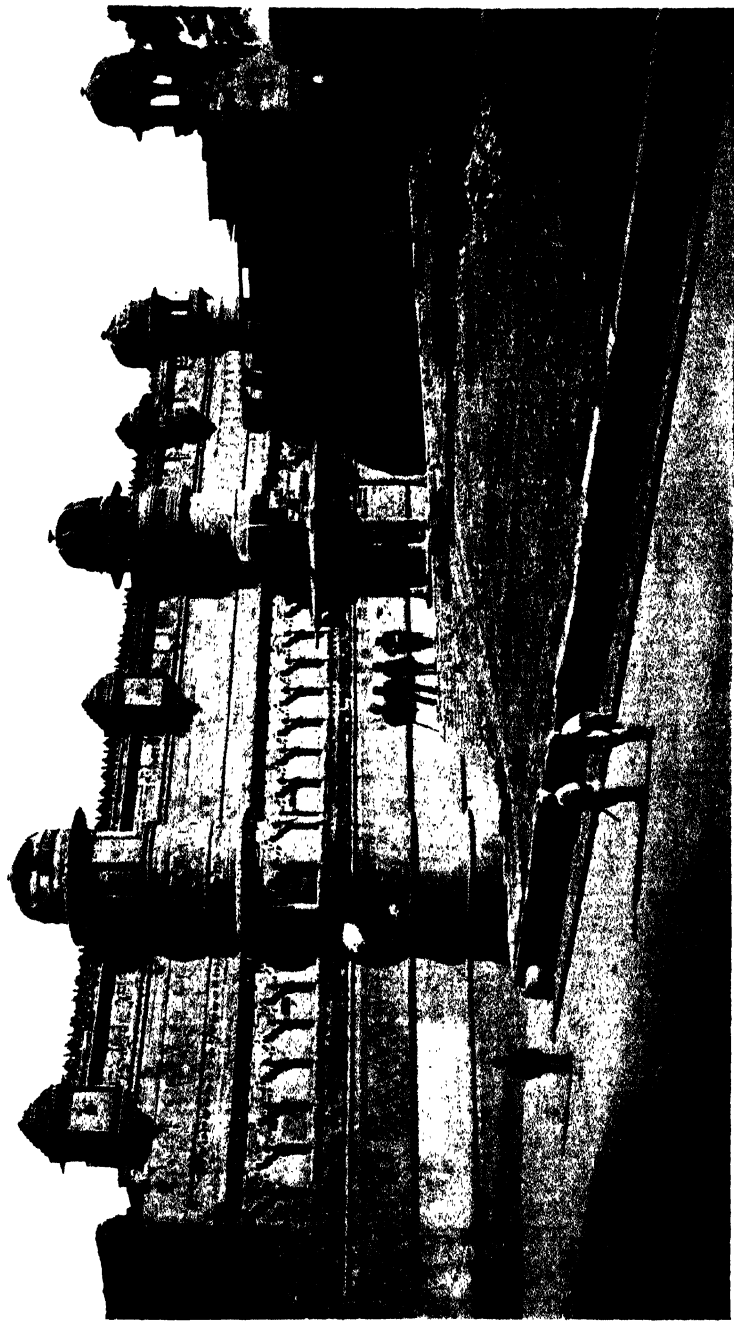

MAN SINGH'S PALACE, GWALIOR





COURTYARD OF MĀN SINGH'S PALACE, GWALIOR





PLATE LXV

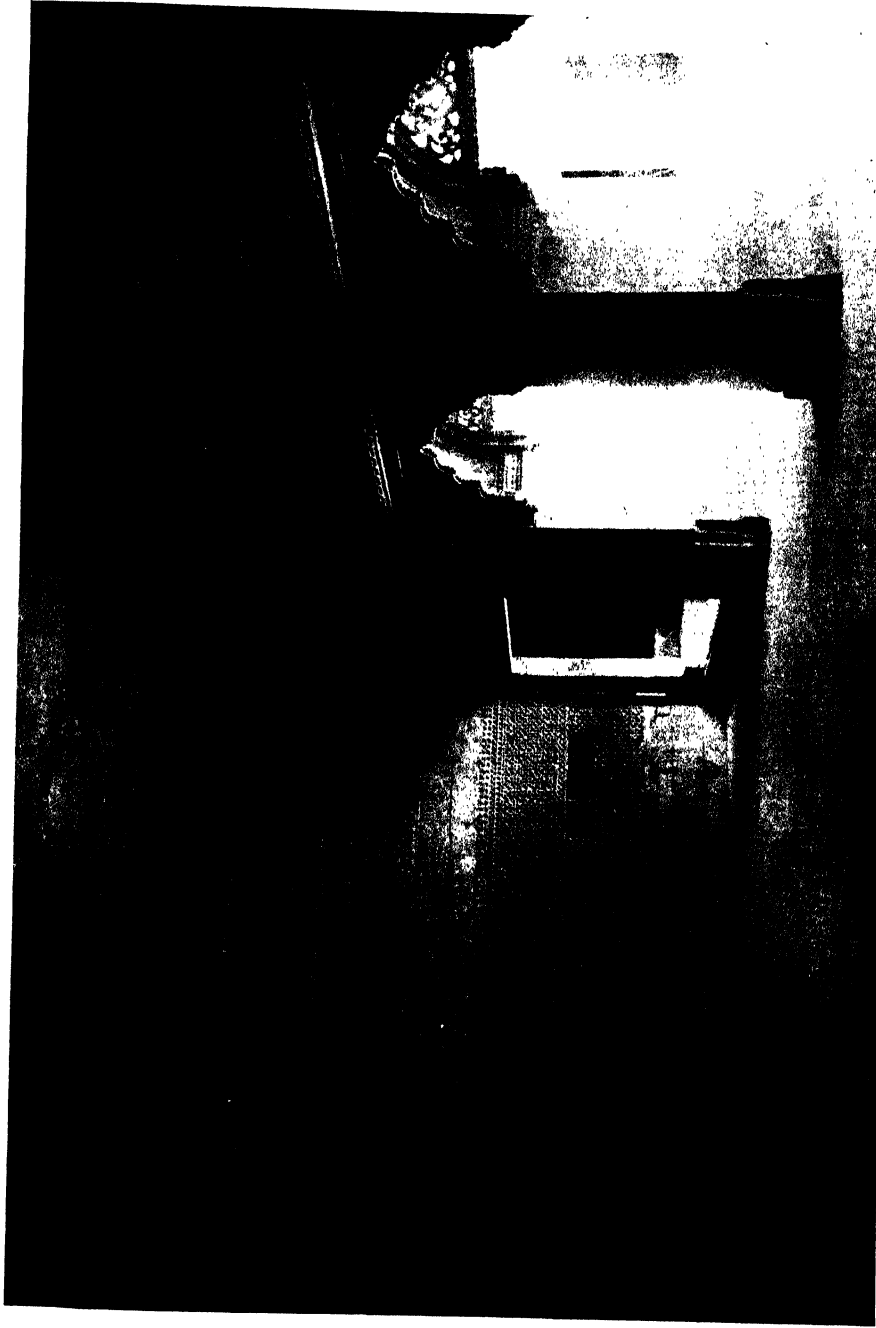

MÁN SINGH'S PALACE, GWALIOR : APARTMENT ADJOINING COURTYARD



## CHAPTER IX

### THE ADVENT OF THE MOGULS

#### SHÊR SHAH'S MOSQUE AND TOMB—HUMÂYÛN'S TOMB

A FEW years after Mân Singh of Gwalior completed his palace, yet another Musulmân invader, Bâbar, the illustrious founder of the Mogul dynasty in India, came to contest the sovereignty of Hindustan with the Afghan rulers of Delhi and Bengal. In 1526, on the field of Pânîpat with only 10,000 men, he defeated and slew Ibrâhîm Lodi ; the next year he overcame the Rajput Râna Sanga of Chitor, near Fatehpur-Sîkrî ; and in 1529 the Afghans in Bengal. But in 1531 the meteoric career of one of the most romantic figures in history was cut short by death.

Bâbar inherited the nature-loving traditions of his race : he was strongly imbued with the Persian culture of his time, which had borrowed much from China as well as from India and the West. His wine-bibbing habits were redeemed by a passionate *joie de vivre* and love of music and poetry. He was no philosopher, like his grandson Akbar ; the wisdom of India's sages had no attractions for him. In his delightful memoirs he expresses forcibly his contempt for all things Indian, and according to Montani, quoted by M. Saladin,<sup>1</sup> directly he had established himself at Agra, he went to Constantinople for several of the pupils of the celebrated architect Sinan, to superintend the building of the new city he laid out there. If this is true, the fact is interesting as being the first

<sup>1</sup> " Manuel de l'art Musulman," p. 509.

definite record of the importation of foreign architects by the Musulmân rulers of India. Architecturally it is of no importance and gives no support to Fergusson's theory of the foreign origin of the Mogul style, for the simple reason that there is no trace of any Byzantine influence in any of the Mogul buildings, or in any Indo-Muhammadan buildings before Bâbar's time.

If Sinan's pupils did come to Agra, the new methods of building they introduced seem to have been no more successful than those of the modern Western teacher, for of all Bâbar's buildings only two now exist, and these are quite insignificant : whereas many of the great Indo-Muhammadan monuments of a much earlier date, built without Western supervision, are still intact.

Objectively, it may be truly said that Bâbar left no impression whatever on the Indian building tradition ; yet as the beginning of a new epoch when the Persian fashions of the Mogul court were reflected in court architecture, Bâbar's reign is a landmark in Indian history.

The student of Indian art is, of course, aware that from time immemorial India had close commercial and political relations with Persia and Mesopotamia, that constant streams of immigrants had continually poured into Hindustan from these and adjacent countries, and that the arts of all of them had had their influence upon the art of India. But the Western observer is too ready to forget that India, even before the time of Buddha, had a civilisation which was peculiarly her own, and that the philosophy and religion contained in that civilisation had a potent influence not only in absorbing the artistic elements derived from the culture of other countries, but in re-shaping and transforming them according to her own ideals. The imported material enriched the stock of

Indian art and added to its strength, but did not create it or profoundly modify its ideals. We may agree that "English Gothic is only an offshoot from the parent stock of France,"<sup>1</sup> but we must never say that Indian sculpture is derived from Græco-Roman, Indian painting from Persian, or that Muhammadan art in India is "a form of the Arabic modified by local influences"<sup>2</sup>; for in India the local influences were the predominating creative forces. Persian art, derived originally from Mesopotamia, had an individuality of its own, but never strong enough at any time to overrule the artistic convictions of India. Asoka brought craftsmen from Persepolis to help his Indian builders, but while Indian art grew less Persian, Persian art became more Indian. Kanishka brought Græco-Roman craftsmen into India, but Buddhism transformed this Hellenic art and made it Indian. Bâbar, Humâyûn, and Akbar brought Arabian, Persian, and Chinese artists and craftsmen with them, but "Mogul" art in India, until Aurangzîb destroyed it, remained always Indian.

The Arabian and Persian influences in Mogul times undoubtedly did, to a certain extent, modify Indian architecture externally—in particular instances and within limited areas, which always seem larger than they really are, because they are areas which come most under British influence and within the cognisance of Anglo-Indian historians. Before the time of Bâbar, Persia had little influence on Indo-Muhammadan architecture. Few, if any, of the previous Musulmân rulers had had direct relations with Persia: Baghdad and Mecca were the spiritual centres for the Muhammadan world; and it was the Arabic calligraphist—not necessarily Arabian by birth—who had most influence upon the Indian craft tradition. But after Bâbar's time the Musulmân courts had many

<sup>1</sup> Lethaby, "Architecture," p. 211.

<sup>2</sup> *Ibid.* p. 163.

close family connections with Persia, and in the seventeenth century Persian fashions were as much in vogue with the Mogul aristocracy as Italian fashions were in France and in England.

In many respects the Persian influence in Indian architecture resembled that of the Italian Renaissance in the latter countries—it was “an art of scholars, courtiers, and the connoisseurship of middlemen.” It was not a strong national impulse from within, as the Renaissance was in Italy itself, but an affectation of the grand “style” of court ceremonial. Structurally, however, it had nothing like the same effect upon Indian building as the Renaissance fashions had upon the building craft of France and England: neither was the Persian tradition either structurally or decoratively so remote from the native tradition of India as Renaissance fashions were foreign to Western Europe. It was rather a return wave of the outflow of India’s own artistic culture which had been poured out over Central and Western Asia in the days of Buddhism, mingled with the other currents from China and from Europe which had joined each other there. ✓ Except upon certain branches of the sumptuary crafts, like fine weaving and decorative pottery, Persian influence upon Indian art in the Mogul times was more subjective than objective. Indian thought, under the domination of the intellectual Brahman priesthood, had lost much of the simple joy of living of the earlier Buddhist times. No doubt it derived much needed refreshment from the robust and healthy outlook of Bâbar’s hardy mountaineers—his “Mongol rascals” as he called them. Bâbar’s own keen artistic temperament, which was inherited by many of his descendants, showed itself in the intense delight he took in laying out his gardens, with their fountains and gurgling watercourses, their marble platforms and pavilions, their spreading plane-trees, stately cypresses and lovely

flowering trees and grassy slopes, where he and his boon companions revelled to their hearts' content, making merry with music and improvised Persian verses and with

The Grape that can with Logic absolute  
 The Two and Seventy jarring sects compute :  
 The Subtle Alchemist that in a trice  
 Life's leaden Metal into Gold transmute.

In his Kabul gardens, when the arghwan flowers began to blow, " the yellow arghwan mingling with the red," or when the pomegranates " hung red upon the trees," Bâbar could find no place in the world to compare with it.

The greatest contribution of the Moguls to Indian art was the spacious formal garden laid out by Persian or Central Asian gardeners,<sup>1</sup> which must have added a rare charm to the seventeenth- and eighteenth-century monuments and palaces, hardly to be realised now that the old art of the formal garden as a branch of architectural design is practically dead in India. The richness and beauty of Persian floral design in the decorative crafts was some compensation for the injury done to Indian art by the exclusion of human interest from its sculpture.

It was not, however, the love of nature or of art, but the doctrine of art for art's sake, which was new to India. The spirit of Indian poetry and painting for ages before the Muhammadan invasion breathed a love of flowers and trees and all animate things as passionate as Bâbar's or any Persian poet's. But to the Buddhist and Hindu artist and poet the beauty of

<sup>1</sup> The symbolism of the Persian and Central Asian gardens with their " four-fold field-plots," planned like miniature Indian villages, was no doubt a part of the old Indian Buddhist tradition ; but the Moguls made a fine art of the laying-out of the flower-beds, paved walks, sculptured stone water-channels, and fountains, co-ordinating them with the buildings into a great artistic unity, the scheme of which has been completely ignored in modern " restorations."



nature had something of greater significance hidden within it—the divine thought which created it. The realisation of this rather than the sensual enjoyment of beauty itself was the whole aim of their contemplation and artistic effort, as it has been in all the highest art.

Just as the Byzantine and Gothic craft tradition gave Renaissance architecture in Europe its pristine vigour and splendour, so Hindu art and craft gave Mogul architecture its vitality and strength, until the time of Aurangzîb. When the Court fashion detached itself from the native traditions of building, and architecture became not a question of sound craftsmanship and scientific structure but of puritanical prejudice and correctness of style, Mogul building became contemptible ; but Indian architecture survived, and the Indian builder continued down to the middle of the nineteenth century to construct buildings which, as Fergusson said, “ will bear comparison with the best erected in Europe in the Middle Ages.”<sup>1</sup> Like that of the Moguls, the fashionable architecture of Europe became for the most part contemptible when another formula, archæological rather than religious—the dogma of a correct classic taste—was imposed upon the Western builder. Nothing is more likely to restore its vitality, both in the West and East, than giving back to Indian builders those opportunities for experimenting with modern materials and adapting their traditions to modern requirements which have been taken from them by the present departmental system.

Since nothing of importance now remains of Bâbar's buildings, we must continue the review of sixteenth-century buildings with the mosque and tomb of Shêr Shah, an Afghan

<sup>1</sup> “ Indian Architecture,” vol. ii. p. 185 (edit. 1910).

noble who had submitted to Bâbar, but revolted against his weak son Humâyûn and drove him into exile in Persia. Shêr Shah ruled with great success at Agra from 1539 until his death in 1545. The mosque in the Purâna Kilâ at Delhi is said to have been built by him in 1541. When the façade of the *liwân* (Pl. LXVI) is compared with that of the *Jâmi' Masjid* at Champanîr the effect of Bâbar's and Humâyûn's Persian predilections upon the ideas of Indian builders can be clearly seen.

There is no trace of Persian craftsmanship, but the Indian builders had evidently been studying pictures by the Persian court painters and taken from them architectural suggestions which pleased them. For the first time in an Indian mosque the Persian recessed portal is used ; it is not a copy, but an Indian adaptation. The wall of the central bay of the *liwân* is reduced in height, so that the dome, as in the great mosque of Baghdad, becomes the important feature in the sky-line of the façade, instead of the minarets and the front wall of the building. The diminutive minarets which surround the base of the central dome are also a suggestion from Persian buildings, but the dome itself is an Indian one, surmounted by the Hindu *Mahâ-padma* and the water-pot. The difference between Persian and Indian craftsmanship can be seen in the fine masonry of the whole façade and its carefully studied proportions : the Perso-Saracenic builders were generally studiously careless with regard to proportions, for they aimed chiefly at the effect of colour produced by the casing of glazed terra-cotta or tiles with which the crude or half-baked bricks used for the core of their buildings were protected. The Indian builder used comparatively little colour, but relied upon beauty of line, fine masonry, and exquisite carving. On the whole, it cannot be said that Bâbar's Persian taste im-

proved the design of Indian buildings. The Jâmi' Masjid of Châmpaṇîr is certainly a greater architectural achievement than the semi-Persianised mosque of Shêr Shah. The interior of the latter building is as purely Hindu in design and craftsmanship as any of the mosques of Gujerat.

The tomb of Shêr Shah, which Fergusson, with his usual bewildering classification, labels as "late Pathân," separating it from the mosque, which he places under "early Mogul," is one of the most stately buildings in India, and important as being a half-way house between the Tâj Mahall built about a century later, and its early Buddhist prototypes.

Mr. Vincent Smith, following Fergusson's lead in attributing everything unusual in Indian architecture to a foreign source, classifies it as "Indo-Persian," and not only asserts that "both the octagonal form and the coloured glazed tiles were importations from Persia,"<sup>1</sup> but rashly suggests that the model of it was the early fourteenth-century Saracenic tomb at Sultanieh.<sup>2</sup> Seeing that the domes of Shêr Shah's tomb are purely Hindu in form and construction, and that nearly all Hindu domes are octagonal at the springing, it would be almost as justifiable to refer to the octagonal baptistery of San Giovanni at Florence as its prototype, and to classify it accordingly as "Indo-Italian." It is true that the *ground-plan* of the sanctuary of Muhammadan tombs, made

. <sup>1</sup> "History of Fine Art in India and Ceylon," p. 406. With regard to the tiles, Mr. Vincent Smith himself notices Mr. Marshall's account of the tile-work recently discovered at Kanishka's stûpa at Peshawar, which points to the existence of enamelled pottery as a localised industry in India as early as the second century A.D. He also admits that the process "might have been invented independently in India" and may have been known to the Hindus of Bengal before the Muhammadan conquest.

<sup>2</sup> Illustrated by M. Saladin, "Manuel de l'art Musulman," figs. 266 and 267.

PLATE LXVI



MOSQUE OF SHÉR SHAH, DELHI  
(From Fergusson's "History")



after the strict Indian tradition, was usually square, the square being changed into an octagon to form the base of the dome. It is true also that Perso-Saracenic tomb-builders of the fourteenth century generally made the plan of the sanctuary octagonal throughout ; but before we assume that Indian buildings of a later date are " Indo-Persian," it is necessary to be sure that the Persian buildings are not in some respects " Perso-Indian," *i.e.* derived from earlier Indian prototypes. It is, I think, quite certain that the Persian or Tartar " bulbous " dome derives from the Indian Buddhist domed canopy and shrine. The octagonal Mongolian tombs in Persia may also be derived, through Turkestan, from the early Buddhist prototypes of the octagonal towers in Bengali temples, and of the vimâna of Jugal Kishore's temple at Brindâban. Buddhist communities existed in Western Persia in the seventh century ; and probably the Mongolian invaders of the thirteenth century contributed Indian elements to the Persian building tradition which they had received through Turkestan. But, in any case, an Indian building should not be classed as " Indo-Persian " because Indian builders, in an age of constant experiment, made such a slight concession to the Persian fashions of their patrons as to convert a square plan into an octagon.

Shêr Shah's tomb is, in fact, less Persianised than the fifteenth-century octagonal tombs at Old Delhi described by Fergusson as " late Pathân."<sup>1</sup> The square form is here resumed in the outer enclosure. The usual grouping of the domes according to the Buddhist-Hindu tradition of the " five jewels " (*panch-ratna*) is slightly modified on account of the octagonal form of the sanctuary, *i.e.* the four minor domes are placed at the angles of the square enclosure, eight smaller

<sup>1</sup> " History of Indian Architecture," vol. ii. fig. 379 (edit. 1910).

cupolas being grouped round the central dome and similar ones are placed on the roof of the corridors which surround the sanctuary of the tomb. There is nothing analogous to this arrangement in any Persian tombs.

Both Fergusson and Mr. Vincent Smith mislead their readers by showing the absurd little kiosk, or cupola, placed on the top of the central dome. This was a grotesque modern restoration, very rightly removed by the Archæological Survey of India under Mr. Marshall's scholarly direction, and replaced by the original Buddhist-Hindu emblems by which all the smaller domes are surmounted. Almost the only Persian or quasi-Persian elements in the whole structure are the eight small finials on the parapets of the cupolas at the angles of the square enclosure. I have already explained that pointed arches are as much Indian as Saracenic: in the sixteenth century all builders in the north of India, both Hindu and Musulmân, used them.

Shêr Shah's tomb is as purely Indian in conception as any Buddhist or Hindu temple. It must not, however, be compared with either of them, but with similar buildings of its own class. It was a fortress-tomb, adapted in sentiment and structure for such a purpose by Indian builders. The term "Pathân" can only be applied to it as a dynastic distinction. As builders or designers the Pathâns had no more hand in it than the Goths had in the building of English Gothic cathedrals.

It is grandly situated in the middle of a large artificial lake, and in dimensions it is one of the most important buildings of its class in India. The terrace on which it is built, formerly connected with the mainland by a bridge, is about 300 feet square. The sanctuary is 135 feet in diameter on the ground, the diameter of the dome being 71 feet, or 13 feet more

PLATE LXVII

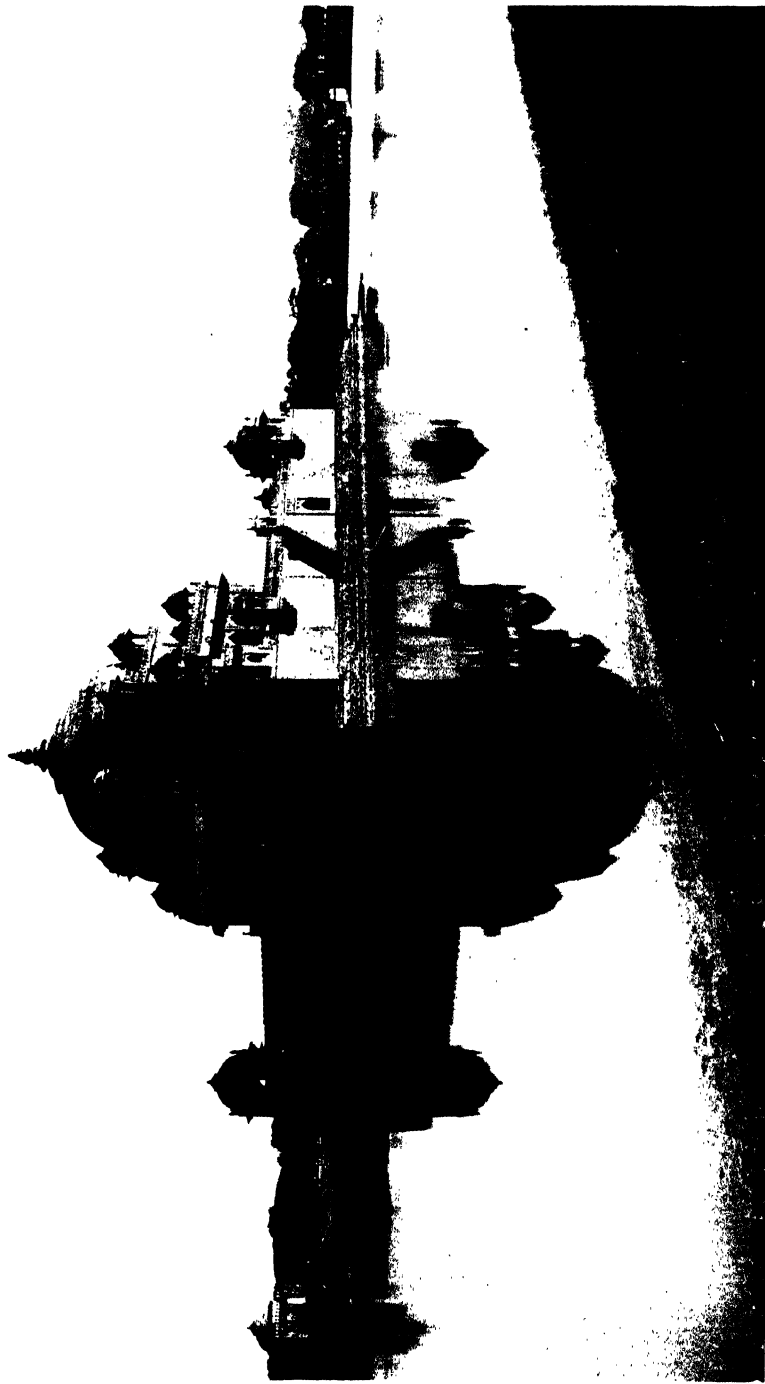

TOMB OF SHĒR SHAH, SAHSARÁM





than the dome of the Tâj. The corridors which surround the sanctuary have a width of 10 feet 2 inches.

The next in chronological order of the great Musulmân tombs of India is the mausoleum of Shêr Shah's Mogul antagonist, Humâyûn, who in 1555 wrested the throne of Delhi from Shêr Shah's son and successor, Sultan Islâm, with the help of a Persian army, but died the following year from the effects of a fall from the staircase of his palace.

The presence of this Persian army, with the Persian craftsmen who accompanied it, on Indian soil, was the determining factor in the design of Humâyûn's tomb, which is perhaps more Persian in character than any other important building in India, though it has an individuality of its own and is not a direct imitation of a Persian building. It might be described as a Persianised version of Shêr Shah's tomb. It stands in a walled enclosure, originally laid out as a formal garden in the usual Mogul style. Little is known of the character of Indian formal gardens before the time of the Moguls; but the innovation here seems to have been more the association of a garden with a tomb than the style of the garden itself. The mausoleum, like that of Shêr Shah, is raised on a large square terrace, 22 feet in height, surrounded by an arcade, Persian in design, but built of red sandstone with white marble inlay. There is little doubt that the masonry of the building was done by Indian craftsmen, and we have here one of the first indications of the development of the art of stone inlay which culminated nearly a century later in the exquisite decoration of the Tâj. All the arches of the tomb are Persian in form, without the characteristic lotus-bud enrichment of the soffits or the pîpal-leaf keystone which show the Hindu designer. At the same time the careful study of

proportion throughout the building shows the feeling of the Indian mason. The brick construction of the central dome, which has an outer casing of white marble, was probably the work of a Persian dome builder ; for this is one of the very rare instances in which the Hindu symbols are omitted from the finial of the dome. The metal kalasha is of the usual Saracenic form.

With all the Persian elements in the details the plan of the whole building is characteristically Indian ; the symbolism of the " five jewels " is here carried further than the roof—it is embodied in the whole structure, as it is in the Tâj. The mausoleum itself, an octagonal apartment 47 feet 4 inches in diameter, is surrounded by four other octagonal chapels 23 feet in diameter, the latter being surmounted by four cupolas which are crowned by the Hindu Mahâ-padma and the water-pot.

Humâyûn's tomb is an eclectic composition of the " grand style," or of what Professor Lethaby characterises as the " big-wiggy " school. It certainly cannot be cited to support Fergusson's theory that the greatness of Mogul architecture was due to foreign inspiration. Fergusson himself, while praising it as " a noble tomb," is constrained to admit that there is a certain coldness and poverty in the design. It has some of the characteristics of modern architectural eclecticism in Europe. In the effort to be " grand " its builders have left a painful impression of pomposity and self-consciousness. The qualities of massive strength and unaffected regal dignity which compel admiration in Shêr Shah's stately tomb at Sahsarâm are only seen in Indian monuments when the native master-builders were not under the control of Persian courtiers.

PLATE LXVIII

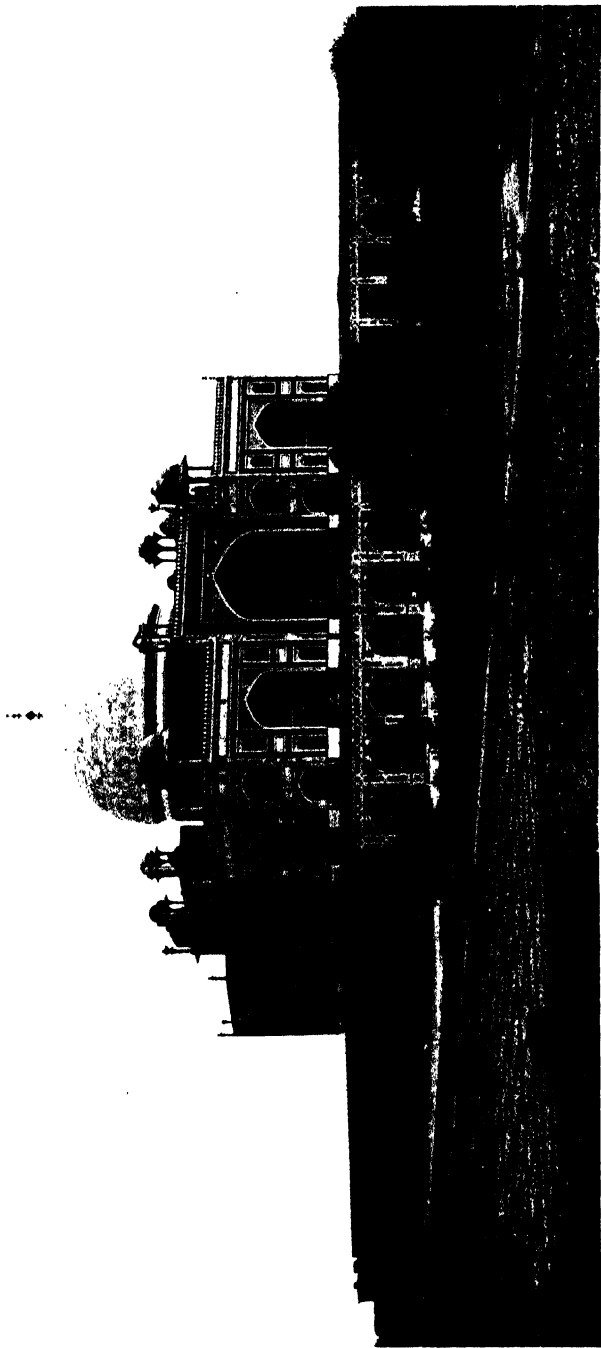

TOMB OF HUMAYŪN, DELHI



## CHAPTER X

### THE SIXTEENTH CENTURY

#### AKBAR—THE BUILDINGS AT FATEHPUR-SĪKRĪ—AKBAR'S PALACE AT AGRA

HUMÂYÛN'S tomb was an episode in Indian architectural history which, but for the great dimensions of the building and for its interest as one of the connecting-links in the evolution of the Tâj Mahall, might well be passed over. It left no more permanent impression upon Indian architecture as a whole than did the smaller Persianised tombs which are scattered over the North of India. The Indian master-builders naturally added the structural elements contained in all of them to their own stock-in-trade, but they did not during the rest of Akbar's long reign remain subject to the dictation of Persian court fashions.

The whole architecture of India in all its wonderful variety is more original and self-contained than any of the great Western schools, except Egyptian. The architecture of medieval Europe owed an immense debt to the Oriental tradition. English architecture was to a great extent created by the Gothic tradition. But there were no buildings placed on Indian soil which were so entirely foreign to India as Byzantine buildings were foreign to Italy, or as Gothic buildings were foreign to England. Under Akbar's beneficent rule Indian builders were free to build for their Mogul patrons, according to their own ideas, just as they had been under the Musulmân sovereigns of Bengal and Gujerat.

Humâyûn died in 1556, leaving to his son, a boy of thirteen, a legacy of difficulties even greater than those which he himself had inherited from Bâbar. But before he was thirty, Akbar (1556–1605) was undisputed master of an empire much greater than his grandfather's, and had done more to consolidate all the heterogeneous racial and religious components of Hindustan than any other ruler since the days of Asoka.

His greatest building activities began in 1569, when he laid the foundation of Fatehpur-Sikrî, near Agra, now a deserted city, but still a wonderful memorial of his genius as a statesman. There is, however, as little warrant for Ferguson's presumption that Akbar played the part of an amateur architect as for his theory that the style of the buildings of Shêr Shah and his Afghan predecessors had been "invented by the Pathâns." Abûl Fazl, Akbar's biographer, makes quite clear the personal predilections of his royal master. He was deeply interested in philosophy and religion, and, being illiterate himself, had books read to him every day. For the same reason he was especially fond of pictures, looking upon the art "as a means both of study and amusement." He personally supervised the work of the court painters every week. Abûl Fazl has much to say about calligraphists and painters, and gives a short biographical sketch of the most celebrated of them. But, whereas Shah Jahân's chroniclers record the names of all the chief builders of the Tâj, Abûl Fazl does not mention one of those who built Fatehpur-Sikrî and Akbar's palace at Agra. Neither does he give any hint that Akbar concerned himself intimately with the art of building. A few short paragraphs in the Âin-i-Akbârî refer to "the splendid edifices which His Majesty plans"; "the mighty fortresses which protect the timid, frighten the rebellious, and please the obedient." Also "the delightful villas and imposing

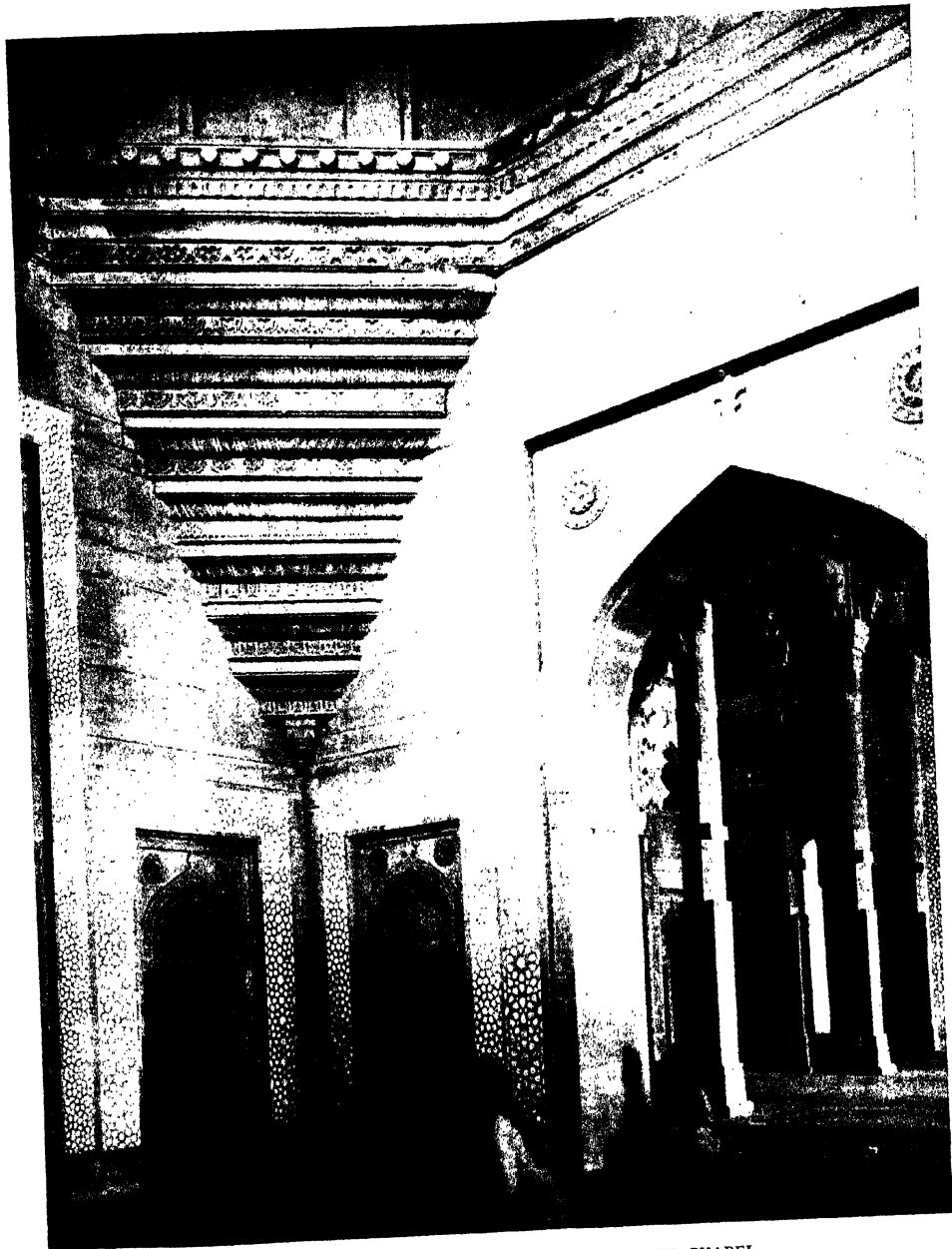

JĀMI' MASJID, FATEHPUR-SĪKRĪ: INTERIOR OF CHAPEL





towers, which afford excellent protection against cold and rain, provide for the comforts of the princesses of the Harem, and are conducive to that dignity which is so necessary for worldly power." Sarais were built for the comfort of travellers, and many tombs and wells dug "for the benefit of men and the improvement of the soil." Schools and places of worship were founded, "so that the triumphal arch of knowledge is newly adorned."

Akbar's personal interest in building was in its economic, not in its artistic, aspect. "His Majesty," says Abûl Fazl, "is a great friend of good order and propriety in business"; and just as he kept strict control over the pin-money of the ladies of the Imperial zanâna, so he regulated the price of building materials, the wages of craftsmen, and collected data for framing proper estimates. The minute particulars given under these heads in the *Âin-i-Akbârî*<sup>1</sup> are evidence of the efficient organisation of his Public Works administration and show what little justification there is for the popular belief that the Moguls were always extravagant builders.

Indirectly Akbar's influence upon the architecture of his time was very great; for whereas both his father and grandfather were Persian in their habits and tastes, Akbar was an Indian of the Indians, and disgusted his orthodox Musulmân courtiers by the enthusiasm with which he entered into the study of Hindu philosophy and religious teaching. He allied himself by marriage with the royal families of Rajputana. Many of his chief ministers and intimate friends were Hindus. There was consequently throughout Akbar's reign or during the last half of the sixteenth century a great reaction against

<sup>1</sup> See Blockmann's translation, vol. i. pp. 222-9. Sections 86 to 90 of the *Âin* fix the prices of building material, the wages of artisans, give data for building estimates, and particulars regarding the weight of different kinds of wood.

the tendency of the Mogul court to adopt purely Persian fashions in building. Akbar's palace at Agra and the buildings of Fatehpur-Sîkrî are essentially a new development of the same Buddhist-Hindu craft tradition which had created the architecture of the preceding Musulmân dynasties in India. The term Mogul as applied to them is useful for the purpose of classification, but it becomes very misleading if it lends itself to the assumption that the Moguls were the master-builders, or that Mogul genius was the creative force behind them. Akbar's buildings, strictly speaking, are Rajput rather than Mogul.

Naturally the fame of Akbar's court attracted to it master-craftsmen from all parts of his dominions, and even from outside ; but it is clear that Akbar, so far from showing a preference for foreigners, was a great admirer of Hindu art and craft. It is equally obvious that Akbar, like any other ruler of his stamp, consulted his master-builders and gave general directions for the arrangement and accommodation he required, but otherwise his interest in building was, as I have said, mostly shown in a careful control of the expenditure.

Fatehpur-Sîkrî, nevertheless, in its great mosque—which was also a university—its palaces, assembly-halls, and public offices, its schools and hospitals, baths, water-works, and its spacious caravanserais for travellers, most of which are still intact, bears witness to Akbar's splendid capacity as an organiser and ruler of men.

Town-planning, as Râm Râz has shown,<sup>1</sup> was a science

<sup>1</sup> Essay on the Architecture of the Hindus, pp. 41-7. Râm Râz describes eight different schemes of planning, which admitted of forty varieties, according to the size of the town or village. Those he gives are all oblong in shape, with two main streets, crossing the centre at right angles to each other, and parallel to two sides of the oblong, the longer street running generally from east to west and the shorter one north to south.

PLATE I.XX



JAMI' MASJID, FATEHPUR-SIKRI: FAÇADE OF IAWAN



recognised in the Hindu Silpa-sâstras for centuries before Musulmân rule in India ; and there are some indications that the Hindu canons were partially observed in the laying out of Fatehpur-Sîkrî. The city, which was an irregular oblong in shape, about six miles in circuit, lay open on the north-west to a large artificial lake, now dry, which mitigated the dust and stifling heat of an Indian summer and afforded all the amenities of a water-frontage. The other three sides were enclosed by fortified walls, which had nine gateways.

The great mosque, placed on high ground in the centre of the city, is oriented auspiciously like a Hindu temple, with the four walls facing the cardinal points and the entrance on the east. The palace buildings have the same aspect, and Akbar's throne in his private audience-chamber, the Dîwân-i-Khâs, was raised upon a single pillar in the centre of it, with a colossal bracketed capital, symbolising the throne of Vishnu, the Upholder of the Universe—the ideal Hindu ruler being regarded as Vishnu's Vicegerent on earth. The five-storied pavilion known as the Panch Mahall, adjoining the Mahall-i-Khâs, is planned after the monastic assembly-halls, or colleges of pre-Muhammadan times in India.

The buildings of Fatehpur-Sîkrî belong almost exclusively to the Buddhist-Hindu tradition ; the admixture of Persian and Arabian elements is much less than might have been expected from the precedent set by Akbar's father and grandfather. Generally speaking, these elements are confined to surface decoration, sculpture, and painting ; for many of Akbar's court painters belonged to the Persian school. But in the great mosque the Persian semi-domed portal is introduced both in the structure of the façade of the lîwân and in the gateways of the quadrangle. Indian builders had been made familiar with this form of construction by the building

## THE JĀMI' MASJID

of Shêr Shah's mosque and Humâyûn's tomb, so its appearance in later buildings is no proof that foreign craftsmen were still taking a part in the construction of them. Every living school of art and craft borrows freely from its neighbours when the opportunity offers, without servile archæological imitation.

The great mosque, from the pulpit of which Akbar pro-

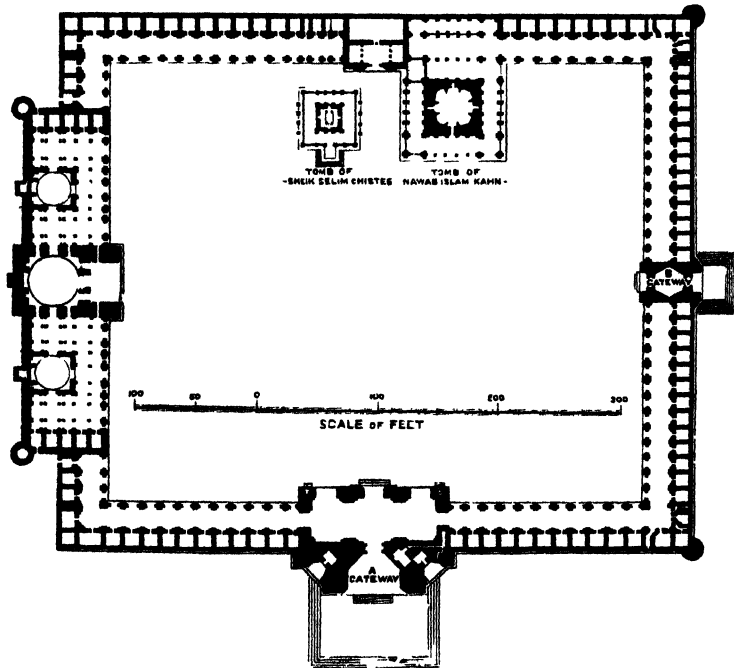
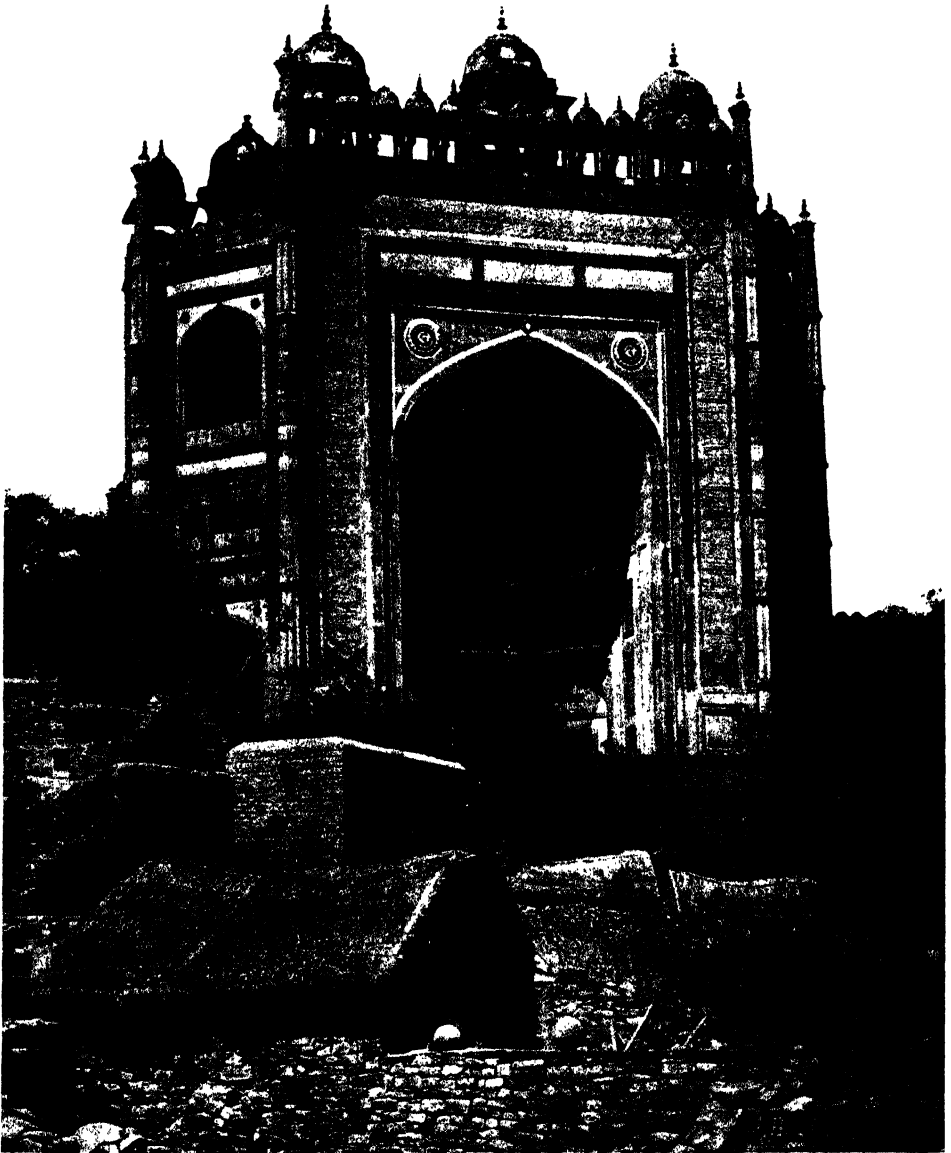

FIG. 38.—Plan of Jāmi' Masjid, Fatehpur-Sikri (from Fergusson's "History").

mulgated his doctrine of the "Divine Faith" in the endeavour to reconcile the conflicting creeds of all his subjects, is an interesting example of this. Looking at the plan of the lîwân (fig. 38), which is quite different from the other Indian mosques and obviously based upon a Persian or Arabian model, one might easily conclude that the building belonged to the Saracenic tradition. An inscription on the mosque itself to

PLATE LXXI



THE BULAND DARWĀZA, FATEHPUR-SĪKRĪ





the effect that " this is a duplicate of the Holy Place " (Mecca or Baghdad) would seem to make this a certainty. Yet in the structure itself the evidence of the Indian master-builders' handiwork and controlling mind gives overwhelming proof to the contrary. It is a purely Indian building, in spite of the eclecticism of its details. Probably one of Akbar's Persian painters drew a rough sketch of one of the famous mosques at Ispahan or Baghdad, and the Emperor showed it to his Indian master-builders and said, " Build me a mosque like this." The result was an entirely original Indian building, as original as it would have been had Akbar been Christian and commanded them to build him a cathedral like Canterbury or Notre Dame de Paris.

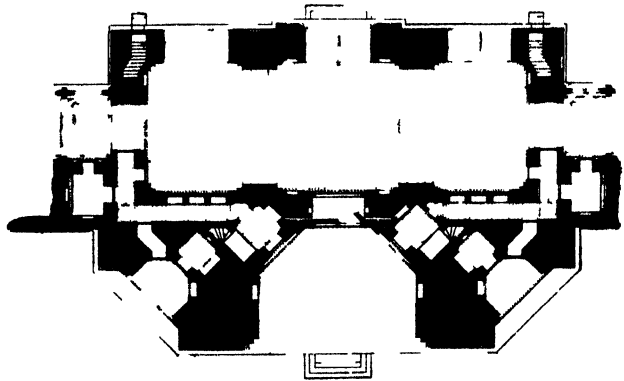

FIG. 39.—Plan of Buland Darwāza (drawn by the Archaeological Survey of India)

There is very little exact reproduction of Persian structural forms, as there is in Humâyûn's tomb, but only adaptation. The pillars and whole structure of the roof are strictly Hindu. In Humâyûn's tomb the dome is obviously Persian ; here the ribbed domes of the *liwân* are constructed on the same principle as the central dome of the Jâmi' Masjid at Champanîr. All the domes have Hindu pinnacles. There seems to be Persian handiwork in some of the decoration and minor structural details, but it is by no means better than the Indian work and not always in tune with it

The *liwân* measures 288 feet by 65 feet. The principal

chapel in the centre is covered by a dome, 41 feet in diameter, of the usual Indian form and construction, but stilted at the base in Arab fashion. The two side chapels have similar domes 25 feet in diameter. The rest of the *liwân* has a flat roof supported on pillars and brackets of pure Hindu design. The quadrangle measures 359 feet 10 inches from north to south, and 438 feet 9 inches from east to west. It contains the tomb of Shaikh Salîm Chishtî, the saint of Fatehpur-Sîkrî, who was Akbar's spiritual adviser ; it is built in white marble in a very ornate style. Adjacent to it is another mausoleum for his grandson, the Nawab Islâm Khan, who was made Governor of Bengal by Jahângîr, and his male descendants. A separate vault, called the *Zanâna Rauza*, was for the Shaikh's female relatives. These buildings, of course, do not belong to the original design of the mosque. The numerous chambers, usually about 10 feet square and covered by domes, which surround the open quadrangle were intended for the maulvis and their pupils. These, together with the noble cloisters in front of them, formed the University buildings of Fatehpur.

The *liwân*, though grandly planned and in some respects one of the finest in India, falls behind the great mosque at Champanîr in that perfect co-ordination between its structural and decorative elements, which, as Professor Lethaby justly observes, is necessary for a great school of architecture. The new elements of the style, brought in by Bâbar's and Humâyûn's Persian craftsmen and by Akbar's court painters, are not so perfectly blended with the old ones as they are at Champanîr. A great deal of the Persian decorative detail was added perfunctorily, so that Professor Lethaby's observations in some of the later Roman buildings might well be applied to it. " The elements of sculpture and painting were

PLATE LXXII



AKBAR'S OFFICE, FATEHPUR-SIKRI



merely formal, and in no way epic ; they were added to a building as adornments, and were not the very soul of its life. The times in history when building, sculpture, painting, and other arts have been perfectly co-ordinated into a higher unity have, indeed, been very few ; but if we are to distinguish between fine building and noble architecture this organic unity must be the test.”<sup>1</sup>

Later in Akbar's reign we shall find that the Indian master-craftsmen had made the Persian tradition their own, so that the structural and decorative elements were once more brought together into that higher unity. One of the most striking examples of this is the famous Buland Darwāza, or High Gate of the mosque, which has been recognised by all authorities as one of the great buildings of the world. An inscription on it shows that it was built towards the close of Akbar's reign to commemorate his conquests in the Dekhan. It will be seen from the plan (fig. 39) that it is a complete structure in itself, containing large halls and a number of smaller chambers, through which entrance is gained to the inner quadrangle of the mosque. It is raised on a platform 42 feet in height above the road ; across the main front it measures 130 feet. From the pavement in front of the entrance to the top of the finials surmounting the gate the height is 134 feet.

Like most of the other buildings at Fatehpur-Sîkrî it is built of red sandstone, and as there is no painted decoration on it, but only carving and discreet inlaying of white marble, we may conclude that the design of the whole structure and the decoration of it was in the hands of Akbar's Indian master-builders.<sup>2</sup> The character of the design supports this

<sup>1</sup> “ Medieval Art,” pp. 12-13.

<sup>2</sup> The Arabic inscriptions would be drawn by expert Muhammadan calligraphists and carved by Indian masons.

conclusion. It is Persian in general form, but the architectural treatment of it is unlike any Persian building and distinctively Indian ; though it may be observed that Persian pendentives with intersecting arches are used in the semi-dome. I have already explained how ingeniously the Indian buildings afterwards combined this structural principle with their own methods in the wonderful domes of Bijâpûr.

Persian builders had seized upon this structural use of the mihrâb not so much for its architectural effect as for the splendid glow of iridescent colour which the reflections of its concave surface gave to their encaustic decoration. It was left to the Indian master-builders to show its architectural possibilities in fine masonry. The fact that Persian motifs are freely used in the carving is no evidence of Persian craftsmanship. It will be remembered that the exquisite floral inlaid decoration of the Tâj, which seems to be purely Persian, was Hindu work. In carpet weaving and other textiles, in painting and in pottery, the Moguls indented largely upon Persia ; but masonry was not a Persian craft, and in all Indian buildings stone construction and decoration, whether it be carving or inlay, almost invariably connote Indian design and craftsmanship.

The most characteristic of the Fatehpur buildings, apart from the mosque, are not generally imposing in size, but are wonderfully interesting as types of the public offices and domestic buildings of the period. These include Akbar's office (Pl. LXXII), and the Dîwân-i-Khâs with Akbar's throne, which has been already mentioned. The former, if it had been built in Europe, would have ranked as a fine example of " classic " taste ; the latter would be admired as an excellent specimen of the Renaissance style. Both are of Hindu design and construction, with the admixture of Saracenic decorative details which the Court fashions of the time dictated ; just as

PLATE LXXIII

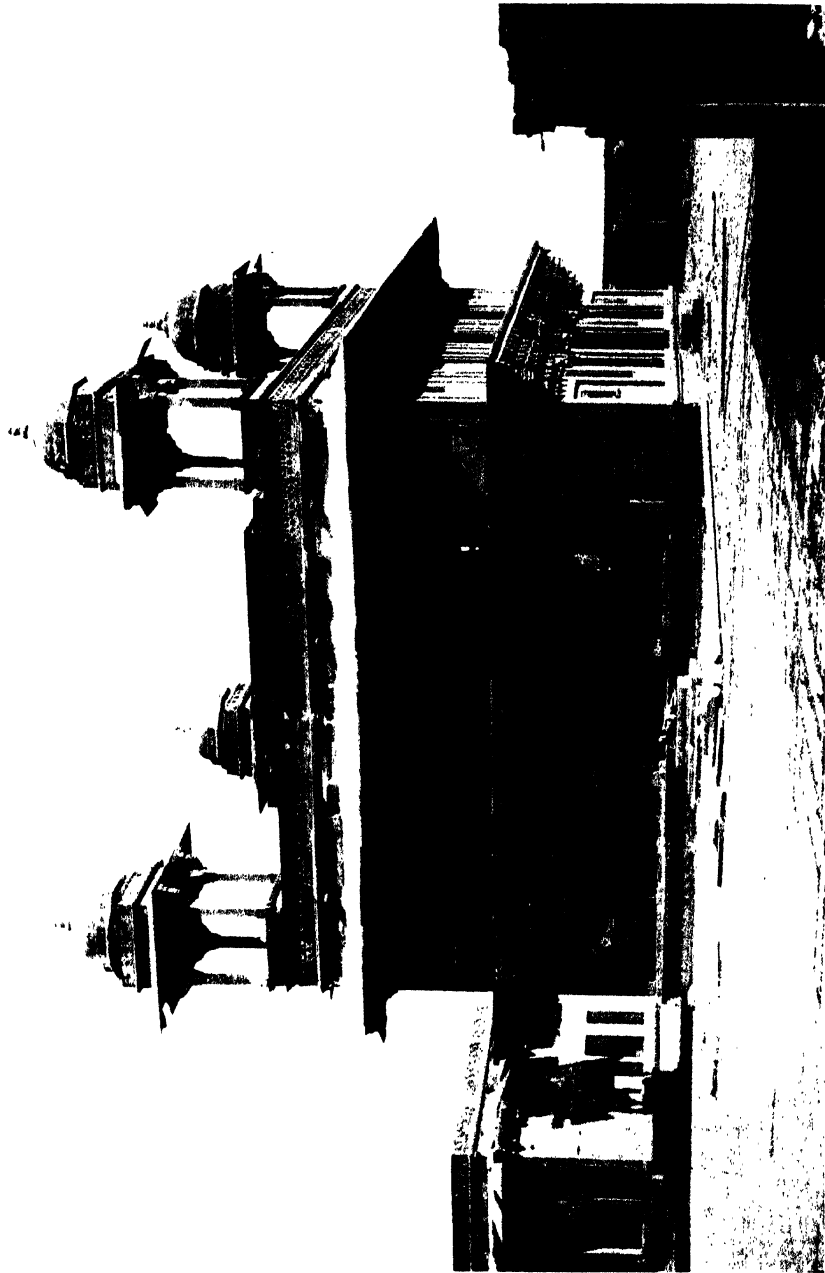

DIWÂN-I-KHÁS, FATEHPUR-SIKRÍ





PLATE LXXIV



*Photo by]*

PILLAR SUPPORTING AKBAR'S THRONE, FATEHPUR-SIKRI

*[Johnston & Hoffmann*



the Hindu craftsman now borrows freely from European trade catalogues to please Anglicised Indians.

The Dîwân-i-Khâs is a square building, about 43 feet on the outside, containing a single vaulted chamber, 28 feet

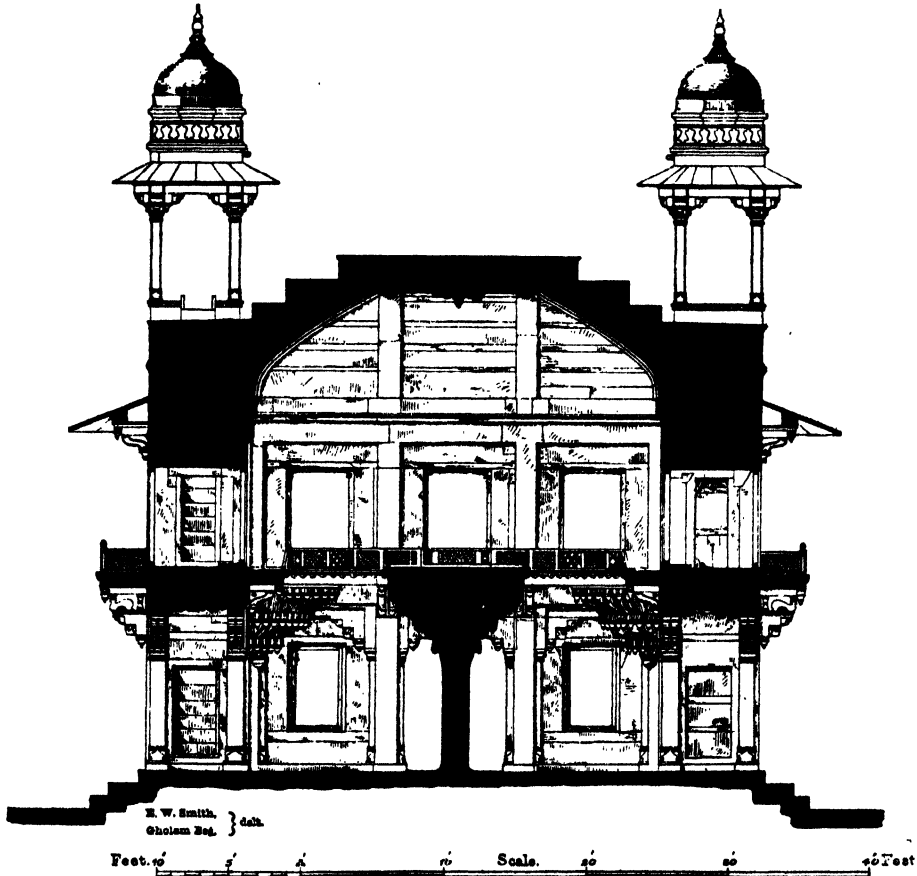

FIG. 40.—Section of the Dîwân-i-Khâs, Fatehpur-Sikri (drawn by the Archæological Survey of India).

8 inches square, in the centre of which is Vishnu's symbolic Pillar or Tree of the Universe, on the top of which Akbar sat enthroned. Surrounding this chamber are corridors containing the staircases which lead to the galleries above ; the

latter run round the building at the height of the top of the pillar, which is connected with them by passages along the diagonals. The vaulted roof, constructed with stone ribs—the interspaces being filled with slabs of stone—took the place of the customary dome so as to provide for a terraced promenade over it. According to the strict Hindu tradition, the roof should have had its “five-jewel” domes; the absence of the central dome in this instance makes the four kiosks at

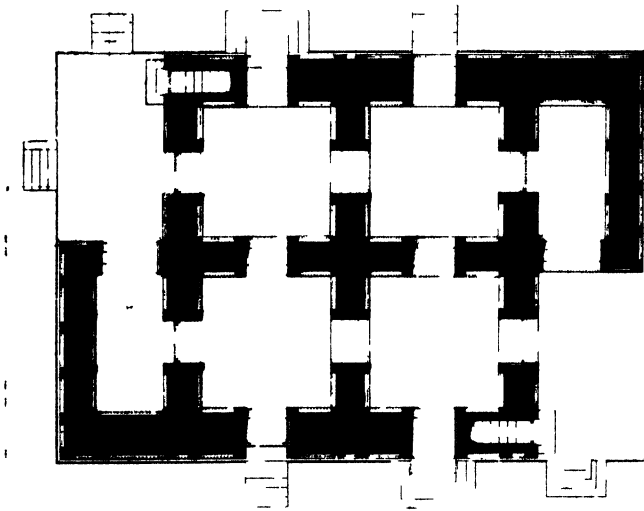
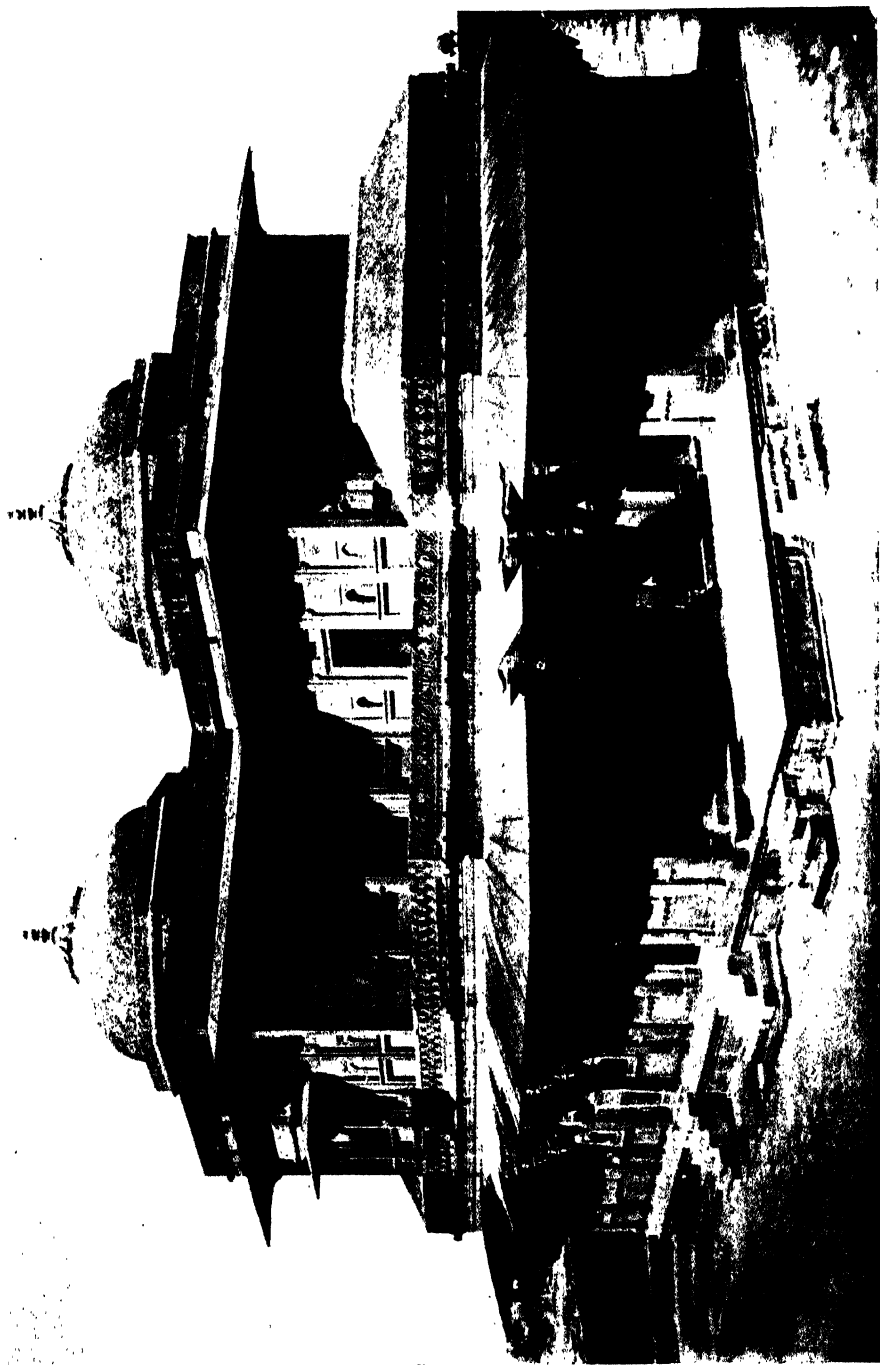

FIG. 41 —Ground Plan of Rajah Bīrbal's House

the corners seem too large for the building. But, in domestic architecture especially, when there is a living building tradition, practical requirements always overrule purely academic considerations. The builders of Akbar's audience-halls and royal villas, though they adopted many structural forms which were used in temples and mosques, made no attempt to work strictly according to “style” and hence were not troubled by those archæological qualms which afflict the modern dilettante and paper architect so grievously.



RAJAH BIRBAL'S HOUSE, FATEHPUR-SIKRI



PLATE LXXXVI



ENTRANCE TO JODH BAI'S PALACE, FATEHPUR-SIKRI





The leading characteristics of the " style " of these buildings—the planning ; the wide projecting dripstones and their supporting brackets, for shade and protection from rain ; the double roofs, domed or vaulted for coolness—are all dictated by considerations of comfort and convenience rather than imitation of other buildings. Centuries of honest building had created a tradition which produced good architectural design without any conscious effort.

The building known as Rajah Bîrbal's house (Pl. LXXV), within the precincts of the imperial zanâna, was probably occupied by one of Akbar's sultânas. It was built in 1572, three years after the commencement of the city. It is a two-storied building raised on a plinth, with entrance porches in the north and south which have double-vaulted roofs ; small steep staircases to the first floor are contained in the thickness of the outer walls. The ground-floor contains a suite of four rooms, each 16 feet 10 inches square ; the walls being treated in a similar way to the exterior with stone pilasters, dados, and arched niches, but very richly carved. These rooms are ceiled with flat slabs of stone extending from wall to wall in single pieces, laid on a carved cornice and supported by carved brackets. The first floor contains two rooms of similar size, opening on to two terraces which were originally enclosed by stone screens. These rooms are covered by double domes of the usual Hindu type built with stone ribs.

The palace of Fatehpur known as Jodh Bâi's Mahall—probably occupied by Akbar's Rajput wife, Mariam Zamânî, the mother of Jahângîr—is a stately building of much larger size. In its classic simplicity it presents a great contrast to the exuberant richness of the other sultânas' residences, and because it was built for a Rajput princess the decoration does not show so much partiality for Persian and Arabian motifs.



PLATE LXXXVII



PANCH MAHALL, FATEHPUR-SIKRI



PLATE LXXVIII

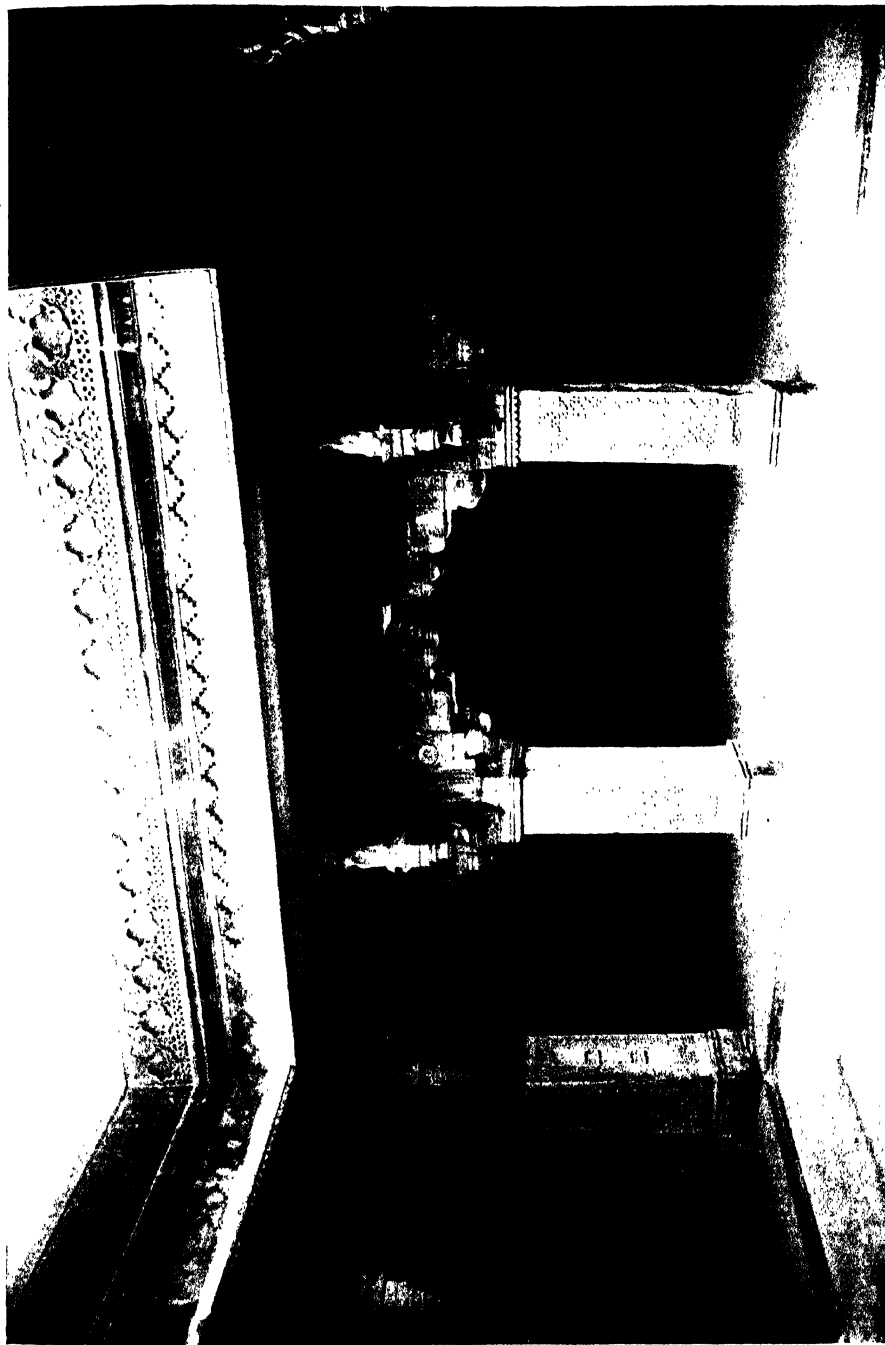

THE JAHANGIRI MAHALL: CORNER OF COURTYARD



after the old Indian assembly-halls frequently alluded to in Buddhist literature, an example of which exists within the fort at Bijâpûr.<sup>1</sup> Pl. LXXVII, which shows a corner of the first floor, will give some idea of the dignified design of this pavilion. The pillars of each story conform to a general scheme, but instead of the dry uniformity of a Greek or Roman "order" every one is varied in the ornament of its cap and base, as well as in its mouldings or other enrichments, so that the eye finds infinite variety of interest in observing the details without any disturbance of the general effect of classic dignity and repose. To realise the inexhaustible invention of the Indian craftsman the reader must consult Edmund Smith's monumental work on Fatehpur-Sîkrî, in which full details of the Panch Mahall and other buildings are given.

From 1585 to 1598 Akbar removed his court to Lahore, and in the latter part of his reign to Agra. The fort at Agra, which is a fine example of his military works, had been commenced in 1566 on the site of an older one built by Salîm Shah, the son of Shêr Shah. The part of the palace inside the fort known as the Jahângîrî Mahall was no doubt commenced by Akbar, though it was probably completed by his son and successor, after whom it was named. The Persianised exterior is uninteresting—another illustration of the fact that, on the whole, Persian influence was an element of weakness in Mogul architecture, and not, as is generally assumed, the source of its creative energy. The interior, which is for the most part purely Rajput, or Hindu, exhibits all the virile imagination and constructive skill of the Indian builder.

The principal apartments are ranged round a quadrangle, 71 feet by 72 feet, which is one of the finest architectural works of Akbar's time. Pl. LXXVIII shows a corner of it after the

<sup>1</sup> See Plate III, "Bijâpûr," by Fergusson and Meadows Taylor, 1866.



very careful restoration carried out by the Archæological Survey in Lord Curzon's Viceroyalty. It is only in India, where a living craft tradition exists, that any restoration of this kind can be safely carried out, for the craftsmen employed were probably descendants of those who built the palace.

In Pl. LXXIX, which shows the ruinous state of the building before restoration, the details of the construction can be better understood. It will be noticed that the small pointed arches under the cornice are constructed in Hindu fashion in single blocks of stone, like woodwork, without voussoirs or keystones. Immediately under these arches the brick core of the main walls of the building can be seen exposed in place where the stone facing has worn away.<sup>1</sup> The dripstone which the massive brackets were intended to support has entirely gone.

There is an outer courtyard on the river side of the palace in which Persian structural details are used freely, but the design of it, like that of the exterior of the palace, is tame and uninteresting. The construction of the massive stone ceiling of one of the principal apartments is shown in Pl. LXXX. It is sometimes assumed by European critics who do not understand Indian conditions, that Indian craftsmen in using stone in this manner were blindly imitating wooden construction, not having sufficient intelligence to adapt their methods to the materials they used. This is an entire misapprehension of the case. Indian builders appreciated quite as well as their craft brethren in Europe the character of the materials they were working with. Methods of lithic construction in Europe have been determined by the difficulty of obtaining good building stone of large dimensions and in sufficient quantities

<sup>1</sup> The architect will, of course, understand that, in India as in Europe, most of the buildings popularly described as of stone or marble have a core of brickwork or concrete.

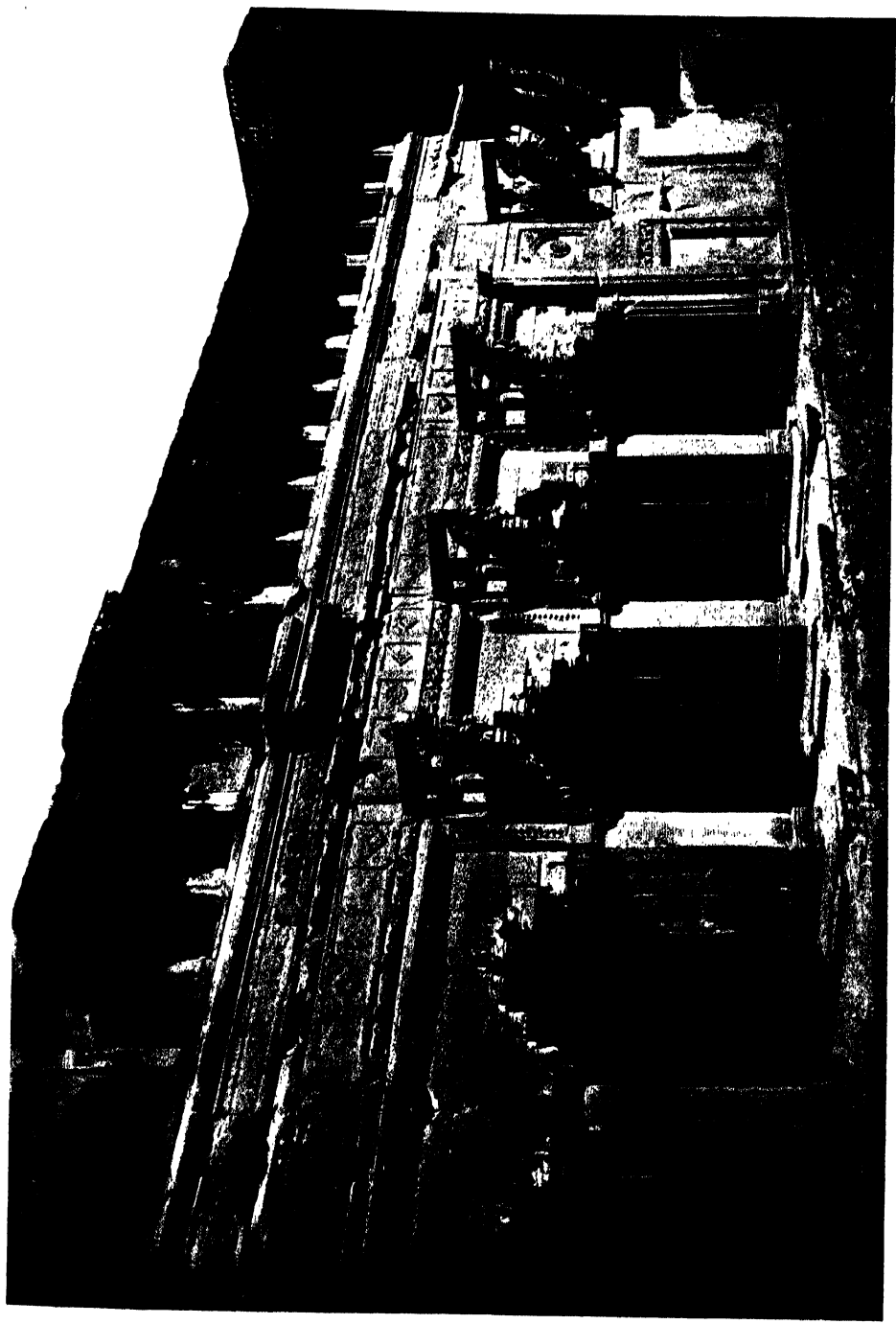
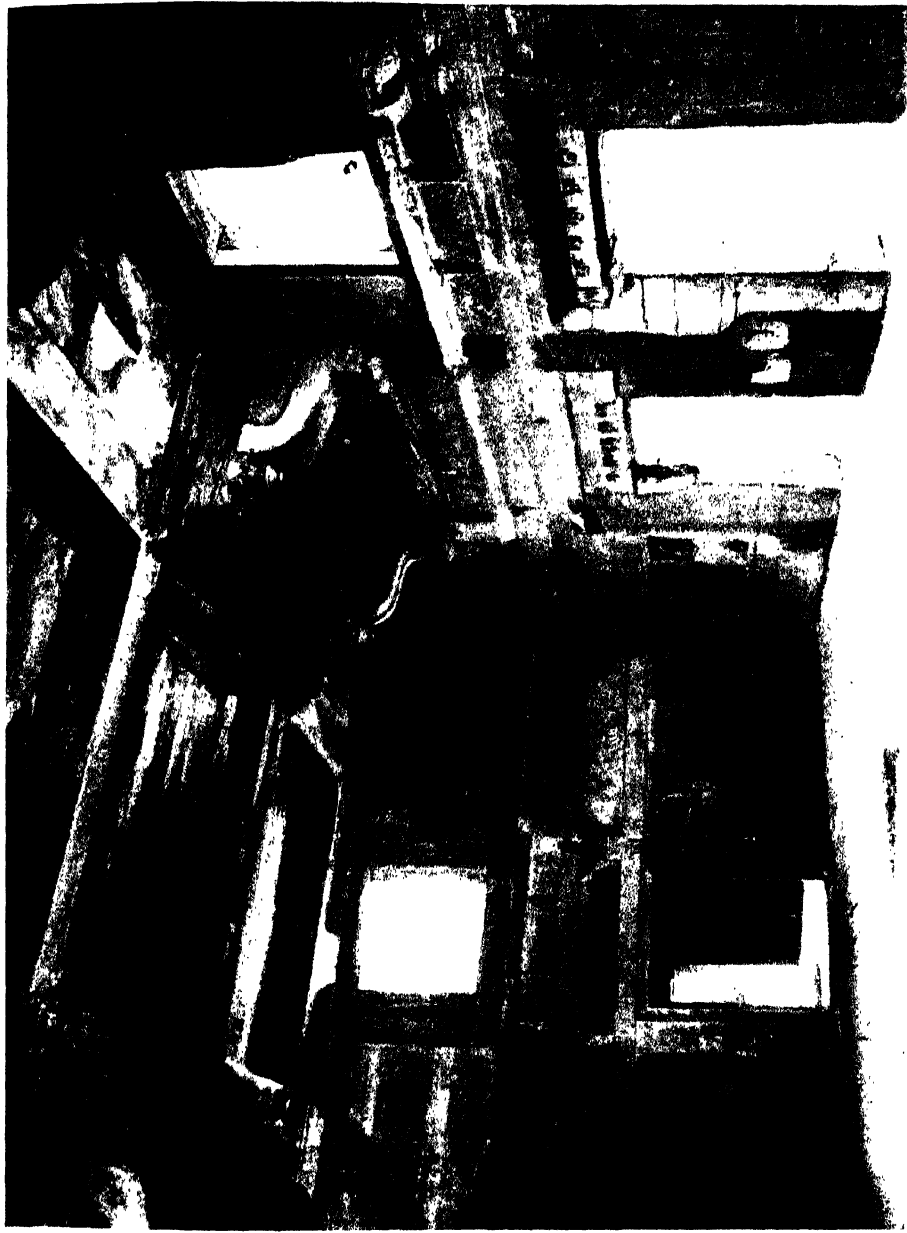



PLATE LXXX



APARTMENT IN THE JAHANGIRI MAHALI, AGRA



near the sites of buildings. The buildings of Fatehpur-Sîkrî, Agra, and many other places in Northern India were close to quarries of sandstone which provided building stone, in unlimited quantities and of almost any dimension, of such fine quality that it could be worked almost as easily as wood. Under such conditions no intelligent craftsman would limit himself to methods of construction which prevail in other places where good building stone is scarce.

The methods which are called lithic in Europe are, in fact, used by Indian builders where conditions analogous to those of Europe obtain. It has been a fatal mistake of the Anglo-Indian architect to impose upon the Indian builder uniform pseudo-scientific methods of construction derived from his own narrow experience, quite regardless of local circumstances which have governed the craft traditions of India.

The last important building in which Akbar was personally concerned was his own tomb at Sikandara, near Agra, which was commenced by himself and completed by his son Jahângîr in 1613. As Fergusson has pointed out, it was, like the Panch Mahall at Fatehpur-Sîkrî, designed after the model of a Buddhist-Hindu many-storied *vihâra*, or monastery, but the traditional domed canopy on the top story was either omitted by Jahângîr,<sup>1</sup> who was not pleased with the original design, or it has fallen into ruin. Though the absence of the dome gives to the whole pyramidal structure a curious truncated appearance, Akbar's tomb is a worthy monument of one of the greatest of Indian rulers.

<sup>1</sup> Compare the omission of the central dome on the Dîwân-i-Khâs at Fatehpur already noticed, p. 176. Mr. Vincent Smith's idea ("History of Fine Art in India and Ceylon," p. 411) that the design was suggested by craftsmen from Cambodia seems to me very far-fetched. There is not the least reason to suppose that Akbar's builders had not seen Hindu structures of this type, like that at Bijâpûr, and their Silpa-sâstras would certainly have preserved the traditional design and rules for the construction of them.

## CHAPTER XI

### VIJAYANAGAR AND BIJÂPÛR

THE ARCHITECTURAL RELATIONSHIP OF VIJAYANAGAR AND BIJÂPÛR — THE VITTHALASWÂMI TEMPLE AND OTHER BUILDINGS AT VIJAYANAGAR—THE JÂMI' MASJID, BIJÂPÛR —IBRÂHÎM'S MOSQUE AND TOMB—THE MEHTAR MAHALL—MAHMÛD'S TOMB—INDIAN STUCCO

I HAVE already mentioned the fact that about 1576 Bengal became a province of Akbar's empire, and that Gaur ceased about the same time to be a great Muhammadan building centre. It was not, however, until the beginning of the seventeenth century that the bent roofs and cornices characteristic of Bengali architecture began to appear in the buildings of Delhi and in Rajputana. In Akbar's buildings, so far as I have observed, there are no indications of the Bengali craftsman's handiwork. The building craft of Rajputana was the creative force in Mogul architecture of Akbar's reign.

But about the time of Akbar's accession in 1556 a new Muhammadan building centre developed in the south of the Dekhan, at Bijâpûr, close to the old one at Kulbarga, and in a country in which for many centuries previously, under Hindu rulers, Indian builders had raised many famous shrines and carried out great works of public utility similar to those in the north of India which had extorted admiration from Alberuni and Mahmûd of Ghaznî.

The dynasty of Bijâpûr had been founded in 1490 by a Turk, Yûsuf Âdil Shah, born in Constantinople. But he and

his two successors had followed the usual practice of Musulmân conquerors in India in using Hindu craftsmen and in building mosques and tombs with the materials of the Hindu temples they desecrated or destroyed. It was not until the more tranquil times of 'Alî Âdil Shah I. (1557-80) that Bijâpûr developed a characteristic building tradition of its own, which was, like all other Indo-Muhammadan architecture, grafted upon the older Buddhist-Hindu traditions but adapted to Muhammadan ritual.

The dynasty lasted until Aurangzâib overthrew it in the middle of the seventeenth century, and during the hundred years dating from 'Alî Âdil Shah's accession, the capital of the kingdom was, as Fergusson observes, "adorned with a series of buildings as remarkable as those of any of the Muhammadan capitals of India, hardly excepting even Agra and Delhi, and showing a wonderful originality of design not surpassed by those of such capitals as Jaunpur and Ahmadâbâd, though differing from them in a most marked degree.<sup>1</sup> He then, as usual, goes on to account for "the largeness and grandeur which characterised the Bijâpûr style" by the Turkish descent of the dynasty and the employment of Persian officers at the Bijâpûr court.

Neither the history of the time nor the buildings themselves, even when examined academically from the Western standpoint, on a basis of "style," give any substantial support to this vague hypothesis. The latter differ very widely in external character and construction from buildings in Turkey or in Persia. From a craftsman's point of view they are, as regards structure and symbolism, as purely Indian as any buildings of the same class in Gujerat or at Fatehpur-Sîkrî. When the gradual evolution of Indian architecture in the pre-

<sup>1</sup> "History of Indian Architecture," vol. ii. p. 269.



ceding centuries is taken into account, it is wholly unnecessary to go to Persia or Turkey to explain the distinctive characteristics of the Bijâpûr school.

We have already seen that in the fourteenth and fifteenth centuries at Kulbarga, close to Bijâpûr and their capital of the Dekhan, and farther north at Mandû, the capital of Mâlhwâ, the local Indian builders, who had been familiar for long centuries with the so-called " Saracenic " arch as a decorative feature, had, after many experiments, made the free use of it a part of their structural tradition. We have also seen that at Delhi, Agra, and Fatehpur-Sîkrî, in the first half of the sixteenth century, Indian builders had likewise made their own some Persian structural elements, such as the semi-domed portal with its characteristic pendentives. Bijâpûr architecture is the logical development of this new school of Indian builders, placed in a new environment and adapting itself to the South Indian craft tradition. There is not the slightest evidence at Bijâpûr of any new importation of foreign builders or craftsmen, but very strong evidence of the Hindu tradition of Southern India.

Constantinople was of course famous throughout the Muhammadan world for the grandeur of its domes, and it is quite conceivable that Mahmûd of Bijâpûr, mindful of his Turkish ancestry, called upon his Indian builders to emulate the glories of St. Sophia, just as Akbar required his mosque at Fatehpur to be " a duplicate of the Holy Place," and as Shah Jahân desired that the tomb of Mumtâz Mahall should be without a rival in the world. But the impartial historian should not for such reasons be so ready to bring in foreign creative inspiration on every occasion when Indian builders thus proved their capacity to satisfy the ambition of their rulers. There is not a detail in the buildings of Bijâpûr,

structural or decorative, which cannot be explained as the logical sequence of the previous history of a living building craft, born in India, continually accumulating fresh experiences by the free exercise of the craftsman's faculties, and continually adapting itself to changing conditions, social, political, and religious.

It is a most significant fact that every one of the great Muhammadan building centres in India was in close proximity to, or on the very site of, ancient Hindu cities famous for their craftsmen. Muhammadan Delhi and Agra rose upon the ruins of ancient Hindu capitals, and their first Musulmân sovereigns drew builders from the Hindu cities of Mathurâ and Kanauj. Ahmadâbâd lies close to Mudherâ and Dabhoi and all the famous ancient shrines of Rajputana. Gaur was the historic capital of Bengal before it was captured by the Afghans—a fighting but not a building race. And at every one of these places it will be found that the distinctive characteristics of Muhammadan buildings were mainly determined by the building tradition of the local Hindu or Buddhist craftsmen. Bijâpûr is no exception to the rule.

To understand the buildings of Muhammadan Bijâpûr, the student must first turn to the ruins of Hindu Vijayanagar and realise the political and craft relationship which existed between the two states during the long period when Bijâpûr was only a fortified outpost of no architectural importance. Early in the fourteenth century the rapid advance of the Musulmân power southwards had forced the Hindu dynasties of the Dekhan and Southern India to forget their ancient rivalries and combine against the common foe. The kings of Vijayanagar, then a small principality on the banks of the Tungabhadrà river, a branch of the Krishnâ, kept the Musulmân armies at bay, and for two centuries afterwards the boundaries of the

empire of Vijayanagar, formed by the coalition of the Hindu kingdoms—stretching right across Southern India and joining with those of Orissa on the east coast—presented an impassable barrier to the further progress of Islâm.

But during these two centuries the mutual relationship between Hindu and Musulmân was by no means invariably hostile. The Sultans of Bijâpûr were willing to accept the aid of a Hindu army in waging war against the rival Musulmân dynasty of Ahmadnagar; disgusted though they were when the Hindu soldiers seized the opportunity to pay off old scores by all manner of excesses, “burning and razing buildings, putting their horses in the mosques, and performing their idolatrous worship in the holy places” (Ferishta). On the other hand, before these events, Deva Râja II. of Vijayanagar (1419–44), finding that his own army was deficient in cavalry and archers, had taken many Musulmâns into his service, allotted to them *jaghirs* or grants of land, erected a mosque for their use in his own city, and commanded that no one should molest them in the exercise of their religion.<sup>1</sup>

A century later this tolerant spirit was emulated by the Muhammadan ruler of Bijâpûr, Ibrâhîm Âdil Shah I. (1534–57), who, like Akbar and most of the great Muhammadan rulers of India, had decided leanings towards Hinduism. He admitted Brahmans into his service, and substituted Mahratti for Persian as the official language of accounts. The foreigners whom he dismissed from his army found service under Râm Râja, the last of the Vijayanagar dynasty, who, like his predecessor, built a mosque for them and ordered the Qurân to be placed before him when the officers came to swear fealty.

At the beginning of the sixteenth century Vijayanagar was at the height of its prosperity, and one of the most splendid

<sup>1</sup> “A Forgotten Empire,” Robert Sewell, I.C.S., p. 72.

cities of the East. It was the great craft centre of the South and the Dekhan, as Gaur and Ahmadâbâd were for Northern and Western India. Paes, the Portuguese traveller, has given a graphic description of it. Climbing a hill from whence he could see a great part of it, the city seemed to him "as large as Rome, and very beautiful to the sight; there are many groves of trees within it, and many conduits of water which flow into the midst of it, and in places there are lakes; and the king has close to his palace a palm-grove and other rich-bearing fruit trees. Below the Moorish quarter is a little river, and on this side are many orchards and gardens with many fruit trees, for the most part mangoes and areca-palms and jack-trees, and also many lime and orange trees, growing so closely to one another that it appears like a thick forest; and there are also white grapes."<sup>1</sup>

The people in the city, he said, were countless in number—no troops, horse or foot, could break their way through them, so great was the number of people and elephants. It was the best provided city in the world; stocked with provisions of every kind. At the irrigation works, which supplied the city with water, Paes saw a vast crowd, which he estimated at fifteen to twenty thousand men, "looking like ants," employed in carrying out extensions or repairs. The palace of the king enclosed a "greater space than all the castle of Lisbon." There were broad and beautiful streets full of fine houses, in which lived many merchants and craftsmen, with many things to sell; and in the "Moorish" quarter at the end of the city there were many "Moors," mostly natives of the country, serving in the royal body-guard.

The great temple of Vitthalaswâmi (Pl. LXXXI), one of the most splendid of Hindu shrines, was commenced about

<sup>1</sup> For the full account see Sewell's "Forgotten Empire," pp. 236-90.

the beginning of the sixteenth century, and work on it was apparently continued until the fall of the city in 1565, after the disaster of Talikota. To the Western architectural student the main interest of the vast ruins of this once famous city, stretching over ten square miles, lies in the clear evidence they afford of the craft process by which the Hindu temple became the Muhammadan mosque and Buddhist-Hindu architecture became "Indo-Saracenic." In the ruins of Hindu Vijayanagar will be found not only the prototypes of Muhammadan Bijâpûr, but illustrations of the process by which the Arab architecture of the seventh, eighth, and following centuries gradually became the style of the pointed arch.

The history of the mutual relations between Hindu and Musulmân is plainly told in the remains of the buildings of the "Moorish" quarter of Vijayanagar. The history of the evolution of the "pointed style" can be traced in the empty niches on the roofs of Hindu temple-pavilions. Pl. LXXXII shows a part of the roof of a pavilion adjoining the Vitthala-swâmi temple, built strictly according to the South Indian-Hindu tradition, which can be traced right back to early Buddhist times, before the Muhammadans came in contact with it. The three larger niches—the shrines from which the images have been removed—give typical examples of the Buddhist-Hindu foliated arch, derived from the conventionalised aura of a Buddhist image. If the elaborate carved scrolls in front of them were broken by a Musulmân iconoclast, or reduced to their simplest form by a Musulmân craftsman, the arches would become the foliated "Saracenic" arches of Mogul buildings at Delhi and Agra, and of Moorish architecture in Africa and Spain.

By a similar process of adaptation the smaller niches would become what Western classifiers have labelled as "stilted

PLATE LXXXII

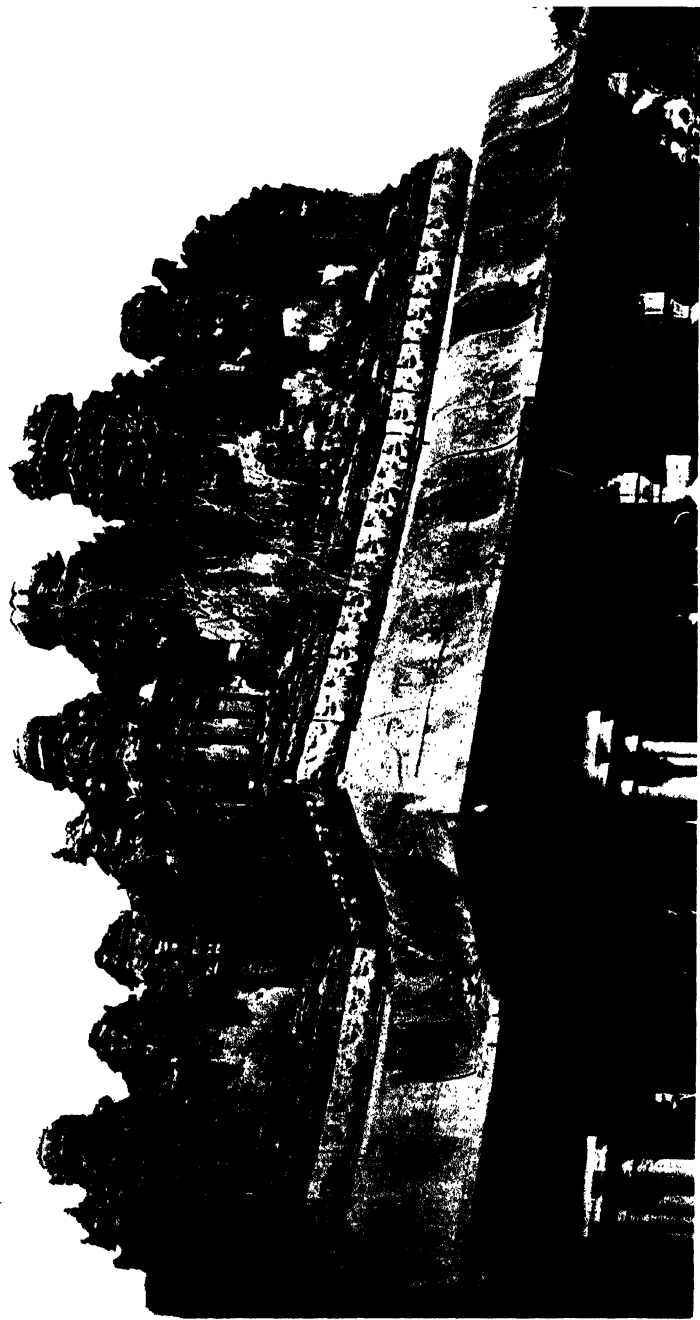

SHRINES ON ROOF OF VIITHALASWAMI TEMPLE, VIJAYANAGAR



Arab " arches, though the type belonged to the craft tradition of India centuries before the advent of the Prophet of Mecca. Again, if the ornamental finials—which are Dravidian or South

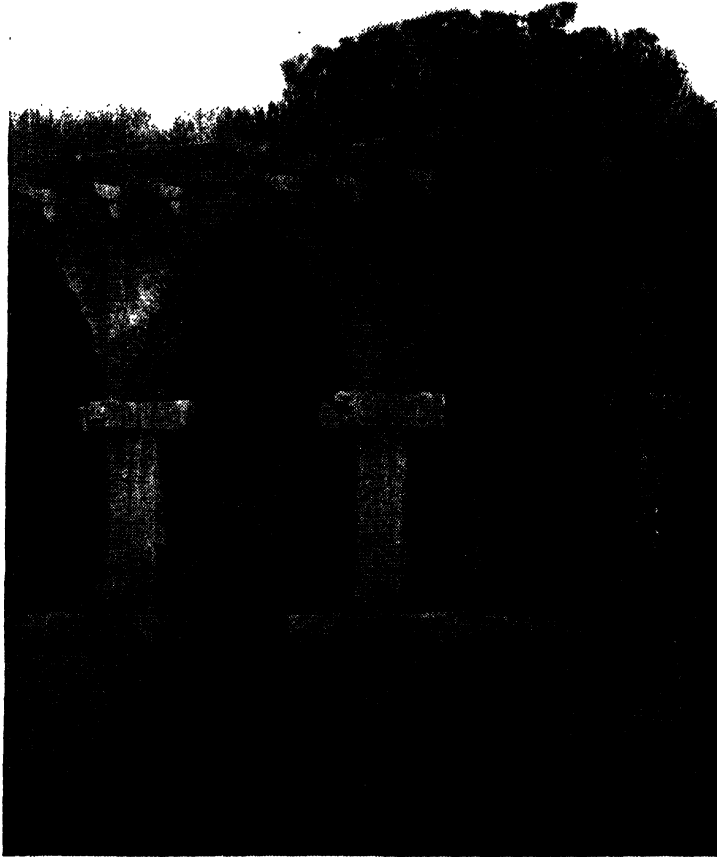

FIG. 43.—Arcade of Râm Râja's Treasury, Vijayanagar.

Indian domes and vaulted roofs in miniature—behind the desecrated shrines are examined critically, it will be seen that the smaller ones are the " bulbous " or lotus domes which first appear in a simplified " Saracenic " form in the minarets of



the Jâmi' Masjid of Bijâpûr, built by 'Alî Âdil Shah I. after the fall of Vijayanagar ; they were used afterwards on a much larger scale in the central domes of mosques and tombs.

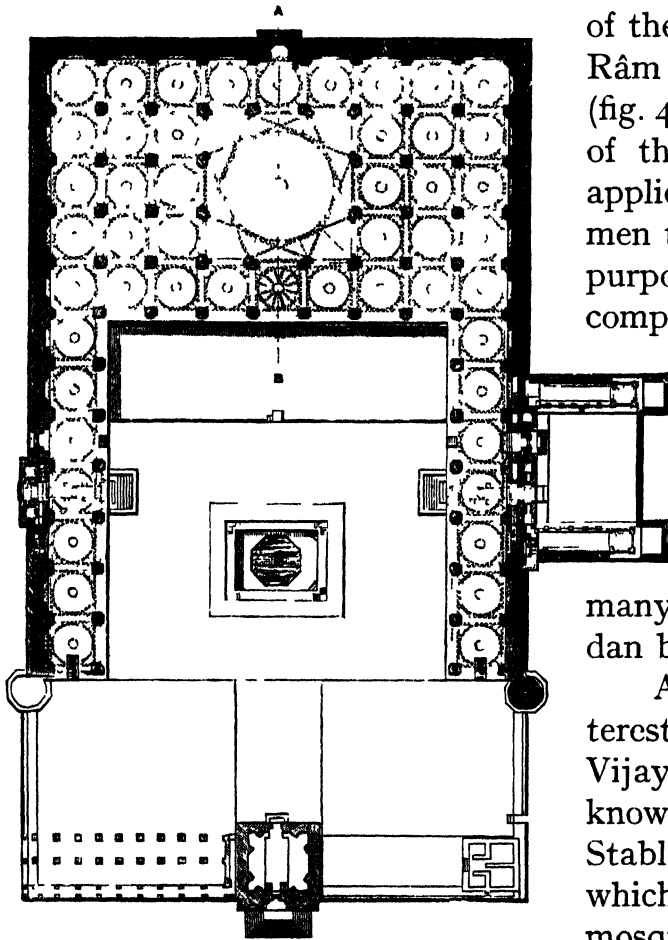

FIG. 44 —Plan of Jâmi' Masjid, Bijâpûr (from Fergusson's "History").

In the ruined façade of the building known as Râm Râja's Treasury (fig. 43) the foliated arch of the Hindu shrine is applied by Hindu craftsmen to purely structural purposes. This is the complete structural basis

of the doorways of the mosque at Bijâpûr, the 'Alî Shâhi-Pîr-ki-Masjid (Plate XXXV), and of many other Muhammadan buildings.

Another very interesting building at Vijayanagar is that now known as "the Elephant Stables" (Pl. LXXXIII), which I take to be the mosque built by Dêva Râja II. for his Muhammadan troops. When or

why it was converted into stables for elephants is a matter of minor interest. It was most evidently built by South Indian craftsmen, adapting their own temple tradition to the ritual

PLATE LXXXIII

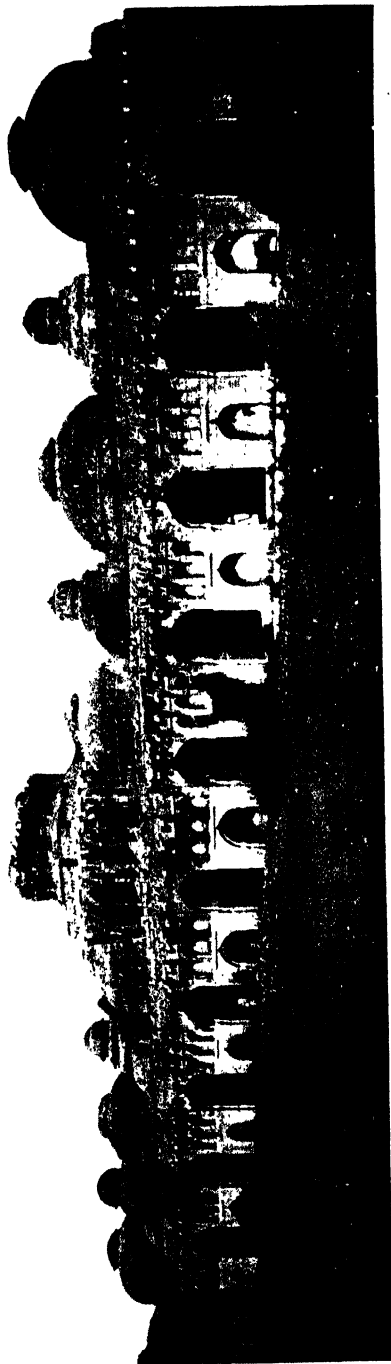

"ELEPHANT STABLES," VIJAYANAGAR



PLATE LXXXIV

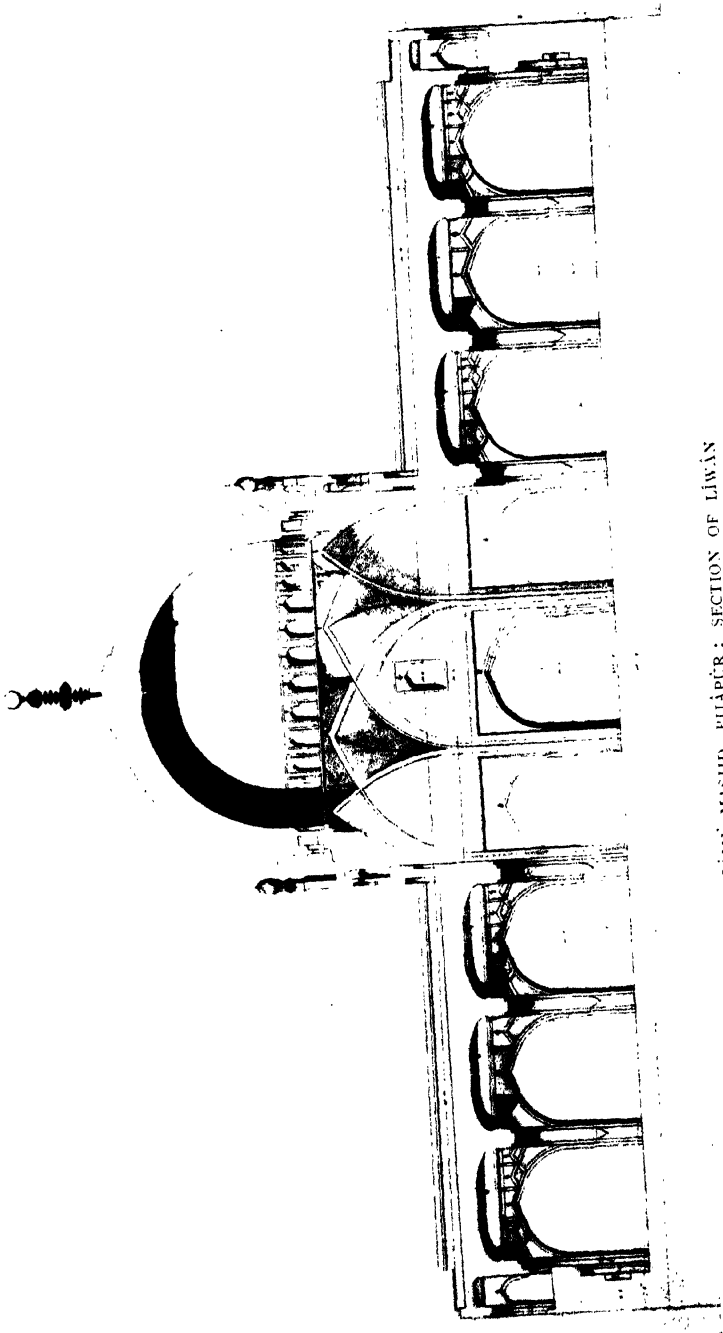

JAMI MASJID, BIJAPUR: SECTION OF LIWAN  
(From Ferguson's "Barrackpore")



## EVOLUTION OF THE BIJÂPÛR "STYLE" 191

of Islâm. The seven larger domes are the prototypes of the domes of the Jâmi' Masjid at Bijâpûr, being themselves only modifications of the Buddhist-Hindu types which are seen in their original form in the four intermediate domes. The decoration of the central doorway is precisely similar to that of the later mosque of 'Alî Âdil Shah.

There are many other buildings at Vijayanagar which show that the Hindu craftsmen, having first adapted their own structural traditions for Muhammadan purposes, proceeded to apply the experience gained in doing so to their own buildings, both secular and religious. Some illustrations of these will be found in Mr. Sewell's valuable work on the history of the city. The further development of the pointed style in the south of India was taken up by the builders of Bijâpûr.

Nearly all of the characteristics which distinguish the buildings of Bijâpûr from the earlier Hindu-Musulmân schools of Mâlhwâ and Kulbarga were derived from the Hindu tradition of Southern India. Those which belong exclusively to Bijâpûr were the result of further experiment after the fall of Vijayanagar. The South Indian builders as soon as they had adopted the arch as a structural expedient began to experiment with it even more boldly than their craft brethren in the north had done. The novelty of it appealed to their craft instinct ; they played with it as children play with a new toy. The " largeness and grandeur " of the Bijâpûr style came from this indigenous creative impulse, not from Persia or from Turkey. It is necessary to bear in mind that in the sixteenth century it becomes impossible to draw distinctions between Muhammadan and Hindu buildings on account of the structural use of the arch, or from the use of pendentives or domes of the puritanised types which had been evolved by Indian craftsmen working for Musulmân employers ; all of them were used

freely in Hindu temples and other buildings which lay within the radius of Muhammadan political influence.

It was not until the overthrow of Vijayanagar in the great battle of Talikota in 1565 that the real architectural history of Bijâpûr begins. Immediately after that event, 'Alî Adil Shah I. with his building resources vastly augmented by the spoils of war—which must have included thousands of skilled Hindu craftsmen—set to work to enclose his own capital with fortified walls, and to celebrate his triumph over the infidel by building a Jâmi' Masjid on a grand scale, in some respects like that of the great mosque at Kulbarga, but with many details repeating those of the great range of buildings at Vijayanagar described above. Nearly all the arches have the Hindu symbolism of the pîpal leaf at the crown. The “bulbous” dome, which appears for the first time on the minarets of an Indian mosque, was also, as I have said, an adaptation of the South Indian Hindu type.

The principal dome, which is 57 feet in diameter, covers the central compartment of the *lîwân*, a square of 70 feet, and is raised up on a clerestory, which corresponds to the *griva* or neck of a Dravidian dome, like the domes of Gujerat mosques which are likewise derived from Hindu prototypes. Though the Turkish crescent crowns the finial, the Hindu symbolism expressed both in the latter and in the lotus-flower arrangement of the pendentives proves that Indian builders were the real creators of the mosque. The rest of the *lîwân* is divided into square compartments in the usual Indian style, and is covered by a terraced roof supported in the same manner as Sidi Sayyid's mosque at Ahmadâbâd with small domes concealed in the thickness of the roof.

Ibrâhîm II. (1580–1626), the successor of 'Alî Âdil Shah, was a liberal patron of Hindu culture, especially of music, and

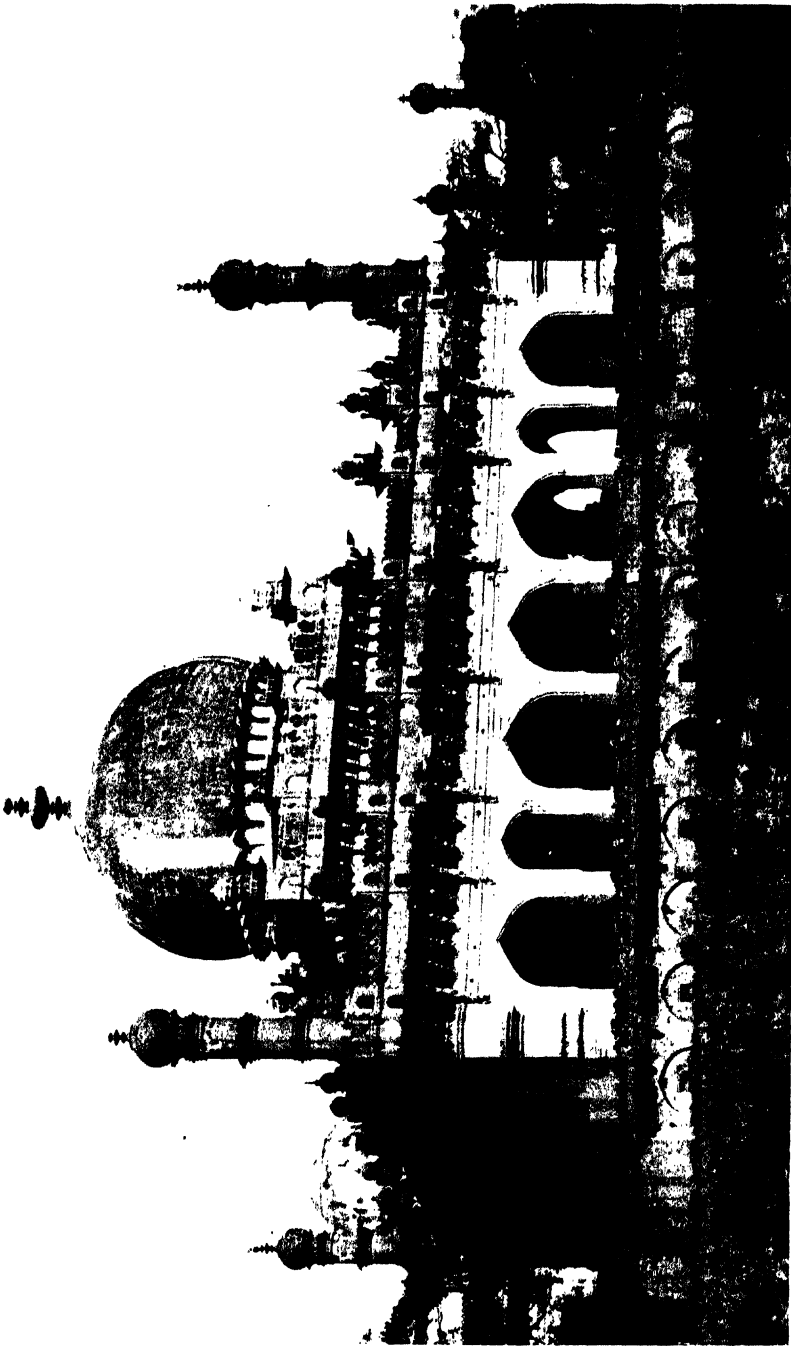

IBRÁHIM'S TOMB, BIJÁPÜR

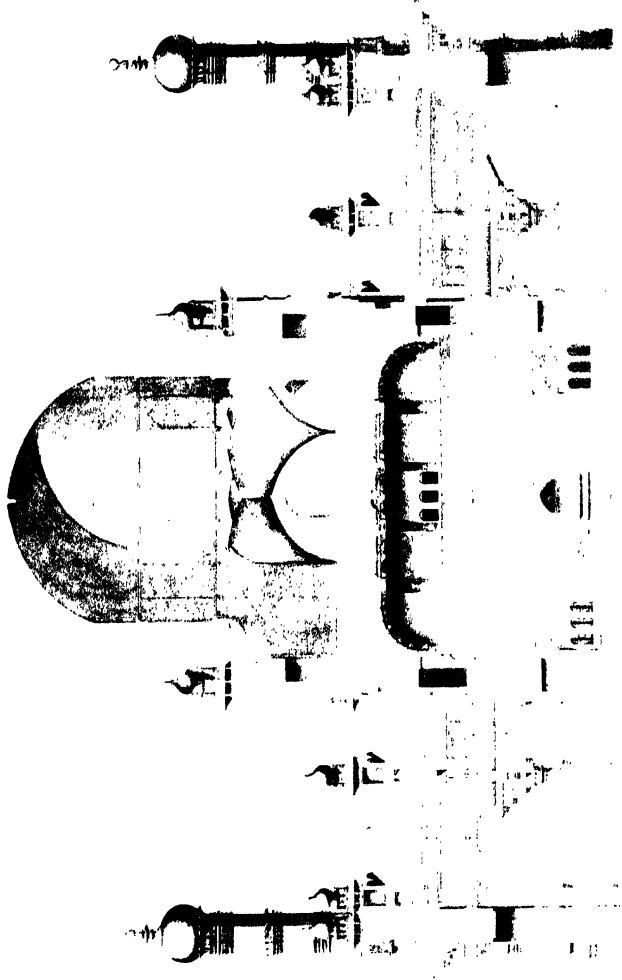



PLATE LXXXVI

TRANSVERSE SECTION THROUGH THE GREAT DOME

PLANS AND SECTIONS  
OF THE TOMB OF IBRÁHÍM  
AT  
BEEJÁPOOR



SECTION OF IBRÁHÍM'S TOMB, BIJÁPŪR  
(From Fergusson's "Bechtupeer")



fell under a suspicion of taking part in Hindu religious rites. Most of the finest buildings at Bijâpûr belong to this reign. Among the most remarkable are the mausoleum and mosque which bear his name. They were commenced under similar circumstances to the Tâj Mahall at Agra, as a memorial of his favourite daughter Zohra Sultâna and of his Queen Tâj Sultâna. Architecturally there is a close connection between the two groups of buildings, for Ibrâhîm's mosque and tomb were the first Muhammadan buildings in which the "bulbous" or lotus-leaf type of dome is used on a large scale, as it is in the Tâj Mahall, and as they were nearly contemporaneous they must have been among "the famous buildings of the world" which were discussed by Shah Jahân's master-builders before the general scheme of Mumtâz Mahall's tomb was decided.

In the seventeenth century this "bulbous" dome became the characteristic form for mosques and tombs in Northern India ; and its first appearance so far south as Bijâpûr is most significant. In the Dekhan it was sculptured in the chapter-houses of Ajantâ, but since the eighth or ninth century it had gradually been supplanted by the bell-shaped sikhara of Buddhist and Hindu temples. In the temples of the south, however, it had retained its earlier lotus-leaf form, as it does in the present day, only rather obscured by the exuberant sculpture added to it.

We have already seen that in the north the dome of the Hindu stone-built porch, stripped of its symbolic sculpture, became the so-called Pathân dome of Fergusson's classification. Precisely the same process of adaptation took place at Bijâpûr in the sixteenth and seventeenth centuries. The lotus-leaf dome of the Hindu vimâna was transformed into the "bulbous" dome of the Muhammadan mosque and tomb. All the main "orders" of the Hindu canon were retained: the

kalasha and the Mahâ-padma beneath it, and the lotus petals at the springing of the dome. But the rather redundant ornaments were omitted, and attention was concentrated on elegance of contour rather than on richness of sculptured decoration. To this end the lotus petals at the base were emphasised ; in the later examples at Golconda and elsewhere the incurving at the base is greatly exaggerated.

The new structural idea in the Bijâpûr domes was the adaptation of the Persian pendentives for repeating internally the Hindu symbolism of the Mahâ-padma under the finial. The development of the Bijâpûr style thus followed the natural course of architectural progress all over the world. The style did not spring ready-made from the brain of a single architect or school of architects, nor was it, like Renaissance architecture in Europe, the conscious imitation of an historic style, but the natural growth of a living building tradition adapting itself to its own environment.

Except for its dome, Ibrâhîm's mausoleum does not differ much from the usual design of contemporary Muhammadan tombs in Gujerat. The sanctuary is a square of 40 feet, covered by a remarkable coved ceiling,<sup>1</sup> constructed with stone ribs and slabs set edge to edge, only supported by iron clamping and the strength of the excellent Indian mortar. Though the flat surface in the centre is a square of 24 feet, the ceiling shows no signs of sagging three centuries after its construction. Above this the walls of the sanctuary are carried up another story, the lotus-petal pendentives changing the square into a circle to form the base of the dome, as in the Jâmi' Masjid. A flat roof of purely Hindu construction, supported by a row of massive piers and an external arcade, surround the sanctuary. The four small domes, which, according to the usual Hindu

<sup>1</sup> The Hindu prototype is shown in fig. 40 (Diwân-i-Khâs, Fatehpur-Sikrî).

PLATE LXXXVII



SECTION OP BREWING: CLEAR VIEW OF LARGES AND INTERSECTION  
OF LARGES AND SMALLER ARCHES TO RIGHT AND LEFT



PLAN OF CEILING

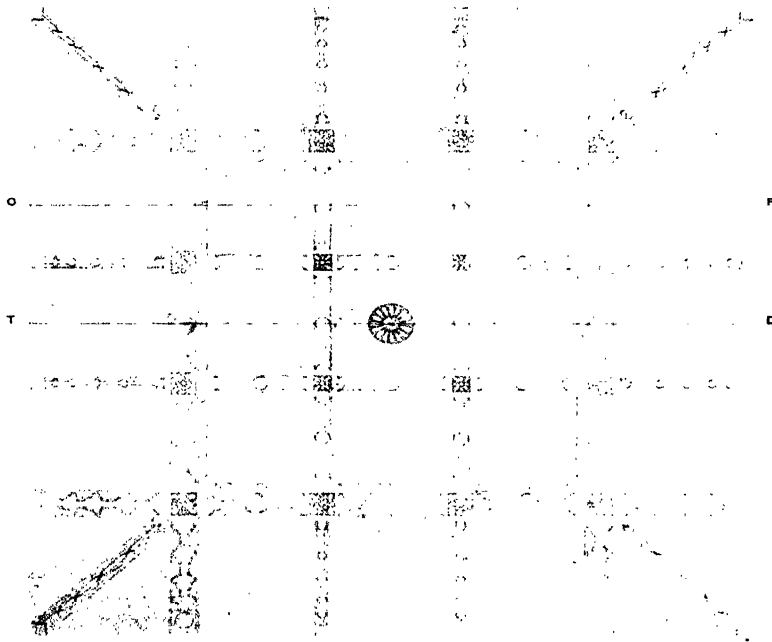

CEILING OF IBRĀHĪM'S TOMB, BIJĀPŪR  
(From Fergusson's "Bijapur")



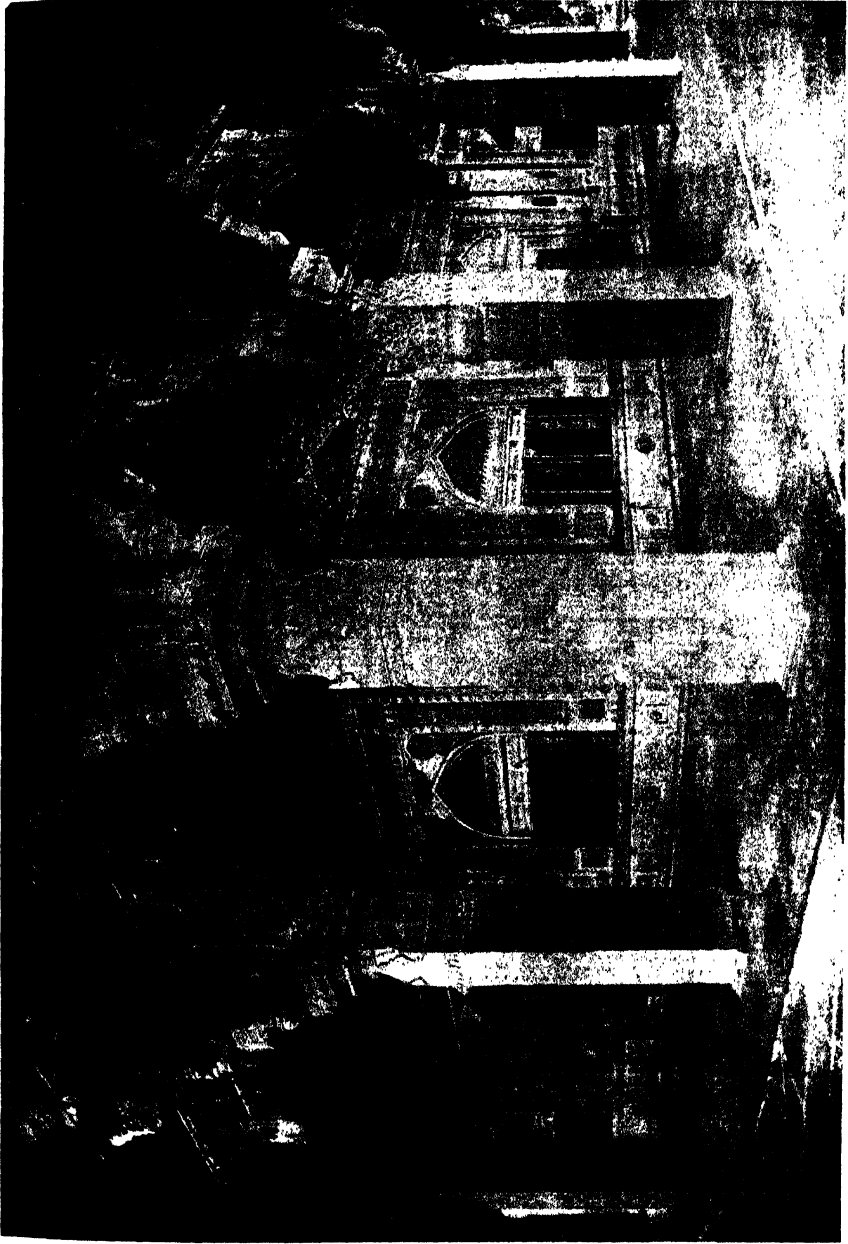

CORRIDOR OF IBRÁHÍM'S TOMB, BUJÁPÓR





symbolism, should appear in the corners of the roof, are here relegated to the top of the minarets.

The corridor surrounding the sanctuary is illustrated in Pl. LXXXVIII, which will explain better than any verbal description the essentially Hindu character of the whole mausoleum. It will be noticed that the arches between the piers with pîpal-leaf crowns are not Saracenic either in form or construction, but are simply Hindu brackets pieced together as in many of the buildings at Fatehpur-Sîkrî, or sometimes cut out of single blocks of stone. Externally the Hindu characteristics are shown prominently in the heavy bracketed cornice and in the design of the minarets and domes.

The mausoleum of Ibrâhîm included a fine mosque of similar character. Both buildings are placed in a splendid enclosed garden, laid out with fountains and water-courses in Mogul fashion, like the enclosure of the Tâj Mahall.

The Ibrâhîm Rauza was not entirely completed until 1626, and several other important buildings at Bijâpûr belong to the seventeenth century : but it will be more convenient to treat the Bijâpûr school as belonging to the previous century, which really determined its character

One of the most delightful buildings of the Muhammadan period in India is that known as the Mehtar Mahall, the Sweeper's Hall. Fergusson, in his erratic way, distinguishing it from the other Bijâpûr buildings which he calls pure " Indo-Saracenic," describes it as belonging to a " mixed Hindu and Muhammadan style." It is not in any way more " mixed " than the Tâj Mahall, but is a perfectly harmonious blend of all the structural and decorative elements which South Indian builders of the sixteenth and seventeenth centuries were using.

The legend which accounts for its name declares that

Ibrâhîm Shah I., being afflicted by a dreadful malady which his physicians were unable to cure, took the advice of an astrologer, who, hoping to profit by the occasion, told him that on the morning of a certain day he should give a great sum of money to the first person he saw. Unfortunately for the canny soothsayer, the king on the appointed day rose at an unusually early hour, and the expected fortune fell to a sweeper in the palace courtyard, who piously devoted it to building the finest mosque which money could build. Most of it was lavished on this beautiful entrance gateway. The tradition is wrong in its date, for the building is certainly one of the later ones of the Bijâpûr school—it probably belongs to the latter part of the reign of the second Ibrâhîm, or the early seventeenth century.

It contains three stories, the floors of the first and second being constructed in the same way as the roof of the sanctuary in Ibrâhîm's tomb. In plan it is a square of 24 feet, and the height to the top of the minarets is 66 feet.

The reign of Ibrâhîm II.'s son and successor Mahmûd Âdil Shah (1626–56) brought Bijâpûr first into alliance and later on into conflict with the Moguls. Shah Jahân's troops ravaged the kingdom up to the gates of Bijâpûr, and Mahmûd only obtained peace by paying an annual tribute to Delhi. These circumstances account for the close connection between the design of the Tâj Mahall and that of Ibrâhîm's Rauza, which was completed about the same time as the foundations of the former were laid.

The chief building of Mahmûd's reign was his mausoleum, the famous Gol Gumbaz, which was commenced, according to custom, in the lifetime of the monarch whose memorial it was to be. Ibrâhîm had surpassed his predecessors in the lavish decoration he had bestowed upon his monument. Mahmûd

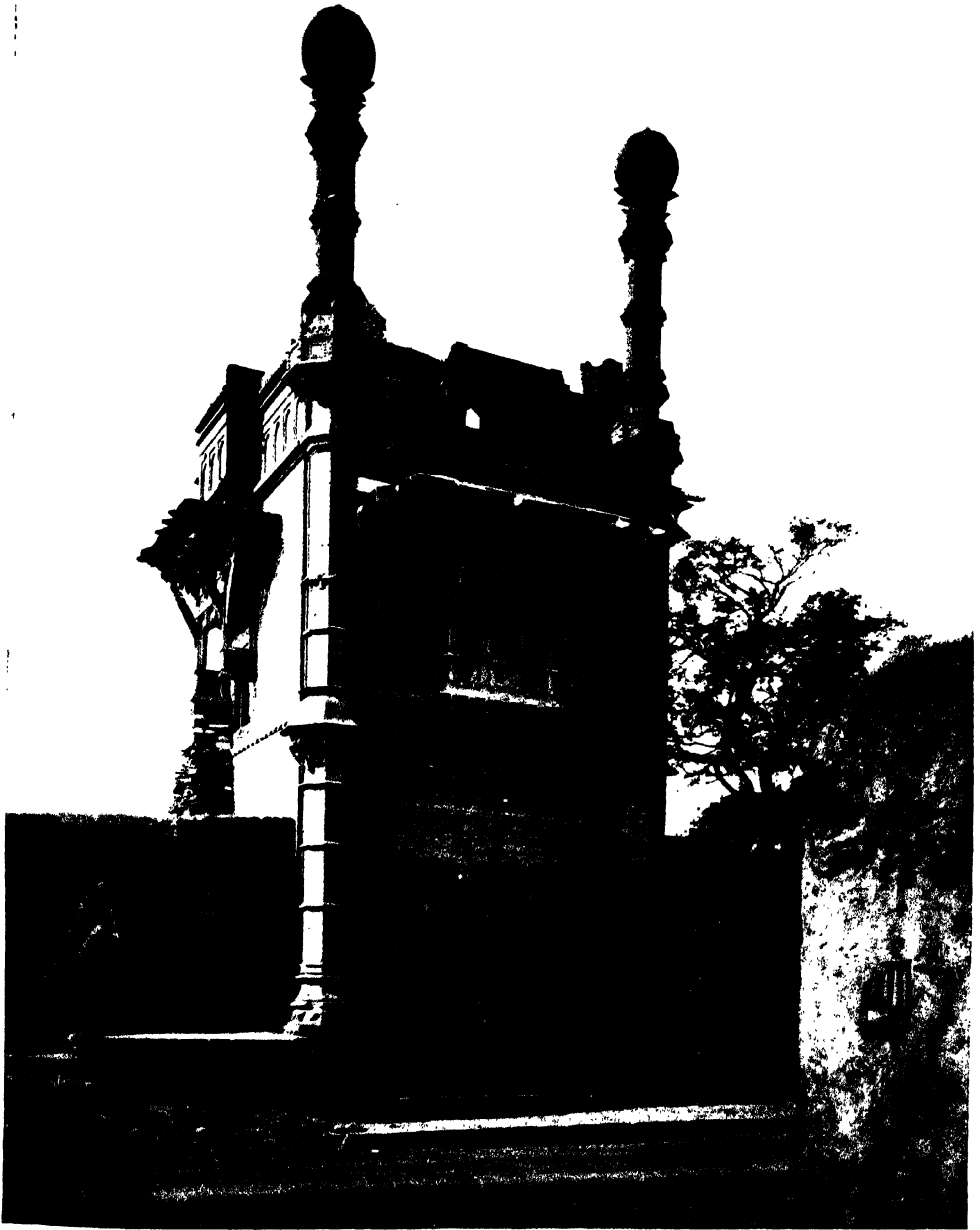

MEHTAR MAHALL, BIJÁPÜR



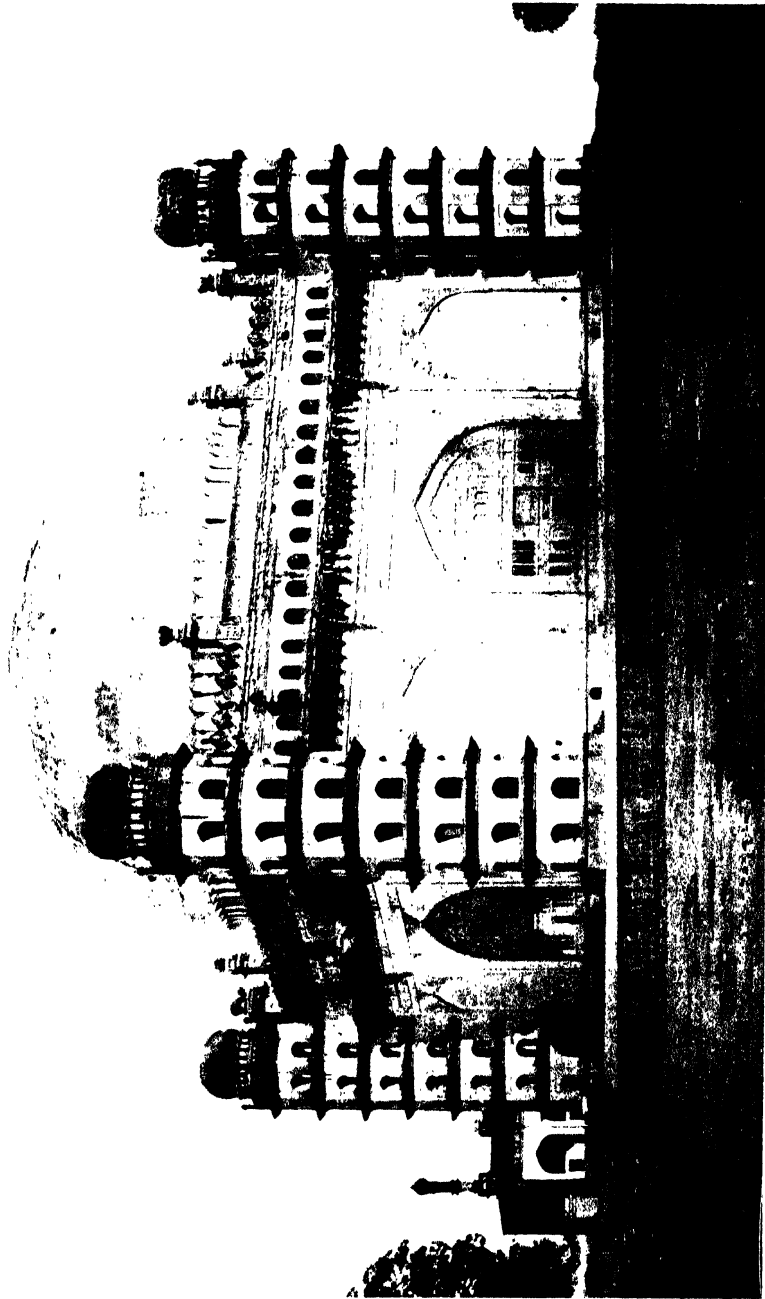

MAHMÚD'S TOMB, BIJÁPÚR



determined to perpetuate his own name by building the greatest dome in the world, and his master-builders gratified his desire; for though in diameter it is exceeded by the Pantheon at Rome, the dome of Mahmûd's tomb, as Ferguson states, "covers more ground clear of support than any dome or vaulted roof in the world, while it is of more difficult construction, being placed upon a square hall instead of on a circular drum."

The principle of construction employed in the Bijâpûr domes has already been explained. The vast hall which the dome covers is 135 feet 5 inches square at the floor level; the dome itself has an internal diameter of 124 feet 5 inches, and was originally gilt outside. The traditional Hindu symbolism of the panch-ratna, as in Ibrâhîm's tomb, is maintained by the five domes—*i.e.* the colossal central one, and the four in miniature on the corner towers which serve as buttresses. The finials of all of them and the pîpal-leaf arches are evidence of the Indian master-builders' handiwork and inspiration.

Taking Mahmûd's tomb by itself as a specimen of archaeological "style," it is easy to mistake it for a Saracenic building belonging to the Arabian or Persian tradition. But considering it in due relation to its own historical context and local environment, it is evidently as much Indian as the stûpas of Asoka or the temples of Vijayanagar.

Most of the buildings of Bijâpûr are faced by and largely constructed of stone—a local basaltic trap which takes a high polish. But, as in other parts of India, there are many equally beautiful buildings in which the brickwork is only covered with an exceedingly fine white plaster, the working of which has developed into a fine art in India. On account of the heavy monsoon rains and the luxuriant growth of parasitic vegetation,



it is generally necessary in India to protect brickwork with some kind of facing. In Bengal terra-cotta, glazed or unglazed, was largely used. In Rajputana and other provinces in the north the abundant supply of sandstone, which could easily be cut into slabs, provided an admirable facing material. When stone or terra-cotta was too expensive, an excellent substitute was found in this white plaster. A fine white sand or powdered limestone was used with it ; the lime was made in some places from the chips left by the stone-cutters, in others from sea-shells.

The practical uses of this plaster were manifold. It prevented the rain from soaking into the brickwork in the wet season, and in the hot weather it kept the house cool by refracting the sun's rays. It was so hard and tenacious that it could be used for floors as well as for walls and roofs ; the high polish which could be given to it prevented the accumulation of dust.

Plates XXVII and XLV show fine examples of brick and plaster-work. For decorative purposes it could be used as a ground for fresco painting (*fresco-buono*), gilding, or painted gesso work, or for plain cut and modelled ornament. For these purposes it was frequently applied to buildings faced with stone, and even statuary commonly received a fine coating of it, like the wax finishing which was considered so important by the famous Greek sculptors.

This art of fine plaster work is still alive in India ; but Anglo-Indian architects have brought with them the modern European prejudice against stucco, and a partiality for plain red brickwork without the necessary protection which keeps it dry in the monsoon and cool in the hot season. For interior decoration European fashion demands wall papers and hangings, ten times more insanitary in the tropics than they are

in a temperate climate. They are really poor and vulgar substitutes for the exquisite Indian polished plaster, which with discreet fresco or gesso enrichment provides a most elegant and distinguished form of decoration, manifestly superior on sanitary as well as artistic grounds, for it is easily cleaned, repaired, and renewed. In ordinary circumstances it is almost as durable as the building itself.

## CHAPTER XII

### HINDU BUILDINGS IN THE SIXTEENTH CENTURY

#### GOVIND DEVA'S TEMPLE AT BRINDÂBAN—HINDUISM AND IDOLATRY—JAINA TEMPLES—MÂN SINGH'S OBSERVATORY, BENARES

IT would be impossible, without extending the scope of this work very largely, to attempt to give a summary of the many important buildings of the sixteenth century belonging to independent or semi-independent Hindu kingdoms. I must confine myself to a few typical ones illustrating the growth of Indian architecture of the period, which will show that Hindu builders, while providing for the architectural needs of the dominant political power, were not slow to use the experience they gained thereby for their own purposes. I have already noticed some of the important buildings of Vijayanagar, with which the Bijâpûr school was so closely connected.

In the north the most remarkable was the temple of Govind Deva, built at Brindâban, the chief centre of the Vaishnavaite sect, near Mathurâ, by the Maharajah Mân Singh of Amber—one of Akbar's trusty Hindu allies—in the last decade of the sixteenth century. It has suffered greatly from the systematic vandalism of Aurangzîb's fanatic followers, who threw down the superstructure of the great porch and razed the sacrarium, or *garbha griha*, containing the image, together with its lofty *gandhi*, or spire, to the ground. Aurangzîb is said to have placed, on the top of the existing building

PLATE XCI

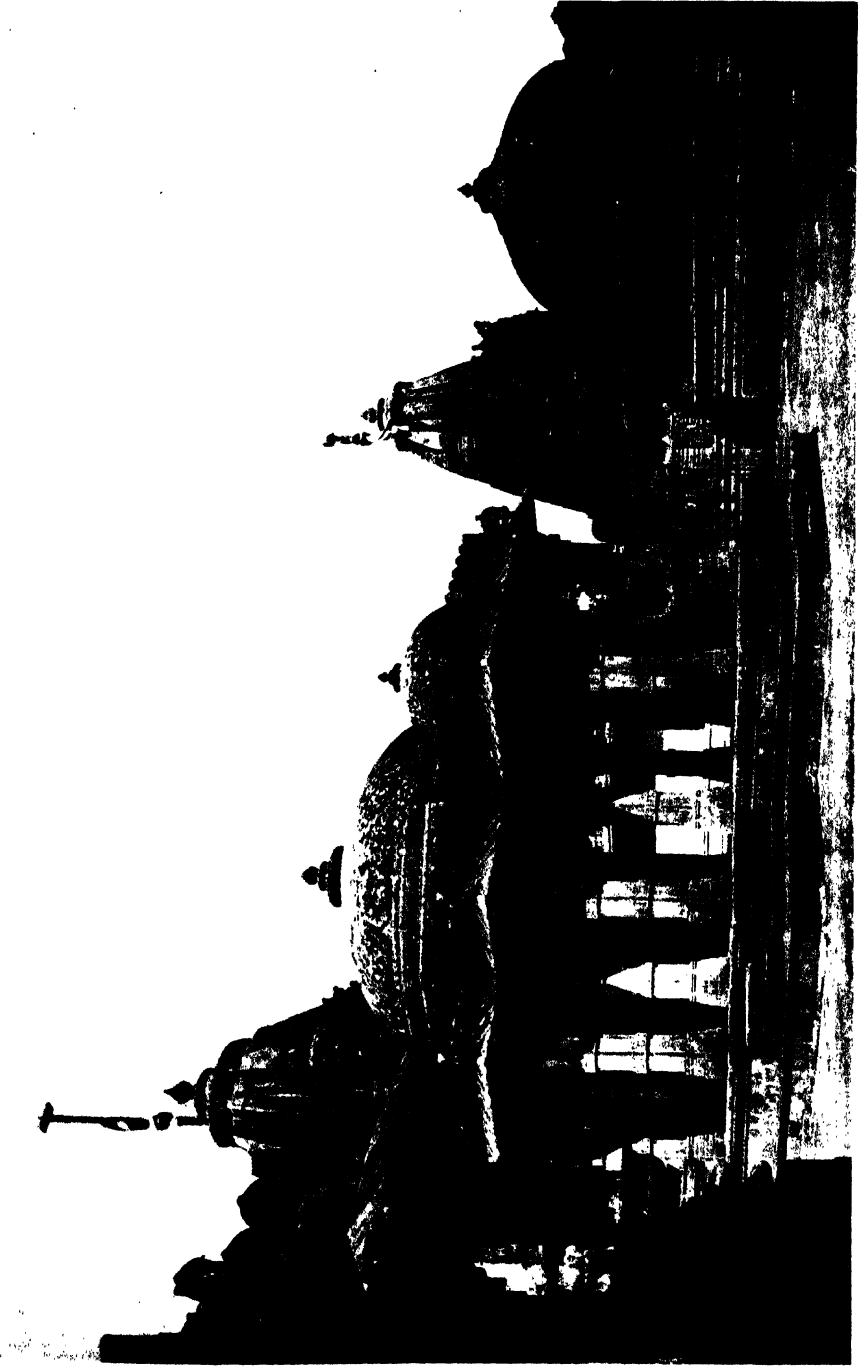

JAIN TEMPLE, PALITANA



PLATE XCII

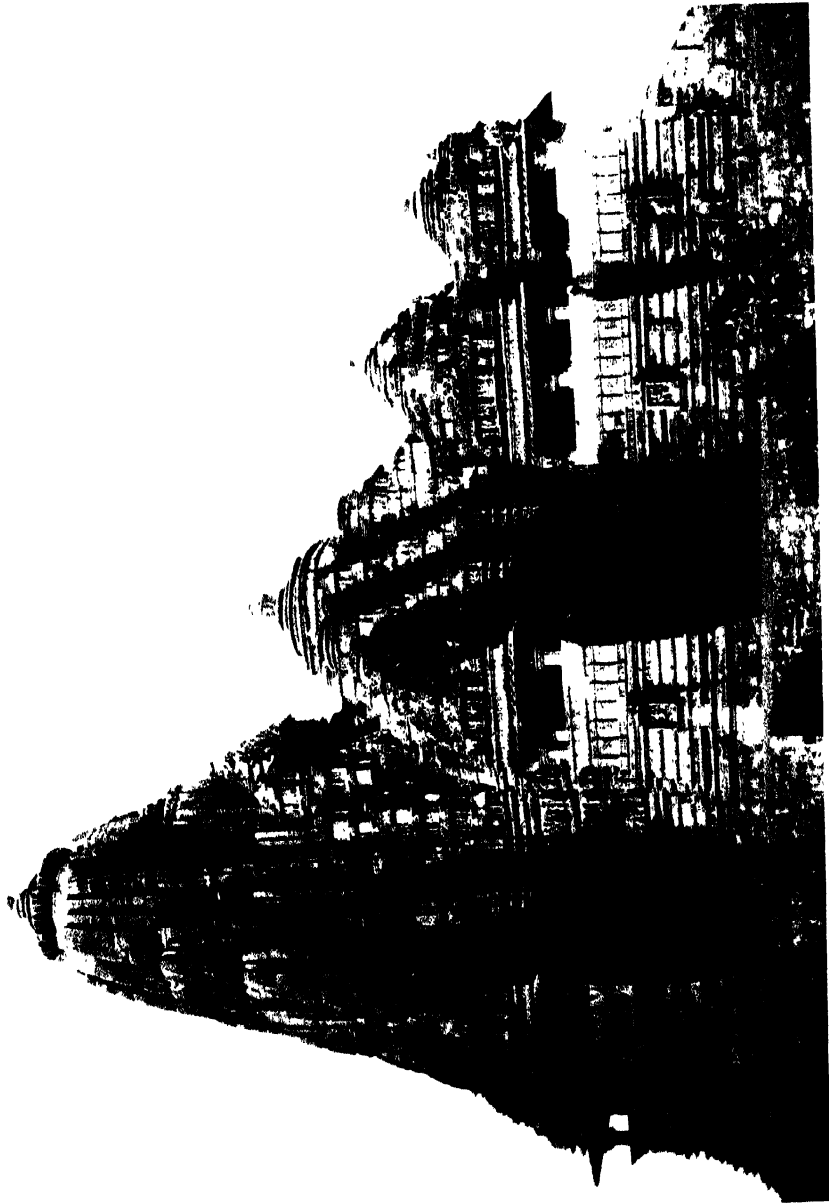

KANDARYA MAHADEVA TEMPLE, KHAJURÁHO



a mosque wall, where he offered up prayers.<sup>1</sup> This accounts for the present stunted appearance of the exterior.

In plan the temple as it now stands is cruciform, and its prototype can be seen in another ruined Vaishnavaité shrine, known as the Sâs Bahû temple (Pl. XXI) at Gwalior, which is five centuries earlier. A comparison of the two temples will show how the religious sentiment of Islâm and the practical experience gained by Hindu builders in the service of Muhammadan rulers had influenced their own craft traditions. First there is a complete absence of figure sculpture in the decorative treatment of the building. It was quite easy for Brahman priests to make such a concession to orthodox Musulmân feeling, and even to join the Muhammadan mullahs in a crusade against idolatry, for anthropomorphic symbolism had only been used by them as a means of popularising the philosophic teaching of Hinduism, and never had been regarded as essential to Hindu religion.

Those prophets of Anglo-India who try to conjure up the bogey of Brahman perfidy whenever the wheels of official machinery get out of gear would do well to note that the most faithful and trusted advisers of the great Muhammadan rulers of India were Brahmans, and that orthodox Hinduism, so far from maintaining an implacable hostility on religious grounds to rulers of an alien race and creed, has always been anxious to restate its own dogmatic teaching so as to avoid offence to the religious feelings of the ruling powers of the State. No sooner were the Muhammadans firmly established in India in

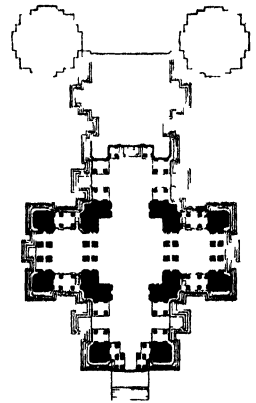

FIG. 45 — Plan of Govind Deva's Temple Brindaban (from Fergusson's 'History')

<sup>1</sup> Growse's "Mathura," pp. 243-4, note.



the thirteenth century than a Hindu teacher, Jaidev, arose to denounce idolatry. He was followed by Ramanand and Kabir in the fourteenth and fifteenth centuries, and by Nanak the Guru of the Sikhs. The Sikh religion was the outcome of the impact of Islâm upon Hindu thought, just as the teaching of the Brahma-Samâj of the present day represents the adjustment of Brahmanical religious ideas in the direction of Christianity.

This crusade against anthropomorphic symbolism has had a marked effect upon Hindu architecture from the thirteenth century to the present day. If the Muhammadan conquest gave a great stimulus to the structural development of the Indian building craft, and kept alive the traditions of Indian painting, it almost entirely suppressed the splendid schools of Buddhist and Hindu sculpture which, at the time of Mahmûd of Ghaznî's invasion, had reached their culminating point at Elephanta and Ellora in the north, and at Tanjore in the south. In the fifteenth and sixteenth centuries the Jain builders of Western India followed Muhammadan custom in omitting sculptured decoration from the exterior of domes (Pl. XCI) ; and the Saiva sect in the north, wherever Muhammadan influence extended, substituted for anthropomorphic images of the Deity the aniconic symbol of the *lingam*.

Except for the absence of figure sculpture and the occasional introduction of the pointed arch, built in Hindu fashion, there is not any striking difference externally between the Sâs Bahû temple of Gwalior and Govind Deva's temple at Brindâban ; but in the interior of the latter the very original use of vaulting with radiating arches, in combination with pillars, brackets, and lintels, gives a fine illustration of the inventive genius of the Hindu craftsman and his capacity for assimilating new ideas. As an architectural achievement it must be said,

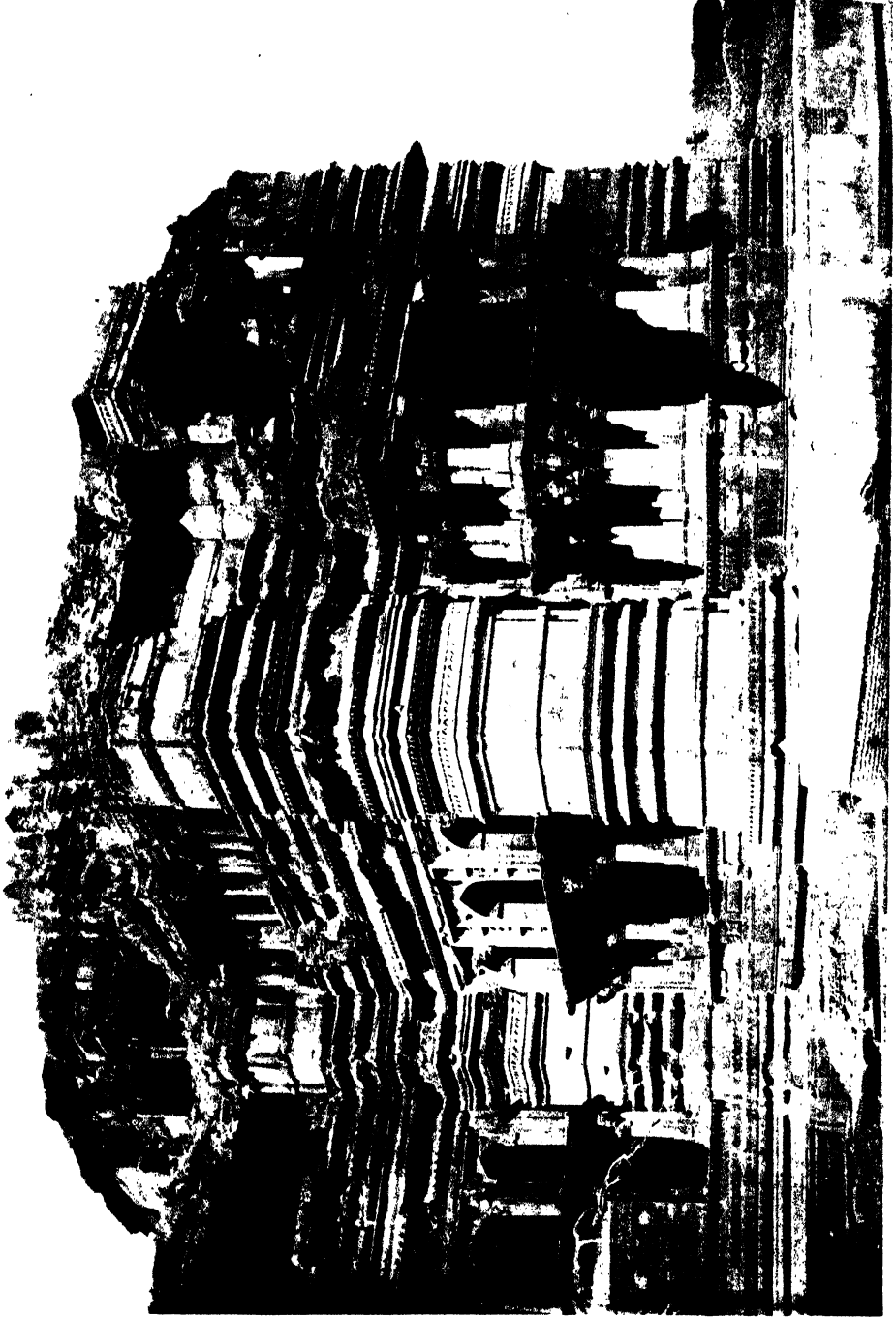

GOVIND DEVA'S TEMPLE, BRINDABAN



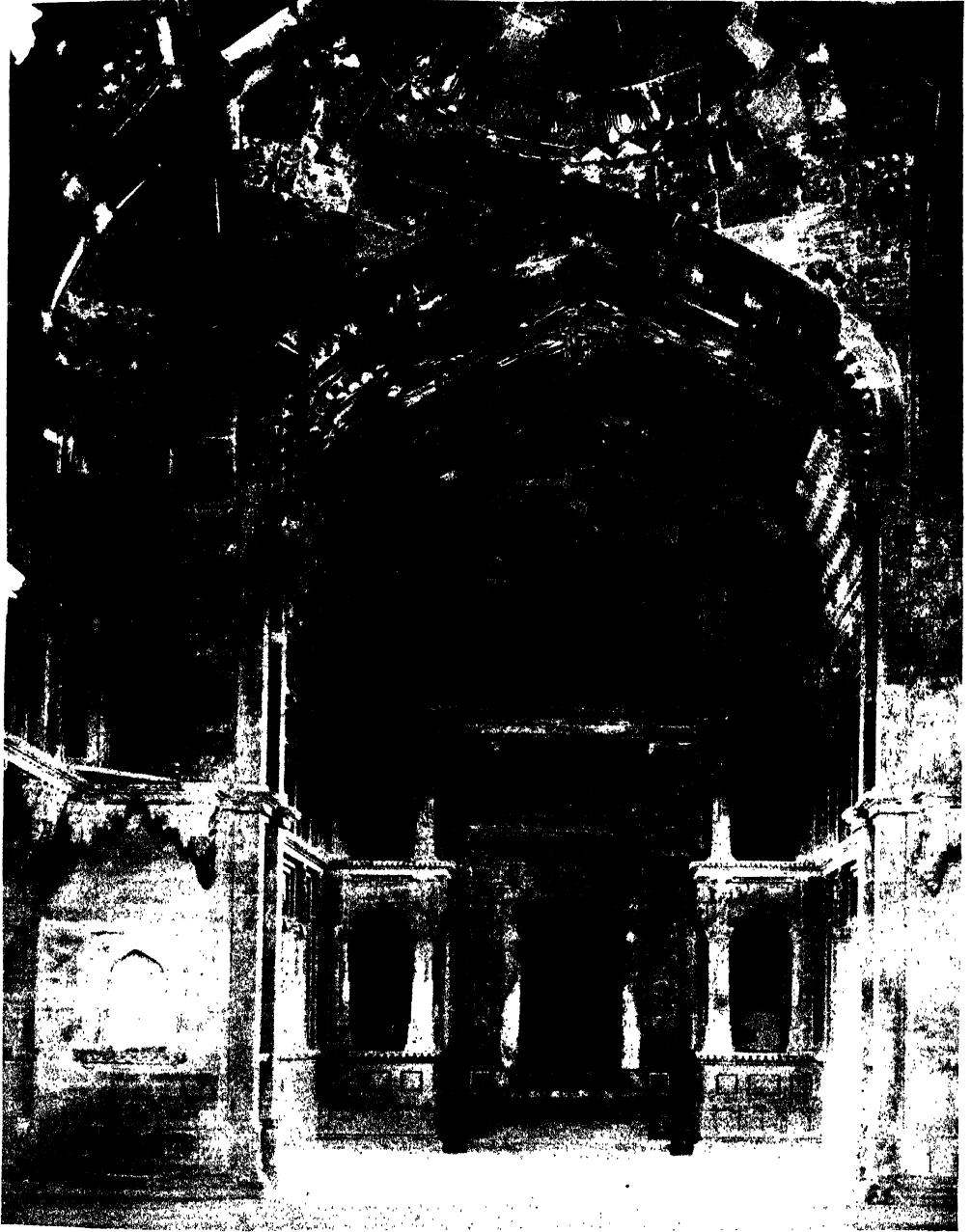

INTERIOR OF GOVIND DEVA'S TEMPLE, BRINDĀBAN



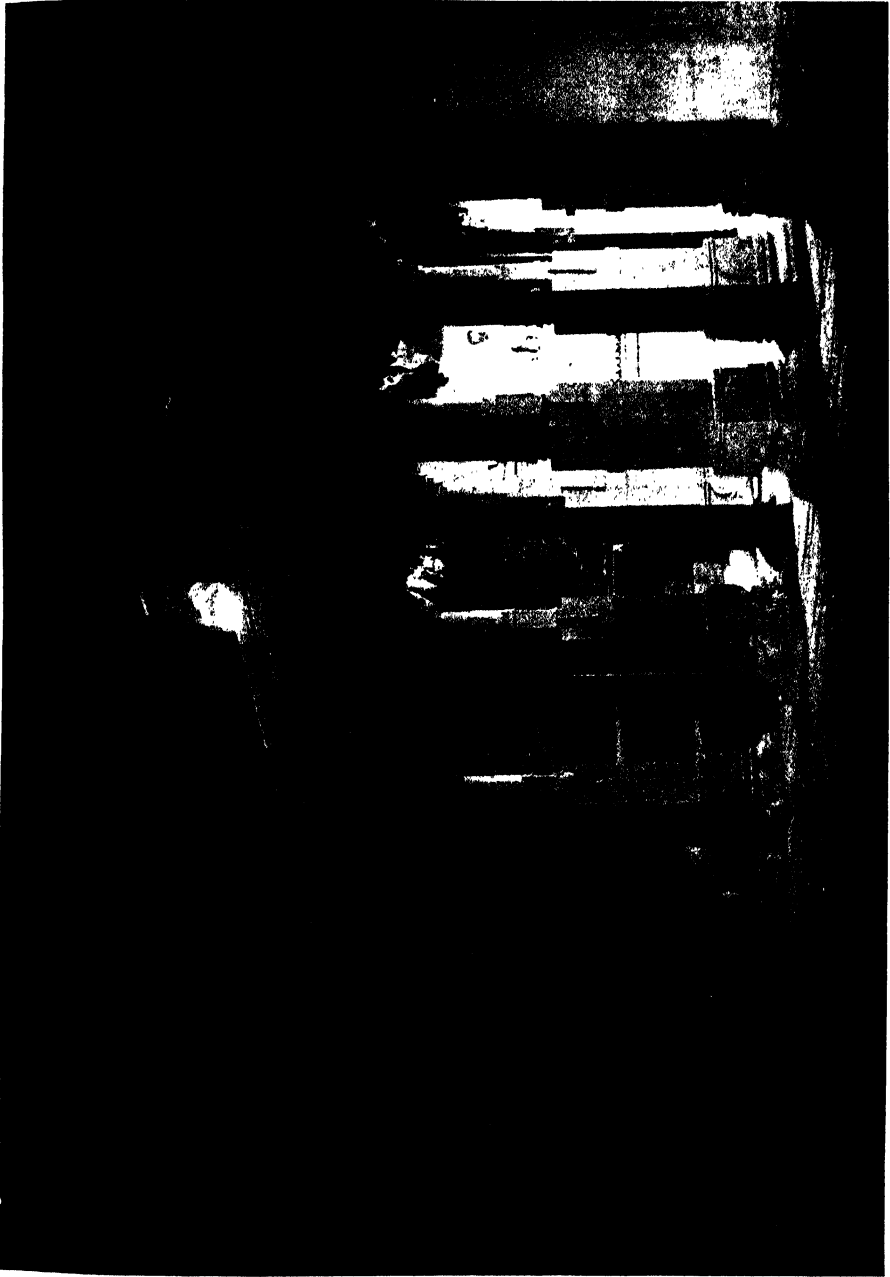

GOVIND DEVA'S TEMPLE, BRINDĀRAN



even in its present condition, to rank higher than Akbar's great mosque at Fatehpur-Sîkrî, which was built about the same time. Only a few fragments of the painted decoration now remain, but sufficient to suggest that before the desecration of the temple there must have been few buildings in Asia to rival it.

The craftsmanship is that of Fatehpur-Sîkrî, but the Hindu builders working on their own ground could deal with structural problems more freely and confidently than they were able to do under the restrictions of Musulmân ritual and custom, with the result that they achieved a structural harmony and decorative unity which are not always felt in the Jâmi' Masjid at Fatehpur.

The building as it now stands represents only the nave or approach to the holy of holies, the *garbha griha*. The intention of the original design externally may be gathered from the earlier Rajput temples, such as the Kandariya Mahadeva (Pl. XCII), which remain intact ; but probably the domes which covered the porch, or nave, were of the puritanised Hindu type, which Fergusson calls " Pathân," for this was the type which was commonly adopted by the Hindu temple builders of the time. Under Akbar's tolerant rule there was a renaissance of Jaina architecture at the sacred hill of Palitâna in Gujerat, and the sixteenth-century Jaina temples with " Pathân " domes and foliated arches (Pl. XCI) can only be distinguished from contemporary Muhammadan tombs of the same province by the spire, or sikhara, over the sacrarium.

Plate XCIV shows part of the interior of the Brindâban temple, but like most Hindu temples it has never been adequately photographed. The characteristic columns which support the roof of the cross aisles (Plate XCV) are of the same type as the symbolic Pillar or Tree of the Universe on which Akbar sat enthroned at Fatehpur-Sîkrî.



Fergusson says of this temple that it is "the only one, perhaps, from which a European architect might borrow a few hints." If architecture in Europe is always to be regarded from the archæological standpoint as a problem of "style," or the adaptation of ancient buildings to modern purposes, this narrow appreciation of Hindu craftsmanship might be accepted. But the architect-craftsman who believes in the possibility of a real revival of the art of building, and understands that the history of Indian architecture is the history of Indian craftsmanship, will find that the Hindu temple-craft was the main source from which all Muhammadan ideas of building in India were derived. If Anglo-Indian architects would avail themselves of their opportunities, as the Muhammadans did, all the conditions necessary for a true architectural renaissance, now wanting in Europe, are present in India in the twentieth century, as they were in the time of Mahmûd of Ghaznî.

Besides this temple Mân Singh also built a palace in the Ghâts at Benares, to which his famous descendant, Raja Jai Singh,<sup>1</sup> a century later added an astronomical observatory. The façade of it fell into ruin and was badly restored in the middle of the nineteenth century. Pl. XCVI shows one of the beautiful stone balconies which belong to the original building. Another palace at Govardhan, near Mathurâ, which has also suffered from modern restoration, is attributed to Mân Singh<sup>2</sup>; but most of the finest Hindu palaces now existing belong to the latter half of the seventeenth or to the eighteenth century.

<sup>1</sup> Jai Singh was employed by the Mogul Emperor, Muhammad Shah, to revise the calendar, which had become very confusing owing to the inaccuracy of the then existing tables. He built four other observatories—at Delhi, Mathurâ, Ujjain, and at Jaipur.

<sup>2</sup> For illustration see Growse's "Mathura," p. 303.

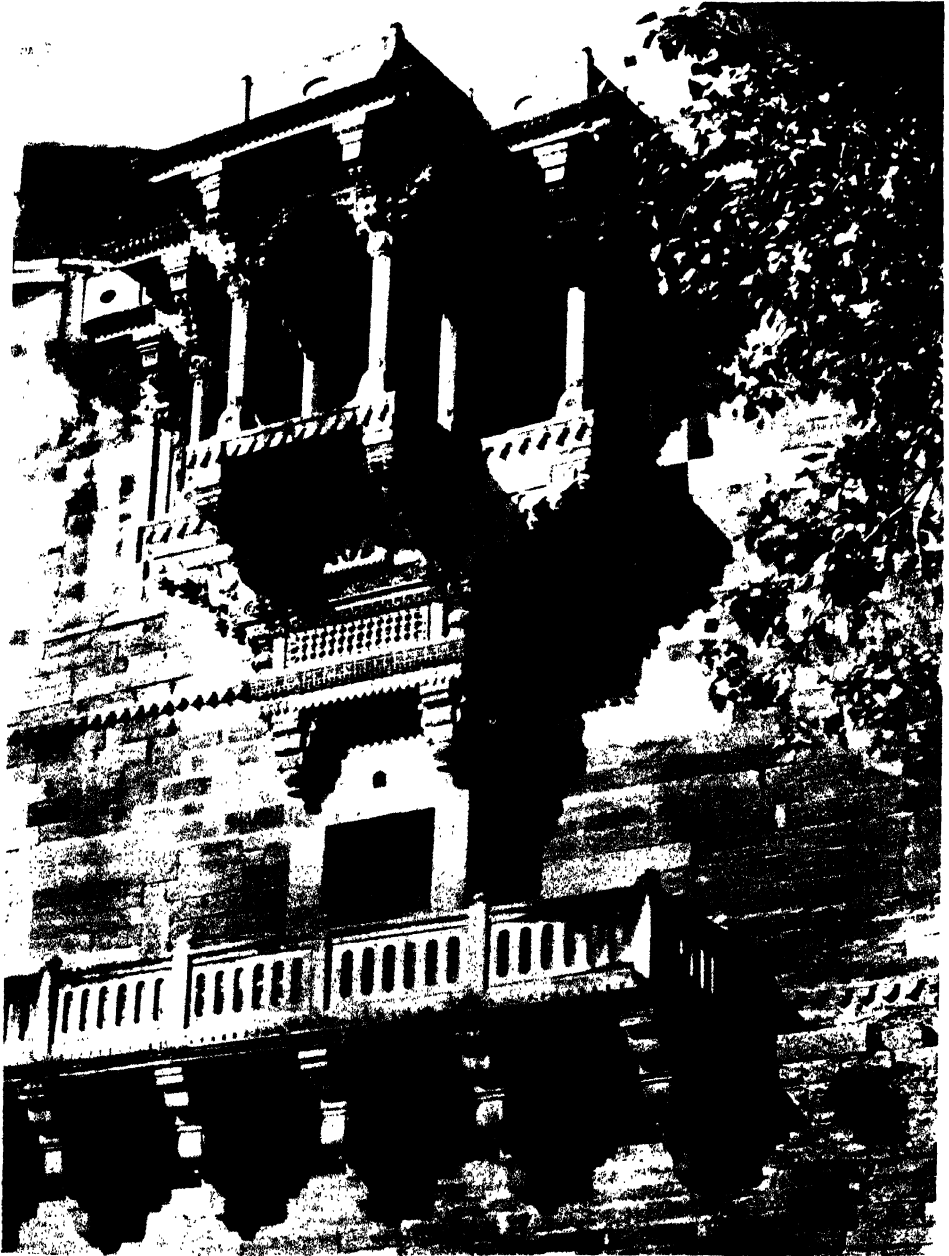

BALCONY OF MÂN SINGH'S PALACE, BENARES



## CHAPTER XIII

### THE SEVENTEENTH CENTURY

BÎR SINGH DEVA'S PALACE, DATIYÂ—PALACES AT JODHPUR—  
MOGUL BUILDINGS AT AGRA AND DELHI—TIRUMALAI NAY-  
YAK'S PALACE AND CHAULTRI, MADURA—CHANDRAGIRI  
PALACE

AKBAR died in 1605, but the architectural history of the seventeenth century practically begins with the later buildings of Jahângîr's reign (1605–28), though the most characteristic of the period belong to Shah Jahân's time. Popular opinion in Europe connects the greatest monuments of the Muhammadan supremacy in India with the two last-named Mogul emperors, but a critical historian will certainly judge the sixteenth century to have been, on the whole, far richer in architectural achievement.

Excluding the Tâj Mahall—which stands apart by itself—Mogul buildings, after the first two decades of the seventeenth century, begin to show a weakening in architectonic design which was the presage of its complete decadence in the reign of Aurangzîb. The sixteenth century all over India was a period distinguished by strong creative energy and constant experiment in building. Neither Jahângîr nor Shah Jahân had Akbar's genius for constructive statesmanship, and so far as their personal influence went they only helped Indian craftsmen to clothe in more costly materials the creative ideas of the preceding century. Sumptuous decoration and lavish expenditure in material rather than intellectuality in design

were the characteristics of the later period of Mogul architecture. The tendency towards over-refinement in structural design and a dilettante prettiness in decoration seen in Jahângîr's and Shah Jahân's buildings was a faithful reflection of the change which took place in the atmosphere of the Mogul court when Akbar's strong mind ceased to govern Hindustan.

Jahângîr inherited the artistic temperament as well as the vices of Bâbar, but, except for his courage, possessed little of his ancestor's redeeming virtues. His court was crowded with adventurers of all nationalities, who were freely admitted to share in the Emperor's drunken carouses. For the three-and-twenty years of his reign the control of State affairs was practically left in the hands of the beautiful and accomplished Empress Nûr Jahân, "the Light of the World," whose name appeared on the Imperial coinage. She used her opportunities in bestowing high offices of State upon her Persian or Mogul relations, and indulged her artistic taste in extravagantly ornate buildings. Shah Jahân, the Magnificent, was a just and impartial ruler, beloved by all his subjects; but he had none of Akbar's force of character, and his palace at Delhi with its effeminate forms and precious inlay belong rather to the category of exquisite *bijouterie* than architecture.

The part which the buildings of Jahângîr and Shah Jahân have played in the history of British India, and the attention bestowed upon them by Anglo-Indian writers, have given to the later phase of Mogul architecture an importance wholly disproportionate to its merits, and has made some of the best European authorities take a completely distorted view of the general character of Muhammadan architecture in India. Thus even Professor Lethaby, who has done so much to promote the intelligent study of Western architecture, would apparently include all Muhammadan buildings in the sweeping

generalisation of "elasticity, intricacy, and glitter—suggestion of fountain spray and singing birds," which may aptly describe the *Dîwân-i-Khâs* at Delhi or *Nûr Jahân's* apartments in the Agra palace, but it has no true application to any architecture for which Akbar or any of the great Muhammadan empire-builders in India were responsible. Nor can it be applied to Indian architecture of the seventeenth century generally.

To judge the latter fairly and see later Mogul architecture in true perspective it is necessary to get away from the effeminate and luxurious atmosphere of the Delhi court into the more stimulating air of Rajputana. The virile architecture of Fatehpur-Sîkrî and of Akbar's fort at Agra was essentially Rajput, and it was the work of the master-builders at the courts of the semi-independent Princes of Rajputana which maintained throughout the seventeenth century the native vigour of Indian architecture, while the craftsmen of the Delhi court indulged the Padshah's taste for Persianised decoration and sumptuous materials—for "glitter, and suggestion of fountain spray and singing birds."

Perhaps the best example of Rajput architecture of the seventeenth century is the noble fortress-palace of *Datiyâ*, built in the first decade of it by *Bîr Singh Deva*, the Bundelâ chief of *Urchâ*,<sup>1</sup> and well worthy to rank beside any of the royal palaces of the West. Obviously this stately pile, with its suggestion of the Doge's Palace, belongs to the same building traditions as *Jodh Bâi's* palace at Fatehpur-Sîkrî and Akbar's palace at Agra; but in Fergusson's disjointed and confusing classification, according to creed and dynasty, the palace of the Hindu prince is styled "Indo-Aryan," while the other two—the work of craftsmen of the same race and building tradition—are treated in a separate compartment as "Mogul."

<sup>1</sup> Fergusson, vol. ii. p. 175.

Fergusson himself called attention to the necessity of a proper survey of the palaces of Rajputana to enable the architectural student to appreciate them properly, but unfortunately nothing seems to have been done in the last fifty years to provide the necessary material for a closer study of them. No doubt Fergusson himself is largely responsible for the absurd notion that Hindu craftsmen were lacking in creative capacity, which has not only made Indian architecture a sealed book to competent Western critics, but has diverted architectural study in India into an historical cul-de-sac.

Pl. XCVII-XCVIII will, however, give a good idea of the exterior of Bîr Singh's palace at Dاتیyâ.<sup>1</sup> It is a massive pile of granite, over 300 feet square in plan and raised upon a vaulted basement about 40 feet high. Above this it is built in four stories ; the two upper ones are ranged round an inner courtyard, like most Indian palaces. In the centre of this courtyard the private apartments of the palace form another square block, also four stories in height. The two lower stories of the main building contain the great public reception-rooms which extend over the whole area of it, the upper ones forming the enclosure of the inner quadrangle. The larger apartments of these upper stories, placed at the four corners and in the middle of each of the four sides of the main building, are crowned with domes, four kiosks with cupolas being grouped round them according to the usual Hindu symbolism. The similar panch-ratna group of domes of the private apartments, rising in the centre of the quadrangle to about 140 feet above the basement, combines with the others to make a singularly pleasing skyline.

The skill with which the outer walls are treated architecturally, without the self-conscious striving after " effect "

<sup>1</sup> See also frontispiece.

PLATE XCVII

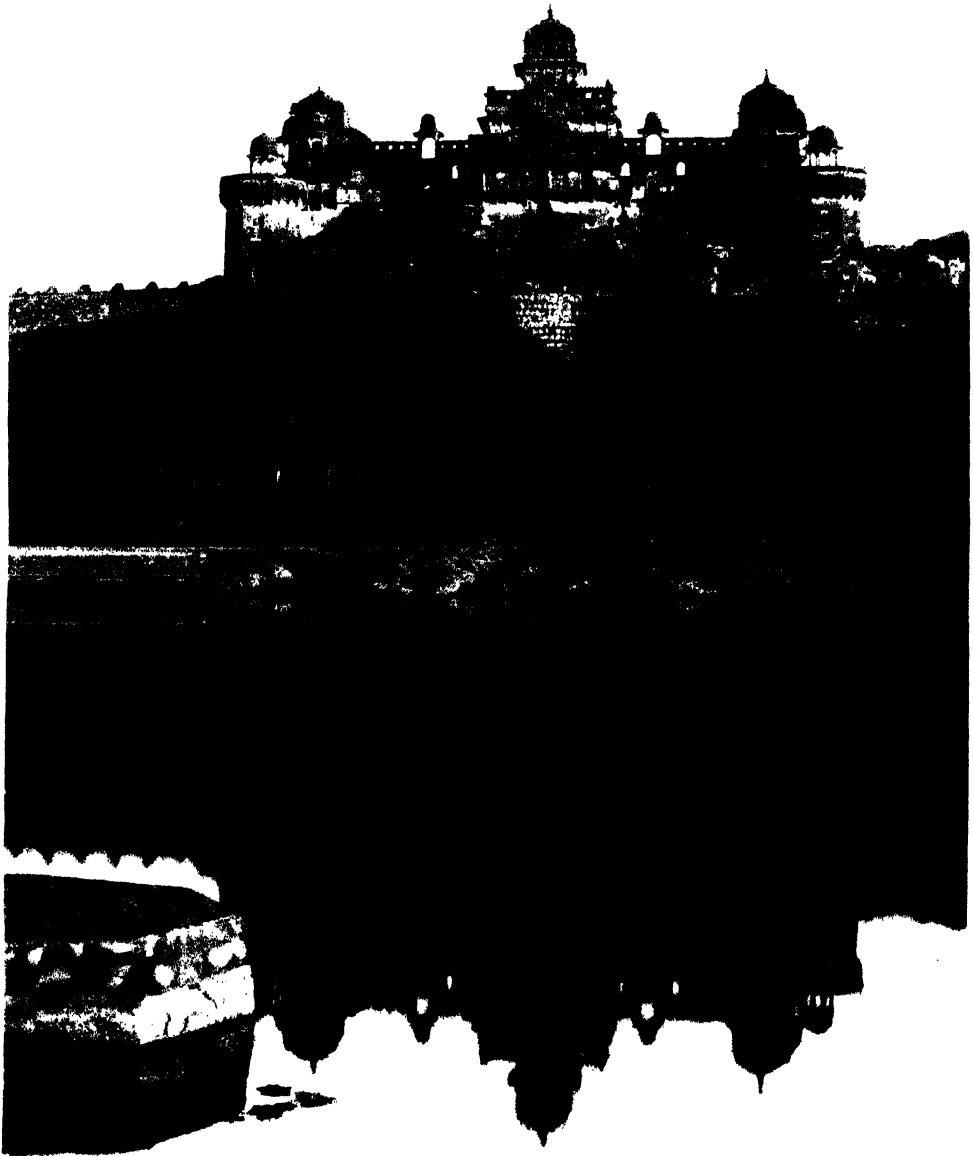

BÍR SINGH DEVA'S PALACE, DATIYÁ : WATER FRONT





PLATE XCVIII

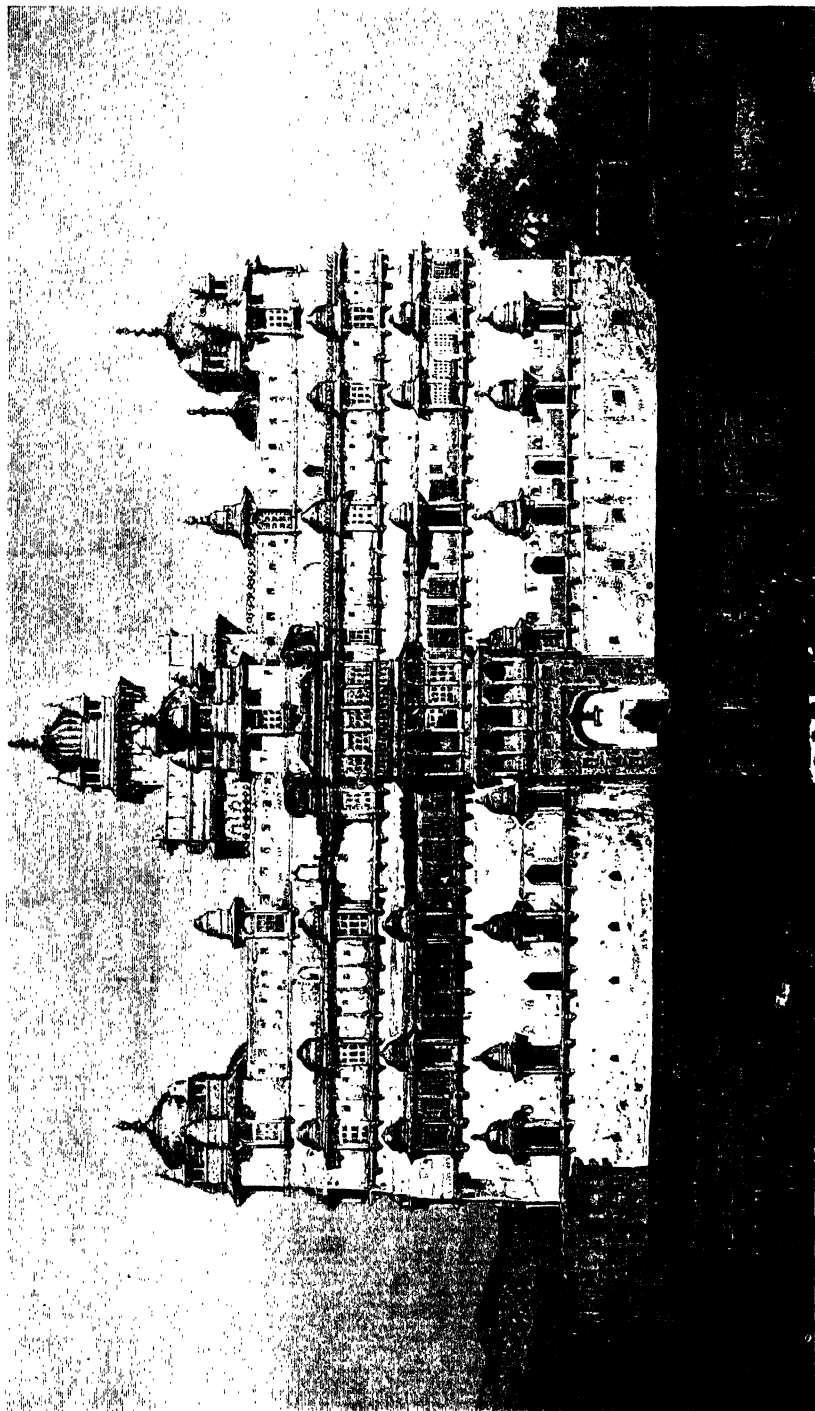

BÍR SINGH DEVA'S PALACE, DATIYÁ: EASTERN FAÇADE  
(From Rousslet's "L'Inde des Rajahs.")



which is characteristic of the creations of the modern architectural stylist, and the harmonious grouping of the buildings collected at the foot of the palace walls—contributing to the impression of a spontaneous organic growth rather than conscious mental effort on the part of the designer—are among the æsthetic factors which make up the romantic charm of this Rajput fortress-palace and distinguish the art of a great living tradition from the “designing” of modern Western architecture.

This so-called “Indo-Aryan” style has exactly the same characteristics, structural and decorative, as the “Indo-Saracenic” of Fatehpur-Sîkrî and Agra. From the builders’ point of view the distinction is entirely fallacious. The illustrations will show the Persianised entrance gateway and the “Saracenic” arches of the windows behind the balconies: they are forms which the seventeenth-century Rajput builder had made his own and used indiscriminately, whether his employer were Hindu or Musulmân.

Bîr Singh built another great palace at Urchâ (Pl. XCIX), hardly less interesting architecturally than the other, and certainly ranking higher than most of the effeminate palatial structures of Jahângîr and Shah Jahân, which owe their charm not to greatness of architectonic conception but to consummate craftsmanship and exquisiteness of decorative detail.

The same might be said of most of the Hindu fortress-palaces of Rajputana. They form a unique chapter in Indian architectural history—as yet unwritten. If *our* poets had sung them, *our* painters had pictured them, *our* heroes and famous men had lived in them, their romantic beauty would be on every man’s lips in Europe. Libraries of architectural treatises would have been written on them. The degradation of artistic culture in India, propagated and encouraged by

Western administrative methods in the name of progress, is only too clearly evidenced in the taste of the "progressive" prince of the present day, who substitutes the pinchbeck "styles" of modern European paper architecture for the magnificent building art of his own master-craftsmen—artists who faithfully and honestly, century after century even to the present day, have adopted their great traditions to the needs of the age in which they lived.

Jodhpur, still the centre of a fine living building craft, was founded in 1498. The fort and palace (Plate C) belong to different periods of the sixteenth and seventeenth centuries. Grandly massed upon a rocky height overlooking the city and an endless expanse of plain—only dotted with other solitary crags rising up like islands in a sea—this splendid pile seen from a distance is one of the most striking in India; and the beautiful details of it seen closely are not less interesting to the architectural student.

Udaipur with its lovely lake and islands palace is another Rajput city as yet unspoiled architecturally by the modern vandal. Chitor, the historic citadel of Rânâs of Mewar, was its parent. The palaces were built at different times, but mostly in the seventeenth and eighteenth centuries. The fine palace of Amber, the parent of the modern Jaipur, was built between 1625 and 1666.

There are, as Fergusson states, twenty or thirty royal palaces in Rajputana and Central India, every one of which would require a volume to describe in detail. For the present I must limit myself to showing a few types and to pointing out the position they take in the history of Indian architecture—a much more important one than is generally recognised.

The buildings of the seventeenth century which can be classified as Mogul have been so often illustrated that it is

PLATE XCIX

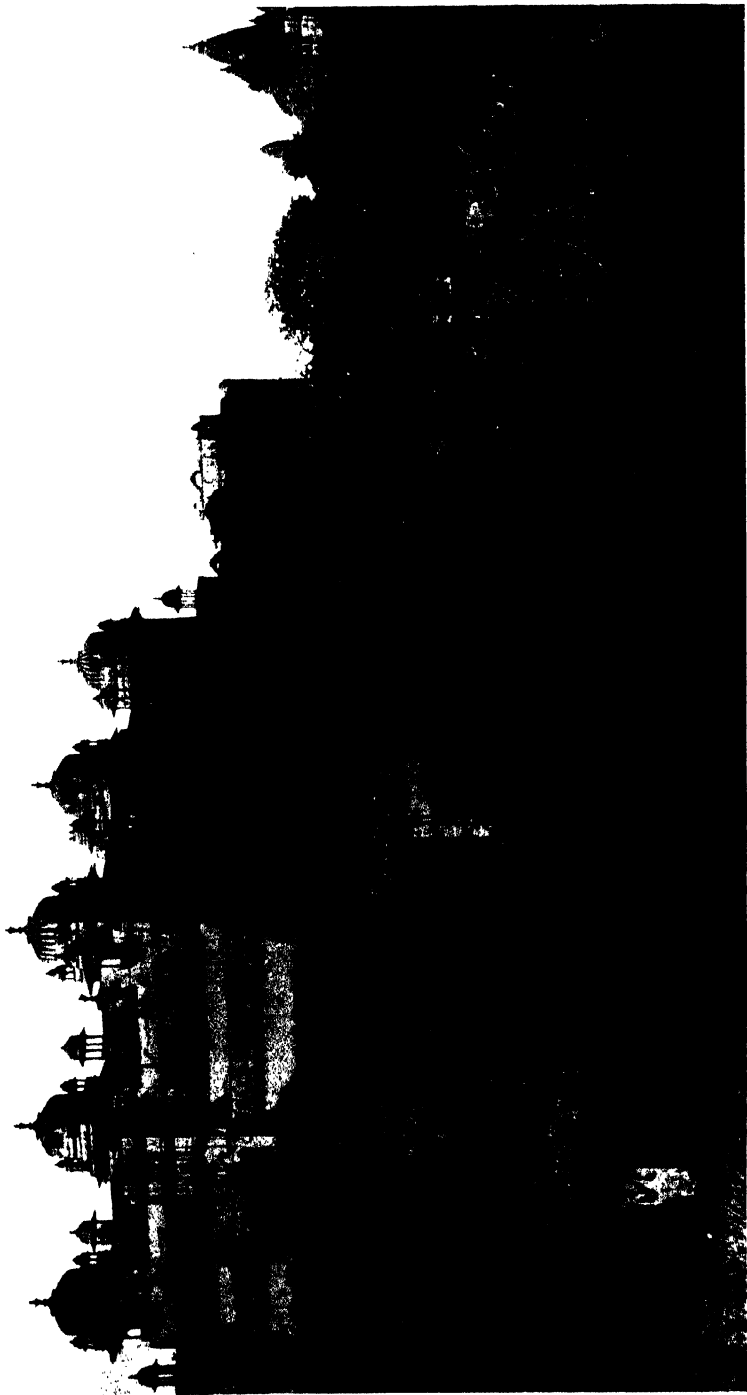

PALACE OF ÚRCHÁ



PLATE C



JODHPUR FORT AND PALACE





almost superfluous to describe them in detail again. It will be more instructive to group them together and point out some of the structural characteristics which differentiate them from the buildings of the preceding century. Fergusson's statement that "there is no trace of Hinduism in the works of Jahângîr and Shah Jahân"<sup>1</sup> is altogether erroneous and misleading. Neither of these Mogul sovereigns had any anti-Hindu prejudices: the joint partnership of Hindu and Musulmân craftsmen in Mogul buildings which Akbar had established remained unbroken until the reign of Aurangzîb. It was only the spirit which animated Mogul art that changed.

Akbar exercised an efficient economical control over his public works expenditure. His personal example and strict supervision of State affairs maintained a high standard of administrative honesty and efficiency throughout his empire—as the monuments of his reign testify. Jahângîr and Shah Jahân were magnificently extravagant and held the reins of State loosely. The court officials placed in charge of the construction of Government buildings used their opportunities to spend lavishly and to fleece unmercifully the unfortunate artisans under their control. During the building of the Tâj (which lasted twenty-two years), many of them, it is said, died of starvation. It must not be assumed that these rapacious Mogul paymasters were the artists who inspired Mogul architecture.

From the structural point of view the influences which account for the differences between Akbar's buildings and the Mogul buildings of the seventeenth century came mostly from Gaur and from Bijâpûr. The break-up of the great Bengal building centre towards the end of the sixteenth century sent many craftsmen of that school to the imperial Mogul court,

<sup>1</sup> "Indian Architecture," vol. ii. p. 288 (edit. 1910).

whence they migrated later on into Rajputana. Their influence became apparent in the bent roof of the Golden Pavilion in the Agra palace, the bent cornice of the Motî Masjid at Delhi, and in the cusped Hindu arches which are characteristic of most of the later Mogul buildings. We have already seen the process of their formation from the arches of Buddhist-Hindu shrines both at Gaur in the fifteenth century and at Bijâpûr in the sixteenth century.

When Aurangzîb's fanaticism drove all but the orthodox Musulmân craftsmen from the Mogul court, the Bengalis and others entered the service of Hindu princes in Rajputana, and from the beginning of the eighteenth century many of the characteristic features of the Bengali tradition appear in Rajput buildings. It is this migration of craftsmen, either voluntary or compulsory, which so long as architecture continued to be the art of building gave the true key to its historical development in all countries.

The striking divergence between the architecture of the later Moguls and the robust local styles of Rajputana which formed the character of Akbar's buildings became more and more apparent as the seventeenth century advanced. It was no doubt due to the same influence which was making itself felt in Europe at this time—the growth of dilettantism in architecture. It is easy to trace Nûr Jahân's feminine taste in her elegant apartments in the Agra palace (Plate CII) known as the Samman Burj ; and especially in the magnificent tomb which she built for her father, Mirza Ghias Beg, Jahângîr's Prime Minister.

This is one of the most eclectic of the Mogul buildings. The general planning is in strict accordance with the Indian tradition, but the usual panch-ratna grouping of domes is varied by the substitution of a Hindu vaulted roof, like that

PLATE CI

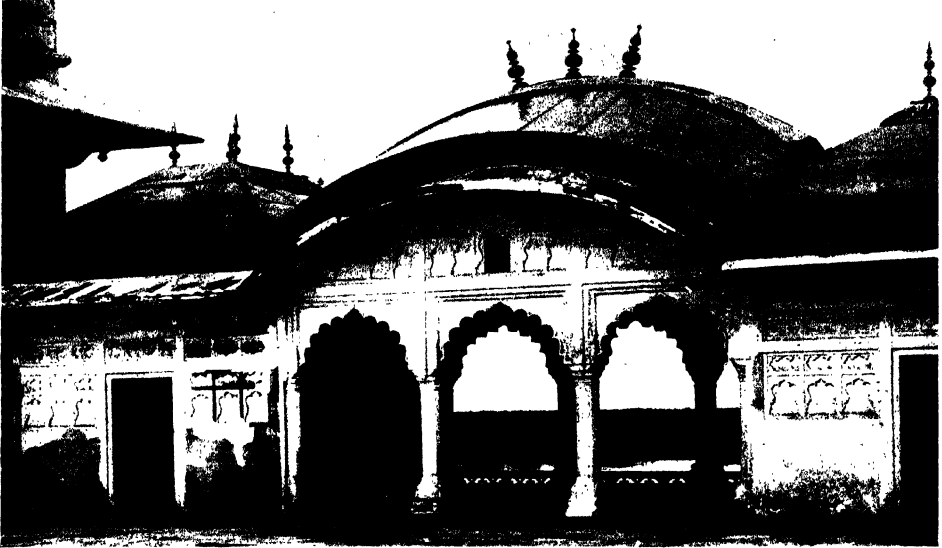

GOLDEN PAVILION, AGRA PALACE

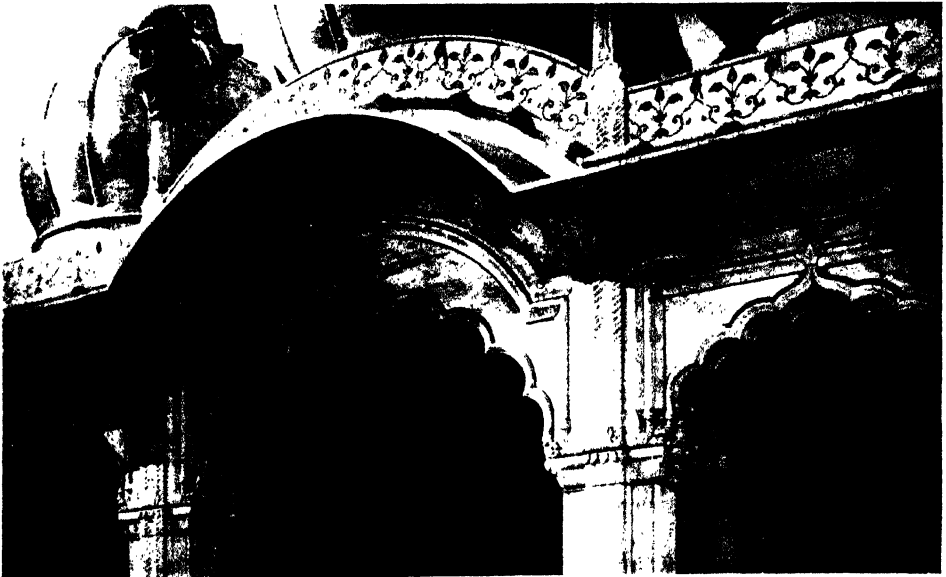

MOTI MASJID, DELHI

BENGALI ROOFS AND CORNICES



PLATE CII

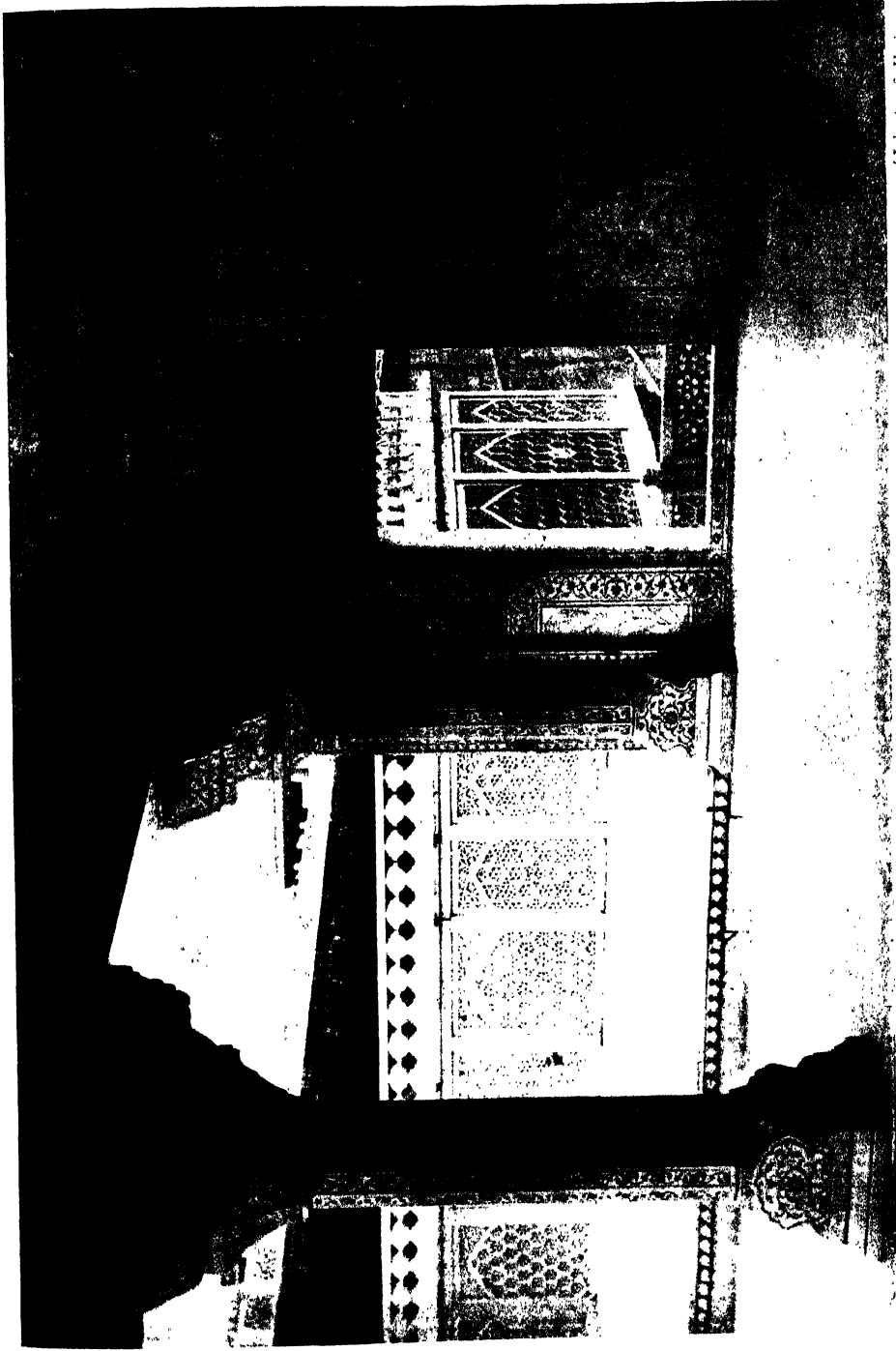

Photo by]

THE SAMMAN BURJ, AGRA PALACE

[Johnston & Hejman



over the porch of Rajah Birbal's palace at Fatehpur (Pl. LXXV), for the central dome over the sanctuary of the tomb. The towers, or stunted minarets, at the four corners of the building follow the precedent of Ibrâhîm's Rauza at Bijâpûr ; but the cupolas surmounting them are of the usual North Indian type.

It is inaccurate to apply the term " Indo-Persian " to Itmad-ud-daulah's tomb and other of Jahângîr's and Shah Jahân's buildings. The structural design of the tomb belongs to the Hindu tradition, upon which all Mogul architecture is based ; and even the inlaid decoration was in all probability entirely designed and carried out by the same Hindu craftsmen who afterwards executed that of the Tâj Mahall. Nûr Jahân's intention was to reproduce in marble and precious inlay the enamelled tile mosaic of Persian tombs ; but Persian craftsmen who were not skilled in fine masonry could not do this for her. The Indian masons, therefore, with their usual versatility adapted their craft to the Empress's taste.<sup>1</sup>

Jahângîr left no marked personal impression upon his palace in the Lahore Fort, where he resided for the greater part of his reign. None of his buildings there can compare with the contemporary princely palaces of Rajputana, nor is his tomb at Shahdara of any great architectural distinction. His idiosyncrasies were more strongly shown in the delightful pleasure-gardens he laid out in Kashmir, near Srinagar, where he with his beloved consort whiled away the tedium of the hot season in airy pavilions with splashing fountains, or under

<sup>1</sup> Even in Wazir Khan's mosque at Lahore, built in the beginning of Shah Jahân's reign, where tile mosaic borrowed from Persia is largely used, it is not applied in the Persian way as a protection to the brickwork, but is panelled out for purely decorative purposes in a manner characteristically Indian. The domes of the mosque and general structural arrangements also maintain an Indian character, though Fergusson labels the building as " Persian."



the shade of the stately avenues of plane trees which lined the water-courses of the gardens. Here, indeed, is the suggestion of "fountain spray and singing birds" which Western imagination applies to the whole area of Indian life.

The beginning of the reign of Shah Jahân brings us back to the point in Mogul architecture from which we started in the second chapter—the building of the Tâj Mahall. If the reader has followed closely the sketch I have given of the gradual development of the Indian building craft from the time of Mahmûd of Ghaznî, it will be clear that the Tâj, like all the other great buildings of the world, is not an isolated phenomenon, the creation of a single master-mind, but the glorious consummation of a great epoch of art. He will recognise in the "five-jewel" grouping of the domes and in the structural design of the whole mausoleum the continuity of the old Buddhist-Hindu building tradition, and the influence of its idealism in the symbols of the five elements into which human clay is dissolved after death. And from the political history of the time he will be able to trace the derivation of the "lotus-leaf" central dome back to its early Buddhist prototype through the domes of Ibrâhîm's tomb at Bijâpûr and the Hindu domes of Southern India, instead of pursuing an archæological will-o'-the-wisp in remote corners of Central Asia. The niches and semi-domed portal will recall the desecrated shrines of Buddhism which the Arabs dedicated to the ritual of Islâm.

The splendour of Shah Jahân's architectural undertakings attracted, as we have seen, master-craftsmen from all parts of the Mogul empire; but the explanation of the lotus dome of the Tâj and other of Shah Jahân's buildings is to be found in the influence of the rival Muhammadan power in the Dekhan upon the craftsmanship of the imperial Mogul court at Agra

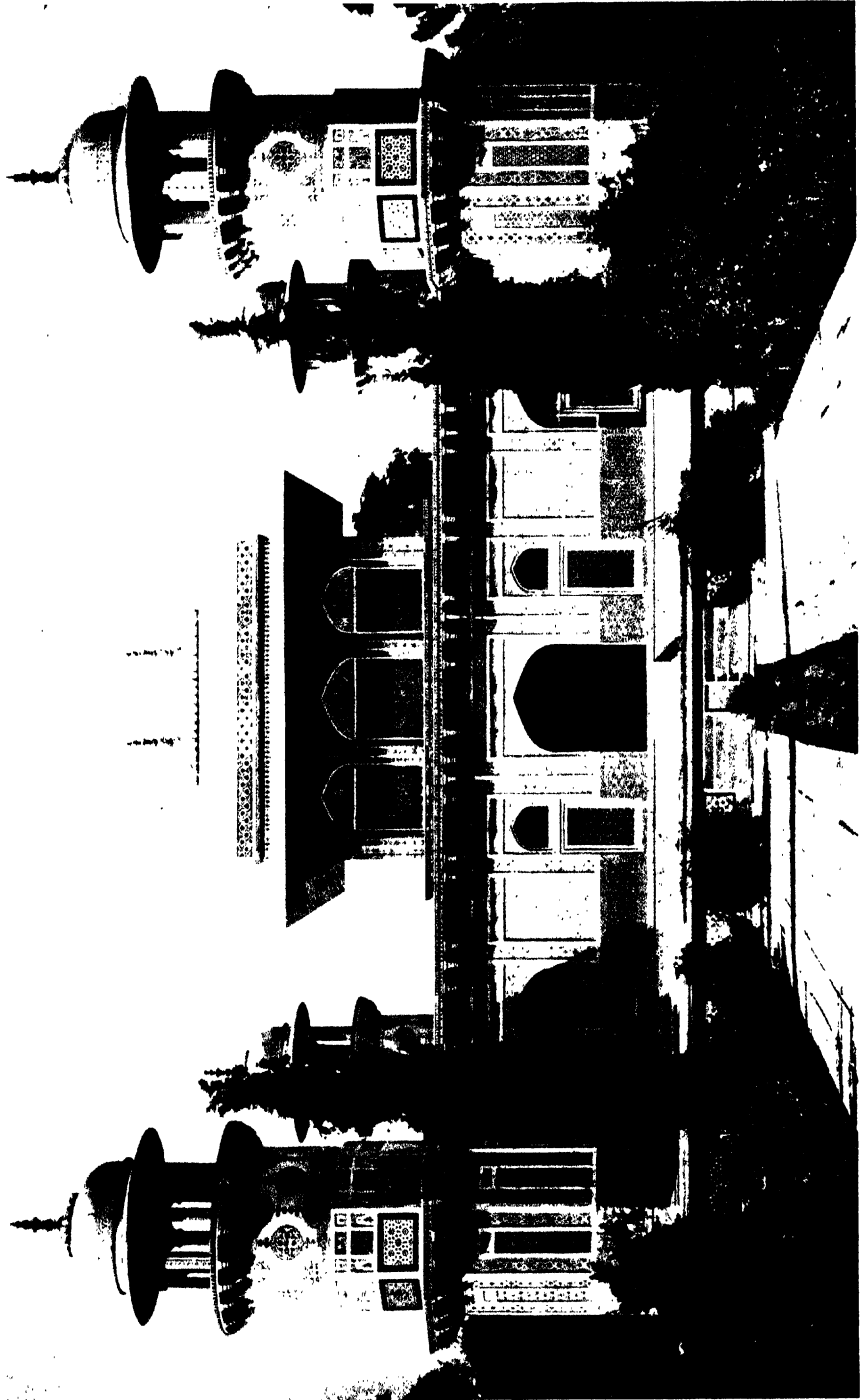

ITMAD-UD-DAULAH'S TOMB, AGRA



and Delhi. Probably, also, the wonderful marble trellis work which surrounds the cenotaph of Mumtâz Mahall must be attributed mainly to Bijâpûr craftsmen, for it has closer affinities to Bijâpûr work than to any other contemporary school of Indian craftsmanship.

This is only one of the instances in which, when the true history of Indian civilisation comes to be written, the highly developed culture of Southern India will be shown to have influenced the civilisation of the north. Western writers in many cases have not only mistaken the sources of Indian inspiration, but have been unable to distinguish the direction in which the various currents of Indian thought have run, and thus have often missed many clues to the origins of the art and civilisation of Europe.

In the Tâj, the Motî Masjid at Agra, and in the palace at Delhi, Shah Jahân's master-builders concentrated themselves more upon the effort to produce a perfect refinement of contour and decoration than upon new experiments in structural design. They applied to building the fine art of line practised by the Mogul court painters and calligraphists, in whose work both Jahângîr and Shah Jahân took a keen personal interest. In this sense the later phase of Mogul building belongs, like the contemporary Renaissance architecture of Europe, to the category of picture architecture ; and is thereby widely differentiated from the virile schools of Rajputana and other parts of India which represent the national tradition of practical building. The tomb of Mumtâz Mahall and the Motî Masjid at Agra have all the delicate perfections of the rare and most exquisite miniature pictures by the best artists of Jahângîr's and Shah Jahân's court. The inlaid decoration translates into marble and precious stones the work of the great masters of calligraphy and the loveliest floral devices which framed Mogul

pictures. The contours of the domes render architectonically the marvellous subtlety of the painter's line.

Among the most perfect of Shah Jahân's buildings, though the least known, are the marble pavilions on the embankment of the lake at Ajmîr which were rescued from departmental vandalism by Lord Curzon. They belong to the same " classic " school of Indian building of which Gujerat and Fatehpur-Sîkrî furnish many examples. In purity of form and perfection of proportion the classic schools of Europe can show nothing finer.

Shah Jahân's builders made one attempt to carry further the great tradition of Akbar's mosque at Fatehpur-Sîkrî in the Jâmi' Masjid at Delhi. It resembles its prototype in its spacious planning and in the triple domes of the lîwân, except that the Bijâpûr type of dome is substituted for that of the northern tradition. One can see, not only in the symbolism of the domes in detail but in the pyramidal piling up of the masses of the whole lîwân, an unconscious echo of the Hindu temple vimâna. Like the latter, Shah Jahân's mosque was designed to be a striking landmark which should attract the eye of the faithful from afar and proclaim the glory of Islâm over the whole surrounding country. From its largeness of conception, pleasing proportions, and the architectonic unity of the design, it must be considered one of the finest mosques of the world; but there is a coldness about the interior which makes it less attractive than many others in India.

According to Fergusson, it was begun in 1644 and completed in 1658. The lîwân is 201 feet in length by 120 feet in width. The two minars at the corners of the façade are 130 feet high.

In Southern India the architectural development which had begun at Vijayanagar in the sixteenth century continued

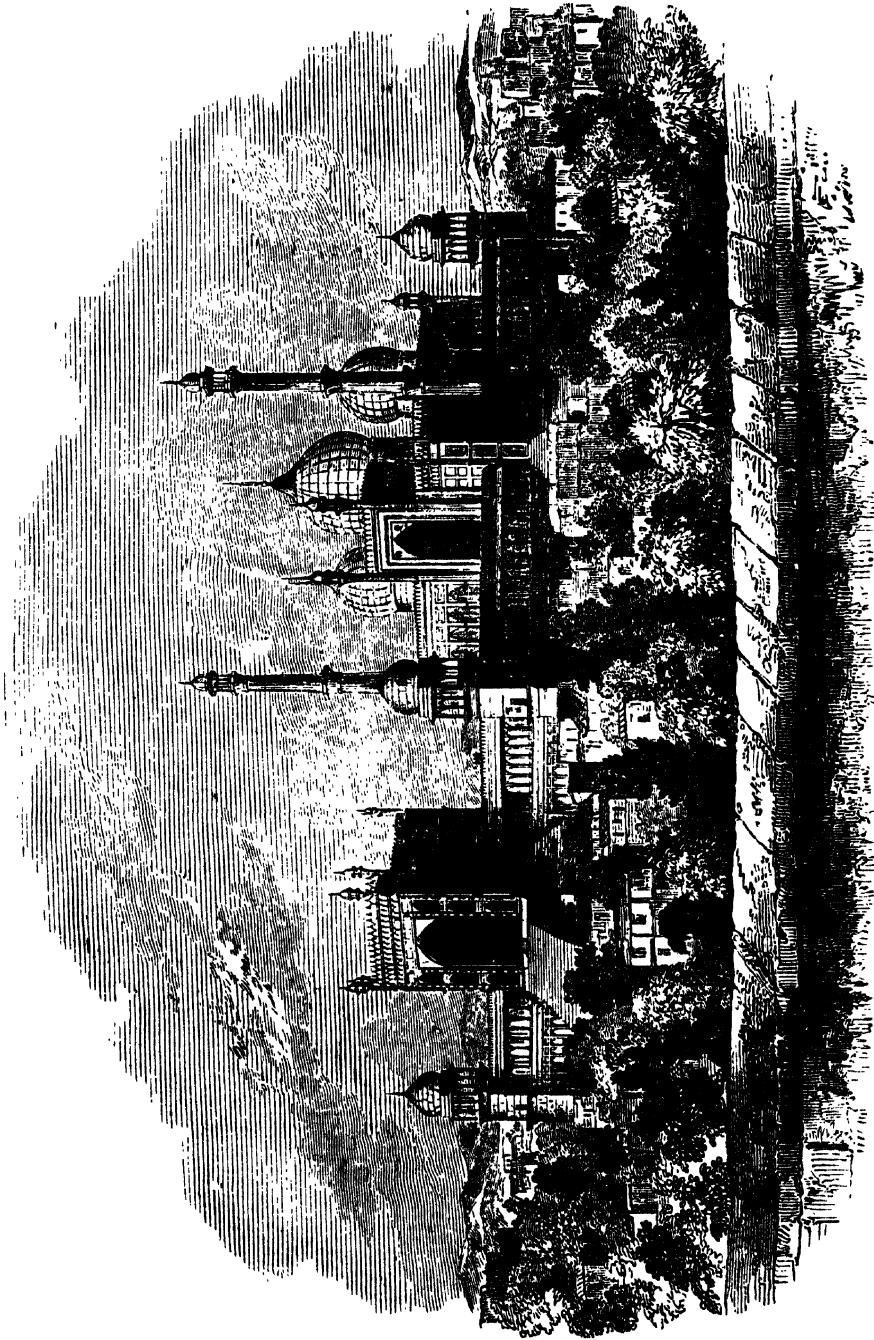

FIG. 46.—The Jami' Masjid, Delhi (from Fergusson's "History").

through the seventeenth under the Nayyak dynasty of Madura, which after the catastrophe of Talikota succeeded the kings of Vijayanagar in upholding the banner of Hinduism against the assaults of Islâm. The palace of Tirumalai Nayyak is one of the finest examples of the skill of the Hindu master-builder in adapting the Hindu arch to structural purposes, in the same way as had been done in the previous century at Vijayanagar and Bijâpûr. Fergusson rightly said of the great audience-hall (Pl. CIV), now used as a court of justice, that it possesses all the structural propriety and character of a Gothic building ; but he misunderstood the origin of the great Hindu foliated arches, and made the usual mistake of calling them " Saracenic."

Fergusson also overlooked the most significant point concerning this last development of Hindu building in Southern India, that it gives a striking indication of what the Indian master-builder might have done—and still might do—for Anglo-Indian architecture if under the British Raj he were given the same opportunities as he enjoyed under Musulmân rulers. For this great palace was the beginning of a new " style," perfectly adapted to modern Anglo-Indian purposes, and fusing into one artistic entity the individual characteristics of the three different cults now prevailing in India—Hindu, Muhammadan, and Christian. The arches are Hindu in form, but Muhammadan in application ; the " classic " columns which support them are Christian by adoption and the whole building is thoroughly European in structural character. The historical explanation of this remarkable amalgamation of architectural ideas is that Vijayanagar for a long time had intimate commercial relations with the Portuguese settlement at Goa, which in fact was almost entirely dependent upon its great trade with the wealthy capital of the South Indian

PLATE CIV



AUDIENCE-HALL, MADURA PALACE







TIRMALAL NAYYAK'S CHAULTRI, MADURA



kingdom. The fall of Vijayanagar was a great blow to the prosperity of Goa, and in the latter half of the sixteenth century the tortures of the Inquisition established by the Portuguese drove the Hindu craftsmen who had built Christian cathedrals and churches there—and even taken them as models for their own temples—to seek refuge at the court of Madura.

The influence of the Hindu craftsman's association with the European builder and his readiness to assimilate new ideas, from whatever source they might come, can be seen not only in the structure of Tirumalai's palace, but also in the marked

“classical” feeling of some of the figure-sculpture in that part of the great temple of Madura which was built about the same time.

Fergusson thought it a curious thing that the same king who built this palace (Pl. CIV) built also the temple pavilion (Pl. CV), which is so totally different in style. If he had reflected on the fact that the builders of the Gothic cathedrals

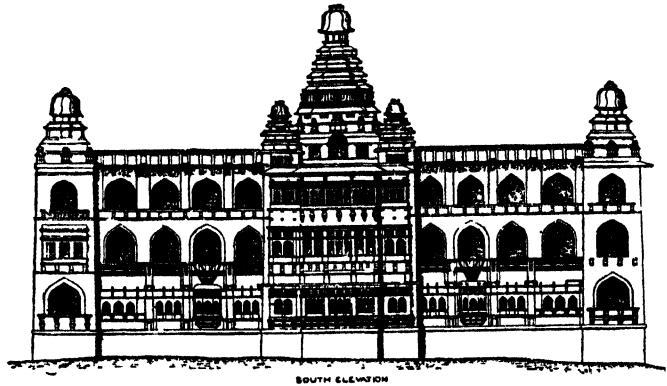

FIG. 47.—South Elevation.

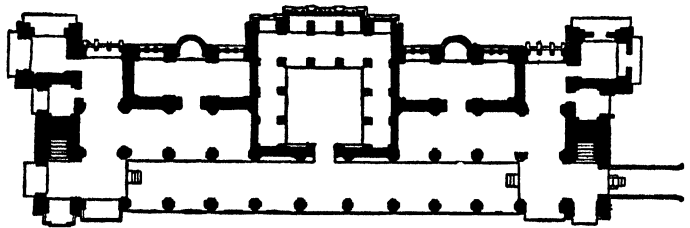

FIG. 48.—Ground Plan.

Chandragiri Palace, drawn by R. F. Chisholm, F.R.I.B.A. (from Fergusson's "History").

in Europe built also the baron's castle, the yeoman's house, and the peasant's cottage, he would have found no reason for surprise at the difference between a Hindu palace and a Hindu temple. But Fergusson did not realise that all the great architecture of India—Musulmân, Hindu, and Buddhist—had its root in temple craftsmanship.

The palace of Chandragiri, in the North Arcot district of Madras, the last stronghold of the Vijayanagar dynasty after the battle of Talikota, is another very interesting seventeenth-century example of the same South Indian school of building, which, had it been allowed to develop, might have easily solved the problem which is now puzzling the brains of British architects in Europe and in India.

Mr. R. F. Chisholm, F.R.I.B.A., who has made an especial study of these two buildings, has given plans and descriptions of the palace of Madura in "The Transactions of Royal Institute of British Architects" (vol. xxvi. 1875-6), and of the Chandragiri palace in "The Indian Antiquary" (vol. xii. 1883).

## CHAPTER XIV

### THE EIGHTEENTH CENTURY TO THE PRESENT DAY

THE DECAY OF THE MOGUL EMPIRE—TOMB OF SAFDAR JANG, DELHI—EIGHTEENTH-CENTURY BUILDINGS AT LUCKNOW—THE SIKANDARA BAGH, AGRA—MODERN RAJPUT ARCHITECTURE: THE CITY OF JAIPUR; PALACES AT DÎG AND UDAIPUR; DOMESTIC BUILDINGS—ANGLO-INDIAN ARCHITECTURE—INDIAN ARCHITECTURE IN THE VICTORIAN PERIOD—MODERN BUILDINGS

WITH the usurpation of Aurangzâib in 1658, Mogul architecture practically ceased to exist as a separate school, though the master-builders, whose occupation at the Delhi court was gone, carried with them into Rajputana the influence of the later Mogul style which was assimilated by the local Rajput schools, not always to their benefit.

There could hardly be a stronger proof that the inspiration of Muhammadan architecture in India came from the Buddhist-Hindu building tradition, and not from any Saracenic sources, than this, that immediately the co-partnership between the Musulmân and Hindu craftsmen—fruitful in great achievements and advantageous to both sides—was broken by the bigot Aurangzâib, so that the orthodox Musulmân builders were thrown upon their own artistic resources, there was not another Musulmân building in India rising above the level of mediocrity. From that time to the present day the living architecture of India has been represented by the

continuity of the indigenous tradition, Buddhist-Hindu in its origin and development.

Aurangzîb revived the iconoclastic orgies of the early Muhammadan invaders, but did not imitate their wise example in enlisting the Hindu builders into their own service. The fine arts were banished from his court, and very few architectural works were undertaken under his auspices which were not tame imitations of earlier buildings. The tomb of his wife, Rabia Daurâni, which is a feeble copy of the Tâj, has been alluded to above.<sup>1</sup>

The tomb of Safdar Jang—one of the Nawab Vazirs of Oudh—near Delhi, a pretentious, ungainly structure built about 1750, shows how mediocre Mogul architecture became as soon as Muhammadan rulers allowed sectarian prejudices to dictate the choice of architect-craftsmen for their buildings.

The stage architecture of the European dilettante began to show itself in India about the end of the eighteenth century. La Martinière at Lucknow, a creation of General Claude Martin, a Frenchman who rose to a high position in the service of the Nawabs of Oudh, is a specimen of it, neither better nor worse than the average in India. The Indian builder in the service of the Nawabs began also to imitate this foreign fashion, and though the immediate result, as shown in a number of palaces at Lucknow, was sometimes bizarre enough, there is no doubt that Indian craftsmanship, if it had been allowed to experiment as freely with European fashions as it had done with the fashions of Muhammadan rulers, would sooner or later have evolved a new tradition of building practically and æsthetically more worthy of Anglo-India than that which Anglo-India has made for itself. The palace of Madura described in the last chapter illustrates one of the most

<sup>1</sup> P. 39.



Photo by]

GATEWAY OF THE SIKANDARA BAGH, AGRA

[Firth & Co.





successful efforts of Indian builders in this direction on a large scale, but there are still to be found, all over India—even in the suburbs of Anglo-Indian cities—many minor buildings in which the Indian craftsman when left to follow his own instinct has succeeded in putting life into the dead styles of Europe by grafting them on to his own living tradition. An excellent

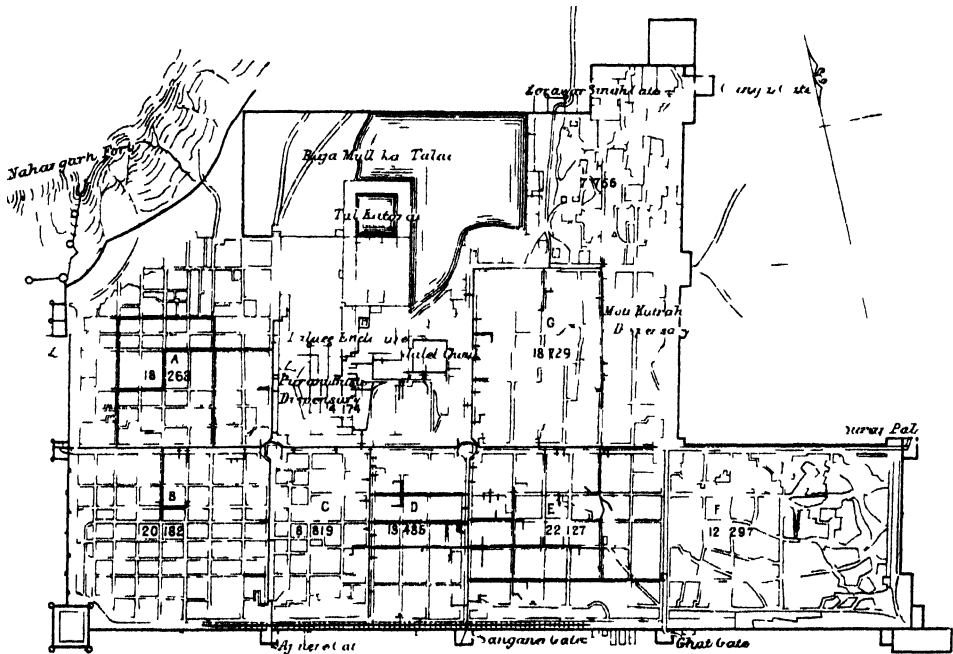

FIG 49 — Plan of the City of Jaipur

illustration of this is shown in Pl. CVI, the entrance gateway to the Sikandara Bagh at Agra, where the native craftsman, with only the banalities of our public works "styles" for models, has built in a classic style which has all the vitality and freedom of a real Pompeian villa.

Outside the atmosphere of the Mogul court, and away from the tutorship of the European dilettante, the indigenous building tradition maintained its native vigour

beyond the middle of the nineteenth century, and even now is astonishingly alive in spite of all the depressing influences which have been brought to bear upon it.

Modern Rajput architecture may be said to have begun with the building of the city of Jaipur in 1728. The palace, built at different periods in the eighteenth century, cannot be compared architecturally with many others in Rajputana, but excellent examples of the modern Indian master-builder's art are found in the city, as in every part of Rajputana and the neighbouring States.

The plan of the city of Jaipur (fig. 49) is especially interesting at a time when town-planning is regarded as a recent invention of European science, for this Indian city is one of those which has not grown up irregularly by gradual accretion : it was laid out at its foundation on a scientific plan according to the traditions of Hindu city builders and the direction of their canonical books called the *Silpa-sâstras*.

The plan given by Râm Râz called *prastara*<sup>1</sup> is very similar to that of Jaipur. The city leans upon the neighbouring hill, defended by the Nahagarh Fort, its main streets running approximately from east to west and north to south, following the directions laid down in the *Silpa-sâstras*.

The palace of Sûraj Mall at Dîg, the capital of the Bharatpur State, was commenced by the chieftain of that name, the founder of the dynasty, about 1725. It consists of a number of detached palatial residences enclosed in a splendid formal garden, with fountains and watercourses, which were intended to rival in magnificence the imperial palace at Agra, which was looted by the Jâts in 1765 ; but the whole scheme

<sup>1</sup> " Essay on the Architecture of the Hindus," Plate XLV. The orientation marked on the plates does not seem to correspond with the quotations from the *Sâstras* given in the text.

PLATE CVII

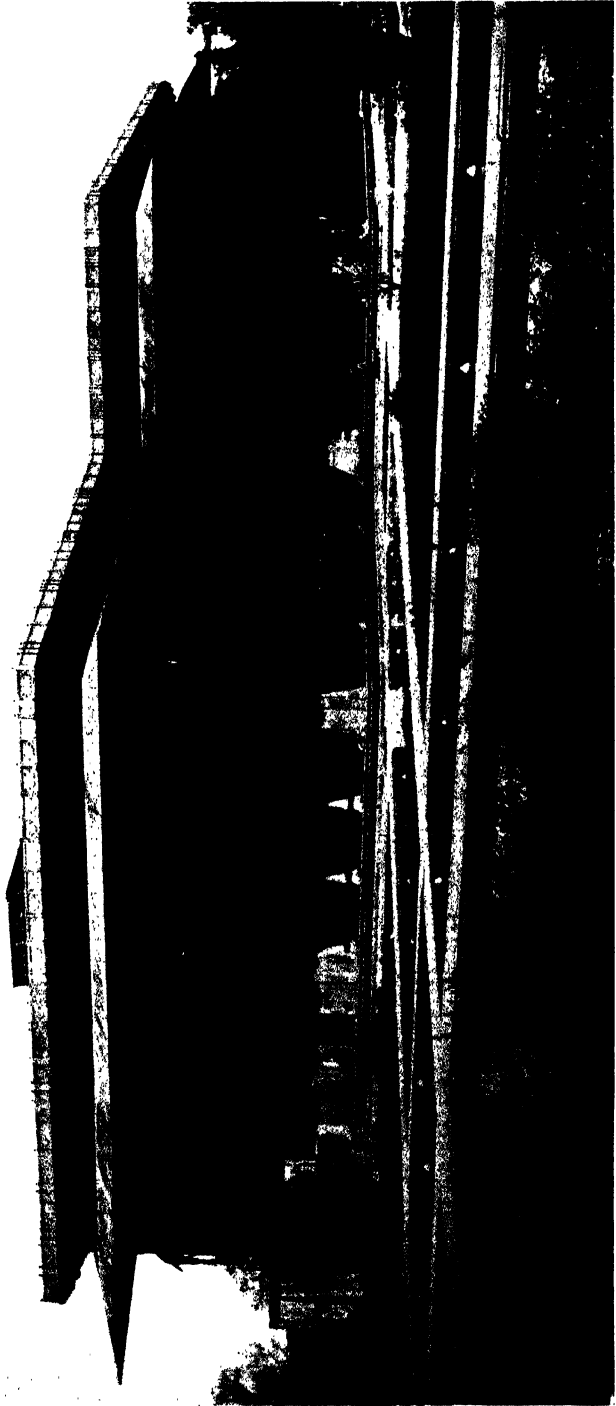

THE PALACE OF DÎG : GARDEN FRONT



was left incomplete on the death of Sûraj Mall two years earlier.

The principal block, the Gopâl Bhawân, was finished about 1750. It combines the elegance of Shah Jahân's palaces with the more robust character of Rajpur architecture, and being better adapted to the amenities of modern life than the earlier fortress-palaces of Rajputama, it is essentially interesting to the modern architect; but few, I think, would agree with Fergusson's judgment that it surpasses other Rajput palaces "in grandeur of conception and beauty of detail."

The Gopâl Bhawân contains the great Dîwân-i-âm, or public reception-hall, which faces the garden front in the south, shown in Pl. CVII. The terraced roof is given more than its usual importance as a place of promenade in the cool of the evening by the omission of domes and cupolas and by being extended on all four sides beyond the walls of the building by a bracketed parapet of pierced stonework. The combination of this parapet with the usual wide dripstone beneath it, which protects the walls from rain and sun, forms the strikingly characteristic cornice of the whole building—more original and beautiful in form than the useless "designed" cornices of Italian Renaissance palaces, which only serve the purpose of providing constant employment for the plumber, plasterer, and paperhanger by diverting the flow of rain-water from the exterior to the interior of the building.

The Gopâl Bhawân is built of red sandstone, and the foliated Hindu arches, hitherto rarely used in Rajput palaces, show that Sûraj Mall gave employment to the craftsmen who since the time of Aurangzîb had ceased to work at the Mogul court. The construction of these wide openings on the bracket principle, in two blocks of stone, instead of by radiating voussoirs, is usually attributed by the Western critic

to an obstinate Hindu prejudice against the Western arch. Really it is the simplest, most practical, and most artistic way of dealing with such a form when good building stone of sufficient size is easily procurable. No intelligent craftsman would go out of his way to build up such a complicated arch in several dozen different wedges when he had good stone at hand for making it in two pieces. Only the European stylist trained by books and paper methods, who tries to teach the practical craftsman his own business, would be so foolish.

The private apartments of the Gopâl Bhawân occupy the north, east, and west sides of the building. The north front (Pl. CVIII) faces a large bathing-tank, and is charmingly diversified by a number of balconies and two large open pavilions with typical Bengali roofs. Placed on the side of the Grand Canal at Venice, it would be acclaimed as the most delightful of Venetian palaces. We have already noticed how Bengali craftsmen had left their mark upon the buildings of Shah Jahân at Agra and Delhi. The Dîg palace evidences their migration into Rajputana, where the characteristic bent roofs and cornices of Gaur were adopted by the Rajput builders and still belong to the local craft tradition.

Pl. CIX shows a representative palatial building in Udaipur belonging to the modern period, or the early part of the eighteenth century. Modern architecture in Rajputana presents many varied local types, racy of the soil and of the sturdy independence of the Rajput people, who, though steadfastly loyal to the British Raj, are still proud of their past history and attached to their own culture and living traditions. For though a "progressive" Prince may assume the architectural fashions of Stratford-atte-Bowe when he builds a new palace, so that his master-craftsmen are employed for the time being in copying the paper patterns prepared by the

PLATE CVIII

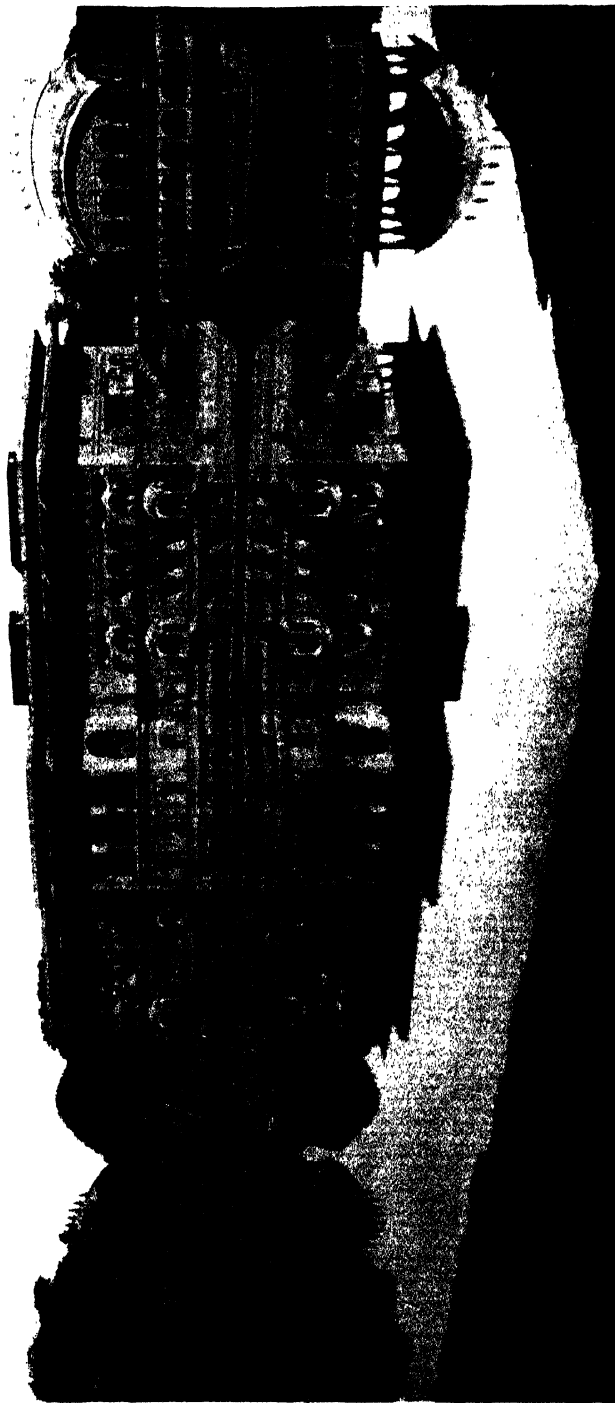

THE PALACE OF D'G: WATER FRONT





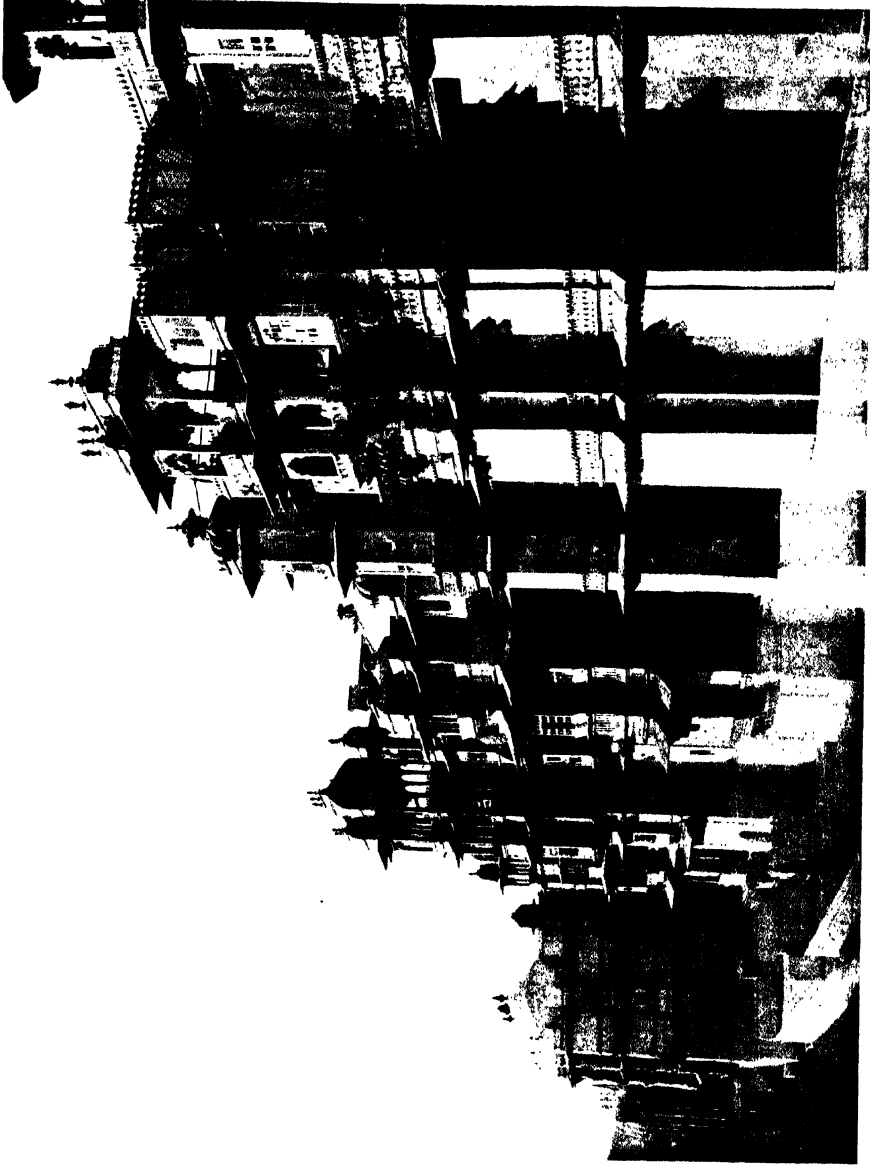

PALACE OF UDAIPUR



European "designer" or by the Indian engineer who has learnt the regulation designs by heart at a technical college or perhaps in a London architect's office—this is a mere episode in the life of the people, like the occasional visit of a European *burra-Sahib*.

The domestic architecture of Rajputana remains, on the whole, a strong living craft. Not only in Rajputana and Central India, but over the greater part of India, it is still true, what Fergusson wrote thirty years ago, that if Indians of the upper classes could be persuaded to take a pride in their own art, their master-builders could even now rival the works of their forefathers : for building is one of the master-crafts which are most closely bound up with the real life of the people, and consequently always retains its vitality longer than the sumptuary arts, which, being less essential to life, are more subject to the caprices of fashion. Pl. CX, a rich merchant's house in Bikanâr, is a superb example of the modern domestic architecture of Rajputana, which often shows a much finer architectural quality than the palatial buildings of the ruling Princes. This one, which probably belongs to the early part of the nineteenth century, is truly as fine as any Mogul Emperor's palace. The Rajput builder of the present day builds almost as well when he is given similar opportunities.

Only within the last few years has it dawned upon the more enlightened of the art critics of Europe that up to the middle of the nineteenth century a great national tradition of painting survived in Northern India. The existence of an even stronger school of building craft in many parts of India is still as much unknown to the Western architectural scholar and practitioner as it is to Anglo-Indian departmentalism. For over fifty years the Public Works Department has made an official monopoly of State buildings in British India, applying

to them its own dryasdust formularies culled from Macaulay's bookshelf, and the products of this system loom so large in the life of Anglo-India that the very existence of the Indian master-builder is sometimes forgotten.<sup>1</sup> But the life of the great caravanserais at Bombay and Calcutta and that of the smaller camps scattered over British India is so remote from the real life of the Indian people that these fashions of the West, though generally adopted by "progressive" Princes and other English-educated Indians, cannot affect Indian art and craft so as to wholly destroy them until all India has become a suburb of London and Paris ; and as that is never likely to happen, there is no reason to expect that Indian civilisation will become extinct or cease to fulfil its great mission in the world.

But there is a real danger, that through ever-increasing facilities for travelling and the over-centralisation of administrative methods, the present gulf between the rulers and the ruled will continue imperceptibly to grow wider and wider.

The Indian craftsman is banished from the court as he was in the days of Aurangzîb ; but it is the art of the court, not the art of the people, that suffers most thereby. For architecture may be a profession, a business, an amusement, or a fashion, but it can never be a living art unless it is deeply rooted in the soil in which it grows. In this deeper sense there is no architecture yet within the confines of Anglo-India, nor even a promise of any development beyond parasitical growths which are sapping the vitality of the real Indian art which lies outside the camp life of the rulers of India. There is nothing at all surprising in this fact. The Muhammadan

<sup>1</sup> The Director of Industries in Madras, Mr. A. Chatterton, declared lately that the Indian master-builder is a figment of my imagination ! I have reason to believe that many Anglo-Indian officials are of the same opinion.

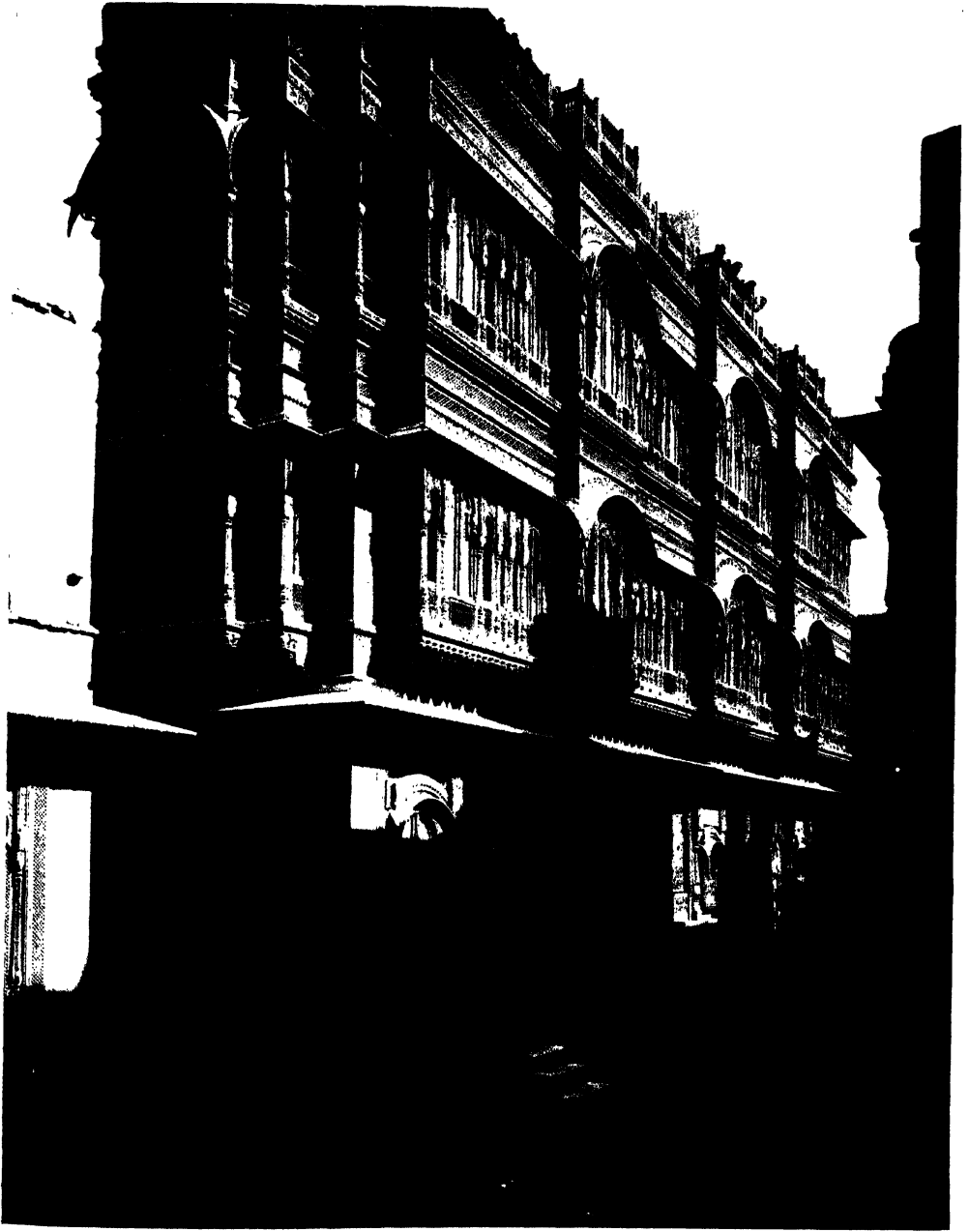

A MERCHANT'S HOUSE, BIKANIR



rulers of India had no architecture they could call their own until they had sat at the feet of the Indian master-builders for several centuries. We have not yet admitted him into the fellowship of art or understood how to make use of the Indian craftsman except in the relationship of master and servant.

That which is called architecture in the Anglo-Indian caravanserais is merely a mechanical process, originally invented by the dilettanti of the Renaissance in Europe, for tricking out the business arrangements of the Anglo-Indian administration in tinsel adornments called “ styles.” The official architect sits in his office at Simla, Calcutta, or Bombay, surrounded by pattern-books of styles—Renaissance, Gothic, Indo-Saracenic, and the like—and, having calculated precisely the dimensions and arrangement of a building suited to departmental requirements, offers for approval a choice of the “ styles ” which please him or his superiors, for clothing the structure with architectural garments in varying degrees of smartness, according to the purpose for which it is intended, at so much per square foot.

When these preliminaries are settled, a set of paper patterns is prepared and contractors are invited to undertake to get these patterns worked out to proper scale and in the regulation materials. Then, at last, the Indian craftsman is called in to assist in the operations, under the supervision of the contractor and subordinate Public Works officials, who check any tendency the craftsman may show to use his imagination or his intelligence in anything beyond copying the departmental paper patterns.

Inevitably under this system, the evils of which are now clearly recognised by architects in Europe, a special type of artisan is created—in India as in Europe—a mechanic who works listlessly for the wages he earns and has no interest in



anything beyond his earnings. The craftsman inevitably becomes (as the Consulting Architect to the Government of India recently declared) master of one art only—the art of scamping. The same might be said of the ordinary artisan produced by the same system in Europe. Inevitably, also, the system tends to the gradual destruction of Indian industry in materials and processes connected with building. Chained to an office at Simla or Calcutta by the traditions of departmentalism which he is powerless to alter, the architect can calculate the cost of steel girders and framework, order them through an Anglo-Indian agency, and get unskilled Indian labour to fit them in position. But it is impossible for him to study thoroughly Indian methods of construction in stone, brick, or wood, and to co-operate with the intelligence and skill of the hereditary Indian craftsman in applying them on the actual site of the building. Similarly, it becomes more “progressive”—in the departmental sense, but no other—to use the European wall-papers, Portland cement, and Messrs. Blank & Co.’s patent paints in place of Indian fine polished chunam, stencilling, or fresco painting.

The Indian craftsman known to Anglo-India belongs almost exclusively to the type of labourer created in the last fifty or sixty years by this departmental system of making architecture a by-study in mechanical engineering. From their experience of him and his work the characteristics of the Hindu craftsman—his patient, plodding labour, his slovenliness, lack of energy, imagination, and creative power—have been drawn by Anglo-Indian critics. From the same narrow field of observation has been formulated the historical theory of Indian art, formulated by Sir George Birdwood and other writers, that it is a mixture of foreign ingredients—Turanian, Egyptian, Chaldæan, Assyrian, Greek, and Sara-



BUILDINGS AT JODHPUR



cenic—received by the Hindu craftsman and patiently compounded century by century with the same assiduous, unpractical, uninspired plodding, under the direction of their foreign masters. The popular idea that Indian architecture began with the Muhammadans and died with the last of the Mogul dynasty comes from the same source.

A practical illustration will make the working of this system more clear than any general statements. The new Military Secretariat offices in Calcutta were one of those buildings in which Lord Curzon took a keen personal interest. The building of it was arranged departmentally in this wise: The plans were, as usual, drawn up by the Public Works Department in consultation with the Military Department; but a new departure was made in this case, by means of a public prize competition, to invoke the aid of extra-departmental talent in the process of fitting a façade to the departmental plans. No instructions were given as to the "style" required, but on account of Lord Curzon's public declarations of sympathy with Indian art, nearly all the drawings sent in were more or less oriental in character. Lord Curzon, however, selected one of the very few which were in the Renaissance "style," on the ground that it was the only "style" suitable for an Anglo-Indian city.

After a certain amount of revision and elaboration under Lord Curzon's personal direction, the usual working drawings were prepared in the official architect's office, and Indian craftsmen of the Public Works type were called in to construct the building accordingly. A difficulty, however, arose with regard to the sculptured ornamentation of the façade. The Renaissance "design" provided for a number of nondescript classical heads connected with Renaissance ribbons and festoons. The official architect wanted to give the sculpture a

symbolical touch by repeating the heads of Mars and Venus alternately throughout the length of the façade, but unfortunately the Indian masons, who could carve finely the Hindu war-god and goddess—Kârttikeya and Durgâ—did not know what Mars and Venus were like. The difficulty was solved by indenting on the School of Art for two antique plaster casts as models. Mars was out of stock, so Juno took his place, and eventually a long row of the Græco-Roman militant goddesses, carved by Indian masons, adorned the façade of the Military Secretariat offices. But the cost of the building was greatly augmented by the “ style ” adopted. An Indian mason can carve Durgâ and Kârttikeya well for fourpence a day without European supervision<sup>1</sup> ; for copying Juno or Venus badly he must be paid eight times that sum and must be carefully watched by European expert “ designers ” paid much more highly.

The European dilettanti who rule India do not generally know that any other system than this is possible or desirable, and the more interest they take in architecture as an archaeological study the more they appreciate the opportunities for selecting “ styles ” which departmental methods afford them. The European architect in India who has followed the trend of the best European practice in the last twenty years knows not only that a better system is possible, but that no real architectural progress can be made under present conditions. He is helpless in the toils of a vicious system, for which the education of the British public schoolboy and University undergraduate is primarily responsible. Knowing little or nothing of Indian craftsmanship outside the official area—for he has been trained entirely in Europe, and is put into official

<sup>1</sup> Fourpence a day are the average earnings of modern architectural sculptors in Orissa, whose work is shown in Plates CXXVII-CXXVIII.

PLATE CXII



*Photo by]*

*[Dr. A. K. Coomaraswamy.*

A SOUTH INDIAN TEMPLE *STAPATHI*



PLATE CXIII



Photo by:

3326

Dr. J. K. Coomaraswamy

INDIAN MASONS AT WORK





harness directly he lands in India—he naturally looks for a remedy in more European supervision, more European teaching, and a closer imitation of European methods.

And so long as the Government of India continue to hold out to architects in Europe tempting commissions by which a fortune can be made in a few years, suggestions for reform of the present system in India are not likely to originate in the united professional opinion of Great Britain, however much interest may be taken in architectural reform in this country.

Meanwhile the Indian master-builder outside the Anglo-Indian gate, though scorned by many of his own countrymen as “ uneducated,” keeps up, as far as he is permitted to do so, the splendid traditions of the practical school of craftsmanship, like that which existed in Europe a century and a half ago, in which his forefathers learnt. He is now seldom allowed—except under the cramping processes of European dictation, or under the supervision of “ educated ” Indian engineers whose architectural qualifications are acquired by copying a few sheets of “ classic ” orders in Anglo-Indian technical colleges—to build the palaces of “ progressive ” Princes or to undertake any public works of importance. But the Indian field is so immense and varied in character that the school of practice which is still left open to him is sufficient to keep up a standard of craftsmanship infinitely higher than that which passes muster in the Public Works Department throughout British India.

As I have already stated, the Archæological Survey of India, through the initiative of Lord Curzon, has for some years past given temporary occupation to many Indian craftsmen in the restoration of the monuments their ancestors built. The Director-General, Mr. Marshall, has frequently testified to their intelligence and skill in work of this kind, and it was

a great misfortune for India that Lord Curzon's interest in craftsmanship did not extend further.<sup>1</sup>

There has been in the last few years considerable activity in temple building in Southern India, owing to the large donations made by wealthy Hindu merchants for that purpose. Plate CXII shows a South Indian *stapathi*, or hereditary temple architect, engaged in preparing drawings for the masons working under his direction (Plate CXIII). Many of the great Hindu temple foundations give permanent employment to master-builders learned in the Silpa-sâstras, and the donations of pious Hindus towards the building of new temples or the repair of old ones, for constructing rest-houses for pilgrims, bathing-ghats, wells, etc., as well as those of orthodox Muhammadans for the building of mosques, help to keep alive the traditions of Indian architecture and of many of the crafts dependent upon it.

This is a factor of extreme importance for the future of Indian architecture, because religious works of this character have always provided the best school of craftsmanship in India. Temple craftsmanship is the foundation of all the great architecture of India, secular as well as religious. Under modern conditions, however, temple building gives little opportunity for structural experiments on a large scale, which are indispensable for the free development of the whole science and art of building. In domestic architecture, the Indian master-builder over the greater part of the country, outside the Anglo-Indian cities, still remains in undisturbed possession.

Even under these restrictions the work of the Indian

<sup>1</sup> Mr. O. C. Ganguly, in an article in the *Modern Review* for March 1912, states that an hereditary architect of Bhuvaneshvar, since the work of the Archaeological Survey in the neighbourhood was finished, sent his son to the village school to qualify for service as a clerk, as no further remunerative work was available in the hereditary craft on which his family had depended from time immemorial.

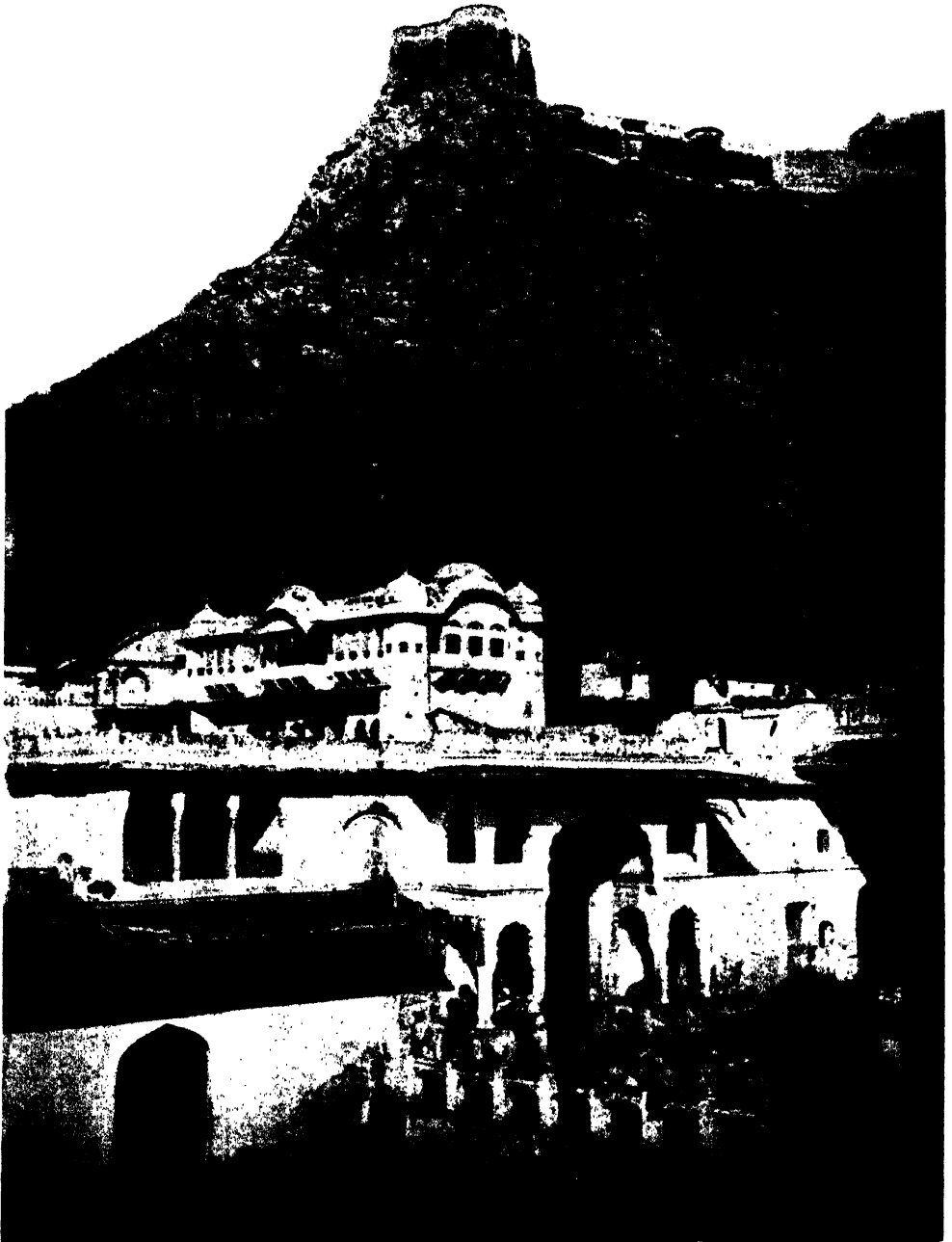

A MODERN INDIAN PALACE, MARWAR



master-builder during the Victorian period—now being commemorated in Calcutta by a building which appears to be an archæological essay on Kedleston Hall and the Radcliffe Library at Oxford—would, if a complete survey of it were made, need no comment to convince expert opinion in Europe of the vitality of Indian craftsmanship, and silence for ever the calumnies so often heaped upon the real Indian craftsman by the incapacity of the Public Works *mistri*. At present I am unable to attempt such a task as thoroughly as I should wish, but I believe that the typical examples which illustrate this chapter will be sufficient for the purpose, though they do not cover a tithe of the whole field. They have not been specially prepared for this work. Any cold-weather tourist in India, whose interest lay in the direction of living craftsmanship as distinguished from archæological dilettantism, could without much difficulty, and without going far from the beaten track, make an album of similar types.

Pl. CXIV is the mansion of a Rajput nobleman of the Jodhpur State built about 1840. His ancestral castle which crowns the hilltop behind belongs to the stormy days before the *pax Britannica* gave the people of Rajputana the security they now enjoy. It will be noticed that the structural details, taken separately, are similar to those which were employed in the Dîg palace, a century earlier ; but the architectonic design as a whole is charmingly fresh and original.

The unprejudiced critic who compares the many different types of Indian buildings, in different localities and different periods, which illustrate these pages cannot fail to be struck not only by the variety of “ styles ” but by the strong individuality which each building possesses. And the fertility of Indian invention is just as conspicuous in buildings of the Victorian period as it is in those of Muhammadan times.

Nothing can be more unjust than the charge so often brought against the Indian master-craftsman that he follows blindly a stereotyped tradition which he cannot adapt to the changing conditions of the times in which he lives. Such an imputation, coming as it generally does from those whose ideas of creative art never get beyond the readjustment, under very close restrictions, of a limited number of antique conventions, is singularly ill-judged.

It is really the modern Anglo-Indian buildings, "designed" according to the archæological rules of the paper-architect—often ignoring conditions of climate, site, local materials, and local craftsmanship—which are deadly in their monotony and lack all the essentials of real architecture. Fergusson, who is so unreliable in his classifications of Indian styles, had a clear intuition of the truth of this matter when he wrote that in India alone at the present day can the real principles of the art of building be observed in action.

To follow the history of Indian architecture in the nineteenth century one must visit the famous cities of pilgrimage, like Benares, Brindâban, Hardwar, and other sacred places of the Hindus. Benares is singularly rich in modern buildings; few of the fine palaces and monasteries which line the banks of the Ganges are earlier than the eighteenth century, or the time of Aurangzîb, who made havoc of the older Hindu temples and built a mosque out of their remains. Not many Anglo-Indians or European tourists who come to admire the wonderful scene which the Ghâts present on some great Hindu festival realise that two of the most stately of these palaces—those at Munshi Ghât (Plate CXV) and Ghuslâ Ghât (Pl. CXVI)—are not, as they well might be, contemporary with the famous buildings of the great Moguls, but belong to the latter half of the nineteenth century. The last named was



Photo by

A MODERN INDIAN PALACE, MUNSHI GHÂT, BENARES

R. C. Macumdar, Benares





built by the Rajah of Nagpur about 1860, and the other by one of his ministers about the same time.

To find anything to compare with them in Europe for largeness of design combined with perfection of craftsmanship one would have to go back to the early days of the Renaissance in Rome or Florence, when the fine craftsmanship of the Middle Ages gave vitality to the classical conceptions of the painter-architects of Italy. In Anglo-India there is not a single building to be placed in the same class with them; none of the Mogul palaces display such a stately front—only the fortress-palaces of the Rajputs compare with them in this respect. It was a strictly practical purpose, and not mere academic “design” or the love of display, which determined the distinctive character of these buildings. They are built on the steep slope of the high bank of the river, so as to allow access to the sacred stream, both in the dry season when the water is below the foot of the Ghât steps, and in the monsoon when the flood rises well above the basement line of the palace itself. In the latter case the inmates of the palace can perform their ablutions in safety from the central staircase within the walls of the building. The principal apartments are placed high up, both for the sake of ventilation and so as to be easily accessible from the main street at the level of the high ground behind the palace.

The competent critic will recognise at a glance the essential difference between these native buildings and the “Indo-Saracenic” of the British engineer-architect. The latter clothes his engineering with external paper-designed adornments borrowed from ancient buildings which were made for purposes totally foreign to those which he has in hand. The engineering is more or less real (according to the skill of the designer); the “style” is purely artificial. The artistry which

may be shown in the building is entirely dependent upon the vitality which the Indian craftsman can put into it : if he is compelled to follow mechanically the “ Indo-Saracenic ” paper patterns, in the designing of which he has no share, according to the usual departmental system, that cannot be of much account. In other words, the engineer supplies the mechanics, the Indian craftsman, so far as he is permitted, the art.

From an artistic point of view the only advantage which this “ Indo-Saracenic ” has over Renaissance or any other European “ style ” is that it gives Indian craftsmanship a somewhat better chance of life. Imitation is said to be the sincerest form of flattery, so it has the negative merit of not being a standing insult to Indian culture and civilisation. As architecture it is no better and no worse than the ordinary departmental product. The engineer-architect does not come, as the Moguls did, to learn the art of building from the Indian master-builder, but—on the false assumption that art in India vanished with the last of the Moguls—to teach the application of Indian archæology to the constructive methods of the West, using the Indian craftsman only as an instrument for creating a make-believe Anglo-Indian “ style.”

The merits or demerits of Anglo-Indian buildings, from an academic point of view as “ designs,” is an irrelevant question which need not be discussed, since they all fail in different degrees in the essentials of real architecture ; and this not so much from want of ability or good training in the architects as from the inherent vice of the system by which the buildings are constructed. Michelangelo or Sir Christopher Wren would have done quite as much injury to Indian craftsmanship as any Public Works engineer has done if he had been given the same responsibilities and had been compelled to follow the same method of fulfilling them. When an organ grinder is

PLATE CXVI

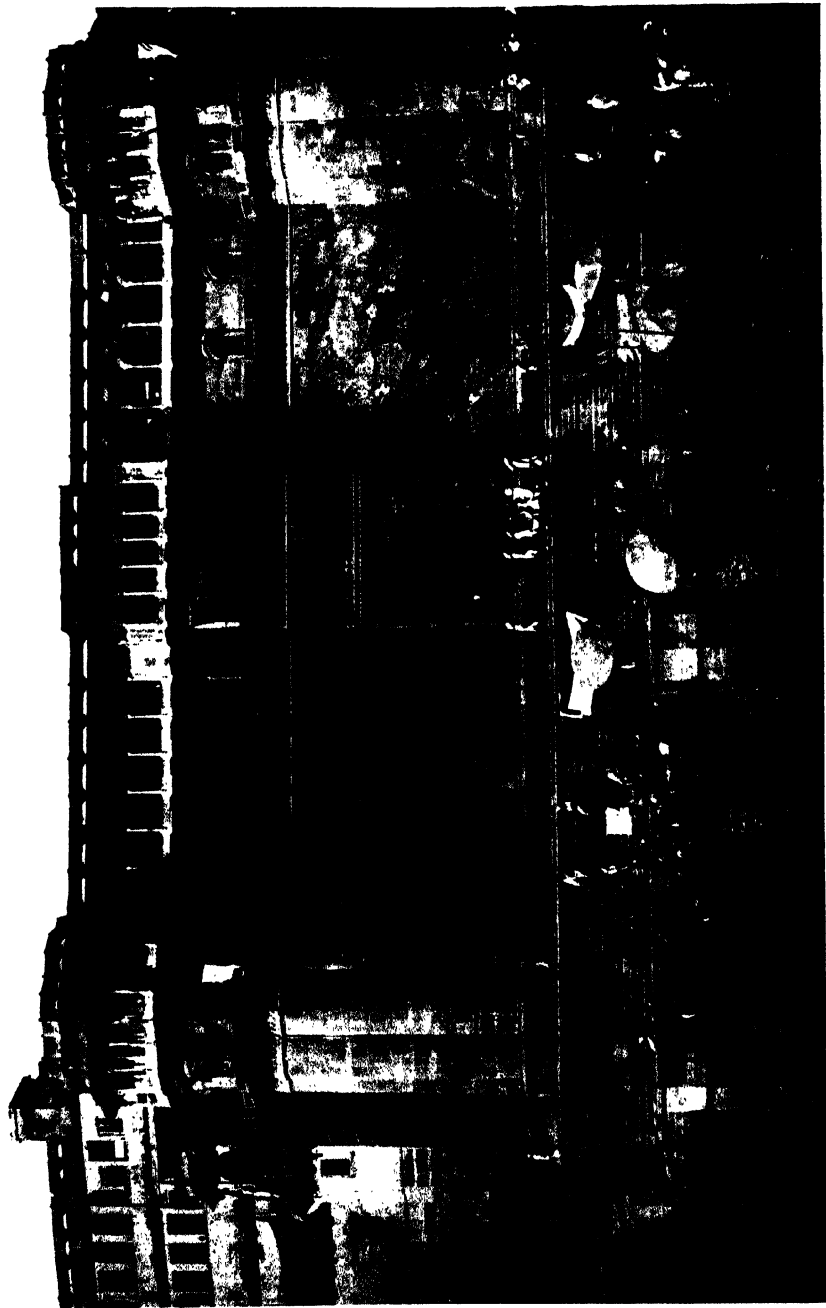

Photo by

335

MODERN INDIAN PALACE, GHUSLÁ GHÁT, BENARES

J. C. Masumdar, Benares



playing Mozart or Strauss, it is idle to discuss which of the three is the best musician.

In these two Benares bathing-palaces the Indian master-builder followed no fixed archæological formulary. He built according to the science and art of building, and was not consciously reproducing a "style." The engineering difficulties which have to be met in building a large palace on the sloping bank of a great river subject to heavy floods are much greater than those which must be considered in ordinary Anglo-Indian departmental buildings. The excellence of the craftsmanship in these two palaces is proved by the present condition of the masonry, which shows no signs of flaw or settlement. In engineering there are few Anglo-Indian buildings to compare with them ; in art, none.

The Indian master-builder's engineering and art are one, and both are adequate for the purpose. Hence his artistic resources have always been sufficient for the practical objects he had in view. The style of these buildings is truly beautiful, like the spontaneous growth of trees and flowers, a quality inherent in their growth and structure, determined by the soil in which they are built, by the materials of which they are made, and by the purpose for which they are intended. The fortress-palace of Dativâ (Pl. XCVII), and the pleasure-house of Surâj Mall (Pl. CVII), are so widely differentiated from these two modern bathing-palaces of Benares, not by change of "style," but by changes of time, place, men, and conditions of life—vital things, not the unrealities of fashion and of taste. And just because they all belong to real life and to the soil on which they are built, the bathing-palace of the nineteenth century is in every way as great in art as the seventeenth-century Rajput fortress or the eighteenth-century garden-palace.

We will turn now for a moment to another great place of Hindu pilgrimage, Brindāban, which contains some important temples built about the same time as these Benares palaces. They are described but not adequately illustrated in Mr. F. S. Growse's manual of Mathurā. The great temple of Rangunath (Vishnu), founded by two wealthy Hindu merchants, the Seths Gobind Dās and Rādha Krishna, was commenced in 1845 and finished in 1851 at a cost of forty-five lakhs of rupees (Plate CXVII). It is one of the largest of modern Indian temples—the outer walls measuring 773 feet in length and 440 feet in breadth—and is interesting for having brought together in one group of buildings the South Indian and the North Indian building traditions. The central part, including the shrine itself and its lofty pyramidal towers, or *gopuras*, was designed by a South Indian temple *stapathi*, or architect; but the pavilions at the east and west entrances were the work of the local master-craftsman. The Indian master-builder now, as in former days, leads a wandering life, and railways give more facilities for travelling than the Indian bullock-cart. When I visited Gayā in 1905 a Hindu temple was being built there by Jaipur craftsmen, and two dharamsālas for pilgrims by craftsmen from the United Provinces.

Mr. Growse also mentions two other modern temples at Brindāban—the temple of Radha Indra Kishore, completed in 1871 at a cost of three lakhs, and the temple of Radha Gopāl, built by the Maharajah of Gwalior about 1860, of which he remarks that the interior arrangement is an exact counterpart of an Italian church and would be “an excellent model for our architects to follow, since it secures to perfection both free ventilation and a softened light.”<sup>1</sup>

The same gifted civilian, while in charge of the Buland-

<sup>1</sup> For plan see Growse's "Mathurā," p. 263.

PLATE CNVII

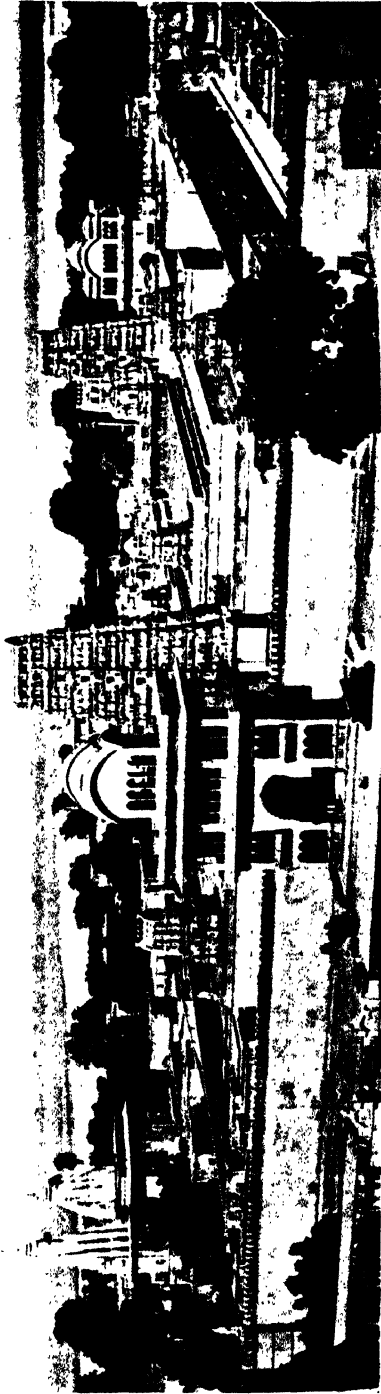

A MODERN HINDU TEMPLE, BRINDĀBAN





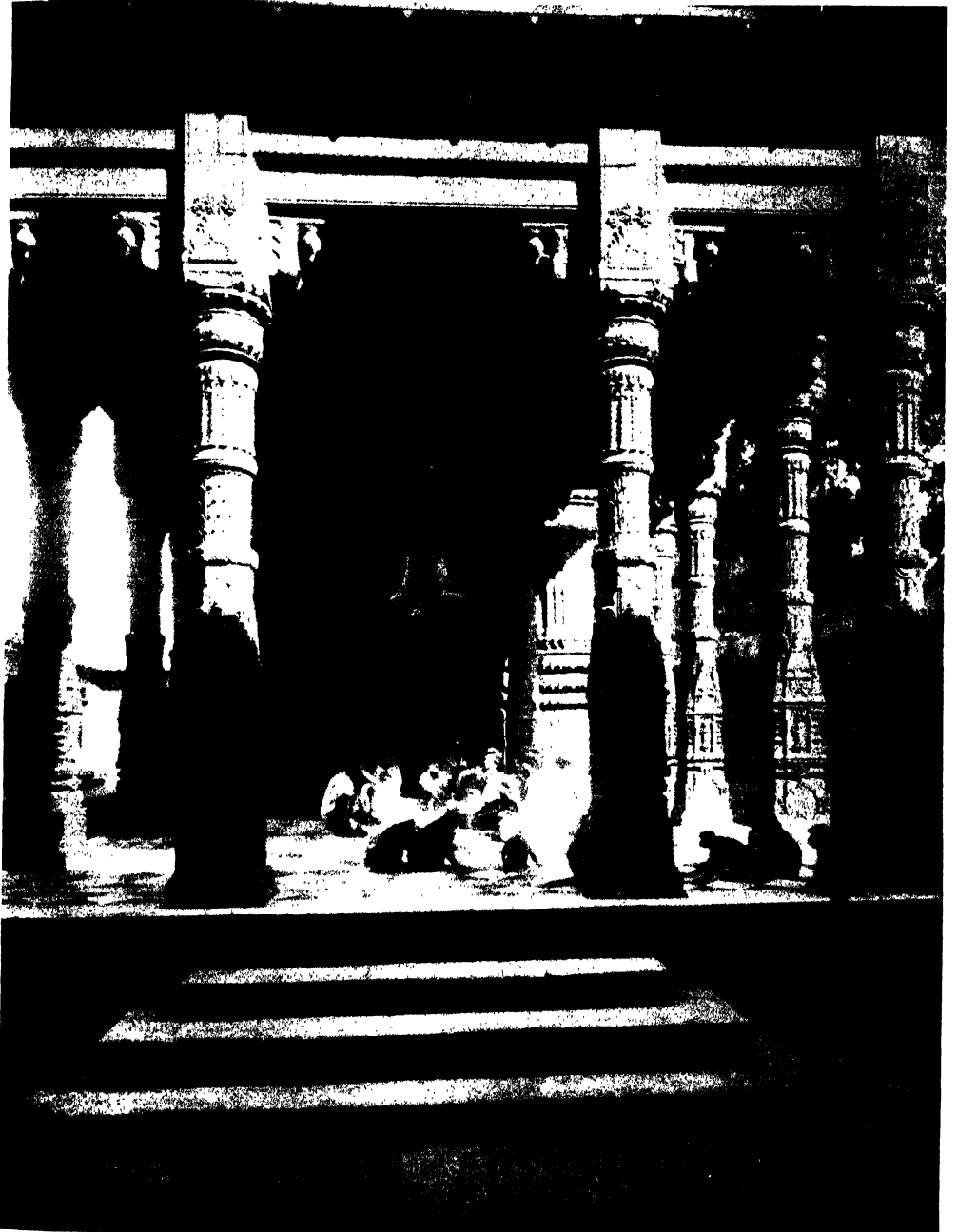

*Photo by*

*[Johnston & Hoffmann*

A MODERN HINDU TEMPLE (DURGÂ TEMPLE, BENARES)



shahar district of the Punjab from 1878 to 1884, exerted himself greatly in the interest of the local building craft, with the result that all the official buildings required in the district were planned and carried out successfully by the Indian master-builder without the intervention of the Public Works "experts." But the department would not tolerate this encroachment upon its prerogatives, and Mr. Growse was called upon for an official explanation, and this being considered unsatisfactory, he was summarily removed from the district.

In his *apologia* written afterwards, Mr. Growse says :

"What I had still more at heart than the artistic education of the wealthy was to improve the status of the poor local artisans by securing them regular and lucrative employment, either with private individuals, or as Government servants under the District Board. I certainly demonstrated their fitness and the economy that would result from their substitution for certificated engineers, but the demonstration was unavailing. The men who were working for me at the time of my transfer have, I fear, derived injury rather than benefits from my exertions on their behalf. I was removed so suddenly that it was impossible for me to wind up their accounts, and since I left they have experienced the greatest difficulty in getting paid for the work which they stayed on to finish. They have too much respect for their art to undertake the clumsy and grotesque erections in which the local squirearchy delight, and they are consequently debarred from private service, while—to complete the frustration of all my hopes for their advancement—a circular has lately been issued which peremptorily forbids their employment under Government. Under this departmental ukase all posts of even Rs. 50 a month in the gift of any District Board must be reserved for the holders of a certificate from the Rurki College of Engineers,

where no orientalism has ever been tolerated. The mistri or indigenous architect thus superciliously excluded from competition may be a skilled craftsman whose work is of sufficient merit to be transported at great expense across the sea and set up for admiration in New York or London ; but in India he cannot be trusted to design or carry out the most petty work in the smallest village : the reason being that he has spent the whole of his life in acquiring a practical mastery of his art, and therefore he had no time to study English and in due course obtain an engineering certificate ; having done so, he is at once qualified for an appointment of Rs. 250 a month, in which he will be freely entrusted with the design and execution of local works, though he may know nothing of architecture beyond the hideous ' standard plans ' provided by the Public Works Department. Is it not an insult to common sense to be thus liberal to bungling apprentices while a master in the art is not allowed even Rs. 50 to supplement his exhibition medal, and then to expect architecture to revive and flourish ? The higher-paid employee can speak English and keep accounts in the European fashion ; but in the real work for which he is engaged he is immeasurably beneath his under-paid brother." <sup>1</sup>

It would be difficult to explain more tersely and accurately the method by which English-educated Indians are led to assist in the extinction of their own art, since the arch-Philistine Macaulay—who was less fit to legislate for the education of Indian youth than a Brahman pandit would be for the British public schoolboy—laid the foundations of modern education in India. This little incident will throw light upon the astonishing ignorance regarding the Indian master-builder

<sup>1</sup> From " Indian Architecture of To-day, as exemplified in New Buildings in the Bulandshahar District," by F. S. Growse, quoted by Mr. O. C. Ganguly in the *Modern Review*, Calcutta, March 1912.

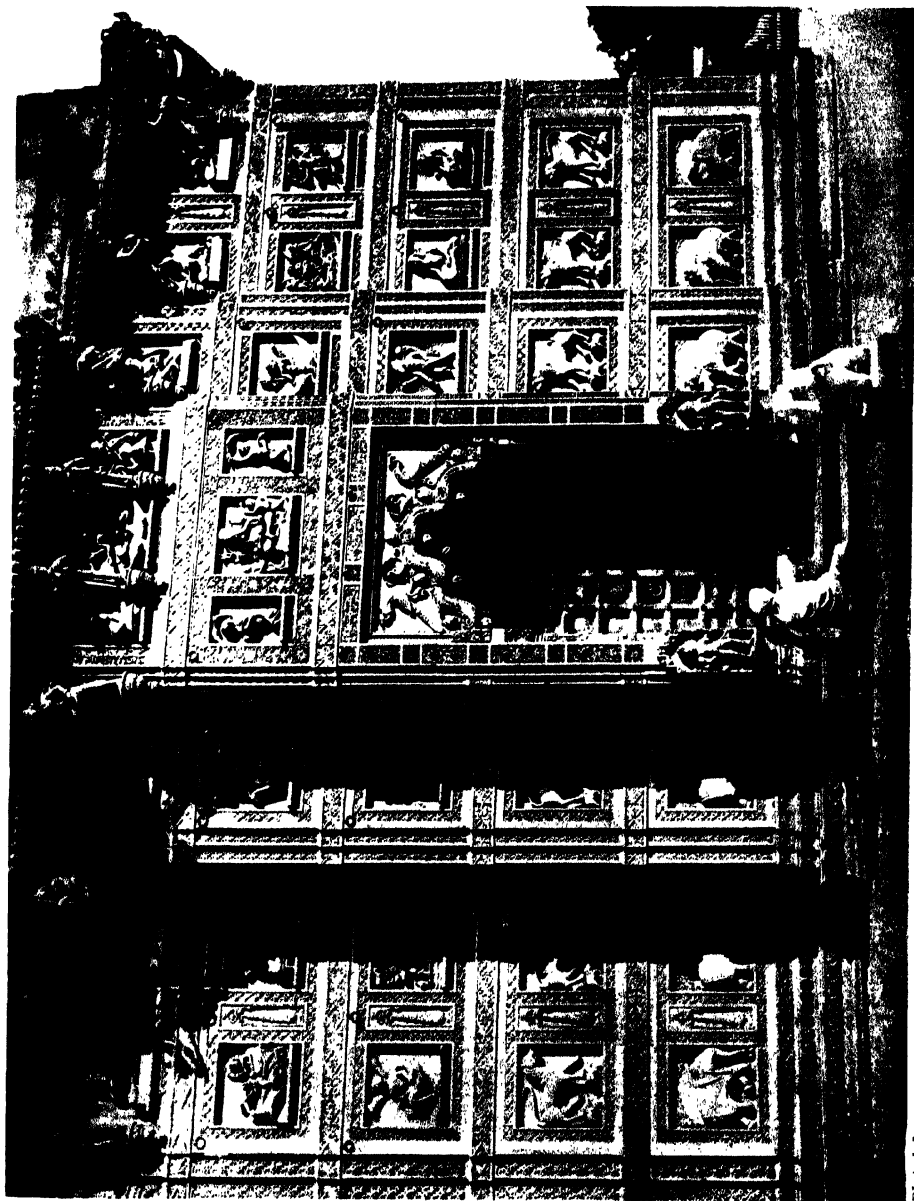

Photo by]

MODERN INDIAN SCULPTURE (TEMPLE AT RAMNAGAR, BENARES)

[Dourne & Scheffner]



PLATE CXX



MODERN INDIAN SCULPTURE (CAHMÉTY TEMPLE, BENARES)





and his work which is shown by many Anglo-Indian district officers of long experience.<sup>1</sup>

We will return now to Benares. The modern temples of Benares are not, as a rule, architecturally interesting, but a fine porch added to the temple of Durgâ, popularly known as the Monkey Temple, about 1865 is an exception (Pl. CXVIII).

The beauty of some of the architectural sculpture of Benares temples executed in the middle of the nineteenth century is, however, very remarkable—as will be evident from the illustrations given in the plates. The front of the temple in the suburb of Ramnagar which was built for the Maharajah of Benares and completed about 1850 might easily be mistaken for a fine example of the Byzantine school; and one would search in vain in modern European architecture for anything to compare with the delightful row of the heavenly Apsaras discoursing sweet music under the cornice of the Ahmêty temple, which was also built about 1850 (Pl. CXX). Yet Anglo-Indian writers will solemnly aver that after the third century A.D. there is little Indian sculpture that can be called art,<sup>2</sup> and in the name of progress, education, and art Indian revenues make provision for costly “Renaissance” sculpture to adorn the Secretariats of Calcutta!

To obtain an insight into the actual condition of the Indian building craft of the present day—outside the departmental enclave—one could not do better than wander through the streets of a modern Indian town in Rajputana or Central

<sup>1</sup> Mr. Vincent Smith (“History of Indian Fine Art,” p. 419 n.) says that, in Northern India, Mathurâ is almost the only town where architecture can be described as “still a living and progressive art”—a statement apparently based upon the fact that Mr. Growse’s district manual is almost the only official document referring to the work of the modern Indian master-builder.

<sup>2</sup> See Mr. Vincent Smith on Archæology in the latest edition of “The Imperial Gazetteer of India.”

India and realise at once its vitality and gradual decadence. Lashkar, the present capital of the Gwalior State, is a typical one. It is a town of about 80,000 inhabitants, founded only a hundred years ago, in which until quite recently the Indian master-craftsmen have built without the supervision and teaching of the European engineer-architect.

There they have built such fine bridges as that shown in Pl. CXXI ; many shops and private houses for rich and poor (Pl. CXXII) ; temples and secular public buildings and *chhatris* to commemorate the death of the ruling Princes (Pl. CXXIV), for though a progressive Indian ruler may employ an architect to design buildings for ceremonial purposes in the latest Western fashion, in matters which concern his religious and intimate private life he will generally call upon the Indian master-craftsman.

Though compared with former times the native master-builder in the present day works everywhere under very depressing conditions, his circumstances in a town like Lashkar are infinitely better than they generally are elsewhere. In the Public Works Department—should he ever gain employment there—he is an insignificant cipher in the sum-total of the departmental system. When he works for the “curiosity” market of the great Anglo-Indian cities he is under the screw of a grasping middleman. Here he is an artist who, even in his poverty, can take pride and pleasure in his work. His employer will testify a personal interest in the master-craftsman's work in various ways. A progressive Prince will not now retain master-builders in his service as Court architects, or bestow honours upon them for the successful completion of a fine building, but the “uneducated” public of Rajputana will still find pleasure in the skill of the local craftsmen and reward them according to its means.

PLATE CXXI



A MODERN MASTER-BUILDER'S BRIDGE, LASHKAR



Mr. J. L. Kipling throws some interesting light upon this subject in his report of the Punjab Exhibition of 1881-2. "In building a house," he writes, "the workpeople are all paid wages more or less regularly, but for any extra spurt, or during the execution of delicate or difficult details, they are often liberally treated with sweetmeats, tobacco, sherbet, etc. In some districts when a carpenter has made a carven *chaukut* for door or window, he takes a holiday to exhibit it, and spreading a sheet on the ground lays it in front of the house it is to adorn, and sits there to receive the congratulations and gifts of his admiring townsmen. As much as Rs. 100 have in one day been thrown to the carver of a particularly good piece of work."

Unfortunately, if a clever young craftsman should attract the attention of an "educated" Indian nowadays, the benevolence of the latter sometimes takes the form of paying for the lad's training in an Anglo-Indian technical college, or he may be despatched to Europe to learn "styles" more thoroughly at the Royal Academy or in a London architect's office. The attractions of an assured income and a small pension in Government service also tend to draw away the sons of the most intelligent and successful craftsmen into the minor posts of the Education or Public Works Departments, or to swell the overfilled ranks of clerical labour.

Under such conditions the deterioration in modern Indian craftsmanship needs no further explanation; the fact that it retains so much vitality might be a greater cause for wonder. One of the signs of its vitality which can be noticed in many modern buildings in Lashkar and elsewhere—the attempts to assimilate the structural forms of the West with those of the indigenous building traditions—is, curiously enough, generally cited as a proof of its utter decadence by the very critics who

deny the modern Indian craftsman's capacity for adapting himself to the needs of departmentalism. The serious architectural student will be deeply interested to observe in India of the present day exactly the same process of hybridisation which constantly recurred in the history of European architecture when a new style was in process of evolution.

The free use of the Western column and classical details in combination with the forms of indigenous Indian "Gothic" affords an exact parallel to the change which took place in English architecture of the sixteenth century, when English master-builders were trying to adapt the fashionable "classical" taste of the period to their own Gothic tradition, and eventually created the Elizabethan and Jacobean "styles" of the archæologist.

It is most interesting to see how a clever Indian master-builder will sometimes convert his own "Saracenic" or Hindu capital into a quasi-Byzantine one, not by the archæological process of imitating ancient Byzantine capitals, but by the same artistic mental process by which Byzantine architecture was originally created. A modern purist would check any possibility of further evolution by teaching the craftsman the correct "style."

The archæological pedant who is thus blighting the life of Indian craftsmanship has lately started work in the town of Lashkar. As one wanders through the town admiring the work of a century of Indian craftsmanship, one is suddenly confronted by a group of "classical" official buildings, including a brand-new, spick-and-span, Greek-temple British Post Office (Plate CXXV), which might have been imported ready made from Bloomsbury or St. Pancras together with the telegraph wires, telephones, and railway engines. Lashkar in the year of grace 1908 became architecturally "progres-

PLATE CXXII

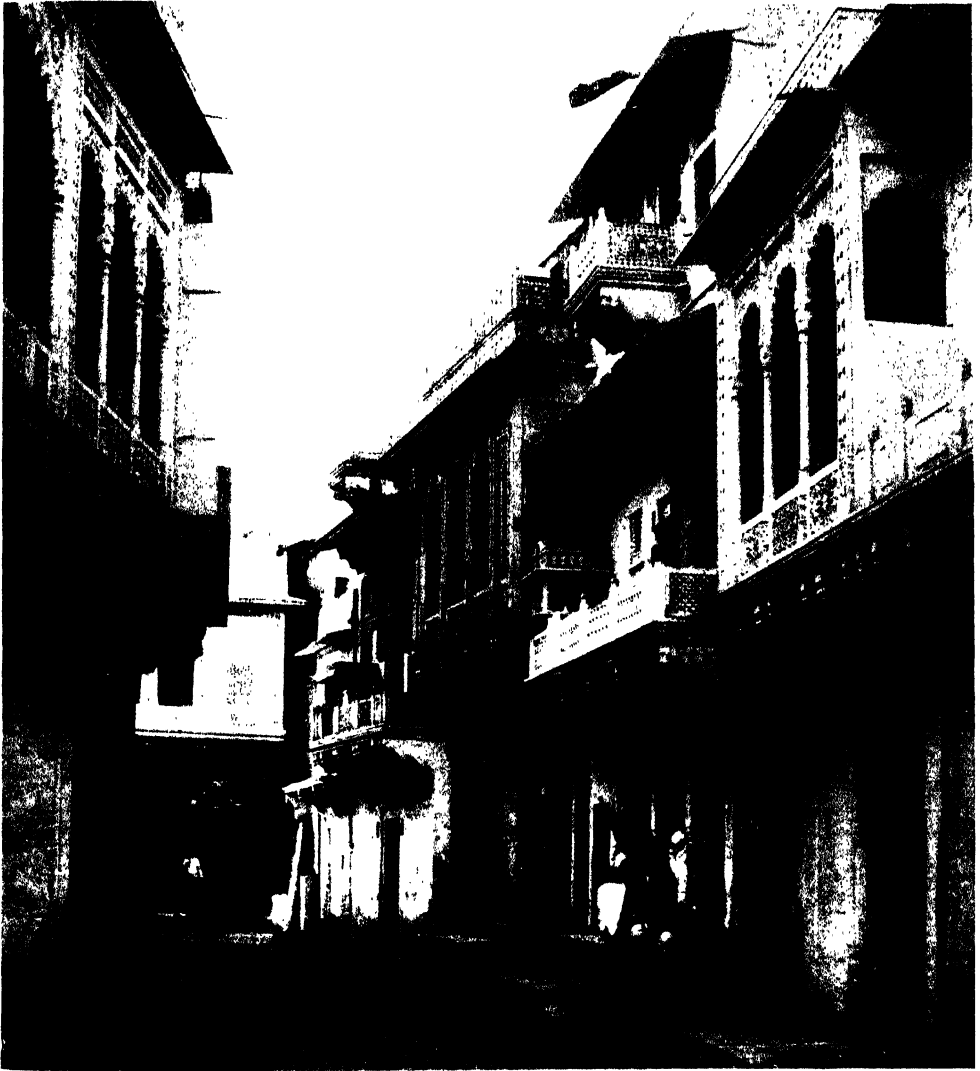

STREET IN A MODERN MASTER-BUILDER'S TOWN (LASHKAR)





PLATE CXXIII

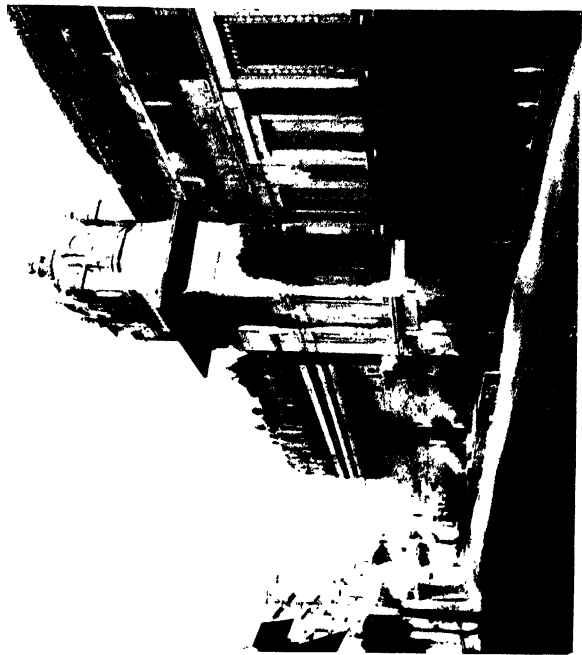
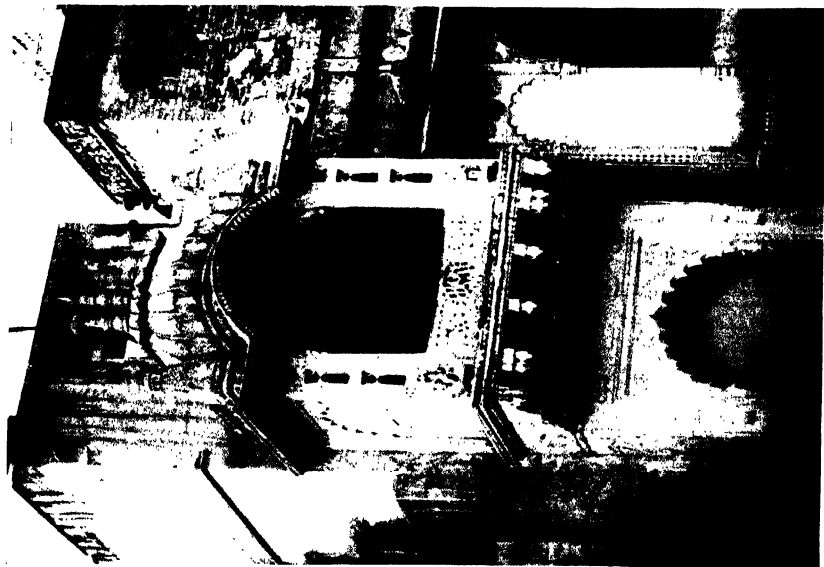

DETAILS OF BUILDINGS, LASHKAR



sive," and the craftsmen of Central India are now learning "styles" under the supervision of the British engineer, who took infinite pains to ensure that the Ionic volutes were correctly drawn and that the classical mouldings were cut according to the rules of the proper classical text-books. The "uneducated" master-builder who does not care for these things has no longer any occupation in the State buildings of Gwalior.

It is a pleasure to turn from a *bêtise* of this kind to an excellent piece of modern work in a neighbouring State, in which the engineer in charge of the railway, not being burdened with a classical taste, has permitted the local craftsmen to follow their own ideas of correctness of style—namely, the State railway-station of H.H. the Maharajah of Alwar (Pl. CXXVI). Here the Indian master-builder is quite up to date and shows his capacity for assimilating foreign ideas by building a very elegant and at the same time a practical railway-station, which puts to shame the banal "Gothic" terminus at Bombay, and is by far the most artistic in all India. Being for the Maharajah's private use only, it is of course small and more ornate than an ordinary railway-station should be; but the Oriental idea of a waiting-room on the roof which has been borrowed from Indian domestic buildings might well be adopted for the comfort of travellers in the design of larger stations in India. Roofs adapted for a temperate climate and a European rainfall are among the many weak points of Anglo-Indian building design.

A survey of the Punjab, Rajputana, Central India, and the adjacent provinces of the North in which Muhammadan influence was predominant for many centuries would by no means exhaust the subject of modern Indian building. Indeed, a great amount of the most valuable material would be

found in those parts of the country occupied by the Hindu kingdoms which resisted the Muhammadan invader more or less successfully. In the former provinces, especially where Mogul influence has penetrated deeply, modern native architectural decoration is sometimes characterised by an insipidity and meretricious prettiness which European critics, who only know Indian art from museums and international exhibitions, erroneously believe to be the common vice of all modern Indian craftsmanship. This degeneracy, needing only skilful and sympathetic artistic treatment, is partly to be accounted for by the influence of modern commercialism, and partly by the restrictions which Musulmân law imposed upon the Indian craftsman, for in those parts of India where the Hindu tradition is purest modern Indian architectural decoration is very different from the emasculated commercial bric-à-brac which is justly despised by the Western critic.

Orissa, one of the ancient Hindu kingdoms which held out longest against the military power of Islâm, is practically an unexplored field, rich in the finest craftsmanship, and one of the most interesting and valuable in the whole of India, because it represents a tradition uninfluenced by Musulmân artistic prejudices.

The two illustrations I give of Orissan buildings are from snapshots taken by myself in a visit to Puri a few years ago. They are examples of modern work carried out by a family of masons still living there. Pl. CXXVII is the entrance to the monastery called the Emar Math, the fine carving of which will bear comparison with that of the most famous of the Orissan temples built by the ancestors of these masons. Pl. CXXVIII is the verandah of a private house built by the same family of craftsmen. During the last fifteen or twenty years these fine sculptors, who are content with earnings of

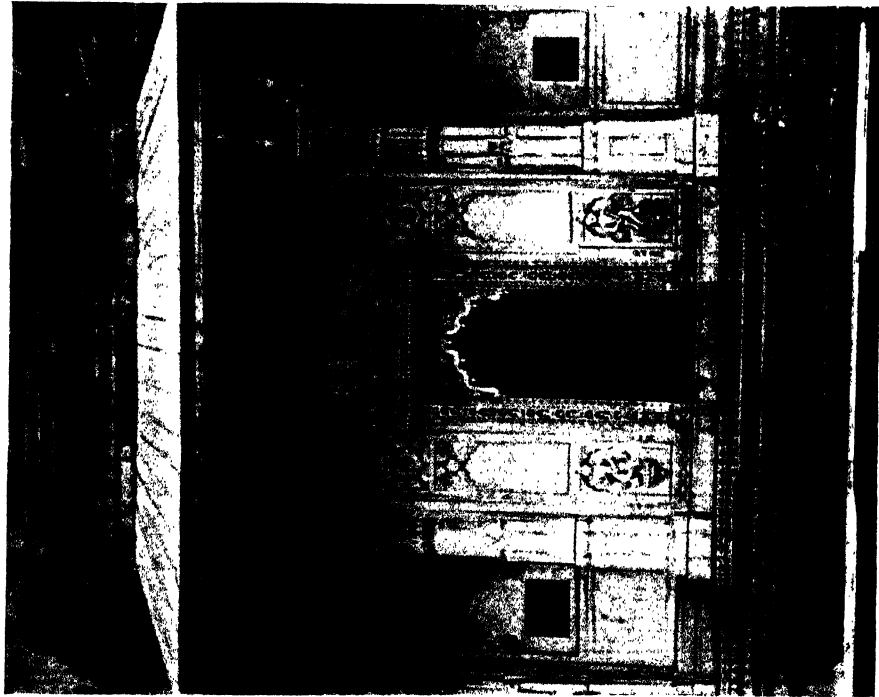

EXTERIOR

A MODERN CHHATRA, LASHKAR



INTERIOR



fourpence to sixpence a day, have been reduced to making trifling stone souvenirs for pilgrims, owing to the lack of more profitable employment. During the same time lakhs of rupees have been, and are still being, spent in Calcutta on the decoration of public buildings with imported commercial terra-cotta and sham Renaissance sculpture.

At Jâjpur, the ancient capital of Orissa, Indian craftsmanship is being preserved in a manner characteristically Indian. A *sâdhu*, or religious mendicant, has devoted his life to begging for money for the restoration of the temple of Biroja in the town, and Orissan stonemasons, paid a pittance sufficient for bare existence, have for many years past given their pious labour to the work. As long as this spirit survives so long will India remain, as it is at present, the finest school of craftsmanship in the world.

I will conclude this slight sketch of the modern Indian building craft with an illustration of a temple gateway built at Benares about twelve years ago by a master-mason named Madlu, from a design by a craftsman, Madhu Prasâd, in the employ of H.H. the Maharajah of Benares (Plate CXXIX).



## CHAPTER XV

### THE FUTURE OF ARCHITECTURE IN INDIA—THE BUILDING OF THE NEW DELHI

FOR nearly eighty years the spell of Macaulay's literary genius has been over the British administration of India in matters educational, and there are still many placed in high authority who maintain that the benefits which India has derived intellectually and morally from British rule are due to the policy he inaugurated of attempting to Europeanise India "in morals, in intellect, in taste, and in opinions," so that Indians shall remain Indian "only in blood and colour." I venture to think that future historians will view the case in a different light, and attribute the great achievements of the British Raj to the wisdom of those of Macaulay's successors who have tried to adjust his crude ideas of education to a better understanding of Indian culture and history.

For Macaulay's policy, pursued to its logical conclusion, was not in the true sense of the word educational—directed towards a fusion or reconciliation of Eastern and Western ideals; it was only a philistine war of extermination against all the intellectual traditions of Hinduism which he did not think worth consideration. He was the great iconoclast of Anglo-India. The fact that both India and the British Raj have so far prospered on this educational foundation cannot be credited to Macaulay's superior insight. The intellectual aristocracy of India has always been ready to consider new ideas with philosophic calm, even those opposed to its most cherished convictions; and the deep religious sense of the

PLATE CXXV



POST OFFICE, LASHIKAR



masses of the Indian people gives them an implicit faith in the inscrutable wisdom of Providence which has sent the White Brahmans of the West to rule over them. But it is confidence in British justice, and not in our intellectual or spiritual mission, as Macaulay conceived it, that keeps India loyal.

India under British rule has given many signs of an intellectual reawakening which fanatical followers of the Macaulay cult are always ready to put forward as proofs of its success. The patent fact is that those Indians who have profited least by Western learning are those who have blindly accepted Macaulay's estimate of Oriental civilisation. The great majority of the English-educated Indians to whom Western ideas have been a real inspiration are those who have cherished most their own intellectual inheritance which Macaulay sought to destroy.

If Indian art, from being kept out of the sun so long, now possessed so little vitality that an educational system which as yet touches only a small fraction of the population could destroy it root and branch, it could not be helped much by a Western artist's pen and ink. I myself do not anticipate that the Macaulay policy, even if British educationists should always continue to interpret it in the sense intended by its author, will ever succeed in fulfilling his intention. The inevitable result will be the exact opposite of that which Macaulay anticipated, to open wider and wider the cleavage it has already made between the educators and the educated. For the more we sap and mine at the foundations of Hindu civilisation, which has made the Indian masses of all people on earth the most amenable to law and order, the nearer we shall bring India into the vortex of anarchy.

There is no real danger that an art, with an unbroken

tradition of over two thousand years behind it, which has maintained so much vitality in spite of the ban which intellectual Europe has put upon it in the last fifty years, should now die of inanition, when the whole of the East is vibrating with a newborn sense of nationality. Whether we like it or not, Indian nationality will grow, and Indian art will grow with it ; nor should we dislike or be ashamed of the inevitable result of the contact of East and West. Under these conditions the worst enemy of the British Raj is our own ignorance of Indian history, of Indian ideas and their relationship to the practical affairs of Indian life as expressed in Indian art and craft, and our persistent habit of regarding art not as essential to life and nationality, but as a hobby and a pastime—a habit which does not prevent every European, from Thomas Atkins to the highest official, considering himself qualified to teach art to the benighted Hindu. By pretending to be artistic in India we only succeed in making ourselves artificial. If we would all, dilettanti and experts alike, give up pretending to teach art, and, like Akbar, put ourselves to school, we should soon understand the true secret of Mogul architecture, and instead of disfiguring utility with our art we should come to be artistic through being useful.

It is no justification of a Public Works system of architecture, based upon a misreading of history, bad art, and pseudo-science, to say that it is British ; there are more excellent ways which are also British. A department which exists *pro bono publico* should not be worked, as it has been, to the detriment of Indian craftsmanship ; neither is it politic to allow the vested interests of a great State monopoly to prejudice Indians against the British Raj. Certainly there are useful things which Indian builders might learn from co-operation with the Western engineer and architect. But

PLATE CXXVI

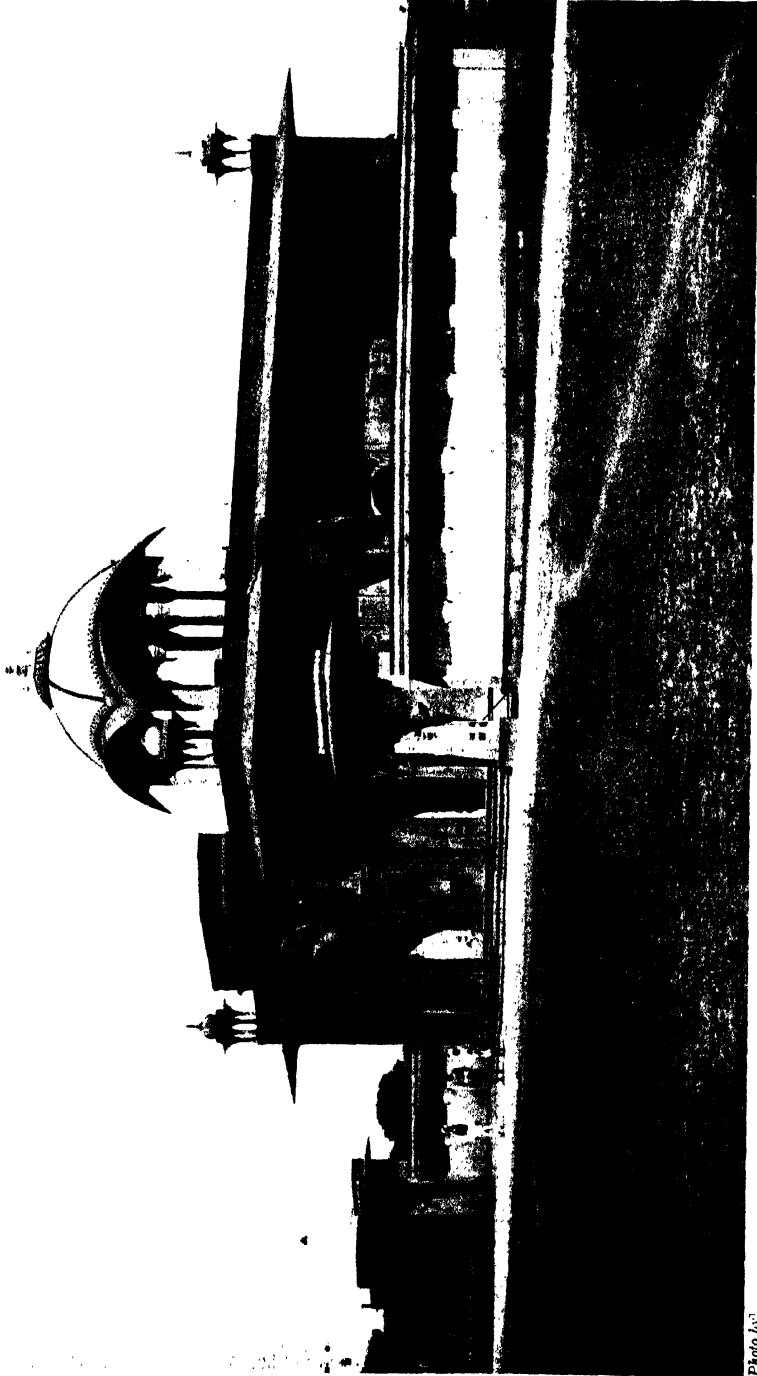

Photo by

A MODERN MASTER-BUILDER'S RAILWAY-STATION (ALWAR)

Johnson & Hoffmann



why is it that in over fifty years, during which all the most important building operations in British India and in many of the Native States have been a close Government monopoly, not a single Indian master-builder has been trained to understand these useful modern things? History proves that the Indian craftsman has always had the capacity for learning and even for teaching his teachers. But there is now no co-operation between the architect and the craftsman, and the education in architecture afforded to Indian students at Anglo-Indian engineering colleges is a relic of Victorian pedagogics in England seventy years ago. A knowledge of architectural drawing less than that of the youngest articled pupil in a modern London architect's office has qualified a European for a professorship. In a good London architect's office of to-day there is always a keen interest in Indian art, however little knowledge of it there may be. The Indian engineer learns just enough art to despise his own architecture and to remain ignorant of any other. The curriculum is such that if by any chance a young Indian master-builder should enter one of these colleges he would end by ceasing to be a first-rate craftsman-architect and become a fourth-rate engineer. The Macaulay system applied to the training of a literary caste for the smooth working of departmental machinery may, with much tinkering, be made serviceable. Applied to Indian art and craft it is unworkable and entirely mischievous.

Indian architecture is said to be medieval and uneconomical; but if the Macaulay theory had justified itself in Anglo-Indian public works, it would not have failed in fifty years to make one Indian architect modern. The best architects in England are now endeavouring—in spite of its medievalism—to revive the old system of co-partnership between the architect and the craftsman which existed in Europe down to



the middle of the eighteenth century,<sup>1</sup> and many young architects are now becoming builders themselves. And this because it is generally admitted that no real art in architecture is possible except under these conditions. The medieval way in Europe is becoming the most modern way, just because there is no other way in art. Unless the British artistic conscience is always to be less sensitive east of Suez, it must also become the new Anglo-Indian way.

Macaulayism in relation to Indian economics is the propaganda of capitalism and machinery, and the misapplication of theories which have not proved successful in Europe to totally different conditions in India. But—the exponents of it say—if we can make these theories succeed in India, it will be splendid for the Empire! That is Macaulay logic. Economy is the modern Philistine's cheap excuse for bad art; but the Philistine's budget economy is seldom true economy, even in engineering. Budget economy does not consider whether a building will remain sound for ten years or for a century: its foresight in this respect is often limited to the duration of the financial year. It does not reckon whether processes which have been tested for only ten or twenty years in temperate climates are cheaper for India than those which have stood the test of centuries of tropical conditions. It does not consider how many good craftsmen are converted into bad mechanics, or driven to find employment in petty clerkships and agricultural pursuits; how many Indian stone-quarries and brick-kilns are closed; and how many indigenous indus-

<sup>1</sup> An influential Committee, called the Beaux Arts Committee of London, with many leading British architects as members, was recently formed to improve architectural teaching in London, this being considered the first necessary step towards "placing architecture in Great Britain on a sound theoretical basis." In India we have been propagating unsound architectural theories for over a century as part of the white man's mission.



MODERN INDIAN SCULPTURE, PURI





VERANDAH OF A MODERN HOUSE, FUNI



tries are injured by the use of foreign methods and foreign materials. It does not take into account the effect of blocking up profitable artistic careers for Indian youth, or of the intellectual injury inflicted upon India by the neglect of all artistic culture in the education of the "educated."

Even from the British standpoint there are considerations of equal importance for ourselves. The history of Indian architecture, if it teaches us anything, should bring to our minds one obvious lesson, writ large on all the monuments of Muhammadan rule, that the cordial relationship which existed between Hindus and Muhammadans at the height of the Musulmân supremacy in India was largely due to the fact that the Muhammadan rulers found in the practice of the arts and in the unprejudiced pursuit of learning for its own sake the best means of reconciling racial and religious differences. When Aurangzâb deliberately broke down the bridge which Akbar and Shah Jahân had built, the Empire of the Moguls quickly crumbled to pieces.

That is a bridge which we have not yet built. The Indian master-builder is there to help us, as he helped the great Mogul, but we have hitherto refused his aid. It is not a healthy sign that when a great imperial project like that of the building of the new Delhi is taken in hand, not a single departmental official—expert or non-expert—could be found tolerably acquainted with the present and past conditions and work of a great industrial community numbering over a million,<sup>1</sup>

<sup>1</sup> According to the Census of 1901, the population supported by "artificers in building" in India was 1,212,196; besides 367,564 supported by "building materials." Twelve years ago a much greater industrial community—that of hand-weaving—numbering over five millions, was similarly ignored departmentally, and it was only through public lectures and other non-official channels that I succeeded in drawing the attention of the department concerned to the importance of the greatest of all Indian industries.

representing a craft so intimately bound up with the real life of the people as that of the builder. Macaulayism, helped by the archæological pedant, instead of building a bridge between East and West, has separated them by a high social wall, through the loopholes of which they occasionally shake hands ceremoniously.

There is a religious aspect of the question which to the earnest Christian may present a real architectural difficulty, in connection with the building of Christian churches and cathedrals in India. The ecclesiastical pedant will insist that they must be either "Gothic," which is a Christian form of architecture, or "classic," which was originally pagan but has become Christian by adoption. If the architectural history of Christianity were better understood the difficulty would at once disappear. India was the original home of the Western Gothic ideal. "Indo-Saracenic" architecture is Eastern Gothic. Let the Western architect teach the Indian master-builder to Christianise his symbolism and structure, as the Muhammadans adapted them for their own ritual, and they would jointly build Indian churches for Christian worship which might be as beautiful as Muhammadan mosques, and perchance lead Indians to understand Christianity better and respect it more. This idea may not appeal to those who cannot recognise a Christian except in petticoats or trousers, but it is good architecture and archæologically consistent.

Western Gothic has been such a miserable failure in India, both in secular and religious buildings, only because Anglo-Indian builders have neither had the practical sense to orientalise it nor the historical sense to recognise its relationship to the Indian branch of the same school.

---

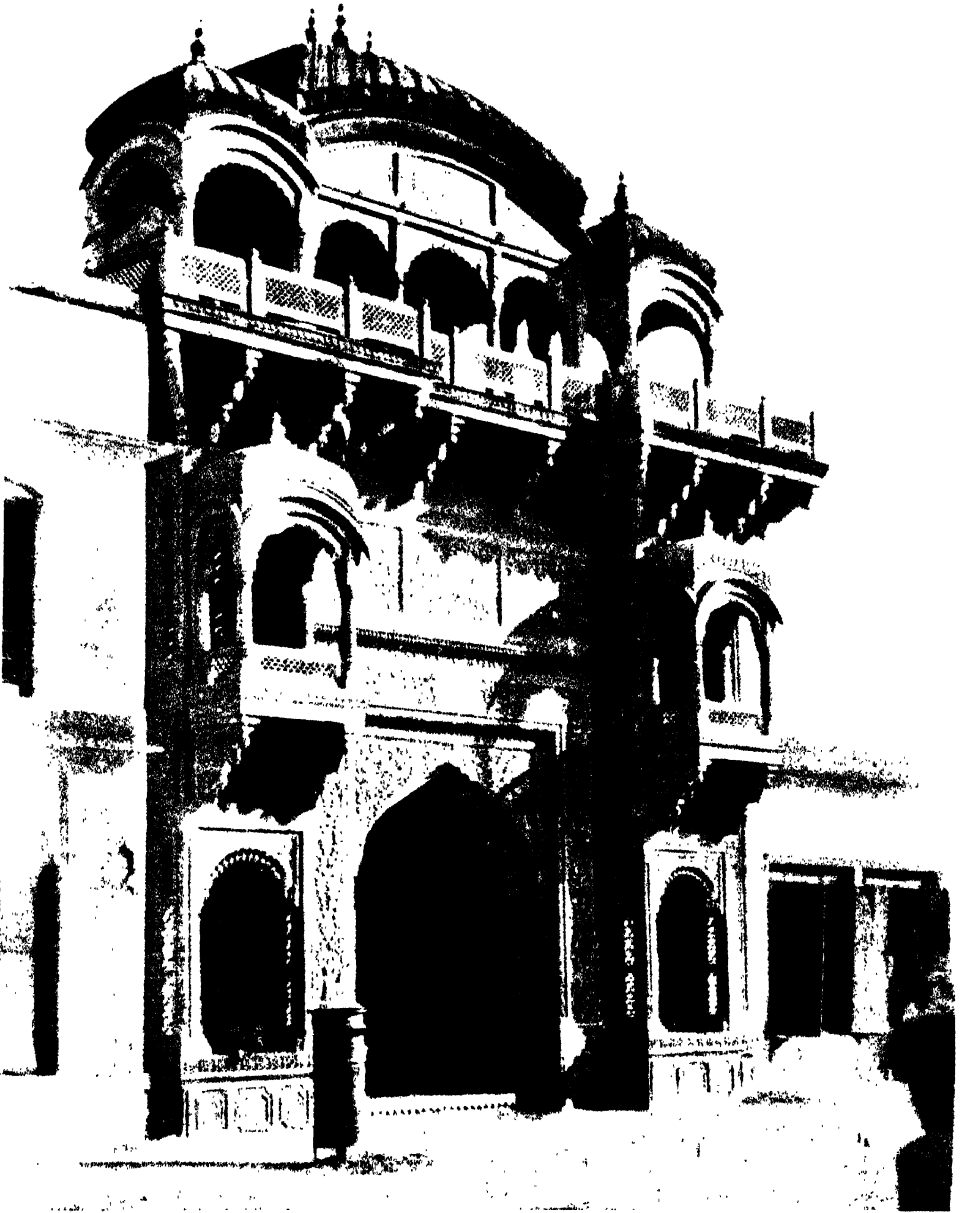

GATEWAY OF A MODERN TEMPLE, BENARES





How will the new Delhi be built ? Will it be the starting-point of real Anglo-Indian architecture, or only the opportunity of a lifetime for the modern Western stylist ? We must wait and see. If the old precedents are maintained, the cut of its official uniform—" Renaissance," " Indo-Saracenic," or whatever its name may be—will be decided by eminent European professors after grave deliberation ; and when the fashion-plates of the latest style have been duly admired by the British public, Indian craftsmen will be summoned from north and from south, from east and from west, as in days of old ; but not to sit in durbar at the Padshah's Court—only to copy the eminent professors' paper patterns. And the things which really matter, both for East and for West, will remain as they were before. The new Delhi will be another splendid make-believe ; and Mr. Kipling will perhaps, after all, prove to be a true prophet. Macaulay's New Zealander will make a note of it.

## CHAPTER XVI

### FOURTEEN YEARS AFTER—AN IMPERIAL OBJECT-LESSON

FOURTEEN years ago the Parliament of Great Britain, the press, and the British public were discussing the issues raised in this book: the "Battle of the Styles" raged furiously in architectural circles and the official doves were considerably fluttered by the petition to the Secretary of State for India, printed in the Appendix, though political India, which looks to the ballot-box for salvation, was not deeply interested in the question. Indian craftsmen and artists count little in politics.

A well-written leader in the "Morning Post"<sup>1</sup> summed up the situation clearly and dispassionately:

"Architecture is now with us no longer a matter in which the national labour can freely and intelligently co-operate, nor even in which the average citizen can interpret himself as an expression of the feelings and ideas of himself and his race, but a strictly enclosed preserve in which a certain number of building-Brahmins go through their stately evolutions for each other's delectation, while an occasional passer-by stops to peep through a hole in the hedge and wonder what it is all about.

"That the imposition upon a country of a foreign style of building is bound to have a paralysing effect on its creative output and labour generally is a proposition which must not only seem inevitably true to every thinking mind, but the truth of which we have ourselves proved up to the hilt by our

<sup>1</sup> Jan. 22nd, 1913.

own melancholy experience. Yet this is the action we meditate in regard to India. We deliberately contemplate inflicting upon Indian life an artistic ideal with which Indian life has nothing in common, and towards which no creative instinct in Indian character can ever naturally turn. This means that we are preparing to administer the *coup de grace* to native Indian architecture and craftsmanship by reducing them to merely mechanical operations, carried out, if carried out at all, in obedience to foreign instructions. Can anyone, intelligently interested in the future of the Indian people or of our rule in India, be indifferent on such a question? The present Government, with whom the decision will ultimately rest, are used to expressing democratic sympathies. Is their notion of popular rights confined to politics only? We venture to say that the present crisis involves consequences far more intimate to the happiness of the Indian people than the giving or withholding of votes. There needs, it would seem, to deal worthily with so great an occasion, a man of more than official calibre. A Burke, a Beaconsfield, a Gladstone, men whose minds were illumined with the imaginative sympathy which transcends politics, would have known how to turn it to account. Let it be remembered that there are two Indias. The intellectual element in Indian life, largely influenced by Western thought, has learnt to formulate its demands and articulate its ideas. But besides the intellectual India there is the India of the Indian people, an India not receptive of European progress or of the methods of a civilisation that is strange to it, but whose hope lies in its being given the opportunity to develop and express its own inherent sentiments and aspirations. In the long run the success of our Indian rule will, perhaps, depend less upon the exact measure of encouragement given to intellectual India than on our capacity to sympathise with the India of the Indian people. The building of the new Delhi will afford an exacting test of our capacity in this latter direction."

The programme suggested in the petition to the Secretary of State was, no doubt, a counsel of artistic perfection ; but, though many official pandits were ignorant of the fact it represented the practice still followed in fine and important buildings both in British India and in the feudatory States. But as there are two Indias, so there are two classes of building craftsmen in India. One contains the ordinary craftsman, exploited by Public Works contractors and usually treated as menial servants by the architectural experts, who, having been drilled according to Western methods, generally possess little power of initiative, though many of them are artistically far above the average Western builders. The second class, outside the Public Works enclave, contains the real Indian master-builder with his assistants and pupils, an artist to his finger-tips—as the illustrations of his work sufficiently show—justifiably proud of his art traditions and capable of adjusting them to modern needs, but unwilling to co-operate in a system which binds him down to artistic servitude, and having good reason to be suspicious of the Public Works contractor. This class has always been treated as non-existent by the Indian bureaucracy.

But even in India the scales which had so long obscured the vision of Public Works officials were beginning to fall. It so happened that the Consulting Architect to the Government of India, Mr. J. Begg, F.R.I.B.A., who soon after his arrival in India had formed the opinion that the Indian craftsmen working under him were “ masters of one art only—that of scamping ”<sup>1</sup> had discovered his mistake. He had gone on leave while a building he had designed was unfinished and his subordinates had forgotten to supply the craftsmen with the indispensable paper patterns for the Indian “ features ” which

<sup>1</sup> *Supra*, p. 230.

Mr. Begg desired to introduce. When he returned he discovered that the Indian craftsmen, given a free hand, had executed these "features" far better without the patterns than they had done before with them. This discovery was followed up by an able young architect, Mr. Gordon Sanderson, employed by the Archæological Survey, who, at the instance of the India Society, had been deputed to investigate "the principles and practice of the living art and craft of India." In a rapid survey of Rajputana, the Central Provinces, and some of the districts of the Punjab he collected a mass of material illustrating the splendid work done by Indian town-builders in bridge construction, street architecture, houses, shops, some imposing palaces for Indian princes, and the beginnings of a great mosque at Bhopal, as large as Shah Jahân's famous mosque at Delhi, which, as Mr. Sanderson observed, bore "eloquent testimony to the fact that the old Indian builders have not lost their skill."<sup>1</sup> The report was published soon after the petition was submitted to the Secretary of State, with a note by the Consulting Architect to the Government of India, pointing out the obvious conclusion to be drawn from the facts collected—that "architecture in India is still a living art." The Government of India, however, endorsed it with the observation that the opinions expressed by the two experts were personal to themselves and in no way bound the Government.

The explanation of this cold douche administered to their technical advisers was that the British Government of the day had not risen to the height of a Burke, Beaconsfield, or Gladstone, but had followed the usual course of letting the "building Brahmins" decide the future of art and craft in India. Two distinguished English architects, without any

<sup>1</sup> Report on Modern Indian Architecture. Govt. Press. Allahabad, p. 12.

Indian experience, were given a free hand as to the "style" suitable for the occasion. They had no difficulty in persuading Lord Hardinge that "style" was everything and Indian art a side issue. In the face of the direct evidence to the contrary given in the official report, the petitioners were informed that the method they urged "has in India, as elsewhere, long ceased to be applicable to works of any magnitude or of utilitarian purpose." The Consulting Architect fell into departmental disgrace for advocating in his annual report a policy of co-operation with the Indian master-builder, for the two city-building experts had decided that empire-building and co-operation were incompatible interests.

From their point of view this conclusion was, of course, inevitable. The Government of India was in a hurry to occupy the new capital. The capacity of the Indian master-builder for such a work was apparently an unknown quantity, and his willingness to co-operate with foreign Brahmins who could not speak his language or understand his ideas was doubtful. To study the question from an Indian angle and to qualify themselves to exchange ideas with Indian builders would have required more time and intellectual exertion than busy London architects could be expected to give. They could not be expected to compromise their architectural reputation for the benefit of Indian art and craft. They had no mandate to reform Indian Public Works methods, but only to build the new Delhi as fast as they could and in a style pleasing to themselves.

Sir Herbert Baker has explained his theory of Imperial æsthetics in a letter to "The Times,"<sup>1</sup> and in a paper read before the Royal Society of Arts.<sup>2</sup>

<sup>1</sup> Oct. 3, 1912.

<sup>2</sup> "Journal of the Royal Society of Arts," July 2, 1926.

“ First and foremost it is the spirit of British sovereignty which must be imprisoned in its stone and bronze.” The architecture of New Delhi should bear testimony to the truth of Lord Curzon’s *dictum*, “ Our work is righteous and it shall endure.” To realise this ideal the architecture of the Roman Empire, as embodying “ the more elemental and universal forms,” should be used as the basis of the style, while Eastern “ features ” must be woven into the fabric as a concession to Indian sentiment. It might be asked, if æsthetics and ethics are allied, why should we not go to the original source of Roman building styles, the Greek orders of architecture, since the Greeks, rather than the Romans, held that æsthetics stood for the highest scale of ethics ? The architect of the Lashkar Post Office (Plate CXXV) must be regarded as a humble disciple of the imperial or international school of building !

There seems to be considerable risk that ethical as well as Eastern features will generally be eliminated in the compounding of this prescription of æsthetic imperialism, by no means a novel one in India. In the discussion at the Royal Society of Arts Sir Herbert Baker, though most convincing as an architectural draftsman, had great difficulty in showing what benefit India will derive from the practical working of this theory, as shown by results achieved at Delhi. “ It has been a disappointment,” he said, “ that it has been impossible to call in the aid of the traditional skill of India in the arts and crafts.” The huge cost of working out the scheme left no money for Indian artists. But as regards the inferior craftsmen employed, “ India will be richer by many thousands of good masons and mistris who will return more highly skilled in their craft to their different stone-working districts.” But, he adds, “ One wonders what these masons will do when the



work stops!" One might also wonder whether by their training in the Delhi workshops they have become better craftsmen than their brethren who keep their artistic soul intact by remaining outside the Public Works enclave. Will they appreciate the æsthetic values of the one-sided partnership between Western and Eastern art when they find that they are always likely to remain apprentices or subordinates with only a menial's share of the profits? For a departmental committee has recently decided that no Indian artist can be found who is qualified to take part in the decoration of the imperial buildings—a decidedly scathing commentary on the Macaulay system of art education which has been followed in Government Schools of Art since they were founded. This does not, however, really mean what it seems to imply, that Indian art is entirely bankrupt, but only that the new School of Indian painting, like the old, is not appreciated by official experts. The alluring prospect which New Delhi holds out is that another art school, with well-paid visitors from Chelsea and St. John's Wood, will be opened in which Indian artists will be taught to think imperially under the supervision of a disciplinarian who will be responsible for law and order. Cannot imperial art be brought into being unless the East remains the humble and obedient pupil of the West. How dull and unimaginative it will be!

Lord Hardinge, who claims New Delhi as "his special child," is convinced that in a few years' time it will be "one of the most beautiful capitals of the world." But if it were to be more beautiful than any city which India has built, or dreamed of, it might still be written down in history as a monument of bureaucratic selfishness, rather than as "the crowning edifice of natural unity" which he intended it to be. A building project, costing India approximately twelve

millions sterling, in which no room could be found for the best type of Indian builders and artists, is likely to be more useful to our enemies than our friends, as political propaganda. It cannot console the Indian craftsman to think that the building of Indian cities may help to rebuild the shops of Regent Street.

The present Prime Minister, who has a better intuitive feeling for artistic values than the Ex-Viceroy, has lately made an eloquent appeal for the preservation of old English cottages.<sup>1</sup> "They are part of our country," he writes, "part of our inheritance, part of our national life. Ought we not then to be proud of them, to protect them, to do everything in our power to save them from decay? We have, however, neither preserved these priceless gems of English craftsmanship nor have we learnt the lesson that many still remain to teach. . . . We have to see if we cannot once again tap the springs of craftsmanship which have not flowed in this country for so long. It is not a hopeless task, but it is a case of craftsmanship lying dormant among the people. It is there, and it has been called up here and there by various arts. I am quite certain that if the right magician's wand were used it would spring again into fertile being throughout the length and breadth of the country. It is peculiarly incumbent on us, and I think we should insist that the old tradition should carry on until a new tradition, possibly linked up with the old, is ready to take charge of these things in England, just as it is so essential that all men who can shall carry on until a generation has grown up to repair the wastage of the Great War."

Is it not equally if not more incumbent on us, as custodians of India's welfare, to tap the springs of craftsmanship which are still flowing abundantly in the East? This would be an easy task, if the desire to undertake it were given us.

<sup>1</sup> Published by the Royal Society of Arts.

The creators of New Delhi have not used that magician's wand, but by their authority and professional prestige have added more power to the machinery which since the middle of the nineteenth century has been pumping the springs of Indian craftsmanship dry. The embellishment of it with "Eastern features," however skilfully it is done, will not even placate dissatisfied Indian politicians or allay the feeling of bitterness which the non-fulfilment of official "hopes and intentions" has aroused.

India, no doubt, will hope that Mr. Stanley Baldwin will find time to study the æsthetic, social, and economic problems involved in the preservation of Indian craftsmanship. One by one the futile schemes recommended to the Government of India for the benefit of Indian art and craft have stranded on the ground that the cost of official building plans has been so heavy that no money can be found for them. The really effective and obvious plan which would save money—to give the Indian artist and craftsman creative work in Government buildings—has not been fairly tried in any part of the New Delhi scheme. Outside the bureaucratic paradise, the egregious order, issued after Mr. Growse's successful experiments from 1878 to 1884,<sup>1</sup> forbidding the employment of the Indian master-builder by District Boards, is apparently still in force. Further discussion of the subject by the Public Works architects in India was forbidden when the New Delhi scheme was approved by Lord Hardinge. So wherever he turns in British India the master-builder finds official doors locked. Votes for Indians have not improved his position. The newly elected bureaucracy has less understanding of art than the old. The support which the highest authority in India has given to the specious doctrines of architectural imperialism

<sup>1</sup> *Supra*, pp. 241-2.

may even induce those Indian Rulers who have hitherto consistently tapped the springs of Indian craftsmanship to think that loyalty to the British raj compels them to adopt the "New Delhi style" in their own palaces and public works, and to use the same Western machinery for pumping those springs as dry as they have become in this country.

There is nevertheless a glimmer of hope in the fact that the full discussion of the subject, which has been only possible in England, has shown that the architectural hierarchy of this country does not, as a body, reject the possibility of working out an official method of building in India which will give the Indian builder something more valuable than the political franchise and help to foster a genuine feeling of co-operation between East and West. In a paper read before the Royal Institute of British Architects,<sup>1</sup> Mr. H. V. Lancaster, F.R.I.B.A., who, in the course of his professional work in India, had seen a sight which to most Public Works officials would seem a fairy-tale or nightmare—two or three hundred Indian building craftsmen working under an Indian mistri, who was solely responsible for the design and carrying out of the work—testified to the excellence of the results achieved under these conditions: "By far the best craftsmanship, and the only architecture showing real development in any of the vernacular styles, I found in works far away from official centres and the influence of Government control. I made enquiries as to the cost of such work and found it less than we should have paid for the same thing—not reckoning over-head charges, which range from 22 to 28 per cent. to cover drawings, estimates, and supervision. Our obsessions are, therefore, not only destructive artistically but

<sup>1</sup> Journal R.I.B.A., March 24, 1923.

cannot even claim the only merit that would excuse them, that of being cheap."

Professor Beresford Pite observed that the problem was of great philosophic as well as imperial interest, and one which demanded the most careful attention and thought. "One is a little amazed, if not shocked, to find the personal standard of individual taste and sense of proportion and fitness in which we have been educated in this little corner of the West applied to the historic architecture of India."

Sir Herbert Baker made a remarkable admission which, if followed to its logical conclusion, might eventually justify the New Delhi in the eyes of India and lead to results worth all the lavish expenditure poured on it. He agreed with Mr. Lanchester that, "in the case of simpler buildings of Indian character," the Indian master-builder might be left in charge, or in sole command.

But what India will ask is—have the architects of New Delhi themselves given a lead in this direction? Have the Public Works architects, who were told that the subject was taboo, been instructed that they are now as free as architects in this country to discuss the possibility of a closer co-operation with Indian builders? Have municipalities and District Boards in those provinces where the best Indian builders are available been invited to provide this small but vital opportunity suggested by Sir Herbert Baker for Indian craftsmanship, by the withdrawal of the Government Order referred to above?

If and when these things occur the building of New Delhi, indirectly and at long last, may give a new lease of life to Indian art and craft, and thereby atone for the many artistic blunders which have done so much to aggravate political unrest. Then both the Indian Princes and people may

respond heartily to the King-Emperor's Message of Hope, without any misgiving that it is only interpreted by departmentalism as propaganda for Empire trade.

The Imperial School of building, inspired or hypnotised by the art of ancient Rome, has had two epoch-making opportunities, one at Calcutta, another at Delhi ; but so far it has not diminished, but rather increased, the number of those who desire the ruin of the Empire. This may be taken as an illustration of the old Roman adage, *Quem Deus vult perdere, prius dementat* ; or it may be that, under Divine Providence, the very magnitude of our artistic blunders, with their serious economic and social consequences, may teach New India more wisdom. In any case, it is not too much to assume that God cares as much for India as He cares for the Empire.



## A P P E N D I X

A PETITION presented to His Majesty's Principal Secretary of State for India, February 6th, 1913.

TO THE MOST HONOURABLE

THE MARQUIS OF CREWE, K.G., ETC., ETC.,  
His Majesty's Principal Secretary of State for India.

### THE HUMBLE PETITION OF THE UNDERSIGNED

Most respectfully sheweth :—

That they would draw your Lordship's attention to an aspect of the question of the new City of Delhi that they fear may be lost sight of in discussions upon a choice of styles that seem to be beside the point and to confuse the issue.

Here, in England, where, broadly speaking, no traditional craftsmen have survived, and where, in place of un-selfconscious artists practising with intelligence and pleasure their various crafts, there are only mechanics dully earning a living, there is unfortunately a show of reason for treating building as a dead art, and for selecting from our museums examples to imitate.

But India is not England (or Europe), and where there are still master-builders and craftsmen and an unbroken building tradition of more than 2,000 years with all that it implies, there can be no serious question of style ; that is better left to the classifiers and historians. The force of genuine craftsmanship is so vital and tremendous, that if its methods are not tampered with, it will always assimilate fresh and foreign forms. English workmen of the sixteenth century by the strength of their inherited craftsmanship made real the architecture of the Renaissance. The native architecture suffered, but the buildings were still living. Indian native architecture would



suffer in the same way if it was required to take its inspiration from abroad, but if left to the craftsmen the product would still be living art.

They submit that the question to be discussed is, not in what style, but by what method the new city should be built ; whether that of the modern architect in an office with his assistants, detached from materials, craftsmen, and site, carrying his buildings to completion upon paper, with pencil-trained mind and hands, and binding with details and specification those who are to build strictly within these limits ; the method that has produced the public buildings of the nineteenth and twentieth centuries, and in India those of the Anglo-Indian cities : or, the method that has given us Westminster Abbey, Saint Sofia, Saint Peter's (Rome), and in India the Taj, the Palaces of Akbar and Shah Jahân, and the great public works of former times, that of the master-builder with his craftsmen, working in accustomed materials upon the site from simple instructions as to accommodation and arrangement such as would have been given to a master-mason or a master-carpenter by a medieval King who required a palace or a castle, or by a Bishop who desired to found a cathedral. This was the method that has produced all the great buildings of the world, and no modern buildings warrant the assumption that it can be safely departed from. That King and Bishop understood crafts in a way that is not general now, and at the present time there seems to be an urgent need for a sympathetic middle-man with a knowledge of building to act as a protecting buffer to the craftsmen, and to interpret to them modern departmental needs.

Your Petitioners feel that the possibility of work upon these lines is now so rare that its value can hardly be exaggerated. Even in these days, when the arts suffer so much in England from its want, the pricelessness of genuine un-selfconscious craftsmanship is not fully realised. Nothing can revive it, once the chain is definitely broken ; it is gone for ever, more hopelessly gone than the general public can understand or imagine.

They submit that it is for the general good, artistically and morally, not only of the United Kingdom and India, but of the world at large, that living craftsmanship should be saved from extinction by a right method of employment ; that politically such a method

will tie the natives of India more closely to the Mother Country, and at the same time give an outlet for the energies of the college-trained Indians to whom all the arts are at present closed ; further, that the use of native master-builders handling native material is financially economical.

That your humble Petitioners beg to lay the foregoing before your Lordship in the earnest hope that your Lordship will be graciously pleased to give them the deepest and most careful consideration.

For which your humble Petitioners, as in duty bound, shall ever pray.

Signatures of :—

PERCY ALDEN, M.P.	GEORGE CLAUSEN, R.A.	E. B. HAVELL.
MARGARET ALLCHIN.	REV. DR. W. F. COBB.	MAURICE HEWLETT.
AMEER ALI, P.C.	SYDNEY C. COCKERELL.	ROBERT HICHENS.
ISABELLE AMEER ALI.	W. WARD COOK.	KATHARINE TYNAN HINK- SON.
SIR WILLIAM R. ANSON, M.P.	DR. ANANDA K. COOMARA- SWAMY.	SIR THOMAS HOLDICH.
C. R. ASHBEE.	W. J. COURTHOPE, M.P.	CLIVE HOLLAND.
ALFRED AUSTIN, Poet Laur- eate.	W. J. COURTNEY.	CANON H. S. HOLLAND.
OLIVER BAKER.	VIOLET EYRE CRABBE.	J. R. HOLLIDAY.
GEORGE P. BANKART.	LIONEL F. CRANE.	ARTHUR HOPKINS, R.W.S.
A. SHAW BANKS.	WALTER CRANE, R.W.S.	ROY HORNIMAN.
H. GRANVILLE BARKER.	W. HARRISON COWLISHAW.	LAURENCE HOUSMAN.
SIDNEY H. BARNESLEY.	LORD DALRYMPLE, M.P.	WILLIAM H. HUDSON.
ADELINE, DUCHESS OF BED- FORD.	REV. DR. PERCY DEARMER.	A. HUGHES.
MGR. ROBERT HUGH BEN- SON.	DAVID ERSKINE.	ARTHUR D. INNES.
NORA BIGHAM.	SIR ARTHUR J. EVANS.	GEORGE JACK.
WALTER B. BLAIKIE.	H. BUXTON FORMAN.	FRED. HUTH JACKSON.
J. HANSHAWE BODELEY.	E. REGINALD FRAMPTON.	JEROME K. JEROME.
SIR J. P. BRABAZON.	EDWARD GARNETT.	WALTER JERROLD.
FRANK BRANGWYN, A.R.A.	CHARLES M. GERE.	E. BOROUGH JOHNSON.
SIR J. FREDERICK BRIDGE.	EDWARD GERMAN.	SIR H. H. JOHNSTON.
ROBERT BRIDGES.	ERNEST W. GIMSON.	HENRY ARTHUR JONES.
ALBERT BRUCE-JOY, R.H.A.	LORD GLENCONNER.	J. KING, M.P.
SIR MAURICE DE BUNSEN.	LADY GLENCONNER.	L. WHITE KING.
SIR PHILIP BURNE-JONES	SIR LAURENCE GOMME.	GERTRUDE KINGSTON.
LADY ARTHUR BUTLER.	CLAYRE ANSTRUTHER GRAY.	DR. W. EGMONT KIRBY.
GILBERT CANNAN.	J. T. GREIN.	CLAUD LAMBTON.
R. CATTERSON-SMITH.	RICHARD C. GROSVENOR.	E. BLAIR LEIGHTON, R.I.
K. H. D. CECIL.	WALTER GUINNESS, M.P.	SIR BRADFORD LESLIE.
	THOMAS HARDY, O.M.	SIR ARTHUR LASENBY LI- BERTY.
	AUSTIN HARRISON.	

SIR OLIVER LODGE.	JOHN PEDDER, R.I.	CHARLOTTE F. SHAW.
LORD LONSDALE.	LIEUTENANT-GENERAL A.	M. SHEFIK.
J. H. LORIMER, R.S.A.	PHELPS.	CLEMENT SHORTER.
H. C. MARILLIER.	LISLE MARCH PHILLIPPS.	CHARLES SIMS, A.R.A.
MARY A. M. MARKS.	EDEN PHILLPOTTS.	MAJOR N. P. SINHA.
CHARLES MARRIOTT.	MARMADUKE PICKTHALL.	FRANCIS HENTY SKRINE.
MAJOR-GENERAL FRANK H.	LADY PLYMOUTH.	JOSEPH E. SOUTHALL.
B. MARSH.	JOHN POLLOCK.	LORD SPENCER.
E. MARSHALL-HALL, K.C.,	SIR WALTER RALEIGH.	DR. W. A. SPOONER.
M.P.	GILBERT A. RAMSAY.	H. DE VERE STACPOOLE.
SIR WILLIAM MATHER.	G. WOOLSCROFT RHEAD.	BASIL STEWART.
AYLMER MAUDE.	R.E.	MARCUS STONE, R.A.
SIR HERBERT MAXWELL.	ERNEST RHYS.	G. A. STOREY, A.R.A.
E. D. MOREL.	SIR JOHN RHYS.	ALICE TRACEY-CLITHEROW.
ARTHUR MORRISON.	B. LEWIS RICE.	C. E. TRACEY-CLITHEROW.
HUGH MORRISON.	F. STUART RICHARDSON.	ALFRED SUTRO.
A. H. HALLAM MURRAY.	SIR W. B. RICHMOND, R.A.	JANE S. TEMPLER.
LORD NAPIER OF MAGDALA.	PROFESSOR WALTER RIPP-	ALFRED H. R. THORNTON.
HENRY W. NEVINSON.	MANN.	DR. MARGARET TODD.
DUKE OF NEWCASTLE.	J. W. ROBERTSON-SCOTT.	SIR ALLISTON TOKER.
MARY ETHEL NOBLE.	E. R. ROBSON.	SIR ADOLPH TUCK.
REV. CONRAD NOEL.	DR. W. H. D. ROUSE.	PROFESSOR H. H. TURNER.
EDWIN A. NORBERY.	LOUISE JOPLING ROWE.	WALTER S. S. TYRWHITT.
ALFRED NOYES.	FRANK O. SALISBURY.	T. FISHER UNWIN.
J. W. ORDE.	ETELKA SARTES.	ALLEN UPWARD.
MAJOR VICTOR PAGET.	R. A. SCOTT-JAMES.	EMERY WALKER.
LADY PAGET, WIDOW OF	ANNE DOUGLAS SEDGWICK	FABIAN WARE.
RT. HON. SIR AUGUSTUS	(MRS. BASIL DE SELIN-	LADY WARWICK.
BERKELEY PAGET.	COURT).	WILLIAM WEIR.
VISCOUNTESS PARKER.	CECIL J. SHARP.	A. RANDALL WELLS.
BERNARD PARTRIDGE.	G. BERNARD SHAW.	JOHN G. WOODROFFE.
JAMES PATERSON, R.S.A.	BYAM SHAW.	PAUL WOODROFFE.
J. BEAUMONT PEASE.		

## THE REPLY

(29TH MAY, 1913.)

“ The Government of India express the view that the particular method urged in the petition has in India, as elsewhere, long ceased to be applicable to works of any magnitude or of utilitarian purpose.

“ They are, however, in full sympathy with the aims of the signatories, and it is their hope and intention that the work of the New Delhi should serve as an encouragement to the best craftsmen

in India to seek employment upon it, and should afford them an ample outlet for their traditional skill in the decorative arts."

### A SUPPLEMENT TO THE PETITION

The following is an extract from a letter written by Mr. Randall Wells, which was sent to the India Office on behalf of the Petitioners :

" I have to express on behalf of the signatories the great satisfaction with which they have learned that the Government of India is in full sympathy with their aims. But they notice with disappointment that the Government of India expresses an opinion differing from theirs as to the possibilities of modern architecture ; a disappointment coupled with surprise in view of that Government's preliminary report, recently issued, upon the subject.

" At the time the petition was presented this report, the material for which seem to have been collected in 1911, was not available, but it entirely confirms the views expressed in the petition and illustrates them with some ninety plates, comprising examples of works both of magnitude and of utilitarian purpose. It is needless to remind you that this report is the joint work of Mr. Gordon Sanderson, under the direction of Dr. J. H. Marshall, and of Mr. J. Begg (Consulting Architect) ; that its evidence as to fact is unimpeachable, and any opinions expressed are those of the most expert advisers upon the subject that the Government can command. It is felt, that this being so, the views of the Government of India expressed in your letter must be those held before this report had been read, and that the signatories may hope for a further communication not only affirming the Indian Government's agreement with their aims, but acknowledging their realisation of the possibilities suggested.

" The last sentence of your letter suggests that there is a proposal to separate one part of Indian building craft from another, to encourage carving and pattern-making at the expense of architecture as a whole. To do this would be to do more harm to Indian architecture than for the Government not to employ Indian craftsmen at all. The result in itself would be bad art, and could only lead eventually to the complete deterioration of the work.

“ The side of Indian building to which the petitioners especially desired to draw attention was the master-builders’ inherited free mastery of construction and design in the larger sense—as will be shown by the photographs and notes in the report—and not so much to the outcome of this, their facility in what are called the decorative arts. It is the emphasis which has been laid upon these that have led to the present misconception of Indian architecture.”

# INDEX

- Abûl Fazl, 12, 166  
*Ad'histhâna*, 26  
 Âdînah Mosque, 55, 90-1, 129  
 Agra, Fort, 42, 179  
   ,, Itmad-ud-daulah's tomb, 213  
   ,, Jahângîrî Mahall, 179-80  
   ,, Motî Masjid, 2, 90, 124, 215  
   ,, Samman Burj, 212  
   ,, Sikandara Bagh, 223  
 Ahmad Shah, 70, 134  
 Ahmadâbâd, 70, 134, 142, 147, 185  
   ,, Jâmi' Masjid, 13, 70-5,  
   138  
   ,, Râni Rupâvatî's mosque  
   and tomb, 143-4  
   ,, ,, Sîparî's mosque and  
   tomb, 146-7  
   ,, Sidi Sayyid's mosque, 145-6  
 Ahmadnagar, 186  
 Ajantâ, frescoes at, 28, 126  
   ,, dâgabâs, 26-7, 64  
   ,, temples, 97  
 Ajmîr, arches at, 49-50, 71-2, 86  
   ,, mosque, 45, 88  
   ,, pavilions, 216  
 Akbar, 151, 152, 153, 165-81, 182, 205,  
   211  
   ,, control of expenditure by, 167,  
   167*n.*, 211  
   ,, fort of, 42, 179, 207  
   ,, office of, 174  
   ,, palace of, 166, 168  
   ,, throne of, 174-5  
   ,, tomb of, 29, 181  
 Akhi Serâj-ud-Dîn, mosque of, 130  
 Alau-d-Dîn, 48  
 Alberûni, 12, 22, 182  
 Alhambra, the, 22, 52  
 'Alî Âdil Shah of Bijâpûr, 190, 191, 192  
 Alî Masjid stûpa, 86  
 Alif Khan, mosque of, 111, 114-15, 131  
 Altamsh, 45, 48, 88  
 Alwar railway-station, 247  
 Amarâvatî, 16  
 Amber, palace at, 210  
 Arches, at Bijâpûr, 92, 191, 193  
   ,, foliated, 82-93, 126, 188, 203,  
   225-6  
   ,, horse-shoe or lotus-leaf, 56, 84,  
   86, 96, 128  
   ,, ornamentation of, 88  
   ,, pîpal-leaf, 84, 88, 92, 145, 163,  
   192  
   ,, pointed, 4, 5, 46, 48, 59, 62, 71-2,  
   82, 88, 135, 180, 188, 202  
   ,, radiating, 57, 59, 67-8  
   ,, round, 87, 88  
 Architecture, Anglo-Indian, 126, 181,  
   198, 222, 228-33, 236,  
   239  
   ,, Arab, 10, 20, 121, 188  
   ,, Buddhist, 10, 57  
   ,, Burmese, 57-8  
   ,, Bengali, 54-60, 121-33,  
   182, 211-12, 226  
   ,, Byzantine, 4, 9, 10, 81,  
   154, 158, 184, 246  
   ,, Christian, 139, 218  
   ,, classic school of, 143, 149,  
   174, 216, 223  
   ,, classification of Indian, 42,  
   121-2, 132, 160

- Architecture, and craftsmanship, Indian, 259  
 ,, diletantism in, 158, 222, 231-2  
 ,, Dravidian or South Indian, 26, 184-92, 234  
 ,, Gothic, 158  
 ,, Hindu, 11, 42, 50, 74-7, 184-91, 208-11, 216-20  
 ,, Italian, 32  
 ,, Jaina, 203  
 ,, modern Indian, 223-49  
 ,, Mogul, 154-8, 165-81, 210-14, 221-2  
 ,, Orissan, 248-9  
 ,, painters, 215  
 ,, Pathân, 13, 41-2, 105, 161, 162  
 ,, Persian, 21, 103, 112, 146, 155, 174, 179-80, 183  
 ,, Rajput, 151, 168, 182, 200-4, 208-10, 226-7, 243-7  
 ,, Renaissance, 138, 156, 225, 237  
 ,, Saracenic schools, 5  
 ,, style in, 37-8, 70, 121-2, 133, 150, 156, 176, 194, 204, 209-10, 238-9, 246
- Art Education, Macaulay system of, 264
- Asoka, missionaries of, 6
- Aura, 84-8
- Aurangzîb, 39-40, 155, 158, 183, 200-1, 205, 221-2
- Bâbar, 153-9, 206
- Baghdad, 13, 141, 155, 159, 171
- Baker, Sir Herbert, 262-3, 268
- Bambu construction, 95-7, 126-7, 130
- Banyan tree, 85
- "Battle of the Styles," 258-9
- Begg, F.R.I.B.A., J, 260, 261
- Benares, bathing-palaces, 236-9  
 ,, temples at, 243
- Bengali architecture, 54-9, 96
- Bijâpûr, 182-3  
 ,, 'Ali Shahi Pîr-ki Masjid, 92  
 ,, construction of domes at, 108-19  
 ,, dynasty of, 92, 182-3  
 ,, Ibrâhîm's mosque and tomb, 93, 192-5  
 ,, Jâmi' Masjid, 111, 116, 190, 191, 192  
 ,, Mahmûd's tomb, 111, 116-19, 196  
 ,, Mehtar Mahall, 195
- Bikanîr, house at, 227
- Bîr Singh Deva, palaces of, 208-9
- Birdwood, Sir George, 230
- Bodh-Gayâ, temple of, 56
- Bodhi tree, 83, 84
- Bon, Dr. Gustave le, 10
- Boud-khâna, 6
- Bôrôbudûr, 24, 28
- Brackets, 16, 68, 87, 93, 119, 145, 195
- Brahmans, Muhammadan rulers and, 167, 186, 201
- Brahma Samâj, 202
- Brindâban, temple of Govind Deva, 200-4  
 ,, modern temples, 240
- British sovereignty, spirit of, 263
- Buland Darwâza, 21, 173
- "Bulbous" or lotus-leaf domes. *See* Domes
- Burgess, Dr., 135*n.*, 142, 147
- Burmese architecture, 57-8
- Calligraphists, 34, 50, 52, 59, 91, 126, 131, 137, 155, 215
- Cambay, mosque at, 53
- Capitals, Hindu, 100
- Chakra, or wheel, 85, 87, 90, 98, 99
- Champanîr Jâmi' Masjid, 74, 95, 105, 107, 134-42, 149, 160, 172  
 ,, Nagna Masjid, 142

Chandi Sewa, 24, 32  
 Chandragiri, palace of, 220  
 Chhatris, 64*n.*  
 Chisholm, Mr. R. F., 23, 220  
 Chitor, 210  
 „ Towers of Victory, 72, 138, 150-1  
 Craftsmen, migrations of, 9, 132, 221, 226  
 Chota Sonâ Masjid, Gaur, 89-90, 130  
 Cousens, Mr., 149  
 „ „ wages of, 33-4, 232, 248-9  
 Curzon, Lord, 180, 216, 231, 233-4, 263

Dabhoi, buildings at, 2, 93, 185  
 Dâgabas, 26, 27, 64  
 Dakhil Gate, Gaur, 81  
 Daryâ Khan, tomb of, 111-15, 119  
 Dativâ, palace of, 40, 207-9, 239  
 D'Avennes, M. Prisse, 7  
 Davids, Professor Rhys, 83*n.*  
 Delhi, Dîwân-i-Khâs, 90  
 „ Golden Pavilion, 133  
 „ Jâmi' Masjid, 2, 135, 216  
 „ Qutb Minar, 49  
 „ „ Mosque, 47, 49, 94  
 „ the new, 255, 257, appendix

Dhar, 66  
 Dholkâ, Alif Khan's Masjid, 77, 114-15  
 „ Hilâl Khân Qâzi's Masjid, 54  
 „ Jâmi' Masjid, 77  
 „ Tâka or Tanka Masjid, 54

Dig, palace of, 40, 224-6, 239-40  
 Domes, Arab, 17, 25, 33  
 „ Bijâpûr, 108, 116-19, 197, 216  
 „ bell-shaped, 97, 100-2  
 „ Buddhist, 16  
 „ bulbous or lotus-leaf, 17, 25, 97, 98-100, 161, 189, 193  
 „ Byzantine, 80, 184  
 „ construction of, 93-120, 139-40, 163  
 „ Decoration of, 99-101, 107-8  
 „ European, 117

Domes, Hindu, 16, 26-7, 44, 93, 94, 105-7, 109, 114, 139, 160, 188, 193  
 „ Indo-Muhammadan, 60, 65, 108-20, 146  
 „ *nava-ratna* grouping of, 144  
 „ *panch-ratna* grouping of, 24, 133, 144, 161, 164, 176, 208  
 „ Pathân, 44, 105-6, 193, 203  
 „ Persian, 17, 33, 99, 109, 164  
 „ ribbed, 96-103, 107, 139

East, springs of craftsmanship in, 265

Fatehpur-Sikrî, 166-79  
 „ „ Akbar's office, 174  
 „ „ Buland Darwâza, 135  
 „ „ Dîwân-i-Khâs, 169, 174-6, 181*n.*  
 „ „ Jâmi' Masjid, 135, 168-74, 202-3  
 „ „ Jodh Bai's palace, 177  
 „ „ Panch Mahall, 169, 178, 181  
 „ „ Rajah Birbal's house, 176-7

Finials, Indian, 99, 104, 107, 159, 161-2, 164, 171  
 „ Persian, 103, 164

Firuz Shah, 49  
 Flinders Petrie, Professor, 6  
 Franz Pasha, 20  
 Fresco, Indian, 198

Gandhâran art, 1, 11, 83  
*Gandhi*, 102, 200  
 Ganguly, Mr. O. C., 234*n.*, 242*n.*  
*Garbha griha*, 200, 203  
 Gardens, Mogul, 36, 65, 156-7, 195, 213  
 Gaur, 42, 54, 91, 128-9, 185  
 „ buildings at, 54-60, 125-33, 211-12



- Gesso, 199  
 Ghazni, 11, 12, 44, 49  
 Ghulâ Ghat, palace at, 236-9  
 Goa, 218  
 Govardhan, palace at, 204  
 Govind Deva's temple, Brindâban, 200-4  
 Griva, 27  
 Growse, Mr. F. S., 240-3, 266
- Hilâl Khan Qâzi, mosque of, 54  
*Hiranya-garbha*, 15  
 Humâyûn, tomb of, 24, 31-2, 159, 163, 165, 170, 171  
 Husain Shah, 123, 127, 129
- Ibrâhîm I. of Bijâpûr, 186  
 „ II. of Bijâpûr, 192  
 „ „ tomb of, 193-5  
 „ Shah of Jaunpur, 69  
 Idealism, Hindu, 27-8, 214  
 „ Muhammadan, 2-4  
 India, petition to Secretary of State for, 258, 260, 271-6  
 Indian life and an artistic ideal, 259  
 „ „ intellectual element in, 259  
 „ „ people, future of the, 259  
 „ „ happiness of the, 259  
 „ „ India of the, 259  
 Iron in buildings, 48, 126-7  
 Itmad-ud-daulah, tomb of, 19, 29
- Jahângîr, 152, 172, 181, 205, 206, 211, 213  
 „ tomb of, 213  
 Jahângîrî Mahall, 179-80  
 Jai Singh, Raja, 204  
 Jaipur, city of, 224  
 Jaunpur, 66, 69-70, 140, 183  
 „ Atâla Masjid, 69-70  
 „ Jâmi' Masjid, 69-70  
 Jodhpur, fort and palace, 210  
 „ modern mansion, 235  
 Junagarh, mosque at, 140
- Kailâsa temple, 27  
*Kalasha, or Kumbhu*, 15, 27, 33, 99, 103, 159, 194  
*Kalsa*, 34  
 Kalugumalai, 97  
 Kandarya Mahadeva temple, 203  
 Khajurâho, temples at, 2, 203  
*Kirtti-mukhi*, 92  
 Kulbarga, 182, 184  
 „ mosque at, 60-3  
 Kumbha Rânâ, 70, 75, 151
- Lanchester, F.R.I.B.A., H. V., 267, 268  
 Langenegger, Dr., 99n., 103  
 Lashkar, 244-7  
 Lethaby, Professor, 39, 146, 155, 164, 172, 206  
 Lighting of mosques, 61  
*Lingam*, 202  
*Lîwân*, 43  
 Living art and craft of India, 261  
 Lotus, symbolism of the, 15-16, 97, 98, 101  
 Lotus-leaf arches. *See* Arches  
 Lucknow, buildings at, 222  
*Lupa-mula*, 27
- Madura, Tirumalai Nayyak's chaultri at, 219-20  
 „ palace of, 218-19  
*Mahâ-padma*, 27, 98-9, 102, 107, 159, 194  
 Mahmûd of Bijâpûr, 196  
 „ of Ghazni, 11, 12, 22, 37, 42, 43, 182  
 „ Shah Begarah of Gujerat, 134, 148, 152  
*Makara*, 85, 87  
*Mâlâ-baddha*, 27  
 Mâlwa, 66-8, 81  
 „ architecture of, 66-8  
 Mâmallapuram, 27, 97  
 Mân Singh of Amber, palace of, 200, 204





