

BIRLA CENTRAL LIBRARY

PILANI (Rajasthan)

Class No.: 669

Book No.: E86M V.3

Accession No.: 45539

Acc. No.....

ISSUE LABEL

Not later than the latest date stamped below.

--	--	--

METALS AND METALLIC COMPOUNDS

BY
ULICK R. EVANS, M.A.

KING'S COLLEGE, CAMBRIDGE

IN FOUR VOLUMES

VOLUME III
THE TRANSITION ELEMENTS

LONDON
EDWARD ARNOLD & CO.

1923

[*All rights reserved*]

*Made and Printed in Great Britain by
Butler & Tanner, Frome and London*

PREFACE

During the past few years so much fruitful research work has been carried out in metallography, crystallography, electro-chemistry, colloid chemistry and geo-chemistry that we are enabled to approach the subject of metals in an altogether new spirit. It is now possible to suggest reasons for phenomena which at one time appeared inexplicable, and to detect regularities where once the facts seemed chaotic. Advantage should surely be taken of the new aspect of the subject in the textbooks. The traditional practice of giving long " catalogues of salts " and empirical accounts of metallurgical processes, is no doubt of use for books of reference. But in books intended for continuous reading, such a method is far too uninspiring, and should be abandoned now that knowledge has advanced sufficiently to offer something better.

In this book, an attempt is made to correlate cause and effect, and to introduce such theoretical views as will serve to connect the known facts in an ordered and elegant sequence. The book is intended for the advanced student of inorganic and metallurgical chemistry, and for those engaged in research in these subjects. The industrial chemist will, I hope, also find it of assistance, whilst certain portions (e.g. those dealing with work-hardening, recrystallization, the effect of impurities on metals, and corrosion) should prove useful to the engineer.

The difficulties which I have experienced in writing the book have served to convince me that the work is really needed. Much information which I regard as being of the greatest importance I have found scattered through the recent volumes of the scientific and technical journals—in many cases in journals which are not commonly considered as being devoted to chemistry at all, and which appear sometimes to have escaped the notice of the writers of standard chemical textbooks.

Of the four volumes, the first is of a generalized character. It begins with an Introduction in which I have endeavoured to condense the elementary principles of general chemistry, physics and geology, a knowledge of which the reader is assumed, in the body of the work, to possess. The body of Volume I is divided into two

parts, "The Study of the Metallic State" (Metallography) and "The Study of the Ionic State" (Electrochemistry). The metallographic portion includes the effects of deformation, annealing and alloying on the properties of metals; the electrochemical portion includes such subjects as the structure of precipitates, the colloidal state, electro-deposition and corrosion; it closes with a chapter on radioactivity. By the treatment of the metallography and electrochemistry of metals in a general fashion, with examples chosen from individual metals, these two subjects are presented in a more satisfactory manner than if they were introduced piecemeal in the sections devoted to the different metals. In addition, a great deal of wearisome repetition is avoided in the subsequent volumes.

The chapters dealing with electrochemistry have presented special difficulties. I do not believe it possible to obtain a proper understanding of the chemistry of metals without some knowledge of electrochemistry and colloid chemistry. In order to throw open these subjects to all, I have made the treatment, as far as possible, non-mathematical. A great obstacle to the attractive presentation of electrochemical principles is the barbarous character of the nomenclature in use; I have not felt justified in introducing a new nomenclature, but have tried to make the best of the existing terms, selecting a terminology which will be definite, even if it is not dignified.

In Volumes II, III and IV, I deal one by one with the individual metals. The order observed is based upon the Periodic Table in a form similar to that made popular by Sir James Walker. The old form of the Periodic Table which classes sodium along with copper has now it is to be hoped few active supporters, although it still ornaments the walls of our lecture theatres, and appears to find favour with the authors of chemical treatises based upon the classical model. In the new table, which accords well with the chemical and electrochemical properties of the elements and is in harmony with modern ideas of the structure of the atom, the elements can be divided into three main classes, and I have allocated a different volume to each class. Volume II deals with the metals of the "A Groups," Volume III with the "Transition Elements" (Group "VIII" of the old table), whilst Volume IV deals with the metals of the "B Groups."

The space devoted to each metal is divided into three main sections. The first deals with the metal and its compounds from the point of view of the academical laboratory. The pure chemistry of the metal and its compounds is here discussed; no reference to ores, technical processes and industrial application is made in

this section, which is therefore fairly concise. The section ends with a summary of the methods of analysis of the metal in question, although the book is not intended as a practical analytical handbook.

The second section deals shortly with the terrestrial occurrence of the metal in question, starting with its origin in the rock-magma, and discussing the probable mode of formation of the important ores and minerals, both primary and secondary.

The third section—which is often the longest—is of a technical character. We start with the ore or mineral, and follow the metal through the processes of concentration and smelting, and finally consider the practical uses of the element, and of compounds containing it; I have tried to show why the properties of the individual metal—as stated in the theoretical section—render it suitable for the various uses to which it is put, and to make the technical section a correct survey of industry carried on at the present time; I have only referred to obsolete methods of procedure in a few places where such a reference is thought to be instructive.

Stress has been laid on the important points, which have been illustrated by a few chosen examples in order to avoid burdening the reader with a mass of names and numbers, which he will not retain, and which can be looked up when required in a table of physical constants or in a detailed book of reference. Proper names have largely been concentrated in the foot-notes, and thus kept out of the text; I have written a book about chemistry—not about chemists. Likewise the figures are frankly diagrammatic, drawn to emphasize the salient points; in the diagrams of technical plants much that is of merely structural importance is omitted. I have only employed the historical order of description where it happens also to be the logical order.

Throughout the book numerous references are given, in foot-notes, to scientific and technical literature; these should be consulted by the reader who wishes to study any given part of the subject in greater detail. In selecting these references, I have not given preference to the work of the actual originators of the various theories or processes, but have sought rather to provide the reader with the most recent information regarding the matter under discussion. The recent papers themselves will include references to the earlier ones, whilst the converse is clearly not true.

In subjects regarding which disagreement prevails at present, I have in most cases departed from the usual custom of giving in turn a summary of the views advanced by the various disputants, as this practice is apt to leave the reader hopelessly bewildered. Rather, I have endeavoured to suggest a standpoint which the

average reader may safely adopt as a working hypothesis, until further research finally decides the question under dispute. If, however, the subject happens to be one of special interest to the reader, he should consult the references in the foot-notes, and form his own opinions. In these foot-notes he will find references to many authorities whose views are not held by the present writer.

As already stated, great efforts have been made to render the book as "up-to-date" as possible, but I have not concealed the fact that uncertainty still prevails on many parts of the subject, and that research is continually being conducted to settle these doubtful points. I have endeavoured to prepare the reader to revise his own opinions without undue reluctance every time he may open a scientific journal.

I wish to return thanks to the numerous friends who have very kindly given information or advice. Especially would I mention Mr. C. T. Heycock, Dr. E. K. Rideal, Prof. H. C. H. Carpenter, and Mr. Maurice Cook. Mr. Cook has prepared the micro-photographs accompanying Volumes I, III and IV of the book, and has shown much skill and patience in obtaining results which illustrate clearly the points described in the text.

U. R. E.

CAMBRIDGE, 1923.

CONTENTS OF VOLUME III

	PAGE
GENERAL PROPERTIES OF THE TRANSITION ELEMENTS	1
Magnetism	7
IRON	28
Terrestrial Occurrence	54
Metallurgy of Iron and Steel	60
Manufacture of Cast Iron.	61
Manufacture of Steel	77
Puddled Iron	101
Ferro-Alloys	104
Electrolytic Iron	105
The Structure and Properties of Iron and Steel	108
Graphitization	117
Carbon-diffusion in the Solid State	119
Thermal Treatment of Steel	123
Effect of Elements other than Iron and Carbon in Steel and Cast Iron	131
Alloy Steels	137
Corrosion and Rusting of Iron and Steel	144
The Compounds of Iron in Technology	153
COBALT	156
Terrestrial Occurrence	165
Metallurgy and Uses	166
NICKEL	172
Terrestrial Occurrence	178
Metallurgy and Uses	181
Nickel-plating	189
Nickel Alloys	192
Nickel as a Catalyst	194
The Nickel Accumulator	198

	PAGE
RUTHENIUM	203
RHODIUM	209
PALLADIUM	212
OSMIUM	222
IRIDIUM	226
PLATINUM	230
Analysis of the Six Platinum Metals	242
Terrestrial Occurrence of the Six Platinum Metals	247
Technology and Uses of the Six Platinum Metals	249
Platinum as an Industrial Catalyst	255

LIST OF JOURNALS REFERRED TO IN VOLUME III AND ABBREVIATIONS EMPLOYED

<i>Amer. J. Sci.</i>	American Journal of Science.
<i>Amer. Machinist</i>	American Machinist.
<i>Analyst</i>	Analyst.
<i>Ann. Chim. Phys.</i>	Annales de Chimie et de Physique.
<i>Ann. Phys.</i>	Annalen der Physik.
<i>Atti Accad. Lincei.</i>	Atti della Reale Accademia dei Lincei.
<i>Ber.</i>	Berichte der Deutschen chemischen Gesellschaft.
<i>Bull. Soc. Chim.</i>	Bulletin de la Société chimique de France.
<i>Bull. Soc. d'enc.</i>	Bulletin de la Société d'encouragement pour l'Industrie Nationale.
<i>Bull. Amer. Inst. Min. Eng.</i>	Bulletin of the American Institute of Mining Engineers.
<i>Can. Mines Dept.</i>	Canadian Department of Mines.
<i>Carn. Schol. Mem.</i>	Carnegie Scholarship Memoirs (Iron and Steel Institute).
<i>Chem. Age</i>	Chemical Age.
<i>Chem. Eng.</i>	Chemical Engineer (Chicago).
<i>Chem. News.</i>	Chemical News.
<i>Chem. Weekblad</i>	Chemisch Weekblad.
<i>Chem. Zeit.</i>	Chemiker-Zeitung.
<i>Chem. Zent.</i>	Chemisches Zentralblatt.
<i>Comptes Rend.</i>	Comptes rendus hebdomadaires des Séances de l'Académie des Sciences.
<i>Econ. Geol.</i>	Economic Geology.
<i>Electric Railway J.</i>	Electric Railway Journal.
<i>Electrochem. Ind.</i>	Electrochemical Industry.
<i>Elektrotech. Zeitsch.</i>	Elektrotechnische Zeitschrift.
<i>Engineer</i>	Engineer.
<i>Engineering.</i>	Engineering.
<i>Eng. Min. J.</i>	Engineering and Mining Journal.
<i>Ferrum.</i>	Ferrum.
<i>Gazetta</i>	Gazetta chimica italiana.
<i>Helv. Chim. Acta</i>	Helvetica Chimica Acta.
<i>Int. Cong. App. Chem.</i>	International Congress of Applied Chem- istry.
<i>Int. Zeitsch. Met.</i>	Internationale Zeitschrift für Metallo- graphic.
<i>Iron Age</i>	Iron Age.
<i>Iron Coal Trades Rev.</i>	Iron and Coal Trades Review.
<i>Iron Trade Rev.</i>	Iron Trade Review.
<i>J. Amer. Chem. Soc.</i>	Journal of the American Chemical Society.
<i>J. Amer. Soc. Mech. Eng.</i>	Journal of the American Society of Mechanical Engineers.

LIST OF JOURNALS

- J. Amer. Soc. Test. Mat.* . . . Journal of the American Society for Testing Materials.
- J. Chem. Met. Min. Soc., S. Africa* . . . Journal of the Chemical, Metallurgical and Mining Society of South Africa.
- J. Coll. Eng., Tokyo* . . . Journal of the College of Engineering, Tokyo Imperial University.
- J. Franklin Inst.* . . . Journal of the Franklin Institute.
- J. Geol.* . . . Journal of Geology.
- J. Inst. Elect. Eng.* . . . Journal of the Institution of Electrical Engineers.
- J. Ind. Eng. Chem.* . . . Journal of Industrial and Engineering Chemistry.
- J. Inst. Met.* . . . Journal of the Institute of Metals.
- J. Iron Steel Inst.* . . . Journal of the Iron and Steel Institute.
- J. Phys.* . . . Journal de Physique.
- J. Phys. Chem.* . . . Journal of Physical Chemistry.
- J. Prakt. Chem.* . . . Journal für praktische Chemie.
- J. Soc. Chem. Ind.* . . . Journal of the Society of Chemical Industry.
- J. Soc. Eng.* . . . Journal of the Society of Engineers.
- J. West Scotland Iron Steel Inst.* . . . Journal of the West of Scotland Iron and Steel Institute.
- Koll. Zeitsch.* . . . Kolloid-Zeitschrift.
- Lieb. Ann.* . . . Liebig's Annalen der Chemie.
- Machinery* . . . Machinery.
- Metallographist.* . . . Metallographist.
- Met. Chem. Eng.* . . . Metallurgical and Chemical Engineering (also called "Chemical and Metallurgical Engineering").
- Met. Ind.* . . . The Metal Industry (London).
- Met. u. Erz* . . . Metall und Erz.
- Min. Ind.* . . . Mineral Industry.
- Min. Met.* . . . Mining and Metallurgy.
- Min. Sci. Press.* . . . Mining and Scientific Press.
- Mitt. Kgl. Mat. Prüfungsamt* . . . Mittheilungen aus dem königlichen Materialprüfungsamt zu Gross-Lichterfelde West.
- Naturwiss.* . . . Die Naturwissenschaften.
- Phil. Mag.* . . . Philosophical Magazine.
- Phil. Trans.* . . . Philosophical Transactions of the Royal Society of London.
- Phys. Rev.* . . . Physical Review.
- Proc. Amst. Acad.* . . . Koninklijke Akademie van Wetenschappen Amsterdam. Proceedings (English Version).
- Proc. Camb. Phil. Soc.* . . . Proceedings of the Cambridge Philosophical Society.
- Proc. Chem. Soc.* . . . Proceedings of the Chemical Society.
- Proc. Inst. Civ. Eng.* . . . Proceedings of the Institution of Civil Engineers.
- Proc. Roy. Soc.* . . . Proceedings of the Royal Society of London.
- Rec. Trav. Chim.* . . . Recueil des travaux chimiques des Pays-Bas et de la Belgique.
- Rep. Bur. Mines, Ontario.* . . . Report of the Bureau of Mines, Ontario.

- Rep. Insp. Alk. Works* Reports of the Chief Inspectors on Alkali (etc.), Works.
- Rev. Met.* Revue de Metallurgie.
- Science* Science.
- Sci. Progress* Science Progress.
- Sci. Rep. Tôhoku Univ.* Science Reports of the Tôhoku Imperial University.
- Sitzungber. Preuss. Akad.* Sitzungsberichte der Königlich Preussischen Akademie der Wissenschaften zu Berlin.
- Smithsonian Misc. Coll.* Smithsonian Miscellaneous Collections.
- Stahl u. Eisen* Stahl und Eisen.
- Times Eng. Supp.* "The Times" Engineering Supplement.
- Trans. Amer. Electrochem. Soc.* Transactions of the American Electrochemical Society.
- Trans. Amer. Inst. Min. Eng.* Transactions of the American Institute of Mining Engineers.
- Trans. Amer. Inst. Chem. Eng.* Transactions of the American Institute of Chemical Engineers.
- Trans. Can. Min. Inst.* Transactions of the Canadian Mining Institute.
- Trans. Chem. Soc.* Transactions of the Chemical Society.
- Trans. Faraday Soc.* Transactions of the Faraday Society.
- Trans. Inst. Gas. Eng.* Transactions of the Institution of Gas Engineers.
- Trans. Inst. Min. Met.* Transactions of the Institution of Mining and Metallurgy.
- U.S. Bur. Mines. Tech. Paper* United States Bureau of Mines, Technological Paper.
- U.S. Bur. Stand. Bull.* United States Bureau of Standards, Bulletin.
- U.S. Bur. Stand. Circ.* United States Bureau of Standards, Circular.
- U.S. Bur. Stand. Sci. Paper* United States Bureau of Standards, Scientific Paper.
- U.S. Bur. Stand. Tech. Paper* United States Bureau of Standards, Technologic Paper.
- U.S. Geol. Surv. Bull.* United States Geological Survey, Bulletin.
- U.S. Geol. Surv. Min. Res.* United States Geological Survey, Mineral Resources.¹
- Zeitsch. Anal. Chem.* Zeitschrift für Analytische Chemie.
- Zeitsch. Angew. Chem.* Zeitschrift für angewandte Chemie.
- Zeitsch. Anorg. Chem.* Zeitschrift für anorganische und allgemeine Chemie.
- Zeitsch. Elektrochem.* Zeitschrift für Elektrochemie.
- Zeitsch. Phys.* Zeitschrift für Physik.
- Zeitsch. Phys. Chem.* Zeitschrift für Physikalische Chemie, Stöchiometrie und Verwandtschaftslehre.
- Zeitsch. Prakt. Geol.* Zeitschrift für Praktische Geologie.

¹ The year stated is always the year of the series ; the year of publication is invariably later.

NOTE ON MICRO-PHOTOGRAPHS IN PLATE

Prepared specially by Mr. MAURICE COOK, M.Sc.

Fig.

- A. **Hypo-eutectoid Steel**, about 0.4% carbon (*pearlitic*). Etched with alcoholic nitric acid. Magnification, $\times 84$.
- B. **Hypo-eutectoid Steel**, 0.64% carbon (*pearlitic*) annealed. Etched with picric acid. Magnification, $\times 800$.
- C. **White Cast Iron**. Etched with alcoholic nitric acid. Magnification, $\times 60$.
- D. **Grey Cast Iron**. Unetched. Magnification, $\times 60$.
- E. **Steel**, 0.95% carbon (*martensitic*). Water-quenched from 900° C. Etched with alcoholic nitric acid. Magnification, $\times 240$.
- F. **Manganese Steel**, 1.3% carbon, 13% manganese (*austenitic*). Water-quenched from 1000° C. Etched with alcoholic nitric acid. Magnification, $\times 120$.

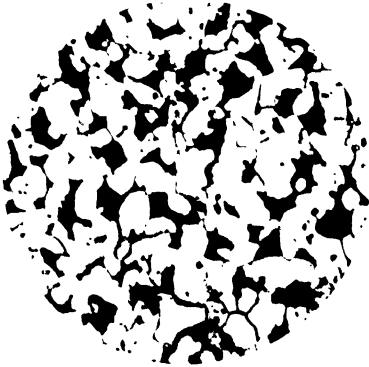

(A) STEEL 40°C. × 84



(B) STEEL 64°C. 800

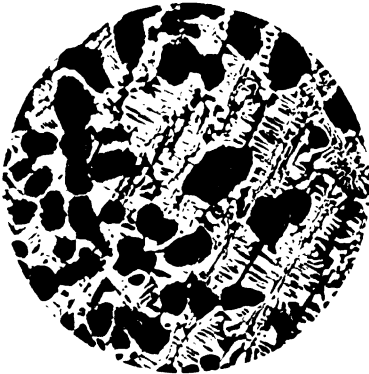

(C) WHITE CAST IRON · 60



(D) GREY CAST IRON · 60



(E) MARTENSITIC STEEL · 240

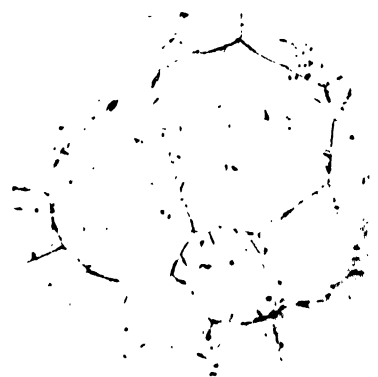

(F) AUSTENITIC STEEL · 120

(For preparation see page xii)

THE TRANSITION ELEMENTS

(Group VIII of the Older Periodic Classification)

	Atomic Weight.		Atomic Weight.		Atomic Weight.
Iron . .	55·84	Ruthenium	101·7	Osmium .	190·9
Cobalt .	58·97	Rhodium .	102·9	Iridium .	193·1
Nickel .	58·68	Palladium.	106·7	Platinum .	195·2

GENERAL PROPERTIES

Whilst studying in turn the "A" groups of the Periodic Table, the reader may have noticed certain tendencies creeping in, which tendencies will be seen to culminate in the "Transition Elements." In the first three groups, the valency of the elements was almost unchangeable, and corresponded in each case to the number of the group. In Group IVA—and still more in Group VA—the valency began to be variable, and at the same time coloured compounds began to appear. The same tendencies were seen in Groups VIA and VIIA; manganese, for instance, exerts its full valency of 7 in the permanganates, but the more stable compounds correspond to much lower valencies. There are various possible explanations for this. It might well be expected that the energy required to deprive an atom of seven electrons would be very great, and that the compounds of heptavalent manganese would probably be endothermic and unstable—which is actually the case. In addition, however, there are certain geometrical considerations which must not be neglected. For instance, in the hypothetical heptachloride, $MnCl_7$, one would have to imagine seven chlorine atoms attached to the manganese atom by the transfer of seven electrons,

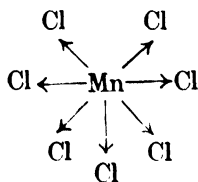

and the question arises: will there be sufficient space to allow them to cluster round the manganese atom without interfering

with one another? The answer to this question is apparently in the negative, for manganese heptachloride does not appear to exist. On the other hand the heptoxide, which can be represented in some such manner as this,

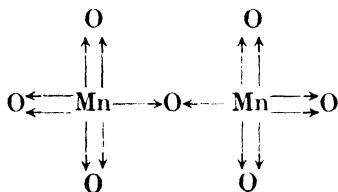

is known. Here, although each manganese atom has lost seven electrons, it is only in union with four other atoms, and spatial interference will not occur.

Passing now to the Transition Elements, we should expect—on the electronic theory of chemical combination—the maximum values of the valency to be 8, 9 and 10, in different cases, as shown in the table below. But, in practice, except in the case of ruthenium and osmium, which have oxides RuO_4 and OsO_4 , the maximum valency is never exerted, and the stabler compounds generally correspond to valencies 2, 3 or 4. Thus the Transition Elements are essentially a group which display variable valency, and which form coloured compounds. The actual valency met with is shown in the table by the numbers placed below the symbols.

Maximum Theoretical Valency	8	9	10
	Fe 2, 3(4)(6)	Co 2, 3(4)	Ni 2(3)(4)
	Ru 2, 3, 4, 6, 7, 8	Rh 3, 4	Pd 2, 4
	Os 2, 3, 4, 6, 8	Ir 3, 4	Pt 2, 4(6)

In the Transition Elements, as in manganese, it is probably spatial considerations which limit the exercise of the full valency. It would be almost impossible to picture ten chlorine atoms attached

to a single nickel atom, as would be necessary if the compound NiCl_{10} were to exist.

A matter of some importance to those who would study the compounds of the transition elements is the existence of bodies (mixed crystals or solid solutions) the *composition of which can vary* within certain limits. Several of the so-called compounds of the transition metals are liable to depart seriously from the composition indicated by the formulæ commonly ascribed to them. Many samples of magnetite, for instance, although homogeneous, contain more oxygen than corresponds to the formula Fe_3O_4 ; the exact composition depends upon the pressure of oxygen in the atmosphere in which the oxide is produced. In the case of the oxides of the six "platinum metals," this variability of composition renders the tabulation of the oxides very difficult. In a few years, when the experimental data have been collected, it may be possible to summarize the state of affairs by means of metal-oxygen equilibrium diagrams showing the variation of the composition of the various series of metal-oxygen mixed crystals (now called oxides) with the temperature and oxygen-pressure. At present, however, the necessary data are not available; and it is doubtful whether in any case such a method of presenting the facts would entirely appeal to the pure chemists of the present day. The conception of a "pure chemical compound" as a body of definite composition is firmly rooted in the minds of many chemists; and although the existing ideas regarding the law of definite proportions will necessarily undergo modification in the near future, it is thought best for the present to adhere as far as possible to the classical method of describing the various "compounds," merely calling attention to the cases in which the proportions of the two components are liable to vary from those prescribed by the ideal formulæ.

A very important property of the transition elements is their power to form **complex salts**, and here again we have to take spatial considerations into account. The complex salts may be formed by combination of the simple salts (chlorides, bromides, cyanides, nitrites, etc.) with the corresponding salts of other metals or of hydrogen. Thus:

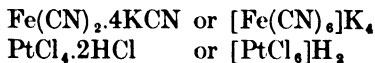

In other cases they may be formed by union of the simple salts with certain substances containing nitrogen or oxygen, such as,

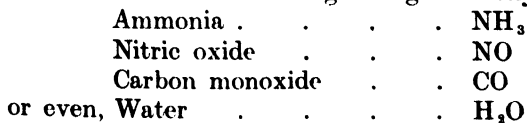

In this way, we get compounds such as,

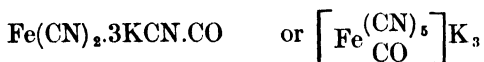
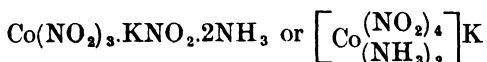

Now the work of Werner has revealed the important fact that, in almost all these compounds, the total number of radicles or molecules *closely attached* to the atom of the heavy metal is equal to *six* (divalent radicles being reckoned as equivalent to two monovalent radicles). The radicles or atoms placed outside the square bracket in the formulæ given above are not required for the stable "group of six" and are free to ionize; those within the square bracket are not free to ionize. We have already noticed the same co-ordination number (six) in previous groups, when considering such salts as potassium titanifluoride, $[\text{TiF}_6]\text{K}_2$, and the green compounds of chromium. But in the transition elements, the question of the co-ordination number assumes special importance. As was pointed out in the introduction (Vol. I, page 32), there is a series of compounds formed by combination of cobaltic chloride (CoCl_3) with 6, 5, 4 and 3 molecules of ammonia, which appear to yield 3, 2, 1 and 0 ions of chlorine respectively from each complex molecule; this can easily be understood when we write the formulæ on the basis of the co-ordination number six:—

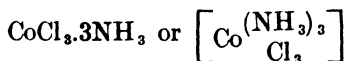
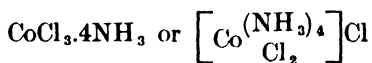
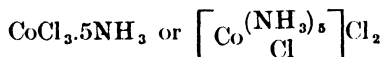
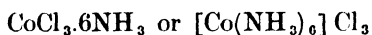

The same sort of relations can be found in other series of complex salts,¹ and, although complications are introduced by the instability of some of the compounds, the mode of ionization of the salts can generally be foretold by writing the formula on the assumption

¹ See A. Werner and A. Miolati, *Zeitsch. Phys. Chem.* **14** (1894), 506, A. Werner, *Ber.* **40** (1907), 15. A classification of the salts into types based on Werner's theory is given in Chapter XVIII of J. N. Friend's "Theory of Valency" (Longmans, Green).

that there is a "group of six" bound to the atom of heavy metal. Only in exceptional cases must another co-ordination number be assumed; for instance, the co-ordination number seems to be four in some derivatives of divalent platinum and divalent palladium, such as,

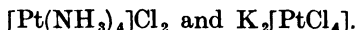

It seems probable that the six atoms, molecules, or radicles which constitute the stable "group of six" are situated at the six corners of an octahedron, the atom of the heavy metal being in the centre (see Fig. 1). This view, which receives support from recent X-ray investigations,¹ serves to explain why there are six, and only six, members of the closely-bound group. It also explains many known facts regarding the existence of isomeric compounds. For instance,

compounds of the type $\left[\text{Co} \begin{matrix} (\text{NO}_2)_2 \\ (\text{NH}_3)_4 \end{matrix} \right] \text{X}$, which have two members of the group of six different from the others, are found to exist in two independent forms. According to the theory just suggested, one form (the *cis-form*) is believed to represent the case when the two (NO_2) radicles exist at adjacent corners (e.g. at A and B), whilst the other (the *trans-form*) represents the case when the same two radicles exist at opposite corners (e.g. at A and F).

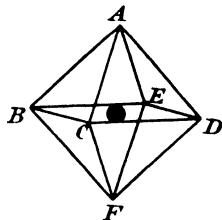

FIG. 1.

There has been a certain amount of discussion regarding the way in which the six members of the stable complex are bound together.

It is admitted by nearly all authorities that the negative atoms or radicles (such as Cl, CN, NO_2 , etc.), whether belonging to the group of six or not, are attracted towards the central metallic atom by electro-static attraction (polar valency), an electron having passed from the central metallic atom to the negative atom or radicle. Werner holds that the other members of the group (NH_3 , NO, H_2O , etc.) are also attracted on to the central metallic atom by what

¹ The arrangement receives confirmation from the X-ray study of potassium stannichloride $\text{K}_2[\text{SnCl}_6]$ by R. G. Dickinson, *J. Amer. Chem. Soc.* **44** (1922), 276. Likewise the X-ray examination of the amines $[\text{Ni}(\text{NH}_3)_6]\text{X}_2$, where X represents Cl, Br, I or (NO_3) , supports the view that the six NH_3 groups are arranged symmetrically round a central nickel atom, and approach it more closely than any other atom of the compound. See R. W. G. Wyckoff, *J. Amer. Chem. Soc.* **44** (1922), 1239, 1260.

The X-ray study of $(\text{NH}_4)_3\text{PtCl}_6$ is described by R. W. G. Wyckoff and E. Posnjak, *J. Amer. Chem. Soc.* **43** (1921), 2292, whilst that of compounds like K_2PtCl_6 , with co-ordination number "four," is described by R. G. Dickinson, *J. Amer. Chem. Soc.* **44** (1922), 2404.

may be called "auxiliary valency." Friend,¹ on the other hand, prefers to think that all the six members are in union with one another, and thus form a stable hexatomic shell, which is comparable to the hexatomic ring present in benzene and benzene derivatives. It is very likely that both views are correct, and that attractive forces exist not only between the metallic atom and the six members clustered around it, but also between one member and another. As explained in the introduction (Vol. I), the electrical theory of chemical force would lead us to admit the possibility of attractive electrical forces existing between two molecules, each of which is uncharged *as a whole*, assuming that the position of the positively and negatively charged portions within the molecules are not extremely close together compared to the distance separating the two molecules from one another.

In various other respects, the transition elements differ from those of the "A groups." Most of the transition elements are distinctly "noble" metals, and all can be deposited electrolytically from aqueous solution with ease; in the "A groups" electrolytic deposition is in no case easy, and only becomes possible in the case of a few of the elements, such as chromium and manganese, which fall near to the transition group. As regards the anodic behaviour, passivity is a common phenomenon in the transition elements, but valve action—so common in the "A groups"—is rarely met with.

Another interesting feature of the group is the occurrence of "ferro-magnetism" in the elements. In magnetic properties, the transition elements show a certain resemblance to the rare earth group. The subject of magnetism is discussed below in a special section.

It should be mentioned here that the transition elements are commonly referred to by chemists as "Group VIII" of the Periodic Table. For some reason there has always been a desire on the part of chemists to prove that the Periodic Table consists of eight—and only eight—groups. Accordingly it has long been customary to confine iron, cobalt, and nickel within a single square of the table. Although tables arranged in that way are still being printed, there has recently been a laudable desire to break away from so purposeless a convention, and to assign to each of these important elements a square of its own. At the same time, it is a fact that iron bears more resemblance to cobalt and nickel (which fall in the same *horizontal* row as iron) than it does to ruthenium and osmium, which

¹ J. N. Friend, *Trans. Chem. Soc.* **93** (1908), 1006; **119** (1921), 1040. Friend's views receive criticism from S. H. C. Briggs, *Trans. Chem. Soc.* **119** (1921), 1876.

fall in the same *vertical* column. It will, therefore, be convenient to study the nine metals in the order :—

Iron, nickel, cobalt,
Ruthenium, rhodium, palladium,
Osmium, iridium, platinum.

The last six elements are known as the “**Platinum Metals.**” They are all noble metals, resembling platinum in colour, and are best known to chemists in the metallic condition. It is a widespread belief that they resemble each other closely, but—apart from the fact that all the compounds are easily reducible to the metallic condition—this is scarcely true. On the contrary, the platinum metals show a remarkable diversity of properties. The two metals on the left, ruthenium and osmium, have numerous series of compounds in which the valency varies from 2 to 8; of these compounds the most remarkable are the volatile oxides, RuO_4 and OsO_4 . The two metals in the centre, rhodium and iridium, have only two series of well-defined compounds; these correspond to valencies of 3 and 4 respectively. The two metals on the right, palladium and platinum, have also two well-developed series of salts, but here the metal exerts a valency of 2 and 4 respectively.

MAGNETISM

If an iron or steel rod is placed axially within a coil of wire through which an electric current is passing, the rod acquires the property of attracting other pieces of iron. Part of this attractive power vanishes when the rod is removed from the coil, but—especially if the rod is composed of a hard steel (e.g. tungsten or chrome steel)—it retains a certain amount of attractive power indefinitely. A piece of steel thus treated is termed a permanent magnet; the attractive power is most marked near the ends of the magnet, which are called the “poles.”

Those substances, like iron or nickel, which are strongly attracted towards a magnet, are said to be **ferromagnetic**; ferromagnetic substances alone are suitable for practical use as magnets. But probably no substance is completely insensible to the presence of a magnet. If a rod-shaped piece of any material is suspended between the poles of a powerful horseshoe-shaped magnet, it will tend to swing so that it lies either parallel to the line joining the poles, in which case the material is said to be **paramagnetic**, or at right angles to that line, in which case the material is called **diamagnetic**. Among the metals both classes occur; bismuth is diamagnetic, and manganese paramagnetic. Ferromagnetic substances can be

regarded as substances endowed with a very intense degree of paramagnetism, although there may be other distinctions between paramagnetic and ferromagnetic bodies.¹

All ferromagnetic substances lose their special intense magnetic properties when heated to a certain temperature, and above this are merely paramagnetic. The nature of this change (which occurs in iron at about 768° C., and is known as the A_2 change) is further discussed in the section dealing with the allotropy of iron. In paramagnetic substances, the magnetism slowly but steadily falls off as the temperature rises,² whilst in diamagnetic substances the property is comparatively independent of temperature.

Units of Magnetism. It has been stated in the introduction of Volume I that the “unlike poles of magnets attract one another, whilst like poles repel one another.” The force acting between two poles depends on the strength of the poles and the distance between them; it is inversely proportional to the square of the distance between the poles. We may at once give a definition of a **pole of unit strength**; when two poles of unit strength are placed *in vacuo* at unit distance (1 cm.) they attract, or repel, each other with unit force (1 dyne). The force acting between two isolated poles of strength m_1 and m_2 placed *in vacuo* at a distance r will be $\frac{m_1 m_2}{r^2}$.

In the vicinity of every magnet there exists a “magnetic field,” and all magnetic substances placed within that field come under the influence of a magnetic force. The **intensity of the magnetic force** at any point in the field may be defined as the mechanical force which would be exerted on a pole of unit strength placed at that point; the unit of the intensity of magnetic force, which is the intensity at a point where the mechanical force on a pole of unit strength would be 1 dyne, is called a “gauss.”

Lines of Force. The direction of the magnetic force in the neighbourhood of a magnet varies from place to place, as is shown clearly if a magnet is placed on a board and iron filings are sprinkled around it, the board being tapped until the filings take up the orientation demanded by the field. Each individual filing behaves like a tiny pivoted needle, and arranges itself in the direction of the magnetic force; consequently there are produced a series of curved

¹ In ferromagnetic bodies, for instance, the permeability varies with the strength of the field in which the body is placed, whilst for paramagnetic bodies the permeability is nearly constant.

² A quantitative law, stating that the susceptibility is inversely proportional to the temperature is enunciated by P. Curie, *Ann. Chim. Phys.* 5 (1895), 289, but does not invariably hold good.

lines starting at one pole and terminating on the other (see Fig. 2).

This simple experiment serves to introduce the conception of "lines of magnetic force." It may be imagined that lines of

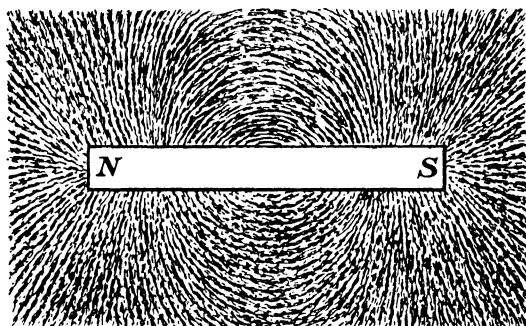

FIG. 2.—Curves produced by Filings round a Bar Magnet.

magnetic force extend outwards from every north pole in all directions through space, in such a way that at any point the direction of the prevailing magnetic force is indicated by the

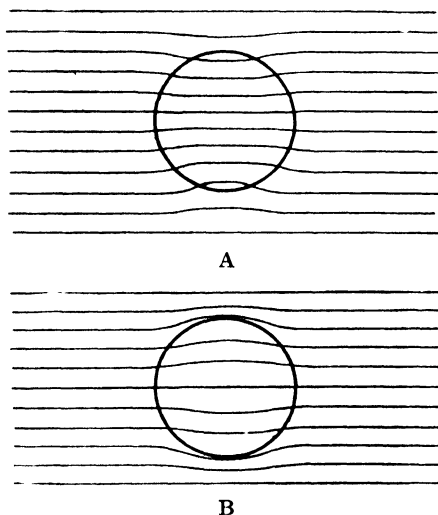

FIG. 3.—Displacement of a Uniform Field by (A) a Paramagnetic Substance, (B) a Diamagnetic Substance.

direction of the lines of force. All the lines that start from a north pole ultimately end upon a south pole. The lines of force will be crowded close together where the magnetic field is intense, but

will be far apart where it is feeble. If we imagine that the number of lines which start from a pole of strength m is $4\pi m$, then the number of lines which cut an imaginary surface of unit area placed at right angles to the lines is a measure of the magnetic force at that point (expressed in gauss).

If in a uniform magnetic field (consisting of a number of parallel lines of force spaced equally from one another) a paramagnetic

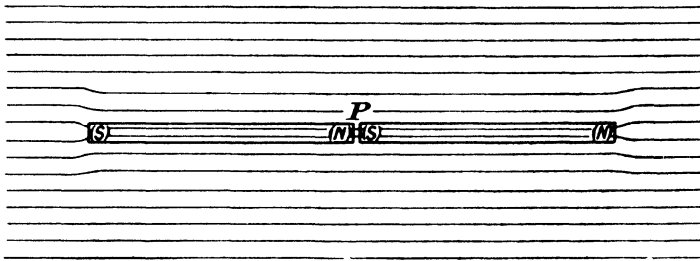

FIG. 4.—Long Rod placed in Magnetic Field.

substance be placed, the lines of force will crowd together to pass through this substance as indicated in Fig. 3(A); on the other hand, if a diamagnetic substance is placed in the field, the lines will diverge from one another, as shown in Fig. 3(B). Let us imagine (Fig. 4) that the object placed in the magnetic field is a long thin rod (the length should be so great compared to the breadth that the irregularity due to the ends can be neglected), and let us compare the total number of lines per unit area within the material, which is called the **magnetic induction** (B), with the number of lines per unit area in the surrounding space, that is the **magnetic force** (H). The ratio of these two quantities we may call the **magnetic permeability** of the substance (μ). Thus,

$$\mu = \frac{B}{H}$$

Clearly for diamagnetic substances the permeability will be less than unity, whilst for paramagnetic substance it will be greater than unity, rising to very high values for ferromagnetic substances like iron. It should be noted that for ferromagnetic substances the permeability is not constant, but depends on the magnetizing force.

It is due to the crowding of the lines of magnetic force into a substance like iron, that a piece of ordinary iron placed in a magnetic field becomes a magnet, so long as the field exists. If we imagine a narrow crevasse cut across the long thin rod at P , we obtain a

north pole where the lines of force leave the iron to cross the crevasse, and a south pole where they reach the other side. If we define the **intensity of magnetization** (I) of the iron as the pole strength per unit area of the crevasse, the number of extra lines of force per unit area due to the magnetization of the iron is, by the convention made above,

$$4\pi I,$$

and since the number of lines of force due to the external field is H , the total number per unit area, i.e. the magnetic induction, is

$$B = 4\pi I + H.$$

Another useful conception is that of **magnetic susceptibility**.

The susceptibility (k) is equal to $\frac{I}{H}$. For diamagnetic substances it is a negative quantity, for paramagnetic substances it is positive.

Most compounds of iron possess paramagnetic properties, but only a few compounds, such as the intermediate oxide Fe_3O_4 ("magnetite"), are magnetic to an extent comparable to that of metallic iron. The magnetic susceptibility of pure magnetite is said to be about one-quarter of that of pure iron. It is noteworthy that crystals of magnetite containing more oxygen than corresponds to the formula Fe_3O_4 are less magnetic, the susceptibility falling off as the oxygen-content rises.¹

There are other ways of obtaining a magnetic field besides bringing a permanent magnet into position. It has already been stated that if a bar of iron be placed within a solenoid (a long helical coil of wire) along which an electric current is passing, it becomes a magnet; the magnetic force within a solenoid of n turns of wire per unit length, and round which a current C is flowing, is

$$4\pi nC.$$

When the current ceases to flow, much of the magnetism of the iron bar vanishes, although not, as we have seen, the whole of it.

Hysteresis and Residual Magnetism. The magnetic properties of a ferromagnetic substance depend not merely on the magnetizing force acting on it at the moment, but on those which have been acting on it in the past. The "**hysteresis effect**" which enters into the magnetization of a bar of iron is shown by the curves of Fig. 5, which indicate the connection between the magnetic force (or magnetizing force) acting upon an iron bar and the intensity of the magnetism produced.

¹ R. B. Sosman and J. C. Hostetter, *Trans. Amer. Inst. Min. Eng.* 58 (1917), 409.

The curves can be obtained as follows.¹ An iron bar is placed inside a coil of wire through which an electric current is passed so as to produce a magnetizing force. By varying the strength of the current, we can vary the magnetizing force. At first, the increase of magnetizing force has a considerable effect upon the iron, as shown by the portion OA of the curve I; but afterwards the iron becomes "saturated," and any further increase in the magnetizing

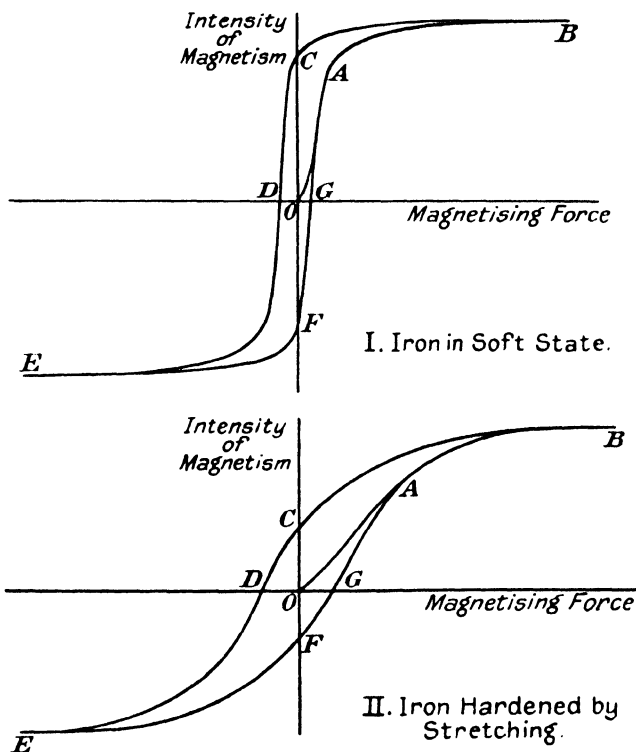

FIG. 5.—Hysteresis of (I) Iron in soft state, and (II) Iron hardened by stretching.

force produces little or no increase in the intensity. If, after reaching the saturation value (point B), we start gradually to decrease the magnetizing force, the effect is shown by the curve BC, which is not the same as the curve OAB. When the magnetiz-

¹ For details, see J. A. Ewing, "Magnetic Induction in Iron and other Metals" (Published by *The Electrician*).

ing force has been entirely removed, the bar still retains some magnetism, as shown by point C. In fact it is only by applying an appreciable force in the opposite direction (point D) that this residual magnetism is removed. Further increase of magnetizing force in the reverse direction causes magnetization of the iron in the new direction, and finally brings us again to a saturation value (point E); and when the magnetizing force is again reduced and once more reversed the connection between magnetizing force and intensity of magnetization is indicated by the curve EFGAB. Further applications of a gradually varying magnetizing force, first in one direction, then in the other, causes the iron to behave in a way indicated by the circuit BCDEFGAB.

The nature of the hysteresis curve varies with different kinds of iron. In soft iron, the curves EFGAB and BCDE lie close together, and the hysteresis effect is small (curves I). But if the iron be hardened by cold-work, or by the addition of other elements, they lie further away from one another (see curves II). In some of the stiffer alloys of iron (e.g. steels containing tungsten or chromium) the curves EFGAB and BCDE lie far apart. The "residual magnetism" left when the magnetizing force is removed is represented by the distance OC, whilst the "coercive force," the reverse force needed to destroy the magnetism, is represented by the distance OD. The exceptional value of the special magnet steels containing tungsten, chromium or cobalt is that the coercive force is large, and such materials, when once magnetized, do not readily lose their magnetism owing to chance exposure to adverse magnetic fields. Furthermore, steels of this kind do not readily lose their magnetism when subjected to mechanical shocks; such materials are clearly suitable for the manufacture of permanent magnets.¹

On the other hand, pure soft iron, with its low hysteresis effect, is more suited for use in the temporary magnets of magneto-electric machinery. It is most important that where—as in the core of a transformer or dynamo armature—a piece of iron may be magnetized and demagnetized perhaps a hundred times each second—the hysteresis-effect should be small; for, if it is not small, the energy consumed in magnetizing the iron core will exceed that recovered the next instant when the iron is demagnetized, and consequently a wastage of energy will occur. There is, in every case, some dissipation of energy, which will reappear in the form of heat, but the amount of energy transformed to heat will be

¹ For the effect of the presence of different elements in iron on the coercive force, residual magnetism, and ability to stand shock, see G. F. Burgess and J. Aston, *Met. Chem. Eng.* 8 (1910), 673.

greater in hard steel than in pure iron. If this were the only cause of loss of energy, then the purest iron would always be used in electromagnetic machinery. Actually, however, there is a second cause of loss due to the so-called "eddy currents" of electricity produced within the cores themselves. These eddy currents are reduced if the core material has a high electrical resistance; consequently, in practice, iron containing silicon, which has a much higher electrical resistance than pure iron, is often employed.

Theories of Magnetism. A ferromagnetic substance only acquires magnetic properties (temporary or permanent) when subjected to a magnetic field—e.g. when placed in proximity with another magnet. Ewing has suggested that all ferromagnetic substances contain numberless particles each of which is a minute magnet, but that in the ordinary (non-magnetized) condition the particles lie with their magnetic axes pointing in all sorts of different directions, so that no magnetic field is produced by the combination. When subjected to an external field, the magnetic particles tend to turn in the same direction, and their cumulative effect is no longer nil. Ewing¹ has constructed a model consisting of a large number of pivoted magnetic needles placed upon a board. Normally the needles point in all sorts of directions, but when a gradually increasing magnetic field is applied to the system, the needles commence to turn in the direction dictated by the applied field; the effect upon the combination of increasing the magnetizing force is analogous to the effect upon a piece of iron, as shown by the curve I of Fig. 5. When the magnetizing force applied is very small, the deflection of the needles from their original position is very small, but a further increase in the magnetizing force causes a considerable disturbance among the needles. Finally the "saturation value" of the system is reached when all the magnets are pointing exactly in the same direction.

The suggested explanation accords well with the fact—already stated—that, in soft iron, in which the particles are presumably tractable, the alternate magnetization and demagnetization requires but little energy, whereas in hard steel, in which the particles are presumably difficult to move, much energy is involved. There is, in fact, a general connection between coercive force and hardness. Although the study of different steels shows that the coercive force (or "magnetic hardness," as it has been called) does not run absolutely parallel with the "mechanical hardness," the abnormalities are not much greater than those met with when we compare

¹ J. A. Ewing, *Phil. Mag.* **30** (1890), 205. Lately an improved model has been described by Sir J. A. Ewing, *Phil. Mag.* **43** (1922), 493; *Proc. Roy. Soc.* **100** [A] (1922), 449.

the values for the mechanical hardness obtained by different methods (e.g. by the Brinell and the Shore tests).¹

That the main phenomena of ferromagnetism can be explained on the assumption that the materials involved consist of an aggregation of minute magnets is now generally agreed. But differences of opinion arise as to the nature of the ultimate magnetic particles. Some authorities, who still believe in the existence of molecules in the solid state, hold that the molecules are individual small magnets.² This may conceivably be true for organic substances, in which the molecule is often the structural unit. But in metals, and inorganic substances generally, recent work on crystal structure has indicated that there is really no such thing as a molecule in the solid state. We must therefore regard the atom—or something within the atom—as the ultimate magnet.³ There is a superficial difficulty connected with the acceptance of this view, because the same atom behaves so differently in different states of combination. Iron, for instance, is highly magnetic in the free state, moderately magnetic in the oxide Fe_3O_4 , and only very weakly magnetic in Fe_2O_3 . However, the difficulty is only an apparent one. In metallic iron, each atom possesses all its electrons, whilst in ferric oxide each atom has lost three electrons, which may well be expected to upset the balance in some way.

Inquiries may be pushed farther as to the seat of magnetism within the atom. If the electrons of the atom are not fixed, but are moving, say, in circular orbits, then each orbit is equivalent to an electric current moving round a circular conductor, an arrangement which—as is well known—produces a magnetic field. A theory of magnetism has been founded on such orbital movements of the electrons.⁴ There are difficulties in accepting the theory in its original form, but Parson⁵ has eliminated many of these by suggesting that the electron itself is not a point-charge moving in a circle, but consists of a continuous revolving ring of electricity; the electricity is supposed to be moving unceasingly round the ring. Two of these ring-electrons or “magnetons” will obviously exert a

¹ W. Wild, *Trans. Faraday Soc.* **15** (1920), iii, 1.

² K. Honda and J. Okubo, *Phys. Rev.* **10** (1917), 705; especially pages 733–738; A. E. Oxley, *Sci. Progress* **14** (1920), 588; *Proc. Roy. Soc.* **98** [A] (1920), 264. See also P. Weiss, *Comptes Rend.* **152** (1911), 367, 688; **156** (1913), 1674.

³ A. H. Compton and O. Rognley, *Science*, **46** (1917), 415; K. T. Compton and E. A. Trousdale, *Phys. Rev.* **5** (1915), 315; A. H. Compton, *J. Franklin Inst.* **192** (1921), 145.

⁴ P. Langevin, *Ann. Chim. Phys.* **5** (1905), 70.

⁵ A. L. Parson, *Smithsonian Misc. Coll.* **65** (1915), No. 11. Compare A. H. Compton, *J. Franklin Inst.* **192** (1921), 145. Sir O. Lodge, *Nature* **110** (1922), 341.

magnetic attraction upon one another, but at the same time an electrostatic repulsion. Since the magnetic and electrostatic forces obey different laws, either the attraction or the repulsion may prevail—according to the distance separating the magnetons and their relative dispositions. Thus it is possible to account for repulsive forces between atoms as well as attractive ones. We have already remarked on this theory (Vol. I, page 29) in considering the cause of the so-called “chemical forces” which link atoms together; it was there stated that the force binding together unlike atoms (e.g. hydrogen and chlorine) appeared to be mainly electrical, but that the forces uniting like atoms (e.g. two hydrogen atoms) may very possibly be of a magnetic character.

All atoms are believed to contain electrons moving in orbits. (If Langmuir’s theory is retained, we may suppose that the orbits are very small, whilst on Bohr’s theory they are comparatively large.) Each ring-electron is equivalent to a small magnet. The question as to whether an atom of a given element will tend to respond readily to an external magnetic field or not, will depend on whether the *combined effect* of the field upon the different small magnets will tend to make the atom turn. If the arrangement of the electrons is quite symmetrical, the “net effect” of an external field on the atom may be nil. All theories of the atom ascribe to the inert gases of Group O a very symmetrical structure, and to this symmetry we attribute the fact that they show practically no response either to chemical forces or to a magnetic field. (Actually the inert gases are weakly diamagnetic for reasons that cannot be discussed here.¹) When, however, valency electrons appear in the atom, one would expect that the symmetry would be upset and that paramagnetic properties would appear. This expectation is realized. The alkali metals of Group IA are weakly paramagnetic, and as we pass from the left of the periodic table to the centre, paramagnetic properties increase, becoming quite pronounced in Group VIA (chromium, etc.), still more important in Group VIIA (manganese), and finally culminate in the ferromagnetism of the transition elements such as iron and nickel. It is noteworthy, however, that there is a return to diamagnetism in Group Ib.

Although the elements of Groups VIA and VIIA are only paramagnetic, they have a certain number of compounds and alloys which must be described as ferromagnetic. The magnetism of certain alloys of manganese, known as the Heusler alloys, has aroused special interest. One class of these alloys contain

¹ Diamagnetic phenomena are probably due to an essentially different cause to that responsible for paramagnetism. See P. Langevin, *Ann. Chim. Phys.* 5 (1905), 80.

manganese, copper and aluminium ; another class contain manganese, copper and tin. It is, however, not so well known that many simple compounds containing manganese, such as the boride (MnB), the two antimonides (MnSb and Mn₂Sb), and in a less degree the phosphide (MnP) are distinctly ferromagnetic.¹

It has already been stated that the magnetism of iron varies with its state of combination. Metallic iron is strongly ferromagnetic, but iron in the ferric state is only paramagnetic ; presumably the difference lies in the loss of three electrons from each iron atom in the ferric compounds. The number of non-nuclear electrons in the Fe⁺⁺⁺ ion is the same as that in the Mn⁺⁺ ion, and it is significant that the atomic magnetism of the ferric compounds is practically the same as that of the manganous compounds ; likewise the atomic magnetism of the manganic compounds (Mn⁺⁺⁺) is the same as that of the chromous compounds (Cr⁺⁺).²

It is natural to seek a cause for the occurrence of such pronounced ferromagnetic properties in metallic iron. Ewing³ has discussed the intra-atomic movements which occur when an iron crystal is magnetized. The movement is most readily understood if we assume that the iron atom has the structure assigned to it by Hull⁴ as a result of X-ray research ; Hull's view of the iron atom is in close accord with Langmuir's general theory of atomic structure, but there is no reason to think that Ewing's conceptions need be abandoned, even if the Bohr theory of atomic structure (with the electrons moving in large orbits instead of small orbits) is found to be nearer to the truth than the Langmuir theory.⁵ According to Hull, two of the twenty-six electrons of the iron atom are close to the nucleus, whilst the other twenty-four are placed along the diagonals of a cube having the nucleus at its centre ; three electrons fall upon the diagonal leading to each corner, as suggested in Fig. 6 (to make the matter clearer the figure departs considerably from the dimensions calculated by Hull). If each electron is a revolving ring of electricity, the arrangement is equivalent to eight little magnets placed diagonally at the corners of the cube, and one little magnet (consisting of the nucleus and two ring-electrons) placed at the centre. We may suppose that when an assemblage of iron atoms are arranged so as to form a crystal of α -iron, the twenty-four

¹ E. Wedekind, *Zeitsch. Phys. Chem.* **66** (1909), 614.

² N. Bohr, *Zeitsch. Phys.* **9** (1922), 51.

³ Sir J. A. Ewing, *Proc. Roy. Soc.* **100**, [A] (1921), 449 ; *Phil. Mag.* **43** (1922), 493.

⁴ A. W. Hull, *Phys. Rev.* **9** (1917), 84.

⁵ The work of W. L. Bragg, R. W. James and C. H. Bosanquet, *Phil. Mag.* **44** (1922), 433, seems to indicate that the Lewis-Langmuir theory of the atom requires modification at least.

outer ring-electrons of each atom are practically fixed, and serve to hold the atom to its neighbours—possibly as the result of the magnetic forces; thus a rigid framework for the whole crystal—consisting of the outer electrons of all the atoms—is provided. But Ewing considers that the central magnet of each atom is capable of swinging about from one position to another. There will be *eight possible positions of equal stability* which it may assume, since it can point in either direction *along any one of the four diagonals*. An external magnetic force is needed to move the central magnet from one of these eight positions to another; but having once

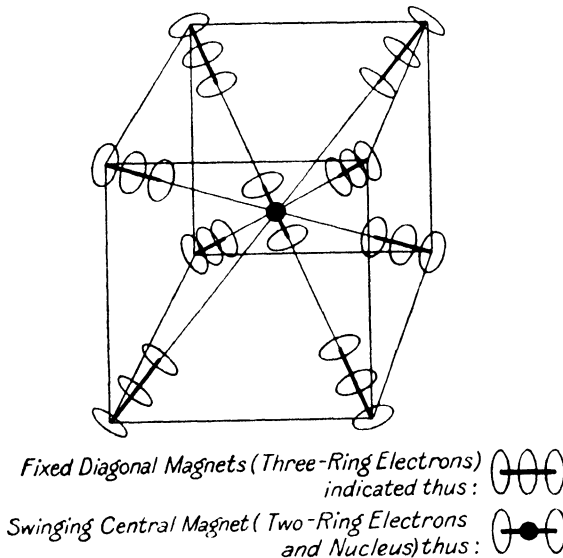

FIG. 6.—Model of the Iron Atom suggested by the Papers of Ewing and Hull (not to scale).

reached this new orientation it will tend to remain there even when the external force is removed. Now when the crystal of α -iron is in the non-magnetized condition, the central magnets of different atoms will point in different directions. A small external magnetic field will produce but little movement of the central magnets owing to the controlling influence of the fixed diagonal magnets. But a larger external force will overcome this controlling influence, and will cause the central magnets of many of the atoms to take up the orientation dictated by the applied field; when the external force is sufficiently large, all the atoms will adopt this orientation and the iron will be saturated. Thus the general form of the magnetization

curve shown in Fig. 5 is accounted for, and, since many of the central magnets will preserve their uniform orientation even after the external force is removed, the phenomena of hysteresis and residual magnetism is likewise explained. Moreover, since the particular arrangement of electrons described above, which allows eight equally stable positions for the central magnet, is peculiar to the iron atom, it will be understood why iron possesses unique importance as a magnetic element. Although Ewing's theory may require some modification in the future—and Ewing has himself suggested some modifications—it is extremely helpful and deserves careful study.

Magnetism and Crystal-Structure.¹ Since both magnetization and crystallization appear to depend, in a way, upon the orientation of atoms, it may be advisable at this point to add a word regarding the distinction between the two conditions. In the crystallized state the atoms are—we believe—arranged with their centres (in the mean position of oscillation) on a regular space-lattice; in popular language the atoms are arranged “in straight rows,” the direction of the rows being the natural cleavage planes along which the crystal tends to split most readily. On the other hand, in the magnetized state, the central parts of the atoms are—according to Ewing's theory—arranged with the magnetic axes pointing in the same direction. A comparison of the X-ray interference patterns of crystalline substances in the magnetized and unmagnetized state appears to show that magnetism does not cause any shifting of the position of the atomic centres.² It seems possible that one can obtain magnetization in the amorphous state,³ just as in the crystalline state, and certainly non-magnetized material is known in both states. This idea is suggested, very crudely, in Fig. 7, which—although it must not be regarded too literally as a complete representation of the truth—may help the reader to appreciate the probable difference between the two types of “orderly arrangement” of atoms known respectively as the magnetized state and the crystalline state.

An interesting connection between magnetism and crystalline structure is shown by an old experiment due to Tyndall. Tyndall found that if a crystal was hung by a thread between the north and south pole of a powerful electro-magnet, it usually sets itself in a definite direction. If it is a paramagnetic substance, it assumes a position such that the principal cleavage direction is parallel to the lines of magnetic force; if diamagnetic, it assumes a position so

¹ A. H. Compton and O. Rognley, *Science*, **46** (1917), 415.

² K. T. Compton and E. A. Trousdale, *Phys. Rev.* **5** (1915), 315.

³ Most glassy substances and liquids are weakly diamagnetic; but a few (like liquid oxygen), are distinctly paramagnetic.

that the cleavage-planes are at right angles to the direction of the lines of force. Since the cleavage-planes are believed to be planes along which the atoms (or, perhaps, in organic substances, the molecules) are packed most densely, this behaviour is quite in accordance with the accepted views of crystal-structure. The Tyndall effect—it should be mentioned—is not greatly affected by the external shape of the crystal; the direction assumed by the suspended crystal is mainly determined by the cleavages.

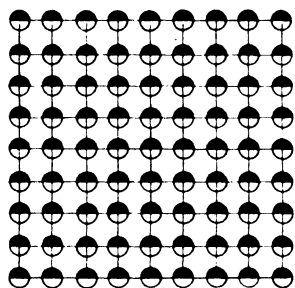

Crystalline Magnetised.

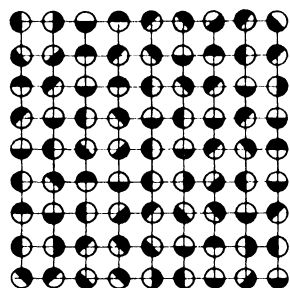

Crystalline Non-magnetised.

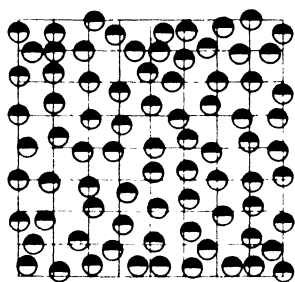

Amorphous Magnetised.

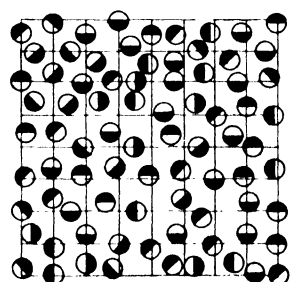

Amorphous Non-magnetised.

FIG. 7.—The Magnetised and Crystalline Conditions.

The thermal movement of the atoms about their mean positions does not necessarily interfere with the ferromagnetism, but, with increasing temperature, the movement becomes more violent, and above a certain point (known as A_2 in the case of iron) the thermal agitation is apparently sufficient to prevent the intra-atomic magnets from retaining their parallel arrangement for any appreciable period. Above this temperature, ferromagnetism gives place to mere paramagnetism, which itself diminishes as the temperature rises.

It is noteworthy that the ferromagnetic condition does not

appear to be dependent upon any single method of arrangement of the atoms.¹ In nickel, the atoms are arranged on a face-centred cubic lattice, but in iron the atoms are arranged on a centred-cube lattice. Nevertheless, a change in the arrangement of the atoms may have a great influence upon the magnetic susceptibility. Thus α -iron, the type of iron usually met with at low temperatures, is ferromagnetic, whilst γ -iron (which although only stable in the pure state at high temperatures, can be obtained in iron alloys at low temperatures) is only paramagnetic. It is interesting to note that a nickel steel containing 25 per cent. of nickel, although practically non-magnetic in its normal state, can be rendered magnetic by being bent backwards and forwards a number of times.² In such a steel, the atoms are arranged on a γ -iron space-lattice, and do not respond freely to a magnetic field; but the bending presumably causes the formation of some other arrangement of atoms (possibly that characteristic of α -iron), and in this changed condition the iron can be magnetized readily.

It is noticeable that in the case of many of the metals in the centre of the periodic table, the compounds in which the usual valency is exerted (e.g. FeO or Fe₂O₃) are only slightly susceptible to magnetism, but that the intermediate compounds, such as

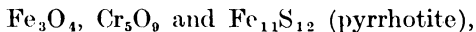

have high values for the magnetic susceptibility. Likewise some of the compounds of molybdenum and tungsten in an intermediate state of oxidation (tungsten bronzes, etc.) are distinctly magnetic. The recurrence of magnetic properties in intermediate compounds can scarcely be accidental. It seems likely that in FeO or Fe₂O₃, the union between atoms is accompanied by the definite transfer of electrons which would tend to destroy the conditions required for magnetization. In the case of the intermediate compounds the union is probably of a rather different character, and does not preclude the maintenance of a magnetized condition.

The Generation of an Electric Current by Electro-Magnetic Means. When a conductor (e.g. a straight wire) is moved in a magnetic field, so as to cut the lines of magnetic force, an E.M.F. is set up in the wire, the magnitude of the E.M.F. being proportional to the rate at which the lines of force are cut by it. Likewise if, instead of moving the conductor, we cause the magnetic field to move relatively to it, the same E.M.F. is set up as in the first case. The production of an E.M.F. when a magnetic field moves relatively

¹ A. W. Hull, *Phys. Rev.* **14** (1919), 540.

² C. A. Edwards and H. C. H. Carpenter, *J. Iron Steel Inst.* **89** (1914), 167.

to a conductor is illustrated by a very simple experiment ; the two ends of a hollow coil of wire are connected to a sensitive galvanometer and a magnet is plunged into the coil ; a momentary current is produced as the magnet is pushed into the coil, and, when the magnet is taken out again, a momentary current is set up in the other direction.

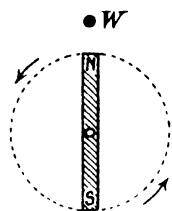

FIG. 8.—Production of Alternating Current in Single Wire.

The same principle is employed on an extremely large scale at our electric generating stations for the conversion of mechanical energy to electrical energy by means of the **dynamo**. If (Fig. 8) a pivoted magnet NS is made to rotate about a vertical axis in the neighbourhood of the straight vertical wire W, an alternating current will be produced in the wire, since the lines of force (first from the north pole and then from the south pole) cut the wire as the magnet rotates. The E.M.F. produced will depend on the rapidity of rotation of the magnet, but for any speed which is likely to be attained in practice, the E.M.F. will be very small, as long as only one single wire is employed. In a practical dynamo (Fig. 9) there will be a large number of conductors, and several magnetic poles. The connections of the conductors with one another, and the arrangement of the poles, must be such that the very small E.M.F.s produced in each individual conductor will combine together to give a very considerable difference of potential between the ends of the two conductors which are joined to the external circuit AB.

In this way, E.M.F.s varying from 50 volts up to 20,000 volts can be obtained. The current generated is normally an **alternating current**, the potential varying with the time in direction and magnitude after the manner indicated in Fig. 10. The "frequency," or number of complete cycles per second, varies in ordinary practice between 25 and 120 cycles. In **continuous current dynamos**, a device known as a **commutator**, which serves to collect the current in such a way that it is sent out on to the external circuit in a single direction only, must be added.

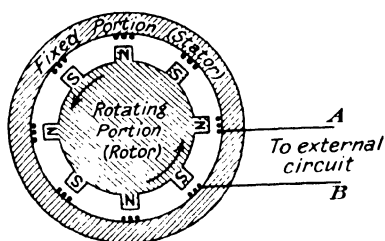

FIG. 9.—Principle of A.C. Dynamo.

The detail of the design of the various forms of dynamos must be sought in one of the numerous works on the subject. The different

methods of arranging the conductors are very numerous. It may, however, be stated at this point that in some dynamos the conductors are on the fixed portion (*stator*) and the magnets on the rotating portion (*rotor*), whilst in others the conductors are attached to the rotor which moves inside magnets fixed to the stator. Dynamos also differ among themselves in the methods by which the magnets are excited.

In practice electro-magnets are always used; these consist of cores of iron wound with coils of wire around which a current may be passed, the iron becoming magnetic whilst the current is passing. In a continuous current dynamo, the coils may be placed "in parallel" with the external circuit (*shunt coils*) so that part of the current provided by the dynamo passes through the coils and serves to excite the magnetism in the cores; or they may be placed "in series" with the external circuit (*series coils*); or again there may be both "shunt coils" and "series coils." In an alternating current dynamo, the exciting current is commonly provided by a separate (continuous current) machine.

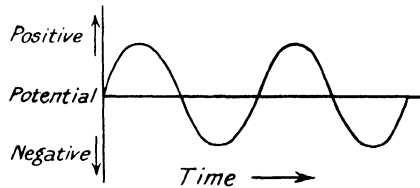

FIG. 10.—Variation of Potential with Time in a Single Phase Current.

In a continuous current dynamo, the coils may be placed "in parallel" with the external circuit (*shunt coils*) so that part of the current provided by the dynamo passes through the coils and serves to excite the magnetism in the cores; or they may be placed "in series" with the external circuit (*series coils*); or again there may be both "shunt coils" and "series coils." In an alternating current dynamo, the exciting current is commonly provided by a separate (continuous current) machine.

An important class of dynamos are those which are wound with three separate windings, spaced in such a way that the maximum value of the E.M.F. is reached in the three circuits at instants separated from one another by intervals equal to one-third of a

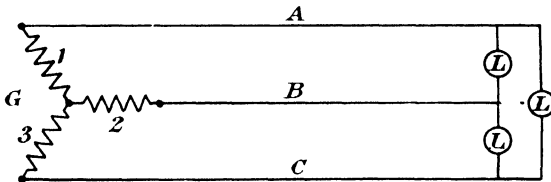

FIG. 11.—Star Connection of Generator.

complete cycle. If the two ends of each winding be kept separate (making six external wires in all), we could use the machine as the source of three separate supplies of ordinary ("single-phase") alternating current. If, however, one end of each of the three windings (1, 2 and 3) is joined together (see Fig. 11), the other three ends can be joined to three mains supplying the so-called "three-phase current"; this is known as the *star connection*,

In Fig. 11 the dynamo, G, is shown sending out three-phase current along the three wires A, B, and C, and the current is used for lighting the lamps, L. The variation of the potential in each of the three wires with the time is shown in Fig. 12. The lamps are placed between each pair of the three conductors, and care should be taken to ensure that the conductivity of the lamps placed between each pair of conductors is roughly the same, so as to impose an equal load on each of the three phases. If this condition can be realized, then the current travelling outwards at a given instant along one

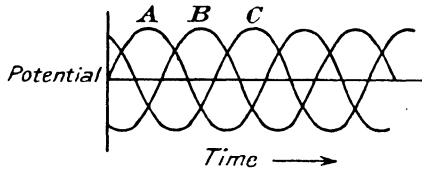

FIG. 12.—Variation of Potential in Three Conductors (A, B, and C) of Three-Phase System.

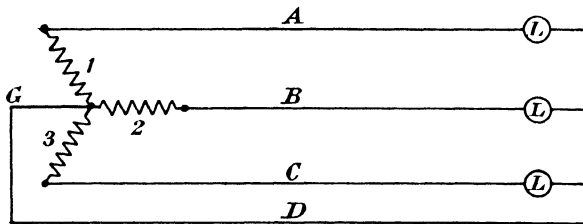

FIG. 13.—Return Wire System.

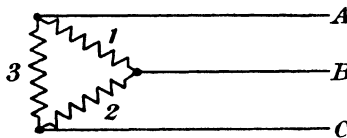

FIG. 14.—Mesh Connection of Generator.

wire is carried back by the other two. If the condition cannot be realized, then it is necessary to have a fourth wire, D (arranged, for instance, as in Fig. 13), to serve for the return of the current.

The necessity for equalizing the load put upon the three phases is of considerable importance. Certain types of plant worked by three-phase current (and especially the electric furnaces used in steel-making, which will be described later in this volume) are apt to have a very variable resistance, and the sudden decrease in the resistance between one pair of wires may upset the balance and cause considerable trouble at the generating station.

An alternative method of connecting the three windings, known as the *mesh connection*, is shown in Fig. 14.

Comparative Advantages of Continuous, Single-Phase and Three-Phase Currents for Practical Purposes. There are many advantages in generating electricity—especially where it is to be produced on a large scale—as alternating, rather than continuous, current. In the first place, it is very easy to transform the energy where it exists as alternating current from one voltage to another by means of the simple “static transformer” (described below); with continuous current, the more complicated “rotary transformers,” which require supervision, must be used. Further, the form of dynamo needed to produce continuous current is more complicated than the alternating-current machine, since it must contain a commutator. Sparking often occurs at the commutator, causing trouble; indeed, the generation of continuous current at very high voltages becomes almost impossible for this very reason. It is true that for certain types of work (e.g. electrolytic processes) continuous current is essential. But in any case the voltage demanded for electrolytic work is much lower than that at which the current would be sent out from the generating station; the installation of some form of transformer at an electrolytic plant would therefore be needed whether high-tension continuous current or high-tension alternating current were received.

As regards the comparative claims of single-phase and three-phase currents, it is preferable—at any rate at a large station—to generate three-phase current. A dynamo equipped to furnish three-phase current will give a larger power-output than a dynamo of equal size furnishing single-phase current. Likewise the size of the conductors is less in the case of the three-phase system.

Electric power is the product of the current and the voltage¹; a given amount of energy can be conveyed either as a weak current sent out at a high voltage, or a powerful current at a small voltage. But since the heat produced in a conductor is proportional to the *square* of the current strength, it will require a much stouter conductor to avoid overheating in the case of the low-tension transmission than in the case of transmission at a high voltage. It is usual to transmit power from the central station at a very high tension (10,000 to 200,000 volts) and then to transform it down to a

¹ There is an *apparent* exception to this rule in the case of alternating-current generation, in which the power measured in watts is generally less than the product of the average current (in amperes) and the average E.M.F. (in volts). This is caused by the fact that the fluctuations in current do not generally keep time with the fluctuations in E.M.F.; the maximum of the current curve may be reached an instant after the maximum of the E.M.F. curve, or *vice versa*.

conveniently low voltage at a small transformer station close to the place where the energy is to be consumed.

Transformers. The use of the static transformer has just been referred to. The principle of this transformer is very simple. Two coils of wire, the primary and the secondary, are wound on a core of soft iron; the primary coil is joined to the source of the alternating current requiring transformation, the secondary being joined to the plant to be supplied with the transformed current. The alternating current passing through the primary coil causes the iron to become magnetized, first in one direction, then in the other. This is equivalent to plunging a magnet into the secondary coil, first in one direction, then in the other, a procedure which, as we have seen, will produce a current in the secondary coil—first in one direction, then in the other. In other words, an alternating current will be generated in the secondary circuit.

As to whether the E.M.F. of the secondary current will be greater or less than that of the primary current will depend on the ratio of the number of turns in the two coils. If the primary consists of a few turns of stout wire and the secondary a large number of turns of thin wire, the voltage in the secondary is higher than in the primary; thus we get a *step-up* transformer. If the secondary consists of a few stout turns, and the primary a large number of fine turns, the voltage in the secondary is smaller than in the primary and we get a *step-down* transformer.

Needless to say, the design of a static transformer calls for attention to many points to which only the briefest reference can be made here. The iron core must be of such a form as to ensure as nearly as possible that all the lines of force generated by the primary coil shall pass through the secondary; any leakage of the lines represents a loss of efficiency. Usually the core is a closed framework of iron. Another trouble is due to hysteresis; as already stated when iron is magnetized and demagnetized successively, the amount of electrical energy consumed during the magnetization exceeds that given up when it becomes demagnetized, the difference appearing as heat in the core; losses of this kind are reduced, if a variety of iron having a hysteresis loop of small area is chosen as the material of the core. Pure iron would be valuable in this respect, but the use of that material energy would cause losses through "eddy currents," set up in the core itself by reason of the surging of the lines of magnetic force in it; these eddy currents may be reduced by making the core consist of a number of thin laminations insulated from one another, and by using a material of lower conductivity, for instance silicon iron. Since the losses due to hysteresis and eddy currents are never entirely eliminated,

and since the lost energy appears as heat in the core, some system of cooling must be adopted; both air-cooling and oil-cooling are employed; the oil used for transformers must be a good electrical insulator, capable of withstanding the high tensions frequently imposed.

Fig. 15 shows the generation of high-tension single-phase current

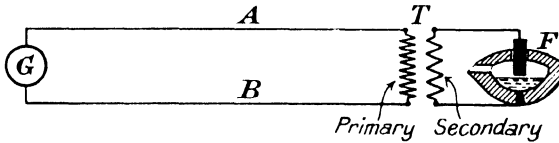

FIG. 15.—Transmission and Transformation of Single-Phase Current.

by the dynamo G, situated at a central station. This high-tension current is sent along the mains A and B to the place where the power is required. Here it is converted by the step-down transformer T to a low-tension current, which can be used for many purposes; in the figure it is shown heating the single-phase electric furnace F.

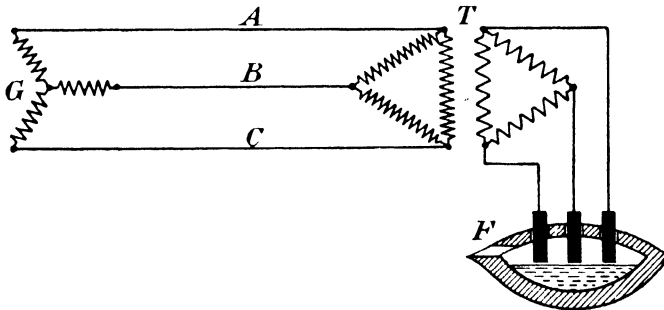

FIG. 16.—Transmission and Transformation of Three-Phase Current.

Fig. 16 shows the analogous arrangement where three-phase current is sent out from the central station, and used - after transformation at T - for the heating of a three-phase furnace F,

IRON

Atomic Weight 55.84

The Metal

Chemically pure iron differs somewhat in properties from the commercial varieties of iron which have become familiar to all. It is a malleable, ductile, and—compared to commercial iron—a soft metal, which assumes a good lustre when polished. It is fairly light, the specific gravity being 7.86, and fuses at a high temperature, namely, 1,530° C.

The properties of iron are, however, much modified by the presence of even very small amounts of other substances. The hardness, for instance, is very greatly increased if small traces of carbon, silicon, or even hydrogen, are present. Moreover, in spite of the fact that the metal is normally extremely tough, iron containing a little sulphur is often extremely brittle; the effects of the different elements upon the properties of iron will be discussed in detail at a later stage.

Finely divided iron (such as is produced by heating the oxide in hydrogen) is pyrophoric and takes fire when brought into the air. On the other hand, compact iron is unaffected by dry air at ordinary temperatures, but becomes superficially changed when heated, an oxidized film of limited thickness being produced. The existence of this film produces a coloration of the surface, which depends mainly on the temperature at which the iron has been heated. These “temper-colours,” as they are called, are probably due mainly to interference between the light-rays reflected respectively from the inner and outer surfaces of the oxide-layer, the wave-length of light thus destroyed being determined by the thickness of the film.¹

The temper-colours produced upon ordinary steel at different temperatures are shown by the following table; the exact temperature at which a given colour appears depends somewhat on the composition of the steel. It will be observed that the order of the colours is that which one would expect from theory. At a low temperature, the thickness is just sufficient to cut out the shortest (violet) rays, and the resultant light is yellow; at a

¹ However, A. Mallock, *Proc. Roy. Soc.* **94** (1918), 566, states that the colour does not alter when the film is rendered thinner by polishing. He regards the colour as due partly to the selective absorption of certain wave-lengths.

higher temperature, longer (yellow) rays are extinguished, and the colour produced is blue.

Temperature.	Colour obtained.
230° C.	Light straw colour
255° C.	Brown-yellow
265-280° C.	Purple
288° C.	Bright blue
300° C.	Dark blue

When heated at high temperatures, iron becomes covered with a comparatively thick bluish-black scale, which is often regarded as the magnetic oxide Fe_3O_4 , although the oxygen-content of the scale decreases as we pass from the outer layers inwards¹; the portions next to the apparently unchanged metal are said to have a composition represented approximately by $6\text{FeO}\cdot\text{Fe}_2\text{O}_3$. Modern research² has shown that even the apparently unchanged parts of the metal below the scale are affected to some extent, for the oxygen penetrates deep into the metal along the grain-boundaries; it appears that at first a solid solution of oxygen in iron is produced, but that when—at a given point—the oxygen-content reaches a certain degree of supersaturation, oxide is thrown out as a separate phase. This oxide first appears as globules along the intergranular boundaries, but as the oxidation proceeds the globules grow until they form continuous layers, thus causing intergranular brittleness in the parts of the metal so affected.

The chemical behaviour of iron varies considerably with its purity. By exercising extraordinary precautions, Lambert³ has produced iron so pure and homogeneous that it is not attacked by pure water containing dissolved oxygen, and even carbon dioxide. But iron purified by ordinary methods is quickly "rusted" by water containing oxygen, although pure air-free water has no action upon it. The red or yellow "rust" produced consists essentially of ferric hydroxide. In the presence of carbon dioxide, or traces of other acids, the attack upon the iron takes place more quickly. The nature of the rusting and corrosion of iron will be fully discussed in the technical section. It need only be mentioned here that the rust does not in any way protect the iron from further attack, since it is neither closely adherent to the metal, nor impervious to water, nor distributed uniformly over the surface; indeed, when once rusting has commenced at a point, the

¹ See analyses by C. G. Mosander, *Ann. Phys.* **6** (1826), 35.

² J. E. Stead, *J. Iron Steel Inst.* **103** (1921), 271. Compare the interesting work on the action of oxidizing gases at low pressures on iron described by H. C. H. Carpenter and C. F. Elam, *J. Iron Steel Inst.* **105** (1922), 83. See also N. B. Pilling and R. E. Bedworth, *J. Inst. Met.* **29** (1923).

³ B. Lambert and J. C. Thomson, *Trans. Chem. Soc.* **97** (1910), 2426. B. Lambert, *Trans. Chem. Soc.* **101** (1912), 2056; **107** (1915), 218.

attack usually continues with an accelerating velocity. On the other hand, the compact film of bluish oxide, generally stated to be Fe_3O_4 , which is formed when steam is passed over iron or when red-hot iron is plunged into water, is of a different character, and does to a considerable extent protect the metal from further corrosion.

Iron dissolves in dilute sulphuric or hydrochloric acid, yielding solutions of a ferrous salt, hydrogen being evolved. It is also attacked by dilute nitric acid (specific gravity below 1.2), but the concentrated acid (specific gravity exceeding 1.3) causes iron to assume the "passive state," in which it is no longer dissolved at any important rate, although it has been shown that a slow dissolution continues after passivity has set in.¹ Passive iron does not precipitate silver from a silver nitrate solution, nor copper from a very dilute copper sulphate. It should be stated that the ultra-pure iron prepared by Lambert also fails to deposit copper from copper sulphate solution, but it does so readily if locally strained by pressure, an electric couple being set up between the strained and unstrained portions.

Anodic Behaviour. The passivity of iron is best studied by experiments on the anodic behaviour of the metal.² When current is forced through a cell furnished with an iron anode immersed in a sulphate solution, the iron will pass into solution readily enough so long as the current density is not too high, ferrous ions, Fe^{++} , being mainly produced. If, however, a certain limiting current density be exceeded, the iron becomes passive, and dissolution practically ceases, the "current efficiency" of the attack dropping from over 99 per cent. to about 1 per cent.³ At the same time, the anodic potential rises quickly; and, if the E.M.F. applied to the cell is sufficient, evolution of oxygen commences. It is noteworthy that when once passivity has set in, mere lowering of the current density does not restore the activity; but if the current is turned off altogether, and the electrode is allowed to rest in the solution, activity generally returns quite suddenly after a certain interval. After this change has taken place the iron has re-acquired the power to be dissolved anodically at low current density.

It should be noted that the presence of acid favours the active condition, whilst alkalis favour the passive state—just the opposite

¹ H. L. Heathcote, *J. Soc. Chem. Ind.* **26** (1907), 899.

² C. Fredenhagen, *Zeitsch. Phys. Chem.* **43** (1903), 1; E. P. Schoch and C. P. Bandolph, *J. Phys. Chem.* **14** (1910), 719.

³ These numbers are quoted from a paper by C. A. Lobry de Bruyn, *Rec. Trav. Chim.* **40** (1921), 30.

to what is observed in the case of molybdenum. In an acid solution, the current density which must be exceeded before passivity sets in is high, and, even if passivity should occur, it soon disappears again after the current has been shut off. On the other hand, in an alkaline solution, a very small anodic current density will bring about passivity, and, even after the current has been discontinued, passivity will remain for a long time if the polarized iron anode is kept in the alkaline bath.

These facts are explained on the assumption that passivity is connected with a protective oxide-film, slowly soluble (as are all the oxides of iron) in acid, and insoluble in alkali; the fact that molybdenum oxide is known to be soluble in alkali and not in acid satisfactorily explains the reverse behaviour of that metal.

It should, of course, be understood that the "oxide-film" is extremely thin—so thin that it does not appreciably alter the reflecting power of the metal.¹ The layer is, however, sufficient to interfere with the expulsion of ions from the iron under the influence of ultra-violet light; the "photo-electric effect" has been measured for active and passive iron, and is found to become greatly diminished when the iron is rendered passive.² It is quite possible that the so-called oxide-film is really composed of a single layer of oxygen atoms attached to the surface of the metal, or possibly a layer of discharged ions rich in oxygen. In any case it is almost certainly wrong to attribute it to any of the oxides (e.g. Fe_3O_4) which are known to us in the massive state.³ In the case of iron which has been rendered passive in nitric acid, or in nitrogen peroxide, it seems quite possible that passivity is connected with a layer of adsorbed nitrogen peroxide.⁴

As has already been noted in the case of magnesium, the presence of soluble chlorides is extremely favourable to the maintenance or the restoration of the active condition. A small amount of sodium chloride will prevent the passivation of iron by immersion in dilute chromic acid. Similarly the presence of a small amount of chlorides may prevent the anodic passivation of iron even at comparatively high current densities. The chloride does not, indeed, prevent the formation of insoluble matter at the anode, but it does prevent it appearing as a thin and compact protective film. When a solution of sodium chloride is electrolysed with an iron anode, the anode becomes covered with a loose black film which on rubbing easily comes off from the metal, leaving a bright

¹ Compare W. J. Müller and J. Königsberger, *Zeitsch. Elektrochem.* 13 (1907), 659; 15 (1909), 742.

² H. S. Allen, *Trans. Faraday Soc.* 9 (1914), 247.

³ U. R. Evans, *Trans. Faraday Soc.* 18 (1922), 1.

⁴ S. W. Young and E. M. Hogg, *J. Phys. Chem.* 19 (1915), 617.

surface below¹; in addition a dirty olive-green precipitate is formed in the solution. On the other hand, in a nitrate solution there is little or no visible change in the surface of the anode, the thin film formed being apparently as compact as the metal itself, and the iron soon becomes passive. Probably the formation of a loose precipitate in the presence of chlorides instead of a continuous thin layer depends largely on the values for the interfacial tension between the materials involved.

Laboratory Preparation. The simplest method of obtaining compact iron from its compounds in the laboratory is by the electrolysis of a salt solution, for instance ferrous sulphate.² The conditions which must be observed to bring about the efficient deposition of iron on the cathode are discussed in the technical section. Electrolytic iron generally contains sufficient hydrogen to make it abnormally hard, but is otherwise extremely pure. The hydrogen-content depends largely on the temperature of deposition, being less than 1 part in 10,000 when the deposition takes place at 75° C., while the iron precipitated from a cold bath may contain nearly 1 part in 1,000. The hydrogen is largely removed when the metal is heated, and the iron becomes soft.

Pure iron can be obtained in a finely-divided condition by heating the pure oxide in a current of hydrogen. The method used by Lambert³ for the preparation of his ultra-pure iron was the following. A solution of very pure ferric chloride was electrolysed between iridium electrodes, and the cathodic deposit was dissolved in nitric acid to yield ferric nitrate. The salt was purified by recrystallizing four or five times from a solution in a concentrated nitric acid, then ignited to yield ferric oxide, which was reduced to metallic iron by heating in an iridium boat in a current of purified hydrogen. For details, the original paper should be consulted.

Compounds⁴

Most of the compounds of iron are derived from the two oxides, FeO and Fe₂O₃. Both these oxides have basic properties, and two large series of salts, known respectively as the ferrous and ferric salts, exist. As usual the basic properties are most pronounced in the lower oxide; solutions of the ferric salts suffer partial hydrolysis with comparative ease. Ferric oxide has also a feeble acidic character, forming readily hydrolysed salts known

¹ G. R. White, *J. Phys. Chem.* **15** (1911), 766.

² A. Pfaff, *Zeitsch. Elektrochem.* **16** (1910), 217.

³ B. Lambert, *Trans. Chem. Soc.* **97** (1910), 2429.

⁴ The chemistry of iron compounds is described in detail by E. Müller, "Das Eisen und seine Verbindungen" (Steinkopff, 1917).

as **ferrites**. More highly oxidized compounds, the **ferrates**, containing hexavalent iron, are known. An oxide, Fe_3O_4 , intermediate in state of oxidation between FeO and Fe_2O_3 , also exists, and certain intermediate salts, which can be regarded as derived from it, have been described.

A. Compounds of Divalent Iron (Ferrous Compounds).

Ferrous oxide (FeO) is a black substance most easily prepared by heating ferrous oxalate—a not uncommon method of obtaining the lower oxide of a metal. It is also formed when the higher oxides are gently heated in a current of hydrogen or carbon monoxide, but in this case there is a danger of a further reduction to the metallic state. When exposed to the air, it very readily becomes oxidized, and can therefore only be preserved in an atmosphere of an indifferent gas. The finely-divided oxide usually produced from the oxalate takes up oxygen with so much vigour, when brought into contact with air, that it often commences to glow brightly; when brought into contact with water, it slowly evolves hydrogen. The corresponding **hydroxide**, $\text{Fe}(\text{OH})_2$, is formed when an air-free solution of a ferrous salt is precipitated with caustic soda. If the presence of air is entirely avoided, the precipitate is white; but, if a trace of oxygen has access to the solution, the colour is greyish-green. Upon continued exposure to the air, the mass darkens further, finally being completely converted to red-brown ferric hydroxide. Here, again, considerable heat is evolved during the oxidation.

Ferrous Salts. When ferrous oxide is dissolved in acids, the ferrous salts are formed; they are more conveniently produced by the dissolution of metallic iron in the acids, hydrogen being in this case evolved. The solutions have usually a pale greenish tint. Ferrous salts are much more stable and less liable to oxidation than ferrous hydroxide, although when the solutions are exposed to the air, slow oxidation does take place; the rate of oxidation is considerably increased by the presence of nitric oxide, which acts as a catalyst.¹ Since ferrous oxide is a strong base, the solutions of the ferrous salts are not specially liable to hydrolysis, and the salts can be obtained without difficulty in the solid state.

Ferrous sulphate, $\text{FeSO}_4 \cdot 7\text{H}_2\text{O}$, is a light-green salt crystallizing in two forms, monoclinic and rhombic, respectively isomorphous with the monoclinic and rhombic forms of magnesium sulphate. The two salts are therefore said to be “isodimorphous.” In the

¹ R. Thomas and E. T. Williams, *Trans. Chem. Soc.* **119** (1921), 749.

case of ferrous sulphate the most stable form is the monoclinic, whereas in the case of magnesium sulphate it is the rhombic. When a supersaturated solution of ferrous sulphate (obtained by evaporating a solution of iron in dilute sulphuric acid) is allowed to crystallize spontaneously, the monoclinic variety is produced. But, when crystallization is started by adding to the solution a crystal of rhombic magnesium sulphate, the ferrous sulphate crystallizes out in the rhombic form; conversely, when in a supersaturated solution of magnesium sulphate, crystallization is initiated by "inoculation" with a crystal of monoclinic ferrous sulphate, monoclinic magnesium sulphate is produced. The rhombic form of $\text{FeSO}_4 \cdot 7\text{H}_2\text{O}$ is isomorphous with the stable varieties not only of magnesium sulphate, but also with the sulphates of zinc, nickel, and most other divalent metals. If the crystallization of the supersaturated solution is started by means of a triclinic crystal of copper sulphate $\text{CuSO}_4 \cdot 5\text{H}_2\text{O}$, then the pentahydrate of ferrous sulphate ($\text{FeSO}_4 \cdot 5\text{H}_2\text{O}$) is produced in triclinic crystals isomorphous with copper sulphate.

The anhydrous sulphate (FeSO_4) is obtained by cautiously heating the hydrate at 300°C ., care being taken that the temperature does not rise too high, or oxides of sulphur will be evolved and ferric oxide left behind. The anhydrous salt is a white, hygroscopic powder.

A double ferrous ammonium sulphate $(\text{NH}_4)_2\text{SO}_4 \cdot \text{FeSO}_4 \cdot 6\text{H}_2\text{O}$ can be obtained from a solution of ferrous sulphate containing ammonium sulphate. It forms green monoclinic crystals which are less liable to oxidation than the simple salt.

Ferrous chloride is obtained in solution by dissolving iron in hydrochloric acid. The solution, when evaporated with exclusion of air, deposits bluish crystals of one of the hydrates (such as $\text{FeCl}_2 \cdot 4\text{H}_2\text{O}$ or $\text{FeCl}_2 \cdot 6\text{H}_2\text{O}$). Although the hydrate, if heated alone, is apt to lose hydrogen chloride, the anhydrous salt can be obtained by heating it in the presence of ammonium chloride. Anhydrous ferrous chloride (FeCl_2) is, however, more readily produced by the action of gaseous hydrogen chloride upon metallic iron. It is a white or greyish body, volatile at a red heat; the vapour density at $1,300^\circ \text{C}$. is normal, indicating that gas consists of simple molecules FeCl_2 ; but, at lower temperatures, association evidently takes place, for the vapour becomes abnormally heavy. Like the anhydrous chlorides of many other divalent metals (e.g. calcium chloride) ferrous chloride is deliquescent, and dissolves in water with the evolution of heat. Ferrous chloride, both in solution and in the solid state, becomes oxidized much more readily than ferrous sulphate.

Ferrous nitrate ($\text{Fe}(\text{NO}_3)_2$) is formed in solution when iron is dissolved in very dilute cold nitric acid. The solution is naturally very unstable, since nitric acid tends to oxidize ferrous salts to the ferric state. A solution free from nitric acid is obtained when ferrous sulphate is precipitated with the equivalent quantity of barium nitrate; this solution, concentrated by evaporation at 60°C ., yields green crystals of ferrous nitrate.

Insoluble ferrous salts, which include the **carbonate**, FeCO_3 , and various **phosphates**, such as $\text{Fe}_3(\text{PO}_4)_2$, are obtained by precipitation of an air-free ferrous salt solution. Both of the salts mentioned are white precipitates, which readily become greenish or blue by absorption of traces of oxygen from the air. The **sulphide**, FeS , on the other hand, is a black precipitate obtained when a ferrous sulphate solution is treated with ammonium sulphide. In a more compact form it is obtained by heating iron in molten sulphur; produced in this way, the sulphide possesses a metallic lustre. The sulphide is readily dissolved by dilute acids, hydrogen sulphide being evolved, and is in fact used in the laboratory for the preparation of that gas.

Ferrous oxalate (FeC_2O_4) is produced as a yellow precipitate when potassium oxalate is added to the equivalent proportion of ferrous sulphate in aqueous solution. If excess of potassium oxalate be added, the yellow precipitate slowly redissolves, an orange solution being produced which contains the double oxalate ($\text{K}_2\text{C}_2\text{O}_4 \cdot \text{FeC}_2\text{O}_4$). The rate of dissolution of the insoluble single oxalate in potassium oxalate is, even at 100°C ., somewhat slow; but the same orange solution of the complex oxalate is quickly obtained when the ferrous oxalate is added to an excess of potassium oxalate, and *not vice versa*. If the addition is made carefully, with stirring, so that potassium oxalate is always, and at all points, in excess, no precipitate will be formed.

Nitroso Compounds. Ferrous salts form interesting additive compounds with nitric oxide (NO). If, for instance, nitric oxide gas is bubbled through a solution of ferrous sulphate, or of ferrous chloride, it is absorbed, the solution becoming greenish-brown or black. On boiling, however, the nitric oxide is again evolved, and the dark colour disappears. The black coloration is apparently due to a compound such as $\text{FeSO}_4 \cdot \text{NO}$ or $\text{FeCl}_2 \cdot \text{NO}$. In aqueous solution an equilibrium is set up between the complex and its constituents

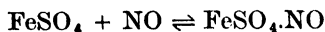

and the quantity of nitric oxide gas absorbed varies with the con-

ditions ; but if an alcoholic solution of a ferrous salt is used, the amount of nitric oxide absorbed is practically equivalent to that of the iron salt present.

The isolation of these "nitroso-compounds" in the solid state is not especially easy, since the brown solutions lose nitric oxide when heated. However, by the addition of alcohol to a strong aqueous solution of ferrous sulphate saturated with nitric oxide, the dark brown compound $2\text{FeSO}_4 \cdot \text{NO} \cdot 13\text{H}_2\text{O}$ has been obtained in crystals.¹

The black coloration due to the same type of compound is obtained very easily by treating a ferrous sulphate solution with sodium nitrite and sulphuric acid ; the nitrous acid (HNO_2) set free is reduced by part of the ferrous sulphate to nitric oxide, which then combines with another portion of the ferrous salt.

An insoluble brown compound $\text{FeHPO}_4 \cdot \text{NO}$ is obtained by mixing solutions of ferrous sulphate and ammonium phosphate, so as to obtain a white precipitate of ferrous phosphate. The mixing is carried out in a vessel containing hydrogen, so as to avoid oxidation. After mixing, the hydrogen is replaced by nitric oxide, which is readily absorbed, the white precipitate turning brown.²

B. Compounds of Trivalent Iron (Ferric Compounds).

Ferric oxide, Fe_2O_3 , is formed in the anhydrous condition when ferrous sulphate ($\text{FeSO}_4 \cdot 7\text{H}_2\text{O}$) is heated in air. The water of crystallization is first driven off, and finally, upon strong heating, sulphur trioxide is expelled. It is possible that ferrous oxide is formed in the first instance, but is immediately oxidized by part of the sulphur trioxide to ferric oxide, so that the reaction can be expressed

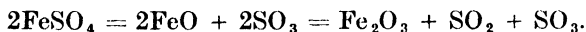

Ferric oxide can also be obtained by heating the ferric salt of any volatile acid such as the nitrate, carbonate, oxalate, or acetate, or by igniting the precipitated "hydroxide." The colour varies considerably according to the method of preparation. The oxide obtained by heating ferrous sulphate has a bright orange-red colour, whilst most of the other salts yield a brown or purplish product. The orange-red oxide darkens considerably on being heated above 650°C ., becoming reddish-brown, and finally acquires at $1,000^\circ \text{C}$. a lustrous black or blue-black appearance (similar

¹ W. Manchot and F. Huttner, *Lieb. Ann.* **372** (1910), 166.

² W. Manchot, *Ber.* **47** (1914), 1601.

to that of the natural "specular iron ore"). These changes are permanent; the original colour does not return on cooling.

It is noteworthy that this striking variation in the appearance of the oxide is merely due to the shape and size of the particles. The arrangement of the atoms in the particles is the same in all cases; there is no occasion to refer the matter to "isomerism." Samples of the powdered oxide prepared in twenty-seven different ways have been examined by means of the X-rays, and in every case the crystal-structure has been shown to be the same.¹ The special cause of the bright colour of the oxide obtained by heating ferrous sulphate is that the particles consist of thin transparent lamellæ; on heating at 700–900° C., the particles unite to form granules, thus producing a darkening of the mass, whilst the oxide becomes denser, and less reactive towards acids, owing to the diminution in the surface area. The oxide obtained by heating the oxalate is granular and dark from the moment of production.

When a solution containing ferric and aluminium salts is precipitated with alkali and the mixed hydroxides are dehydrated by heating, the product is reddish brown if iron is in excess, but yellow if aluminium is in excess; the function of the aluminium hydroxide appears to be to prevent the agglomeration of the ferric oxide particles, which would cause the red colour. Other substances, such as calcium sulphate, if co-precipitated with ferric hydroxide, have a similar effect, causing the colour of the product to be yellow.²

It may be remembered that the variation of the colour of ferric oxide has already been referred to in the section on "Ceramics" (Vol. II) in connection with the colour of bricks.

The corresponding "**ferric hydroxide**" (usually written $\text{Fe}(\text{OH})_3$) is a brownish-red voluminous and rather gelatinous precipitate, which is obtained when a ferric salt solution is precipitated with ammonia. The study of its behaviour on freezing suggests that the precipitate is not a definite hydrate, for the amount of chemically combined water is found usually to be much less than would correspond to the formula $\text{Fe}(\text{OH})_3$, and varies with the mode of formation.³ Ruff,⁴ it is true, claims to have produced three hydrates of definite composition by heating the precipitated

¹ J. A. Hedvall, *Zeitsch. Anorg. Chem.* **121** (1921), 217.

² J. H. Yoe, *J. Phys. Chem.* **25** (1921), 196.

³ H. W. Foote and B. Saxton, *J. Amer. Chem. Soc.* **38** (1916), 588; **39** (1917), 1103. Compare the work of J. M. van Bemmelen, *Zeitsch. Anorg. Chem.* **20** (1899), 185, who as a result of the study of the vapour pressure during the dehydration of precipitated ferric hydroxide, concludes that it contains no definite hydrates.

⁴ O. Ruff, *Ber.* **34** (1901), 3417.

hydroxide for some days under a very high pressure (5,000 atmosphere), the composition depending on the temperature, thus:—



According to later writers¹ only the second compound, $\text{Fe}_2\text{O}_3 \cdot \text{H}_2\text{O}$ (which may be written $\text{FeO}(\text{OH})$), has any real existence as a chemical individual.

Colloidal solutions of the hydroxide are produced by peptization of the precipitated hydroxide. Thus, when precipitated ferric hydroxide is shaken with a solution of ferric chloride, it appears to pass into solution, a deep red liquid being obtained. A great deal of ferric chloride can then be removed by dialysis, but as the peptizing agent is removed, the solution becomes more and more unstable and the particles tend to join together to form larger secondary aggregates. Finally, before the last trace of chloride is removed, a visible precipitate of ferric hydroxide appears. If, on the other hand, an appreciable amount of ferric chloride is left in the liquid, it can be preserved unchanged for some time, although it is at once flocculated by the addition of alkali.

The colloid particles of ferric hydroxide have a positive charge, apparently owing to the adsorption of ferric ions. The colloidal solution, as explained in Chapter VII (Vol. I), can be regarded as the solution of a complex salt of indefinite composition

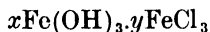

which is dissociated into the two ions

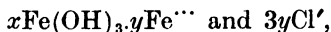

the first ion being, of course, the colloidal particle.² As the amount of ferric chloride in the liquid diminishes, the value of y necessarily becomes smaller; that is, the charge on each particle diminishes. The particles therefore tend to join together to form larger aggregates, and finally produce flocks of visible size, which constitute the precipitate.

Colloidal solutions of ferric hydroxide are also produced by interaction of ferric chloride and sodium hydroxide in rather dilute solution, care being taken that one of the reagents is continually in excess. Thus by running 20 c.c. of $\frac{N}{100}$ sodium hydroxide into

¹ E. Posnjak and H. E. Merwin, *Amer. J. Sci.* **47** (1919), 311. Compare H. B. Weiser, *J. Phys. Chem.* **24** (1920), 277.

² Compare W. Pauli and J. Matula, *Koll. Zeitsch.* **21** (1917), 49.

30 c.c. of $\frac{N}{100}$ ferric chloride, which is continually shaken during the process, a colloidal solution is produced in which the particles have positive charges due to adsorption of ferric ions; if, on the other hand, the conditions are reversed, 20 c.c. of $\frac{N}{100}$ ferric chloride being added to 30 c.c. of $\frac{N}{100}$ sodium hydroxide, the particles have a negative charge, due to the adsorption of hydroxyl ions. If the two reagents are mixed in equivalent proportions, precipitation occurs.¹

Ferric hydroxide "sols" are also obtained directly by the hydrolysis of ferric salt solutions. When a cold solution of ferric acetate is subjected to dialysis, so as to remove the acetic acid which is formed by hydrolysis, a deep blood-red or reddish-brown liquid is obtained, which is known as the **Graham colloid**; it is coagulated by traces of sulphuric acid, and by alkalis (but not by hydrochloric acid), the precipitate being of a gelatinous character. On the other hand, when dilute ferric acetate solution is heated for some time, so as to drive off most of the acetic acid as vapour, an orange-red or brick red solution known as the **Péan de St. Gilles colloid** is produced. This liquid also gives a gelatinous precipitate with sulphuric acid, but on treatment with hydrochloric acid it gives an orange-red precipitate of a sandy character, which, if washed free from acid, redissolves in pure water; in this respect the Péan de St. Gilles colloid differs from the Graham colloid. The solutions of the Péan de St. Gilles colloid appear opalescent by reflected light; it is sometimes referred to as "meta-ferric hydroxide." The difference between the Graham and Péan de St. Gilles colloids is probably largely due to the difference in the size of the particles; the particles appear to be smallest in the case of the Graham solutions.² But just because the particles are very small in these blood-red solutions, they coalesce readily, yielding a gelatinous coagulum, which is much less readily broken up (peptized) than sandy precipitates containing the larger particles. There is no sharp distinction between the Graham and Péan de St. Gilles colloids. The size of particles obtained varies continuously according to the conditions of preparation.

The colour varies with the size of the particles. The smallest particles, present in the Graham colloid, confer a reddish-brown

¹ F. Powis, *Trans. Chem. Soc.* **107** (1915), 818.

² W. D. Bancroft, *J. Phys. Chem.* **19** (1915), 232 H. B. Weiser, *J. Phys. Chem.* **24** (1920), 277.

colour; larger particles confer a yellowish colour. But continued boiling of the yellow colloid seems to lead to the formation of still larger particles, which possess a brick-red colour.¹

The gradual variation of colour with the size of the particles is shown clearly when the particles of different sizes are separated by centrifuging. Like many other hydroxides, ferric hydroxide, prepared by the precipitation of ferric chloride by ammonia, is capable of being peptized by pure water if washed quite free from the precipitant by means of a centrifuge. If after several washings the hydroxide is suspended in water and run through the centrifuge, the bigger particles will be thrown outwards on to the walls of the rotating vessel where the liquid enters the centrifuge; this deposit is found to have a yellowish-brown colour. The smaller particles will be deposited further from the entrance, and here the deposit is observed to be dark red; the smallest particles of all will remain suspended in the liquid that emerges from the centrifuge, and this is found to have a cherry-red colour.²

Ferric Salts. When a solution containing a ferrous salt is heated with an oxidizing agent, e.g. nitric acid, the corresponding ferric salt is formed. Ferric oxide is less strongly basic than the lower (ferrous) oxide, and there is a considerable tendency for the salts to hydrolyse. In consequence, although the ion Fe^{+++} is probably colourless, the solutions of ferric salts are usually orange-red or brown in colour due to the presence of colloidal hydroxide or of basic salts, which in some cases separate out on standing; upon the addition of free acid, the colour becomes paler, and in the case of the sulphate and nitrate, disappears.³

There is little difficulty in obtaining the solid salts by the concentration of the solutions. For instance, by boiling a solution of ferrous sulphate containing nitric and sulphuric acids, and evaporating the solution obtained, the yellowish-white **ferric sulphate** is deposited.⁴ It is worthy of note that some varieties of this salt have a peculiarly low "velocity of dissolution," although the equilibrium "solubility limit" is quite high. When introduced into water the salt may appear, to a hasty observer, to be prac-

¹ H. B. Weiser, *J. Phys. Chem.* **24** (1920), 319, describes experiments to show the "step-wise change" from the brown colloid (small particles) through the yellow to the brick-red colloid (large particles).

² R. Bradfield, *J. Amer. Chem. Soc.* **44** (1922), 965.

³ See S. U. Pickering, *Proc. Chem. Soc.* **29** (1913), 192.

⁴ Different statements regarding the amount of water of crystallization have been published. A careful investigation by M. P. Appleby and S. H. Wilkes, *Trans. Chem. Soc.* **121** (1922), 337, has established the fact that the normal salt is $\text{Fe}_2(\text{SO}_4)_3 \cdot 7\text{H}_2\text{O}$ or $\text{Fe}_2\text{O}_3 \cdot 3\text{SO}_3 \cdot 7\text{H}_2\text{O}$, but from highly acid solutions an acid salt $\text{Fe}_2\text{O}_3 \cdot 4\text{SO}_3 \cdot 9\text{H}_2\text{O}$ is deposited. A basic salt $7\text{Fe}_2\text{O}_3 \cdot 15\text{SO}_3$ also appears to exist.

tically insoluble. As in the corresponding case of anhydrous chromic chloride, the rate of dissolution is said to be greatly increased by the presence of a reducing agent, a trace of ferrous sulphate being effectual.¹ The solution of ferric sulphate is brownish, and possesses an acid reaction, being largely hydrolysed. If the solution containing potassium sulphate is concentrated by evaporation, it deposits octahedral crystals of **iron alum**, $\text{K}_2\text{SO}_4 \cdot \text{Fe}_2(\text{SO}_4)_3 \cdot 24\text{H}_2\text{O}$, isomorphous with the other alums. This is less soluble than most other ferric salts, and is therefore more easy to obtain in a state of comparative purity. The colour of the salt varies with the purity; some varieties are colourless, but more often the salt has a violet colour. At one time the colourless salt was regarded as the purer, the violet colour being ascribed to the presence of manganese. But recent work has shown that the violet colour is characteristic of pure iron alum, whilst in the apparently colourless varieties the colour is masked by the presence of brown ferric hydroxide.²

Ferric chloride, FeCl_3 , is formed when a ferrous chloride solution is oxidized with nitric acid in the presence of hydrochloric acid, or when ferric hydroxide is dissolved in hydrochloric acid. If the solution is evaporated and then cooled, one of the four hydrates ($2\text{FeCl}_3 \cdot 12\text{H}_2\text{O}$; $2\text{FeCl}_3 \cdot 7\text{H}_2\text{O}$; $2\text{FeCl}_3 \cdot 5\text{H}_2\text{O}$; $2\text{FeCl}_3 \cdot 4\text{H}_2\text{O}$) is deposited. As to which one appears depends on the concentration of the solution, when it is cooled down; the equilibrium diagram has been given in the Introduction (Vol. I, p. 65). The hydrates are yellow or red solids. It is difficult to prepare the anhydrous salt by heating the lowest hydrate, for this compound, when ignited, evolves—like so many other hydrated chlorides—hydrogen chloride, ferric oxide being left. The anhydrous salt is therefore obtained in a dry way, namely, by heating metallic iron in a rapid stream of dry chlorine gas; the chlorine must be in excess or ferrous chloride is produced. Under the proper conditions, ferric chloride sublimes, forming crystalline plates, often possessing a greenish metallic lustre, but which appear deep red when viewed by transmitted light. It is quite volatile about 450°C .; the vapour density indicates that at low temperatures there is partial association of the FeCl_3 groups to form more complex molecules Fe_2Cl_6 , whilst at high temperatures there is dissociation into ferrous chloride (FeCl_2) and chlorine. On account of the values of the vapour density at low temperatures, many chemists prefer to write the formula of the solid substance as Fe_2Cl_6 .

Anhydrous ferric chloride is deliquescent and extremely soluble

¹ N. R. Dhaw, *Proc. Amst. Acad.* **22** (1920), 570.

² J. Bonnell and E. P. Perman, *Trans. Chem. Soc.* **119** (1921), 1994.

in water; it is also soluble in alcohol and ether. The aqueous solution is reddish-brown and reacts strongly acid, being largely hydrolysed into colloidal ferric oxide and hydrochloric acid. This hydrolysis is favoured by a rise of temperature, and ferric chloride solutions which are too dilute to show any red-brown colour at ordinary temperatures nevertheless become distinctly red-brown when heated. Such a solution may throw down colloidal ferric hydroxide, if treated with a little sodium chloride. If, however, it is allowed to cool, the red-brown colour gradually disappears.

When a concentrated solution of ferric chloride is treated with excess of hydrochloric acid the hydrolysis is naturally diminished, and the red-brown colour disappears, but is replaced by a rather intense yellow colour. The coloration has been compared to that produced when hydrochloric acid is added to cobalt or copper chloride, and is probably due to a complex anion containing iron.¹

Ferric nitrate is obtained when iron is dissolved in hot dilute nitric acid. The ferrous nitrate which is formed in the cold is readily oxidized by the excess of acid at higher temperatures. The brown solution yields pale violet crystals of the composition $\text{Fe}(\text{NO}_3)_3 \cdot 6\text{H}_2\text{O}$.

Insoluble and undissociated ferric salts are formed by double decomposition in the usual way. When sodium acetate in excess is added to a ferric salt solution, the colour becomes dark brown. If such a solution is boiled, an insoluble **basic ferric acetate** is thrown down as a dark red-brown precipitate. When a solution of potassium thiocyanate is added to a solution of a ferric salt, an intense blood-red coloration due to **ferric thiocyanate** $\text{Fe}(\text{CNS})_3$, a salt which, although quite soluble, is largely undissociated, especially when the thiocyanate is in excess. The coloration grows very weak, however, when the solution is diluted, which is thought to be due to the fact that the dissociation of the salt into its colourless ions, Fe^{+++} and $(\text{CNS})^-$ increases with the dilution. The solid thiocyanate can be obtained, if the ferric salt and the alkaline thiocyanate are allowed to interact in alcoholic solution.

Ferric carbonate does not appear to exist as a definite compound, probably owing to the weakly basic character of ferric oxide. Ferric hydroxide, exposed to carbon dioxide gas even under pressure, fails to absorb any appreciable amount.² When ammonium carbonate is added to a solution of ferric salts, a colloidal solution (or under some conditions, a precipitate) of ferric hydroxide is obtained.

¹ F. G. Donnan and H. Bassett, *Trans. Chem. Soc.* **81** (1902), 954.

² F. K. Cameron and W. O. Robinson, *J. Phys. Chem.* **12** (1908), 561.

Ferric phosphate, FePO_4 , is formed by precipitation of a ferric salt with sodium phosphate, and is a yellow-white precipitate. When washed with water, however, it suffers gradual hydrolysis, phosphoric acid being removed and a basic phosphate, or ferric hydroxide, being left behind.¹ The salt is insoluble in water and—unlike many phosphates—in dilute acetic acid, although dissolved by stronger acids. The arsenate is formed in an analogous way, and is a yellowish-white precipitate.

Ferric oxalate is produced when ferric hydroxide is dissolved in a concentrated solution of oxalic acid. A green-yellow solution is produced, which decomposes upon exposure to sunlight, insoluble yellow ferrous oxalate being precipitated and carbon dioxide being evolved.



On account of its instability, ferric oxalate is difficult to isolate in the solid state, but the double **potassium ferric oxalate** crystallizes out readily, if potassium oxalate is added to the green solution. This salt is also green. It is rather curious that, whereas in general ferrous salts are green, and ferric salts yellow, ferrous oxalate is yellow and ferric oxalate green.

The **sulphide**, Fe_2S_3 , is a little difficult to isolate as it is somewhat unstable. Some authorities have denied its existence, but the formation of ferric sulphide when moist ferric hydroxide is treated with hydrogen sulphide appears to have been definitely established.² The sulphide is a black substance, which when moist tends to decompose according to the reaction,



but which becomes quite stable when dried over phosphorus pentoxide. It forms soluble complex sulphides with alkaline sulphides; for instance, **potassium ferri-sulphide**, $\text{K}_2\text{S} \cdot \text{Fe}_2\text{S}_3$ or $\text{K}[\text{FeS}_2]$, is obtained by heating iron with sulphur and potassium carbonate, and can be dissolved out by water. The potassium salt is a purple crystalline substance; the solution yields with silver nitrate a brown precipitate of silver ferri-sulphide, $\text{Ag}[\text{FeS}_2]$.

The Ferrites. Ferric oxide, in addition to its basic character, can also act as a weak acid, forming salts with alkalis, which are, however, much more readily hydrolysed than the corresponding aluminates. Ferric hydroxide is undissolved by dilute sodium hydroxide and is only slightly dissolved by concentrated sodium

¹ F. K. Cameron and J. M. Bell, *J. Phys. Chem.* **11** (1907), 363.

² V. Rodt, *Zeitsch. Angew. Chem.* **29** (1916), i, 422.

hydroxide ; but if it is fused with sodium hydroxide and the product is extracted with 30 per cent. sodium hydroxide solution, the liquid obtained contains sodium ferrite, $\text{Na}_2\text{O} \cdot \text{Fe}_2\text{O}_3$ or NaFeO_2 ; the excess of alkali serves to restrain the hydrolytic decomposition. The solid salt can be obtained by careful crystallization. The solution is pale yellow when pure materials are used, but, as commonly produced, is often green, owing to a trace of a manganate.¹ It is very unstable ; when diluted and boiled, ferric hydroxide is precipitated. Sodium ferrite may also be obtained by boiling a solution of the corresponding ferrate (see below).

Several insoluble ferrites are known, such as the brown **calcium ferrite**, which is formed when ferric oxide and quicklime are strongly heated together.

C. Compounds of Hexavalent Iron.

The Ferrates.² The ferrates are more highly oxidized salts, derived from an unknown oxide FeO_3 , which has a well-developed acidic character ; in consequence they are less liable to hydrolysis, but are unstable in another respect, readily evolving oxygen. Potassium ferrate, K_2FeO_4 , is formed when ferric oxide is heated with fused potassium nitrate. Upon extraction with water, a very deep purplish red liquid is obtained, which deposits dark red prisms, isomorphous with potassium sulphate. The solution evolves oxygen when heated, generating potassium ferrite, which in its turn decomposes, depositing ferric hydroxide.

In view of the fact that the ferrates are analogous in formulæ to the sulphates and chromates, it is not surprising to find that **barium ferrate**, BaFeO_4 , is insoluble ; the latter is a dark red precipitate obtained by adding barium chloride to the potassium ferrate solution.

D. Intermediate Compounds.

Ferroso-ferric oxide, Fe_3O_4 . When metallic iron is heated in steam, it becomes converted superficially to an oxide the composition of which approximates to that indicated by the formula Fe_3O_4 . The same oxide is formed when iron is ignited in air at a very high temperature. It is a black substance which, unlike the other oxides of iron, is strongly attracted by the magnet. There appears, however, to exist a series of homogeneous mixed crystals of a composition extending between Fe_3O_4 and Fe_2O_3 ; the compositions of specimens of ferroso-ferric oxide do not always correspond to the

¹ See F. Haber and W. Pick, *Zeitsch. Elektrochem.* 7 (1900), 215, 724.

² For electrolytic methods of obtaining ferrites and ferrates, see G. Grube and H. Gmelin, *Zeitsch. Elektrochem.* 26 (1920), 459.

formula Fe_3O_4 , but vary with the temperature and oxygen-pressure under which the oxide has been formed.¹

A hydrated form of ferroso-ferric oxide is precipitated when a mixture of ferrous and ferric salts in the calculated proportions is treated with caustic soda; it is a greenish or brown-black powder. This mode of formation suggests that there may exist in a solution containing both ferrous and ferric salts, certain salts of an intermediate state of oxidation, corresponding to the oxide Fe_3O_4 . Actually some of these salts have been isolated. For instance, a solution of ferroso-ferric oxide (Fe_3O_4) in concentrated hydrochloric acid yields, on concentration over sulphuric acid, the chloride $\text{Fe}_3\text{Cl}_8 \cdot 18\text{H}_2\text{O}$. Intermediate sulphates have also been obtained in the solid state from solutions containing mixtures of ferrous and ferric sulphates.

When freshly precipitated ferrous compounds, such as the hydroxide, carbonate, or phosphate, which are white when pure, suffer slow oxidation owing to the presence of dissolved air, the colour does not become brown immediately—as would be expected if a ferric compound was the substance formed—but green. This, again, is suggestive of the fact that compounds intermediate in their state of oxidation between ferrous and ferric bodies are at first produced; on further exposure to the air, the brown ferric compounds are formed. Moreover, it is considered by some chemists that the pale green colour usually shown by soluble ferrous salts and their solutions—generally ascribed to the ion Fe^{2+} —is really due to the presence of partially oxidized salts of this nature.

E. Compounds of Tetravalent Iron.

Iron disulphide, FeS_2 . The disulphide of iron possesses special importance owing to the fact that it occurs in nature as “iron pyrites.” It can be produced artificially by heating ferrous sulphide gently with sulphur, and forms yellow crystals with a brass-like lustre. In nature it is found in cubes as well as in other crystalline forms.

F. Miscellaneous Compounds Containing Iron.

Complex Cyanides of Iron. The compounds of iron and cyanogen are so important that they call for treatment in a special paragraph. The tendency to form complex cyanides will be

¹ R. B. Sosman and J. C. Hostetter, *J. Amer. Chem. Soc.* **38** (1916), 807. However, A. Smits and J. M. Bijvoet, *Proc. Amst. Acad.* **21** (1919), 389, suggest that the series of mixed crystals may not be continuous but broken; according to this view, there will be one class of mixed crystals containing rather less oxygen than Fe_2O_3 , and another class with rather more oxygen than Fe_3O_4 .

observed in many metals, notably copper, silver and gold, but nowhere is it more marked than in the case of iron. If a solution of a ferrous salt (e.g. ferrous sulphate) is treated with excess of potassium cyanide, a yellow solution is obtained, which on crystallization yields bright yellow tablets with the composition $4\text{KCN}\cdot\text{Fe}(\text{CN})_2$. Since a solution of this salt shows the reactions neither of a ferrous salt nor of a cyanide, but has properties peculiar to itself, it is represented, not as an ordinary double salt, but as a complex cyanide thus,



Similarly when a ferric salt is treated with excess of potassium cyanide, the corresponding ferric complex salt is formed, which has the composition $3\text{KCN}\cdot\text{Fe}(\text{CN})_3$, but which apparently ionizes in the way indicated by the formula,



It is a deep red salt, readily obtained in large crystals which frequently appear greenish by reflected light; the solution is deep yellow. The salt is more easily produced by the oxidation of the ferrocyanide. When a solution of potassium ferrocyanide is saturated with chlorine gas, the ferricyanide is formed and can be obtained by crystallization,



The reverse change of ferricyanide into ferrocyanide occurs when the former is treated with a reducing agent, and also when a solution of a ferricyanide is exposed to the light. The ferrocyanide and ferricyanide of potassium are often known as the "yellow prussiate" and "red prussiate" respectively. The sodium and ammonium salts are also soluble, and are formed in analogous ways.¹

Many insoluble ferrocyanides and ferricyanides exist, and can be formed by precipitation. For instance, potassium ferrocyanide gives a white precipitate with salts of zinc and lead and a reddish-brown precipitate with cupric salts and with uranyl salts. Potassium ferricyanide, on the other hand, gives a yellowish precipitate with salts of zinc, a yellow-green precipitate with cupric salts, but no precipitate with lead or uranyl salts. Many of these precipitates are undissolved by dilute mineral acids, but are decomposed by alkalis, the alkali-metal ferrocyanide or ferricyanide being regenerated.

¹ The existence of the so-called " β -ferrocyanides" and " β -ferricyanides" has aroused interest, but it is now fairly certain that they are not isomeric with the ordinary ferrocyanides and ferricyanides, but contain products of partial decomposition. See S. H. C. Briggs, *Trans. Chem. Soc.* **117** (1920), 1026. G. M. Bennett, *Trans. Chem. Soc.* **111** (1917), 490.

But of quite special interest are the ferrocyanides and ferricyanides of iron. Some of the salts consist only of iron and cyanogen; others are double salts containing potassium as well as iron, and in many cases these latter salts possess an apparent solubility in water, actually yielding colloidal solutions.

When a ferrous salt solution is precipitated with excess of potassium ferrocyanide, a **potassium ferrous ferrocyanide** $\text{Fe}^{\text{II}}\text{K}_2[\text{Fe}^{\text{II}}(\text{CN})_6]$ is thrown down; if air is entirely excluded, this is a white precipitate, but it is difficult to secure the complete absence of dissolved oxygen, and the precipitate is—or rapidly becomes—blue, owing to the formation of potassium ferric ferrocyanide.

When a ferric salt is precipitated with potassium ferrocyanide, one of two possible **ferric ferrocyanides** may be produced. If the potassium salt is in slight excess, a double salt containing potassium, known as **Soluble Prussian Blue**, $\text{Fe}^{\text{III}}\text{K}[\text{Fe}^{\text{II}}(\text{CN})_6]$, is mainly produced¹; this is a dark blue precipitate, which, although insoluble in potassium ferrocyanide, yields a blue colloidal solution when treated with pure water. From the colloidal solution, it can be reprecipitated by addition of potassium chloride; or it can be separated from the water by filtration through a suitable membrane.

If, however, the ferric salt is in excess, another dark blue precipitate, containing only iron and cyanogen, namely, **Insoluble Prussian Blue** $\text{Fe}_4^{\text{III}}[\text{Fe}^{\text{II}}(\text{CN})_6]_3$ is produced; this is not dissolved by water or by dilute acids. It is decomposed by alkalis.

The "Prussian Blues," which have just been described, are formed by the interaction of *ferric* salts with *ferro*-cyanides. By the interaction of *ferrous* salts with *ferric*-cyanides, it might be thought that different bodies (ferrous ferricyanides) would be obtained. This expectation is, however, not always realized; for when ferrous sulphate is treated with a slight excess of potassium ferricyanide, a blue precipitate ("Soluble Turnbull's Blue") is obtained, which is really a mixture of compounds, but the main constituent of which appears to be identical with the main constituent of the Soluble Prussian Blue described above. Upon closer examination of the matter it will be seen that **potassium ferrous ferricyanide** $\text{Fe}^{\text{II}}\text{K}[\text{Fe}^{\text{III}}(\text{CN})_6]$ has the same composition as **potassium ferric ferrocyanide** $\text{Fe}^{\text{III}}\text{K}[\text{Fe}^{\text{II}}(\text{CN})_6]$; the constitutions of the two salts only differ by the fact that the ferrous iron is outside the

¹ E. Müller, *Chem. Zeit.* 28 (1914), 281, 328, who has studied in great detail the composition of the precipitates produced when the reagents are mixed in different proportions, states that three salts $\text{Fe}_4^{\text{III}}[\text{Fe}^{\text{II}}(\text{CN})_6]_3$, $\text{Fe}^{\text{III}}\text{K}[\text{Fe}^{\text{II}}(\text{CN})_6]$ and $\text{Fe}^{\text{II}}\text{K}_2[\text{Fe}^{\text{II}}(\text{CN})_6]$ are present

bracket in one case and inside in the other. The identity of the two differently represented compounds can be explained if Friend's view of the constitution of complex salts be adopted.¹

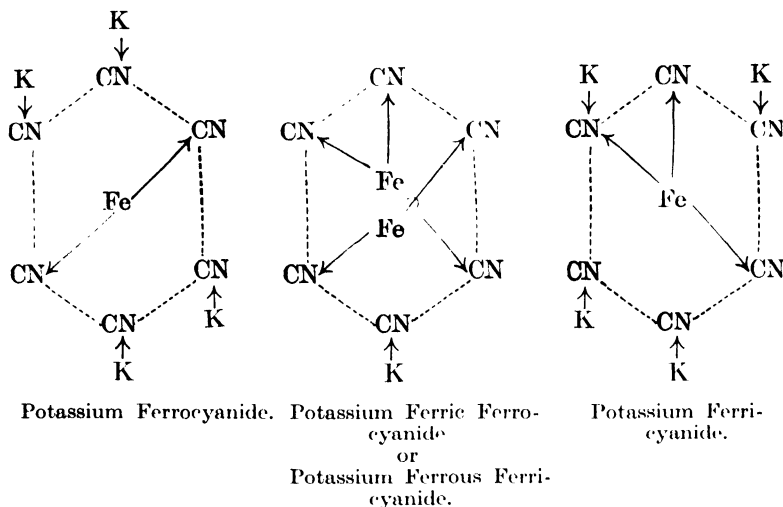

Although, for convenience, the six cyanogen radicles have been shown above as joined in a hexagonal ring, the same argument holds good if we imagine them joined in an octagonal (six-cornered) shell.

But whatever views are held on the question of the constitution of the soluble Prussian and Turnbull's Blues, a body differing (even in composition) from "Insoluble Prussian Blue" must be expected when potassium ferricyanide is treated with ferrous sulphate in excess. For here, even assuming that the precipitate obtained is free from potassium, ferrous ferricyanide $\text{Fe}^{\text{II}}_3[\text{Fe}^{\text{III}}(\text{CN})_6]_2$ or $\text{Fe}_6(\text{CN})_{12}$ cannot be identical in composition, with ferric ferrocyanide $\text{Fe}^{\text{III}}_4[\text{Fe}^{\text{II}}(\text{CN})_6]_3$ or $\text{Fe}_7(\text{CN})_{18}$; the last-named compound contains more cyanogen. It has indeed been stated that the precipitate formed by the interaction of potassium ferricyanide and excess of a ferrous salt ("Insoluble Turnbull's Blue") has the same composition as ordinary Insoluble Prussian Blue.² But such

¹ J. A. N. Friend, *Trans. Chem. Soc.* **109** (1916), 715. To some extent, although not entirely, this standpoint reconciles the views of E. Müller (*Chem. Zeit.* **38** (1914), 281, 328, *J. Prakt. Chem.* **90** (1914), 119), who holds that both Prussian and Turnbull's Blues are really ferrocyanides, with those of P. Wöringer (*J. Prakt. Chem.* **89** (1914), 51), who holds that they are both ferricyanides.

² K. A. Hofman, O. Heine and F. Höchtlen, *Lieb. Ann.* **337** (1904), 1. Compare A. Eibner and L. Gerstaecker, *Chem. Zeit.* **37** (1913), 137, 178, 195.

statements are now generally discredited. According to Müller, insoluble Turnbull's blue still contains potassium; it probably consists largely of the compound $KFe^{II}_2Fe^{III}_5[Fe^{II}(CN)_6]_6$.

When a ferric salt is treated with a ferricyanide, a deep greenish-brown coloration, but no precipitate, is produced. The solution may contain a **ferric ferricyanide**, but it is not easy to isolate that salt in the solid state.

Action of Acids on Potassium Ferrocyanide. By the action of acids upon potassium ferrocyanide, other interesting bodies are produced. Concentrated hydrochloric acid, added to a strong solution of potassium ferrocyanide at ordinary temperatures, causes the precipitation of **ferrocyanic acid**, $H_4Fe(CN)_6$, a white compound, which becomes blue when exposed to the air. It is soluble in water and is a powerful acid.

If warmed with 30 per cent. sulphuric acid, potassium ferrocyanide is partly decomposed; hydrocyanic acid (HCN) is evolved as a gas, whilst potassium and ferrous sulphates are produced in solution,

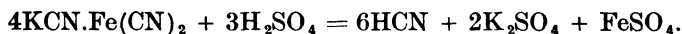

The ferrous sulphate interacts with the undecomposed ferrocyanide and produces a form of potassium ferrous ferrocyanide ($FeK_2[Fe(CN)_6]$) having the same composition as that produced by precipitation in aqueous solution, but much less liable to atmospheric oxidation. When oxidized by a *powerful* oxidizing agent, e.g. hydrogen peroxide, it yields, not ordinary potassium ferric ferrocyanide (Soluble Prussian Blue), but a substance known as **Williamson's Violet**, usually stated to have the same composition as Soluble Prussian Blue.¹ This is a very stable substance, unattacked even by strong acids, and only slowly dissolved by alkalis.

When potassium ferrocyanide, in the powdered state, is treated with concentrated nitric acid, diluted with an equal part of water, it suffers partial decomposition, hydrocyanic acid and other gases being evolved; if, however, the solution is warmed for some time, it will be found to have acquired the property of giving an intense purple coloration when treated with excess of alkali and a trace of an alkali-metal sulphide. If the solution is cooled, allowed to deposit potassium nitrate, filtered, and concentrated further, it deposits red crystals of **sodium nitroprusside**,

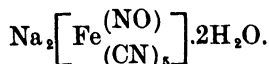

¹ The composition is somewhat variable according to the method of preparation. See J. Messner, *Zeitsch. Anorg. Chem.* 9 (1895), 138.

This salt forms a delicate reagent for sulphides, since the solution gives the purple coloration mentioned above in the presence of small traces of alkali-metal sulphides; the nature of the complex sulpho-compound produced is still uncertain. A solution of sodium nitroprusside decomposes spontaneously upon exposure to light.

The insoluble nitroprussides of barium, silver, copper and other metals are obtained by precipitation, and by decomposing the barium salt with sulphuric acid, the rather unstable **nitroprussic acid**, $H_2[Fe(NO)(CN)_5]$, is obtained.

Carbonyls of Iron.¹ Like nickel and manganese, iron has the power of combining with carbon monoxide. It forms no less than three "carbonyls." When finely divided iron, made by heating ferrous oxalate, is allowed to absorb carbon monoxide, a small amount of the carbonyl forms upon the surface of the iron, and can be separated by distillation at about 120° C. By alternately allowing the iron to stand in carbon monoxide gas, and distilling off the carbonyl, a considerable amount of the latter can be prepared. It is a liquid of composition $Fe(CO)_5$, having a boiling-point 102.6° C. The preparation of the carbonyl is made difficult by the fact that the carbonyl is itself adsorbed by iron, forming a protective film upon it, which interferes with the reaction.² Thus, although the formation of carbonyl commences with a considerable velocity, the iron soon becomes "passive" (or "poisoned") and only recovers its activity when heated to 100–120° C., at which temperature the carbonyl is volatilized. A better yield of the carbonyl can be obtained by heating finely-divided (pyrophoric) iron at 210° C. in carbon monoxide under a high pressure (100 to 300 atmospheres).³

The penta-carbonyl is decomposed if exposed to air or moisture, and also when the vapour is heated. It is soluble in benzene, ether and petrol. If the solution is exposed to the light, it evolves carbon monoxide, and orange crystals of a lower carbonyl $Fe_2(CO)_9$ appear. If the ethereal solution of this latter compound is heated to 50°–60° C., it deposits dark green prisms of the tetra-carbonyl, $Fe(CO)_4$.

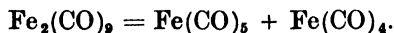

The tetra-carbonyl is comparatively stable, but decomposes when heated to 140° C.

¹ L. Mond and F. Quincke, *Trans. Chem. Soc.* **59** (1891), 604; L. Mond and C. Langer, *Trans. Chem. Soc.* **59** (1891), 1090. Also Sir J. Dewar and H. O. Jones, *Proc. Roy. Soc.* **76** [A] (1905), 558; **79** [A] (1907), 66.

² A. Stoffel, *Chem. Weekblad* **8** (1911), 722; *8th Int. Cong. App. Chem.* (1912), Section II, p. 225.

³ R. L. Mond and A. E. Wallis, *Trans. Chem. Soc.* **121** (1922), 30.

Iron sheets are moderately pervious to carbon monoxide at a red-heat, but this fact is possibly quite unconnected with the formation of any carbonyl.

Effect of Nitrogen and Hydrogen upon Iron. Iron nitride¹ is not easily prepared by direct combination of the metal with nitrogen, for the complete transformation into nitride would require a very high pressure—several hundreds of atmospheres. The nitride, Fe_2N , is, however, readily obtained by heating finely divided iron in *ammonia* between 500° and 700° C. If ordinary compact iron is employed, a brittle film of nitride is produced on the surface, which is easily broken off, although the layer below also contains nitrogen, which is absorbed especially at the boundaries of the grains. Thus the presence of even small amounts of nitrogen in iron render it fragile.

The nitride is a grey substance which is fairly stable in air; it liberates hydrogen and yields salts of ammonia when treated with dilute acids,

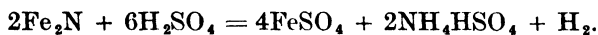

On heating in an inert gas at 600° C. the nitride decomposes into iron and nitrogen.

Iron readily absorbs hydrogen when used as a cathode—preferably in an acid bath, but in this case no definite hydride appears to be produced. The gas seems to penetrate into the metal along the intergranular boundaries, and, since it causes a certain amount of expansion, intergranular fracture is likely to occur on the least shock. Thus the iron becomes brittle. This matter will be referred to again in the technical section.

Analytical

Aqueous solutions of ferric salts give a blue precipitate with potassium ferrocyanide, but no precipitate—only a green or brown coloration—with the ferricyanide; ferrous salts give a blue precipitate with potassium ferricyanide, and a white or pale blue precipitate with potassium ferrocyanide. With potassium thiocyanate, ferric salts give a deep blood-red coloration; ferrous salts produce no coloration.

Iron is not precipitated as a sulphide from acid solutions, and thus the metals which are so precipitated can be separated from

¹ G. J. Fowler, *Trans. Chem. Soc.* **79** (1901), 285. E. B. Maxted, *J. Soc. Chem. Ind.* **37** (1918), 105T.; N. Tschischewski, *J. Iron Steel Inst.* **92** (1915), 47; G. Charpy and S. Bonnerot, *Comptes Rend.* **158** (1914), 994. See also A. A. Noyes and L. B. Smith, *J. Amer. Chem. Soc.* **43** (1921), 475, who suggest that other nitrides (possibly Fe_8N , Fe_6N and Fe_4N) exist.

it; if the iron afterwards is oxidized to the ferric state by boiling the solution with nitric acid, it can be completely precipitated as hydroxide by the addition of ammonia even in the presence of ammonium chloride. The solution must be boiled before filtration, or much ferric hydroxide may remain in colloidal solution. The precipitate is somewhat gelatinous, and may prove troublesome to wash, although, as a rule, it does not cling to the filter-paper nearly so closely as do most other gelatinous hydroxides.

Certain other metals are also precipitated at the same time by ammonia; these include aluminium, chromium, uranium, and the rare earth metals. Aluminium hydroxide can be removed by extraction with hot caustic alkali, and uranium by means of ammonium carbonate. The separation from chromium is best conducted by oxidizing the chromium to the state of chromate; the iron can then be thrown down by means of ammonia, the chromium remaining in solution. If rare-earth metals happen to be present, they can be separated from the acidified solution as a mixture of insoluble oxalates.

If iron and manganese occur together in solution, and the iron is precipitated with ammonia in the ordinary manner, the ferric hydroxide is likely to carry down some manganese with it. Under these circumstances, it is preferable to precipitate the iron as the basic acetate; sodium acetate is added to the neutral solution and the basic acetate is thrown down on boiling.

Both basic acetate and hydroxide yield ferric oxide (Fe_2O_3) on moderate ignition; iron is usually weighed as this oxide.

A very useful reagent for the separation of iron from other metals is the ammonium salt of nitroso-phenyl-hydroxylamine,



commonly known as "Cupferron."¹ From weakly acid solutions, "cupferron" precipitates iron, and also copper if present; but nickel, cobalt, aluminium, chromium, zinc, manganese and cadmium remain in solution. From a strongly acidified solution, iron alone is precipitated and copper remains in solution. The reddish precipitate of the iron salt of nitroso-phenyl-hydroxylamine is washed with water, then with ammonia, and finally again with water, and can be ignited to give ferric oxide, which is weighed.

Iron is sometimes precipitated electrolytically and weighed as metal; for this purpose the solution containing the iron salt is added to a solution of ammonium oxalate. The mixture is

¹ O. Baudisch, *Chem. Zeit.* 33 (1909), 1298. A convenient summary of analytical processes based upon "cupferron" is given by S. A. Braley, *J. Ind. Eng. Chem.* 11 (1919), 1144. See also R. Fresenius, *Zeitsch. Anal. Chem.* 50 (1911), 35. G. E. F. Lundell, *J. Amer. Chem. Soc.* 43 (1921), 847.

electrolysed hot (about 85° C.), the process being preferably conducted in a platinum dish, which is used as cathode. About 6–7 volts are applied, and, if the anode is rotated so as to stir the solution, the deposition will be complete in about half an hour.¹ The solution should be kept slightly acid with oxalic acid, so as to prevent the possible precipitation of ferric hydroxide. The presence of nitrates is to be avoided, as they prevent the complete precipitation of the iron. Other metals which can be precipitated on a cathode must be separated beforehand by chemical means; but it is possible by observing the right conditions to bring about the quantitative deposition of iron in the presence of manganese or aluminium.

In rapid analysis, iron is usually determined volumetrically. Advantage is taken of the fact that it forms two series of stable salts; it is assumed that other metals of this character are not present in the solution. In the usual method, the iron is converted entirely to the ferrous state, and then titrated with an oxidizing reagent. If the iron is partly in the ferric condition at the commencement, it is reduced either by saturating the boiling acidified solution with sulphur dioxide or hydrogen sulphide gas, the excess of the gas being afterwards expelled by boiling. Reduction may also be effected by the action of metallic zinc in the presence of acid; in this method, however, there is a danger of the introduction of iron as an impurity in the zinc. As an alternative it is possible to reduce the ferric salts by the addition of a slight excess of a solution of stannous chloride in hydrochloric acid; the slight excess of stannous chloride is then removed by adding mercuric chloride, a reagent which is reduced by stannous salts (but not by ferrous salts) to insoluble mercurous chloride.

Having reduced the iron, by one of these methods, to the ferrous condition, it is titrated with an oxidizing agent. In the absence of chlorides, the most convenient oxidizer is potassium permanganate, which is run into the solution—strongly acidified with sulphuric acid—until the appearance of a slight pink colour shows that the permanganate is present in excess. In the presence of chlorides, however, titration with permanganate is inaccurate, for the permanganate oxidizes hydrochloric acid, liberating chlorine. Although the error due to this cause is reduced by adding lead chloride or manganous salts to the solution, this procedure does not render the method strictly accurate.

Therefore in the presence of chlorides it is necessary to titrate the ferrous salt solution with potassium dichromate; but as the colour of the dichromate is not so intense as that of the permanganates, it is necessary to use a "side-indicator," a drop of the liquid being

¹ A. Fischer, *Chem. Zeit.* 31 (1907), 25.

tested from time to time during the titration with a drop of potassium ferricyanide on a porcelain slab, so as to ascertain at what point the removal of ferrous salts is complete. This is rather a troublesome process. An electrometric method for determining the end-point has also been worked out, and yields satisfactory results.¹ It is discussed in Chapter IX, Vol. I.

If the iron is wholly in the ferric state, it may be estimated by adding potassium iodide to the faintly acid solution, and titrating the iodine liberated with thiosulphate.²

TERRESTRIAL OCCURRENCE

Iron is one of the commonest metals that occur in the earth; the average rock-magma is thought to contain about 4 per cent. of iron. Much of the iron crystallizes out in the very first stages of the consolidation, as the oxide

Magnetite	.	.	.	Fe_3O_4
and sometimes as the sulphides				
Pyrites	.	.	.	FeS_2
Pyrrhotite	.	.	.	which can be regarded as FeS , containing excess of sulphur in solid solution (the resultant composition is often about $\text{Fe}_{11}\text{S}_{12}$).

All of these minerals are found in the ultrabasic portions of intrusions. Pyrites and pyrrhotite occasionally contains small quantities of other metals, such as copper and nickel. It is probable that pyrites, which has a high melting-point, has always crystallized from the magma in the solid condition in the early stages of the crystallization of the magma; on the other hand, pyrrhotite has usually separated from the mixed silicates as a liquid phase, and has not solidified until a much lower temperature was reached.³

The iron compounds which separate from an intrusive mass are considerably heavier than the rest of the magma, and tend to sink; the siliceous portion, which is comparatively acid in character, rises at the same time. This sinking of the heavy minerals is probably the main cause of the separation of the original igneous intrusion into acidic and basic proportions. The "sunken segregate," which is the part most rich in iron, will only occasionally

¹ G. S. Forbes and E. P. Bartlett, *J. Amer. Chem. Soc.* **35** (1913), 1527; J. C. Hostetter and H. S. Roberts, *J. Amer. Chem. Soc.* **41** (1919), 1337; G. L. Kelley and R. T. Bohn, *J. Amer. Chem. Soc.* **41** (1919), 1776.

² I. W. Wark, *Trans. Chem. Soc.* **121** (1922), 358.

³ J. H. L. Vogt, *J. Geol.* **29** (1921), 636.

come to be accessible to mankind. If, however, after differentiation has occurred deep down in the crust, further upward movement occurs, masses rich in magnetite may be pushed up comparatively near to the surface, and in the course of subsequent ages may be laid bare by denudation. It is probable that some of the huge masses of magnetite ores found in Scandinavia have been formed in this way.¹ Often the iron-ore occurs as streaks and bands in rocks of a less basic character, such as labradorite, or sometimes even granite. Vogt has attributed this streakiness to differentiation "in depth," followed by the extrusion of the segregates upwards into their present position.

It is noteworthy that iron ores of direct igneous origin are very liable to contain titanium, which is, of course, an important constituent of the original magma; this fact detracts from the economic value of the ores. The titanium may occur as a minor constituent of magnetite, but in the more titaniferous rocks, the distinct mineral



occurs.

Of the minerals mentioned above, magnetite is a heavy, opaque, black mineral, often showing a slightly metallic lustre; it is attracted by a magnet, but only a few natural samples have themselves the power to attract ordinary iron, such specimens being known as "loadstone." Ilmenite is also a black, heavy, sub-metallic mineral, but is not attracted by the magnet. Pyrites and pyrrhotite are both minerals of a brassy-yellow colour; pyrites is often found in cubes, or other forms belonging to the cubic system; pyrrhotite is distinctly magnetic. Another mineral, marcasite, having the same composition (FeS_2) as pyrites may be mentioned at this point, although it is not in general of magmatic origin. It forms crystals belonging to the rhombic system, paler than those of pyrites.

Sometimes fine shining crystals of



occur in igneous rocks, but most of the hæmatite ore which is of commercial importance has, as we shall see, a different mode of origin.

¹ These are described in detail by F. Beyschlag, J. H. L. Vogt, and P. Krusch in "Deposits of useful Mineral and Rocks"; translation by S. J. Trusscott (Macmillan). See also J. W. Gregory, *Trans. Chem. Soc.* 121 (1922), 756, 759. Gregory says that some of the ores of Swedish Lapland (e.g. those of Routivaara) are real magmatic secretions, "as truly igneous as granite or basalt," whilst others (e.g. those of Gellivaara) have been deposited by descending waters.

Although iron ore occurs in largest quantity in the ultra-basic portions of rock masses, it is a constituent of many minerals, like augite and hornblende, which are found in rocks of intermediate character. Generally speaking, the iron-content of the igneous series becomes smaller as we pass from basic to acidic, but even granite usually contains 1 per cent. or more of iron, occurring partly as grains of magnetite ; in addition, occasional particles of pyrites are not uncommon in igneous rocks—especially those of basic composition.

When igneous rocks are exposed to the weathering action of water and air, the iron compounds are usually attacked along with the other minerals. The dissolution of iron is greatly accelerated by the presence of acidic substances in the water—such as carbon dioxide, or the so-called “humic acids,” which are formed in peat bogs and elsewhere from the decomposition of vegetable matter. Furthermore, where pyrites has been attacked, the sulphuric acid produced greatly aids in the decomposition of all the other minerals present.

It is clear, therefore, that all water running off hills made of igneous rocks—or other rocks containing ferruginous minerals—is likely to contain iron in solution. This will generally in the first place exist as a stable ferrous salt. Sooner or later, the further action of oxygen will convert it to the corresponding ferric salt, which probably will be at once hydrolysed, ferric hydroxide being formed. In some cases, this second stage of the weathering process may commence before the water leaves the igneous rock from which the iron is derived, and the igneous rock soon becomes stained with a rusty-brown deposit of ferric hydroxide. Generally, however, the water will flow down from the hills still carrying much ferrous iron in solution, and the deposition of ferric hydroxide will commence in the rivers. The banks of certain small streams in Yorkshire which have their origin in rocks rich in iron pyrites are covered in some places with a deposit of iron ochre several inches deep.¹ But an especially favourable place for the oxidation is a shallow lake or bog, where the rate of progress of the water towards the sea becomes very much reduced. Here the ferrous compounds will become completely oxidized, and the ferric hydroxide—first produced in colloidal solution—will gather together to form a precipitate, and sink. In certain lakes in Sweden, surrounded by granitic rocks, “bog iron ore” is being laid down at a rate of an inch every five or ten years. It is known that in some places the action of certain bacteria aids considerably in the oxidation of the iron to the ferric condition.

¹ J. Haworth and J. Evans, *J. Soc. Chem. Ind.* 40 (1921), 91r.

The composition of bog iron ore is variable ; when first produced it consists of more or less gelatinous hydroxide, and the water-content is by no means constant. The name "limonite" is applied generally to amorphous hydroxide ores containing capillary water. As, however, these ores become consolidated and lose their water, crystalline minerals of fairly constant composition may be produced, namely,

	Gæthite	.	.	.	$\text{Fe}_2\text{O}_3 \cdot \text{H}_2\text{O}$
and	Hæmatite	.	.	.	Fe_2O_3

The fibrous forms of gæthite are often included in the general term "limonite."¹

The colour of the ores derived in this way depends on the state of dehydration and upon other conditions, varying from yellow to different shades of brown and red. Naturally they often contain clay and other foreign matter. The clay-ironstone which occurs in the coal measures of this and other countries probably represents an old bog iron ore ; it was possibly laid down in the same swamp in which—during periods when the conditions happened to become favourable—the plants grew that have since become converted into coal.

In general, however, most of the iron present in the rivers will reach the sea, either in suspension as ferric hydroxide, or in solutions as a ferrous salt. The former will be deposited with the other suspended matter, and we thus get ferruginous sandstones, which in some cases may be sufficiently rich in iron oxide to constitute important ores of iron. The soluble ferrous salts will not be deposited directly ; but they may interact chemically with any calcareous matter (shell fragments, coral fragments, etc.) which is being deposited, according to some such reaction as

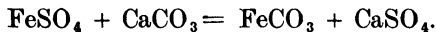

The calcium carbonate is thus replaced, in part or whole, by iron carbonate, known to mineralogists as

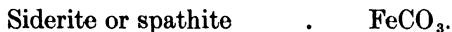

Thus, when the calcareous bed comes to be consolidated, it will form, not a pure limestone, but a ferruginous limestone or ironstone. In extreme cases, the calcium carbonate may be wholly replaced by iron carbonate.

In other instances, a bed of limestone, which was pure at the time of consolidation, may subsequently be converted into ironstone

¹ E. Posnjak and H. E. Merwin, *Amer. J. Sci.* **47** (1919), 311, give a detailed classification of all hydrated iron ores, and correct numerous erroneous statements made by older writers.

by the action of infiltrating waters containing iron salts. Possibly a single bed may come to be converted almost wholly into ironstone in one place, whilst it remains fairly pure limestone in other places, to which the supply of ferrous salts has not penetrated.

It seems likely that the British iron-ores of Jurassic age, of which the Cleveland ore is a famous example, are really limestones converted—probably during the period of formation—more or less completely into ironstone. In the upper parts of the formation, the ferrous carbonate has since—as a result of subsequent changes—become oxidized to ferric oxide. Thus the upper part of the Cleveland ore-deposits—now largely “worked out”—was a brownish oxidized rock, but the lower part, which is now being mined, is a greenish-grey oolitic rock containing ferrous carbonate, and a great deal of siliceous matter.¹ It contains 25–30 per cent. of iron.

The so-called Clinton ores of the Appalachian Mountains (U.S.A.) and the well-known Minette ores² of Lorraine and Luxemburg are also of sedimentary origin. Geologists still differ somewhat as to how far the iron compounds were deposited directly, or how far they were produced after the consolidation of the beds by interaction between iron salts and the original constituents of the deposit. The extensive iron ores of the Lake Superior district were probably once ferrous carbonate rocks of aqueous origin, but have since undergone change; the iron now occurs as limonite, hæmatite and magnetite. Some of the magnetite ores of Scandinavia are probably replacement products, the iron having been deposited by percolating waters which contained iron derived from other rocks (possibly since destroyed). These secondary deposits are more valuable as ores than the other Swedish magnetites which are of direct igneous origin, since they usually contain less titanium.³

Another interesting series of iron compounds are those of Elba. The ores have been thought by some geologists to be altered sediments, but the fact that they occur in rocks (mainly limestones) of numerous different geological ages is inconsistent with this view. They are probably contact deposits due to the proximity of certain granitic intrusions. The common mineral is the shining form of hæmatite known as “specular iron ore.” The oxygen content of the crystals is often less than would correspond to the composition Fe_2O_3 , and may actually vary in different zones of the same crystal. It is noteworthy that a complete series of mixed crystals varying

¹ F. H. Hatch, *J. Iron Steel Inst.* 97 (1918), 71.

² H. Ansel, *Zeitsch. Prakt. Geol.* 9 (1901), 81. See also P. Nicou, *J. Iron Steel Inst.* 104 (1921), 15.

³ J. W. Gregory, *Trans. Chem. Soc.* 121 (1922), 759.

in composition between the limits Fe_3O_4 and Fe_2O_3 exist, and many minerals described by prospectors as "magnetite" (having been identified as such by testing with the magnet) have a composition nearer to Fe_2O_3 than Fe_3O_4 . The magnetism decreases steadily as the oxygen content increases.¹

Beds of ironstone which are of sedimentary origin are liable to contain phosphates—no doubt derived from animal sources. This is specially true of the Minette ores, and greatly interfered with their industrial use until about the year 1878, when the successful development of the basic steel process removed the special objection to the use of phosphatic pig-iron in steel-making.

The five ore-fields of the world which are probably of greatest extent are those of Lake Superior, Lorraine and Luxemburg, Sweden, Cuba, and Brazil; of these the Brazilian field is largely undeveloped. Some of the Swedish ores are specially prized on account of their purity. The British ores—although not of very great extent, nor of outstanding purity—are valuable owing to the fact that they are situated in convenient proximity to coal-fields. However, much foreign ore is imported into this country, mainly from Spain and the Mediterranean, and is smelted near the ports by the aid of British coal. The foreign ore is richer than the British (containing on the average 50 per cent. of iron as compared with 30 per cent. for British ores), and is more free from phosphorus than the majority of British ores. However, during the war, useful experience was gained in the employment of low-grade ores of British origin, and the latest works have been designed specially to treat this class of ore.²

Practically all iron-ores of commercial value contain manganese—a fact which is of some importance in metallurgy.

Iron compounds occur in small quantities in very many other sedimentary rocks. Many shales, for instance, contain large amounts of finely-divided pyrites derived from the disintegration of igneous rocks. Some of these, which are suitable for use as "alum shales," have been referred to in the section on Aluminium (Vol. II, p. 199).

¹ R. B. Sosman and J. C. Hostetter, *Trans. Amer. Inst. Min. Eng.* 58 (1917), 409.

² F. H. Hatch, *J. Soc. Chem. Ind.* 38 (1919), 219R.

METALLURGY OF IRON AND STEEL

General. The first substance produced from iron ores, in the **blast furnace**, is a hard but slightly brittle substance containing 3 to 4·5 per cent. of carbon, along with some silicon; this substance is known as **pig-iron**. Being much more easily fusible than pure iron, it is more adapted for direct production from the ores, as it can readily be separated from the slag-forming constituents; moreover, it constitutes an extremely useful material ("foundry iron") for making iron castings, in cases where malleability is not required.

From pig-iron, **steel** is made by the removal of most of the carbon and other non-metallic impurities in an **open-hearth furnace**, or in a **Bessemer converter**. During the last stage of the steel-making operation, a certain amount of fresh carbon is usually added to the molten steel so as to bring up the carbon content to the required value. Steel may contain carbon in any quantity up to about 2 per cent., although most of the steel now made contains far less than this; in general, steel is softer and more malleable, the less carbon it contains. Steel with less than about 0·2 per cent. of carbon is often called **mild steel**; very mild steel, that is, iron with as little as 0·1 per cent. of total impurities—is sometimes known as **ingot iron**.

In the preparation of steels of high quality, the final elimination of undesirable impurities, such as sulphur, is often conducted in the **electric furnace**. Electric furnaces have also proved valuable for the preparation of **alloy steels**, containing other metals besides iron, and even for the production of high-carbon steels of special quality, simply by the melting up of a mixture of materials (often largely scrap-steel) which is calculated to give the required composition. The **crucible furnace** is also used for the same purpose.

Another product which is now of less importance than was once the case is the so-called **puddled iron** ("wrought iron"). This is a material low in carbon, produced from pig-iron under conditions, such that—during the final stage of decarburization—the metal is no longer fused but is in a pasty state. It has a carbon-content of about 0·1 per cent., similar to that of many specimens of mild steel (produced by decarburization in the completely liquid state), but differs from the latter in possessing a fibrous structure, which is due to the method of production; it also contains a certain amount of slag-material.

Other important changes are brought about in iron and steel by the addition, or elimination, of carbon—locally or otherwise—in the solid state. The addition of carbon by diffusion into solid iron is known as **cementation**. It was at one time extremely important as a means of producing high-carbon steel of high quality from low-carbon material. Now it is used mainly for producing a surface-layer of hard high-carbon material upon an object of which the body consists of comparatively soft (and malleable) low-carbon steel; the process is known as **case-hardening**. The converse operation of decarburization in the solid condition is also extremely important, being employed in the production of the so-called “**malleable castings**.” The casting is originally made in cast-iron, which is easily fusible and easy to cast, but which yields a non-malleable casting; the latter is then rendered malleable by the removal of carbon.

It will also be necessary to consider the extraordinary changes brought about in iron and steel, including alloy-steels, by subsequent **heat-treatment**, such as quenching and tempering. In order to understand these changes, some notion of the metallography of iron is needed.

Finally, in addition to the materials obtained by thermal methods, an appreciable amount of very pure iron is now produced by electrolysis of an aqueous solution of a salt.

Manufacture of Cast Iron

Preliminary Treatment of Ores. Most iron-ores are sufficiently rich to pass to the smelter without special concentration, although some American magnetite ores are now subjected to magnetic concentration. The disadvantage of concentrates—and also of those natural ores which are of a powdery character—is that they require to be sintered or briquetted before they can be smelted.

Almost all ores, whether the iron be present as oxide or as carbonate, require a calcination before they are fit to enter the blast-furnace. The object of the calcination is to drive off moisture, organic matter, and, in the case of a carbonate ore, carbon dioxide. After the operation, the iron should be left as oxide (either Fe_2O_3 or Fe_3O_4).

The calcination is sometimes carried out in heaps or stalls, but is more often conducted in a kiln. Various forms of kilns are used, one of which is shown in Fig. 17. The kiln consists of a circular chamber of steel plates lined with firebrick and supported on hollow iron pillars, P; an inverted cast-iron cone, C, stands in the centre

of the floor. The furnace is filled with a mixture of lumps of ore and small coal (or other cheap fuel) which is fed in at the top from trucks. Sufficient air is admitted at the bottom, and at the apertures A, to burn the coal; the heat generated serves to dry the ore and—if carbonates are present—to drive off carbon dioxide.

In some kilns gas-heating is used, no coal being mixed with the charge. In many places, the waste gases from the blast-furnaces or from coke ovens are used for this purpose.

In the case of ores of a powdery character, the calcining is often combined with the briquetting or sintering process.¹ In the briquetting process proper, the fine ore is ground up moist to give

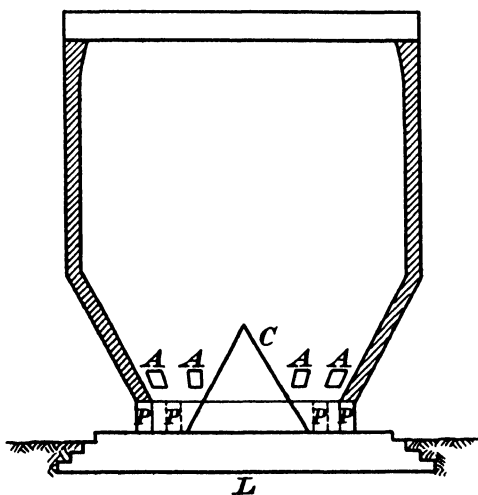

FIG. 17.—Kiln for the Calcination of Iron Ore.

a plastic mass, a binder (such as clay) being added in most cases; the mass is pressed into briquette form in a moulding machine, and the briquettes are then burnt in a brick-kiln, and acquire the necessary strength and hardness. It is probable, however, that sintering may become more successful than briquetting. In the **Dwight-Lloyd process**, which has proved very satisfactory in America, an intimate mixture of fine ore and powdered fuel is fed continuously on to an endless conveyor, and, by the burning of the fuel, the ore particles are fused superficially, and adhere together, so that porous lumps of sinter are produced. The principle of the plant is shown in Fig. 18. The mixture of fine ore and fuel falls from the chute A on to "pallets" fixed to a moving con-

¹ G. Barrett and T. B. Rogerson, *J. Iron Steel Inst.* 96 (1917), 7.

veyor; each pallet has a floor composed of a herringbone grate, and, when they pass over the suction boxes S, a current of air is sucked through the mixture of ore and fuel. The fuel is ignited at B, and burns in the air which is drawn through it. The sintered mass produced in each pallet is turned out automatically into C, at the other end of the plant, and the pallets then return on the under-side of the conveyor, and are ready to be filled with more

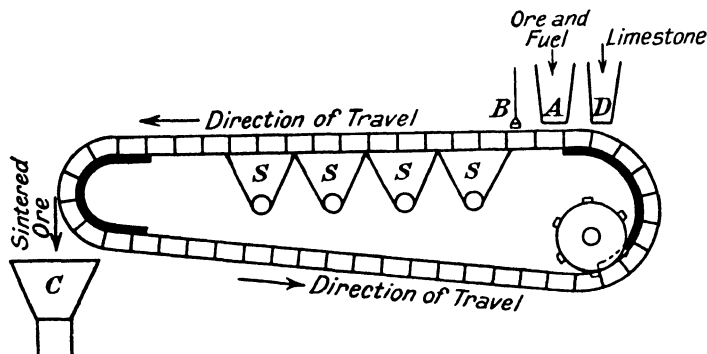

FIG. 18.—Dwight-Lloyd Sintering Plant.

ore and fuel. It is a common practice to sprinkle a little broken limestone—by means of the chute D—upon the bed of the pallets; the limestone serves to protect the grate-bars from undue burning.

Blast-Furnace Reduction.¹ The charge fed into the blast-furnace consists of calcined ore, coke, and usually limestone. The coke must be specially prepared for the purpose by heating coal rather tightly packed in special ovens,² so as to produce a dense strong material. (The porous coke obtained at the gasworks would be too weak to withstand the pressure to which it would be subjected in the blast-furnace, because the choice of materials and conditions needed to obtain the maximum production of coal-gas allow too much “frothing” of the coal, and yield a coke containing large pores, and consequently without mechanical strength.³) Many Scottish blast-furnaces burn splint coal instead of coke. The limestone is required in all cases in which the ore is of a siliceous character, its function being to combine with the somewhat infusible silica, yielding a fusible slag consisting mainly of calcium

¹ See T. Turner, “The Metallurgy of Iron” (Griffin). A. H. Sexton and J. S. G. Primrose, “Metallurgy of Iron and Steel” (Scientific Publishing Co.).

² For a description of a modern coking plant see G. S. Cooper, *J. Iron Steel Inst.* 90 (1914), 17.

³ Sir G. Beilby, *J. Soc. Chem. Ind.* 41 (1922), 341. Compare R. Lessing, *Trans. Inst. Gas Eng.* (1912) 242.

silicate. Occasionally, as at Frodingham, the ore contains sufficient calcareous matter to render the addition of limestone unnecessary. And indeed in any ore excessive addition of limestone must be avoided, since this would defeat the very purpose of the addition; very "limey" slags are usually difficultly fusible and sticky. A distinctly basic slag is, however, quite advisable if the ore or fuel contains much sulphur, which is then kept in solution in the slag

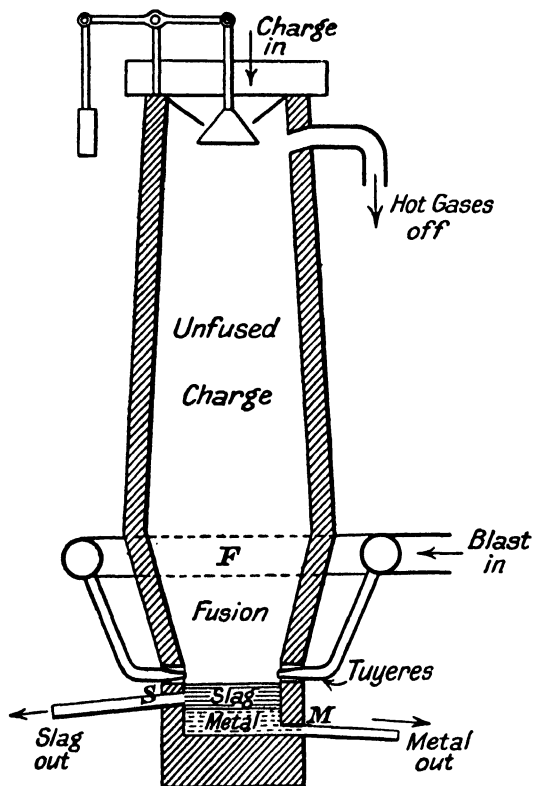

FIG. 19.—Iron Blast-Furnace.

as calcium sulphide, instead of entering the metallic phase as ferrous sulphide.

The blast-furnace consists of a shell of brickwork, usually cased externally with riveted steel, and lined internally with good refractory firebrick. It is generally considered that the most suitable height for a blast-furnace is about 75 ft. The general form of the furnace is shown in Fig. 19. The circular shaft broadens slightly as we pass from the top downwards, reaching the broadest point

about two-thirds of the way to the ground. Below this point the walls slope inwards at an angle of $70-75^{\circ}$, until we reach the level of the "tuyeres," through which the blast of air is forced into the furnace; the sloping portion is known as the "bosh," whilst the comparatively narrow space at the bottom is known as the **crucible**. The nozzles of the tuyeres are inserted into the furnace through a ring of holes at the top of the crucible. Since this region of the furnace is extremely hot, the tuyeres are surrounded by jackets containing cooling water. At one time the cooling water was forced into the jacket by pressure, and consequently, if the water-jacket happened to burn through, water would be shot into the white-hot region of the furnace, causing an explosion. In many of the newer furnaces, however, the cooling water is drawn through the cooling-jacket by suction, instead of being forced through by positive pressure; in this way the danger of explosions is greatly reduced. In the larger furnaces, water-cooling is also applied to the "bosh."

Working of the Blast-Furnace. When the blast-furnace is in full working order the charging is almost continuous. In some works, barrows containing the charges of ore, coke and limestone are brought up to the top of the shaft by a vertical hoist and emptied into the furnace by hand. Most furnaces are, however, now provided with mechanical means of charging, being equipped as a rule with an inclined hoist up which skips or buckets containing the charge are sent; in such cases it is generally arranged for the skips or buckets to discharge their burden more or less automatically into the mouth of the furnace, thus largely dispensing with manual labour.¹ An iron cone or "bell" counterpoised by a weight which keeps it normally pressed up against the bottom of the hopper, seals the mouth and thus prevents an undue escape of gas during charging.

The charge continuously descends through the furnace, which is always kept full practically to the top. The molten products produced during the descent separate in the crucible into two layers, consisting of molten slag and molten pig-iron respectively, which are periodically allowed to run out through the separate tapping-holes S and M placed at different levels. These holes are not, as a rule, kept open continuously, but are opened at intervals, when sufficient iron and slag have collected in the crucible.

Whilst the charge is descending, air is being forced in through the nozzles of the tuyeres under a considerable pressure (4 to 10 lb. per sq. in.); it passes up through the mass, burning the coke and producing the necessary heat. The temperature maintained is

¹ For details of different systems see N. Kapp, *J. Iron Steel Inst.* 90 (1914), 104; D. E. Roberts, *J. Iron Steel Inst.* 105 (1922), 51.

about 3,800° C. on the level of the tuyeres, about 2,600° C. at the broadest point of the furnace, and falls off from that point steadily as we go upwards, being only about 300° C. just below the mouth.¹

The blast-furnace fulfils two distinct functions:—

- (1) The *reduction* of the oxide to metal, brought about chiefly in the upper and middle portions;
- (2) the *fusion* and consequent *separation* of the iron produced from the slaggy matter, which occurs in the intensely hot lower region.

(1) When the charge of ore, coke and limestone enters the mouth of the furnace, partial reduction of the iron oxide by the carbon monoxide formed lower down in the furnace commences through such reactions as

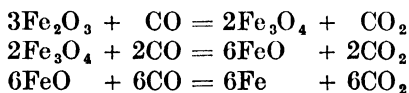

The reduction may commence at a comparatively low temperature, but only becomes complete as the charge descends into the middle portion of the furnace. As will subsequently be explained, it is quite impossible to avoid a large amount of carbon monoxide passing out from the top of the furnace unused. Numerous accessory changes occur near the top of the furnace; one of these is the spontaneous decomposition of carbon monoxide according to the equation



This change is brought about by the iron oxide, which acts as a catalyst, the finely-divided carbon being thus deposited on the surface of the iron-ore.

Another important reaction occurring fairly high up in the furnace is the decomposition of the limestone into lime (CaO) and carbon dioxide.

(2) As the charge descends through the furnace, coming nearer to the seat of the blast, it becomes hotter and hotter. Finally such a temperature is reached that fusion actually takes place. The fusion of the iron is first rendered possible by the fact that the reduced metal absorbs the finely-divided carbon clinging to it, and the melting-point is thus lowered; the fusion of the slag, on the other hand, is brought about by the combination of the siliceous gangue with the lime, forming a fusible silicate mixture. Fusion commences below the point F. The molten drops of iron are heavier than the molten drops of silicates (slag); consequently

¹ F. Clements, *J. Iron Steel Inst.* 101 (1920), 139.

in the crucible two fused layers are formed, the molten iron below, and the molten slag above.

Periodically when the crucible becomes full, the slag-hole S and iron-hole M are opened, and the two materials are run out. The moulds provided for the metal are formed, in most English works, of sand; a flat piece of ground of considerable area is covered with sand, the surface of which is raked into a grid-system of ridges and trenches. The molten iron issuing from the furnace is caused to run through the trenches in the sand and solidifies in them. Before it is quite cold it is broken up into long bars (or "pigs"), usually by the application of a sharp blow at a suitable place. At some works automatic machines designed for rapid "pig-casting" are employed, in which the molten iron pours from a ladle into permanent moulds (generally of metal). In one form the moulds are attached to an endless band, which travels forward at such a rate that when one mould is full another takes its place. The moulds filled with metal travel forward, being cooled with water, and discharge the solidified metal at the farther end; the empty moulds then return along the under-side of the moving band to the filling-point, and are ready to be filled once again.

The slag pouring out of the slag-hole is allowed to accumulate separately. It is produced in very large quantities, and it was formerly one of the chief problems of the ironmaster to know what to do with it. To a large extent it has been broken up, and used as material in the reclaiming of land, or for road-making, or even as ballast. Another use is in the manufacture of "slag wool"; slag when quickly cooled sets to a glass, and slag-wool can be regarded as a cheap substitute for glass-wool. The wool is made by passing a jet of steam into molten slag; droplets of slag are carried off, each of which is followed by a fine thread of slag. Slag-wool is used as a heat-insulating material, for example in "packing" hot-water pipes to prevent heat-loss by radiation. More recently blast-furnace slag has come to be important as a material in the manufacture of cements (see Vol. II, p. 142).

The Thermal Economy of the Blast-furnace.¹ The blast of air forced in at the tuyeres no doubt primarily burns the coke to carbon dioxide, but the carbon dioxide—passing upwards through further layers of intensely hot coke—reacts at once according to the equation



¹ Some factors not always fully considered are discussed by H. E. Wright, *J. Iron Steel Inst.* 101 (1920), 179. The equilibrium relations are dealt with in detail by R. Schenck, "Physical Chemistry of Metals": translation by R. S. Dean (Chapman & Hall). See also J. E. Johnson, Junior, "Principles, Operation and Products of the Blast-furnace" (McGraw-Hill).

This change is never quite complete, the equilibrium

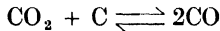

being established. The system "carbon, carbon monoxide, carbon dioxide" is, according to the phase rule, bivariant, and, at a given total pressure, there will be a definite equilibrium ratio of carbon dioxide carbon monoxide corresponding to each temperature, as indicated by the curve AB of Fig. 20, which refers to a pressure not far

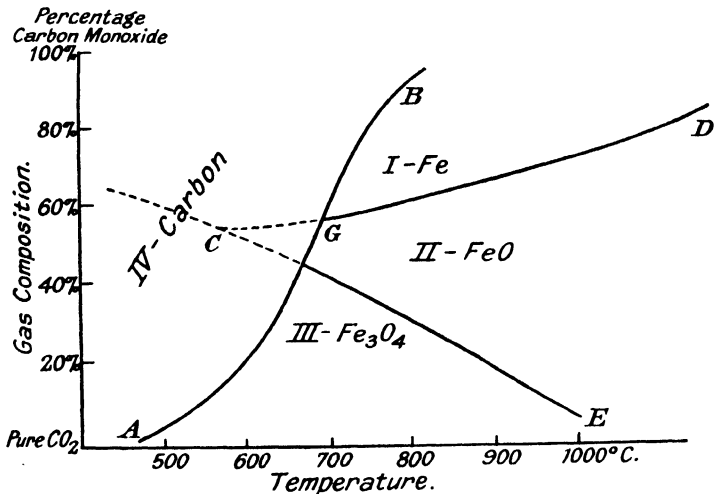

FIG. 20.—Equilibrium between Iron and its Oxides.

removed from that of the atmosphere.¹ The higher the temperature, the greater the amount of carbon monoxide in the equilibrium mixture. Thus in the lower and hotter part of the furnace we find the reaction taking place in the sense,



whilst in the upper and cooler parts—as already stated—we find the converse change occurring,



with the important result that finely divided carbon is deposited upon the ore as it descends.

Now the actual reducing agent of the iron oxide is the carbon monoxide formed in the manner just explained. The reduction

¹ A. Boudouard, *Ann. Chim. Phys.* **24** (1901), 28. Compare V. Faleke, *Zeitsch. Elektrochem.* **27** (1921), 268.

probably takes place in the three stages suggested above, and each of these is really a balanced reaction. For instance, the last stage, which can be written

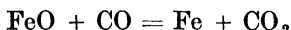

is capable of taking place in either direction, according to the ratio of the two gases present.

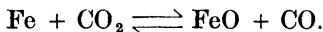

The equilibrium proportions of the gases for different temperatures is shown by the curve CGD of Fig. 20.¹ If carbon monoxide is brought into contact with heated ferrous oxide, it will reduce it to the metallic state, until the ratio $\frac{\text{carbon dioxide}}{\text{carbon monoxide}}$ reaches the value indicated by the curve; after this no further reduction to the metallic state can take place. If by any accident the gas came to contain more dioxide than the amount shown by the curve, then metallic iron would actually become oxidized, until the ratio was rectified. The lower curve CE represents in a like manner the conditions needed for the equilibrium,

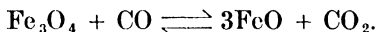

It is clear therefore that under all conditions represented by the area I, metallic iron is the stable solid phase, whilst in those represented by areas II and III, the stable phase is respectively ferrous oxide (FeO) and magnetite (Fe₃O₄). In the area IV to the left of the line AGB, the gas contains more carbon monoxide than corresponds to stable conditions, and would tend to deposit carbon; the dotted lines in this area represent conditions of metastable equilibrium between iron and the two oxides.²

The diagram serves to show that metallic iron is only capable of existing as a stable phase under conditions represented by the area

¹ G. Chaudron, *Comptes Rend.* **172** (1921), 152. Compare also E. Terres and A. Pongracz, *Zeitsch. Elektrochem.* **25** (1919), 386; A. Smits and J. M. Bijvoet, *Proc. Amst. Acad.* **21** (1919), 386; W. Reinders, *Proc. Amst. Acad.* **19** (1916), 175; F. E. C. Scheffer, *Proc. Amst. Acad.* **19** (1916), 644; A. Matsubara, *Min. Met.* **170** (1921), 31. A summary of the whole question is given by E. D. Eastman, *J. Amer. Chem. Soc.* **44** (1922), 975. The curve given in many textbooks, which shows a minimum at about 680° C., is due to E. Baur and A. Glaessner, *Zeitsch. Phys. Chem.* **43** (1903), 354; it probably does not represent the true equilibrium conditions.

² It is likely that near the top of the diagram there is an area in which mixed crystals of carbon and iron are the stable solid phase. Possibly near the bottom of the diagram there is an area in which ferric oxide (Fe₂O₃) is the stable phase. But if it is true that a continuous range of mixed crystals exist varying from Fe₂O₃ to Fe₃O₄, it will not be possible to show a single line separating the Fe₂O₃ area from the Fe₃O₄ area. See A. Smits and J. M. Bijvoet, *Proc. Amst. Acad.* **21** (1919), 386. To avoid controversial issues, these areas are not shown in the diagram.

I, that is in the presence of considerable excess of carbon monoxide. It will now be understood why there must always be an excess of carbon monoxide in the residual gases. As already stated, a small part of this excess of monoxide spontaneously decomposes in the higher (and cooler) parts of the furnace, yielding carbon dioxide and finely divided carbon, a fact which tends to reduce the ratio of monoxide to dioxide in the emergent gases ; likewise a little carbon monoxide may be used up in the cooler parts of the furnace in the *partial* reduction of ferric oxide (say, to Fe_3O_4). But these changes are not rapid at the temperatures prevailing in the upper part of the furnace, and the gases usually leave the furnace with about two-thirds of the carbon in the state of monoxide.¹

It is clear, therefore, that the furnace requires more coke than would appear to be necessary for the reduction of the iron ore if the complete oxidation of the carbon was possible. But in most cases, especially where the ore and fuel are impure, and the proportion of slag-forming material in the charge is large, the amount of fuel must be increased still further, in order to raise the whole of the charge to the high temperature needed for fusion ; and since about two-thirds of this excess fuel will be burnt only to carbon monoxide, the amount needed to heat the charge is very much larger than one would expect. The energy of the excess fuel burnt is, of course, largely represented by the combustible carbon monoxide in the emergent gases, and partly by the heat carried off by these gases, as well as by the slag and the metal. Whilst, however, comparatively few attempts have hitherto been made to recover the heat carried off by the slag and metal, it is a universal practice to collect the gases that leave the furnace at the top and to utilize the energy resident in them. The gases are in part burnt, in the so-called "Cowper Stoves," with a view to pre-heating the air-blast before it is forced into the furnace through the tuyeres ; in this way fuel is economized, since otherwise the air would have to be brought to the furnace-temperature through the combustion of extra fuel within the furnace. But, with economical working, only a portion of the emergent gases is needed for this purpose, and the rest can be used to supply power for driving the whole of the machinery of the works, including the hoist for charging the furnace and the engine for blowing in the air ; not infrequently there is sufficient power left over to generate electrical energy which can actually be utilized outside the works. The raising of power by means of waste gases can be brought about indirectly by burning the gases in boilers, the steam produced being used to drive steam engines. It is, however, more economical to burn the gases directly

¹ See Sir L. Bell, *J. Soc. Chem. Ind.*, 9 (1890), 704-709.

in gas-engines of suitable design, although, before this is possible, the gases must be freed from the vast burden of dust which is carried by them as they leave the furnace. Indeed it is becoming customary to clean the whole of the gases—even those portions used in Cowper Stoves and in boilers—since the dust is an extremely bad conductor, and interferes with the free transference of heat in each case.¹ Therefore it will be advisable first to say a few words about the cleaning of the gas, and then to describe shortly the principle of the Cowper Stoves.

In the **cleaning of the gases**,² numerous processes are used. A good deal of the coarser dust can be eliminated simply by passing the gases through a cooling-chamber, when much of the moisture of the gases is deposited and the larger dust particles come down with it. For the elimination of the smaller particles, more drastic treatment is needed, and filtration through bags made of a special cloth has become common; in order to avoid any chance of the deposition of moisture on the filter cloth, it is customary to warm the gases slightly after they leave the cooling-chamber and before they enter the filter-bags. After filtration, and further cooling, the gases are sufficiently free from dust to be suitable for use in gas engines.

Lately, however, electrostatic systems of cleaning have become important for the removal of the final portion of fine dust, and have also been used in this country for the main cleaning operation.³ During the war, blast-furnace dust acquired a considerable value as a source of potash (which arose from impurities in the ore and fuel), and at many blast-furnaces salt was intentionally added with the charge, so as to increase the yield of potassium chloride.

The dust contains a considerable amount of iron, and in many cases is briquetted and returned to the furnace. Coal tar and ammonia are also recovered from blast-furnace gases in some places.⁴

The **Cowper Stoves** are tall chambers the interiors of which are filled with brick checkerwork, through which the hot gases pass; sufficient air is admitted to the stoves to burn all the carbon monoxide, and the heat produced is largely absorbed by the brick-work, which soon becomes intensely hot. Two stoves are connected to each furnace. The blast is forced in through the first (hot) stove and becomes heated before passing to the tuyeres; the waste

¹ J. E. Stead, *J. Iron Steel Inst.* **101** (1920), 40.

² S. H. Fowles, *J. Iron Steel Inst.* **103** (1921), 75; W. E. Gibbs, *J. Soc. Chem. Ind.* **41** (1922), 189r.

³ A. Hutchinson and E. Bury, *J. Iron Steel Inst.* **102** (1920), 65. See also section on potassium (Vol. II of this work).

⁴ R. Hamilton, *J. Soc. Chem. Ind.* **35** (1916), 663.

gases pass out through the second stove, and heat up the brickwork in that. As soon as the first stove is become too cold to heat the blast efficiently, the second is ready to take its place. The course of the gases is therefore changed, the blast is forced through the newly heated stove into the tuyeres, whilst the waste gases from the furnace-top are now burnt in the first stove, which is thus heated up again. This "regenerative" system of heating is, of course, essentially the same as that described in connection with the manufacture of glass.

Since the reactions of the blast-furnace require about 5 tons of air for every ton of iron produced, it is obvious that if the air sent into the furnace were cold, a very considerable amount of heat would have to be expended in raising it to the temperature of the furnace; in consequence, the "pre-heating" of the blast causes a considerable economy of fuel.

At some works it has also been found economical to "dry" the blast; for if water-vapour is forced into the furnace, endothermic reactions between water and the hot coke will take place, such as

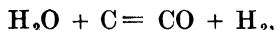

which will produce a cooling just where the highest temperature is required; to avoid this, the air may be dried by passing it through refrigerating tubes, where it will deposit most of its moisture, before it enters the stoves. Calcium chloride has also been employed for the drying of the blast. The system has, however, never come into general favour in this country. As a matter of fact, the average absolute content of moisture in the English air is not so great as is often supposed, and it is generally considered that the system of drying the blast is not remunerative.¹ However, with the recent rise in fuel prices, it is not impossible that the matter may be reconsidered.

Continuity of Working. In the description of the smelting process that has been given, it is assumed that the blast-furnace is in continuous operation. In general, when once the furnace has been started, it ought to continue indefinitely; ore, limestone, and coke are charged in almost continuously at the top, and iron and slag are run out intermittently at the bottom. There is no essential reason why the process should be interrupted until the interior of the furnace has become so worn as to need repair, which may occur every few years.

It is in fact very important that interruption should be avoided, because the furnace cannot be let out or rekindled quickly: rapid

¹ W. W. Hollings, *J. Iron Steel Inst.* 102 (1920), 91. The use of dry blast is, however, strongly advocated by A. K. Reese, *Engineering* 114 (1922), 312.

heating or cooling would cause the thick walls to crack. A cold furnace requires many weeks to "light," that is to bring into working operation, and it may be months before the maximum output is reached. A small fire is first lighted in the bottom of the furnace, and very gradually the shaft is filled up with fuel containing small quantities of ore and limestone, only sufficient air being blown in to keep the charge alight. When the shaft is practically full, the air-blast is gradually strengthened, the charges added are allowed to contain more and more ore and limestone, and the iron and slag produced are allowed to run out occasionally through the tap-holes.

Since it is so undesirable—when once the furnace has been started—to interrupt the working, anything that tends to block the shaft or to damage the walls must be avoided. Blockage—partial or complete—may be caused by the formation of difficultly fusible materials in the furnace. This is somewhat likely to occur if titanium is introduced with the charge, because infusible substances containing titanium are liable to be formed. It is for this reason that ores containing titanium are looked upon with disfavour by iron-smelters, although it has been shown that with care titaniferous ores can be smelted in an ordinary blast-furnace without any blockage occurring.¹

Where the obstruction occurs in the crucible, causing the blocking of a tapping hole, it may often be possible to bore another tapping hole at a new place. Obstructions of the charge in the shaft, which may gradually come to prevent the upward passage of the blast-gases, as well as the downward passage of the charge above ("scaffolding" or "hanging") require more drastic treatment. Sometimes the introduction of an extra tuyere through the walls at the point where the obstruction exists may cure the scaffolding. Sometimes there is no remedy except to allow the furnace to cool gradually down, and to break up the material in the shaft.

The deposition of solid carbon in the upper part of the furnace through such reactions as

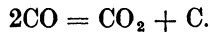

which have already been referred to, is a possible cause of "hanging." In other cases obstruction is connected with the use of powdery ores. Moreover, if the composition of the slag is not correct, the lack of fluidity of the latter may occasion obstruction. The addition of limestone to the charge must therefore be carefully regulated, according to the amount of siliceous matter introduced along with

¹ See three abstracts on the subject in *J. Iron Steel Inst.* 89 (1914), 638. Compare, however, J. A. Heskett, *J. Iron Steel Inst.* 101 (1920), 201.

the ore. If the ore is a highly calcareous one, it may actually be necessary to add, not limestone, but silica, in order to bring the slag to the suitable composition; commonly, however, the same object can be attained by mixing a limey ore with a siliceous ore.

Another important cause of blockage is to be attributed to the presence of unduly large lumps in the charge; they may stick at the side of the furnace, and form scaffolds; when the finer material below moves down, the scaffold is left unsupported and a sudden slip will occur. This slip may cause a sudden evolution of gases, since the charge falls suddenly from a comparatively cool to a very much hotter part of the furnace; consequently an explosion may occur which may damage the furnace. If the dimensions of the bell are such that the larger lumps are thrown into the central part of the shaft, this trouble is unlikely to be experienced.

If it is necessary, owing to a strike or some other cause, to suspend temporarily the operation of a blast-furnace, the furnace is "damped down" by charging in a quantity of coke, and then carefully shutting off the access of air to the furnace. Under these conditions the furnace maintains its temperature wonderfully well, and, even after some weeks' stoppage, the operation can be resumed with comparatively little further delay.

Electrothermal Production of Pig-iron.¹ In the thermal production of pig-iron, a considerable amount of the heat produced by the combustion of the fuel in the air-blast is used in heating up the iron and the slag-forming constituents to the point at which they become fused; the proportion of the fuel used in this way varies with the amount of impurities in the ore. Moreover, of the coke entering the furnace only about one-third can be burnt to carbon dioxide, the remainder leaving the furnace as carbon monoxide. Although the energy content of the emergent gases is recovered and utilized (in the pre-heating of the blast, and in the driving of machinery) yet any process in which the volume of gases leaving the furnace is materially reduced would be worthy of consideration.

In the electrothermal smelting of iron, the heating is brought about electrically. The oxide is mixed with sufficient charcoal or coke to reduce it to the metallic state—calculated on the assumption that two-thirds of the fuel becomes oxidized only to car-

¹ H. J. Hanson, *Iron Trade Rev.* 53 (1913), 1003; J. Härden, *Electrochem. Ind.* 7 (1909), 16; *Met Chem. Eng.* 12 (1914), 444; J. W. Richards, *Electrochem. Ind.*, 5 (1907), 165; A. Coutagne, *Rev. Met.* 17 (1920), 450. See also *Electrochem. Ind.* 7 (1909), 153; 8 (1910), 11; *Iron Coal Trades Rev.* 90 (1915), 57.

bon monoxide, and no air is forced into the furnace. In this case, carbon, directly or indirectly, is the actual reducing agent, and we have to deal with changes which are highly endothermic :



The reduction by means of carbon would cause a lowering of temperature, if it were not for the fact that the temperature is maintained at its high level by the expenditure of electrical energy.

Although it is clear that here—as in the blast-furnace—the gases leaving the furnace must contain about twice as much carbon monoxide as carbon dioxide, they will be comparatively small in volume, being the result solely of the reduction ; they do not include the products of combustion of fuel burnt in order to bring about the fusion. Consequently the total amount of energy carried off will not be very great. The gases will, moreover, be quite free from inert diluents, such as nitrogen, which is the major constituent of blast-furnace gas.

Nevertheless electrothermal smelting is unlikely to be more profitable than blast-furnace treatment, except in countries where fuel is scarce and where electric energy—based on water-power—is cheap. The Scandinavian industry deserves a brief mention. One type of furnace used in the electrothermal reduction resembles the blast-furnace in shape, but the place of the tuyeres is occupied by the electrodes ; the crucible is usually wider than in the blast-furnace. In Sweden charcoal is used as the fuel. The charge, consisting of ore, limestone, and charcoal is shot in continuously through the bell at the top, as in the blast-furnace, and descends through the shaft where it meets the escaping gases from the crucible, and, consequently, absorbs much of the heat which would otherwise be carried away. When it reaches the crucible a very high temperature is produced by the powerful electric current passing between the electrodes. At this very high temperature the endothermic reduction of the iron oxide by the carbon becomes possible, and molten pig-iron and slag are formed, and run away through the tapping hole. There may be three or four electrodes connected to a source of polyphase alternating current.

In Norway, where power is cheaper even than in Sweden, but where charcoal is scarce, several attempts have been made to use coke as a fuel. The first attempts were unsuccessful because—owing to the fact that coke is a far better conductor than charcoal—the type of furnace which worked well with charcoal was not adapted for smelting with coke. Subsequent attempts have proved

¹ This number is quoted from A. J. Allmand, " Principles of Applied Electro-chemistry " (Arnold).

that, in a suitable furnace, it is perfectly possible to smelt iron ores electrically with the use of coke as a reducing agent.

Owing to the high temperature reached in the electric furnace, it is possible to smelt ores containing a quantity of titanium which would possibly cause trouble in the blast-furnace.

Composition of Pig-iron. The properties, structure, and uses of pig-iron will be dealt with later, as well as the effect of the various impurities upon it. But, since pig-iron is the raw material of steel-making, it is advisable here to give some idea of the ordinary composition of pig-iron. The only essential constituents are the iron, carbon and silicon. The carbon content usually falls between 2 per cent. and 4.5 per cent. The silicon is very variable; in "white cast iron" it is usually below 1 per cent., but grey iron contains much more silicon, which sometimes reaches 3.5 per cent. Since manganese is an almost invariable constituent of iron-ores it is usual to find 0.5 to 1.5 per cent. of this element in pig-iron. Small quantities of sulphur occur in all pig-iron, but in grey iron this should not exceed 0.1 per cent. Phosphorus, on the other hand, may reach 2 per cent. in iron made from a phosphatic ore (e.g. Cleveland ore); in "hæmatite pig-iron" the phosphorus-content is often negligible.

The Manufacture of Steel¹

General. The production of steel from pig-iron can be described in popular language as the "burning off" of the minor constituents of the pig-iron; these constituents include carbon, manganese silicon, and sometimes phosphorus and sulphur. A certain amount of fresh carbon is usually added towards the end of the process, according to the character of the steel required. The removal of the phosphorus and sulphur only proceeds in the presence of a slag of distinctly basic character, and thus we have to divide all steel-making processes into two classes:—

- (1) *Acid*, which are considered to give the best product, but which demand raw material of high quality, free from phosphorus.
- (2) *Basic*, which are necessary where a pig-iron containing phosphorus is the raw material.

Naturally acid processes must be carried out in a furnace with a siliceous lining, whilst basic processes require furnaces lined with a basic substance, such as calcined magnesite or dolomite; otherwise interaction between slag and lining would occur. The basic processes have attained a very special importance in the Minette District, where the ores always contain phosphorus.

It is common also to classify processes according to the type of furnace in which they are carried out, thus:—

- (a) Open-hearth process,
- (b) Bessemer process,
- (c) Electric-furnace process.

Actually the chemistry of the process is distinctly different according to the kind of furnace employed. From the chemical standpoint, the oxidation of the main impurities may be effected in two quite distinct ways, although in some processes (e.g. in the ordinary form of the open-hearth process) both agencies contribute towards the desired result. The two ways are:—

- (i) Elimination by *oxidizing gases*, either directly or indirectly;
- (ii) Elimination by the addition of *oxides of iron* (added as ore, scale or rust) to the charge.

The Open-hearth Process,² by which most of the world's

¹ F. W. Harbord and J. W. Hall, "The Metallurgy of Steel" (Griffin). D. Carnegie, "Liquid Steel" (Longmans).

² Much valuable information regarding the points upon which efficient open-hearth practice depends is given by F. Clements, *J. Iron Steel Inst.* 105 (1922), 429.

output of steel is produced at the present time, is carried out in a gas-fired regenerative furnace, very similar to that described for the manufacture of glass, but designed to give a higher temperature. As a matter of fact, the regenerative principle was applied to steel by Siemens after it had been applied successfully to glass.

The gaseous fuel employed is generated close to the furnace in a separate producer. Normally the producer consists of a brick-lined chamber in which air and steam are forced—or drawn—through a bed of incandescent coal.

Now if a current of dry air were passed up through a column of red-hot coal, the latter would be partially burnt, carbon monoxide being formed. The gas passing out of the producer would consist therefore of carbon monoxide and nitrogen, and could be used as a gaseous fuel, since the carbon monoxide will burn in air, forming carbon dioxide. But considerable heat is evolved in the first partial combustion to carbon monoxide :—



about half that evolved in the further burning of the carbon monoxide to dioxide :—



It is obvious therefore that during the burning of carbon monoxide only about two-thirds of the energy stored in the coal is evolved as heat. About one-third is evolved at an earlier stage, namely, during the production of the carbon monoxide; and, unless the carbon monoxide is used while still hot from this preliminary combustion, one-third of the energy is quite lost. Even with this loss, the practical convenience of gaseous fuel over solid fuel in steel-making is so great that it might be worth while to submit to the sacrifice; but fortunately the loss can largely be avoided by introducing steam along with the air. The steam acts upon the coal, producing hydrogen and carbon monoxide, and the change

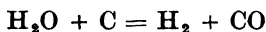

is endothermic, involving the absorption of 39,360 cal. Thus the reaction between steam and coal tends to cool the charge, neutralizing in part the effect of the production of carbon monoxide according to the exothermic equation,

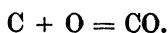

Theoretically, if the steam and air were injected in such a proportion that the result of the two changes would be neither an evolution nor an absorption of heat, a gaseous fuel would be produced having exactly the heating capacity of the solid fuel consumed. But, in practice, owing to the amount of heat lost in radiation, etc., the exothermic

change must be allowed slightly to predominate. The avoidance of undue evolution of heat in the producer is beneficial in another way; it prevents the excessive destruction of the bars of the producer, which would certainly occur if the steam were not introduced.

Thus **Producer gas**, in the modern sense, is the product of the injection of a mixture of air and steam into a column of incandescent coal, in such proportions that sufficient heat is evolved in the action to maintain the high temperature of the column. It consists of a mixture of carbon monoxide and hydrogen, diluted with a great deal of nitrogen (introduced with the air), and a little carbon dioxide.

Various types of gas-producers are used in steelworks. The column of coal, which is usually only about 5 feet deep, can be supported upon **bars**, or upon a "**water-bottom**." In the "modern Siemens" producer (Fig. 21) the coal A rests upon a

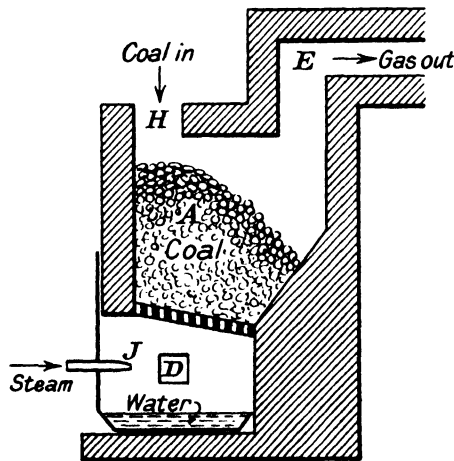

FIG. 21.—Siemens producer (diagrammatic).

system of fire-bars, and is consumed in the current of air admitted through the doors D and of steam injected under some pressure through the nozzle J. The gas formed by the action of air and steam upon the incandescent coal passes off through the exit pipe E. The ashes produced by the burning of the coal fall through the bars into the ash-tray, which usually contains cooling-water, while the constantly descending column of coal is continually replenished by fresh coal introduced through the charging-hopper H.

In the water-bottom producers (Fig. 22) a similar arrangement is

used, but the column rests not upon bars but on the floor of the shaft, which is closed by a water-seal; the ashes produced by the descending column fall into the water and pass under the lower edge of the producer into the external trough T, being, in some types, pushed continuously through the water, by means of an Archimedian screw. The heat remaining in the ashes is given up to the water and is thus employed usefully in the raising of steam.

Several attempts have been made to employ in the steel furnace, instead of specially prepared producer gas, the waste gases from the coke ovens in which the coke destined for the blast-furnace is

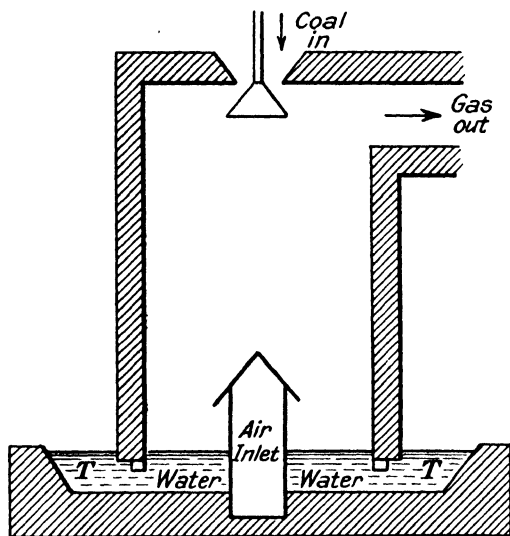

FIG. 22.—Water-bottom Producer.

prepared.¹ It is thought that the design of the furnace should be slightly modified if this form of fuel is to be used.²

Arrangement of a Regenerative Gas-fired Furnace.³ An open-hearth furnace is shown diagrammatically, in Figs. 23 and 24. The principle of the heat economy is identical with that described in connection with the melting of glass (Vol. II, page 60). The gas from the producer passes in through the regenerator R_1 , filled with a checkerwork of hot bricks; here it acquires a high temperature

¹ G. S. Cooper, *J. Iron Steel Inst.* **90** (1919), 40.

² H. Wolfram, *Stahl u. Eisen*, **37** (1917), 902.

³ For details of modern design see C. H. F. Bagley, *J. Iron Steel Inst.* **98** (1918), 289.

and thus enters the furnace extremely hot. At the same time the air required to burn it is blown in through the regenerator R_2 , where it also is pre-heated. Thus both gas and air enter the furnace at a high temperature. On mixing with the air the gas burns, the flame passing over the surface of the charge. The products of combustion, which are naturally very hot, pass out at the other side of the furnace, partly through the generator R_3 and partly through R_4 , on their way to the stack, thereby serving to heat up the checkerwork in these chambers. When the chambers R_3 and R_4 have become very hot, and the others, R_1 and R_2 , comparatively cool, the positions of the controlling valves are altered, and the air and gas pass in through R_3 and R_4 , while the hot products of combustion pass out through R_1 and R_2 . In an ordinary steel furnace this reversal of the valves takes place about once in 20–30 minutes.

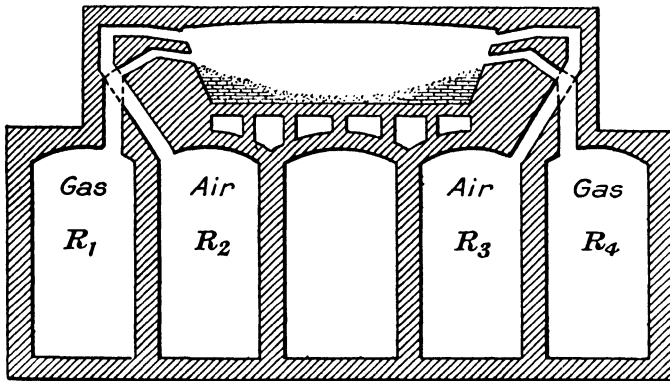

FIG. 23.—Open-hearth Steel Furnace (Longitudinal Section).

It is found best to keep the pressure in the furnace at the atmospheric value, a slight positive pressure being maintained in the inlet ports, and a slight negative pressure (suction) on the outlet side. The satisfactory working of the furnace depends very much on the size and position of the ports.

A common method of arranging a series of open-hearth furnaces, which are usually built in a long row, is seen from Fig. 24. The furnaces F are built up on a high level, and are charged and controlled by men standing on the platform P , through the working doors D . The gas-producer is set on a lower level and the gas passes through flues to the regenerator system. The valves controlling the path of the gas and air through the regenerator system are usually set below the platform; they can be actuated by means of a lever by the man on the platform, who wears dark blue glasses,

and is able to watch the surface of the slag in the furnace without undue inconvenience. The regenerator system is placed below the furnace, and is often separated from it by an air-space. The hearth of the furnace slopes down from the front to the back, where the tapping-hole *T* is situated; when the tapping time arrives, the plug of the tapping-hole can be punctured and the whole charge of the furnace can be run off down the gutter *C* to the ladle *L*, a vessel large enough to take the whole charge. This ladle is set on rails and moves over a series of moulds *M* placed in the casting-pit *A*; from the ladle the steel can be run through a hole in the bottom so as to fill in turn all the moulds. Thus the steel is cast into ingots.

The shape of the furnace proper is shown in Fig. 23, as viewed from the front (platform), and in Fig. 24 as viewed from the side. The roof is dome-shaped, or practically level; in old furnaces, it was

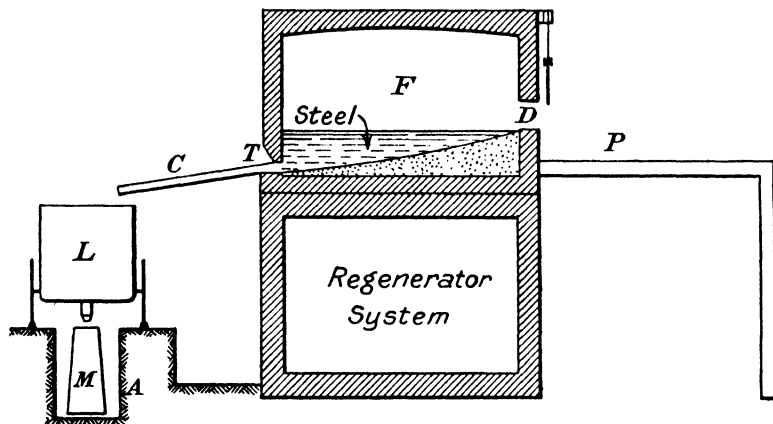

FIG. 24.—Open-hearth Steel Furnace and Casting Pit (Cross-section).

made convex, with a view to deflecting the hot gases downwards on to the charge, but was found to burn away too quickly. The lining which forms the bottom of the hearth is saucer-shaped as viewed from the front, sloping gently downwards to the centre; as has been mentioned, when regarded from the side, it has a distinct slope towards the back of the furnace.

The making of this lining is an operation needing some care. If an acid lining is required, the corners of the brick-constructed furnace are usually first filled up with silica bricks, as shown in Fig. 23, so as to aid the arching of the sides; the hearth is then covered with a thick layer of silica sand, distributed so as to give the correct contour, and by gradually heating the furnace, the silica is fritted together so as to produce a firm bottom. In the making of a basic hearth the

process is similar, but magnesite or dolomite bricks are used, covered with a plastic mixture of calcined magnesite (or dolomite) and tar, which is found to give on baking a good hard hearth. Basic materials are, however, too friable to be used for making the roof of the furnace, which must generally be made of some kind of siliceous firebrick. At the points where the silica of the roof comes in contact with the basic oxides of the hearth, there is some danger of the two substances interacting, with the production of fusible basic silicates. This, however, does not readily occur unless the silica is pressing heavily on to the basic hearth; if the weight of the roof is supported, not upon the basic hearth, but on the external brickwork, very little "fritting" will occur. If necessary, the silica and the calcined dolomite can be kept apart by a layer of a neutral material, such as chromite.

Raw Materials of the Open-hearth Process (or Siemens Process). In addition to pig-iron, the raw materials utilized in the open-hearth process comprise invariably a quantity of scrap-steel; one of the advantages of the open-hearth process is that it offers a method of remelting the scrap, which is now obtained in large quantities, into a useful form. The pig-iron is often used in the form of cold "pigs," but if the blast-furnace and steel-furnace are close together much fuel is economized by transferring the pig-iron from the blast-furnace, whilst still molten, into a large gas-fired furnace or "mixer," where it is kept in the molten state until it is required in the steel furnace. Often part of the removal of impurities actually takes place in the mixer.

Where cold "pig" is used, the charging of the furnace takes a considerable time—perhaps eight hours if conducted by hand; however, it is usually carried out in half an hour by a charging machine. The charge then takes perhaps three hours to melt completely. The pig-iron melts first, and usually flows over the steel-scrap, protecting it from oxidation; but a certain amount of iron oxide is always formed on the surface of the steel, and, moreover, a good deal of oxide is introduced with the steel-scrap as "rust" and "scale." Apart from this, a determined amount of iron oxide ore (hæmatite) is added in small quantities so soon as melting is complete. Whatever its origin, the iron oxide quickly commences to oxidize the manganese and silicon of the pig-iron, a slag of manganese silicate being produced. The oxidation of the carbon also commences, causing a brisk evolution of carbon monoxide gas. The bath is thus said to "boil;" in fact there would be a danger—if the hæmatite were added too quickly—that the bath would boil over.

When the oxidation due to the iron oxide has subsided, the boiling becomes less vigorous, but the carbon of the metal continues to be:

oxidized by the excess of air admitted to the furnace. Probably less than half of the carbon present is, under average conditions, oxidized by the ore or oxide added, the remainder being oxidized by the air blown into the furnace.¹ Of course the metal is actually protected from direct contact with the gases passing over it, on account of the layer of light slag floating on the surface, but the oxidation is brought about indirectly through the medium of the slag. It is considered that iron oxide (or iron silicate) in the slag acts as oxygen-carrier. The ferric compounds oxidize the carbon of the molten pig-iron, wherever the slag and metal come into contact; during the "boil," it should be noted, the surface of contact becomes increased, since globules of steel are carried up by the bubbles into the slag above. The ferrous compounds produced in the slag are then reoxidized by the air, and the action continues until most of the carbon has been removed. It is obvious that the thickness of the slag layer should not be too great, or this indirect oxidation of the impurities by the air will be considerably impeded. The presence of an undue amount of slag is also detrimental on account of its bad conductivity for heat.²

The procedure of the basic open-hearth process is essentially similar to that of the acid open-hearth process, but a certain amount of lime or limestone is placed on the hearth of the furnace before the iron or scrap is charged, and further quantities are introduced later along with the additions of iron ore.

The curves given in Fig. 25 show the gradual elimination of the various foreign impurities from the iron during the basic open-hearth process; it will be observed that the operation occupies many hours. The pig-iron used in this case is highly phosphatic, but it will be noticed that the phosphorus is gradually eliminated—especially during the latter part of the operation. The phosphoric oxide is largely taken up by the limestone of the charge, producing a slag rich in calcium phosphate. In practice, however, the basic lining of the hearth also plays a certain part in the dephosphorizing; this is to be avoided as much as possible since the frequent relining of the furnace is highly undesirable. A considerable elimination of sulphur often occurs in the presence of basic slag—but this has long been regarded as a rather uncertain factor. It was formerly thought that desulphurization could only be carried out when there was manganese in the slag; but it is now known that in the presence of a slag rich in lime the sulphur passes almost completely into the slag as calcium sulphide. Limey slags are apt to be somewhat

¹ J. H. Whiteley and A. F. Hallimond, *J. Iron Steel Inst.* 99 (1919), 199; especially p. 226.

² C. H. F. Bagley, *J. Iron Steel Inst.* 99 (1919), 182.

sticky and infusible, but by adding fluorspar to the charge the stickiness can be reduced, and it is possible to obtain in the open-hearth furnace satisfactory steels from pig-iron containing an appreciable amount of sulphur.¹ However, desulphurization proceeds best under non-oxidizing conditions—such as are obtained most easily in the electric furnace.

Even in the acid process small additions of limestone along with the iron ore are often made towards the end of the process. For if the slag should become too siliceous, there is a danger of the reduction of silicon by the carbon or iron² of the metal phase, and silicon will again reappear in the metal.

When the foreign impurities are largely eliminated, the recarburizing charge is added. For mild steel containing less than

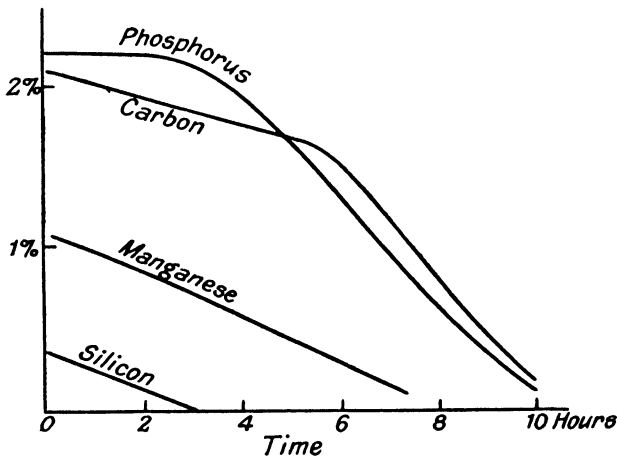

FIG. 25.—Removal of Impurities in the Basic Open-hearth Process.

0.2 per cent. of carbon, this may consist mainly of ferro-manganese ; the manganese serves to remove oxygen from the steel—a matter which will be considered more fully at a later stage. For high-carbon steels some extra carbon is needed, and this can be introduced by adding anthracite ; sometimes carbon is introduced by throwing in a few pigs of pig-iron before the ferro-manganese. After recarburization, the furnace is tapped and the charge run off into the ladle. The lining of the furnace is generally found to require patching before it is ready for another charge.

In the basic process it is unwise to recarburize in the presence of

¹ J. E. Stead, *J. Iron Steel Inst.* 101 (1920), 70.

² Most authorities say that carbon will reduce the silicon, but B. Yaneske, *J. Iron Steel Inst.* 99 (1919), 255, says that iron is the reducing agent.

the slag, because the carbon will cause a reduction of the phosphorus in the slag and that element will again enter the metallic phase. For this reason, the steel is preferably run off liquid from the furnace, and then recarburized in the ladle; even in the acid process recarburization in the ladle has become very common.

If a "special steel" is to be made, i.e. a steel containing another metal, such as nickel, vanadium, chromium, etc., the metal in question, or more frequently an alloy containing the same (ferro-vanadium, ferro-chrome, etc.), is added along with the recarburizing charge.

An important point to be borne in mind in the consideration of the open-hearth process is the production of a very fluid slag which can be brought into good contact with the metal, and which will run out entirely with the steel without solidifying on the way, when the furnace is tapped. A "sticky" slag may arise in the basic process if the slag is too limey, or in the acid process if it is too siliceous. Oxides of manganese and iron appear to increase fluidity; the addition of fluorspar as a "thinner" for the slag has already been referred to.

Talbot Process. Many furnaces have been designed which are built upon rockers and are thus able to be tilted up at any time during the process in order to pour away the metal or the slag, the tapping of the furnace being thus rendered unnecessary. The possibility of pouring off the slag is of special advantage in the basic process. In general when these "tilting furnaces" are used, the procedure does not differ materially from that described above except in the method by which the finished steel is run out of the furnace. The Talbot process, however, differs in many essential respects from the standard open-hearth practice and requires special description.

The process is carried out in a very large gas-fired tilting furnace (holding 200 tons or more), which can be tilted into a suitable position for pouring off either the slag or the metal, as required (see Fig. 26). The pig-iron is always introduced in the molten state into the furnace, and practically the whole of the oxidation is carried out by the addition of ore or some other form of ferric oxide. There is little or no oxidation by the gases that heat the furnace.

The furnace is always basic-lined, and phosphatic pig-iron is generally used, lime as well as iron ore being added to the charge. An essential feature of the process is that the furnace is never emptied. When the phosphorus has been eliminated from the metal in the furnace, the slag is poured off, and then *one-third* (only) of the steel is tipped out into the ladle, where the requisite ferro-manganese is added. Ore and lime are next added to the furnace,

and then a fresh charge of molten pig-iron, which is usually poured in in two portions. Since the molten metal entering the furnace necessarily has to sink down through the layer of basic slag, a rapid elimination of impurities occurs. Finally the slag is poured away and further ore and lime are added in small quantities to finish the metal. It is then possible to pour off one-third of the metal, and repeat the operation indefinitely. In normal working, a 200-ton furnace is "drawn" (to the extent of one-third) every seven hours; the output of these tilting furnaces is thus very great.

The main advantage of keeping the furnace always at least two-thirds full is that slag never comes in contact with the lining at the bottom; in consequence the life of the lining is greatly prolonged, and it is possible to finish off the steel with a slag of a

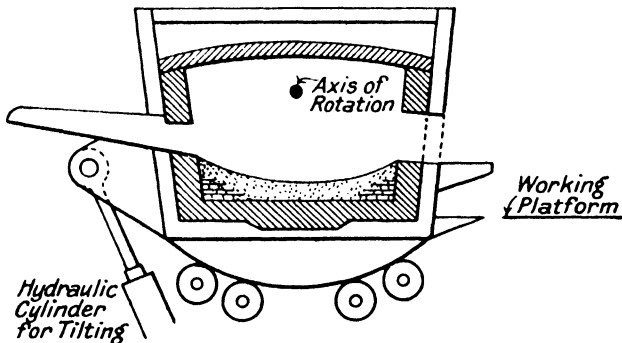

FIG. 26.—Talbot Tilting Furnace.

composition which would quickly destroy the bottom of an ordinary basic furnace. Further, if there happens to be any unexpected increase in the impurities during any one batch of raw materials, it is divided over three distinct charges and so the final effect is rendered less serious. The process has been used in this country with success for some time, and is being adopted on the Continent.¹

The Talbot process works best when the raw material is almost exclusively pig-iron. Five per cent. of steel scrap may be added, but the additions of large quantities of scrap tend to cool the bath. At the end of the war, when scrap was plentiful but pig-iron expensive, the Talbot process was temporarily at a disadvantage compared with the standard open-hearth process, which works best with a scrap addition of about 20 per cent.

¹ F. Schuster, *J. Iron Steel Inst.* 89 (1914), 51; J. Puppe, *Stahl u. Eisen*, 42 (1922), 46.

The Bessemer Process. Whilst in the Talbot process the oxidation of impurities is wholly brought about by iron oxide, and in the open-hearth process it is partly brought about by the same agency, in the Bessemer process the elimination of the foreign elements is brought about exclusively by forcing air through or over the surface of the molten pig-iron. The heat generated in the combustion is relied upon to keep the charge hot, no external fuel being used.

At first sight this would appear to be a great economy of fuel, but the economy is—at least in part—illusory; where iron ore is added to the charge, the amount of steel obtained is more than equivalent to the pig-iron or scrap metal employed. On the other hand, in the Bessemer process, metal is actually lost during the operation, being carried out of the furnace by the rush of gases passing through the charge.

A pig-iron comparatively rich in silicon is required for the Bessemer process, so as to provide the necessary heat; and as the temperature varies with the amount of silicon in the raw materials, the product is distinctly more variable and less reliable than that of the open-hearth process, which is, moreover, slower and much more capable of being controlled. In this country, the Bessemer process has lost much of its former importance, but in Germany and America Bessemer steel is still largely produced. Much of it is subjected to a further refining in the electric furnace, and thus yields a product of very high quality.

Where possible, it is customary to use the molten pig-iron coming from the blast-furnace without allowing solidification to take place. If the blast-furnace is too far away, the solid pigs are remelted—usually in a small shaft-furnace or “cupola.”¹

The converter, which is shown in Fig. 27, is constructed with a steel shell. It is supported by means of trunnions, so that it can be tilted at will from the normal vertical position for blowing (1) to the position for charging (2) or the position for pouring out the charge (3). One of these trunnions is solid, and carries the turning gear. The other is hollow and serves to convey the blast from the blowing-engines to the wind-pipe W, which carries it to the tuyeres. In the older form of converter the blast is introduced from a blast-box B at the *bottom* of the converter, and the air rises through the metal in bubbles. But in the more recent *Tropenas* converter, tuyeres are arranged at the *side*, and the blast is forced over the surface of the molten metal, preferably between the surface of the metal and the

¹ In the “Stock” oil converter, the pig-iron is melted in the converter itself by means of oil-fuel, thus dispensing with the cupola. See D. D. MacGuffie, *Met. Ind.* 21 (1922), 109.

layer of slag that covers it.¹ The side-blown converter is considered to give a product more free from occluded gases than the bottom-blown type.

The entire steel shell is lined internally with a very thick lining. Since this has frequently to be renewed, the bottom of the shell, and also the hood, are often made removable. The lining in the acid process is usually of *gannister* (a sandstone found in the coal measures) mixed with just sufficient clay to make it plastic. The

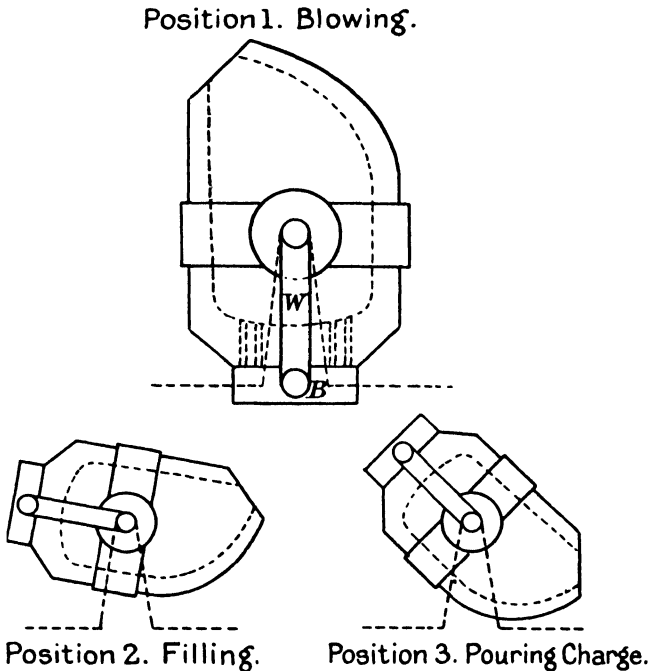

FIG. 27.—Bessemer Converter.

lining in the basic process usually consists of calcined dolomite made plastic by admixture with a little water-free tar; in some works, calcined magnesite (i.e. magnesia) is used. The lining is worn out more quickly in the basic process—where in practice it plays a considerable part in the elimination of the phosphorus—than in the acid process. But, in either case, the lining requires renewal very frequently.

The procedure of renewing the lining of a converter varies somewhat with the form; in the bottom-blown converter, the bottom

¹ Compare G. Muntz, *Met. Chem. Eng.* 12 (1914), 379.

is removed, and the whole is then swung upside down. A mould is then inserted in the converter, having the same shape but a smaller size than the shell. It is kept clear of the shell by being held up at a few points with bricks. The space between the mould and the shell has now to be filled with the plastic moist gannister (or the calcined-dolomite-tar mixture, if a basis lining is needed) and this is rammed tightly down. When the mould is removed, the lining remains, and becomes quite firm when dried and baked by gentle heating. The bottom of the bottom-blown type of converter is lined separately.¹

When lined, the converter is tilted into the position (2), and the charge of molten pig-iron is run in from a large ladle. The blast is then turned on, and the converter is swung into the normal position (1); in this position the air is forced in small bubbles through—or over the surface of—the molten metal, and rapidly brings about oxidation of the foreign metals. Let us assume, first of all, that an acid lining is being employed, and accordingly that the pig-iron treated contains little or no phosphorus. The way in which the foreign elements are oxidized and removed is shown in Fig. 28 (A) which indicates the composition of the molten metal in the converter at various times after the commencement of the blow. The most easily oxidizable elements are the silicon and manganese, and these are removed first, much heat being evolved at that stage. The oxides of silicon and manganese produced combine together, yielding manganese silicate, which forms a readily fusible slag. No gaseous oxidation-product is formed at this period, and consequently there is practically no flame at the converter mouth; torrents of sparks—consisting of drops of molten iron or slag carried out by the air-blast—may, however, be seen to issue from the mouth. After five minutes or more (as may be seen from the curve) most of the manganese and silicon will have been oxidized away, and the elimination of carbon will commence; carbon monoxide will be produced by the air-blast passing through the molten metal, and a flame will appear at the mouth of the converter. As far as possible the carbon monoxide should be burnt within the converter, so as to conserve the heat, and in order to provide air for the combustion of the carbon monoxide, there is sometimes provided (as in the Tropenas converter) an auxiliary set of upper tuyeres through which extra air is forced as soon as the appearance of a flame at the mouth indicates that carbon monoxide is being produced. About 10–20 minutes after the commencement of blowing, the production of carbon monoxide dies away, and the time has come for the addition

¹ For details of lining a basic converter, see M. Backheuer, *Stahl u. Eisen*, 41 (1921), 954.

of the deoxidizing and recarburizing charge, consisting of ferro-silicon and ferro-manganese; the latter substance is usually in powdery form, and may be flung into the mouth of the converter enclosed in a fabric bag. The blast is continued just long enough to bring about thorough mixing, and to make the whole charge thoroughly molten,

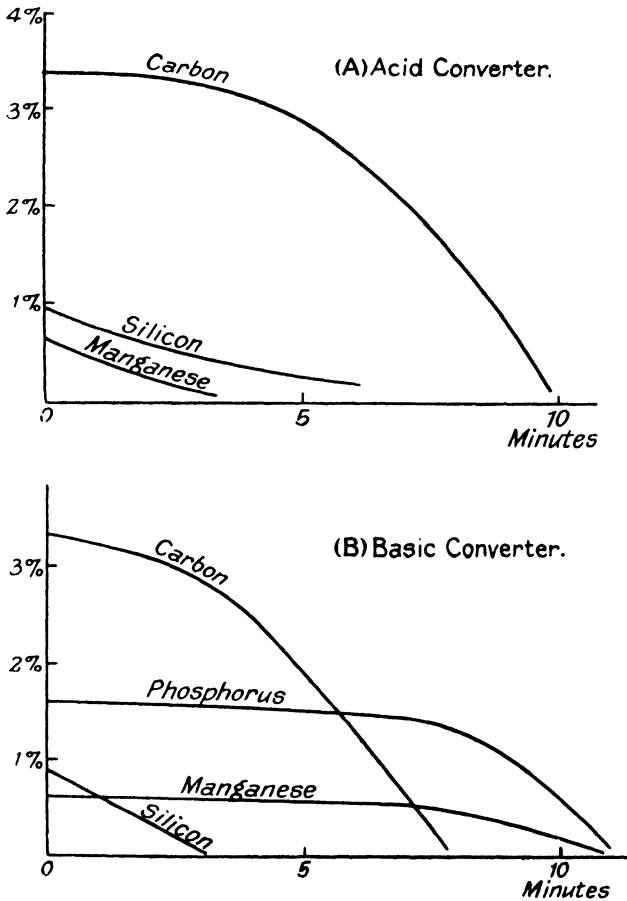

FIG. 28.—Elimination of Impurities in (A) Acid, (B) Basic Converter.

and then the converter is tipped into the pouring position (3) and the whole molten charge is poured into the ladle, which is capable of receiving the whole amount of the molten steel; the slag produced being lighter than steel floats on the top. Sometimes, metallic aluminium is added to the steel whilst in the ladle to remove the last trace of oxygen which has survived the deoxidizing action of the

silicon and manganese, and which would tend to produce unsound ingots or castings.

The procedure is very similar when a basic-lined converter is used, but in this case lime is added to the charge in order to remove phosphorus from the pig-iron as calcium phosphate. The presence of the basic addition—which is favourable to the formation and removal of the acidic oxide of phosphorus—is not favourable to the oxidation of the manganese. Consequently manganese behaves—virtually—as a less oxidizable metal in the basic than in the acid process. As a result, carbon is oxidized even at the commencement of the “blow” (see Fig. 28, B), and a flame is produced almost from the first. After the elimination of carbon has ceased, the operation is not stopped, since the phosphorus must still be removed. The oxidation of the phosphorus, when once it has begun, is fairly rapid, but there is no visible signal to show when the process is complete; in this respect the basic process differs from the acid process, in which the dropping of the flame is a sure indication that the operation should be stopped, and it follows that the basic process yields a less uniform product than the acid process. Almost the only way of finding out when the phosphorus is completely eliminated is by taking out a sample of the steel and observing the fracture produced on breaking it. A skilled man can gauge from this test the progress of the operation. When the phosphorus has been sufficiently reduced, the recarburizing charge may be added, but—as in the basic open-hearth process—it is unwise to do this whilst the slag is in contact with the metal. It is best, therefore, to pour off the light slag so far as possible from the converter before adding any ferro-manganese, or, as an alternative, to add the ferro-manganese to the metal in the ladle.

The basic Bessemer process—or “Thomas process,” as it is sometimes called—is still of great importance in the Minette district for the treatment of phosphatic ores.

Agricultural Importance of Basic Slag. The basic slag both from Bessemer and open-hearth steelworks is finely ground and used as a fertilizer for grasslands. As stated in the section on calcium (Vol. II, page 132), the German basic slag, produced by the Bessemer process, is more soluble in citric acid than most of the British (open hearth) slag; but it is thought that the testing of basic slags by means of citric acid does not necessarily afford a complete indication of their value as fertilizers.¹

It is now established that the comparatively inert character of open-hearth slag is due to the addition of fluorspar—which, as has

¹ See especially G. S. Robertson, *Trans. Faraday Soc.* 16 (1921), 291.

been stated already, is very common in open-hearth practice.¹ Crystals of a stable fluoride-phosphate of calcium, which is in fact identical with the natural mineral fluor-apatite $(\text{CaF})\text{Ca}_4(\text{PO}_4)_3$, are found in the slag, and this complex salt is not quickly decomposed under ordinary agricultural conditions, although the phosphorus will be brought into solution if sufficient time is allowed. It is stated that for use on arable land in the North and West of England, slag containing fluor spar is almost as good as that without fluor spar, because in those parts the growing season is comparatively long; in the East of England, the slag free from fluorine is greatly to be preferred.²

Electrothermal Preparation of Steels. The electric furnace offers certain great advantages in the manufacture of steel. It gives a means of heating the material without the introduction of gases, and consequently makes it possible—when required—to maintain a high temperature combined with a neutral non-oxidizing atmosphere; thus the elimination of impurities is easily regulated. It provides a way of reaching a high temperature quickly, and accurately controlling the same, and actually a higher temperature is obtainable than is easily produced in the ordinary furnace. Thus it comes about that it is possible to remove sulphur very completely in the electric furnace, whereas the efficient elimination of that most objectionable impurity is comparatively difficult in the open-hearth and Bessemer processes; it must be remembered that, in a gas-fired furnace, there is a continual chance of the introduction of sulphur and other impurities with the gas.

On the other hand, electricity is an expensive form of energy, and its generation involves an expensive installation. For this reason the electric furnace is comparatively rarely used for the complete conversion of pig-iron into steel. It is customary to commence the elimination of foreign elements by a purely thermal process, and to complete the refining in the electric furnace. For instance, as has been already stated, the Bessemer process does not yield a steel of sufficient quality for modern requirements, and, some years ago, steelmakers in all countries appeared to be faced with the necessity of replacing their Bessemer converters by open-hearth furnaces. In this country the Bessemer converters have indeed ceased to exist at most of the great steelworks. But in countries where power is cheap, the change has in part been rendered unnecessary by the advent of the electric furnace. By the erection of an electric furnace plant, the steel from the Bessemer converter can be further

¹ See D. A. Gilchrist, and N. Louis, *J. Soc. Chem. Ind.* **36** (1917), 261; F. Bainbridge, *Trans. Faraday Soc.* **16** (1921), 302.

² E. J. Russell, *Trans. Faraday Soc.* **16** (1921), 262.

refined in an electric furnace, and the product will have a quality equal, or superior to, that produced in the open-hearth process in a single operation. Another useful function of the electric furnace is to treat the steel produced in the open-hearth furnace, and work it up into a material of even higher quality, such as, until recently, could be produced only by the "crucible process" (see below); in fact, the electric furnace now affords the cheapest means of obtaining steel of this superlative quality.

In this country, the electric furnace is mainly used simply as a melting furnace in the production of steel castings. A mixture of steel scrap or other material which is already of high quality is used, little or no refining being aimed at. It has also proved admirably adapted for melting together ordinary steel (usually scrap) and ferro-alloys in the preparation of special "alloy steels." Metals like vanadium which, if added to steel in an open-hearth furnace, tend to become oxidized and thus to pass into the slag, can safely be added under the non-oxidizing conditions of the electric furnace. During the war, numerous electric furnaces were installed at the great industrial centres, the electric steel being used principally for bullet-proof plates, aeroplanes, motor-cars, armour-piercing shells and shrapnel helmets. Although electric steel is normally regarded as a more expensive type than the ordinary open-hearth variety, it is stated that, on the Tyne—owing to the use of cheap electric power raised from coke-oven gases—electric steel can be produced at a price which will allow it to compete with ordinary steel.¹

Most of the modern electric steel-furnaces are arc-furnaces. As a rule, the shell of the furnace is made of steel plates, riveted together, the lining being usually basic, composed of a magnesite or dolomite mixture. The roof is almost always composed of silica brick. The furnaces are usually mounted, like a Talbot furnace, so that they can be tilted to pour out the charge. The E.M.F. employed varies in different cases from about 50 volts to about 120 volts.

We may divide the principal furnaces into two main classes, according to whether use is made of the hearth as an effective electrode or not. It is convenient to refer to the furnaces of these two classes as being of the "Girod" and "Hérault" types respectively, although it must be understood that many other inventors have designed furnaces belonging to each class. There is also a third class of furnaces, of which the Stassano furnace—much

¹ J. E. Stead, *J. Iron Steel Inst.* **101** (1920), 77. For a discussion of the function of the electric furnace in steel metallurgy, see F. A. J. Fitzgerald and others, *Trans. Amer. Electrochem. Soc.* **34** (1918), 121-142; also L. B. Lindemuth, *Trans. Amer. Electrochem. Soc.* **37** (1920), 299.

used in Italy—is typical; in this class the current does not pass through the metal at all. The metal is heated by an arc passing directly between two or more electrodes which come close together just above the metallic surface; this type will not be considered further.

In the **Héroult** type (Fig. 29) all the electrodes are suspended

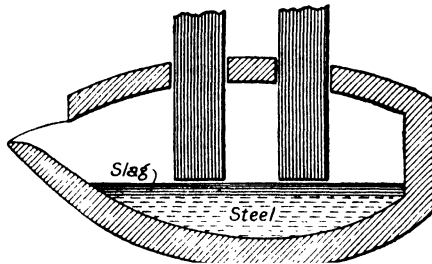

FIG. 29.—Héroult Type of Electric Furnace.

a short distance above the slag layer. The current passes, as an arc, from one electrode to the metal, and thence, as another arc, to another electrode. In small furnaces, where there are two electrodes only, they are connected to a source of single-phase alternating current. The larger furnaces have three electrodes, which are connected to the source of a three-phase alternating current. Since

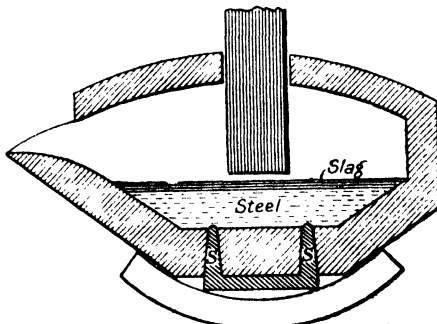

FIG. 30.—Girod Type of Electric Furnace.

most power companies and corporations transmit their electrical energy in the form of three-phase current, the easy adaptability of this type of furnace to the three-phase system is a distinct advantage.

On the other hand, in the **Girod** type (Fig. 30) there is one electrode (or a series of electrodes) above the slag, but the hearth

itself constitutes an electrode, being made conducting by the introduction of a number of steel rods S which pass through the bottom of the furnace. In the older Girod furnaces, the upper electrode and the conducting hearth were respectively joined to a source of single-phase alternating current. In such a furnace the current only traverses one arc during its path.

The Girod type as just described is not readily adapted to the employment of a three-phase current. It might be thought possible, perhaps, by placing two electrodes above the bath, and joining two of the three-phase conductors to these upper electrodes and the third to the hearth, to bring about the desired result. But a little consideration will show that the portion of the current which passes between the two upper electrodes will have to pass two arcs, whilst the current which enters by the hearth electrode has only one arc

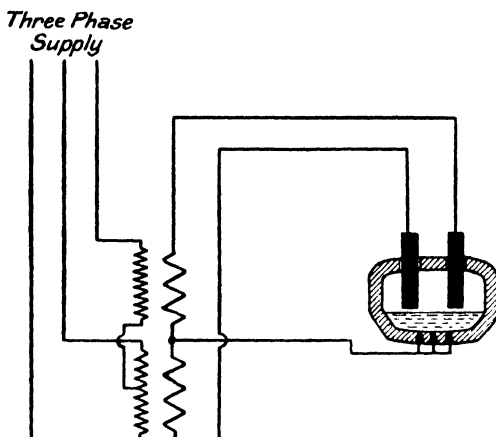

FIG. 31.—Two-phase Furnace worked from Three-phase Main.

on the path. The variation of the resistances in the three possible paths would make the direct employment of a three-phase current in the ordinary way impossible. Various means have been adopted to overcome this difficulty; a special transformer has been devised which allows an equal load to fall on all three phases, notwithstanding the inequality of the resistances.¹ Alternatively, by means of a transformer based on the so-called "Scott connection" (shown in Fig. 31), it is possible to convert the three-phase current to a two-phase current, which is well adapted for use in a furnace where the hearth acts as one electrode. The Scott connection, however, is said to result in a considerable loss of energy.²

¹ H. Etchells, *Trans. Faraday Soc.* **14** (1919), 71.

² E. A. Wilcox, *Trans. Amer. Electrochem. Soc.* **37** (1920), 379.

A furnace having electrodes both above and below the bath has one advantage, namely, that—owing to certain electro-magnetic forces set up by the current—the metal is kept in constant circulation, and the heat produced is consequently distributed throughout the steel.¹ Nevertheless, possibly owing to the difficulties appertaining to this type of furnace, which have been referred to above, the majority of the furnaces erected recently appear to have been of the Héroult type.

In the newer electric furnaces an automatic device is often fitted, which regulates the distance between the electrodes and the molten bath, so as to keep the current normal.² If no device of this sort is installed, it is necessary to have a man watching the ammeter all the time, and adjusting the electrodes according to the fluctuations of current which are occurring incessantly, owing to the consumption of the electrodes and other causes. Bad regulation may be a cause of much annoyance to the central generating station from which the power is derived, as well as to other customers supplied from the same source; but increasing experience, and the introduction of automatic regulators and cut-outs, has greatly reduced the troubles arising from this cause.

The electrodes are stout rods or blocks of carbon or graphite, sometimes having a thickness of over 2 feet. They are very rapidly consumed and have to be renewed at frequent intervals; the manufacture is usually conducted close to the steelworks.³ The electrode-holders are commonly water-jacketed. In order to be able to use up the old electrode-stump taken off when a nearly consumed electrode is replaced by a new one, electrodes are now made with screw ends, so that the stumps can be screwed on to the new electrodes. Great care must be taken in choosing the dimensions of the electrode needed to carry any given current. If they are too thick, they will carry off, by thermal conduction, much heat from the furnace. If they are too narrow, the electric resistance is great, and much heat will be developed in them by the powerful current passing through. In either case, energy will be wasted. Similar consideration applies to the choice of electrode material. Unfortunately just those forms of carbon which conduct electricity

¹ J. Bibby, *Trans. Faraday Soc.* 14 (1919), 79; especially p. 81.

² Different forms of this device are described by W. G. Mylius, *Trans. Amer. Electrochem. Soc.* 39 (1921), 357.

³ The ingenious "self-baking electrode" system, in which a plastic mixture of coke, anthracite, pitch and tar rammed into an iron casing is used for lengthening the electrodes, and becomes baked automatically as it descends into the furnace in which it is to be used, is described by J. W. Richards, *Trans. Amer. Electrochem. Soc.* 37 (1920), 174. It has been used in Norway in the manufacture of ferro-silicon.

best—and so avoid the “Joule heat-effect”—also conduct heat best, and lead to the greatest escape of heat by conduction.

Owing to the expenses connected with the consumption of electrodes, and the possibility of introducing impurities into the steel by means of the electrode, efforts were made some years ago to develop a class of furnaces in which electrodes are entirely dispensed with. “**Induction furnaces**”—as they are called—act on the principle of the ordinary static transformer. An alternating current is passed through a “primary” wire coil and induces an alternating current in the secondary coil, which consists of the molten steel to be treated contained in an annular channel. Since the secondary coil consists of many turns of wire, and the primary coil consists of a single turn (namely the steel in the channel), the induced current will be stronger than the inducing current. The current produced in the steel is sufficient to raise the temperature to the point required, but the fact that the steel has to be contained in an annular channel makes refining difficult. There are also other objections, and, although induction furnaces are still used in Germany and Scandinavia for *melting* purposes in the manufacture of steel castings, it is unlikely that they will come to have any great importance in the *refining* of steel.

Nature of the Electro-refining Process. One of the advantages of the electric furnace in steel-refining is that there is no need to introduce gases into the furnace. In consequence, all the oxidation of impurities is brought about by iron oxide (ore or mill scale) which is added with the charge; air plays no part in the action, and the steel can be obtained free from oxygen. Another advantage is that sulphur can be almost completely removed from the steel; the removal of sulphur—as well as of oxygen—takes place, for the most part, after the oxidation is over. It is noteworthy that the electric furnace—in contrast with the open-hearth furnace—is rather less successful in removing phosphorus than in eliminating sulphur.¹

The electrothermal refining process may be divided into two stages:—

- (1) The *oxidation* period, during which silicon, manganese, phosphorus and part of the sulphur are eliminated;
- (2) the *deoxidation* and *desulphurization* period.

The charge of steel-scrap, or low-quality steel (or in some cases pig-iron) is fed into the furnace, and at the same time iron-ore or mill-scale, together with lime, is thrown in. In many cases the steel is introduced in the molten condition; otherwise it must be melted in the furnace. An arc-furnace always behaves rather irregularly

¹ C. G. Carlisle, *J. Iron Steel Inst.* **102** (1920), 121.

during the melting of the charge, as the contact between the various pieces of steel is uncertain. Moreover, as the miscellaneous heap of steel-scrap melts, it gradually subsides, and the electrodes have to be lowered. It is therefore an advantage if the raw material can be introduced in the molten state.

As soon as the molten metal comes in contact with the iron ore, a violent reaction between the iron oxide and the foreign elements occurs. The silicon is soon oxidized, a slag of manganese, iron and calcium silicates being produced. The carbon is also rapidly eliminated, carbon monoxide being evolved. Finally, phosphorus is also oxidized, being absorbed by the lime as calcium phosphate, which passes into the slag. When the oxidation period is complete, the furnace is carefully tilted, so as to run off the slag; for, if the slag were left in contact with the metal during the deoxidizing period, the phosphorus would be reduced once more and would return to the metallic phase. After tipping off the phosphate slag, a further quantity of slag-forming materials, lime, sand and fluorspar are added; the calcium silicate produced constitutes a slag, the fluidity of which is increased by the fluorspar present. A reducing agent, consisting of coke (preferably petroleum coke), coal, or even broken pieces of electrode, and in addition ferro-silicon—and often ferro-manganese—is at the same time added. First the oxygen, dissolved as ferrous oxide in the iron must be removed by reduction, oxygen-free steel being left. Then sulphur-elimination commences. The sulphur may be regarded as being present as ferrous sulphide dissolved in the metal. At very high temperatures, such as are reached in the electric furnace, ferrous sulphide becomes comparatively soluble in the slag, and a certain proportion passes into that phase; there it reacts with the excess of lime, ferrous oxide being produced,

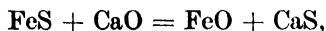

and the ferrous oxide is quickly reduced to the metallic state and is thus removed. In consequence, more ferrous sulphide passes from the metal into the slag, and is destroyed in its turn; this continues until the steel is practically free from sulphur. When the sulphur-elimination is complete, the furnace is tilted again, and the steel run out into moulds.

Some disagreement exists as to what is the reducing agent which is directly responsible for the destruction of the ferrous oxide in the slag, and thus indirectly for the elimination of sulphur; it is generally felt that the ferro-silicon as such does not bring about the reduction. It has been stated that calcium carbide is the real reducer. It is perfectly true that calcium carbide is formed under

exactly those conditions which are favourable to efficient desulphurization—namely, a high temperature, a basic slag, and the presence of carbon. But it is not certain whether it plays any more than a minor part in the work of desulphurization, although its presence in the slag may be regarded as a favourable sign that the proper conditions are being maintained.¹

Crucible Steel. It is sometimes desired to melt together small quantities of high-quality materials, in proportions carefully calculated to yield a steel of a certain composition, under conditions which will avoid the introduction of impurities. If this is the sole object, and if there is no desire to “refine” the steel during the melting, the old crucible furnace is probably still unsurpassed. Here the materials are melted in covered pots of fire-clay or of a graphite composition lined with fire-clay, set in a regenerative gas-fired furnace; the heat reaches the steel through the walls of the crucible, and there is no direct access of the gases to the metal. Although this is an expensive way of heating the metal, it clearly avoids the introduction of impurities, on the one hand, and the removal of the oxidizable constituents of the mixture on the other. The advantages of the furnace as a “melter” are the same as those of the electric furnace; but whereas an electric furnace is greatly to be preferred where steel castings of any size are to be produced, the crucible furnace is still considered to give the most reliable product where small amounts of steel of superlative quality are required, especially the steel used in cutlery and small tools. Even for these purposes, it has been asserted by some authorities that the electric furnace gives as reliable a product, but it is probable that the special reliance still placed upon crucible steel is justified, because the makers of crucible steel have the advantage of 180 years’ experience, whilst the electric furnace has only developed within the last fifteen or twenty years. It is quite possible, however, that in the near future the electric furnace may displace the crucible furnace altogether.

The crucible furnace has long been used at Sheffield, for the high-carbon steels required both for cutlery and tools. These can be produced by fusing “puddled iron” (see below) with carbon, or with pure Swedish pig-iron; or alternatively by fusing puddled iron to which carbon has been added by cementation (see below). Although no refining in the ordinary sense is attempted, it is usual

¹ According to F. T. Sisco, *Met. Chem. Eng.* 26 (1922), 17, the presence of calcium carbide in the slag is highly desirable because it brings about thorough deoxidation of the metal—a result which he considers of at least equal importance to thorough desulphurization; whilst carbide in the slag favours deoxidation of the metal, excess of lime in the slag favours desulphurization.

to add a deoxidizer to the mixture before the steel is poured.

The crucible furnace is also employed for the manufacture of alloy steels by melting ordinary steel (or its constituents) together with a calculated quantity of a ferro-alloy.

Puddled Iron (Wrought-Iron)

In the manufacture of steel from pig-iron, the material is kept in a state of fusion throughout the decarburization process, and the steel is run out molten from the furnace. In the puddling process a comparatively cool furnace is used, and as decarburization continues, and the melting-point of the metal rises, the iron particles become solid, a pasty mixture of metal and slag being thus obtained. From this mixture slag can largely be pressed out from the metal by means of a powerful hammer, or by some other squeezing device, and a soft highly-malleable metal is left, still containing some slag, and possessing a fibrous structure; this is known as **wrought** or **puddled iron**. The carbon-content is always low, but not necessarily lower than that of modern dead-mild steel. In fact, it is possible to convert wrought-iron into dead-mild steel merely by melting the former. The essential differences between the two materials are differences of structure.

Wrought-iron was at one time a material of the greatest importance, being used for a great number of purposes to which mild steel is now applied. Moreover, in the old days wrought-iron was the material from which steel itself was always made. At that time, when very high temperatures were less easily obtained than is now the case, steel (or "fusible strong-iron") of necessity contained more carbon than wrought-iron ("infusible strong-iron"), and was made from the latter by recarburization; it follows, therefore, that steel was more expensive than wrought-iron. With the introduction of the Bessemer and open-hearth processes, in which steel is prepared directly from pig-iron in one operation, steel became cheaper than wrought-iron; and, since the new form of low-carbon steel ("mild steel"), the production of which was made possible by those processes, was found to be suitable for many of the purposes previously fulfilled by wrought-iron, the importance of wrought-iron has gradually dwindled, until now the amount manufactured—compared to the output of steel—is inconsiderable. Many authorities are of the opinion that the manufacture will practically cease in the near future; this prediction, however, has been made more than once in this last forty years, but the prophets have been proved to be wrong.

The "puddling" process is conducted in a small reverberatory

furnace (Fig. 32), the hearth *H* of which is heated by flames from the grate *G*. The furnace is provided with an adequate working-door at the side through which the mass on the hearth can be stirred or "puddled." A "fettling" of iron-ore or scale is placed on the hearth, together with a certain amount of scrap iron which soon becomes oxidized; as soon as the furnace is hot, broken "pigs" of the pig-iron to be treated are thrown in. The temperature of the furnace is sufficient to melt the pig-iron, and, when fusion is complete, the whole charge is stirred up by the workman with a rabble inserted through the side-door. This operation brings the oxide into intimate contact with the iron, and the various foreign elements (carbon, manganese and silicon) are readily oxidized, the oxide being at the same time reduced to the metallic

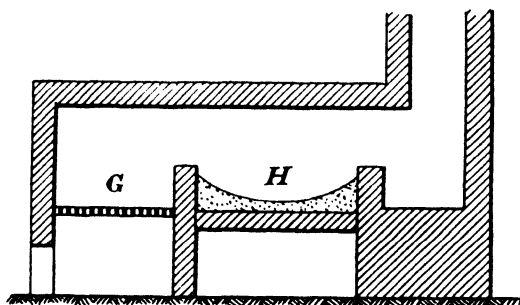

FIG. 32.—Puddling Furnace.

state; a great evolution of carbon monoxide occurs, causing the mass to swell up, and a certain amount of slag (manganese silicate, etc.) is formed. As the iron becomes purer, the melting-point is raised, and finally, as stirring continues, it becomes apparent that the metal is no longer liquid, the mass consisting of a stiff pasty mixture of iron particles and slag. This is worked into "balls," each weighing perhaps 80 lb., and the balls are then lifted, one by one, from the furnace on the end of a long rod, and transferred to the steam-hammer, where they are hammered hot, an operation which presses out the superfluous slag and squeezes together the iron particles; finally the metal is rolled into bars and allowed to cool. It still contains a certain amount of slag (up to 2 per cent.).

The stirring, balling and transferring of the stiff pasty iron from the furnace demands a combination of strength, skill and endurance which is not usually to be found among workmen, and the work is naturally one of the most highly-paid kinds of manual labour. Many attempts have been made to devise mechanical puddlers,

but most of them have not met with any very great success.¹ Lately a new mechanical puddling process has been put into operation in America, which is stated to give great satisfaction.²

The manufacture of wrought-iron in the puddling furnace usually occupies less than two hours. It may seem curious that the process should proceed more quickly than the similar operation of oxidizing away the impurities of pig-iron, as conducted in the open-hearth furnace, seeing that in the latter case a higher temperature is used, so as to maintain complete fusion. In the open-hearth process, however, the molten metal becomes covered with a layer of slag, and the last part of the oxidation is brought about by the air, acting, indirectly, through the slag-layer. In the puddling process, on the other hand, almost the whole of the oxidation is brought about by the iron oxide of the fettling, which is stirred into intimate contact with the metal.

Owing to the small size of the furnace, which is designed only to take a charge with which a single man can deal, the heat losses are unduly great. Various methods of economizing fuel have been suggested. The use of liquid pig-iron, direct from the blast-furnace, or even pig-iron melted in a cupola, would result in a reduction of the coal bill.³

The special virtue of puddled iron appears to be due to its fibrous character. The mechanical treatment causes all the slag particles to become elongated into threads in the direction of rolling. Thus, in a bar or rod of puddled iron, all the most probable planes of weakness lie in one direction parallel to the length of the bar, in which direction fracture is exceedingly improbable. Thus certain kinds of vibration and of continued shock are resisted better by puddled iron than by steel, although the latter is superior in tensile strength. Consequently, whilst some authorities regard the puddled iron industry as essentially wasteful and therefore doomed, others predict a revival of the demand for this material for certain constructional purposes where vibrations have to be resisted.⁴ Its malleability, the ease with which it is welded, and a remarkable freedom from blow-holes, are other valuable properties. For the shoeing of horses, and for smith's work generally, it is probably unequalled.

In the manufacture of chains and hooks, puddled iron is greatly to be preferred to steel. An iron hook, if overloaded, will, as a rule, gradually straighten out and thus will give warning before it

¹ C. H. Desch, *J. West Scotland Iron Steel Inst.* 25 (1918), 195; *Iron Coal Trades Rev.* 98 (1919), 191.

² E. C. Kreutzberg, *Iron Trade Rev.* 71 (1922), 365.

³ J. E. Fletcher, *Engineering*, 108 (1919), 804, 836.

⁴ G. G. Roberts, *Electric Railway J.* 49 (1917), 484.

fails ; a steel hook will often snap unexpectedly if used to support an excessive load.

Ferro-Alloys ¹

Alloys of iron with elements like silicon, manganese, chromium, tungsten, molybdenum and vanadium—in most cases containing carbon also—are produced on a large scale, since an alloy of this kind constitutes a convenient material for the introduction of the special element into steel.

In general, ferro-alloys are prepared by heating a mixture of oxides (containing the metal in question and also iron) with carbon, coke, or anthracite in the electric furnace ; the use of the electric furnace readily gives the temperature needed for the reduction and for the fusion of the alloy, and, at the same time, avoids risk of the removal of the more precious element (which is in each case readily oxidized) into the slag. For the manufacture of ferro-manganese, however, the electric furnace, although used successfully in America,² is perhaps rather less suitable on account of the volatility of manganese at high temperatures. In this country, ferro-manganese is generally manufactured in a blast-furnace, similar to that used for making pig-iron. In many British furnaces the charge consists of Indian manganese ore (containing both manganese and iron), dolomite and coke. Much manganese is lost in the slag, and no doubt much more is carried away by the furnace gases.³ Alloys of various compositions are made, those rich in manganese (70–80 per cent.) being called **ferro-manganese**, whilst those with comparatively little manganese (16–20 per cent., for instance) are known as **spiegel-eisen**.

In most other cases, ferro-alloys are manufactured by reducing the mixed oxides with coke or anthracite in an electric furnace. Wherever possible, the alloys are poured out from the furnace molten. But in the case of **ferro-tungsten** and **ferro-molybdenum**, the melting-point is extremely high ; and where the alloys are only made in fairly small quantities their heat capacity is usually too small to allow them to be run out liquid. It is therefore necessary to employ an intermittent process, the furnace being allowed to cool down after each melt, and the solid contents being broken up. This applies especially to the richer grades of ferro-tungsten and ferro-molybdenum, and involves the use of

¹ F. J. Tone, *Trans. Amer. Electrochem. Soc.* **29** (1916), 66 ; C. B. Gibson, *Trans. Amer. Electrochem. Soc.* **37** (1920), 225 ; H. Peile, *J. Soc. Chem. Ind.* **36** (1917), 113 ; R. J. Anderson, *Trans. Amer. Electrochem. Soc.* **37** (1920), 265.

² R. M. Keeney and J. Lonergan, *Min. Met.* **170** (1921), 30 ; E. S. Bardwell, *Trans. Amer. Electrochem. Soc.* **38** (1920), 333.

³ P. M. Tyler, *Iron Age*, **106** (1920), 711.

what the Americans call a "knock-down furnace," part of the walls being dismantled and rebuilt between each heat. It is stated that ferro-molybdenum with 55 per cent. of molybdenum is produced in America in a tapping furnace, but for ferro-tungsten the knock-down type is still needed.¹ In the manufacture of ferro-molybdenum a mixture of sulphide ore, lime and coke is generally used instead of oxidized ore, owing to the volatility of the oxide; the sulphur in the product can be kept as low as 0.1 per cent.

Ferro-silicon is made on a very big scale, the grades low in silicon being produced in the blast-furnace, and those rich in silicon in the electric furnace. Commercial ferro-silicon usually contains a phosphide of iron, and when exposed to damp air gradually gives off the poisonous gas, phosphine, a fact which has led to several fatalities, especially on ships carrying the material. In consequence, it was at one time forbidden to carry ferro-silicon on British passenger ships. Pure ferro-silicon, which is now made at Niagara, is not a dangerous substance.² Alloys containing iron, manganese and silicon, known as "silico-manganese" and "silico-spiegel," are also manufactured.

Ferro-chromium and **ferro-vanadium** are made largely in the electric furnace. To meet the requirements of the steelmakers, a ferro-vanadium low in carbon is desired, and in the manufacture of this alloy, silicon is often used as a reducing agent in the place of carbon. In addition, much ferro-vanadium is made by a modified "thermite process," aluminium being employed as the reducing agent.

Electrolytic Iron

The purest form of commercial iron is obtained by the electrolysis of an aqueous solution of a salt, such as ferrous chloride or ferrous sulphate. The hydrion concentration of the solution employed must be regulated carefully. If the bath is absolutely neutral, there may be a danger of the deposition of oxide along with the iron. But if the bath is strongly acid, there will be much waste of current through evolution of hydrogen, and in addition "pitting" of the deposit is likely to occur. Pitting is mainly caused by the adhesion of hydrogen bubbles to the surface of the cathode; where a bubble is resting on the surface, no deposition can take place, and a depression in the deposit will be the result.

¹ R. M. Keeney, *Bull. Amer. Inst. Min. Eng.* **140** (1918), 1321.

² C. E. Fellow, *J. Soc. Chem. Ind.* **33** (1914), 774. The manufacture of pure ferro-silicon in America is described by F. A. Raven, *Trans. Amer. Electrochem. Soc.* **37** (1920), 329.

It is found that the addition of much acid to the bath results in a complete change in the structure of the deposit; instead of consisting of the normal V-shaped crystals, the deposit obtained from a strongly acid bath has usually a fibrous character.¹

The current efficiency of iron-deposition is apt to be very low unless the right conditions are observed. If, for instance, the bath is strongly acid and the current density low, practically the whole of the current may be employed in the production of hydrogen, since the evolution of that gas actually demands a smaller depression of the cathode potential than is needed for the production of iron. However, an increase in the current density (which will involve a greater depression of the cathode potential), a decrease in the acidity and an increase in the bath temperature all favour the production of metal as opposed to the production of hydrogen, and under suitable conditions a current efficiency of over 95 per cent. should easily be realized.

A process² which is used in America consists essentially of the electrolysis of a cold solution of ferrous sulphate and ferrous chloride containing ammonium sulphate; it is stated that ammonium oxalate is also added. The anodes consist of bars of mild steel, usually made by the basic open-hearth process; the cathodes are thin sheets of electrolytic iron previously prepared. Deposition is continued until the iron is about $\frac{1}{2}$ in. thick, and then the cathode is replaced.

In a German process, which has been used for some years, a bath consisting of a hot concentrated solution of ferrous chloride and calcium chloride is said to be employed. A French process has been developed in which iron oxide is periodically added to the bath; the addition probably serves to prevent undue acidity. In this process it is possible to obtain iron tubes directly by deposition upon a long revolving mandrel, the deposit obtained being both compact and smooth.³

Electrolytic iron as it leaves the bath contains much hydrogen, and is generally brittle. If the material is annealed at 500–600° C., the hydrogen is driven off, and the iron becomes ductile and wonderfully soft. Indeed, electrolytic iron was used by the Germans during the war in the place of copper for shell bands.⁴

Electrolytic iron is likely to come into use as a raw material for making high-quality steels by melting in a crucible furnace

¹ W. E. Hughes, *J. Iron Steel Inst.* **101** (1920), 322; *Electrician* **85** (1920), 530; *Trans. Faraday Soc.* **17** (1922), 442.

² O. W. Storey, *Trans. Amer. Electrochem. Soc.* **25** (1914), 489; **29** (1916), 357.

³ L. Guillet, *J. Iron Steel Inst.* **90** (1914), 66.

⁴ R. L. Mond, *Trans. Faraday Soc.* **15** (1920), iii, 129.

or electric furnace; the total impurities (excluding hydrogen) are usually only about 0.03–0.04 per cent. The sheets are highly suitable for “stamping,” whilst the ductility of the material (which will “yield” to a stress instead of fracturing) gives a considerable value to electrolytic iron tubes. Electrolytic iron is also likely to be of value for electro-magnetic purposes, although its rather high electrical conductivity somewhat restricts its use for alternating-current work. Silicon iron, which has a lower conductivity, is generally preferred for the cores of electro-magnetic machinery, since its use involves less risk of the loss of energy through the production of “eddy currents.” Good results have been obtained with the use of cores built up of very thin laminæ of electrolytic iron, insulated from one another, a device which reduces to a minimum the production of eddy currents; but the use of very thin laminations is somewhat extravagant of space.¹

Electrolytic deposits of iron have long been used for the facing of electrotypes. During the war, local electro-deposition of iron became quite common for the “building up” of portions of steel mechanism which had become worn by use, and which otherwise would have been thrown away. Likewise, entirely new parts which had accidentally been machined a few thousandths of an inch too low could be saved from the scrap-heap by the electro-deposition of the necessary thickness of iron.²

¹ E. Gumlich, *Stahl. u. Eisen*, **41** (1921), 1249.

² W. A. Macfayden, *Trans. Faraday Soc.* **15** (1920), iii, 98.

THE STRUCTURE AND PROPERTIES OF IRON AND STEEL.¹

Before it is possible to understand the properties and uses of the different forms of iron and steel, as well as the changes produced by different kinds of heat treatment, it is necessary to have some knowledge of the equilibrium diagram of iron-carbon alloys.

Allotropy of Pure Iron. The cooling-curve of pure iron has already been discussed in Chapter III (Vol. I). When pure molten iron is allowed to radiate away heat at a uniform rate in a slowly cooling furnace, the fall of temperature is "arrested" at three points, namely, at 1,530° C., a little below 898° C. and about 768° C. Of these, the highest arrest (at 1,530° C.) corresponds to the melting-point of iron, and is due to the heat evolved in the solidification of the metal. The next arrest, known as A_3 , which occurs at or below 898° C., corresponds to a definite allotropic change in the iron, and is accompanied by a marked alteration in the crystalline structure. The arrest about 768° C., known as A_2 , is not accompanied by an alteration of structure,² but is accompanied by the appearance of ferro-magnetic properties in the iron. This change appears to be essentially different from ordinary allotropic changes (such as the A_3 change), in that it is really a gradual change spread over a considerable range of temperature. The appearance of magnetism is likewise gradual. Ferro-magnetic properties commence to appear at about 790° C., but become gradually more marked as the temperature falls through the range 790°–700°.³ The appearance of ferro-magnetism at A_2 is accompanied by a slight change in other physical properties, namely, the coefficient of expansion, electric resistance and specific heat.⁴

¹ C. A. Edwards, "The Physico-chemical Properties of Steel" (Griffin); W. Rosenhain, "Introduction to Physical Metallurgy" (Constable); A. Sauveur, "Metallography and Heat Treatment of Iron and Steel" (Sauveur & Boylston); W. H. Hatfield, "Cast Iron in the Light of Recent Research" (Griffin); H. M. Howe, "Metallography of Steel and Cast Iron" (McGraw-Hill).

² J. E. Stead and H. C. H. Carpenter, *J. Iron Steel Inst.* 88 (1913), 119; D. Ewen, *Int. Zeitsch. Met.* 6 (1914), 1. Confirmed by H. S. Rawdon and H. Scott, *Met. Chem. Eng.* 22 (1920), 787.

³ K. Honda, *J. Iron Steel Inst.* 91 (1915), 199.

⁴ The view has been expressed that it is really the change in specific heat which causes the apparent arrest at A_2 on cooling-curves and heating-curves, and that there is no true absorption or evolution of heat. It is certainly a fact that in pure gas-free iron the arrest at A_2 is much less marked than was at one time supposed. (See H. C. H. Carpenter, *J. Iron Steel Inst.* 87 (1913), 315.) There appears, however, to be good evidence for a real heat-effect at A_2 . Those interested should consult A. McCance, *J. Iron Steel Inst.* 89 (1914), 225, and also F. C. Thompson, *Trans. Faraday Soc.* 11 (1915-16), 134.

But all these physical changes are also gradual, being distributed over a range of temperature, and cannot be concentrated at a single point, as in the case of a proper allotropic change.¹

Another striking difference between the changes at A_2 and A_3 , respectively is that whilst, in pure iron, the maximum heat-effect accompanying the A_2 change occurs practically at the same temperature on a heating-curve as on a cooling-curve, this is not the case with the A_3 change. The arrest-point Ac_3 invariably lies above Ar_3 and the difference between Ac_3 and Ar_3 becomes more pronounced as the rate of heating or cooling is increased.²

For such reasons, it is considered by most of those who have studied the subject that the A_2 change should not be regarded as an allotropic transformation at all. There has been a considerable amount of controversy upon this point, controversy caused, for the most part, by the absence of any accepted definition of the word "allotropic." Those who prefer to regard the form of iron existing between A_2 and A_3 as a separate modification, apply the name β -iron to it; but most metallographists now use the name α -iron to include iron (whether magnetic or non-magnetic) at all temperatures below A_3 ; the name γ -iron is applied to the form existing above A_3 . Some writers use the word "ferrite" as synonymous with α -iron.

A recent study of the crystal-structure of iron at different temperatures by means of the X-rays supports the view that the so-called β -iron is crystallographically identical with α -iron. In both α - and β -iron the atoms are arranged on a body-centred cubic space-lattice, but in γ -iron they are arranged upon a face-centred cubic lattice.³ It is interesting to find that at temperatures above $1,400^\circ\text{C}$., iron reverts to the body-centred cubic lattice which was present in α -iron,⁴ and to iron at temperatures above $1,400^\circ\text{C}$., the name δ -iron is applied. The transformation between γ -iron and δ -iron can be detected by means of cooling-curves or heating-curves,⁵ but is more clearly indicated by a sudden break in the curve connecting paramagnetism with temperature⁶; the change is known as A_4 . We can tabulate the states and changes of pure iron in the manner shown in the table on the next page.

¹ C. Benedicks, *J. Iron Steel Inst.* **89** (1914), 407.

² G. K. Burgess and J. J. Crowe, *Trans. Amer. Inst. Min. Eng.* **47** (1913), 665.

³ A. Westgren, *J. Iron Steel Inst.* **103** (1921), 303.

⁴ A. Westgren and G. Phragmén, *J. Iron Steel Inst.* **105** (1922), 241.

⁵ R. Ruer and R. Klesper, *Ferrum* **11** (1914), 257.

⁶ P. Weiss and G. Foex, *J. Phys.* **1** (1911), 745.

Temperature Region.	Name of Form.	Space Lattice.
Between melting-point (1,530° C.) and A_4 (about 1,400° C.)	δ -iron	Body-centred cube
Between A_4 and A_3 (about 900° C.)	γ -iron	Face-centred cube
Between A_3 and A_2 (768° C.)	Non-magnetic α -iron (sometimes called β -iron)	Body-centred cube
Between A_2 and ordinary temperatures	Magnetic α -iron	Body-centred cube

Before leaving the subject of the transformations in iron, it may be useful to tabulate two other transformations to which definite symbols have been assigned, although they are only found in alloys of iron with carbon, not in the pure metal. These are:—

A_1 , the “pearlite-eutectoid” change in steels, which will be repeatedly referred to in the succeeding paragraphs.

A_0 , a gradual magnetic change in cementite (Fe_3C). It occurs in the neighbourhood of 200° C., but, like A_2 , is distributed over an appreciable range of temperatures.¹ The transformation is accompanied by a change in the electrical resistance,² and no doubt in other properties; but it has no great practical importance.

Equilibrium Diagram of Iron-Carbon Alloys³ (see Fig. 33). Pure iron melts at 1,530° C.; that is to say, pure solid iron is in equilibrium with pure liquid iron at that temperature (point C). But carbon is quite soluble both in liquid iron and also (at high temperatures) in solid iron, and the melting-point is lowered by the presence of this impurity; the lowering is indicated by the

¹ K. Honda, *J. Iron Steel Inst.* **98** (1918), 375.

² I. Iitaka, *Sci. Rep. Tôhoku Univ.* **7** (1918), 167.

³ For the determination of the equilibrium diagram, see H. C. H. Carpenter and B. F. E. Keeling, *J. Iron Steel Inst.* **65** (1904), 224. A certain alteration in the solidus curve has been proposed by N. Gutowsky, *7th Int. Cong. App. Chem.* (1909), Sect. IIIA, p. 49, further details being given by F. Wüst, *Zeitsch. Elektrochem.* **15** (1909), 565. A modification of the curve bounding the cementite area is proposed by W. N. Tschischewsky and N. Schulgrin, *J. Iron Steel Inst.* **95** (1917), 189. The lines showing the “stable” equilibrium (between graphite and other phases)—as opposed to the “metastable” equilibrium (between cementite and other phases)—are mainly due to R. Ruer and N. Ilgin, *Metallurgie*, **8** (1911), 97; R. Ruer and J. Biren, *Zeitsch. Anorg. Chem.* **113** (1920), 98; R. Ruer, *Zeitsch. Anorg. Chem.* **117** (1921), 249. See also R. Ruer and F. Goerens, *Ferrum*, **13** (1917), 1; **14** (1917), 161.

liquidus curve CB and the solidus curve CD. For instance, molten iron containing 3 per cent. of carbon can be cooled to about 1,260° C. before solidification can commence; at that temperature, the curve CB is intersected, and the separation of iron can take place, but this iron will contain a certain amount of carbon in solid solution. A solution of carbon in solid γ -iron is called **austenite**.¹ The

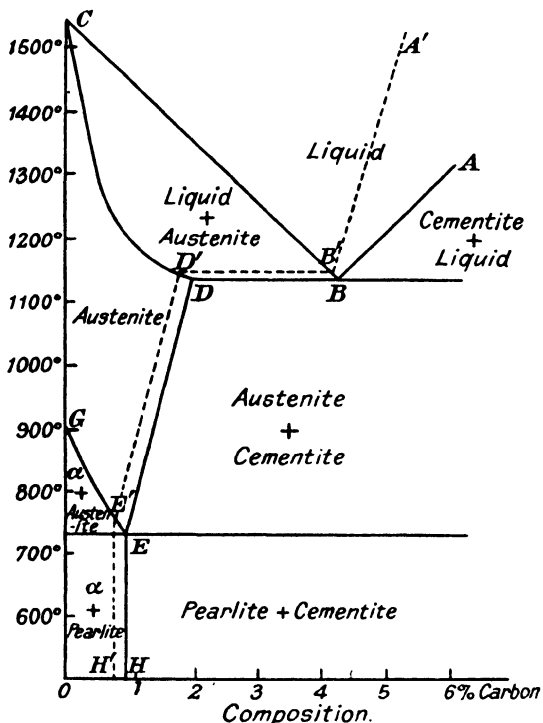

FIG. 33.—The System Iron-Carbon (founded on results of work by Carpenter, Keeling, Gutowsky, Tschischewsky, Schulgrin, Ruer, Iljin, Biren, Goerens, and others).

composition of the austenite which will at any given temperature be in equilibrium with liquid of the composition shown by the liquidus

¹ Many authorities define austenite as a solid solution of cementite (Fe_3C) in γ -iron. Our knowledge of crystal-structure founded on the X-ray study of crystals renders it, however, highly improbable that Fe_3C molecules have any independent existence in austenite. See Z. Jeffries and R. S. Archer, *Met. Chem. Eng.* 24 (1921), 1057; 26 (1922), 249. However, since austenite often deposits cementite, and rarely deposits free carbon, it is sometimes convenient to refer to it loosely as a "solution of cementite in γ -iron."

curve CB is indicated by the solidus curve CD. It will be noticed that a molten iron containing 3 per cent. of carbon will, when it commences to solidify, deposit a solid austenite with about 0.7 per cent. of carbon. As solidification proceeds and the temperature falls, the liquid becomes richer and richer in carbon; the variation of composition of the liquid and of the solid (austenite) in equilibrium with it is shown by the curves CB and CD.

If the molten iron contains less than 2 per cent. of carbon, it may solidify entirely to austenite. For instance, an iron with 1 per cent. of carbon will commence to deposit austenite at about $1,450^{\circ}\text{C}$.; the austenite first deposited will contain about 0.2 per cent. carbon. As the temperature falls, the liquid becomes gradually more rich in carbon and the concentration of carbon in the austenite will grow also until finally, at about $1,180^{\circ}\text{C}$., the solid phase contains as much carbon as the original liquid. In other words, the whole has solidified as a solid solution, which—if the cooling has been sufficiently slow—will be perfectly uniform.

But if the molten iron contains more than 2 per cent. of carbon, another phase will appear before it is wholly solid. If the cooling is very slow, graphite (the solubility curve of which is represented by the dotted line B'A') may perhaps be formed. But if the cooling is moderately quick, a white, hard crystalline carbide, known as **cementite** (Fe_3C), will be the form in which the carbon will separate out; the solubility curve of cementite (which is not known with any accuracy) is represented by the curve BA. Although cementite is actually metastable to graphite, yet the separation of cementite is so much more common (at least in the case of steels) that we shall only consider, for the present, the possibility of the separation of cementite, and will defer the consideration of graphite-deposition to the special section on "graphitization."

If, then, a molten iron with, say, 3 per cent. of carbon is cooled down, it will commence to deposit austenite at $1,260^{\circ}\text{C}$., and as solidification proceeds, the liquid becomes richer and richer in carbon, as indicated by the liquidus curve CB. But at the temperature $1,145^{\circ}\text{C}$. (point B) the solubility curve of cementite is cut, and any further cooling would render the liquid supersaturated towards cementite. Consequently at that temperature, the whole of the material still liquid will solidify, as an austenite—cementite eutectic, of composition corresponding to the point B, that is, with 4.3 per cent. of carbon.

Consequently, just below $1,145^{\circ}\text{C}$. iron-carbon alloys of every composition should be solid. The alloy containing 4.3 per cent. of carbon (point B) will consist entirely of an austenite—cementite

eutectic (the austenite of which has about 2 per cent. of carbon); alloys containing more than 4.3 per cent. of carbon will contain crystals of previously separated cementite embedded in the eutectic, while those with less than 4.3 per cent. of carbon contain crystals of austenite embedded in the eutectic; alloys with less than about 2 per cent. of carbon¹ will consist solely of austenite, which may be perfectly homogeneous if the solidification process has been sufficiently slow.

The description just given shows the nature of the iron-carbon alloys *just below* 1,145°C. On cooling the alloys further, fresh changes take place. The solubility of carbon in solid austenite drops with the temperature, and consequently the austenite having 2 per cent. of carbon gradually deposits cementite as it cools, becoming weaker in carbon during the process. This weakening is shown by the curve DE.

But the most important changes are due to the facts that γ -iron is unstable at low temperatures and that α -iron, the variety stable at ordinary temperatures, does not hold carbon in solid solution. It has been mentioned that pure γ -iron changes to α -iron (or according to some authorities, to β -iron) at A_3 (about 900°C.). But the presence of dissolved carbon depresses the transformation-point, as is shown by the curve GE.² When austenite of any given composition deposits pure carbon-free α -iron, the austenite remaining necessarily becomes richer in carbon, and the temperature of the transformation (A_3) drops as the carbon accumulates in the surviving austenite.

At the point E corresponding to a composition of 0.9 per cent. of carbon, and a temperature of about 727°C.,³ the curves GE and DE intersect, and below this temperature (known on cooling-curves as A_1) all the austenite surviving in the alloy becomes converted to a "eutectoid" of α -iron and cementite, a *eutectoid* being similar in structure to a *eutectic* mixture, although not formed from a fused bath. A special name, **pearlite**, is assigned to this

¹ This figure (2 per cent.) appears to the present writer a fair value to assume after considering the work of different investigators. Ruer gives a lower value, whilst Carpenter and Keeling give a higher value.

² Most authorities show an angle in the line GE at the temperature corresponding to the A_3 transformation, but the evidence for this change of direction appears to be insufficient. Since A_3 is a gradual transformation, a sharp angle appears to be unlikely.

³ This value has been found by a magnetic method by K. Honda, *Sci. Rep. Tôhoku Univ.* 5 (1916), 285, for the *equilibrium* transition-point. Many authorities give rather lower temperatures. On cooling-curves, the A_1 point often falls much below the equilibrium point, especially if the cooling is rapid and impurities are present. On heating-curves the A_{c1} point lies rather above the equilibrium point.

important eutectoid.¹ The appearance of pearlite in a micro-section is very characteristic, commonly consisting of wavy parallel lamellæ, although, as we shall see, pearlite can also exist in other forms; the structure of lamellar pearlite is shown in Fig. B of the frontispiece. The lamellæ represent alternate ridges of hard cementite with grooves of soft ferrite between them, and the structure causes, owing to the diffraction of light, a pearly appearance (hence the name "pearlite").

At temperatures below 727° C. no further changes occur (apart from the A_0 magnetic change in cementite), and it is possible therefore to tabulate the constituents of iron-carbon alloys at ordinary temperatures as follows:—

(1) **Pure iron** consists of grains of α -iron alone, showing a granular structure, similar to that of most pure metals, the polygonal grains having generally smooth but slightly curved boundaries.

(2) **Hypo-eutectoid steels**, containing less than 0.9 per cent. of carbon, consist of crystals of primary α -iron along with pearlite. The pearlite areas usually occur as "islands" in a network of α -iron. All the milder steels are of this class. Fig. A of the frontispiece shows a hypo-eutectoid steel etched with nitric acid at a low magnification ($\times 84$); here the α -iron is white, and the pearlite, which is not resolved by the microscope, appears black, being much more attacked by the etching agent than the structurally free α -iron. Fig. B shows a hypo-eutectoid steel, etched with picric acid and viewed at a high magnification ($\times 800$), at which the two constituents of the pearlite can be distinguished. The greater part of the plate consists of lamellar pearlite, but there is also an area occupied by white primary α -iron.

(3) **Eutectoid steels**, containing 0.9 per cent. of carbon, consist of the eutectoid pearlite alone.

(4) **Hyper-eutectoid steels** containing between 0.9 per cent. and 2 per cent. of carbon contain crystals of cementite as well as areas of pearlite; often the cementite forms a network similar to the network of ferrite in hypo-eutectoid steels. Many cutlery steels and other high-carbon varieties are of this class.

(5) Alloys with 2 to 4.3 per cent. of carbon contain, in addition, the remains of a eutectic of cementite and what was once austenite, but which has decomposed to an intimate mixture of α -iron and cementite, often irresolvable under the microscope. Many samples of cast iron ("white cast iron") are of this character. Fig. C of the frontispiece is a section of white cast iron, consisting of black primary crystals set in a black-and-white eutectic ground-

¹ An interesting discussion of the structure of pearlite is due to N. T. Belaiew, *J. Iron Steel Inst.* 105 (1922), 201.

mass. The white constituent is cementite, and the black constituent *was*, at the moment of solidification, austenite; but it has changed on cooling to an irresoluble mixture of α -iron and cementite. (In *grey cast iron*, the decomposition of cementite to iron and carbon introduces a further complication, which will be considered later.)

(6) Alloys with more than 4.3 per cent. of carbon may contain crystals of primary cementite buried in the eutectic just mentioned. Some cast irons belong to this class.

The main fact to remember, however, is that—in an iron-carbon alloy in which the formation of free carbon has been avoided but which is otherwise in equilibrium—the *only ultimate constituents are α -iron and cementite*. Of these constituents, α -iron is soft and malleable; cementite is hard and brittle. It may be expected, therefore, that the tensile strength and hardness will increase, and the malleability decrease, with the carbon-content; this is found to be true. In order that a steel may be “strong” for practical purposes, there is needed a certain proportion of firm hard matter interwoven with a malleable, non-brittle constituent. Such a combination is provided by the eutectoid pearlite, and as a matter of fact the strength of annealed steel depends mainly on the pearlite which it contains. Alloys with 0.9 per cent. of carbon consist entirely of pearlite. Those with more than 0.9 per cent. contain structurally free cementite, and, when the quantity of free cementite becomes appreciable, there is a considerable danger of brittleness.

For industrial purposes we can distinguish the following varieties of iron and steel¹ :—

(1) **Nearly pure iron** with less than about 0.1 per cent. of carbon (including ingot-iron, dead-mild steel, puddled iron, etc.). This is soft, malleable, but with comparatively low tensile strength. Suitable for smith's work, for stamping and for many electromagnetic purposes.

(2) **Mild steel**, containing less than 0.3 per cent. of carbon. Mild steel is not especially hard, but moderately strong; malleable, and not brittle. Suitable for structural purposes; the varieties fairly low in carbon (containing, say, 0.1 per cent.) are suited for rolling into the sheets required for the manufacture of “tin-plate.”

(3) **Medium-carbon steel** with 0.3 to 0.7 per cent. of carbon. This is stronger than mild steel and is used for railway rails, tyres, and many similar purposes.

(4) **High-carbon steel**, with 0.7 to 1.4 per cent. of carbon (or more); this is harder than the other varieties of steel, but rather more fragile towards shock. Suitable for tools, springs, cutlery,

¹ Numerous analyses of the steels used for different purposes are collected by D. Carnegie and S. C. Grandwyn, “Liquid Steel” (Longmans).

etc. This type of steel is commonly hardened further by heat-treatment (*see below*).

(5) **White cast iron**, containing more than 2.5 per cent. of carbon; very hard and brittle. Comparatively feeble. Unsuitable for most purposes, except as the first step in the formation of "malleable castings." (The structure of *grey cast iron* will be considered later.)

Although in the classification given above, only the carbon-content has been considered, it should be remembered that nearly all steels contain silicon (0.02 to 0.2 per cent.), manganese (0.2 to 1 per cent.), with traces of sulphur (up to 0.05 per cent.) and phosphorus (up to 0.05 per cent. or sometimes more). The effect of these other elements is considered later.

Our knowledge of the equilibrium diagram of the iron-carbon alloys is largely derived from a study of *cooling-curves*.¹ It has already been stated that the cooling-curve of pure iron shows arrests at the melting-point, and also at A_3 and A_2 . The same arrests are shown on the cooling-curves of mild steel, but the arrest due to solidification and that due to the A_3 change occur at lower temperatures than in pure iron. If the steel contains as much as 0.4 per cent. of carbon, A_3 is so much depressed that it becomes merged with A_2 ; with a further increase of carbon-content, the combined transformation $A_{2,3}$ is depressed still further. All steels show in addition another arrest, A_1 , which is not shown by pure iron. This arrest is due to the formation of the eutectoid, pearlite. Under equilibrium conditions it should occur at about 727° C., but on cooling-curves, Ar_1 is often in the neighbourhood of 700° C. The duration of the A_1 arrest increases with the carbon-content; a steel of eutectoid composition with 0.9 per cent. of carbon, shows the longest arrest at this temperature, the A_3 and A_2 changes being merged in the A_1 change.²

In recent years certain other methods of detecting transformations have been used to investigate cases where the thermal method is unsatisfactory. In the *magnetic* method, largely developed by Japanese workers,³ the variation of the magnetic properties of

¹ See especially the curves given by H. C. H. Carpenter and B. F. E. Keeling, *J. Iron Steel Inst.* 65 (1904), 238. Also F. Wüst, *Zeitsch. Elektr.-chem.* 15 (1909), 565.

² K. Honda, *Sci. Rep. Tôhoku Univ.* 5 (1916), 289, considers the term "merging" inappropriate. In steel with .44 per cent. carbon, the A_1 change can be distinguished by a sharp-evolution of heat which occurs in the midst of the gradual heat-evolution connected with A_2 , this latter heat-evolution being spread over a considerable range of temperature both above and below A_1 .

³ K. Honda, *J. Iron Steel Inst.* 98 (1918), 375; K. Honda, *Sci. Rep. Tôhoku Univ.* 5 (1916), 285.

the iron is plotted against the temperature ; it is specially suited to locate transformation-points in very slowly-cooled steels, or very slowly-heated steels. On the other hand, the *dilatometric* method, in which the volume of steel is plotted automatically against the temperature, is largely due to French investigators¹ ; it is suited for following the changes in very rapidly-cooled samples of metal.

For the exploration of certain parts of the diagram, the method of quenching specimens from a known temperature has been used (see Vol. I, p. 209). This has been especially valuable for obtaining the solidus curve (CD),² and also for the curve bounding the graphite area (D'E').³

Graphitization

Grey Cast Iron. Two assumptions have been made above in order to simplify the survey of the subject. It was assumed first of all that no graphite-formation took place ; secondly, it was assumed that in other respects the conditions were always those of equilibrium. The modifications to be introduced, when the conditions are such that these assumptions cease to be justifiable, must be considered in turn.

If molten iron containing carbon is allowed to cool *very slowly*, there is a possibility of a chemical change taking place, namely, the splitting up of the cementite into iron and free carbon. This change is most often met with in cast iron, although not unknown in steel. When molten cast iron is cooled comparatively quickly, "white cast iron" is produced, containing its carbon in the combined state as cementite. If the cooling is slow the decomposition of cementite, with the formation of flakes of graphite, may occur ; in such a way "grey cast iron" is produced. The flakes of graphite are well shown by Fig. D of the frontispiece, which is an unetched section of grey cast iron ; the structure is very different from that of Fig. C, which is a microphotograph of white cast iron.

Most samples of cast iron contain part of the carbon in the free state, part in the combined state. Commonly a casting will consist of white cast iron on the surface, where cooling has been very rapid, but will consist of grey graphitic cast iron in the interior. In some cases graphitization will be local in character, and "mottled cast iron" is the result.

Grey cast iron being comparatively free from the brittle component cementite, at least in the form of crystals of appreciable

¹ P. Chevenard, *Comptes Rend.* **164** (1917), 916.

² N. Gutowski, *7th Int. Cong. App. Chem.* (1909), Sect. IIIA, p. 49.

³ R. Ruer, and N. Iljin, *Metallurgie*, **8** (1911), 97.

size, it is far less fragile than white cast iron, and can be machined. It is the type of material which is aimed at for ordinary castings; there is a further advantage in that the conversion of molten pig-iron to a grey casting is accompanied by an expansion and thus a sharper casting is produced in grey iron than in white. Nevertheless the large flakes of graphite provide easy planes of fracture through grey cast iron, which, although less fragile than white cast iron, has no great strength. Moreover, it is entirely without malleability.

The difference between free carbon (graphite) and the combined carbon (present as cementite) is readily seen when cast iron is dissolved away by an acid. The free graphite is left undissolved, whilst the carbon present as cementite passes away, largely, as hydrocarbons. Thus white cast iron leaves little solid residue when dissolved in acid, whilst grey cast iron leaves a noticeable residue of graphite flakes.

Much discussion has taken place concerning the mechanism of graphitization during casting, some metallurgists considering that the graphite is deposited directly from fused metal. It appears exceedingly probable that graphite is normally formed by the decomposition of *solid* cementite, and that the change occurs mainly at a range of temperature (about 900° to 1,140° C.) just below the eutectic point.¹ The decomposition,

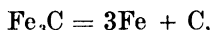

is thought by some authorities to require the presence of carbon monoxide as catalyst, which may act in some such manner as is indicated by the equations

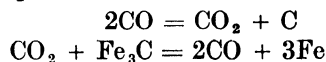

However this may be, it is found that if the cast iron be kept molten at a high temperature (1,300°–1,400° C.) for some time so that it loses its dissolved gases, graphitization does not occur, or occurs extremely slowly. Even in the presence of the gases, graphitization takes an appreciable time, and can be avoided by cooling the metal quickly through the zone 1,150°–900° C.; hence the formation of white cast iron in quickly-cooled castings.

The rate of graphitization depends very much upon the presence of other impurities in the metal. Silicon enters in part into the

¹ K. Honda and T. Murakami, *J. Iron Steel Inst.* **102** (1920), 287; R. Ruer, *Zeitsch. Anorg. Chem.* **117** (1921), 249; W. H. Hatfield, *Proc. Roy. Soc.* **85** [A] (1911), 1; P. D. Merica and L. J. Gurevich, *U.S. Bur. Stand. Tech. Paper* **129** (1919); K. Tawara and G. Asahara, *J. Iron Steel Inst.* **99** (1919), 565.

composition of the cementite and renders it unstable¹; thus the presence of silicon in iron is favourable to the formation of the grey, graphitic form, even where the cooling has been fairly rapid. On the other hand, sulphur has the opposite effect, being favourable to the retention of carbon in the combined condition; thus irons containing much sulphur are liable to be "white" after casting. Manganese—in the absence of sulphur—has a similar effect; but—in the presence of sulphur—small quantities of manganese may actually aid graphitization, by removing the sulphur from the molten metal, as globules of manganese sulphide, which is insoluble in liquid iron.

Although graphitization is usually met with in cast iron, it is not unknown in high-carbon steels; steels containing about 1.25 per cent. of carbon, if annealed for five hours at about 830° C., often develop black graphite within the free crystals of cementite.²

Since cementite is probably at all temperatures *metastable*, it is natural to attempt to obtain an iron-carbon equilibrium diagram, showing the *stable* condition of affairs where graphite (not cementite) stands in equilibrium with the iron. The general form of the "stable" diagram³ is similar to that of the "metastable" diagram (Fig. 33, p. 111). But in the place of the line ABDEH bounding the areas within which cementite is present, we have the slight higher line A'B'D'E'H' (dotted in Fig. 33). The position of the ferrite-graphite eutectoid (point E') lies about 12° C. higher than that of the analogous ferrite-cementite eutectoid (point E) and corresponds to a composition of 0.7 per cent. carbon.

Carbon-Diffusion in Solid Iron and Steel

Cementation. It is convenient to consider at this point the processes in which carbon is added to iron or steel—or taken away from it—when the metal is in the solid state. The manufacture of high-carbon steel through the recarburization of puddled iron without fusion, was, at one time, the normal method of making high-carbon steel, and it is still practised to some extent. In the "cementation process," as it is called, the bars of wrought iron are embedded in powdered wood-charcoal, in rectangular fire-clay boxes set in a furnace. Hot gases from a grate pass round the outside of the boxes, and raise the contents to a yellow heat. The bars are kept at this temperature for about two weeks and are

¹ See W. H. Hatfield, "Cast Iron in Light of Recent Research" (Griffin).

² Cases are mentioned and illustrated by A. Sauveur, "Metallography and Heat Treatment of Iron and Steel" (Sauveur & Boylston).

³ R. Ruer and N. Iljin, *Metallurgie*, 8 (1911), 97; *Zeitsch. Anorg. Chem.* 113 (1920), 98; R. Ruer, *Zeitsch. Anorg. Chem.* 117 (1921), 249.

then slowly cooled. The carbon will then be found to have been absorbed, and to have penetrated right through the iron bars, which may contain as much as 1.8 per cent. of carbon. The bars retain their original shape, but the surface is covered by blisters; hence the name "blister-steel." The blisters are due to the action of carbon on the ferrous silicate of the slag included in the puddled iron; the ferrous silicate is reduced and carbon monoxide is produced. Where the raw material is slagless (e.g. a mild steel) cementation causes no blisters.

Blister steel may be rendered compact by treatment under the hammer, in which "**shear-steel**," which still contains slag, is obtained, or it may be melted up in a crucible furnace—under these circumstances the slag separates, and one variety of **crucible steel** is left.

The manufacture of steel by cementation of low-carbon iron (mainly Swedish charcoal iron) has long been associated with Sheffield, and the process has yielded a product which has justly made the city famous all over the world. Nevertheless, as J. H. Hall has remarked, "it is hard to see the special virtue of spending two weeks soaking carbon into the iron in the solid state, and then melting the product, when the two operations can be carried out simultaneously in a few hours."¹

The mode of transfer of the carbon into the iron during cementation has been a subject of much discussion. The view has been advanced that the carbon diffuses through the metal in a state of solid solution. It has been shown that when two pieces of steel with different carbon contents are pressed into perfect metallic contact, and heated *in vacuo* at 900°–1,000° C., carbon passes from the richer to the poorer sample.² (Perfect contact between the two pieces is essential.) But under the conditions of the technical cementation process, in which the temperature is usually rather lower and air has access to the metal, many authorities consider that carbonization is, at least in part, due to another cause.³ For, under these circumstances, carbon monoxide is formed on the surface of the metal. Hot iron is quite permeable to this gas, and it is very likely that the carbon monoxide penetrates the metal and decomposes within it according to the equation



¹ J. H. Hall, "Steel Foundry" (McGraw Hill).

² F. W. Adams, *J. Iron Steel Inst.* **91** (1915), 255. Compare G. Tammann and K. Schönert, *Stahl u. Eisen*, **42** (1922), 654, who have investigated the effect of numerous special elements (molybdenum, tungsten, nickel, and manganese), in promoting or obstructing the penetration of carbon through steel.

³ G. Charpy and S. Bonnerot, *Comptes Rend.* **150** (1910), 173.

liberating carbon in the interior. It has also been suggested that cyanogen and the cyanides, if present, play some part in the introduction of carbon into iron.

Local Cementation or Case-hardening.¹ In many instances, it may be desired, after shaping, to provide a highly carbonized shell for steel articles of a low carbon-content. Under these circumstances, it is usual to subject the article to cementation for such a time that carbon is absorbed by the surface, but does not penetrate far into the metal; in this way, it is possible to obtain a surface capable of being hardened, without causing in the body of the article the comparative brittleness which is characteristic of high-carbon material.

The nature of the carbonizing agent used will depend on the depth of the carbonized layer required.² Where it is desirable that the high-carbon region should extend to an appreciable depth, and that the carbon-content should gradually diminish as we pass into the body of the metal, a suitable method is to pack the objects to be hardened in the mixture of animal and vegetable charcoal, often containing barium carbonate and sometimes common salt, and then to heat them for many hours. Where a thin coat of very highly carbonized material is demanded, cyanides or ferrocyanides are added to the charge. Paraffin vapour, acetylene, calcium cyanamide, and numerous other substances have been used as carbonizing agents. Where a cyanide case-hardener is used, the "case" contains an appreciable quantity of nitrogen, which probably plays an important rôle in the hardening.³

Case-hardening is of especial importance in the manufacture of armour plate, and also in the manufacture of machine-parts which have to be exposed to wear. Certain special steels, such as chrome-nickel steel, are peculiarly suited to case-hardening.

Malleable Cast Iron.⁴ In cementation and case-hardening the carbon-content after shaping is increased without fusion. We now pass to the analogous process in which the carbon-content of articles is reduced without fusion. It is well known that steel is an extremely difficult material to cast, on account of its high melting-point; steel castings, if carelessly made, are often found, when tested, to contain flaws, or otherwise to be unsatisfactory.

¹ See D. K. Bullens, "Steel and its Heat Treatment" (Chapman & Hall), Chapter X. Many practical points regarding the procedure in different countries are given by D. K. Bullens, *Iron Age*, 92 (1913), 953, and by R. A. Mullholland, *Iron Age*, 96 (1915), 1041, 1111, 1166.

² A method of measuring the depth is described by J. Galibourg and M. Ballay, *Rev. Met.* 17 (1920), 216.

³ H. Fay, *Met. Chem. Eng.* 24 (1921), 289.

⁴ W. H. Hatfield, *J. Iron Steel Inst.* 96 (1917), 307.

On the other hand, cast iron is very suitable for casting, but has not the strength of steel ; being almost entirely without malleability, it must necessarily break, if stressed even for a moment beyond the yield-point.

If it were possible to cast articles in cast iron, and afterwards to lower the carbon-content of the material without destroying the shape, the process would have many advantages. Actually, such an operation is possible if the carbon to be removed is present as cementite ; it is difficult to remove free graphite from a casting.

The castings to be treated therefore must be of white cast iron, and this involves a very rapid cooling of the molten pig-iron in the moulds. Metal moulds are therefore used in the foundry, and a certain amount of sulphur in the pig used is looked upon as not undesirable in European practice. When the white castings have been made, they are embedded in powdered iron oxide (hæmatite), and heated for several days in a reverberatory furnace or air-furnace at about 900° C. During this process the iron oxide removes a certain amount of carbon from the outer layer, and the carbon from the interior moves out to replace it, being oxidized in its turn. Finally the carbon-content of the casting becomes similar to that of steel and the material becomes quite malleable. If the casting is now cooled down slowly, it will be found to be quite strong and to have a considerable capacity for withstanding shocks.

In American practice an iron with less sulphur is used, and a rather lower temperature is employed (800° C.). Under these conditions, only the outer portion of the casting is decarbonized. In the interior, the change is not mainly one of carbon-removal ; the cementite here decomposes into iron and carbon, the latter being in a finely-divided form (temper-carbon). Thus an American malleable casting, if broken open, is seen to have a black interior surrounded by a white rim ; the name of "black-heart casting" has been applied to the American type. The fine temper graphite, in contrast to the large flakes of graphite present in grey cast iron, does not reduce the strength of the material. In the "black-heart" process, it is the transformation of carbon to the fine graphitic state—rather than the removal of carbon—which is the essential cause of malleability.¹

The manufacture of these black-heart malleable castings is improving as experience is gained ; the malleability of modern castings—as judged from the percentage elongation—is much greater than that of the earlier castings. For whereas an elongation of 10 per cent. was once thought good, elongations of 20 per cent. can now be obtained. It was at one time thought that the special

¹ J. B. Deisher, *Met. Chem. Eng.* 17 (1917), 383.

strength of the castings was due to the low-carbon skin, but it has been shown that this is not the case.¹

Thermal Treatment of Steel

It has been assumed hitherto, in considering the structure of steels, that the cooling has been fairly slow ; if the cooling is made rapid, the "pearlitic type" of steel is not obtained.

A solid steel consists, at any temperature above A_{c_3} , entirely of austenite. If this is cooled slowly to ordinary temperature, it changes to a steel consisting of α -iron (or, if the steel is hyper-eutectoid, cementite) along with pearlite. In the case of a *hypoeutectoid* steel, the precipitation of α -iron always commences at the most unstable places—namely, the edge of the austenite grains. As α -iron is thrown out, the remaining austenite becomes richer in carbon. Finally, when it comes to contain just over 0.9 per cent. of carbon, the austenite becomes metastable with regard to cementite, and a layer of cementite may be thrown out. This renders the austenite again metastable with regard to α -iron ; consequently α -iron and cementite are thrown out in alternate lamellæ, forming the complex which we know as "pearlite." The final structure obtained after slow cooling is thus a "network" of α -iron enclosing pearlite in the meshes. The network indicates the boundaries of the original grains of austenite which existed at the high temperature. The structure of a slowly cooled *hyper-eutectoid* steel is similar, but here the network consists of cementite, not α -iron.

If, however, the hot steel is suddenly cooled to low temperatures by being plunged into ice-cold water, the sudden cooling does not result in the production of pearlite ; the steel will be found to be intensely hard and somewhat brittle, and, when examined in a micro-section, appears to consist wholly of a new constituent, to which the name **martensite** has been applied. The appearance of martensite is quite different from the lamellar appearance of pearlite ; the aspect is "acicular" or needle-like, as is shown by Fig. E of the frontispiece, which represents a section of a martensitic steel etched with alcoholic nitric acid.

Martensite is the "quenching product" of austenite, just as pearlite is the product of slow cooling. So long as the steel consisted entirely of austenite before quenching, the network of α -iron will be entirely absent from the quenched steel. If, however, quenching is conducted from a temperature just below A_{r_3} , so that a certain amount of free α -iron is already present at the moment

¹ E. Touceda, *J. Amer. Soc. Mech. Eng.*, 41 (1919), 593.

of quenching, this α -iron will not be changed by the quenching operation, although the whole of the austenite present at the moment of quenching will appear as martensite after the operation. Thus, by quenching from below A_{r_3} , we get a steel consisting of α -iron and martensite.

When martensitic steel is heated ("tempered") between 250° and 300° C., it loses its brittleness, whilst retaining much of its hardness. If the annealing is continued long enough, however, the special hardness vanishes altogether. If the tempering process is studied by means of micro-sections, it is found that the "martensite" first turns to a constituent known as "troostite," which appears very dark in the etched sections. Troostite on further heating gives rise to "sorbite,"¹ which is less dark in colour, but, like troostite, is not resolvable under a microscope of ordinary power. Sorbite in its turn gives rise to pearlite, consisting of an aggregate of α -iron and cementite; sometimes the pearlite produced is not the familiar "lamellar" variety, but contains the α -iron and cementite as globules or granules. The globular (or granular) form of pearlite is not, however, essentially different from the lamellar variety; it can actually be produced from lamellar pearlite by heating at A_{c_1} .²

The probable facts of heat treatment can be summarized in tabular form thus:—

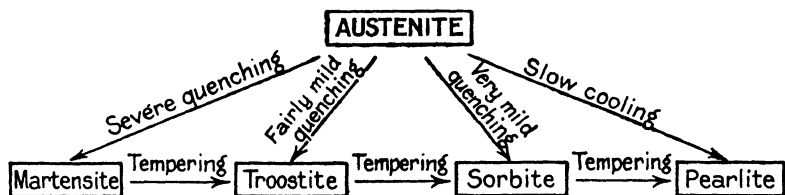

The troostite and sorbite are characterized by moderate hardness combined with ductility, sorbite being the more ductile of the two, whilst pearlite corresponds to the final—comparatively soft—state. In the ordinary hardening of a steel tool or other article, it is quenched from a temperature just above A_{c_3} , by plunging into water or oil or by spraying with water; water causes a more

¹ For excellent high-power microphotos of troostite, sorbite, etc., see Sir R. Hadfield and T. G. Elliott, *Trans. Faraday Soc.* 16 (1920), I, 156. See also C. Benedicks and E. Walldow, *Trans. Faraday Soc.* 16 (1920), I, 183.

² K. Honda and S. Saitô, *J. Iron Steel Inst.* 102 (1920), 261. Compare H. M. Howe and A. G. Levy, *J. Iron Steel Inst.* 94 (1916), 210. The cause of the change from lamellar to globular structure is suggested by J. H. Whiteley, *J. Iron Steel Inst.* 105 (1922), 339. Compare A. Portevin and V. Bernard, *J. Iron Steel Inst.* 104 (1921), 145.

rapid lowering of temperature than oil, but introduces a danger of cracking in some high-carbon steels. The article is then tempered either by heating in an oxidizing flame, or on an iron plate, or alternatively by immersion in a bath of hot oil or fused salt. The quenching renders the steel martensitic, and therefore hard and brittle, whilst the tempering renders it troostitic or sorbitic; to obtain the sorbitic structure, a rather higher temperature and a longer treatment is needed, which is sometimes spoken of as "toughening." In all cases, the temperature of the treatment needs careful regulation according to the purpose for which the steel is to be used. The interference-colours that appear on the surface of iron exposed to air are often used to gauge the temperature. Thus it is customary to recommend that files should be tempered at a "light straw," axes at a "purple," springs at a "blue heat," and so on.

It is worth noticing that if steel be quenched less rapidly than is required for the formation of martensite, it is possible to produce directly troostite or even sorbite without any subsequent tempering. Various systems for the local hardening of articles are founded on this fact. For instance, by passing a flame rapidly over the wearing surface of a toothed gear-wheel (just as one might pass a paint brush over the surface) the sudden cooling which takes place at each spot after the flame has passed on, due to the conduction of heat into the interior, causes a hardened layer about $\frac{1}{16}$ inch in thickness.¹ The surface of tramway rails can be hardened in an analogous manner; an oxy-acetylene flame is made to pass slowly over the rails, and quenching is in this case aided by a jet of water which closely follows the flame; a sorbitic coat of about $\frac{3}{16}$ inch depth is produced. A rather similar treatment has been introduced at certain British and American mills for the superficial hardening of rails intended for use on railways.²

Nature of Martensite, Troostite and Sorbite. In spite of the great importance of steel hardened by quenching and tempering, the character of the constituents is still a little uncertain. Before any attempt is made to decide the ultimate nature of martensite, troostite or sorbite, emphasis must be laid on the important fact that somewhat analogous structures are met with in other quenched alloys, but only in those alloys in which some transformation would take place on slow cooling, the change being retarded—or at least modified—by quenching. Certain alloys of copper and aluminium (aluminium bronzes), copper and tin (bronzes), copper and zinc (brasses) undergo at temperatures between 400° and 600° C.

¹ *Iron Coal Trades Rev.* 100 (1920), 213.

² *Engineering*, 106 (1918), 625.

transformations of this kind. By the heat treatment of aluminium bronzes, bronzes and brasses of suitable composition, an acicular structure recalling martensitic steel can be produced ; and in certain cases, structures supposed to be analogous to the troostitic and pearlitic (granular and lamellar) states of steel are obtained, although here the analogy is rather less convincing.¹ It is evident that the appearance associated with martensite, troostite, and sorbite is due to the structure rather than to the composition of the areas so styled, and that the characteristic appearance and properties are due to the fact that the results of the change at A_1 will be different according to the time allowed for the change to take place.

Now the change occurring in steels at A_1 on slow cooling is a double one : γ -iron becomes α -iron, and since the latter does not normally hold carbon in solution, the precipitation of iron carbide (cementite) follows. We can write the two stages thus :—

(1) The conversion of austenite to α -iron containing dissolved carbon.

(2) The liberation of Fe_3C from the α -iron, and the separation of cementite as a distinct phase in particles of appreciable size.

It is very generally considered that the change (1) occurs, in ordinary steels, with very great velocity ; it seems that quenching cannot entirely prevent it, although it is noteworthy that in quenched high-carbon steels certain austenitic areas survive at ordinary temperature, whilst certain alloy steels (e.g. nickel steels) can be obtained at ordinary temperatures exclusively in the austenitic condition. In general, however, quenched steels consist mainly or entirely of martensite. Recent investigations of the crystal-structure, carried out by means of the X-rays, appear to show that in martensitic steels the atoms are arranged in the same way as in pure α -iron, whilst in austenitic steels (e.g. nickel steels) they are arranged in the same way as in γ -iron.² It is thus clear that, in general, the change from γ - to α -structure is not prevented by the quenching.

On the other hand, it would appear that change (2) is much slower, even at high temperatures, and that, when the steel is quenched, it practically does not take place at all. If this view is accepted, then we have to regard martensite essentially as a solution of carbon in α -iron (or of cementite in α -iron). On tempering, the temperature is raised sufficiently high for change (2) to take place gradually, the precipitated cementite being at first (i.e. in troostite) in an ultra-microscopic (or colloidal) state of division. As tempering proceeds the particles increase in size ; sorbite probably corresponds

¹ A. Portevin, *Comptes Rend.* **17** (1920), 350 ; *Rev. Met.* **16** (1919), 141.

² A. Westgren, *J. Iron Steel Inst.* **103** (1921), 303.

to the stage at which the individuals begin to approach microscopic dimensions, whilst in pearlite, a larger size, discernible under the microscope, has been reached. At the same time, the precipitation of Fe_3C from the solid solution—which is incomplete in troostite—becomes more complete as tempering proceeds, although it seems possible that fully annealed pearlitic steel still retains a little carbon in solid solution.¹ According to the view just suggested, we can define the constituents as follows² :—

Martensite . . .	Solution of carbon (or Fe_3C) in α -iron.
Troostite . . .	Colloidal solution of Fe_3C in α -iron (particles very small).
Sorbite . . .	Very fine mosaic of Fe_3C in α -iron (barely resolvable under microscope).
Granular Pearlite .	Mosaic of Fe_3C and α -iron.

The passage from martensite through troostite and sorbite to pearlite is a gradual one; some metallographists apply the name “osmondite” to the stage between troostite and sorbite. The dividing line between “sorbite” and “pearlite” really depends on the power of the microscope employed to examine the steel.³

Cause of the Influence of Cooling-rate on Structure.⁴ The fact that a hypo-eutectoid steel, which on slow cooling yields a network of α -iron surrounding islands of pearlite, yields on rapid cooling a steel of different appearance, is not in itself surprising. The production of the network of “pro-eutectoid” α -iron must involve diffusion in the solid state, and clearly during rapid cooling there is no time allowed for this diffusion. If the grains of the austenite are large, the distances over which diffusion has to take place are greater, and the necessary diffusion may not occur even if the cooling is comparatively slow. In such cases, the α -iron will be thrown out of solution *within* the grains of austenite; the crystallization of the α -iron then appears to follow the cleavage planes of the original austenite crystals. By fairly rapid cooling of a steel consisting of large austenite grains, a structure is produced which appears in the micro-section as a grid of white bars (α -iron) on a black background. This is called the **Widmanstätten**

¹ K. Inouye, *J. Coll. Eng. Tokyo* **10** (1920), 145.

² Compare the views of C. Benedicks, *Koll. Zeitsch.* **7** (1910), 290, and of H. Le Chatelier, *Comptes Rend.* **165** (1917), 172.

³ Compare W. Rosenhain, “Introduction to Physical Metallurgy” (Constable), 1914 edition, pp. 183, 184.

⁴ Compare A. Portevin, *Rev. Met.* **16** (1919), 141; C. H. Desch, *Trans. Faraday Soc.* **10** (1915), 255; Z. Jeffries and R. S. Archer, *Met. Chem. Eng.* **24** (1921), 1065; a most instructive paper by A. F. Hallimond, *J. Iron Steel Inst.* **105** (1922), 359, should also be consulted. See also N. T. Belaiew, *Met. Chem. Eng.* **25** (1921), 584; *J. Inst. Met.* **29** (1923).

structure; it has long been known in the iron of meteorites, where it is sufficiently coarse to be visible to the naked eye.

It has been suggested that the curious acicular structure of martensite, although it is quite distinct in appearance from the Widmanstätten structure, may be due to rather a similar cause. Since martensitic structure can be obtained in steel of eutectoid composition, the "needles" of martensite cannot consist of the "pro-eutectoid" α -iron; but it seems likely that in martensite the general change from γ -iron to α -iron has proceeded preferentially in certain directions, and thus the orientation of the "needles" is related in an ordered manner to the crystal directions of the original austenite grains. Certainly the general appearance of martensite, as illustrated in Fig. E of the frontispiece, does suggest that the "needles" do not point in all directions in haphazard manner, but are arranged preferentially along certain directions.

It is interesting to note that on slow cooling (such as would lead to the formation of pearlite), and even on restrained quenching (such as would produce troostite), the Ar_1 transformation occurs at about 600° – 700° C.; but on rapid quenching (such as would yield martensite), it occurs at much lower temperatures. This has been found not only by means of thermal curves,¹ but also by the dilatometric² and magnetic³ methods. The change at 600° – 700° C. which gives rise to pearlite or troostite is known as Ar' ; the low-temperature change which gives rise to martensite is known as Ar'' . The latter usually occurs about 350° C., but according to Portevin and Chevenard it is accompanied in some steels by a further distinct change below 200° C., which they distinguish as Ar''' . Steels which are cooled fairly slowly show only Ar' , and are found to be pearlitic or troostitic. If the cooling-rate is increased, Ar'' (and possibly Ar''') appear as well as Ar' , and the steels are partly martensitic, partly troostitic. If the quenching is made more severe, Ar' disappears and only Ar'' (and possibly Ar''') is observed; the steels are then wholly martensitic. Finally in some steels it is possible to quench so quickly that Ar'' begins to diminish and possibly may disappear; the steel produced will then be austenitic. In the alloy steels, it is not only the cooling-rate which decides whether pearlite, troostite, martensite, or austenite will be produced. The temperature to which the steels have been heated before being cooled is an equally

¹ Compare the cooling-curves and micro-photographs of chromium steels given by C. A. Edwards, J. N. Greenwood, and H. Kikkawa, *J. Iron Steel Inst.* **93** (1916), 114.

² P. Chevenard, *Rev. Met.* **16** (1919), 17; A. M. Portevin and P. Chevenard, *J. Iron Steel Inst.* **104** (1921), 117; A. Poucholle, *Comptes Rend.* **174** (1922), 611. *Warning*.—Some French writers refer to Ar'' as Ar_2 , the term which English writers apply to the magnetic transformation in pure iron at 768° C.

³ K. Honda and T. Kikuta, *J. Iron Steel Inst.* **105** (1922), 393.

important factor; the reason for this is not in all cases apparent.

Cause of Hardness. The origin of the great hardness of martensitic steel has given rise to much discussion. According to Jeffries and Archer¹ the main cause of hardness is the fine-grained character of martensite. If pure iron is cooled very slowly through the A_3 point, so that the transformation of γ - to α -iron occurs at temperatures not far below the equilibrium transition-point, large crystals are produced, because the velocity of crystallization is so great at that temperature that there is no time for the formation of numerous nuclei. If pure iron is quenched, a finer grain is produced, because the transformation takes place at lower temperatures. If the iron contains carbon, the grain is likely to be still finer, because the carbon not only lowers the reversible transformation points, but seems also to cause a retardation to the change itself; as already stated, the actual transformation which gives rise to martensitic steel seems to occur about or below 350°C ., and it is not surprising that the grain is so fine that the individual α -iron crystals cannot be distinguished under the microscope.² This fineness of grain may be the cause of the peculiar hardness of martensite. In addition, the presence of carbon or carbide in solid solution may be a contributing cause. In troostite, which contains numerous very small (colloidal) hard particles of cementite in the grains of α -iron, the presence of these particles upon possible planes of slipping will interfere with gliding, and hence with deformation; this is probably the main cause of the moderate hardness of troostite. In sorbite and granular pearlite the particles, being larger, are less numerous, and the hardness is therefore smaller.

Another possible cause of the very great hardness of martensite may, however, be suggested.³ Both stages of the change from austenite to pearlite appear to be accompanied by volume-changes; stage (1) is accompanied by an expansion, and stage (2) probably by a contraction.⁴ If change (1) alone takes place, the expansion involved sets up considerable internal stresses in the steel. It is possible to regard the hardness of quenched steel as being due to the presence of amorphous material in the steel, caused by the stresses and volume-changes accompanying the process, and by the

¹ Z. Jeffries and R. S. Archer, *Met. Chem. Eng.* **24** (1921), 1057; **25** (1922), 249. Compare the work of N. S. Kurnakow and A. N. Achnasarow, *Zeitsch. Anorg. Chem.* **125** (1922), 185, on non-ferrous eutectics; they find that rapid quenching decreases the grain size and increases the hardness.

² There is no reason to think that the apparent "needles" which are seen in a micro-section of martensitic steel are the ultimate α -iron crystals.

³ Compare the views of C. A. Edwards, *Trans. Faraday Society*, **10** (1915), 248; H. C. H. Carpenter, *Engineering* **107** (1919), 340, 386; A. McCance, *Trans. Faraday Soc.* **10** (1915), 257; J. C. W. Humphrey, *Trans. Faraday Soc.* **10** (1915), 240.

⁴ Compare H. de Nolly and L. Veyret, *J. Iron Steel Inst.* **90** (1914), 165.

short time allowed for the atoms to array themselves in the ordered manner characteristic of crystals. According to this view the hardening of steels by quenching is due to the same ultimate cause as the hardening of aluminium or copper by external mechanical deformation; but, in the case of quenching, the stresses causing the disarrangement, or "amorphization," are produced internally.

Grain-size and Heat-treatment. One of the many peculiar advantages of iron and steel is that even if—during the process of manufacture—the grain-size of an article has become coarse, it can usually be made fine by heating for some time a little above Ac_3 and cooling again. Above Ac_3 steel consists entirely of austenite, and all trace of the original α -iron structure is lost. If the metal is afterwards cooled, the structure produced when the iron re-enters the α -range is, in general, independent of that which existed before the heat-treatment, and is usually quite fine. The metal commonly shows, after cooling, the ordinary α -iron "network," indicating the position of the boundaries of the austenite grains existing above Ac_3 . Where an unduly high temperature has been employed in annealing, so that the austenite grains have become coarse, a gross network is likely to be obtained. Thus in the heat-treatment of steel the use of temperatures far above Ac_3 should be avoided.¹

In the purer varieties of iron, cases of abnormal coarseness of grain are sometimes met with which require special explanation. It appears that a heating of one hour just above Ac_3 does not entirely destroy all traces of the original α -iron. If therefore a thin sheet of pure, electrolytic iron is heated for an hour above Ac_3 and is then cooled again, the few particles of α -iron which have escaped destruction will act as nuclei for the recrystallization of α -iron, when the iron passes below Ar_3 , and a very coarse structure is obtained.² The production of these coarse crystals is avoided if the iron is very rapidly quenched from above Ac_3 , presumably because under these conditions crystallization of α -iron commences spontaneously at numerous points other than the nuclei referred to above. It is also prevented if the heating above Ac_3 is continued for twenty-four hours, which allows time for the destruction of all traces of the original α -iron; consequently, even on slow cooling, the coarse structure is not developed.

The phenomenon is best seen in thin sheets, presumably because in a thin sheet a comparatively large number of nuclei per unit volume represents only a small number of nuclei per unit area, and

¹ See D. K. Bullens, "Steel and its Heat Treatment" (Chapman & Hall), Chapter III.

² J. E. Stead and H. C. H. Carpenter, *J. Iron Steel Inst.* 88 (1913), 119. Compare H. M. Howe, *J. Iron Steel Inst.* 88 (1913), 152.

the grains produced are of remarkable extent. It is only observed in iron sheet of exceptional purity, such as is produced by the electrolytic process. In sheet made of mild steel or puddled iron, the impurities (slag, manganese sulphide, carbide, etc.) seriously interfere with the growth from the various centres of crystallization. It is noteworthy, however, that the variety of thermally produced pure iron known as "Armco" is often quite brittle between 800° and 900° C. if it has previously been heated above A_{c_3} .¹ This brittleness seems to be connected with an abnormally coarse structure, which possibly should be explained in the same way as that observed in electrolytic iron.

The Effect of other Elements than Iron and Carbon in Steel and Cast Iron ²

It is now necessary to consider the effect of other elements which may be present, through design or accident, in iron and steel.

Silicon is an invariable constituent of ordinary cast iron, and where ordinary (grey) cast iron is desired its presence in quantities between 1.0 and 3.5 per cent. is really necessary, in order to bring the carbon—at least in part—into the graphitic state. Larger quantities are used in the "acid-proof" varieties of cast iron; these will be referred to again in the section on corrosion; they resist the attack of acids and other reagents wonderfully well, but are extremely fragile. Small quantities of silicon are added to steel (in the form of ferro-silicon) as a deoxidizer, whilst large quantities are employed in certain special "silicon steels," used for springs and other purposes; as already stated, silicon is a constituent of the iron used in this country for the cores of electro-magnetic machinery.

Sulphur is generally regarded as an extremely objectional element. In cast iron, as already stated, it facilitates the retention of carbon in the combined state; therefore the presence of sulphur in cast iron in quantities above about 0.15 per cent. makes it unsuitable for the production of good grey castings, even if the silicon-content is fairly high. The presence of sulphur in steel is liable to render the material extremely brittle under shock. Apparently it exists in the molten steel as iron sulphide, which is quite soluble in the liquid metal, although far less soluble in the solid state. On solidification, therefore, the metal tends to crystallize comparatively free from sulphur, which accumulates at

¹ W. J. Brooke and F. F. Hunting, *J. Iron Steel Inst.* 96 (1917), 233.

² F. W. Harbord and J. W. Hall, "Steel" (Griffin), Chapter XVI; J. E. Stead, *J. Iron Steel Inst.* 94 (1916), 5; W. H. Hatfield, "Cast Iron in Light of Recent Research" (Griffin).

the boundaries of the original grains of γ -iron. This network of iron sulphide does not in every case produce any serious lowering of the tensile strength, but is extremely likely to cause failure under shock. Where—as is occasionally the case—the sulphide forms round or oval patches, its presence is not harmful, but wherever it exists as a network, or in thin layers, it renders the iron liable to cracking.¹ Thus the presence of iron sulphide in iron or steel is to be avoided. The brittleness is most marked at high temperatures, and is referred to as *red-shortness*. It is to be noted that iron sulphide has a fairly low melting-point (950° C.), and clearly above that temperature the strength of iron containing a continuous sulphide network must disappear almost entirely.²

If, however, the liquid steel contains a sufficient quantity of manganese, the sulphur will be wholly present in the fused steel as manganese sulphide, which, being insoluble in molten steel, separates as globules whilst the metal is liquid. Consequently, after solidification, manganese sulphide is not found as a network, such as causes the flaws in manganese-free iron, but can be recognized in micro-sections as greyish globules, which are comparatively harmless. Manganese sulphide has a much higher melting-point than the sulphide of iron. Thus the bad effects of small amounts of sulphur are largely avoided, if the proper quantity of manganese is present. But clearly it will not be desirable to have an unduly large quantity of the manganese sulphide globules in the metal; consequently the sulphur content should in any case be kept very low. Opinion is somewhat divided³ as to how far sulphur can be tolerated in the presence of manganese, but—at any rate in steel intended for structural purposes—it is wise to demand a very low sulphur content.

It is noteworthy that sulphur is sometimes intentionally added to steel which is required for rolling into rails. The steel, when rolled, acquires a fibrous structure, similar to that of wrought iron, the particles of manganese sulphide becoming elongated in the direction of rolling. The planes of weakness due to sulphides still exist, but are arrayed lengthwise—a direction in which fracture is unlikely to occur; in the transverse direction (in which fracture, if it does occur, will be far more dangerous) there is very little chance of fracture occurring. For special purposes these fibrous sulphide steels are stated to possess a positive advantage over ordinary

¹ J. O. Arnold, *Metallographist*, 3 (1900), 273.

² H. Le Chatelier and Ziegler, *Bull. Soc. d'enc.* 101 (1902), 368.

³ For an opinion comparatively favourable towards sulphur see C. R. Hayward, *Trans. Amer. Inst. Min. Eng.* 56 (1916), 535. Compare E. E. Thum, *Met. Chem. Eng.* 26 (1922), 1019; F. C. A. H. Lantsberry, *J. Soc. Chem. Ind.* 41 (1922), 409R.

steels.¹ The so-called "free-cutting fibrous" steel contains about 0.15 per cent. of sulphur.²

Phosphorus³ is soluble to a considerable extent in liquid iron or steel. On solidification it partly remains in solid solution in the metal, causing brittleness at low temperatures (*cold-shortness*); but, under certain circumstances, the phosphorus may separate in part as a metallic phosphide (Fe_3P or, perhaps, Mn_3P_2). This free phosphide is thought by some authorities⁴ to do comparatively little harm, although it can scarcely be beneficial to the steel.

The proportion of phosphorus which will separate out as a separate phase depends, no doubt, on the rate of cooling, and on the presence of other elements, notably carbon; in consequence a statement of the phosphorus-content of an alloy does not convey any certain information as to the degree of brittleness at low temperatures. For this reason phosphorus is one of the most insidious impurities met with. The proportion of phosphorus held in solid solution can, however, be ascertained by treating a sample of the metal in acid, when the portion in solid solution is evolved as gaseous phosphine (PH_3).

It is highly desirable that—except for certain special purposes—the phosphorus-content of steel should be kept very low.⁵ As we shall see, phosphorus has a tendency to become concentrated in the last solidifying portions of a mass of steel, and consequently segregation of phosphorus in certain parts of a steel ingot is a common phenomenon. Improved methods of ingot-making which tend to reduce segregation may, however, serve to render safe the use of steel, with a higher *average* content of phosphorus than would be tolerated at present. During the war, when it was difficult to supply the requirements of low-phosphorus steel, it was found possible to relax slightly the restrictions regarding phosphorus. Thus, for shell-steel, up to 1915, 0.04 per cent. of phosphorus was regarded as the maximum. In October, 1915, steel with 0.06 per cent. of "phosphorus + sulphur" was allowed, whilst later, steel with 0.08 per cent. of the two elements was found to be safe.⁶

Phosphorus is very detrimental in high-carbon steel, which it renders brittle. In low-carbon steel it is sometimes actually a

¹ See, however, E. H. Saniter, *J. Iron Steel Inst.* **94** (1916), 109.

² J. E. Stead, *J. Iron Steel Inst.* **94** (1916), 73.

³ The somewhat complicated relationship between iron, carbon, and phosphorus is further discussed by J. E. Stead, *J. Iron Steel Inst.* **58** (1900), 60; **91** (1915), 140; **94** (1916), 50; **97** (1918), 389. The method of detecting variations of phosphorus-content by means of cupric chloride solution is described by the same author.

⁴ H. Jüptner von Jonstorff, *J. Iron Steel Inst.* **51** (1897), 224.

⁵ See F. W. Harbord, *J. Iron Steel Inst.* **94** (1916), 112.

⁶ See F. H. Hatch, *Times Eng. Supp.* (1919), 270.

desirable constituent. In certain cycle parts, the presence of phosphorus (up to 0.1 per cent.) allows a clean and bright "finish" after turning on the lathe. And in the manufacture of the steel sheets intended for making into tin-plate, the presence of a trace of phosphorus prevents the sheets from sticking together.

In cast iron, the presence of phosphorus causes cold-shortness, but this form of iron has, in any case, but little power of withstanding shock, and, consequently, the presence of phosphorus is less objectionable than in steel. Phosphorus actually confers one advantage, for it makes the melting-point of the cast iron lower, and renders the molten metal more fluid.

Oxygen is rarely met with in cast iron, but frequently occurs (possibly as ferrous oxide) dissolved in molten steel, especially that made by the Bessemer process, in which the carbon has been eliminated by the action of an air-blast. It is objectionable in more than one way, but the main effect is to cause unsoundness in an ingot or casting through the formation of blow-holes. If during the solidification of an ingot the oxygen (or ferrous oxide) interacts with the carbon or carbide present to yield carbon monoxide or carbon dioxide, a regular effervescence of gas will occur, the steel being said to be "wild." Any ingot or casting made under these conditions will be honeycombed and full of blow-holes. To guard against the danger of blow-holes, a **deoxidizer** such as ferromanganese is always added, either in the furnace or in the ladle, before steel is allowed to solidify. The deoxidizer must contain an element having a high attraction for oxygen which will reduce any ferrous oxide present; the stable oxide (e.g. manganese oxide) produced should be insoluble in liquid steel, so that it will either pass into the slag (if any is present), or separate as harmless globules in the metal. Numerous elements have been found to fulfil these requirements, and in almost every case the deoxidizer is added as a ferro-alloy. In many instances, notably manganese and vanadium, the metal, if added in sufficient quantity, has a specific action upon the steel, in addition to its function as a deoxidizer; such cases are considered in the section dealing with alloy steels. The following are some deoxidizers which have been used:—

Manganese . . .	added as spiegeleisen.
Silicon . . .	added as ferro-silicon.
Aluminium . . .	added as metal.
Titanium . . .	added as ferro-titanium or similar alloy.
Zirconium . . .	added as ferro-zirconium.
Cerium . . .	added as ferro-cerium.
Vanadium . . .	added as ferro-vanadium.
Boron . . .	added as ferro-boron.

In several cases, the element added may render comparatively harmless, not only oxygen, but other objectionable non-metals. Thus manganese also counteracts the effect of sulphur, whilst titanium and vanadium combine with nitrogen, the presence of which is a cause of appreciable brittleness in some steels, especially those produced in the old bottom-blown Bessemer converter.

Manganese has already been referred to more than once. In iron ore it is almost always present, and is a welcome constituent, tending to reduce the amount of sulphur found in the pig-iron produced, and also to counteract the evil effects of that element upon the mechanical properties of the pig-iron. Moreover, where manganiferous pig-iron is used in the manufacture of steel, the manganese aids in the elimination of all non-metallic impurities in the furnace, and especially that of sulphur, since manganese sulphide is far more soluble in slag than in molten iron. In addition, manganese is added very frequently as a deoxidizer, just before casting, and then renders both oxygen and any residual sulphur comparatively harmless. Care should be taken not to add too great an excess of manganese to steel, or it will actually cause a certain amount of brittleness; the residual manganese should, in ordinary steels, not exceed 2 per cent. The striking changes in the property of steels caused by the addition of larger quantities of manganese (over 7 per cent.) will be dealt with in the section on "alloy steels."

The Defects of Steel Ingots.¹ It does not fall properly within the province of this book to discuss the casting or fashioning of steel or any other material; but the effect of impurities upon steel is so closely connected with the problem of ingot-making that it is necessary at this point to say a word on the subject. When an iron ingot-mould is filled with molten steel from the ladle, and the steel is allowed to solidify without any special precaution being observed, the ingot obtained may be defective for at least five different causes:—

(1) If the addition of deoxidizer has not been properly regulated, the steel will be wild and frothy, and the resultant ingot will be full of **blow-holes**.

(2) In any case, the crystallization commences at the edge of the mould, and the crystallites grow inwards; the whole mass shrinks as it cools, and by the time the whole is solid, there will be a long cavity, or **pipe**, running from the top perhaps half-way down the ingot (see Fig. 34, A). The shrinkage will be greater,

¹ A. W. and H. Brearley, *J. Iron Steel Inst.* 94 (1916), 137; J. N. Kilby, *J. Iron Steel Inst.* 94 (1916), 193.

and therefore the pipe more considerable, when the molten metal has been poured into the mould very hot.

(3) Further, when the liquid has been poured at a temperature far above its melting-point, the crystallization will commence only at the cool surfaces of the mould, and the whole ingot will come to consist of long finger-like crystallites extending from the edge, and meeting one another—as shown in Fig. 34, B—in diagonal lines, which come to be **planes of weakness**. In casting from a lower temperature, crystal-nuclei may be formed spontaneously in the centre of the ingot, and the grains in the interior may be of the normal “equiaxed” variety. Thus the special planes of weakness will be avoided.

(4) Certain impurities in the steel—notably phosphorus—tend to become **segregated** in the last solidifying portions. The iron which first crystallizes is comparatively free from phosphorus, whilst the central and last solidifying portions of the ingot is very rich in phosphorus. Thus, although the phosphorus content of the liquid steel may be extremely low, the local phosphorus content of certain parts within the solid ingot becomes dangerously high.¹ When the ingot is afterwards rolled—for instance—into rails, parts of the rails may contain more phosphorus than is safe.

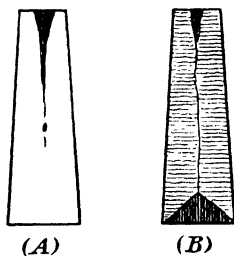

FIG. 34.—Defects in Ingots.
(A) Pipe, (B) Planes of Weakness.

Numerous serious railway accidents—especially those occurring on American railways—must probably be regarded as the indirect result of segregation.

(5) Where a long pipe has been produced, and the mould is open to the air, atmospheric oxygen may cause the formation of oxides in the interior of the ingot, and on rolling into rail, these oxides may be the cause of flaws.

Of these defects the first (blow-holes) can be largely eliminated by suitable furnace conditions, and the proper regulation of the deoxidizing charge; the third (diagonal weakness) can be overcome by casting at a moderately low temperature. The fifth defect (atmospheric oxidation) is avoided at some works by introducing the steel into the mould through the bottom, and excluding the air; this method, however, is apt to be wasteful of material as the steel left in the channels feeding the moulds has afterwards to be treated as scrap and remelted.

The main troubles to be overcome, however, are **piping** and

¹ J. E. Stead, *J. Iron Steel Inst.* 91 (1915), 140.

segregation. Piping can be avoided and segregation can be reduced by the system known as the "feeder heads." Here the top portion of the mould is lined with firebrick, which, being a bad conductor of heat, keeps the steel at the top liquid. When shrinkage occurs in the lower part of the mould, molten steel descends from the top, and prevents the formation of a cavity. With ingots produced by such a method, it is only necessary to discard about 12 per cent. of the total steel, whilst in an ingot produced without a feeder head at least 25 per cent. must be scrapped, owing to piping. Sir R. Hadfield has improved the process by applying heat to the steel surface so as to keep this portion liquid until the very last moment; a little slag is placed on the surface, and covered with hot charcoal, which is kept aglow by means of an air-blast. This process is used on a large scale at Sheffield.¹

Alloy Steels

General. It has been stated above that, in ordinary "carbon steels," the change

Austenite \rightarrow pearlite

can only be arrested by very rapid cooling, and that the arrest appears, even in that case, to be only partial, an intermediate product (martensite) being obtained. Where, however, there are other metals present in solid solution in the austenite, the change can be controlled much more easily. The presence of nickel in steel reduces the temperature at which the A_1 transformation occurs; and, since all reactions proceed more slowly at low temperatures than at high temperatures, a comparatively slow cooling may be sufficient to inhibit the formation of pearlite. Thus a steel with 7 per cent. of nickel, when cooled slowly, will behave just in the same way as a similar steel without nickel behaves when quenched.² The structure obtained in a nickel steel may be austenitic, martensitic, troostitic, or pearlitic, according to the rate of cooling and also according to the nickel-content; at a constant cooling-rate, a high nickel-content favours the retention of austenite or martensite, whilst in the low-nickel steels troostite or pearlite may be obtained.

The addition of chromium to steel actually *raises* the temperature at which the A_1 change occurs on very slow cooling, but it has a

¹ Sir R. Hadfield and G. K. Burgess, *J. Iron Steel Inst.* **91** (1915), 40; J. E. Stead, *J. Iron Steel Inst.* **101** (1920), 79, 80.

² Compare C. A. Edwards, *Engineering*, **105** (1918), 267. See also H. Scott, *U. S. Bur. Stand. Sci. Paper*, No. **376** (1920).

specific influence in reducing the *velocity* of the change. Thus steels containing 0.1 per cent. of carbon and 7-22 per cent. of chromium are martensitic even if quite slowly cooled; but it can be shown that if the steel is cooled with quite exceptional slowness, a troostitic or even pearlitic structure can be developed.¹

The advantages of obtaining the hardened form of steel without quenching (a process which is always liable to cause internal stresses) will be obvious to all. Steels containing sufficient alloying element to attain hardness on ordinary cooling in air are known as "air-hardening" or "self-hardening" steels.

The addition of manganese to steel likewise renders it easy to obtain a martensitic, or even—if sufficient is added—an austenitic structure. A 1 per cent. carbon steel containing 5 per cent. of manganese is wholly austenitic when quenched, but the amount of manganese needed to obtain austenite at ordinary temperatures must be increased if the carbon-content is reduced.² Here also the structure depends on the rate of cooling; a steel which is austenitic if cooled in the ordinary way may be martensitic or even pearlitic if cooled very slowly. The typical polygonal austenitic structure of a water-quenched manganese steel is shown in Fig. F of the frontispiece.

Austenitic steels often become martensitic if cooled in solid carbon dioxide or in liquid air; the change produced can most easily be demonstrated by the fact that the steel which is non-magnetic before the low-temperature treatment is rendered magnetizable by that treatment.³

Whilst the main effect of adding metals to steel is to restrain the A_1 transformation, their presence naturally has a specific effect upon the steels. The metals of Group VIA (tungsten, molybdenum, and chromium) form hard carbides which possess considerable stability even at high temperatures, and this is probably an important factor in determining the properties of tool-steels containing those elements.

The function of vanadium in steel has been much discussed. Some writers have asserted that it acts mainly as a "scavenger," removing oxygen and nitrogen from the steel. It has, however, other important functions, which are still not entirely understood.

¹ C. A. Edwards, J. N. Greenwood, and H. Kikkawa, *J. Iron Steel Inst.* **93** (1916), 114. Compare A. Portevin, *Comptes Rend.* **153** (1911), 64; see also A. M. Masloff, *Rev. Met. (Extraits)* **15** (1918), 37; J. H. G. Monypenny, *J. Iron Steel Inst.* **101** (1920), 493; T. F. Russell, *J. Iron Steel Inst.* **104** (1921), 247.

² J. H. Hall, *J. Soc. Chem. Ind.* **34** (1915), 57, gives a curve connecting the necessary manganese content with the carbon content. See also A. Portevin, *Comptes Rend.* **165** (1917), 62.

³ Compare J. Hopkinson, *Proc. Roy. Soc.* **48** (1890), 1.

Carbon has apparently a greater affinity for vanadium than for iron, and in vanadium steels much of the carbon exists as the carbide V_4C_3 and not as cementite (Fe_3C). In fact, in steels containing more than about 5 per cent. of vanadium practically all the carbide is present as V_4C_3 and none as Fe_3C . The carbide V_4C_3 resembles Fe_3C in many ways, but it appears to be less "mobile" and does not readily segregate. Consequently steels which contain V_4C_3 in the place of Fe_3C remain fine-grained even under conditions which would produce a coarse grain in ordinary steels; likewise they do not readily pass from the troostitic or sorbitic conditions into the softer condition associated with the presence of laminated pearlite.¹ Vanadium steels are also harder, and have a higher elastic limit and tensile strength, than steels containing iron carbide, although—possibly owing to the fine grain—the increase in hardness is not accompanied by any appreciable increase in brittleness. Consequently vanadium is a beneficial constituent in steels of many kinds; its favourable influence upon the high-speed tool-steels containing molybdenum or tungsten is especially remarkable, and will be referred to again.

The special constituent of an alloy steel is usually introduced as a ferro-alloy, although in the case of nickel steels it is commonly added as metallic nickel. Tungsten is sometimes added as ferro-tungsten, sometimes as tungsten powder. If the latter material is employed, great care must be taken to ensure that it dissolves completely and becomes distributed uniformly throughout the molten steel; there is a danger that the tungsten may sink to the bottom of the crucible and remain undissolved. With ferro-tungsten, which has a much lower melting-point than pure tungsten, the danger of segregation is much less.²

It is now possible to describe briefly the main classes of alloy steels.

Manganese Steels. Until about 1883, the employment of manganese in steel was confined to the addition of small quantities as a deoxidizer; the presence of any amount exceeding about 2 per cent. was carefully avoided, as it was known to cause brittleness. It was, however, discovered by Hadfield³ that the addition of 7.5 per cent. of manganese causes an entire change in the character of the metal, and the manufacture of manganese steel, the first of the alloy steels, was commenced shortly after this discovery.

Commercial manganese steel may contain 9–14 per cent. of manganese. When heated to 1,000–1,100° C., and quenched in

¹ J. O. Arnold and A. A. Read, *J. Iron Steel Inst.* **85** (1912), 215.

² J. W. Weitzenkorn, *Met. Chem. Eng.* **26** (1922), 504.

³ R. A. Hadfield, *Proc. Inst. Civ. Eng.* **93** (1888), 1.

water, the structure becomes polygonal and wholly austenitic (see Fig. F of frontispiece). It is almost invariably used in the austenitic condition. If annealed at 500°C ., the austenite begins to break up and the alloy becomes brittle and useless, acquiring at the same time a needle-like structure similar to that of martensitic carbon steel. The fact that annealing destroys the value of manganese steel is a great hindrance to its more frequent use, since it is impossible to remove the internal stresses which result from the quenching.

Manganese steel in the austenitic state is extremely resistant to wear; it is usually described as very hard, but actually it gives a rather low hardness value when subjected to the indentation test. It can be made to "flow" perceptibly when struck by the hammer. These properties are due to the fact that the material has a rather low elastic limit, combined with high tensile strength and elongation. Its extraordinary resistance to wear is probably connected with the same fact. Manganese steel is used for the jaws of rock-crushing machinery and on railways for switch-points and for the rails themselves at sharp curves; in the war it proved valuable for steel helmets. But the very properties which render it so valuable in service make it practically impossible to machine, and this fact has greatly limited its use.

In the austenitic (γ -iron) state, manganese steel is non-magnetic. However, it acquires magnetism when heated at 500 – 525°C ., the return of magnetic properties being accompanied by the appearance of the acicular (martensitic) structure, and of the brittle condition referred to above.¹ The transformation from the non-magnetic to the magnetic form is accompanied by the evolution of heat.

Nickel and nickel-chrome steels are now used on a very large scale by engineers for constructional work,² being better capable of withstanding alternating stresses (such as are continually present in industrial districts owing to high-speed machinery, etc.) than are ordinary steels. Nickel steels have proved valuable for bridges, and nickel-chrome steels are used both in aeroplane and motor-car construction. The composition employed varies with the purpose for which the steel is intended, but a steel with 3 per cent. of nickel, 1.5 per cent. of chromium, and 0.3 per cent. of carbon has proved generally useful. As in the case of manganese steels, many of the valuable properties are only developed after heat-treatment, but in the varieties comparatively rich in nickel, quenching is not needed. Air-cooling from an appropriate temperature gives the desired character; this is a great advantage, as it avoids the internal stresses

¹ Sir R. A. Hadfield and B. Hopkinson, *J. Iron Steel Inst.* **89** (1914), 106.

² F. C. A. H. Lantsberry, *J. Soc. Chem. Ind.* **36** (1917), 983.

which quenching invariably produces. The varieties low in carbon are excellent for case-hardening. Nickel and nickel-chrome steels have proved very valuable in this country in the "drop-forging" industry. **Nickel-manganese steels**, containing also vanadium, were employed during the war for the manufacture of shrapnel helmets.¹

Chromium steels (containing 12 per cent. of chromium and 0.3 per cent. of carbon) are much used for stainless cutlery; they resist corrosion wonderfully well. This matter will be considered further in the section on the corrosion of iron and steel. Another class of chrome steels is used for the manufacture of permanent magnets.² High-carbon chrome steels, made in the electric furnace, have proved valuable for ball bearings.³

Chrome-vanadium steel is in very great favour in America, owing to the great range of properties which it can assume by proper heat-treatment, aided by case-hardening; it has been used for gears, springs, axle-shafts, the cones and race-ways of bearings, dies, and numerous other purposes.⁴

Steels containing **tungsten** without other special element are used for some purposes, for instance, in the manufacture of permanent magnets. But the main importance of tungsten to the steel-maker is its employment, along with chromium and vanadium, in the manufacture of high-speed tool steel.

High-speed Tool Steel. The ordinary high-carbon steel, hardened by quenching and subsequent tempering, is quite satisfactory for tools employed only at low temperatures, but it will clearly be useless for high-speed work in which the tool may become red-hot, since at that temperature the return of the steel to the comparatively soft pearlitic condition will soon occur. The steel required for modern high-speed tools must possess "red-hardness," that is, power to withstand high temperatures without softening. This is rendered possible by the presence of tungsten or molybdenum in solid solution in the iron; either tungsten or molybdenum can prevent the softening change referred to above from taking place, and retain the steel in a hard condition.

The modern high-speed steel has, besides iron and carbon, two essential constituents, namely,—

- (1) tungsten or molybdenum;
- (2) chromium.

¹ J. A. Coyle, *Met. Chem. Eng.* **20** (1919), 618.

² E. Gumlich, *Stahl u. Eisen*, **42** (1922), 41, 97.

³ F. T. Sisco, *Met. Chem. Eng.* **26** (1922), 71.

⁴ F. J. Griffiths, *Iron Age*, **100** (1917), 266. *Times Eng. Supp.* Dec. 17, 1913.

In addition, they very commonly contain

(3) vanadium,

the presence of which is practically essential in the case of molybdenum steels, and certainly adds greatly to the efficiency of tungsten steels also; certain steels containing vanadium can be quenched in water from a white heat without fear of cracking. The advisability of replacing tungsten by molybdenum appeared at one time open to question; the amount of molybdenum required in tool steel (5-6 per cent.) was known to be much smaller than that of tungsten (14-20 per cent.), but the molybdenum steels were found to be erratic in character. The recent work of Arnold and others has, however, established the fact that certain molybdenum steels containing vanadium are perfectly reliable.¹ The amount of chromium in a high-speed tool steel is usually about 4 per cent.; that of vanadium perhaps 1 per cent., whilst the carbon-content is often about 0.6 per cent.

Before a tungsten-chrome steel tool acquires the needed properties, it must be heated to about 1,300° C., and then quenched in oil or in an air-blast (water-quenching is used for some steels). An old method which is still largely used is first to quench the steel from its high temperature into a bath of molten lead at about 620° C., followed by further cooling to ordinary temperature in an oil-bath. The object of the heating at the extremely high temperature (1,300° C.) is to bring tungsten, which exists in the tool as a rather stable tungsten carbide (WC) or as iron tungstide (Fe₂W), into solid solution in the iron, and this requires an exceptionally high temperature.² The limits of temperature within which the tool may be heated are rather narrow; one particular steel, for instance, requires to be heated to a temperature between 1,300° and 1,320° C.³ If the temperature is too high, the steel will be "burnt"; if too low, the tungsten will remain undissolved, and the steel will have little or no superiority to an ordinary chrome-steel. One function of the chromium in the chrome-tungsten steels is thought to be that it assists in some way the entry of tungsten into solution; if too little chromium (e.g. less than 3 per cent.) is present, the complete solution of tungsten does not readily occur. When the conditions are right, sections of the steel, after cooling, should be austenitic, consisting of large white polygonal

¹ J. O. Arnold, *Engineer*, 129 (1920), 480.

² C. A. Edwards and H. Kikkawa, *J. Iron Steel Inst.* 92 (1915), 6. Compare A. H. d'Arcambal, *Met. Chem. Eng.* 25 (1921), 1168. J. A. Matthews, *J. Amer. Soc. Test. Mat.* 19 (1919), Part II, 142, thinks that the temperatures suggested by Edwards are too high. H. K. Ogilvie, *Engineer*, 134 (1922), 282, says 1,250° to 1,300° C.

³ J. H. Andrew and G. W. Green, *J. Iron Steel Inst.* 99 (1919), 305.

grains, comparatively free from carbide or tungstide particles.

After the hardening at this high temperature, the tool is sometimes given a "secondary hardening" by heating at about 600° C. The austenitic (polygonal) structure disappears during this process, and is replaced by a granular, patchy or spotty structure; sometimes an acicular ("martensitic") appearance is produced.¹ The cutting efficiency of the steel increases during the secondary hardening, which is often regarded as bringing the steel into a condition analogous to that of martensitic carbon steel. Only steels containing tungsten (or molybdenum) in solution are hardened to any extent in this way by treatment at 600° C.; the behaviour is shown by tungsten steels free from chromium, but the degree of hardness attained is considerably enhanced by the presence of chromium.

The numerous changes which occur during the heat-treatment of high-speed tool steel are, however, somewhat complicated. Arnold and his co-workers have isolated the following compounds from steels containing chromium, tungsten, molybdenum and vanadium.²

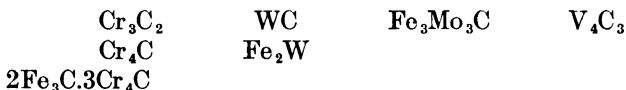

Some of these substances are extremely hard, and no doubt fulfil an important rôle in the steel. It is stated, for instance, that a good tool steel should, in its final state (after secondary hardening), have minute hard globules of the tungstide Fe_2W distributed uniformly throughout the tough ground-mass; these are supposed to act like the teeth of a saw.³ Much work has been carried out upon the transformations occurring in high-speed steel, the magnetic method being used—as well as the thermal method—to detect changes. But many points remain undecided.

Other Special Elements in Steel. Cobalt has been used in alloy steels to some extent. The cobalt steels are understood to resemble nickel steels in mechanical properties; they are said to withstand corrosion well. Of especial interest are the magnetic properties of cobalt steels. By employing a steel containing 35 per cent. cobalt and other elements for the construction of magneto-machines, it is hoped greatly to reduce the size of the magnet needed and to simplify the design of the machines.⁴

¹ H. C. H. Carpenter, *J. Iron Steel Inst.* **71** (1906), 383; C. A. Edwards and H. Kikkawa, *J. Iron Steel Inst.* **92** (1915), 24. Excellent microphotos of the steels both in the quenched and annealed conditions are also given by C. A. Edwards, *J. Iron Steel Inst.* **77** (1908), 104.

² J. O. Arnold and F. Ibbotson, *J. Iron Steel Inst.* **99** (1919), 407.

³ K. Honda and T. Murakami, *J. Iron Steel Inst.* **101** (1920), 647.

⁴ E. A. Watson, *J. Inst. Elect. Eng.* **59** (1921), 452.

Proposals have been made to use uranium in the place of tungsten in high-speed tools; but owing to its easily oxidizable character, it appears to be unsuited for this type of steel.¹ Possibly it may prove valuable in other special steels. There is no reason to think that uranium can confer any properties on steel which cannot be obtained by the use of other elements (chromium, nickel, vanadium, etc.), but it might be used as a substitute for these elements. The accumulation of uranium residues as by-products at the radium works is stimulating research upon the subject of utilizing those residues in steel-making. The difficult problem of making a ferro-uranium with fairly low carbon-content has now apparently been solved.²

The use of zirconium³ in the steel for motor-car construction has been advocated. It is claimed that—owing to the great strength of zirconium steel—the thickness of certain parts of the structure can be reduced by the use of that material. Recent work has indicated that the function of zirconium—like the function of titanium—is merely that of a scavenger.⁴

CORROSION AND RUSTING OF IRON AND STEEL

The corrosion of iron and steel is a subject of immense practical importance, and of some small complexity. Practically all commercial grades of iron and steel are essentially heterogeneous, and electro-chemical corrosion couples are readily set up; it is probable that nearly all the corrosion of iron actually met with in practical work is of an electro-chemical character. Lambert—by exercising extraordinary precautions—succeeded in preparing iron so pure and so uniform that it did not rust when placed in water containing oxygen; but the smallest amount of impurity (e.g. a trace of platinum derived from the dish employed in the preparation of the material) was sufficient to cause rusting; or again, local pressure upon part of the iron surface was capable of causing a corrosion couple between the stressed and unstressed portions.⁵ It is evident, therefore, that the amount of heterogeneity required to enable active corrosion to take place—assuming the other conditions are favourable—is very small. It is wrong to assume that, under working conditions, cast iron which contains a large proportion of foreign

¹ See E. Polushkin, *Rev. Met.* **17** (1920), 437; J. A. Matthews, *J. Amer. Soc. Test. Mat.* **19** (1919), Part II, p. 153.

² R. M. Keeney, *Bull. Amer. Inst. Min. Eng.* **140** (1918), 1321.

³ J. Garçon, *Bull. Soc. d'Enc.* **131** (1919), 148.

⁴ *U.S. Bur. Stand. Tech. Paper*, **207** (1922).

⁵ B. Lambert and J. C. Thomson, *Trans. Chem. Soc.* **97** (1910), 2426; B. Lambert, *Trans. Chem. Soc.* **101** (1912), 2056.

substance will necessarily be corroded more readily than mild steel, which contains only a small amount; even the mild steel is quite sufficiently heterogeneous to cause very rapid corrosion if other conditions are favourable. On the other hand, the character of the surface exposed is undoubtedly of some importance. Most metallic articles have a skin of comparatively uniform character covering the surface, and, if this skin is removed at any point, exposing the more heterogeneous portions below, corrosion is likely to occur; for instance, where a thread has been cut in a cast-iron pipe, corrosion may set in, even though the unbroken parts of the surface are unaffected.¹

The occurrence of corrosion is, however, determined more by the character of the liquid in which it comes into contact and by other external conditions, than by the purity of the metal. We can distinguish three main cases:—

- I. Corrosion by *acids* accompanied by evolution of *hydrogen gas*.
- II. Corrosion by immersion in *waters containing dissolved oxygen* (“rusting”).
- III. Corrosion occasioned by *stray electric currents*.

I. **Corrosion by Acids.** This case is comparatively unimportant, and also comparatively simple. Corrosion couples of the type

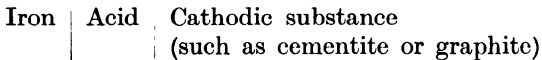

are set up. Iron passes into solution at the anodic parts of the surface yielding a soluble salt, and hydrogen appears in bubbles on the cathodic portions. As in all cases in which gases are evolved, considerations of surface energy (*overpotential*) enter into the matter. The character of the foreign substance which constitutes the cathodic areas must be taken into account, and probably also the size of the particles. Probably this is the reason why cast iron dissolves in dilute hydrochloric or sulphuric acid very much quicker than mild steel, although, in the absence of acid, cast iron and steel undergo “rusting” at about the same rate. The dissolution of grey cast iron soon exposes graphite, which has a low overpotential value, and is an ideal cathodic substance for the corrosion couple; there is no graphite in ordinary steel.

With nitric acid, the conditions are reversed.² Probably cast iron when first immersed in nitric acid commences to pass into the combined state very quickly; that is to say, the current density at

¹ Compare the case described by A. B. Bradley, *J. Soc. Chem. Ind.* **36** (1917), 1071.

² W. D. Richardson, *Trans. Amer. Inst. Chem. Eng.* **13** (1920), i, 265.

the anodic portions of the corrosion couples is high. But this very fact renders the metal passive, and cast iron is, "in the long run," less attacked by nitric acid than is steel. It is also worthy of note that concentrated sulphuric acid has very little action on cast iron—a matter of some importance in chemical industry.

It is interesting to observe that white cast iron, which contains no graphite, is much less attacked by dilute non-oxidizing acids than grey cast iron. If a casting is chilled sufficiently to produce a white surface-layer, it is comparatively immune to the action of acids, even though the interior is grey.

The rate of attack of cast iron by acids is most remarkably reduced by the presence of silicon. Modern acid-proof iron contains between 12 per cent. and 19 per cent. of silicon, but the alloys of this character are extremely brittle. They are nevertheless largely used for plant in sulphuric acid and other works. Their non-corrosive properties—which are very remarkable—are probably due to the formation of a protective skin of silica, which is undissolved by acid.

It should be understood that the *rate of corrosion of iron or steel by acid gives absolutely no indication of its behaviour to ordinary water*. The so-called "acid immersion test" for determining the liability of iron or steel to "rust" is utterly useless.¹ To give only one example, the addition of 2.4 per cent. of molybdenum to a certain steel has been found to increase its corrosion by 10 per cent. sulphuric acid about six times, but slightly reduces the rate of attack by tap-water.²

II. Corrosion by Water containing Oxygen.³ In the ordinary "rusting" of iron by water, the presence of dissolved oxygen is needed. The oxygen acts as a depolarizer, and removes the hydrogen from the cathodic portions in a manner which involves no evolution of gas. For this reason the "overpotential" value of the cathodic particles is of no special importance. Nor (if we limit our survey to the commercial forms of iron) is the "purity" of the material of importance; steel is just as liable to rusting as grey cast iron. The factor which limits the rate of corrosion is generally the rate of the diffusion of dissolved oxygen to the surface of the iron.⁴

The iron enters the ionic condition at the anodic portions of the surface, yielding a soluble ferrous salt, whilst the removal of hydrogen

¹ See A. S. Cushman, *Trans. Faraday Soc.* **11** (1915-16), 240.

² L. Aitchison, *Trans. Chem. Soc.* **107** (1915), 1531.

³ W. A. Tilden, *Trans. Chem. Soc.* **93** (1908), 1356; W. H. Walkor, *J. Amer. Chem. Soc.* **29** (1907), 1251; E. Heyn and O. Bauer, *Mitt. Kgl. Mat. Prüfungssamt.* **26** (1908), 1.

⁴ See U. R. Evans, *J. Inst. Met.* **28** (1922), 119.

ions at the cathodic portions leaves the solution alkaline at these points. If, for instance, the water contains a little sodium chloride, the immediate soluble products would be ferrous chloride at the anodic portions and sodium hydroxide at the cathodic portions. When these diffuse to meet one another, they may interact and form ferrous hydroxide. This will not, under ordinary circumstances, be precipitated as such, being comparatively soluble; but it soon combines with further oxygen, yielding ferric hydroxide. The ferric hydroxide first appears in colloidal solution, but is finally precipitated in the familiar yellow-brown form, often at an appreciable distance from the metallic surface. The growth of ferric hydroxide from rusting iron has been studied under the microscope. The hydroxide often assumes curious globular or thread-like forms, reminiscent of the growth of living organisms.¹

The rust—not being formed in close contact with the metal, and being of a non-compact character—will not protect the metal from further attack. In fact, it may actually stimulate local corrosion in indirect ways (as explained on page 418, Vol. I).²

The essentially distinct character of the reactions at the cathodic and anodic areas of iron is well shown by means of the so-called "ferroxyl indicator." A surface of iron or steel is covered with a solution of gelatine containing a trace of potassium ferricyanide and phenol-phthalein. This liquid soon produces a film of jelly over the surface of the metal. The iron gradually undergoes corrosion. Ferrous chloride is formed at the anodic portions, and reacts with the ferricyanide to give a blue precipitate, whilst the alkali produced at the cathodic portions yields a pink coloration owing to the presence of phenol-phthalein. Thus the whole surface of the metal becomes a mosaic of blue (anodic) and pink (cathodic) patches.³

Although the presence of oxygen is the main factor in determining the rate of rusting, other matters are of some importance. The presence of chlorides—as usual—favours corrosion, because they prevent the iron from becoming passive. Acidity favours corrosion for the same reason, and also because a high hydron concentration is clearly conducive to the reaction at the cathodic portions of the corrosion couple. Thus waters containing salts of magnesium, which cause an acid reaction through hydrolysis, have been found

¹ A. Ackermann, *Koll. Zeitsch.* **28** (1921), 270.

² Compare also the theory of J. A. N. Friend, *Trans. Chem. Soc.* **119** (1920), 932, who thinks that colloidal iron hydroxide acts as an oxygen-carrier.

³ W. H. Walker, *J. Amer. Chem. Soc.* **29** (1907), 125. Also A. S. Cushman and H. A. Gardner, "Corrosion and Preservation of Iron and Steel" (McGraw Hill).

to be especially corrosive,¹ and the same applies to some waters containing free carbon dioxide. Nevertheless, many of the "acid" waters used for industrial or domestic purposes, are also "hard" waters, and are apt to deposit a scale of calcium carbonate upon the metallic surface, which may protect the metal.² Thus attempts to treat acid waters with alkali have not always resulted in a diminution of corrosion, but sometimes the reverse. Distinctly alkaline waters tend to allow the iron to become passive, and are thus unlikely to cause rusting.

Oxidizing substances present in the water sometimes act in the same way as oxygen. The presence of a trace of free chlorine—or of sodium hypochlorite—in a water supply which has been sterilized with one of these substances will act as a stimulator of rusting.³ On the other hand, chromates act in the opposite way, since they render the iron passive.

Where the water available for the feeding of boilers is of an unsuitable character, it is often subjected to preliminary treatment. The forms of treatment include:—

(a) *Removal of dissolved oxygen* by the addition of a reducing agent such as tannin,⁴ or ferrous sulphate (in the presence of alkali).⁵ More often the water is heated, or passed over scrap iron, to remove the oxygen.⁶ Numerous plants for preventing corrosion by these means have been designed.

(b) *Addition of alkaline substances*, such as lime or sodium carbonate, to remove the acidity.

(c) *Addition of passivating agents*, like chromates. The amount of chromate needed to render iron passive depends mainly on the amount of chloride present in the water.

As regards the question of the relative merits of different kinds of iron (cast iron, steel, puddled iron, etc.), it cannot be said that there is much to choose between them. In all these kinds, there is usually sufficient heterogeneity to produce corrosion at the maximum rate which the supply of dissolved oxygen permits. Under some conditions, one type of material may prove rather better, and under other circumstances another.⁷ The same applies to steels made by different processes; Bessemer and open-hearth steels, basic and

¹ Compare also the rapid corrosion of pipes laid in Sorel Cement. See E. K. Rideal, *J. Soc. Eng.* **4** (1913), 245.

² Compare J. Tillmanns, *Chem. Zeit.* **39** (1915), 815.

³ G. L. Clark and R. B. Iseley, *J. Ind. Eng. Chem.* **12** (1920), 1116.

⁴ P. G. Jackson, *J. Soc. Chem. Ind.* **40** (1921), 26R.

⁵ J. W. Cobb and G. Dougill, *J. Soc. Chem. Ind.* **33** (1914), 403.

⁶ F. N. Speller, *Trans. Amer. Electrochem. Soc.* **32** (1917), 281; *J. Franklin Inst.* **193** (1922), 515; P. West, *J. Ind. Eng. Chem.* **14** (1922), 601.

⁷ Compare W. D. Richardson, *Met. Chem. Eng.* **23** (1920), 243.

acid steels, behave—on the average—about equally well.¹ Occasionally some serious case of failure has caused engineers to become suspicious of one class of material; but usually it has been proved that it is the exceptional conditions rather than the material which has been the cause of failure. For instance, the rapid corrosion of a long steel pipe-line which supplied water to the Coolgardie goldfield in Australia caused a great prejudice against steel. But the water in question was rich in sodium and magnesium chlorides, and cast-iron pipes do not seem to have fared very much better.²

The action of saline waters, and particularly sea-water, on cast-iron articles often produces a curious form of attack sometimes known as “graphitization.”³ The object often retains its shape almost unchanged, but is found—after long exposure to such waters—to be soft enough to be cut with a knife; at this stage, the object consists largely of graphite, which has escaped attack, whilst the metallic portion has been largely oxidized.

It is known that the presence of certain elements in iron and steel has a marked influence on the rate of corrosion. The presence of sulphur, for instance, in steel or cast iron renders it very liable to corrode, probably because sulphuric acid soon comes to exist in the corrosion product. On the other hand, certain metals, like chromium and, in a smaller degree, nickel, when present in solid solution in steel, have a marked influence in rendering it non-rusting. Probably they either reduce the E.M.F. of the corrosion couple, or favour the passage of the iron into the “passive” condition. The presence of chromium (20–23 per cent.) or nickel (6–9 per cent.) in steel has been found to alter the electrode potential so much that the alloy is more “noble” than pure copper.⁴ Only metals which exist in solid solution in the α -iron are likely to have this effect; metals like vanadium, which enter the carbide phase, are without benefit.

Stainless cutlery, as already stated, contains about 12–14 per cent. of chromium, and has proved very satisfactory. The same steel has been used with success in the making of pumps, with good results, and has recently been tried for the manufacture of turbine blades.⁵ The comparative immunity of chromium steel from oxidation is shown by the study of the temper colours obtained

¹ L. Pendred, *Trans. Faraday Soc.* **11** (1915–16), 238.

² E. J. Fox, *J. Soc. Eng.* **4** (1913), 265.

³ J. N. Friend, *Carn. Schol. Mem.* **11** (1921), gives numerous examples. See also J. W. Shipley, *J. Soc. Chem. Ind.* **41** (1922), 311r.

⁴ B. Strauss, *Naturwiss.* **8** (1920), 812.

⁵ *Engineering*, **112** (1921), 592; *Engineer*, **131** (1921), 598; **132** (1921), 504; Sir R. Hadfield, *Trans. Faraday Soc.* **11** (1915–16), 183.

when chromium steel is heated in air. The colours appear in the same order as in ordinary steel; but, for the attainment of any given tint, a higher temperature is needed in the case where the steel contains chromium.¹

The presence of small amounts of copper in steel is believed by many authorities to afford considerable protection against corrosion, especially *atmospheric* corrosion. The evidence on the subject is, however, somewhat conflicting.² There seems little doubt that under some conditions copper-bearing iron or steel will rust less quickly than similar material free from copper; copper-bearing steel is, for instance, especially resistant towards the sulphurous air of industrial districts. But under other conditions the presence of copper is certainly ineffectual in stopping corrosion, and actually seems to increase the rate of attack of iron *immersed* in acid liquids containing iron salts.³ Many causes have been suggested to account for the action of copper. It seems that the presence of copper is most beneficial in steels containing sulphur, which, in the absence of copper, would rust very readily. Possibly the copper removes the sulphur from the iron as a separate phase consisting of stable copper sulphide. However, copper seems to be beneficial even in iron free from sulphur, and it is probable that the rust formed on copper-iron is of a more protective character than that formed on copper-free iron; undoubtedly it is usually darker, denser, and more closely adherent.⁴

The protection of iron by the application of a continuous covering of another material has been discussed in Chapter XIV (Vol. I). Where a **paint-film** is employed, the character both of vehicle and pigment is important. The former should as far as possible be impervious to gas and moisture, as well as a non-conductor of electricity; the latter should be basic rather than acidic, and also a non-conductor. Great care must be taken to prevent "crinkling" of the coat, which is due to the expansion attending the "setting" of linseed oil. Many facts of great commercial importance have been arrived at by the patient and extensive researches of Friend. He finds, for instance, that polymerized linseed oil affords better protection than raw oil when used as a paint vehicle, and fine pigments give better protection than coarse

¹ J. H. G. Monypenny, *J. Iron Steel Inst.* **101** (1920), 494.

² See *Engineering*, **111** (1921), 213; E. A. and L. T. Richardson, *Trans. Amer. Electrochem. Soc.* **30** (1916), 379; **38** (1920), 221; A. S. Cushman, *Trans. Amer. Electrochem. Soc.* **30** (1916), 390; Sir R. Hadfield, *Proc. Roy. Soc.* **101** [A] (1922), 472.

³ J. A. Aupperle and D. M. Strickland, *Trans. Amer. Electrochem. Soc.* **39** (1921), 123.

⁴ D. M. Buck, *Trans. Amer. Electrochem. Soc.* **39** (1921), 109.

pigments, since they are more thoroughly in contact with the oil.¹ Two thin coats are found to protect iron from *atmospheric* corrosion rather better than a single thick coat containing as much pigment as the two thin coats; but when the plates are *immersed in water*, the reverse effect is observed.² The proportions in which the pigment and oil are mixed are also of importance; Friend considers that the "chief functions of a pigment, other than decorative, are to afford mechanical support to the linocyn and to reduce the permeability of the paint"; to attain this, a sufficiency, but not an excess, of pigment is required.³ Clearly unsuitable painting may be worse than no painting at all; in one series of experiments the painted plates were found to be eaten right through in places, whilst on the unpainted plates, similarly exposed, the corrosion, although spread over the whole surface and consequently involving a greater destruction of metal, was less serious, because less localized.

Where, instead of a paint-film, a **metallic covering** is used, it is possible to divide the metals into two classes according as they stand above or below iron in the Potential Series:—

(a) Metals which only afford protection when the covering is continuous, but which rather stimulate corrosion where the iron is exposed:—

Copper, nickel, tin, and lead.

(b) Metals which do not stimulate corrosion, and may afford some protection even at places where the iron is exposed, although in practice this protection cannot be relied upon:—

Zinc, aluminium.

Although wet rust has no protective action on iron, yet the more compact forms of iron oxide do have a considerable influence. The mill-scale which coats the metal as it leaves the mill will, if intact, largely interfere with rusting. But if it is partially removed, any flakes that remain will stimulate that worst type of corrosion—namely, "pitting"—by setting up the corrosion couple,

Iron | Water | Scale particle.

Thus when mill-scale is removed from iron, it must be removed completely.⁴

The intentional production of an adherent blue oxide-coat on steel for protective purposes is a common operation, and is known as "blueing." There are various methods, one being the im-

¹ J. N. Friend, *Carn. Schol. Mem.* 9 (1918), 77.

² J. N. Friend, *J. Iron Steel Inst.* 103 (1921), 367.

³ J. N. Friend, *Carn. Schol. Mem.* 11 (1922), 90.

⁴ W. H. Walker, *Trans. Amer. Electrochem. Soc.* 14 (1908), 182.

mersion of the article for a few minutes in fused sodium nitrate containing manganese dioxide.¹

The use of zinc protector bars, as well as the electrolytic method of protecting iron (Cumberland process), have already been discussed in Chapter XIV (Vol. I).

III. Corrosion by Stray Currents from Tramways, etc. This matter also was dealt with in Chapter XIV (Vol. I). It is the most serious cause of corrosion of steelwork in large towns, and does not demand the presence of oxygen. It applies mainly to buried pipes, etc., which are corroded wherever they behave as anodes to the stray currents passing through the ground; the coating of the metal with a non-conducting paint, or with a mixture containing tar and hydrocarbon oil, is usually recommended.

Even the steelwork of ferro-concrete buildings is affected by the same cause. Here the results may clearly be very serious, for, not only is the steel destroyed, but the oxidation of the metal is accompanied by an expansion, which may crack the surrounding cement. Fortunately, owing to the alkaline character of cement, the corrosion is generally negligible, but there is a certain amount of danger if chlorides are present in the cement.² It is noteworthy that even in cases where the iron is the cathode to the stray current, although there is no corrosion, there is a certain amount of softening in the cement, apparently due to the concentration of sodium, through ionic movement, near the iron surface; this change is, however, not likely to be a source of danger.

Embrittling of Iron by Hydrogen. Somewhat allied to corrosion is the brittleness produced in iron by any treatment which causes the evolution of hydrogen under pressure upon the surface of the metal.

When iron articles which are intended to be electro-plated are subjected to the preliminary cleansing operation, either by pickling in acid, or by cathodic treatment in acid solution, much hydrogen is evolved on the metal, which becomes quite brittle. When cathodic cleaning is carried out in a bath of neutral sodium sulphate, the brittleness produced is said to be negligible.³

A similar brittleness is produced when iron is brought into contact with hot concentrated caustic soda, a reagent which attacks it appreciably, with evolution of hydrogen.⁴ The tensile strength is

¹ For details, see W. B. Greenleaf, *Machinery*, **24** (1918), 997.

² E. B. Ross, B. McCallum and O. S. Peters, *U.S. Bur. Stand. Tech. Paper*, **18** (1913).

³ S. C. Langdon and M. A. Grosman, *Trans. Amer. Electrochem. Soc.* **37** (1920), 543, especially page 567.

⁴ P. D. Merica, *Met. Chem. Eng.* **16** (1917), 496.

not greatly affected, but the iron is liable to fail if subjected to alternating stresses or to sudden shocks; the brittleness generally disappears on standing. The cause of the brittleness is not fully understood. But it is known that the iron after cathodic treatment—or after immersion in corrosive liquids—is considerably supersaturated with hydrogen owing to overpotential, and it has been suggested that the liberation of this gas in the interior of the metal may be the immediate cause of the cracking which develops.¹

Whatever the explanation may be, failures of steel tubes in the evaporators used for concentrating alkali, and also in autoclaves in which reactions with hot concentrated alkali are carried out, have been rather frequently reported.² The cracking is inter-granular, and occurs most noticeably where the metal is in tension—facts which recall to mind the season-cracking of brass. Similar failures have been found with other liquors; probably one reason why it is most noteworthy in the case of caustic alkalis is the unusually high temperature and high concentration reached in these solutions.

THE COMPOUNDS OF IRON IN TECHNOLOGY

Although the compounds of iron are of far less technical importance than the metal and its alloys, yet there are numerous most essential industrial processes in which compounds of iron are concerned.

The mineral iron pyrites (FeS_2), for instance, is the source of much of the sulphur dioxide which is used in the **sulphuric acid manufacture**. The residue left over after the pyrites has been burnt to yield sulphur dioxide consists largely of iron oxide. It can actually be used as iron ore in the blast-furnace, but must first be roasted again so as to drive off all the sulphur, and briquetted. If—as is often the case—the pyrites contains comparatively precious metals like copper, it can be roasted with salt, which converts the copper into copper chloride, and then washed with water (see Volume IV). After the leaching out of the copper, the remaining iron can be briquetted and used in the blast-furnace.

Bog iron ore is used in the **purification of coal-gas** to remove hydrogen sulphide and hydrocyanic acid. The artificial iron hydroxide obtained in the purification of bauxite is used for the

¹ See the various views put forward by T. S. Fuller, *Trans. Amer. Electrochem. Soc.* **36** (1919), 113; R. E. Zimmerman, p. 129, and W. D. Bancroft, p. 130.

² See C. E. Stromeyer, *Engineering*, **104** (1917), 645. Compare E. Worsley, *Engineering*, **104** (1917), 657. See also J. A. Jones, *Trans. Faraday Soc.* **17** (1921), 102; C. H. Desch, *Trans. Faraday Soc.* **17** (1921), 20.

same purpose. The gas to be purified is passed over the iron hydroxide, which becomes converted to sulphide (and cyanide). After the oxide is beginning to lose its power of absorbing the two gases, it can be revived by exposure to the air, which reconverts the sulphide to oxide, sulphur being liberated. After a given quantity of oxide has been used and revived a large number of times, it comes to contain too much free sulphur and cyanogen products to be an efficient purifier. It is therefore replaced. From the "spent" pyrites many valuable by-products, such as potassium ferrocyanide, can be isolated by suitable treatment.

The burnt pyrites obtained from the sulphuric acid works has also been used in purifying coal-gas, but on account of the high temperature of production is often a less active absorbent. It is stated to be efficient as an absorbent for hydrogen sulphide only so long as it contains ferrous sulphate.¹

Of the salts of iron, ferrous sulphate or "copperas" occurs as a by-product in several processes. Probably the cheapest source is afforded by the use at chemical works of towers filled with scrap iron which serve to remove acid fumes from waste gases which have to be discharged into the air.² Copperas gives on ignition ferric oxide, which is largely used as a pigment under the name of **Venetian Red**; another variety of the oxide (**rouge**) is important as a polishing material for metals.

Various natural forms of ferric hydroxide yield pigments on grinding and levigating. **Yellow ochre** is obtained in this way; on cautious ignition it loses water yielding **red ochre**. Other red pigments are obtained from natural ores by grinding and washing without burning. Some ochres, which contain bituminous matter, yield on burning a brown pigment known as **Vandyke brown**. Several other natural pigments (Sienna, Umber, etc.) contain manganese as well as iron. The various pigments containing iron oxide have many uses. Some forms are used for coating ship bottoms, others as a colouring matter in paper or rubber. The natural varieties are employed in the anti-corrosive paints used for covering steelwork, but most artificial varieties (Venetian red) are looked upon with disfavour for this purpose, as they are apt to stimulate corrosion, rather than to prevent it. This is no doubt due to the presence of residual sulphuric acid.

Another important pigment containing iron is ferrous ferricyanide (or possibly ferric ferrocyanide), different grades of which are known under different names (**Paris blue**, **Prussian blue**, etc.). Most of these are essentially the same, although some of

¹ G. Weyman, *J. Soc. Chem. Ind.* 37 (1918), 333r.

² 15th Rep. Insp. Alk. Works (1913), 32.

the commercial products contain other complex cyanides such as

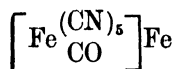

which give the pigment a violet tinge. Prussian blue is usually made by adding potassium ferrocyanide to an acidified solution of ferrous sulphate (copperas); the white precipitate of ferrous ferrocyanide soon oxidizes through exposure to the air, becoming a deep blue.

Iron compounds are also utilized in large quantities in the manufacture of **writing ink**.¹ Blue-black ink is made by mixing a solution of iron sulphate or chloride with an extract of fermented "galls," or with hydrolysed solution of tannin. The mixture thus obtained probably contains the ferrous salts of various organic acids (gallic, gallo-tannic, etc.), but the ferrous salts are practically colourless, and an organic dye (aniline blue, phenol blue, or indigo) is added to render the ink visible. Thus, when the ink is applied to the paper it is blue; but after drying, the ferrous compounds become oxidized, presumably to the corresponding ferric salts, which are black, and the writing becomes dark and permanent.

Like other salts containing metals in the trivalent state, the ferric salts have been used in tanning ("tawing"), and also as mordants in dyeing.

¹ C. A. Mitchell, *J. Soc. Chem. Ind.* **41** (1922), 93R.

COBALT

Atomic weight 58.97

Cobalt is intermediate in properties between iron and nickel and is therefore placed between them in the periodic system, although apparently the mean weight of cobalt atoms is actually higher than that of nickel atoms. Aston's work on positive rays has, however, shown that nickel contains atoms of two kinds, having masses 58 and 60 respectively.¹ The heavier kind of nickel atom has thus a mass greater than the *average* mass of the cobalt atoms. It is very likely that further work will show that cobalt atoms are not all of a single size.

The Metal²

Cobalt has the same colour as iron, and the metal takes a bright lustre on polishing. Pure cobalt is harder as well as stronger than pure iron. It is, however, scarcely malleable, and the maximum strength is only a little greater than the yield-point. Commercial cobalt, containing carbon and other impurities, has been shown by Kalmus to be not only stronger, but also more malleable than the pure metal. The melting-point of cobalt (1,478° C.) is similar to that of iron; the specific gravity is 8.8. The metal also resembles iron in being magnetic; the magnetic properties disappear about 1,150° C., the change being, no doubt, analogous to the A₂ change in iron.³

Cobalt stands in the Potential Series on the noble side of iron, and is less rapidly attacked by reagents. It dissolves, however, in dilute sulphuric or hydrochloric acids, and is also attacked by dilute nitric acid. Concentrated nitric acid renders it passive. Cobalt can also be made passive by anodic treatment, but the current density required is higher—other things being equal—than in the case of iron.⁴ The finely-divided metal becomes converted to oxide on exposure to the atmosphere, but compact cobalt requires to be heated before it is sensibly attacked.

Laboratory Preparation. The preparation of cobalt from its compounds on a small scale is easily accomplished by electrolysis.

¹ F. W. Aston, *Nature*, **107** (1921), 520.

² H. T. Kalmus and C. Harper, *J. Ind. Eng. Chem.* **7** (1915), 6.

³ W. Guertler and G. Tammann, *Zeitsch. Anorg. Chem.* **42** (1904), 353.

⁴ H. G. Byers and C. W. Thing, *J. Amer. Chem. Soc.* **41** (1919), 1902.

An ammoniacal solution of a cobalt salt containing ammonium sulphate when electrolysed deposits metallic cobalt on the cathode.

The finely-divided metal can also be obtained by heating one of the oxides in a stream of hydrogen above 500°C .¹

Compounds

The only stable series of simple cobalt salts corresponds to the ferrous salts, and are derived from the oxide CoO . Many cobaltic salts, derived from Co_2O_3 , have also been prepared, but the simple cobaltic salts are unstable. Numerous ammonia derivatives of cobaltic salts are known in which the cation consists of a cobalt atom surrounded by a "group of six." There are also some complex cobaltic salts containing cobalt in the anion. A higher oxide, CoO_2 , which has no analogue among the iron oxides but which corresponds to iron pyrites (FeS_2), is known, whilst an intermediate oxide (Co_3O_4), corresponding to magnetite, exists.

A. Compounds of Divalent Cobalt (Cobaltous Compounds).

Cobaltous oxide, CoO , is formed when the metal is exposed to steam, or, when the higher oxides are gently heated in a current of hydrogen; but in the last case it is difficult to prevent further reduction to the metallic state. It is also obtained if the higher oxides are heated in air above $1,000^{\circ}\text{C}$. The monoxide is a grey or, occasionally, a yellow-green substance, which is much more stable to the air than is ferrous oxide, being—except in a fine state of division—not perceptibly oxidized by exposure at ordinary temperatures. The **hydroxide**, $\text{Co}(\text{OH})_2$, is obtained from cobaltous salt solutions by precipitation with caustic alkali; on adding sodium hydroxide to a solution of cobaltous sulphate, a blue precipitate is formed at first, but the rose-coloured hydroxide is produced when alkali is added in excess. The blue precipitate always contains much $(\text{SO}_4)''$, and is often regarded as a basic sulphate. Apparently, however, the $(\text{SO}_4)''$ is merely adsorbed, for it can mostly be removed by repeated extraction with hot water, leaving a blue hydroxide.² The red and blue hydroxides probably bear the same relation to one another as the red and blue salts described below.

Blue and Pink Cobalt Salts. The cobaltous salts are formed when the metal, or its lowest oxide, is dissolved in acid. The

¹ H. T. Kalmus, *J. Ind. Eng. Chem.* **6** (1914), 107.

² A. Hantzsch, *Zeitach. Anorg. Chem.* **73** (1912), 304. Compare the views of N. G. Chatterji and N. R. Dhar, *Trans. Faraday Soc.* **16** (1921), Appendix, p. 125.

solutions are usually rose-coloured in the cold, but become blue when heated. A similar change in colour occurs in the solid salts; for the hydrated salts, which are pink, lose water when heated, becoming converted to blue compounds. This fact has led some chemists to believe that the colour-change observed in the solution is really a dehydration-process; it is possible to suppose that, at ordinary temperatures, the dissolved salt molecules or cobaltous ions are hydrated and appear pink, but that at higher temperatures they are not closely bound to the solvent and are therefore blue; another variation of the same theory supposes that the blue salts—although not anhydrous—contain a smaller number of water molecules than the pink salts. But these suggestions do not explain all the facts. For instance, a pink cobalt solution is turned blue by the addition of hydrochloric acid, or of calcium chloride. An alcoholic solution of cobalt chloride is also blue, but the addition of zinc, tin, or mercuric chloride will restore the pink colour of an alcoholic, or even of a warmed aqueous solution.

The explanation appears to be provided by the study of the behaviour of the pink and blue solutions on electrolysis.¹ If the blue solution of cobalt chloride containing calcium chloride is electrolysed, the blue constituent travels towards the anode; if the pink solution of cobalt chloride containing mercuric chloride is electrolysed, the pink constituent travels towards the cathode. Presumably, therefore, the solutions contain complex salts such as $\text{Ca}[\text{CoCl}_4]$ and $\text{Co}[\text{HgCl}_4]$. Complex anions containing cobalt are on this hypothesis blue, but cobalt cations are pink. The fact that cobalt enters the anion when calcium chloride is present, but is turned out when mercuric chloride is added is perfectly in keeping with our independent knowledge of the special tendency of mercury to enter into complex ions of this character.

If this explanation is to be extended to the colour changes in solutions of simple cobalt salts, we have to assume that there is an equilibrium between simple and complex ions, thus:—

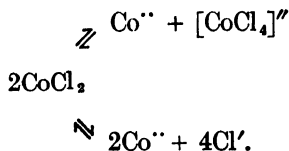

The Co^{++} ion (possibly hydrated) would confer a pink colour, and the complex anions such as $[\text{CoCl}_4]^{--}$ a blue colour. The amount

¹ F. G. Donnan and H. Bassett, *Trans. Chem. Soc.* **81** (1902), 939. Compare also J. E. Marsh, *Chem. News*, **109** (1914), 193.

of the two ions present would depend on the temperature and the nature of the solvent.

It is probable that this explanation is essentially correct. At the same time, a study of the absorption spectra of the various pink and blue solutions ¹ suggests that the matter may be somewhat more complicated than is indicated above. The absorption spectrum of the blue solution obtained by warming ordinary cobalt chloride solution is not identical with that produced by the addition of hydrochloric acid. It is possible that more than one complex anion can exist—each having its own absorption spectrum. It has even been suggested ² that many of the pink compounds are complexes of the type $[\text{CoX}_6]$ with the full co-ordination number six, whilst the blue compounds are built up on the basis of the co-ordination number four, containing ions of the type $[\text{CoX}_4]^{2-}$. According to this view, the blue colour of the alcoholic solution of cobalt chloride is due to the salt $\text{Co}[\text{CoCl}_4]$, as is generally believed; but the red colour obtained when excess of mercuric chloride is added is due to the compound

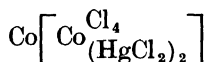

with the co-ordination number six.

A few of the salts can now be considered. The **sulphate**, $\text{CoSO}_4 \cdot 7\text{H}_2\text{O}$, may be prepared by crystallization from a solution of the metal in sulphuric acid; it forms rose-coloured monoclinic prisms, isomorphous with ferrous sulphate. The **nitrate**, $\text{Co}(\text{NO}_3)_2 \cdot 6\text{H}_2\text{O}$, may be isolated in the solid state by the cautious evaporation of its solution; it is also pink. The **chloride** is produced as a red hydrate ($\text{CoCl}_2 \cdot 6\text{H}_2\text{O}$) by the concentration of the solution; it is possible to drive off the whole of the water by cautious heating at 110°C ., without the formation of cobalt oxide and hydrogen chloride. The anhydrous chloride (CoCl_2), which is blue, can also be obtained by the action of chlorine gas on the metal.

The insoluble cobaltous salts are obtained by precipitation. The **carbonate**, CoCO_3 , is a bright red precipitate obtained by the action of sodium bicarbonate containing free carbon dioxide. Several **phosphates** are known; a red precipitate is obtained when common sodium phosphate is added to cobalt chloride. **Cobalt sulphide**, CoS , is a black precipitate produced when ammonium sulphide is added to a cobalt salt; although not pro-

¹ W. N. Hartley, *Trans. Chem. Soc.* **83** (1903), 401; H. C. Jones and H. S. Uhler, *Amer. Chem. J.* **37** (1907), 126.

² A. Hantzsch and Y. Shibata, *Zeitsch. Anorg. Chem.* **73** (1912), 309.

duced in the presence of dilute acids, the precipitate, when once formed, is only very slowly redissolved by dilute acids. Aqua regia attacks it more readily.

B. Compounds of Trivalent Cobalt (Cobaltic Compounds).

Cobaltic oxide, Co_2O_3 , is obtained when cobaltous nitrate is ignited; if the temperature of ignition is too high, it loses oxygen, yielding the intermediate oxide Co_3O_4 . It is a black-brown powder. The **hydroxide**, $\text{Co}(\text{OH})_3$, is obtained when a cobaltous salt is treated with sodium hypochlorite solution, preferably containing free alkali. If alkali is present, however, the dark brown precipitate contains far more oxygen than corresponds to the formula $\text{Co}(\text{OH})_3$, the exact oxygen-content depending on the concentration of sodium hypochlorite, the amount of alkali present, and other factors.¹ The precipitate acts as a catalyst causing the decomposition of the excess of sodium hypochlorite present, oxygen being evolved in bubbles.

Such simple cobaltic salts as exist at all are very unstable. If hydrated cobaltic oxide is acted on with well-cooled hydrochloric or sulphuric acid, it dissolves without gas-evolution, forming a dark yellow solution; but, when any attempt is made to evaporate these solutions by heating, they decompose, evolving chlorine or oxygen, and cobaltous salts are left. **Cobaltic sulphate**, $\text{Co}_2(\text{SO}_4)_3 \cdot 18\text{H}_2\text{O}$, however, can be prepared in the solid state by the anodic oxidation of a solution of cobaltous sulphate; if the cobaltous sulphate is placed in the anodic compartment of a divided cell, and is kept very cool throughout the electrolysis, blue crystals of the sulphate separate. They are very unstable, and the blue solution evolves oxygen at room temperature. If the solution contains ammonium sulphate, the double salt **cobaltic ammonium alum**, $(\text{NH}_4)_2\text{SO}_4 \cdot \text{Co}_2(\text{SO}_4)_3 \cdot 24\text{H}_2\text{O}$, separates in blue octahedra, isomorphous with the other alums. **Cobaltic fluoride**, CoF_3 , can be obtained electrolytically in an analogous way, and is a green substance.

Several green complex cobaltic salts have been prepared which appear to contain cobalt as a complex anion.² By the action of hydrogen peroxide on a solution of potassium oxalate containing cobalt oxalate, a crop of green crystals comes down; these consist of a complex potassium cobaltic oxalate, having the composition

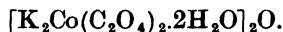

Other cobaltic compounds are obtained by the addition to

¹ O. R. Howell, *Trans. Chem. Soc.* **123** (1923), 65.

² R. G. Durrant, *Trans. Chem. Soc.* **87** (1905), 1781.

cobaltous solution of alkali-metal nitrites, which act first as oxidizing agents, and then as precipitants. When potassium nitrite is added to a solution of cobaltous chloride, **potassium cobaltinitrite**, $3\text{KNO}_2 \cdot \text{Co}(\text{NO}_2)_3$ or $\text{K}_3[\text{Co}(\text{NO}_2)_6]$, separates as a bright yellow precipitate. It is almost insoluble in water—one of the few sparingly soluble potassium salts—and only very slowly attacked by acids. **Sodium cobaltinitrite**, which is formed when sodium nitrite is added to a cobaltous salt, is quite soluble; its solution is sometimes used in the laboratory as an indicator for potassium salts.

The Cobaltamines. When a solution of a cobaltous salt is rendered ammoniacal and exposed to air, or treated with an oxidizing agent, ammonia derivatives of the cobaltic salts (often referred to as cobaltamines) are produced. These are a large family of compounds, more stable than the amines of most other metals,¹ and have awakened special interest owing to the diverse colours of the different classes. The mode of ionization of the cobaltamines accords—on the whole—with Werner's theory, although, in some cases, the question is complicated by reversible reactions with water. For instance, the salt $[\text{Co}(\frac{\text{NH}_3}{\text{H}_2\text{O}})_5]\text{Cl}_3$, in an acidified solution, readily loses water and yields $[\text{Co}(\frac{\text{NH}_3}{\text{Cl}})_5]\text{Cl}_2$. Consequently, the amount of chlorine ions in the solution—as ascertained by the conductivity-measurement or by any other method—is apt to be a rather variable quantity.

Details of the methods of isolating the different members of the family must be sought in one of the larger textbooks.² It is only possible here to sketch roughly the conditions under which a few of the more important compounds are formed. When, for instance, a concentrated solution containing cobaltic chloride, ammonium chloride, and ammonia is treated with bleaching powder for twenty hours at a low temperature, then boiled with concentrated hydrochloric acid, dark violet-red crystals of the so-called "**purpureo-cobaltic chloride**" $[\text{Co}(\frac{\text{NH}_3}{\text{Cl}})_5]\text{Cl}_2$ are obtained. From the chloride, other purpureo-salts of similar colour, and having the general composition $[\text{Co}(\frac{\text{NH}_3}{\text{Cl}})_5]\text{X}_2$ can be obtained.

¹ A. B. Lamb and A. T. Larson, *J. Amer. Chem. Soc.* **42** (1920), 2024, discuss the question of the relative stability of the different amines.

² "Gmelin—Kraut's Handbuch der anorganischen Chemie," Vol. V, Part I (C. Winter).

When the purpureo-chloride is dissolved in warm dilute ammonia it combines with water, yielding a solution of the brick-red "**roseo-chloride**" $\left[\text{Co} \begin{matrix} (\text{NH}_3)_5 \\ (\text{H}_2\text{O}) \end{matrix} \right] \text{Cl}_3$. As stated above, acids reconvert the roseo-chloride to the purpureo-chloride.

If, however, the purpureo-chloride is warmed with comparatively concentrated (20 per cent.) ammonia, and ammonium chloride, in a closed vessel, it combines with a further molecule of ammonia, and yields, on cooling, an orange or wine-red precipitate of the "**luteo-chloride**" $[\text{Co}(\text{NH}_3)_6]\text{Cl}_3$.

If an ammoniacal solution of cobaltic chloride is oxidized with air, treated with hydrogen chloride and then with ammonium chloride, the green "**praseo-chloride**" $\left[\text{Co} \begin{matrix} (\text{NH}_3)_4 \\ \text{Cl}_2 \end{matrix} \right] \text{Cl}$, mixed with the purpureo-chloride, is obtained. To obtain a praseo-salt free from purpureo-salts, the mixture can be dissolved in sulphuric acid; the addition of concentrated hydrochloric acid gives the green sulphate $\left[\text{Co} \begin{matrix} (\text{NH}_3)_4 \\ \text{Cl}_2 \end{matrix} \right] \text{SO}_4\text{H}$, which, when washed with dilute hydrochloric acid, regenerates the chloride.

The salts of the type $\left[\text{Co} \begin{matrix} (\text{NH}_3)_4 \\ (\text{NO}_2)_2 \end{matrix} \right] \text{X}$, which have been referred to in the introductory section of this volume (p. 5), are of interest owing to the fact that they exist in two isomeric forms. One form (the "cis" form) apparently represents the case where the two (NO_2) groups occupy adjacent positions in the shell surrounding the cobalt atom; in the other form (the "trans" form) they occupy opposite corners of the shell.

C. Compounds of Tetravalent Cobalt.

It has been mentioned that when a cobaltous salt is oxidized by sodium hypochlorite, the precipitate contains more oxygen than corresponds to the formula $\text{Co}_2\text{O}_3 \cdot x\text{H}_2\text{O}$; under certain circumstances the oxygen-content may approach the value represented by the formula $\text{CoO}_2 \cdot x\text{H}_2\text{O}$. The precipitate is either a mixture of the oxides Co_2O_3 and CoO_2 (hydrated), or perhaps consists of a solid solution of variable oxygen-content. If the oxidizing agent employed is sodium hypoiodite (that is, a mixture of iodine and concentrated caustic soda), a black precipitate with an oxygen-content nearly corresponding to that of the dioxide, CoO_2 , is obtained.¹ A hydrated form of the dioxide is said to be precipitated

¹ A. Metz, *Zeitsch. Anorg. Chem.* 86 (1914), 358.

on the anode when a solution of double cobalt ammonium fluoride is electrolysed.¹

The dioxide has a certain acidic character, forming salts which are known as the **cobaltites**. They are preferably obtained by fusing cobaltic oxide with other basic oxides in the presence of air in the electric furnace. The magnesium salt (MgCoO_3) is a hard, deep red mass with a metallic lustre; barium cobaltite (BaCoO_3) is nearly black.

D. Intermediate Compounds.

Intermediate oxide of cobalt, Co_3O_4 , is formed when either of the other oxides are heated in the air between 750° and 910° C.; but if heated too strongly it loses oxygen, yielding the monoxide CoO .² Co_3O_4 is a black substance, which, when obtained in the compact state, has a metallic lustre and is very hard. It is analogous in composition to the magnetic oxide of iron, but has no marked magnetic properties. The intermediate oxide is unattacked by most dilute acids and even by aqua regia, but sulphuric acid has an appreciable solvent action upon it; it dissolves in fused potassium bisulphate.

E. Miscellaneous Compounds.

Complex Cyanides of Cobalt. When potassium cyanide is added to a cobaltous salt, the red **cobaltous cyanide**, $\text{Co}(\text{CN})_2 \cdot 3\text{H}_2\text{O}$, is precipitated. If, however, excess of potassium cyanide is added, the precipitate redissolves, forming a red solution, which contains the complex salt, **potassium cobaltocyanide**, $\text{K}_4[\text{Co}(\text{CN})_6]$. The salt can be precipitated as a violet powder from a strong cool solution by the addition of alcohol. It is analogous to potassium ferrocyanide, but is much less stable, for on the addition of an acid to the solution, it is converted to **potassium cobalticyanide**, $\text{K}_3[\text{Co}(\text{CN})_6]$, hydrogen being evolved; in the presence of an oxidizing agent, for instance dissolved oxygen, the conversion takes place without the addition of acid. It is rather surprising that, whilst the simple cobaltous salts are so much more stable than the simple cobaltic salts, the cobaltocyanides are much less stable than the cobalticyanides, especially since, in the analogous iron compounds, the ferrocyanides are more stable than the ferricyanides. But the stability of the simple ions is, of course, no criterion of the stability of complex ions.

Several insoluble cobalticyanides can be obtained by precipitation, for instance ferrous cobalticyanide, which is white; cobaltous

¹ E. F. Smith, *Trans. Amer. Electrochem. Soc.* **27** (1915), 30.

² H. T. Kalmus, *J. Ind. Eng. Chem.* **6** (1914), 115.

cobalticyanide, $\text{Co}_3[\text{Co}(\text{CN})_6]_2$, is a pink precipitate, but becomes blue when heated.

Cobalt Carbonyls.¹ When finely-divided cobalt (obtained by the reduction of the oxide by hydrogen) is heated at 150°C . in a current of carbon monoxide under at least 30 atmospheres pressure, a tetra-carbonyl is formed. A special steel apparatus, capable of standing high pressure, and lined with copper to protect the steel from the gas, is required for the preparation. The carbon monoxide is first compressed in a cylinder from which it is allowed to flow through the steel vessel containing the heated cobalt. It leaves the vessel by an adjustable outlet valve, and passes through a glass tube where the carbonyl is deposited in orange crystals of composition $\text{Co}(\text{CO})_4$; the production is accelerated if the pressure is increased to 200 atmospheres. The crystals can be preserved in a sealed tube containing carbon monoxide, but decompose if exposed to the air. They are soluble in ether, alcohol and other organic solvents.

The tetra-carbonyl melts at 51°C ., and about 60°C . it gives off carbon monoxide, leaving the black tri-carbonyl $\text{Co}(\text{CO})_3$, which can be purified by dissolution in warm benzene; on cooling the pure tri-carbonyl is deposited. The tri-carbonyl readily decomposes if exposed to air.

Analytical

A trace of a cobalt salt confers a fine blue colour on a borax bead; this forms a sensitive test for cobalt.

The metal is not precipitated by hydrogen sulphide from a hot acid solution, nor is it precipitated by ammonia in the presence of ammonium chloride. It is, however, precipitated by ammonium sulphide from an ammoniacal solution. These facts serve for the separation of cobalt from most metals.

Three other metals, nickel, zinc, and manganese, are, however, precipitated under the same circumstances. The separation of cobalt from zinc depends on the fact that zinc is precipitated as sulphide when hydrogen sulphide is bubbled through a cold solution containing a trace of free sulphuric or hydrochloric acid, whilst cobalt remains in solution. If, on the other hand, the solution contains a weaker acid, for instance acetic acid, together with sodium acetate which serves to reduce the hydrion concentration, and if hydrogen sulphide is bubbled through at 80°C ., cobalt is completely precipitated as sulphide (together with nickel, if present), but manganese stays in solution.

¹ L. Mond, H. Hirtz and M. D. Cowap, *Trans. Chem. Soc.* 97 (1910), 798.

The separation of cobalt and nickel can be accomplished by adding a solution of α -dimethyl-glyoxime followed by ammonia; the nickel is brought down as a red precipitate, but the cobalt remains in solution.

A comparatively rapid method of separating cobalt from ferric iron, copper, zinc and arsenic, but not from nickel or manganese, is to add tartaric acid, then ammonia, and finally potassium iodide. Cobalt is thrown down as the ammine $[\text{Co}(\text{NH}_3)_6]\text{I}_2$ and nickel, if present, is also precipitated as the analogous compound $[\text{Ni}(\text{NH}_3)_6]\text{I}_2$. The function of the tartaric acid is to prevent the precipitation of iron by the ammonia.¹

Having obtained the cobalt in a solution free from other metals by one of the methods described above, it can be precipitated as the higher oxide by means of alkali in the presence of an oxidizing agent, such as bromine or potassium persulphate. The latter is preferable, since in the case of bromine it is necessary to add so much caustic alkali that there is a danger of the inclusion of alkali in the precipitate.² However obtained, the precipitate is dried, reduced by ignition in hydrogen to the elementary condition and weighed as metallic cobalt.

Alternatively, it is possible to deposit the cobalt electrolytically on a weighed cathode from a hot solution of the sulphate containing ammonium acetate and made alkaline with ammonia.³

TERRESTRIAL OCCURRENCE

Cobalt is a metal commonly associated with igneous intrusions of a basic character. The most important deposits.⁴ occur in the Temiskaming District of Ontario (the mining region being known generally as the "Cobalt District"). Besides cobalt, the minerals found in that region contain nickel, arsenic, silver and copper. The minerals are probably connected with certain intrusions of very early geological times (Huronian), but are not thought to be of direct igneous origin. Many geologists consider that they were deposited by thermal waters ascending from the intrusion. The minerals found include the arsenide and arsenide-sulphide of cobalt, known as,

Smaltite	CoAs ₂
and Cobaltite	CoAsS

¹ W. R. Schoeller and A. R. Powell, *Analyst*, **42** (1917), 189, 388; **44** (1919), 275.

² L. Dede, *Chem. Zeit.* **35** (1911), 1077.

³ E. F. Smith, *J. Amer. Chem. Soc.* **26** (1904), 1607.

⁴ W. G. Miller, *Eng. Min. J.* **76** (1903), 888; R. E. Hore, *Econ. Geol.* **3** (1908), 599; W. L. Whitehead, *Econ. Geol.* **15** (1920), 103.

together with arsenides and sulphides of nickel. Of the two cobalt minerals mentioned smaltite is a "tin-white" mineral, whilst cobaltite is grey. It seems probable that the nickel minerals were deposited first by the ascending waters, and that the cobalt arrived at a later stage, since niccolite (NiAs) is sometimes found in reddish crystals set in a grey ground mass of smaltite; but this view is not universally accepted. The native silver, which occurs in films or threads or mossy growths, appears to have been deposited in the last stages of the primary mineralization.

Deposits having, probably, a similar mode of origin occur in Saxony and Bohemia, where both cobalt and nickel minerals are found. Likewise cobalt is found in New Caledonia—also a nickel-mining district. All these localities are, however, of much less practical importance than Ontario.

Cobalt minerals are easily oxidized, and weathering products—containing the arsenate, sulphate, carbonate, and oxide of cobalt—are found along the outcrop of the cobalt deposits. The presence of cobalt in certain secondary manganese ores has already been mentioned in the section on manganese (Vol. II). The fact that cobalt is sometimes found in the ashes of seaweed indicates that cobalt is to some extent carried down in solution into the sea.

METALLURGY AND USES

The greater part of the world's supply of cobalt now comes from Ontario. At one time the complex ores were worked only for their silver, and the cobalt was largely lost in the slag. But the increased demand for cobalt—stimulated by the energy of the Canadian authorities in investigating new uses for the metal—has made it remunerative to work the ores for cobalt also.

The ores are usually concentrated by gravity methods—aided, in recent years, by flotation—before being subjected to the smelting operation proper.¹ It is stated that the ores and concentrates smelted in Ontario contain 4–10 per cent. of cobalt, 2–8 per cent. of nickel, 14–40 per cent. of arsenic, with a silver content ranging from 2 per cent. to 20 per cent.²

The process of smelting³ is usually carried out in a blast-furnace, often run with a rather low blast-pressure, because the ore always contains a considerable proportion of "fines." The charge consists of the ore mixed with limestone or siliceous fluxes, according to

¹ R. E. Dye, *Trans. Can. Min. Inst.* **20** (1917), 11; J. M. Callow and E. B. Thornhill, *Trans. Can. Min. Inst.* **20** (1917), 28.

² *J. Soc. Chem. Ind.* **36** (1917), 441.

³ S. B. Wright, *Trans. Can. Min. Inst.* **21** (1918), 269; R. W. Bridges, *Eng. Min. J.* **101** (1916), 646. See also O. Barth, *Met. u. Erz.* **16** (1919), 267.

requirements and fuel. The results of the smelting is to produce three separate substances, which are immiscible in the liquid state :

(1) *Bullion*, consisting of the easily reducible metals, like silver and copper, in the elemental condition ; this is found as a button when the solidified speiss is broken up.

(2) *Speiss*, a mixture of fused arsenides of cobalt, nickel and other metals ; and

(3) *Slag*, representing the rocky materials of the ore complex ; as far as possible, the more oxidizable metals of the ore, such as iron, should be eliminated in the slag, which is generally thrown away.

The bullion is further treated for the recovery of silver, by melting in an oil-fired tilting furnace acting on the principle of the Bessemer converter. An air-blast is passed through the molten bullion, which tends to oxidize the impurities. Oil-heating is not needed for the first half-hour, as the heat of oxidation of the base metals maintains the temperature. After about three hours the silver has reached a purity of over 99 per cent., and it is casted into ingots, which are sent to the silver refinery for further treatment.

The speiss which still contains some silver, as well as cobalt and nickel, is finely ground, mixed with salt and roasted—usually in a reverberatory furnace. This converts most of the remaining silver to chloride. The ore is extracted, first with water, which dissolves out some of the cobalt, nickel and copper as chlorides, and then with sodium thiosulphate so as to recover the silver, which is afterwards precipitated by means of sodium sulphide. The desilverized speiss is then mixed with siliceous fluxes, passed through the blast-furnace a second time to remove iron, again roasted with salt, and extracted as before, first with water and then with sodium thiosulphate. The residue is next mixed with sodium nitrate and sodium carbonate, and roasted in a reverberatory furnace ; this treatment converts the arsenic to the state of sodium arsenate, which can afterwards be leached out with water.

The residue left at this stage consists of oxides of cobalt, nickel and iron ; they may be dissolved in acid (hydrochloric or sulphuric) and the three metals must then be separated by fractional precipitation. As already stated, the quantitative separation is difficult, but a rough parting is carried out in the following way. Sufficient lime is added to precipitate the iron as hydroxide. Next sodium hypochlorite is added, and the cobalt is brought down as cobaltic hydroxide ; finally, by the addition of further milk of lime, nickel also is precipitated. The hydroxide of cobalt can be ignited

to give the oxide Co_3O_4 , which is used as the material for the manufacture of other cobalt compounds. If metallic cobalt is required, the oxide is reduced by heating with carbon in an oil-fired furnace. In one Canadian smelting works, the crude metal obtained is separated magnetically from the excess of carbon and remelted in an electric furnace. It can be granulated, if required, by pouring molten into water.

The watery extract obtained after the leaching of the salt-roasted speiss with water contains copper, cobalt, and nickel. The copper is removed with scrap iron, and then the cobalt or nickel are precipitated with alkali.

An important by-product of the cobalt-silver industry is white arsenic (arsenious oxide). The fumes from the various roasting furnaces must not be allowed to escape directly into the air, but are passed through a bag-house where large amounts of crude arsenious oxide is caught. On redistillation, it yields a much purer grade of white arsenic.

Cobalt Plating. The main future of cobalt in the unalloyed state appears to be as a material for plating iron, steel, brass, and other materials.¹ At present, nickel is largely used for this purpose, but it has been stated that cobalt-plating is actually more durable and less liable to corrosion than nickel-plating. Certain trials with cobalt-plated articles of a kind which are subjected to considerable abrasion in use (skate-blades and automobile parts), appear to indicate that this form of plating has unusually good wearing qualities. The plating adheres well to the steel, and shows no tendency to strip at the edges.

The plating of steel with cobalt is carried out in the same way as nickel-plating. The articles to be plated are made the cathodes, whilst the anodes are of cobalt. The bath consists of a solution of a cobalt salt. One bath which has been highly recommended is simply a saturated solution of cobalt ammonium sulphate. Largely owing to the fact that the cobalt salt is far more soluble than the corresponding nickel compound, satisfactory plating can be carried out at a current density far exceeding that possible with the analogous nickel bath. It was stated in 1915 that good deposits of cobalt could be obtained four times as quickly as was possible with the fastest nickel-plating solution then in use; rapidity of plating is, it should be stated, an important factor in determining the costs of plating an article. Since that time, however, those interested in nickel-plating, stimulated by the possible competition of cobalt, have made considerable advances in rapid nickelling.

¹ H. T. Kalmus, C. H. Harper and W. L. Savell, *Trans. Amer. Electrochem Soc.* 27 (1915), 75; B. Carr, *Trans. Faraday Soc.* 16 (1921), 488.

Another good cobalt-plating bath, containing cobalt sulphate, sodium chloride and boric acid, is even more rapid. Probably the boric acid serves to maintain the hydrion concentration within the correct limits, thus combining clean deposits with high current efficiency, whilst the chloride prevents the cobalt anodes from becoming passive, and thus avoids danger of the bath becoming depleted of cobalt salts. Since cobalt is much less liable to passivity than nickel, one of the main troubles met with in nickel-plating arises only to a much smaller extent in plating with cobalt.

Cobalt Alloys. Several alloys containing cobalt seem likely to have a considerable importance. "Stellite,"¹ an alloy containing cobalt, chromium, and tungsten, with some carbon, has been strongly advocated for the manufacture of tools; it is said to be far superior to high-speed tool steel as regards the life of the tools. Stellite is used also for surgical instruments and some automobile parts. It has good anti-corrosive properties, being unattacked by hot caustic alkalis, or by the acids contained in fruit juices. Stellite is very stable towards atmospheric oxidation, and has been suggested as a substitute for platinum in jewellery.²

In some varieties of stellite, molybdenum is used in the place of tungsten, whilst a modified alloy of the same class, known as Festel metal, consists of cobalt, iron, and chromium; Festel metal has been used for table knives.

An alloy of cobalt and chromium, analogous to nichrome, has been recommended for the winding of electric furnaces; it is said to be even more immune from oxidation than the nickel-chromium alloy used at present.³ Other binary alloys of cobalt and chromium have been used for dental and surgical instruments.

In addition, cobalt is to some extent used in alloy steels in the place of nickel. A steel with 35 per cent. of cobalt possesses valuable properties for the manufacture of permanent magnets.

Cobalt as a Colouring Agent in the Glass and Ceramic Industry. Cobalt oxide added to a glass mixture, even in such small quantities as 0.1 per cent., produces a very deep blue coloration in the resultant glass, the coloration being, of course, analogous to that produced when a trace of cobalt is added to fused borax. In addition to the use of cobalt oxide in the manufacture of blue glass proper, a considerable amount is employed in the manufacture

¹ S. B. Wright, *Trans. Can. Min. Inst.* **21** (1918), 272; L. Guillet and H. Godfroid, *Rev. Met.* **15** (1918), 339; K. L. Kronfeld, *Amer. Machinist*, **52** (1920), 293; E. Haynes, *Trans. Amer. Electrochem. Soc.* **37** (1920), 507.

² E. Haynes, *J. Ind. Eng. Chem.* **9** (1917), 974.

³ C. Baskerville, *Iron Coal Trades Rev.* **88** (1914), 501.

of blue enamels (for coating iron), and likewise as a colouring material in the ceramic industry.

In very much smaller quantities, cobalt is used in both the glass and ceramic industries to aid in masking the green or yellow colours which are produced by traces of iron. In glass, mixtures of manganese and cobalt oxides are used for this purpose, chosen to produce a bluish-violet tint complementary to the yellow-green colour caused by ferric iron. In certain kinds of china, the body is "whitened" by the addition of cobalt.

Cobalt Pigments. If a much larger proportion of cobalt than is used in cobalt glass is added to a fused mixture of silicates, a crystalline potassium cobalt silicate can be isolated on cooling. This is sometimes used as a pigment under the name *smalt*. It is made by fusing sand, potash, and cobalt oxide in a small glass furnace, the product being granulated by running into water, after which it is ground. It is levigated, so as to separate the grains of medium size, which alone are of value; the finer grains have too light a colour. The composition of smalt is rather variable, but the crystals obtained by adding cobalt oxide to a solution of silica in fused potassium fluoride have the composition $K_2O.CoO.3SiO_2$.¹

Various other blue and green pigments contain cobalt. "**Thenard's Blue**" is essentially a cobalt aluminate. The blue precipitate obtained when a solution containing the salts of cobalt and aluminium is precipitated with sodium carbonate has been employed, but a finer blue is produced when freshly precipitated cobalt phosphate is heated with freshly precipitated aluminium hydroxide. The main constituent of the pigment is probably the spinel $CoO.Al_2O_3$. A green aluminate, containing more cobalt oxide, has also been produced, but requires a longer period of heating; the formula $7CoO.5Al_2O_3$ has been assigned to it. An important green pigment known as **Rinman's green** is produced by the union of cobaltous oxide with zinc oxide. It does not consist of a definite compound, but of mixed crystals having a variable composition, $(Zn,Co)O$, which belong—as does pure zinc oxide—to the hexagonal system.² It is often made by heating cobalt phosphate with zinc hydroxide.

Cobalt Salts as Driers. Like the compounds of many other metals with more than one oxide, cobalt compounds catalytically aid the absorption of atmospheric oxygen by linseed oil and other oils of that class, and are much employed as "driers" in paints and varnishes. Various cobalt compounds have actually been used for

¹ A. Duboin, *Comptes Rend.* **172** (1921), 972.

² J. A. Hedvall, *Zeitsch. Anorg. Chem.* **86** (1914), 201; **121** (1922), 221.

this purpose, but, as in the case of manganese, there is a considerable advantage in introducing the metal as the "linoleate." Comparative experiments appear to show that cobalt compounds are more efficient driers for linseed oil than those of any other metal, being superior to the compounds of manganese, cerium, or lead.¹ For olive oil, there seems to be little to choose between cobalt and manganese.

¹W. M. Mackay and H. Ingle, *J. Soc. Chem. Ind.* **36** (1917), 317.

NICKEL

Atomic weight 58.68

The properties of nickel are related to those of cobalt and iron, which precede it in the periodic table, whilst it bears also a resemblance to copper, which follows it.

The Metal

Nickel is a grey-white metal, capable of assuming a brilliant lustre when polished. The specific gravity (8.8) is a little higher, and the melting-point somewhat lower (1,452° C.) than in the cases of cobalt and iron. Nickel is rather harder than pure iron. As in the case of iron, the presence of non-metals, such as hydrogen, oxygen, sulphur, or excess of carbon, is apt to render it brittle. The pure metal is ductile and malleable. It is magnetic at low temperatures, but—as in the case of iron—the magnetism disappears when heated.¹ The disappearance occurs in nickel between 345° and 370° C., the magnetic transformation being shown by an arrest on the “cooling-curve”²; the change seems to be accompanied by a discontinuity in the curves connecting the electrical resistance, thermo-electric properties,³ and coefficient of expansion⁴ with the temperature.

Nickel stands only just on the reactive side of hydrogen in the Potential Series, and consequently displaces hydrogen with no great readiness. However, when nickel is immersed in hydrochloric acid containing platinic chloride, black platinum is gradually deposited on the nickel, and then a slow evolution of hydrogen commences. By dilute nitric acid the metal is rather more readily attacked, but concentrated nitric acid renders nickel—like iron—passive.

Nickel can easily be rendered passive by anodic treatment in a bath from which chlorides are absent, the current density required to bring about passivity being much lower than in the case either of iron or cobalt.⁵

Nickel is remarkably stable towards atmospheric oxidation, and

¹ P. Curie, *Ann. Chim. Phys.* **5** (1895), 391; K. Honda, *Ann. Phys.* **32** (1910), 1008.

² Balkow, *Int. Zeitsch. Met.* **6** (1914), 115.

³ E. P. Harrison, *Phil. Mag.* **3** (1902), 177, 191.

⁴ E. Jänecke, *Zeitsch. Elektrochem.* **25** (1919), 9.

⁵ Compare H. G. Byers and C. W. Thing, *J. Amer. Chem. Soc.* **41** (1919), 1902.

the compact metal suffers no appreciable change under ordinary conditions. It is probable that an invisible protective film is produced over the surface, for the finely divided metal oxidizes readily in air without previous heating, and may actually be pyrophoric.

Nickel takes up hydrogen gas even more readily than iron, being capable of dissolving seventeen times its own volume of that gas. Finely-divided nickel saturated with hydrogen is a powerful reducing agent. The hydrogen is probably partly adsorbed upon the surface, partly dissolved within the metal; the absorption of hydrogen by metals is considered further in the section on palladium.

Laboratory Preparation. Nickel is best obtained from its compounds by the electrolysis of the aqueous salt solutions, a shiny deposit being produced on the cathode. A solution of the sulphate, made faintly acid with acetic or boric acid, or, indeed, any of the plating-baths mentioned in the technical section, will serve the purpose. The question of the character of the deposit and the current efficiency will there be discussed. Finely divided nickel is prepared, as a black powder, by heating the oxide strongly in a current of hydrogen.

Compounds

All the salts of nickel are derived from the oxide NiO , corresponding to ferrous and cobaltous oxide. Higher oxides, Ni_2O_3 , NiO_2 , and possibly others exist, but they seem to have no basic character. It is interesting to note that the salts in which the metal is trivalent are, in the case of iron, quite fairly stable; in the case of cobalt, they are unstable, except the complex salts; and in the case of nickel they are practically absent.

A. Compounds of Divalent Nickel (Nickelous Compounds).

Nickelous oxide, NiO , is formed when the finely divided metal, or the carbonate or nitrate, is ignited in air at a high temperature. It is also obtained by heating the metal in steam, or by the reduction of the higher oxide in hydrogen at 206°C . The anhydrous oxide has a green colour, but becomes yellow when heated. The **hydroxide**, $\text{Ni}(\text{OH})_2$, is prepared by treating an aqueous solution of a salt with caustic alkali, and is a pale green precipitate. It dissolves in acids forming green solutions of nickelous salts, and resembles copper hydroxide in being soluble in ammonia, with the formation of a violet-blue liquid.

The **nickelous salts** are formed in solution when the metal or the hydroxide is dissolved in an acid. The hydrated salts are

green in the solid state, and form green solutions ; but, as in the case of cobalt compounds, the anhydrous salts have a different colour, being, in most cases, yellow. Most of the anhydrous salts have the power of absorbing ammonia gas, giving violet additive compounds ; some heat is evolved during the absorption of the gas.

The **sulphate**, as obtained by crystallization from aqueous solution at room temperature, has the composition $\text{NiSO}_4 \cdot 7\text{H}_2\text{O}$; the green rhombic crystals are isomorphous with the sulphates of iron, magnesium, zinc, and many other metals. The yellow anhydrous salt (NiSO_4) is obtained when the crystals are strongly heated. A solution of nickel sulphate containing ammonium sulphate deposits deep green crystals of the double salt **nickel ammonium sulphate**, $(\text{NH}_4)_2\text{SO}_4 \cdot \text{NiSO}_4 \cdot 6\text{H}_2\text{O}$, isomorphous with the corresponding iron compound.

Nickel nitrate, $\text{Ni}(\text{NO}_3)_2 \cdot 6\text{H}_2\text{O}$, is very soluble and deliquescent, and is best prepared by evaporating the solution of nickel in dilute nitric acid. A solution of nickel or nickel oxide in hydrochloric acid deposits green crystals of the hydrated **chloride**, $\text{NiCl}_2 \cdot 6\text{H}_2\text{O}$, but if evaporated to dryness in a current of hydrogen chloride gas, the anhydrous chloride sublimes. The latter can also be prepared by the direct action of chlorine on the metal. It can be purified by sublimation in a stream of an inert gas, and then forms golden flakes ; but if heated in air it is largely converted to oxide.

The insoluble salts of nickel include the **carbonate**, NiCO_3 , and various **phosphates** ; these are green precipitates obtained by double decomposition. The **sulphide**, NiS , on the other hand, is a black precipitate, formed when ammonium sulphide is added to a nickel salt. It is not formed in the presence of acids, but when once precipitated it is not redissolved—or at least only very slowly redissolved—on boiling with hydrochloric acid. It is not dissolved by excess of pure ammonium sulphide ; but “yellow ammonium sulphide,” which contains polysulphides, dissolves it (or, perhaps, peptizes it) to a sufficient extent to cause a brown coloration in the filtrate.

When potassium cyanide is added to a nickel salt solution, a green precipitate of **nickel cyanide**, $\text{Ni}(\text{CN})_2$, is formed. This dissolves in excess of the precipitant, and from the solution, the double salt, $2\text{KCN} \cdot \text{Ni}(\text{CN})_2$, can be obtained by recrystallization. Although this salt probably behaves in solution to a certain extent as a complex salt, $\text{K}_2[\text{Ni}(\text{CN})_4]$, the solution contains sufficient nickel ions to show most of the ordinary reaction of nickel. Nickel can be completely precipitated as nickelic oxide by the addition of caustic alkali and a hypochlorite to a cyanide solution ; this fact

has been used to detect nickel in the presence of iron and cobalt, which possess more stable complex cyanides. On the other hand, nickel is not precipitated by ammonium sulphide from a cyanide solution, and this fact serves to separate it from zinc, which has a less marked tendency towards the formation of complex anions, and can be precipitated under these conditions.

B. Compounds of Trivalent and Tetravalent Nickel.

Higher Oxides of Nickel. When nickelous nitrate is heated in air at a low temperature, the black product contains more oxygen than the monoxide, and is generally described as being nickelic oxide (Ni_2O_3). The oxygen content appears to be variable, and according to some authorities,¹ the product often contains NiO_2 . When heated strongly, it loses oxygen, nickelous oxide being produced. When a nickelous salt is treated with alkali in the presence of an oxidizing agent, such as sodium hypochlorite, a black precipitate is produced which is generally described as the trihydroxide, $\text{Ni}(\text{OH})_3$. But here again the oxygen-content is very variable, depending upon the oxidizing agent used, and upon the conditions of precipitation.² It seems possible that a series of solid solutions with oxygen-content varying from Ni_2O_3 to NiO_2 can exist. The black peroxides have no basic character; when treated with sulphuric or hydrochloric acid, a nickelous salt is formed, oxygen being evolved in the one case and chlorine in the other.

There are indications that the oxides NiO_2 and Ni_2O_3 (and also solid solutions of composition intermediate between the two) may be formed by the anodic oxidation of nickelous oxide during the charging of the "nickel accumulator." This matter will be discussed in the technical section, but it may be mentioned at this point that the results seem to indicate that the oxide Ni_2O_3 has a real existence. The higher oxide NiO_2 is black and very unstable. It appears to have a weak acidic character, since a derivative, $\text{BaO} \cdot 2\text{NiO}_2$, is formed when nickelic oxide (Ni_2O_3) and barium carbonate are heated in the presence of air in the electric furnace.

Higher Sulphides of Nickel. Two sulphides corresponding to the oxides just described are known. By treating nickel carbonyl with a solution of sulphur in carbon disulphide, Ni_2S_3 is obtained as a black precipitate. The other sulphide, NiS_2 , corresponding to

¹ J. N. Friend, "Textbook of Inorganic Chemistry," Vol. IX, Part I, p. 117 (Griffin); W. Vaubel, *Chem. Zeit.* **46** (1922), 978, states that if nickel oxide is treated with nitric acid, then heated to drive off the acid, and finally heated in an airbath at 280° - 330° C., the product has the composition NiO_2 .

² I. Bellucci and E. Clavari, *Atti Accad. Lincei*, **14** (1905), ii, 234; O. R. Howell, *Trans. Chem. Soc.* (1923).

iron pyrites, is made by strongly heating nickel and potassium carbonate with sulphur; after removal of soluble substances by water, a grey powder (NiS_2) is left behind.

C. Miscellaneous Compounds.

Nickel carbonyl, $\text{Ni}(\text{CO})_4$.¹ Nickel shows a greater affinity for carbon monoxide than does iron or cobalt. Only one carbonyl of nickel is known, but this is characterized by considerable stability, and can be obtained without the employment of pressures exceeding that of the atmosphere. If finely divided nickel, obtained by reducing the oxide in hydrogen, is warmed to about 30°C . in a current of carbon monoxide, and if the gas is led off through a U-tube cooled in ice, a colourless liquid collects in the U-tube.² This is nickel carbonyl. It is quite volatile at low temperatures, giving off a heavy poisonous vapour, and actually boils at 43°C . The vapour is stable above the boiling-point, possessing a normal density at 50°C . When heated to about 60°C . it decomposes, usually with an explosion, but, in the presence of uncombined carbon monoxide it is more stable. Nickel carbonyl freezes at -25°C .

The liquid carbonyl is scarcely decomposed by air-free water, in which it dissolves to a small extent, or even by aqueous solutions of acids or alkalis. It is readily soluble in benzene, alcohol, chloroform, and other organic solvents, the solutions being fairly stable. On the other hand, nickel carbonyl is quickly oxidized by the air, with the formation of nickel hydroxide.

If a stream of carbon monoxide containing nickel carbonyl vapour is passed through a heated glass tube, a metallic mirror of nickel, containing carbon, is produced.

Analytical

Nickel compounds impart a brownish-yellow colour to a borax bead heated in the oxidizing flame; in the reducing flame the bead becomes greyish, owing—it is said—to the formation of metallic nickel.

Solutions of nickel salts are usually green, but become blue when treated with excess of ammonia. Copper, also, yields an intense blue colour with ammonia.

An extraordinarily sensitive test for nickel (known as the "glyoxime test") depends upon the fact that α -dimethyl-glyoxime

¹ L. Mond, C. Langer, and F. Quincke, *Trans. Chem. Soc.* **57** (1890), 749. J. Dewar and H. O. Jones, *Trans. Chem. Soc.* **85** (1904), 203.

² E. Tassilly, H. Pénaud, and E. Roux, *Bull. Soc. Chim.* **29** (1921), 862, recommend a temperature of 45°C . and a pressure of 3 cm. of mercury.

added to an ammoniacal solution containing a nickel salt produces an intense scarlet coloration.¹ This reaction will serve to detect nickel at a concentration of one part in 1,000,000 parts of water ; if carried out carefully, it is even possible to detect one part in 30,000,000.²

Like cobalt, nickel yields a black precipitate with ammonium sulphide in the presence of ammonia.

The separation from other metals is carried out in exactly the same way as that of cobalt, whilst the method of separation of nickel from cobalt by means of dimethyl-glyoxime was referred to in the section dealing with the latter metal. Most of the remarks made with reference to the precipitation of cobalt apply also to nickel ; it is better to precipitate it by potassium persulphate in the presence of a little alkali than to precipitate by means of bromine, since in the latter method a large excess of alkali is needed, and the precipitate always contains adsorbed alkali. The rapid method of throwing down cobalt by means of potassium iodide and ammonia can be applied equally well to nickel.

Having removed all other metals from the solution containing nickel, it is best to deposit the nickel electrolytically and weigh it as metal. A solution containing excess of ammonium oxalate is often recommended, but this must be warmed during electrolysis ; moreover the deposit of nickel is liable to contain carbon which, under certain circumstances, may cause sufficient increase in weight to constitute a perceptible error. If the nickel is deposited from a solution containing ammonium sulphate and excess of ammonia, these objections are avoided ; electrolysis is conducted at the ordinary temperature.³

Where nickel has been separated from cobalt by means of dimethyl-glyoxime, the red precipitate, which has the composition $C_8H_{14}N_4O_4Ni$, can be filtered through a Gooch crucible, dried at $120^\circ C.$, and weighed.

A volumetric method of estimating nickel depends on titration with potassium cyanide in a slightly ammoniacal solution, silver iodide being used as an indicator. The solution (containing sodium citrate to prevent precipitation of iron, if present) is made alkaline with ammonia and treated with a known amount of silver nitrate and excess of potassium iodide. Cyanide solution is run in until the silver iodide begins to dissolve ; when no turbidity reappears on standing for fifteen minutes, it is known that cyanide is present in excess. Afterwards a "blank" titration is carried out with a

¹ L. Tschugaeff, *Ber.* **38** (1905), 2520.

² A. Chaston Chapman, *Trans. Chem. Soc.* **111** (1917), 213.

³ W. J. Marsh, *J. Phys. Chem.* **18** (1914), 705.

solution containing the same amount of silver nitrate, but no nickel ; and the titration reading is subtracted from the result of the previous experiment.¹

TERRESTRIAL OCCURRENCE

Nickel is a metal almost invariably associated with the most basic portions of intrusive rock masses. There are two localities possessing special importance owing to the occurrence of nickel. The first is the Sudbury district of Ontario (Canada), where the ores also contain copper, and the second is New Caledonia. In addition nickel ores occur in the Erzgebirge, in Norway, and elsewhere, but such ores are comparatively unimportant.

In the Sudbury district all the rocks have been folded into the form of a basin or syncline (see Fig. 35).² The nickel-copper ores

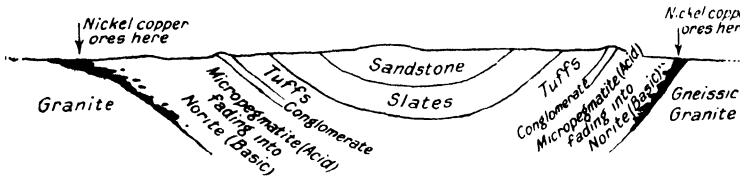

FIG. 35.—Sudbury Syncline, simplified section, facing South-west.

occur in an intrusive igneous mass, the inner and higher portions of which are comparatively acid in composition, being syenitic and even granitic ("micro-pegmatite"); in the outer and lower portions, however, near the junction with the country rock, the composition becomes highly basic, the rock passing gradually into a "norite." It is at the extreme fringe of the norite, resting upon the country rock itself, and also in the offshoots from the main intrusion, that the sulphide minerals containing copper and nickel are found. There has indeed been very much controversy regarding the origin of the ores.³ It seems probable that the sulphides must have separated from the silicate rock-mass whilst the whole was still

¹ F. E. Lathe, *J. Soc. Chem. Ind.* **41** (1922), 270r.

² Founded on the diagram given by A. P. Coleman, *Rep. Bur. Mines, Ontario*, **14** (1905), Part 3.

³ See J. H. L. Vogt, *Zeitsch. Prakt. Geol.* (1893), 125; D. H. Browne, *Econ. Geol.* **1** (1906), 467; A. E. Barlow, *Econ. Geol.* **1** (1906), 454, 545; W. Campbell and C. W. Knight, *Eng. Min. J.* **82** (1906), 909; C. W. Dickson, *Trans. Amer. Inst. Min. Eng.* **34** (1903), 3; W. G. Miller and C. W. Knight, *Eng. Min. J.* **95** (1913), 1129; C. W. Knight, *Eng. Min. J.* **101** (1916), 811; **102** (1916), 554; C. F. Tolman and A. F. Rogers, *Eng. Min. J.* **103** (1917), 226; E. Howe, *Econ. Geol.* **9** (1914), 505; M. A. Dresser, *Econ. Geol.* **12** (1917), 563; W. Lindgren, *Econ. Geol.* **15** (1920), 535; J. W. Gregory, *Trans. Chem. Soc.* **121** (1922), 756.

molten, since (as is well known to smelters) molten sulphides ("matte") are not miscible, except at extremely high temperatures, with molten silicates ("slag"); it is suggested that the high specific gravity of the sulphides, which are much heavier than the silicate-mixture, caused the separation of the two phases, the sulphide phase naturally sinking to the bottom. It is very probable that the differentiation of the sulphides and the silicates took place deep in the earth's crust, before the molten rock was forced up into the present position. On the other hand, some geologists assert that the concentration of copper and nickel in the places where they are now found took place long after the main intrusive igneous mass had solidified, and assume that the ores were deposited by thermal waters. It is extremely likely that not all the ores were produced in the same way; some of the deposits may have been a segregation from the molten magma, as suggested above; others may have been deposited by thermal waters arising from the mass or perhaps from some later intrusion.

The main sulphide mineral found at the edge of the intrusions is the iron sulphide,



but it exists in fine admixture with the copper mineral



and the nickel mineral



It is stated that the copper mineral is mainly found at the extreme outside of the igneous mass, right against the wall of the country rock, whilst the nickel is principally concentrated rather further from the edge. This is a matter of some little interest, as the same segregation of copper at the edge is met with when an artificially prepared mixture of fused iron, copper and nickel sulphides (the "matte" of the smelters) is allowed to solidify in a furnace.

The Sudbury ore contains on the average about 3 per cent. of nickel and $1\frac{1}{2}$ per cent. of copper, as well as an appreciable amount of silver, gold, palladium, and platinum. It is commonly stated that the nickel occurs in the pyrrhotite itself, replacing the iron—as in a mixed crystal. But a study of etched and polished sections of the ore-mass—prepared in a manner similar to sections of alloys—has made it certain that the nickel occurs in a separate phase, namely, as pentlandite. The pentlandite is not easily distinguished from the pyrrhotite—both being minerals of a pale bronze yellow colour and metallic lustre; but if the rock section is etched with

hydrochloric acid, the pyrrhotite is more readily attacked than the pentlandite, and the difference is made clear.¹

In addition to the nickel-copper ores of the Sudbury district, a considerable amount of nickel occurs in the complex cobalt-silver ores of the Temiskaming district of Ontario, mainly as the arsenides

Nicolite	NiAs
Chloanthite	NiAs ₂

and the sulphide

Millerite	NiS.
-----------	---	---	---	---	------

Nicolite is a pale copper-red mineral, whilst chloanthite has a tin-white colour. Millerite is peculiar in occurring in slender hair-like crystals.

The Temiskaming ores have been referred to in the section on cobalt. They are situated within 100 miles of Sudbury, and like the Sudbury ores are of Pre-Cambrian age.²

By the weathering of nickeliferous ores along the outcrop, various sulphates, oxides, carbonates, and arsenates have been produced.

The nickeliferous deposits of Norway are also found in a fringe of pyrrhotite and other minerals separating an intrusive norite from the country rock, and would seem therefore to have an origin similar to the Sudbury ores. On the other hand, the ores of New Caledonia are somewhat different, occurring in a serpentine rock. This must originally have been peridotite, that is, a highly basic igneous rock composed essentially of the mineral

Olivine	(Mg,Fe)SiO ₄
---------	---	---	---	---	-------------------------

This particular peridotite evidently contained nickel, as well as iron and magnesium. As was stated in the section on magnesium (Vol. II), peridotites readily undergo changes; and, when the mass of the olivine became hydrated, as the result of weathering, to

Serpentine	3MgO.2SiO ₂ .2H ₂ O,
------------	---	---	---	---	--

various hydrated silicates containing nickel, such as

Garnierite	(Mg,Ni)SiO ₃ .nH ₂ O,
------------	---	---	---	---	---

were also formed.³ As to whether garnierite is really a definite chemical compound is a little doubtful. The nickeliferous silicates are mainly found in the cracks which form an intricate network throughout the whole mass of serpentine, but also occur at some points in irregular masses. Undoubtedly water percolating through

¹ W. Campbell and C. W. Knight, *Eng. Min. J.* **82** (1906), 909.

² The connection between the Sudbury ores, the Temiskaming ores, and the gold ores of the Porcupine District is discussed by W. G. Miller and C. W. Knight, *Eng. Min. J.* **95** (1913), 1129.

³ F. D. Power, *Trans. Inst. Min. Met.* **8** (1900), 426.

the cracks has assisted in concentrating the nickel at certain points. The ore as mined contains 5-8 per cent. of nickel, although in some of the veins, in which nickel has become concentrated by the action of water, the content may reach 15 per cent. The New Caledonian ore, unlike that of Sudbury, contains no copper.

METALLURGY AND USES

Treatment of the Sulphide Ores of the Sudbury District, Ontario. As already stated, the Sudbury ores consist essentially of sulphides of iron, copper, and nickel; the first-named metal predominates. The treatment consists of two main processes:—

(1) The “**smelting**”; that is, the elimination of most of the iron, and the rocky matter, so as to produce a “**matte**” consisting of sulphides of nickel and copper. This is carried out near the mines in Canada.

(2) The so-called “**refining**” of the matte; that is, the separation of nickel and copper from one another, and the production of nickel in the metallic state. This has for some time been carried out—

(a) in Wales (near Swansea) where the **Mond Process** is used,

(b) in the United States, where the **Orford Process** is employed.

It is now being conducted also—

(c) in Canada itself, where the **Hybinette electrolytic process** is worked.

(1) **The Smelting of Sudbury Ore in Canada.**¹ The elimination of the iron from copper-nickel ores is carried out in very much the same way as from ordinary copper ores. The ore is partly roasted in heaps in an open roast-yard so as to expel a portion of the sulphur and oxidize part of the iron. The coarse ore is piled on a layer of “cord-wood,” and is then covered with a layer of fine ore, which prevents undue access of air. The roasting is started by lighting the wood, but the temperature is afterwards maintained by the heat of combustion of the sulphur, the slow combustion continuing for two or three months; the sulphur dioxide is allowed to escape into the air. This method of “heap-roasting,” however, is incapable of dealing with the greater portion of the fine ore, which is generally sintered in Dwight-Lloyd machines (see p. 62) or roasted in a multiple-hearth roaster.

A mixture of roasted ore, unroasted (“green”) ore, fuel, and

¹ *Mond Nickel Company Report*, July, 1914; especially pp. 22-28; T. W. Gibson, *Min. Ind.* 28 (1919), 481; see also *J. Soc. Chem. Ind.* 40 (1921), 209x.

if necessary a fluxing material to render the slag fusible, is then fed into a water-jacketed blast-furnace, similar to those used in ordinary copper smelting (see Fig. 36). The molten products of the blast-furnace flow into a settler or fore-hearth (preferably lined with chromite), and there separate into two layers, slag and matte. The slag represents the rocky constituents of the ore, and also contains much of the iron which has been oxidized during the roasting; the nickel and copper have fortunately a much lower affinity for oxygen, and do not enter the slag to any great

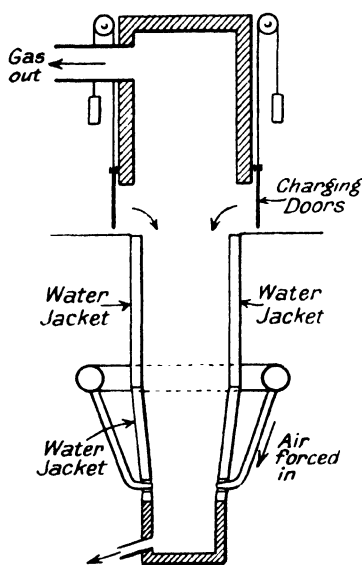

FIG. 36.—Water-jacketed Blast Furnace for Nickel and Copper Smelting.

extent. The matte consists of molten sulphides of nickel and copper, but still contains much iron. It is removed still liquid to a converter (also similar to those used in copper-smelting), a certain amount of siliceous nickel-copper ore being added, and air is then blown through the molten matte until the remaining iron and a part of the sulphur are oxidized; the iron oxide combines with the silica present in the ore which was added, and forms a slag. The heat of combustion of the sulphur maintains the necessary high temperature. After the process is complete, the contents are tipped into a settler, and separate again into two layers, slag and matte. The matte obtained consists almost entirely of sulphides of copper and nickel, and should only contain

about 1 per cent. of iron.

At some smelting establishments it has been found possible to reduce very much the proportion of roasted ore in the blast-furnace charge—or even to omit it altogether. In such cases, the conversion of the iron sulphide to ferrous oxide will be effected in the blast-furnace, and, owing to the heat of combustion of the sulphur, the amount of fuel needed for the charge can actually be reduced (as in the “pyritic” smelting of copper ores). There is a further advantage in employing unroasted ore; for where the ores are previously roasted, some of the iron may enter the furnace as ferric oxide, which requires reduction to the ferrous state before

it will enter the slag at all readily—another cause of fuel wastage. Thus the extensive use of green ore in the blast-furnace—apart from the avoidance of the expense of roasting—represents a real economy of fuel. But in spite of this economy, the application of “pyritic” smelting to nickel ores presents difficulties, as in most cases it leads to the production of a low-grade matte.¹

(2) “**Refining**” of the Nickel-copper Matte. Each of the three processes used for separating nickel and copper depend on some essential difference in the chemical behaviour of the two metals. Thus :—

(a) Nickel has a volatile carbonyl ; copper has none (the principle of the Mond process).

(b) Copper sulphide is soluble in fused sodium sulphide ; nickel sulphide is not (the principle of the Orford process).

(c) Copper is more “noble” than nickel, and can be precipitated by the latter from a salt solution in the metallic condition (the essential principle of separation in the Hybinette process).

The three processes can now be discussed in turn :—

(a) The **Mond Process**² is conducted at Clydach, near Swansea, (Wales), the raw material being copper-nickel matte imported from Sudbury. It depends on the fact that nickel forms a volatile carbonyl when carbon monoxide is passed over the warm metal. Since copper forms no such compound, it is possible, from a mixture of finely-divided nickel and copper, to distil off the nickel in a stream of carbon monoxide, and leave the copper behind. The nickel carbonyl is decomposed at a higher temperature (180° C.), and therefore metallic nickel is deposited if the gas is passed through a heated tower. The “distillation” of nickel in a current of carbon monoxide differs, therefore, from ordinary distillation in the fact that the “condenser” is hotter than the “still.”

The matte is first roasted in a mechanically-rabbed furnace, so as to yield a mixture of nickel and copper oxides, care being taken that the temperature does not rise too high. Under these conditions the nickel oxide produced will be in a form not quickly dissolved by dilute acids, whereas part of the copper will be converted to an oxide—or perhaps a basic sulphate—which can readily be extracted with warm dilute sulphuric acid. After the roasting, therefore, the product is leached with that acid, so as to remove as much copper as possible. Comparatively little nickel is dissolved out, and a considerable proportion of the copper (about one-third) is also left in the insoluble residue.

The undissolved residue, consisting of nickel and copper oxides,

¹ See *Min. Sci. Press*, 119 (1919), 428.

² A. P. Coleman, *Min. Sci. Press*, 107 (1913), 412.

is sent to the **reducing tower**, where it is reduced by means of water-gas (i.e. a mixture of hydrogen, carbon monoxide, and carbon dioxide), with the production of finely-divided nickel and copper. The reduction takes place in cylindrical iron towers working on the same principle as a multiple-hearth roaster. The towers contain about twelve horizontal shelves, one above the other. Alternate shelves (first, third, fifth, etc.) have openings at the periphery, the remainder having openings at the centre. The finely powdered oxide falls in through a hopper on to the top shelf, and is worked outwards by rabblers attached radially to a central rotating shaft towards the openings, where it falls on to the second shelf. Here the rabblers, fitted with blades pointing in the opposite direction, move it towards the centre. Thence it falls on to the third shelf. In this way it passes in turn over all the shelves in the tower, and meeting a current of water-gas which is blown in below is completely reduced to the metallic state before it reaches the bottom. The temperature of the higher part of the tower is kept at about 330°C ., the upper shelves being heated by means of producer-gas, whilst the lower shelves are water-cooled.

The finely divided metals drawn out from the bottom of the reducing tower are fed into the top of a similarly constructed "**volatilizing**" tower, kept at a temperature of about 50°C .; up this tower a stream of carbon monoxide passes. A large portion of the nickel is converted into carbonyl, and is carried off by the stream of carbon monoxide. The gas-stream is made to pass through a dust-chamber where it deposits most of the mechanically suspended matter, and then enters the "**decomposer**."¹ The latter is a cylindrical vessel filled with small nickel granules and heated to 180°C . The nickel carbonyl, coming in contact with the hot nickel granules, becomes decomposed owing to the high temperature, and deposits nickel upon them; thus the granules grow continually in size. To prevent the granules from growing into contact and thus cohering, they are kept in motion; granules are continuously withdrawn at the bottom by means of a worm conveyor, and those withdrawn are automatically raised to the top of the cylinder, and reintroduced. When the average size of the granules has reached that required for the market, the tower is emptied, and the full-size grains are sifted from the undersized ones (which have been produced by the deposition of nickel upon dust-particles carried over from the volatilizer). The undersize particles are reintroduced into the tower, and serve as nuclei for the deposition of nickel during the next run.

¹ W. C. Roberts-Austen, *Proc. Inst. Civ. Eng.* 135 (1898), 38, describes an early pattern of decomposer which is not unlike that now in use.

The whole of the nickel introduced into the volatilizing tower is not converted to carbonyl ; much remains with the copper drawn off at the bottom. Therefore the product obtained from the volatilizing tower is always returned to the roaster, then extracted with sulphuric acid as before, and the insoluble residue again sent to the reducing tower ; after this it is passed into the volatilizer for the second time. The material in practice may travel through the roaster, reducer, and volatilizer six or seven times before the whole of the nickel is obtained from it.

The carbon monoxide recovered by the decomposition of the carbonyl in the decomposer can be used to volatilize a further quantity of nickel, and passes back into the volatilizing tower. Of course, in practice, it is always necessary to add a little fresh carbon monoxide, and a reserve supply is kept in a small gas-holder.

Great care is exercised, in conducting the process, to prevent the escape of nickel carbonyl, which is a deadly poison ; so successful are the precautions adopted at Clydach that cases of poisoning are practically unknown.

The nickel produced by the Mond process is of high purity (about 99.8 per cent. nickel) ; it always contains far less iron than the matte from which it is made. It is probable that the iron is not to any considerable extent reduced to the metallic state in the reducing tower. If, however, the temperature in the reducing tower rises too high, reduction of iron may occur and, since iron also has a volatile carbonyl, it may distil over along with the nickel.¹

Besides metallic nickel, the process furnishes several other valuable products, such as copper sulphate, nickel sulphate, and small amounts of silver, gold, platinum and palladium. The solution obtained by leaching the roasted matte with sulphuric acid contains much copper sulphate, and only a little nickel sulphate. Most of the copper sulphate is recovered by crystallization, and sulphuric acid is added to the mother-liquor which is used to leach fresh roasted matte. After the same solution has been used several times to leach roasted matte, it comes to contain an important quantity of nickel sulphate ; it is therefore allowed to deposit as much copper sulphate as possible, and is then freed from copper by treatment with a mixture of metallic nickel and copper obtained from the reducing tower. This gives a solution containing a large amount of nickel sulphate, and the salt may be recovered by crystallization, and sold to the nickel-platers.

¹ According to F. H. Thorp, "Outlines of Industrial Chemistry" (Macmillan).

The material which has travelled through the leaching tanks, volatilizer, and reducing tower six or seven times, and which has given up nearly all its copper and nickel, contains valuable amounts of the precious metals. Silver is extracted with nitric acid and precipitated as chloride. Gold, platinum, and palladium are then extracted with aqua regia; of these, gold is precipitated in metallic form with ferrous sulphate. The acid filtrate is next treated with ammonium chloride, which precipitates platinum as ammonium platinichloride $(\text{NH}_4)_2\text{PtCl}_6$, whilst, on adding ammonia to the liquid, palladium also comes down as the ammine $\text{PdCl}_2 \cdot 2\text{NH}_3$.

(b) The **Orford Process**,¹ used in New Jersey, depends on the fact that copper sulphide is soluble in fused sodium sulphide. If the matte is fused with sodium sulphide, and allowed to separate, two layers will be formed. The top layer will contain the sodium sulphide, most of the copper sulphide, and any iron sulphide which may have survived the previous operations; the lower layer will consist of nickel sulphide, with only a little copper sulphide in it.

The process is conducted in the following way. The matte is melted with crude sodium sulphate and coal (or coke) in a reverberatory furnace lined with magnesite. The sulphate is reduced by the fuel to sulphide. After five hours, the charge is stirred with poles of green wood and allowed to separate, in the furnace, into two layers which are tapped separately.² The top layer is a valuable source of copper, whilst the bottom layer consists of nickel sulphide still containing a little copper and iron. It is sometimes again treated with sodium sulphate and coal to remove a further portion of copper.

Having produced sufficiently rich nickel sulphide, the reduction to the metallic state presents no special difficulty. The sulphide is roasted to oxide on the hearth of an ordinary reverberatory furnace. At this stage it is usually leached with sulphuric acid to remove the last traces of copper. Sometimes common salt is added to the charge before roasting; this converts any copper still present into the soluble chloride, which can subsequently be washed out by water alone. The purified nickel oxide is then mixed with fuel, and reduced to the metallic condition, usually in an oil-fired furnace. The nickel produced is often cast into anodes, and subjected to a final electrolytic refining, which probably serves to eliminate the non-metallic, rather than the metallic, impurities.

¹ See W. Borchers, "Metallhütten-betriebe" (Knapp, 1917), Vol. II.

² *Eng. Min. J.* 80 (1905), 1107.

(c) **The Hybinette Electrolytic Process.**¹ This process was developed in Norway, and is now being used in Canada. The nickel-copper matte is first roasted—usually in a multiple-hearth roaster—to expel most of the sulphur, and is then extracted with 10 per cent. sulphuric acid. This acid extracts most of the copper, as in the case of the Mond process; but in the Hybinette process the copper is recovered in metallic form by electrolysis of the solution between cathodes of sheet copper and insoluble anodes of lead. The sulphuric acid regenerated can be used to leach a further supply of roasted matte.

The residue left undissolved by the sulphuric acid contains 65 per cent. of nickel, about 27–32 per cent. of copper, 3–8 per cent. of sulphur, and a trace of iron. It is cast into anodes which are placed in bags of special canvas and fixed in position in the nickel-depositing cells. The cells are thus divided into cathodic and anodic compartments, and the solution is run constantly into the cell over the cathode, and is allowed to flow out at the same rate from the anode compartment. The cathodes consist of iron plates, previously rubbed over with a thin wash of water and graphite, the latter serving to prevent the unduly firm adhesion of the nickel deposit to the iron. The liquid as it enters the cell near the cathode consists of a pure nickel sulphate solution—nearly free from copper—and consequently fairly pure nickel is deposited on the cathode. A corresponding amount of metal is dissolved at the anodes, but, as these contain copper as well as nickel, the liquid leaves the cell containing much copper. It is then run into vessels in which it is treated with pieces of waste anode-material; interchange of the two metals occurs, copper being precipitated in a brown, spongy, metallic form (“cement copper”), whilst nickel takes its place in the solution; the reaction can be written

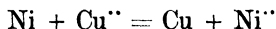

The solution is thus freed from copper, and can be returned to the cathodic compartment of the cell for deposition of nickel.

When the anodes become too much eaten away, they are replaced, the remaining portions being used in the purifying vessels for the precipitation of cement-copper. The precious metals (silver, platinum, palladium, gold), which are usually present in nickel ores, are not dissolved by the anodic reaction, and remain behind in the “anode slime,” which is carefully preserved and treated separately for the recovery of those metals. One of the advantages

¹ See *Report of the Royal Ontario Nickel Commission* (1917), 475–480; J. B. Kershaw, “*Electrometallurgy*” (Constable), gives some details regarding the process in its earlier form.

of the electrolytic process over the Orford process is that it allows a more complete recovery of the precious metals.

As already mentioned, the Hybinette process has for many years been used in Norway.¹ It is stated, however, that Norwegian nickel-production is at present at a standstill.²

The Smelting of the Silicate Ores of New Caledonia.³ The treatment of garnierite ores is more simple than that of the sulphide ores, since there is little or no copper in the former. Garnierite contains iron as well as nickel, however, and the separation of the two metals depends on a principle which is, in some respects, the converse of that used in the treatment of sulphide ores. In sulphide ores, the iron is converted to silicate by roasting and fusing with a siliceous slag, while the nickel remains as sulphide; in ores like garnierite, in which the metals are present as silicates at the commencement of the process, the nickel is converted to sulphide by treatment with calcium sulphide, whilst the iron remains as silicate.

The smelting is conducted in a small water-jacketed blast-furnace. The charge consists of ore, limestone, gypsum, and coal or coke; the gypsum is quickly reduced to calcium sulphide, which reacts with nickel silicate to produce nickel sulphide and calcium silicate; the latter mixes with the iron and magnesium silicates of the garnierite to form a slag. Consequently the liquid flowing out of the furnace separates into two layers, the lower one consisting of a nickel sulphide matte, and the upper one a silicate slag. The matte is roasted to yield nickel oxide, which is then reduced by heating with charcoal or coke in a retort or crucible furnace.

Some of the New Caledonia ore is shipped as such to France, where it is smelted and refined. But now a large amount of matte is produced in New Caledonia, and sent to France, or some other industrial country, for "refining"—that is, for reduction to the metallic state.

Uses of Nickel. Since nickel withstands corrosion and keeps bright better than most common metals, it finds extensive application, especially as it combines desirable mechanical properties with chemical stability. Pure nickel is used in the production of cooking utensils, whilst in the laboratory—and even at the chemical works—nickel crucibles are largely employed for processes involving fusion with caustic soda.

For many purposes it is possible to obtain satisfactory resistant properties by plating with nickel articles made of other materials.

¹ J. W. Richards, *Trans. Amer. Electrochem. Soc.* **20** (1911), 411.

² *J. Soc. Chem. Ind.* **39** (1920), 438*n*.

³ *Royal Ontario Nickel Commission Report* (1917), pp. 453–455.

It should be noted, however, that nickel is seriously attacked by damp air containing sulphur dioxide—a gas commonly present in the atmosphere of large towns.¹

Nickel-plating

The principle of nickel-plating is extremely simple. The article to be plated is scrupulously cleansed and then made the cathode of an electrolytic cell, being immersed in a solution of a nickel salt; the anode consists of a plate of nickel. When a current is passed through the solution, nickel should be deposited at the cathode, whilst an equal amount (under ideal conditions of working) is dissolved at the anode. But various troubles may occur at each electrode, and these will be considered in turn.

(i) *At the Anode.* If the current density becomes too high, the nickel may become passive, and the current (which ought to be devoted to the dissolution of nickel) may actually be expended upon the evolution of oxygen. This will render the bath acid, and at the same time the concentration of the nickel in the bath will fall. When once the anode has actually become passive, quantitative redissolution will not recommence even when the current density is reduced. It is noteworthy that commercial cast anodes, which are usually impure and contain both iron and carbon, become passive much less readily than anodes of pure rolled nickel. The difference may be due not only to the presence of the impurities, but also to the fact that the cast anodes corrode in such a manner as to keep the surface rough.² The anodic current efficiency can be improved by the addition of chlorides to the solution.

(ii) *At the Cathode.* If the current density is excessive, the potential may become sufficiently negative for the evolution of hydrogen; in such a case, the whole of the current will not be devoted to the deposition of nickel. This is all the more likely to occur if the hydron concentration is high, i.e. if the solution is strongly acid. Therefore, an undue acidity is, as in the case of iron-deposition, to be avoided. As little as 0.07 per cent. of hydrochloric acid lowers the current efficiency of nickel-deposition to about 80 per cent., whilst 0.14 per cent. of hydrochloric acid reduces the current efficiency to 40 per cent.³

On the other hand, if we start with a neutral bath, and hydrogen-evolution does occur, the bath will be rendered alkaline along the

¹ U. R. Evans, *Faraday Society* (1923).

² Compare S. A. Tucker and H. G. Loesch, *J. Ind. Eng. Chem.* 9 (1917), 841.

³ R. Reidel, *Zeitsch. Elektrochem.* 21 (1915), 5.

surface of the electrode, and a basic salt or hydroxide may be momentarily deposited. This will cause the nickel deposit to be incoherent. Thus, hydrogen evolution may be the precursor of a incoherent deposit, if a certain slight acidity is not maintained in the body of the solution. In any case the adherence of hydrogen bubbles to the cathode may prevent deposition at certain points, and thus give rise to pitting.

As in the case of iron-deposition, an increase in the bath temperature is favourable to the deposition of nickel—as opposed to the evolution of hydrogen—since the normal electrode potential of nickel becomes less negative as the temperature rises. Another factor which favours the deposition of nickel, and so raises the current efficiency, is the concentration of nickel in the solution; it is advisable to work with as strong a bath as possible. The higher the nickel concentration of the solution, the higher the permissible current density, and the more rapid the plating-process becomes. This is a most important point, which will be returned to later.

So far as possible, the plater must try to make the amount of current lost in the evolution of oxygen at the anode balance that wasted in the production of hydrogen at the cathode. When this condition is fulfilled, the bath—as a whole—will grow neither more acid nor more alkaline, and the nickel concentration will remain constant. If the balance cannot be maintained it may be necessary to keep adding nickel salts to the bath.

Another trouble connected with the deposition of nickel is the peeling of the deposit. Sometimes a perfectly smooth, compact deposit may be formed, but when this becomes thick it may commence to peel off from the basis metal in flakes or tight rolls. The peeling is less likely to occur if the deposition is conducted from a hot bath. The tendency to peel seems to be connected with the presence of hydrogen in the deposit, the escape of which gives rise to volume-changes which create a state of tension in the film. The use of a warm bath may prevent the film from taking up so much hydrogen. It is noteworthy that if the deposition is begun from a hot solution so that the first-deposited portions of the nickel layer adhere strongly to the basis metal, it can be continued from a cold bath without fear of peeling.¹

It seems that the peeling is comparatively rarely met with where perfectly pure nickel free from iron is being deposited on the cathode.² In any case, the presence of much iron in the deposit

¹ R. Riedel, *Zeitsch. Elektrochem.* **22** (1916), 281. Compare V. Kohlschütter and H. Schödl, *Helv. Chim. Acta*, **5** (1922), 490.

² K. Engemann, *Zeitsch. Elektrochem.* **17** (1911), 910.

is undesirable, since it renders the plating more liable to corrode. But since commercial cast nickel anodes generally contain a quantity of iron, it is difficult to avoid altogether the co-deposition of iron along with nickel.¹ The use of pure nickel anodes may introduce fresh difficulties, because they dissolve less easily, as already mentioned; it is therefore a common practice to employ at least a certain proportion of easily soluble, impure cast anodes. But if the bath contains chlorides, pure anodes can be used without serious risk of passivity, and thus the presence of any serious quantity of iron in the solution can be avoided.²

For a long time the standard nickel-plating bath consisted essentially of a saturated solution of nickel ammonium sulphate. This salt has given excellent results, but it is not particularly soluble, and, for the reasons explained above, it is only possible to obtain good plating at a high current density by maintaining a high concentration of nickel in solution. Now the cost of nickel plating can be greatly reduced if the plating is conducted rapidly because, for the same capital cost, a given plating-plant will have a much larger output of work. For this reason, nickel-platers—although they have shown themselves loth to abandon the double sulphate—have tended to turn to solutions containing more soluble salts. Undoubtedly, the very rapid plating which has been proved to be possible in the case of cobalt has stimulated interest in the possibility of obtaining similar rapid results with nickel.

Now the simple sulphate, $\text{NiSO}_4 \cdot 7\text{H}_2\text{O}$, is an extremely soluble salt, and its saturated solution is eminently suited for rapid plating. Since, for satisfactory anodic dissolution, chlorides must be present, it is advisable to add some nickel chloride also. Further, the hydron concentration must be adjusted within narrow limits. This could be done by adding a very small, carefully calculated quantity of a strong acid (e.g. hydrochloric acid); but it is far preferable to add a fairly large quantity of a weakly-ionized acid (such as boric acid) which—even if added in excess—can never produce an undue concentration of hydron, but which will act as a “reservoir” for hydron, and maintain the slight acidity for an indefinite period.³ Boric acid is indeed wonderfully effective for avoiding “burnt deposits” on the one hand, and low current efficiency on the other.

In this way, it is possible to arrive at the composition of a

¹ D. F. Calhane and A. L. Gammage, *J. Amer. Chem. Soc.* **29** (1907), 1268.

² F. C. Mathers, E. H. Stuart, and E. G. Sturdevant, *Trans. Amer. Electrochem. Soc.* **29** (1916), 383.

³ L. H. Hammond, *Trans. Amer. Electrochem. Soc.* **30** (1916), 128.

“rapid plating bath” on scientific principles.¹ Concentrated solutions containing nickel sulphate, with some nickel chloride and boric acid, give good deposits at much higher current densities than is possible with the older baths. As a rule they work best when warm. Many nickelling baths contain ammonium citrate, which prevents the formation of the sludge of ferric hydroxide that is otherwise likely to appear; on the other hand, by keeping the iron in solution and allowing it to be deposited with the nickel, they render the deposit darker. In some cases, magnesium salts are also added; they increase the conductivity, and are said to render the deposit whiter.

It is fair to add that the use of rapid baths has been subjected to much criticism. The critics state that some of the baths advocated do not give a satisfactory and adherent deposit.

The types of articles which come up for nickel-plating are very varied, and the details of the process vary accordingly. Large articles are suspended separately in the bath, whilst small articles such as safety-pins, pencil-cases, rivets, etc., are placed in quantities in wire baskets or trays, which are connected with the negative pole of the dynamo, the articles being constantly stirred or shaken about, so that all parts become nickelled.²

In the nickelling of cycle-parts to protect them from rusting it is sometimes the practice to apply a coat of nickel, then a coat of copper, and then a thinner surface covering of nickel.

Nickel-plating, like iron-plating, has been used for the restoration of the worn parts of machinery to their original dimensions.³

The so-called “black nickelling”—used to give an “oxidized” or “bronze” finish to brass articles—can be conducted from a bath containing nickel sulphate, zinc sulphate, and sodium thiocyanate; the black colour appears to be due to nickel sulphide.⁴

Nickel Alloys

It is convenient to refer first to **Monel metal**,⁵ an alloy consisting of nickel and copper, roughly in the proportions in which they occur naturally in many samples of Sudbury ore; it can be manufactured directly from the copper-nickel matte produced in that district, the work of separation of the two metals being thus avoided.

¹ O. P. Watts, *Trans. Amer. Electrochem. Soc.* **29** (1916), 395. Compare C. P. Madden, *Trans. Amer. Electrochem. Soc.* **39** (1921), 483.

² See G. Langbein, “Electrodeposition of Metals”: translation by W. T. Brandt, 1920 (Hodder & Stoughton).

³ *Engineering*, **111** (1921), 655.

⁴ *Met. Ind.* **21** (1922), 457.

⁵ J. Arnott, *J. Inst. Met.* **23** (1920), 545; P. D. Merica, *Met. Chem. Eng.* **24** (1921), 291.

It is only necessary to roast the matte and then to reduce the mixed oxides with charcoal.

Monel metal usually contains about 67 per cent. nickel, 29 per cent. copper, and 2–4 per cent. of iron and manganese. Metallographically, it consists of a single solid solution of nickel and copper. Its use depends not only upon the valuable mechanical properties, but also on the resistance to oxidation and to chemical corrosion. It has the tensile strength of a steel with 0.35 per cent. carbon, and—unlike many copper alloys—it retains its strength at high temperatures. Monel metal withstands shocks extremely well, and the properties appear to be almost unaffected by cold deformation. It is largely used for turbine blades, valves, and valve seats, and is especially useful where superheated steam is employed. As regards the chemical properties,¹ Monel metal is extremely resistant to corrosion at high temperatures. It is particularly suitable for use in strong alkaline solutions, and is used in the mechanical filters designed for filtering caustic soda from calcium carbonate in the manufacture of the former substance. Towards acid solutions it is rather less stable, but is used for the acid pickling tanks at one very large American tinplate works. It has also proved useful for various purposes in places like Panama, where most ordinary metals quickly become corroded owing to the peculiar atmospheric conditions.

Naturally, the favourable character of the mechanical properties involves the disadvantage that the manufacture of Monel metal articles is difficult; both the forging and the machining of Monel metal have presented various problems which, however, have largely been solved. Specially shaped tools must generally be used upon Monel metal. The casting of Monel metal is also difficult, owing to the considerable shrinkage of the alloy. Care must be taken, furthermore, that the liquid alloy does not absorb carbon or silicon, as these elements may render it brittle.

In many countries, nickel-copper alloys are used for coinage purposes. These coinage alloys are almost white, even where the percentage of copper is high; they are hard and very durable. The coins struck in France in 1920 contained 25 per cent. of nickel, 75 per cent. of copper.²

Another interesting alloy of nickel is **nichrome**, an alloy containing 11–25 per cent. of chromium, and usually iron (up to 25 per cent.). Aluminium, molybdenum, copper, and manganese have been used in special varieties. Nichrome is remarkably

¹ W. E. Oakley, *Met. Ind.* 6 (1914), 62; *Met. Chem. Eng.* 12 (1914), 68; *Met. Chem. Eng.* 14 (1916), 110.

² *J. Soc. Chem. Ind.* 39 (1920), 167R.

resistant to atmospheric oxidation even when exposed to the air at very high temperatures. The thin oxide-film formed upon the surface must have very remarkable protective properties. In the form of wire or ribbon nichrome has proved useful in the winding of small electric resistance furnaces. Nichrome crucibles have been used for brass-melting. The boxes used to contain steel articles which are to undergo heat-treatment may be made of cast nichrome.¹

German silver (or **nickel silver**) is a whitish alloy of nickel, copper, and zinc, much used in the arts; it may contain 48–67 per cent. of copper, 7–30 per cent. of nickel, 18–36 per cent. of zinc, but the composition varies considerably according to the purpose for which the alloy is intended. Alloys with comparatively small amounts of nickel have a very distinct yellowish tinge, but are often used for articles which are intended for electro-plating. German silver consists of a single solid solution, and can be regarded as an α -brass containing nickel.²

A similar alloy, which often contains tungsten in addition to the other three metals, is known as **platinoid**—on account of a certain resemblance to platinum. It may consist of 60 per cent. copper, 14 per cent. nickel, 24 per cent. zinc, and 1–2 per cent. tungsten. Platinoid wire is employed in various kinds of electrical apparatus, for instance, in rheostats, Wheatstone bridges and potentiometers, where a wire having a rather high resistance is needed.

Nickel is also added to steel to a considerable extent. It may be added as the metal, or as a rich nickel-iron alloy. **Nickel steel**—unlike special steels containing more valuable metals—can be made economically in the open-hearth furnace, the charge of nickel being added to the molten steel shortly before the furnace is tapped. It is the most important of the special steels, and is largely used for engineering work as well as for motor-car building, armour plate and other uses. Many nickel steels also contain chromium and vanadium. They are more resistant to corrosion than ordinary steels, and are specially suitable for case-hardening.

Nickel as a Catalyst ³

Although nickel compounds are comparatively ineffective as oxygen-carriers (“driers”), metallic nickel is largely used as a

¹ *Met. Chem. Eng.* **15** (1916), 159. Also R. M. Major, *Trans. Amer. Electrochem. Soc.* **37** (1920), 461; J. F. Kayser, *Trans. Faraday Soc.* (1923).

² For a discussion of the equilibrium diagram of the ternary alloys of copper, zinc, and nickel, see E. Tafel, *Metallurgie*, **5** (1908), 375, 413.

³ E. K. Rideal and H. S. Taylor, “Catalysis in Theory and Practice” (Macmillan); C. Ellis, “Hydrogenation of Oils” (Constable).

hydrogen-carrier in the hardening of oils and fats. Most of the animal fats which are suited for human food consist of the glycerine salts of certain "saturated" fatty acids. On the other hand, the cheaper vegetable oils—linseed, cotton-seed, palm-kernel, olive and soya-bean oils—as well as fish and whale-oils, consist largely of the glycerine salts of "unsaturated" acids, containing relatively less hydrogen; these are, in most cases, not suitable for the direct preparation of edible materials, such as margarine and lard.

Clearly if hydrogen can be made to combine with the unsaturated compounds, so as to form saturated compounds, a great economic problem is thereby solved. A reaction, originally introduced by Sabatier and Senderens for the hydrogenization of organic compounds of a different kind, has been adapted to this end. It consists in heating the substance in a stream of hydrogen—usually under pressure—in the presence of a suitable catalyst. As a catalyst, some metal capable of adsorbing hydrogen is required. In the laboratory, rare metals like palladium or platinum are often used, but in technology a cheaper material is naturally to be preferred, and finely-divided nickel—a catalyst which has also proved very useful in the laboratory—is very generally employed, although palladium and also to some extent platinum has been used in Germany. The process has been used for the hydrogenization both of the fats (glycerides) and of the free fatty acids.

The finely divided nickel is prepared in various ways. By the precipitation of a nickel salt solution with alkali, the hydroxide is obtained. This is heated to yield the anhydrous oxide, and the latter is then reduced in a stream of hydrogen gas, so as to give spongy metal. In general, the lower the temperature the more active will the nickel be as a catalyst.¹ The best temperature for reduction varies with the nature of the substance to be hydrogenized, but often seems to be about 300–350° C. It is convenient to precipitate the nickel within a porous substance, and thus obtain a large active surface. For instance, pumice² soaked in nickel nitrate solution and then dried and reduced in hydrogen at 300° C. is quite efficient; a very active catalyst can be prepared by precipitating nickel carbonate within a porous body like infusorial earth or charcoal and then reducing in hydrogen.³ However produced, the finely divided nickel is easily oxidized, and must be kept out of contact with the air. A very convenient catalyst for the hydro-

¹ P. Sabatier, *J. Soc. Chem. Ind.* **33** (1914), 735. See also J. B. Senderens and J. Aboulenc, *Bull. Soc. Chim.* **11** (1912), 641.

² T. W. A. Shaw, *J. Soc. Chem. Ind.* **33** (1914), 771.

³ C. Kelber, *Ber.* **49** (1916), 55.

genization of cotton-seed oil is obtained by heating nickel formate in the oil itself.¹

The hydrogen required for the process can be made by passing steam over iron; the iron oxide produced can afterwards be reduced with "water-gas" (hydrogen and carbon monoxide) and used again. Another method which has the advantage of giving a very pure hydrogen is the electrolysis of water; it is used considerably in districts where power is cheap.² To some extent the hydrogenization of fats is conducted in connection with the electrolytic alkali industry, in which hydrogen is produced as a by-product. Attempts have been made to use the hydrogen of water-gas, prepared by passing steam over incandescent coal, directly for the hydrogenization of oils; but it is difficult to free it from carbon monoxide.³

It is possible to carry out hydrogenization in a very simple manner, namely by bubbling hydrogen through the oil, the catalyst being immersed or suspended in the latter.⁴ But commercial plants are often much more complicated. In some processes the oil carrying the finely divided nickel in suspension is injected as a fine spray into a vessel filled with hydrogen, usually at considerable pressure, and kept at a temperature of about 180° C. Sometimes a foamy mixture of oil, catalyst, and hydrogen is injected into the vessel in which the hardening occurs. In other cases, a stream of hydrogen carries a "mist" of the unsaturated fat in fine drops over nickelized pumice. If the substance to be treated is volatile, it can be passed over the nickelized pumice in the gaseous state mixed with hydrogen; but this is not possible in the case of the glycerides, which would decompose if gasified. It has been shown possible also to obtain rapid hydrogenization by allowing the ordinary liquid oil to fall down a tube containing layers of the catalyst, hydrogen being forced upwards through the tube at the same time.

The oil passing out from the hydrogenizer is freed from the nickel catalyst by filter-pressing whilst still hot. Since the saturated bodies are mostly solid at the ordinary temperature—in contrast with the unsaturated oils—the product usually solidifies on cooling.

Fresh nickel—if prepared under proper conditions—is very active as a catalyst. It seems likely that the hydrogen attaches itself

¹ A. Brochet, *Bull. Soc. Chim.* **27** (1920), 897, 899.

² J. B. C. Kershaw, *Engineer*, **134** (1922), 314; E. F. Armstrong, *J. Soc. Chem. Ind.* **41** (1922), 392R.

³ For the commercial methods of obtaining and purifying hydrogen, see E. K. Rideal, *J. Soc. Chem. Ind.* **40** (1921), 10; also E. B. Maxted, *J. Soc. Chem. Ind.* **40** (1921), 169R.

⁴ E. R. B. Bolton, *J. Soc. Chem. Ind.* **41** (1922), 386R.

to the nickel surface, possibly as single atoms, and is then passed on to the organic substance, which possibly may also have attached itself to the nickel.¹ If, however, another foreign substance is present, which is capable of being adsorbed by nickel, it may act as a "poison." Sulphur and sulphur compounds, such as hydrogen sulphide, are particularly potent in reducing the catalytic activity of nickel, becoming adsorbed upon the nickel surface, which consequently loses its power of adsorbing hydrogen.² Naturally, the very forms of nickel which are most active as catalysts are most susceptible to "poisoning." It is necessary, therefore, to free the hydrogen gas that is to be used from the impurities which exercise this unfavourable action on the nickel. All volatile compounds of sulphur, and, in a lesser degree, those of arsenic and phosphorus, act as poisons. Another impurity which must be carefully excluded is carbon monoxide, a matter of some little importance in view of the desire to employ cheap water-gas as a source of hydrogen.³ Nitrogen, on the other hand, has but little poisoning action, although its presence in hydrogen serves to dilute the latter, and in addition it does appear slightly to diminish the adsorptive power of the catalyst.⁴

Hydrogenization of unsaturated fats is used to a large extent in the preparation of foodstuffs, both margarine and lard-substitute. The process often really serves a second purpose. As well as converting liquid oils into solid fats, it removes certain objectionable impurities present in the raw materials which are difficult to remove otherwise.⁵ Small traces of nickel can often be detected (by the glyoxime reaction) in many samples of fatty foods thus prepared. There is no serious ground for alarm by reason of the possibility of nickel-poisoning, since physiological tests have shown that the small quantity of nickel actually found is quite harmless.⁶ It is inevitable that small particles of nickel may sometimes penetrate the fabric of the filter-press, and escape with the fat, but, so long as the nickel is kept in the metallic condition, the quantity will be small. The only real danger is that the nickel may become oxidized, and that a fatty salt of nickel (nickel soap) may be formed,

¹ Compare the views of E. F. Armstrong and T. P. Hilditch, *J. Soc. Chem. Ind.* **39** (1920), 120r; **41** (1922), 67r. See also E. K. Rideal, *Trans. Chem. Soc.* **12** (1922), 309, who shows that the combination of hydrogen and ethylene in the presence of nickel is best explained if both reactants are supposed to become adsorbed upon the nickel surface.

² W. D. Bancroft, *Trans. Amer. Electrochem. Soc.* **32** (1917), 439; **37** (1920), 21; I. Langmuir, *J. Amer. Chem. Soc.* **38** (1916), 2274.

³ E. B. Maxted, *Trans. Faraday Soc.* **13** (1917-18), 36.

⁴ R. Thomas, *J. Soc. Chem. Ind.* **39** (1920), 16r.

⁵ E. R. Bolton, *J. Soc. Chem. Ind.* **41** (1922), 384r.

⁶ W. Clayton, *J. Soc. Chem. Ind.* **36** (1917), 1206.

which would perhaps pass out with the fat ; this is only likely to occur, if an oil containing free fatty acid is being treated.

Some authorities have strongly advocated the use of nickel oxide—made by the wet method—as a catalyst, and have claimed that its action is essentially different from that of nickel.¹ Others state that the oxide—when used as a catalyst—is quickly reduced to metallic nickel, and that it is really the metallic nickel which serves as the catalyst.²

The Nickel Accumulator³

Before leaving the subject of nickel, the Edison alkaline accumulator must be mentioned. In this cell, the active substances on the two electrodes in the uncharged condition consist respectively of ferrous oxide and hydrated nickelous oxide ; the electrolyte is alkaline, 20–25 per cent. potassium hydroxide with 1.5–5 per cent. of lithium hydroxide being recommended. Thus, in the discharged state, the system may be represented



(The oxides taking part in the changes are really hydrated, but, as the water-content varies with the conditions, it is left out of account.) When the cell is charged, the iron is reduced to the metallic condition, whilst the nickelous oxide is oxidized. It is probable that the primary product of oxidation is the peroxide (NiO_2), but this oxide is unstable, and after being formed, it slowly evolves oxygen, or reacts with any nickelous oxide which may still be present.⁴ If the cell is allowed to stand after charging, the oxygen-content of the product gradually falls off and finally reaches a value which corresponds roughly to the formula Ni_2O_3 . As the oxygen-content falls off, the potential at the electrode drops, and finally it becomes constant when the composition becomes constant at Ni_2O_3 . We can represent the cell in the charged state as

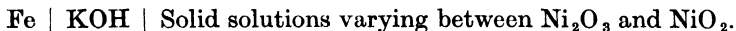

¹ F. Bedford and E. Erdmann, *J. Prakt. Chem.* **87** (1913), 425 ; E. Erdmann, *J. Prakt. Chem.* **91** (1915) 469. See also J. B. Senderens and J. Aboulenc, *Bull. Soc. Chim.* **17** (1915), 14 ; R. Willstätter and E. Waldschmidt-Leitz, *Ber.* **54** (1921), 113, state that metallic nickel quite free from oxygen has no catalytic activity, but C. Kelber, *Ber.* **54** (1921), 1701, who has also studied the question, states that it is more active when free from oxygen than when it contains oxygen.

² W. Normann and W. Pungs, *Chem. Zeit.* **39** (1915), 29, 41 ; W. Normann, *Chem. Zeit.* **40** (1916), 757.

³ L. C. Turnock, *Met. Chem. Eng.* **15** (1916), 259 ; A. E. Kennelly and S. E. Whiting, *Trans. Amer. Electrochem. Soc.* **6** (1904), 135 ; C. W. Bennett and H. N. Gilbert, *Trans. Amer. Electrochem. Soc.* **23** (1913), 359 ; *Met. Ind.* **2** (1910), 115. See also *U.S. Bür. Stand. Circ.* **92** (1920), which gives much practical advice on the use of this accumulator.

⁴ F. Foerster, *Zeitsch. Elektrochem.* **13** (1907), 414 ; **14** (1908), 285.

The E.M.F. needed to charge the cell must be sufficient to form the oxide NiO_2 , but the oxygen-content of the positive plate during the discharge is lower than corresponds to that formula. Consequently it is not surprising that the E.M.F. obtained when the cell is discharged is considerably less than that required to charge the cell; this is clearly a cause of loss of energy. Moreover, the E.M.F. tends to fall off as the discharge takes place—a further practical inconvenience. Fig. 37 shows the charging and discharging curves.

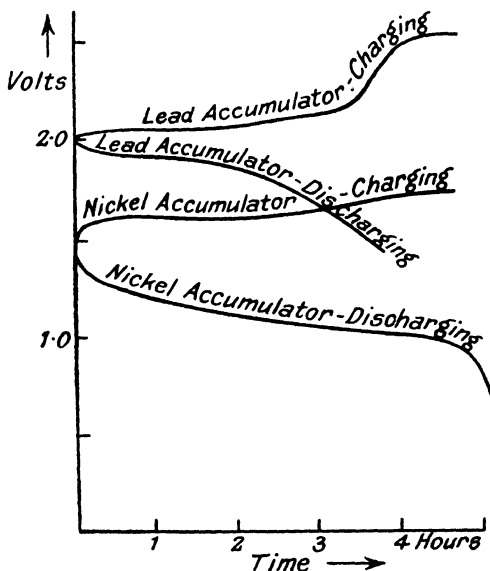

FIG. 37.—Charge and Discharge Curves of Lead and Nickel Accumulators.

charging curves of a nickel accumulator (along with the corresponding curves of the lead accumulator, for comparison). The cell must be charged at 1.7 volts (on the average), and only gives about 1.2 volts on discharge; thus the voltage efficiency represented as a fraction is about $\frac{1.2}{1.7}$ or 0.7. And since, during the latter

part of the charging, much current is expended on the evolution of oxygen gas, the current efficiency—at a normal rate of charging—is only 75 per cent. Consequently the energy efficiency¹ is about

$$0.7 \times 75 \text{ per cent.} = 52.5 \text{ per cent.}$$

¹ According to A. E. Kennelly and S. E. Whiting, *Trans. Amer. Electrochem. Soc.* 6 (1904), 146.

This compares unfavourably with the lead accumulator, which has an energy efficiency of about 80 per cent.

It is probable that a considerable part of the difference between the values of the charging and discharging E.M.F.s must be referred to irreversible reactions at the negative (iron) pole, which becomes active during the charging process, and comparatively passive during the discharge.¹

Another objection to the alkaline accumulator is the loss of charge on standing. Most of the NiO_2 that is present in the freshly oxidized electrode will gradually decompose when the battery is stored, oxygen being evolved.



Thus the accumulator loses, by storing for a day, about 10 per cent. of its charge, the E.M.F. diminishing from about 1.5 volts to about 1.3 volts. On the other hand, a further storage produces very little further "loss of charge"; consequently, for storing over long periods, the nickel accumulator may compare not unfavourably with the lead accumulator.

In construction the nickel accumulator plates differ radically from those of the ordinary lead accumulator. If the plates were made by pressing a pasty material of nickel oxide or of finely divided iron into an open grid, as in the lead accumulator, they would soon drop to pieces in use; for the volume-changes occurring when iron is converted to oxide, or when nickel peroxide is reduced, are very serious. Consequently the porous masses of iron and nickel oxides, which form the negative and positive plates respectively, are completely enclosed in perforated pockets of nickel-plated steel. Each plate has twenty-four pencil-shaped pockets, arranged side by side in two rows of twelve; each pocket is packed full of the porous mass which is tightly pressed down into the pocket, a considerable pressure being employed. The finished plates are, of course, much more durable than those of the lead accumulator, being wholly sheathed in steel. The Edison cell can thus be subjected to violent joltings, which would prove fatal to the ordinary lead accumulator.

The plates are set parallel to one another, as in the lead accumulator, the positive and negative ones being arranged alternately; the two outside plates being negative. There may be four positive plates and five negative plates in a cell. All the positive plates in one cell are connected together; similarly all the negative plates are connected together. The whole series is contained in a rectangular case also constructed of nickelled steel, the plates

¹ Compare F. Foerster and V. Herold, *Zeitsch. Elektrochem.* 16 (1910), 461. See also A. J. Allmand, "Applied Electrochemistry" (Arnold).

being separated from the case, and from one another, by means of hard rubber. The plates are covered, to within a short distance of the top, with the electrolyte, containing potassium and lithium hydroxides. The liquid penetrates, through the perforation of the steel envelopes, into the interstices of the porous mass. Nevertheless, possibly because the mass of iron and nickel oxides is not sufficiently porous, and consequently does not present sufficient active surface, only a portion of the material seems to take part in the changes, for the capacity of the plates is only a fraction of the theoretical value. The presence of the lithium hydroxide increases the capacity somewhat.

Various other proposals have been made with a view to increasing the capacity of the battery—and, incidentally, the charging and discharging rate. Many attempts have been made to utilize mixtures of oxides in preparing the active material. It has been proposed, for instance, to mix oxides of bismuth, cobalt, copper, mercury, or silver with the nickel oxide of the positive plate. Similarly, since iron is open to objection as a material for use in the negative plate, owing to the tendency to polarization and even to passivity, attempts have been made to replace it, in part or wholly, by cadmium. For a long time it has been customary to mix a little mercury with the iron of the negative plate; it seems to render the behaviour of the iron electrode less irregular. The cause of the action of mercury is still uncertain; it possibly serves to increase the conductivity of the mass.

The chief practical advantage of the Edison accumulator over the old lead accumulator is its mechanical strength. The plates can be subjected to rough usage without becoming broken. But this is due to the construction of the plates, and does not seem to be essentially bound up with the use of iron and nickel oxides as the active materials. The construction of the cell has a further advantage. Since there is no fear of the plates dropping to pieces, the cells may be charged or discharged abnormally quickly—when occasion demands—without fear of permanent injury.

But it was originally hoped that the nickel cell would solve the problem of the light accumulator, and in this respect it can hardly be said to have fulfilled expectations. It is perfectly true that nickel and iron are considerably lighter than lead, and have smaller atomic weights; in the reaction

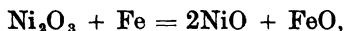

the weight of material theoretically needed to produce one ampere-hour is considerably less than in the reaction

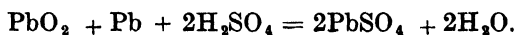

But the E.M.F. provided by the alkaline cell is much less than that of the lead cell, and if we consider the weights needed to store equal amounts of *energy*, there is less theoretical advantage in the use of the alkaline accumulator. However, in any case, theoretical calculations of the weight required are of little interest, since a large proportion of the material takes no real part in the changes. In the case of the lead cell (of the ordinary form), the "dead weight" is usually greatest, on account of the massive character of the plates which support the active mass. In the nickel cell, the dead-weight of the sheath, etc., is probably less serious, but it is clearly necessary to attribute the comparative lightness of the Edison cell to the superior mechanical strength of iron over that of lead, rather than to differences in specific gravity or atomic weight. Since buckling of the plates—so common in the lead accumulator—need not be feared in the Edison cell, it is possible to place the plates very close together without danger that they will touch; in one type of Edison cell, the clearance is only 0.04 in. Therefore, the volume and weight of the electrolyte is less than in the lead cell. In spite of these considerations, the advantage in weight of the Edison cell as compared to the *lightest* forms of the lead accumulator is not very marked. Two American authorities, shortly before the war, stated that "when referred to equal amounts of power delivered, the Edison Battery weighs about 25 per cent. less, and costs about 25 per cent. more, than the Ironclad Exide battery."¹

On account of the superior mechanical strength, the rapid charging rate and the slightly lower weight of the nickel accumulator, as compared with the lead cell, the former is to be preferred for traction purposes.

¹ C. W. Bennett and H. N. Gilbert, *Trans. Amer. Electrochem. Soc.* **23** (1913), 366.

RUTHENIUM

Atomic weight 101.7

Ruthenium, rhodium, and palladium have much in common with iron, cobalt, and nickel, but possess much higher melting-points, and are very much more "noble" in character. In the ruthenium-rhodium-palladium family, however, it is the first metal (ruthenium) which is the most noble—whilst in the iron-cobalt-nickel family it is the last (nickel).

The Metal

Ruthenium is a silver-white metal, with a brilliant lustre, hard and rather brittle. It is a little heavier than lead, the specific gravity being 12.2. The melting-point is extremely high (1,950° C.); the metal can only just be melted in the oxy-hydrogen flame.

Ruthenium stands nearly at the "noble" end of the Potential Series, and is more resistant to reagents than any of the metals which have, up to this point, been described. Like gold, it is not attacked by any single acid, and it appears to be more noble than gold in that compact ruthenium is only very slowly dissolved even by aqua regia. Finely divided ruthenium, however, is comparatively quickly attacked by aqua regia. It is probable that ruthenium does not really stand on the "noble" side of gold in the Potential Series, and that the comparative immunity of the former metal from attack by aqua regia is due to a tendency to become passive, a tendency common to all the "transition elements."

Ruthenium is not changed by exposure to the air at ordinary temperatures, but when heated in oxygen, it becomes covered with a brown or bluish film of dioxide; if fused it takes up oxygen more rapidly, a certain amount of the volatile tetroxide also being produced, which is recognizable by the odour. In addition, oxygen apparently becomes dissolved in the molten ruthenium, but when the metal is cooled, this oxygen is given up again, an effect not unlike the "spitting of silver" being produced. The similarity of the ruthenium-rhodium-palladium metals to silver in this and in other respects is not surprising in view of the fact that silver follows next after palladium in the periodic table.

Ruthenium is dissolved by sodium hypochlorite, and also by fused mixtures of potassium carbonate and nitrate; in the first

case ruthenium tetroxide is mainly produced, in the second case potassium ruthenate.

Laboratory Preparation. The metal is easily prepared from its compounds, many of which are decomposed by gentle heating alone. The oxides or chlorides yield the metal in a black, finely divided form when heated in hydrogen. Again by the action of zinc, or almost any reactive metal, on the aqueous solution of a ruthenium salt, a black spongy form of the metal is produced.

The preparation of ruthenium from materials containing a mixture of the platinum metals may be carried out by one of the methods referred to in the analytical section.¹

Compounds

Various compounds of ruthenium are known in which the metal appears to exercise valencies of 2, 3, 4, 6, 7, and 8 respectively. The two lowest oxides of ruthenium, Ru_2O_3 and RuO_2 , have a basic character, several salts corresponding to each of them being known. One or two salts derived from an unknown lower oxide, RuO , have been described. Compounds derived from the unknown acidic oxides RuO_3 and Ru_2O_7 can be prepared; these are analogous to the manganates and permanganates. A curious volatile oxide, RuO_4 , is known, which is without derivatives.

The passage from one class of ruthenium compounds to another is accompanied by colour-changes. For instance, a red solution of the sulphate $\text{Ru}(\text{SO}_4)_2$, containing tetravalent ruthenium, when reduced with sulphur dioxide gas gradually becomes blue, and then becomes colourless or pale yellow.² From the blue solution, a blue sulphite, $\text{Ru}_2(\text{SO}_3)_3$ containing trivalent ruthenium, can be precipitated by the addition of alcohol, whilst the final (yellow or colourless) solution yields pale yellow crystals, which are believed to be the dithionate, RuS_2O_6 , containing divalent ruthenium.

A. Compounds of Trivalent Ruthenium.

The sesqui-oxide, Ru_2O_3 , may be present in the mixture produced when finely divided ruthenium is heated in air. The corresponding hydroxide $\text{Ru}(\text{OH})_3$ is obtained when the chloride (RuCl_3) is precipitated with caustic soda. The hydroxide is dark brown, and is difficult to wash free from alkali; if the water is

¹ For the preparation of pure ruthenium from commercial ruthenium, see also A. Gutbier and C. Trenkner, *Zeitsch. Anorg. Chem.* **45** (1905), 167.

² U. Antony and A. Lucchesi, *Gazetta*, **28** (1898), ii, 139; **30** (1900), ii, 71. See, however, H. Remy, *Zeitsch. Anorg. Chem.* **113** (1920), 235.

driven off by heating in carbon dioxide, the black anhydrous oxide is left.¹

The corresponding salts are formed when the hydroxide is dissolved in acids, yellow solutions being produced. They are more easily prepared in other ways. The chloride, for instance, is formed when the higher oxide (RuO_4) is dissolved in hydrochloric acid, chlorine being evolved in the reaction. It is a brown crystalline substance, hygroscopic and very soluble in water, yielding a yellow solution, which when warmed becomes ink-black owing to hydrolysis, the coloration being usually attributed to a basic chloride. When a solution containing alkali-metal chlorides is concentrated by evaporation, brownish double salts such as **potassium ruthenium chloride** ($\text{RuCl}_3 \cdot 2\text{KCl}$ or K_2RuCl_5) can be isolated in the solid state.

The other salts are less stable. A blue **sulphite** ($\text{Ru}_2(\text{SO}_3)_3$) has been mentioned above as being formed from the sulphate of tetravalent ruthenium by reduction with sulphur dioxide. Certain double **nitrites** corresponding to the cobalti-nitrites can be obtained by double decomposition. By the action of sulphuretted hydrogen on a solution of the chloride (RuCl_3), a grey-black precipitate is obtained; this is a mixture of sulphides, and contains also free sulphur. It is very likely that Ru_2S_3 may be present. One action, however, of hydrogen sulphide upon the trichloride is to cause reduction; the clear liquid left when the sulphide precipitate has settled is often blue,² and probably contains the dichloride (RuCl_2).

All the salts have the power of combining with nitric oxide, just as have the ferrous salts. By the action of aqua regia on ruthenium trihydroxide $\text{Ru}(\text{OH})_3$, red crystals of the compound $\text{RuCl}_3 \cdot \text{NO} \cdot \text{H}_2\text{O}$ can be obtained. By combination with potassium chloride a violet-brown double salt $2\text{KCl} \cdot \text{RuCl}_3 \cdot \text{NO}$ or $\text{K}_2 \left[\text{Ru} \begin{matrix} \text{Cl}_5 \\ (\text{NO}) \end{matrix} \right]$ is produced.

B. Compounds of Tetravalent Ruthenium.

Ruthenium dioxide, RuO_2 , is said to be the oxide mainly produced when ruthenium is strongly heated in oxygen; it is more conveniently prepared by heating the corresponding sulphate, $\text{Ru}(\text{SO}_4)_2$, and remains as a black powder when all the oxides of sulphur have passed away. If heated above $1,000^\circ \text{C}$., it breaks up into ruthenium and the volatile tetroxide (RuO_4). Below 600°C ., however, the tetroxide itself breaks up into the dioxide and oxygen. Thus the dioxide displays an apparent volatility, and when metallic

¹ A. Gutbier and F. Ransohoff, *Zeitsch. Anorg. Chem.* **45** (1905), 253, 254 (especially the footnote).

² See A. Gutbier and C. Trenkner, *Zeitsch. Anorg. Chem.* **45** (1905), 173.

ruthenium is heated in a porcelain tube in a current of oxygen, a ring of fine crystals consisting of the dioxide appears in the cooler part of the tube, and sometimes also a black amorphous body containing rather more oxygen.

Only a few of the salts are known, even in solution; in all cases the yellow-red solutions are unstable. The simple **chloride**, (RuCl_4) , for instance, is difficult to isolate, as it readily loses chlorine. Double salts, such as potassium **ruthenichloride**, $2\text{KCl}\cdot\text{RuCl}_4$ or $\text{K}_2[\text{RuCl}_6]$, corresponding to the platinichlorides, are known. The potassium salt is best obtained by the action of a fused mixture of potassium hydroxide and potassium chlorate upon metallic ruthenium; the product of this fusion is extracted with cold water, and the solution is made acid with very dilute hydrochloric acid and then allowed to evaporate *in vacuo* over quicklime.¹ It deposits red-brown crystals which, like potassium platinichloride, are somewhat sparingly soluble in cold water; the salt is decidedly unstable.

By the action of hydrogen sulphide on a ruthenichloride, a mixture of sulphides is precipitated.² If thrown down from a hot solution, the precipitate corresponds approximately to the formula, RuS_2 . When this precipitate is oxidized with nitric acid, the **sulphate**, $\text{Ru}(\text{SO}_4)_2$, is obtained; it is a yellow-brown substance, with a yellow-red solution.

C. Compounds of Divalent Ruthenium.

Very few undoubted compounds of divalent ruthenium are known in the solid state. The exact nature of the yellow compound formed by reduction of the higher ruthenium salts with sulphur dioxide is still a little doubtful; if, as suggested above, it is a dithionate, RuS_2O_6 , it is presumably a compound of divalent ruthenium. A **chloride** (RuCl_2) probably exists—as has been remarked—in the blue solution obtained by reducing the higher chlorides with hydrogen sulphide; the same blue solutions can be obtained by reduction with sodium amalgam. They are very unstable and the reduction should be carried out in an atmosphere of carbon dioxide. The addition of caustic soda to the blue solution yields a brownish coloration or precipitate.³

Complex cyanides exist which are rather more stable. By heating potassium cyanide with the nitroso-derivative of potassium ruthenium chloride, $2\text{KCl}\cdot\text{RuCl}_3\cdot\text{NO}$, **potassium ruthenocyanide**, $\text{K}_4[\text{Ru}(\text{CN})_6]$ is produced. It is a colourless substance, isomorphous

¹ U. Antony and A. Lucchesi, *Gazetta*, **29** (1899), ii. 82.

² For details see F. M. Jaeger and J. H. de Boer, *Proc. Amst. Acad.* **23** (1920), 95.

³ H. Remy, *Zeitsch. Anorg. Chem.* **113** (1920), 229.

with potassium ferrocyanide, and, like the latter, gives precipitates with salts of various metals. The ruthenocyanides of zinc and lead are white; with ferrous salts a green precipitate is obtained, but ferric salts produce a violet coloration only.

D. Compounds of Hexavalent and Heptavalent Ruthenium.

Although the oxides RuO_3 and Ru_2O_7 have not been prepared in the free state, derivatives are known in which they appear combined with basic oxides. It is clear that an acidic character must be ascribed to these two oxides. If finely divided ruthenium is treated with a fused mixture of caustic potash and potassium nitrate, it is oxidized. When the mass is extracted with water, an orange-yellow solution is obtained, from which dark prisms of **potassium ruthenate**, K_2RuO_4 , can be isolated by crystallization. They usually appear green by reflected light, but are red by transmitted light. If chlorine gas is bubbled through the solution, further oxidation occurs; the liquid darkens, and deposits black crystals of **potassium perruthenate**, KRuO_4 . This is much less soluble, and the solution, which is dark green, is very unstable and readily decomposes, oxygen being liberated. The analogy between the ruthenates and perruthenates on the one hand, and the manganates and permanganates on the other, is very close.

E. Compounds of Octavalent Ruthenium.

Ruthenium tetroxide, RuO_4 . In many respects the tetroxide is the most interesting compound of ruthenium, being a volatile substance. When a stream of chlorine gas is bubbled through a 4 per cent. solution of potassium ruthenate, and is led out into a well-cooled receiver, a golden solid (ruthenium tetroxide) collects in the receiver:

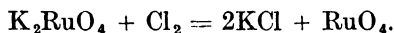

It can afterwards be freed from water by distillation over calcium chloride under reduced pressure. The tetroxide melts about 25°C . to an orange-coloured liquid. It cannot be boiled at atmospheric pressure without decomposing, but can be distilled under reduced pressure without difficulty; the vapour has also a yellow colour, and is explosive. Ruthenium tetroxide is a very powerful oxidizing agent,¹ reacting with explosive violence with alcohol or sulphur. The vapour attacks india-rubber and oxidizes mercury. The tetroxide appears to have feeble acidic properties; when concentrated ammonia is added to the concentrated solution of the

¹ A. Gutbier, *Zeitsch. Anorg. Chem.* **95** (1916), 177.

tetroxide, a grey-brown liquid is obtained which on evaporation yields the salt $(\text{NH}_4)_2\text{RuO}_6$.¹

F. Miscellaneous Compounds.

Ruthenium Carbonyls.² Ruthenium has an unstable volatile carbonyl, which can only be produced by the use of very high pressures. The method of preparation is analogous to that used for the preparation of cobalt carbonyl. Ruthenium black is subjected to the action of carbon monoxide at 300°C . under 400 atmospheres pressure; the carbon monoxide passing out from the apparatus is capable of depositing a ruthenium mirror on heated glass. If, however, it is passed into a cool tube a small amount of an orange deposit can be obtained; this is a ruthenium carbonyl, but its composition is still uncertain. Later work has indicated the existence of a second carbonyl, which is non-volatile.³ This body has the composition $\text{Ru}(\text{CO})_2$; it is prepared by heating powdered ruthenium in carbon monoxide at 250°C . under 350 atmospheres pressure, and may be extracted from the residue with alcohol. On evaporating the solution in a current of hydrogen, the dicarbonyl is left as a brown powder.

¹ F. Krauss, *Zeitsch. Anorg. Chem.* **119** (1921), 217.

² L. Mond, H. Hirtz, and M. D. Cowap, *Trans. Chem. Soc.* **97** (1910), 809.

³ R. L. Mond and A. E. Wallis, *Trans. Chem. Soc.* **121** (1922), 30.

RHODIUM

Atomic weight 102.9

The Metal

Rhodium is very similar to ruthenium. Like the latter it is a hard, silver-white metal, but it is more malleable and ductile. Its melting-point ($1,970^{\circ}\text{C.}$) and specific gravity (12.1) are both similar to those of ruthenium.

Like ruthenium, compact rhodium is scarcely dissolved by ordinary acids, or even by aqua regia, but it is more readily attacked by chlorine gas. Rhodium is not changed by exposure to the atmosphere at the ordinary temperatures, but the molten metal takes up oxygen; the oxygen is given up on cooling, the phenomenon of spitting being observed.

Laboratory Preparation. Metallic rhodium can easily be obtained from its compounds. By the reduction of the aqueous solutions with a more reactive metal (e.g. zinc), the black, finely divided form is obtained. If a zinc-rhodium alloy is treated with hydrochloric acid the rhodium is left as a grey powder, which contains both oxygen and hydrogen. When heated in a tube, it explodes with a flash, the phenomenon being due to the sudden combination of the occluded hydrogen and oxygen. If oxygen is completely excluded during the preparation, the product is not explosive.¹

If it is desired to prepare rhodium from materials containing the other platinum metals, one of the methods referred to in the analytical section may be adopted.

Compounds

The main compounds of rhodium correspond to the oxides Rh_4O_3 and RhO_2 , the most important ones being derived from Rh_2O_3 . There are indications of the existence of more highly oxidized compounds, but they are much less well developed than in the case of ruthenium. Certain preparations supposed to represent compounds of divalent rhodium (e.g. a supposed oxide RhO , and a supposed sulphide RhS) have been described; but there is no reason to think that they are definite chemical individuals.²

¹ E. Cohen and Th. Strengers, *Zeitsch. Phys. Chem.* **61** (1908), 728.

² E. Leidié, *Ann. Chim. Phys.* **17** (1889), 280-283.

A. Compounds of Trivalent Rhodium.

The **sesquioxide**, Rh_2O_3 , is most easily produced by heating the nitrate, and is a grey powder; the black hydroxide, $\text{Rh}(\text{OH})_3$, is produced from the solution of the corresponding chloride by precipitation with excess of potassium hydroxide. When once dried, it becomes almost insoluble in acids. If sufficient caustic potash is not added to give an immediate precipitate, a yellow form gradually separates out, which is much more readily soluble in acids. The yellow form is also dissolved by excess of caustic alkali; the solution presumably contains a compound analogous to the ferrites.

The salts of trivalent rhodium are formed when the yellow variety of the hydrated oxide is dissolved in an acid, and can be obtained by crystallization. They are mostly yellow or red crystalline substances having a yellow or rose solution (hence the name "Rhodium" from "Rhodos," a rose). The **chloride** can best be obtained by the action of chlorine gas on the finely divided metal, and is a red substance. The solution is red when concentrated, yellow when dilute. It combines with ammonia to form amines,

such as $[\text{Rh}(\text{NH}_3)_6]\text{Cl}_3$, which is colourless, and $\left[\text{Rh} \begin{array}{c} (\text{NH}_3)_5 \\ \text{Cl} \end{array} \right] \text{Cl}_2$,

which is yellow. Several double chlorides are known; for instance, **sodium rhodium chloride**, $3\text{NaCl}.\text{RhCl}_3$ or $\text{Na}_3[\text{RhCl}_6]$, can be obtained in red prisms by crystallization from a solution containing both chlorides.

The **sulphate**, $\text{Rh}_2(\text{SO}_4)_3.12\text{H}_2\text{O}$, is obtained by dissolution of the hydroxide in dilute sulphuric acid, and forms a series of true alums, which crystallize in yellow octahedra. Of these **cæsium rhodium alum**, $\text{Cs}_2\text{SO}_4.\text{Rh}_2(\text{SO}_4)_3.24\text{H}_2\text{O}$, is the easiest to obtain, on account of its slight solubility. A yellow **nitrate**, $\text{Rh}(\text{NO}_3)_3$, is also known. Various complex **cyanides**, such as $\text{K}_3[\text{Rh}(\text{CN})_6]$, and also some complex **nitrites**,¹ have been isolated.

By passing hydrogen sulphide into a boiling solution of rhodium trichloride, a black precipitate is obtained. This seems to be the acid sulphide, $\text{Rh}(\text{SH})_3$. The normal sulphide can be made by the action of hydrogen sulphide on the dry chloride.

B. Compounds of Tetravalent Rhodium.

Rhodium dioxide, RhO_2 , is obtained, when the metal is fused with a mixture of caustic potash and potassium nitrate. The oxidation is comparatively slow; the sesquioxide is formed at first, and it may be necessary to repeat the fusion several times, before the oxidation is complete.

¹ E. Leidié, *Comptes Rend.* 111 (1890), 106.

The oxide has an acidic character ; the derivatives have not been isolated in a state of purity, but they appear to be formed in the following way. The yellow form of the trihydroxide ($\text{Rh}(\text{OH})_3$) is soluble in caustic alkali, as has been remarked above. When this solution is oxidized by passing through it the gaseous mixture produced by the action of hydrochloric acid on potassium chlorate, it becomes first red and then blue.¹ At the same time a green precipitate appears, which is probably the hydroxide, $\text{Rh}(\text{OH})_4$. It has been suggested that the blue solution contains a compound of hexavalent rhodium, namely, the sodium salt, Na_2RhO_4 .

The green hydroxide dissolves in hydrochloric acid, giving a blue solution. Presumably this contains the tetrachloride, RhCl_4 , but the solution is unstable, slowly evolving chlorine, and yielding the yellow solution of the trichloride, RhCl_3 .

¹ P. Alvarez, *Comptes Rend.* **140** (1905), 1341.

PALLADIUM

Atomic weight 106.7

The Metal

Palladium, like rhodium, resembles silver in its general appearance. It is rather lighter than rhodium (specific gravity 11.5), and melts at a considerably lower temperature, namely, 1,549° C., only just above the melting-point of iron.

In chemical properties, palladium shows a general resemblance to rhodium and ruthenium, but is distinctly less noble; it has also much in common with silver, which stands on the other side of it in the periodic table. Unlike the other "platinum metals," palladium is soluble in strong nitric acid and even in concentrated sulphuric acid; the dissolution of palladium in nitric acid—like that of silver and copper—appears to be catalytically accelerated by the presence of nitrous acid.

Although the bright lustre of palladium is quite unchanged by exposure to the air at ordinary temperatures, the metal becomes covered with a coat of bluish oxide if heated to a moderate temperature; on strong heating, however, this oxide is decomposed, and the substance resumes its metallic appearance. Nevertheless, fused palladium absorbs a considerable amount of oxygen, which it "spits" out when cooled—just as does silver—at the moment of solidification.

Laboratory Preparation. Different methods of reduction yield palladium in seemingly different forms. By the electrolysis of a warm, well-stirred solution of palladium chloride or palladium ammonium chloride containing sulphuric acid, a compact coating of palladium appears on the cathode.¹ If dry palladium ammonium chloride, $\text{PdCl}_2 \cdot 2\text{NH}_4\text{Cl}$, is heated in a current of hydrogen, a dark "sponge" of palladium is obtained. A finely divided type of palladium ("palladium black") is obtained by the action of a reducing agent such as sodium formate upon a solution of a palladium salt; it consists of very fine particles, but almost invariably contains oxygen, which is not removed completely even upon heating *in vacuo* to dull redness.² By the action of hydrazine hydrate on palladium chloride in the presence of a protective colloid (such as

¹ R. Amberg, *Zeitsch. Elektrochem.* 10 (1904), 386; S. Cowper-Coles, *Trans. Inst. Min. Met.* 7 (1899), 270.

² L. Mond, W. Ramsay, and J. Shields, *Proc. Roy. Soc.* 62 (1897), 290.

sodium lysalbinat), a stable black colloidal solution of palladium is obtained.¹ Another colloidal solution—much less stable—can be prepared by passing an arc between two palladium wires below the surface of water containing a trace $\left(\frac{N}{1000}\right)$ of sodium hydroxide.²

Compounds

The oxides of palladium are known, PdO and PdO₂, and a series of compounds exists corresponding to each. Lower compounds such as Pd₂O and PdCl have been described, but their individuality is doubtful; on the other hand, the sub-sulphide (Pd₂S), formed when palladosammine chloride (PdCl₂·2NH₃) is heated with sulphur, is commonly recognized as a chemical individual.³

A. Compounds of Divalent Palladium (Palladous Compounds).

When finely divided palladium is heated in a stream of oxygen, it absorbs that gas. If the temperature is about 810° C., the composition begins, after some hours, to approach that indicated by the formula PdO, and the product probably consists largely of **palladous oxide**. The pressure of oxygen corresponding to the equilibrium,

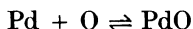

has been determined at different temperatures.⁴ It becomes equal to one atmosphere at about 860° C., and consequently the monoxide decomposes if heated in an open vessel above that temperature. The anhydrous oxide is bluish, greenish brown or black according to the method of preparation. The **hydroxide**, prepared by precipitation of a palladous salt solution by an alkali (preferably sodium carbonate), or by the hydrolysis of such a salt solution, is dark brown.

When the hydroxide is dissolved in an acid, a brown or red solution of a palladous salt is obtained. The salts are more readily prepared from the metal. When palladium is acted upon by nitric acid (specific gravity 1.35–1.40), a solution is obtained from which it is possible to isolate, by crystallization, brown prisms of the **nitrate**, Pd(NO₃)₂. Like other palladous salts, this is immediately hydrolysed in the absence of free acid; when water is added to the crystals, a basic nitrate is at once formed. The **sulphate**,

¹ C. Paal and C. Amberger, *Ber.* **37** (1904), 132.

² C. Bredig and M. Fortner, *Ber.* **37** (1904), 798.

³ F. Roessler, *Zeitsch. Anorg. Chem.* **9** (1895), 55.

⁴ L. Wöhler, *Zeitsch. Elektrochem.* **11** (1905), 836; **12** (1906), 781.

$\text{PdSO}_4 \cdot 2\text{H}_2\text{O}$, can be obtained by dissolving the metal in strong sulphuric acid (preferably in the presence of nitric acid); the normal salt is reddish-brown and gives a basic salt when treated with water.

The **chloride**, PdCl_2 , is obtained when palladium is acted upon by hydrochloric acid containing free chlorine. The solution may be concentrated by evaporation over quicklime, and deposits a reddish hydrated chloride, which yields the dark brown anhydrous chloride, when cautiously heated. But if heated too strongly it loses chlorine. The anhydrous chloride is also obtained by heating spongy palladium in dry chlorine. Various amines are known. By evaporating a solution of palladous chloride containing ammonia yellow crystals of $\text{Pd} \left[\begin{array}{c} \text{Cl}_2 \\ (\text{NH}_3)_2 \end{array} \right]$ are obtained. On repeated evapor-

ation with ammonia, however, two more molecules of ammonia are taken up, and colourless $\text{Pd}[(\text{NH}_3)_4]\text{Cl}_2$ is produced.

The double palladous chlorides are more easy to prepare in the solid condition than the single chloride. If, for instance, potassium chloride is added to a solution of palladous chloride, the complex salt, **potassium palladochloride**, $2\text{KCl} \cdot \text{PdCl}_2$ or $\text{K}_2[\text{PdCl}_4]$, can be obtained by crystallization in reddish dichroic prisms. It will be noticed that in all the complex salts of divalent palladium, the co-ordination number is four, not six.

Of special interest is the **iodide**, PdI_2 , which is rather insoluble. It is obtained as a black precipitate by adding potassium iodide to palladous chloride; the precipitate is somewhat soluble in excess of potassium iodide. The **sulphide**, PdS , can be obtained, mixed with other sulphides, by precipitating an aqueous solution of a palladous salt with hydrogen sulphide, but it is more conveniently prepared by passing the vapour of sulphur over heated palladium. As is so often the case, the wet method yields a black finely divided precipitate, while the dry method yields a compact product retaining something of the metallic appearance of the metal. Another insoluble palladous salt is the **cyanide**, $\text{Pd}(\text{CN})_2$; since it is very easily dissolved by excess of potassium cyanide, it is best obtained by adding mercuric cyanide to a palladous salt, when it comes down as a yellow precipitate. The solution in potassium cyanide contains the complex **potassium palladous cyanide**, $2\text{KCN} \cdot \text{Pd}(\text{CN})_2$ or $\text{K}_2[\text{Pd}(\text{CN})_4]$, which can be isolated in colourless crystals.

B. Compounds of Tetravalent Palladium (Palladic Compounds).

It is doubtful whether **palladic oxide** (PdO_2) can be obtained in the pure anhydrous condition. It is sometimes stated to be formed

upon the surface of a palladium anode used in the electrolysis of acidulated water, but it is questionable whether any definite oxide is formed anodically. The corresponding hydroxide is obtained as a red or brown precipitate by the addition of caustic alkali to a palladic salt (e.g. potassium palladichloride). It darkens, and partly decomposes, when any attempt is made to dry it.

Palladic salts of oxy-acids are difficult to produce. For when the hydroxide is treated with such an acid, oxygen is evolved, and a palladous salt is produced. Palladic hydroxide can be dissolved by hydrochloric acid, however, without the evolution of gas, and the brown solution may be considered to contain the **chloride**, PdCl_4 . The same brown solution is obtained by dissolving palladium in aqua regia. When evaporated, it loses chlorine, and the simple chloride cannot therefore be isolated. But, by adding alkali-metal chlorides to the solution, various double chlorides can be obtained in the solid state, owing to their feeble solubility. For instance, if a solution of palladium in aqua regia is treated with a potassium chloride, **potassium palladichloride**, 2KCl.PdCl_4 or $\text{K}_2[\text{PdCl}_6]$, is deposited, after gentle evaporation, in brown-red crystals.

The corresponding **sulphide** (PdS_2) is also known. When palladous sulphide is fused with sulphur and sodium carbonate, and the mass is extracted with water, the solution contains a complex sulphide, $\text{Na}_2\text{S.PdS}_2$ or $\text{Na}_2[\text{PdS}_3]$. If the solution is then treated with dilute hydrochloric acid, the simple palladic sulphide is precipitated as a dark-brown powder.

Palladium and Hydrogen ¹

One of the most interesting features of palladium is its remarkable power of taking up hydrogen gas. The metal will absorb several hundred times its own volume of gas. Palladium black takes up hydrogen with far greater velocity than the same weight of compact palladium at the same temperature and pressure, and also holds a greater amount when it reaches the final state of saturation. The amount taken up depends both on the temperature and pressure. The metal suffers no very violent change in appearance, when it takes up the gas, although there is an increase in volume, a decrease in electrical conductivity,² and an alteration in mechanical properties; it may be imagined that a palladium-hydrogen alloy is formed.

This power to absorb hydrogen in "alloy form," without the loss

¹ A good summary of views is given by A. W. Porter, *Trans. Faraday Soc.* **14** (1919), 192.

² G. Wolf, *Zeitsch. Phys. Chem.* **87** (1914), 575; E. A. Harding and D. P. Smith, *J. Amer. Chem. Soc.* **40** (1918), 1508; **41** (1919), 1892.

of metallic properties, is characteristic of the metals which fall in the centre of the Periodic Table. Nickel, palladium and platinum display it in the most striking manner, but the other transition elements, such as iron, can also take up a considerable quantity of hydrogen; the neighbouring elements in the Periodic Table from vanadium on one side to copper on the other possess the power in a smaller degree. On the other hand the metals at the two ends of the table combine with hydrogen in perfectly definite proportions, forming (in every case) a single compound; the compound has in most cases a composition agreeing with the usual valency of the metal, and has none of the properties of the metal from which it is derived. The following are a few of the definite "hydrides" which are formed by elements at the two ends of the Periodic Table:—



It is quite likely that the power to absorb hydrogen in "alloy-form" possessed by the transition elements and their neighbours is connected with the small value of the atomic volume, and may thus be correlated with the special power of the same elements to form complex salts, and also with their magnetic properties.¹

In considering the behaviour of metals towards hydrogen, we have to deal with two separate phenomena:—²

(1) *Surface adsorption* of atoms or molecules of hydrogen attaching themselves to the *surface* of the metal. The amount of hydrogen adsorbed will clearly be determined by the *active surface* of the metal, and will also be greatest if the surface is clean and free from other adsorbed substances ("poisons").

(2) *True solution* or absorption within the *interior* of the metal. The amount of gas dissolved will be proportional to the *volume* of the metal.

Now it seems extremely probable that whenever a metal takes up hydrogen it is first adsorbed upon the surface, and then gradually diffuses into the interior. The main reason why black finely divided palladium takes up hydrogen more quickly than compact palladium is that it has a greater surface. One reason why it takes up a larger amount of hydrogen—when finally saturated—is that in palladium black there is hydrogen adsorbed as well as hydrogen dissolved, whilst in bright palladium, the surface area is much smaller, and

¹ Compare D. P. Smith, *J. Phys. Chem.* **23** (1919), 186. But W. C. McC. Lewis, *Trans. Chem. Soc.* **117** (1920), 630, thinks the dielectric capacity is all-important, since it determines the power to break up the hydrogen molecule into atoms.

² Compare A. Holt, E. C. Edgar, and J. B. Firth, *Zeitsch. Phys. Chem.* **82** (1913), 513.

the amount adsorbed upon that surface can almost be neglected.

Since adsorption is largely dependent upon the cleanliness of the surface, it would be expected that other substances which are capable of being adsorbed would interfere with the entry of hydrogen into palladium. Many of the substances, which were mentioned as "poisons" to a nickel catalyst, reduce the amount of hydrogen which will be taken up by finely divided palladium. Hydrogen sulphide, for instance, depresses not only the rate of occlusion of hydrogen by freshly reduced palladium, but also the total amount which is finally taken up.¹

Surface adsorption appears to be practically an instantaneous process; the amount of hydrogen adsorbed decreases as the temperature rises. On the other hand, the diffusion of the gas into the interior requires time, and the rate of diffusion will increase as the temperature rises. Thus a rise of temperature will generally be unfavourable to surface-adsorption, but may sometimes be favourable to true solution, for instance in cases where the metal is exposed to the gas only for a limited time. In general, the total amount of hydrogen taken up by all varieties of palladium in a state of saturation falls off as the temperature rises.²

It seems probable that at very low temperatures (below 0°) the hydrogen is practically all adsorbed upon the surface, whilst at high temperatures it is practically all in solution. Above 140° C. the amount of hydrogen taken up by palladium wire is found to be independent of the diameter of the wire; this would seem to indicate that surface adsorption is at that temperature no longer an important factor in the occlusion of hydrogen by wire. On the other hand, palladium black (which has an infinitely greater surface than the wire) still takes up a larger amount of hydrogen at 140° C. than palladium wire, and its power to absorb hydrogen only becomes as low as that of the wire when a temperature of about 600° C. is reached.

The difference between surface adsorption and true solution is clearly shown in certain experiments upon the action of hydrogen on another closely analogous metal, platinum.³ In "platinum black," a very finely divided variety, the amount of hydrogen occluded was found to decline with a rise in temperature, whilst in

¹ E. B. Maxted, *Trans. Chem. Soc.* **117** (1920), 1280; this is best shown by the curves on pages 1284 and 1285.

² A. Sieverts, *Zeitsch. Phys. Chem.* **88** (1914), 103; C. Hoitsema, *Zeitsch. Phys. Chem.* **17** (1895), 1. Compare, however, A. Gutbier, G. Gebhardt, and B. Ottenstein, *Ber.* **46** (1913), 1453, who find a minimum at 20° C. The apparent discrepancy is to some extent explained in the light of recent experimental work by J. B. Firth, *Trans. Chem. Soc.* **119** (1921), 1120.

³ A. Gutbier and O. Maisch, *Ber.* **52** (1919), 1368.

“spongy platinum,” which, although porous, has a much smaller active surface, the amount taken up was found to increase as the temperature was raised.

If a sample of palladium is already covered with an adsorbed film of some tenacious substance, or “poison,” its power to take up hydrogen will be reduced. It is found possible to “clean” or “activate” the surface of palladium (i.e. to rid it of adsorbed “poisons”) by heating it, preferably *in vacuo*; in fact, such treatment is almost always necessary before palladium becomes really active in taking up hydrogen at low temperatures. Possibly the poisons are removed by volatilization, possibly by oxidation, possibly by diffusion into the interior; in many cases, no doubt, all three factors will enter into the “cleaning” by heat. In the case of palladium black “poisoned” by hydrogen sulphide, it appears that the hydrogen sulphide is decomposed, pure hydrogen being evolved on heating at 100° C. *in vacuo*.¹ On cooling, the palladium has recovered much of its power of occluding hydrogen.

The heat treatment of a sample of palladium may, however, affect the power of taking up hydrogen in other ways. When, for instance, “palladium black” is ignited, it undergoes a kind of “sintering,” “palladium sponge” being formed. Either the small particles adhere together to form larger ones, or the large particles grow at the expense of the small ones; at any rate the surface area of the material diminishes, and the capacity of taking up hydrogen falls off.²

Furthermore, the annealing of any metallic substance usually produces a certain amount of “recrystallization,” as is well known from work on metallography. Palladium in a perfect crystalline condition probably takes up hydrogen less readily than metal in which the atoms are in a disordered state. Since annealing will alter the respective proportions of the perfectly “crystalline” material and the more or less “amorphous” material present in the metal, it will clearly alter the behaviour of any sample of palladium towards hydrogen. There is no occasion to assume—as some investigators³ apparently think necessary—that two definite and separate allotropic forms of palladium exist. The view that the passage between the crystalline and “amorphous” condition is a gradual one—which is now held by many metallographists—is not

¹ E. B. Maxted, *Trans. Chem. Soc.* **115** (1919), 1050; **117** (1920), 1280.

² A. Sieverts, *Zeitsch. Phys. Chem.* **88** (1914), 125. Compare R. Wright and R. C. Smith, *Trans. Chem. Soc.* **119** (1921), 1633.

³ J. H. Andrew and A. Holt, *Proc. Roy. Soc.* **89** [A] (1913), 170; A. Holt, *Proc. Roy. Soc.* **90** [A] (1914), 226; J. B. Firth, *Trans. Chem. Soc.* **117** (1920), 171; **119** (1921), 1120. Compare also A. Sieverts, *Zeitsch. Phys. Chem.* **88** (1914), 105, 451.

inconsistent with the established facts regarding the absorption of hydrogen by palladium.

We have shown, therefore, that the heating of a sample of palladium may affect its power to take up hydrogen in three ways :

- (1) By driving off "poisons," thus cleaning and activating the surface.
- (2) By "sintering," and thus reducing the active surface.
- (3) By "recrystallization."

It is not surprising, therefore, to find that no two samples of palladium behave in exactly the same way towards hydrogen, the differences in their behaviour being caused by slight differences in the thermal history of the different samples.

Nothing has been said hitherto about the state of the hydrogen in the palladium. No definite compound has been isolated. The amount of hydrogen taken up varies continuously both with pressure and temperature. A general relation between the pressure and the amount of hydrogen absorbed at constant temperature has been established ; it applies both to palladium wire and palladium black, although it is only valid for comparatively low pressures and moderately high temperatures (above 138° C.). The amount of hydrogen taken up by palladium is approximately proportional to the square root of the pressure. This important law has been found by Sieverts¹ to apply not only to palladium, but also to copper, iron, nickel, tantalum—as well as to several alloys of these metals. It can only be reconciled with the law of Mass Action, if we assume that the hydrogen enters the metal as single atoms, so that the equilibrium is represented by the equation,

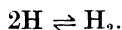

The fact that the hydrogen molecule is split up when hydrogen enters a metal no doubt accounts—in part at least—for the powerful reducing properties of metals containing hydrogen.

It is simplest to think of a palladium-hydrogen alloy as a solid solution of hydrogen in palladium. Sieverts has, however, proceeded to show that, although—as stated above—the amount of hydrogen taken up by palladium at pressure P can be indicated approximately by the expression, $K\sqrt{P}$, it is more accurately given by the expression,

$$K_1\sqrt{P} + K_2P,$$

where K_1 and K_2 are constants depending on the temperature ; K_2 is much smaller than K_1 , and, consequently, the second term of

¹ A. Sieverts, *Zeitsch. Phys. Chem.* 77 (1911), 591 ; A. Sieverts and E. Bergner, *Ber.* 44 (1911), 2394 ; A. Sieverts, E. Jurisch, and A. Metz, *Zeitsch. Anorg. Chem.* 92 (1915), 329.

the expression is always very much less important than the first, and for rough purposes can often be neglected. Nevertheless, its presence in the more accurate expression would seem to indicate that hydrogen molecules as well as single hydrogen atoms are present in the palladium.

Even the expression given above does not hold good for palladium black at low temperatures—except at very low pressures. As soon as the hydrogen pressure has passed a certain value (depending on the temperature), the amount of hydrogen taken up increases very quickly, as is shown by the curves in Fig. 38.¹ This was attributed

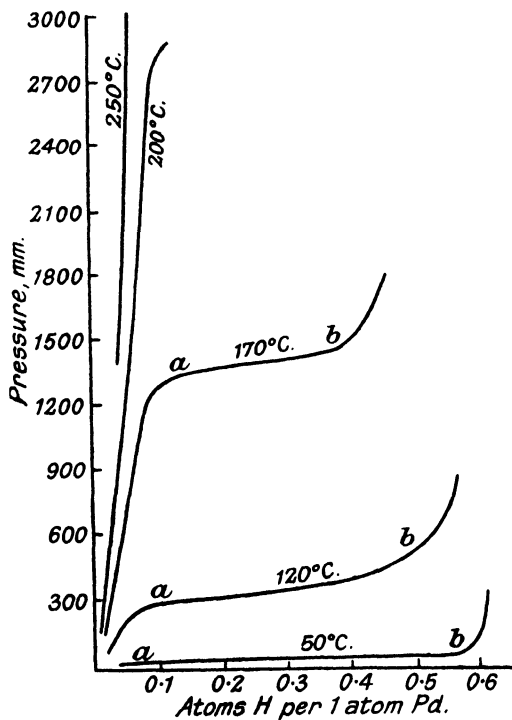

FIG. 38.—The Absorption of Hydrogen by Palladium at Different Temperatures.

at one time to the appearance of two immiscible solid solutions in the alloy at this point; according to the phase rule, the pressure of hydrogen in equilibrium with a two-phase alloy will be independent of the proportions in which the hydrogen-rich phase and the hydrogen-poor phase are present. According to this theory, the

¹ C. Hoitsema, *Zeitsch. Phys. Chem.* 17 (1895), 22.

isotherms should be perfectly horizontal during the portions of the curves marked *ab*. Actually there is a slight slope, and most chemists are disposed to abandon the notion of two immiscible solid solutions. The sudden increase of concentration at a critical pressure does not occur at high temperatures.

Palladium can be charged with hydrogen by cathodic treatment, and it is interesting to observe the variations of the potential during the charging process and after the interruption of the current.¹ The cathodic method of saturating the metals with hydrogen has proved useful in studying the effect of the presence of a second metal on the solubility of hydrogen in palladium. It is found that gold, which forms a complete series of solid solutions with palladium, reduces the quantity of hydrogen taken up upon cathodic treatment to an extent which increases regularly with the gold-content of the alloys. Alloys consisting of 75 per cent. gold, 25 per cent. palladium are almost without solvent power for the gas.²

One rather interesting consequence of the fact that hydrogen dissolves in palladium is that thin palladium foil is perfectly permeable to the gas at high temperatures. About 250° C., the leakage of hydrogen through the walls of a palladium tube can be demonstrated experimentally.³

Most of the statements made in connection with the entry of hydrogen into palladium apply equally well to other metals which absorb hydrogen. Thus platinum black has a remarkable power of taking up hydrogen; compact platinum has comparatively little, although it can be charged with hydrogen by cathodic treatment. Again, all kinds of rhodium black (prepared in different ways) take up hydrogen; but the blackest samples (which are presumably the most finely divided and have the greatest surface area) take it up most readily.⁴

Closely connected with the power of palladium and other metals to absorb hydrogen and other gases is their catalytic activity. If a cold mixture of oxygen and hydrogen is passed over asbestos within which finely divided palladium has been precipitated, combination takes place quietly at ordinary temperatures. Palladium saturated with hydrogen is—as already remarked—a powerful reducing agent; it reduces ferric salts (in aqueous solution) to ferrous salts, and can convert a chromate to a chromic salt.

¹ D. P. Smith and F. H. Martin, *J. Amer. Chem. Soc.* **38** (1916), 2577.

² A. J. Berry, *Trans. Chem. Soc.* **99** (1911), 463.

³ T. Graham, *Phil. Trans.* **156** (1866), 430.

⁴ A. Gutbier and O. Maisch, *Ber.* **52** (1919), 2275.

OSMIUM

Atomic weight 190.9

The three metals, osmium, iridium and platinum, are similar in general properties to ruthenium, rhodium and palladium, but are on the whole more noble, and less fusible. Osmium has a special similarity to ruthenium, which falls just above it in the periodic table.

The Metal

Osmium is, like the other elements just mentioned, a lustrous white silvery metal. It is the heaviest substance known, the specific gravity being 22.5, practically double that of lead. Osmium has also one of the highest melting-points (about 2,500° C.), but it falls considerably below the melting-point of tungsten.

Compact osmium is unaffected by most acids and by aqua regia; but the finely divided metal is perceptibly dissolved, not merely by aqua regia, but even by fuming nitric acid. Hot selenic acid¹ also attacks osmium, yielding osmium tetroxide. Compact osmium is attacked by fused sodium peroxide, and by a fused mixture of potassium nitrate and hydroxide.

At ordinary temperatures, osmium undergoes no change, when exposed to the atmosphere, although the finely divided metal becomes slowly oxidized when gently heated at about 200° C. The compact metal is readily oxidized when strongly heated in air, giving off poisonous vapours of the volatile tetroxide (OsO₄). In the formation of a volatile tetroxide, osmium shows a similarity to ruthenium, but it should be noticed that osmium tetroxide is formed much more readily, and is much more stable, than ruthenium tetroxide. The comparative ease with which osmium becomes oxidized by air at high temperatures is in distinct contrast to its remarkable resistance to corrosion by aqueous solutions.

Laboratory Preparation. Metallic osmium can be obtained by the electrolysis of the solution of a compound, or, in a black pseudo-amorphous state, by reduction with zinc or a reducing agent. If the vapours of the volatile tetroxide are passed into a solution containing a reducing agent (e.g. hydrazine hydrate), reduction occurs, finely divided osmium being produced.

Where it is desired to isolate osmium from materials containing

¹ K. Hradecky, see *Chem. Zent.* 21 (1917), i, 949.

a mixture of platinum metals, the method mentioned in the analytical section, depending upon the distillation of osmium as the tetroxide, is available.

Compounds

In its power of combination, osmium resembles ruthenium, which stands just above it in the periodic table, more closely than the other elements of the group. As in the case of ruthenium, there are numerous series of compounds; compounds exist corresponding to valencies of 2, 3, 4, 6 and 8, but in each series the number of stable compounds known is comparatively small. In many cases there is a clear analogy between the compounds of osmium and ruthenium.

The most highly oxidized compounds will be considered first.

A. Compounds of Octavalent Osmium.

When a stream of oxygen is passed over osmium heated in a tube, the volatile **tetroxide**, OsO_4 , is formed, and may be condensed as colourless needles in a cooled vessel. The oxide is also formed when nitric acid acts on the metal. The substance melts below 100°C ., and is very volatile at the melting-point. The vapour has an unpleasant odour, and is very poisonous; it attacks the eyes, producing temporary—or even permanent—blindness, and acts also on the skin and on the lungs. The vapour density has the normal value corresponding to the formula OsO_4 .

Osmium tetroxide is quite soluble in water. The solution is neutral to litmus. By the action of hydrogen sulphide on the solution, the corresponding **sulphide**, OsS_4 , is thrown down as a brown precipitate. A solution of osmium tetroxide in strong potassium hydroxide has an orange colour, and contains an orange "per-osmate," $2\text{KOH}\cdot\text{OsO}_4$, which has been isolated in the solid state.¹

Another interesting compound of octavalent osmium is the **octafluoride**, OsF_8 , which is formed by passing fluorine rapidly over finely divided osmium at 250°C .; if the stream is too slow, lower fluorides, OsF_6 or OsF_4 , alone are produced. The octafluoride, which is very volatile, must be condensed in a vessel cooled with solid carbon dioxide and alcohol. It is a yellow solid, melting at about 35°C ., and giving off an irritating, odorous vapour.²

B. Compounds of Hexavalent Osmium (The Osmates).

When a solution of the tetroxide (OsO_4) in strong caustic potash

¹ L. Tschugaev, *Comptes Rend.* **167** (1918), 162.

² O. Ruff and F. W. Tschirch, *Ber.* **46** (1913), 929.

is acted upon by a reducing agent, such as alcohol or a nitrite, the red colour becomes more intense, and deposits violet-red crystals of **potassium osmate**, K_2OsO_4 . The osmates are closely allied to the ruthenates, and thus to the manganates and the sulphates; it is not surprising, therefore, to find that the osmates of calcium, strontium and lead are insoluble.

C. Compounds of Tetravalent Osmium.

The **tetrachloride**, $OsCl_4$, is produced when chlorine is passed over osmium heated in a tube and sublimes forward, condensing in the cooler part of the tube. It is a red substance, the solution being yellow. Various double chlorides are also known. If chlorine is passed over a heated mixture of finely divided osmium and potassium chloride, and the residue is extracted with water, the complex salt, **potassium osmichloride**, $2KCl.OsCl_4$ or $K_2[OsCl_6]$, corresponding to potassium ruthenichloride, is produced. This is also a red salt with a yellow solution.

When the dry chloride is heated with sodium carbonate, the grey-black **oxide**, OsO_2 , is produced. The black precipitate formed when a solution of the chloride is treated with caustic alkali consists mainly of the corresponding hydroxide. When a solution of osmium tetroxide, or of potassium osmate, is reduced with alcohol, the same product is obtained; if protected from oxygen during drying, it is found to be pyrophoric, and takes fire (or even explodes) when brought into the air. The pyrophoric character is supposed to be due to the presence of some organic substance.¹

When the solution of the double chloride is precipitated with hydrogen sulphide, the yellow **sulphide**, OsS_2 , is said to be precipitated; it is also produced when hydrogen sulphide is bubbled through a solution of an osmate, the gas acting first as a reducing agent, and then as a precipitant.

D. Compounds of Trivalent Osmium.

When a solution of a higher oxide in hydrochloric acid is boiled with a reducing agent, such as mercury or alcohol, the solution produced contains the **trichloride**, $OsCl_3$, mixed with higher chlorides. The trichloride is more easily produced in the solid state by heating ammonium osmochloride $(NH)_3[OsCl_6]$ in a current of chlorine at $350^\circ C$.; it is a brown-black powder.² Double chlorides are much more readily isolated; potassium osmochloride, $3KCl.OsCl_3.3H_2O$ or $K_3[OsCl_6].3H_2O$, is a red crystalline substance obtained by adding ammonia to a solution of the volatile tetroxide

¹ O. Ruff and H. Rathsburg, *Ber.* **50** (1917), 485.

² O. Ruff and F. Bornemann, *Zeitsch. Anorg. Chem.* **65** (1910), 451.

in potassium hydroxide, the solution being afterwards saturated with hydrogen chloride. The ammonium salt is prepared by the reducing action of hydrogen sulphide on a solution of osmium tetroxide in hydrochloric acid; ammonium chloride is added to the solution, which on evaporation deposits red crystals.

When the aqueous solution of potassium osmochloride is treated with alkali, a brown-red precipitate consisting of the hydrated sesquioxide, $\text{Os}_2\text{O}_3 \cdot n\text{H}_2\text{O}$, is thrown down; if, on the other hand, the dry double chloride is heated with sodium carbonate in a current of carbon dioxide, the anhydrous oxide, which is black, is said to be produced.

E. Compounds of Divalent Osmium.

When an aqueous solution of osmium tetroxide is reduced with sulphur dioxide, a blue liquid is obtained. This contains the sulphite, OsSO_3 , and that salt may be isolated by cautious evaporation of the solution; if dried *in vacuo*, it is said to be black. When the blue solution of the sulphite is treated with a caustic alkali, the hydroxide is thrown down as a blue-black precipitate, which oxidizes readily in the air. If the solid sulphite is heated with sodium carbonate in a current of carbon dioxide—to prevent oxidation—the anhydrous oxide, OsO , is obtained as a grey-black powder.

Apart from the sulphite mentioned above, few salts of divalent osmium are known. A chloride, OsCl_2 , is formed to a small extent when osmium is heated in a tube in a current of chlorine, but is usually mixed with higher chlorides. It is also produced when the trichloride is heated under reduced pressure.¹ The dichloride is dark brown in colour; it is scarcely dissolved by cold water, but on prolonged boiling with water it yields a pale yellow solution.

Certain complex cyanides of divalent osmium exist, which are analogous to the ferrocyanides. For instance, potassium osmocyanide, $\text{K}_4[\text{Os}(\text{CN})_6] \cdot 3\text{H}_2\text{O}$, is formed when a solution of osmic tetroxide in alkali is mixed with a solution of potassium cyanide, and evaporated. Apparently part of the cyanide acts as a reducing agent. The salt can be purified by recrystallization and then forms yellow tablets; the solution gives a light violet precipitate with ferrous salts and a darker violet precipitate with ferric salts.

¹ O. Ruff and F. Bornemann, *Zeitsch. Anorg. Chem.* **65** (1910), 454.

IRIDIUM

Atomic weight 193.1

Iridium bears the same general relation to osmium as rhodium does to ruthenium.

The Metal

The metal itself resembles the other platinum metals, being white and lustrous. It is only slightly less heavy than osmium (specific gravity, 22.4) and, like osmium, has a very high melting-point (2,290° C.). It is very hard and is much more brittle than platinum.

In some respects it is the most "noble" of the platinum metals. The massive metal does not dissolve perceptibly even in aqua regia, but is somewhat attacked by fused potassium bisulphate, and combines with chlorine at high temperatures. The finely divided metal, however, is soluble in aqua regia. The compact metal is not changed by heating in air, but the black, finely divided or spongy iridium takes up oxygen.

Laboratory Preparation.¹ Like the other metals of the group, iridium is easily reduced to the metallic state. The chlorides (including the double chlorides) decompose when heated, leaving a spongy mass of grey or black iridium. Solutions of iridium salts yield the black finely divided metal when treated with zinc or with an organic reducing agent. If platinum, palladium or osmium are present in the finely divided metal, they can largely be removed by repeated extraction, first with nitric acid containing nitrous acid, which dissolves away osmium and palladium, and afterwards with diluted aqua regia, which dissolves away the platinum. Rhodium, if present, can be eliminated by fusion with potassium bisulphate, which converts the rhodium to a soluble compound easily removed by subsequent washing with water. Iridium is left as an insoluble sesquioxide, which is easily reducible to metallic iridium.²

Colloidal iridium can be obtained by methods analogous to those employed for obtaining colloidal palladium. An explosive form of impure iridium—analogueous to explosive rhodium—is prepared by the action of an acid upon a zinc-iridium alloy.

¹ For the preparation of pure iridium from impure materials see G. Matthey, *Proc. Roy. Soc.* **28** (1879), 466.

² U. Antony, *Gazetta*, **22** (1892), i, 275.

Compounds

The compounds of iridium bear a certain analogy to those of rhodium, which falls above iridium in the periodic table. Like the rhodium compounds, they correspond to valencies of four and three. No volatile tetroxide, such as is formed by osmium, has been isolated in a pure state, although the fact that iridium can be volatilized in oxygen between 750° and $1,000^{\circ}$ C. has been interpreted as showing that such an oxide does exist.¹ As in the case of rhodium, lower compounds have been described, but there is at present no definite reason for considering them to be chemical individuals; thus when iridium trichloride is heated it loses part of its chlorine, yielding between 720° and 740° C. brown-green crystals, said to be the dichloride, IrCl_2 , whilst between 740° and 850° C. a blue-black monochloride is stated to be obtained.²

A. Compounds of Tetravalent Iridium.

When the finely-divided metal is dissolved in aqua regia, the solution contains the tetrachloride, IrCl_4 . By evaporation of this solution at a low temperature (below 40° C.), the solid chloride is said to be obtained as a reddish-black salt. It is prepared in a state of greater purity by treating a suspension of ammonium iridichloride in water with chlorine gas.³ The complex chlorides are, as usual, more easy to obtain in the crystalline condition, owing to their comparatively low solubility; thus, by the addition of potassium chloride to the solution of iridium in aqua regia, it is possible to obtain dark red crystals of **potassium iridichloride**, $2\text{KCl}.\text{IrCl}_4$ or $\text{K}_2[\text{IrCl}_6]$.

By the addition of caustic alkali to a solution of the chloride, a blue precipitate of the hydroxide is obtained; when heated in a current of carbon dioxide, this loses water, and the black anhydrous **dioxide** (IrO_2) is left; but the latter readily loses oxygen if heated too strongly.

The decomposition pressure of iridium dioxide at different temperatures has been measured; it becomes equal to that of the atmosphere at about $1,100^{\circ}$ C. Thus finely divided iridium heated in oxygen at atmospheric pressure at $1,070^{\circ}$ C. becomes oxidized to dioxide, but, if the dioxide is heated at $1,110^{\circ}$, partial decomposition occurs. The question is, however, rendered complicated by the existence of solid solutions of iridium in the dioxide.⁴

¹ L. Wöhler and W. Witzmann, *Zeitsch. Elektrochem.* **14** (1908), 107.

² L. Wöhler, *Chem. Zeit.* **35** (1911), 798.

³ M. Delépine, *Ann. Chim.* **7** (1917), 287.

⁴ L. Wöhler and W. Witzmann, *Zeitsch. Elektrochem.* **14** (1908), 97.

When a well-cooled solution of lithium iridichloride is saturated with hydrogen sulphide, the **sulphide**, IrS_2 , is thrown down as a brown precipitate. Upon treatment with concentrated nitric acid, this yields the **sulphate**, $\text{Ir}(\text{SO}_4)_2$, as an amorphous brown body having a yellow solution.¹

B. Compounds of Trivalent Iridium.

When a solution of the tetrachloride is reduced with sulphur dioxide the red colour changes to green, and the solution contains the green **trichloride**, IrCl_3 . In the presence of potassium chloride, a complex potassium iridium chloride, $3\text{KCl} \cdot \text{IrCl}_3$ or $\text{K}_3[\text{IrCl}_6]$, is easily isolated in soluble green prisms, which contain three molecules of water of crystallization.²

By treatment of the green solution with alkali at 100°C ., the **hydroxide** is slowly precipitated; when thrown down by an alkali carbonate, or very dilute caustic alkali, the precipitate is green, but in the presence of much caustic alkali it is black; the different colours are probably due to variation in the water-content. Both forms are readily oxidized by exposure to air, and the hydroxide is consequently best prepared in an atmosphere of carbon dioxide. It is difficult to obtain the hydroxide free from alkali. It is likewise difficult to drive off the water by heating, so as to yield the anhydrous oxide (Ir_2O_3), because decomposition occurs according to the equation



At higher temperatures the dioxide produced may itself partly decompose, with the evolution of oxygen. It is doubtful whether the oxide Ir_2O_3 has yet been prepared in a pure state.³

The salts of oxyacids are prepared by dissolving the hydroxide in the acids in question; only a few are known. The **sulphate**, $\text{Ir}_2(\text{SO}_4)_3$, is a yellow substance when pure; but if it contains salts of tetravalent iridium, it may appear violet. True alums formed by combination with the sulphates of the alkali metals are known, all of which crystallize in yellow octahedra. The **sulphite**, $\text{Ir}_2(\text{SO}_3)_3 \cdot 6\text{H}_2\text{O}$, is produced, along with a basic salt, when sulphur dioxide is passed through water containing the hydrated oxide in suspension; it is yellow, and, although soluble in water containing sulphur dioxide, is scarcely soluble in pure water.

The **sulphide**, Ir_2S_3 , is thrown down as a brown or black pre-

¹ E. Rimbach and F. Korten, *Zeitsch. Anorg. Chem.* **52** (1907), 409.

² For details of the chloride and complex chlorides of trivalent iridium, see M. Delépine, *Ann. Chim.* **7** (1917), 292-339.

³ L. Wöhler and W. Witzmann, *Zeitsch. Anorg. Chem.* **57** (1908), 334.

precipitate when hydrogen sulphide is passed into a solution of one of these salts.

A series of complex **cyanides** and complex **nitrites** exist, corresponding to the ferricyanides and to the cobaltinitrites. **Potassium irido-cyanide**, $3\text{KCN}.\text{Ir}(\text{CN})_3$ or $\text{K}_3[\text{Ir}(\text{CN})_6]$, is formed when ammonium iridi-chloride, $(\text{NH}_4)_2[\text{IrCl}_6]$, and potassium cyanide are fused together; it is a colourless substance. **Potassium irido-nitrite**, $\text{K}_3[\text{Ir}(\text{NO}_2)_6]$, is produced as a white precipitate when potassium nitrite is added to a hot solution of the sulphate.

PLATINUM

Atomic weight 195.2

Just as palladium is less noble than ruthenium and rhodium, so platinum is less noble than osmium and iridium; platinum has much in common with gold, just as palladium possesses points of similarity to silver, and nickel to copper.

The Metal

Platinum resembles the other members of the group in appearance, possessing a white metallic lustre; it is a very heavy metal, slightly less heavy than osmium and iridium (specific gravity 21.4); the melting-point (about 1,755° C.) is also lower than that of osmium or iridium. It is softer than iridium, and, unlike that metal, is very malleable and ductile.

Platinum is not attacked by pure hydrochloric or pure nitric acid. It is perceptibly attacked by boiling strong sulphuric acid and is dissolved fairly readily by aqua regia; the finely divided metal is dissolved by a cyanide solution, especially in the presence of air. It is also oxidized by fused potassium nitrate, but is comparatively resistant to fused potassium bisulphate. Platinum is attacked by gaseous chlorine. The solubility of platinum in acids is reduced if a little iridium is alloyed with it, and is increased if it contains a less noble metal.

Finely divided platinum takes up oxygen from the air. At least part of the amount taken up probably remains adsorbed upon the surface, but it is considered by many chemists that an oxide is actually produced; this view is thought to be supported by the fact that after exposure to the air the finely divided metal has acquired an oxidizing character (it liberates iodine from potassium iodide) and also has become partially soluble in hydrochloric acid.¹ Platinum foil heated for many weeks in oxygen at about 430° C. becomes covered with a dark coat of oxide, which decomposes at a higher temperature. The compact metal suffers no visible change by exposure to the air at ordinary temperature.

When a platinum vessel is heated in the *reducing flame* of a burner fed with commercial coal-gas, a porous sooty layer is produced on the surface, and, in time, a hole may be worn through

¹ L. Wöhler, *Ber.* 36 (1903), 3475.

the vessel. This has been shown to be due to the presence of carbon disulphide in the flame, which is said to form an additive compound, PtCS_2 , with platinum; sulphur-free flames are harmless.¹ Impure platinum, containing iron and rhodium, is corroded in this way with especial rapidity.

Platinum vessels heated in a non-luminous (*oxygen-rich*) flame do not suffer the kind of corrosion just described. Nevertheless they lose weight to an appreciable extent when heated in an oxidizing atmosphere.² This loss of weight does not appear to be due to true volatilization because it does not occur when the metal is heated *in vacuo*. It has been shown that minute particles are shot off from the heated surface, and it is thought that this is due to the formation of an endothermic oxide which is stable at high temperatures, and which decomposes at lower temperatures.

Molten platinum dissolves oxygen with avidity, but gives up most of it on cooling, the phenomenon of "spitting" being observed.

Platinum, like palladium, dissolves hydrogen; the absorption takes place most quickly in the case of finely divided metal, but platinum foil is appreciably pervious to the gas.

Laboratory Preparation.³ Platinum is obtained in the metallic state from its salts by the ordinary methods. The state of aggregation depends on the method of reduction. If a solution of platinum chloride is reduced with an organic reducing agent, such as hydrazine hydrate, in the presence of a protective colloid, such as sodium lysalbinat, a black-brown colloidal solution of platinum is obtained. It can be freed from excess of electrolytes by dialysis, and can afterwards be evaporated on a water-bath. This leaves a black deposit of dry "colloidal platinum"; if the residue is again treated with water, the colloidal solution of platinum is regenerated.⁴

If the solution of platinum chloride is reduced by another metal, for instance zinc, a black deposit is obtained, which can be separated by filtration from the liquid; it is known as "platinum black" and is a very active catalyst. Another way of obtaining finely divided black platinum is by dissolving an alloy of platinum and a baser metal, e.g. zinc, in an acid; the base metal is dissolved,

¹ F. Mylius and C. Hüttner, *Zeitsch. Anorg. Chem.* **95** (1916), 257.

² J. H. T. Roberts, *Phil. Mag.* **25** (1913), 270; G. W. C. Kaye and D. Ewen, *Proc. Roy. Soc.* **89** [A] (1913), 58; L. Holborn and L. Austin, *Sitzungsber. Preuss. Akad.* (1903), 245. Compare Sir W. Crookes, *Proc. Roy. Soc.* **86** [A] (1912), 461.

³ For the preparation of pure platinum from impure materials, see G. Matthey, *Proc. Roy. Soc.* **28** (1879), 464; E. Wichers, *J. Amer. Chem. Soc.* **43** (1921), 1268.

⁴ C. Paal and C. Amberger, *Ber.* **37** (1904), 124.

and platinum black is left behind, often in an "explosive" form, the explosive properties being due to the presence of oxygen and hydrogen. When platinum black is heated, it undergoes the same kind of "sintering" as has been noticed in the case of palladium; the colour changes from black to grey, the volume diminishes appreciably, and the surface area (as indicated by the power of adsorbing gases) becomes considerably reduced.¹

The form of platinum known as "**spongy platinum**" is obtained by heating platinum ammonium chloride, and is a black or grey porous mass.

Finally, compact lustrous platinum can be obtained by the electrolysis of a solution of platinum chloride containing free acid²; citric acid has been found a convenient reagent to maintain the hydron concentration within the correct limits; the platinum deposited forms a bright coating on the cathode, but has a tendency to peel off.

Finely divided platinum can be welded together so as to produce the compact metal. For instance, if a pasty mixture of spongy platinum and water is pressed together in a mould, the particles adhere together; if the product is then heated strongly, and hammered, the whole becomes quite coherent, and when it is burnished the bright metallic lustre appears.

Catalytic Activity. Like other substances which readily adsorb gases on their surface, platinum has a considerable catalytic activity in favouring gaseous reactions. Platinum black brings about the combination of oxygen and hydrogen at a low temperature. It is possible, for instance, to "light" a Bunsen burner by holding a wire carrying finely divided platinum in the path of the gas-air mixture issuing from the mouth. Again, a red-hot platinum wire, held above the surface of an alcohol-ether mixture contained in a dish, may remain red-hot indefinitely; a local combustion of the vapour is brought about on the surface of the platinum, and the heat thus evolved is sufficient to maintain the temperature of the wire, although insufficient to ignite the mixture.

The addition of platinum black, or, better still, colloidal platinum, to hydrogen peroxide quickly brings about the decomposition of the latter substance. Spongy platinum, suitably prepared, is a very active catalyst for bringing about the combination of unsaturated organic acids with hydrogen.³

¹ R. Wright and R. C. Smith, *Trans. Chem. Soc.* **119** (1921), 1683.

² W. J. McCaughey, *Trans. Amer. Electrochem. Soc.* **15** (1909), 523; W. J. McCaughey and H. E. Patten, *Trans. Amer. Electrochem. Soc.* **17** (1910), 275.

³ For method of preparing a form with high catalytic activity see F. Feulgen, *Ber.* **54** (1921), 360.

As in the case of other catalysts which depend upon a surface-action, the activity of platinum is quickly destroyed by the presence of "poisons." Many of the important "poisons" are volatile substances, like the compounds of sulphur and arsenic, but it has also been found that the presence of non-volatile metals prevents the occlusion of gases, and hence destroys the catalytic activity. The absorption of hydrogen by platinum is reduced by mere traces of lead, the reduction being proportional to the amount of lead present; mercury and zinc likewise act as poisons.¹

It is possible, by treating a platinum catalyst with a carefully regulated quantity of carbon disulphide, to render it incapable of catalysing certain reactions whilst still effective in bringing about others.²

Compounds

Most of the compounds of platinum are derived from the two oxides PtO and PtO₂, both of which are known. The two classes of salts correspond closely to the palladous and palladic salts; it will be recollected that platinum falls just below palladium in the periodic table. A trioxide, PtO₃, is also known. Intermediate oxides of platinum have been described, as well as chlorides³ such as PtCl₃ and PtCl; but there seems no convincing reason to regard these as chemical individuals.

A. Compounds of Tetravalent Platinum (Platinic Compounds).

When platinum is heated in chlorine below 500° C., **platinic chloride**, PtCl₄, is slowly produced. It is more easily prepared by heating platinichloric acid (*see below*) at 165° C. in a current of hydrogen chloride for fifteen hours.⁴ It is a red substance, having a yellow solution. Platinic chloride combines with ammonia in different proportions to form ammines; the series is of some interest, because Werner⁵ has used it in order to illustrate his theory. The conductivity rises steadily as the number of ammonia groups in the molecule increases, thus yielding support for the formulæ assigned by Werner to the compounds:—

¹ E. B. Maxted, *Trans. Chem. Soc.* **117** (1920), 1501; **119** (1921), 225; **121** (1922), 1760.

² G. Vavon and A. Husson, *Comptes Rend.* **175** (1922), 277.

³ L. Wöhler and S. Streicher, *Ber.* **46** (1913), 1591.

⁴ W. Pullinger, *Trans. Chem. Soc.* **61** (1892), 422.

⁵ A. Werner and A. Miolati, *Zeitsch. Phys. Chem.* **14** (1894), 510.

	Molecular Conductivity.
$[\text{Pt}(\text{NH}_3)_6]\text{Cl}_4$	522.9
$\left[\text{Pt} \begin{array}{c} (\text{NH}_3)_5 \\ \text{Cl} \end{array} \right] \text{Cl}_3$?
$\left[\text{Pt} \begin{array}{c} (\text{NH}_3)_4 \\ \text{Cl}_2 \end{array} \right] \text{Cl}_2$	228
$\left[\text{Pt} \begin{array}{c} (\text{NH}_3)_3 \\ \text{Cl}_3 \end{array} \right] \text{Cl}$	96.75
$\left[\text{Pt} \begin{array}{c} (\text{NH}_3)_2 \\ \text{Cl}_4 \end{array} \right]$	Very small

The complex chlorides are among the most easily prepared compounds of platinum. If platinum is dissolved in aqua regia, and the solution is evaporated with hydrochloric acid until all the nitric acid is driven off, the residue consists of brown-red crystals of **platinichloric acid**, 2HCl.PtCl_4 , or $\text{H}_2[\text{PtCl}_6]$; this substance is sometimes known as **platinic chloride**. If potassium chloride is added to the solution, the less soluble potassium salt, **potassium platinichloride**, 2KCl.PtCl_4 , or $\text{K}_2[\text{PtCl}_6]$, is deposited in reddish octahedra. This salt, although soluble to the extent of 1.1 per cent. in water at 20°C ., is almost insoluble in water containing alcohol. The solubility of the platinichlorides of the different alkali-metals varies with the atomic weight, those of caesium and rubidium being very sparingly soluble, whilst the platinichloride of sodium is freely soluble. The solutions have a yellow colour, which is ascribed to the complex ion $[\text{PtCl}_6]''$.

By precipitation of a solution of platinic chloride, or a complex chloride, by alkali, a hydrated oxide or **hydroxide** is obtained; the precipitate is apt to contain alkali, but this can largely be avoided by working in the following way.¹ Excess of concentrated sodium hydroxide is added to boiling platinic chloride. This gives a yellow solution containing sodium platinate. It is then allowed to cool, and is precipitated with acetic acid, the precipitate being washed by decantation. The product is almost white at first but becomes yellow on drying; when heated at 100°C . it loses part of the combined water and becomes black, but it is impossible to expel the whole of the water without causing decomposition. Thus the anhydrous oxide, PtO_2 , cannot be prepared in that way.

Few platinic salts of oxy-acids are known. The **sulphate**,

¹ L. Wöhler, *Zeitsch. Anorg. Chem.* **40** (1904), 423.

$\text{Pt}(\text{SO}_4)_2$, has, however, been obtained as a brown mass from a solution of the hydroxide in sulphuric acid.

The **sulphide**, PtS_2 , can be prepared by precipitation. When hydrogen sulphide is bubbled through a solution of potassium platinichloride, a black precipitate of platinic sulphide is formed. At low temperatures, it may absorb excess of hydrogen sulphide, forming a lighter-coloured acid sulphide; but, if the precipitation is carried out at 90°C ., this occurrence is avoided.

Although most of the complex cyanides (proper) belong to the platinous series, certain complex platinic thiocyanates are known. When, for instance, a solution of potassium platinichloride is boiled with potassium thiocyanate, it becomes deep red and on cooling deposits red crystals of **potassium platinithiocyanate**, $2\text{KCNS.Pt}(\text{CNS})_4$ or $\text{K}_2[\text{Pt}(\text{CNS})_6]$; other platinithiocyanates are known, those of the heavy metals being insoluble.

B. Compounds of Divalent Platinum (Platinous Compounds).

When platinichloric acid (H_2PtCl_6) is heated at 300°C . it loses hydrogen chloride and part of its chlorine, and yields **platinous chloride**, PtCl_2 ; any remaining platinichloric acid may afterwards be removed by washing with water. As thus prepared, platinous chloride is a green-grey or brown powder, almost undissolved by water, but dissolving in the presence of hydrochloric acid. Platinous chloride combines with ammonia, giving different compounds according to the conditions under which the two bodies interact.¹ The diammine, which is known both in cis- and trans- forms,

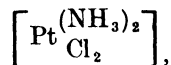

is yellow, whilst the tetrammine



which is obtained only in excess of ammonia, is usually colourless, although a yellow modification has also been described. When, however, a solution of platinous chloride is treated with ammonia, the main product is a green compound having the same empirical composition as the yellow diammine. This is generally known as "Magnus' green salt," and is readily separated from the true

¹ The various empirical methods described by different authors for isolating the different amines are collected in Gmelin-Kraut's Handbuch. If the equilibrium diagram of the system $\text{PtCl}_2\text{-NH}_3$ could be worked out, showing the conditions under which the different compounds are stable, the subject could probably be expressed quite simply.

ammines owing to its smaller solubility in hot water; it is now generally regarded as a platinumchloride, thus,

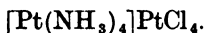

It will be noticed that, as in the ammines of the divalent palladium salts, the co-ordination number is here four, not six.

Various complex chlorides are known. **Potassium platinumchloride**, 2KCl.PtCl_2 or $\text{K}_2[\text{PtCl}_4]$, is obtained by the action of a reducing agent on the platinumchloride, $\text{K}_2[\text{PtCl}_6]$. The most convenient reducing agent is cuprous chloride; the rather insoluble potassium platinumchloride is made into a paste with water, and cuprous chloride—also rather insoluble—is added. Since the two insoluble substances interact to give soluble products, the paste gradually clarifies, and finally, after filtration, the clear liquid is evaporated, and deposits red crystals of potassium platinumchloride.

Like cuprous chloride, platinumous chloride can combine with carbon monoxide. When the chloride is heated in carbon monoxide at 250°C ., yellow needles with the composition $2\text{PtCl}_2.3\text{CO}$ are obtained, along with other compounds. Platinumous chloride also forms compounds, such as $\text{PtCl}_2.\text{PCl}_3$ and $\text{PtCl}_2.2\text{PCl}_3$, with phosphorus trichloride.

By precipitating platinumous chloride, or preferably potassium platinumchloride, with a caustic alkali, the black **hydroxide** is obtained, although it is difficult to wash free from alkali. By carefully heating in air, it is said to be converted to the grey anhydrous **platinumous oxide**, PtO ; but it is doubtful whether the whole of the water can be driven off without causing decomposition.

It is noteworthy that finely divided platinum (platinum black), when exposed to the air, absorbs oxygen; the product is sometimes considered to contain platinumous oxide.¹ It undoubtedly possesses powerful oxidizing properties.

The **sulphide**, PtS , is formed as a black precipitate when hydrogen sulphide is bubbled through a solution of platinumous chloride.

There are very few oxy-salts in the platinumous series. When a solution of potassium platinumchloride is treated with potassium bisulphite, yellow crystals of the **double sulphite**



appear. There are also **complex nitrites** and **complex cyanides**, such as have been met with in the other metals. **Potassium platinumnitrite**, $2\text{KNO}_2.\text{Pt}(\text{NO}_2)_2$ or $\text{K}_2[\text{Pt}(\text{NO}_2)_4]$, is obtained by

¹ L. Wöhler, *Ber.* 36 (1903), 3475. Compare also L. Wöhler and W. Frey, *Zeitsch. Elektrochem.* 15 (1909), 129.

evaporating a solution containing potassium platinochloride and potassium nitrite; it forms colourless monoclinic crystals.

Potassium platino-cyanide,

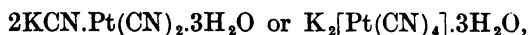

is formed when spongy platinum dissolves in a solution of potassium cyanide. It is more easily produced by adding platinous chloride to a solution of potassium cyanide. It crystallizes out in rhombic prisms, which are yellow when viewed by transmitted light, but the faces show a blue metallic lustre by reflected light. Various other platino-cyanides can be obtained, and are remarkable for the variety of colours represented.¹ The **copper** salt is a green insoluble substance obtained by precipitation; when treated with baryta-water, it gives the **barium** salt, which is yellow when viewed by light transmitted in one direction, and green in the other. By interaction of the barium salt with magnesium sulphate, **magnesium platino-cyanide** is produced; this is red when viewed by transmitted light, but appears green by light reflected from the ends. The acid from which these salts must be regarded as being derived, **platino-cyanic acid**, $\text{H}_2[\text{Pt}(\text{CN})_4]$, is obtained by the action of hydrogen sulphide on the copper salt. It can be isolated in well-formed crystals by recrystallization from alcohol-ether. One hydrate is red by transmitted, blue by reflected light; another is green by transmitted, golden by reflected light.

Several of the platino-cyanides exist in more than one form, and the study of such compounds is very interesting if considered from the stereo-chemical standpoint.

Complex thiocyanates also exist. **Potassium platinothio-cyanate**, $2\text{KCNS}(\text{CNS})_2$ or $\text{K}_2[\text{Pt}(\text{CNS})_4]$, is formed as a red crystalline precipitate when a solution of potassium thiocyanate and potassium platinochloride is evaporated and allowed to cool.

C. Compounds of Hexavalent Platinum.

Platinum trioxide, PtO_3 , is obtained by the electrolytic oxidation of a solution of platinic hydroxide ($\text{Pt}(\text{OH})_4$) in sodium hydroxide.² The success of the preparation depends on keeping the solution cooled down to 0°C ., since the trioxide is very unstable and loses oxygen at room temperature. Platinum electrodes are used, the anode and cathode compartments being separated by a porous partition. The cathode compartment contains 2N sodium hydroxide, whilst the anode compartment contains 2N sodium

¹ L. A. Levy, *Trans. Chem. Soc.* **93** (1908), 1446; **101** (1912), 1081; *Proc. Camb. Phil. Soc.* **14** (1907-8), 159, 378.

² L. Wöhler, *Zeitsch. Elektrochem.* **15** (1909), 769.

hydroxide in which the platinum hydroxide has previously been dissolved. About 3.5 volts are applied to the cell, and after current has passed for some time, a golden layer appears on the anode; the layer soon peels off, yielding flakes which may be washed with ice-water and dried. The product, which is yellowish-green when dried, contains alkali in a quantity represented by the formula $3\text{PtO}_3 \cdot \text{K}_2\text{O}$. If washed with seminormal acetic acid, the colour changes to red-brown, and is then free from alkali; but in spite of careful cooling, it is difficult to avoid loss of oxygen, and the product usually contains rather less oxygen than is indicated by the formula PtO_3 .

At ordinary temperatures, loss of oxygen from platinum trioxide is very rapid at first, solid solutions having a composition intermediate between PtO_2 and PtO_3 being formed; the rate of decomposition slows down, however, and even after four weeks the product still contains more oxygen than is represented by the formula PtO_2 .

The trioxide is undissolved by dilute sulphuric acid, but evolves chlorine when treated with hydrochloric acid.

Platinum as an Inert Electrode Material

Platinum electrodes are frequently used in the laboratory for the electrolysis of ordinary solutions of salts in cases where insoluble electrodes are demanded, as, for example, in the estimation of a metal by electro-deposition. Even when used as the anode, the platinum is practically unattacked, although if the solution contains a chloride a platinum anode undoubtedly does lose weight perceptibly on repeated use. The platinum anode is generally assumed to take no part in the reaction, although this assumption is possibly inexact—a matter which will be considered in further detail below.

Since platinum is, to all intents and purposes, an inert electrode-material, the value of the potential at a platinum electrode is determined by two factors:—

(1) It is affected by the *presence of hydrogen or oxygen* dissolved in—or adsorbed upon—the platinum. These elements may be imparted to the platinum by passing hydrogen or oxygen in gaseous form over the surface (as in the so-called “hydrogen electrode”); or they may be produced upon the surface by preliminary cathodic—or anodic—polarization. By preliminary cathodic treatment the potential at a platinum electrode immersed in acid may be depressed below -0.1 volt, whilst by anodic treatment it may be raised above $+1.5$ volt.

(2) It is affected by the *character of the solution* in which the

platinum is immersed, varying according as the solution is acid or alkaline, or according as it possesses an oxidizing or reducing character.

The employment of the sudden alteration of the potential at a platinum electrode in analysis has been discussed in Chapter IX, Vol. I. It is not proposed to repeat at length what was said there, but it may be recalled that the potential of a hydrogen-saturated platinum electrode

in acid is about	0.0 volt,
in neutral solution is about	- 0.4 ,,
and in alkali is about	- 0.8 ,,

The sudden change of potential which occurs when an acid is *just* neutralized with alkali, can be used to indicate the end-point in the titration of acids by alkalis, under circumstances where an ordinary indicator cannot be used.

Similarly, in the case of a platinum electrode free from hydrogen, the value of the potential depends mainly on the oxidizing or reducing character of the solution. The potential of platinum immersed in

acidified potassium dichromate is about	+ 1.12 volt.
acidified ferrous sulphate is about	+ 0.50 ,,

This fact is used in the titration of dichromates by ferrous salts, for the sudden drop in potential occurring at the point at which the dichromate becomes completely destroyed is a clear indication of the end-point.

When a piece of platinum foil is to be used as a hydrogen electrode, it is found necessary to cover it with a deposit of black amorphous platinum. This can be deposited electrolytically from a bath containing 3 per cent. of platinum chloride and a trace (0.02 per cent.) of lead acetate. It is probable that the function of the platinum black is simply to increase the active area of the electrode. It seems reasonable to suppose that the electromotive activity of the hydrogen electrode is due to that portion of the hydrogen which is adsorbed on the surface; if so, the greater the surface is made, the less becomes the danger that the electrode may become appreciably unsaturated, which would cause the potential to depart from its proper value.

Similarly the electrodes of the cells used for determining the conductivity of liquids (compare Chapter V, Vol. I) are usually coated with black platinum, as this increases the "capacity" of the electrode; that is to say, it allows a larger amount of current to pass before the platinum becomes appreciably polarized through the accumulation of hydrogen or oxygen on the electrodes. Probably,

if it were possible to use alternating current of very high frequency, it would make no difference whether black or bright electrodes were used¹; but for current of the ordinary frequency the increase of area caused by blackening is essential in order to avoid polarization.

Does a Platinum Anode become Oxidized?² Consider the electrolysis of an acid solution of normal hydron concentration in an electrolytic cell fitted with blacked platinum electrodes, to which a gradually increasing E.M.F. is applied. When the anodic potential exceeds 1.23 volts, the surface of the anode becomes supersaturated with oxygen. But—owing to over-potential—no

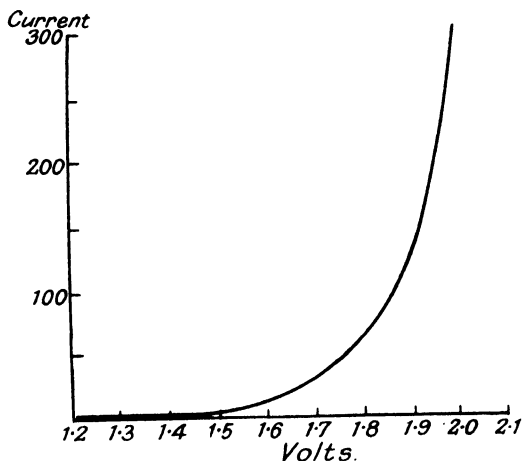

FIG. 39.—Polarization Curve of a Platinum Anode.

evolution of oxygen in bubbles will occur until the potential exceeds about 1.50 volts; and consequently, whilst the potential is between + 1.23 and 1.50 volts, no appreciable current will pass, apart from a small current accounted for by the leakage of oxygen, not in bubble-form, through the material of the electrode. Above 1.50 volt oxygen commences to be produced in bubbles, and the current rapidly rises (see Fig. 39).

¹ W. A. Taylor and S. F. Acree, *J. Amer. Chem. Soc.* **38** (1916), 2415. A different view of the value of platinizing is advanced by H. F. Haworth, *Trans. Faraday Soc.* **16** (1921), 385.

² F. Foerster, *Zeitsch. Phys. Chem.* **69** (1909), 236; K. Bennewitz, *Zeitsch. Phys. Chem.* **72** (1910), 202; R. Lorenz and E. Lauber, *Zeitsch. Elektrochem.* **15** (1909), 206; R. Lorenz and P. E. Spielmann, *Zeitsch. Elektrochem.* **15** (1909), 293, 349; E. P. Schoch, *J. Phys. Chem.* **14** (1910), 665; P. E. Spielmann, *Trans. Faraday Soc.* **5** (1909), 88; G. Grube, *Zeitsch. Elektrochem.* **16** (1910), 621; G. Grube and B. Bulk, *Zeitsch. Elektrochem.* **24** (1918), 237.

If, after this stage has been reached, the current is stopped, and the anode is allowed to stand in the solution, it retains for some considerable time an elevated potential, since it is heavily charged with oxygen. Gradually, however, this occluded oxygen diffuses away and the potential drops as indicated in Fig. 40. It will be noticed that, under the conditions to which the curve applies, over sixty days are required for the potential to drop from 1.5 volt to 1.1 volt.

It does not appear ever definitely to have been decided how far the oxygen-charge of the polarized electrode is adsorbed upon the surface, and how far it is dissolved within the electrode, although this point is of great importance. It is, however, probably the

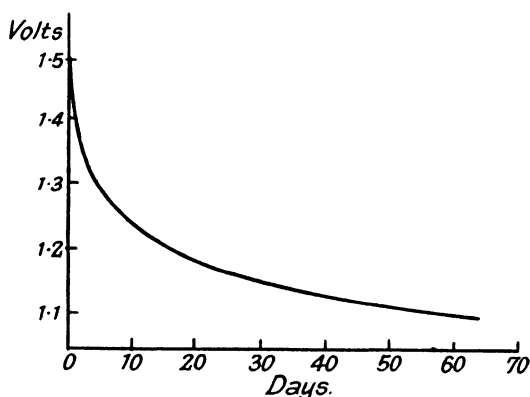

FIG. 40.—Self-discharge of a Polarized Black Platinum Electrode on standing in Acid.

concentration of oxygen existing upon the surface which determines the value of the potential of the electrode at any moment.

If now we perform a similar experiment with a cell fitted with a bright platinum anode (not covered with platinum black), the over-potential is greater, and evolution of oxygen in bubbles does not commence until an anodic potential of about 1.67 volt is reached. According to Lorenz, when a polarized cell of this sort is allowed gradually to discharge itself through a high-resistance voltmeter,¹ arrests occur in the fall of the anodic potential at certain values (see Fig. 41); it is considered by some chemists that these arrests indicate the existence of definite oxides of platinum within—upon—the polarized electrode.

It is very doubtful whether this is the right interpretation, and

¹ For details of method see R. Lorenz, *Zeitsch. Elektrochem.* **14** (1908), 782; R. Lorenz and E. Lauber, *Zeitsch. Elektrochem.* **15** (1909), 207.

the whole matter requires to be reviewed afresh in the light of modern knowledge of adsorption, crystal-structure, and gas-diffusion through solids, and with due regard to the criteria now adopted in the study of alloys for determining the presence of definite inter-metallic compounds. All that can be said at the present time is that an anodically polarized platinum electrode always possesses a considerable charge of oxygen, and that its immunity from attack is probably in part due to this charge of oxygen; the state of a platinum electrode is comparable to that of passive iron, but in platinum the current density needed to produce passivity seems to be extremely small, possibly zero. The "electromotively active"

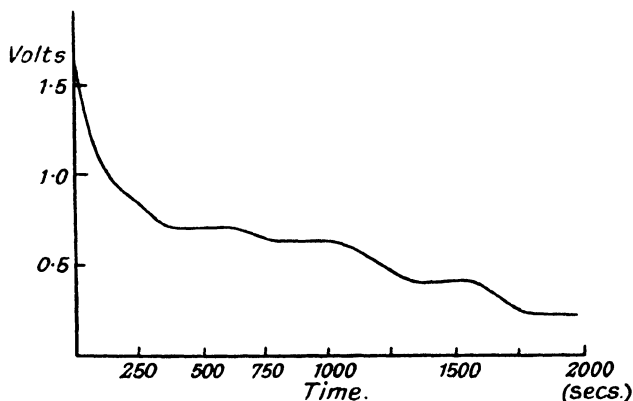

FIG. 41.—Discharge of a Polarized Bright Platinum Electrode through a "Polarization-Galvanometer" (Lorenz).

oxygen which determines the potential of the electrode is probably the part adsorbed on the surface, but a further quantity exists in the interior, which serves as a "reservoir" and keeps the surface layer replenished. This oxygen occluded in the interior may exist as a solid solution of oxygen in the metal, or possibly as a solid solution of an oxide in the metal,¹ or even (according to some writers) as a solid solution of one oxide in another.

Analysis of the Six Platinum Metals²

The analysis of all six platinum metals is conveniently considered in a single section. The metals in the elemental state are dis-

¹ In the view of the present writer, there is probably no real distinction between a "solid solution of oxygen in a metal" and a "solid solution of an oxide in the metal"; there is no reason to suppose that the "oxide molecules" have any distinct existence in the crystal-structure.

² Much useful information is given by J. N. Friend, "Textbook of Inorganic Chemistry" (Griffin), Vol. IX, Part I, Chapter X.

tinguished by the manner in which they resist the action of acids and other corrosive agents, whilst in the combined state their presence is generally revealed by the easy reducibility of the various compounds. Nearly all the salts of the platinum metals blacken when strongly heated. They can more easily be reduced to the elemental condition by means of a reducing agent. Metallic zinc precipitates the metals from a salt solution in a spongy or finely divided form, which is unchanged by hydrochloric acid. Hydrazine hydrate added to a solution containing a platinum metal usually gives a black or yellow coloration, or a black precipitate of the metal.

The easy reducibility of the platinum metals provides a method of separating them from the less noble metals, which are not reduced to the metallic state so readily.

The variety of colours represented among the compounds of the different metals suggests various simple colour-reactions which may serve as tests for the different metals and enable us to distinguish one from another. Actually, however, the application of such tests usually depends upon the metal being in a certain state of oxidation; moreover, the metals form complex salts of comparative stability, which in some cases may not show all the reactions of the metal in question. With this warning we may proceed to consider a few of the more important tests for the individual metals.¹

Platinum is detected by means of potassium iodide, which imparts a deep rose colour to a solution containing platinum chloride; one part of platinum in two million can be detected by this test, which is best carried out in the presence of a few drops of acid. Salts of divalent platinum, on the other hand, give a black precipitate with potassium iodide. Palladium in the palladous condition is also precipitated by potassium iodide, whilst tetravalent iridium gives a yellow coloration. With stannous chloride a platinum salt yields a blood-red or yellow solution, due to colloidal platinum protected by a tin compound; if the solution is shaken with ether, the coloration passes into the ether.

Platinum can be distinguished from gold in that a platinum salt is not reduced by oxalic acid, a reagent which reduces gold to the metallic state.

When potassium chloride is added to a concentrated solution of the tetrachloride of platinum, a yellowish-red crystalline precipitate of potassium platinumchloride, K_2PtCl_6 , comes down. But this does not distinguish platinum with certainty from the other metals:

¹ The reactions of the six metals are shown in tabular form by F. Mylius and A. Mazzucchelli, *Zeitsch. Anorg. Chem.* 89 (1914), 7.

iridium, for instance, gives a black-red precipitate under the same conditions, and the other metals are precipitated by chlorides if present in sufficient concentration.

Iridium can be distinguished from platinum in the following way. Sodium carbonate is added until the solution is just alkaline; the liquid is heated to 100° C., cooled and treated with a little weakly alkaline sodium hypochlorite, which produces a deep blue precipitate of the tetrahydroxide $\text{Ir}(\text{OH})_4$.¹

Palladium in the divalent condition can be distinguished from the other metals of the group by the white precipitate of palladous cyanide obtained by adding mercuric cyanide. Another reaction characteristic of palladium is the yellow precipitate produced when dimethyl-glyoxime is added to an acidified solution containing divalent palladium²; it will be remembered that nickel, which stands just above palladium in the periodic table, gives a reddish precipitate with the same reagent.

Osmium is detected by the odour of the excessively poisonous osmium tetroxide when a compound is heated with concentrated nitric acid. A fairly delicate colour-reaction for osmium in the state of the tetroxide depends on warming the solution with excess of thiocarbamide, together with a little hydrochloric acid. A reddish coloration indicates the presence of osmium.³

Ruthenium in the tetravalent condition gives a dark violet coloration on the addition of potassium thiocyanate; none of the other five metals yield this violet tint, although trivalent rhodium and tetravalent platinum produce a yellow colour. The action of hydrogen sulphide on ruthenium salts produces a dark precipitate and the filtrate has a blue colour. When in the metallic state, ruthenium can be detected by the action of fused potassium hydroxide and nitrate. A green mass is produced, containing potassium ruthenate; on dissolution in water, an orange solution is obtained, which yields a black or dark brown precipitate of the hydroxide when treated with an acid.

Rhodium in the finely divided metallic state is attacked by fused potassium bisulphate, yielding a yellow product which becomes red in contact with hydrochloric acid. This reaction serves to distinguish it from the other metals of the group.⁴ Characteristic colour changes are also produced when the gases evolved from the action of hydrochloric acid upon potassium chlorate are passed into

¹ F. Mylius and A. Mazzucchelli, *Zeitsch. Anorg. Chem.* **89** (1914), 14.

² M. Wunder and V. Thüringer, *Zeitsch. Anal. Chem.* **52** (1913), 110, 660.

³ L. Tschugaeff, *Comptes Rend.* **167** (1918), 235.

⁴ H. Moissan, "Chimie minerale" (Masson).

an alkaline solution of a rhodium salt. The liquid becomes yellow-red and afterwards red; a green precipitate then appears, which redissolves, giving a blue liquid.¹

The separation of the platinum metals from one another is a somewhat tedious process. Numerous methods have been described.² Where, as usually is the case, the mixture to be analysed is a natural alloy consisting mainly of the six metals, the actual dissolution of the alloy presents difficulty, since alloys containing much osmium and iridium will not be completely soluble even in aqua regia. In some cases it is convenient to heat with dry sodium chloride in a current of chlorine, a condensing apparatus being provided to prevent the loss of volatile chlorides. In other cases, the alloy can be ignited with a fused mixture of nitre and sodium hydroxide, or with sodium peroxide and sodium hydroxide.³

Assuming the first method to have been adopted, the metals are transformed into chlorides; both fixed and volatile portions are treated with water containing a little hydrochloric acid, and the solution is then nearly neutralized with sodium carbonate and brought near to the boiling-point; then sodium nitrite is added until the solution is nearly neutral to litmus; and finally a further quantity of sodium carbonate. After boiling for a few minutes, the liquid is filtered. During the neutralization process, any base metals (iron, lead, silver, zinc, tin, copper, bismuth, etc.) which may be present are precipitated as hydroxides or carbonates, and gold is precipitated in the metallic condition, whilst the platinum metals remain in solution as complex nitrites of remarkable stability (or in the case of osmium, as a complex chloride).

The first step in the separation is to distil away the osmium and ruthenium, which have volatile tetroxides. The solution is made alkaline with sodium hydroxide and introduced into a still fitted with ground joints, and is warmed, whilst a current of chlorine gas is passed through. This carries off the tetroxides of the two metals, which are condensed in a receiver containing hydrochloric acid and cooled in ice. On redistilling the distillate, this time from an acid solution, only the osmium comes over as tetroxide, whilst practically

¹ P. Alvarez, *Comptes Rend.* **140** (1905), 1341.

² Described at length in Sir W. Crookes' "Select Methods of Chemical Analysis" (Longmans). See also M. Leidié, *Chem. News.* **83** (1901), 19; M. M. Liedié and Quennessen, *Chem. News.* **88** (1903), 3. One alternative method is given by M. Wunder and V. Thüringer, *Zeitsch. Anal. Chem.* **52** (1913), 740, and another by J. W. Mellor, "Treatise on Quantitative Inorganic Chemistry" (Griffin).

³ If a low-grade ore is to be treated, it is best to "collect" the platinum by means of lead and then to cupel the lead button, according to the procedure to be described in the assay of silver and gold ores (see Vol. IV). For further details see C. W. Davis, *U. S. Bur. Mines Tech. Paper*, **270** (1921).

all the ruthenium remains fixed as a complex chloride. The condensing system in the second distillation consists of three flasks in series, the first filled with hydrochloric acid, the others with sodium hydroxide. The first flask may receive a little ruthenium, as well as osmium, and requires subsequently to be returned to the still and treated again. Thus a separation of ruthenium and osmium, not only from the other metals, but also from each other, is possible.

The solution containing the four non-volatile metals, left on the first distillation, is acidified and boiled; sodium nitrite is added until the solution is neutral. The solution is allowed to cool and ammonium chloride is added, which causes the precipitation of iridium and rhodium as complex nitrites of the type

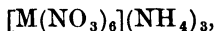

which are insoluble in ammonium chloride. The precipitate is filtered off, and evaporated with hot aqua regia several times, which converts both metals to chlorides. After evaporation to remove aqua regia, the residue is dissolved in cold water, and ammonium chloride added. This precipitates the iridium as $(NH_4)_2[IrCl_6]$, but the rhodium, which remains in the trivalent state, notwithstanding the evaporation with aqua regia, is not precipitated. Thus the separation of rhodium and iridium from one another—and from the other metals—is rendered possible.

The solution containing palladium and platinum is evaporated with hydrochloric acid to convert nitrites to chlorides, and is reduced with hydrogen so as to yield palladium and platinum in the black metallic state. They are then redissolved in aqua regia, and thus a solution free from any accumulation of sodium salts is obtained.

The palladium is reduced to the palladous state by means of a current of nitrogen peroxide, and by adding ammonium chloride it is possible to precipitate the platinum as ammonium platinum-chloride, $(NH_4)_2[PtCl_6]$, whilst leaving the palladium in solution.

In this way, the separation of the six metals can be arrived at. For details the papers referred to should be consulted. In each case, it is best to reduce the metal—after separation from the others—to the elementary state, and to weigh it in that condition.

If only iridium and platinum have to be separated, it may be convenient to precipitate them both as complex chlorides of the type $K_2[MC_6]$, and treat the mixture with hot potassium nitrite solution, which reduces the iridium to a fairly soluble green trivalent compound, whilst the platinum remains as the almost insoluble tetravalent compound. The treatment must be repeated until the action of potassium nitrite gives no further green colour.

The quantitative separation of platinum from gold is a matter of some small importance. Most processes depend on the fact that, of the two metals, gold is the more easily reduced to the metallic state. A solution of ferrous sulphate added to an acid solution containing both metals as chlorides causes complete precipitation of the gold, but leaves the platinum in solution. Another rather quicker method¹ involves the use of hydrogen peroxide in alkaline solution as reducing agent. Recently it has been shown that the separation of the metals may be brought about electrolytically.² The metals are assumed to be present as chlorides in a slightly acid solution, and sodium acetate is added to reduce the acidity. By electrolysis at a comparatively low E.M.F. (0.7 volt) the gold is completely precipitated as metal on a platinum dish which serves as cathode; a rotating platinum dish serves as anode, and during the electrolysis the temperature is gradually raised to 50°–60° C. Afterwards, the platinum may be deposited separately by electrolysis at a slightly higher E.M.F. (1.5 volt).

TERRESTRIAL OCCURRENCE OF THE SIX PLATINUM METALS (ruthenium, rhodium, palladium; osmium, iridium, platinum)³

The six platinum metals usually occur together in nature, and it is convenient to consider their geo-chemistry in a single article. They occur only in the very minutest trace in rock-magma, but, in a few places, have separated out in appreciable quantities in the ultra-basic portions of intrusive masses. The platinum metals are usually associated with the mineral chromite. In view of the "noble" character of the metals, it is not surprising that they occur in the elementary condition in the rock-mass.

In the Ural Mountains, ultra-basic igneous rocks, such as dunite and serpentine, which contain considerable amounts of chromite, also contain small grains of platinum-alloys, sparsely disseminated in the rock-mass. These rocks have in every case undergone much disintegration through weathering, and a large amount of material has been removed—and is still being removed—by the agency of running water; thus grains of platinum find their way into the streams which flow from the mountains.

Now of all the suspended particles carried down by the streams, the platinum-metal grains are by far the heaviest, and these will be dropped—along with the coarser sand-particles—as soon as the velocity of the current is seriously reduced. In this way, placer

¹ L. Vanino and L. Seemann, *Ber.* **32** (1899), 1968.

² W. D. Treadwell, *Helv. Chim. Acta*, **4** (1921), 364.

³ J. F. Kemp, *U. S. Geol. Surv. Bull.* **193** (1902), 11.

deposits, containing a sufficient content of precious metals to be of industrial importance, have been formed. A certain amount of platinum is also found in the detrital deposits left on the site of the eroded igneous rock.

The composition of the heavy grains of platinum alloys varies very much, even within the Ural Mountain region. Often they contain 75–85 per cent. of platinum, with much smaller amounts of the other five metals, and a considerable amount of iron (2–15 per cent.). In many places, however, grains are found consisting essentially of an alloy of iridium and platinum, the former usually predominating, whilst in others we find an alloy of iridium and osmium; traces of the other three metals usually occur in most of the alloys, and sometimes they become important constituents.

Very similar sands and gravels are found in numerous streams in the States west of the Rocky Mountains, in British Columbia, Oregon, and California; here also the platinum is often associated, in the original basic igneous rock, with chromite, and occasionally nuggets containing platinum, chromite, and sometimes olivine are found in the gravels. Some of the deposits contain more gold than platinum, and owe their economic importance mainly to the first-named metal. The black sands of the Pacific Coast¹ contain platinum, iridium, and osmium derived from peridotite and similar ultra-basic rocks existing in the mountains.

Another district, which in 1917 became the main source of the world's platinum supply, is the Choco District of the Republic of Columbia. Here also placer deposits are found, mainly on the San Juan River (which flows into the Pacific Ocean south of Panama) and its tributaries; both chromite and gold are common associates of the platinum.

In addition, platinum occurs in the ores of other metals associated with ultra-basic rocks. The ores of Sudbury (Canada), consisting mainly of sulphides and arsenides of iron, nickel, and copper, contain small amounts of an arsenide of platinum known as



Ontario has now become one of the most important producers of platinum, and also of palladium. In addition a great deal of platinum and palladium has been obtained from gold-copper mines in Nevada. As a matter of fact, most gold ores and many copper and silver ores contain small traces of platinum.

Palladium also occurs with gold in certain ores in Minas Geraes, Brazil.

¹D. T. Day and R. H. Richards, *U. S. Geol. Surv. Bull.* **285** (1905), 150.

TECHNOLOGY AND USES OF THE SIX PLATINUM METALS

In 1913 most of the world's supply of platinum came from the Urals, but even before the outbreak of war, production had begun to decline, and it is probable that the Russian supplies would in any case have failed in a few decades. The unsettled condition of Russia which followed the war almost brought the platinum-mining industry to a standstill, although operations have now recommenced.¹ During the war a very considerable shortage of platinum had arisen in Western Europe and America, and great efforts were made to develop to the full the Columbian deposits; the Columbian output accordingly became very large. The amount of platinum obtained from the Ontario nickel ores is also, as stated above, very considerable.

The preliminary treatment of placer deposits containing platinum is essentially similar to that of gold deposits (see Vol. IV). The separation of the metallic grains from the worthless minerals is based upon the higher specific gravity of the former. In many of the rivers, dredges are at work, very similar to those used for gold-dredging. These dredges scoop up the sand and gravel from the bed of the stream in buckets attached to a continuous moving belt; the buckets deliver it on to tables, where the heavier particles are retained; the lighter and worthless portions are thrown back into the river, preferably well to the stern of the vessel, so as not to be scooped up a second time. Where the deposits occur above the present water-level, the gravel must be washed to separate the precious constituents. The sluices or riffle boxes used are similar to those employed in washing gold. In many places, especially in Russia,² quite primitive methods have survived. The coarse gravel is separated on a screen, whilst the suspension of finer material in water is made to flow down an inclined plane, the bottom consisting of matting on which wire netting is laid. The heavy particles get "caught" in the corners formed between the wire and the matting, whilst the worthless light material is swept away. Before the war, 80 per cent. of the Russian platinum output was obtained by hand labour, whilst only 20 per cent. was obtained by dredging. At the end of the war, none of the Russian dredges were working.³

In the United States and in other places, where the other heavy minerals occurring in the "black sands" are comparatively magnetic substances, like magnetite, chromite, garnet, and monazite, magnetic separation has been used for the final stage of concentration.

¹ *Met. Chem. Eng.* **26** (1922), 176.

² L. Perret, *Trans. Inst. Min. Met.* **21** (1911-12), 647.

³ J. M. Hill, *Eng. Min. J.* **108** (1919), 131.

The crude metals obtained by washing are sent to the refining centres. Before the war most of the Russian platinum was refined in this country, as well as the relatively small supplies from India and Australia, and a considerable fraction of the Columbian and Canadian output. The Columbian supplies are now largely refined in the United States, whilst part at least of the platinum occurring in the Canadian nickel ores is worked up in that country.¹ A certain amount of platinum is obtained as a by-product at many gold, silver, and copper refineries in different parts of the world; the extraction of platinum from nickel ores was discussed on page 186.

The crude platinum received in granules at the refinery contains the metals in widely varying proportions according to the source from which it comes. Moreover, even the grains obtained from a single deposit are not all of the same kind. Often two different kinds of metallic grains can be distinguished:

(1) Dull grains of **crude platinum** containing 5–10 per cent. of iron, a little copper and gold, small amounts of iridium, palladium, and rhodium, and still smaller traces of osmium and ruthenium.

(2) Brighter grains of **iridium-osmium**, consisting mainly of iridium (55 per cent.) and osmium (30–40 per cent.), the remainder consisting of platinum, rhodium, ruthenium, and sometimes palladium.

Wet Extraction of Platinum Ores. The two kinds of grain just mentioned differ in their behaviour towards aqua regia. The crude platinum is completely dissolved by that reagent, whereas the iridium-osmium remains undissolved. Thus the treatment of a sample with aqua regia yields a rough separation of the two kinds of grains, where they occur mixed together. The solution and the undissolved residue are treated separately.

(1) The **solution** which contains chiefly platinum, but also iron, copper, gold, iridium, palladium, and rhodium, is evaporated to dryness, yielding the chlorides of the metals. It is heated to 125°–150° C., and in this way the palladium and most of the iridium are converted to a lower chloride; platinum remains as the tetrachloride. The mass is then dissolved in water containing a little hydrochloric acid, and ammonium chloride is added. A large part of the platinum is precipitated as ammonium platinichloride, $(\text{NH}_4)_2\text{PtCl}_6$; the other metals, being in a lower state of oxidation, will remain, for the most part, in solution. On further concentration of the solution, however, iridium is also deposited as a double salt. The remaining precious elements are then precipitated in the

¹ *Can. Mines Dept.*, No. 547 (1921), 54.

metallic state by means of iron. The residue is again dissolved in aqua regia, and, after the addition of ammonium chloride, is again fractionally crystallized in order to separate platinum and iridium. The palladium and rhodium remain in the mother-liquor; the former can be precipitated from an ammoniacal solution, as the sparingly soluble ammine, $\text{Pd}(\text{NH}_3)_2\text{Cl}_2$.

If a complete separation of platinum and iridium is desired, the various fractions of double chlorides must be recrystallized several times. But often there is no object in preparing a platinum salt free from iridium, because an alloy of platinum containing at least 2 per cent. of iridium is actually used for many technical purposes. The double salts can be reduced to the metallic condition by heating, a black spongy metal being obtained.

(2) The **undissolved residue** (*osmiridium*), which includes any heavy residual mineral matter (such as chromite), is heated strongly in an air-stream. Osmium and ruthenium, which have stable volatile tetroxides, are attacked, and the oxides of these metals distil forward. The oxides condense in the cooler parts of the tube, but as the tetroxide of ruthenium is unstable it decomposes, depositing the dioxide on the tube much closer to the heated portion of the vessel than the point where the tetroxide of osmium condenses. The oxides are subsequently reduced to the metallic condition. The danger of poisoning by the volatile tetroxide is a matter deserving notice.¹

The iridium, still containing some ruthenium which has escaped oxidation by the air-stream, has next to be brought into solution. The residue is mixed with salt and heated in a current of chlorine; this vigorous treatment converts the iridium to sodium iridium chloride and the ruthenium to the analogous body. On extraction of the mass with water, the pure iridium salt may be obtained by crystallization.

Dry Treatment of Platinum Ores. A different way of treating the crude ores is to mix them with galena (lead sulphide) and scrap iron, together with borax and glass, which function as fluxes. The iron reacts with the galena producing molten lead, which acts as a "collector," dissolving the platinum dispersed throughout the mass; the lead can be run out into moulds, and is afterwards "cupelled" (that is, exposed in the molten state to an oxidizing blast). The lead is thus oxidized, and the platinum metals remain behind.

Most of the osmiridium remains undissolved by the molten lead, but it can be recovered by heating the residue with zinc under a

¹ R. A. Cooper, *J. Chem. Met. Min. Soc. S. Africa*, **22** (1922), 152.

covering of ammonium chloride. Molten zinc dissolves even the osmium and iridium. After cooling, the zinc can be dissolved in acid, leaving osmium and iridium as a dark sponge.

Various modifications of the two processes just given are possible, and the details of the method will vary with the nature of the product to be treated. For the treatment of ores, wet methods are often preferred to dry methods¹; but for the recovery of platinum from precious metal scrap, use is frequently made of molten lead as a collector.

Consolidation of Platinum Metals. In order to bring the powdery or spongy metals obtained by reduction into the compact form, the powder is pressed into a coherent mass in a metal cylinder, and the mass is then subjected to strong heating. In the case of platinum, it is not absolutely necessary to melt the metal, as it can be welded into the compact form below the melting-point. But, in practice, it has become usual to bring the metals to fusion by means of the oxy-hydrogen blowpipe.

As a matter of fact a considerable proportion of the platinum which arrives at the refinery does not come from the mining districts, but consists of "scrap" from the jewel and dental industries, together with miscellaneous platinum articles which have become damaged, and are sold for remelting.² At the termination of the war, a great deal of platinum from dismantled munition factories also passed back into the hands of the refiners.

Uses of the Platinum Metals. Of the six platinum metals, two, **rhodium** and **ruthenium**, occur in such a small amount as to be of little importance. A rhodium-platinum alloy is, however, used in the construction of thermo-couples for pyrometric purposes and rhodium crucibles are said to have been manufactured. **Palladium** is less noble than the other metals, but palladium-gold alloys have been used as a substitute for platinum. They are employed in dentistry and also in jewellery. On account of its power of absorbing hydrogen, palladium is an effective catalyst in the hydrogenization of oils and fats. It has been used in the place of nickel for that purpose in Germany, and has the great advantage that it allows hydrogenization to take place at a considerably lower temperature than nickel, 80° C. instead of 180° C.; this is of great practical importance, because the valuable "vitamines," which are almost entirely destroyed by treatment at 180° C., to some extent escape destruction at 80° C.³ Silver articles are sometimes electroplated with palladium, which is not darkened by exposure to sul-

¹ *Chem. Eng.* 16 (1912), 99.

² J. P. Dunlop, *U. S. Geol. Surv., Min. Res.* (1916), 44.

³ J. C. Drummond, *Chem. Age*, 5 (1921), 550.

phuretted hydrogen ; palladium is, for the same reason, sometimes used instead of "silvering" on glass in scientific instruments.

Osmium and **iridium** are chiefly used in alloys with platinum ; such alloys are generally less attacked by chemicals than pure platinum. Osmium, which has an unusually high melting-point, was employed for a short time as a material for the filaments of electric lamps, but it is inferior to tungsten, quite apart from its costliness. Iridium, or an osmium-iridium alloy, is used for tipping the gold nibs of fountain pens.

Platinum itself is technically the most important metal of the group. Since it combines a high melting-point with great resistance towards attack by reagents—whether acid or alkaline—its value in the manufacture of chemical apparatus is very great. In addition, the great malleability and ductility, and the possibility of welding the metal, render it easy to work. Often alloys with 2–20 per cent. iridium, which are more resistant to corrosive agencies than pure platinum, are used ; but for work at high temperatures, pure platinum is generally considered more satisfactory. Dishes and crucibles of platinum scarcely alter in weight with use, and are very suitable for quantitative analysis. Care must be taken, however, not to heat metals of low melting-point, such as lead, zinc, or tin, in platinum vessels, since these metals alloy with the platinum and so would destroy the vessels. For many purposes there is practically no substitute for platinum, although in certain circumstances tantalum vessels, and in other circumstances fused silica ware, can be used in place of platinum apparatus.

Platinum is more suitable as an anode material than any other substance, not being anodically attacked in ordinary salt solutions. In a chloride solution a pure platinum anode is perceptibly corroded, but platinum-iridium anodes are quite satisfactory. In the early days of electro-chemical industry, when platinum was comparatively cheap, platinum electrodes were commonly employed. Now, owing to the increased price of platinum, they are only used in exceptional cases, having been replaced, wherever possible, by electrodes of carbon or Acheson graphite. In electrotechnics, platinum is very valuable, since it is not oxidized by air at the temperature of the electric spark ; in the contact-points of magnetos, the armatures of electric bells and of induction-coils, as well as in telegraph keys, the employment of platinum is to be desired, although substitutes (tungsten, molybdenum, and numerous alloys containing chromium, nickel, cobalt, etc.) are now used.

Closely connected with the non-corroding properties of platinum comes its use for surgical instruments. The smaller weights used

in the chemical balance-room are—for the most accurate purposes—made of platinum.

Clearly, in certain cases, articles made of a cheap metal covered with platinum would prove of value. It is not very easy to obtain an adherent coating of platinum on a base metal by electrical deposition, and, for at least one industrial purpose, it is customary to apply the platinum covering by purely mechanical means. The difficulties met with in the **electrical deposition of platinum** are connected with the fact that a freshly deposited film of platinum is always in a state of tension—a state of affairs which is usually ascribed to the hydrogen occluded by the metal; on account of this tension, the deposit readily comes peeling off in a tight roll. Under certain conditions, however, this can be avoided; as in the case of nickel-plating, the most adherent deposits appear to be obtained from a warm bath. The adhesion depends on the nature of the base metal, and it is sometimes advisable to apply a coat of copper or of gold, and then to deposit the platinum upon that.

As in the case of nickel-plating, the bath tends to become alkaline during deposition, and when this occurs the deposit is liable to become black and spongy. The use of a weak acid in the bath has suggested itself, and a hot plating bath containing potassium platinichloride and citric acid is said to give good results.¹ The current density must be kept rather high; if too low, the plating, although brighter, is apt to be non-adherent.

Platinum plating is used by the makers of chemical balances in Germany; the details of the process employed do not appear to have been made public.

Another use of platinum is connected with the fact that it possesses a coefficient of expansion similar to that of glass, and can thus be “sealed through glass.” None of the cheap metals are so satisfactory for the purpose, and until comparatively recently platinum was considered the only material suitable where a wire has to pass through glass, e.g. for the wires conveying the current to the filament of an electric lamp. Iron² approaches most closely to platinum as regards the “coefficient of expansion,” but it is very difficult to make a satisfactory sealing of iron and glass, especially since the iron is likely to become oxidized if heated. Now, however, an alloy of iron with 46 per cent. of nickel and about 0.15 per cent. of carbon is extensively used for the purpose; this material has practically

¹ W. J. McCaughey, *Trans. Amer. Electrochem. Soc.* **15** (1909), 523; W. J. McCaughey and H. E. Patten, *Trans. Amer. Electrochem. Soc.* **17** (1910), 275. Other baths are given by G. Langbein, “Electro-deposition of Metals,” translation by W. T. Brannet (Baird).

² H. J. S. Sand, *Chem. News.* **102** (1910), 166, described a device for making an air-tight joint of iron through glass.

the same coefficient of expansion as glass, and can be drawn into wire which can then be coated with copper. Such copper-coated wire can be sealed through glass without undue trouble, and is extensively used in the electrical industry.¹

It happens also that platinum has the same coefficient of expansion as the material used in the making of artificial teeth. This fact accounts in part for the very large quantity of platinum used in dentistry.

A large proportion of the platinum produced is used for jewellery, Jeweller's platinum usually contains about 10 per cent. of iridium, which renders it harder. Since platinum has no special artistic merit, it is probable that the chief attraction of platinum is actually the rarity of the metal. If this somewhat unfortunate fashion were to disappear, a great deal of platinum would be liberated for more important purposes.

Platinum as an Industrial Catalyst

The Contact Process of Making Sulphuric Acid. An important use of platinum in chemical industry is due to the fact that it facilitates the combination of sulphur dioxide and oxygen according to the reaction

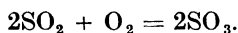

In the "contact process" of making sulphuric acid, sulphur dioxide mixed with air is passed over finely divided platinum; combustion takes place, and the sulphur trioxide formed is afterwards allowed to combine with the requisite amount of water, yielding sulphuric acid. Various precautions have to be observed. The sulphur dioxide must be rendered perfectly free from dust, and from such impurities as arsenic compounds, since otherwise the platinum catalyst will be "poisoned," and will become ineffectual. Another factor which requires careful attention is the temperature. If the temperature be too low, the reaction will only occur very slowly. If it is too high, the change can never become even approximately complete. For the equilibrium

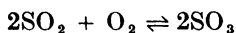

shifts with the temperature; as usual, a rise of temperature alters the equilibrium in a sense unfavourable to the exothermic reaction

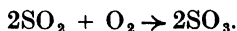

An intermediate temperature must therefore be chosen, and it is

¹ A. D. Lumb, "The Platinum Metals" (Imperial Institute Monographs), page 11; K. Arndt, *Elektrotech. Zeitsch.* **42** (1921), 345.

found that the best temperature to maintain in the apparatus is about 400° – 425° C.

The sulphur dioxide needed for the process is obtained by burning, in excess of air, pyrites, or some other natural sulphide, such as zinc blende; in many American plants, sulphur itself is used. The mixture of sulphur dioxide and air produced passes to the cleaning plant, where the gases are freed from dust-particles, then cooled to 100° C., scrubbed first with water, afterwards with dilute sulphuric acid, and finally dried by means of concentrated sulphuric acid. When quite clean, they can be admitted to the contact tubes, which are filled with the catalyt. Since much heat is evolved in the

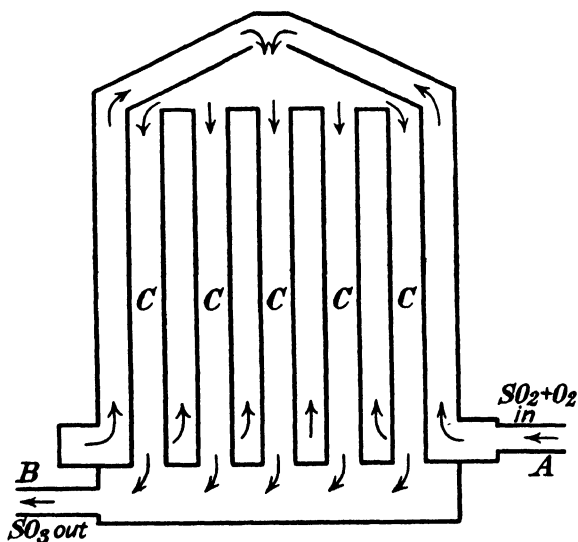

FIG. 42.—Principle of Heat Exchange in a Contact Plant.

combination of sulphur dioxide and air, the temperature would certainly rise above 400° C. in places, unless some means were taken to prevent it. In some plants, the principle of "heat exchange" suggested in Fig. 42 is adopted. The comparatively cool mixture of sulphur dioxide and air is admitted through A to the space surrounding the contact-tubes C and thus serves to cool the latter; at the same time, the gases themselves become preheated. The gases then pass down the contact-tubes, and emerge through B largely converted to sulphur trioxide.

The system of "heat exchange" just described—wherein the reacting gases are cooled and the entering gases are simultaneously

preheated—would seem to represent the ideal arrangement, and such an arrangement has actually given good results at many plants. Nevertheless, the interchange of heat is not easy to realize, owing to the bad conductivity of gaseous substances, and at some works other devices have been used to ensure a high percentage conversion. In many American plants, it has become customary to pass the reacting gases over a series of trays containing catalyst at different temperatures. In the first tray the temperature is kept very high ($560^{\circ}\text{C}.$), and the reaction therefore proceeds apace until the equilibrium amount of sulphur trioxide is formed; but just because the temperature is high, the amount of trioxide corresponding to equilibrium conditions will not exceed about 85 per cent. The gas then passes on, through a cooling vessel, to the second tray, kept at a slightly lower temperature (520°), and thence to the third, fourth, and fifth trays, maintained perhaps at 500° , 450° and 380° respectively; at each stage the amount of sulphur trioxide corresponding to equilibrium conditions increases, and the mixture emerges from the last tray almost completely converted to trioxide.¹

The contact material should if possible fulfil two conditions:—

- (1) The *maximum active surface* of catalyst must be exposed to the gases, and
- (2) When the catalyst does finally become poisoned, it must be capable of being *separated easily* from the vehicle, for repurification.

In some plants, “platinized asbestos” is used, being made by soaking asbestos in a platinum salt solution, drying and heating until the salt is decomposed. This fulfils the first condition, but not the second; consequently, in plants using asbestos the purification of the gases must be very efficient. In the **Grillo process**, now used in this country, the finely divided platinum is suspended, not in asbestos, but in a porous soluble salt such as anhydrous magnesium sulphate, obtained by heating the hydrated sulphate. This salt is very feathery and highly porous, and has the advantage of being soluble. Consequently, if the platinum becomes poisoned and inefficient, the salt is taken from the contact plant, placed in vessels and treated with water. The salt is dissolved away, and the platinum black is left. It is then possible to wash the platinum with hydrochloric acid and other reagents, which remove the impurities. If necessary the platinum can be dissolved in aqua regia and reprecipitated without serious loss.

The contact process is found more economical for the manufacture of concentrated sulphuric acid than the old lead-chamber method,

¹ F. C. Zeisberg, *Trans. Amer. Electrochem. Soc.* **36** (1919), 187.
M.C.—VOL. III. S

in which a gaseous catalyst (oxide of nitrogen) is used. The plant is much more compact, and the process gives a concentrated acid without evaporation or distillation. Since, however, the initial expense of the platinum is a serious consideration, it is not surprising that attempts have been made to use a cheaper catalyst. In Germany a process was started some years ago in which a ferric oxide catalyst was used ; but it is a much less active catalyst than platinum, and the action only proceeds at a quite high temperature, 600° C. At this temperature, the equilibrium

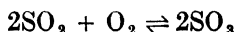

is reached when only 75 per cent. of the sulphur is oxidized to the state of trioxide. Thus in the presence of the iron catalyst, the reaction can never be complete, and the gases emerging from the contact tower contain much unoxidized sulphur dioxide. This fact has probably limited the employment of the process. On the other hand, the iron oxide catalyst is cheap and does not so easily become poisoned with arsenic ; moreover, when it does become inactive, it can cheaply be replaced. Thus the careful cleaning of the gases is unnecessary.

In the Mannheim process, which, although originating in Germany, has been largely used in the United States, the first stage of the oxidation of dioxide to trioxide is carried out at a high temperature with iron oxide as catalyst. A 60 per cent. conversion is thus obtained, and the gases are then cooled and purified, and caused to react further at a lower temperature, by means of a platinum catalyst.

Platinum in Nitric Acid Manufacture.¹ Another important technical operation which depends upon the action of a platinum catalyst is in the manufacture of nitric acid from ammonia ; the process consists in passing a mixture of ammonia gas and air over heated platinum gauze. The reaction is exothermic, and, when once the plant is in operation, the heat evolved is sufficient to maintain the temperature of the gauze ; in many plants, the principle of "heat exchange"—already described—has been adopted with success, the hot emergent gases being used to preheat the gases entering the plant.

¹ J. R. Partington, *J. Soc. Chem. Ind.* **40** (1921), 185r ; C. S. Imison and W. Russell, *J. Soc. Chem. Ind.* **41** (1922), 37r.

AUTHOR INDEX

- Aboulenc, J., 195, 198
 Achnasarow, A. N., 129
 Ackermann, A., 147
 Acree, S. F., 240
 Adams, F. W., 120
 Aitchison, L., 146
 Allen, H. S., 31
 Allmand, A. J., 75, 200
 Alvarez, P., 211, 245
 Amberg, R., 212
 Amberger, C., 213, 231
 Anderson, R. J., 104
 Andrew, J. H., 142, 218
 Ansel, H., 58
 Antony, U., 204, 206, 226
 Appleby, M. P., 40
 Archer, R. S., 111, 127, 129
 Armstrong, E. F., 196, 197
 Arndt, K., 255
 Arnold, J. O., 132, 139, 142, 143
 Arnott, J., 192
 Asahara, G., 118
 Aston, F. W., 156
 Aston, J., 13
 Aupperle, J. A., 150
 Austin, L., 231

 Backheuer, M., 90
 Bagley, C. H. F., 80, 84
 Baikow, 172
 Bainbridge, F., 93
 Ballay, M., 121
 Bancroft, W. D., 39, 153, 197
 Bandalph, C. P., 30
 Bardwell, E. S., 104
 Barlow, A. E., 178
 Barrett, G., 62
 Barth, O., 166
 Bartlett, E. P., 54
 Baskerville, C., 169
 Bassett, H., 42, 158
 Baudisch, O., 52
 Bauer, O., 146
 Baur, E., 69
 Bedford, F., 198
 Bedworth, R. E., 29
 Beilby, Sir G., 63
 Belaiew, N. T., 114, 127

 Bell, J. M., 43
 Bell, Sir L., 70
 Bellucci, I., 175
 Benedicks, C., 109, 124, 127
 Bonnett, C. W., 198, 202
 Bennett, G. M., 46
 Bennewitz, K., 240
 Bergner, E., 219
 Bernard, V., 124
 Berry, A. J., 221
 Beyschlag, F., 55
 Bibby, J., 97
 Bijvoet, J. M., 45, 69
 Biren, J., 110, 111
 Bohn, R. T., 54
 Bohr, N., 17
 Bolten, E. R. B., 196, 197
 Bonnell, J., 41
 Bonnerot, S., 51, 120
 Borchers, W., 186
 Bornemann, F., 224, 225
 Bosanquet, C. H., 17
 Boudouard, A., 68
 Bradfield, R., 40
 Bradley, A. B., 145
 Bragg, W. L., 17
 Braley, S. A., 52
 Brandt, W. T., 192, 254
 Brearley, A. W., 135
 Brearley, H., 135
 Bredig, C., 213
 Bridges, R. W., 166
 Briggs, S. H. C., 6, 46
 Brochet, A., 196
 Brooke, W. J., 131
 Browne, D. H., 178
 Buck, D. M., 150
 Bulk, B., 240
 Bullens, D. K., 121, 130
 Burgess, G. F., 13
 Burgess, G. K., 109, 137
 Bury, E., 71
 Byers, H. G., 156, 172

 Calhane, D. F., 191
 Callow, J. M., 166
 Cameron, F. K., 42, 43
 Campbell, W., 178, 180

- Carlisle, C. G., 98
 Carnegie, D., 77, 115
 Carpenter, H. C. H., 21, 29, 108, 110,
 111, 113, 116, 129, 130, 143
 Carr, B., 168
 Chapman, A. C., 177
 Charpy, G., 51, 120
 Chatterji, N. G., 157
 Chaudron, G., 69
 Chevenard, P., 117, 128
 Clark, G. L., 148
 Clavari, E., 175
 Clayton, W., 197
 Clements, F., 66, 77
 Cobb, J. W., 148
 Cohen, E., 209
 Coleman, A. P., 178, 183
 Compton, A. H., 15, 19
 Compton, K. T., 15, 19
 Cook, M., xii
 Cooper, G. S., 63, 80
 Cooper, R. A., 251
 Cowap, M. D., 164, 208
 Cowper-Coles, S., 212
 Coyle, J. A., 141
 Crookes, Sir W., 231, 245
 Crowe, J. J., 109
 Curie, P., 8, 172
 Cushman, A. S., 146, 147, 150

 d'Arcambal, A. H., 142
 Davis, C. W., 245
 Day, D. T., 248
 Dean, R. S., 67
 de Boer, J. H., 206
 Dede, L., 165
 Deisher, J. B., 122
 Delépine, M., 227, 228
 de Nolly, H., 129
 Desch, C. H., 103, 127, 153
 Dewar, Sir J., 50, 176
 Dhar, N. R., 41, 157
 Dickinson, R. G., 5
 Dickson, C. W., 178
 Donnan, F. G., 42, 158
 Dougill, G., 148
 Dresser, M. A., 178
 Drummond, J. C., 252
 Duboin, A., 170
 Dunlop, J. P., 252
 Durrant, R. G., 160
 Dye, R. E., 166

 Eastman, E. D., 69
 Edgar, E. C., 216
 Edwards, C. A., 21, 108, 128, 129,
 137, 138, 142, 143
 Eibner, A., 48
 Elam, C. F., 29
 Elliott, T. G., 124

 Ellis, C., 194
 Engemann, K., 190
 Erdmann, E., 198
 Etchells, H., 96
 Evans, J., 56
 Evans, U. R., 31, 146, 189
 Ewen, D., 108, 231
 Ewing, Sir J. A., 12, 14, 17, 18, 19

 Falcke, V., 68
 Fay, H., 121
 Feulgen, F., 232
 Firth, J. B., 216, 217, 218
 Fischer, A., 53
 Fitzgerald, F. A. J., 94
 Fletcher, J. E., 103
 Foerster, F., 198, 200, 240
 Foex, G., 109
 Foote, H. W., 37
 Forbes, G. S., 54
 Fortner, M., 213
 Fowler, G. J., 51
 Fowles, S. H., 71
 Fox, E. J., 149
 Fredenhagen, C., 30
 Fresenius, R., 52
 Frey, W., 236
 Friend, J. A. N., 4, 6, 48, 147, 149,
 150, 151, 175, 242
 Fuller, T. S., 153

 Galibourg, J., 121
 Gammage, A. L., 191
 Garçon J., 144
 Gardner, H. A., 147
 Gebhardt, G., 217
 Gerstacker, L., 48
 Gibbs, W. E., 71
 Gibson, C. B., 104
 Gibson, T. W., 181
 Gilbert, H. N., 198, 202
 Gilchrist, D. A., 93
 Glaessner, A., 69
 Gmelin, H., 44
 Godfroid, H., 169
 Goerens, F., 110, 111
 Graham, T., 221
 Grandwyn, S. C., 115
 Green, G. W., 142
 Greenleaf, W. B., 152
 Greenwood, J. N., 128, 138
 Gregory, J. W., 55, 58, 178
 Griffiths, F. J., 141
 Grosman, M. A., 152
 Grube, G., 44, 240
 Guertler, W., 156
 Guillet, L., 106, 169
 Gumlich, E., 107, 141
 Gurevich, L. J., 118

- Gutbier, A., 204, 205, 207, 217, 221
 Gutowski, N., 110, 111, 117

 Haber, F., 44
 Hadfield, Sir R., 124, 137, 139, 140,
 149, 150
 Hall, J. H., 120, 138
 Hall, J. W., 77, 131
 Hallimond, A. F., 84, 127
 Hamilton, R., 71
 Hammond, L. H., 191
 Hanson, H. J., 74
 Hantzsck, A., 157, 159
 Harbord, F. W., 77, 131, 133
 Hörden, J., 74
 Harding, E. A., 215
 Harper, C., 156, 168
 Harrison, E. P., 172
 Hartley, W. N., 159
 Hatch, F. H., 58, 59, 133
 Hatfield, W. H., 108, 118, 119, 121,
 131
 Haworth, H. F., 240
 Haworth, J., 56
 Haynes, E., 169
 Hayward, C. R., 132
 Heathcote, H. L., 30
 Hedvall, J. A., 37, 170
 Heine, O., 48
 Herold, V., 200
 Heskett, J. A., 73
 Heyn, E., 146
 Hilditch, T. P., 197
 Hill, J. M., 249
 Hirtz, H., 164, 208
 Höchtlén, F., 48
 Hofman, K. A., 48
 Hogg, E. M., 31
 Hoitsema, C., 217, 220
 Holborn, L., 231
 Hollings, W. W., 72
 Holt, A., 216, 218
 Honda, K., 15, 108, 110, 113, 116,
 118, 124, 128, 143, 172
 Hopkinson, B., 140
 Hopkinson, J., 138
 Hore, R. E., 165
 Hostetter, J. C., 11, 45, 54, 59
 Howe, E., 178
 Howe, H. M., 108, 124, 130
 Howell, O. R., 160, 175
 Hradecky, K., 222
 Hughes, W. E., 106
 Hull, A. W., 17, 18, 21
 Humphrey, J. C. W., 129
 Hunting, F. F., 131
 Husson, A., 233
 Hutchinson, A., 71
 Hüttner, C., 231
 Hüttner, F., 36

 Ibbotson, F., 143
 Iitaka, I., 110
 Iljin, N., 110, 111, 117, 119
 Imison, C. S., 258
 Ingle, H., 171
 Inouye, K., 127
 Iseley, R. B., 148

 Jackson, P. G., 148
 Jaeger, F. M., 206
 James, R. W., 17
 Jänecke, E., 172
 Jeffries, Z., 111, 127, 129
 Johnson, J. E., 67
 Jones, H. C., 159, 176
 Jones, H. O., 50
 Jones, J. A., 153
 Jurisch, E., 219

 Kalmus, H. T., 156, 157, 163, 168
 Kapp, N., 65
 Kaye, G. W. C., 231
 Keeling, B. F. E., 110, 111, 113, 116
 Keeney, R. M., 104, 105, 144
 Kelber, C., 195, 198
 Kelley, G. L., 54
 Kemp, J. F., 247
 Kennelly, A. E., 198, 199
 Kershaw, J. B. C., 187, 196
 Kikkawa, H., 128, 138, 142, 143
 Kikuta, T., 128
 Kilby, J. N., 135
 Klesper, R., 109
 Knight, C. W., 178, 180
 Kohlschütter, V., 190
 Königsberger, J., 31
 Korten, F., 228
 Krauss, F., 208
 Kreutzberg, E. C., 103
 Kronfeld, K. L., 169
 Krusch, P., 55
 Kurnakow, N. S., 129

 Lamb, A. B., 161
 Lambert, B., 29, 32, 144
 Langbein, G., 192, 254
 Langdon, S. C., 152
 Langer, C., 50, 176
 Langevin, P., 15, 16
 Langmuir, I., 16, 17, 197
 Lantsberry, F. C. A. H., 132, 140
 Larson, A. T., 161
 Lathe, F. E., 178
 Lauber, E., 240, 241
 Le Chatelier, H., 127, 132
 Leidié, E., 209, 210, 245
 Lessing, R., 63
 Levy, A. G., 124
 Levy, L. A., 237
 Lewis, W. C. McC., 216

- Lindemuth, L. B., 94
 Lindgren, W., 178
 Lobry de Bruyn, C. A., 30
 Lodge, Sir O., 15
 Loesch, H. G., 189
 Lonergan, J., 104
 Lorenz, R., 240, 241, 242
 Louis, N., 93
 Lucchesi, A., 204, 206
 Lumb, A. D., 255
 Lundell, G. E. F., 52
- McCallum, B., 152
 McCance, A., 108, 129
 McCaughey, W. J., 232, 254
 Macfayden, W. A., 107
 MacGuffie, D. D., 88
 Mackay, W. M., 171
 Madden, C. P., 192
 Maisch, O., 217, 221
 Major, R. M., 194
 Mallock, A., 28
 Manchot, W., 36
 Marsh, J. E., 158
 Marsh, W. J., 177
 Martin, F. H., 221
 Masloff, A. M., 138
 Mathers, F. C., 191
 Matsubara, A., 69
 Matthews, J. A., 142, 144
 Matthey, G., 226, 231
 Matula, J., 38
 Maxted, E. B., 51, 197, 217, 218, 233
 Mazzucchelli, A., 243, 244
 Mellor, J. W., 245
 Merica, P. D., 118, 152, 192
 Merwin, H. E., 38, 57
 Messner, J., 49
 Metz, A., 219
 Metzl, A., 162
 Miller, W. G., 165, 178, 180
 Miolati, A., 4, 233
 Mitchell, C. A., 155
 Moissan, H., 244
 Mond, L., 50, 164, 176, 208, 212
 Mond, R. L., 50, 106, 208
 Monypenny, J. H. G., 138, 150
 Mosander, C. G., 29
 Müller, E., 32, 47, 48, 49
 Müller, W. J., 31
 Mullholland, R. A., 121
 Muntz, G., 89
 Murakami, T., 118, 143
 Mylius, F., 231, 243, 244
 Mylius, W. G., 97
- Nicou, P., 58
 Normann, W., 198
 Noyes, A. A., 51
- Oakley, W. E., 193
 Ogilvie, H. K., 142
 Okubo, J., 15
 Ottenstein, B., 217
 Oxley, A. E., 15
- Paal, C., 213, 231
 Parson, A. L., 15
 Partington, J. R., 258
 Patten, H. E., 232, 254
 Pauli, W., 38
 Peile, H., 104
 Pellew, C. E., 105
 Péneau, H., 176
 Pendred, L., 149
 Perman, E. P., 41
 Perret, L., 249
 Peters, O. S., 152
 Pfaff, A., 32
 Phragmén, G., 109
 Pick, W., 44
 Pickering, S. U., 40
 Pilling, N. B., 29
 Polushkin, E., 144
 Pongracz, A., 69
 Porter, A. W., 215
 Portevin, A., 124, 126, 127, 128, 138
 Posnjak, E., 5, 38, 57
 Poucholle, A., 128
 Powell, A. R., 165
 Power, F. D., 180
 Powis, F., 39
 Primrose, J. S. G., 63
 Pullinger, W., 233
 Pungs, W., 198
 Puppe, J., 87
- Quennessen, 245
 Quincke, F., 50, 176
- Ramsay, W., 212
 Ranschoff, F., 205
 Rathoburg, H., 224
 Raven, F. A., 105
 Rawdon, H. S., 108
 Read, A. A., 139
 Reese, A. K., 72
 Reinders, W., 69
 Remy, H., 204, 206
 Richards, J. W., 74, 97, 188
 Richards, R. H., 248
 Richardson, E. A., 150
 Richardson, L. T., 150
 Richardson, W. D., 145, 148
 Rideal, E. K., 148, 194, 196, 197
 Riedel, R., 189, 190
 Rimbach, E., 228
 Roberts, D. E., 65
 Roberts, G. G., 103
 Roberts, H. S., 54

- Roberts, J. H. T., 231
 Roberts-Austen, Sir W. C., 184
 Robertson, G. S., 92
 Robinson, W. O., 42
 Rodt, V., 43
 Roessler, F., 213
 Rogers, A. F., 178
 Rogerson, T. B., 62
 Rognley, O., 15, 19
 Rosenhain, W., 108, 127
 Ross, E. B., 152
 Roux, E., 176
 Ruer, R., 109, 110, 111, 113, 117, 118,
 119
 Ruff, O., 37, 223, 224, 225
 Russell, E. J., 93
 Russell, T. F., 138
 Russell, W., 258

 Sabatier, P., 195
 Saitô, S., 124
 Sand, H. J. S., 254
 Saniter, E. H., 133
 Sauveur, A., 108, 119
 Savell, W. L., 168
 Saxton, B., 37
 Scheffer, F. E. C., 69
 Schenck, R., 67
 Schoch, E. P., 30, 240
 Schödl, H., 190
 Schoeller, W. R., 165
 Schönert, K., 120
 Schulgrin, N., 110, 111
 Schuster, F., 87
 Scott, H., 108, 137
 Seemann, L., 247
 Senderens, J. B., 195, 198
 Sexton, A. H., 63
 Shaw, T. W. A., 195
 Shibata, Y., 159
 Shields, J., 212
 Shipley, J. W., 149
 Siemens, Sir W., 78, 79
 Sieverts, A., 217, 218, 219
 Sisco, F. T., 100, 141
 Smith, D. P., 215, 216, 221
 Smith, E. F., 163, 165
 Smith, L. B., 51
 Smith, R. C., 218, 232
 Smits, A., 45, 69
 Sosman, R. B., 11, 45, 59
 Speller, F. N., 148
 Spielmann, P. E., 240
 Stead, J. E., 29, 71, 85, 94, 108, 130,
 133, 136, 137
 Stoffel, A., 50
 Storey, O. W., 106
 Strauss, R., 149
 Streicher, S., 233
 Strengers, Th., 209

 Strickland, D. M., 150
 Stromeyer, C. E., 153
 Stuart, E. H., 191
 Sturdevant, E. G., 191

 Tafel, E., 194
 Tammann, G., 120, 156
 Tassilly, E., 176
 Tawara, K., 118
 Taylor, H. S., 194
 Taylor, W. A., 240
 Terres, E., 69
 Thing, C. W., 156, 172
 Thomas, R., 33, 197
 Thompson, F. C., 108
 Thomson, J. C., 29, 144
 Thornhill, E. B., 166
 Thorp, F. H., 185
 Thum, E. E., 132
 Thüringer, V., 244, 245
 Tilden, W. A., 146
 Tillmanns, J., 148
 Tolman, C. F., 178
 Tone, F. J., 104
 Touceda, E., 123
 Treadwell, W. D., 247
 Trenkner, C., 204, 205
 Trousdale, E. A., 15, 19
 Tschirch, F. W., 223
 Tschischewski, N., 51, 110, 111
 Tschugaeff, L., 177, 223, 244
 Tucker, S. A., 189
 Turner, T., 63
 Turnock, L. C., 198
 Tylor, P. M., 104
 Tyndall, J., 19

 van Bemmelen, J. M., 37
 Vanino, L., 247
 Vavon, G., 233
 Vaubel, W., 175
 Veyret, L., 129
 Vogt, J. H. L., 54, 55, 178
 von Jonstorff, H. J., 133

 Waldschmidt-Leitz, E., 198
 Walker, W. H., 146, 147, 151
 Walldow, E., 124
 Wallis, A. E., 50, 208
 Wark, I. W., 54
 Watson, E. A., 143
 Watts, O. P., 192
 Wedekind, E., 17
 Weiser, H. B., 38, 39, 40
 Weiss, P., 15, 109
 Weizenkorn, J. W., 139
 Werner, A., 4, 5, 233
 West, P., 148
 Westgren, A., 109, 116
 Weyman, G., 154

- White, G. R., 32
Whitehead, W. L., 165
Whiteley, J. H., 84, 124
Whiting, S. E., 198, 199
Wichers, E., 231
Wilcox, E. A., 96
Wild, W., 15
Wilkes, S. H., 40
Williams, E. T., 33
Willstätter, R., 198
Witzmann, W., 227, 228
Wöhler, L., 213, 227, 228, 230, 233,
234, 236, 237
Wolf, G., 215
Wolfram, H., 80
Woringer, P., 48
- Worsley, E., 153
Wright, H. E., 67
Wright, R., 218, 232
Wright, S. B., 166, 169
Wunder, M., 244, 245
Wüst, F., 110, 116
Wyckoff, R. W. G., 5
- Yaneske, B., 85
Yoe, J. H., 37
Young, S. W., 31
- Zeisberg, F. C., 257
Ziegler, 132
Zimmermann, R. E., 153

SUBJECT INDEX

- Accumulator, nickel, 198
Acids, effect on iron and steel, 145
Acid immersion test, 146
Acid steel process, 77, 83, 90
Adsorption of hydrogen on metals, 197, 216
Agricultural use of basic slag, 92
Air-hardening, 138
Alkaline accumulator, 198
Allotropy of iron, 108
Alloy steels, 137
Alternating current, 22
Alum shales, 59
Armco, 131
Asbestos, platinized, 257
Atmospheric corrosion, 150
Atomic structure of iron, 18
Austenite, 111
" Balling " (puddled iron), 102
Basic slag, 92
Basic steel process, 77, 84, 92
Bessemer process, 88
" Black heart " castings, 122
Black nickelling, 192
Blast-furnace, cobalt, 166
 iron, 63
 nickel, 182
Blister steel, 120
" Blow " (Bessemer process), 90, 92
Blow-holes, 135
" Blueing " (protective process), 151
Bog iron ore, 56
" Boil " (steel-making), 83
Bosh, 65
Briquetting, 62
" Building up " of iron surfaces by electrolysis, 107
Calcination of ores, 61
Carbide of iron, 112
Carbides in tool steel, 143
Carbon-diffusion in solid iron and steel, 119
Carbonizing agents, 121
Carbonyls of cobalt, 164
 of iron, 50
 of nickel, 176, 183
Carbonyls of ruthenium, 208
Case-hardening, 121
Cast iron. composition, 76
 grey, 117
 malleable, 121
 manufacture, 61
 mottled, 117
 white, 114, 116
Catalytic activity of nickel, 194
 of palladium, 221, 252
 of platinum, 232, 255
Cementation, 119
Cementite, 112
Chalcopyrite, 179
Charcoal in pig-iron making, 75
Chloanthite, 180
Choco District ores, 248
Chrome-vanadium steels, 141
Chromite accompanying platinum, 247, 248
Chromium steels, 141, 149
Cleaning of blast-furnace gases, 71
Cleveland ores, 58
Clinton ores, 58
Clydach, 183
Cobalt, alloys, 169
 analytical, 164
 compounds, 157
 District, 165, 180
 in glass and ceramic industry, 169
 in steel, 143
 metal, 156
 metallurgy and uses, 166
 pigments, 170
 plating, 168
 salts as driers, 170
 terrestrial occurrence, 165
Cobaltamines, 161
Cobaltite, 165
Coercive force, 13
Coinage, nickel-copper, 193
Coke, for blast-furnace, 63
Colloidal solutions of ferric hydroxide, 38
 of palladium, 213
 of platinum, 231
Commutator, 22
Complex cyanides of iron, 45

- Complex salts, 3
 Concentration of ores, 61, 166
 Continuous current, 22, 25
 Cooling-curve method of detecting transformation points, 116, 128
 Cooling-rate, influence on structure, 127
 Coordination number, 4
 Copper in steel, 150
 sulphate as by-product of Mond process, 185
 Copperas, 154
 Corrosion of iron and steel, 144
 resistance of cobalt to, 168
 resistance of nickel to, 172, 188
 resistance of platinum to, 253
 Cowper stoves, 70, 71
 Crucible of blast furnace, 65
 process for steel, 100
 Crystal-structure, connection with magnetism, 19
 of iron allotropes, 109
 Cupferron, 52
 Cyanides of iron (complex), 45

 " Damping-down " of blast-furnaces, 74
 Decomposer (Mond process), 184
 Dental use of palladium and platinum, 252, 255
 Deoxidation of steel, 91, 98, 134
 Deoxidizers, list of, 134
 Dephosphorization of steel, 84, 86, 98
 Desulphurization of steel, 84, 98, 99
 Diamagnetism, 7, 9, 16
 Differentiation, magmatic, 54, 179
 Diffusion of carbon in solid iron and steel, 119
 Dilatometric method of detecting transformation-points, 117, 128
 Discharge curves of accumulators, 199
 of polarized platinum electrode, 241, 242
 Dredging for platinum, 249
 Driers, cobalt, 170
 " Dry blast " system, 72
 Dust-separation from blast furnace gases, 71
 Dwight-Lloyd sintering process, 62, 181
 Dynamo, 22

 Eddy currents, 26
 Edison accumulator, 198
 Electric furnace, 27
 Electrodeposition of cobalt, 168
 of iron, 105
 of nickel, 189
 of platinum, 254

 Electrodes for electric steel furnaces, 97
 Electrolytic production of iron, 105
 of nickel, 187
 Electrostatic cleaning of gases, 71
 Electrothermal production of pig-iron, 74
 of steel, 93
 Embrittlement of iron by hydrogen, 152
 Equilibrium diagrams :
 Iron and its oxides, 68
 Iron-carbon alloy-system, 111
 Eutectoid, 113, 114
 Explosive iridium, 226
 platinum, 232
 rhodium, 209

 Feeder heads, 137
 Ferrates, 44
 Ferric compounds, 36
 Ferrite (α -iron), 109
 Ferrites (salts), 43
 Ferro-alloys, 104, 105
 Ferrocyanic acid, 49
 Ferrocyanides and ferricyanides, 46
 Ferromagnetism, 7
 Ferroso-ferric oxide, 44
 Ferrous compounds, 33
 Ferroxy indicator, 147
 Ferruginous limestone, 57
 Festel metal, 169
 Fluorspar in steel-making, 85, 86, 92

 Garnierite, 180
 Gauss (unit of intensity of magnetic force), 8
 German silver, 194
 Girod electric furnace, 94
 Glyoxine test for nickel, 176
 Goethite, 57
 Gold, by-product of nickel industry, 186, 187
 Graham colloid, 39
 Grain size and hardness, 129
 and heat-treatment, 130
 Graphitization (in corrosion), 149
 (production of grey cast iron), 117
 Grillo process, 257

 Hæmatite, 55, 57, 58
 " Hanging " in blast-furnace, 73
 Hardening of oils, 195, 252
 of steels, by cementation (case-hardening), 121
 of steels, by quenching and tempering, 123
 of steels, by restrained quenching, 125
 Hardness, magnetic, 14
 mechanical (martensite, etc.), 129

- " Heat exchange " principle, 256, 258
 Heat treatment of steels, 123
 Héroult electric furnace, 94
 High-speed tool steels, 141
 High-tension transmission, 25
 Humic acids, 56
 Hybinette process, 187
 Hydrogen, effect on iron, 51, 152
 effect on palladium, 215
 Hydrogenization of oils, 195, 252
 Hyper- and Hypo-eutectoid steels, 114
 Hysteresis, magnetic, 11, 26
- Ilmenite, 55
 Induction furnaces, 98
 " Ingot iron," 60, 115
 Ingots (steel), defects in, 135
 Ink, 155
 Intensity of magnetic force, 8
 of magnetization, 11
 Iridium, analytical, 242, 244
 compounds, 227
 metal, 226
 technology, 249
 terrestrial occurrence, 247
 uses, 253
 Iron, allotropy, 108
 analytical, 51
 atomic structure, 17
 carbon alloys, 110
 carbonyl, 50
 cast, 61, 76, 114, 116, 117
 complex cyanides, 45
 compounds, 32, 153
 crystal-structure, 17, 109
 metal, 28, 108
 metallurgy, 60
 nitride, 51
 puddled, 101
 structure and properties, 108
 terrestrial occurrence, 54
 wrought, 101
 Iron-stone, 57
- Jewellery, palladium-gold alloys in,
 252
 platinum in, 255
 stellite in, 169
- Kilns for calcining iron-ore, 61
 " Knock-down " furnaces, 105
- Ladle, 82
 Limestone for blast-furnace, 63
 Limonite, 57
 Lines of magnetic force, 9
 Lining of Bessemer converter, 89
 of open-hearth furnace, 82
 " Luteo-salts," 162
- Magnetic induction, 10
 method of detecting transforma-
 tion-points, 116, 128
 permeability, 10
 susceptibility, 11
 Magnetism, 7
 Magnetite, 11, 44, 54, 55, 59
 Magneton, 15
 Manganese, effect on iron and steel,
 132, 135, 139
 Manganese steels, 139
 Mannheim process, 258
 Martensite, 123, 125, 128, 129
 Mesh connection, 25
 Metallic coverings for iron, 151
 Microphotographs, xii
 Mild steel, 115
 Millerite, 180
 Minette ores, 58
 Mixer, 83
 Mond process, 183
 Morel metal, 192
- Network structure, 123, 127
 New Caledonian ores, 180, 188
 Niccolite, 180
 Nichrome, 193
 Nickel accumulator, 198
 alloys, 192
 analytical, 176
 as a catalyst, 194
 compounds, 173
 isotopes, 156
 metal, 172
 metallurgy, 181
 plating, 189
 silver, 194
 steels, 140, 149, 194
 terrestrial occurrence, 178
 uses, 188
 Nickel-chrome steels, 140, 194
 Nickel-manganese steels, 141
 Nickelling, black, 192
 Nitric acid, manufacture, 258
 Nitride of iron, 51
 Nitrogen, effect on iron and steel, 51
 135
 Nitroprussides, 49
 Nitroso-derivatives of iron, 35
 of ruthenium, 205
- Ochre, 154
 Olivine, 180
 Open-hearth process, 77
 Orford process, 186
 Osmiridium, 251
 Osmium, analytical, 242, 244
 compounds, 223
 metal, 222
 technology, 249

- Osmium, terrestrial occurrence, 247
uses, 253
- Oxygen, as a factor in rusting, 146
effect on iron and steel, 134
- Paints, protective, for iron and steel,
150
- Palladium, analytical, 242, 244
and hydrogen, 215
as by-product of nickel industry,
186, 187
compounds, 213
in oil-hardening, 195, 252
metal, 212
technology, 249
terrestrial occurrence, 247
uses, 252
- Paramagnetism, 7, 9
- Paris blue, 154
- Passivity of cobalt, 156
of iron, 30, 148
of nickel, 172, 189
- Péan de St. Gilles colloid, 39
- Pearlite, 113, 123, 127
globular or granular, 124
- Peeling of nickel deposit, 190
- Pentlandite, 179
- Peridotite, 180
- Permanent magnets, 13
- Phosphorus, effect on iron and steel,
133
- Pig-casting, 67
- Pig-iron, composition, 76
production in blast furnace, 63
production in electric furnace, 74
- Pigments, cobalt, 170
iron, 154
- Piping, in ingots, 135
- Pitting (in corrosion), 151
in electrolytic deposition, 106, 190
- Placer deposits, 247, 248
- Platinoid, 194
- Platinum, analytical, 242
anodic behaviour, 240
as by-product of nickel industry,
186, 187
as industrial catalyst, 255
as inert electrode material, 238
compounds, 233
electrical deposition of, 254
in oil-hardening, 195
metal, 230
substitutes, 253, 254
technology, 249
terrestrial occurrence, 247
uses, 253
- Poisoning of catalysts, 197, 217, 233,
255
- Potash from blast-furnace dust, 71
- "Praseo-salts," 162
- Pre-heating of blast, 72
- Producer gas, 78, 79
- Prussian blue, 47, 154
- Puddled iron, 101
- Purification of coal-gas by iron oxide,
153
- "Purpureo-salts," 161
- Pyrites, 45, 54, 55, 153
- Pyrrhotite, 54, 55, 179
- Quenching, 123, 128, 139, 142
- Recarburizing charge, 85
- Reducing tower (Mond process), 184
- Red ochre, 154
- "Red shortness," 132
- "Refining" of nickel matte, 183
- Regenerative system in blast-fur-
nace, 72
in open hearth steel furnace, 80
- Regulator for electric furnace, 97
- Residual magnetism, 13
- Rhodium, analytical, 242, 244
compounds, 209
metal, 209
technology, 249
terrestrial occurrence, 247
- Ring electrons, 15, 18
- Rinman's green, 170
- "Roseo-salts," 162
- Rust, 29, 146
- Ruthenium, analytical, 242, 244
compounds, 209
metal, 203
technology, 249
terrestrial occurrence, 247
- Saturation (magnetic), 12
- "Scaffolding" in blast furnace, 73
- Scott connection, 96
- Secondary hardening, 143
- Segregation in steel ingots, 133, 136
of iron in magma, 54
- Self-hardening steels, 138
- Serpentine, containing nickel, 180
containing platinum, 247
- Settler, 182
- Shear steel, 120
- Siderite, 57
- Siemens producer, 79
steel process, 83
- Sienna (pigment), 154
- Silicon, effect on iron and steel, 131
- Single-phase current, 23, 25
- Sintering of iron ore, 62
of palladium black, 218
of platinum black, 232
- Slag, basic, 92
blast-furnace, 67
- Slag-wool, 67

- Smaltite, 165
 Sorbite, 124
 Space-lattice of iron, 109
 Spathite, 57
 Spatial considerations, 1, 5
 Specular iron ore, 58
 Sperrylite, 248
 "Spitting" of metals containing oxygen, 203, 209, 212, 231
 Splint coal, 63
 Spongy platinum, 232
 "Stable" and "metastable" diagrams of iron carbon alloys, 119
 Stainless cutlery steel, 149
 Star connection, 23
 Stassano electric furnace, 94
 Steel, manufacture, 77
 structure and properties, 108
 Stellite, 169
 Stray electric currents as cause of corrosion, 152
 Sudbury ores, 178, 181, 248
 Sulphur, effect on iron and steel, 131
 Sulphuric acid manufacture, 153, 255

 Talbot process, 86
 Tanning (tawing), iron salts in, 155
 Temiskaming ores, 165, 180
 Temper colours, 28, 125
 Tempering, 125
 Thenard's blue, 170
 Thermal method of detecting transformation-points, 116, 128
 Thermal treatment of steels, 123
 Three-phase current, 23, 25
 Tilting furnaces, 86
 Titaniferous iron ores, 55, 73, 76

 Toughening, 125
 Transformer, 26
 Treatment of waters (for boiler feeding), 148
 Troostite, 124, 128, 129
 Tropenas converter, 88
 Tungsten steels, 141
 Turnbull's blue, 47
 Tuyeres, 65, 88

 Umber (pigment), 154
 Ural Mountain ores, 247, 249
 Uranium in steel, 144

 Valency, variation, 1, 7
 Vanadium, function in steels, 138, 142
 Vandyke brown, 154
 Venetian red, 154
 Volatilizing tower (Mond process), 184

 Water-bottom producer, 79
 White cast iron, 114, 116
 Widmanstätten striature, 127
 Williamson's violet, 49
 Wrought iron, 101

 X-ray study of crystal-structure of :
 α , β , and γ -iron, 109
 complex salts, 5
 ferric oxide, 37
 martensitic and austenitic steels, 126

 Yellow ochre, 154

 Zirconium in steel, 144

ABRIDGED FORM OF PERIODIC TABLE.

O.	IA.	IIA.	IIIA.	IVA.	VA.	VIA.	VIIA.	Transition Elements.	IB.	IIB.	IIIB.	IVB.	VB.	VIB.	VIIb.	O.			
2 He	3 Li	4 Be	5 B									6 C	7 N	8 O	9 F	10 Ne			
10 Ne	11 Na	12 Mg	13 Al									14 Si	15 P	16 S	17 Cl	18 Ar			
18 A	19 K	20 Ca	21 Sc	22 Ti	23 V	24 Cr	25 Mn	26 Fe	27 Co	28 Ni	29 Cu	30 Zn	31 Ga	32 Ge	33 As	34 Se	35 Br	36 Kr	
36 Kr	37 Rb	38 Sr	39 Y	40 Zr	41 Nb	42 Mo	43 —	44 Ru	45 Rh	46 Pd	47 Ag	48 Cd	49 In	50 Sn	51 Sb	52 Te	53 I	54 Xe	
54 Xe	55 Cs	56 Ba	57 La	58 Ce															
			57-71 Rare Earth Metals																
86 Nt	87 —	88 Ra	89 Ac	90 Th	91 UX ₃	92 U		76 Os	77 Ir	78 Pt	79 Au	80 Hg	81 Tl	82 Pb	83 Bi	84 Po	85 —	86 Nt	

See VOLUME II

VOLUME III

VOLUME IV of this work

