

Birla Central Library

PILANI (Jaipur State)

~~Engg. College Branch~~

Class No :- 599

Book No :- L61M

Accession No :- 45101

Acc. No. 45/01

ISSUE LABEL

Not later than the latest date stamped below.

--	--	--

MAMMALIAN PHYSIOLOGY

A COURSE OF PRACTICAL EXERCISES

A NEW EDITION

BY

E. G. T. LIDDELL

D.M., FELLOW OF TRINITY COLLEGE
OXFORD

AND

SIR CHARLES SHERRINGTON, O.M.

M.D., D.Sc. (CANTAB.), F.R.S.

WAYNFLETE PROFESSOR OF PHYSIOLOGY IN THE
UNIVERSITY OF OXFORD

OXFORD
AT THE CLARENDON PRESS
LONDON : HUMPHREY MILFORD

1929

Printed in Great Britain

TO
OUR CLASS PUPILS

PREFACE TO SECOND EDITION

IN the preparation of this new edition I have invited the collaboration of my friend and colleague Dr. E. G. T. Liddell of Trinity College. He and I have been associated already through a number of years in teaching from the book. He has undertaken much of the labour of the revision. That his experience should thus be utilized and his judgement made of service here is at once a pleasure to me and an advantage to the reader.

C. S. S.

THE exhaustion of the original edition has given opportunity to revise this book for reissue. Some rearrangement of the exercises has been made and new matter has been introduced. One new exercise has been added. Our intention has been to bring the practical work up to date in scope and method, according as experience has directed.

It is a pleasure to tender here our grateful acknowledgements to friends and colleagues, some at hand, some at a distance, for kindly advice and suggestions. In particular we are indebted to Professor J. Mellanby, F.R.S., for Exercise XXI, to Dr. Howard Florey in respect of Exercise XXII, and to Miss S. Cooper and Mr. R. S. Creed for the observation with the oncometer, as well as for their help in many other ways.

E. G. T. L.

C. S. S.

OXFORD.

September, 1929.

PREFACE TO FIRST EDITION

A CERTAIN broadening of scope of the practical work customary among us for students in animal physiology has become desirable, and has seemed so for some time past in the opinion of not a few. A number of facts fundamental to physiology can be seen by the student very readily and appropriately in the frog. But other facts there are, of great value and interest especially to the future practitioner of medicine, which can be better displayed and more easily obtained in the mammalian preparation. Although that preparation as available for a class-student is merely a carcase, the circulatory activity which it retains for the time being, and the temporary survival of many of its glandular and muscular tissues and of its simpler nervous structures, render obtainable from it under suitable precautions a number of reactions which can be studied with extreme advantage by the student for himself. The exercises detailed in the following pages consist of experiments of that kind. Several of them are repetitions, simplified in accordance with the limits of the preparation and of the student's experience, of famous observations which in the hands of the masters who first made them marked distinct advances in natural knowledge. The particular experiments chosen are of course not the only ones which might have been selected. In such a choice each teacher will to some extent have his own predilections. The mammalian preparation decapitate or decerebrate is capable of serving many uses for practical class-instruction. The particular experiments included here are, however, all such as experience actually proves the student to be well able, with ordinary care on his part and some supervision on the part of his teacher, to accomplish successfully for himself. The actual performance by the student of some few such main experiments gives him, I am convinced, a better insight into their general significance and into the problems they touch than does any mere inspection at a demonstration however skilfully conducted. Indeed, paradoxical though it may sound, the more skilfully a demonstration experiment is performed the less from it do some students learn.

The course as arranged here has taken shape gradually under experience during the endeavour to devise the kind of teaching needed. It has come to comprise twenty-two lessons, each consisting of somewhat less than three hours' work. On the twenty-four lesson cycle as followed in this University,

two class-meetings remain over for repetition of such particular items as the student may want to revise before examination.

To the student's directions for each exercise is subjoined a short annotation concerning the source and bearings of some of the more salient observations included in the exercise. If in these remarks the trend is often historical, it is because that approach has seemed to enable the student best to assess for himself the intellectual cost and value of the observations he is repeating.

The illustrations supplied both in the plates and text-figures have all been drawn from preparations and apparatus as used in the class. The graphic records reproduced have been obtained by the class-students themselves. At the end of the volume an Appendix contains suggestions as to methods of arrangement and preparation for the class based on experience of its actual working.

The interest uniformly shown by the class-students has furnished evidence welcome to me that the course in their eyes possesses real utility. In many instances a fresh impulse seemed to have been imparted to their physiological study. The class-work has certainly vivified for them the reading of the systematic texts.

I am not so sanguine as to suppose that the choice of method or the selection of object which I have adopted will always appeal to others as the best. Nor can I hope to have escaped, in a venture like the present, all errors of omission or commission. I would, however, say that I have been at pains throughout to choose the suitable and to describe it correctly. As it is, the course and its syllabus have been cited with approval in a Memorandum issued by the Board of Education last year. Sir George Newman states that the course is there drawn attention to 'as an illustration of the kind of Applied Physiology which should in my view be taught in all schools of physiology'.

By some of those who have taken the course I have been told that they traced to it a measure of facility in technique which proved of service to them when entering upon independent investigation later on in one field or another of experimental medicine.

C. S. S.

CONTENTS

LIST OF PLATES		xii
EXERCISES		
I. Obs.	1. Intestinal movement and tone	1
,,	2. Adrenal extract on intestinal movement and tone	2
,,	3. Adrenal extract on spleen	2
,,	4. Adrenal extract on arterial wall	5
II. ,,	5. Revival of beat of the excised heart by coronary perfusion	7
,,	6. Influence of temperature on beat	10
,,	7. Cooling and warming the pacemaker	10
III. ,,	8. Chloroform on excised mammalian heart	13
,,	9. Adrenal extract on excised mammalian heart	13
IV. ,,	10. Inspection of the lungs and beating heart <i>in situ</i>	17
,,	11. Effect of raising intrapericardial pressure	18
,,	12. Further inspection of heart and great vessels <i>in situ</i>	18
,,	13. Inspection of the heart inhibited by the vagus	19
,,	14. Inspection of capillary circulation	19
,,	15. Measurement of speed of flow of blood in a capillary vessel	20
V. ,,	16. Graphic record of carotid pressure	26
,,	17. Stimulation of distal vagus on arterial pressure	26
,,	18. Escape of ventricle from vagus, and influence of adrenal extract upon	28
,,	19. Paralysis of cardiac vagus by atropine	31
VI. ,,	22. Adrenal extract on arterial pressure	33
,,	23. Asphyxia and arterial pressure	33
,,	24. Amyl nitrite and arterial pressure	36
,,	25. Measurement of venous pressure	36
,,	26. Occlusion of the coronary arteries on heart-beat	37
VII. ,,	27. Distal end of n. splanchnicus on arterial pressure	40
,,	28. The adrenal gland and the splanchnic reaction	41
,,	31. Pituitary extract and arterial pressure	44
,,	32. Splanchnic n. vasoconstriction in kidney and gut	44
,,	33 A. Inspection of chyle and lacteals	44
,,	34. Chromaffin reaction of adrenal medulla	44
,,	35. Time of the lesser circulation	44
VIII. ,,	37. Aortic insufficiency on arterial pressure and pulse	50
,,	38. Reducing action of the tissues on methylene blue	51
,,	37. (<i>Continued</i>) Calibration of membrane manometer	54
IX. ,,	39. Heart rate and n. accelerantes	56
,,	40. Gravity and arterial pressure	59
,,	41. Recurrent laryngeal and the vocal cords	59
X. ,,	42. Renal secretion and venous injection of saline	61

CONTENTS

X.	Obs.	43.	Diuresis by urea	63
	„	44.	Diuresis by pituitary extract	64
	„	45.	Diuresis by caffeine citrate	64
	„	46 A.	Detrusor action of n. pelvicus	64
XI.	„	47.	Specific gravity of the blood	66
	„	48.	Dilution of the circulating blood by saline injection	67
	„	49.	Haemorrhage and sp. gr. of blood	68
	„	50.	Perfusion of kidney with normal saline	68
	„	51.	Adrenal extract and the renal vessels	69
	„	52.	Amyl nitrite and the renal vessels	69
XII.	„	54.	Secretory action of corda tympani	72
	„	55.	Pilocarpine and salivary secretion	73
	„	56.	Atropine and salivary secretion	73
	„	57.	Air-embolism	73
	„	58.	Expansion of the lungs by aspiration: pneumothorax	73
XIII.	„	59.	Inspection of respiratory movements of larynx	76
	„	60.	Reflex swallowing	76
	„	61.	Reflex closure of glottis: cough	77
	„	62.	Graphic of respiratory movements of chest	77
	„	63.	Phagetic efficacy of water, dilute alcohol and oil. Arrest of respiratory movement by swallowing	77
	„	64.	Reflex swallowing by stimulation of superior laryngeal nerve	78
	„	65.	Vagus and respiratory rhythm	80
XIV.	„	66.	Vasopressor reflex	81
	„	67.	Depressor nerve	82
	„	68.	Respiratory waves of the arterial pressure	83
	„	69.	Reflex cardiac inhibition	84
XV.	„	70.	The spinal knee-jerk	86
	„	71.	Conductive direction of the spinal roots	86
	„	72.	Galvani's experiment with metals	90
XVI.	„	73.	The decerebrate knee-jerk	92
	„	74.	The rule of the roots tested by pinna reflex	93
	„	75.	Head-shake reflex of auditory meatus	95
XVII.	„	77.	Cervical sympathetic and vessels of the pinna	96
	„	78.	Circulatory changes and the volume of the kidney	97
	„	79.	Haemorrhage and arterial pressure	98
	„	80.	Restoration of arterial pressure by gum-saline injection	98
	„	81.	Retardation of clotting by 'decalcification'	99
XVIII.	„	82.	Proprioceptive reflex of tibialis anticus	103
	„	83.	Reflex of ankle flexor to single break-shock	105
	„	84.	Motor twitch contraction compared with reflex	106
	„	85.	Measurement of latencies of reflex and motor twitch	107
XIX.	„	86.	The 'shortening reaction'	109

CONTENTS

xi

XIX.	Obs. 87.	The stretch-reflex	109
	„ 88.	The 'lengthening reaction'	110
	„ 89.	Reflex inhibition of posture	110
	„ 90.	Reflex inhibition of contraction	110
XX.	„ 92.	Inhibitory action of cerebellar cortex	113
	„ 93.	Spinal transection on decerebrate rigidity	116
	„ 94 A.	Spinal reflex flexor tetanus	117
	„ 94 B.	Motor-nerve tetanus	117
XXI.	„ 96.	Action of secretin	118
	„ 97.	The flow of bile after the intravenous injection of (a) secretin (b) bile salts	120
XXII.	„ 101.	Intravenous injection of bacteria	122
	„ 102.	Phagocytosis of bacteria	123
	„ 103.	Amoeboid movement of leucocytes. Phagocytosis of carmine particles	123
	„ 104.	Fate of intravenously injected bacteria	124

Observations additional to the preceding, which may be omitted at the first performance of the exercises

V.	Obs. 20.	Arterial pressure and faradization of the spinal cord	126
	„ 21.	Antidrome conduction in the spinal cord	126
VII.	„ 29.	Central end of n. splanchnicus on arterial pressure	128
	„ 30.	Asphyxia on arterial pressure after section of both n. splanchnici	128
	„ 33 B.	Lymphatic drainage of peritoneal cavity through the diaphragm	128
VIII.	„ 36.	Aortic stenosis on arterial pressure and pulse	129
X.	„ 46 B.	Reflex contraction of the bladder	129
XII.	„ 53.	Reflex salivary secretion	129
XVI.	„ 76.	The rule of the roots and the pinna reflex	130
XIX.	„ 91.	Reflex rhythm in crossed extensor reflex	131
XX.	„ 95.	Occlusion of reflex effect	131
XXI.	„ 98.	The flow of pancreatic juice and bile after injecting bile into the duodenum	132
	„ 99.	The flow of bile only after injecting bile into the ileum	132
	„ 100.	Absorption of fat into the lacteals of the small intestine	133
APPENDIX			135
INDEX OF NAMES			161

LIST OF PLATES

PLATE

- I. Inspection of heart and lungs *in situ*. Exerc. IV.
- II. Preparation of carotid and vagus. Arrangement of Hg manometer for arterial pressure. Exerc. V, &c. Plan of innominate and subclavian ligations for aortic valve experiment. Exerc. VIII.
- III. Splanchnic nerve experiment. Exerc. VII.
- IV. Accelerator nerve experiment. Exerc. IX.
- V. Hydraemic plethora experiment. Exerc. X. Preparation of external jugular vein. Exerc. VI. Cervical sympathetic on the blood-vessels of the ear. Exerc. XVII.
- VI. Salivary secretion experiment. Exerc. XII. Electrode for unipolar stimulation. Exerc. V.
- VII. Magendie's experiment on the spinal nerve-roots. Exerc. XV.
- VIII. Conductive direction of spinal nerve-root tested by pinna reflex. Exerc. XVI.
- IX. Direct and reflex reactions of mammalian nerve-muscle preparation. Exerc. XVIII, XIX, XX.

EXERCISE I

RHYTHMIC MOVEMENT AND TONE OF INTESTINE; INFLUENCE OF ADRENAL EXTRACT ON INTESTINE, SPLEEN, AND ARTERIAL WALL

I. SEE that your recording apparatus is in order, and that the recording surface travels from right to left about 15 mm. a minute. Attach a rubber or glass syringe to the rubber tube at end of the glass tube (G, text-fig. 1) on standard and blow some air through the Ringer-Locke solution in the beaker.

II. *Dissection.* In the carcase of the freshly-killed rabbit, provided for you in the tray, open the abdomen freely in the mid-line and excise with scissors about 10 cm. length of small intestine, emptying it by gentle pressure with the fingers before excising it. The duodenum usually affords a better preparation than the ileum; but the piece should not be taken from quite close to pylorus. Place it in cold Ringer-Locke fluid. Also the spleen; also a piece of the thoracic aorta about 5 cm. long. Take care in excising these to handle them with as little damage to them as possible.

III. From the length of small intestine lying in the cold 'Ringer-Locke' cut off with sharp scissors by two clean cuts a piece 2 cm. long. It will measure longer when it is relaxed. Holding this gently with the fingers, pass through its wall about 3 mm. from the cut edge a needle carrying a thread. Withdraw needle and by the thread tie the gut closely down to the taper bent end of the glass tube affixed to the table-standard. Attach a pin-hook and thread through the lip of the opposite end of the intestine.

Obs. 1.
Intestinal movement and tone.

Place the piece of intestine thus attached to the glass tube in the beaker of cold Ringer-Locke fluid so that intestine is wholly plunged; clamp glass tube in position on the vertical standard. Bring the shorter arm of the writing lever vertically over intestine; slip over it a non-slip loop of the thread from intestine. Nearly counterpoise lever (with a small lump of clay, W, text-fig. 1) so as to allow 'tonus' as well as 'beat' of intestine to show.

See that the glass style (P, text-fig. 1) at end of lever's long arm—which may have with advantage a length of 30 cm.—marks at all heights on drum surface and over a considerable arc. Place a small low gas-flame under the outside beaker which serves for water-bath to the inner beaker.

Start the recording drum; note movements of intestine, beginning when thermometer in inner beaker indicates about 30° C. Later, when bath is at 35° C., withdraw the gas-flame. The beats will be about 10–20 a minute.

EXERCISE I

Obs. 2. Adrenal extract on intestinal movement and tone. IV. Add 0.5 c.c. of solution of adrenalin (i.e. adrenal extract) 0.01 per cent. to the Ringer-Locke fluid (about 300 c.c.) in the beaker. Note the effect (1) on the beat and (2) on the tonic length of the strip. Note the slight pink

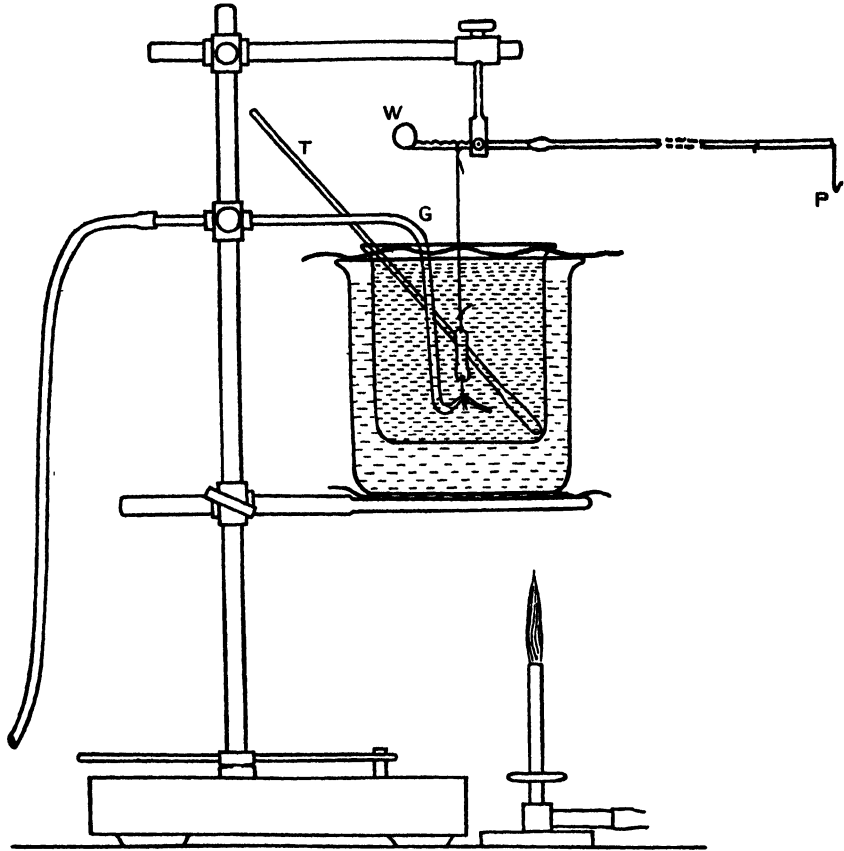

TEXT-FIG. 1. Arrangement for recording movements of intestinal strip in warmed Ringer-Locke fluid. G, tube for aerating the fluid and serving as fixation for thread from intestinal strip; P, glass writing-point slung in sleeve end of straw lever; W, counterpoise for writing lever; T, thermometer. The vertical standard carrying both water-bath and recording lever rotates in its base up to the small stop on the base, allowing adjustment to the recording surface by a single movement.

colour gradually tinging the solution. [Try the ileocolic sphincter's contraction with adrenalin.]

Obs. 3. Adrenal extract on spleen. V. Empty and rinse out the inner beaker. Refill it with cold Ringer-Locke fluid and blow some air through as before. Fix a strip of excised spleen to glass tube in the bath and to writing lever above, lengthwise

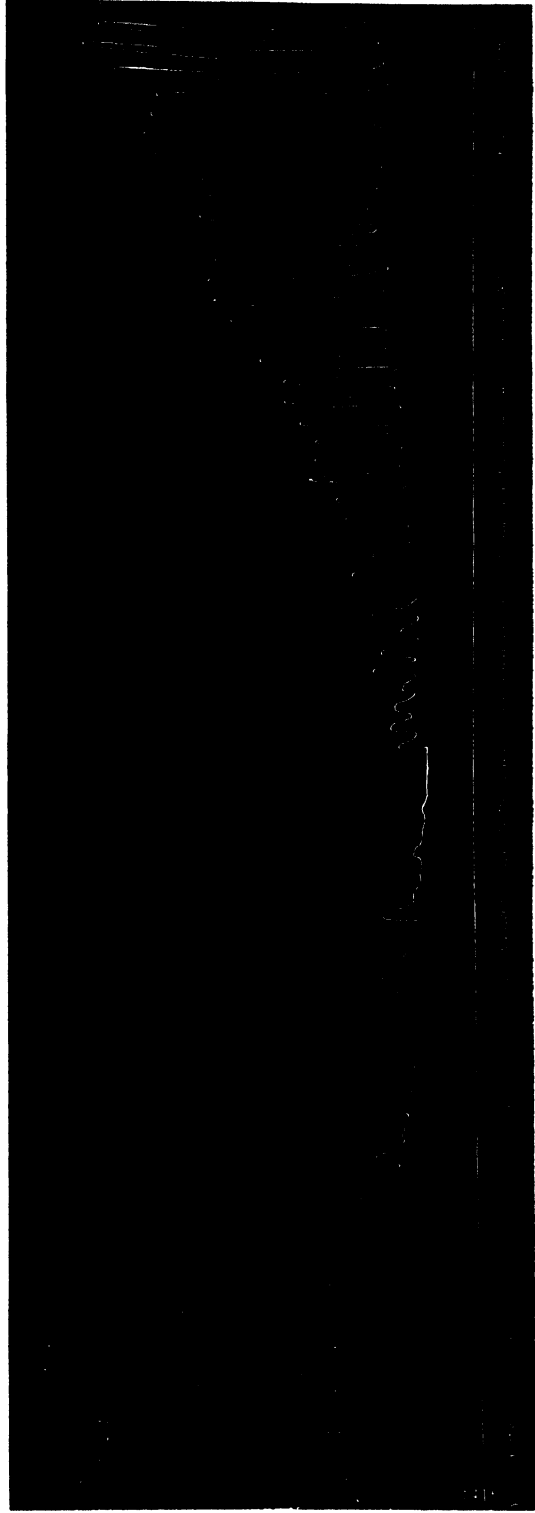

TEXT-FIG. 2. Pendular contractions of excised piece of duodenum (rabbit) in Ringer-Locke fluid at 35° C. (J. A. Barnett).
Inhibitory effect of adrenal extract. Time marked below, 2' intervals.

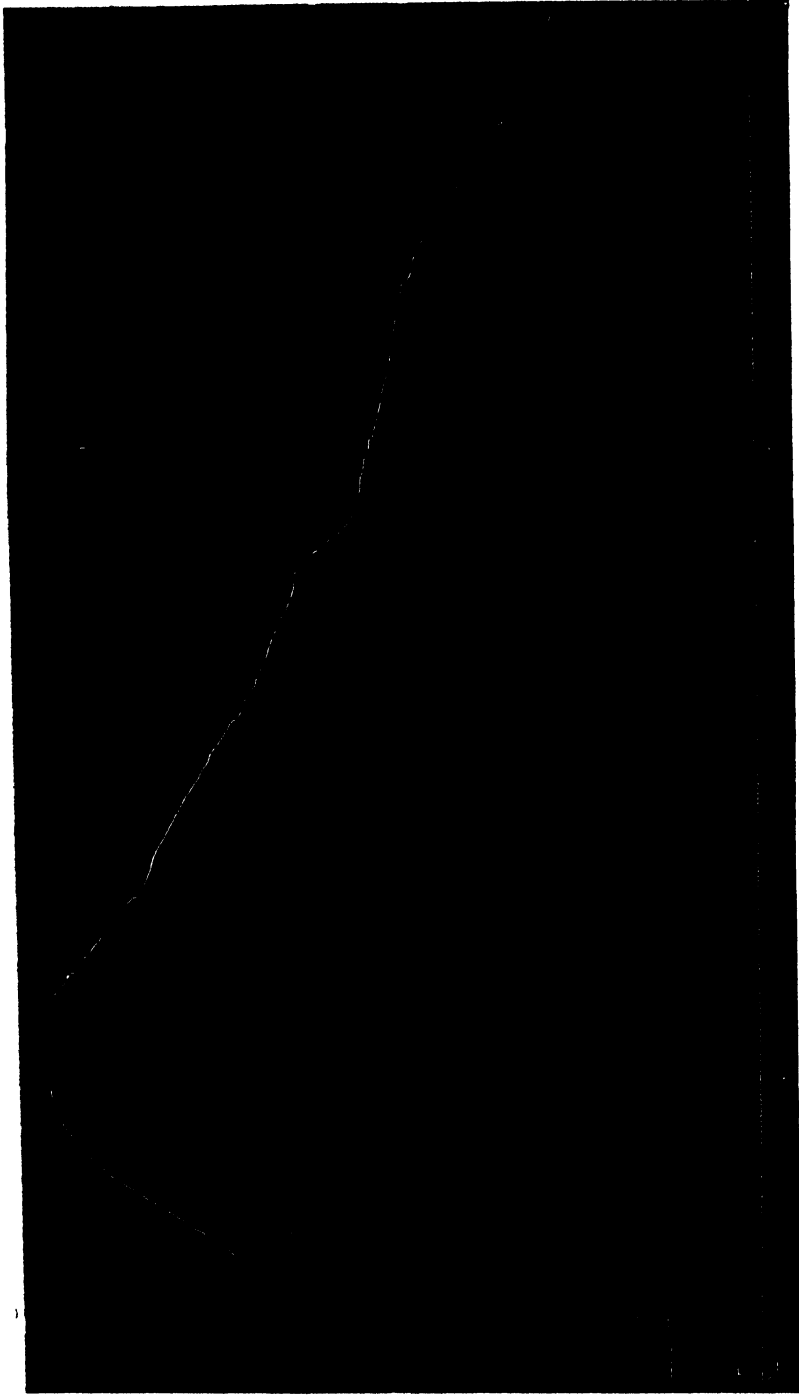

TEXT-FIG. 3. Strip of excised spleen (rabbit) in Ringer-Locke fluid at 35° C.; contraction caused by adrenal extract (J. M. Smith).
T, time in 2" intervals; S, signal indicating when adrenal extract was added to the fluid, giving a dilution of 1 in 5,000,000.

between them, as you did the gut. Warming the bath as before observe the graphic record. Probably there is no beat. When the bath reaches 35° C. add adrenalin as before, and observe the result.

VI. Empty and rinse out the inner beaker. Refill it with fresh Ringer-Locke fluid and blow air through as before. From the piece of aorta taken OBS. 4.
Adrenal extract
on arterial wall.

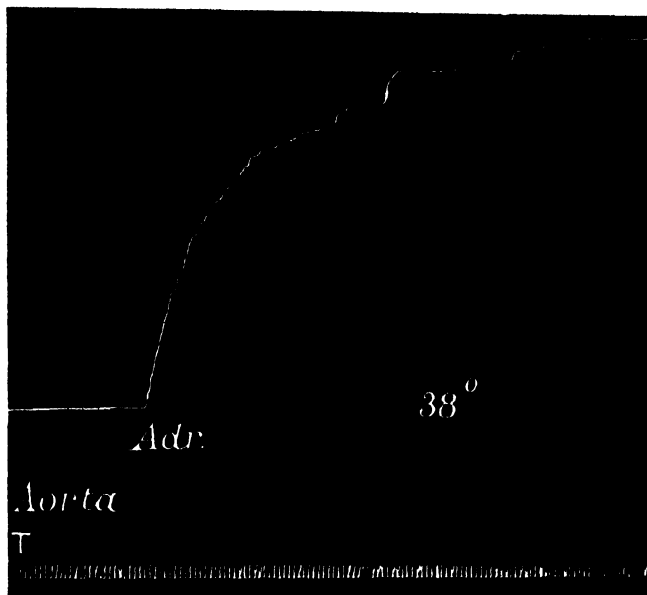

TEXT-FIG. 4. Strip of excised aorta (rabbit) in Ringer-Locke fluid at 38° C.; adrenal extract (E. Denniston).
T, time in 2' intervals.

from the cold Ringer-Locke fluid carefully cut a spiral band about 4 mm. wide and 2-3 cm. long. Fix the excised strip of aorta to glass tube and writing lever as with spleen, and see that it is completely immersed in the bath. Put the strip under stretch by hanging a 5 gm. weight to the writing lever at a distance from the fulcrum similar to that of the attachment of the arterial strip but on opposite side. Keep stretched for five minutes. Take off weight and let the strip write a horizontal line for a couple of minutes. Apply flame to rewarm the bath. Probably no beats will be seen. Add three drops of adrenal extract solution as before when the temperature of the bath reaches 37° C. Observe and record the result.

ANNOTATION

Obs. 1. Ringer-Locke fluid is a 'normal saline' for mammalian tissues, isotonic with and resembling in composition the saline contents of mammalian blood plasma. S. Ringer established (1884, *Jnl. of Physiol.* iv, p. 20, and subsequent papers)

the importance of adding certain minute quantities of Ca and K to the 0.6 per cent. NaCl saline fluid then in use as normal for the frog's heart and amphibian tissues. For mammalian tissues, especially the heart, F. S. Locke (1901) devised a saline



TEXT-FIG. 5. Exsected piece of ileum (cat) in Ringer-Locke fluid at 35° C. Pendular and 'tonic' waves of contraction inhibited by adrenal extracts (E. Woods). *t*, time in 4" intervals. *s*, signal indicating when adrenal extract was added.

having a content of Na, Ca, and K in quantities normally present in rabbit's blood-serum (*Jnl. of Physiol.* xxxvi, p. 220, 1907), and this is now in general use in physiological laboratories; it is what is here referred to as 'Ringer-Locke'. Its composition is:—

0.015 p. cent.	sodium bicarbonate	} in dis- tilled water.
0.024	„ calcium chloride	
0.042	„ potassium chloride	
0.92	„ sodium chloride	

The water should be distilled in apparatus of glass, not metal, the merest traces of certain metallic ions being poisonous to many living tissues, e.g. heart. When used for perfusing the heart, Locke has shown that the addition of 0.1 per cent. glucose is an improvement.

Obs. 2. 'Adrenalin' is the name adopted for the active principle extracted from the medulla of the adrenal gland. The physiological powers of such extracts were dis-

covered by Oliver and Schäfer in 1894 (*Jnl. of Physiol.* vols. xvi, p. i; xvii, p. ix; and xviii, p. 230). Its activity is mainly or entirely due to the substance adrenaline first isolated in purity by Jokishi Takamine (1901, *Am. Jnl. of Physiol. and Proc. of Physiol.* Dec. 1901, *Jnl. of Physiol.* vol. xxvii, p. xxix), and synthesized in its racemic optically inactive form by Dakin, 1905 (*Proc. Roy. Soc. B.* 76, p. 494). Synthetic laevo adrenaline has (Cushny, *Jnl. of Physiol.* xxxvii. 130, 1908; xxxviii. 259, 1909) the same potency as natural (laevo) adrenaline, whereas the dextro-rotatory part of the synthetic adrenaline has only one-thirteenth that strength. Langley pointed out, 1901 (*Jnl. of Physiol.* xxvii, p. 237), that in practically all points of its action 'adrenalin' produces effects like those of stimulation of the sympathetic nerves; thus in this exercise it inhibits the movements and tonus of the muscular coats of the intestine (text-figs. 2 and 5), and causes contraction of the muscular

coats of the spleen (text-fig. 3) and of almost all arteries (here aorta, text-fig. 4).

With the excised intestine as reagent Cannon and Hoskins were able to detect adrenalin in a dilution of 1 part in 200 millions. Papers to consult are Gunn and Underhill, *Quart. Jnl. of Experim. Physiol.* vol. viii, p. 275, 1915, and H. S. Gasser, *Jnl. Pharmacol. and Expt. Therapeutics*, vol. xxvii, p. 395, 1926.

If performed with cat's intestine instead of rabbit's, you will probably find the rhythm slower than with the latter, and your recording surface should travel very slowly, but the rate of beat is different from different parts of the intestine. The cat's ileum tends to give slow tonic contractions on which the less slow pendular contractions are superposed (text-fig. 5); the rabbit's ileum rarely exhibits the former (Young, *Quart. Jnl. of Experim. Physiol.* vol. viii, p. 349, 1915). Rabbit's duodenum beats better.

EXERCISE II

REVIVAL OF BEAT OF THE EXCISED MAMMALIAN HEART; INFLUENCE OF TEMPERATURE THEREON

I. See that the perfusion apparatus (text-fig. 6) is ready for use. One of the glass reservoirs R, R' should be filled with Ringer-Locke fluid at room temperature; the fluid used is as in exerc. I except that it contains 1 per cent. glucose in addition to the inorganic salts. See that the clamp on perfusion-reservoir tube acts freely. Open the tap of the oxygen cylinder and slightly adjust it so that oxygen bubbles *slowly* through the Ringer-Locke fluid in the reservoir. Five or six bubbles in the half-minute is a sufficient stream.

Make ready a strong thread ligature loosely tied with the first tie of a reef-knot; this is for slipping round the aorta. Also have ready a packing-needle about 10 cm. long threaded with fine string about 20 cm. long.

II. *Dissection.* Place the dead rabbit provided for you supine in the iron tray. The following dissection should be done in a good light as rapidly as due care will permit with full assistance from your fellow worker. Make an

Obs. 5.
Revival of beat of the excised heart by coronary perfusion.

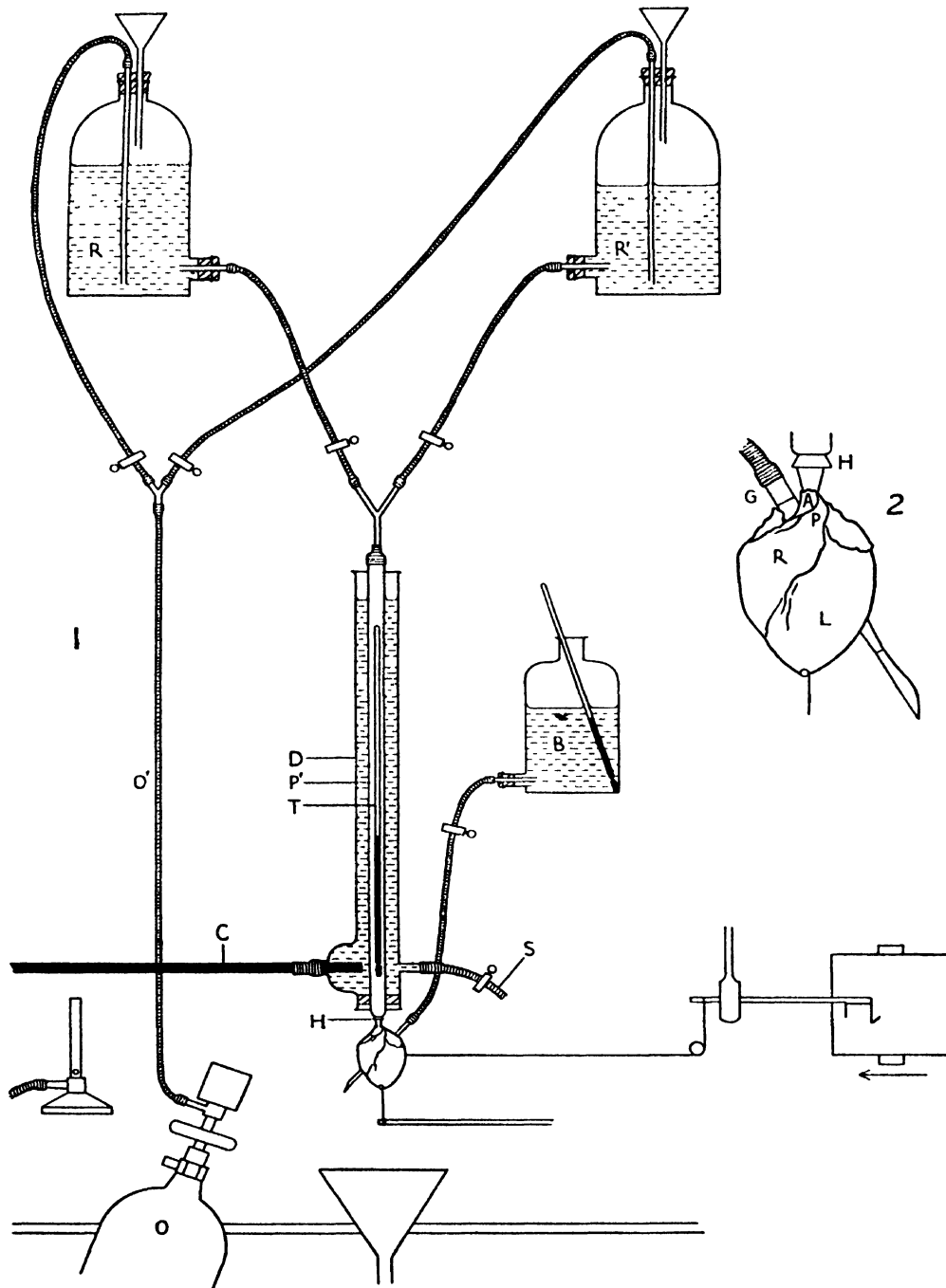

TEXT-FIG. 6. 1. Simple perfusion apparatus for excised mammalian heart, an essential part being the device for warming the perfusion fluid as it descends through a central glass tube *P'* containing the thermometer *T* and jacketed by a cylindrical glass tube *D*. This latter contains water which is warmed by the conduction of heat along the copper rod *C* from the Bunsen

incision through the skin along the whole length of the sternum and to a point 5 cm. beyond the xiphoid. Rapidly and freely reflect back the skin on either side of the incision and retract it with clip-weights. Make carefully with the scalpel a median cut 4 cm. long through the abdominal wall behind the xiphoid. Lift xiphoid and free it by lateral cuts with strong scissors, thrusting one blade through the diaphragm but without touching heart or lungs. Cut through with the scissors the cartilages of the lower ribs of each side, well back, to avoid jagged rib-ends injuring the heart. Raising sternum with left hand, cut with the scissors a shield-shaped piece of the front of the chest consisting of posterior $2/3$ sternum, the corresponding costal cartilages and their rib-ends, and the musculature attached. Pick up the front of pericardium with the fine forceps and open it cautiously with fine scissors. Enlarge opening freely. The venae cavae, pulmonary artery and aorta, and the right and left auricles are to be rapidly identified. Lay preparation on its left side. Draw right lung aside from heart, make out its root, and cut that through with large scissors. Turn the preparation on its right side and similarly cut through root of left lung.

Make out clearly the aorta and its first large branch, the innominata. Cut through aorta about 5 mm. proximal to innominata. Cut through superior vena cava 1 cm. above right auricle. Tilt apex of heart gently over to left and expose and then cut a snip in it. Carefully pass the packing-needle up through inferior cava and through right auricle and out through the cut superior cava. Pull the needle through and leave the string threaded through inf. cava, auricle, and sup. cava. Tie the two ends of the string together. This is to help finding later the orifices of the two cavae. Cut inferior cava across at the point of entrance of the string.

III. The heart thus freed is gently lifted from the chest and placed on the cork plate in the cold Ringer-Locke fluid. Gently wash away clots which adhere. Find stump of superior cava and, holding it open with fine

flame. R, R', reservoirs for Ringer-Locke fluid. o, oxygen cylinder with o' supply tube to the perfusion reservoirs. B, reservoir for warm or cold water supplying thin glass tube passed through right auricle from vena cava superior to vena cava inferior (experiment on warming or cooling the 'pace-maker'). P', thin-walled glass tube through which the perfusion fluid flows from the reservoirs to the aortic cannula H. T, thermometer with scale from 0° C. to 50° C., lying within and nearly filling P'. s, rubber side tube and clamp for letting warmed water out of jacketing tube.

2. Diagram of heart with aortic stump s tied upon H, the cannula of the perfusion apparatus. P, pulmonary artery. R, L, right and left ventricles. G, thin-walled glass tube passing through the superior and inferior venae cavae and attached above to the rubber tube from the reservoir for cold or warm water (for influence of temperature on 'pace-maker').

forceps, direct into it a stream of cold Ringer-Locke fluid from the wash-bottle and wash out blood from inside heart chambers, avoiding the entrance of air-bubbles.

Loosen clamp on tube from reservoir in the perfusion apparatus and allow the perfusion fluid (Ringer-Locke) to dribble slowly from the heart cannula (H, text-fig. 6). Slip round the aortic stump the noose of an untied ligature ready for tightening. Seizing firmly with the fine forceps the cut edge of the aorta above the thread-noose, and supporting the weight of the heart with the other hand, bring the heart to the perfusion cannula and draw the aorta over the cannula nozzle. Get your colleague now to tighten the ligature round the aorta on the neck of the cannula, and to secure it. See that the lower end of the cannula lies well above the commencement of the coronary arteries. Take care that no air-bubbles are included in the aorta or cannula in the making of this connexion. If the ventral aspect of the heart is not towards you when the organ hangs suspended on cannula, turn the aorta on the cannula so as to bring the ventral face of ventricles to the front.

Note whether the coronary vessels still contain blood or are now washed clear with Ringer-Locke fluid. Note the temperature (τ , text-fig. 6) of the inflowing fluid and what quantity is passing through the heart.

Pass a fine needle carrying a thread with split shot or glass bead through apex of left ventricle (text-fig 6, 2). Remove needle, leaving thread, and by the thread secure apex of heart to the horizontal rod below it (text-fig. 6), thus steadying the suspended organ.

Steadying the heart with the left hand, attach a pin-hook through the visceral pericardium half-way up right ventricle. Attach the fine thread from the pin-hook in right ventricle to a writing lever arranged for recording beat on drum (text-fig. 6).

OBS. 6.
Influence of
temperature
on beat.

IV. The heart is probably by this time beating. Inspect the heart's action and take records of it. Count the frequency of the beat. Note the temperature of the perfusion fluid. Bring temperature to 37° C. by moving the Bunsen flame to a suitable distance along the copper rod. Record effect on beat-rate.

Heighten temperature up to but not beyond 42° C. : record the progressive change in beat-rate.

Reduce the temperature to about 30° C. again. This can be done quickly by letting out some of the warm water in the jacket by the rubber side-tube (s, text-fig. 6).

OBS. 7.
Cooling and
warming the
pace-maker.

V. Find with the looped string the orifices of superior and inferior venae cavae. Pass the thin-walled glass tube through the right auricle, entering at

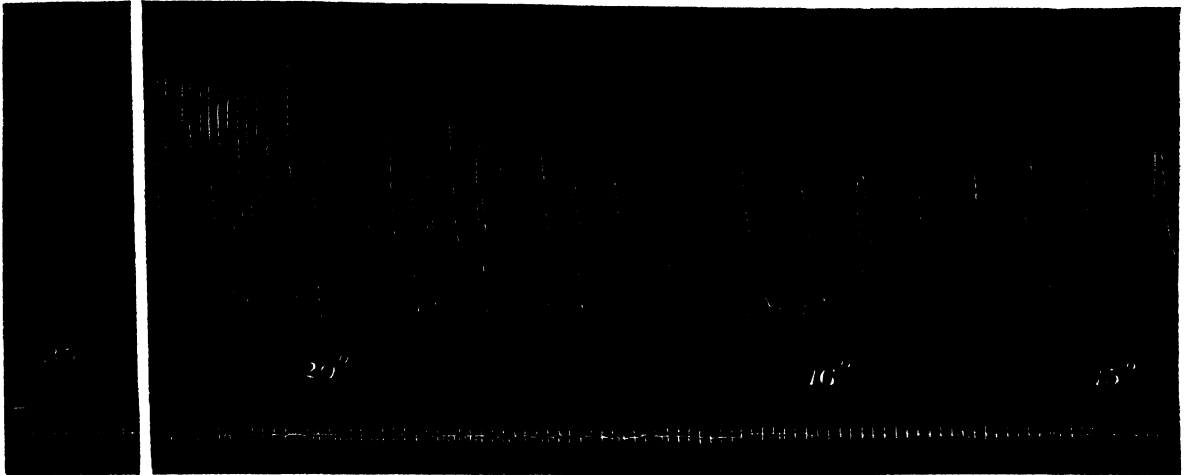

TEXT-FIG. 7. Beating of excised mammalian heart (rabbit) under coronary perfusion with Ringer-Locke fluid; effect of lowering the temperature of the perfusion fluid (W. R. Green-shields and A. H. Plummer). Time marked in 1".

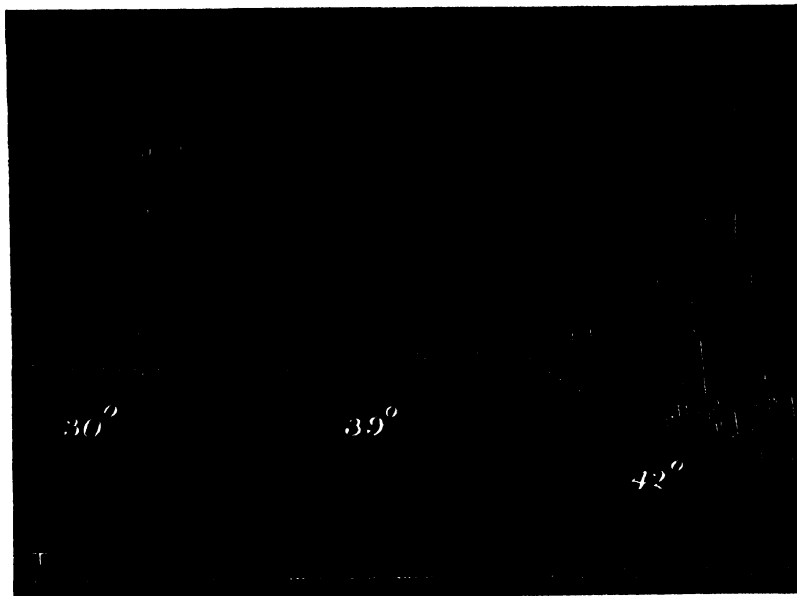

TEXT-FIG. 8. The same; effect of raising the temperature. (M. H. MacKeith and H. L. Rayner.)

superior cava, and so that its lower end projects from inferior cava (text-fig. 6, 2). Connect the upper end of the tube (text-fig. 6, 2) with the rubber tube from reservoir (B, text-fig. 6, 1), keeping the clamp on the rubber tube closed.

Fill this reservoir with ice-cold water, and by opening the clamp allow this to stream through the thin glass tube in the auricle. See that heart-beat is being recorded, the temperature of the coronary supply being about 35° C. Note the result on the rate of beat. By opening the side-way clamp as well as the reservoir delivery clamp, empty the reservoir of remaining cold

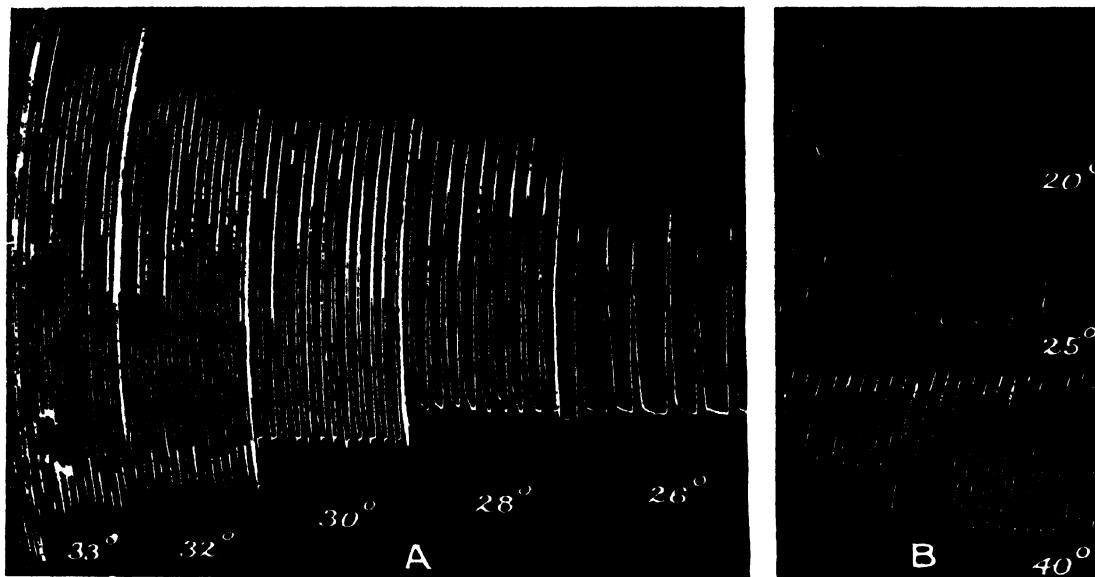

TEXT-FIG. 9. Excised rabbit heart, coronary perfusion. A, cooling of perfusion fluid (D. B. Pauw and F. A. D. Petersen); B, warming of perfusion fluid (C. C. H. Chavasse and E. G. T. Liddell).

water; then fill it with water at 40° C. Open the reservoir delivery clamp and allow this to flow through the tube in the auricle. Note the change in the rate of beat.

ANNOTATION

Obs. 5. The basal fact is demonstrated that the bloodless mammalian heart, excised after it has ceased to beat in the fresh carcase, can be revived to activity and maintained beating by perfusing the coronary blood-vessels with oxygenated normal saline solution.

The procedure has its foundation in the experiments of H. Newell Martin, 1881 (*Studies from Biol. Lab., Johns Hopkins University*, especially the paper by Martin and C. Applegarth, *Johns Hopkins Biol.*

Studies, vol. iv, 1890), and the further developments by Langendorff, *Arch. f. d. gesammte Physiol.* lxi, 1895; Townsend Porter, *Amer. Jnl. of Physiol.*, vol. i, p. 511, 1898, and F. S. Locke, *Centralbl., f. Physiol.*, vol. xiv, p. 670, 1900; *ibid.* vol. xv p. 490, 1901. The pressure-head of the fluid as supplied in the experiment is below that normal in the coronary artery; the speed of flow, however, owing to the viscosity coefficient of the Ringer-Locke being less than that of blood, is not so deficient.

The simple method here used (text-fig. 6) for warming the perfusion fluid is that devised by Professor J. A. Gunn (*Jnl. of Physiol.* vol. xlvi, p. 506, 1913), and modified by W. T. Dawson (*Jnl. of Lab. and Clin. Med.* vol. x. p. 853, 1925).

Obs. 6. Is in effect a modification of the experiment by H. Newell Martin, *Phil. Trans. R. S.*, London, vol. 174, p. 663, 1883. The excised cat's heart beats quickest at 41.3° (H. N. Martin), i.e. about 200 per minute. The lethal temperature is 44.5° C. (H. N. Martin, 1890).

As exemplifying the kind of result obtained in this exercise with the rabbit's

heart the following actual class observation may be given. Temperature in thermometer 13° C., heart still beating; temp. 15° C., 2 beats in 11"; temp. 20° C., 6 beats in 10"; temp. 25° C., 12 beats in 10"; temp. 35° C., 18 beats in 10"; temp. 42° C., 22 beats in 10".

Between the temperatures 26° and 40° the rate of heart-beat in the mammalian lung-heart preparation is a linear function of the temperature. (Knowlton and Starling, 1912, *Jnl. of Physiol.* vol. xlv, p. 217). But it would be a fallacy to assume that as this implies a direct temperature 'coefficient' in the strict sense of that term.

EXERCISE III

ADRENAL EXTRACT AND CHLOROFORM ON THE ISOLATED MAMMALIAN HEART UNDER CORONARY PERFUSION

I. See that the perfusion apparatus for the isolated heart is ready (exerc. II). One of the two reservoirs (text-fig. 6, 1, R') contains 500 c.c. of Ringer-Locke fluid with 100 mg. of chloroform per litre. The other reservoir contains Ringer-Locke fluid without CHCl_3 .

II. *Dissection.* From the recently killed rabbit provided for you in the tray remove the heart as in your previous perfusion experiment (exerc. II). Connect the excised heart with the perfusion apparatus supplied with the pure Ringer-Locke fluid as in exerc. II, and obtain a graphic record of the beat of the ventricle at a temperature of 35° C.

III. Open the supply-tube from the CHCl_3 reservoir and close that from the pure Ringer-Locke solution. The amplitude of the beat soon begins to diminish (text-fig. 10). When the amplitude of the beat has been reduced to about one-quarter of its previous amount, cut off the CHCl_3 supply and re-supply the normal Ringer-Locke solution. Observe the further diminution and the gradual recovery of the heart's beat. Note that the rate of beat is not altered if the temperature of the perfusion fluid containing the CHCl_3 be maintained.

OBS. 8.
Chloroform
on excised
mammalian
heart.

IV. When the chloroform effect has passed off, inject into the rubber supply-tube by a needle-syringe 1 c.c. of 0.002 adrenalin. The injection should be slow, e.g. occupy about 30". Note and record effect on heart.

OBS. 9.
Adrenal extract
on excised
mammalian
heart.



TEXT-FIG. 10. Influence of coronary perfusion of CHCl_3 in strength of 0.01 per cent. in Ringer-Locke fluid on the isolated rabbit-heart (J. M. H. Campbell and G. Perkins). τ , time in seconds; s, signal showing the time of perfusion of the CHCl_3 solution; in the latter part of the recovery period the temperature of the normal Ringer-Locke fluid administered rose slightly, and the beat-rate increased in consequence.

ANNOTATION

Obs. 8. See Sherrington and Sowton, Committee of the Brit. Med. Assoc. 1903 (*Brit. Med. Jnl.* 1903, and *Thompson Yates' Reports*, vol. v, p. 69, Liverpool, 1903). A solution ten times weaker than the 0.01 per cent. which you use in the experiment will cause distinct depression of the beat. The effect produced by a given percentage of CHCl_3 in Ringer-Locke is greater than in blood and than in blood diluted with saline solution (Sherrington and Sowton, *Brit. Med. Jnl.* 1904), the solution tension being higher in the Ringer-Locke.

Obs. 9. The effect of adrenal extract upon the perfused heart was discovered by Oliver and Schäfer and is mentioned in their original paper (see Annotation to exerc. I). The effect resembles that produced by stimulating the sympathetic cardiac nerves. Adrenal extract greatly increases oxygen consumption by the heart (Barcroft and Dixon, *Jnl. of Physiol.* vol. xxxv, p. 182, 1910), and roughly proportionately to the increase in beat-rate (Lovatt Evans and Sagoro Ogawa, *ibid.* vol. xlvii, p. 446, 1914).

EXERCISE IV

INSPECTION OF THE LUNGS AND BEATING HEART *IN SITU*; INFLUENCE OF INTRA-PERICARDIAL PRESSURE AND OF FARADIZATION OF THE VAGUS NERVE. THE CAPILLARY CIRCULATION VIEWED BY THE MICROSCOPE

I. Attached to the tubing from the ventilating pump a decapitate carcass is provided. The inflations supplied by the pump to the lungs are at the rate of about 30 a minute. The amount of distension of the lungs by each inflation can be increased or lessened by constricting or leaving freer the short rubber tube on the side arm of the tracheal cannula, adjusting the little spring clip on it. Examine the preparation for indications of a satisfactory condition of circulation, respiration, and nervous system. The heart-beat should be easily perceptible by palpation through the chest-wall; should be regular and of a rate of about 100 per minute. If the ventilation of the lungs is too slight or too forcible, readjust by regulation by the spring clip. Readjustment of the lung ventilation will often improve an enfeebled heart's action. The knee-jerk should be brisk; to elicit it lift the limb slightly by the thigh with hip semiflexed and tap the patellar tendon, e.g. with the handle of scissors.

II. Set your Ringer-Locke fluid containing cotton-wool swabs to warm to 37°C . See that you have ready, in addition to the usual operating instruments, (1) a bent packing-needle armed with strong string through a hole bored near the needle's point, (2) a cutting bone-forceps; both are provided. Prepare pericardial cannula and funnel; also the inductorium, &c., for faradic stimulation of the vagus.

III. *Operation.* Some general advice as to operating for physiological work may here be offered.

Before making the initial incision feel with the finger-tips for bony points which may be indicated, by your instructions or your own knowledge, as helpful guides to the structures you want to expose by your wound and identify them on the mounted skeleton. Having determined the direction and extent you mean to give to your skin incision, clip off with coarse scissors the longer hair from the skin, and moisten the skin well with a soaked but squeezed-out pledget from your warm saline. The saline should always be used warmed fully to 37° C. Steadying with the fingers of the left hand the skin above the place where your incision will begin, cut the moistened skin with a quick stroke, employing as much as possible of the whole length of the scalpel's

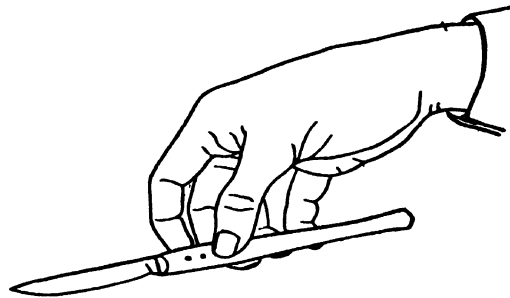

TEXT-FIG. 11. Mode of holding scalpel for a free incision, so as to employ to the full the length of the cutting edge, e.g. when incising skin.

cutting edge. A good method of holding the scalpel for this purpose is 'comme un archet', like a fiddle-bow (text-fig. 11). The scalpel used should be a fairly large-bladed one, with a freely convex curve of cutting edge—that is, it should not have been worn down to a sort of one-sided dagger, as often are the scalpels brought into the physiology class-room. The same method of scalpel use is effective for any free clean incision wherever required. For physiological work a mode of using the scalpel which should be scrupulously avoided is niggling with the point; slow and ineffective, it causes numerous small haemorrhages, and obscures the deeper structures by leaving frayed edges of fascial and connective tissue. It may be useful in some dissections in the dead animal, but is wholly unsuitable for operating on living tissues. Only in the limited steps of the deeper portion of an operation should the cutting with the knife be confined to the knife's point, and even then but rarely.

Of course no artery, vein, or nerve desired for experiment should during the operation for its exposure and isolation be for that purpose picked up by the forceps. Such structures should indeed be touched as little as possible, for every touch tends to damage the life of their histological elements.

Constant recourse should be had to warm squeezed-out pledgets of cotton-wool from the Ringer-Locke fluid as swabs for removing blood which has obscured the structures in the wound. If for any reason you have to pause at some stage of operating, cover the exposed tissues with a warm squeezed-out swab to prevent cooling and drying of them. Use freely the clip-weights for retracting the edges of the wound.

The threads which are used for passing under vessels and nerves should be wetted in the saline before being so used; a dry thread passes less easily and drags on and disturbs the tissues more.

The bleeding from larger vessels, especially from arteries, requires artery-clamp forceps, two of which are provided. Usually it is enough to leave the clamp forceps on for a few minutes, after which, on removal of the forceps, the bleeding-point will be found to have closed; if not, the bleeding-point should be ligated with a thread applied while the artery-forceps are still hanging on to it; the artery-forceps can then be removed.

While you do the operative dissection, your colleague, besides helping at the time of insertion of cannulae, &c., should swab for you, deal with points of haemorrhage, retract, supervise the ventilation, &c.

IV. Place the preparation fully supine with all four limbs extended with a clip-weight attached to each foot. The chest can be stayed from rolling over by propping with a hot-water bottle laid either side, the bottle being kept from slipping by a small wool pledget, jammed under its outer edge. Feel for the junction of the 3rd costal cartilage with sternum. From this level make a skin incision (Pl. I, figs. 1, 2, 3, after p. 20) along mid-ventral line to nearly as far as half-way down the xiphoid process of the sternum. Across the anterior and posterior ends of this incision make transverse ones extending 4 cm. to the animal's right side, 3 cm. to left. Reflect the skin to either side; then reflect the pectorals, and then the recti muscles, and retract with four clip-weights.

Feel for the 7th costal cartilage joining sternum on right side; pass closely under it, 3.5 cm. from the sternal edge, a string by means of the eye-pointed packing-needle (Pl. I, fig. 2). Tie the string tightly round the cartilage. Ligate in this way in succession the 7th, 6th, 5th, and 4th rib cartilages of the right side, close to their junction with their ribs. With strong scissors cut the cartilages close to the sternal side of the ligatures, and cut also the soft tissues in the same line from 7th space to 4th inclusive. These ligatures prevent bleeding from the intercostal arteries. Raising the sternal edge of this incision, look under the sternum for the right internal mammary artery. From the right 4th intercostal space pass the rib-needle transversely across under the sternum and deep to both internal mammary arteries, bringing the ligature out through the 4th left space. Ligate the sternum tightly, occluding the internal mammaries. Cut through the base of xiphoid and 7th, 6th, 5th, and 4th left costal cartilages and their soft attachments. There is less need to ligate these costal cartilages since the internal mammary artery has been tied. Turn back the sternum with its cartilages attached, bending or breaking it at the 4th space, and retracting it (Pl. I, fig. 3) when so reversed with a heavy hook-weight.

Obs. 10.
Inspection of
the lungs and
beating heart
in situ.

V. Note (1) the rhythmically inflated lung lobes (Pl. I, fig. 3 (L)) of pale pink colour, (2) the heart beating in the pericardial sac (Pl. I, fig. 3 (s)); also (3) the thymus and the diaphragm, and the superior vena cava (Pl. I, fig. 3 (v)). Regulate the lung inflation to reduce conveniently the lung expansion so that it does not obscure the view of the heart. Note that the lungs, even when inflated fully, do not cover wholly the front of the heart and pericardium. This area not covered by the lungs is delimitable on the front of the unopened chest by percussion, and is known as the 'area of precordial dullness'. Note the right phrenic nerve coursing along the right side of the pericardium to reach the diaphragm.

OBS. 11.
Effect of raising
intrapericardial
pressure.

VI. With fine forceps pick up a small fold of the pericardium not far from the apex of the heart; cut with fine scissors an opening about 4 mm. long in the pericardial sac. Insert through this opening the nozzle of the pericardial cannula (Pl. I, fig. 4) and tie it securely in by a ligature embracing the hole in a water-tight way. Connect the cannula with the rubber tube from the funnel. The saline for filling it should be warm, about 35° C. Starting with zero-pressure in the pericardium, gradually raise the funnel and so increase the pressure in the pericardial sac. Observe the increments on the centimetre scale, and note the effect upon the heart. The pericardium is sufficiently transparent to allow the auricles to be watched; observe especially the right auricle. The pressure should not be increased beyond 6 cm. of water. Note impending asphyxia, and the onset of asphyxial convulsions. Do not carry the experiment at all beyond that point; when it is reached, at once relieve the intrapericardial pressure by lowering the funnel or by freely opening the pericardial sac; scissors should be ready at hand for doing the latter without delay.

OBS. 12.
Further inspec-
tion of heart and
great vessels
in situ.

VII. Remove the cannula. Bare the heart freely from the pericardium (Pl. I, fig. 5). Note the movements of systole and diastole and the twisting motion of the heart accompanying them. Note the colours of right and left auricles respectively. Make out clearly the aorta, pulmonary artery, and superior and inferior venae cavae. Note the difference in colour between sup. vena cava and the pulmonary veins. Note the 'sinuses of Valsalva', especially well seen at the root of the pulmonary artery. Turn the heart towards the preparation's left side and make out the meeting of the sup. and inf. venae cavae with the right auricle. Take the heart gently between fingers and thumb and feel the hardening of the ventricles, especially of the left, at systole. Pass threads cautiously round (1) superior cava, (2) inferior cava, (3) pulmonary artery, and (4) aorta. Observe thoroughly the effects of

partially or completely occluding for a few seconds each of these vessels by drawing on its thread. Notice the extensibility of the aortic wall as shown by the swelling up of the vessel on the proximal side of the occluding ligature; also its elasticity as shown by its return on releasing the thread. Carefully replace the sternal flap over the thorax.

VIII. Make a lengthwise incision (Pl. II, figs. 1, 2, 3, 4, facing p. 34) for 3 cm. along the right side of the neck, starting about 1 cm. from the mid-line at the level of the cricoid cartilage, which can easily be felt. Draw to the right with a weighted clip the medial edge of the muscle, sterno-mastoid, exposed through the wound. The vagus nerve will be seen lying beside the carotid artery; another nerve, much smaller, the cervical sympathetic, accompanies the vagus. Free the vagus nerve carefully by separating from it the other structures with fine forceps and scalpel; the nerve itself must not be injured, least of all picked up with the forceps. Under its upper freed course pass a thread by means of a blunt curved mounted needle. Ligate the nerve and cut it across with fine scissors headward of the ligature. Lifting the nerve by the ligature, dissect its distal part downward towards the thorax and free it from all surroundings for at least 2 cm. Bring the stimulating apparatus to a convenient position for exciting the nerve by the hand-electrodes, the secondary coil of the inductorium being at 12 cm. on the scale.

OBS. 13.
Inspection of the
heart inhibited
by the vagus.

Raise the sternal flap and hook it back so as to bring the heart into full view. Apply the electrodes to the nerve-trunk well lifted from the wound; air insulation guards against escape of the exciting current to other structures than the nerve. The nerve and electrodes should be so held (Pl. II, fig. 3) that one terminal of the electrodes touches the nerve on one side and the other touches it on the other. The equal passage of the current through the whole thickness of the nerve-trunk is thus favoured. After the electrodes are in position, get your co-worker to open the short-circuiting key in the second circuit, the current and interrupting hammer in the primary having been already started. Note the slowing of the heart-beat; the slowing leads to complete arrest. Each stimulation should not be prolonged beyond 5". Note that one shock alone is without obvious effect on the heart.

Using a stimulus strong enough to completely arrest the beat, keep it applied for a longer period and note that after a varying time the ventricle 'escapes' from the inhibition, though the auricles do not. The ventricles then beat independently of the auricles.

IX. It is very much worth while to complete your impressions of the circulation, as obtained above, by viewing with the microscope the movement

OBS. 14.
Inspection of
capillary
circulation.

of the blood in the arterioles, capillaries, and venules. This can be done well and readily in the following way: Into the dorsal subcutaneous lymph-sac of a small frog inject some 25 per cent. aqueous solution of urethane, in the dosage 0.2 c.c. of the solution per 14 grm. weight of frog. Place the injected frog under a bell-jar; in about 10' its breathing movements will have ceased, its reflexes will have been suspended, and it is ready for examination. Lay it ventral side downward on a moist glass plate not too large for the microscope stage to carry. Observe the interdigital web of the hind foot, using with transmitted light an objective of about 8 mm. focal distance. No fixation of the animal is needed; the digits are simply spread to expose the web favourably. The body of the frog is kept covered with wet filter-paper. After the lower power a 5 mm. objective can be used. Distinguish between arterioles and venules; map out a small capillary district with its supply arteriole and drainage venule.

Obs. 15.
Measurement
of speed of
flow of blood
in a capillary
vessel.

X. Find a longish capillary; put a micrometer scale into the ocular of the microscope; turn the ocular so that the micrometer scale lies parallel with the capillary. Note with stop-watch the time taken by a red blood-corpuscle in travelling a certain length of the capillary as measured by the micrometer. Removing the frog from the microscope stage, find the value of the micrometer scale divisions by means of a stage-micrometer. Calculate the speed of the capillary flow per second from these data. When you have finished your observations, rinse the frog with water and replace it under the bell-jar to recover.

ANNOTATION

Obs. 10 and 12. These might be styled 'Harvey observations' because repeating, under the more favourable conditions of modern technique, inspections of the beating heart *in situ* which so largely helped William Harvey to his discovery of the circulation, a discovery announced to the Royal College of Physicians of London in a course of lectures there in 1616 (the year of Shakespeare's death) and published in the *Exercitatio de Motu Cordis et Sanguinis* in 1628. The *De Motu Cordis* is easily obtainable (in English) as a volume of Everyman's Library Series (2s.). In instance of the lesson's apt illustration of it the following sentence may be cited: 'Si

quis cordis motum diligenter in viva dissectione animadvertit, videbit non solum, quod dixi, cor sese erigere et motum unum facere cum auriculis continuum, sed undulationem quandam et lateralem inclinationem obscuram, secundum ductum ventriculi dextri, et quasi sese leviter contorquere', &c.

Obs. 11. In regard to the pericardial pressure effects the following may be consulted: François-Franck, Marey's *Travaux de Laboratoire*, 1877, p. 107; Cohnheim's *Allgemeine Pathologie*, 2nd edit., vol. i, p. 21, 1882; W. S. Lazarus-Barlow, *General Pathology*, pp. 49-53, London, 1898; T. Lewis, *Jnl. of Physiol.* 1908, vol. xxxvii,

PLATE I. Inspection of thoracic contents. (Ex. IV).

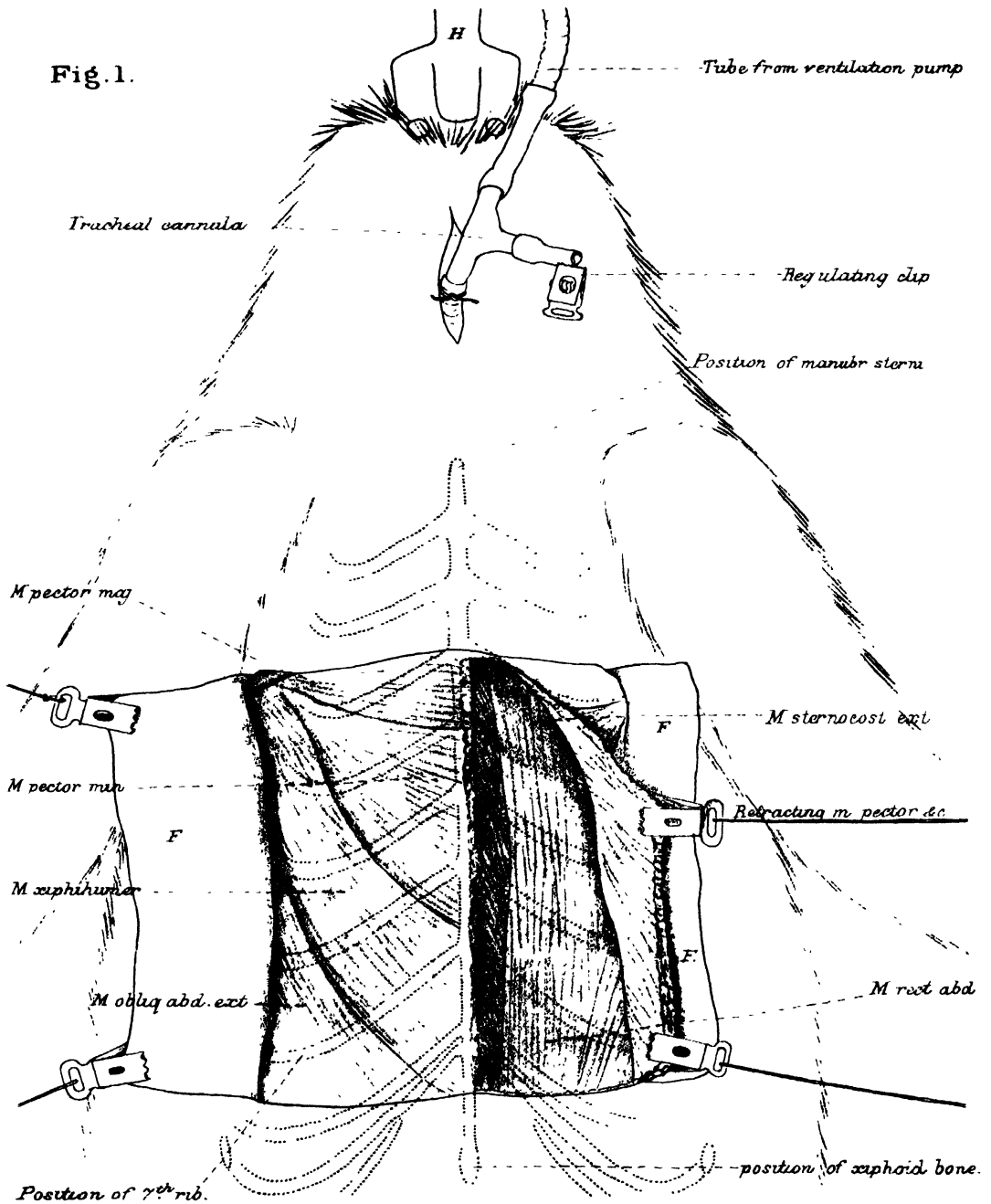

Fig. 1 1st stage, F, skin flap; H, end of clamp fixing neck-stump. Fig. 2 2nd. stage, F, skin-flap; N, needle passed under 4th rib; dotted black line indicates limits of flap to be formed from chest-wall. Fig. 3 3rd stage, F, skin-flap; L, lung-lobe; S, pericardial sac; V, sup, ven, cava; broken black line indicates left limit of pericardium. Fig. 4. Cannula for pericardium, actual size. Fig. 5. Heart as exposed on opening pericardium. R, r. ventricle; L, l. ventricle; r, r auricle; l, l, auricle, p, pulm. art.; a, aorta; s, sup, ven. cav.; i, position of inf. ven. cav.

Fig. 2.

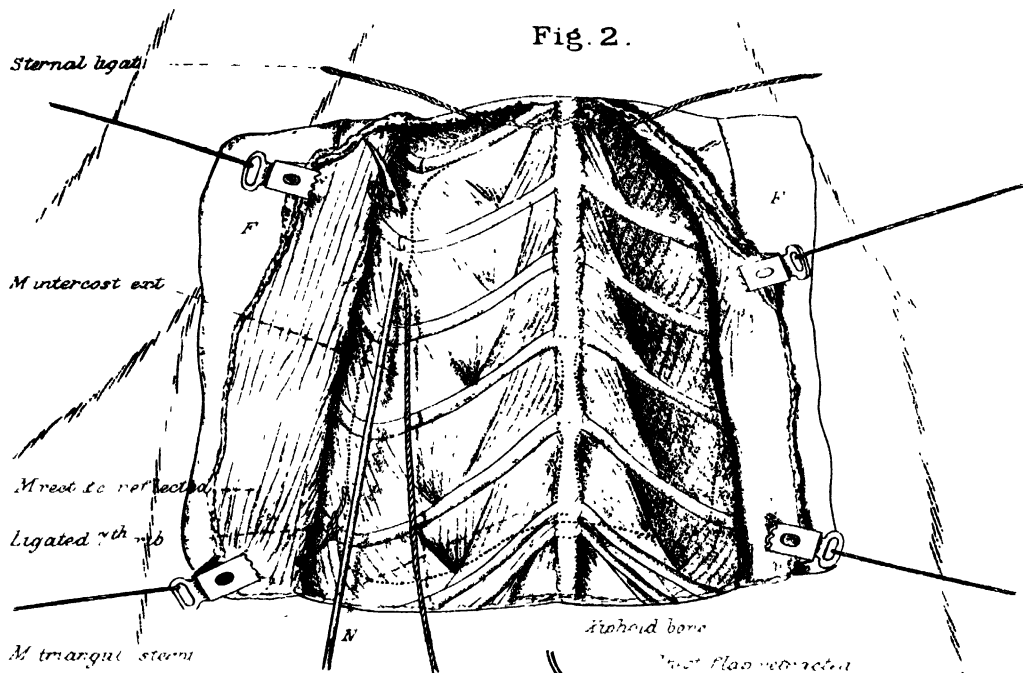
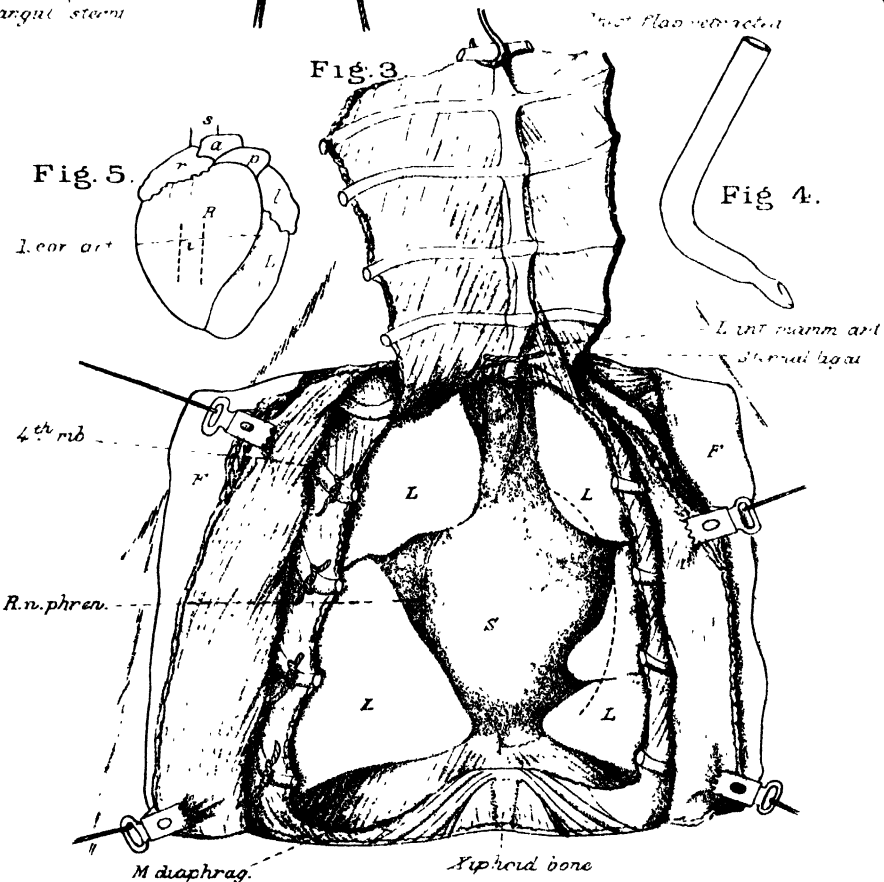

Fig. 3.



p. 213; Yas Kuno, *ibid.* 1917, vol. li, p. 221.

Obs. 13. E. and E. H. Weber, in 1845 (Omodei, *Annali di Medicina*, Naples), discovered the inhibitory action of the vagus on the heart. Having noted that voltaic currents applied to the central nervous system of the frog sometimes slow the heart-beat, they sought for the nerve-trunk by which this effect should be transmitted, and found it in the vagus. The inhibitory action of nerves was at that time unknown, and, even after the Webers' publication of their discovery, that a nerve distributed to muscle should when stimulated not only not excite it but should arrest its activity, appeared at first incredible to many. Volkmann, it seems, had met the phenomenon in the frog two years earlier, but had disregarded it, believing it a fallacy of experimentation. The first mammal to which the Webers extended their discovery was the cat, and the part of this exercise which deals with the vagus repeats virtually the first mammalian observation by the Webers (Wagner's *Handwörterb. d. Physiol.* iii. 2. 32, 1846), except that the exercise uses as stimuli induction currents instead of voltaic, and observes the cardiac effect by inspections of the exposed heart instead of by feeling and counting the pulse.

Obs. 14. Harvey used a simple lens for his work on the development of the embryo, and in his day the compound microscope had not come into use; his death, aetat. 80, occurred eight years before the appearance of Hooke's *Micrographia*, and four years before the discovery of the capillaries. With no means of seeing actually how the blood passes from the

arteries into the veins, Harvey had inferred the existence between them of communicating 'pores'. Descartes, in the *Discours de la Méthode*, 1637, where he refers to Harvey's discovery, writes: 'petits passages aux extrémités des artères par où le sang qu'elles reçoivent du cœur entre dans les petites branches des veines'. Marcello Malpighi, of Bologna, discovered (1661) the communication to be in fact formed by microscopic tubelets, the capillaries. The average length of a capillary is only 2 mm., so that the reality was not much different from Harvey's presupposition. Malpighi first told of his discovery of the blood-capillaries in a letter to Borelli, the physiologist, at Pisa (*De Pulmonibus, Epist.* ii; *Opera*, tom. ii, London, 1686), describing them in the frog's lung, and prefacing his letter with the quotation 'magnum certum opus oculis video'. In 1672, in a letter to the Royal Society, London, he described the streaming of the blood as seen by the microscope from arteries and veins through the capillaries of the chick embryo of the third day (*De ovo incubato; Opera*, tom. i, London, 1686). Loewenhoeck, of Delft, was the first to use for such observations the web of the frog's foot (*Epistolae ad Soc. Regiam Anglican.*, Louvain, 1719, p. 155. Letter 122, Jan. 1700), the observation which you repeat in § ix above.

Later references on capillaries are: Dale and Richards, *Jnl. of Physiol.* 1919, vol. lii, p. 110; Krogh, *The Anatomy and Physiology of Capillaries*, New Haven, 1922; Lewis, *The Blood Vessels of the Human Skin and their Responses*, London, 1927; and Forbes et al. 1928, vols. 19-20, *Arch. Neurol. and Psychiatry*.

EXERCISE V

GRAPHIC OF ARTERIAL PRESSURE, INFLUENCE OF VAGUS, OF ATROPINE, AND OF FARADIZATION OF THE SPINAL CORD. ANTIDROME CONDUCTION IN DORSAL COLUMNS OF SPINAL CORD

I. A decapitated carcass supplied with pulmonary ventilation is provided as for exerc. IV. See, as for exerc. IV, that it is in good order. Set the Ringer-Locke warming and get ready the instruments and apparatus. For the present exercise these are:

(1) A straight glass cannula about 4 mm. external diameter, with neck and oblique-mouthed smooth-lipped opening at the nozzle end, for insertion into artery; this end is of about 2 mm. diameter, distal to neck. The cannula about 3 cm. long. The cannula should have been previously cleaned and boiled in water. It should now lie ready for use in a small vessel of Ringer-Locke fluid, which need not be warm. It is useful to have two such cannulae ready, one having a finer nozzle than the other. It is well to use a cannula with as free a bore at its arterial end as the artery will take.

(2) A glass filler-up, i.e. a piece of straight glass tube about 8–9 mm. wide for 10 cm. of its length and beyond that at one end drawn out into a coarse capillary of about 2 mm. external diameter and at least 6 cm. long. Its other end is armed with a rubber teat. It should lie ready filled with Ringer-Locke fluid in the vessel with the cannula.

(3) The mercurial manometer (P, fig. 5, Pl. II) attached to the kymograph, with clean mercury enough to give a column of 12 cm. height in each limb of the manometer. The upper end of the proximal limb of the manometer is armed with about 4 cm. of strong rubber tubing with a clamp (A) on it. If the mercury column is in order, close this clamp. The side-branch of the proximal limb of the manometer is connected by thick rubber tubing (pressure-tubing) (B) with a glass T-piece. One branch of this latter has attached to it a rubber tube about 1.5 m. long, leading to a pressure-bottle (D) of 2-litre capacity, placed in a wooden lidless box, this latter suspended by a strong cord passing over a pulley attached to the ceiling, the cord descending again to a cleat on the kymograph or animal table. The pressure-bottle contains a litre of either aqueous half-saturated $MgSO_4$ or Na_2SO_4 solution, or of 1 per cent. sod. citrate solution. A strong screw-clamp (E) opening by hinge, and therefore allowing the clamp to be applied without undoing the tube is placed on the tube from pressure-bottle to manometer, as close as practicable to the latter.

The other branch of the glass T-piece is armed with about 50 cm. length

of thick-walled rubber tubing of about 4 mm. bore. This is the junctional (J) tube. On it, about 2 cm. from its free end, is a small screw-clamp (L). See that this tube is cleanly washed out with fluid from the pressure-reservoir, and clamp it.

Make sure that there is no air caught in the column of fluid between the Hg in the proximal limb of the manometer and the junctional tube. If there is, get it out by opening the clamp (A) on the top of the proximal limb of the manometer and allowing fluid from the pressure-bottle to drive it up. This done, close the clamp on the top of the proximal limb of manometer. The pressure-bottle is now to be pulled up to a height which depresses the Hg in the proximal limb of the manometer 8 cm. below that in the distal, this being the usual pressure in the carotid artery of the decapitate preparation. Close the clamp on the rubber tubing from the pressure-bottle. (If this is left open and the pressure from the bottle is higher than the blood-pressure, anti-coagulant fluid will enter and rapidly poison the preparation. If, on the other hand, the clamp is left open when the bottle-pressure is too low, the preparation empties itself of blood into the bottle. All readjustments of the bottle-pressure must be made with the artery occluded.) Squeeze the junctional rubber tubing briskly once or twice between finger and thumb and see that the Hg column oscillates freely and that the float rides on it freely and does not stick or plunge. The distal limb of the manometer must be quite dry and clean. See that the glass-pen carried by the float (F) writes clearly on the kymograph paper. To ensure this the manometer must be brought close to the kymograph and the weighted guide-thread hanging from the kymograph must be duly adjusted to keep the glass-pen against the sooted paper. Inverted as a cap over the top of the distal limb of the manometer is a bit of wider glass tube drawn to a point and then broken there. This serves as the lower guide for the float. See that the height at which the pen writes is such that there is clear room for a fall of 4 cm. and for a rise of 4 cm. This is to be done by adjusting the height of the kymograph paper, not by altering the height of the manometer stand; the latter should be so placed that when the Hg columns of the two limbs are of equal height their tops should be about on the same level as the heart of the preparation on the experiment table. The manometer and its tubing are now ready for use.

(4) See that the kymograph runs at a speed that carries the recording paper about 1 cm. in 3", and in a direction from right to left as you face it. See that the time-signal marking seconds works and that the signal for marking the period of stimulation marks. Both should be so placed as not to hamper the record of the manometer. It is important to know the correction for 'longitude' of the stimulation-marker in relation to that of the

manometer-pen's mark. To record this, set the kymograph running for a cm. or so, then stop it; then squeeze the junctional tube so as to make a vertical mark with the manometer-pen and then close and open the stimulation-marker circuit. The marks made by the two should be as nearly as practicable in the same vertical. To know the 'disparation of the longitudes' is necessary for reading latent periods, &c. Then run the kymograph on for a cm. and stop it.

(5) Have ready three mounted ligatures, i.e. cotton threads about 20 cm. long, threaded through 3 curved mounted needles (see exerc. IV); they should be so threaded that one end hangs about 2 cm. beyond the needle's eye. Wet them and put them within handy reach on the operation table, along with a dish of Ringer-Locke containing the arterial cannula and 'filler-up'.

(6) Have ready a needle-syringe; see that its needle is patent, and that its piston fits well.

II. *Operation for Carotid* (Pl. II, figs. 1, 2, 3, 4). Place the preparation supine. Attach a clip-weight to each foot and set the hind-limbs symmetrically extended and the fore-limbs similarly extended backwards on either side of the chest. See that the animal lies symmetrically: it will tend to lie to one side: obviate this by placing a warm bottle on each side of its chest.

The operation for exposure of the carotid is the same as that performed in exerc. IV for exposing the vagus nerve in the neck. In the present exercise it is preferably done on the left side, reserving the right side for the vagus.

Standing on the preparation's right side, make with the scalpel an incision 4 cm. long and 1 cm. to left of mid-line of neck from level of cricoid backwards. Avoid external jugular vein, which lies subcutaneously and lateral, i.e. to the right of the wound on right side of neck. Dissect down along median side of sterno-mastoid muscle. The carotid artery (c) comes into view accompanied by the internal jugular vein, which usually is much smaller than the external jugular, and by the vagus nerve (*Vag*) (large) and the cervical sympathetic (*Sy*) (small). The carotid artery lies to the median side of the jugular vein. Note the small thyroid branch from carotid; it usually springs from carotid at a level near behind the space between cricoid cartilage and the first cartilage ring of the trachea. Expose the artery for 3 cm. from thyroid branch backward, separate from it by blunt dissection with the mounted needle the nerves and vein without actually touching the vessels or nerves, and free it from its own sheath of connective tissue.

III. *Insertion and securing of the cannula and connexion of it with the manometer.* With the mounted needles pass three threads round the artery,

(1) (Pl. II, figs. 4 and 5) at the origin of thyroid artery; (2) (Pl. II, figs. 4 and 5) about 6 mm. nearer thorax; (3) (Pl. II, figs. 4 and 5) about 1 cm. lower than (2). Tighten (1); make the first noose of a reef-knot with (2), leaving the noose drawn down to about 4 mm. diameter but untied; tie the two ends of (3) together in a knot close to their free tips. If thyroid branch of carotid rises unusually low you may prefer to insert your arterial cannula headward of it: in that case you must ligate the thyroid artery itself a little way up its course, or you will have embarrassing haemorrhage when inserting the cannula.

Bring the free end of the junctional tube, with clamp L shut on it, the clamp being about 2 cm. from its free end, close to the artery and conveniently for picking up with left hand. Have arterial cannula and 'filler-up' in a small shallow dish of Ringer-Locke convenient for right hand. Open clamp E. Clamp with artery-forceps the knot in ligature (3), and so place the forceps that under its weight the thread drags on and occludes the carotid. Straighten and steady the piece of the carotid round which thread (2) lies as a noose by drawing on the free end of thread (1) with a light clip-weight or with the left hand. With the right hand snip with fine sharp scissors (Pl. II, fig. 4) an oblique opening half through the carotid about 4 mm. headward of the noose (2), the obliquity of the opening being towards the heart. Exchange the scissors for the glass cannula filled at its nozzle end with Ringer-Locke, and insert the nozzle into the cut artery towards the heart so that the neck of the nozzle penetrates as far as the place at which the noose lies. Let go of the cannula gently when it is thus engaged in the artery. If thread (1) is being held in the left hand, it will now be necessary to let go. Place tip of a finger of left hand on the free end of the inserted cannula, so as to keep it in place, and with thumb and forefinger of each hand tie the noose tight round the neck of cannula and then complete and tie the reef-knot. Fill the cannula completely with Ringer-Locke by the 'filler-up', seeing that no bubble of air is included in it. Take the end of the junctional tube between the left thumb and forefinger at a point between free end and the closed clamp and compress it closely. Loosen the clamp L partly with right hand. Hold the cannula close below its free end firmly between right thumb and forefinger, and with the left push the mouth of the junctional tube over that of the cannula, relaxing the compression of the tube somewhat in doing so, thus allowing the fluid to overflow from the end of the junctional tube and run into and overflow that of cannula as well. A fluid junction free from all air-bubbles is thus obtained. Close clamp E. Then at once relax the compression of the proximal point of the carotid by thread (3). Open freely the clamp L on junctional tubing. Observe the movement of the Hg in the

manometer and of the manometer float. Arrange the junctional tube in such a way that the artery is not too curved or stretched, and leave it in some position in which the movements of the Hg are full and free. The junctional tube must rest adjusted to suit the artery, and usually requires some support. Swab up the fluid that escaped from the junctional tube into the wound. Protect artery from drying up by replacing skin of wound and by a swab of cotton-wool wet with Ringer-Locke.

OBS. 16. **Graphic of carotid pressure.** IV. Note that the record of the arterial pressure shows oscillations (text-fig. 12) of two kinds; the smaller and quicker are synchronous with the heart-beats and recur at a rate which may be anything between 80 and 120 a minute. The larger and slower are synchronous with the chest movements produced by the respiratory pump. These latter closely resemble the respiratory undulations of the arterial pressure observable in the living animal breathing for itself, but are in an inverse sense, because the conditions of mechanical pressure in the chest are the reverse in the preparation ventilated by the pump of those obtaining in natural breathing.

Not unfrequently rhythmic undulations of much longer period (text-fig. 12) than the respiratory occur on the arterial-pressure record. As the preparation is decapitate these cannot be instances of rhythmic action of the bulbar vasomotor centre; their causation is obscure.

Measure the height of the arterial pressure by measuring the difference in level between the Hg columns in the proximal and distal limbs respectively of the manometer.

OBS. 17. **Stimulation of distal vagus on arterial pressure.** V. Choose the right vagus if the left carotid is used for the blood-pressure, because the left vagus may have been damaged by some flooding of the wound with half-saturated $MgSO_4$ in attaching arterial cannula to junctional tube of manometer. The *right* vagus more readily produces stand-still of the heart.

Expose the vagus (Pl. II, fig. 3) as in exerc. IV, ligate and prepare it for distal stimulation towards the thorax. When the nerve is not in use replace it carefully in the wound and leave it protected from getting dry by closing the skin or by a small swab of wool moistened with Ringer-Locke.

To obtain the effect on the blood-pressure record, close the key in primary circuit of inductorium, the secondary circuit being short-circuited; start the movement of the kymograph and, after it has run about 15", apply the faradic stimulus by opening the short-circuiting key. Do not apply the stimulation for more than 5"-10" unless there is special reason for longer stimulation.

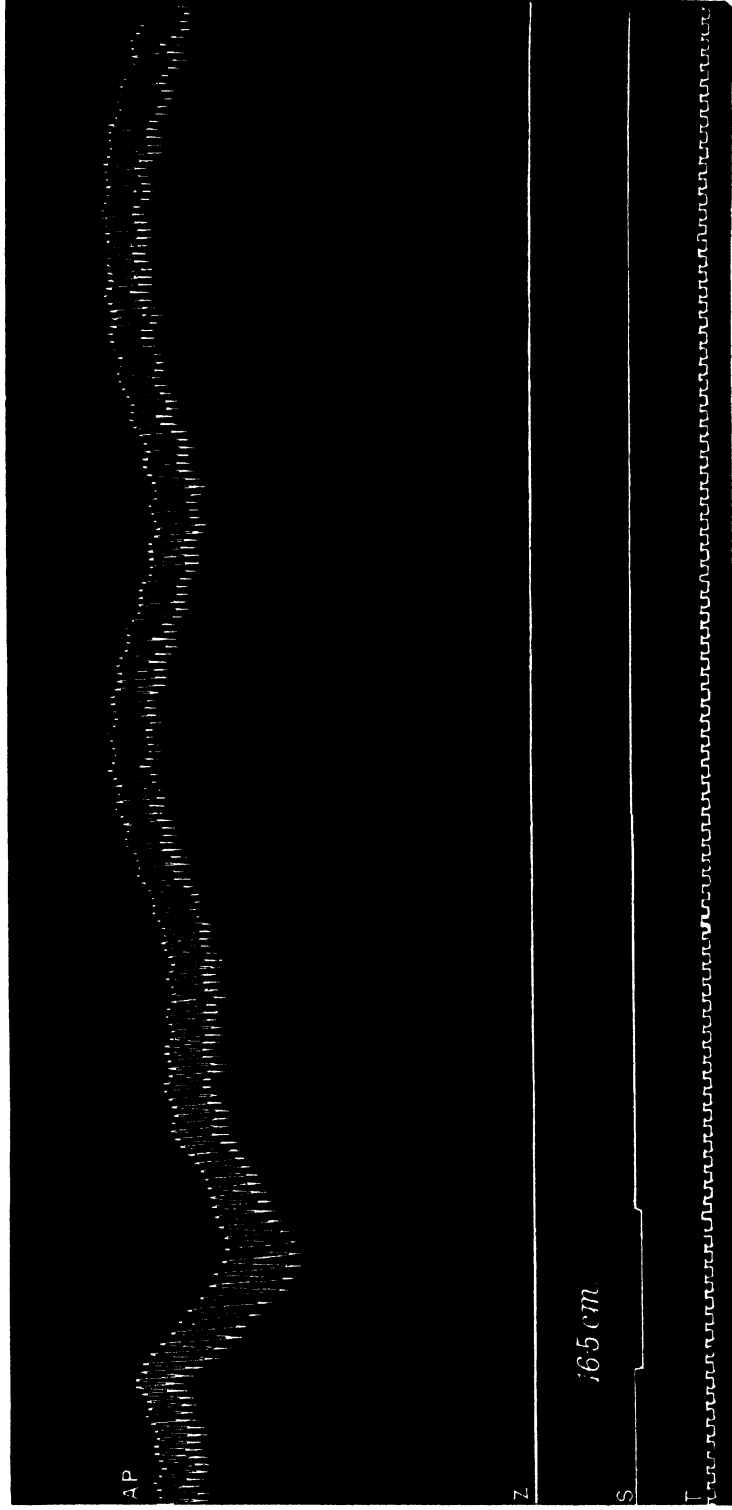

TEXT-FIG. 12. Carotid pressure; weak stimulation of distal trunk of right vagus nerve followed by long oscillations of mean arterial pressure; decapitate preparation (W. C. Davison and K. F. D. Waters). z, zero of arterial pressure; s, signal marking time of vagus stimulation at 16.5 cm. on inductorium scale; τ , time in 2' intervals.

Observe (text-fig. 13) the latency of the effect; the character of the fall; the character of the recovery; and the influence of varying strengths of stimulus. Stop the kymograph's travel during the intervals between observations.

OBS. 18.
Escape of
ventricle from
vagus, and
influence of
adrenal extract
upon.

VI. Faradize vagus with the coil at such a distance on scale as has been found to ensure complete temporary arrest of the pulse. Prolong the stimulation until the ventricle escapes (text-fig. 13 c), i.e. begins to beat; after the slow ventricular beat has established itself for 3-4 secs., cease faradization. Observe that the escape of the ventricles from the vagal inhibition occurs more readily with the left vagus than with the right.

Inject 0.5 c.c. of weak adrenal extract with the needle-syringe per venam, and, after the arterial pressure has fallen to its previous level, repeat faradization; the ventricle will be found to escape earlier than it did before. To inject with the needle-syringe per venam use the following procedure:

VII. *Intravenous injection of drugs* (text-figs. 14, 15). In the decapitate preparation the veins are usually rather fully distended, the arterial tonus being low. This makes injection into them the more easy. If the quantity of fluid to be injected is, as with atropine, adrenalin, pituitrin, &c., not more than 4 c.c., it can be introduced conveniently by a needle-syringe.

To do this, the syringe, without its needle, is filled with saline and the efficiency of the piston tested. With the syringe filled, the fit of the needle to the nozzle is tested and the needle tried to see that it is not blocked. The syringe is next filled with the needle off, and all air expelled carefully by holding the syringe vertical with nozzle upward and driving it out by the piston, then taking up further from the vessel containing the solution enough to completely fill the syringe. The needle is then pushed firmly upon the nozzle and air expelled from the needle, holding the syringe vertical as before. The metal guard on the piston-handle is then screwed to the appropriate place for delivery of the dose decided on. The syringes, if not marked in c.c., are usually marked off in one-twentieth divisions of their capacity; 17 of these make approximately 1 c.c. The loaded syringe is then placed ready to the right hand.

A vein suited for injection is the great saphenous; a good point in it lies 2-3 cm. above the ankle. To use the vein there (text-fig. 14) the limb is kept straightened by the string-weight clip attached to a digit. As a guide a line (text-fig. 14) is taken on the front of the ankle from midway between the malleoli to the mid-point of the median aspect of the knee. The operator stands to the preparation's right-hand side. In this line where it crosses front edge of subcutaneous face of tibia, about 2.5 cm. above the malleoli,

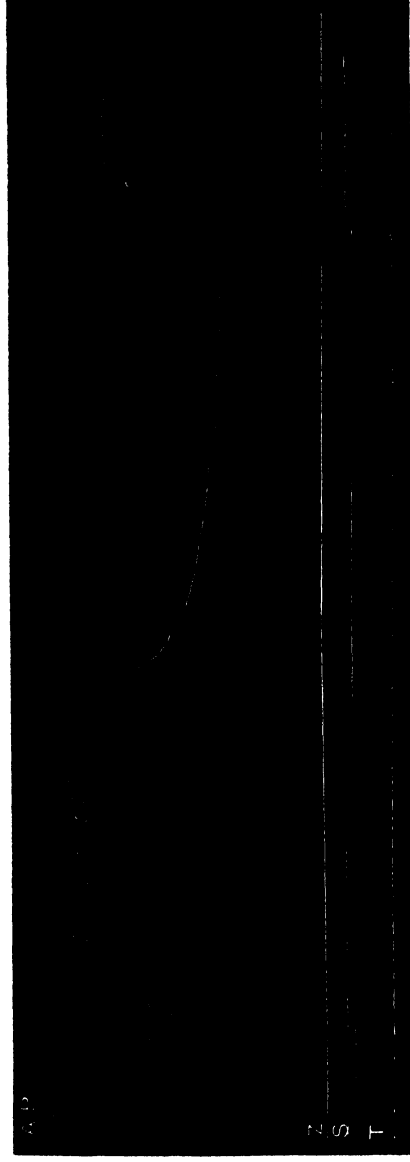

A

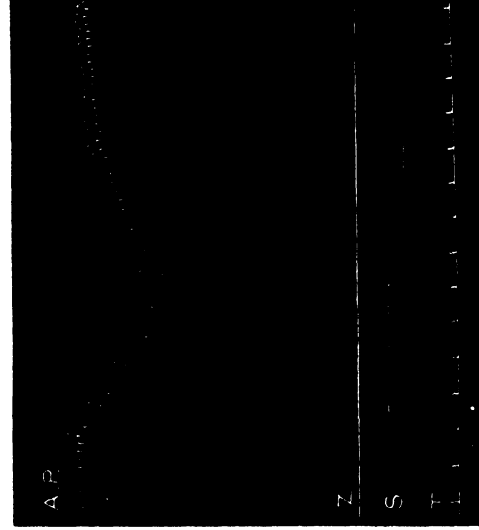

B

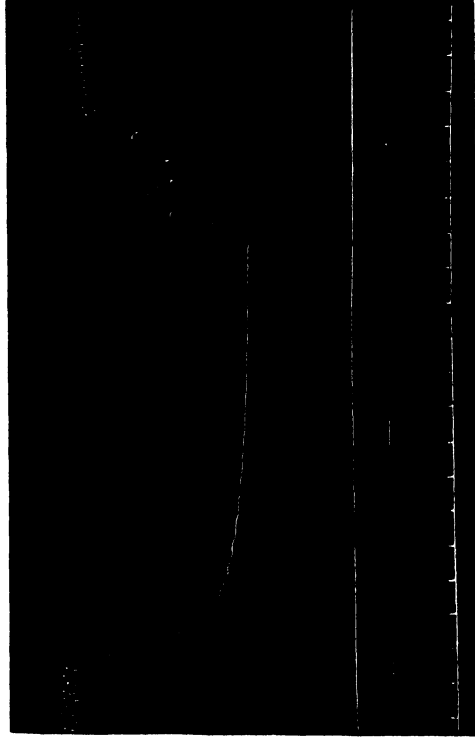

C

TEXT-FIG. 13. Carotid pressure showing effects of weak and strong stimulation of distal trunk of severed right vagus nerve. Decapitate preparation (T. G. Hobson and O. S. Phillips). The lower right tracing shows the escape of the ventricle from vagus inhibition towards the end of a prolonged vagus stimulation, exhibiting the slow 'natural' rhythm of the ventricle during continued suspension of the auricular beat by vagal inhibition. A.P., arterial pressure, Hg manometer; z, zero of arterial pressure; s, signal marking time of faradization of vagus, in top tracing by fall of signal line, in lower tracings by rise of signal lines: stimulus strength, secondary coil at 15 cm. from zero of scale for lower left-hand tracing, for lower right-hand at 10 cm. from zero; τ , time in 2' intervals.

EXERCISE V

a fold of *skin* in the direction of the line is picked up between thumb and forefinger of left hand, and, with large scissors in the right hand, this fold is cut from below upward; the cut is not carried farther than to leave the flap still attached above. On releasing the fold a button-hole wound exposing the vein results. Any layers of connective tissue covering the vein are removed by blunt dissection with the mounted needle or, after being picked up carefully with fine forceps, are cut off with fine scissors till the vein lies clearly bare for 1 cm. The mid-finger of the left hand is then placed on the skin at the top end of the wound, compressing the vein there. The right hand

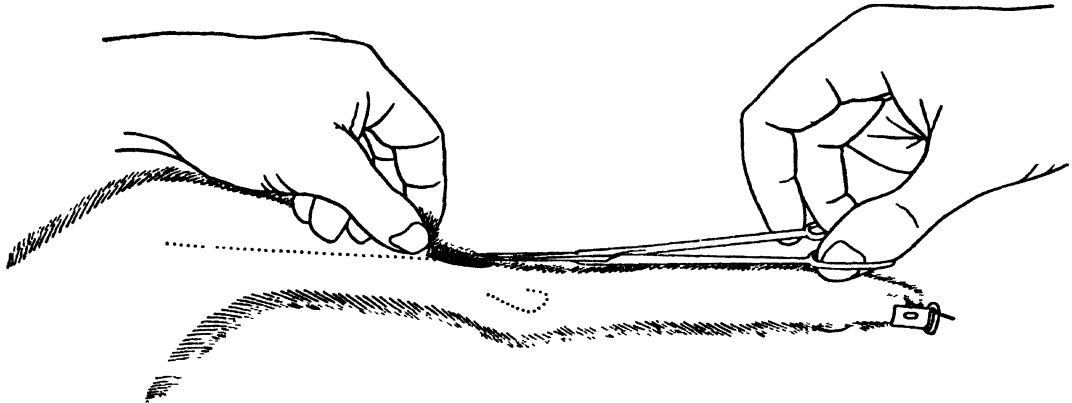

TEXT-FIG. 14. Position of left-hand limb and mode of exposing the great saphenous vein for intravenous injection by the needle-syringe. The position of medial malleolus and the general course of the saphenous indicated by dotted lines.

holding the barrel of the syringe, as a fiddle-bow is held, between thumb and forefinger, leaves the little finger free to press the handle of the piston (text-fig. 15). The needle-point is introduced very obliquely into the distended vein near the lowest end of the wound and threads the vein with the distal cm. of the needle, care being taken not to prick the vein from the inside. A branch of the saphenous nerve often crosses the vein in the wound; this, if touched, excites reflex movement and will disturb the manipulation. It is best, when the nerve is seen, to snip it across with scissors at the top end of the wound and thus prevent the reflex. If the introduction of the needle into the vein fails by pricking the vein across or by missing and simply entering a vein-sheath of connective tissue, it is best at once to withdraw the point and re-enter the vein slightly higher up in the wound; that is why the vein should be employed at the lowest part of the wound at first. The introduction of the needle-point being satisfactory, the finger of the left hand is withdrawn from compressing the vein above, and the syringe is

emptied as far as the piston-guard by pushing the handle with the little finger of the right hand.

If it be desired to inject more than one syringe-full the syringe nozzle is freed from the needle, which is left in the vein; the syringe is refilled and then reinserted into needle-base. When the injection is done the needle is withdrawn and the vein is clamped at the pricked spot with a bull-dog clip if bleeding ensues, which usually is not the case.

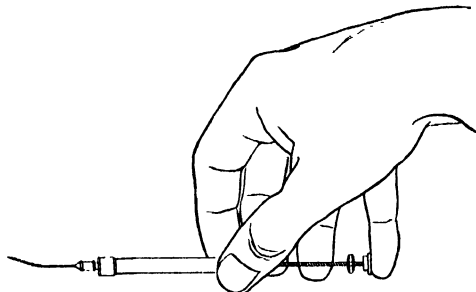

TEXT-FIG. 15. Needle-syringe and mode of holding it for inserting needle-point into vein and for delivering the injection. The stop on the piston is screwed down as far as the mark on the piston-stem limiting the quantity to be injected as desired.

VIII. Inject with the needle-syringe per venam 0.5 c.c. of atropine sulphate sol. (1 per cent. diluted 5 times, i.e. 1 + 4 Ringer-Locke), i.e. 1 mg. atropine sulphate. During, or within 8" of the completion of, the injection let the vagus stimulation be repeated with a strong stimulus. The inhibitory effect will have disappeared.

[*Observations 20 and 21, additional to this Exercise, are described p. 126. Faradization of spinal cord and arterial pressure; antidrome conduction in the spinal cord.*]

Obs. 19.
Paralysis of
cardiac vagus
by atropine.

ANNOTATION

Obs. 16. If it is permissible to regard the preceding exercise (exerc. IV) as following Harvey's *Exercitatio* of 1628, the present exercise may be regarded as following Stephen Hales's *Haemastatics* of 1737. Hales was the first to measure the pressure of the blood, 1737 (*Statical Essays, Haemastatics*, vol. ii, London). He measured it manometrically by ligating a brass tube to the crural artery of a horse, and connecting the metal tube with a vertical glass one. He observed that the blood-column rose to

a height of 8' 3", with oscillations due to the heart-beats and ranging between 3" and 10". Poiseuille improved (1828) the procedure by using a U-tube containing Hg as manometer and by employing a sodium carbonate solution in the junctional tube to retard clotting (*Recherches sur la force du cœur aortique*, Paris). The float riding on the Hg and carrying a pen for writing on travelling recording-paper is due to Ludwig (1847, *Arch. f. Physiol.*).

Mean arterial pressure is well given by

the Hg manometer; but for the details of such rapid changes of the pressure as the pulse the inertia of the Hg columns is too great to give them faithfully. These are recorded better by spring resistances such as are provided by metal membranes of limited yield, slight inertia, and perfect elasticity, applied to the artery directly, or by very short and restricted fluid connexions. Your graphic records in the exercise, therefore, although perfectly reliable for the slower changes of pressure, do not show adequately either the extent or the details of the pulse-curve; you can see this by comparing them with pulse-records taken with the sphygmograph, or with records you will obtain (exerc.

VIII) when using the rubber membrane-recorder.

The mean arterial pressure as you find it in this exercise is considerably lower than that of the normal cat, since the bulbar vasomotor centre has been removed by the decapitation, and the arterial wall throughout the systematic system is therefore relaxed. The distribution of blood owing to this abnormal dilatation of the arterioles departs, therefore, from its normal relative proportioning in arteries, capillaries, and veins respectively; the arteries are under-filled, the veins are somewhat overfilled, which latter circumstance facilitates your intravenous injection with the needle-syringe.

PLATE II

ARTERIAL-PRESSURE OBSERVATION (Exerc. V).

Figs. 1, 2, 3, and 4, dissection for carotid and vago-sympathetic; figs. 1, 2, and 3, on r. side; fig. 4 on l. side.

FIG. 1. 1st stage: κ , position of top of sternum; Sh , top of r. shoulder. Dotted black line from κ to top ring of trachea marks mid-ventral line of neck; broken black line marks position of median edge of sterno-mastoid muscle.

FIG. 2. 2nd stage: *Vag.*, vagus; *Sy.*, cervical sympathetic.

FIG. 3. 3rd stage: vagus ligated, lifted, and electrodes applied; *Lig. vag.*, ligated vagus; *Sy.*, cervical sympathetic *in situ*; \mathbf{E} , hand-electrodes.

FIG. 4. Carotid prepared for insertion of cannula; *Vag. sy.*, vagus and sympathetic; $Sh.$, top of left shoulder; black dotted line marks mid-ventral line of neck.

FIG. 5. Scheme of arrangement of manometer, pressure-bottle, clamps, and junctional tube for connexion with the carotid artery. \mathbf{P} , manometer; \mathbf{F} , float riding on Hg in distal limb of manometer and carrying pen for writing on the kymograph paper; \mathbf{A} , clamp on rubber tubing attached to top of proximal limb of manometer; \mathbf{B} , rubber pressure-tube attached to side-branch of proximal limb of manometer; \mathbf{E} , clamp on rubber tube from pressure-bottle \mathbf{D} ; \mathbf{J} , junctional rubber pressure-tube from manometer to join glass cannula (\mathbf{N}) ligated into carotid artery \mathbf{C} ; \mathbf{L} , clamp on junctional rubber tube near the end which will receive the arterial cannula; \mathbf{N} , glass cannula ligated into carotid; \mathbf{C} , carotid artery with the three threads 1, 2, 3, distal, middle, and proximal respectively; \mathbf{H} , heart.

RUPTURE OF AORTIC VALVE (Exerc. VIII).

FIG. 6. Diagram for experiment of rupture of aortic valve and effect on arterial pressure (exerc. VIII). \mathbf{v} , ventricle; \mathbf{a} , r. auricle (appendix); \mathbf{F} , fat covering root of aorta; \mathbf{A} , aortic arch; \mathbf{s} , sup. vena cava.

PLATE II.

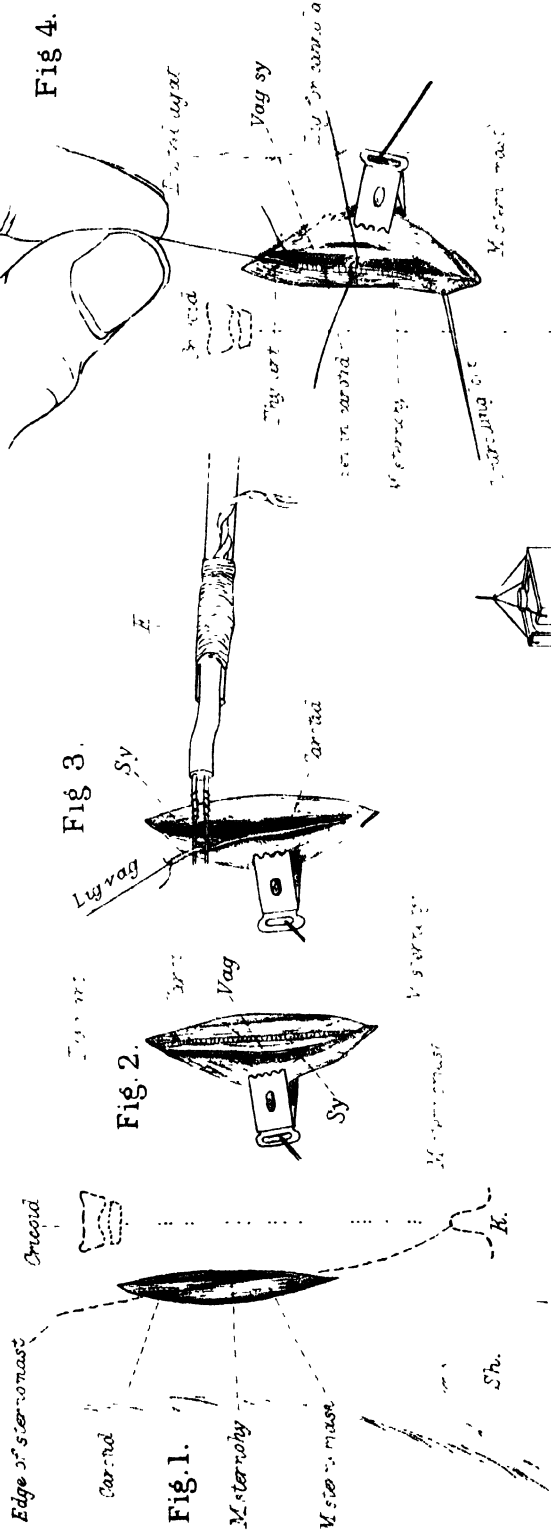

Fig 4.

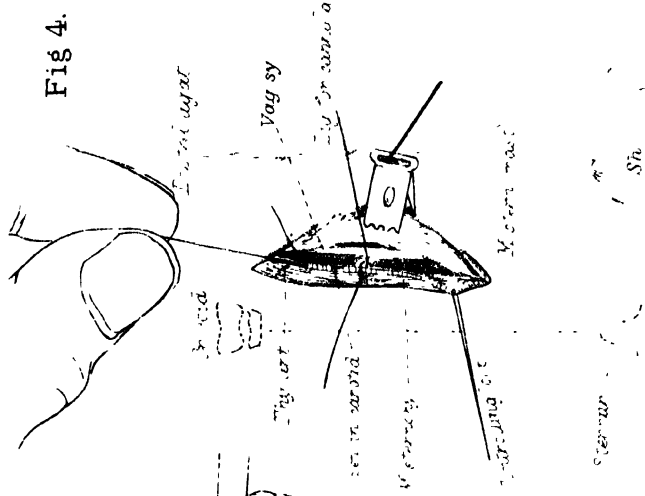

Fig. 5.

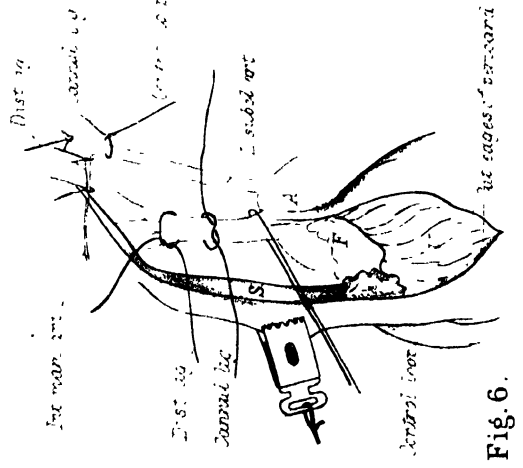
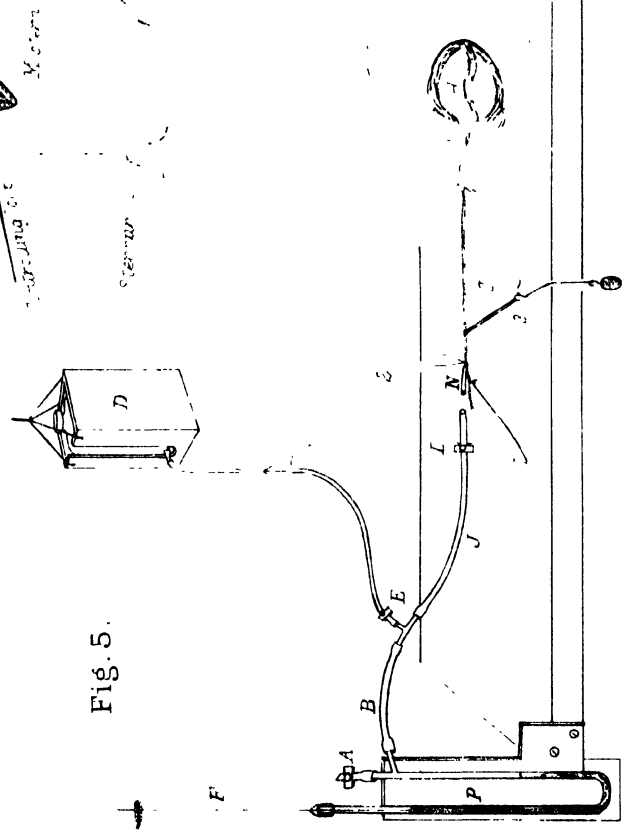

Fig. 6.

EXERCISE VI

ARTERIAL-PRESSURE RECORD; INFLUENCE OF ADRENAL EXTRACT; OF ASPHYXIA; AND OF AMYL NITRITE; MEASUREMENT OF VENOUS PRESSURE; OCCLUSION OF CORONARY VESSELS

I. A decapitated carcass supplied with pulmonary ventilation is provided as for exerc. IV. See as in exerc. IV that it is in good order.

II. Set the Ringer-Locke fluid warming and get ready the instruments and apparatus for a kymographic record, and for intravenous injection by the needle-syringe. Get ready also a manometer for observation of venous pressure. This latter manometer contains half-saturated Na_2SO_4 solution instead of Hg, has no float, its junctional tubing is not pressure-tubing, and it has no reservoir-bottle attached to it; no graphic record is taken by it, so that it need not be brought up to the kymograph, but it should have a paper scale in cm. marked on its mounting for reading the venous pressures by. Have ready glass cannula for insertion into vein. See that you have also at hand (1) adrenal extract, (2) amyl nitrite, (3) a few fine entomological pins.

III. *Operation.* Expose one of the carotids (see exerc. V), preferably left, leaving right side free for external jugular vein later; attach to the artery the Hg manometer, &c., as in last exercise, and obtain an arterial-pressure record by the kymograph as last time.

IV. Give an injection of adrenal extract by the great saphenous vein (see exerc. V). The dose may be $\frac{1}{2}$ c.c. of the 0.1 per cent. solution of adrenalin provided for you. It should be injected while the kymograph is running (text-fig. 17). Note the resulting rise of arterial pressure.

OBS. 22.
Adrenal extract
on arterial
pressure.

V. Set the kymograph running, and after half a minute or so clamp or detach the rubber tube from the respiration-pump to the trachea. Note the resulting disappearance of respiratory undulations from the arterial-pressure record. Observe the colour of the blood in the arterial cannula; its bright arterial tint will continue for many seconds, and the pressure record will show little further change so long as the scarlet colour in the cannula continues. After a variable but always lengthy period, e.g. 100–200 secs., the blood will rather suddenly darken, and then a rise of a. p. will take place. Following this there usually occurs (text-fig. 18) a change in the rate of the heart-beat, the rate falling suddenly to one-half, and then

OBS. 23.
Asphyxia and
arterial pressure.

sometimes again suddenly to one-third or one-quarter. This is due to heart-block, the ventricle responding only to every second or, at a later stage,

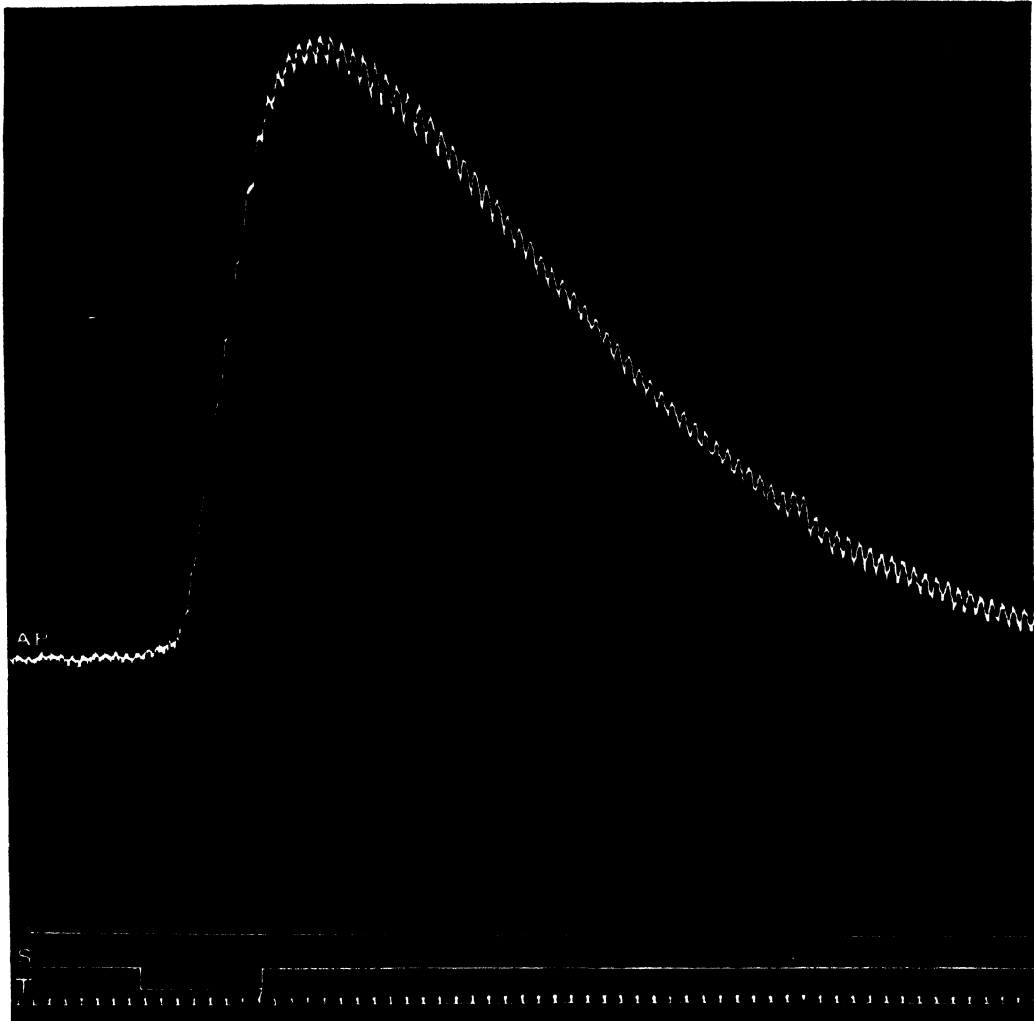

TEXT-FIG. 17. Arterial-pressure record showing effect of intravenous injection of adrenal extract; decapitate preparation (D. Collier and W. Peacey). A.P., carotid pressure; z, zero-line of Hg manometer; s, signal-line showing time of injection of adrenal extract; t, time in 2" intervals.

every third beat of auricle. When this heart-block has occurred and lasted for a few seconds it is time to relieve the asphyxial condition, otherwise the preparation will be convulsed or its circulation permanently damaged for the further steps of the exercise. Clotting in the cannula also may occur

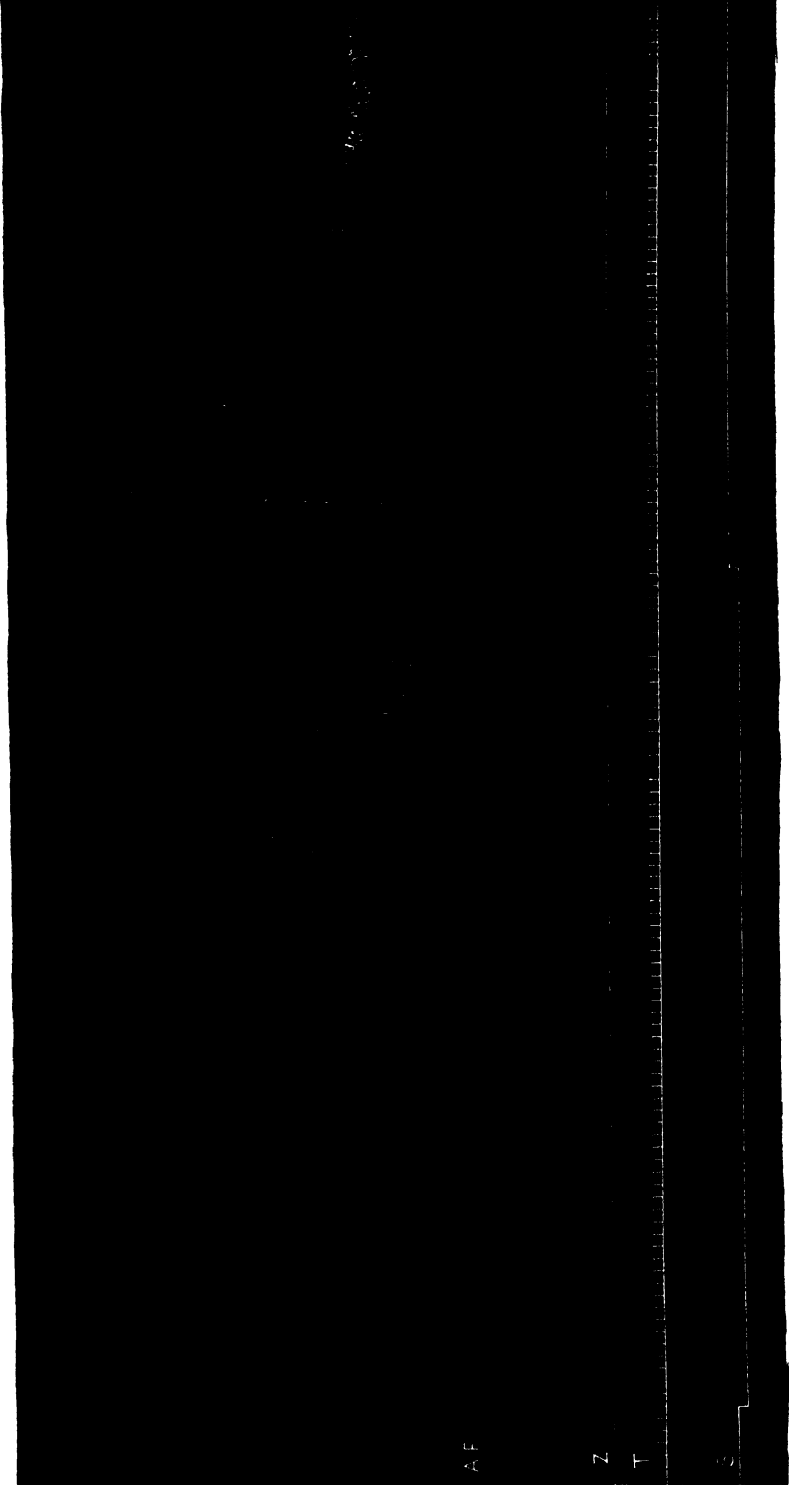

A.F.

Z

T

S

TEXT-FIG. 18. Effect of asphyxia on arterial pressure in the decapitate preparation (J. G. Johnstone and C. F. Krige). A.P., carotid pressure by Hg manometer; z, zero-line of arterial manometer; T, time in 2nd intervals; s, signal marking the time during which the ventilation-pump was disconnected from the tracheal cannula; it will be seen that it was reconnected very soon after the 2nd and profounder stage of heart-block (1 ventricular beat to 3 of auricle) had set in.

owing to imperfect oxygenation. Unclamp or reattach, therefore, the respiratory tube. Almost immediately this is done the colour of the blood in the arterial cannula will brighten, the heart-block will cease, and a great rise of a. p. will be shown by the record. This rise is, however, temporary.

Obs. 24.
Amyl nitrite and
arterial pressure.

VI. Mix one drop of amyl nitrite with 2 c.c. Ringer-Locke in a watch-glass. Fill the needle-syringe with the mixture and inject 1 c.c. of it into

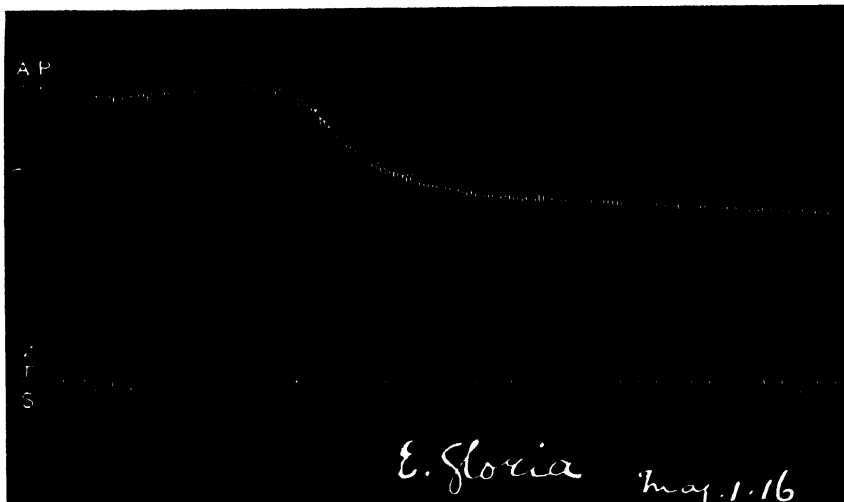

TEXT-FIG. 19. Effect of amyl nitrate on arterial pressure (E. Gloria). A.P., carotid-pressure record by Hg manometer; Z, zero-line of manometer; T, time in 2" periods; S, signal-line showing time of injection of amyl nitrite into saphenous vein.

the saphenous vein. The kymograph should be running at the time the injection is made (text-fig. 19).

Obs. 25.
Measurement of
venous pressure.

VII. Have ready a glass cannula similar to that used for artery but with rather larger nozzle. Place it on the experiment table in Ringer-Locke, along with a filler-up pipette. Have ready also three fine cottons in mounted needles. Place the venous manometer on the operation table.

Expose the external jugular vein low down in the neck, preferably on side opposite to that used for the carotid.

The fur obscures the contour of the skin, but with the preparation supine and the forelimb retracted feel at the root of the neck just in front of the head of the shoulder. A triangular space can be made out, apex anteriorly. This is the space between the cleidal and sternal portions of sterno-cleido-mastoid muscle; they converge as they pass forward. The cleidal portion combined with the cephalo-humeral muscle is lateral, the sternal is to the

median side. Make an antero-posterior incision through the skin from the middle of this space and carry it about 4 cm. forward.

Retract the edges of the skin wound. Observe the vein and the branches entering it. In a length between two branches pass three ligatures as for an artery. Occlude the vein at its heart end by drawing on the proximal ligature-controlling loop and attaching a small weight to the loop thread-ends. This prevents the vein from emptying and makes the opening of the vein easier. Then tie the distal ligature. With fine-pointed scissors cut obliquely half through the vein 3 mm. distal to the middle ligature. Slip the cannula nozzle into the opening in the vein and insert so that neck of nozzle comes under the ligature; tie the cannula securely in. Fill the cannula with Ringer-Locke from the filler-up. Attach the junctional rubber from manometer to the cannula in the same way as is done in the arterial pressure procedure, your colleague helping you to avoid inclusion of any air by running Ringer-Locke from the filler-up pipette over the junction as it is made. Release the occluding loop as soon as this is done. Observe the pressure and its oscillations; note the relation of the latter to the puffs of the ventilating-pump. Compare them with those in the arterial-pressure Hg manometer.

VIII. Get ready inductorium and circuits and hand-electrodes for faradic stimulation. Have at hand two or three fine entomological pins. Expose one of the vagi in the neck; ligate and isolate it for electrical stimulation as in exerc. IV, and as in that exercise expose the heart by removing part of the front of the chest.

Obs. 26.
Occlusion of
the coronary
arteries on
heart-beat.

Note the position of the left and right coronary arteries (Pl. I, fig. 5). Faradize the distal stump of the vagus, and while the heart is restrained from beating rapidly pass one of the fine pins under the left coronary vessels, through the cardiac tissue, and as high up the course of the vessels as possible. Directly the pin is inserted cease the stimulation. Repeat the manœuvre with the right coronary vessels.

The heart continues to beat as before. Twist a thread tightly round the projecting ends of the left coronary pin so as to occlude the coronary vessels. Note the result. Repeat with the right coronary vessels.

ANNOTATION

Obs. 22. For adrenal extract see Annotation, exerc. I. Its action on the blood-pressure is 'peripheral' not 'central'; it constricts; that it does not produce the vasoconstriction by acting on the vasomotor centre in the bulb is proved by

your experiment on the decapitate preparation.

Obs. 23. For the effect of asphyxia on the arterial pressure in the decapitate preparation see Sherrington, *Jnl. of Physiol.* xxxviii, 375, 1909. The onset of the

EXERCISE VI

asphyxial rise of pressure is much slower in the decapitate preparation than where the bulbar vasomotor centre remains; in the latter case the rise begins in about 5"-20" as against 80"-160" or more in the former. The sudden change in pulse-rate due to heart-block (Sherrington, *l.c.*; Roaf

and Sherrington, *Q. Jnl. Exp. Phys.* iii. 209) was analysed by T. Lewis and G. C. Mathison (*Heart*, vol. ii, p. 47; 1910).

The main factor in the production of this asphyxial a.p. curve is lack of oxygen; precisely similar curves are produced by ventilating the lungs with nitrogen.

EXERCISE VII

ARTERIAL PRESSURE, SPLANCHNIC NERVE AND ADRENAL GLAND;
PITUITARY EXTRACT; VASOCONSTRICTION IN KIDNEY AND GUT;
CHROMAFFIN REACTION; CHYLE; PULMONARY
CIRCULATION-TIME

I. A decapitate preparation is provided. See that it is being properly ventilated and is in good condition.

II. Get ready apparatus: recording arterial manometer, induction circuits and hand-electrodes, for stimulating splanchnic nerve, and needle-syringe. Have at hand (α) pituitary extract, (β) potassium bichromate, 2 per cent. solution, (γ) methylene-blue 0.2 per cent. dissolved in normal saline.

III. Prepare the right carotid for kymographic observations as in previous exercises, but leave the control thread and cannula thread loose, to be used later when the cannula is inserted and connexion made with the manometer. Close the wound with a clip.

Exposure and Stimulation of the Splanchnic Nerve (Pl. III, and text-figs. 20, 21, 22).

IV. *Operation.* Lay the preparation on its left side, with the hind-limbs flexed to relax the abdominal wall. Clip the hair off the right loin and identify the bony landmarks of this region on the mounted skeleton. Palpate gently to detect the kidney of the right side in the preparation. The upper pole of the kidney is a guide to the position of the adrenal body and of the splanchnic nerve which runs towards it.

Extend the right hind-limb with a weighted clip attached to one of the digits. Make a straight incision (Pl. III, fig. 1), about 7 cm. long, parallel with and about 5 cm. to the right of the dorsal mid-line. This incision should pass over about the middle of the last rib. The headward end of the incision should lie as far forward as the eleventh rib; thirteen is the normal number of ribs in the cat. The posterior end of the incision will lie about half-way between the crest of the ilium and the last rib. Across each

end of the longitudinal incision make a transverse one extending about 2 cm. to either side of it. Reflect the skin and clip back the skin-flaps.

Note the lumbo-dorsal aponeurosis (Pl. III, fig. 1) covering the back muscles; from it slopes headward and ventrally the latissimus dorsi and posteriorly and ventrally the obliquus externus of the abdomen. The latter muscle is partly overlapped by latissimus dorsi. Through the external oblique emerge in parallel series 3 nerves with accompanying blood-vessels. The most anterior of these is a branch of the last thoracic nerve.

Along the line followed by the longitudinal skin incision cut through latissimus dorsi and the spinal aponeurosis, and reflect these to either side (Pl. III, fig. 2). The longissimus dorsi is thus exposed.

With the handle of the scalpel follow out the interval between the external oblique and longissimus dorsi; the main trunks of the nerves and vessels whose branches were previously seen will thus be followed; the most anterior of these nerves is the last (13th) thoracic (13, Pl. III, fig. 2); in the line of incision it lies a full centimetre behind the last rib. Follow it up in the direction of the vertebral column and sever it as far proximal as may be. Deep to this nerve a thin sheet of muscle is seen, its fibres slanting headward and ventral (upward and to the right). Cut it free from its attachment to the last rib and reflect it towards the spine.

Posterior to this muscle the aponeurosis of the muscles of the abdominal wall is thin for a short area, but becomes thicker farther back. The splanchnic nerve lies deeply under this aponeurosis. Feel along the lateral edge of longissimus dorsi for the edges of the transverse processes (Pl. III, fig. 3) of the 1st, 2nd, 3rd, and 4th (Pl. III, fig. 1) lumbar vertebrae. The ends of these processes form an interrupted ridge (in the position shown in Pl. III, fig. 1). The aponeurosis of origin of the muscles of the abdominal wall takes its dorsal attachment from this ridge.

Retract the longissimus dorsi as far dorsally as practicable, and detach the abdominal aponeurosis from the ridge from 1st transverse process in front to 4th behind. Reflect the abdominal aponeurosis ventrally (to animal's left). A large lengthwise-running muscle overhung by the bony transverse processes is now seen; this is the psoas. Through the thin transparent membrane of the peritoneum ventral to psoas certain of the contents of the abdomen are now visible (Pl. III, fig. 3).

Note the somewhat pale kidney with some veins radiating over it; posterior and dorsal to this some fatty tissue. Forward, emerging from below the last rib, is the posterior edge of the dark-tinted liver, moving freely forward and backward with the respiratory movements.

Push carefully with the scalpel handle the peritoneum and anterior end

of kidney laterally away from the psoas and explore the ventral face of that muscle. Make out deep in the anterior end of the wound a strong muscular slip running backwards and dorsally, the right pillar of the diaphragm (Pl. III, fig. 4). On this and between it and psoas the splanchnic nerve (s) is seen as a smallish nerve-trunk running backwards and somewhat ventrally, sloping as though to reach the anterior end of the kidney, but plunging into fatty tissue closely posterior to the free edge of the diaphragm pillar. Expose the nerve without actually touching it; in exposing it avoid rupturing any of the blood-vessels, large or small, because a very little blood will much obscure the parts.

As the nerve is followed headwards there will be seen a smaller nerve which lies close to it in its headward portion but diverges from it as it passes backward. This is the main sympathetic trunk; if doubt is felt as to its recognition, following it posteriorly soon discovers a ganglion which is one of the vertebral of the sympathetic chain.

Return to the kidney; carefully and gently explore its headward end with the finger and note the opaque buff-coloured adrenal body surmounting it and about the size of a coffee-bean. Retracting with the scalpel-handle away from the adrenal body, note the wide short vein passing from the body to the inferior vena cava. Pushing carefully across the ventral face of the vena cava at a level about 12 mm. posterior, expose the similar vein of the left adrenal body.

OBS. 27.
Distal end of
n. splanchnicus
on arterial
pressure.

V. While your co-worker holds aside with flat retractors the viscera without damage to them, pass, by means of a bent needle in handle, a thread round the right splanchnic as far proximal in its course as possible (Pl. III, fig. 5). Tie this and cut the nerve proximal to the ligature; free the peripheral stump of the cut nerve and see that you have at least 2 cm. of it free for being lifted by the ligature when later the electrodes are applied. Leave the thread and nerve easily accessible for stimulation. Bring the edges of the wound together and fasten them by a clip, to protect the underlying tissues from drying.

Return to the carotid artery. Bring the right forelimb into a posture of extension, leaving it retracted alongside the chest by means of a hook-weight attached to the paw. See that the arterial tube from the manometer easily reaches the exposed artery. The pressure provided in the manometer should be about 70 mm. Hg. Choose a cannula and insert it into the artery, making the connexions with manometer as in previous exercises.

VI. Open the loin wound carefully. When the kymograph record has been running satisfactorily for half a minute or so, place the secondary coil at

13 cm., close the primary circuit, and start the magnetic interruptor. Holding up the splanchnic nerve by the ligature, apply to it the needle electrodes, setting them cross-wise on the nerve and seeing that they are not in contact with any other part or tissue. Then un-short-circuit the electrodes (shunt key in secondary circuit) and stimulate.

An increase of blood-pressure ensues almost immediately. To obtain full effect a stimulation period of about 5" may be required. The rise occurs

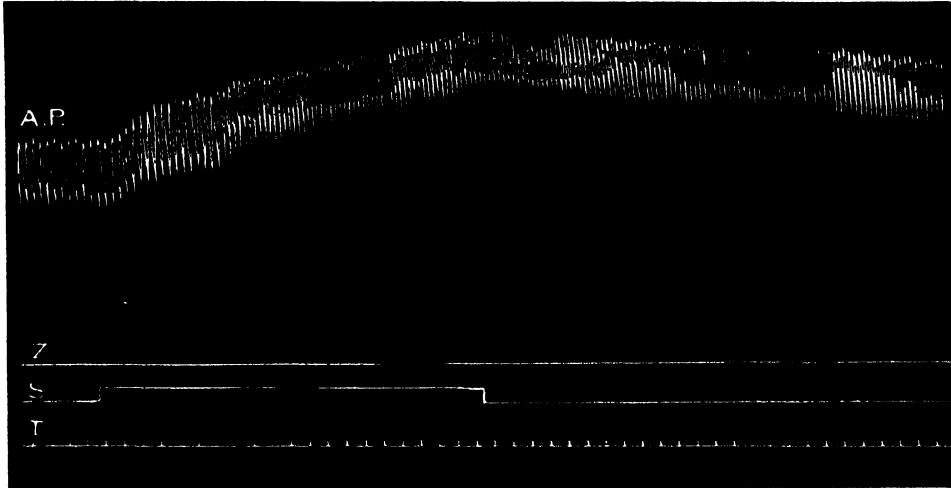

TEXT-FIG. 21. Arterial pressure and distal end of splanchnic nerve; decapitate preparation (W. S. Penfield and E. Woods). A.P., carotid-pressure record by Hg manometer; z, zero-line of arterial pressure; s, signal-line showing time of faradization of distal trunk of severed splanchnic nerve; t, time in 2" intervals. Note acceleration of heart coincident with the second rise of arterial pressure.

in two steps; the earlier of these is due to direct action of the vasoconstrictor nerve-fibres on the muscular coat of the arteries and arterioles; the slight fall which almost invariably breaks the ascent of the curve is to be regarded as caused by discharge from the adrenal medulla of a small amount of adrenalin whose action contributes also to the subsequent reascent and heart acceleration. Secretory fibres to the adrenal medulla are contained in the splanchnic nerve. A very small dose of adrenalin causes in the cat a slight transient fall of arterial pressure, though a larger dose produces a rise (Cannon and Nice, *Amer. Jnl. of Physiol.* 1913, vol. xxxii, p. 44). Note the quickening of heart-rate in the second rise.

VII. Pass a ligature round r. adrenal vessels: the gland is almost sessile on the inferior vena cava. Leave the ligature loose but ready to tie.

Stimulate the splanchnic nerve again, recording the effect with the

OBS. 28.
The adrenal gland and the splanchnic reaction.

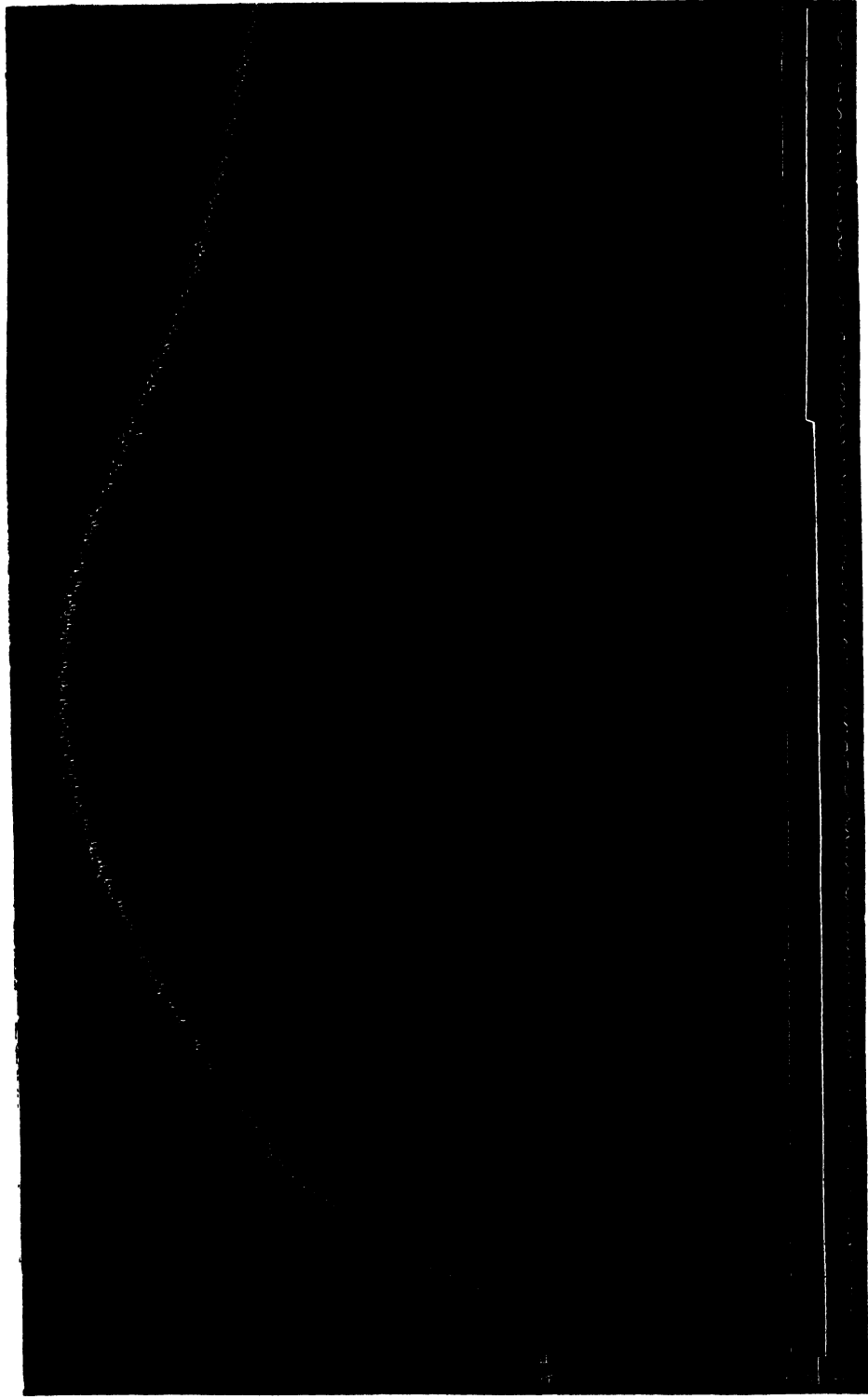

TEXT-FIG. 22. Effect of stimulation of distal piece of severed splanchnic nerve upon carotid pressure; decapitate preparation; ♂ full grown (F. A. D. Petersen and W. J. Skafte). A.P., carotid pressure, Hg manometer; z, zero-level of blood-pressure; s, signal marking time of faradization of splanchnic nerve; T, time in 2" intervals. Note cardiac acceleration ensuing suddenly at a point on the line of ascent.

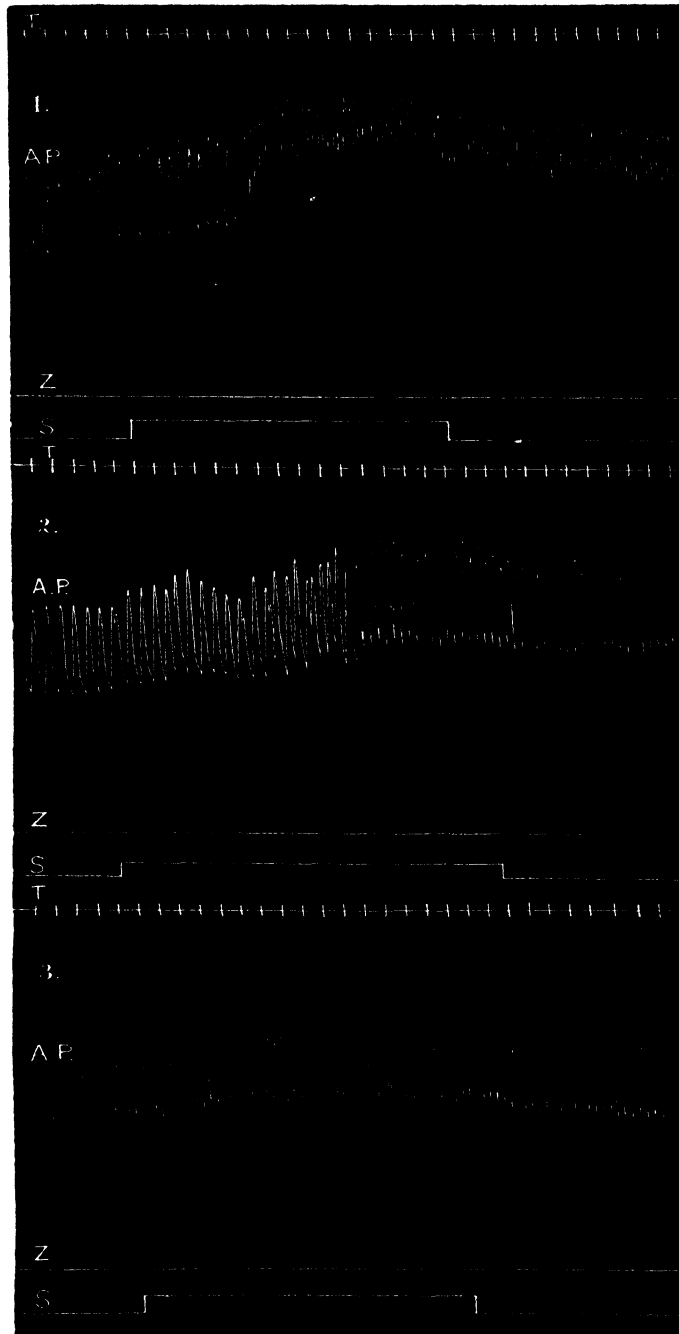

TEXT-FIG. 23. Arterial-pressure record and effect of stimulation of distal trunk of severed right splanchnic nerve; decapitate preparation (E. Britten Jones and T. L. Ormerod). A.P., carotid pressure recorded by Hg manometer; z, zero-level of manometer; T, time in 2" intervals; s, signal showing period of stimulation of splanchnic nerve. 1, after looping but not tying the vessels of right adrenal gland; 2, after ligation of vessels of right adrenal gland; 3, after removal of right adrenal gland.

kymograph. Then draw tight the noose round the right adrenal vein. Repeat the stimulation, recording the result. The rise in arterial pressure is now usually a simple one without the two successive steps it showed previously. Remove right adrenal altogether; repeat stimulation as before.

[For additional observations 29, 30, Central end of *n. splanchnicus* on *a. p.* and *asphyxia* on *a. p.* after section of both *n. splanchnici*, see p. 128.]

OBS. 31.
Pituitary
extract and
arterial pressure.

VIII. Place 2 c.c. of Ringer-Locke in a watch-glass; open the glass capsule containing pituitary extract by notching the stem with a file and then breaking it across at the notch. Add the contents to the Ringer-Locke, and take up 1 c.c. in the needle-syringe. Inject the syringeful per venam (saphenous vein) while the kymograph record is running, and while your co-worker marks with the signal the time and duration of the injection. Observe the result (text-fig. 24). Refill the syringe from the watch-glass. When the rise of pressure due to the injection has fully subsided, repeat the injection. Observe the result; it will probably be a fall of arterial pressure; if a rise, the rise will be very much smaller than on the first injection, thus differing from the adrenal extract reaction.

The kymographic part of the exercise finishes with this observation.

OBS. 32.
Splanchnic n.
vasoconstriction
in kidney and
gut.

IX. Lay bare the right kidney and note closely the colour of it and the size of its venules. Stimulate the splanchnic nerve—no kymographic record is necessary—and note the pallor which ensues in the kidney and any change in size of venules.

Repeat the observation on a loop of small intestine.

OBS. 33 A.
Inspection of
chyle and
lacteals.

X. Note the milk-white lymphatic vessels in the mesentery; they might be mistaken for nerves. Prick one, and examine the escaped chyle under the microscope. The animal was fed with milk a few hours before being killed. (The minute semi-translucent oval seed-like bodies in the mesentery near the vessels are Pacini end-organs.)

[For additional observation 33 B, *Lymphatic drainage of peritoneal cavity through the diaphragm*, see p. 128.]

OBS. 34.
Chromaffin
reaction of
adrenal
medulla.

XI. Remove the left adrenal gland and place it in 2 per cent. potassium bichromate solution. In an hour's time examine it by cutting it across and inspecting the cross-section. Note the difference in colour between the cortex and medulla.

OBS. 35.
Time of the
lesser
circulation.

XII. Place a cannula in the right external jugular vein, its nozzle directed towards the heart. Fill the glass syringe provided for you with Ringer-Locke strongly coloured with methylene-blue. Expose the right renal

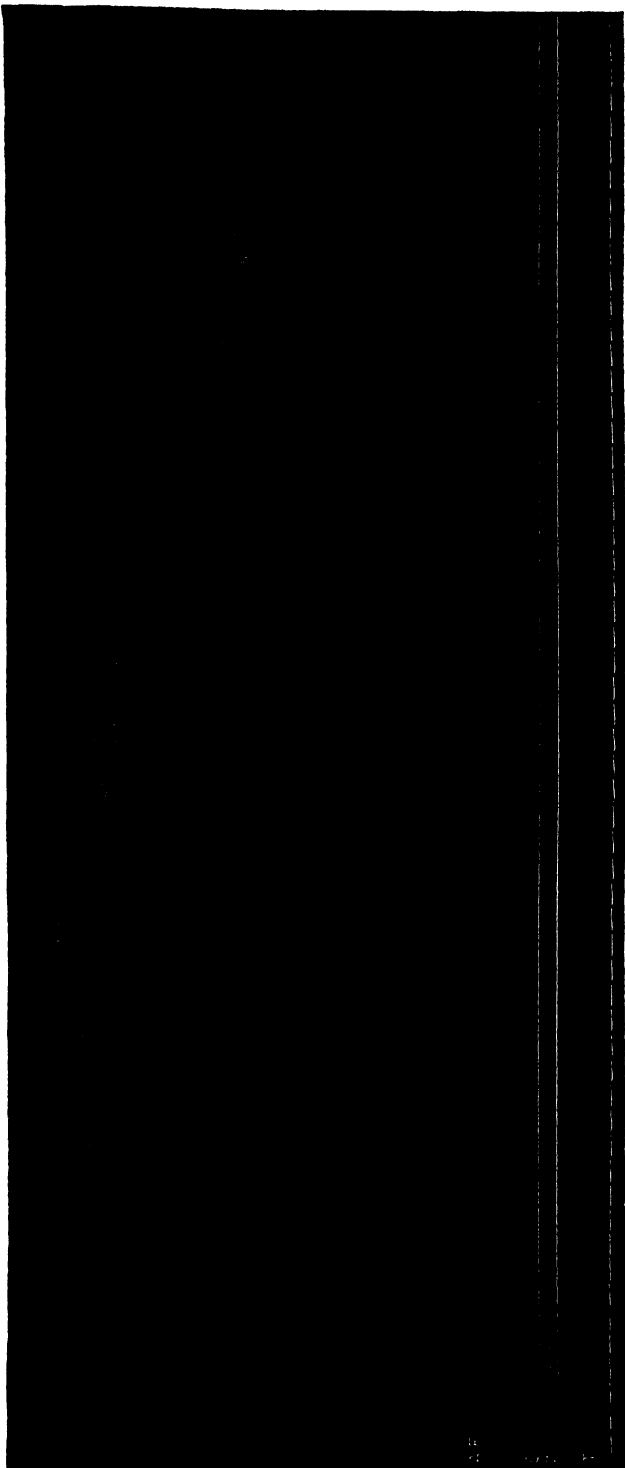

TEXT-FIG. 24. Pituitary extract and arterial pressure; decapitate preparation (E. F. Hollman and W. S. Penfield). A.P., carotid pressure by Hg manometer; s, signal-line showing time of intravenous injection of pituitary extract; z, abscissa axis of arterial pressure; T, time in 4" intervals.

artery freely and slip a piece of white card under it. Attach the syringe by rubber tubing to the jugular cannula, avoiding air in the connexion. Have stop-watch ready. Inject the methylene-blue solution into the vein and note with the watch the time elapsing between the injection and the appearance of blue in the renal artery. This affords a rough estimate of the time taken in the transit of blood through the pulmonary circulation.

ANNOTATION

Obs. 27, 28. Of all individual efferent nerves the splanchnic exerts the most powerful vasoconstrictor effect as measured by its influence on the general arterial pressure. It is perhaps the most important vasomotor nerve in the body. This is because it contains vasoconstrictor nerve-fibres for so large a vascular area, namely, that of the abdominal viscera. It thus dominates directly and indirectly the distribution of the blood for the time being throughout the vascular system. Its vasoconstrictive influence can therefore be studied not only by direct inspection of the blanching of the intestine, kidney, &c., but also, as in the first part of this exercise, by observing the rise of general arterial pressure which its stimulation produces. De Cyon and Ludwig discovered (1866) the vasoconstrictor effect of stimulating the peripheral stump of this nerve (*Ber. d. Sachs. Gesellsch. d. Wissensch., math.-phys. Cl.* p. 315). The cardiac acceleration they did not notice.

Johansson noted, 1891 (*Arch. f. Physiol.* p. 103), that the rise of a. p. produced by splanchnic-nerve stimulation occurs in two steps. In the cat a distinct slight fall commonly separates the steps, and T. R. Elliott, investigating this, found, Jan. 1912, that the fall and second rise are caused by secretion into the blood of adrenalin, thus confirming the statement by R. P. Dreyer, 1899, based on other grounds (*Amer. Jnl. of Physiol.* vol. ii, p. 203), that the splanchnic nerve contains secretory fibres for the adrenal medulla,

which, as a ductless gland, sheds its secretion directly into the blood. Elliott's paper, *Jnl. of Physiol.* vol. xlv, p. 396, should be read. The second rise of a. p. exhibits concomitant acceleration of the heart. Anrep proved, Dec. 1912 (*Jnl. of Physiol.* vol. xlviii, p. 307), that this acceleration is due to the adrenal secretion provoked by the splanchnic stimulation, and that it persists after extirpation of the accelerator nerves, i.e. by action of the adrenalin (cf. your previous exerc. III, §III) on the accelerator receptive substance (Langley) in the heart. Cf. also Parsons and Swale Vincent, *Trans. Roy. Soc. Canada*, xi. 129. The relative degree of acceleration of heart is great in proportion as the beat-rate is slow prior to the splanchnic stimulation, e.g. in your experiment.

For functional differences between r. and l. splanchnic nerves, consult J. H. Thompson, *Jnl. of Physiol.* lxxv. p. 441, 1928.

Obs. 31. The remarkable heightening of arterial pressure produced by intravenous injection of extract of the pituitary body was discovered by Oliver and Schäfer in 1895 (*Jnl. of Physiol.* vol. xviii, p. 276). Howell, in 1898, pointed out that the effect is confined to extracts of the posterior lobe (*Jnl. of Experim. Med.* vol. iii, p. 215). For the effects of the extract see the original papers and Sir E. Sharpey Schafer's *The Endocrine Organs*, Part 2, London, 1926. Your own experiment shows that the effect on the blood-pressure

PLATE III Stimulation of Splanchnic nerve (Ex.VII).

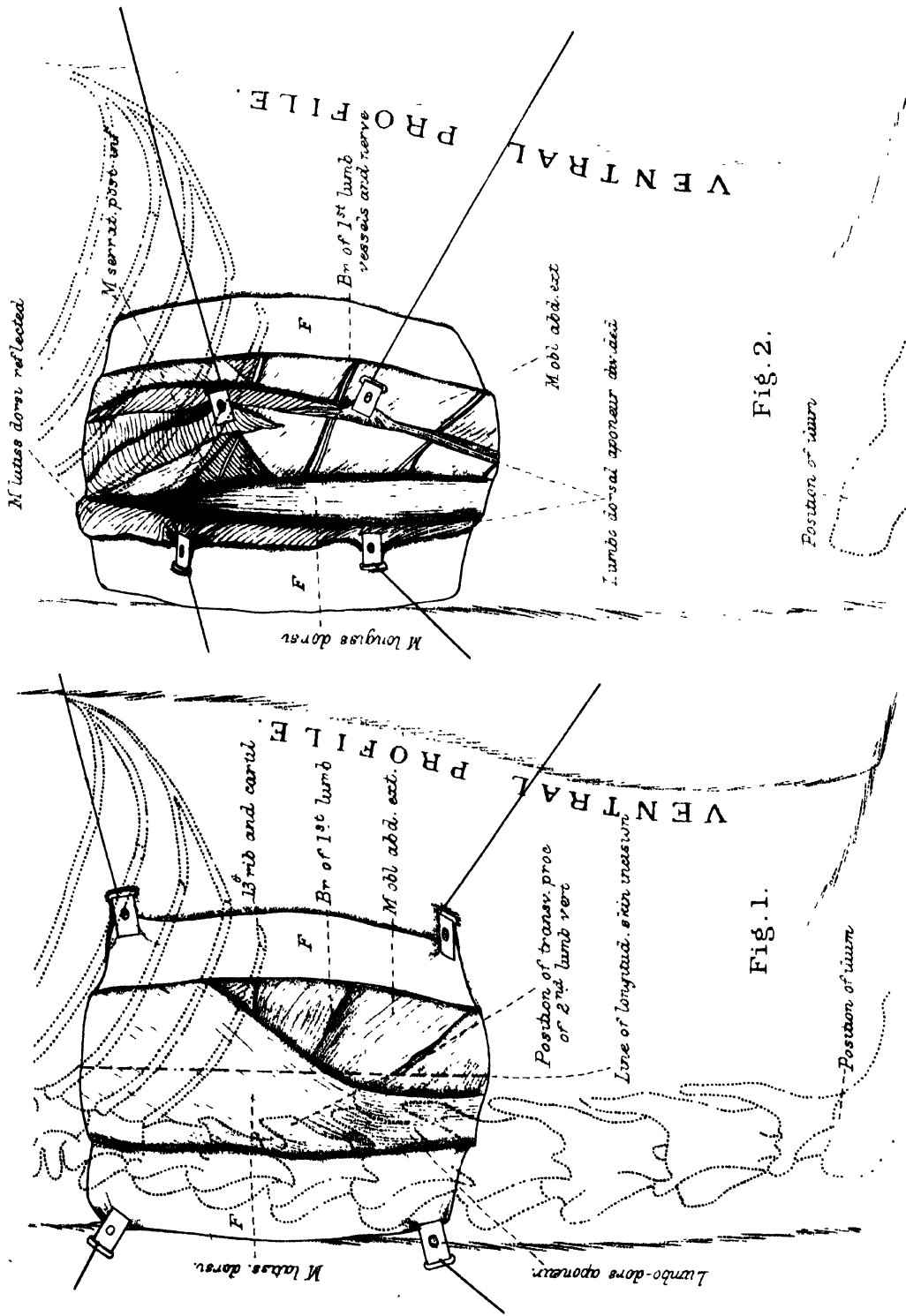

Fig. 1. 1st. stage. F. skin flap. Fig. 2. 2nd. stage. F. skin flap. 13, last thoracic nerve.

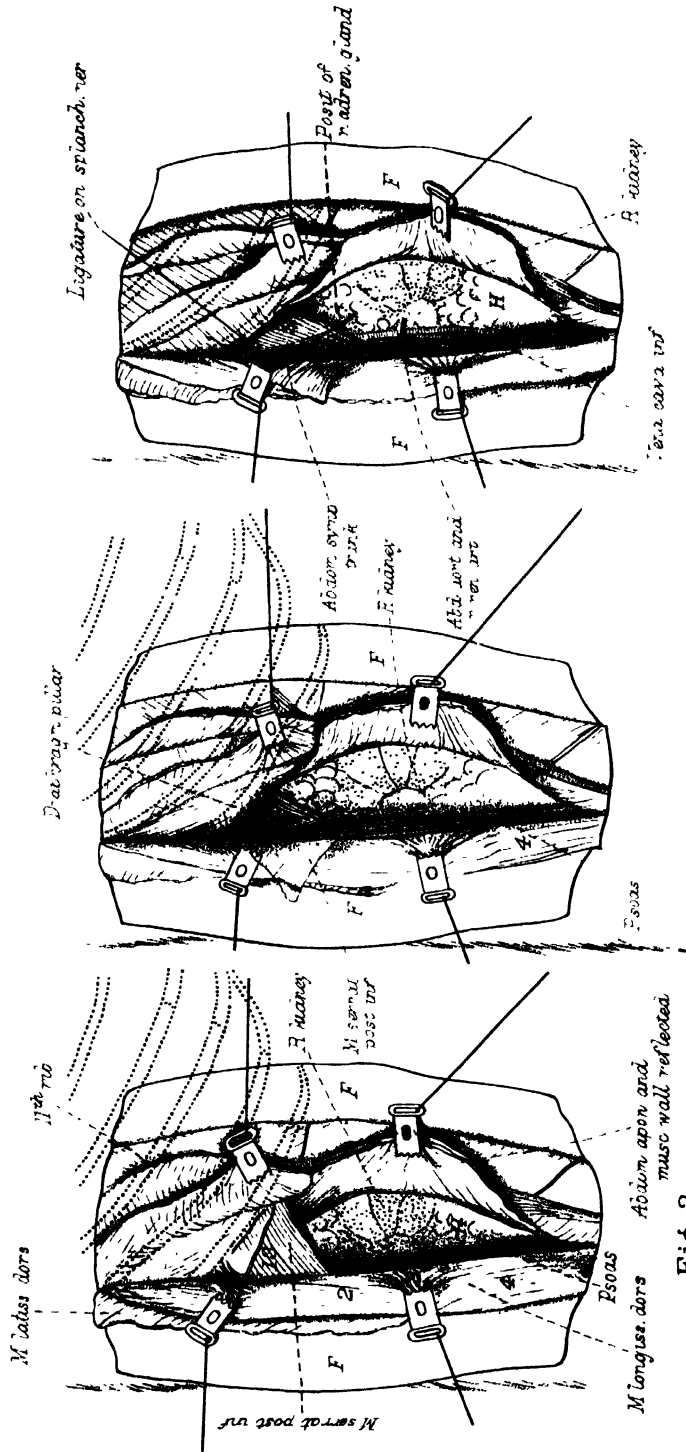

Fig. 3.

Fig. 4.

Fig. 5.

Fig. 3. 3rd. stage, abdominal wall detached from transv. processes of 1st, 2nd 3rd. and 4th lumbar vertebrae 2, 3 4, positions of tips of transv. proc. of 2nd, 3rd 4th, lumb. vert., F, skin-flap, 13, 1st thorac. nerve, H, fat covering kidney Fig 4. 4th stage splanchnic nerve exposed; H, fat covering kidney, F, skin-flap, 4 tip of transv. proc. of 4th lumb. vert. Fig. 5. 5th stage. S, splanchnic nerve; H, fat covering kidney; F, skin-flap.

is not due to action of the extract upon the vasomotor centre in the bulb, your preparation being decapitate.

Obs. 34. The chromium salt reaction detects in general the scattered cell-collections of the so-called 'paraganglia' or chromaffin bodies: for special references consult, among others, Gaskell's *Involun-*

tary Nervous System, London, 1916, J. F. Gaskell's monograph, *Phil. Trans. B.* vol. ccv, 1914, and Sir E. Sharpey Schafer's *The Endocrine Organs*, Part 1, London, 1924.

Obs. 35. This method used is that of G. N. Stewart, *Jnl. of Physiol.* vol. xv, p. 1, 1894.

EXERCISE VIII

ARTERIAL PRESSURE AND PULSE; THE EFFECTS OF AORTIC STENOSIS AND OF AORTIC INCOMPETENCE. REDUCTION POWER OF THE TISSUES AS INDICATED BY METHYLENE-BLUE

I. A decapitate preparation is provided. See that it is being properly ventilated and is in good condition.

II. The observation required from the arterial-pressure record in this exercise regards mainly a change in amplitude of the oscillations of the pulse. For this the Hg manometer, owing to its inertia, is less suitable than is a so-called 'membrane manometer'. A simple form of membrane manometer is therefore provided. Its membrane is of rubber; its plan of construction is shown in text-fig. 25.

To get ready this manometer, clamp it by its holder to a vertical stand, open the two brass taps and the screw-clip on the longer rubber tube attached to one of the brass pipes leading to the capsule carrying the membrane. Fill the manometer and its connecting tube with half-saturated $MgSO_4$ solution from a syringe inserted into the free end of the longer rubber tube, driving the air out by the fluid introduced, and when the air is entirely expelled and the fluid without bubbles issues from the short rubber tube at the other end of the manometer, close the brass taps, screw tight the clamp at the syringe-end of the longer rubber tube, and withdraw the syringe.

Clamp the filled manometer, with its connecting-tube attached, to the vertical standard on the kymograph; moisten the middle of the top of the membrane with a droplet of gum solution, place the small aluminium button on the membrane where moistened with gum. The edge of the wedge-shaped top of the button should lie transverse to the lever, which should rest upon it. Adjust the pivot of the lever so that the lever inclines downward, its writing-point being rather lower than its pivot. Bring the lever to the recording-paper of the kymograph and see that its writing-point keeps in light touch with the paper when it rises and falls. This can be tested by squeezing the rubber tube and so driving the membrane upward. See that

the free end of the connecting-tube reaches well to the upper part of the chest, suitably for the left subclavian artery, into which the arterial cannula will be inserted.

By adopting certain conditions which slightly increase the manipulative difficulties but enhance the value of the features of the record, the membrane manometer provided can be made to exhibit approximately the form of the individual pulse-waves. For this a reduction is required, as far as practicable, of the inertia of the moving parts in the recording system, namely, of the

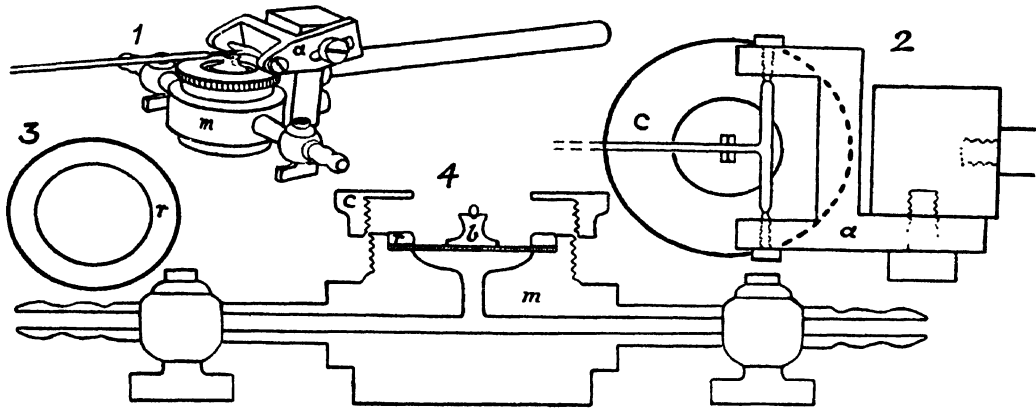

TEXT-FIG. 25. *Simple form of membrane manometer.*—1, small-scale view; 2, plan from above; 3, brass ring-washer; 4, elevation section. 2, 3, and 4 are actual scale. *a*, slotted adjustable piece carrying the pivot-bearings; *m*, the body containing the chamber and tube-borings; *r*, the ring-washer fixing the rubber disk-membrane when *c*, the cover-nut, is screwed down; *b*, aluminium button seccotined to top surface of the rubber membrane; the light grass-stem writing-lever rides in a notch cut in the ridge of the button-top.

writing lever, and especially of the junctional fluid column between artery and writing-lever. The free-vibration period of the system is thus shortened. Sufficient reduction can be obtained by employing for the junction between arterial cannula and manometer a pressure-tubing of not more than 2 mm. bore and a length of not more than 20–25 cm.; and for writing-lever a grass-stalk not more than 10 cm. long inclusive of a small thin oil-paper style tied on with fine silk and not glued, the lever resting on the aluminium saddle about 0.5 cm. from the lever's axle, i.e. multiplying amplitude of displacement of membrane-centre about 20 times.

The arterial cannula, which will be inserted into the subclavian, should have a nozzle-neck as little narrowed as is compatible with security of ligation, and a nozzle-opening well shaped and sloped but also as free as possible. The subclavian will take a nozzle of 2.5 mm. external diam. Freedom of nozzle-channel favours the registration of the pulse-form.

See that the Hg manometer is also at hand although not attached to the kymograph. You will use it for calibrating the membrane manometer.

Have at hand the packing-needle with eyelet at its sharp end, also strong scissors and string, for the operation of opening the chest, as in exerc. IV. Also strong wire stylets provided, for passing into the innominate artery and breaking the aortic valve.

Arrange kymograph gear to allow a speed of travel of recording-surface up to 1-2 cm. per second.

III. *Operation.* Place the preparation supine with the hind-limbs extended by clip-weights to the feet, and the fore-limbs drawn somewhat away from the sides of the chest and retracted by weights.

Expose the innominate and left subclavian arteries in the chest by the method followed in exerc. IV (Pl. I), modifying that procedure by opening the thorax not farther back than the 5th intercostal space and carrying the excision of the portion of the chest-wall through the top ribs completely to the base of the neck. Beginning with the right 5th space, pass the sternal ligature securing the internal mammary arteries as soon as you have cut the 5th, 4th, and 3rd right ribs and pass the ligature from the right. The freed flap of chest-wall should be turned to the preparation's right instead of neckward, and retracted to the right with a heavy hook-weight. Take care not to wound the large veins when cutting through the 1st ribs.

The contents of the top of the thorax being thus bared to view, note (see Pl. II, fig. 6) the superior vena cava and the great arterial trunk (innominate) to left of it, springing from the aorta. From the innominate arise (in the cat) left carotid, right carotid, and right subclavian. Lay bare the innominate right up to the origin of its first branch; for doing so it is well to draw the superior cava to the right by attaching a light clip-weight to the tissue near the vein.

The innominate artery is about 22-25 mm. long up to its first branch. Pass three threads (Pl. II, fig. 6) under the innominate as follows: (1) a thread where the trunk breaks up into its three main branches; (2) a thread 6 mm. lower down the trunk; (3) a thread round the root of innominate at its origin from the aorta. With threads (1) and (2) tie for each the first bend of a reef-knot, but leave them untightened. With thread (3) make a simple loop, the far ends of the thread being knotted together so that a clip will grip the knot without slipping. Cut open the pericardium at its upper part (Pl. II, fig. 6) and expose the ascending aorta down towards the heart; it is partly covered by fatty tissue attached to it. The right auricular appendix partly overlaps its root; the pulmonary artery springs from in front and passes up to the left of it.

IV. Note the large artery springing from the aortic arch to the left beyond the origin of the innominata; this is the left subclavian. The opening you have made in the chest exposes the left subclavian for a long portion of its length, as it slopes neckwards and towards the left to emerge from the chest and enter the axilla. A relatively small branch springs from it before it emerges from the chest; this is the left internal mammary. Free the upper part of subclavian from tissue and ligate it close below the internal mammary. Then below this ligature place two others, the upper to secure the cannula you are going to insert, the lower a loop to occlude the artery during insertion of the cannula. Insert the cannula towards the heart with the precautions for blood-pressure records (exerc. V); connect with the membrane-manometer tube, taking care to avoid air just as in previous exercises with the Hg manometer. Record a sample of the subclavian pressure with the kymograph, and take pains to place the connecting-tube so that the pulsations are as free as possible and the tube fixed so as to secure that.

[*Additional observation 36, Aortic stenosis on a. p. and pulse, is described on p. 129.*]

OBS. 37.
Aortic insufficiency on arterial pressure and pulse.

V. Oil the end of the wire stylets for rupturing the aortic valve and lay them ready for use. Choose for this the largest stylet you think you can insert. Return to the innominate artery. Tie (Pl. II, fig. 6) the thread (1). Attach a weight to the thread (3) and arrange the weighted thread so that it occludes the innominate completely close to its origin from aorta. Set the kymograph record running. Note that the pulse oscillations are, relatively to the mean pressure, much larger than in your records taken with the Hg manometer. Steadying the innominate by the thread (1) held in left hand, cut with sharp fine scissors half through the innominate 4 mm. distal to ligature-thread (3), which is still loose. Seize the right edge of the gaping cut in the artery with fine forceps in left hand and pass into the artery towards the heart the end of the wire stylet previously oiled. Loosen the most proximal thread-loop and pass the wire down; it will meet with obstruction at the aortic valve. Feel with the *finger* for the seat of obstruction and assure yourself that it is at the aortic orifice and that the wire has not passed through into the ventricle. Press the wire down against the obstruction, supporting the aorta with the fingers of the other hand. The obstruction will be felt to suddenly yield; this means the breaking of a cusp of the valve. Withdraw the wire a few millimetres and twist it a little in the aorta: thrust it down again; it will meet obstruction at the same level as before; break this down as before. Then at once withdraw the wire, drawing tight the ligature (2) as the wire leaves the artery.

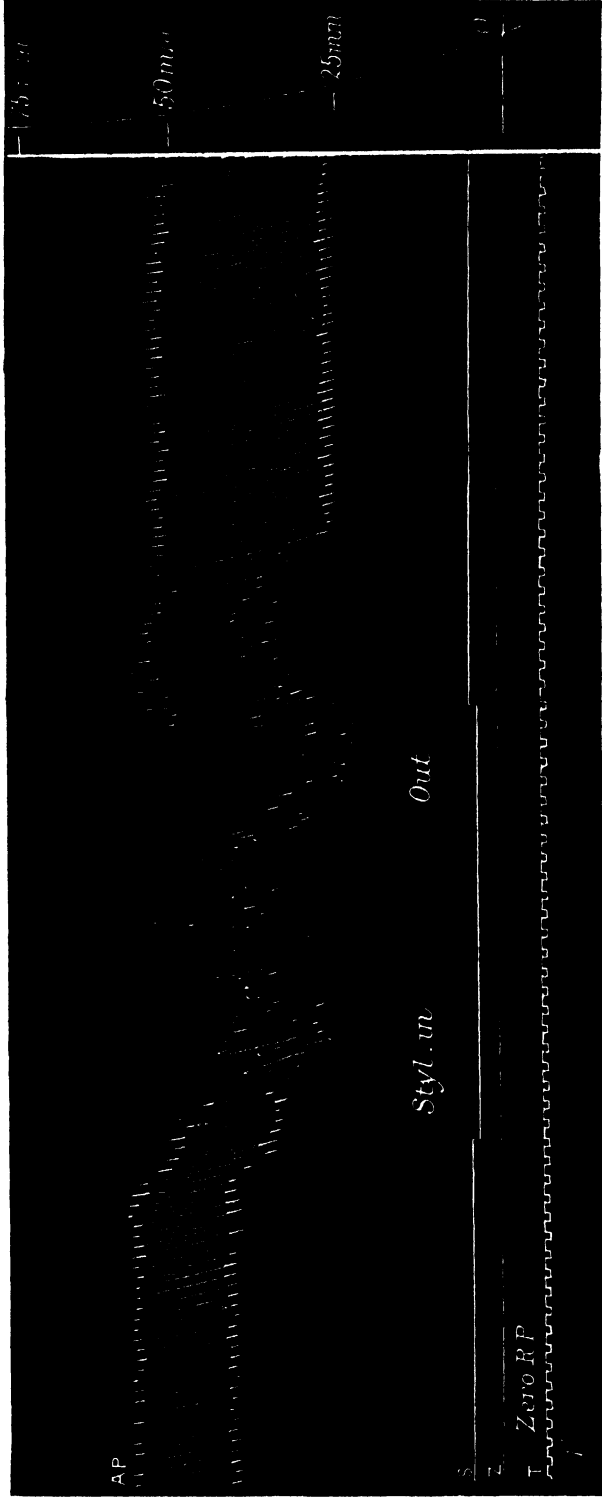

TEXT-FIG. 26. Effect of rupture of aortic valve upon the pulse oscillations of the arterial pressure (subclavian artery); decapitate preparation (N. B. Dreyer and E. G. T. Liddell). A.P., arterial-pressure record with the membrane manometer; S, signal-line indicating the insertion and withdrawal of the stylet rupturing the valves; z, zero-line of arterial pressure; T, time in seconds. To right, the record of the gauging of the membrane manometer in values of pressure of the Hg manometer.

VI. Replace the chest-wall flap over the opening in chest. Observe the change in the kymograph record of the subclavian, and see that the connecting-tube and cannula have not been shifted from the favourable position in which they lay before the innominate was dealt with. The cardiac pulsations have become much more marked, although the systolic maximum has altered little (text-figs. 26, 27). The pulsations will increase in depth still further, though the mean pressure may not fall much. The aortic regurgitation accentuates the pulse-waves by causing the diastolic pressure of each pulse-wave to fall abnormally low (water hammer-pulse of aortic insufficiency). A further effect which often occurs is considerable irregularity of the pulse-frequency, also a reduction of the pulse-rate. In this latter case the slowing of the pulse-rate tends of itself to increase the pulse oscillations, especially with a Hg manometer record. Note the change in the pulse-form (text-fig. 27). The auricular systole may make itself felt as a pressure rise in the aorta (text-fig. 27).

VII. Tie off the left subclavian artery permanently by ligating with the controlling proximal thread already round it. Clamp the junctional tube to manometer. Detach the junctional tube from the subclavian cannula. Shift the operation table somewhat from the kymograph. The calibration of the membrane manometer and the actual inspection of the aortic valve-lesion produced remain to be done. These do not require the living preparation and are deferred to the end of the exercise; see § IX.

OBS. 38.
Reducing action
of the tissues on
methylene blue.

VIII. Have ready a 50 c.c. burette clamped to a standard and armed below with about 20 cm. rubber tubing with pinch-cock, 30 c.c. of 0.2 per cent. methylene-blue solution in Ringer-Locke fluid, a glass cannula with fine nozzle for insertion into a vein and its glass stem fitting the rubber tube on the burette. Set the methylene-blue solution to warm to 38° C.

Expose the femoral vein at the groin, turning the fat-pad covering its upper part upward and inward. Pass a thread ligature round the vein at its uppermost part, a fine silk ligature loosely tied with the first bend of a reef-knot round the vein about 6 mm. lower down, and a thread ligature again about 4 mm. lower still. Pour the warm methylene-blue solution into the burette and open pinch-cock to let out any air-bubbles. With the glass cannula ready to hand, and with the top and bottom threads occluding the vein by a pair of artery forceps attached to and dragging on them, open the vein just distal to the middle ligature by a snip with fine scissors half through it. Insert the cannula with nozzle pointing towards the heart. Tie tight the silk ligature securing the neck of the cannula. Tie tight the distal ligature. Fill the cannula with Ringer-Locke. Release the pinch-cock of the burette, preventing outflow from burette by compressing the rubber tube near its

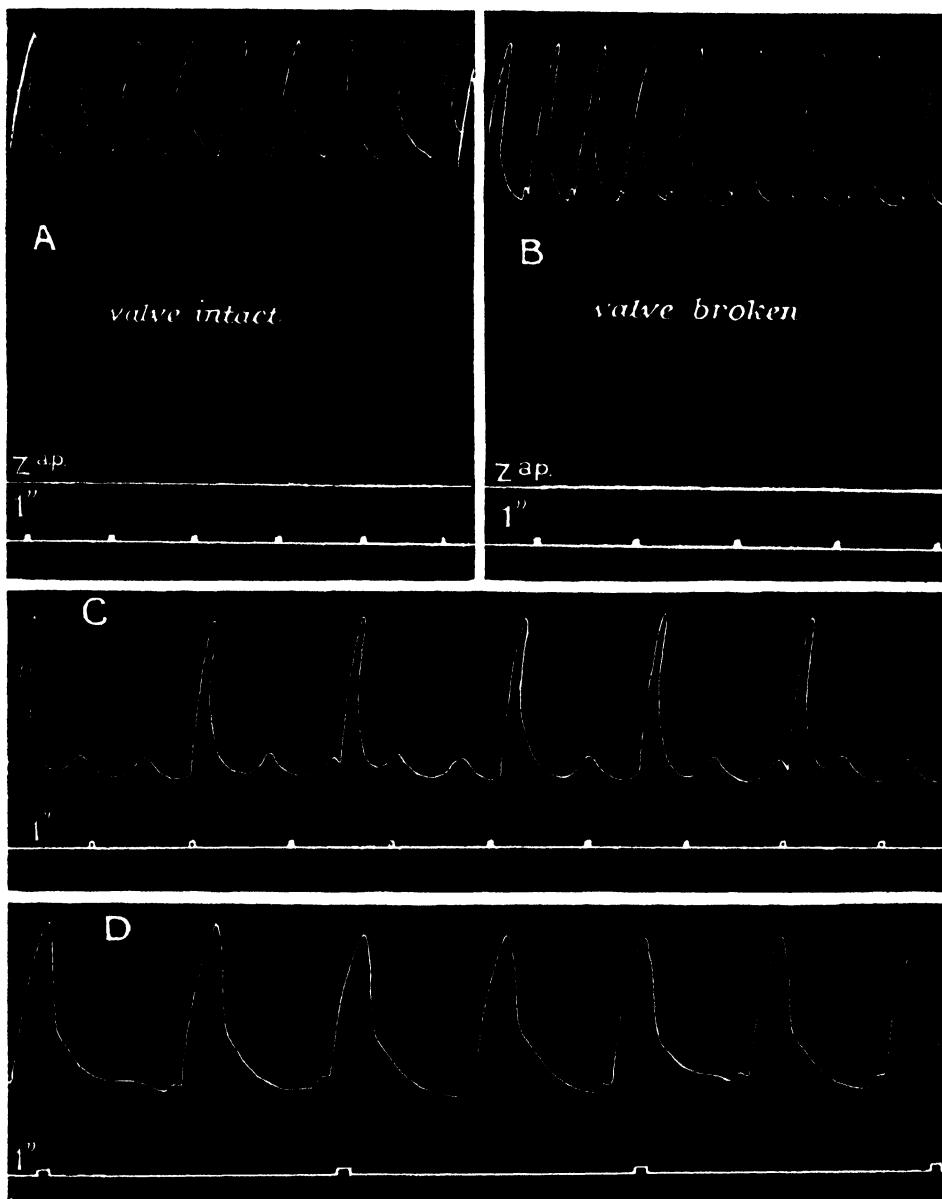

TEXT-FIG. 27. Arterial pressure recorded by simple form of rubber membrane manometer (A) before and (B, C, D) after rupture of a cusp of the aortic valve; decapitate preparation (N. B. Dreyer and C. S. S.). In B note the drop in the diastolic pressure; also, in B, C, D, the collapsing form of the pulse-wave descent, and the transmission of an auricular pulse-pressure wave into the artery (subclavian). C is taken later than B and D, and the ventricular beat's sequence upon auricular has become intermittent and irregular. z^{a.p.}, level of zero-pressure in the manometer; 1", time in seconds.

free end between finger and thumb. Slip the rubber tube over the free end of the venous cannula, avoiding all air entering the connexion.

Replace the pinch-cock on the rubber tube. Release fully the proximal thread compressing the vein. Note the height of the methylene-blue solution in the burette, and, releasing partially the pinch-cock, allow 5 c.c. to run into the vein in about 1'. Feel the heart, and, if its beat is fairly strong, allow another 5 c.c. to run from burette into vein; and so on until 20 c.c. have been injected.

Allow about 15' to elapse from end of injection. Open carefully the abdomen along the median line; note the colour of the intestine, spleen, one kidney, the pancreas, the abdominal lymph-glands, and the muscles and subcutaneous tissue of the abdominal wall. In doing this displace the viscera as little as practicable. Then close the abdominal wound carefully and fully.

Allow another 10'–15' to elapse. Reopen the wound, note the appearances again, and extend the opening into the chest, to observe the colour of the heart, lungs, and thymus gland.

Then remove the artificial ventilation of the lungs. The heart will then fail and the circulation cease. When that has happened perform a post-mortem examination, making the following observations:

Note that when first exposed certain organs are fully blue, namely, the pancreas, thymus, lymphatic glands, and, to a less extent, the spleen; that certain others are not at all blue, namely, the lungs, the muscles, the liver, the adrenal glands; while others are slightly greenish-blue, e.g. kidneys and intestine.

Take out rapidly one kidney, one adrenal, a piece of liver, the spleen, a piece of the lung, and cut each open in turn. Note the blue mottling of the cortex and kidney, the absence of blue from the renal medulla, the deep blue of the adrenal medulla, the absence of blue from the adrenal cortex. Note that with exposure to air the blue intensifies in the parts already blue and that other parts not previously blue become so, e.g. renal medulla.

Cut open a piece of the gut and note that the mucosa is blue, the muscular coat not so. Note that the liver and lung become mottled with blue.

Expose a portion of the spinal cord; note that the surface of the cord becomes bluish under exposure, and that the cross-section of the cord, though not blue when first cut across, becomes blue, the grey matter in a few seconds taking a bright blue tint. The urine is slightly greenish.

OBS. 37 (cont.).
Calibration
of membrane
manometer.

IX. To estimate the actual pressure values of the membrane manometer's records, Obs. 36 and 37, it is necessary to gauge the manometer. This may now be done as follows:

Calibration of the membrane manometer. The manometer and its recording

parts were left undisturbed in their position on the kymograph, except for disconnexion from the arterial cannula. Join the side-branches of the T-tube leading from the kymograph's reservoir bottle to the connecting-tube of the membrane manometer on the one hand and to the connecting-tube of the Hg manometer on the other. Lower the reservoir bottle to the level of the manometers. Open the top branch of the proximal limb of the Hg manometer tube and allow the Hg columns to balance at their zero, and then close it again. Move the kymograph recording-paper to a clean part of the surface, and mark the level of the manometer-lever, thus getting zero mark (text-fig. 26). Then raise the reservoir bottle slowly till the Hg manometer shows 25 mm. pressure. Mark the membrane manometer's lever record at this pressure 25. Raise the reservoir bottle till the Hg manometer shows successively 50, 75, and 100 mm. pressure, marking the corresponding heights of the membrane manometer's record. Shift the recording surface to a fresh place and reverse the process, lowering the pressures.

With these marks as standards, note the values of the systolic and diastolic pressures obtained before and after breaking the aortic valves.

The kind of result you may expect to find is instanced by the following quotation from data yielded by an individual class experiment: Before the breaking of the aortic valve, systolic pressure 55 mm. Hg, diastolic pressure 36 mm. Hg; after the breaking of the valve, systolic pressure 53 mm. Hg, diastolic pressure 22 mm. Hg.

X. Remove the heart from the preparation. Dissect it under water, and ascertain the valvular lesion you have made. The usual lesion is a large tearing away of the attached base of one of the cusps from the wall of the Valsalva sinuses.

ANNOTATION

Obs. 37. Rupturing a cusp of the aortic valve bears on a common variety of heart disease where the valve, owing to changes in its texture or actual loss of its substance, fails to close properly. A characteristic symptom of such valvular disease is the abnormal increase of the oscillations of the arterial pulse (Hodgkin, *Lond. Med. Gazette*, iii, 433, 1829; Corrigan, *Edinb. Med. and Surg. Journ.*, xxxvii, 225, 1832). The increased oscillation is due to an abnormally low diastolic arterial pressure, while the systolic is little less than, sometimes even above, normal. With a little care, the inertia of the membrane manometer and fluid junctions can be kept within limits

not too great to follow fairly the oscillations of the pulse. Even with the Hg manometer the increased pulse oscillations can be seen, and the Hg manometer shows perhaps more clearly than do most pulse-recorders the compensatory adjustment on the part of the heart. This compensation maintains, or nearly so, the mean arterial pressure, despite the diastolic leakage of blood back into the ventricle after its delivery into the aorta at systole.

Experimental study of aortic insufficiency by operative rupture of the valve in animals (dog, horse) was first made by Cohnheim (*Allg. Pathol.* vol. i, p. 38, 1877) and by Marey (*Trav. de Laborat.* p. 249,

Paris, 1878). The problems raised, although in a sense pathological, are answerable mainly by physiological considerations; for an excellent account of these consult Marey, *La Circulation du Sang*, pp. 677-80, figs. 325-6, Paris, 1879.

Obs. 38. Methylene-blue observation (P. Ehrlich, 1886). This experiment shows

that the avidity of the tissues for oxygen is so great that they are able to decompose the methylene-blue molecule, with the formation of a colourless reduction product, which on exposure to the air undergoes oxidation again, and re-forms methylene-blue.

EXERCISE IX

NERVI ACCELERANTES; GRAVITY AND ARTERIAL PRESSURE; RECURRENT LARYNGEAL AND THE VOCAL CORD

I. A decapitate preparation is provided. See that it is being ventilated suitably, and is in good condition.

II. Get ready the Hg manometer for arterial pressure, kymograph (exerc. V), and electrical circuits for stimulating with the hand-electrodes (exerc. IV).

III. Prepare the right carotid (exerc. V) for blood-pressure observation, but go no farther than passing the ligatures. Leave the dissection moistened with Ringer-Locke and covered by replacing the skin, secured by a clip.

Obs. 39.
Heart-rate and
n. accelerantes.

IV. *Operation.* Place preparation on its left side. Draw right forelimb forward with shoulder and elbow fully extended, and attach a heavy clip-weight to the paw to keep the limb in position. Attach clip-weights to hind feet, drawing them backwards. Feel through the skin the dorsal edge of scapula. Make a skin incision (Pl. IV, fig. 1), about 7 cm. long, parallel with and about 2 cm. to right of the mid-dorsal line; the front end of the incision should be on a level with the front of the head of the humerus; the posterior end should lie on a level with the posterior border of the scapula. At each end of this incision make a transverse one extending from mid-dorsal line laterally for about 7 cm., and at right angles to the longitudinal incision. Reflect the two skin-flaps and retract them with clip-weights.

The muscles covering scapula lie exposed (Pl. IV, fig. 2); note the posterior edge of cephalo-humeral, the anterior edge of latissimus dorsi, and the trapezius between them. Cut through this last near the mid-dorsal line, reflect outward the portion covering the supra-scapular fossa, and detach it from the scapular spine. Cut through the rhomboidei muscles and pick up with artery forceps the points which bleed. Retract the cut edges.

The scapula thus partially freed is now to be displaced (Pl. IV, fig. 3) laterally; this can be done suitably by adducting the right forearm towards

the neck and rotating it clockwise as looked at from behind, and then retaining it in this position by a clip-weight to the paw and by a heavy hook-weight fixed to the top of the muscular mass covering dorsal edge of scapula, so pulling the wing of the shoulder laterally (Pl. IV, fig. 3). The hook-weight may be hung over a cross-piece in a short standard with heavy base, this giving better leverage for the purpose than the table-edge. The lateral luxation of the shoulder-blade is assisted by somewhat flexing and lifting the truncated neck. This slackens the levator anguli scapulae (Pl. IV, fig. 3), which, conjoined posteriorly with serratus magnus, stretches as a thick muscular band backwards and to the right from the lateral processes of the cervical vertebrae in front to the hind end of scapula behind.

Explore with the finger the deep space lateral to this muscular band, and note the supra-scapular nerve, and, posterior and deep to that, the brachial flexus, and posterior to that again the first rib. Feel with the finger *dorsal* to levator ang. scap. the rest of the first rib, following it to its articulation at the vertebra. Then make out with the finger the second and third ribs.

Reflect laterally the origins of serratus from the second rib, first intercostal space, and posterior border of first rib. Refer to the cat's skeleton provided in the class-room and note the shape of the first and second ribs. Scrape bare the dorsal edge and anterior and posterior faces of the second rib from its articulation out laterally to the already detached serratus magnus, thus exposing about 4 cm. of the rib. Carefully dissect away the muscular sheet of the first intercostal space for the area demarcated by the bared portion of the second and first ribs.

With the oblique-edged cutting-pliers cut carefully through the second rib at its farthest laterally-cleared part; seize with strong forceps the rib so cut closely medial to the cut point; lift it and carefully free its deep surface. The subclavian vein must not be wounded. Remove the piece of the rib thus freed.

Ganglion stellatum (Pl. IV, fig. 4), the most anterior of the thoracic ganglia of the sympathetic, lies within the first interspace or somewhat further forward, in line with the neck of the first rib. It is probably covered by fat in tough connective tissue, especially laterally. The ganglion has a grey pearly appearance, which distinguishes it from fat. A small artery passes obliquely lateral and headward of the ganglion. Posterior to the ganglion, in the cut edge of the muscles dissected from the posterior edge of the second rib, is the second intercostal nerve; at this nerve's extreme proximal course a fine branch passes from it to the ganglion; this is the white ramus communicans of the second thoracic nerve. Headward of the ganglion, partly covered by first rib, is a large nerve running almost parallel

with the edge of the rib; this is the first thoracic nerve going to the brachial plexus. A small branch from the median edge of the anterior end of the ganglion is seen passing towards the first thoracic nerve; this is a grey (post-ganglionic) ramus.

The ganglion is seen to have two other branches:

- (a) from its posterior end a largish branch; this is the main cord of the sympathetic and passes to connect with the vertebral ganglion of the sympathetic next behind the stellatum itself.
- (b) a branch from the top of the ganglion passing directly headward; this enters the neck as the cervical sympathetic.

Ligate with fine silk the white ramus from second thoracic nerve. Cut it, as well as the branches (a) and (b).

Lifting the ganglion (Pl. IV, fig. 5) somewhat by drawing gently on the ligated ramus, free it gradually by snipping carefully the thin tough connective tissue which binds it down. As it is freed and lifted, branches (usually double) are clearly seen passing ventrally from the ganglion and sloping towards the sternum (to reach vena cava superior). Also two branches from the deep face of the ganglion; these latter must be cut. The ganglion with the accelerantes branches are thus fully freed.

To apply electrodes to the latter, lift the ganglion well clear of all tissues by means of one of the ligatures in the left hand and apply the electrodes to the origins of the accelerantes from the ganglion, taking care that the part of the accelerantes stimulated and the electrode points themselves are clear for a distance of several mm. from all contact with the tissues.

Cover the dissection with a cotton-wool swab wrung out in warm Ringer-Locke fluid.

V. Return to the right carotid; establish its connexion by means of cannula with the kymograph tubing (previous exerc. V). Obtain graphic pressure-trace.

VI. *Observation of the accelerantes effect* (text-fig. 28). Uncover thoracic wound. Set going the induction coil's primary circuit. Apply electrodes to the accelerantes, as described above. When you are ready your colleague opens the bridge-key of the secondary circuit. Mark abscissa for moment of commencement of stimulation on the arterial pressure-trace. Measure the long latency of the accelerator effect, also the long after-action. Compare duration of latency and of after-effect with those of your vagus inhibition curve (previous exercise). Repeat with various strengths of stimulating current. The length of the after-action is greater with stronger than with weaker currents.

It sometimes happens that the faradization of the nerve produces inhibition of the heart by escape of the stimulating current to cardiac branches of the vagus; the accelerantes in their farther course to the heart soon join the cardiac branches of the vagus. This escape is likely to occur if the accelerantes are not well cleared by dissection. When this escape occurs the result as shown by the kymograph record is (1) vagus inhibition, followed, on withdrawal of the stimulus, by (2) the accelerantes effect. This is in accord with observations that prove that when vagus and accelerantes are separately but concurrently faradized the vagus effect predominates during the stimulation but does not prevent the accelerantes effect taking place afterward. A way of avoiding in the present experiment the escape of the stimulation to the vagus, if that occurs, is to stimulate mechanically. This can be done by placing a thickish thread round the body of the ganglion and drawing it tight, crushing the ganglion. A pure accelerantes effect is thus obtained, and with a second ligature farther distal can be repeated. Another way of avoiding vagus complication is to inject atropine (cf. exerc. V, obs. 19).

VII. Detach the tracheal cannula from the flexible tube which connects it with the ventilation-nozzle on operation table and quickly insert a short length (e.g. 30 cm.) of suitably sized rubber tube, joining tracheal cannula to flexible tube from ventilation-nozzle, rotating the nozzle in the table-top so that it is directed to the side on which kymograph stands. The junction between preparation and 'blower' having been thus lengthened, place the small board (provided) under the preparation and lift it somewhat off the table without disturbing the connexion of carotid with kymograph, while your colleague moves the table aside from under the board. Keeping the carotid of the preparation at its previous level, and while your colleague takes the other end of the board and prevents the preparation from slipping, tilt the board until it and the preparation are nearly vertical, the neck-stump retaining its old level in regard to manometer, the trunk and limbs being below it, the 'feet-down' position. Observe the effect on the carotid pressure. After a minute restore the board and preparation to their former position. Replace it on the table. Detach the extra length of respiration-tubing, and rejoin the tracheal tube to the 'blower'-nozzle as before. Press on the preparation of the abdomen with your hand and note the effect on the carotid pressure.

OBS. 40.
Gravity and
arterial pressure.

VIII. Turn to the neck-stump of the preparation. Observe the epiglottis and by drawing it forward bring the glottis and vocal cords into view. The latter exhibit no movement because the vagus trunks have been severed by the decapitation, and the laryngeal nerves are branches of these.

OBS. 41.
Recurrent
laryngeal and
the vocal cords.

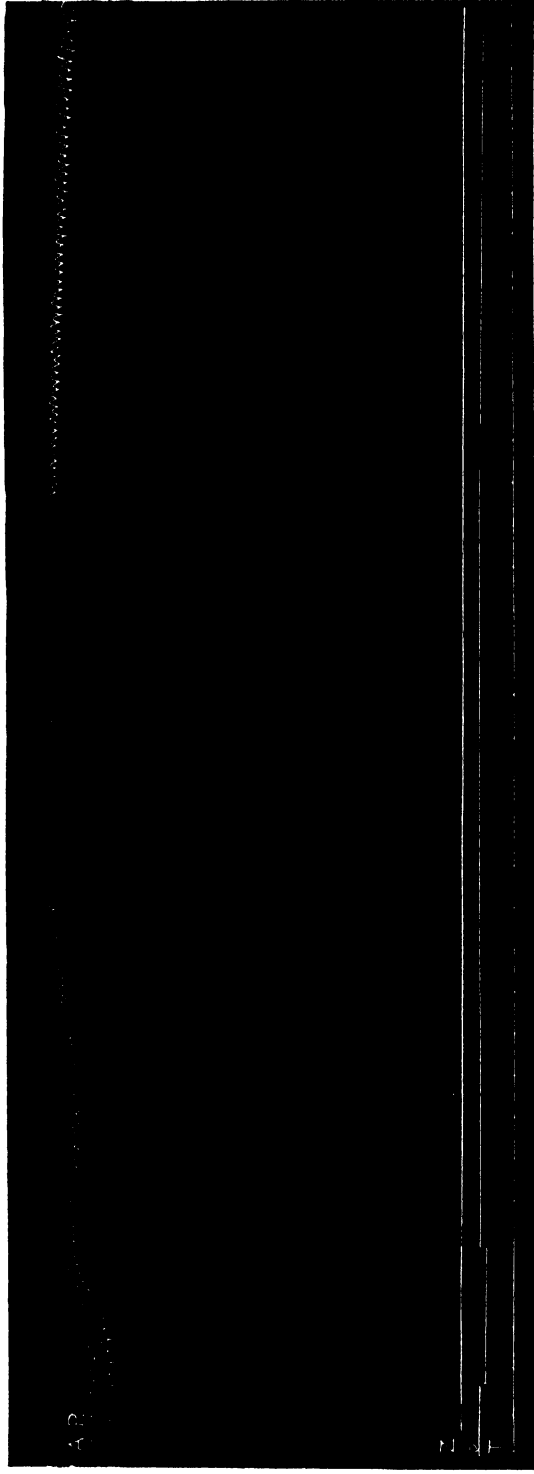
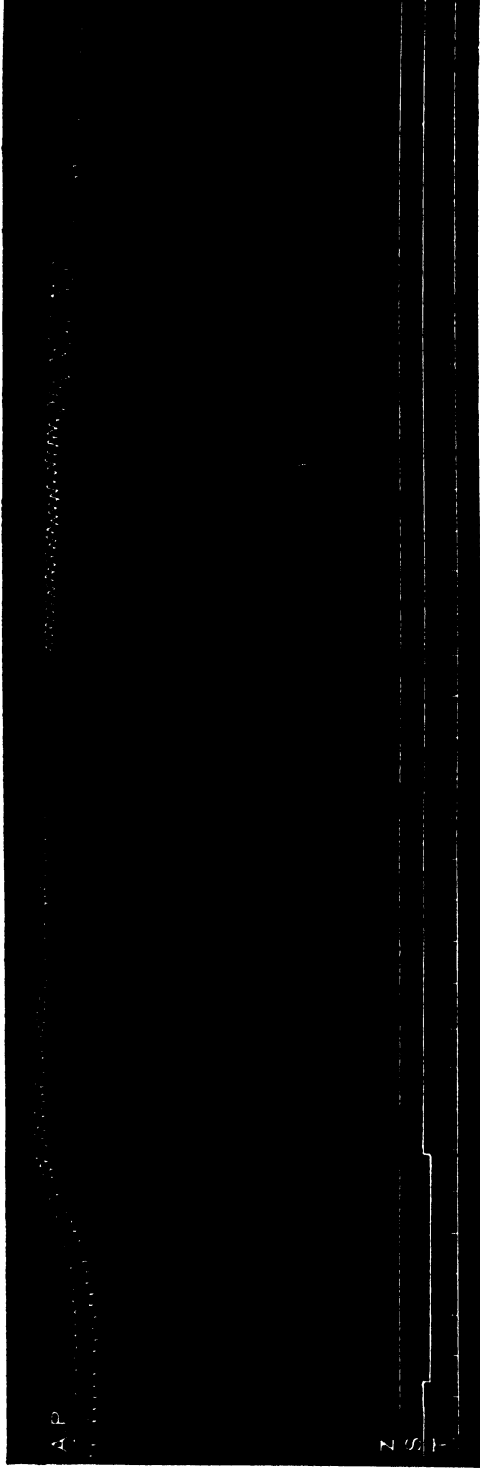

TEXT-FIG. 28. Effect of stimulation of *n. accelerans* on arterial-pressure record; decapitate preparation (C. W. Armstrong and G. H. Rosedale). A.P., carotid pressure by Hg manometer; z, zero-level of arterial pressure; s, signal-line marking time of stimulation; τ , time in 2" intervals. In the upper record the faradization was weak, i.e. secondary coil at 15 cm. inductorium scale; in the lower the faradization was for a shorter duration but, stronger, i.e. 9 cm. of inductorium scale. In the upper tracing the latency is longer than in the lower, and the after-effect is shorter.

PLATE IV Stimulation of Nervus accelerans. (EX. IX.)

FIG. 1. Position of *gla stellatum* Humerus

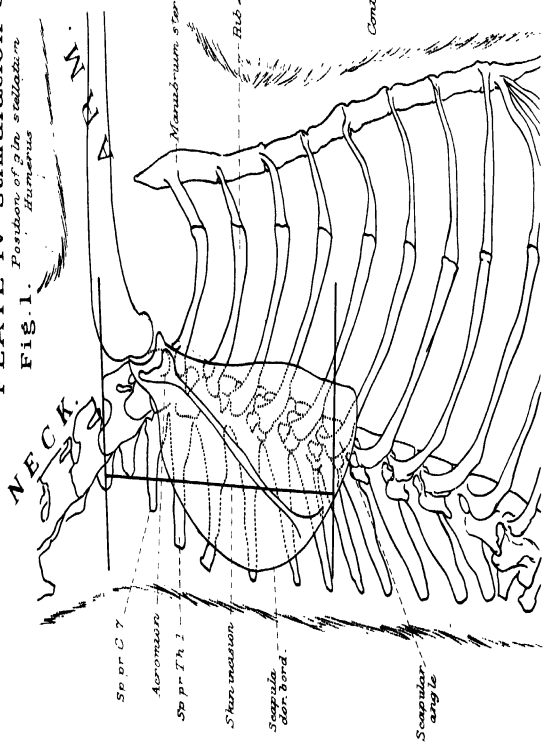

FIG. 2.

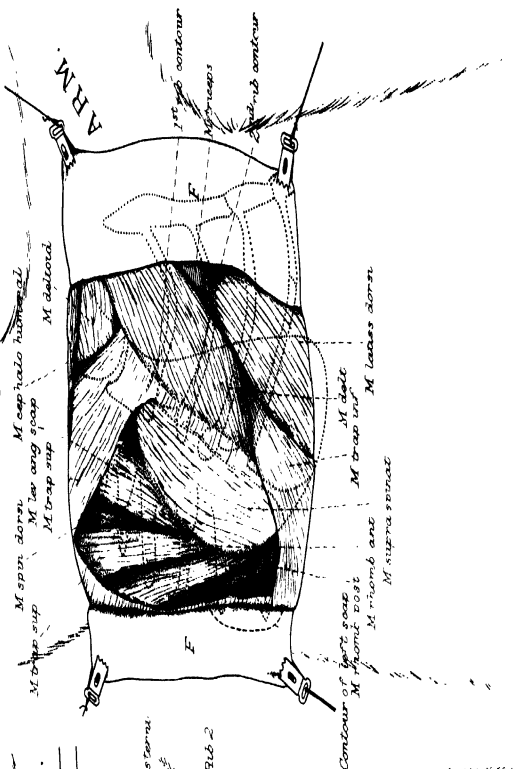

Fig. 1. Skin incision and contour of bony points

Fig. 2. Exposure of shoulder muscles. F. skin-flap.

NECK

FIG. 3.



Fig. 3. 3rd stage: scapula luxated. F. skin-flap; stage piece of and rib exposed exposing ganglion stellatum on pleura. F. skin-flap.

NECK

FIG. 4.

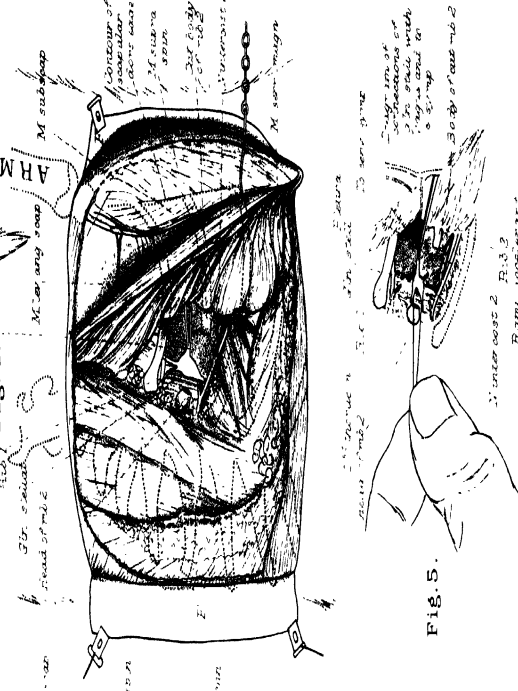

Fig. 4. 4th stage: pleura, B. bronchial plexus. C. contour of 5th rib. W. stage piece of and rib exposed exposing ganglion stellatum on pleura. F. skin-flap.

FIG. 5.

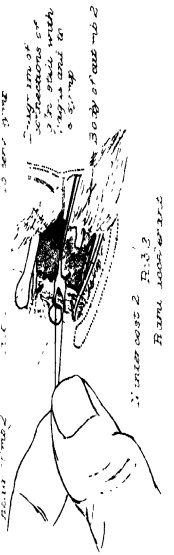

Fig. 5. Ganglion stellatum lifted for fasciectomy of rami accelerantes

IX. Expose the trachea above the tracheal cannula. Note a small nerve running along its ventro-lateral aspect, on either side; this is recurrent laryngeal. Dissect it carefully for about 15 mm. Ligate it at the posterior end of the portion you have dissected up. Cut it posterior to the ligature. Lift the freed portion by the ligature. Faradize the distal end. Observe the movement of the corresponding vocal cord.

ANNOTATION

Obs. 39. The quickening of the heart obtained by stimulating the sympathetic nerve-branches passing ventrally from ganglion stellatum was discovered (in the dog) by the Russian physiologists M. and E. de Cyon in 1866 (*Centralbl. f. Med. Wiss.*); they gave the name *nervi accelerantes* to these branches. E. de Cyon was the discoverer also of the *nervus depressor*,

1870 (see later, exerc. XIV). The operative procedure followed here for reaching the stellate ganglion is that introduced by H. K. Anderson, 1904 (*Jnl. of Physiol.* vol. xxxi; *Proc. Physiol. Soc.* p. xxxi).

Obs. 40. See L. Hill, 1895 (*Jnl. of Physiol.* vol. xviii, p. 15); also Flack and Hill, *Text-book of Physiology*, London, 1919.

EXERCISE X

HYDRAEMIC PLETHORA

I. A decapitate preparation is provided. See that it is being properly ventilated and is in good condition.

II. Set the Ringer-Locke fluid warming to 37° C., and see that you have a cannula for the urethra, a 50 c.c. burette and a vertical stand for holding it, a rubber tube and clamp attached to the burette, a cannula for the jugular vein, and a beaker containing about 50 c.c. of aqueous 10 per cent. Na₂SO₄ solution. Also a needle-syringe and a 0.5 c.c. capsule of pituitary extract. Also a glass piston-syringe of about 30 c.c. capacity. Observe in the skeleton the arrangement of the pubic bones and pubic arch.

III. *Operation.* A. *Exposure of urethra and insertion of urethral cannula* (Pl. V, figs. 1, 2, 3). Place preparation supine with all four limbs symmetrically extended by four clip-weights attached one to each foot.

Note the position of the nipples of the inguinal mammae. Make out by feeling through the skin and abdominal wall the anterior border of the symphysis pubis; then of the pubic arch; also the contour of the urinary bladder (Pl. V, fig. 1). Make a medial longitudinal skin incision, beginning in front nearly as far forward as the cross-level between inguinal mammillae,

Obs. 42.
Renal secretion
and venous
injection of
saline.

and carried back along the whole length of pubic symphysis. Expose through the subcutaneous fat the linea alba of the abdominal wall and the crest of the symphysis pubis throughout the length of the skin incision. Clear off the muscular attachments (adductor femoris) from the symphysis and from the anterior ramus of pubes for the extent shown in the figure (Pl. V, fig. 1), taking care not to cut the blood-vessels descending from abdomen over the pubic ramus r. and l., but turning them aside. Clear the abdominal edge of the pubes from the attachments of the obliquus ext. abdominis and rectus abdominis. With the cutting bone-pliers cut through the symphysis at junctions of its third and most posterior fourths (Pl. V, fig. 2). Insert jaw of bone-pliers from abdominal edge deep to pubic ramus, keeping close to deep face of ramus, and cut through rami in positions marked in figure, allowing about 1.5 cm. width between the two cuts. Cut off pubis. Remove the bone so freed by detaching carefully with scalpel the obturator externus attachments r. and l. from its sides and deep face.

With dissecting-forceps tear through fat tissue deep to symphysis in mid-line, exposing the membranous urethra, which appears as a pale tough-walled duct. Pass, with curved mounted needle, a strong thread round urethra about level of top of symphysis. Tie thread in loose running noose round urethra. Lifting urethra by thread in left hand, cut obliquely half through urethral duct (Pl. V, fig. 2) with fine sharp scissors about 3 mm. distal to thread-ligature.

The glass urethral cannula (Pl. V, fig. 3) armed with rubber tube, clamped by clip, filled with Ringer fluid at 37° C., and lying ready to right hand, is then inserted into opening in urethra and passed up so that its free end lies within bladder above the sphincter. Cannula should be 20–30 mm. to neck for this. Tie cannula in position by drawing tight and securing the thread; the tie must be quite tight or cannula will slip.

Cover pubic incision, &c., with warm moist swab.

B. *Exposure of external jugular vein and insertion of cannula.* Turn to neck: carefully lay bare right ext. jug. vein (Pl. V, fig. 5). To expose the vein, feel through the skin for the triangular hollow between the sternal and clavicular origins of the sterno-cleidomastoid muscle (see exerc. VI, § VII). Make a skin incision about 4 cm. long from nearly as far forward as the level of the cricoid cartilage along the median edge of the cleidomastoid.

Pass fine silk in loose running noose round vein, about 4 cm. above top of sternum. Pass similarly another about 6 mm. nearer sternum, and another about 6 mm. nearer still to the sternum. The position of these ligatures must depend upon the side-branches of the vein which you expose. The distal and proximal threads should include between them a length of the vein free from

side-branches: see figure. Occlude the vein by means of the third (proximal) ligature by allowing a pair of artery-forceps or light weight to drag slightly on it. Tie tight the first (distal) ligature. Lift the vein slightly by the thread of the first ligature just tied. Open vein by oblique incision half through it just distal to the second (middle) ligature. Insert glass cannula into proximal end of vein and tie it in by tightening and securing silk ligature (middle ligature). Fill cannula with warm Ringer fluid, excluding air.

IV. Arrange (Pl. V, fig. 4) a small dish between hind-limbs and lead a rubber tube from urethral cannula so that its free end, cut obliquely to give a drip-point, overhangs the floor of dish, and fix tube in that position with a little modelling clay.

Probably there will be no urinary flow; the blood-pressure is so low that the urinary secretion is in abeyance. Wash out bladder by injecting 30-40 c.c. Ringer-Locke at 37° with glass syringe; note that most of what you put in does not run out again; the postural tonus of the bladder adjusts itself to the new quantity. Expel some of the fluid from the bladder by light pressure on the viscus through abdominal wall. Continue observation for urinary flow for 5'.

V. *Venous injection of Ringer-Locke.* While this observation is in progress fill the 50 c.c. burette in its vertical stand with Ringer fluid at 37° C., and get rid of all air from it and from the rubber tube provided with clamp attached to its lower end. Bring the burette-stand into position near right side of neck, so that its rubber tube can be connected with jugular cannula. Connect tube with cannula, taking care to exclude air from junction and keeping clamp closed. The level of fluid in burette should be at the top of the graduation of the burette.

VI. The 5' having elapsed and urinary flow, if any, been noted for that time, open clamp on burette tube partially and allow 40 c.c. of the Ringer-Locke to run slowly into vein. Observe urinary flow, if any; probably there will be none.

Half fill burette again; run in 25 c.c. more fluid slowly; and observe urinary flow, if any, for a further 5'. While this is in progress, fill burette with warm 20 per cent. urea solution in Ringer-Locke, clamp being closed on burette.

VII. *Venous injection of 20 per cent. urea solution.* The 5' being elapsed, open partially the clamp on burette-tube and run into the vein slowly 1 c.c. from the burette. Count the drops of urine minute by minute for say 10';

Obs. 43.
Diuresis by urea.

they will have much diminished in ten minutes' time. If no marked increase of flow has occurred in 5' give another 1 c.c. of the urea solution, and look for diuresis again.

OBS. 44. VIII. After an interval of 5' give by injection with needle-syringe into saphenous vein a 0.5 c.c. dose of pituitary extract, and again observe diuresis. Flow increases to perhaps 40 drops per min.
Diuresis by pituitary extract.

OBS. 45. IX. After 10', during which the pituitary-flow subsides, inject by jugular vein and cannula 10 c.c. of 1 per cent. solution of caffeine citrate. An increase of urinary flow sets in about 2' later, and may amount to 20-40 drops per min.
Diuresis by caffeine citrate.

OBS. 46 A. X. Expose through an abdominal opening the right (or left) pelvic visceral nerve as it approaches the side of the neck and base of the bladder. The nerve is easily found by extending the abdominal incision freely, and turning the bladder somewhat to one side. The nerve is seen low down on the lateral aspect of the viscus. Ligate the nerve and cut it central to the ligature. Paralyze the distal piece lifted by the thread of the ligature. Note the contraction of the bladder produced, and that it is unilateral, giving the organ a curved asymmetrical appearance.
Detrusor action of n. pelvicus.

[*Reflex contraction of the bladder, obs. 46 B, is described as a variant of this observation on p. 129.*]

ANNOTATION

Obs. 42, 43. The counterpart of this experiment in the human being is described in *Human Physiology*, Douglas and Priestley, 1924.

Obs. 44. The diuretic action of extract of the posterior lobe of the pituitary body was discovered by Schäfer and Magnus (*Jnl. of Physiol.* vol. xxvii, p. ix, 1901).

Obs. 45. The diuretic effect of the xanthine compound, caffeine, was examined first by Schroeder, *Arch. f. exper. Path. u.*

Pharm. xxiv, 39, 1887. Its diuretic action is best seen in rabbit and man, and is said not to occur in the cat, but under the above conditions of experiment it occurs regularly. It is best to make the observations with pituitary extract before that with caffeine, because experience with the experiment shows that pituitary extract is apt to fail in producing diuresis if administered soon after the caffeine citrate diuresis has been evoked.

PLATE V.

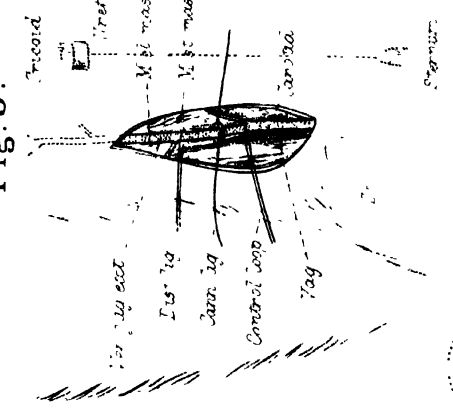
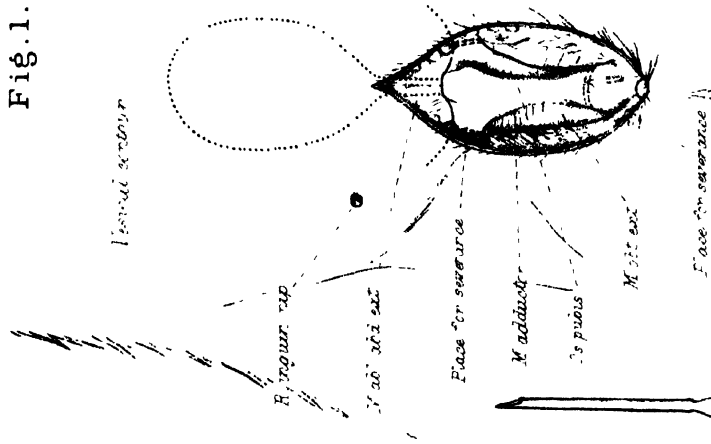

Fig. 2.

Fig. 3.

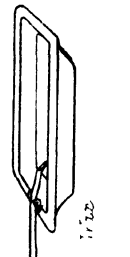

Fig. 4.



Fig. 5.

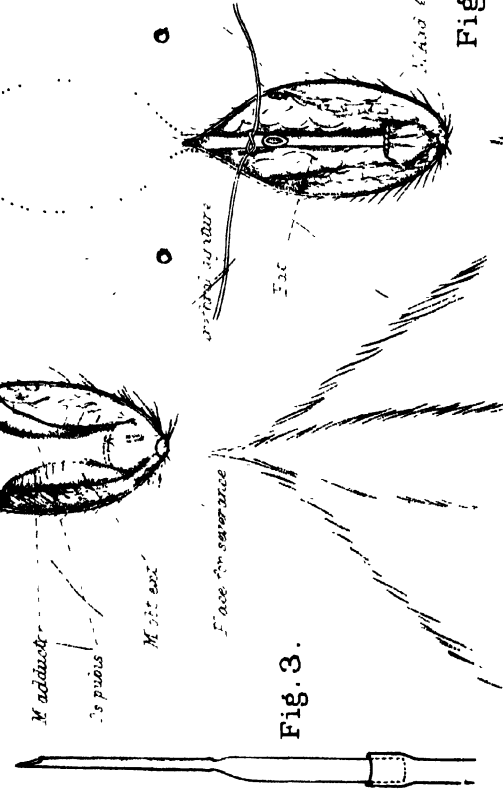

Fig. 6.

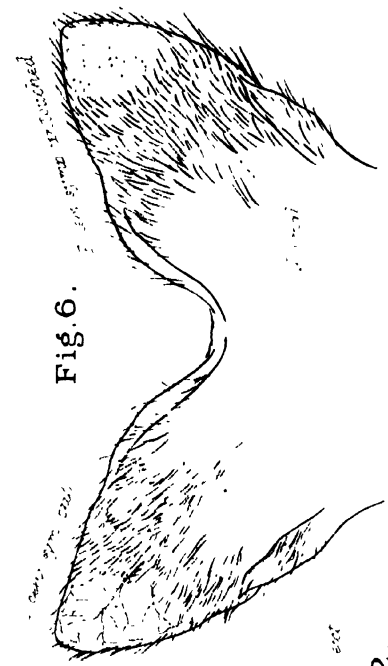

Fig. 7.

PLATE V

HYDRAEMIC PLETHORA EXPERIMENT (Exerc. X).

- FIG. 1. Operation, 1st stage; pubic symphysis cleared.
- FIG. 2. Operation, 2nd stage; pubic symphysis removed; urethra exposed and incised for insertion of cannula.
- FIG. 3. Glass cannula for urethra, actual size.
- FIG. 4. Arrangement for observing urinary flow.
- FIG. 5. Preparation of r. ext. jugular vein. Dotted black line gives mid-ventral line of neck. *Sh.*, top of r. shoulder.

INFLUENCE OF CERVICAL SYMPATHETIC ON BLOOD-SUPPLY OF THE PINNA (Exerc. XVII).

- FIG. 6. Tips of pinnae shaven, moistened with glycerine, and viewed by transmitted light. L., left pinna with vascular dilatation ensuing after severance of left cervical sympathetic trunk; R., right pinna normal, right cervical sympathetic trunk being untouched.
- FIG. 7. Left pinna on faradization of distal (anterior) portion of cut left cervical sympathetic trunk; the network of vessels connecting central artery with marginal vein has shrunken out of sight.

EXERCISE XI

SPECIFIC GRAVITY OF BLOOD; PERFUSION OF RENAL VESSELS WITH RINGER-LOCKE; INFLUENCE OF ADRENAL EXTRACT AND AMYL NITRITE; HAEMOLYSIS.

I. A decapitate preparation is provided. See that it is being ventilated properly and is in good condition.

II. Fill six of the small test-tubes in the rack about five-sixths full with sp. gr. fluids of the following gravities: 1.054, 1.050, 1.045, 1.042, 1.038, 1.034, 1.030. The test-tubes should be arranged in definite order in the rack and the number of the sp. gr. of the fluid in each tube written opposite on the rack. Capillary pipettes rectangularly bent at tip are provided. Arm two of the capillary pipettes with rubber tubing, and place ten more of the pipettes in readiness for speedy use.

See that the pressure apparatus for perfusion of the kidney is in order. Arrange the height of the reservoir so that it will stand about 70 cm. above the preparation on the experiment table.

Obs. 47. Sp. gr. of the blood. III. 1. *Operation.* Place the decapitate preparation supine, with the limbs symmetrically extended by clip-weights attached to the feet.

A. To the skin above the left knee attach a heavy clip-weight, keeping that thigh somewhat abducted. Clip the hair from the left groin. Make an incision about 4 cm. long through the skin over the fold of groin about 1 cm. lateral to the mid-line of the groin. Reflect the skin and subcutaneous fat towards the medial side of the thigh, exposing the femoral nerve and the femoral vessels (Pl. IX, fig. 6) as they enter the thigh from under Poupart's ligament. Sever the femoral nerve at its exit from the psoas muscle. Close below Poupart's ligament it will be seen that the femoral artery and vein each have a branch passing laterally outwards under the femoral nerve; this branch is the *circumflexa lateralis* (Pl. IX, fig. 6). About 12 mm. lower down another branch leaves the femoral artery on its medial side. With the curved mounted needle pass a fine thread under the femoral artery about 5 mm. proximal to circumflexa branch, also similar threads under the artery at two other points, one about 5 mm. distal to the first ligature, and another close above the junction of femoral with medial branch. Tie loosely the first loop of a reef-knot with the middle ligature, and make loops with the two others. Attach an artery-forceps to the most distal loop.

Choose a suitable short glass cannula for insertion into the femoral artery

and fill it with Ringer-Locke fluid. Attach clip-weights to the proximal and distal ligatures, so that the weights drag on the loops and thus occlude the femoral above and below; then at once, steadying the artery by the distal tied thread, cut with the points of fine scissors an oblique slit in the femoral about 2 mm. distal to the middle (untied) thread-loop. Insert the point of the cannula through the slit into the artery with its point directed towards the heart. Secure the cannula by tightening the thread-loop round the neck of the cannula.

B. Expose the external jugular of the right side (see exerc. X, § III, B) and insert into it a glass cannula directed towards the heart. Bring the burette containing 50 c.c. of warm Ringer-Locke within reach of the jugular cannula and establish connexion free from all air-bubbles between the jugular cannula and the burette by suitable rubber tubing. Allow about 5 c.c. of the Ringer-Locke to flow into the jugular and then close the clamp on the rubber tube.

III. 2. *Observation of the sp. gr. of the blood.* Bring the test-tube rack and armed pipettes to the preparation table. With a fine pipette empty as much fluid as you easily can from the arterial cannula. Release proximal loop on the femoral artery by moving the weight so that it no longer drags on the occluding thread. The blood from the artery enters the cannula. Let it overflow somewhat, and then draw up into one of the armed capillary pipettes an amount of blood sufficient to rather more than fill the capillary portion of the pipette. Replace the weight so that the thread again occludes the artery. Keeping the free end of the rubber tubing attached to the capillary pipette closed by the mouth, insert the capillary vertically into the test-tube containing sp. gr. fluid 1.054; expel a minute quantity of the blood and note whether as it leaves the pipette it sinks or rises in the fluid. If the latter, repeat in the fluid of next lower gravity, and so on, until a fluid is found in which it does not rise. The sp. gr. of the blood is thus determined.

IV. Open the clip on the rubber tube between burette and jugular vein, and allow 30 c.c. of the Ringer-Locke to enter the circulation. When nearly 30 c.c. have entered repeat the observation on the sp. gr. of the blood. Note that the sp. gr. of the blood is lower than before. After 30 c.c. has entered the circulation close the clamp on the burette-tube and repeat as quickly as possible the observation on the sp. gr. of the blood. Then repeat observations on sp. gr. of blood at intervals of 3 min. for about ten minutes. The blood tends to return to its original sp. gr. Clots which form in the cannula may be removed by passing a fine wire down it and through its neck into the artery.

Obs. 48.
Dilution of the
circulating
blood by saline
injection.

Obs. 49. V. Draw 15 cc. or more of blood from the artery. Wait 5 minutes. **Haemorrhage and sp. gr. of blood.** The sp. gr. will be found to have fallen since the last observation in § IV was made. Remove the test-tubes, capillary pipettes, &c., from the preparation table.

Obs. 50. VI. 1. Place on the experiment table the vertical iron standard carrying the bottle containing about 300 c.c. of Ringer-Locke fluid warmed to 38° C. **Perfusion of kidney with normal saline.** See that the level of the fluid is about 70 cm. above the preparation. The rubber tube attached to the exit of the bottle should be long enough to reach down to the preparation easily; place the standard so that this tube can reach the left kidney, which is to be exposed. The tube should fit the arterial cannula you are going to use, and should be provided with a spring clamp.

VI. 2. Make a free incision along the mid-line of the abdomen from xiphoid nearly to pubes. Drawing the intestine towards the left side of the abdomen, push the scalpel through the right wall of the abdomen far back and from within, and carry a free incision lengthwise down it. Through this opening push the omentum and intestines, thus evacuating the abdomen of them. Place round them where they lie outside the abdomen a moist warm wrapping of cotton-wool squeezed out in warm Ringer-Locke. Observe the left kidney and renal artery and vein. With the curved mounted needle place round the renal artery three fine silk-thread loops. Tie tight the one farthest from the kidney. Attach artery-forceps to the loop nearest to the kidney and with it occlude the artery temporarily. Cut an oblique slit with fine scissors half through the artery a couple of mm. on the heart side of the middle loop; insert an arterial cannula with its nozzle directed towards the kidney, and secure it by tightening the noose round its neck.

VI. 3. Repeat this procedure on the renal vein, securing in it a small glass cannula with its point directed toward the kidney; this cannula should be previously armed with about 10 cm. length of rubber tube carrying a small point-ended piece of glass tube. Bring the rubber tubing from the pressure reservoir of warm Ringer-Locke to the preparation and, unclamping it but controlling its outflow between finger and thumb of left hand, establish connexion free from all air-bubbles between it and the cannula in the renal artery. The pressure-head may be about 70 cm. of water. The fluid perfuses the kidney and, admixed with blood, escapes from the renal vein cannula and tubing in a rapid stream of drops. Receive this stream in a small shallow beaker, fixing the tubing over the edge of the beaker by modelling clay in such a way that the drops drip from the glass point and are therefore small.

See that renal artery and vein are not twisted or kinked. Count the drops issuing in 20". Observe the appearance of the kidney.

VII. When the rate of outflow seems steady, inject 1 c.c. of adrenalin solution 1 in 20,000 into the lumen of the rubber tube attached to the renal artery. This can be done by filling a hypodermic syringe with the solution (all air-bubbles excluded) and thrusting the needle obliquely through the rubber tubing about 5 cm. from the arterial cannula. 17 div. of the syringe scale = 1 c.c.

Obs. 51.
Adrenal extract
and the renal
vessels.

In a few seconds the rate of flow from the venous cannula begins to be less. Observe the no. of drops per 20" from interval to interval. Observe the appearance of the kidney.

VIII. Mix one drop of amyl nitrite with 1 c.c. of Ringer-Locke and inject this, as above, into the arterial tube. After about two minutes the outflow-stream increases.

Obs. 52.
Amyl nitrite and
the renal vessels.

ANNOTATION

Obs. 47, 48. Spec. grav. of blood. The method used is that of Roy (*Jnl. of Physiol.* vol. v, p. ix, 1880). These reactions can be observed with greater completeness by the haemoglobinometer, for instance the Haldane haemoglobinometer, or by the haematocrit.

Obs. 51. Adrenal extract; compare with the previous results in exercises I, obs. 4, VI, obs. 22, and VII, obs. 32. Pituitary extract, although causing vasoconstriction in most organs, causes dilatation of the renal vessels along with diuresis: cf. exerc. X, obs. 44.

Obs. 52. Cf. result in exerc. VI, obs. 24.

EXERCISE XII

SALIVARY SECRETION; AIR EMBOLISM; EXPANSION OF LUNGS BY ASPIRATION

I. See that the preparation at your table is in good order. Note that it is decerebrate. It may not require artificial respiration. At the time of decerebration the r. and l. carotids were occluded by ligatures; the r. artery was released about 5' after decerebration, freeing the circulation in the right submaxillary region. *See that it is still free.*

II. Have ready for use, besides the ordinary apparatus as in exerc. IV, the following:

(1) A thin-walled narrow glass cannula (Pl. VI, fig. 3, facing p. 75) drawn to fine capillary size for about 15 mm. at one end, and with the lips of this end sloped off on grindstone and smoothed by slight fusion in the

flame: this is the cannula for the submaxillary gland duct: see that it is clean and patent throughout.

(2) A piece of barometer-tubing, about 2 mm. bore and about 50 cm. long, armed at one end with 10 cm. of small rubber tubing, and fixed horizontally in a clamp carried by a chemical standard. A good plan is to use a tall standard on large base, the standard tall enough to reach at least 10 cm. higher than the experimental table on which the preparation lies.

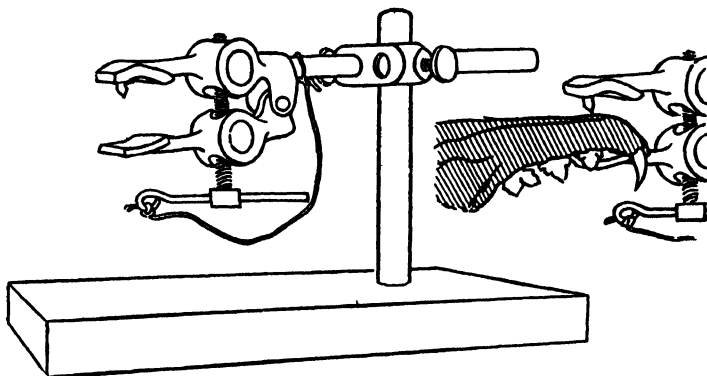

TEXT-FIG. 29. Mandible-clamp for bulbo-spinal preparation, carried by short standard on a leaden base. To the right, the way in which the clamp engages the mandible, the small projecting screw catching behind the symphysis as the clamp-screw is turned.

(3) Needle-syringe (see that this is clean and in good working order) and atropine sulphate, 1 per cent. sol., as in exerc. V.

(4) Pilocarpine nitrate, 2 per cent. sol.

(5) A watch-glass.

III. *Operation* (Pl. VI, figs. 1, 2, facing p. 75). Place preparation supine, with limbs symmetrically post-tracted by clip-weights. The symphysis of the mandible is secured between the blades of a small retort-clamp, the under blade lying just posterior to the canines, the screw-tooth in the other blade lying close behind the symphysis of the jaw (text-fig. 29). This clamp is best fixed to the stable standard by an obliquely adjustable screw-clamp, allowing the mandible to be fixed in its natural position sloping upward and forward, the preparation being supine.

Skin incision: along mid-ventral line from 1 cm. behind symphysis of jaw in front to hyoid bone behind; the hyoid can be felt through the skin in the mid-line about 1 cm. in front of top of thyroid cartilage. From ant. end of this incision a lateral one at right angles to it to the preparation's right side as far as the ramus of the jaw; from post. end of median incision a lateral one at right angles to it and extending 3-4 cm. to the right. Reflect the skin

laterally as far as the outer border of the lower jaw (Pl. VI, fig. 1). Note the masseter muscle covering the posterior part of the mandible. The field of structures thus exposed is mainly a muscular one, but at the posterior lateral part of it, and close median to the angle of the jaw, can be seen, lying in an area between two veins which meet behind it to a trunk receiving the hyoid vein, two large lymphatic glands covered by a smooth tough capsule. The muscles seen are the mylohyoid in the median field overlapped laterally by the digastric. The latter at a point in its median edge opposite the lymphatic glands shows a whitish structure, the tendinous intersection between its anterior and posterior bellies; this intersection lies about 0.5 cm. in front of a transverse line drawn between the angles of the jaw. Note the transverse direction of the fibres of mylohyoid, and the antero-posterior direction of those of digastric. Make out the delicate dentated tendinous intersection between right and left halves of mylohyoid as exposed along the anterior half of the median edge of the wound; make out also the posterior border of the mylohyoid. At the posterior edge of mylohyoid and plunging forward and medianward under it, but also visible through the muscle, note a large nerve-trunk, hypoglossal. Beginning at the hinder edge of the muscle close to, but without injuring, hypoglossal nerve, cut through the thin sheet-like mylohyoid near to the median line and right up to the anterior end of the wound. Carefully reflect the muscle laterally along with the digastric quite to the ramus of the jaw for the anterior two-thirds of the length of this latter. In thus reflecting the mylohyoid and digastric there comes into view (Pl. VI, fig. 2), between them on the lateral side and the tongue muscles on the median side, the lingualis nerve crossing transversely the ducts of the retro-lingual and submaxillary glands. A small vein usually comes from the tongue and passes across the ducts to perforate mylohyoid about 6 mm. anterior to the lingualis. This must be double-tied and severed between the ligatures. The mylohyoid and digastric should now be detached in front from the horizontal ramus of the jaw, starting from a point about 1 cm. from the symphysis and going backward as far as the anterior edge of masseter muscle. Retract these muscles lateralwards by a heavy clip-weight and the cut edge of the mylohyoid medialwards. Lingualis nerve can be followed deeply under the ramus of the jaw. Of the two salivary ducts running forward close together and parallel with one another in the valley between ramus of jaw and the muscles of the tongue, the median is Wharton's (submaxillary), the other is the retro-lingual. Do not clear the ducts by dissection, but bring them more into view by stretching the oral mucosa with your finger from within the mouth.

[*The additional observation of Reflex salivary secretion Obs. 53 is described on p. 129.*]

OBS. 54.

Secretory
action of
corda
tympani.

IV. Draw the tongue forward and to the left with a clip-weight and dry the mucosa with a cotton-wool pledget. Note that the lingualis nerve, as traced in the distal direction along its course, gives off, proximal to crossing the ducts, two lateral branches (Pl. VI, fig. 2); one, the larger, turns forward, the other, much smaller, a delicate filament sometimes difficult to see, leaves the posterior edge of lingualis to pass to the ducts and run along them aborally. This latter is the *corda tympani*, the secretory nerve to the sub-maxillary gland. Ligate the lingualis as far proximally as you can. Faradize it with the coil about 12 cm. on the scale while your colleague observes the mucous membrane to the right side and under the tongue. A bead of saliva on the mucous membrane reveals the openings of the ducts.

Sever lingualis central to the ligature, and lifting by the ligature the distal clump thus made, free it by careful dissection with fine scissors, working towards its crossing of the ducts, but stopping short of the point where the *corda tympani* leaves it, usually about 4 mm. from the ducts.

Under the ducts, as far forward as possible, pass a fine ligature well anterior to the place of crossing of the ducts by lingualis nerve. Tie the ligature tight. Have the duct cannula partly filled with saline solution ready to hand. It is not a matter of importance if some air-bubbles be in the cannula; the flow of saliva will later soon expel them. See, however, before inserting the cannula that it is patent; a little blood may get into the fine capillary end and clot there. Ascertain that it is really patent, e.g. by blowing through it into your saline. Stimulate the nerve again until the secretion of saliva makes the duct more tumid and distinct. Then lifting the tied ligature on the ducts with the left hand, cut an oblique opening in one of the ducts about half through it, 3 mm. or so behind, i.e. on the gland side of, the ligature. It does not matter which of the ducts you choose; the glands of both are supplied by *corda tympani*. If one of the ducts be obviously the larger choose that. Faradize the stump of lingualis prepared proximal to its place of crossing the ducts, the coil being about 15 cm. on the scale and the faradization lasting about 5". A bead of saliva is seen to ooze from the cut in the duct and shows better the lumen of the duct. Taking the tied ligature with the left hand, insert with the other the cannula into the duct in the direction towards the gland. The cannula, if passed for 10 mm. or so into the duct, is gripped by it and requires no ligation to hold it there. When the cannula is in, release the ligature, and let the cannula lie, supported on the tissues. Faradize again for 5"; saliva flows into the cannula.

Bring the barometer-tube to the table into a convenient position and connect it with the duct of the rubber tubing. Bring the fluid column in the barometer tube into view by injecting some saline with a hypodermic syringe

into the rubber junction tube, and see that the outflow is clear. Faradize for 15". Saliva enters the barometer-tube and flows along it during the stimulation at the rate of about 5 cm. per 10". As the stump of lingualis for stimulation is very short, it may be better, for avoiding escape of current, to stimulate it by the unipolar faradization method. The stigmatic electrode for that purpose is figured (Pl. VI, fig. 4). Note that no swallowing ensues on the stimulations. Set the barometer tube vertical and faradize again. Note pressure. Collect some saliva for chemical examination. Faradize and observe the colour of the tongue on its right side.

V. Fill the needle-syringe with pilocarpine nitrate, 0.2 per cent. solution. Inject 0.5 c.c. into a saphenous vein (see exerc. V). Observe the effect upon the salivary flow.

Obs. 55.
Pilocarpine and
salivary
secretion.

VI. Fill the needle-syringe with 1 per cent. atropine sulphate solution. Prepare the saphenous vein at the ankle (cf. exerc. V). Inject half the syringeful into the vein. Faradize the corda tympani again; note the result.

Obs. 56.
Atropine and
salivary
secretion.

VII. Expose a jugular vein low down in the neck. Insert and ligate into it a glass cannula directed towards the heart. Attach a short piece of rubber tubing to the cannula. Inject with a syringe some air into the vein; note the effect of the air-embolism.

Obs. 57.
Air-embolism.

VIII. Two pressure-bottles of about 2 litres capacity each, and with their lower tubulures connected by a rubber tube about 0.75 metre long, are provided. Each bottle is about one-third filled with water. One of the bottles (A) has in its upper tubulure a stopper (cork or rubber) through which pass two glass tubes. One of these, of about 6 mm. outer diameter, is narrowed, giving a constriction about 1 cm. above its lower end, so that the trachea can be secured to it by a ligature and will not slip off it. The upper end of the other glass tube has a short piece, e.g. 3 cm., of rubber tube attached that can be closed by a spring clip. The two bottles are placed side by side on the table. The upper tubulure of A should have an internal diameter of at least 3 cm.

Obs. 58.
Expansion of
the lungs by
aspiration:
pneumothorax.

Dissection. The carcass, detached from the ventilation-pump, is placed supine, and the heart, lungs, and trachea are removed from it. This can be suitably done with a large strong pair of scissors thus: Standing on the right side of the carcass, pick up with the left hand a fold of skin over the mid-line of the lower part of the sternum and lift the wall of the thorax, and with the scissors in the right hand cut open the upper part of the abdomen by a cut transverse to the mid-ventral line just below the xiphoid of the sternum.

Carrying the cuts with the scissors well lateral and then headward through the ribs both to right and left, expose the contents of the chest without injuring them. Lifting up the flap so made in the ventral wall of the chest, extend the flap into the base of the neck through the first ribs and clavicles. The heart, lungs, and trachea have thus been laid bare. Cut the trachea across below the place of insertion of the tracheal cannula. Grasping the upper end of the trachea with the left hand and lifting it, free it by tearing the loose connective tissue, assisting with a few cuts with the scissors; follow the viscera down into the thorax and free similarly the lungs and heart entirely, taking care not to injure the lungs. Cut the venae cavae and aorta. Remove the trachea, lungs, and heart so freed; probably a length of the oesophagus is attached to them; this can be stripped from them.

Remove from the upper tubulure of bottle A the cork with its two glass tubes. Draw the upper end of the trachea over the lower end of the glass tube unprovided with rubber and clip, and secure the trachea to it by a strong ligature, tying at the constriction. Lifting the lung-heart preparation by the cork with the left hand, push the heart gently through the upper tubulure of bottle A and then the lungs, and reinsert the cork into the tubulure. The lungs are collapsed and hang with the heart in the bottle. Close the clip on the rubber tube of the other glass piece passing through the cork.

Bring the other pressure-bottle over the table-edge and lower it to about 30 cm. below bottle A. As the water runs out of A into the other bottle the lungs expand. Note the manner of their unfolding.

ANNOTATION

Obs. 53-6. Salivary secretion is a striking instance of secretion under nervous control. The secretory action of *corda tympani* was first shown in the mixed lingualis-corda nerve (in the dog) by C. Ludwig (1851, *Mitth. d. naturforsch. Gesellsch. z. Zurich*, No. 50); Cl. Bernard definitely traced the effect to the corda tympani (1858, *Compt. rendus*, Paris, Jan. 28; *Leçons sur la physiol. et la path. du système nerveux*, tome ii, p. 146; Paris, 1858), and he first called attention to the concomitant vasodilator action of the nerve on the gland (*Journ. de la Physiologie*, tome i, p. 651; Paris, 1858). He had previously discovered (1851) vaso-

constrictor nerves. For corda-secretion in the submaxillary of the cat, refer to J. N. Langley, *Jnl. of Physiol.* vol. i, p. 86, 1878; vol. vi, p. 92, 1885; and vol. xi, p. 128, 1890. Also to the same for influence of atropine and pilocarpine, and indeed for all points connected with the secretion part of the exercise. Consult also Pavlov's *Physiology of Digestion*, transl. by W. H. Thompson, 2nd edit. 1910. For the anatomy of the salivary glands of the cat consult Ranvier's *Étude anatomique*, *Archives de physiol. norm. et pathol.*, p. 240; Paris, 1886.

In § IV the lingualis nerve, after being

PLATE VI.

Fig. 1.

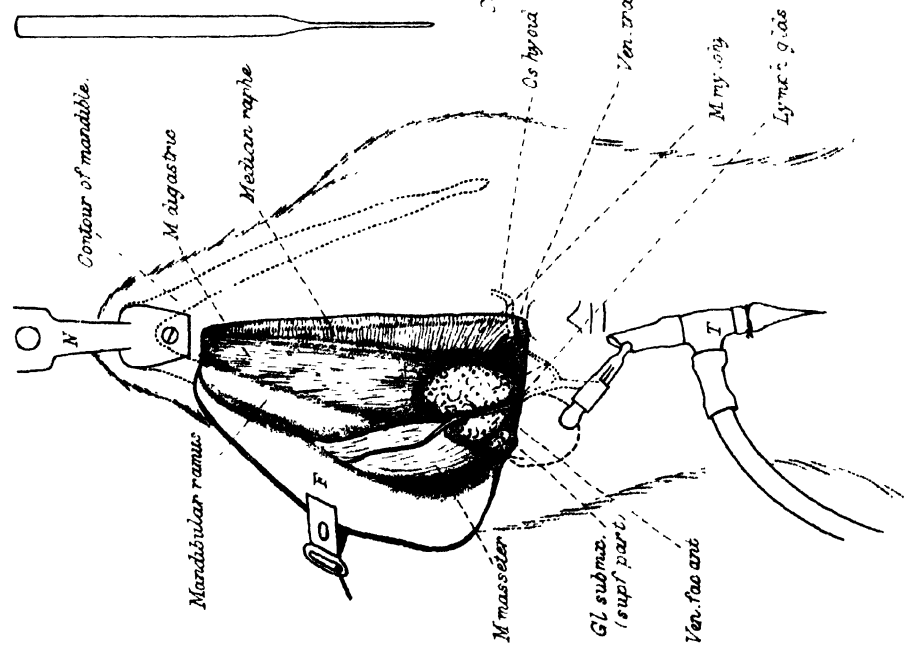

Fig. 1.

Fig. 4.

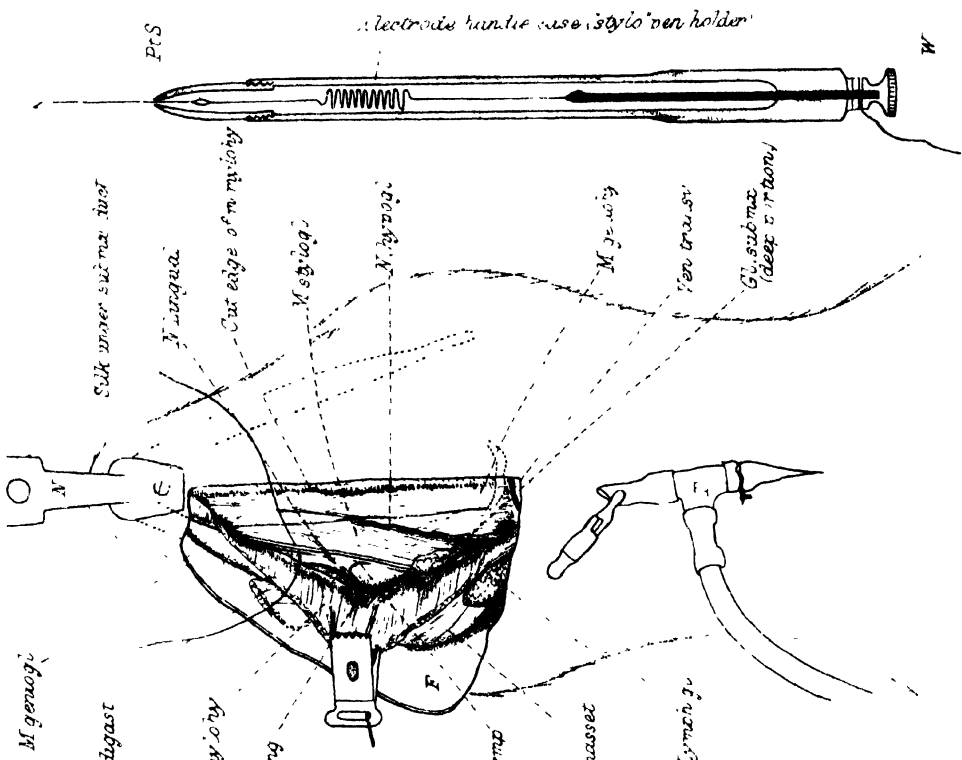

Fig. 2.

severed centrally, is used merely as a convenient structure for supporting the corda tympani, which by itself alone is too minute and delicate to be handled isolatedly for the application of the electrodes.

In repeating this exercise the anterior

belly of digastric need not be so fully detached as before acquaintance with the dissection, and the mylohyoid muscle's post. edge having been found, that muscle can be incised nearer the line of the ducts, and not so much of it reflected.

PLATE VI

OBSERVATIONS ON SALIVARY SECRETION (Exerc. XII).

FIG. 1. Operation, 1st stage. F, skin-flap; T, tracheal tube; N, ventral blade of jaw-clamp.

FIG. 2. Operation, 2nd stage; gland ducts and corda tympani nerve exposed. F, skin-flap.

FIG. 3. Glass cannula for duct, actual size.

FIG. 4. Stigmatic electrode for unipolar faradization (exerc. V). W, stout wire; PtS, junction of silver wire spring with platinum terminal.

EXERCISE XIII

REFLEXES OF PHARYNX AND LARYNX. GRAPHIC OF RESPIRATORY MOVEMENT OF CHEST AND ABDOMEN; INFLUENCE OF DEGLUTITION UPON THEM. INFLUENCE OF SEVERANCE AND OF STIMULATION OF THE VAGUS ON RESPIRATORY RHYTHM

I. The decerebrate preparation provided for you is supported by a vertical standard so that pharynx is well raised. See that it rests in a position allowing freedom for the chest movements.

II. Have in readiness, in addition to the ordinary apparatus, the following:

(1) Small laryngoscope mirror on wire handle, for insertion against the fauces. If your working-place is in a good light the large laryngoscope mirror for wearing on the forehead is not required, the pharynx being open to inspection without it in the decerebrate preparation; (2) large watch-glasses containing (a) water, (b) 25 per cent. alcohol, (c) olive oil; (3) a fountain-pen filler with the usual rubber cap, and marked at a point indicating 0.5 c.c. of content; (4) a long bristle mounted on a penholder; (5) the wire stethograph (text-fig. 30).

See that the kymograph is arranged for carrying the recording-paper slowly; see that the paper travels from right to left when viewed from in front.

OBS. 59.
Inspection of
respiratory
movements of
larynx.

III. Clear the faucial entrance to pharynx of mucus with a moist swab. Turn preparation so that the light falls into faucial entrance. The head should not be flexed, but rather extended on neck. Observe soft palate; draw tongue forward; observe epiglottis, the free end of which is probably in its normal position, i.e. tucked up above edge of velum palati. Stitch a beaded thread to tip of epiglottis. Keep tongue drawn forward by clip-weight to tip. Observe the vocal cords by resting the warmed laryngoscope mirror against the back of the soft palate: note the vocal cords and their respiratory movements; they move wider apart at each inspiration.

OBS. 60.
Reflex swallow-
ing.

IV. Place 1 c.c. of water on middle of dorsum of tongue. No response. Place 1 c.c. of water on tongue farther back, so that it runs into the glosso-epiglottidean pockets. Swallowing follows. Note that inspiration is inhibited at each swallow. Insert the tip of the little finger into the pharynx and press lightly against the posterior wall. Observe the constrictive contraction when deglutition ensues.

Slit soft palate sagittally in middle line nearly back to its posterior edge.

With a moistened small camel-hair brush press against the roof or top of posterior wall of pharynx, imitating pressure of a bolus. Swallowing ensues.

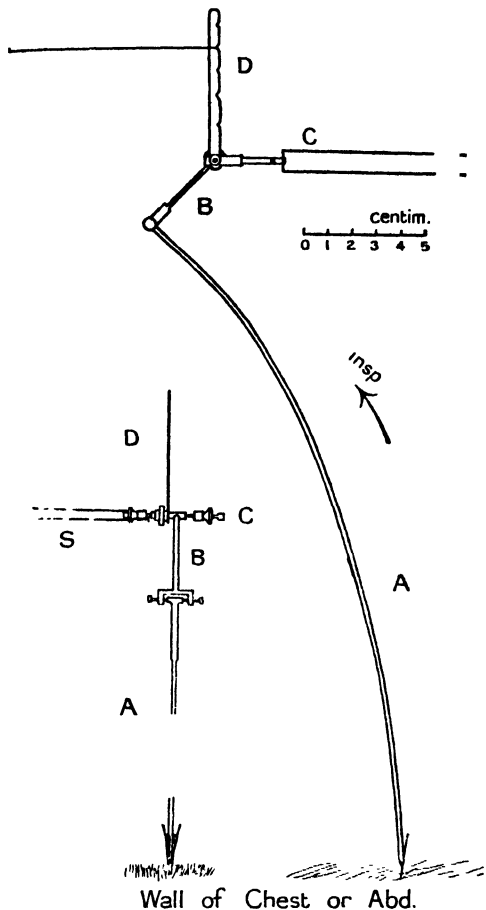

TEXT-FIG. 30. Simple stethograph for respiratory movements of chest or abdomen. A, stiff wire stem hinged to B, which in turn is fixed to a bearing shown in the left-hand figure at C. The bearing carries also fixed to it the short thin aluminium piece D, to which a thread going to an ordinary myograph lever (not shown) is attached. The wire stem is armed with a needle-point to obviate its slipping on the skin. The bearing is carried by C, which is rigidly attached to a holder S, clamped to any suitable standard.

the water quickly but gently into the pre-epiglottidean pouch, not touching

V. Touch lightly with the tip of a long bristle mounted on a penholder the anterior end of the arytaenoid cartilage or the mucous fold between the arytaenoids. Sharp protective closure of glottis immediately ensues, so forcible sometimes as to produce an audible click; also a reflex strong expiratory cough.

OBS. 61. Reflex closure of glottis; cough.

VI. Note point near xiphoid where respiratory movement seems most ample. Bring stethograph to table and place receiving end of it on the spot chosen in ventral wall of preparation. See that movement of vertical limb of recorder is as free as possible. Adjust table and preparation so that distance from vertical limb of recorder to kymograph crank-lever recorder is sufficient to keep taut the thread between them. Attach thread of recording-lever to the stethograph arm. Kymograph should be running slowly.

OBS. 62. Graphic of respiratory movements of chest.

Record respiratory movement, arranging that inspiration is recorded by an upstroke. Note that the inspiratory movement lasts longer than the expiratory, and that the expiration is followed by the expiratory pause (text-fig. 31).

VII. Load a pipette (the fountain-pen filler) with 0.5 c.c. water. Inject

OBS. 63. Phagetic efficacy of water, dilute alcohol, and oil.

Arrest of respiratory movement by swallowing. the mucous surface with the glass pipette. Observe the promptness of the ensuing swallow and the number of the swallows induced—usually one. Note that the respiratory movement is inhibited during the swallowing.

Take up 0.5 c.c. of the dil. alcohol (1 part ethyl alcohol, 3 parts water) in the pipette and repeat the procedure, introducing it into pre-epiglottidean region. Observe result—a prompt swallow, followed usually by 3 or 4 more.

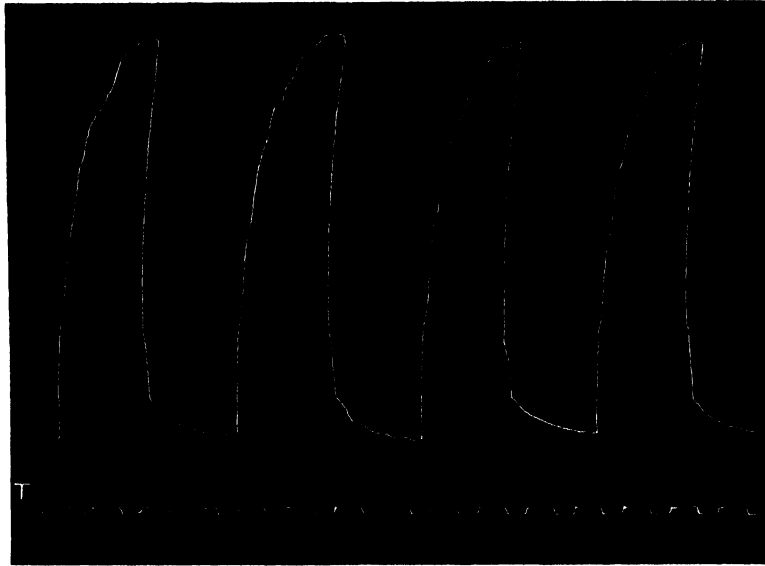

TEXT-FIG. 31. Respiratory movements of chest (bulbo-spinal preparation) recorded by stethograph of text-fig. 30 (L. S. Laffitte). Inspiratory movements upward; expiratory movements followed by respiratory pause. T, time in seconds.

Repeat the observation with 0.5 c.c. water. Take up 0.5 c.c. oil in the pipette: introduce it into pre-epiglottidean pouch as before. Note result—usually no swallow, or one only after long delay. Repeat the observation with 0.5 c.c. water.

OBS. 64.
Reflex swallowing by stimulation of superior laryngeal nerve.

VIII. *Operation.* Lower preparation and place it supine on table with clip-weights to feet, extending them symmetrically. Expose the superior laryngeal nerve. To do this, follow upward carefully the dissection, already made in the preparation supplied you, for ligating the carotid. Double tie the submaxillary vein and sever it between the ligatures; extend the wound deeply behind the angle of the jaw; a branch from the vagus nerve will be met sloping downwards and inwards to enter the side of the larynx above the thyroid cartilage: this is the superior laryngeal nerve. Ligature it close to

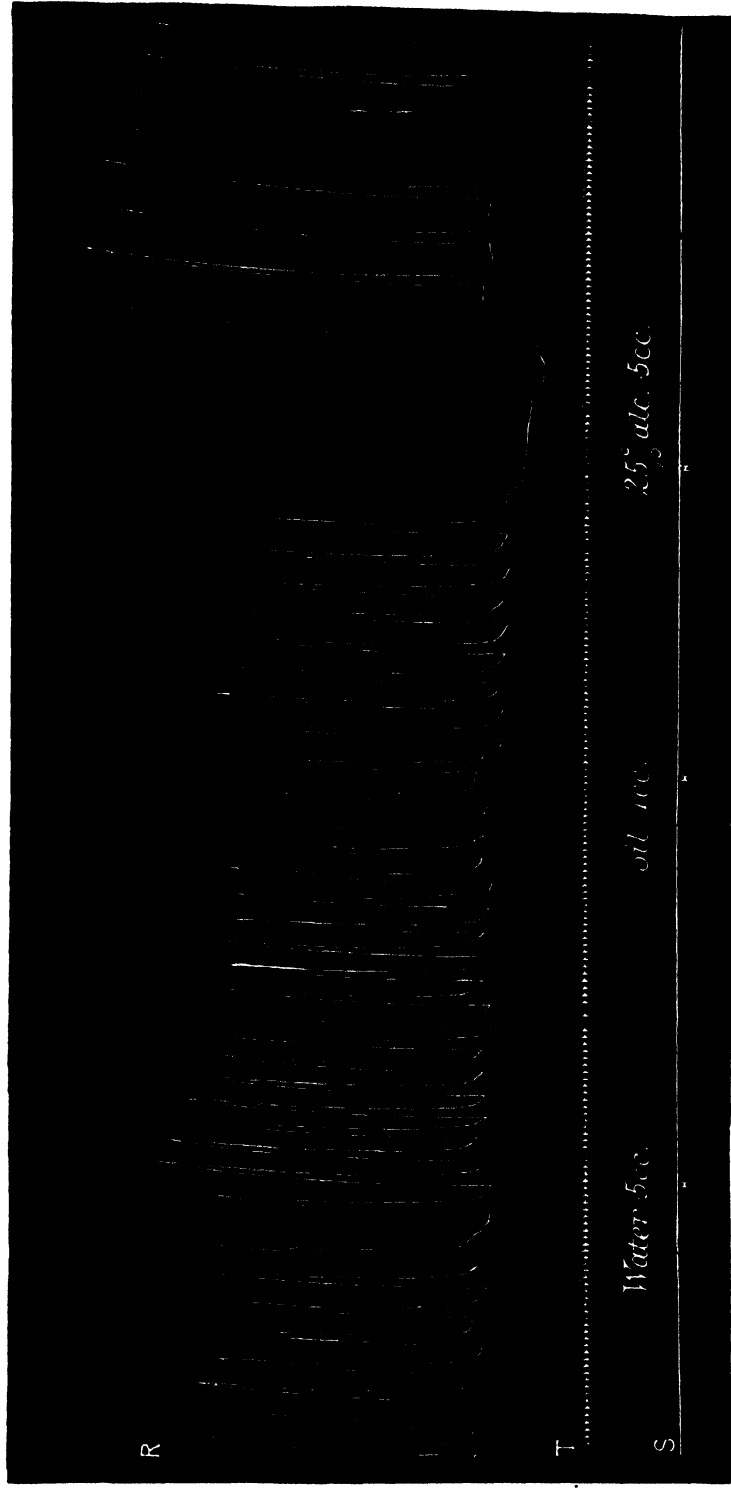

TEXT-FIG. 32. Respiratory movements of chest by recording stethograph of text-fig. 30, showing respiratory interruptions induced by reflex swallowing; bulbo-spinal preparation (E. H. Cluver and J. G. Johnstone). R, stethograph record; T, time in seconds; S, signal marking introduction of water 0.5 c.c., of oil 1 c.c., and of ethyl alcohol (25 per cent. in water) 0.5 c.c. into glosso-epiglottidean pouch.

larynx, carefully dissect it proximal to ligature for about 15 mm. Sever distal to ligature.

Faradize the lifted proximal stump, the secondary coil being at a distance from primary such as just suffices to cause contraction of muscle when applied to some muscle exposed in the preparation, e.g. about 22 cm. on the induction scale. A strong stimulus will excite other reflex effects and not swallowing. Note result—a promptly evoked swallow, or a series of swallows, and temporary arrest of respiratory movements; also closure of the glottis.

These can be recorded by attaching a thread with a small hook to hyoid bone, a headward movement of larynx accompanying each swallow. Note the refractory period of the reflex swallow and the inhibition of respiratory movement of chest.

OBS. 65.
Vagus and
respiratory
rhythm.

IX. Expose right and left vagus nerves in neck well below the cricoid cartilage. Also the right recurrent laryngeal on trachea (exerc. IX). Note movements of vocal cords again; then cut right recurrent nerve; observe the motionless paralytic position of right vocal cord. Adjust carefully the record of movements of respiration of chest-wall, and when this is running regularly cut with a single snip of sharp scissors the right vagus nerve in neck where exposed below the cricoid cartilage. Observe that slower and ampler movement of ventilation of chest ensues. Observe further effect on the record. Ligate central end of right vagus and faradize mildly the central stump. Observe effect on the record; with very weak stimuli, short arrest of respiratory movement in the expiratory position; with stronger, a longer arrest in the inspiratory position, followed by quickened rhythm. Cut the left vagus; the respiratory rhythm becomes still slower and deeper. Detach recording stethograph. Observe interior of larynx.

ANNOTATION

Obs. 60. That even the first phase, the lingu-faucial, of deglutition is essentially a reflex act was pointed out first by Marshall Hall, 1836 (*Lect. on the Nerv. System*; London). Alcock (*Dubl. Jnl. of Med. Science*, vol. x, p. 260, 1836) and Magendie (*Leçons sur les fonctions du système nerveux*, vol. ii, p. 293; Paris, 1839) showed a direct afferent nerve for it to be glosso-pharyngeal.

Obs. 63. Longet (*Traité de physiologie*,

tom. 1, p. 110; Paris, 1842) and Meltzer (*Arch. f. Physiol.* p. 212; 188) examined the inhibition of the respiratory rhythm which accompanies deglutition. That rhythmic reflex deglutition along with respiratory arrest and closure of the glottis is evoked by faradizing the central end of the superior laryngeal branch of the vagus was noted by the elder Waller and J. L. Prevost, 1870 (*Archives de physiologie normale et pathologique*, tom. iii, pp. 185 and 343; Paris).

Obs. 65. Careful study of the effect on the respiratory rhythm of severance of the vagi in the neck was first undertaken by Legallois, 1812 (*Expériences sur le principe de la vie*, p. 160; Paris), the discoverer of the bulbar respiratory centre. On the whole question of the respiratory effects of severance and stimulation of the central ends of the vagi consult the masterly paper by H. Head, 1889 (*Jnl. of Physiol.* x. 1-70, 279-90).

EXERCISE XIV

VASO-DEPRESSOR AND CARDIO-INHIBITORY REFLEXES; THEIR DISSOCIATION BY ATROPINE. VASO-PRESSOR REFLEX FROM AFFERENT LIMB-NERVE

I. The preparation provided is decerebrate. See that it is in good condition; if necessary, the 'blower' should be attached.

II. With the 25 per cent. aqueous solution of ethyl-urethane provided inject intraperitoneally about 0.5 grm. urethane per kilog. of body-weight. Or if reliable curare is available inject a small dose intravenously [and begin artificial respiration]. This is in order to obviate the reflex movements of the skeletal muscles during the experiment.

III. Arrange the induction apparatus for faradic stimulation; the kymograph, &c., for arterial-pressure record. Set the Ringer-Locke fluid warming to 38° C. Have ready a needle-syringe for intravenous injection. Some atropine sulphate, 1 per cent. sol., is provided in a small test-tube.

IV. Expose the carotid of the left side and prepare it for connexion with the kymograph in the usual manner (exerc. V), but do not actually connect it yet.

V. Expose the peroneal nerve at outer side of right knee.

Operation. Lay the preparation on its side with the hind-limb on which the nerve is to be exposed uppermost and extended at knee by a weight attached to foot. Make out through the skin the head of fibula and the posterior border of the biceps muscle running over outer side of top of calf. About 1 cm. in front of posterior edge of biceps, and parallel with it, make a 5 cm. skin incision, starting above about level of fibular head, but well behind it. The thin biceps muscle is then seen and through it the peroneal nerve-trunk running deep to and parallel with the muscle's fibres. Cut down to it. Ligate it at distal end of wound, sever distal to ligature, and free it for 3 cm., raising it by the thread of ligature. The operation involves no

Obs. 66.
Vaso-pressor
reflex.

bleeding. Connect the carotid artery to the manometer. (N.B. The arterial pressure of decerebrate preparations is usually higher than that of decapitate.)

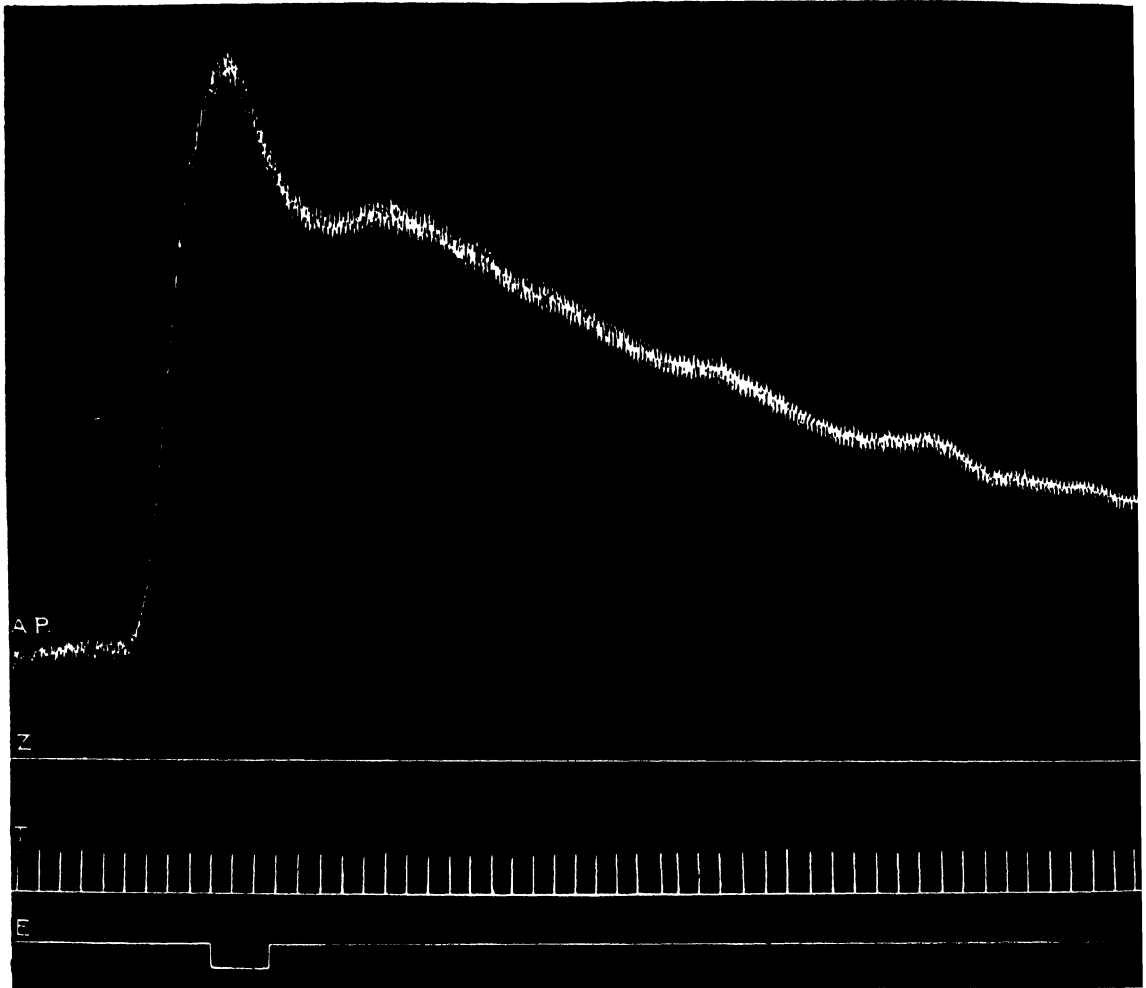

TEXT-FIG. 33. Carotid-pressure record showing pressor reflex evoked from afferent nerve; decerebrate preparation (J. H. Mather and C. S. S.). A.P., carotid pressure by Hg manometer; z, abscissa-line of arterial pressure; T, time in 5" intervals; E, signal-line showing duration of the faradization of the central piece of the severed peroneal nerve. Curare had been given to obviate reflex movement of the skeletal muscles, but this is not necessary.

Faradize the central end of the peroneal nerve. Observe the blood-pressure record; it rises in result of this stimulus (text-fig. 33).

OBS. 67. VI. *Operation.* Place preparation supine with all four limbs symmetrically extended. Fix the symphysis of the mandible in the mandibular clamp.
Depressor nerve.

It may be convenient now to disconnect the left carotid artery from the cannula. Occlude the artery with the looped ligature. Expose the right vagus and sympathetic in the upper part of the neck by the dissection already described (exerc. IV, Pl. II). Before separating them at all expose them forward well beyond the level of the thyroid branch from the carotid, following them by turning aside laterally the lowest piece of the submaxillary gland, and reaching the superior laryngeal branch of the vagus nerve. Look for a small nerve running along with the vagus and sympathetic. This may not be easy to detect. One way is to lift the whole conjoined vago-sympathetic and note whether it is not distinguishable into three strands: the smallest of the strands will be the depressor. The sympathetic in the undisturbed position of the nerve stands lies medial to and slightly behind the vagus and is considerably smaller than the vagus.

The depressor nerve is a filament much smaller again than the sympathetic and usually runs along with the vagus on the medial aspect and slightly in front of that trunk: a minute blood-vessel on the vagus-sheath often marks the separation between the vagus and the small nerve sought. The sympathetic at this level lies usually on the medial side of the vagus; when it does so the small nerve—the depressor—lies between them and along their superficial aspect. But sometimes the sympathetic early crosses to the outer side of the vagus, and then the depressor does not lie between them. If the depressor nerve is not made out by inspection of the vagus and sympathetic before they are disturbed, it is helpful to free vagus from the tissue it lies on and slip as lifter a small glass slide under it, and raise gently; this flattens the trunk somewhat, and the depressor twig running along with it can then be made out as a slender strand separable from it, though more or less closely adherent to it. If this search fails to find the depressor, search for it by turning to the vago-sympathetic of the other side of the neck.

With a fine-pointed needle mounted in holder scrape gently through the tissue binding the depressor to the main vagus for a length of a couple of millimetres at a level of at least 1 cm. below the cricoid cartilage; then ligate the depressor at that point with fine silk. Cut it below, i.e. on the thoracic side of the ligature. Lifting it by the ligature, carefully isolate it from vagus for at least 2 cm. headward.

Ligate and sever below the ligature the vagus trunk as low down in the neck as practicable, and dissect the trunk up for at least 2 cm.

VII. Connect the left carotid with the kymograph manometer again, taking care to remove any blood-clots before doing so. Take a sample record of the arterial pressure. Note the natural respiratory undulation of the

Obs. 68.
Respiratory
waves of the
arterial pressure.

blood-pressure, the rise *following* inspiration, not preceding it as with pump-ventilation (cf. exerc. V). If the pressure level is irregular it can usually be made steadier by attaching the respiration pump-tube to the tracheal cannula and artificially ventilating the preparation.

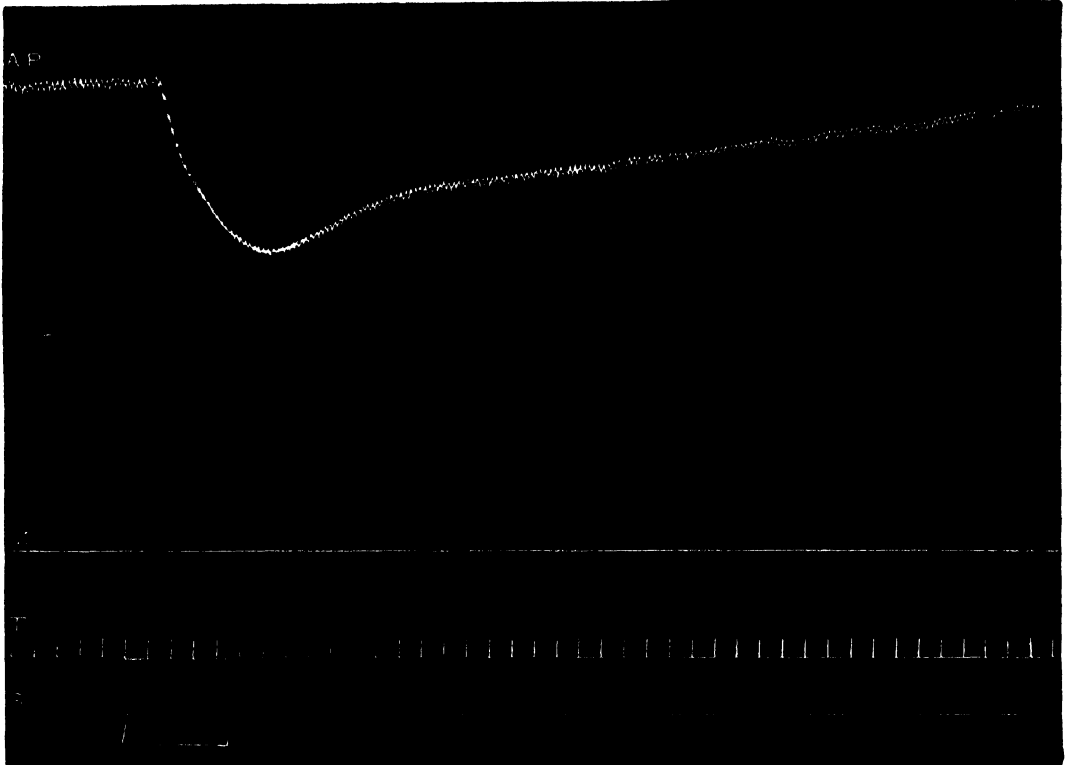

TEXT-FIG. 34. Arterial-pressure record showing depressor reflex evoked from the n. depressor; decerebrate preparation (H. V. Forster and C. S. S.). A.P., carotid pressure by Hg manometer; z, zero-line of manometer pressure; T, time in 3" intervals; s, signal-line showing time of faradization of central end of severed n. depressor.

VIII. Faradize the central end of the prepared depressor nerve with a weak current, not much above the strength which just elicits muscular contraction when the electrodes are applied directly to some muscular surface exposed in the wound, e.g. 15 cm. on the inductorium scale may be about the strength. Note the ensuent gradual though somewhat rapid decline of the mean pressure (text-fig. 34). There may be a slight slowing of the heart's frequency.

IX. Faradize similarly the central end of the prepared vagus trunk. Note the ensuent decline of the carotid mean pressure. There is almost always a slowing of the heart's frequency.

OBS. 69.
Reflex cardiac
inhibition.

Faradize the vagus with slightly increased strength of current; distinct slowing of the heart's frequency will, if not evident before, become evident. This is reflex cardiac inhibition through the cardio-inhibitory centre in the bulb acting on heart *via* efferent cardio-inhibitory fibres in the opposite uncut vagus. If there is no cardiac inhibition the fall of pressure may be preceded by a small rise of pressure. The fall of mean arterial pressure is due partly to the cardiac inhibition (an effect already studied by you in exerc. V), and partly to afferent fibres which, like those in the depressor branch, exert a depressor influence upon the tonic activity of the vasomotor centre in the bulb.

X. To dissociate these two effects give atropine intravenously (for method and dose see exerc. V, p. 31).

Repeat the stimulations of § IX. If the fall of arterial pressure obtained by stimulation of the depressor in § VI has been complicated by cardiac inhibition, repeat also the stimulations of that section.

ANNOTATION

Obs. 66. The peroneal here typifies the effect of most afferent nerves on the blood-pressure. It is the vagus trunk (below its superior, and still more below also its inferior, laryngeal branch), and especially its depressor branch, which are exceptions, exerting depressor effect on the mean arterial pressure.

Obs. 67. Repeats on the cat the discovery, made by E. de Cyon and C. Ludwig, 1866, *Ber. d. Sächs. Gesellsch. d. Wiss., Math.-Phys. Kl.* 307, in the rabbit, that an afferent nerve passing from the heart (aorta) to the bulb by way of the vagus nerve causes a reflex lowering of the

arterial pressure. It does so by lessening the vasoconstrictive tone exerted by the vasomotor centre in the bulb upon the arterial system both visceral and cutaneous, W. M. Bayliss, 1893 (*Jnl. of Physiol.* xiv. 303). The role of the carotid sinus in reflex control of arterial pressure has been investigated by Sollman and Brown, *Amer. Jnl. of Physiol.* xxx, p. 88, 1912; Nash, *Jnl. of Physiol.* lxi, p. xxviii, 1926; Florey and Marvin, *Jnl. of Physiol.* lxiv, p. 318, 1928; and Heymans, *Amer. Jnl. of Physiol.* lxxxv, p. 498, 1928. For 'depressor' reflex action in general consult Samson Wright, *Jnl. of Physiol.* lxvi, p. 387, 1928.

EXERCISE XV

KNEE-JERK; MAGENDIE'S RULE OF THE SPINAL ROOTS

I. The preparation is decapitate. See that it is being ventilated properly and is in good condition.

II. Get ready the inductorium and circuits and the ordinary bipolar hand-electrodes. See that in addition to your usual operating instruments you have (provided for you) the strong cutting bone-pliers for laminectomy and the 'lifting' vertebral forceps (text-fig. 35); nibbling pliers are also useful. Also a zinc- and copper-wire fork for the Galvani observations.

Obs. 70.
The spinal knee-jerk.

III. With the preparation lying on its side, lift one hind-limb by the thigh and, holding it vertical and semiflexed at hip, elicit the knee-jerk by a slight tap, e.g. with the scalpel-handle on the patellar tendon. Note the free flail-like fall of the leg at knee which follows on the brief contraction. This indicates the full relaxation of the vastocruerus muscle after its brief reflex contraction. The completeness of this fall is characteristic of the knee-jerk in conditions where, as in the decapitate-preparation, the vastocruerus and the other extensor muscles are not exhibiting tonic (postural) action. It should be noted for contrast with the decerebrate form of the knee-jerk to be examined in the next following exercise (XVI, obs. 73).

Obs. 71.
Conductive direction of the spinal roots.

IV. Magendie's rule states that of the spinal roots the dorsal are (1) afferent and (2) not efferent, and the ventral are (3) efferent and (4) not afferent. You have therefore four points to establish. The following experiment does this upon the lumbar roots, their 6th and 7th pairs being chosen for preference, because they are large and long, not difficult to expose, and innervate among other muscles tibialis anticus, a muscle easily used for the myograph if desired.

Operation. Place the preparation prone, with the hind-limbs symmetrically extended backward and pelvis raised and supported on a warm bottle, so that the circulation and the ventilation of the lungs are not impeded by pressure against table. The forelimbs flexed at elbow should help to obviate compression of the chest upon the table which, by hindering the venous return to the heart, is liable to flood the vertebral operation wound and obscure the dissection of the roots.

Skin-incision (Pl. VII, fig. 1). Make out, by feeling through the skin, the tops of the iliac crests. Along the mid-dorsal line make out the tip of the spinous process of the 7th lumbar vertebra; it lies (Pl. VII, fig. 1) at the level

of a line drawn across between the anterior edges of the right and left iliac crests, or a little in front or behind it. Passing the finger forward along mid-dorsal line from the 7th spinous process, make out in succession the 6th, 5th, 4th, and 3rd spinous processes. Make a skin incision parallel with the mid-dorsal line about half a cm. to left of that, and from a level close forward of the 4th spinous process in front to a level 2 cm. behind the 7th spinous process behind. At each end of this incision make a transverse skin incision about 6 cm. long and extending somewhat farther to left than to right of the longitudinal incision.

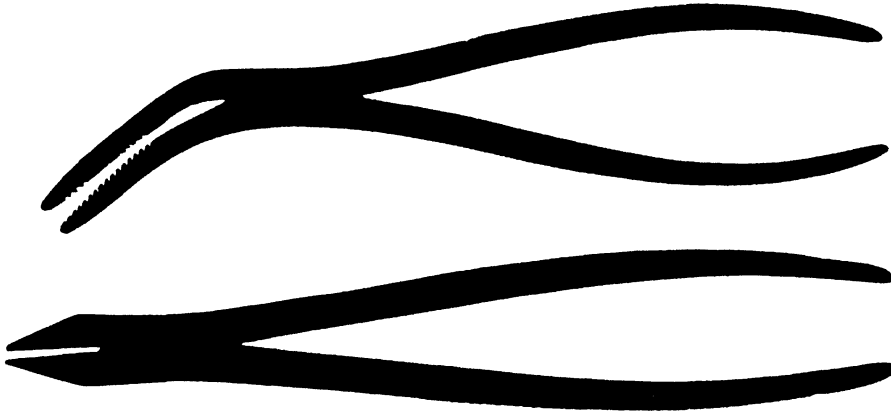

TEXT-FIG. 35. Cutting-pliers for laminectomy, below: above, billed forceps for holding and lifting the vertebral spinous process with left hand while the pliers cut the lamina.

Reflect and retract the skin laterally to each side. The silvery lumbodorsal fascia is exposed, joining laterally, to left, the ext. oblique muscle of the abdominal wall. Make two incisions, one either side of and close to the spinous processes of the 4th, 5th, 6th, and 7th vertebrae, each right through the depth of the muscle down to the bone, keeping close to the spinous processes. Then an incision through the fascia into the muscular mass covered by it along a line just lateral to the easily-felt left articular processes of the same vertebrae. Between the incisions the muscular tissue is removed by rapid dissection, best started from the median side and running laterally, cleaning the dorsal surfaces of the vertebrae (Pl. VII, fig. 2). With the oblique-jawed bone-cutting pliers (text-fig. 35) cut off the articular processes as fully and deeply as possible: the spinous processes are left. Then cut away the spinous process of the 1st sacral vertebra. Then, standing to left side of the preparation, take with the left hand, by means of the oblique-billed bone-forceps (the 'lifting forceps' (text-fig. 35)), the spinous process of the

7th lumbar vertebrae and lift it somewhat; with the right hand engage the point of one blade of the oblique-jawed bone-cutting pliers under the posterior edge of the lamina of that vertebra well to one side of the root of its spinous process, and proceed to cut through the lamina. This can only be done by a succession of small cuts because of the risk of pressing the under blade of the forceps upon the spinal cord in the vertebral canal; with care, the risk of this is small. The cutting through of the lamina is next repeated on the opposite side of the spinous process. The median piece of the lamina thus freed, the spinous process is felt to yield more to the lifting pull of the left hand and can be cut free with strong scissors and removed. The fat covering the spinal theca in the vertebral canal is then seen. The manoeuvre is then repeated for the 6th and 5th and posterior part of 4th lumbar vertebrae, becoming easier as the opening enlarges.

The operator, changing over to the right side of the preparation, cuts out carefully with the tips of the cutting-pliers the lamina of the 1st sacral vertebra. The opening in the vertebral canal (Pl. VII, fig. 3) is next widened by removing with the cutting-pliers or nibbling-forceps the overhanging stumps of the articular processes. In doing this, tiresome bleeding may occur. This can be largely escaped by avoiding wrenching with the pliers, and by keeping the spinal column lifted somewhat by the oblique-billed forceps holding the spinous process of the 4th lumbar vertebra, thus preventing the abdomen of the preparation being pressed against the table. The bleeding is venous, and when it occurs can be lessened by raising the pelvis so as to lift the abdomen slightly from the table. It is a little headward of the truncated stump of each articular process that each corresponding ganglion will be found.

The fat in the canal is carefully pushed aside so as to lay bare the spinal theca. Through this transparent membrane the spinal cord with the dorsal rootlets and median longitudinal blood-vessel (Pl. VII, fig. 3) is seen lying in the clear cerebro-spinal fluid.

With a blunt seeker carefully explore the left lateral edge of the theca and make out the roots of the spinal nerves. The ganglia lie close outside the spinal theca; each is easily found by following a spinal root from the latter's point of emergence from the theca. A guide to identification of the segmental numbers of the roots is that the 7th lumbar root issues from the theca about 3 mm. posterior to a line drawn across between the headwardmost points of right and left iliac crests, which are easily felt. Its ganglion, into which the root plunges after leaving the theca, lies about 4 mm. further back still. Also there is a difference in size between the roots, the 7th being rather thicker than the 6th and often much thicker than the 8th.

A point of the theca at the headward end of the wound is then carefully picked up with the fine dagger-tipped forceps and is snipped open by fine scissors. The cerebro-spinal fluid gushes out, flooding the floor of the wound. This fluid is sopped up with cotton-wool pledgets. The operator, standing to the preparation's right, then engages the tip of one blade of fine-pointed oblique-bladed scissors under the thecal membrane at the posterior end of the small hole cut in it and runs the scissors along the median line backward, slitting the theca for its whole exposed length (Pl. VII, fig. 4), taking care to lift the theca slightly on the under limb of the scissors, so as to ensure the scissors-point not touching the cord itself.

V. The 7th nerve of left side is now returned to. The set of rootlets composing its dorsal root (Pl. VII, fig. 5) is clearly made out tapering peripherally, and spreading out fan-like as it passes to enter the cord at the dorso-lateral fissure of the latter. A vein often runs along with it. A coarse thread is passed under this dorsal root as far down towards its ganglion as practicable and is tied tight. Release the l. hind-limb and let it lie so that any flexion of ankle or knee may be freely seen. Sever the root carefully distal to the ligature, and lift the proximal part of the root by the ligature. Faradize it close proximal to the ligature with fine electrodes of about 2 mm. separation. Observe movement in l. limb. Repeat stimulation mechanically, by ligating. *Dorsal root gives a central response (reflex)*. The ventral root of the 7th nerve can then be clearly seen; note that it is smaller than the dorsal root, and note how it takes a course to reach the more ventral aspect of the cord.

VI. Turn to the 6th nerve (Pl. VII, figs. 5, 6, 7). Observe the line of entrance of its fan-shaped group of dorsal rootlets into the dorso-lateral fissure of the cord. With a curved blunt needle in holder pass a thread under this set of rootlets near, i.e. 4 mm. from, their line of entrance into cord. Tie tight the ligature, and with the fine elbowed scissors carefully cut through the rootlets proximal to the ligature, unless, as often happens, the rootlets give way along that line as the ligature is tied. With the ligature gently raise the bundle of rootlets and trace it peripherally, freeing it where necessary.

Lifting with the left hand the dorsal root of 6th lumbar by means of its ligature, so that it lies free from all fluid and tissue, apply to it, close distal to the ligature, fine-pointed electrodes of about 2 mm. separation, one point on either side of the root. Faradize, beginning with weak currents and somewhat rapidly running the coil up to 10 cm. or 9 cm. No response is

observable, no movement occurs, in result of the excitation. Repeat stimulation mechanically, by ligating.

Stimulation therefore of the dorsal root distal to its place of severance produces no obvious effect either on the limb or elsewhere.

VII. Turn to the ventral root of the 7th nerve; expose it down to where it joins the dorsal root at the ganglion. Ligate it near the ganglion. Cut it distal to its ligature. Raising it by the thread, free it well towards the spinal cord. Faradize it, well lifted from surrounding tissue, and observe whether or no any movement results. Repeat the stimulus mechanically, by ligating. No movement results. *Ventral root gives no central response.*

VIII. The ventral root of the 6th nerve is exposed when the dorsal root is lifted (Pl. VII, figs. 6, 7). Follow the ventral root to the cord under which it plunges. Ligate it as far proximal as possible; cut proximal to the ligature. Lift the root by the ligature and free it by light dissection towards the ganglion. Holding the ligated end well free from fluid and tissues, faradize it as in the previous observations. Note that there is contraction of muscles in the left hind-limb.

Expose the tendon of tibialis anticus to the inner side of the left foot below ankle. Cut and ligate its tendon. The muscle contracts on stimulating the ventral root of the 6th lumbar nerve.

Stimulation of the ventral root distal to its point of severance produces therefore contraction of certain muscles. Its fibres are therefore efferent and motor.

Finally, cut the spinal cord across, behind the attachment of the 7th nerve, and, by cutting the dorsal roots of the 7th and 6th nerves of the right side close to the cord, free it. Attaching a thread to the theca at the posterior end of the freed stump of cord, lift the stump by the ligature. This brings into good view the ventral root of the right 6th nerve and gives favourable opportunity for repeating the above observation. Ligate this close to the cord. Cut it proximal to the ligature. Stimulate with faradization; note the low threshold of stimulation required to give motor effects.

OBS. 72.
Galvani's
experiment
with metals.

IX. A useful and interesting manœuvre for distinguishing the motor roots from the afferent is Galvani's experiment with metals. This succeeds with motor roots but not with afferent—that is, it provokes a muscular twitch in the limb from the motor root, but does not from the afferent, or does so very rarely. The reasons for its failure to provoke a reflex contraction are not far to seek. The stimulus, a brief weak constant current, is not a very suitable one for evoking response through the reflex centre, even when that latter is in good condition. The class preparation, with its low arterial

PLATE VII. Functions of spinal nerve roots, (Ex. XV).

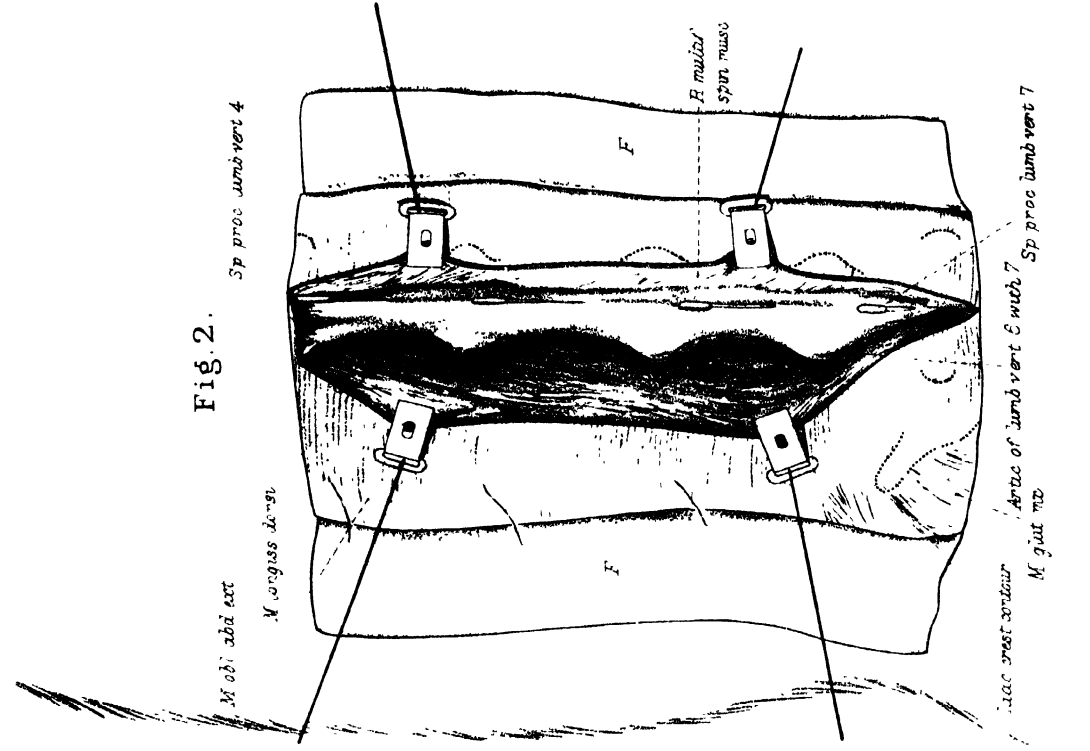
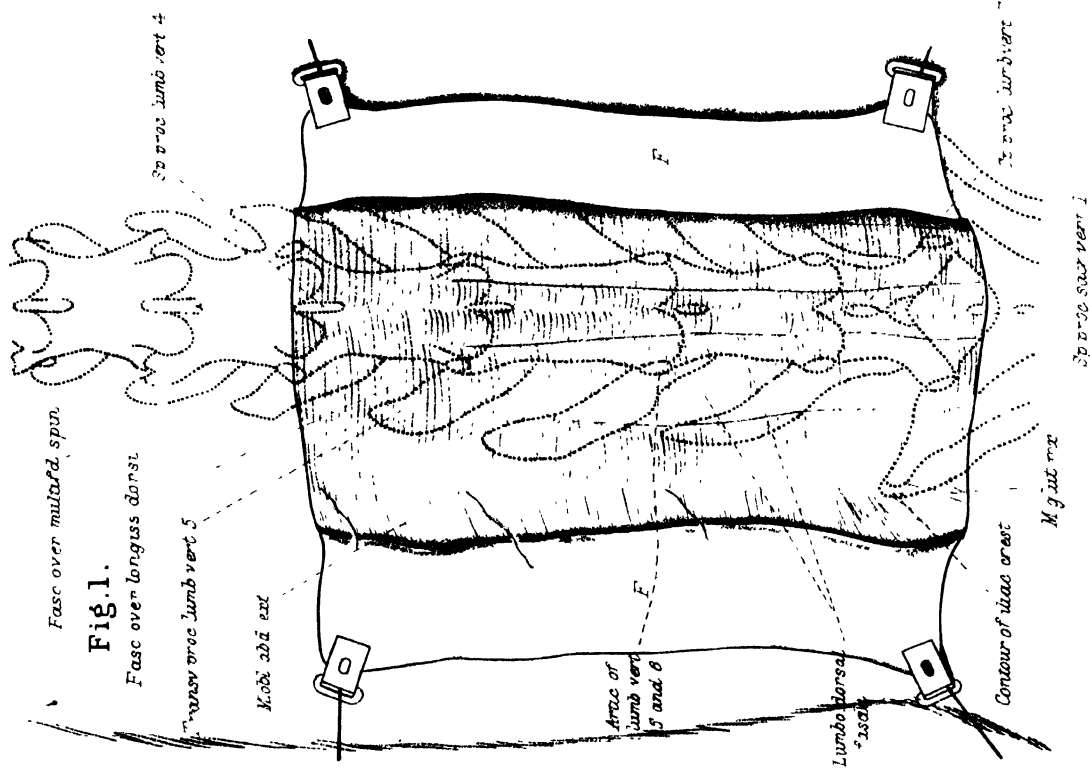

Fig. 1. 1st stage: F, skin flap retracted. Fig. 2. 2nd stage: vertebrae exposed; F, skin-flap.

pressure after decapitation and a fall of body temperature which can hardly be avoided, will probably exhibit somewhat depressed reflex power.

The Galvani experiment can be readily made by applying a small Y-shaped fork of copper and zinc wire soldered together at the handle end. The stalk end of the Y is held in the hand, and of the two free ends, one copper, one zinc, and 3 mm. apart, one is brought under the root-bundle it is desired to test and the root-bundle lifted on it so as to be insulated in air for about 6–7 mm. The handle of the Y-wire is then rotated slightly, so as to make its other free end touch the root-bundle; if the root is motor a twitch results.

Or the experiment can be done by raising the root-bundle with the small brass handle-hook used for separating the roots, and then touching the root with the point of the fine scissors, touching with the scissors at the same time some part of the brass wire of the hook.

ANNOTATION

Obs. 70. The knee-jerk stands as prototype of a numerous group of reflexes of the proprioceptive class. For recent work see: Fulton, J. F., and Liddell, E. G. T., *Proc. Roy. Soc.* vol. 98 B, p. 577, 1925; Ballif, L., Fulton, J. F., and Liddell, E. G. T., *Proc. Roy. Soc.* vol. 98 B, p. 589, 1925; Fulton, J. F., *Muscular Contraction and the Reflex Control of Movement*, Baltimore and London, 1926; Fulton, J. F., and J. Pi-Suñer, *Amer. Jnl. of Physiol.* vol. 83, p. 548, 1928; Denny-Brown, D., *Proc. Roy. Soc.* vol. 103 B, p. 321, 1928.

Obs. 71. Follows closely the original experiment made by F. Magendie in 1822 (*Jnl. de Physiologie*, Paris, tome ii, pp. 276–9 and 366–71), which discovered the functional difference between the ventral spinal roots and the dorsal spinal roots, the former being efferent, the latter afferent. Magendie's observation was conducted on the lumbo-sacral roots of the puppy; for exciting the roots he used the Voltaic current as well as mechanical stimuli.

The well-known slight variation in level of the spinal roots in the posterior region of the vertebral column affects this exercise

practically not at all. The directions given apply to what may be termed the standard cat, but in some cats the spinous process of the seventh lumbar vertebra lies slightly behind the transverse level of the iliac crests, while in some it lies farther forward from it than usual. In the latter case it may happen that the student mistakes seventh lumbar root for sixth, but there is no practical difference in the procedure desirable for the one and the other, and the seventh root supplies motor fibres to tibialis anticus as does the sixth. The seventh root has an available length of about 30 mm., whereas the available length of the sixth is about 25 mm.

Obs. 72. Galvani's 'experiment with metals' was made on the sciatic nerve and muscles of the leg of the frog, 1791 (*De Viribus Electricitatis in Motu Muscularis*, Bologna). From it sprang the long and important controversy with Volta, which led to the latter's discovery of the Voltaic pile and the Voltaic current. The experiment is used in this exercise merely as a convenient device for distinguishing, owing to the feeble current it employs, between

the easily excited nerve-muscle twitch and the less easily excited 'reflex twitch'.

The experiment's results may be vitiated, if the induced currents employed are pushed to excessive strength, by escape of the stimulating currents to other structures than the isolated root examined. For this reason mechanical stimulation, by ligating with a rather coarse thread, supplies important control observations. If preferred, the mechanical stimulation may be employed prior to the faradic. The whole experiment can, if the cord be well protected from cooling, &c., be strikingly

demonstrated by 'ligation stimuli' apart from electrical.

W. M. Bayliss has shown, 1900, that there is an important exception to the Magendie 'rule' of spinal root conduction, in that (*Jnl. of Physiol.* vol. xxxvi, p. 173) the dorsal roots contain efferent vasodilator fibres, and that these fibres, like the afferent fibres of the dorsal roots, belong to nerve-cells of the dorsal root-ganglia. His experiments have demonstrated the existence of these efferent vasodilator fibres in the lumbar dorsal roots you use in this exercise, as well as in various other dorsal roots of the spinal series.

EXERCISE XVI

DECEREBRATE KNEE-JERK; RULE OF CONDUCTION OF THE SPINAL NERVE-ROOTS TESTED BY PINNA REFLEX

I. Decerebrate preparation. See that the preparation is in good circulatory and reflex condition. The tracheal tube has been inserted far back, close to sternum, in order that respiratory ventilation may not be impeded by the posture of the preparation required in the exercise.

II. There are required in addition to your usual instruments (1) the cutting bone-forceps (exerc. XV) and (2) a fine hook-ended seeker (Pl. VIII, fig. 4); see that these are provided ready for you.

Arrange the inductorium circuits for unipolar faradization (see exerc. V); attach the copper plate as diffuse electrode to the planta of one hind-foot of preparation; see that the stigmatic hand electrode is ready for use.

Obs. 73.
The decerebrate
knee-jerk.

III. With the preparation lying on its side, examine the knee-jerk as in § III of preceding exerc. XV. Note differences between this reflex as now exhibited and as seen in that exercise. The contraction is now as ample or more so, but the return fall is not free. An increment of postural extension at knee persists for a time after each jerk-contraction of the knee-extensor. This is well seen if two or three jerks are elicited in quick succession; the posture of the knee becomes cumulatively more extended. The flail-like drop of the leg below the knee is checked by a remainder of contraction, and the fall may excite a second though smaller jerk-contraction, giving a brief *clonic* reaction in response to the single tap on tendo patellae. The jerk

does not terminate, therefore, in any free pendular swing, as it does in the decapitate preparation. The form of the jerk now present is the form characteristic of the decerebrate preparation. The reason is that the knee-jerk muscle, vastocrureus, is with other extensor muscles exhibiting postural (tonic) contraction (cf. exerc. XIX).

IV. i. *Operation for 2nd cervical ganglion.* (Pl. VIII, figs. 1, 2, 4.) Place the preparation prone, with a wooden block under the neck, and a hook-weight hung on the string which has been attached to the skin over occiput stump; or the mandible-clamp can be fixed by a ball and socket joint clamp to a short strong vertical standard. The front end of the neck is thus drawn forward, somewhat opening the space between atlas and axis vertebrae (in which space the 2nd cervical ganglion lies) without embarrassing the circulation and the ventilation of the lungs.

Skin incision along mid-dorsal line from occiput for 5 cm. backward. At posterior end of this transverse incision extending for 2.5 cm. to either side of it. Reflect laterally the skin-flaps and retract them by clip-weights. Clavio-trapezius muscle is thus exposed, and overlapping it, in front, a small triangular piece of levator auris longus, and, behind, a small piece of acromio-trapezius muscle.

Cut through these muscles in the mid-line. Feel with the finger, in the median interval between their cut edges, the ridge of the spinous process of axis. Cut through the muscles next underlying, biventer cervicis, both along median line and along posterior edge of the wound, and retract the freed portions laterally.

Two longitudinally running slug-shaped muscles, the recti capitis post. maj., are then seen one to either side of the mid-line. Incise carefully between them and reflect them laterally from the surface of the spinous process of the axis. This has to be done with care because they cover the ganglion of the 2nd cervical nerve of either side (Pl. VIII, fig. 2) near the base of the beak of the spinous process of axis. The ganglion is exposed as the muscles are being freed and drawn aside; the overhanging beak of the spinous process is at the same time laid bare. Make out the fibrous membrane between the posterior edge of the lamina of atlas in front and axis behind, and note the root of 2nd cervical nerve lying on and plunging through that membrane to reach the spinal cord itself. Clear the muscles from the median part of the lamina of atlas, and retract them aside both from atlas and axis. When the ganglion of each side has been seen, clip off with the oblique-jawed cutting bone-pliers the whole overhanging beak of the spinous process of axis. Follow very carefully by dissection with the small scalpel the root of

Obs. 74.
The 'rule' of
the roots tested
by pinna reflex.

the 2nd cervical nerve of the left side. Follow up the median end of the root, still sheathed in a prolongation from the dura mater, and observe the separation between dorsal root and ventral. There is usually a slight separation into two of the dorsal root in its sheath: this must not be mistaken for the separation between the dorsal root and the smaller ventral root. The latter root lies slightly anterior as well as ventral to the dorsal.

Having ascertained the distinction between dorsal and ventral root, pass the small brass hook between them to open up their separation (Pl. VIII, fig. 4) and then withdraw it. Cover dorsal neck wound with a warm moist swab.

IV. ii. Test the pinna reflex of the left ear by gently twisting or crumpling the tip of the pinna between finger and thumb. This elicits the reflex, whose response consists in a quick retraction of the pinna and usually a folding back of the free end of the pinna. The motor nerve executive of the response is the 7th cranial. The dorsal root of the 2nd cervical nerve contains a large share of the afferent nerve-fibres which specifically evoke the reflex (see text-fig. 36 p. 130).

IV. iii. Follow carefully the nerve-trunk of 2nd cervical of left side laterally from the ganglion, exposing it without dragging on it or on the ganglion, and not actually touching either. It has two (Pl. VIII, fig. 3) relatively superficial branches passing laterally over muscle, and a third, a deeper, descending closer to the side of the bone (atlas). It is the deeper branch (Pl. VIII, fig. 3) which contains afferent fibres from the pinna: these have passed by way of n. auricularis magnus and are *en route* to enter the spinal cord by the ganglion and dorsal root of the 2nd cervical nerve. Carefully expose this branch and pass a ligature of coarse thread round it as far from ganglion as practicable. In doing so, despite of all care, you will probably excite the retraction and back-folding reflex of the pinna; be on the look-out for that; it is the reflex by which you are going to test the conductivity of the spinal nerve-roots. The coarse thread-loop passed round the nerve-branch is for stimulating the nerve mechanically by ligation. Ligature, tightening steadily and rather slowly and watching the while the ipsilateral pinna. Reflex retraction of the pinna will be evoked.

Place similarly round the nerve a second ligature, closely proximal to the former, but leaving it loose for the present. With the fine hook-seeker (Pl. VIII, fig. 4) carefully separate the dorsal root of the nerve from the ventral and cut the dorsal root completely through with the small, fine-pointed scissors. (Note that the cutting of the root probably excites the reflex of the pinna during its performance.) Then re-stimulate the nerve-trunk by ligating as before. No reflex is evoked.

PLATE VIII.

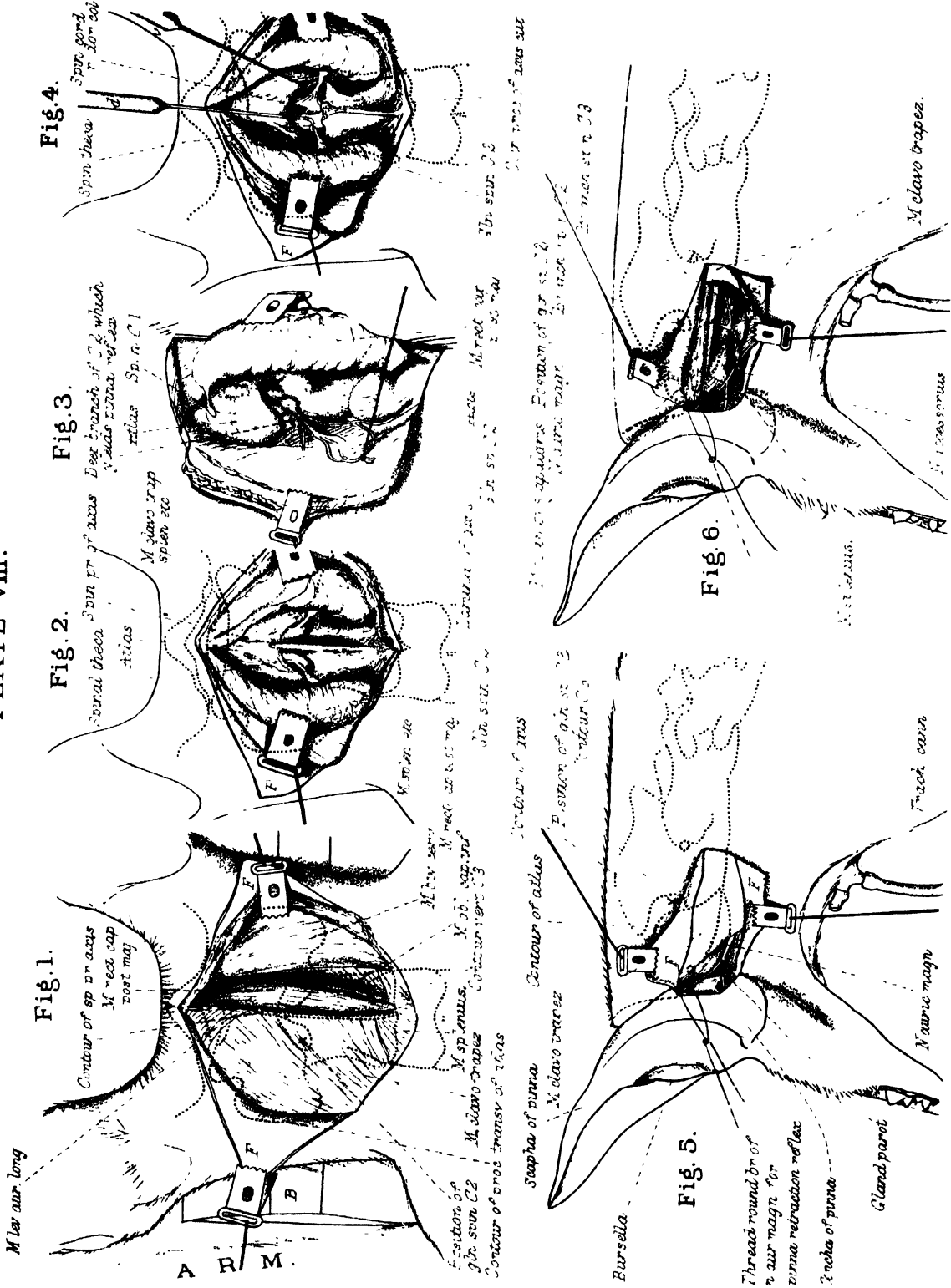

IV. iv. Cut the nerve distal to the ligatures and free it up to the ganglion ; raising the stump by the ligature, faradize it with unipolar electrode, using a weak stimulus. No reflex results, unless there be escape of current, and this, the nerve being short, is not unlikely to take place unless the current is very weak, and it may then be too weak to excite the reflex. The observation with faradism is therefore less reliable than with the mechanical stimulus.

IV. v. Repeat the observation with the nerve of the right side, but with the difference that the ventral root is cut (Pl. VIII, fig. 4) instead of the dorsal. Severance of the ventral root does not annul or in any way affect the reflex.

V. Free the occipital stump and neck of the preparation from all clip-weights ; support the stump in prone position lightly by a finger under the mandibular symphysis so that neck may be free to move. Blow through a small tube into the concha ; a rapid rotatory shake of the occipital stump will ensue. Repeat by squirting a few drops of water into the concha. Note that the ensuing rotation of the neck is clockwise as viewed from in front of the preparation when the concha stimulated is the left, anti-clockwise when the concha is the right. This is a protective reflex preventing entrance of noxa into the auditory meatus. The chief afferent nerve is auricular branch of vagus.

Obs. 75.
Head-shake
reflex of audi-
tory meatus.

[Obs. 76. p. 130 is a more complete but longer form of Obs. 74, employing as afferent the great auricular nerve.]

ANNOTATION

Obs. 73. See annotation to Obs. 70, p. 91 ; also for clonus cf. Viets, H., *Brain*, vol. xliii, p. 269, 1920 ; and Denny-Brown, D., *Proc. Roy. Soc.* vol. civ. B, pp. 274-7, 1929. skin-reflex to test the Magendie 'rule'. For account of the pinna reflexes and of the head-shake reflex protecting auditory meatus see *Jnl. of Physiol.* vol. li, p. 404, 1917.

Obs. 74, 75. The exercise uses a specific

PLATE VIII

PINNA REFLEX AND CONDUCTION IN THE SPINAL ROOTS (Exerc. XVI).

FIGS. 1, 2, and 3. Exposure of 2nd spinal ganglion and of 2nd cervical nerve (obs. 74).

FIG. 1. 1st stage. F, skin-flap ; B, wooden block supporting neck.

FIG. 2. 2nd stage. Ganglia and spinal theca exposed. F, skin-flap.

FIG. 3. Dissection of 2nd cervical nerve of left side, left lateral aspect, showing the deep branch which contains afferent fibres from pinna via n. auric. magnus.

FIG. 4. 3rd stage. Spinal theca opened ; dorsal and ventral roots of ganglion separated for severance of either. F, skin-flap ; D, hook raising dorsal root of ganglion outside spinal theca ; V, hook passed under ventral root of ganglion inside the opened spinal theca.

FIGS. 5 and 6. Exposure of great auricular nerve (obs. 76).

FIG. 5. 1st stage. F, skin-flap.

FIG. 6. 2nd stage. F, skin-flap.

EXERCISE XVII

INFLUENCE OF CERVICAL SYMPATHETIC ON BLOOD-VESSELS OF THE PINNA. CIRCULATORY CHANGES AND THE VOLUME OF THE KIDNEY. HAEMORRHAGE AND ARTERIAL PRESSURE; RESTORATIVE EFFECT OF GUM-SALINE INJECTION. CLOTTING OF BLOOD

I. The preparation is decerebrate. See that it is in good condition.

II. Get ready the inductorium circuits for faradic stimulation.

OBS. 77. **Cervical sympathetic and vessels of the pinna.** III. Place the preparation supine with all four limbs symmetrically extended. Expose the left cervical sympathetic by a dissection similar to that already described for exposure of the vagus nerve (exerc. IV, Pl. II), remembering that sympathetic runs along with vagus on the medial side of that nerve, and is much the smaller nerve. Separate the sympathetic from vagus trunk by working with the point of a mounted needle between the two nerves. Pass a ligature round the sympathetic nerve after carefully separating it from the vagus nerve; the ligature should lie about 15 mm. behind the level of the cricoid cartilage. Tie the ligature. Sever the nerve posterior to the ligature, and dissect the nerve headward for about 2 cm., raising the nerve by the ligature as it is followed headward.

Raise the neck-stump of the preparation so that the attached pinnae are easily inspected and in a good light. Observe the condition of the blood-vessels of the skin of the pinnae (Pl. V, fig. 6). The observations can be made either by looking at the front concave surface by reflected light or by looking at the convex surface by transmitted light. If the former, note fine diverging vessels (arteries) sloping towards the flattened border of the pinna near the tip. If the latter, shave carefully a piece of the ear-surface, about the size of a sixpence, near the tip. Spread a drop of strong glycerine over the shaved surface, and so place the ear that the light of the window comes through it to the eye; screen the eye from the window light elsewhere as you look at the pinna. Compare the vascularity of the two pinnae, right and left, in this way. The vascularity of the left, that is of the side on which the cervical sympathetic has been cut, will probably be obviously the greater. Feel with the fingers the tips of the two pinnae; that of the left will probably be perceptibly the warmer.

Faradize for 5" the head end of the cut left sympathetic. The fine arteries as seen from the front surface of the left pinna will shrink and become almost invisible. After cessation of the stimulation they will re-appear.

Repeat the faradization, this time stimulating for 10". Note that, as

observed from the back of the pinna by transmitted light, the central artery becomes smaller, the connecting vessels between it and the marginal vein will shrink and many of them disappear, but the marginal vein will still remain easily seen (Pl. V, fig. 7). The connecting vessels will begin to reappear about 3" after cessation of the stimulation.

IV. Weigh the decerebrate carcass on the scales. Estimate the dose for the sample of curare provided which is required to obviate such slight reflex movements as might occur and disturb the observation. Inject the dose intravenously and observe that decerebrate rigidity disappears in one or two minutes. Because of paralysis of the diaphragm it is necessary to apply artificial respiration from the pump.

OBS. 78.
Circulatory
changes and the
volume of the
kidney.

Turn the preparation to lie on its right side and hold it by clamping the jaw. Prepare for stimulation (*a*) the central end of the left sciatic nerve, and (*b*) the distal end of the right vagus nerve. Then, to expose the left kidney, incise the skin from a point over the last rib, 3 cm. lateral to the mid-dorsal line, and extend the incision caudally for some 5 cm. At the ends of this incision, make short incisions at right angles, extending for 2 cm. ventrally. Retract the skin-edges with clip-weights. Palpate the kidney. Incise the posterior abdominal wall which overlies it in a direction parallel to the lumbar vessels. Then, after carefully incising the peritoneum, the kidney is exposed. By gentle manipulation the kidney can be pressed upward through the opening. Clean the kidney free from fat, taking care not to injure the vessels at the hilum, and return it to the abdominal cavity.

Insert a cannula into the right carotid artery and obtain a graphic tracing. Bring the oncometer near the dorsal edge of the abdominal opening and put a little warm Ringer fluid into it. Smear vaseline along its top edge and into the groove in which the 'stalk' of the kidney will lie. Take care that the outlet tube of the oncometer is not blocked with vaseline or Ringer fluid. Bring the kidney to the surface again, turn it dorsally, and place it in the oncometer without stretching or drawing on the renal vessels. Smear vaseline over the vessels and then seal the oncometer with a glass plate. Replace the skin-flaps as far as possible. Connect the oncometer by rubber tubing to the piston recorder, interposing a T-piece provided with screw-clips or a tap for the suitable regulation of pressure. The kidney volume should now show small changes in volume synchronizing with the heart-beats.

Having the a. p. and oncometer records one above the other, stimulate the central end of the sciatic nerve to cause a small rise in a. p. Note the accompanying change in kidney volume. Similarly, stimulate the vagus nerve, and afterwards also observe the results of asphyxia.

OBS. 79.
Haemorrhage
and arterial
pressure.

V. Have ready (1) a 50 c.c. beaker and glass rod for whipping the blood; (2) 2 conical centrifuge-tubes, in a rack, also 5 c.c. of 25 per cent. potassium oxalate solution and a small pipette; (3) an arterial cannula with curved shank and with 10 cm. of rubber tubing attached; (4) a small evaporating-dish; (5) 50 c.c. of gum-saline solution (Bayliss's fluid) in a beaker, and a syringe, of 25 c.c. capacity or more: the rubber on cannula should fit the nozzle of this syringe; (6) a beaker stands on a wire-gauze-covered tripod over a small Bunsen burner or spirit-lamp; a thermometer in the beaker.

Get ready mercury manometer, cannula, and kymograph for a carotid-pressure observation as in previous exercises, except that manometer should be set for a pressure commencing at about 120 mm. Hg.

Place with the tube-pipette 5 drops of the pot. oxalate solution at the bottom of one of the centrifuge-tubes.

Proceed to a carotid-pressure record as in previous exercises, e.g. exerc. V. After a sample graphic stop the kymograph.

Place preparation supine, with limbs extended symmetrically. Abduct one knee with a clip-weight (Pl. IX, fig. 6), and in that thigh expose the distal end of the external iliac artery and the top of the femoral and place three loops, the middle at the top of the groin, in readiness for insertion of cannula into femoral. Tie the distal ligature and, controlling the artery by weighting the proximal looped thread, insert the arterial cannula provided with rubber tubing into the femoral artery, nozzle towards the heart. Secure cannula by tying middle ligature. Restart the kymograph. Bring glass beaker to the cannula and, releasing the femoral artery from the weighted proximal thread, allow about 30 c.c. blood to flow into beaker. Note effect on the pressure record. Stop the kymograph. Stir the blood in the beaker with the glass rod to defibrinate it. Set the whipped blood to stand and sediment.

VI. Draw off into the small evaporating-dish about 10 c.c. of blood from femoral and set it aside.

VII. Similarly draw off into each of the centrifuge-tubes enough blood to half fill it, and at once mix the blood and pot. oxal. solution, by inverting once; avoid shaking and frothing. Set to stand.

Measure up approximately the total quantity of blood withdrawn in §§ V, VI, VII, and measure out a quantity of the gum-saline equal to the blood withdrawn.

OBS. 80.
Restoration of
art. pressure
by gum-saline
injection.

VIII. Note the arterial pressure. Inject through the femoral cannula with the syringe the quantity of gum-saline fluid measured out, warmed to 38°C. Observe effect on carotid pressure.

IX. Note that the blood has not clotted in the tube containing pot. oxalate, but has clotted in the other tube. Before centrifuging, make the quantity of blood in the centrifuge-tubes equal. Centrifuge the blood. Note the plasma and the leucocyte layer on the top of the red corpuscle sediment in the oxalate tube.

Obs. 81.
Retardation of
clotting by
'decalcification'

X. Return to carotid-pressure record; note the amount of restoration of the pressure which the gum-saline injection has maintained.

ANNOTATION

Obs. 77. Repeat the observations by which Claude Bernard, Brown-Séquard, and the elder Waller discovered the existence of vasoconstrictor nerves. Bernard (*Comptes rendus de la Soc. de Biologie*, p. 163; Paris, 1851) observed that section of the cervical sympathetic was followed by vascular dilatation and rise of temperature in the corresponding ear (rabbit), and (*Comptes rendus de la Soc. de Biologie*; Paris, Oct.-Nov. 1852) that galvanization of the upper stump of the cut nerve caused vasoconstriction and fall in temperature of the ear. In August 1852 this latter fact had been announced by Brown-Séquard from independent observations (*Philadelphia Medical Examiner*). A. Waller, almost at the same time and independently, observed it and communicated it to the Acad. des Sciences, Paris (*Comptes rendus*, Feb. 28, 1853). Bernard regarded the change in temperature as more or less independent of the vascular change; Waller considered the change in temperature secondary and consequential to the vascular change; subsequent knowledge has confirmed the latter view.

Obs. 78. This repeats the experiments of J. Cohnheim and C. S. Roy, *Virchow's Archives*, vol. xlii, p. 424, 1883, and of J. R. Bradford, *Journ. of Physiol.* x, p. 358, 1889.

Obs. 79. Withdrawal of blood from the circulation even rapidly, as by arterial haemorrhage, up to 25 per cent. of the

total blood does not produce much fall in the a. p. The pressure is maintained by vasomotor adjustment of the vascular tone and more gradually by the circulating blood absorbing fluid from the tissues. Loss of more than 35 per cent. of the total blood does, however, seriously lower the a. p. It may be assumed that an adult cat in good nutrition has 50 c.c. blood per kilo of its weight.

Obs. 80. To counteract the effects of severe haemorrhage, Richard Lower, applying Harvey's discovery of the blood-circulation, devised the operation of transfusion. He carried out the experiment first, in 1665, at Oxford. He transfused blood directly from the carotid of one dog into the jugular vein of another. He used two short silver tubes tied into the above vessels and connected them by a piece of freshly-excised artery (*Phil. Trans. Roy. Soc.* vol. i, p. 353; London, 1666. *Tractatus de Corde*, cap. iv, p. 174; London, 1669). Lower's method proved efficacious, and Denis of Paris employed it successfully in the following year, transfusing from a lamb into a man. The method has, however, dangers, e.g. intravascular clotting, haemolysis, &c., to which the chemical knowledge of the time was not adequate. Recourse was subsequently taken to intravenous injection of 'normal' saline solutions. A previous exercise (exerc. X) showed that 'normal' saline injected *per venam* is not retained

in circulation, but transudes through the capillary walls almost as rapidly as it is introduced.

To remedy these defects a saline fluid was devised by Bayliss (1916, *Proc. Roy. Soc. B.* vol. lxxxix, p. 380, Bayliss's fluid is gum (arabic) 6 parts, Sod. Chl. 0.9, water 100.

§ V. It might seem more convenient to use a carotid for the haemorrhage; but if

this be done the manipulations are liable to irritate the vagus nerve lying alongside the artery; such irritation tends to make the arterial pressure irregular and to disturb the observation of the pressure.

Obs. 81. The hindering of clotting of drawn blood by addition of pot. oxalate ('decalcification') was discovered by Arthus and Pagés, 1890 (*Archives de physiologie normale et pathologique*, p. 739).

EXERCISE XVIII

SPINAL REFLEX, IPSILATERAL FLEXION INSTANCED BY THE ANKLE FLEXOR (TIBIALIS ANTICUS). PROPRIOCEPTIVE REFLEX. COMPARISON BETWEEN REFLEX AND PERIPHERAL CONTRACTION

I. The preparation is decapitate. See that it is properly ventilated and is in good condition. Set the Ringer-Locke fluid warming in readiness for operation.

II. Get ready the recording myograph and stimulating apparatus (text-fig. 37) on the experiment table, to which the operation table can be brought close. The verticle spindle carrying the myograph recording-drum has clamped to it below the drum a horizontal rod which revolves with the drum. A vertical standard which can be placed within reach of the horizontal rod carries a key for the primary circuit of the inductorium; a lever in this key projects so that when it is at an appropriate height the horizontal rod in its revolution meets it and opens the key. The key itself is set on a movable joint so that its lever can be horizontal or slightly tilted upward and the horizontal rod on the drum-spindle opens the key only when the lever of the key is horizontal. It is horizontal when it is set against a stop on the joint which carries it. Adjust this bridge-key on its vertical standard so that it is struck open by the drum-spindle's horizontal rod when the key-lever itself is horizontal and is not touched by the drum-spindle's horizontal rod when the key is slightly tilted up. Arrange the secondary circuit of inductorium so that its short-circuiting bridge-key is clamped to the table near the standard carrying the primary circuit-key.

The recording-lever is of the bell-crank pattern with after-load support. The resistance is provided by a thin piece of rubber tubing attached by

strong thread close to the axis of the lever. The resistance can be varied by varying the stretch of the rubber by an adjustable clamp fixing the lower end of the rubber strip.

Arrange the recording-drum so that its direction of rotation is such that the horizontal rod carried below it on the same spindle will knock open the

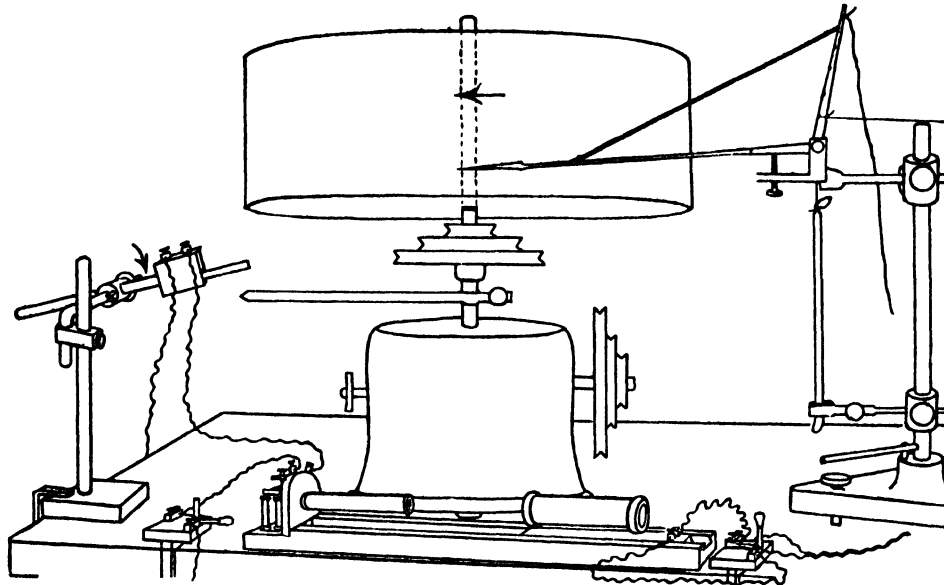

TEXT-FIG. 37. Scheme of arrangement of recording-apparatus, &c., for comparison of reflex contraction to single break-shock with peripheral break-shock twitch. To left is shown the break-key; it can be depressed in the direction of the arrow so as to be knocked open by the revolution of the horizontal striker clamped to the spindle of the recording-drum. The drum is driven from the horizontal step-pulley. The spring resistance for the muscle-lever is shown as furnished by a strip of rubber tubing, but a short coiled steel spring is better, as more durable and taking less room.

lever of the primary circuit-key when that is set. The direction is preferably from right to left when viewed from in front. The speed of translation of the recording-surface should be not less than 25 cm. a second (i.e. with ordinary sized drum about one revolution in 2 secs., with the larger Palmer drum about one revolution in 4 secs.).

Electrodes: The ordinary hand-electrodes stuck by modelling clay to a brass cross-piece held in an ordinary vertical standard.

The glass-tube electrodes (Pl. IX, fig. 5), if preferred, are best secured by stitching.

Determine, by attaching the wires from the secondary coil to a small galvanometer and noting the direction of the needle deflection when the key

in the primary circuit is opened, which of the wires is the kathode for the break-induced current, and mark that wire by tying a cotton to it.

See that the drill (text-fig. 38) and 2 drill-pins and the brass rods and heavy standards for holding them are at hand.

III. i. *Operation.* Place preparation supine, with neck-stump and fore-quarters turned somewhat to the right. Attach clip-weight to each hind-foot and put limbs in an extended position. Attach a heavy clip-weight to skin of front of left knee to keep the knee somewhat abducted (the operation posture is indicated in Pl. IX, fig. 6).

III. ii. At a point in the left inguinal flexure well lateral to the mid-point of the groin, commence a skin incision 5 cm. long running lengthwise down the thigh and then curving parallel with but below the fold of the groin. The inguinal pad of subcutaneous fat is exposed: reflect this upward with the skin. Note the position of the femoral vein and artery; about 8 mm. lateral to the latter the lower end of ilio-psoas muscle is seen, and emerging from it the femoral nerve. The nerve and muscle are to be cut across somewhat above Poupart's ligament, care being taken to avoid the iliac vein, which is separated from ilio-psoas only by the thin tendon of the psoas parvus, which should form the medial limit of the transection of the ilio-psoas.

Pectineus muscle and the superficial division of the obturator nerve emerging from it may also be cut through—though this is not essential. Close the wound.

III. iii. (Pl. IX, fig. 3.) Remove the clip-weight from left foot. On the medial edge of the foot (left) feel for a bony tubercle half-way between the point of the heel and the root of the first toe. This tubercle marks insertion of tibialis anticus. Pinch up a fold of skin over this and snip off the skin-fold with the strong scissors; this avoids cutting the subcutaneous vein, which a scalpel-cut always wounds. The tendon is displayed with a vein crossing it. With the bone-pliers detach the bony tubercle into which the tibialis tendon is inserted. Then free the tendon with the tubercle attached. Ligate the tendon just above the tubercle so that this latter prevents the ligature (fine fishing line) slipping. Free the tendon up beyond the annular ligament incising this latter.

III. iv. Lay the preparation upon its right side. Expose left sciatic nerve (Pl. IX, figs. 1, 2). Make incision through skin, starting from a point midway between tuber ischii and great trochanter and prolonged downwards to close above and behind the outer condyle of femur. From the top end of

this incision carry a skin incision forwards for about 4 cm., and from bottom end another for 2 cm. Reflect the skin-flap forward. At the level of the tuber ischii a vein is seen coming up from postero-lateral aspect of thigh and plunging between muscles. Carry incision into this intermuscular space and follow the space downward. The gluteus maximus, in the cat a smallish thin muscle, lies in front of this: cut its lower tendinous end and reflect it upwards. Open the intermuscular space towards its depth: the sciatic trunk will then be seen; expose it carefully: the proximal part of the nerve-trunk shows a large branch passing backwards; this is the nerve to the hamstring muscles; cut it. Follow the nerve-trunk downwards; it will be seen to consist of two divisions, a smaller anterior between which and the rest of the nerve-trunk runs the minute but obvious *comes nervi ischiadici* artery. Enlarging the incision downwards, the two divisions of the trunk can be followed to where they begin to diverge. Separate the posterior division, the tibial (popliteal) nerve, from the anterior, the peroneal nerve, and pass a thread round the whole tibial nerve as far peripheral as your wound allows. Tie the thread tightly. Carefully free the nerve-trunk from the adjacent tissues for some 3-4 cm. proximally to the ligated point. Do not cut the nerve. In thus separating and dissecting out the tibial nerve take care not to injure the peroneal nerve; the latter is the motor nerve of the muscle whose contraction you will study. The tibial nerve you will use as the afferent nerve, from which to evoke reflex contraction of the muscle. Replace the nerve in the wound and close the skin with a clip.

III. v. (Pl. IX, fig. 7.) Insert a steel drill (text-fig. 38) into the lower end of tibia and fibula of the left leg from within outwards parallel with main ankle-joint surface of tibia and about 5 mm. above the joint. Expose the inner face of the inner condyle of femur; insert a steel drill through lower end of femur from within outwards and parallel with the drill through tibia fibula.

Place the preparation on its right side.

Screw on to the brass ends of the two drill-pins the two brass rods provided and clamp these latter to the heavy based standards provided, arranging that they hold the leg-shank nearly horizontal, with its distal end directed toward the myograph-lever, but with the ankle somewhat lower than the knee, and a heavy clip-weight attached to the foot so as to keep the foot out of the way of the thread to the myograph. Knee and hip are placed in fairly full flexion (Pl. IX, fig. 7).

IV. Bring the operation table to the myograph table. Tie the thread from the myograph-lever to the thread attached to tibialis anticus tendon.

Obs. 82.
Proprioceptive
reflex of tibialis
anticus.

Screw down the after-load stop from under the writing-lever so that the latter is no longer supported by the stop. Lift the recording-lever by placing a finger under its distal end, and raise the lever till the point of it is near the level of the top of the drum. Withdraw the finger briskly so as to let the lever fall freely. Note that after its fall the lever reascends and then

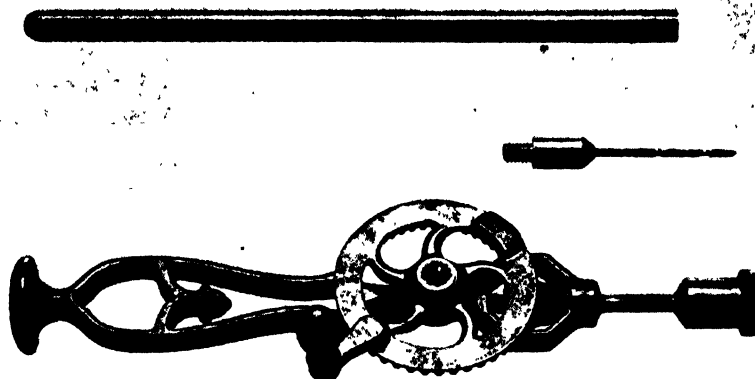

TEXT-FIG. 38. Drill for inserting drill-pins into femur and tibia to fixate the limb for the myograph. The drill-pin screws into the drill-head for insertion, and is then left in the bone by unscrewing the drill-head from it; the brass rod at top of figure is bored, at its left-hand end in figure, with a screw-thread, enabling it to screw on to the inserted drill-head; the rod is then fixed by a clamp to a vertical or other standard as required for fixating the limb.

drops again. This reascent is partly due to mechanical vibration, but mainly due to a contraction of the muscle in response to the sudden pull on the muscle produced by the fall of the lever (text-fig. 39).

V. Open wound in left thigh. Lift by its thread the prepared tibial uncut nerve, and arrange it on the bare standard-carried electrodes, assuring complete air insulation. The electrodes should straddle the nerve-trunk and have an interpolar distance not less than 8 mm. If the sheathed electrodes are used (Pl. IX, fig. 7), place the nerve in its continuity in the split glass tube. Insert the electrodes through the distal of the two side-openings in the glass tube, in such a way that the platinum terminals lie against opposite

sides of the nerve-trunk and do not touch the glass. Two stitches to the adjacent tissue will keep the glass tube in position. See that the edge of the glass where the nerve emerges from the tube does not compress or bend the nerve-trunk and that the electrode which is kathode for the break-shock is the higher up the nerve-trunk, i.e. the nearer to the spinal cord.

VI. The vertical standard carrying the writing-lever rotates, and at a certain place its further rotation is checked by a stop at the base of the standard (see text-fig. 37). Rotate the

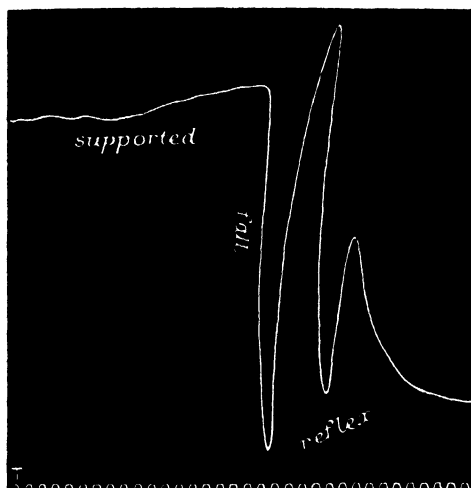

TEXT-FIG. 39. Proprioceptive reflex of tibialis anticus evoked by sudden slight stretch, e.g. fall of lever (K. A. J. Mackenzie and N. L. Watt). The resulting reflex is in this instance clonic, i.e. double (C. Asayama). r, time marked in $\cdot 03''$.

standard up to this check: then place the standard so that the lever-point writes lightly on the drum; see that the arc described by the lever's writing-point is aligned to the drum-surface and that the point can write lightly but clearly over a good vertical height of the drum-surface. This position of the lever having been arranged, clamp the base carrying the myograph standard to the table; the base should not be moved again. Similarly the position of the drum should not be moved again. Arrange that thread from tendon to lever is just taut; this is best done by shifting the operating table or the screw for 'after-loading' the writing-lever. Adjust the tightness of the rubber-band resistance of myograph to oppose suitable resistance to the muscle. Set the after-load support so as

to just support the lever in this position. Then rotate the lever-standard slightly in a direction carrying it away from the check-stop and the writing-point away from the drum-surface; the thread from tendon to lever will have its tension altered by this, but will return to previous tightness when the standard is rotated back to the stop for the record.

Place the secondary coil at 25 cm. on the inductorium scale. With the myograph-lever not touching the recording-drum, and, with the bridge-key in secondary circuit closed, close the key in the primary circuit. Set the drum revolving. Open the short-circuit key. Lightly strike open with the finger the key in the primary circuit. Note whether a contraction results. Repeat the manœuvre, short-circuiting the make-shock each time, and

Obs. 83.
Reflex of ankle flexor to single break-shock.

shifting the position of the secondary coil on the inductorium scale to ascertain the weakest break-shock which excites, and taking care to strike open the short-circuit key with approximately the same speed each time. Note the threshold stimulus thus determined.

Bring the writing-lever into contact with the drum. Push the secondary coil step by step nearer the primary and note on the stationary drum at each step the height of the reflex contraction to the break-shock, as given by

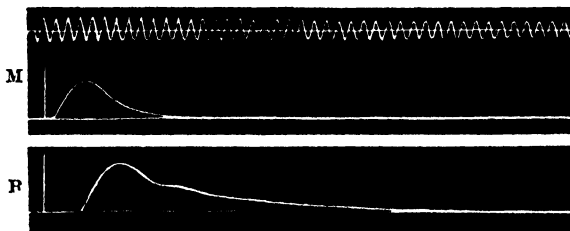

TEXT-FIG. 40. Tibialis anticus muscle. Spinal preparation; cat. Comparison of reflex contraction in response to a single break-shock applied to afferent nerve with maximal twitch of same muscle elicited through motor nerve (N. B. Dreyer and C. S. S.). M, motor maximal twitch; R, reflex contraction to break-shock applied to ipsilateral popliteal nerve as afferent. The vertical marks show the moment of delivery of the stimulus in each case. Tuning-fork above, 100 p. sec.

striking open the break-key with the finger. When a point is reached where the contraction ceases to increase further [i.e. is maximal], withdraw the lever-point slightly from the drum-surface by rotating the lever-standard. Raise the primary circuit key out of the course of the revolving striker of the drum-spindle. Set the drum running. Bring the writing-point into contact with the drum-surface again by rotating the lever-standard up to its check-stop. When the drum has given several revolutions choose a moment when the

striker has just passed the place where it would meet the primary circuit key were it lowered, and lower that key quickly and quietly as far as the stop on it allows, the short-circuit key of the secondary circuit still remaining closed. Then at once open the short-circuit key. The reflex contraction is recorded on the drum. Then rotate the lever-standard slightly back again to withdraw the lever-point from the drum-surface, and finally reclose the short-circuit key.

VII. Remove the electrodes from the tibial nerve. Ligate the peroneal nerve tightly as high up the thigh as the wound allows. Apply the electrodes to the nerve distal to the ligature. Place the break-shock kathode this time distal to, i.e. nearer to the muscle than, the anode. Leave the electrodes and nerve so arranged, taking that they are well isolated from the edges of the wound. Push the secondary coil away from the primary as far as the 35 cm. mark on the inductorium scale. Repeat the manœuvre for finding the break-shock threshold stimulus as before, and note the value obtained.

OBS. 84.

Motor twitch
contraction com-
pared with reflex.

PLATE IX Response of flexor Muscle (Ex. XVIII).

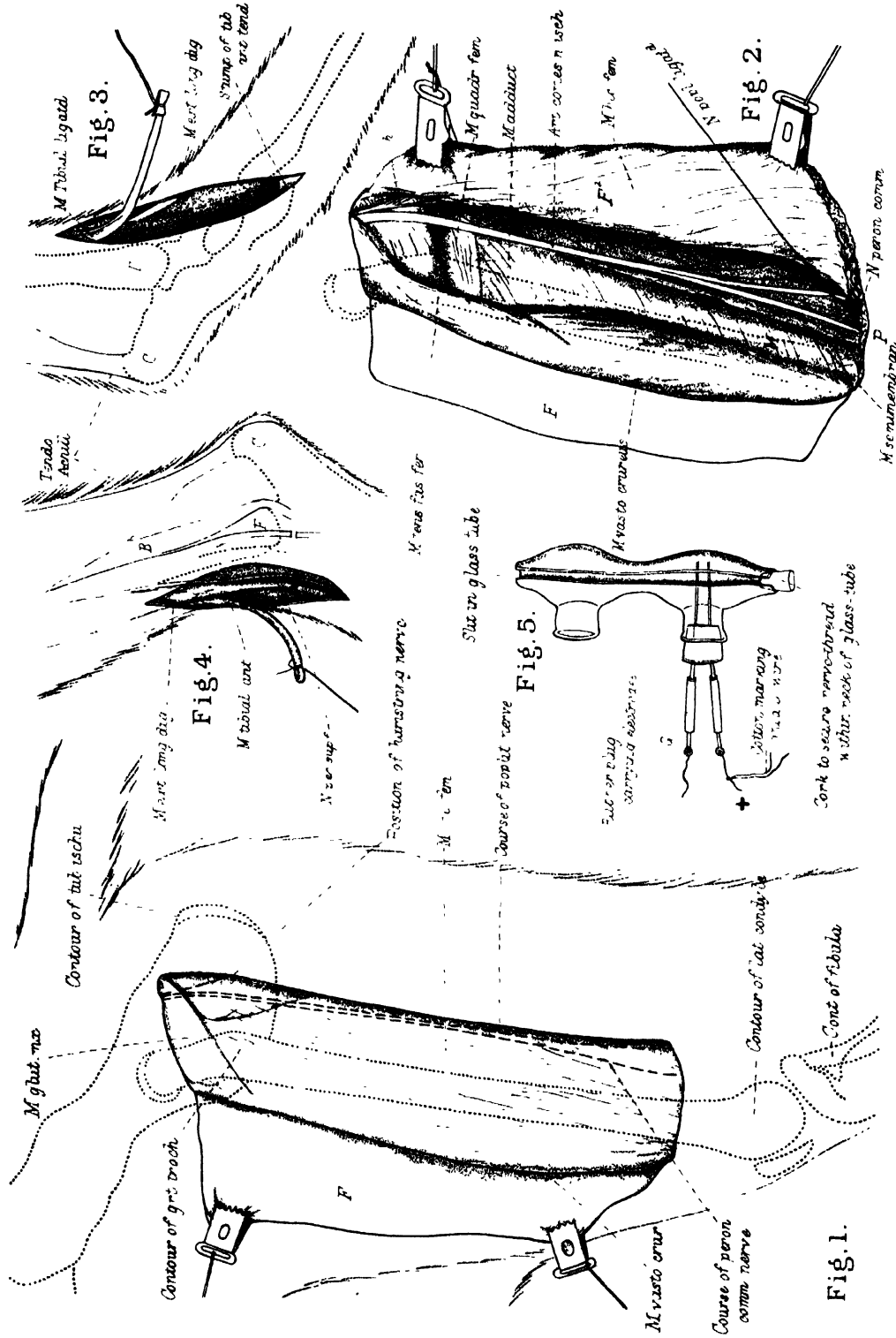
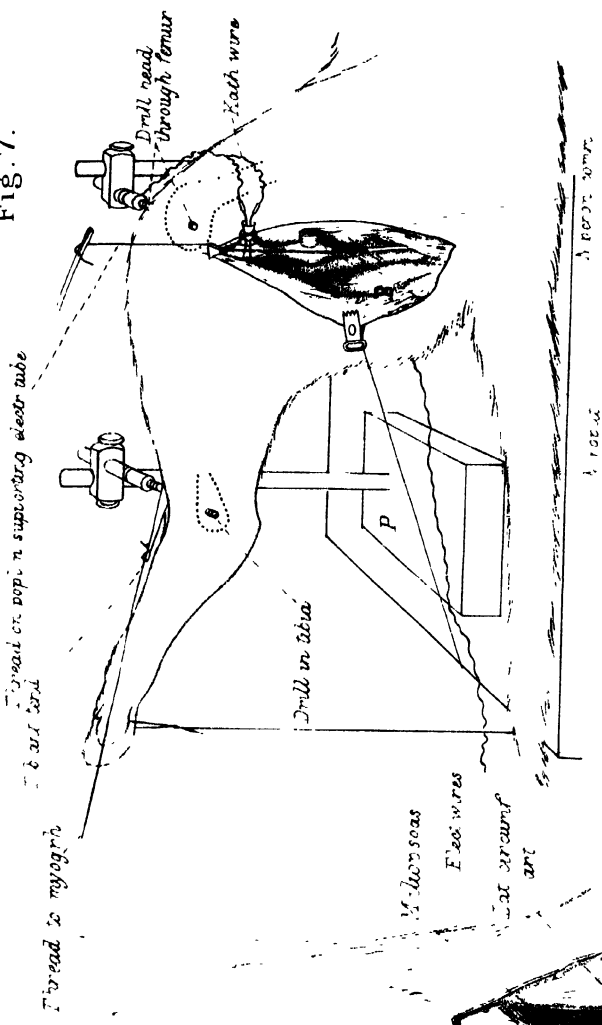

Fig. 1. Afferent and efferent nerve, 1st stage. Fig. 2. 2nd stage. F, skin-flap. Fig. 3. muscle-flap retracted. h, ham-string nerve. Fig. 4. Tendons at ankle, 1st stage: medial aspect; T, contour of tibial malleolus C, contour of calcaneum Fig. 5. 2nd stage: lateral aspect; F, contour of fibula; B, peroneus brevis, Fig. 5. Electrodes and glass electrode-sheath; g, brass-tubetlet connecting platinum terminal with wire of zincy circuit; + anodal wire.

Fig. 7.



Thread in myogonion

Drill in popl. n. supporting electro tube

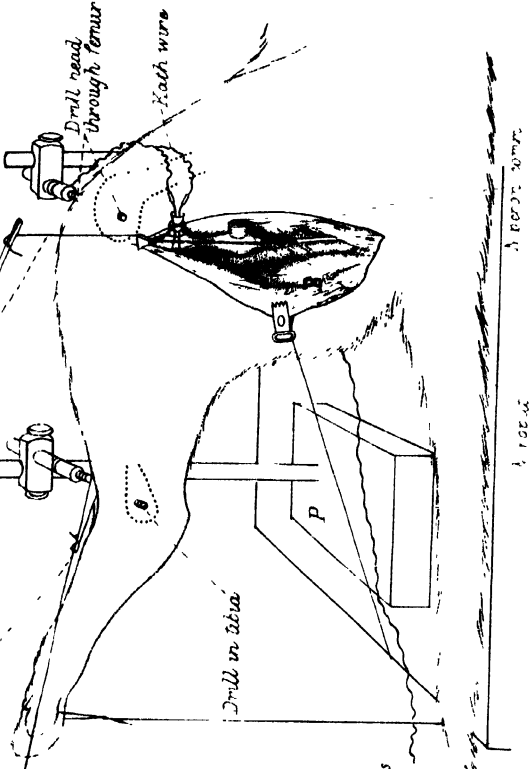

Inguic. ripples

Mob. ad. i. exi

Fat reflect.

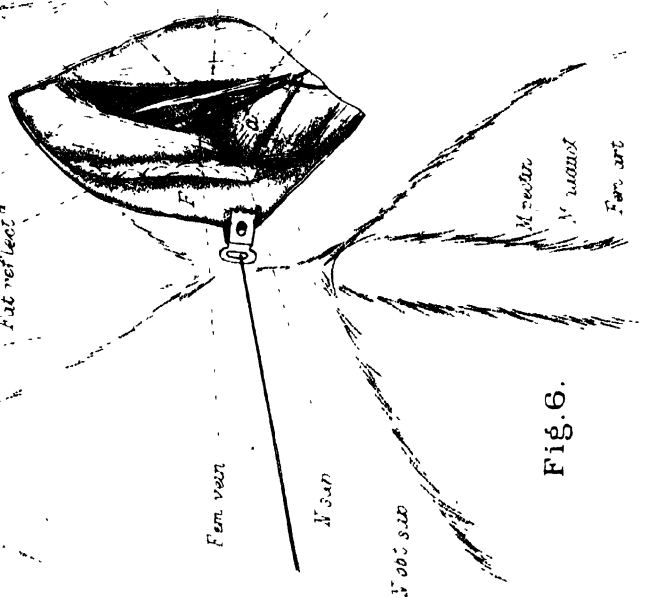

Fig. 6.

Fig. 6 Femoral nerve. F. Skin-flap retracted. Fig. 7 Arrangement for ipsilateral flexor-muscle reflex. B. biceps fem. retracted. P. lead base of standard carrying drill-head.

Then push the secondary coil nearer to the primary by some 8–10 cm., and obtain a record of the contraction to the break-shock given by the automatic striker, using the same manoeuvre as before. Swing off the myograph from the drum-surface. Then stop the driving-gear for the drum.

VIII. To measure the latent period between stimulus delivery and beginning of the contraction. Close the bridge-key. Close the primary key. Turn the drum by the hand slowly and bring the striker on the drum-spindle close to the primary key lever. Rotate writing-lever standard so that the writing-point again touches drum. Push the secondary coil 5 cm. or so closer to the primary. Open the bridge-key. Then very slowly rotate the drum slightly so that drum-spindle striker just opens the primary key. The contraction which occurs marks on the drum the ordinate corresponding to the moment when the stimulus is delivered by the drum-striker's opening of the primary key.

Obs. 85.
Measurement
of latencies of
reflex and motor
twitch.

Compare the two contraction curves, reflex and peripheral, obtained and note the difference of the latencies.

Bring near to the drum-surface a 100 sec. tuning-fork clamped firmly to a vertical rotating standard, the rotation carrying as far as a check. Adjust to drum-surface when the fork standard is up to the check. Set the drum going, and, when it is in full course, set fork vibrating and swing the recording style of the fork to the drum-surface, i.e. up to the check. This measures speed of drum-surface and therefore of the time-relations of the myograms and their latencies; after one revolution of drum, swing fork off it.

IX. Repeat § IV, p. 103; note that the contraction resulting from fall of lever is now absent, i.e. the contraction was reflex.

ANNOTATION

Obs. 82. For observations on the proprioceptive reflex of tibialis anticus see paper by Chuai Asayama, 1916, *Quart. Jnl. of Experim. Physiology*, vol. ix, p. 265.

Obs. 83, 84–5. The longer latency of the reflex contraction than that of the peripheral contraction cannot be accounted for wholly by the greater length of nerve-trunk which the impulse has to travel in the former case; the difference is too great, and indicates a delay in impulse trans-

mission in the reflex process situate in the spinal cord.

Although its latency is longer and its threshold of stimulation higher than with the break-shock applied to motor nerve, the muscle contraction in reflex response is sometimes greater both in height and duration: cf. C. Sherrington and S. C. M. Sowton, *Jnl. of Physiol.* vol. xlix, p. 331, 1915; N. B. Dreyer and C. Sherrington, *Proc. Roy. Soc. B.* vol. xc, p. 272, 1918.

D. Denny-Brown, *ibid.* vol. civ, p. 252, scarcely ever is it as great (cf. S. Cooper, fig. 31 A, Pl. 14, 1929. On the contrary, D. Denny-Brown, and C. S. Sherrington, the reflex *tetanic* contraction is never *ibid.* vol. c, p. 448, 1926. greater than the maximal motor tetanus;

EXERCISE XIX

REFLEX ACTION IN AN EXTENSOR MUSCLE (QUADRICEPS); POSTURAL REFLEXES, AND REFLEX INHIBITION OF THE CROSSED EXTENSION REFLEX. RHYTHM OF REFLEX RESPONSE

I. The preparation is decerebrate. See that it is in good condition. It should exhibit extensor rigidity, reflex 'standing'; this reflex posture in the decerebrate condition is maintained even when the preparation lies on its back or side; the limbs offer resistance to passive reflexion of their joints. Examine this in the fore-limb. With the preparation lying on its side, place one hand on the dorsal edge of the upper-lying scapula and, with the other hand under the pads of the corresponding fore-foot, exert pressure such as were the extensors of shoulder and elbow not acting would fold the limb. A considerable resistance is felt, but this, when the pressure exceeds a certain degree, almost suddenly yields. This is the 'lengthening reaction', so called because in it the extensor muscles yield, undergoing an inhibitory relaxation which allows of their lengthening. In the hind-limb, test the resistance to passive flexion of the knee.

II. Get ready on the experiment table the myograph, two induction apparatus for faradic stimulation and two pairs of stimulating electrodes. The myograph-drum should be arranged for moving (right to left) at a slow rate, e.g. about 1 cm. a second. In addition to your usual operating instruments a large cutting bone-forceps is provided. The automatic break-key and the striker attached to the drum-spindle for the previous exercise are not wanted for this. It is necessary to have two drill-pins and two strong vertical standards preferably clamped to, or screwed into, two strong horizontal rods each carried separately by clamps on the kymograph frame high enough for the horizontal rods to be able to overlap the experiment table's top. One of these standards is for the drill-clamps fixing the limb; on the other for the torsion wire recorder. See that the lever's writing-point is set at right angles to the radius of the drum; the extensions of the lever will be rather ample; if not at right angles to the radius the point tends to leave the drum-surface when the arc is long.

III. *Operation.* The operation resembles somewhat that of exerc. XVIII.

The same structures on the front and at the back of the thigh are exposed in both, but in the present exercise the femoral nerve, instead of being cut as a whole, has its branch to the quadriceps femoris muscle left uncut, while conversely, instead of the peroneal division of the sciatic nerve being separated and left uncut, the whole sciatic trunk, with its combined peroneal and popliteal divisions, is cut and treated as one nerve. In this exercise, as in the last, the hamstring branch of the sciatic is severed.

a. Expose the right femoral-nerve at its exit from psoas as in the previous exercise (XVIII, §III ii, see Pl. IX, fig. 6). Follow the nerve up into the psoas, also for a short distance below that muscle. The nerve will be seen to consist of three divisions (Pl. IX, fig. 6), a small lateral one which branches off to supply the sartorius muscle, a medial one which is the saphenous nerve, and a large main division between the other two; this last is the nerve of quadriceps extensor. Sever the two former and leave the latter intact. Sever the ilio-psoas muscle completely across; to do so use the small scissors, snipping it through piecemeal about the level of Poupert's ligament.

Repeat the operation on the left groin, but cutting the nerve to quadriceps.

b. Lay the preparation on its right side and expose the sciatic nerve by the same procedure as in the last exercise (Pl. IX, figs. 1, 2) but not carrying the exposure so far down the limb. Sever the hamstring division of the sciatic near its origin above. Ligate tightly as a single trunk the rest of the sciatic (peroneal and tibial nerves together) low down. Dissect it up carefully for about 4 cm.

c. Place the preparation on its left side and similarly prepare; ligate the right sciatic after severing its hamstring nerve.

d. Keeping the fore-quarters and head-stump of the preparation turned on left side, so arrange the standard and clamped drill-rod that the right thigh is supported in a nearly vertical posture with the right hip flexed almost to a right angle (text-fig. 41).

IV. Note the posture of the right knee-joint; it is maintained in a greater or less degree of extension. If the extension is not well marked it can be improved by gently raising the stump below the knee, while steadying the thigh with the other hand, thus giving the knee a more extended posture; on releasing the stump the extended posture thus passively given is more or less maintained (plastic tonus, the 'shortening reaction').

OBS. 86.
The 'shortening reaction'.

V. Steadying the thigh with one hand, press with the other on the leg below the knee so as to flex the knee. Note the resistance offered at first by the extensor muscle thus stretched. This resistance is active and is reflex (stretch-reflex). At a certain degree of pressure the knee will be found to

OBS. 87.
The stretch-reflex.

yield, and when released will retain approximately the degree of flexion imposed on it. This is the 'lengthening reaction' already observed, § I, but it is now observed in the isolated *vastocrureus* muscle, and thus shown to be a proprioceptive reaction of that muscle itself. It is called the 'lengthening reaction' because in it the postural (tonic) length of the muscle is increased.

OBS. 88. The 'lengthening reaction'.

Elicit the knee-jerk. Note that it has the characters met with in exerc. XVI, obs. 73, p. 92.

OBS. 89. Reflex inhibition of posture.

VI. Apply a pair of electrodes (the bare standard-carried pattern or preferably the glass-sheathed pattern) to the prepared right sciatic nerve, as in exerc. XVIII, § V (Pl. IX, fig. 5). Use the 'shortening reaction' to give the knee a posture of extension. While it is in the extended posture, i.e. at an angle of something more than 90°, your partner faradizes the central portion of the ligated ipsilateral sciatic nerve. Note that this stimulation causes the leg to drop into flexion. This is due to reflex inhibition of the postural tone of the right quadriceps muscle. The cessation of the stimulus may be followed by a return of the extension of the knee (post-inhibitory rebound) or it may not. Rebound is more likely to occur when the pre-existing tonus of the preparation is strong and the stimulus is fairly strong but brief, i.e. not more than 1".

OBS. 90. Reflex inhibition of contraction.

VII. Expose the right patella and tendon. Detach the latter from the tibia by removing from the tibia with strong bone-pliers the tubercle into which the tendo patellae is inserted. Free the patella from its articular attachments. Insert a drill into and through the condylar end of the femur from the outer side into the great trochanter where exposed at proximal end of the sciatic wound. Attach the drill-pins in condyle and trochanter to the brass screw-holder and clamp these to a vertical standard. Pass the steel hook through the patellar tendon proximal to the detached tibial tubercle and hook to the short arm of the isometric myograph. Arrange a pair of electrodes, preferably carried in glass tube, to the contralateral sciatic central to its ligature; connect these electrodes with the shorting-key of the secondary circuit of the other inductorium.

Faradize the left sciatic. Note that extension of the right knee ensues. Bring the myograph-lever to the recording-drum surface. Faradize left sciatic again, and about 3" later faradize right sciatic for 5" while left is being faradized. Continue stimulation of left sciatic for about 3" after cessation of stimulus to right sciatic. Note the effect (text-fig. 42).

Vary the combination of the right and left sciatic stimuli in respect of sequence, time, and strength. Note the results.

[For add. obs. on Reflex rhythm in crossed extensor reflex (extensor), Obs. 91, see p. 131.]

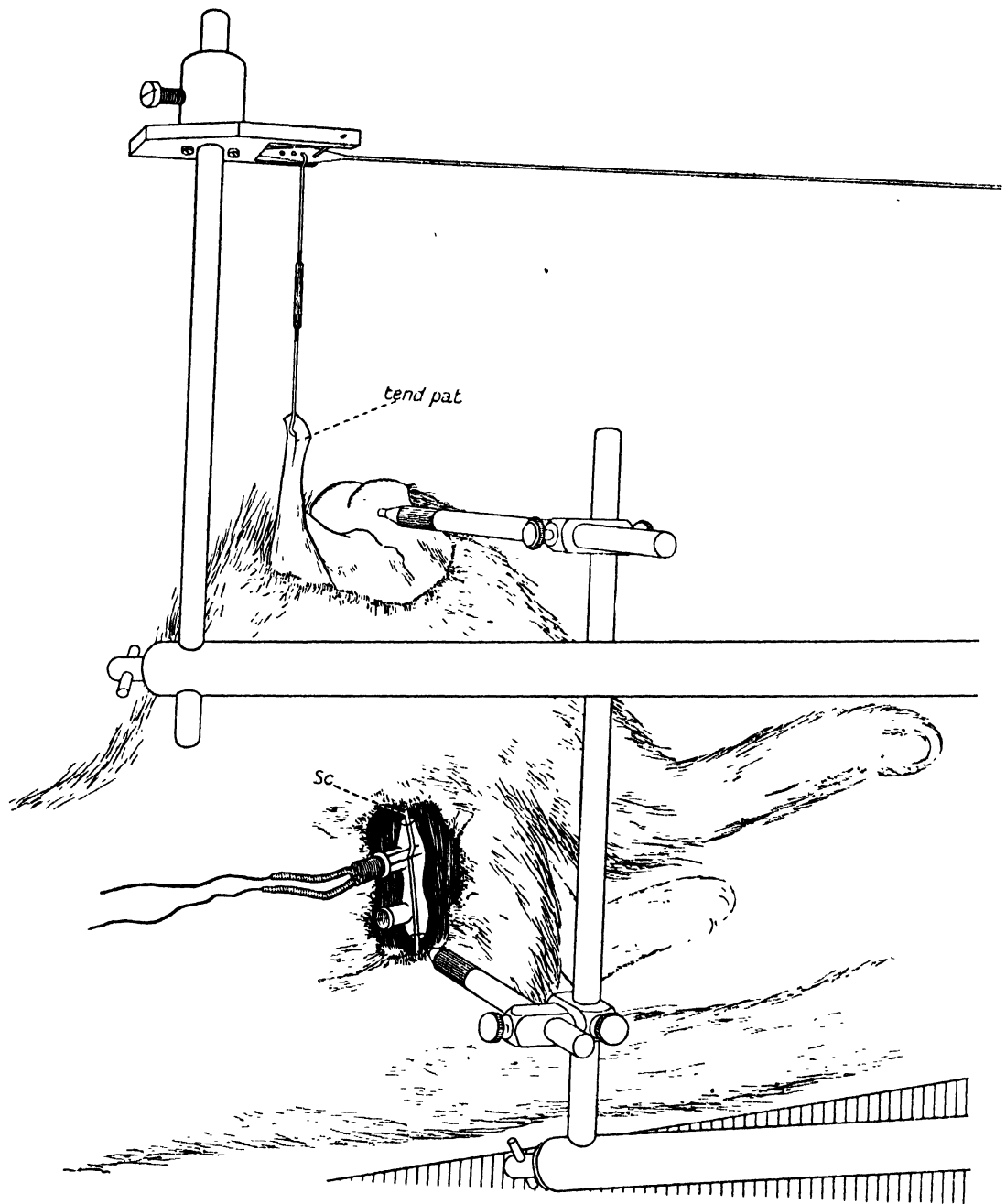

TEXT-FIG. 41.
For description see text.

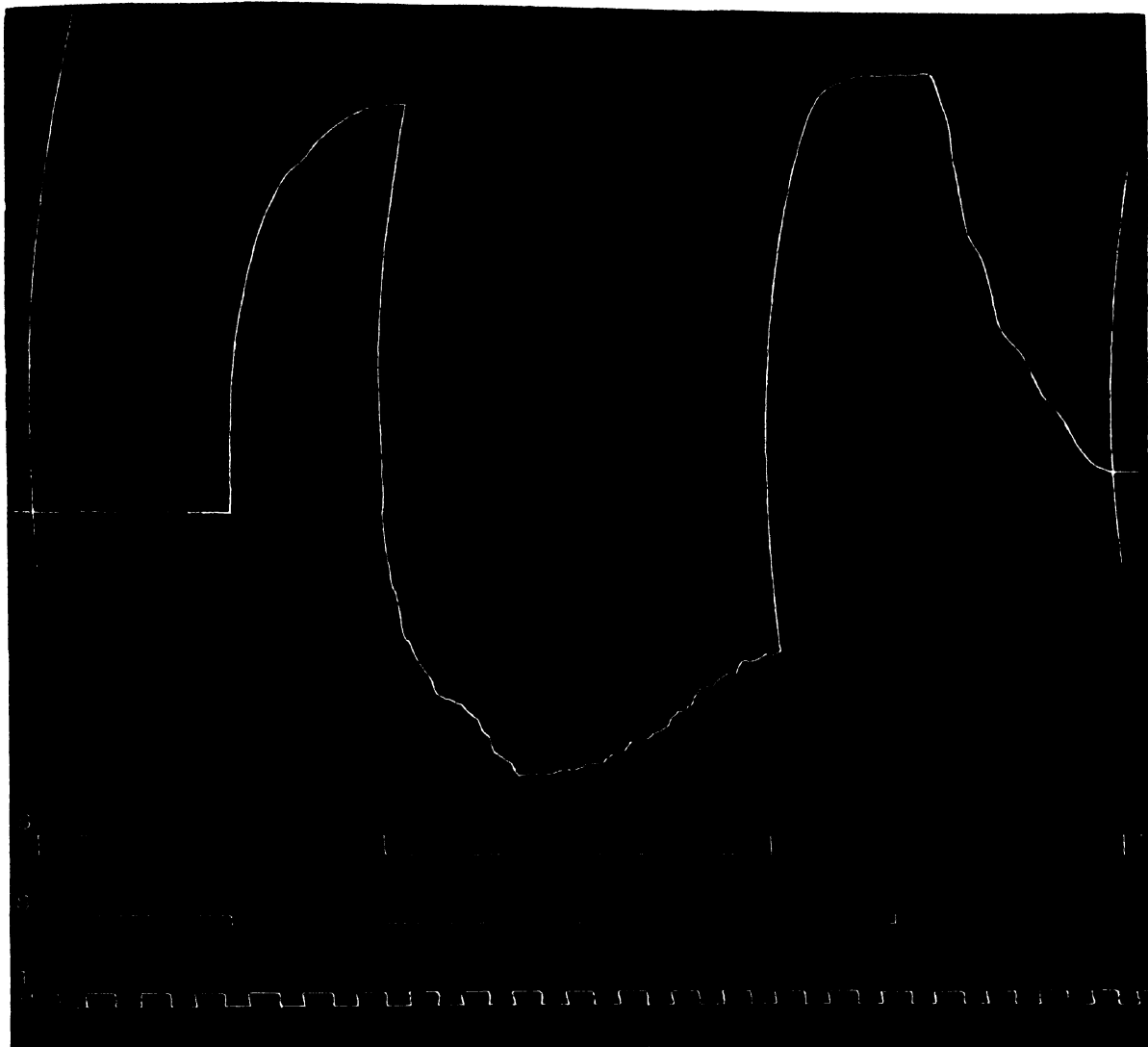

TEXT-FIG. 42. Myogram, quadriceps muscle, decerebrate preparation, showing postural tone and reflex contraction, and reflex inhibition of both (C. W. Armstrong and A. E. Thomas). Uppermost line, muscle trace; upper signal-line marks time of stimulation of central end of severed ipsilateral peroneal nerve; lower signal-line, time of stimulation of central end of severed contralateral peroneal nerve; τ , time in seconds. At beginning the muscle shows a certain degree of steady postural (tonic) contraction; stimulation of contralateral afferent nerve (r. sciatic) evokes a strong reflex contraction, the muscle-record rising from the tonic line; stimulation of ipsilateral afferent (l. sciatic) causes immediate relaxation not only of the contralateral reflex but of the postural contraction as well, although the faradization of contralateral afferent is maintained unaltered all the time. Stimulation of ipsilateral afferent is then withdrawn and, after a marked though brief latency, postural contraction and contralateral reflex return to their full previous amount. Contralateral stimulation is then withdrawn and the contralateral reflex subsides; a residue of postural contraction (tone) remains. The vertical arcs recorded show the relative 'longitudes' in relation to the signal-marks.

ANNOTATION

This exercise illustrates postural activity of skeletal muscle and the central inhibition which plays a large part in the co-ordination of muscular acts. In the decerebrate preparation all those muscles which are commonly employed in the maintenance of the erect posture are in a state of exaggerated reflex tonus. The exercise illustrates this on the main extensor muscle of the knee and isolates it by nerve section of all the nerves of the limb except the quadriceps nerve itself, the bony and fascial attachments of the muscle not being disturbed until later.

The exercise shows—

(1) that this muscle retains its tonic postural action so long as its own nerve (afferent and efferent) remains intact. The afferent nerve-fibres on which the postural reflex depends are those coming up from the muscle itself; in other words, its postural activity is a proprioceptive reflex. The stimulus which thus actually excites the proprioceptive organs in the muscle appears to be the slight mechanical stretch of the muscle. The reflex posture, like the knee-jerk itself, may thus be regarded as a stretch-reflex.

(2) that this proprioceptive reflex is inhibited when other afferent nerves of the limb, e.g. central stump of ipsilateral sciatic, are stimulated.

(3) that, conversely, stimulation of the afferent nerves of the crossed fellow-limb,

e.g. contralateral sciatic, increases the postural tonus of the extensor muscle, and also excites a reflex contraction of it, a movement of active further extension of the knee.

(4) that this reflex contraction and increased reflex tonus of the extensor can, like the proprioceptive reflex, be inhibited by stimulation of the ipsilateral limb-afferents, e.g. in this exercise central stump of left sciatic nerve. In all these cases the seat of the inhibition lies not in the muscle but in the centres in the spinal cord and bulb.

(5) that a strong and not too long continued reflex inhibition is followed, on withdrawal of the inhibitory stimulus, by an increase of the tonus contraction; this post-inhibitory increase of postural activity is commonly termed 'rebound'.

For relevant papers, cf. C. Sherrington, *Proc. Roy. Soc.* lx, p. 411, 1896; *Brain*, vol. xxxviii, p. 197, 1915; E. G. T. Liddell and C. S. Sherrington, *Proc. Roy. Soc.* vol. xcvi B, p. 212, 1924; *ibid.* xcvi B, p. 267, 1925; J. F. Fulton and E. G. T. Liddell, *ibid.* xcvi B, p. 577, 1925; D. Denny-Brown and E. G. T. Liddell, *Jnl. of Physiol.* vol. lxiii, p. 144, 1927; J. F. Fulton, *Muscular Contraction of the Reflex Control of Movement*, Baltimore and London, 1926; J. F. Fulton and Pi-Suñer, *Amer. Jnl. of Physiol.* vol. lxiii, p. 144, 1928; D. Denny-Brown, *Proc. Roy. Soc.* vol. civ B, p. 252, 1929.

EXERCISE XX

EXCITATION OF CEREBELLAR CORTEX; SPINAL TRANSECTION; SPINAL REFLEX TETANUS: ITS RHYTHM, TENSION AND AFTER-DISCHARGE. OCCLUSION OF REFLEX EFFECT

I. The preparation is decerebrate. See that it is in good condition and note the degree of decerebrate rigidity in the limbs.

II. Have ready for use the induction coil, a torsion-wire interrupting key (see below) and stimulating electrodes, both the hand pattern and the glass-sheathed; bone-pliers, modelling clay, and some 2 per cent. novocain solution coloured with a little methylene-blue; a strong standard with clamp for clamping it to the table edge, and an isometric myograph (e.g. see text-fig. 44) to fit the standard and capable of dealing with tensions up to 3.5 kils., and a small double hook of adjustable shank-length.

III. The decerebrate preparation has been made in the usual way with the guillotine (p. 155); the whole of the front, i.e. cerebral, portion of the cranium has therefore been removed. Carefully open the skin-flaps which have been drawn together so as to cover the cut end of the brain-stem. Cautiously remove the pad of cotton-wool without disturbing the clots which closed the vertebral arteries. If the tentorium cerebelli has not been removed by the guillotine at the decerebration, that has now to be done. It is bony and must be removed piecemeal with nibbling forceps; first, however, detaching from it the dura mater by lifting this latter and excising with a sharp knife. Pinching or pulling on the dura must be avoided, since it evokes generalized reflex effects. Care must also be taken during the operation not to lift the head higher than just to counteract the venous oozing from the diploë. Otherwise air may be sucked into the sinuses and air embolism of the heart ensue (see p. 73). As far as possible stop the openings in the diploë with modelling clay or bone-wax.

Obs. 92.
Inhibitory action
of cerebellar
cortex.

Removal of the tentorium exposes the anterior surface of the cerebellum. Observe the laminated arrangement of the folia. Note in the mid-line the vermis cerebelli, running as a broad ridge antero-posteriorly, and bounded on each side by a well-filled vein. Lateral to these veins are seen the wider and flatter lateral hemispheres of the cerebellum. The cerebellar cortex should have a pinkish bronze tinge showing that the circulation in the small vessels is brisk. Unless the cortex has this colour, and unless it is kept warm by frequent application of fresh warm swabs, it will be found not to respond to faradization.

Let your co-worker hold the preparation up so that the degree of rigidity in its limbs may be examined more readily. Using bipolar electrodes and currents which are weak but perceptible to the tongue, faradize the anterior cerebellar surface just lateral to the vein. Note the inhibition of rigidity which ensues in the ipsilateral limbs. It has a long latent period (5") but proceeds to definite totality. Other areas of the cerebellar cortex (so far as you have exposed it) yield nothing unless much stronger currents are used. Any effects then observed are probably due to escape of current to other structures, e.g. in the brain stem, and are not genuine cortical cerebellar effects.

Control the accuracy of your first observation (that the cerebellar cortex is excitable) by narcotizing the surface with a small swab just moistened with the 2 per cent. novocain solution. After a brief application the inhibitory effect on stimulation disappears.

IV. Replace the skin-flaps so as to protect the cerebellum and brain-stem. Leave the head somewhat raised by a thread attached to a low standard, taking care that the tracheal tube and breathing are unimpeded.

Place the animal as for the exposure of the lumbar spinal cord (exerc. XV, p. 86). Proceed to etherize the preparation with ether sprinkled on a light cloth held before the openings of the tracheal cannula. Your co-worker can supervise and control this, watching the respiration, the heart-beat, and degree of rigidity, to guard against pushing the etherization too far, while, taking the last rib (13th) as guide, you proceed in the manner of exerc. XV to expose by laminectomy the spinal cord about the level of the tenth thoracic segment. Lay bare a length of one full segment, without opening the theca. Avoiding the place of attachment of the spinal nerve-pair, pick up with the fine-tipped splinter-forceps the uncut spinal theca from its dorsal aspect without engaging the spinal cord itself. Lifting the cord somewhat from its bed cut through it with scissors. In doing so take care not to cut into or prick the veins underneath the cord: their bleeding will obscure the contents of the vertebral canal and may of itself prove a dangerous haemorrhage. Directly the cord has been cut the administration of ether should cease.

V. Introduce into the primary circuit of your stimulating inductorium an interrupting key enabling interruptions as low as 20 and as high as 40 a second. Convenient because noiseless and needing no extraneous motor is the key figured text-fig. 43. A steel wire (*a*) stretched horizontally between two low standards (*b*, *b'*) on the wooden base carries midway along its length

a horizontal cross-piece of soft iron (*c*), which is the armature of a small electro-magnet (*e*). The electro-magnet is set in a socket concentric with the wire, and its poles, equidistant from the wire, lie one over one end of the armature, the other under the other end of it. The pull of the poles forms therefore a torsing couple for the wire at its mid-length. From that end of the armature, above which the magnet pole lies, an amalgamated needle sticks

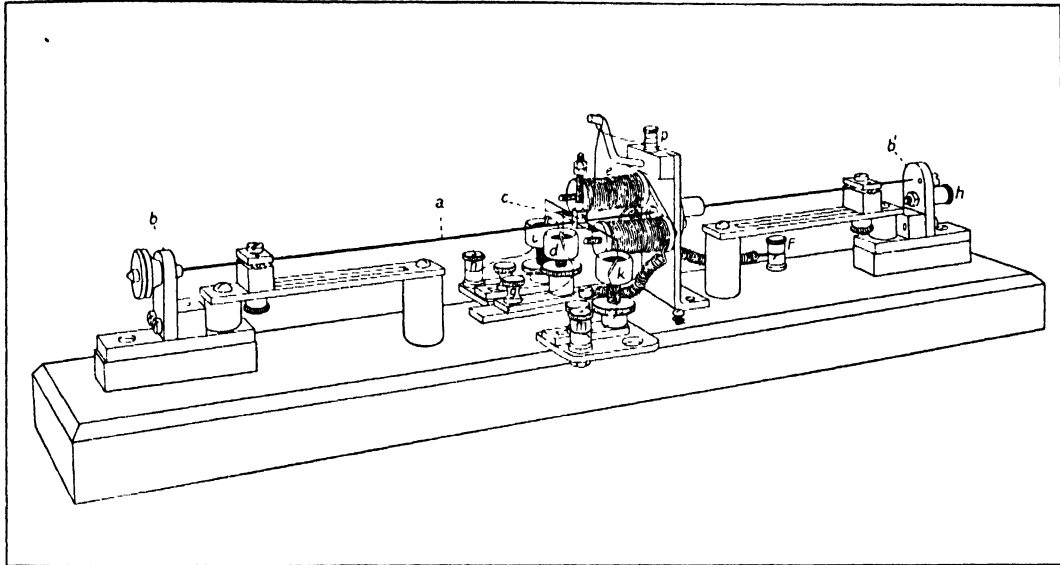

TEXT-FIG. 43. For description see text.

down so that, when it swings, it dips in a mercury pool (*d*) contained in an adjustable ebonite cup below.

(i). Connect the binding screw (*f*) with one terminal and the binding screw (*h*) with the other terminal of a 2-volt accumulator. The circuit passes from (*f*) through the coils of the electro-magnet to binding screw (*g*) of the mercury pool (*d*) and so, when the armature-needle dips, to the cross-piece armature, the stretched wire and from binding screw (*h*) to the accumulator whence it is completed through a bridge-key to (*f*). The steel wire and its weighted system (armature, &c.) when the circuit is completed, make pendular vibrations about the long axis of the wire, the pull of the electro-magnet and the rigidity of the torsed wire alternately breaking and remaking the current. The frequency of the pendular vibrations with a given wire can be varied (1) by raising and lowering a screw-bob working on a small upright carried by the rocking armature, (2) by altering the free length of the wire between the two adjustable clamps. The foregoing is the driving circuit of the key. No further contact-key is needed in the driving circuit.

The mercury pool (*d*) is set so that the armature-needle when the armature is at rest just fails to reach the mercury; the key can then be started or stopped with the finger by a touch at the end of the cross-wire armature.

(ii). The armature carries an insulated cross-wire from the two ends of which amalgamated needles dip into adjustable pools (*i*, *k*). When the armature is caused to vibrate by closing the driving circuit, the primary circuit of the inductorium is made and broken at these pools. The binding screws (*m*, *n*) connect with the mercury of the pools, while a fine copper wire (38 S.W.G.) connects with the cross-wire at its mid-point from binding screw (*p*). Adjust the height of the ebonite cups (*i*, *k*) so that the needles of the cross-wire dip into the mercury pools only toward the lowest part of the oscillation of the armature ends. Connect the binding-screws of the two cups together through a bridge-key, and leave the bridge-key open. Connect the primary coil circuit of your inductorium to binding-screw (*p*) and to the binding-screw of one of the mercury cups. On then setting the key going by means of its own driving circuit there will be an interruption of the primary coil circuit for each complete oscillation of the torted steel wire. On closing the bridge-key between the mercury cups there will be two interruptions for each such oscillation. By closing the bridge-key during stimulation you can therefore without other alteration of your stimulus series double its frequency.

VI. *Myograph*. The myograph can with advantage be of isometric type (see figs. 41, 44). A short steel wire fixed at one end to a brass frame and with its other end free, but supported on a V-cut bearing, carries close to this bearing a stiff short brass double-arm soldered strongly to it. The double-arm has on one side of the wire holes for receiving the steel hook from the muscle tendon; on the other side of this wire the brass double-arm carries a light writing lever some 20 cm. in length. The myograph is carried on a rigid standard clamped to the table (or to an arm from the kymograph).

Obs. 93.
Spinal tran-
section on
decerebrate
rigidity.

VII. Note that extensor rigidity such as was present prior to your severing the spinal cord is present no longer behind the seat of the transection, *e. g.* is gone from hind-limbs and tail; but in front of the transection, *e. g.* in fore-limbs and neck, is more marked than before.

VIII. *Operation*. The ankle-flexor tibialis anticus is prepared as in exerc. XVIII, p. 102, with the ipsilateral tibial (popliteal) nerve as afferent. In severing the nerves at the groin cut the internal saphenous low enough to leave a central stump convenient for stimulation if desired. The drills, &c., can be arranged as in previous exerc., p. 103. The fixation posture can with

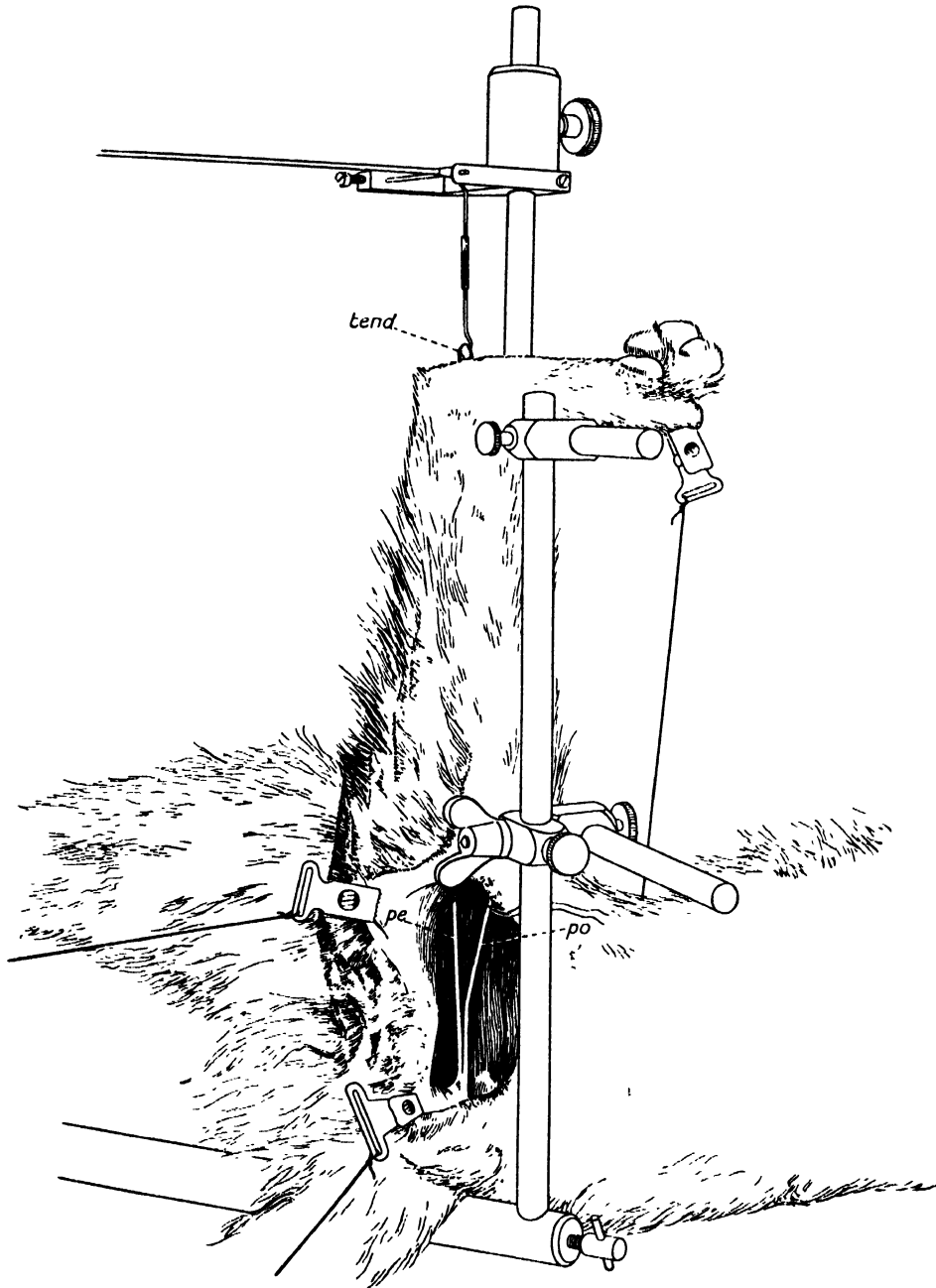

TEXT-FIG. 44.

For description see text.

advantage be as follows (fig. 44): preparation supine, thigh well flexed, leg below knee vertical with foot upward. Insert the small steel double-hook through the muscle tendon close to its still attached bony tubercle. Adjust the height of the myograph so that the resting muscle is just taut.

Arrange the stimulating electrodes on the ligated (but uncut) afferent nerve central to the ligature; and leave them in place.

IX. By using the secondary coil at appropriate distances record (1) a weak reflex tetanus and (2) a stronger, better maintained reflex tetanus, in each case with the bridge-key between the mercury cups in parallel (*a*) open, and (*b*) closed. With frequencies below 30 a sec. the stimulus rhythm is given clearly by reflex tetanus. Finally, with the bridge-key closed, and pushing cautiously the secondary coil up toward primary, obtain and record as powerful a reflex tetanus as the preparation will yield.

OBS. 94 A.
Spinal reflex
flexor tetanus.

X. Detach the tendon from the myograph, and remove the electrodes from the afferent nerve. Expose and ligate tightly the peroneal nerve, which contains the motor nerve supply of your muscle. Arrange the electrodes upon the peroneal nerve distal to the ligature. Re-attach the tendon to the myograph. See that the quiescent muscle is just taut. This can be adjusted without shift of the myograph by turning the screwshank of the hook. Record samples of weak, moderate and final maximal tetanus for comparison without those of the reflex. Note the absence of after-discharge, the more marked stimulus-rhythm, and the greater tension attainable by the motor-nerve tetanus.

OBS. 94 B.
Motor nerve-
tetanus.

XI. Detach the tendon. Calibrate the myograph with a spring-balance.

[*For additional observation 95, Occlusion of reflex effect, see p. 131.*]

ANNOTATION

Obs. 93. For excitation of cerebellar cortex, see F. Bremer, *C.R. Soc. Biol.* vol. lxxxvi, p. 955, 1922; *Arch. Intern. Physiol.* vol. xix, p. 189, 1922; F. R. Miller and F. G. Banting, *Brain*, vol. xlv, p. 104, 1922; F. Bremer, *Journ. Neurol. et Psychiat.* vol. xxv, p. 520, 1925; F. R. Miller, *Physiol. Rev.* vol. vi, p. 124, 1926; D. Denny-Brown, J. C. Eccles, and E. G. T. Liddell, *Proc. Roy. Soc. B.* vol. civ, p. 518,

1929; also C. Sherrington, *Phil. Trans. B.* cxc, Croonian Lect. 1897; *Jnl. of Physiol.* vol. xxii, p. 319, 1898.

Obs. 94. For myographic characters of spinal flexor tetanus see E. G. T. Liddell and C. Sherrington, *Proc. Roy. Soc. B.* vol. xcv, pp. 142 and 299, 1923; J. F. Fulton, *Muscular Contraction and Reflex Control of Movement*, Baltimore and London, 1926.

EXERCISE XXI

THE PREPARATION OF SECRETIN. PANCREATIC SECRETION AND THE ACTION OF SECRETIN. THE SECRETION OF BILE

I. *Preparation of secretin.* For this exercise it is necessary to have ready a solution of secretin. This may be prepared from material (sheep or pig) taken fresh from the slaughter-house or from the carcase of a cat used in a previous exercise. The duodenum is excised and washed through under the tap. Slit it open along its whole length. Scrape off the mucosa thoroughly with a long-bladed scalpel and collect the scrapings on a clean glass plate. Mix them with an equal volume of clean sand which has been moistened with a few drops of $\cdot 15/N$ HCl. Transfer this paste to an evaporating dish and add enough $\cdot 15/N$ HCl to give a free suspension. Raise the mixture to boiling over the flame. When actively boiling add $2/N$ NaOH drop by drop until the mixture as tested by litmus is almost neutral, i.e. faintly acid. On removing the flame, the coagulated proteins will sink, leaving a clear supernatant liquor. Filter this through glass wool as quickly as possible. The filtrate contains crude 'secretin'.

Or (J. Mellanby), instead of employing acid, extract the mucous membrane with 5 per cent. NaCl solution, or Ringer's fluid, or water, taking one part of mucous membrane ground up with sand and boiling it with two parts of the extractive, and filtering. These extracts are as potent as the acid extract.

Obs. 96.
Action of
secretin.

II. A decerebrate preparation is provided. See that it is in good condition on the warmed table and, if necessary, ventilated by the pump.

Operation. Place the preparation supine with the limbs extended by clip-weights. Standing on the right side of the preparation, make a mid-line incision through the abdominal wall from the root of the xiphoid cartilage backwards two-thirds of the way to the symphysis pubis, taking care not to injure the abdominal contents. Note the coils of jejunum exposed at the upper part of the incision. Turn them to the left and expose the duodenal loop. Lift the duodenum and turn it carefully to the preparation's left side. The pancreas will be seen attached to the mesenteric border of the duodenum (text-fig. 45), lying within the duodenal loop of mesentery. Improve your access to the duodenum by cutting away the cartilaginous xiphoid, and retracting the edges of the abdominal wound. Where the pancreas and duodenum cohere, lift the duodenum and draw it to the left side with a clip-weight. Make out the common bile duct. It descends from the liver to reach

the pancreatic edge of the duodenum about one inch below the pyloric sphincter. It is tinged with bile. Immediately below the bile duct and in close relation to it, the pancreatic duct emerges from the head of the pancreas and opens into the duodenum by the same orifice as the bile duct. The ducts may be made more evident by pressing gently on the gut with the handle of a scalpel to blanch the neighbouring tissues. It will probably be necessary

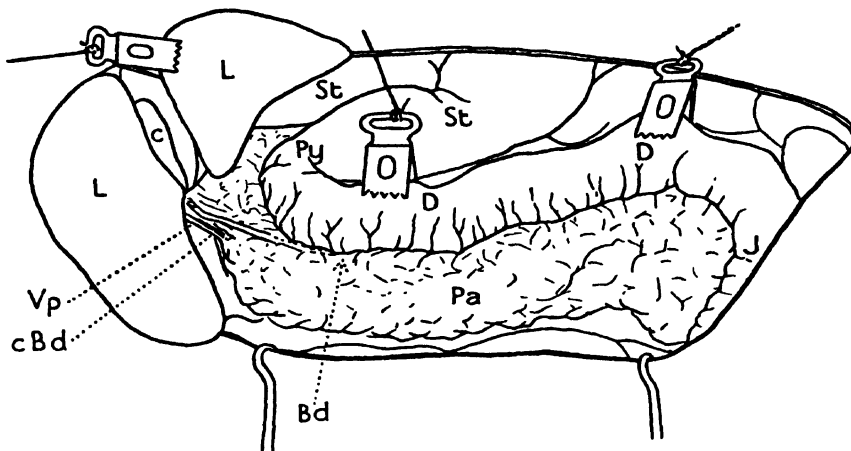

TEXT-FIG. 45. Pancreatic-duodenal junction (cat) viewed from right side, duodenum being drawn over towards preparation's left by clip-weights. L, cystic lobe of liver; St, stomach; Py, pylorus; D, duodenum; J, jejunum; Pa, pancreas; cBd, common bile duct; C, gall-bladder; Vp, portal vein; Bd, indicates by arrow the place where the main pancreatic duct usually enters duodenum; hook-weights retract the right edge of abdominal opening.

to remove some tissue by blunt dissection. Check haemorrhage with cotton-wool pledgets or with artery forceps, carefully applied. Having identified the ducts, pass a ligature of strong thread under both.

Before proceeding further, inject with a hypodermic syringe 5 c.c. of secretin solution into the saphenous vein and wait for about three minutes. The secretin solution removes viscid resting juice from the duct and the continued secretion of juice assists the subsequent operations. An incision is now made into the pancreatic duct with small sharp scissors. A free flow of pancreatic juice ensues. Insert a cannula into the duct and tie it firmly in position by means of the ligature previously passed around the ducts. Close the abdominal wound as far as possible and place the preparation on its left side with the cannula exterior. The collection of juice is made easier by attaching a small piece of right-angled glass tubing to the cannula. The drops of juice can be counted with a watch. Give, if necessary, further injections of secretin, refilling the syringe by detaching it from the needle,

which is left *in situ* in the vein. The amount of juice secreted after the injection of 0.5 mgm. pilocarpine (vagal juice) may be observed also. The effect of vagal paralysis on the secretion of pancreatic juice after secretin is observed by injecting 2 mgm. atropine.

Obs. 97.
The flow of bile
after the intra-
venous injection
of (a) secretin,
(b) bile salts.

III. With the abdominal cavity of the preparation open gently press on the thorax, immediately above the diaphragm, between the fingers and thumb of the right hand. This depresses the liver and brings the gall-bladder into view. In the fasting animal the gall-bladder is distended with dark green bile, but in the digesting animal the bladder may contain only a small quantity of golden yellow bile. With the aid of an assistant carefully puncture the gall-bladder with the needle of a hypodermic syringe and remove the greater part of the bile. Make a free incision into the bladder and tie a wide cannula into it by a stout ligature. The cannula should have a bore of about 1 mm. to allow the viscid bile of the fasting animal to flow into it. In the previous observation the common bile duct was included in the same ligature as the pancreatic duct, so that now all the bile secreted by the liver flows out by the cannula in the bile-bladder. Place the animal on the left side and bring the bile cannula to the exterior. Attach the cannula to a right-angled piece of glass tubing to facilitate the collection of bile.

It may be observed that bile is being continuously secreted, slowly in the fasting cat but rapidly in the digesting cat. Before observing the effects of various procedures on the rate of biliary flow, it is advisable to wait until the freshly secreted bile (yellow in colour) falls at a steady rate from the cannula. The effect on the bile flow of an intravenous injection of secretin may be observed. Note that the latent period before the bile flow is influenced is long, e.g. 3'. Unless the extract contains bile salts, the flow induced is small. The effect of bile salts in the secretion of bile by the liver may be observed after the intravenous injection (slowly) of 1 c.c. of bile or .1 gm. of bile salts dissolved in 5 c.c. Ringer. The cholagogue action of bile salts is very large if used in appropriate concentrations.

[Additional observations to this exercise, Obs. 98, 99, 100, are to be found on p. 133.]

ANNOTATION

Obs. 96. This repeats the essential observation of W. M. Bayliss and E. H. Starling (*Proc. Roy. Soc.* vol. lxi, p. 352, 1902). The duodenal mucosa yields a substance 'secretin', which when circulating in the blood-stream excites secretory activity in the pancreas. For such excitants Bayliss and Starling, at the suggestion of W. B. Hardy, introduced the term *hormone*. The hormones form in Sharpey-Schafer's nomenclature the excitant group of 'autacoids' (*Endocrine Organs*, London, 1924, Pt. 1). Consult also W. M. Bayliss, *Principles of General Physiology*; and J. Mellanby and A. St. G. Huggett, *Jnl. of Physiol.* vol. lxi, p. 122, 1926; and

J. Mellanby, *ibid.* vol. lxi, pp. 419 and 489, 1926; *Proc. Physiol. Soc.* p. xxxvii, vol. lxi, 1926; vol. lxiv, p. 331, 1928; and vol. lxvi, p. 1, 1928; see this last for the preparation of pure secretin. In relation to the method of employing acid extraction it is well not to carry the 'neutralization' to full completeness lest the neutral point be overstepped. If the solution become alkaline it is more difficult to filter even if re-neutralized by adding more acid; further, *secretin* is easily destroyed by boiling in alkaline solution. The preparations made in the way described retain their properties for several days.

EXERCISE XXII

AMOEBOID MOVEMENT; PHAGOCYTOSIS, INTRA-VENOUS INJECTION OF BACTERIA

I. See that the decapitate preparation provided on the warm table is in good condition and is being properly ventilated by the pump.

II. Materials necessary are: six microscopic slides previously thoroughly cleaned in a potassium bichromate-sulphuric acid mixture; eight coverslips; plasticine; arterial cannula with rubber extension; two test-tubes; four centrifuge tubes of 15 c.c. capacity; eight Pasteur pipettes, one with capillary end cut off flat for collecting white corpuscles *v. i.* § V; sodium citrate solution (1.5 per cent in 0.85 per cent. sod. chloride); a culture of bacteria, e.g. *B. pyocyaneus* or *B. coli*, on agar; six watch-glasses; blotting or filter paper; a dilute suspension of carmine in normal saline; melted paraffin wax in a vessel with a small brush; a loop of wire on a handle for proceeding with the bacterial culture. Also, for § XI, have three freshly sterilized shallow glass dishes with glass lids, and three cotton plugged test-tubes containing sterile gelatin culture medium.

III. A microscope is provided with objectives $\frac{2}{3}$ ", $\frac{1}{8}$ ", and $\frac{1}{2}$ " (oil immersion), and a warm stage of brass to be clamped on the microscope stage. A micro gas-burner from which the upper tube has been unscrewed is placed

under the long arm of the warm stage; its flame is to be adjusted to keep the stage at about 38°C. This adjustment can be judged by putting on the stage two bits of wax, one melting at 35° C., the other at 39° C. A thin felt pad between warm stage and microscope stage is helpful but not essential.

IV. A bit of the plasticine is rolled out between the palm of the hand and the table into a long cord-like piece about 1 to 1.5 mm. in diameter. On to each of four of the cleaned glass slides curl a piece of this plasticine so that its ends overlap without touching and enclose a circular space, thus G.

V. Insert the rubber-armed cannula into the carotid artery of the preparation. Draw 15 c.c. blood into one of the centrifuge tubes and put aside to clot. Again release the carotid and fill up a watch-glass with blood. Rapidly transfer some of this blood, by a Pasteur pipette, to the circles of the four prepared slides flush to the level of the top of the plasticine ring. Apply clean coverslips to the plasticine ring and press down, taking care not to break the thin glass. A disk of blood is thus imprisoned on each slide. Place the slides in an incubator at 37° C.

VI. Put 5 c.c. normal saline into a clean test-tube. Sterilize the wire loop by passing it through a Bunsen flame; so soon as cool take with it a loopful of bacteria from the agar culture, and transfer this to the inside of the test-tube; mix thoroughly by adding a loopful of saline from the bottom of the tube and rubbing the two against the side of the tube. Repeat till an opalescent bacterial suspension in the saline has been obtained. Sterilize the loop again in the flame.

Take the centrifuge tube (§ V) in which the blood has now clotted, and with a glass rod break up the clot, and centrifuge the tube to obtain serum. Pipette off some serum, and in a watch-glass mix it with a small quantity of carmine suspension till the fluid is pinkish. Put aside.

VII Return to the decapitate preparation. Place 12 c.c. of sodium citrate solution (§ II) in each of three centrifuge tubes and then into each draw from the carotid about 3 c.c. of blood. See that the blood and citrate solution are well mixed, and assist the mixing by tilting but not shaking the tubes. Balance the tubes and set them centrifuging at a moderate speed.

OBS. 101.
Intravenous
injection of
bacteria.

VIII. Pour (§ VI) into a clean watch-glass enough of your bacterial suspension to fill from it a needle-syringe. The syringe need not have been sterilized. With it inject (excerc. V, p. 30) about 0.5 c.c. into the saphenous vein, toward the heart, of the preparation. Wash out the syringe.

IX. i. In the centrifuged tubes the corpuscles will now be sedimented. A thin creamy layer is discernible above the red mass. Support the tube vertically and take the Pasteur pipette with specially cut end (§ II). Squeeze the bulb slightly and gently lower the point of the pipette until it is just in contact with the white layer. Be careful not to dip below this. By gently releasing the bulb suck some of the white layer into the pipette. Blow this out into a watch-glass. With a clean long Pasteur pipette take some of your bacterial suspension and blow it into another watch-glass.

Obs. 102.
Phagocytosis
of bacteria.

Take from the watch-glass some white corpuscles into the pipette and mix them thoroughly with the bacteria in the second watch-glass, drawing up and expelling the mixture several times. When well mixed draw up into the middle of the capillary portion of the pipette a column about 25 mm. long. Seal the free end of the capillary portion in a flame. Make three such preparations and place in the incubator at 37° C.

ii. At the end of 15, 30, and 60 minutes take one of these tubes, break off the sealed tip, and expel the contents upon a clean slide (presence of grease spoils the preparation); make a smear preparation, as for a blood-film. Dry and fix over a flame as with a blood-film. These smear preparations are to be stained by Leishman's stain and examined later.

X. After placing your capillary leucocyte-bacteria mixtures in the incubator, and while waiting the necessary time before examining them, return to your plasticine-ring slides (§ V) which by now will have been incubated for nearly an hour. See that the warm stage on the microscope is of right temperature. Remove the coverslip from the slides. Take away the ring of plasticine and with it the clot of blood which will adhere to it. Carefully wash the slide in normal saline, at 38° C., to free it from remaining red corpuscles; this must be done gently or the leucocytes adhering to the glass will be also removed. Suck up redundant saline from the slide with blotting paper. Place a drop of the serum containing carmine particles over the place on the slide where the leucocytes are likely to be. Cover with a coverslip. Paint some melted paraffin wax round the coverslip to prevent evaporation of the fluid under it. Speed in these manipulations is essential for success.

Obs. 103.
Amoeboid
movement of
leucocytes.
Phagocytosis of
carmine
particles.

Place the slide on the warm stage for microscopical observation. Use, with a pin-hole diaphragm, first the $\frac{3}{8}$ " and then the $\frac{1}{8}$ " objective. Locate some leucocytes; they occur often in patches. Their granularity readily differentiates them from the red corpuscles. The oil immersion is of use to examine the leucocytes when found. Watch some, and make drawings at intervals. If your first preparation fails to show any leucocytes make further preparations from the slides still in the incubator.

OBS. 104.
Fate of intra-
venously injected
bacteria.

XI. Warm the three gelatin culture-medium tubes to liquefy the jelly. Turning to the preparation, open the thorax quickly but carefully to expose the heart. Take a Pasteur pipette having a strong capillary portion tapered to a fine sharp end; thrust this end through the wall of the right auricle and collect in the pipette some 0.5 c.c. of blood. After slightly withdrawing with a twisting movement the cotton-wool plug from one of the 'gelatin' tubes, hold the tube slanted in the left hand, insert into it the end of the capillary pipette, and introduce the whole of the blood-sample into the 'gelatin' tube. Withdraw the pipette and lightly replug the tube. Mix the blood and melted jelly without frothing by tilting and retilting the tube twice or thrice. Partly raising the lid of one of the sterile shallow glass vessels pour out into the vessel the blood-gelatin mixture from the unplugged tube. Replace the vessel lid and let stand to cool and set.

Expose the urinary bladder and with a fresh capillary-ended pipette thrust through its wall, withdraw a sample of urine and sow it in nutrient jelly by the same procedure as for the heart blood, finally leaving the plate-culture to set. If the urinary bladder be empty take instead bile from the gall-bladder.

Expose the spleen. Sterilize a clean scalpel by passing it through the Bunsen flame. Incise with it the spleen. With sterilized forceps and scissors cut a fragment from the spleen-pulp. Introduce it into the remaining gelatin-medium tube. With the wire loop in holder freshly sterilized (§ VI) crush the piece of spleen-pulp in the tube and mix it with fluid gelatin medium. Withdraw the wire loop and pour the gelatin sown with spleen-pulp in the remaining plate-culture dish. Cover and let stand for the jelly to set.

XII. These 'plate-cultures', kept at room temperature, e.g. 20° C., will be ready for examination in about 48 hours. The colonies, if any, will then be visible as semi-translucent circular spots ranging up to some 3 mm. across (if *B. pyocyaneus* they may already have a greenish tinge and show some liquefaction of the gelatin). The urine (and bile) will however yield no colonies of the injected bacteria—though under your manipulations the plates may have failed to escape some accidental contamination with mould-spores, &c. Probably also from the plate-culture of the blood-sample there will also be absence of any colonies of the injected bacteria, although several millions were injected into the circulation not much more than an hour before the blood-sample was taken. On the other hand the spleen-pulp culture is likely to show colonies of the injected bacilli. Bacilli injected into the blood-stream are rapidly withdrawn from it by the reticulo-endothelial organs, e.g., spleen, but nevertheless, even when non-pathogenic, remain viable in those organs for a time.

ANNOTATIONS

§ IV. The plasticine ring method for obtaining leucocytes was devised by C. W. Ponder, 1908 (*Lancet*, vol. ii of that year, p. 1746, with figs).

Obs. 104. The rapid disappearance of micro-organisms from the blood-stream after injection into it of even millions of them was first observed by Watson Cheyne (*Trans. Pathol. Soc.*, London, 1875). Cohnheim suggested that this disappearance was by way of the secretory organs. But ob-

servation established later [W. Wyssokowitch (*Zts. f. Hygiene*, vol. i, p. 5); C. S. Sherrington (*Jnl. of Pathol. and Bacteriol.*, vol. i, pp. 258-88, 1894)]; by the culture method, that the withdrawal is in fact due mainly to retention of the micro-organisms by the tissues of the liver, spleen, and red marrow. If the injected micro-organisms are pathogenic, they may later reappear in the general blood-stream and multiply.

ADDITIONAL OBSERVATIONS

It is recommended that these observations be omitted at the first performance of the exercises.

OBS. 20.
Arterial pressure
and faradization
of the spinal
cord.

(Supplementing
Exerc. V. p. 31).

In order to ensure success in the following observations (20, 21), it is well to attempt them as soon as possible after decapitation before the cut stump of the cord has cooled by exposure.

Have ready (1) in a small basin 50 c.c. strong salt solution, e.g. sodium chloride added to excess to 50 c.c. warm water; soak in it some cotton-wool, squeezing out the air so as to soak it thoroughly. (2) The small thin copper plate provided with binding-screw attached. (3) The single-wire electrode in a stylo-penholder as provided (Pl. VI, fig. 4), with a binding-screw on the handle end. (4) The short bandage provided.

Wet thoroughly the toe-pads and cushions of one hind foot of the preparation with the strong salt solution. Apply a squeezed-out thin pad of the cotton-wool soaked in strong saline to the planta and make the pad press well against and between the toe-pads and cushions. Place over the pad the copper plate, bending it to suit the shape of the foot, and with the binding-screw outwards; bind the plate firmly in position by means of the bandage, leaving the binding-screw projecting; fix the bandage by tying it.

Remove the neck-stump clamp, unscrewing it from the atlas. Expose the top severed end of the spinal cord by carefully removing the pledget of cotton-wool so as to avoid restarting hæmorrhage there. Arrange the neck-stump on the operation table so that the preparation lies without disturbance to the arterial-pressure connexion with the manometer.

Connect with an insulated wire the binding-screw on the copper plate on foot with one post of the short-circuit key in the secondary circuit of induction. Connect similarly with fine wire the binding-screw of the single-wire hand electrode to the other post of the short-circuit key. The copper plate forms the diffuse electrode; the single-wire hand electrode is the stigmatic electrode. With a fine camel-hair brush wipe off blood from the cut surface of the spinal cord, and make out the grey matter and the lateral white columns. Set the primary circuit running for faradization and open the short-circuit key in the secondary.

Steadying the neck-stump with one hand, with the other apply the point of the stigmatic electrode to one of the lateral columns for 3–8 secs., while your colleague notes any effect on the arterial-pressure manometer (text-fig. 16). A rise of pressure of somewhat gradual and stepped culmination ensues, which is soon accompanied by quickened pulse-rate; note the latency of both effects, and the long after-action on withdrawal of stimulus. If no effect results from moderate faradization, shave off a thin slice of the cord with a sharp scalpel and reapply the electrode.

Note that stimulation of the cross-face of the *dorsal* columns produces no effect on the blood-pressure, unless the currents be strong, when there is escape to the lateral columns.

OBS. 21.
Antidrome
conduction in
the spinal cord.
(Exerc. V, p. 1).

Stimulation of the cross-face of the dorsal columns does, however, evoke muscular movements; the movement evoked from the lateral division (*cuneatus*) is in the ipsilateral fore-limb, that from the medial (*gracilis*) division is in the ipsilateral hind-limb; in both cases the movement is flexion, in the hind-limb usually of ankle or knee, in the fore-limb

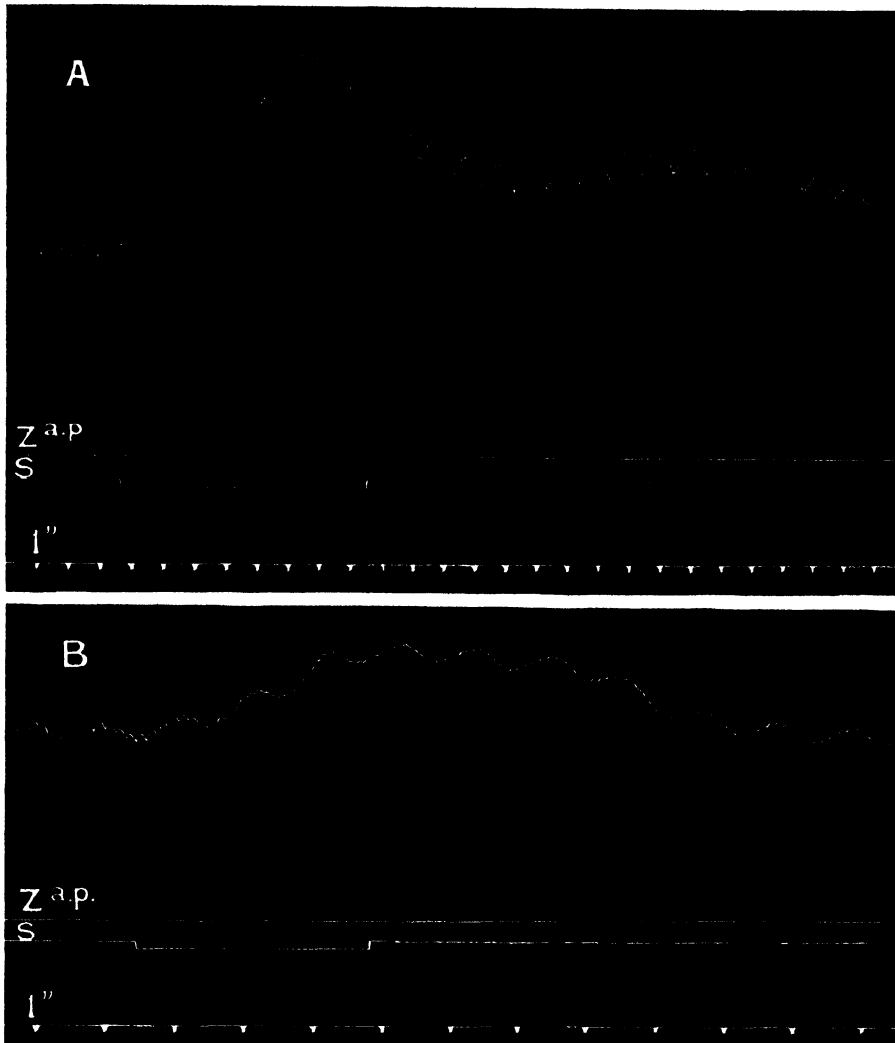

TEXT-FIG. 16. Unipolar excitation of exposed transverse surface of lateral column of spinal cord at first cervical level; effect on arterial pressure. Decapitate preparation (E. G. Cox and N. B. Dreyer). z^{a.p.}, zero level of pressure; s, signal marking time of faradization; 1", time in secs. In B the quicker drum makes more obvious the cardiac acceleration.

of elbow. These movements are due to antidrome conduction down the dorsal root-fibres composing these columns, collaterals coming off from the *cuneatus* fibres in the brachial region, from the *gracilis* fibres in the lumbo-sacral.

OBS. 29.
Central end of
n. splanchnicus
on art. pressure.
(Supplementing
Exerc. VII, p.41)

On *repetition* of exerc. VII, this observation can be made early. Pass with the bent mounted needle a ligature round the central end of one splanchnic nerve. Insert arterial cannula and connect with manometer, if this has not been done.

Faradize with the hand electrodes the central stump of the splanchnic nerve, lifting it by its thread and taking care that the electrodes are applied isolatedly to the nerve. Maintain the stimulation for 5"-10". Observe effect on arterial pressure (text-fig. 20). Stop kymograph.

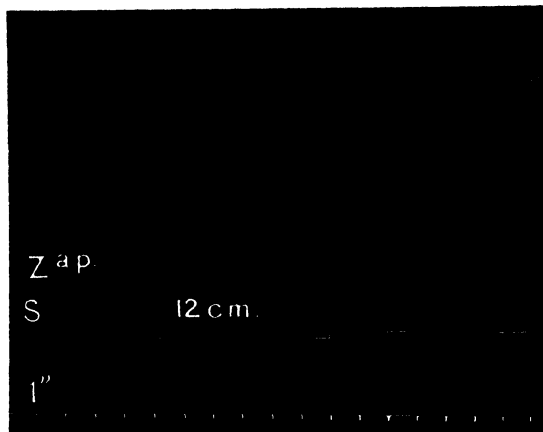

TEXT-FIG. 20. Effect of stimulation of central end of splanchnic nerve on arterial pressure; decapitate preparations (B. G. V. Mellé and J. L. Shipley). z^{a-p}, zero-level of pressure; s, signal marking time of faradization; 12 cm., distance of secondary coil; 1", movement of drum in secs.

OBS. 30.
Asphyxia on
art. pressure
after section
of both n.
splanchnici.
(Exerc. VII, p.
44).

Deepen the splanchnic wound with the fingers and the scalpel handle, carefully pass across the inferior vena cava, already exposed, and the abdominal aorta towards the left side of the preparation. The left splanchnic nerve is then at once met with. Sever it. Readjust the wound and cover it.

Set the kymograph running, and induce asphyxia as in exerc. VI, § V. Compare the effect on the arterial pressure with that obtained in exerc. VI.

OBS. 33 B.
Lymphatic
drainage of
peritoneal cavity
through the
diaphragm.
(Exerc. VII, p.
44).

Obtain the carcass of a rabbit, e.g. one which has just been used in exerc. II, but the thorax only should have been opened. Proceed by cutting through the thoracic wall and vertebral column with shears above the insertion of the diaphragm and removing the whole of the upper part of the body. Take care to avoid opening the abdominal cavity.

A clear view of the central tendon of the diaphragm is thus obtained. Make an incision 5 mm. long through the belly-wall in mid-line and near the umbilicus. Hold up the edge of the incision with forceps and inject 20 c.c. of graphite ink suspension (see Append. p. 149) into the peritoneal cavity and close the wound with sutures. Lift the

carcase by the hind limbs and slowly bring it to the vertical position with the diaphragm hanging downwards. Observe the diaphragm during this manoeuvre. The numerous lymphatic capillaries on the pleural surface become filled with ink in a few seconds. If they do not appear press gently with the hand on the abdomen.

Return to the exposed root of the aorta, and carefully separate it somewhat from pulmonary artery and auricle. With blunt curved needle pass a thick thread round the aorta root, introducing the thread from the animal's left side. Tie loosely the first bend of a reef-knot and leave the thread-ends loose for pulling upon.

Start kymograph, and after a few seconds draw on the thread noose round aortic root, partly occluding the vessel. Observe effect on the arterial graphic. Release the drag on the thread. Then carefully tighten somewhat the tie of the thread, so as to constrict but not occlude the vessel. Note effect on the kymograph record. Then remove the thread altogether.

For this, to the rubber tube from the urethral cannula a piece of bent glass-tubing is attached. The distal end of the glass tube is curved upward and then down for a couple of cm., so as to hook over the edge of a low beaker, the tube's free end being about 5 cm. above the bladder level. Before attaching the tube to the rubber from the urethral cannula the amount of fluid in the bladder is adjusted, by injection through the urethral cannula, so as to suffice for providing a short column of fluid in the proximal part of the glass tube. This fluid column exhibits slight rhythmical oscillations of niveau with the respiratory (pump) movements of the chest, but usually no contractions of the bladder occur, even though the viscus contains a considerable volume of fluid, so long as the preparation lies undisturbed.

The arrangement being adjusted and the preparation at rest, stimuli to the forelimbs, e.g. squeezing of the foot, are found to produce no effect upon the bladder, although they evoke local reflex movement of the limb. But stimuli to the tail, and especially to the perineum, provoke bladder-contraction, the niveau of the fluid in the glass tube rising after a short latent period and falling back as the contraction passes off. A cotton-wool pledget from cold water laid against the perineum evokes the reflex well. The bladder does not empty itself completely.

For this observation the lingualis nerve must be intact, i.e. the observation must be made *before* obs. 54.

Paint a little dilute acetic acid over the mucous surface of the tongue; this often causes an increased flow of saliva by reflex action, the efferent nerve being the corda tympani, the secretory nerve you are going to excite electrically.

Follow the lingual nerve beyond its crossing over the ducts distally for 15 mm. It runs a wavy course which straightens on protracting the tongue by a clip-weight. Ligate the nerve-twigs as far distal as you can. Sever distal to the ligature; lifting the central stump with the thread, free it for 1 cm. Drawing the tongue forward and to the left with a clip-weight, dry the mucosa with a cotton-wool pledget. Faradize the central stump of lingualis nerve with the coil at about 12 cm. on the scale while your colleague observes the mucous membrane to the right side and under the tongue. The appearance of saliva as a bead will reveal the openings of the ducts in the mucosa. Insert cannula as in Obs. 54 and repeat; note flow. Take off the clip-weight retracting digastric muscle; note that the muscle contracts on stimulation of central end of

Obs. 36.
Aortic stenosis
on art. pressure
and pulse.

(Supplementing
Exerc. VIII, p.
50).

Obs. 46 B.
Reflex contrac-
tion of the
bladder.
(Exerc. X. p. 64).

Obs. 53.
Reflex salivary
secretion.
(Exerc. XII, p.
71).

lingualis. The contraction is part of the reflex of opening of the mouth which lingualis sometimes causes.

OBS. 76.
The 'rule' of
the roots and
the pinna
reflex.
(Supplementing
Exerc. XVI, p.
95).

A more complete but longer form of Obs. 74 employs the great auricular nerve (see schema, text-fig. 36) in its course behind the ear as the afferent nerve for excitation instead of the 2nd cervical nerve-trunk near the axis vertebra. The procedure then is as follows:

VI. i. *Operation for great auricular nerve.* (Pl. VIII, figs. 5, 6.) Lay the preparation on its side—on right side preferably, as the accompanying diagrams show operation for left side.

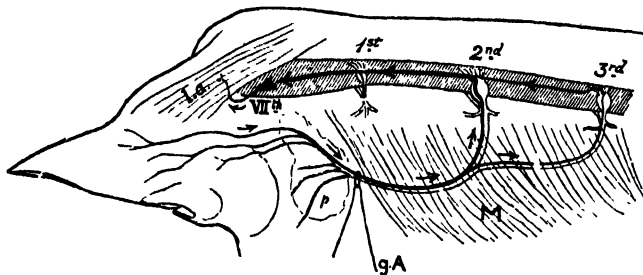

TEXT-FIG. 36. Scheme of reflex path used in employing pinna reflex for testing the conduction of afferent root of 2nd cervical nerve and *auricularis magnus* trunk. VIIth, the left facial nerve; 1st, 2nd, 3rd, first, second, and third left cervical nerves; p, part of parotid gland; l.a., *levator auris longus* muscle; g.A., thread loop round great auricular nerve in superficial part of its course (ligation provides stimulus); m, muscles of neck covering deeper course of great auricular nerve. Spinal cord and bulb indicated by shaded area.

Skin incision from a point on the posterior face of the concha of the pinna, about 2 cm. behind the free lateral edge of pinna and about half-way between the lower end of that free edge and the lower end of the little lateral skin-pocket, the bursella, on that edge. From the above starting-point the skin incision is carried backwards along the side of the neck for about 5 cm., tending slightly toward the dorsum. From anterior end of it an incision at right angles to it is carried for 2 cm. dorsally: from the posterior incision a similar one for 2 cm. ventrally. Reflect the skin-flaps and retract with clip-weights.

The great auricular nerve is thus exposed (Pl. VIII, fig. 5) emerging from under anterior border of m. clavio-trapezius and running towards the parotid gland and concha; the nerve passes forward and divides just behind the concha of the ear into branches; some of these twigs turn ventrally, some continue horizontally, but those which slope dorsally are the essential ones for the experiment; pass a ligature under them and leave it untied.

Follow the nerve-trunk backward under cephalo-humeralis, cutting through part of this muscle and retracting it laterally to expose the nerve. Just under the muscle the nerve seems to be joined by a nerve, n. accessorius, which crosses it—this crossing is the 'carrefour' (Pl. VIII, fig. 6). Without damaging the great auricular nerve, cut through the accessorius nerve to either side of great auricular itself. Follow the great auricular nerve backward. It lies upon the splenius muscle, and proceeds to dip under *levator scapulae ventralis*; the dissection is facilitated by retracting with clip-weight

the lateral edges of these muscles. Carefully open up the intermuscular space into which the nerve plunges; in doing so some bleeding may be caused, but pursue the nerve until a point is reached where the nerve divides into two, a more posterior trunk which passing inward and backward joins the 3rd cervical nerve, and an anterior which passes inward to join the 2nd cervical nerve (Pl. VIII, fig. 6). Carefully sever with the scissors the former of these two divisions, and when cutting it note the pinna of the ear; this will probably give a retractive movement; the movement is a spinal reflex, the motor nerve of the pinna being the 7th cranial. Take pains not to damage in any way the anterior of the two divisions. Remove the retracting clip-weights; replace the skin-flaps over the wound.

Operation for 2nd cervical ganglion, same as on p. 93, § IV, i, but with addition of severance of 1st cervical nerve by clearing left side of arch of atlas and cutting the nerve as it emerges from that bone. A thread was left loosely looped round the dorsal branch of the great auricular nerve on the left side. Draw it steadily tight upon the nerve, crushing the latter by this ligation. While this is done your colleague observes the pinna; probably the pinna reflex is evoked.

Turn to the dorsal neck wound; remove the swab; pass the small brass hook carefully under the dorsal root, and, drawing the root slightly away from the ventral, sever the dorsal root with fine-pointed scissors, not injuring the ventral in so doing.

Place another thread ligature round the dorsal branch of the great auricular nerve, a millimetre central to the previous one. Tighten the second ligature in the same manner as the first, observing the pinna, as before. No reflex response ensues.

Expose the great auricular nerve on the right side, repeating the whole of the procedure on that side also.

Turning to the dorsal neck wound, incise the dura mater of the spinal cord longitudinally in the mid-line, taking care not to injure the cord itself. Open the dura freely on the right side. The fan-shaped set of filaments of the dorsal root of right 2nd cervical nerve are thus exposed. Make out ventrally to them the smaller ventral root.

Evoke the pinna reflex of right side by ligating tightly the dorsal division of the great auricular, as you did on the left.

Carefully pass the small brass hook under ventral root (Pl. VIII, fig. 4) of right 2nd cervical, avoiding engaging in the hook any filaments of the dorsal root. Drawing the ventral root slightly forward and laterally, sever it with fine scissors without harming the dorsal root. Cover the wound with a warm moist swab.

Pass a ligature round dorsal branch of great auricular, and draw it tight proximal to the former ligature. The reflex response is still elicited by the crushing of the nerve.

Have ready an isometric myograph with a stout wire. Arrange the torsion-wire contact breaker (described in exerc. XX) to give shocks at 10 per second and at double this rate. Use it with the inductorium to stimulate a crossed nerve and obtain a graphic record of the reflex response at these rates of stimulation. Compare your record with the one obtained from the flexor reflex (Obs. 95), and note the 'smothering' of the rhythm in the crossed extensor reflex, although the rate here used is slower than in the flexor observation.

For this a second induction apparatus is wanted. The interrupting key can be the ordinary spring-hammer belonging to the primary coil with a frequency of about

Obs. 91.
Reflex rhythm
in crossed
extensor reflex.
(Supplementing
Exerc. XIX,
p. 110.)

Obs. 95.
Occlusion of
reflex effect.
(Supplementing
Exerc. XX,
p. 117.)

35 a sec. Ligate the central stump of ipsilateral internal saphenous nerve and arm it with the additional electrodes. The rest of the arrangement is as for Obs. 94 A, except that the frequency of the stimulus series (for the popliteal nerve from the torsion-key (p. 115)) should be adjusted to be not less than 45 a second.

The procedure can then be as follows. Record a short, e.g. 0.5 sec., reflex tetanus evoked by strong stimulation in the internal saphenous nerve. Next record similarly a short reflex tetanus evoked by strong stimulation of the popliteal nerve. After a short interval repeat the stimulation of the popliteal, and during this stimulation repeat the stimulation of internal saphenous. A suitable moment at which to introduce the reflex from internal saphenous is when the precurrent reflex contraction (due to popliteal) has just reached its plateau-tension. The two stimulations can be discontinued in any sequence. The increase of contraction-tension evoked by internal saphenous when intercurrent in the reflex contraction evoked by popliteal shows a deficit as compared with that evoked by it when stimulated alone. This is caused by afferent fibres in internal saphenous playing upon some of the same motor-units of tibialis muscle as are excited by the popliteal. The impulses evoked by internal saphenous in these motor units find their muscle-fibres already engaged in a complete mechanical tetanus and fail therefore to intensify the tetanic tension appreciably further, just as with a motor nerve to double the frequency of a stimulation which is already evoking a complete tetanus hardly heightens the mechanical tension further. The seeming inefficacy of the intercurrent added reflex has been termed 'occlusion of effect'. It is not inhibitory, and the added reflex can support and steady the original one.

Occlusion is given not only by the above nerves but by a great variety of others (see references).

Obs. 98.

The flow of pancreatic juice and bile after injecting bile into the duodenum.

(Supplementing Exerc. XXI, p. 120.)

A cat which has been used to observe the flow of pancreatic juice after the intravenous injection of secretin may be used also to demonstrate the absorption of bile from the duodenum as a factor in the secretion of pancreatic juice and bile. The following dilution of bile is made up: 2 c.c. ox bile, 7 c.c. Ringer, 1 c.c. 1.5 per cent. NaHCO_3 . This dilute bile is injected into the duodenum immediately below the entrance of the pancreatic and bile ducts. Within a short time (varying from 10 to 30') pancreatic juice should flow freely and the secretion should continue for an hour or so. At the same time there should be a considerable augmentation of the flow of bile from the liver. These effects are due to the absorption of bile salts from the duodenum. These salts carry the secretin contained in the duodenal mucous membrane into the blood and so to the pancreas where the secretin excites the pancreas to secrete. The bile salts also are carried to the liver, there causing the secretion of more bile.

Obs. 99.

The flow of bile only after injecting bile into the ileum.

Inject a dilute solution of bile, similar to that described above, into the ileum. This part of the intestine may be identified by its relation to the caecum. About 15 to 30 min. after the injection there is a greatly augmented flow of bile from the liver, but there is no secretion of pancreatic juice. The dilute bile is readily absorbed, and the bile salts therefore exert their action as cholagogues. The mucous membrane of the ileum contains no secretin; therefore the bile salts carry no secretion into the blood and no secretion of pancreatic juice is observed.

Take a fasting cat and prepare it as in the previous experiments. Tie a ligature round the pancreatic and bile ducts to prevent the secretion of pancreatic juice and bile from entering the intestine. Examine the mesentery of the small intestine. Observe the lacteals which are visible as transparent lines. Now inject the following emulsion into the duodenum immediately below the entrance of the pancreatic and bile ducts: 2 c.c. olive oil emulsion, 7 c.c. Ringer, 1 c.c. 1.5 per cent. NaHCO_3 . Within 30' the lacteals of the mesentery will be observed as white lines engorged with fat.

In making the injection of emulsified oil and bile it is essential to observe that the fluid does not pass into the stomach by relaxation of the pyloric sphincter.

It is evident that emulsified fat in the presence of bile is rapidly absorbed from the intestine and that previous hydrolysis of fat into fatty acid and glycerol is not essential for the absorption.

Obs. 100.
Absorption of fat into the lacteals of the small intestine.

ANNOTATIONS TO THE ADDITIONAL OBSERVATIONS

Obs. 20, 21. Unipolar faradization is particularly suitable for stimulating nervous surfaces where the direction of the fibres to be excited lies mainly at right angles to the plane of the surface. It is therefore fitted for experiments on point to point stimulation of cut planes of the central nervous system or the natural surfaces of the bulb or cortex cerebri. It is also often useful for stimulating peripheral nerves which are difficult of access, by reason of the cut stump being very short, &c. There is no need to insulate the preparation from the copper top of the operation table; the fur and skin offer such resistance as makes that precaution unnecessary.

For observations with unipolar faradization, cf. Alfred Fröhlich and Sherrington (*Jnl. of Physiol.* xxviii. 14; 1901), T. Graham Brown and Sherrington (*Quart. Jnl. of Exp. Physiol.* iv. 193, 1911), F. R. Miller (*ibid.* vi. 68, 1913), A. F. S. Leyton and Sherrington (*ibid.* xi. 135, 1917).

For the limb movements dependent on antidrome conduction down the root-fibres of the dorsal columns see Sherrington, 'Antidrome Conduction in the Central Nervous System' (*Proc. Roy. Soc.* vol. 61, p. 243, 1897).

Obs. 29. Instances a purely spinal vasomotor reflex. Immediately after severance

of the cord from the brain such reflexes are greatly depressed ('spinal shock'), and for a considerable period. In the course of days or weeks they recover, as is found in cases of spinal transection in the cervical region (Sherrington, *Integrat. Act. of the Nervous Syst.* p. 242). The depression may be due to loss of some tonic support of the spinal vasomotor centres from the great vasomotor centre in the bulb. (Cf. F. H. Pike, *Am. Jnl. of Physiol.* xxx. 436.)

Obs. 33 B. Repeats the experiment described by H. Florey (*Brit. Jnl. of Exp. Pathol.* vol. viii, p. 479, 1927).

Obs. 46 B. Consult Head and Riddoch's paper describing vesical reflexes in human paraplegia, *Brain*, vol. xl, p. 188, 1918.

Obs. 53. The flow of saliva and the movement of swallowing and movements of tongue caused by stimulation of the central end of the severed lingualis are reflex; the swallowing and tongue movements certainly, the salivary flow probably, though not indubitably, since escape of current may have occurred on to the corda tympani. This you can control by ligating centrally.

Together with the fibres of the lingualis proper there are fibres from the corda tympani (*nervus intermedius*), and these are some of them afferent; they contribute

to the reflex effect, and are competent of themselves alone to produce it; this can be shown by severance of the third division of the Vth nerve in the skull; the reflex still persists then.

Obs. 92. This observation repeats experiments described by E. G. T. Liddell and

C. S. Sherrington, see *Proc. Roy. Soc. B*, vol. xcv, p. 142, 1923; and *ibid.* 299.

Obs. 96. For reflex occlusion in flexors see M. Camis, *Jnl. of Physiol.* vol. xxxix, p. 228, 1909; S. Cooper, D. Denny-Brown, and C. S. Sherrington, *Proc. Roy. Soc. B*, vol. c, p. 448, 1926.

APPENDIX

Management of the foregoing course of exercises has suggested certain measures and devices economizing time and outlay as well as conducing to the successful performance of the experiments. Mention of some of these may, it is hoped, prove useful to others when arranging exercises of the kind.

A. GENERAL ARRANGEMENTS

It has been our custom for the students to work in pairs. To a number of the experiment-places a recording kymograph has been fitted. At other experiment-places there is no need for a recording apparatus, a Brodie operating table alone being sufficient. Other places still require merely an ordinary laboratory table with space at one end for the necessary inductorium and for accessory apparatus and for the preparation (viscus or carcase) at the other. To these places all that is required in the matter of recording is an ordinary small drum driven by cord or clock-work. By arranging that at each class-meeting different experiments, some requiring recording apparatus and others not, are done at the several experiment-places the above equipment easily suffices. The distribution of different experiments to the several tables for each class-meeting also lessens the labour of preparation for the class. A table when once arranged requires thus no rearrangement. A place having been got ready for a particular experiment or small group of experiments, each student pair passes to that table on reaching that exercise in the course. One Brodie respiration pump supplied with branching tubing amply suffices for nine experiment-places. One Brodie clock served by a small accumulator similarly suffices for the time-markers at nine places; the most suitable time unit to give is 2".

An enamelled iron pail for refuse at the side of each experiment table helps to keep the place and room tidy and saves the labour of the servant in cleaning up after the class-meeting.

The time which has been available for each class-meeting has been 2½ hours; the exercises as arranged in this book are plotted to meet a time allowance of that duration for each exercise. An accessory advantage accruing to the institution of a mammalian practical class is that it relieves the demonstration course of a number of elementary experiments, thus shortening the course, or allowing room in it for other experiments of a more advanced kind.

No elaborate fixation apparatus is required for the preparation. For it 'animal-holders' in the usual sense of the term are unneeded and unsuitable. The reactions of the carcase, decapitate or decerebrate, do not express themselves as general movements. The preparation remains passive, prone, or on its side, in whichever position it be laid, throughout the operation. But it is necessary to give the carcase definite postures suitable for this or that observation. For the supine position the contour of the back against the table renders the balance difficult, and to work with it in the supine position the neck-stump may be held at its top by a clamp to prevent rolling over, and the limbs steadied by 50-grm. weights strung to clips attached one to a single foot, as for dissection of the dead body.

As to the operative and instrumental procedure described for the experiments, they are doubtless in various respects rough and imperfect. In extenuation it can be said that for student classes one is often led, after trying the more delicate and complex, to revert in some respects to the simpler as in fact really adequate and better suited to the instruction in view. Thus, the membrane blood-pressure recorder has been, for all but one exercise, discarded in favour of the old mercury manometer. Again, the opening incisions recommended may seem unnecessarily extensive. Experience with students shows, however, that for the less practised hand a free operative room in which to conduct the ultimate steps is a necessary condition of success, at least at a first performance of the exercise. The larger wound of course increases haemorrhage and tends also to greater cooling of the preparation, but the student soon learns to deal promptly with such bleeding as may occur, and after a few reminders acquires the habit of covering exposed tissues on which he is not actually at work with warm swabs wrung out from his saline at 38° C.

For instruction in the operative procedure it is of considerable assistance to have in the class-room a cat's mounted skeleton. The skeleton is set on a wooden base carrying a strong frame which encloses the skeleton but leaves it free to view on all sides and from above. The frame can be set on its side, or top, or end, and thus the skeleton, when referred to, can be laid in any position corresponding to that of the preparation for the particular operations in view. Instruction in the operations is much assisted by simple diagrams; those furnished with these pages have served this purpose; indeed, with these beside them, most students need little further help in the matter of their dissections.

As books of reference on the anatomy of the cat, Mivart's *The Cat*, London, 1881, and Reichard and Jennings, *The Anatomy of the Cat*, New York, 2nd ed., 1901, can be recommended; the latter is the more suitable for the student's purpose in this course. Strauss-Durokheim's monumental *Anatomie descriptive et comparative du Chat*, Paris, 1845, though to be found in most scientific libraries, is rather difficult of access, and its nomenclature of muscles is unusual. The anatomical nomenclature used here in the operative directions for the exercises follows Reichard and Jennings.

For the operative and instrumental technique of each exercise to be shared fairly between the two students forming a working pair requires a little supervision. As to operative instruments, each student brings two scalpels, one large, one small, two scissors, one large, one small, and two dissection-forceps, one large and one small ('dagger-tipped splinter-forceps'). In addition, there are provided at each working-place, i.e. for each pair of students, for all exercises after exerc. III, two pairs of small artery-forceps, eight clip-weights, one hook-weight, and a one-litre enamelled iron mug containing Ringer-Locke fluid and some cotton-wool pledgets soaking in it, with a ring-tripod and small 'midget' Bunsen burner for warming the fluid; also cotton and thread with a pair of mounted needles bent in the flame for passing thread round vessels and nerves.

As regards convenient and economical provision of this small armentarium for each working-place the following remarks may be useful. 1. Clip-weights; these dispense with hand-held retractors during operation, and also serve instead of ties to the table to give and maintain suitable posture to the preparation. They are cheaply and efficiently provided by spring necktie-clips with lead weights of various size attached to them by string, so that the

weights can hang over the table-edge. In addition, a bent-wire hook with a heavier weight, e.g. 250 grm., attached is required for certain experiments, as for retracting sternal flap in exercs. IV and VIII, for scapula in exerc. IX, and occipital stump in exerc. XVI. 2. Mounted curved needles for carrying threads round tissues to be ligated. For these a glover's needle, No. 3 size, is pushed point downward into the end of a wooden pen-holder. The glover's needle has a triangular shaft; the ordinary sewing-needle tends to rotate in the handle under use. After mounting, the needle is bent in the flame to a right angle about 6 mm. from the eye-end. It will carry thread or cotton of suitable size, i.e. Nos. 35 and 20. 3. A packing-needle with hole drilled near its point, the hole being large enough to carry string, is useful in the exercises in which the chest has to be opened or a loop of intestine or other hollow viscus removed between ligatures. It serves also as an efficient and cheap substitute for the surgical aneurism needle usually employed for ligating a cannula into the trachea. Several sizes can be obtained and can be given any desired curvature in the flame. 4. The 'midget' Bunsen, besides being economical in initial cost and in use of gas, has the advantage of avoiding the overheating of the Ringer-Locke. Experience shows that the student, while engaged in the experiment, is very liable to neglect the warming of the saline, which in the quantity, i.e. half-litre, allowed him requires repeated attention with the ordinary Bunsen flame, but with the 'midget' can be left with the flame adjusted under it.

For some of the exercises a hypodermic syringe is supplied; the ordinary cheap form answers well, preferably graduated in fractions of 1 c.c. For most exercises are wanted an ordinary inductorium with an accumulator or other cell, and the wires and two ordinary brass keys for the two circuits. The wires from the bridge-key of the secondary circuit to the electrodes are preferably a light twisted double-flex with the colour of one strand different from that of the other. The lightness and combination to a single cable facilitate manipulation of the electrodes; the differentiation by colour helps identification of the pole, e.g. kathode of break-induced current, where that is required. A few of the exercises require a pair of bone-cutting surgical pliers; these are supplied. Special items of apparatus suited to certain of the exercises are mentioned below under the exercise to which their use applies.

Experience shows that students when entering upon the course are prone to proceed in physiological dissections by ways permissible enough in the anatomical room with the dead subject, but highly detrimental to living tissues. Thus, he is likely to pick up with his forceps the nerve-trunk or blood-vessel which he has to isolate for some step in his experiment, and in this way will crush the nerve-fibres in the former or cause intravascular clotting in the latter. Also his favourite scalpel is prone to be one with its blade shortened and worn to a tooth-pick shape, a sort of tiny one-edged dagger, and with this, held like a pen, he is at first prone to scabble in the living tissues, making slow progress with the dissection and confusing his wound with frayed edges of connective tissue, fat, and muscle, and small haemorrhages from wounded veins. He has usually to be taught to prefer a full-bladed scalpel and to use with freedom the greater length of the blade. For the skin incisions it has to be impressed on him to slip short the fur, to wet the skin where it is to be incised, and, holding his scalpel as a fiddle-bow is held, to make a swift clean cut of the required direction and length. He also does not realize at first that a 5 cm. skin cut will in most cases mean a 6 cm. skin wound owing to retraction of the cutaneous tissues.

A practical fact of some utility brought home to the student by carrying through the exercises is the importance of reasonable speed as an element of success in dealing

with warm-blooded tissues and organs. With them undue slowness in procedure brings derangement and damage by cooling, inspissation, drying, and the blocking of vessels and cannulae by clots of mucus. The student whose sole experience is with the frog hardly realizes the delicacy in some respects of the tissues of mammalian life. With frog preparations the omission to get ready the inductorium or mechanical apparatus before exposing the animal tissues can be repaired by allowing the latter to lie waiting although ready, because temperature and even evaporation changes are often too slight and slow to matter much ; but with the warm-blooded preparation such a mistake is apt to be fatal.

A fact which is surprising, but meets, probably, most teachers and examiners, is that a student who may have quite satisfactorily performed some experiment from his practical course is yet, on being questioned, found to be unaware of the point which the experiment inculcates. Hence in the instructions for the present course the succinct mention at the head of each exercise of what the exercise aims at. Short statements concerning the history of some of the experiments followed in the exercise are, partly for the same purpose, appended to the exercise. These 'annotations' contain a certain number of references to original sources, with a view to helping and encouraging the student to seek such sources either in the Departmental or in the University library.

The sequence of arrangement of the successive exercises in the following pages is one which has been found appropriate ; but it is open to wide modification without real impairment of the efficacy of the course. As arranged, the exercises on organs isolated from the body in a surviving state are taken first ; then those on the circulation, commencing with the Harvey observations by inspection, i.e. the simplest method ; then those on respiration and secretion ; then those on the central nervous system ; and finally the experiment on phagocytosis and the opsonic action of serum. The experiment on the pancreas and secretin is placed late because exposure of the pancreatic duct makes some demand on skill the student will have required. On the other hand, the exercises on phagocytosis, and that illustrating the treatment of haemorrhage by transfusion of gum-saline, are placed late as bridging toward Pathology, a subject which the student will pursue next after his physiological course is finished.

B. REMARKS ON THE PRACTICAL CONDUCT OF INDIVIDUAL EXERCISES

EXERCISE I

A suitable style for the writing-lever can be made with glass as follows: Glass tubing drawn in the flame to fine capillary size for about 8 cm. length, and somewhat narrower than an ordinary vaccine tube, is bent over a small flame (a lighted match is enough) at right angles about 1 cm. from one end and again about 5 cm. from the other, both bends being in the same direction. The longer bent end is then bent again half-way down its length, this time in a direction at right angles both to its own original direction and to that of the middle stem whose two ends were bent before. The top of the end beyond the last-made bend is then fused to a tiny smooth knob. To fit this style to the straw recording-lever this latter is for the greater extent of its length split lengthwise and one half of its resulting halves cut away. But the straw is left tubular for its

terminal 15 mm. or so; this is then slit along one side carefully, and the middle piece of the glass style is slipped through the slit, so as to lie freely in the tubular collar which the straw forms for it. It then swings on an axis parallel with the lever length, and its friction is minimal. This style rides easily over the seam in the recording-paper, and writes well whichever way the recording-surface is travelling. It has long been a favourite in this laboratory for recording slow movements such as are under observation in this exercise. The Bayliss writing-point (Stirling's *Practical Physiology*, p. 376, 4th ed.) also answers excellently. It is convenient for the writing-lever, the saline bath, and the rod to which the preparation is tied, to be carried all of them by the same vertical standard; one adjustment to the recording-surface then moves them all.

The use of 'artificial platinum' which can be fused into the glass tube allows of a convenient hook being used for attachment of the lower end of the piece of tissue. This forms a convenient deviation from the arrangement shown in text-fig. 1.

The rabbit is in our experience preferable to the cat, because in the former the beat of the intestine and the contraction of the spleen and aorta are more readily and quickly obtained. If a time-marker is used a suitable stroke is every tenth second.

OBS. 1. Cat's intestine in our experience shows a slower rhythm than rabbit's. In either case a duodenal piece beats quicker than an ileal. W. C. Alvarez states that the beat-rate varies inversely as the distance from the pylorus (*Amer. Jnl. of Physiol.* vol. xxxv, p. 177, 1914). If the exercise is to be done at a class-meeting when at another table the next following exercise is being done, the same carcass which furnishes the heart for exerc. II can provide the intestine, spleen, and aorta for exerc. I. It is then preferable for the heart preparation to be removed before taking the viscera for this exercise. The rabbit is best killed as the gamekeeper kills it, by a quick blow behind the occiput.

Ringer-Locke's fluid seems as serviceable for intestine as is Van Tyrode's, and has the advantage that, being in use for other experiments, the preparation of a special saline for the intestine experiment is avoided. The Ringer-Locke for this experiment need not have oxygen bubbling through it; but it is well to blow air through it before use. For the present exercise it need not have the dextrose recommended by Locke for perfusion of the heart (see next exercise). The stock fluid keeps better without it.

EXERCISE II

For the graphic of this exercise and for some of those following the piece of travelling paper required is longer than that sufficing for frog-muscle work. A suitable length to allow at each place for such exercises is 120 cm. Such lengths are more conveniently not kept cut, but are cut fresh from the stock-roll as wanted, with a straight-edge and sharp knife. The cut should be truly at right angles to the paper-length, and so also the join of the cut ends when gummed. If not fairly truly joined the paper will not run smoothly on the drum, and as it travels will climb or sink, with liability to confuse the comparison of pressure values, &c.

For sooting, the joined band supported by the two hands stretching it inside is moved slowly over the sooting flame until there is sufficient deposit. When the soot-layer is desired specially fine and uniform a good method is the following: The lamp of a small paraffin cooking-stove with flat ribbon wick 10 cm. broad, set on a slate on the

floor, is covered by a removable tall tin chimney also resting on the slate. The chimney—60 cm. tall, and of oblong cross-section with converging sides—has its two sides which are parallel with the lamp-wick more convergent than the others, and these leave at top a slit-vent 26 cm. long parallel with the lamp-wick and something less than 1 cm. in breadth. A side-opening with hinged lid low down in the chimney enables the hand to be passed through to adjust the lamp-burner. The smoke issuing from the vent is of fine grain and evenly distributed, and the paper passed over it runs no risk of scorching. Though the sooting is rather slow the extra time is repaid where a trace may be intended for photographic reproduction or for mounting as a transparency (see below) for the projecting lantern.

Fixing. The mastic varnish is made by dissolving 260 grm. gum-mastic in 2000 c.c. methylated spirit or once-used alcohol from the histology class. Frequent shaking is necessary, and it is well to prepare the varnish three days before use. For a 1 m. graphic the fixative is put in a shallow iron tray on the floor and the paper slowly and evenly drawn through it and then drained vertically from all excess. Suspended vertically, with both sides free to the air, the tracing is dry in a few minutes.

A satisfactory and even simpler varnish is made by shaking together 220 c.c. of 'White Hard Spirit Varnish' and 550 c.c. of 97 per cent. alcohol.

Graphics as Transparencies for Lantern Projection.

Effective transparencies for the projecting-lantern can be prepared by cutting the required piece from the fixed and varnished sooted paper, passing it through turpentine and mounting it in Canada balsam between lantern-slide covers or other suitably-sized glass plates, and binding the edges with lantern-slide binding-strip paper in the usual way. An actual record is thus available as a permanent lantern slide. Glazed white paper for kymograph and similar work is supplied by the makers in various thicknesses; the thinner kinds yield the best transparencies. A thin paper for long tracings runs closer and more flexibly round the recording-drum.

Perfusion.—The perfusion apparatus here used is that of J. A. Gunn (*Jnl. of Physiol.* vol. xlvii, p. 506, 1913), as modified by W. T. Dawson (*Jnl. of Lab. and Clin. Medicine*, vol. x, p. 853, 1925). 'The outer jacket, which contains water, is about 30 cm. long and 4 cm. in diameter, provided with two side tubes, one bulbed at its junction for the entrance of a piece of copper wire of about 6 mm. diameter and 20 cm. long. . . The connection with the side tube of the outer jacket is made by a sleeve of rubber tubing wired in place. This connection does not seem to perish very quickly and is cheap and easily renewed. A lighted Bunsen is set under the rod a few minutes before it is desired to use the apparatus, and while perfusion is proceeding the temperature may be regulated by shifting the burner to a suitable position to keep the temperature constant.' The rod may be replaced by a bundle of copper wires soldered together at the proximal end. Addition of dextrose to the Ringer-Locke fluid is not essential; class experience obtains excellent results without it.

As to the rabbit serving as preparation, one's experience indicates for preference an animal about three-quarters grown, not long-haired and not albino.

OBS. 5. Cat's heart is as suitable as rabbit's, but requires a larger supply of fluid. A heart from a preparation lost by $MgSO_4$ inflow in an a. p. exercise still serves for perfusion experiment. A kitten's heart is also very satisfactory.

Experience shows that for most students a somewhat difficult part of the exercise is in the excision of the heart, frequent causes of failure being wounding of the heart, or rough handling of it, or extreme slowness in the procedure of removal, with resultant patchy clots in the coronary system. Beginners may save time by omitting the passage of the thread through the venae cavae for the observation of warming the pace maker. An occasional source of failure is the insertion of the aortic cannula too low or too far down into the aorta, so that the nozzle of the cannula blocks the orifices of the coronary arteries or renders incompetent the aortic valve. The perfusing fluid then enters the ventricle instead of perfusing the coronary vessels. For the purposes required here the rabbit is killed preferably about 5'-10' before the dissection is to be begun, and by the method used in provision for exerc. I.

In the perfusion apparatus it is important to keep the stalk of the Y-piece, attached to the vertical perfusion-tube, short, and to secure it firmly in the warm-water jacket, and thus prevent unsteadiness of the heart cannula when the beating heart hangs from it.

Obs. 6. Should the heart have failed, by over-heating, after the first part of the exercise, it may happen that a decapitated cat-preparation serving for some other exercise at another table is by this time finished with: the heart from it can then furnish the second part of this perfusion experiment, as it will have become practically free from the CHCl_3 with which it was originally dosed.

Obs. 7. The 'warming of the pace-maker' part of the exercise, though simple and rather rough in method, provides an observation of interest and theoretical importance and works reliably.

EXERCISE III

A purpose of this exercise is to afford the student further practice in carrying out the quick removal of the heart without injury to it. It is the removal of the heart which seems to present the main difficulty to the student.

Obs. 8. Ether may be preferred to CHCl_3 as more akin to modern surgical practice; in that case an appropriate concentration is given by 1 c.c. ether per litre Ringer-Locke. It should be freshly prepared; it loses concentration more rapidly than the CHCl_3 solution. In practice it is preferable to observe the effect of chloroform before that of adrenalin, because, vice versa, the adrenalin leaves a condition in which the heart is dangerously sensitive to the depressant action of chloroform.

EXERCISE IV

1. *Instruments required by the student.* In addition to the instruments brought with him, the student is supplied at his place (for two students) with the retracting-clips, bent mounted needles, thread and cotton, small artery-forceps, mug of Ringer-Locke over midget Bunsen, eye-holed bent packing-needle and string, inductorium, voltaic cell, bridge-keys and wires, and hand-electrodes. The packing-needle should not be too large and have been curved freely in the flame close behind its eye-holed point. It serves for passing the string for occluding the intercostal arteries when ligating the ribs, and the internal mammaries when ligating the sternum. A large strong-bladed pair of scissors is provided for cutting the ribs. The above set of instruments are supplied similarly for all the exercises succeeding this one.

In addition to them, for this exercise there are wanted a glass funnel on small stand, rubber tubing, and glass cannula for pericardium (Pl. I, fig. 4).

2. *Procedure for providing decapitate preparation.*¹

(1) The animal (cat) is deeply anaesthetized with chloroform-ether mixture.

(2) An ordinary small sharp packing-needle threaded with string is passed horizontally through the upper lip across the labial fissure, and the string tied in a short loop giving less than 1 cm. play.

(3) The animal is then laid supine on the operating table with limbs extended symmetrically by clip-weights attached to feet, and a warm bottle either side of the trunk to keep the supine posture symmetrical. The hexagonal-sided ribbed glass bottles in which chemicals are supplied serve the purpose well because they do not slip. The head and neck are kept straight and extended by hooking to the string muzzle-loop a weight (150 grm.). The administration of the chloroform-ether is continued freely.

(4) A short lengthwise median incision is made over the cricoid region, and one edge of it retracted by a light clip-weight. Each common carotid is ligated closely posterior to its thyroid branch, and a short-shanked tracheal T-cannula (glass) is inserted into the larynx close below the vocal cords and tied in. The side-branch of tracheal cannula has a 1 cm. bit of rubber tube on its end and tie-clip, making the size of the open end of tube adjustable. The animal is then placed prone, with warm water-bottle under pelvis; this, by raising the abdomen somewhat from the table, avoids the embarrassment of respiration and circulation liable in the prone position. The string weights are removed from the fore-paws and the fore-limbs flexed at elbow and shoulder, relieving the chest from pressure. A lengthwise incision is then made through the skin over occiput and for some 5 cm. farther back, and across it a transverse incision at level of the atlas. The prominent wing-like transverse processes of the atlas vertebra are felt for and deep side-incisions are carried through the neck muscles at the level of the posterior edges of these transverse processes. The large beak-like spinous process of the axis is then nipped off with the bone-pliers. With a packing-needle about 15 cm. long a strong string is passed right across ventrally close under the body of the axis between the trachea and oesophagus on the one hand and the vertebral column on the other, and just behind the transverse processes of atlas. The string is tied as tightly as possible around the vertebral column; it lies in the cross-cut. By it the vertebral arteries are occluded where they pass (see below, p. 153, text-fig. 49) from transverse process of axis to transverse process of atlas. A single twist for the first loop of the reef-knot is better than a double twist, because when pulled it sinks better and more closely compresses. The string should be thick, strong, and soft. It is not cut short off after tying, its ends being left for looping over a branch arm from a vertical support when the preparation is later removed to the student's experiment table.

(5) To decapitate, the head is held flexed by the left hand while with the right a Liston double-edged amputation knife of 12 cm. blade-length is passed vertically down in the mid-dorsal line with the blade-width transverse to the long axis of the neck. The point is entered just behind occiput and thrust through occipito-atloid space until the edges feel the side-limits of the space; the neuraxis is thus completely severed. The place of transection lies about 4 mm. behind the point of the calamus scriptorius, and passes through the posterior part of the pyramidal decussation. The width of the

¹ Sherrington, *Jnl. of Physiol.* vol. xxxviii, p. 375; 1909.

knife-blade should not exceed 12 mm. or the blade may jam in the vertebral canal. The blade-edge is then, without withdrawing the knife, pressed against the left occipito-atloid joint while with the left hand the head is turned toward the preparation's right side. This opens the left occipito-atloid joint, and the knife is swept laterally as well as downward and forward through it, an assistant, if available, holding the neck-string backward to steady the preparation as the cut is made. The left hand still retaining hold of the head, the transversely-cut spinal cord is in full view, and twisting the head now somewhat to the preparation's right the knife-edge is passed through the right occipito-atloid joint and forward and downward through what remains of the right side of the neck. The head thus severed is pithed and thrown away.

(6) Respiratory movement ceased of course when the knife transected the neuraxis. The haemorrhage is extremely slight. The carcass is now taken to the student's operation table, where the ends of the neck-string ligature are looped over a cross-piece on a vertical standard set ready for it, and arranged so that the neck-stump is supported about 15 cm. above the rest of the carcass lying on the table. The short flexible tubing from the nozzle of the 'blower' (ventilation pump) in the table-top is then joined to the tracheal cannula. The tie-clip clamp on the bit of rubber tube on the side-branch of the tracheal cannula is adjusted to give a suitable degree of inflation under the strokes of the blower. Experience shows that although delay in attaching the ventilation pump should not exceed 2-3 min., the urgency is not greater than that. Spontaneous occurrence of reflexes, e.g. scratch reflex, usually gives warning that ventilation is insufficient, or asphyxial excitation impending.

(7) It is well to wait 3'-6' before lowering the neck-stump down fully to the level of the rest of the carcass on the table-top. If there is any oozing haemorrhage from the vertebral canal it can be controlled and arrested by keeping the neck-stump raised for longer or by raising it still higher, or, if necessary, by tying a string tightly round the projecting condyles of atlas. Occasionally there may be a smart arterial bleeding from one or other side of the atlas; this is due to one or other vertebral artery having escaped compression by the string ligature passed behind the wings of atlas at the time of operation. It can be easily stopped at once by compressing between the finger and thumb of left hand laterally the muscular stump of the neck close behind the wings of atlas and, with fine forceps in the right hand, stuffing the exposed foramen in arch of atlas, through which pass the vertebral artery and 1st cervical nerve, with a minute pledget of cotton-wool.

(8) Before lowering the preparation to the horizontal position for use by the student the truncated neck is secured in a holder so as to enable the student to place it readily in any pose suitable for his exercise and supported during his manipulations. The holder consists of a small chemical retort clamp modified (text-fig. 46) by provision of a pair of small screws set in the lip of each blade, enabling the blade to grip securely the margin of the neural arch and body respectively of the atlas, which already lie exposed and projecting from the neck-stump. The clamp should not be tightened so much as to compress the spinal cord; such pressure provokes, and may continue to provoke for a long time, reflex movements, e.g. scratch reflex, &c., recurrence of which will disturb the student's work. After the holder has been fixed a pledget of dry cotton-wool is laid *lightly* against the free cut face of the spinal cord between the lips of the clamp, to protect the exposed tissue, a film of clot soon forming under it. The preparation being

then lowered horizontally on the table, the stem of the clamp itself is fixed horizontally in the clamp of a short brass standard provided with a low flat lead base. The position of the standard on the table is suited of course to the tube from the 'blower' to the trachea.

To make thus a preparation for a student's table takes but a short time, requiring longer for description than for execution. The anaesthetization occupies more time than does all the rest of the procedure. Full anaesthetization having been secured previously by an assistant, it is not difficult in 30' to supply five decapitate preparations and place them ready for a class at their five respective tables. The decapitation is

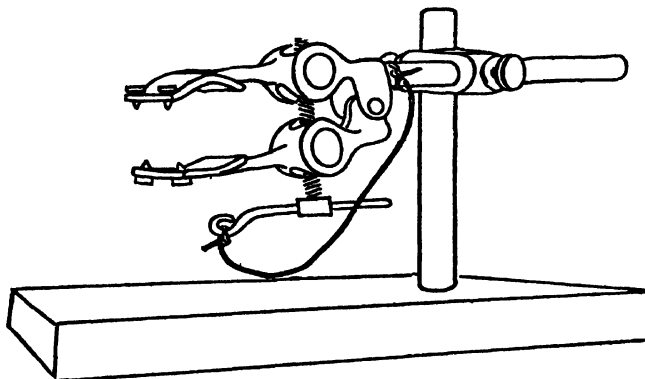

TEXT-FIG. 46. Clamp for steadying the neck-stump of the decapitate preparation by holding the atlas vertebra. The points of the small screws in the lips of the blades engage the margins of the body and neural arch respectively. The short standard is set in a lead base.

preferably made in a side-room attached to the class-room, and the preparations are arranged on the students' tables preferably before the class comes into the class-room. The preparation is a durable one, with ordinary care long outlasting any requirements of a class.

Certain conditions are, however, necessary to ensure its lasting properly. *Warmth and Ventilation.* The carcase tends to cool with corresponding enfeeblement of its reactions. The surface on which it lies should therefore be warmed. This can be secured readily by providing on the student's table a low wooden box with a sheet of tin or copper let into its top wall, the box containing an electric lamp which should be lighted beforehand so as to warm the box before the carcase is placed on it. More convenient than the separate box is an arrangement by which the student's table-top itself includes a warm chamber for the carcase to lie upon. The student's work-table figured (text-fig. 47) fulfils this and other convenient conditions; it is that with which my own classes have carried out the exercises, both on the decapitate and decerebrate preparations in recent years. It is a simplification of Brodie's table which answers all the class requirements well and is not expensive. A large part of the table-top is formed by the sheet-copper roof of a shallow metal box let into the table. The copper is flush with the table surface, but sinks slightly to a drainage-hole three-quarters down it from its head end, four shallow diagonal gutters leading to the drainage-hole. The vertical tube from the

drainage-hole goes through the metal box, and a vessel set on the shelf under the box receives the drainings. In the box are two sockets for electric lamps which warm the air in the box. At the head end of the table-top, rather to one side of the mid-line, is a short curved tube which can be rotated in its socket in the table so that the free end of the curved nozzle can be directed as desired. This tube under its socket joins, below the table-top, a wide metal pipe which runs through the whole length of the warm chamber, and jutting beyond the chamber's farther end is there narrowed to a short curved nozzle under the table-top. To this latter nozzle the flexible metal tubing

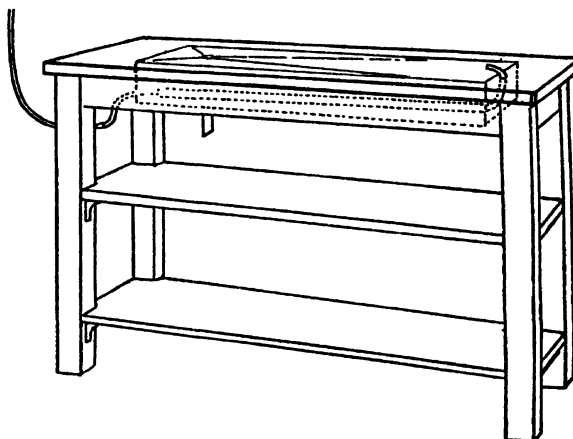

TEXT-FIG. 47. Student's operation table, of simplified Brodie pattern, with metal box, warmed by electric lamp, let into top. The flexible tube from the chest-ventilation pump is attached at the tail-end of the table to a wide metal pipe which runs through the warm chamber under the table-top; at the head end of the table-top this metal pipe is brought up to a short curved narrow brass tube which delivers the air from the pump warmed by passage through the length of pipe in the warm chamber. The curved brass tube is made to swivel round towards any desired direction.

leading from the ventilation pump is attached. The air is therefore delivered warmed to the trachea attached to the nozzle at the head end of the table. A piece of flexible metallic tubing 14" long, such as is used for connecting Bunsen burners to the fixed gas-supply, connects the respiratory supply nozzle with the tracheal cannula. The rate of rhythm of the puffs from the 'blower' must be arranged of course by the frequency of strokes of the pump, and must therefore be the same for all the tables which the pump supplies. But the amount and pressure of the air delivered to the lungs at each table is adjustable as desired by adjustment of the tie-clip on the side-piece of the tracheal cannula. More convenient in respect to its occupying less room in the neck-wound is a simple straight unbranched tracheal cannula with a side-hole over which a piece of rubber tube, sheathing the adjacent part of the cannula, can be slipped so as to occlude the side-hole more or less as desired. But for students' work this has the drawback that it soon gets stuck to the cannula, and to adjust it requires a wrenching twist which if not carefully done may dislodge the cannula. One Brodie-Palmer pump driven by a small water motor easily serves six separate tables.

Of further help for maintenance of the preparation's temperature is a warm bottle—the six-sided half-litre glass bottle of chemical reagent purveyors answers well to place against the side of the preparation or under pelvis when in prone position. This serves also as a useful prop to support the trunk of the carcase in suitable positions.

Failure of maintenance of the temperature during a class-period is, as experience shows, usually due to the student's mistakes in using imperfectly warmed saline and in leaving wound surfaces unduly exposed. As to the respiration, the accident most likely to disturb the preparation is blocking of the trachea or its cannula with mucus. Glass instead of metal for the cannula has, besides greater cleanliness, the advantage of allowing the collecting of mucus to be seen. A small feather passed through the cannula and twisted will relieve this, bringing the mucus with it on withdrawal.

The operation table-top stands 110 cm. from the floor, the upper limit of convenient height for operating for students, some of whom are women. For this height of table the Brodie kymograph table is improved by shortening the legs by 7 cm. There is room on the table for operating instruments and for the indispensable litre-mug of warm Ringer-Locke and soaked cotton-wool pledgets; also for the bridge-key of the secondary circuit to be clamped on table-edge when in use for stimulation. Cleats are not provided round the table-edge; they prove inconvenient rather than helpful for preparations such as those used in this course, not requiring rigid fixation. An upper and lower shelf in the table frame serve for inductorium, cell, &c.

Obs. 12, 13. Prof. Noel Paton combined with the inspection of the heart the registration of the movements of auricle and ventricle respectively, by, for instance, a pair of Brodie class-demonstration heart-levers (*Essentials of Experimental Physiology*, T. G. Brodie, London, 1898, p. 140). The graphic observation so obtainable makes an excellent exercise readily performed by the student. It is not included in the exercise as arranged here because the time it requires precludes the student's reaching some other points which by restricting the procedure to inspection he can reach and are important for him early in his course. It is to be remembered that the student, when once introduced to the graphic method, tends to lean too exclusively on the written record even to the neglect of inspection of what is happening in the living parts *ad oculos* before him. An early exercise wholly devoted to observation by actual inspection has, therefore, its educational value. Should, however, the time-limits permissible for the course allow the content of the exercise to be spread over two consecutive class-meetings the auriculo-ventricular graphic has special value for that part which deals with escape of ventricle under *r. vagus* inhibition.

Obs. 14, 15. *Circulation in the frog's web*. For this observation ethyl-urethane in the dose mentioned excellently replaces curare and has the advantages of greater invariability of action and dosage and of its solution keeping without deterioration; it interferes with the heart's action much less than do many of the samples of curare now procurable.

EXERCISE V

The student's instructions for this exercise are given in considerable detail because two of the items of technique, namely, kymographic registration of arterial pressure and intravenous injection by the needle-syringe, are basal for many observations that follow.

Connecting Artery with Manometer.

Every teacher will have his own manipulative procedure; that described merely exemplifies one of several plans of routine which may be adopted. What is of importance is that the student should have practice and attain skill in a reliable routine. Following the above instructions students do in fact obtain very uniform success. A mistake they tend to at first is to leave open, after connecting the artery with the manometer, the clamp on the tube from the reservoir pressure-bottle; this is of course, unless immediately remedied, fatal to the preparation, especially if the solution used be MgSO_4 . MgSO_4 (half-saturated) proves, however, more effectual than Na_2SO_4 (half-saturated) as a preventive of clotting. Student's carotid records run often for $2\frac{1}{2}$ hours without meeting interruption from clotting.

In providing arterial cannulae it is well to make them of variously sized nozzle, but all from glass tubing of one size, e.g. 3 mm. external diameter, fitting the rubber pressure-tubing of 2.5 mm. bore. The cannulae are straight and short, e.g. 3 cm. length. The bulbous cannulae with side-branch, which are less easily made and more expensive to buy, are not a necessity.

It may be noted that with the technique given a student can, if need be, e.g. during a class examination, perform an arterial-pressure experiment single-handed and entirely unaided.

The operative steps in preparation for the arterial-pressure record, &c., are preferably done with the table shifted a few feet from the kymograph, although the latter has been got ready. Otherwise the student is hampered by the kymograph, and the manometer, float, guides, &c., may be disturbed. After the operation the table is brought up close to the kymograph. The rubber pressure-tube, junctional between manometer and arterial cannula, can without disadvantage have 60 cm. length.

Intravenous Injection.

Students find more difficulty with the intravenous injection, hence the importance of the instruction to them to take a distal point of the exposed vein for insertion of the needle-syringe, so allowing, in case of a failure at a first attempt, the opportunity of a reattempt more proximally.

OBS. 20. For faradization of the spinal cord. The procedure given departs somewhat widely from that usually followed, e.g. *Handbk. of the Physiol. Lab.* (Burdon Sanderson), p. 240, but presents the following advantages: (1) No general convulsion is caused and therefore curare is not required; (2) the precise seat of stimulation of the cord is seen and can be confined to the most effective point, namely, lateral column, exposed in transverse section; (3) the observation can, by simply shifting the stigmatic electrode, be extended to the provocation of localized reflex movements in ipsilateral fore-limb or hind-limb as desired. These latter demonstrate antidrome conduction down the dorsal white column.

It is noteworthy that although moderate faradization of the face of the lateral column at top of the cord so readily gives vasopressor reaction in the decapitate preparation, faradization, even pushed to extreme, of an afferent limb-nerve, e.g. sciatic, as a rule quite fails. Very occasionally is any effect obtained. The experiment as repeated by the class, some 80 times in six years, yielded clear reflex effect on the arterial

pressure only twice—in both instances a rise, but not of large extent. In the spinal mammal when transection-shock has passed off, e.g. some weeks after the transection, large rises of art. pressure on faradization of afferent limb-nerves are easily obtained.

EXERCISE VI

OBS. 23. The observation as arranged in the student's instructions relieves the asphyxia before the onset of convulsive movements of the skeletal musculature. It can of course be carried further than so arranged; in that case the student should understand that the a. p. record becomes complicated by mechanical effects from the contracting muscles; there is, moreover, then a risk that the movements of the neck-stump may detach the carotid cannula from the junctional tube to manometer. But the asphyxial effect, even when pushed to produce general convulsions, can be recovered from by resuming the chest ventilation, and a fair circulatory condition re-established although the heart-beat under the prolonged asphyxia had become extremely slow and feeble.

OBS. 25. Students find more difficulty in inserting a cannula into a vein than into an artery.

OBS. 26. Entomological pins, silvered or gilt, sizes 18, 19, serve excellently. They also make good hand-electrode tips, and good tips for vibrating spring contracts in Hg pools.

EXERCISE VII

For this operation the student gets much help from the mounted skeleton (see p. 136) laid on its left side in the operative position. The splanchnic effect seems particularly marked in the adult male in the breeding season.

OBS. 29. This is omitted from a first performance of the exercise because (1) it involves severance of the nerve midway in its course, tending to leave stumps somewhat difficult and short for clean stimulation; (2) considerable reflex movement may accompany the stimulation of the central stump, making difficult the holding in place of the electrode during stimulation. The stimulation is best done by unipolar faradization, the end of the single-wire electrode being bent into a little loop through which the nerve is lightly drawn by its attached ligature. The rise of a. p. evoked by stimulation of central end of splanchnic nerve is, so far as we are aware, the only evidence usually obtainable from the freshly severed spinal cord of the existence of spinal vasomotor centres, unless direct faradization of cord and the rise in asphyxia be accepted as such. The somatic nerves, e.g. central sciatic, *very* rarely evoke any perceptible vasomotor reflex, although later, i.e. when cord has been severed for weeks or months, they do so readily (Sherrington, *Integrat. Action of the Nervous System*, p. 242, 1906).

OBS. 27, 28. These do not always, at least as a student's exercise, succeed in demonstrating very convincingly the liberation of adrenalin on stimulation of *n. splanchnicus*. The failure may be due to the amount liberated being sometimes very small owing to exhaustion of the gland. A convincing demonstration of the splanchnicus as 'secretory' to the adrenal can be shown, although in a manner scarcely open to performance by the student himself, by aseptic ablation of the superior cervical ganglion of the sympathetic, and later, after the wound has healed, faradization of the distal splanchnicus.

The denervated pupil dilates widely on faradization of the nerve. The denervated pupil is an extraordinarily delicate reagent for adrenalin entering the blood-stream.

OBS. 33 A. Advantage is taken of the abdominal contents being exposed for the student to see the mesenteric lymphatics as they appear when containing chyle; students may mistake them for nerves, which indeed to the naked eye they resemble. To ensure chyle the animal should have a meal of fat—more effectual than milk—9–18 hrs. before the class hour.

The contingency that the lacteals when first seen may be taken for nerves is not fanciful or unlikely. Aselli indeed, when he first noticed them, so mistook them. He says 'Eos primo aspectu nervos esse ratus', but adds 'non magnopere moratus sum'; and then he called his friends Tadini and Septali to see the new sort of 'veins' he had discovered, pricking these vessels to show the milky fluid they held (*De Lactibus sive lacteis Venis*, p. 19; Milan, 1627).

OBS. 33 B. *Preparation of graphite ink* (see C. K. Drinker and E. D. Churchill, *Proc. Roy. Soc. B*, vol. ci, p. 462, 1927). The crude substance is sold under the name of Hydrokollag -300.

Stir up the sediment at the bottom of the bottle. A portion in grams of the contents is then mixed with double the number of c.c. of water to which has been added enough sodium hydroxide to give a pH 8.5. Drive off the ammonia contained in the commercial preparation by sending an air-current through the above mixture for some hours, e.g. through one night. Then add an equal quantity of 1.8 per cent. sodium chloride. Allow it to stand before use for 24 hours at least, in order to get rid of the larger aggregates.

EXERCISE VIII

OBS. 36. The stenosis induced does not very closely fulfil the conditions of aortic valve stenosis. The observation does not, however, in the hands of a practiced student, endanger the next and more important experiment, aortic incompetence.

OBS. 37. As stylets, hard drawn brass wire No. 9 S.W.G. (0.144 inch diam.) or No. 10 S.W.G. (0.128 inch diam.), or No. 11 is suitable. The stylet may be about 15–18 cm. long. The end introduced into the artery should be oiled and smooth but flat across, not conical. If not abruptly flat-ended it is liable to slip past the valve without engaging in a cusp. The valve-lesion made consists almost invariably of detachment of a major part of the middle of the attached border of a cusp.

A suitable membrane-manometer readily made by a laboratory mechanic is the following: Its dimensions are larger than those usually described and thus more easily manipulated. It works quite satisfactorily for observations of the kind required by the exercise. It consists (see text-fig. 25, p. 48) of a turned brass block bored horizontally with a 3 mm. smooth boring right through, and again at right angles vertically to meet that boring but not to pass beyond it. The upper end of the vertical boring is enlarged into a shallow circular cup 14 mm. in diameter and 2.5 mm. deep. A couple of brass tubes of the same 3 mm. internal diameter, and fitted each with a stop-cock, are screwed into the sides of the brass block, their tubulures continuing the block's horizontal boring. Their free ends are turned down in the lathe to allow rubber pressure-tubing of 2 mm. bore to be passed over them without difficulty though fitting

tightly. A circular shelf is left round the small cup-like excavation at top of the block. On this rests the rubber membrane. A brass ring rests on the shelf above the membrane, and this and the membrane are clamped watertight by a brass screw cap tapped with a thread for a male thread cut on the outer face of the upper part of the block. To the body of the block between the two side tubulures is screwed a rectangular brass piece which carries in the limbs of a yoke two small screw pins on which the writing-lever is pivoted. The stem of the writing-lever passes above the centre of the rubber membrane which forms the roof of the shallow cup-chamber. The lever where it crosses the membrane rests on a little aluminium saddle which is seccotined centrally to the top of the membrane. The writing-lever is a small straw tipped with a little paper point, as light as possible. The bearing of the lever is adjustable in relation to the membrane by tilting the brass yoke-piece which carries it.

A rubber disk suitable for the manometer can be cut from a Martin elastic surgical bandage, gauges 21, 22, or 23; or from a piece of bicycle-wheel tyre's inner tubing. 'Dress-improver' rubber is too thin for this sized capsule. For cutting the disk, which must fit the capsule shelf accurately, a cork-borer of appropriate diameter answers, but a steel punch is better, the rubber for cutting lying on the cross-grain of a piece of hard wood. For connecting arterial cannula with manometer, rubber-pressure tubing of 2 mm. bore is better than the 2.5 mm. bore used for the other kymographic exercises. The connecting-tube should be as short as practicable, e.g. 20 cm. The subclavian artery, where used for this experiment, will take a wider-nozzled cannula than the carotid; if well sloped off the nozzle-point can have an external diam. 2-3 mm. If the left subclavian be used low down there is no need for separate ligation of the left internal mammary.

A difficulty which may meet the student is that in pushing the stylet down against the valve to rupture a cusp the stylet may drag the innominate and tear that vessel where it was cut partially through for admission of the stylet. There is then less to hinder the valve retiring before the stylet without breaking, and to break it becomes difficult. To avoid the innominate's tearing and yielding it is well to hold, when inserting the stylet and when pushing the stylet against the valve, the innominate itself, not by the ligature tied round its distal end, but by grasping with the dagger-tipped forceps one edge of the cut opening in the artery.

During the manipulation for breaking the valve the lie of the cannula connecting left subclavian artery with the manometer may be shifted, so that the line of connexion of that artery with the manometer becomes partially kinked. Such a shift at once impairs the height of the oscillations of the pulse record which it is a main object of the exercise to study in comparison with those obtained before the valve is broken.

EXERCISE IX

OBS. 39. The method of Anderson, *Jnl. of Physiol.* vol. xxxi, *Proc. Physiol. Soc.* p. xxi, 1904, for exposing the accelerantes gives an excellent exercise. As here adopted the operation wound is large, but the result unfailingly successful. The student can restrict his opening incisions somewhat at a second performance of the exercise. Unipolar faradization has some advantages for the stimulation of the exposed nerves.

OBS. 41. In providing the decapitate preparation for this exercise it is well for the

tracheal cannula inserted to be one with external branches as short as practicable and to be put into the trachea low down near the sternum, care being taken not to include the recurrent laryngeal nerves in the ligature securing the cannula. In severing the neck the decapitating knife may with advantage be carried forward ventrally somewhat farther than usual, thus retaining as amply as possible for the student the parts about larynx and epiglottis.

EXERCISE X

The decapitate preparation for this exercise is preferably female, absence of prostate making easier the assurance that the bladder end of the urethral cannula lies actually in the viscus suitably beyond the sphincter vesicae. The failure of the end of the cannula to lie free beyond the sphincter is a not infrequent difficulty for the student at the start of the experiment; the remedy is, of course, the insertion of a longer cannula or of the same cannula through a more proximal opening in the urethra.

OBS. 44. The assumption is made that the pituitary extract does not cause contraction of the bladder itself. The assumption is based on control observations with the ureters tied off near the kidneys and the employment of intravenous doses of the extract up to twice as large as used in the exercise. Occasionally a slight and very transient contraction was found to follow the injection, at an interval of 2–3 minutes, long after the circulatory effect had appeared. This contraction may indeed have had some other source than the pituitary extract injected. Usually no bladder contraction at all resulted from the injection. Contraction of the bladder, is, however, among the effects sometimes ascribed to pituitrin. Under the conditions of the observation in the exercise it does not seem to be usual in the cat.

OBS. 45. The cat preparation exhibits caffeine citrate diuresis reliably in experience with the exercise.

EXERCISE XI

OBS. 47. The capillary pipettes provided are short pieces of 5 mm. diam. glass tube drawn at one end to small capillary size for a length of 6–7 cm. The terminal 4 mm. of the capillary is bent to a right angle with the stem, so that when the tube is inserted vertically into the sp. gr. fluid the blood issues horizontally from the capillary end, and its rising or falling in the fluid is more easily examined.

The insertion of the cannula into the artery close distal to a side branch tends to avoid interruption by clotting.

OBS. 50. If the Ringer-Locke be too cool, e.g. 20°–25° C., the flow through the kidney is very slow, perhaps only 4 drops per 20", instead of some 15 drops per 20" as is usual with the Ringer-Locke at 36° C.

EXERCISE XII

To provide for this and other student exercises a decerebrate preparation the following is a serviceable method, a feature in it being the employment of the 'decerebrator'.¹

¹ Sherrington, *Jnl. of Physiol.* vol. xlix, 1915, *Proc. Physiol. Soc.* p. lii; Miller and Sherrington, *Quart. Jnl. of Physiol.* vol. ix, p. 147, 1916.

i. The animal, deeply anaesthetized, is placed supine on the operating table, with all four limbs retracted symmetrically by a clip-weight attached to each foot.

ii. A short string is passed by means of a small packing-needle horizontally through upper lip, entering below one nostril and emerging below the other; this is tied in a reef-knot not quite close to the lip, and in it is caught a hook the string of which carries a 100-grm. weight hanging over the end of the operating table. This keeps the neck and head steady and extended.

iii. Through a short median incision in the cricoid region the common carotids r. and l. are tied or looped close below their thyroid branch.

iv. A tracheal cannula may be inserted, preferably low down, e.g. 2 cm. above sternum, because less irritative to the respiratory centre than if higher. In tying in the cannula thus low down care is taken not to include the recurrent laryngeal nerves running up beside the trachea. The insertion of a tracheal cannula is for most exercises merely a precaution lest breathing should lapse for a time after decerebration, and artificial ventilation be then needed.

v. The animal is then placed prone, the clip-weights are detached from the fore-paws and the fore-limbs flexed at elbow and shoulder supporting the chest; a warm bottle is placed under the pelvis, relieving the abdomen from pressure against the table. A median incision is made along the scalp back to occiput, exposing in front the fronto-parietal suture of the skull. In old animals, where there may be difficulty in detecting the suture, it can be revealed by slightly smearing the cranium with blood, or by pressing on the cranial vault with the handle of the scalpel so as to cause a yielding at the suture which a blood smear then makes evident. From the suture, without regard to the little forward or backward running dentation which its median 3-4 mm. often shows, 30 mm. are measured off backward along the median line, and the point so reached is marked by a small cross-cut slightly notching the median ridge. For a large animal 31-32 mm. should be allowed instead of 30 mm. The point lies about 6 mm. in front of the external occipital eminence.

vi. The animal, still deeply anaesthetized, is next placed on the 'decerebrator,' set ready on a table, preferably a low one.

The decerebrator consists of a wooden frame (text-fig. 48) supporting an inclined block (N, text-fig. 48) on the front face of which slides a yoke-piece (Y, text-fig. 48) fixable at the desired height by a clamp. The head of the deeply anaesthetized animal is given a suitable inclination by pushing the open mouth over the upper end of the flanged piece (T, text-fig. 48) of a steel plate fixed to the front face of the inclined block. The flange running upward from the steel plate lies above the tongue in the mouth. The upper edge of the steel plate on either side of this tongue-guard presses against the anterior edge of the ascending ramus of the lower jaw close ventral (posterior) to the point at which the line *v-v* (text-fig. 49, A) meets that border of the ramus. The open jaws and cranium are thus kept and supported at the desired angle.

The apparatus is used as follows:

Pelvis and hind quarters are set astride the saddle carried by P, text-fig. 48, and the position of the saddle-standard is shifted suitably to the length of the animal. The head is introduced between the sides of the steel plate carried on the yoke-block Y, text-fig. 48, so that the tongue-guard T of the steel plate lies in the mouth above the tongue which it protects. The head is moved down so that the coronary processes of the jaw

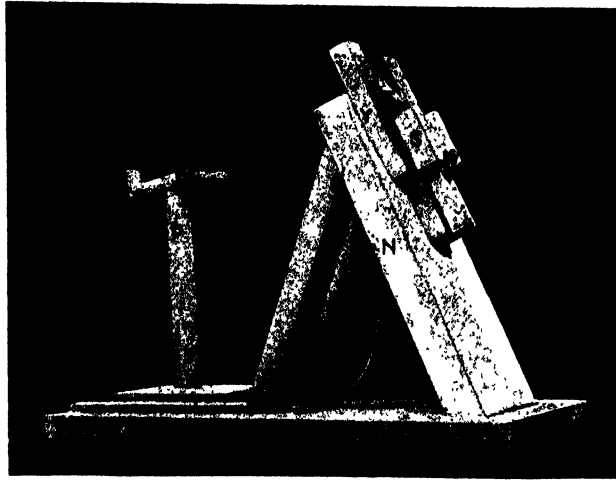

TEXT-FIG. 48. The decerebrating frame.

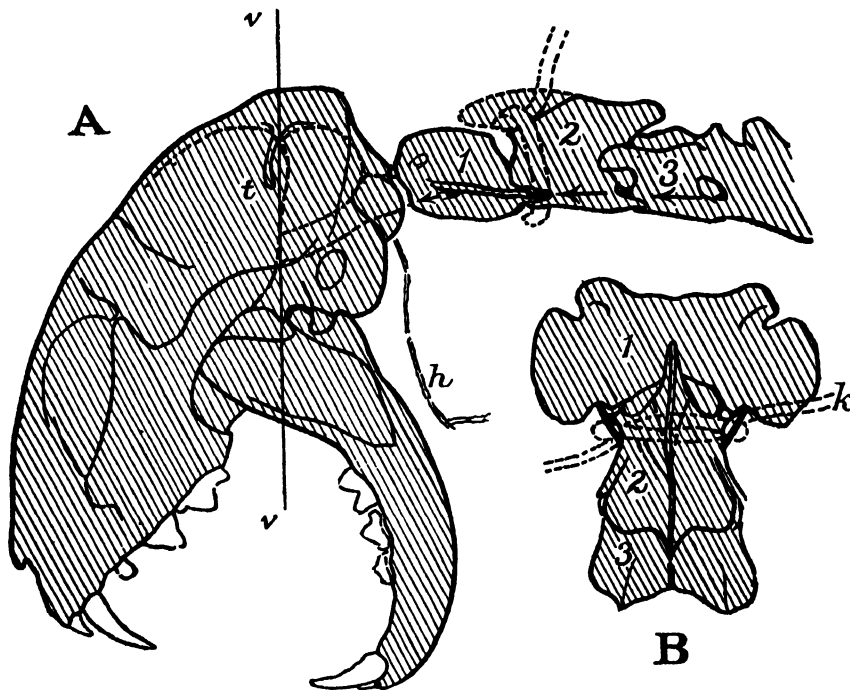

TEXT-FIG. 49. A. Diagram showing plane of severance, $v-v$, by the decerebrator, and action of ligature in occluding vertebral arteries behind lateral wings of atlas vertebra; t , occipital lobe of cerebrum; h , hyoid bone; arrows indicate course of vertebral artery; the cord ligature is indicated in broken line; 1, 2, 3, cervical vertebrae. B. First three vertebrae viewed from dorsal aspect, with vertebral arteries (black) passing from axis to atlas, and cord ligature for compressing them.

come to lie against the bottoms of the bays in the steel plate symmetrically either side of the tongue-guard. The apices of the upper canines then lie about 5 mm. from the anterior face of the steel plate. The free top of the tongue-piece lies over the epiglottis within the fauces.

vii. The decerebrator has a strong gut cord or thong (c, text-fig. 48) threaded through a hole traversing the steel plate and the wooden block. The cord's upper end carrying a steel hook, projects freely through the hole and above the V-notch in s.

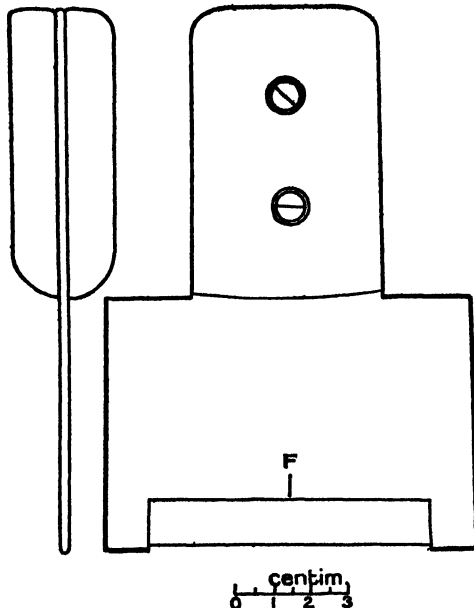

TEXT-FIG. 50. Knife for decerebrator, showing the rounded end-shoulders protecting the cutting-edge.

The hook is now caught in the snout cord-loop (see ii above) and the thong is drawn tight by pulling on it below where (text-fig. 48) it hangs free under the wooden arch of the decerebrator. The cord is then fixed firmly on the side-cleat provided. The cord thus immobilizes the head in the position given by the steel plate.

The brass-bound wooden piece, which with its clamp-screw loose has been low to be out of the way of the cord's emergence from the steel plate, is now slid up so as to meet the snout and support it in its V-notch. It is not pushed up so far as to push the head out of the position that has been given it. It serves simply to prevent the slipping or yielding of the head under the knife.

viii. The knife, of the shape and dimensions given in text-fig. 50, is now taken in the left hand, the operator standing with the animal sidewise to him, its head to his left, i.e. he faces the decerebrator on the side opposite to that looked at in text-fig. 48. Holding the knife vertical, with the bevelled edge of its blade forward, he sets the mid-point of the edge of the blade in the small notch he has marked (see v above) on the mid-line of the skull, the blade truly transverse to the length of the skull. Noting the horizontal line engraved on the side-piece of the steel plate nearest him, he now, without removing the knife-blade from the notch on the skull, adjusts the direction of the plane of the blade so that a continuation of that plane downward will meet the engraved line on the steel plate. The knife under the stroke of the mallet will of course follow the direction thus set. The direction is nearly vertical. Three smart mallet-strokes on the knife-handle suffice for the severance of the head. Under the deep anaesthesia the severance causes no spasm or convulsion. If the knife-blade is suitably sharp the respiratory movements are usually not interrupted, but if the knife is not sharp there is more concussion and respiration may stop. The respiration is more likely to be interrupted in old animals than in young.

ix. The head having been thus separated, the preparation is lifted from the decerebrator. It is best lifted by holding the neck between thumb and finger close behind

the wings of the atlas, thus compressing the vertebral arteries (see text-fig. 49). The preparation is placed on the experiment table. The occipital stump is supported above the rest of the carcass by a string loop passed through the skin of the stump and slung on the cross-piece of a standard. A pledget of dry cotton-wool is laid against the base of the posterior colliculus where that has been cut through, to ally haemorrhage. The preparation can be lowered to horizontal on the table without haemorrhage in about 5' and is then ready for use. If one of the carotids has been merely looped, not ligated, it can be gently released, attention being paid to whether there is recurrence of haemorrhage or no. Haemorrhage from the base of the cut neuraxis can always be controlled by temporary compression of the vertebral arteries behind the lateral wings of the atlas (see above, text-fig. 49).

The severance effected by the decerebrator takes the line *v-v* in text-fig. 49. It removes the head along a coronal plane sloping from near the *inion* past the mandibular joint and emerging into the mouth through the coronoid processes of the lower jaw. The rest of the mandible, and the tongue protected by the tongue-guard of the decerebrator, remain intact. The plane passes between cerebrum and cerebellum, shaving off usually from the former the extreme posterior tip of the occipital lobes, which lie loose in the remnant of skull, and taking usually from the latter the frontmost piece of its median lobe along with a median slip of the bony tentorium. The hemispheres and basal ganglia of the cerebrum and both the colliculi are removed with the head.

Employment of the decerebrator presents several advantages. It is speedy; after the animal has been anaesthetized the procedure occupies about four minutes. There is greater regularity of the level of severance than is easily attainable by the ordinary operative procedure. The total removal of the head except for a remnant of the occiput and of the lower jaw leaves no room for doubt that the whole cerebrum and brain back to the pons have actually been ablated, and that the preparation is merely a temporarily surviving carcass. Under conditions where the teacher may find himself obliged without skilled assistance to make ready the preparations for his class he can, using the decerebrator, do so single-handed without risk of failure, and speedily, although not so speedily as if a skilled assistant co-operated. If an assistant is available he can usefully compress the vertebrae (text-fig. 49) between finger and thumb behind the atlas wings as the preparation lies in the decerebrator at the moment of actual severance of the head (§ viii). The decerebrator has been employed for provision of the class preparations now for upwards of fifteen years, and has worked satisfactorily in the hands of all who have employed it.

OBS. 53-6. In providing the decerebrate preparation for this exercise the tracheal cannula should be introduced well posterior to the cricoid and its projecting limbs be short; more room is thus given for the student's dissection. The carotid of the side on which the gland is to be used should not be ligated but merely looped, so as to be controlled at the time of decerebration and then released as soon as danger of haemorrhage has passed. If the circulation in the submaxillary region is stopped permanently the salivary secretion is not obtainable.

The student's operation is here described in a form suitable for one without previous acquaintance with the region involved or with the manipulation of smallish gland-ducts. After having performed the experiment once the student will find he can curtail his incisions; thus he can do without an anterior transverse incision, the longitudinal

incision can stop 1 cm. in front of hyoid, and he can make the lengthwise skin incision 1 cm. to right of median line; the whole wound is thus smaller and the structures are less exposed to cooling.

A difficulty is the relatively small size of the ducts. The more median, the submaxillary proper, is usually slightly the larger. It does not matter for this exercise which of them be chosen, the submaxillary or the retrolingual; the corda tympani is secretory to both the glands. The capillary-ended cannula need not be tied in; the duct retains it quite well if the cannula be inserted for 10 mm. or so. The student's difficulty in regard to the small size of the duct is largely obviated by the capillary unnozzled cannula and by not having to tie it in. A student may mistakenly 'clean' the ducts by dissection proximal to the lingualis nerve, thus destroying the corda tympani which accompanies the ducts. Even then secretion may be excited by faradizing the ducts near the gland.

EXERCISE XIII

In making the preparation to be used by the student the tracheal cannula should be inserted quite low down, e.g. a couple of cm. or so, above the top of the sternum, and in doing this care should be taken that the recurrent laryngeal nerves, which lie close to and on the trachea, are not included in the ligature which ties the cannula in the trachea. The oesophagus at this level lies not only deep to, but somewhat on the left side of, the trachea. The low insertion of the tracheal cannula gives the student more room for his dissection; but it has the disadvantage that the air supplied to the lungs is less moist, and secretion is apt to collect in the air-passage and hamper respiration in the later stages of the exercise.

The observations follow the procedure of Miller and Sherrington (*Quart. Jnl. of Exp. Physiol.* vol. ix, p. 147, 1915). Reflex swallowing is one of the earliest reflex reactions to emerge in the decerebrate preparation.

Obs. 62. The simple stethograph (Miller and Sherrington, *ibid.*) used is easily applicable to the preparation whatever the position given the latter.

Obs. 65. For recording the effect of vagus on respiratory movement it is well to ensure that the lever-point remains in contact with the recording-surface over a considerable sweep of its arc, because the excursion of the movements and the height of their base-line may vary considerably during the observations.

EXERCISE XIV

Obs. 67. In the cat the depressor branch of the vagus is usually less separate from the main trunk than in the rabbit. According to some descriptions the depressor runs a more separate course on the left side than on the right, but experience in class has hardly borne that out. In getting ready the preparation for decerebration before giving it out to the class-room the vago-sympathetic is necessarily exposed when the carotid is ligated; one can then usually note whether the nerve-trunk is obviously three-stranded and, if it is so, allocate the preparation for this exercise. If the student fail to distinguish the depressor nerve as a separate branch, the closely similar depressor effect

from stimulation of the vagus trunk below its superior laryngeal branch attains practically the same object for him, especially after paralysing the cardio-inhibitory efferent endings with atropine.

EXERCISE XV

Obs. 71. The raising of the pelvis somewhat above the table-top by placing a support (hot-water bottle) under it greatly lessens the risk of venous bleeding during the lateral widening of the laminectomy wound. Such bleeding can seriously impede the dissection by obscuring the nerve-roots; with the above precaution very little bleeding occurs.

Obs. 72. The employment of Galvani's experiment with metals for diagnosing rapidly between efferent and afferent roots in the cauda equina region after the dural theca has been opened is often helpful to those tracing the roots for the first time.

EXERCISE XVI

Obs. 74, 76. These take advantage of the fact that the ganglion and junction of the dorsal and ventral roots of the 2nd cervical nerve lie outside the vertebral canal. They can therefore be exposed with minimal exposure of the spinal cord itself. Risk of cooling and of otherwise damaging the cord is thus lessened, with avoidance of the consequent depression of the reflex reactions, a likely source of failure in the reflex part of the previous exercise.

The tracheal cannula is introduced far back, close to the sternum, to escape the neck-block on which the neck-stump rests, which will otherwise interfere with the air-supply to the chest.

In decerebrating for this exercise the pinnae and occipital skin should, when the animal is fixed in the decerebrator, be drawn backward as far as practicable. Retraction of the pinnae is favoured by a transverse skin incision through the scalp across the posterior end of the median longitudinal scalp incision made for decerebration.

EXERCISE XVII

Obs. 77. In making the decerebrate preparation the pinnae should be preserved as for exerc. XVI. A small animal, not black-haired, is preferable.

Obs. 78. The renal oncometer is that devised by E. A. Schäfer and B. Moore (*Jnl. of Physiol.* vol. xx, p. 5, 1896), and is easily made from Stent's dental composition or, more permanently, from vulcanite.

The piston-recorder consists of a vertical brass cylinder (7 mm. bore) provided with a vulcanite piston having 0.125–0.175 mm. clearance. Olive-oil is suitable for lubrication. The top of the piston is fashioned to be a knife-edge operating a light straw lever which is delicately counterbalanced by a small adjustable weight and provided with a Bayliss writing-point. The instrument has been designed and is made by Mr. C. J. O'Neill, University Laboratory of Physiology, Oxford. It is well to mount it on a stand with a screw adjustment for grading the writing pressure suitably.

Obs. 80. For Bayliss's gum-saline gum-acacia may be used, if desired, instead of gum-arabic. A suitable gum-acacia is that sold as 'Turkey-elect', but any clean variety will serve. Tap-water can be used for dissolving.

EXERCISE XVIII

OBS. 83. 'Spontaneous' twitching of the tibialis muscle may trouble the reflex stage of the exercise. Usually this can be stopped or lessened by painting with novocain solution (2 per cent. in Ringer's saline fluid) the skin edges of the inguinal and ischial dissection-wounds.

It might be thought that the tendons of extensor longus digitorum and peroneus longus should be severed in order to avoid complication of the tibialis record. Experience shows that this is not actually the case; and though their severance is easily carried out, and for research is advisable, this slight addition to the operative procedure has been omitted since the student has a good deal to get through in the time available. Severance of the muscles attached to the great trochanter of femur has also been omitted and severance of upper end of the rectus femoris (a small muscle in the cat) for similar reasons as not actually necessary, though of course advisable if the observations are conducted for research.

The speed of movement of the travelling recording-surface should not be less than 20 cm. a sec. With the larger Palmer student-drum this means one revolution in 5", with the smaller (ordinary size) drum one revolution in 2.5". The manipulation for the exercise is therefore easier with the larger drum. The recording-lever of the myograph is preferably one with a screw 'after-load' support. The resistance offered by the myograph is preferably a spring and not a weight. A coiled letter-weight spring is lighter and more durable than rubber tube or band, and takes less room.

In some patterns of recording-drum the drum is carried on the rotating spindle by a spring catch, and when the drum stops or starts quickly it is liable to 'lag' or 'rush' on the spindle, upsetting the time-relations of the records and rendering the marking of the latencies erroneous. For this experiment the drum must be clamped to the spindle firmly so as to retain a fixed position on it.

Good material for the writing-point of the myograph-lever is oil tracing-paper: this has sufficient spring in it, and the spring is not affected by moisture.

III. v. This is the ordinary twist-drill. Although the class-instruction in the exercise directs drilling and fixation of the lower end of the femur, for accurate fixation of the tibialis muscle the insertion of the drill should be into the head of the tibia itself. This latter course offers risks (1) of weaker hold by deviating into this joint cavity, (2) of damage to the upper part and even the nerve-supply of the tibialis muscle itself. The easier and safer course is therefore given for the exercise, although it is not to be recommended for strict myograph work.

EXERCISE XIX

Decerebrate rigidity (*Jnl. of Physiol.* vol. xxii, p. 319, 1898) is essential for the first part of this exercise, which makes use of it in the vastocrureus for the examination of postural reflexes and as a background against which to exhibit the reflex inhibition of that muscle. A convenient form of myograph is the partially isometric contrived by attaching a strong elastic band near the axis of an isotonic lever. In some ways more suitable than the above, especially for the stretch-reflex, is the more completely

isometric recorder shown in text-figs. 41, 44. The length of wire (steel music wire) can be 50 mm. between clamped point and the free bearing. The tension developed in the stretch-reflex is much less than that obtained in the crossed extension reflex. The myograph resistance for the former is therefore insufficient for the latter. It is convenient to have interchangeable wires for these two observations. A suitable thickness for the stretch-reflex is 18 S.W.G. (1.219 mm.), for the crossed extension reflex 14 S.W.G. (2.03 mm.). The rigidity rapidly ensues on decerebration; it appears early, before the ether-chloroform narcosis employed during the performance of the actual decerebration has passed off or even greatly diminished. The grade of rigidity establishing itself varies somewhat; for this exercise the grade does not matter much, even a small degree sufficing for the observation. It is well to remember that the degree of rigidity at the knee (vastocruureus) is greater in the supine position of the preparation than in the lateral position (Magnus and de Klejn, *Arch. f. d. ges. Physiol.* cxlv. 455, 1912). Occasionally the rigidity after setting in wanes and may disappear; this may result from haemorrhage from the brain-stump into the posterior cranial fossa, behind the tentorium cerebelli; removal of the blood or checking of further haemorrhage will then restore the rigidity.

In the exercise severance of the rectus femoris muscle as a precaution against occurrence of flexion at the hip is not included in the procedure. It is best done at the iliac origin of the muscle; but its omission makes no practical difference to the results of the exercise. Similarly, severance of the glutei, obturator internus, gemelli, and quadratus lumborum as a precaution against extension of hip in the contralateral reflex, though necessary for research work, is unnecessary for the exercise and is omitted.

Obs. 90, 91. A handy device for concurrently opening the induction short-circuit, for stimulation, at the same time as making the signal circuit, is a pair of electric-light switches mounted conversely side by side with their buttons yoked by a wooden handle, so that one movement of the handle opens the one key and closes the other.

EXERCISE XX

Obs. 93. The plane of transection for the decerebration should lie slightly further forward than for previous exercises; instead of being inter-collicular it should be just precollicular, in order, though producing the rigidity, to spare the brain-stem path from the cerebellum.

V. i and ii. For fuller description of torsion wire key, see Sherrington *Proc. Roy. Soc. B*, vol. xcv, 1923, and for its employment for doubling stimulus rate, *ibid.* vol. xc, p. 270, 1918.

More rigid fixation is obtained by inserting the proximal drill into the head of the tibia itself. Insertion into the femoral condyles as described in the text of the exercise avoids risk of damage to the nerve-supply of the tibialis muscle. But a careful student, if warned, can use the head of the tibia without damaging the nerve.

EXERCISE XXI

Even a small amount of haemorrhage in the adjacent tissue may greatly embarrass the search for the duct.

In order to avoid reflex movements disturbing the abdominal operation a dose of ethyl-urethane, 0.5 gm. per kilo. cat, may be given hypodermically to the animal about an hour before the chloroform anaesthesia and decerebration, or a dose of curare after decerebration.

The operation sometimes excites reflex retching. The likelihood of retching is increased if there be oozing into the pharynx from the occipital stump; such blood is reflexly swallowed and seems to provoke retching.

EXERCISE XXII

For the purpose of the exercise *B. pyocyaneus* recommends itself because quick growing at room temperature, yielding colonies soon, specifically recognizable even with the naked eye, and innocuous as class material.

INDEX OF NAMES

- Alcock, 80.
Alvarez, W. C., 139.
Anderson, H. K., 61, 150.
Anrep, V., 46.
Applegarth, C., 12.
Armstrong, C. W., 60, 111.
Arthus, 100.
Asayama, C., 105, 107.
- Ballif, L., 91.
Banting, F. G., 117.
Barcroft, J., 15.
Barnett, J. A., 3.
Bayliss, W. M., 85, 92, 100, 121, 139, 157.
Bernard, Cl., 74, 99.
Borelli, 21.
Bradford, J. R., 99.
Bremer, F., 117.
Brodie, T. G., 135, 144, 145, 146.
Brown, E. D., 85.
Brown, T. Graham, 133.
Brown-Séquard, 99.
- Camis, M., 134.
Campbell, J. M. H., 14.
Cannon, W. B., 7, 41.
Chavasse, C. C. H., 12.
Cheyne, W. W., 125.
Churchill, E. D., 149.
Cluver, E. H., 79.
Cohnheim, 20, 55, 99, 125.
Collier, D., 34.
Cooper, S., v, 108, 134.
Corrigan, 55.
Cox, E. G., 127.
Creed, R. S., v.
Cushny, A. R., 7.
Cyon, E. de, 46, 61, 85.
Cyon, M. de, 61.
- Dakin, H. D., 7.
Dale, H. H., 21.
Davison, W. C., 27.
Dawson, W. T., 13, 140.
Denis, 99.
Denniston, E., 5.
Denny-Brown, D., 91, 95, 108, 112, 117, 134.
Descartes, R., 21.
Dixon, W. E., 15.
Douglas, C. G., 64.
Dreyer, N. B., 52, 53, 106, 107, 127.
Dreyer, R. P., 46.
Drinker, C. K., 149.
- Eccles, J. C., 117.
Ehrlich, P., 56.
Elliott, T. R., 46.
Evans, Lovatt, 15.
- Flack, M., 61.
Floreay, H. W., v, 85, 133.
Forbes, H. S., 21.
Foster, H. V., 84.
François-Franck, 20.
Fröhlich, Alfred, 133.
Fulton, J. F., 91, 112, 117.
- Galvani, 90, 91, 157.
Gaskell, J. F., 47.
Gaskell, W. H., 47.
Gasser, H. S., 7.
Gloria, E., 36.
Greenshields, W. R., 11.
Gunn, J. A., 7, 13, 140.
- Haldane, J. S., 107.
Hales, Stephen, 31.
Hall, Marshall, 80.
Halliburton, W. D., 128.
Hardy, W. B., 121.
Harvey, W., 20, 21, 31, 99.
Head, H., 81, 133.
Heymans, C., 85.
Hill, L., 61.
Hobson, T. G., 29.
Hodgkin, 55.
Hollman, E. F., 45.
Hooke, 21.
Hoskins, R. G., 7.
Howell, 46.
Huggett, A. St. G., 121.
- Jennings, 136.
Johansson, 46.
Johnstone, J. G., 35, 79.
Jones, E. Britten, 43.
- Klejn, de, 159.
Knowlton, F. P., 13.
Krige, C. F., 35.
Krogh, A., 21.
Kuno Yas, 21.
- Laffitte, L. S., 78.
Langendorff, O., 12.
Langley, J. N., 7, 46, 74.
Lazarus-Barlow, W. S., 20.

- Legallois, 81.
 Lewis, T., 20, 21, 38.
 Leyton, A. S. F., 133.
 Locke, F. S., 6, 12.
 Loewenhoeck, 21.
 Longet, 80.
 Lower, R., 99.
 Ludwig, C., 31, 46, 74, 85.
- MacKeith, M. H., 11.
 Mackenzie, K. A. J., 105.
 Magendie, 80, 86, 91, 95.
 Magnus, R., 64, 159.
 Malpighi, M., 21.
 Marey, E. J., 20, 55.
 Martin, H. Newell, 12, 13.
 Marvin, H. M., 85.
 Mather, J. H., 82.
 Mathison, G. C., 38.
 Mellanby, J., v, 121.
 Mellé, B. G. V., 128.
 Meltzer, S. J., 80.
 Miller, F. R., 117, 133, 151, 156.
 Mivart, St. John, 136.
 Moore, B., 157.
- Nash, R. A., 85.
 Newman, G., viii.
 Nice, L. B., 41.
- O'Neill, C. J., 157.
 Ogawa, S., 15.
 Oliver, G., 7, 15, 46.
 Ormerod, T. L., 43.
- Pacini, 44.
 Pagés, 100.
 Palmer, C. F., 145.
 Parsons, J. P., 46.
 Paton, D. N., 146.
 Pauw, D. B., 12.
 Pavlov, I. P., 74.
 Peacey, W., 34.
 Penfield, W. S., 41, 45.
 Perkins, G., 14.
 Petersen, F. A. D., 12, 42.
 Phillips, O. S., 29.
 Pike, F. H., 133.
 Pi-Suñer, J., 91, 112.
 Plummer, A. H., 11.
 Poiseuille, 31.
 Ponder, C. W., 125.
 Porter, Townsend W., 12.
- Prevost, J. L., 80.
 Priestley, J. G., 64.
- Ranvier, L. A., 74.
 Rayner, H. L., 11.
 Reichard, 136.
 Richards, A. N., 21.
 Riddoch, G., 133.
 Ringer, S., 6.
 Roaf, H. E., 38.
 Rossdale, G. H., 60.
 Roy, C., 69, 99.
- Sanderson, J. Burdon, 147.
 Schroeder, 64.
 Septali, 149.
 Sharpey-Schafer, E., 7, 15, 46, 64, 121, 157.
 Shipley, J. L., 128.
 Skaife, W. J., 42.
 Smith, J. M., 4.
 Sollman, T., 85.
 Sowton, S. C. M., 15, 107.
 Starling, E. H., 13, 121.
 Stewart, G. N., 47, 74.
 Stirling, W., 139.
 Strauss-Durckheim, 136.
- Tadini, 149.
 Takamine, J., 7.
 Thomas, A. E., 111.
 Thompson, J. H., 46.
 Thompson, W. H., 74.
 Tyrode, 139.
- Underhill, S. W. F., 7.
- Viets, H., 95.
 Vincent Swale, 46.
 Volkmann, E., 21.
 Volta, 91.
- Wagner, 21.
 Waller, A. V., 80, 99.
 Waters, K. F. D., 27.
 Watt, N. L., 105.
 Weber, E., 21.
 Weber, H., 21.
 Woods, E., 6, 41.
 Wright, Samsom, 85.
 Wyssokowitch, W., 125.
- Young, A. W., 7.

PRINTED IN GREAT BRITAIN AT THE UNIVERSITY PRESS, OXFORD
BY JOHN JOHNSON, PRINTER TO THE UNIVERSITY

