

BIRLA CENTRAL LIBRARY

PILANI (Rajasthan)

Class No:- 627

Book No:- D185C

Accession No:- 31567

Acc. No

ISSUE LABEL

Not later than the latest date stamped below.

--	--	--

CENTRIFUGAL PUMPS

*This book is produced in full compliance
with the government's regulations for con-
serving paper and other essential materials.*

CENTRIFUGAL PUMPS

BY

R. L. DAUGHERTY, A. B., M. E.

PROFESSOR OF MECHANICAL AND HYDRAULIC ENGINEERING, CALIFORNIA
INSTITUTE OF TECHNOLOGY; FORMERLY PROFESSOR OF HYDRAULIC
ENGINEERING, RENSSELAER POLYTECHNIC INSTITUTE.
AUTHOR OF "HYDRAULIC TURBINES"

FIRST EDITION

TENTH IMPRESSION

McGRAW-HILL BOOK COMPANY, Inc.

NEW YORK AND LONDON

1915

CENTRIFUGAL PUMPS

BY

R. L. DAUGHERTY, A. B., M. E.

PROFESSOR OF MECHANICAL AND HYDRAULIC ENGINEERING, CALIFORNIA
INSTITUTE OF TECHNOLOGY; FORMERLY PROFESSOR OF HYDRAULIC
ENGINEERING, RENSSELAER POLYTECHNIC INSTITUTE.
AUTHOR OF "HYDRAULIC TURBINES"

FIRST EDITION
TENTH IMPRESSION

McGRAW-HILL BOOK COMPANY, Inc.

NEW YORK AND LONDON

1915

COPYRIGHT, 1915, BY THE
MCGRAW-HILL BOOK COMPANY, INC.

PRINTED IN THE UNITED STATES OF AMERICA

PREFACE

The extensive use and increasing popularity of centrifugal pumping machinery make it necessary for many to become familiar with this subject in all its phases. In this book an effort has been made to cover the following ground: To illustrate and explain all the essential features of construction of modern centrifugal pumps, to present a clear and intelligible theory which shall be entirely general in its nature, to explain by this theory the pump characteristics and connect the theory with the actual facts, to present a thorough discussion of the factors affecting efficiency, to consider the characteristics of various types of pumps and their suitability for different services, to compare centrifugal with displacement pumps, and to present various general laws and factors leading to a better appreciation of the field of service of such pumps and a better means of selecting the proper combinations. While this is not primarily a book on design, it is believed that a thorough study of the foregoing will be of value to prospective designers, and in addition the methods of design of centrifugal pumps are outlined.

The material in this book is based upon a study of the performances of 123 turbine and 51 volute centrifugal pumps made by 17 and 12 different companies respectively. The field covered by them ranged from 1 to 11 stages, heads from 7 to 1843 ft., capacities from 108 to 132,000 gal. per minute, speeds from 62 to 20,000 r.p.m., and efficiencies from 30 to 87 per cent. A considerable portion of the work is also founded upon the analysis of tests made by the author upon a volute pump and a turbine pump for both of which all information regarding dimensions and other quantities was obtainable. With the turbine pump an extensive and accurate series of tests was made at various speeds from 700 to 2,000 r.p.m. Both of these pumps were regular commercial pumps of good design, not freak pumps built for experimental purposes only.

The author has drawn upon trade catalogues and several books and papers for much of his material, due credit for which is given in the text, but it is believed that a very great deal of the

following treatise will be found to be new. The common usage regarding terms employed has been followed as far as possible, but in cases where there were no precedents or where the usage was illogical and confusing, new terms have been created. It is hoped that eventually some of these things may become standardized.

The book has been so written as to serve the needs of the practising engineer who wishes to obtain a grasp of this subject. By the insertion of problems and questions it is believed that it will be found equally well adapted for use as a text.

The author wishes to express his gratitude to the various manufacturers, whose names are attached to the illustrations in the book, for their valuable assistance in furnishing such material. He is also indebted to Mr. F. G. Switzer, Fellow in Sibley College, for aid in performing the experimental work and for his criticism of the proof.

R. L. D.

ITHACA, N. Y.,
January, 1915.

CONTENTS

	PAGE
PREFACE	v
CHAPTER I	
INTRODUCTION	1
Definition—Classification—Reaction turbine <i>vs.</i> turbine pump— Historical development—Conditions of use—Pump size—Rated head and discharge.	
CHAPTER II	
DESCRIPTION	16
The impeller—Diffuser—Clearance rings—Stuffing boxes—The case—Balancing.	
CHAPTER III	
INSTALLATION AND OPERATION	40
Priming—Foot valves and strainers—Suction lift—Piping connec- tions—Pumps in series and in parallel—Operating a centrifugal pump.	
CHAPTER IV	
GENERAL THEORY	44
Notation—Relation between absolute and relative velocities— Equation of continuity—General equation of energy—Losses of head in pipes—Head developed by pump—Centrifugal action or forced vortex—Free vortex—Illustration of centrifugal pump losses—Definitions of efficiencies—Duty—Abbreviations—Con- version factors—Useful formulas—Problems.	
CHAPTER V	
THEORY OF CENTRIFUGAL PUMPS	59
Theorem of angular momentum—Torque exerted by impeller— Power imparted by impeller—Head imparted by impeller—Losses of head—Head of impending delivery—Relation between speed, head, and discharge—Use of factors—Hydraulic efficiency— Maximum hydraulic efficiency—Maximum gross efficiency— Experimental analysis—Effect of number of vanes—Defects of the theory—A corrected theory—Value of the theory—Problems.	

CHAPTER VI

	PAGE
CHARACTERISTICS	88
Definition of characteristics—Description of pumps tested— Head-discharge curves at constant speed—Power-discharge curves at constant speed—Efficiency-discharge curves at constant speed— Impending delivery or shut-off—Maximum efficiency-speed—Zero lift and maximum discharge—Constant discharge-variable speed— Constant lift-variable speed—Constant static lift with friction- variable speed—Constant static lift with friction-constant speed— Efficiency of pump and pipe line—Characteristic curves—Prob- lems.	

CHAPTER VII

DISK FRICTION	107
Definition—Theory—Experimental results—Summary of results— Approximate formulas—Conclusions—Problems.	

CHAPTER VIII

FACTORS AFFECTING EFFICIENCY	111
Efficiency of a single pump—Efficiency of a series of pumps—Type of impeller—Efficiency-capacity—Efficiency-head—Efficiency-speed —Efficiency-G.P.M./ \sqrt{h} —Efficiency-specific speed—Pumps with high specific speeds—Effect of number of stages—Summary —Problems.	

CHAPTER IX

CENTRIFUGAL PUMPS <i>vs.</i> DISPLACEMENT PUMPS.	128
Relative speeds—Comparative size—Comparative efficiency— Comparative cost—Comparative characteristics—Advantages of centrifugal pumps—Advantages of displacement pumps— Problems.	

CHAPTER X

COMPARISON OF TYPES OF CENTRIFUGAL PUMPS	132
Maximum efficiency of turbine <i>vs.</i> volute pumps—Average effi- ciency of turbine <i>vs.</i> volute pumps—Rising <i>vs.</i> falling characteris- tics—Problems.	

CHAPTER XI

GENERAL LAWS AND FACTORS.	136
General relations—Values of ϕ and c for maximum efficiency— Values of the ratio D/B —Diameter and discharge—Specific speed —Illustrations of specific speed—Determination and use of fac- tors—Problems.	

CONTENTS

ix

CHAPTER XII

	PAGE
PUMP TESTING	144
Purpose of test—Measurement of head—Measurement of water— Measurement of speed—Measurement of power—Plotting curves— Problems.	

CHAPTER XIII

COSTS	153
Costs of centrifugal pumps—Cost of pumping—Problems.	

CHAPTER XIV

ROTARY AND SCREW PUMPS	158
Rotary pump—Screw or propeller pump.	

CHAPTER XV

APPLICATIONS OF CENTRIFUGAL PUMPS	160
Steam power plants—Fire pumps—Deep well pumps—Mine pumps—Dredging—Waterworks—Miscellaneous uses.	

CHAPTER XVI

DESIGN OF A CENTRIFUGAL PUMP	168
Empirical procedure—Layout of impeller vanes—Layout of a mixed flow impeller—Rating chart—Problems.	
APPENDIX A.	179
Test data.	
APPENDIX B	183
Review questions.	
APPENDIX C.	187
Table of $3/4$ powers of numbers.	
INDEX	189

For notation see page 44.
For abbreviations see page 56.
For conversion factors see page 56.
For useful formulas see pages 57, 137, 139.

CENTRIFUGAL PUMPS

CHAPTER I

INTRODUCTION

1. Definition.—Centrifugal pumps are so called because of the fact that centrifugal force or the variation of pressure due to rotation is an important factor in their operation. However, as will be shown later, there are other actions which have important effects.

In brief the centrifugal pump consists of an impeller rotating within a case as shown in Fig. 1. Water enters the impeller at the center, flows radially outward, and is discharged from the circumference into the case. During this flow through the impeller, the water has received energy from the vanes resulting in an increase both in pressure and velocity. Since a large part of the energy of the water at discharge from the impeller is kinetic, it follows that in any efficient pump it is necessary to conserve this kinetic energy and transform it into pressure.

For the sake of simplicity the water is shown as entering the impeller in Fig. 1 with a positive pressure by which is meant a pressure that is greater than that of the atmosphere. However, the pressure at this point is usually less than that of the atmosphere in which case we call it negative. Likewise the axis of rotation need not necessarily be vertical as shown.

2. Classification.—Centrifugal pumps are broadly divided into two classes:

1. Turbine pumps.
2. Volute pumps.

While there are still other types, the two given are the most important and are representative of all the others.

The turbine pump is one in which the impeller is surrounded by a diffuser containing diffusion vanes as shown in Figs. 2 and 3. These provide gradually enlarging passages whose function it is to reduce the velocity of the water leaving the impeller and thus

efficiently transform velocity head into pressure head. The casing surrounding the diffusion ring may be either circular and concentric with the impeller or it may be of a spiral form. While the latter may be slightly superior from the standpoint of efficiency, the cost of production is usually slightly greater.

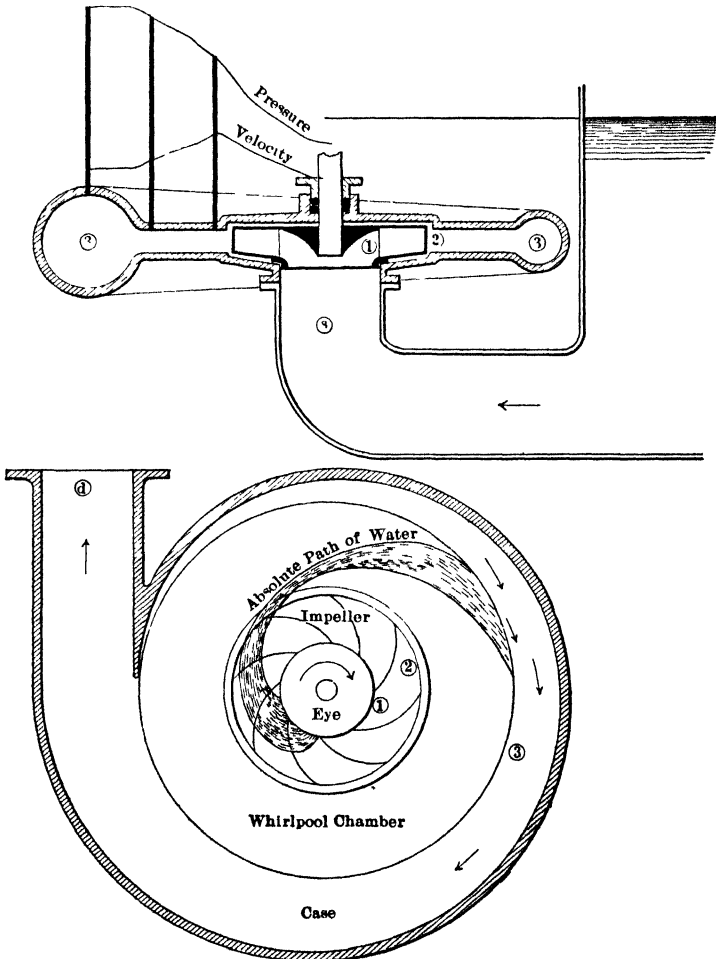

FIG. 1.—Centrifugal pump with whirlpool chamber and spiral case.

The volute pump is one which has no diffusion vanes but, instead, the casing is of a spiral type so made as to produce an equal velocity of flow at all sections around the circumference

and also to gradually reduce the velocity of the water as it flows from the impeller to the discharge pipe. Thus the energy transformation is accomplished in another way. The spiral is often

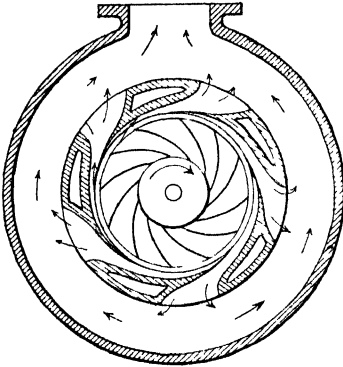

FIG. 2.—Turbine pump with circular case.

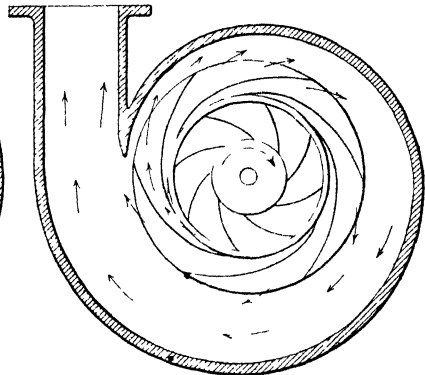

FIG. 3.—Turbine pump with volute case.

called a volute, whence the pump has received its name. (See Fig. 4.) The taper portion between the case proper and the discharge flange is often called the nozzle.

Occasionally pumps have been built with what is called a whirlpool chamber as shown in Fig. 1. This consists of a ring

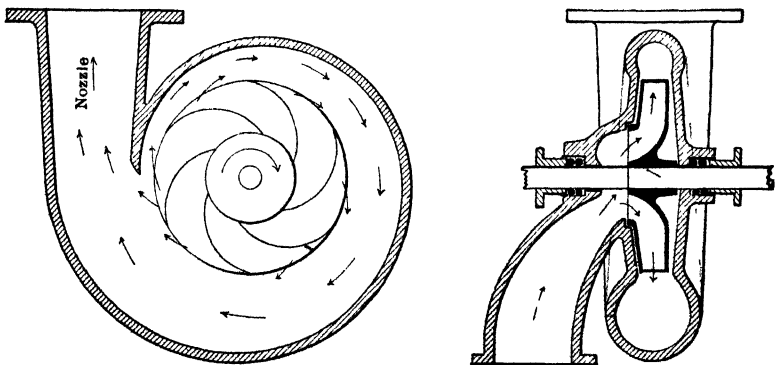

FIG. 4.—Volute pump.

surrounding the impeller, the width of which, parallel to the shaft, is the same as that of the impeller. Since the water from the impeller enters this space with a velocity having a tangential

component, it may be seen that the path of the water will be some form of spiral and that its velocity will gradually diminish as it approaches the outer circumference, with a consequent increase in pressure. This whirlpool chamber is then surrounded by either a circular or a spiral case in the same manner as the turbine pump. In fact it is but little different from the turbine pump except that the diffusion vanes are absent. It may be seen that this construction adds to the size of the case as compared

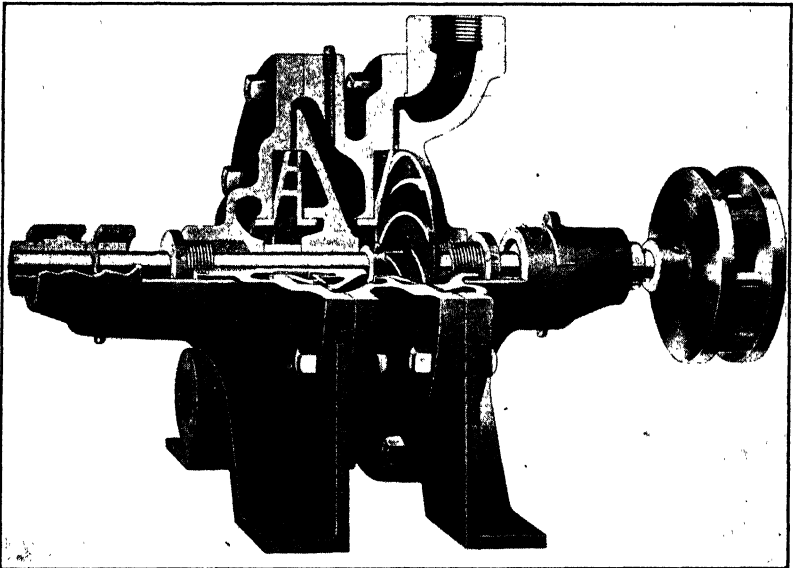

FIG. 5.—Two-stage turbine pump. (*Chicago Pump Co.*)

with the volute pump and thus makes it more expensive. Also unless the outer diameter of the whirlpool chamber is large as compared with the inner diameter, the pressure transformation will not be made very effectively. Experimental work has indicated that the actual efficiency of the whirlpool chamber is not very high in any event. It is believed to be better to add the diffusion vanes so as to produce the turbine pump, as the outer diameter can then be materially reduced, while at the same time the vanes are held to improve the efficiency. The whirlpool chamber is, therefore, seldom used except in a very reduced form with some volute pumps as shown in Fig. 9. For these

reasons it is not thought to be necessary to consider it as a separate type

In order to produce a cheap pump the impeller may be set concentrically in a circular case. The efficiency of such a pump

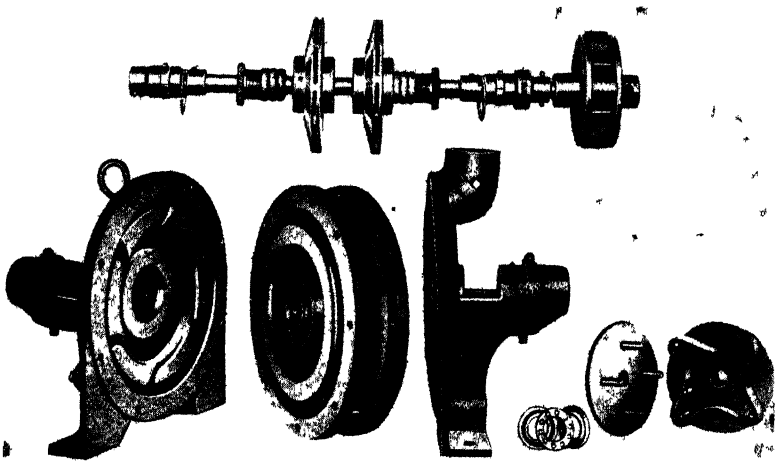

FIG. 6 —Details of turbine pump. (*Chicago Pump Co.*)

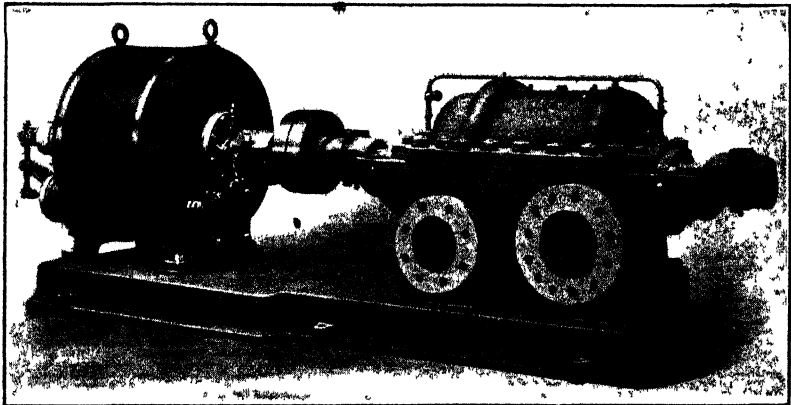

FIG. 7.—Multi-stage turbine pump with split case. (*Henry R. Worthington*)

is necessarily low, in fact, as will be shown later, the efficiency cannot rise above 50 per cent. Its only merit is cheapness of construction, largely because the same case can be used for a large number of sizes of impeller.

In this connection it should be emphasized that a "rotary pump" is not a centrifugal pump. The rotary pump is shown in Fig. 99. It is positive in its action and is essentially a displacement pump, though of the rotating rather than the reciprocating type.

The term "centrifugal pump" will be understood to cover both the turbine and the volute pump as well as any other sub-

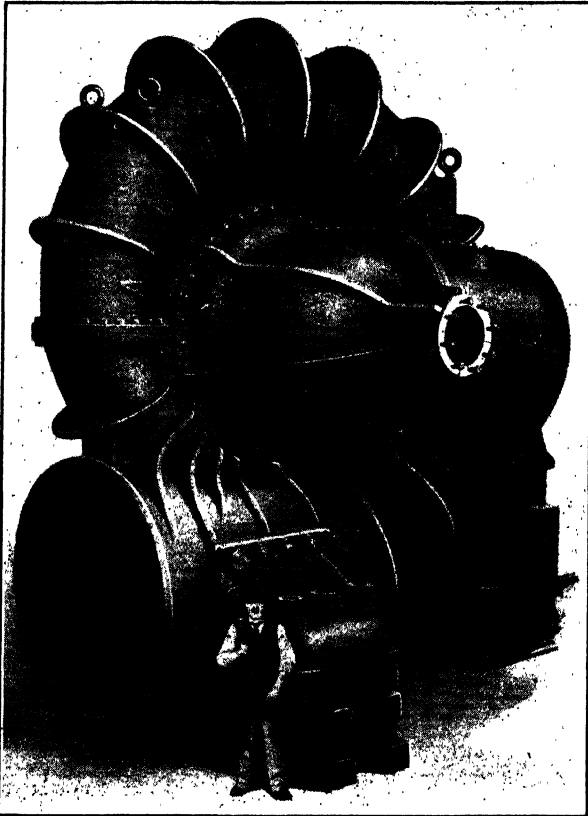

FIG. 8.—72-in. double-suction volute pump. (*Alberger Pump and Condenser Co.*)

ordinate forms. By some the expression "centrifugal pump" is restricted in its meaning to the volute and similar types, while the first named is designated as a "turbine pump." But as may readily be seen, they differ only in minor detail so that the turbine pump is also a centrifugal pump. By some it is proposed to

call them "turbine centrifugal pumps" and "volute centrifugal pumps."

Pumps are also further classified as single-stage or multi-stage pumps according to whether there is but one impeller, as in Fig. 9, or whether there are two or more impellers through which the water flows in series as illustrated in Fig. 5.

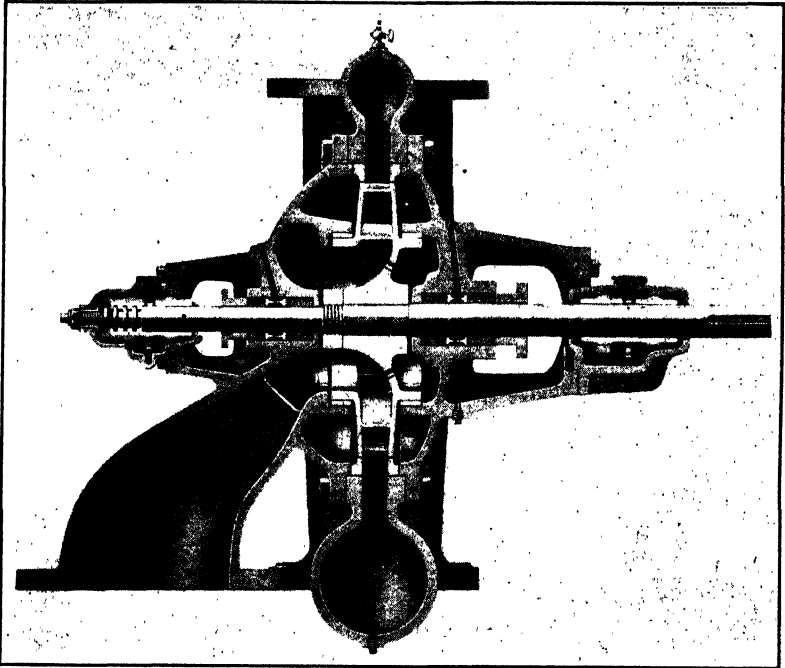

FIG. 9.—Volute centrifugal pump. (*Alberger Pump and Condenser Co.*)

Still a further classification may be made as to how the case can be opened up. We may have the split case type as shown in Fig. 7 or the side plate type as in Fig. 9.

Pumps may also be classified as horizontal or vertical shaft types. The former have already been shown, the latter type is illustrated in Fig. 10. The latter may be either submerged beneath the water or it may be above the water level.

Sometimes the distinction is made as to whether a centrifugal pump possesses a *rising* or a *falling* characteristic. The latter in turn may be subdivided into *flat* or *steep* characteristics. (See

Fig. 11.) By a rising characteristic is meant that when the pump runs at constant speed the head increases as the discharge is increased from zero. After a certain value is reached, however, the head begins to fall again. A falling characteristic means that

the head continuously decreases as the discharge increases from zero. The meaning of flat or steep is readily seen from the figure.

Other less fundamental classifications will be made throughout the text.

3. Reaction Turbine vs. Turbine

Pump.—It is often stated that the turbine pump is nothing but a reaction turbine reversed, but such a statement may be misleading. It is true that they have many things in common but their differences are as striking as their similarities. The vector relations of the velocities, for instance, are analogous in the two cases, yet the actual appearances of the velocity diagrams are usually unlike, since the relations of angles and vane curvature are different. It might be possible to run one machine as the other but the resulting efficiency would be low. It does not seem possible to design a good machine which shall be equally well adapted for either purpose except

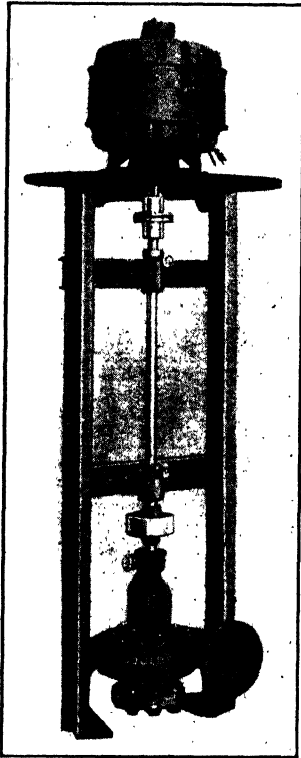

FIG. 10.—Vertical shaft pump.
(Goulds Mfg. Co.)

at a considerable sacrifice of efficiency.

The fundamental equations may be applied alike to either type, but as soon as certain special relations are introduced into these fundamental equations the result may be that the equations cannot be used for both alike.

It is also well worth noting that in the turbine one of the steps is the transformation of pressure head into velocity head, while with the pump we are concerned with converting kinetic energy into pressure energy. The former operation can be more efficiently performed than the latter. Also with the inward flow

reaction turbine we have flow taking place through converging passages, while with the centrifugal pump the flow takes place through diverging passages with a resulting instability of stream lines. For both of these reasons it will be found that centrifugal pumps have not attained as high efficiencies as have been reached with reaction turbines.

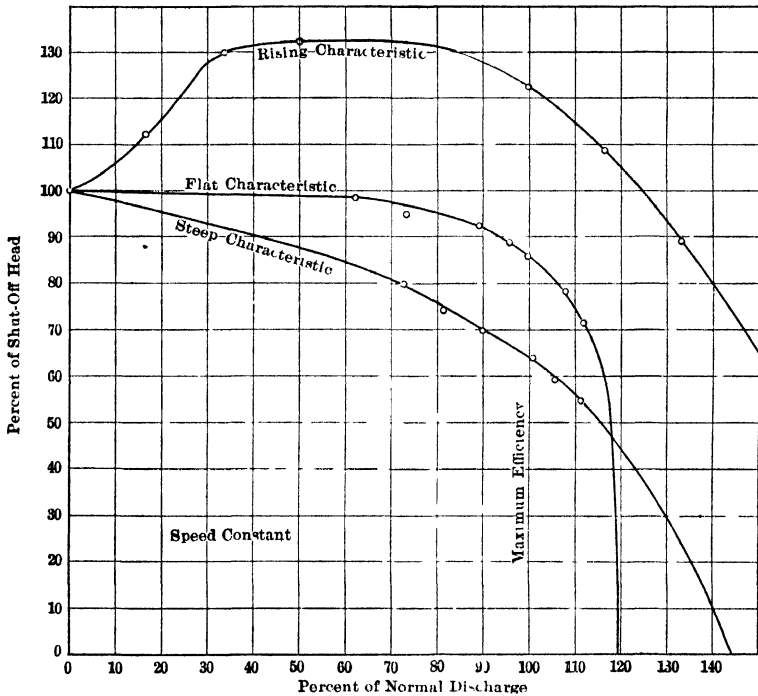

FIG. 11.—Head-discharge characteristics.

4. Historical Development.—The centrifugal pump of today is a product of the last 20 years, though its origin is of comparatively early date. Like numerous other inventions, the centrifugal pump had many pioneers in its development so that it is difficult to justly assign the credit to any single man for certain particular features.

It is said that Johann Jordan designed a crude centrifugal pump in 1680, while Papin built one in 1703. Euler discussed their theory in 1754. But these early pumps were merely regarded as curiosities. The first practical centrifugal pump,

called the Massachusetts pump, was built in the United States in 1818. (See Fig. 12.) In 1830 a pump having a fairly good efficiency was built by McCarty at the dock yards of New York. About 1846 centrifugal pumps began to be manufactured in England by Appold, Thompson, and Gwynne. Appold improved the pump by the addition of curved vanes in 1849. The addition of diffusion vanes so as to produce the turbine pump is credited by some to Osborne Reynolds who designed such a pump in 1875. This pump was not built until 1887 and their commercial manufacture was taken up by Mather and Platt in 1893. By others

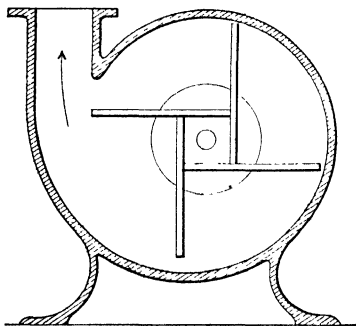

FIG. 12.—The crude Massachusetts pump.

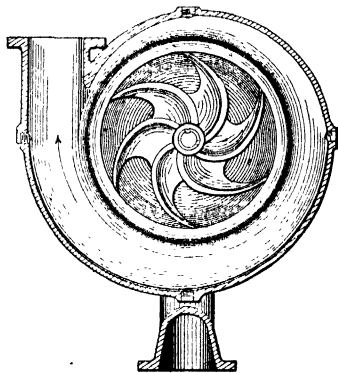

FIG. 13.—The open type of impeller with curved blades.

the first turbine pump of good design is said to have been produced by Sulzer, the Swiss engineer, in 1896. About the same time turbine pumps were built by Byron Jackson, of San Francisco, and others.

The placing of centrifugal pump impellers in series so as to produce the multi-stage pump was first done by W. H. Johnson in America in 1846. He built a 3-stage pump, but it appears to have been of little commercial importance. Sulzer is generally given the credit for being the first to manufacture multi-stage pumps of any importance. In 1894 he built a 3-stage pump without diffusion vanes, and in 1896 he constructed a 4-stage turbine pump. The latter had a capacity of 5,000 G.P.M. under a head of 460 ft.¹

¹ For details of the historical development see "Evolution of the Turbine Pump," Proc. Inst. of Mech. Eng., 1912, page 7; W. O. Webber in Trans. Amer. Soc. of Mech. Eng., 1905, page 764; Greene, "Pumping Machinery," page 43.

Although the centrifugal pump has been in existence for a considerable period, it is only within the last few years that it has been widely used or rapidly improved. The reason for this is that the centrifugal pump is a relatively high-speed machine and until recent years there was no form of motive power well suited to it. In the days of the slow-speed steam engine the reciprocating pump was better adapted to the conditions. But with the introduction of the steam turbine and the electric motor the conditions were reversed. For such sources of motive power the reciprocating pump is not as well adapted as the centrifugal pump.

5. Conditions of Use.—Centrifugal pumps are used under a wide range of conditions. They may lift water from a few feet up to several thousand. The Southwark Foundry and Machine Co. of Philadelphia has built a small capacity pump (500 G.P.M.) to deliver water against a head of 2,070 ft. Sulzer has built a number of centrifugal pumps for mine drainage to work against heads of 2,000 ft. or more. What is probably the largest capacity mine pump delivers 2,500 G.P.M. against a head of 2,000 ft. when running at 1,450 r.p.m. It is a 7-stage turbine pump driven by a 1,900-h.p. motor.

The largest rate of discharge of a single centrifugal pump has run as high as 300 cu. ft. per sec. (134,500 G.P.M., or 194,000,000 gal. per 24 hr.). The I. P. Morris Co. is building four such units for the Utah Power and Light Co. to operate against a head of 16 ft. when running at 77.5 r.p.m. A photograph of one of the impellers is shown in Fig. 21 and a sectional elevation of the pump may be seen in Fig. 14. It will be noted that the casing and suction tube are formed in concrete, the casing being of the volute type, this construction being similar to that of recent vertical shaft, single runner turbine units. The vanes surrounding the impeller are really not diffusion vanes as they are drawn to conform to the free path of the water. They are cast solid with the foundation ring, which supports the pump head cover and forms the top of the suction tube, and are designed to carry the weight of the concrete floor above the pumps and the weight of the equipment. The steady bearing is of the *lignum vitæ* type, located immediately above the impeller. This bearing is lubricated by water only, thus adding to the cleanliness of operation. Another large capacity pump built by the I. P. Morris Co. for drainage at New Orleans delivers 294 cu. ft. per sec. under a

head of 11 ft., including friction in short suction and discharge pipes, the efficiency under these conditions being 77.5 per cent. Under a head of 10 ft. the discharge was 320 cu. ft. per sec. with an efficiency of 74.0 per cent. The diameter of the discharge is 72 in., that of the impeller being 9 ft. 4 in. It is driven by a 500-h.p. motor.

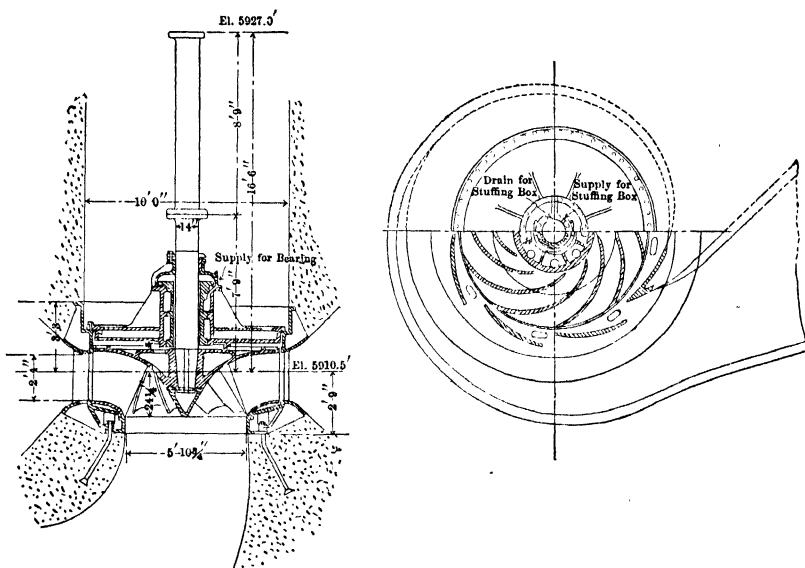

FIG. 14.—Sections of a large centrifugal pump. Capacity 135,000 G.P.M., $h = 16$ ft., $N = 77.5$ r.p.m. (I. P. Morris Co.)

A large capacity pump built by the Southwark Foundry and Machine Co. is shown in Fig. 15. The diameter of the discharge is 76 in. and that of the impeller 70 in. The normal capacity is 130,000 G.P.M. against a head of 7 ft. at 87 r.p.m. This pump delivered 168,000 G.P.M. under a head of 1.0 ft. at 50 r.p.m. and 90,000 G.P.M. under a head of 13 ft. at 115 r.p.m. The duty is expected to be 95,000,000 ft. lb. per 1,000 lb. of steam.

The largest steam turbine driven centrifugal pump has been built by the De Laval Steam Turbine Co. It is shown in Fig. 107, page 166. The discharge is 159 cu. ft. per sec. (71,260 G.P.M., or 102,610,000 gal. per 24 hr.) against a head of 58.7 ft. at 345 r.p.m. This is equivalent to 1,057 w.h.p. The duty, including auxiliaries, is 120,500,000 ft. lb. per 1,000 lb. of dry

steam at 150 lb. gage. The size of the discharge is 48 in., the pump alone being 11 ft. lengthwise of the shaft and 10 ft. high.¹

The greatest horse-power of any type of centrifugal pump is

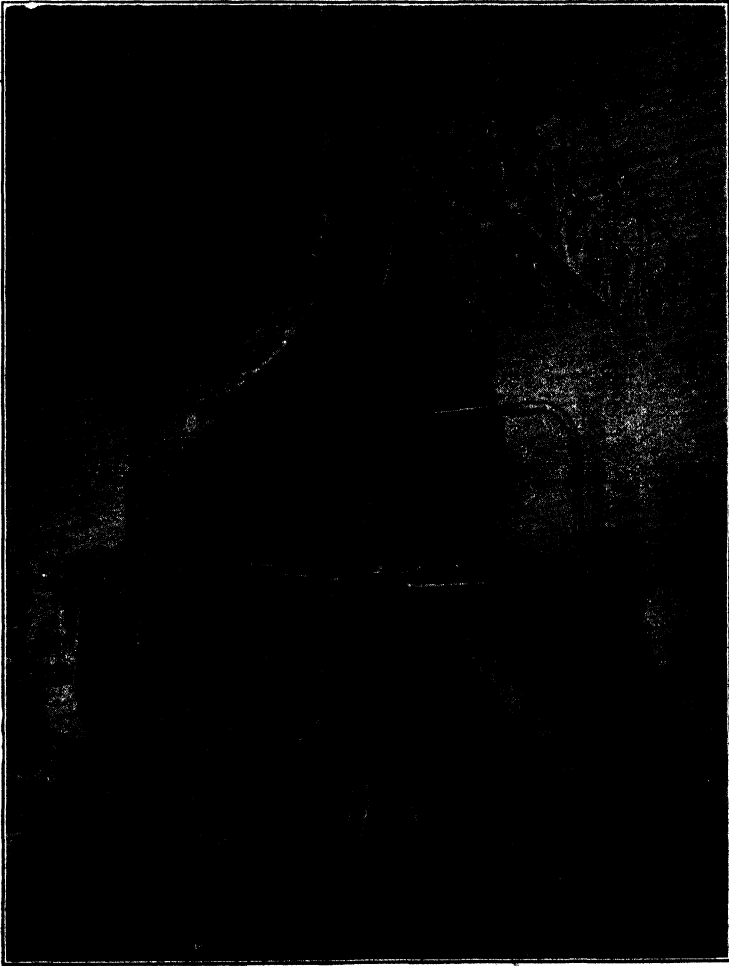

FIG. 15.—Large 76-in. centrifugal pump. (*Southwark Foundry and Machine Co.*)

probably that of a pump recently installed by Sulzer Bros. in Italy. A single-stage pump running at 1,002 r.p.m. delivers 32,530 G.P.M. at a head of 498.6 ft. with an efficiency of 81.0

¹ *Power*, Vol. 40, page 644, Nov. 3, 1914.

per cent. The water horse-power is 3,590 and the brake horse-power 4,430. It is driven by an electric motor.¹ For the vast majority of pumps the horse-power is less than 500 and rarely does it go over 1,000. The pump noted above is remarkable also for the high head per stage and its good efficiency.

The diameters of the discharge pipe connections may range from an inch or less up to 76 in. Probably the largest centrifugal pump in point of size was one built by Prof. James Thompson of England for lifting water to a height of 4 ft. The diameter of the impeller was 16 ft. and that of the whirlpool chamber was 32 ft.

For large pumps under low heads speeds as low as 30 r.p.m. may be met with. High rotative speeds are naturally found only with impellers of small diameters. Speeds up to 3,000 r.p.m. are common. As illustrations of some moderately high speeds the following may be mentioned: A 2-stage De Laval pump delivering 275 G.P.M. under a head of 350 ft. at 3,000 r.p.m., a 5-stage De Laval pump delivering 500 G.P.M. under a head of 1,450 ft. at 3,000 r.p.m., and a pump of German make with an impeller 7 in. in diameter delivering 900 G.P.M. under a head of 120 ft. at 3,300 r.p.m. The highest rotative speed employed is 20,000 r.p.m. This was with a single-stage De Laval volute pump with an impeller 2.84 in. in diameter. The pump delivered 250 G.P.M. against a head of 700 ft. with an efficiency of 60.0 per cent., which was very good. The highest peripheral speed used was with a single-stage Rateau pump having an impeller 3.15 in. in diameter. Running at 18,000 r.p.m. it delivered 189 G.P.M. against a head of 863 ft. with an efficiency of 60.0 per cent. also. This pump developed a head as high as 995 ft. with a discharge of 82 G.P.M.

Centrifugal pumps have been built with as many as 12 stages. In some instances these are all in one single case, but for such a large number it is more usual to divide them up between two pumps in series. These two pumps are usually placed on the opposite sides of the driver and reversed so that the end thrust of one will balance that of the other. The objection to so many stages in a single case is that it necessitates a very long shaft, which will be subject to vibration. It is customary to limit the head per stage to a value of from 100 to 200 ft., but this has been greatly exceeded in a few cases mentioned above.

¹ Power, Vol. 40, page 413, Sept. 22, 1914.

6. Pump Size.—By the size or number of a centrifugal pump is meant the diameter of the discharge pipe connection expressed in inches. (This is unlike the practice with water turbines which are rated according to the diameter of the runner.) Since the design is usually such that the velocity of the water at this place does not differ widely from 10 ft. per sec., it may be seen that this size gives an index of the capacity of the pump. This may be seen to be true by an inspection of Fig. 16. A few values may also be cited which are beyond the scale of the curve. A 54-in.

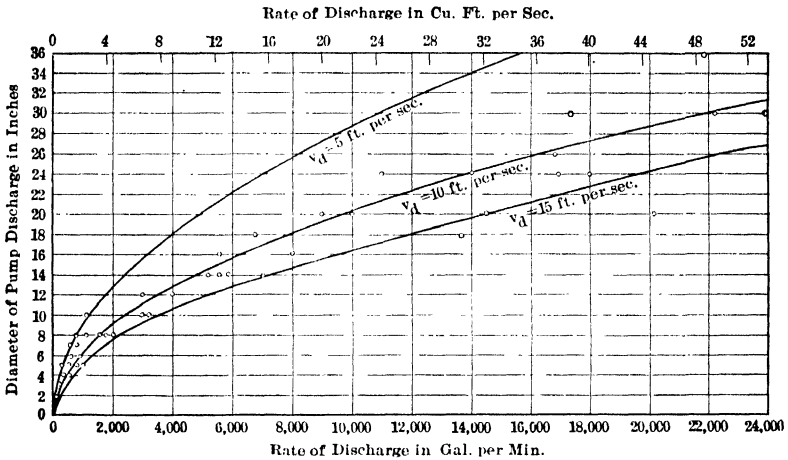

FIG. 16.—Relation between pump capacity and the size of the discharge flange.

pump was rated at 75,000 G.P.M. corresponding to a velocity of 10.5 ft. per sec. Two 72-in. pumps had discharges of 125,500 and 132,000 G.P.M. corresponding to velocities of 9.9 and 10.4 ft. per sec. respectively. Since the velocity of flow at discharge may really vary from 5 to 15 ft. per sec., this rating cannot be relied upon exactly. Nevertheless it is a very convenient “rule of thumb.” As will be shown later, the capacity of any given pump depends upon the speed at which it is run.

7. Rated Head and Discharge.—As may be seen in Fig. 11, the rate of discharge of a centrifugal pump running at a given speed will vary according to the head against which the pump works. The rated head and discharge for the pump will be the values for which the efficiency is a maximum. This value of the discharge is often designated as the *normal discharge*. These values will be different for different speeds.

CHAPTER II

DESCRIPTION

8. The Impeller.—Impellers are either of the open or the enclosed type. The former is shown in Fig. 13, page 10. It may be seen that this was a natural evolution of the impeller of the primitive pumps such as that in Fig. 12. In 1849 it was demonstrated that curved vanes were superior to the straight vanes. It was also found desirable to add a *web* at one side of the vanes

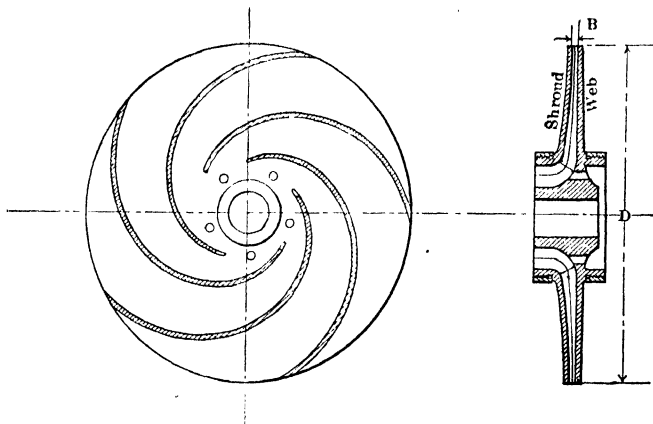

FIG. 17.—Single suction impeller.

in order to stiffen them, thereby enabling them to be made thinner. This web extends from the center to the outer circumference in most cases though it may not always do so. The impeller was further improved by the addition of a *shroud* on the outside, thus producing the enclosed or shrouded impeller.

Impellers may be either single suction, called also side suction, or double suction as shown in Figs. 17 and 18. The latter is used for larger discharges than would be possible with the same diameter of impeller of the former type. It has the further advantage that end thrust is eliminated. The double suction impeller may have two separate suction pipes or the water passages may be divided within the case as in Fig. 24.

Impellers are usually cast in one piece and are made of iron, brass or bronze. The last mentioned is much better as it does not corrode. This not only prolongs its life but enables it to retain its smooth finish, which is conducive to better efficiency.

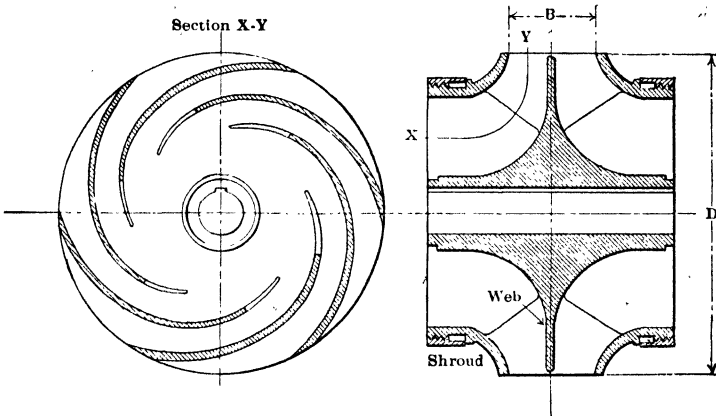

FIG. 18.—Double suction impeller.

For very high speeds it is sometimes necessary to machine the impeller out of solid steel forgings. In other cases blades pressed out of sheet steel may be riveted or cast to the web. In the best pumps the impeller will be finished all over. But for purposes such as dredging, where the impeller is subjected to great wear, this is an unnecessary expense. In some instances where



FIG. 19.—Impellers of a 4-stage pump. (*Henry R. Worthington.*)

acid is to be pumped cast-iron impellers have been employed without any finishing. The skin of the casting enables it to withstand the acid better. Also, owing to their comparatively short life, it is desirable to keep their cost as low as possible. It would be better, if possible, to make them of some acid-proof metal.

In some instances impellers have half vanes inserted in order to improve the guidance of the water and prevent instability of flow due to too greatly diverging passages. Such are illustrated in the section drawing in Fig. 64.

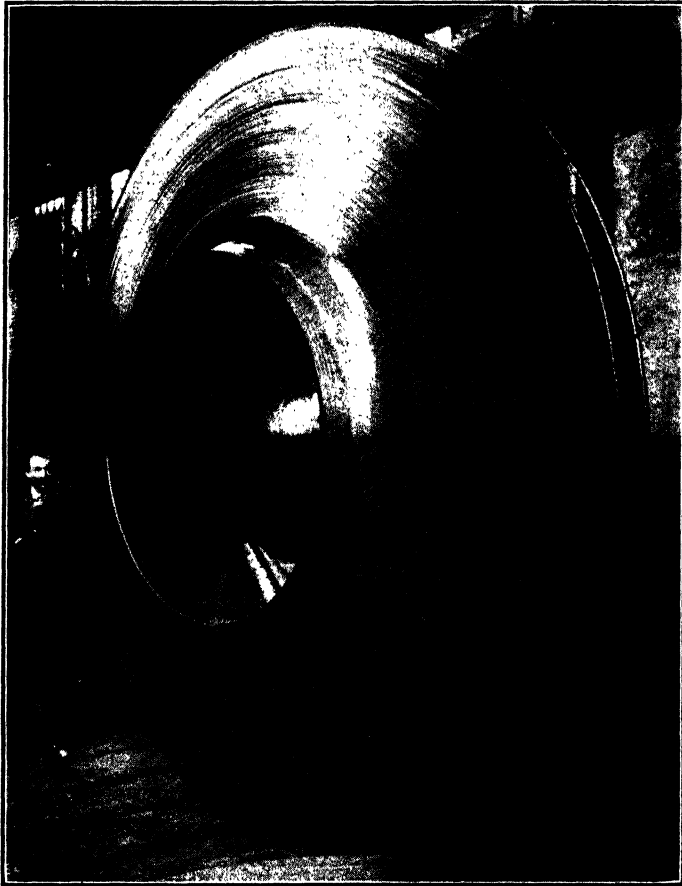

FIG. 20.—Impeller for a 42-inch centrifugal pump. Diameter of impeller = 144 inches, capacity = 44,800 G.P.M., $h = 35$ ft., $N = 100$ r.p.m. (R. D. Wood and Co.)

The ratio of the diameter of the impeller to the width at exit, D/B in Figs. 17 and 18, is often called the *type* of the impeller. It may readily be seen that a given discharge area may be secured with either a large diameter and a narrow width or a small diameter and a large width. It will be shown later that this materially

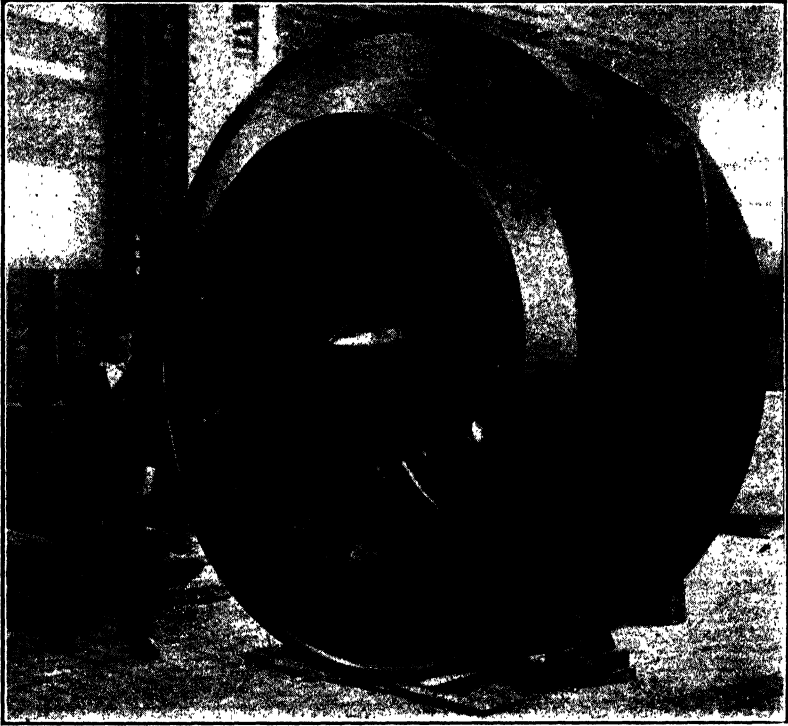

FIG. 21.—Single suction impeller. Diameter = 110 inches, weight = 22,500 lb. Capacity 134,500 G.P.M., $h = 16$ ft., $N = 77.5$ r.p.m. (*I. P. Morris Co.*)

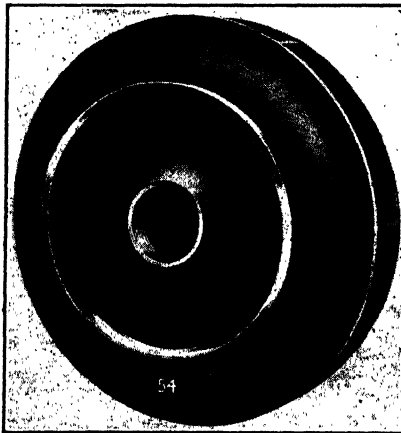

FIG. 22.—Double suction impeller. (*De Laval Steam Turbine Co.*)

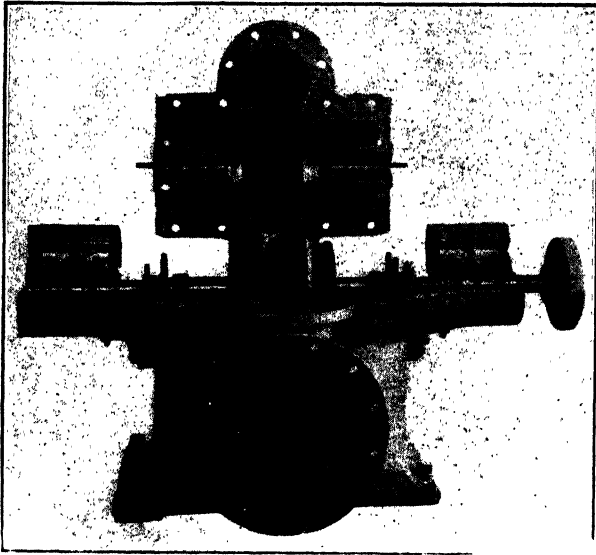

FIG. 23.—Double suction impeller in split case. (*Platt Iron Works.*)

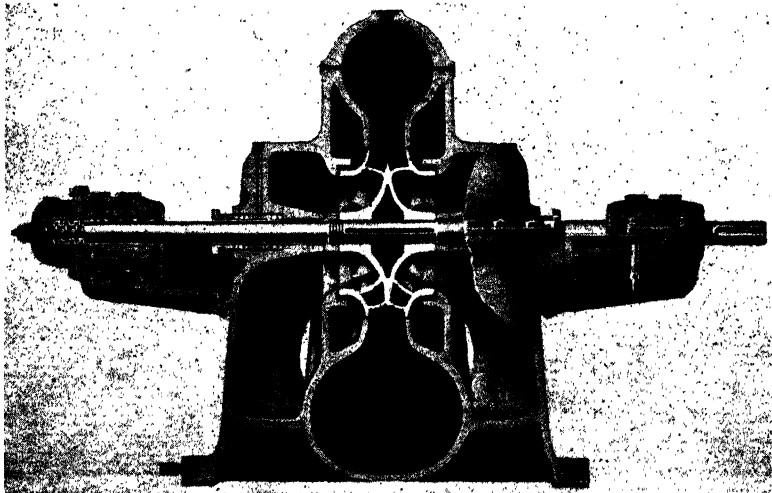

FIG. 24.—Double suction volute pump. (*Alberger Pump and Condenser Co.*)

affects the efficiency of the pump. Values of this ratio may range from 2 to 70, though these are not necessarily absolute limits.

9. Diffuser.—The diffusion vanes are usually of bronze or steel. It is very desirable that they be finished smooth in order to minimize the losses, hence they are left open on one side so that they can be machined. A cover plate is then bolted on to form the complete diffuser.



FIG. 25.—Diffusion vanes for turbine pump. (*Henry R. Worthington.*)

If the case is circular as shown in Fig. 2, the vanes are so constructed as to discharge the water nearly radially. Such a direction of flow is more desirable as may be seen by noting the stream lines shown in the figure.

If the case is spiral, as in Fig. 3, the diffuser is so designed as to send the water into the case with a velocity having a tangential component, as this is then more desirable. The velocity of discharge from the diffuser may be high for there is still opportunity to further transform velocity into pressure, the same as in the plain volute pump without the diffusion vanes. For this rea-

son the velocity of flow in the case itself may be permitted to be much higher in the spiral case than in the circular case.

10. Clearance Rings.—In order to reduce the leakage of water from the discharge to the suction sides of the impeller, close-running fits are employed. These are called clearance rings or wearing rings. As wear will cause these spaces to enlarge, the rings are generally made separate from the impeller and case so that they may be renewed.

It is desirable that these rings be of as small a diameter as possible in order to reduce the leakage area to a minimum.

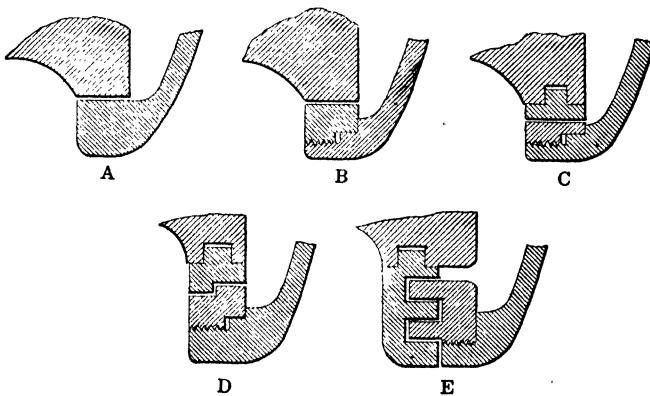

FIG. 23.—Various forms of clearance rings.

Therefore the rings are placed as near to the “eye” of the impeller as possible. Sometimes both an outer and an inner set are employed.

In order to impede the flow of water and at the same time permit of large clearances, labyrinth rings (Fig. 26E) are employed. It is of advantage not to have the clearances too close, otherwise vibration of the shaft or end play would bring the surfaces into contact.

The rings are usually made of bronze.

11. Stuffing Boxes.—Water is prevented from leaking out at the high-pressure end of the shaft, and air from leaking in at the suction end by means of stuffing boxes. (See Fig. 9.) The packing on the suction end is usually divided into two parts by means of a gland cage, which leaves an open space. Water is admitted into this space so that it may be drawn into the pump rather than air. Thus the suction is prevented from being destroyed.

In a multi-stage pump water is prevented from leaking along the shaft from one stage to another merely by means of a long close-running fit. (See Fig. 32.)

12. The Case.—Cases are usually made of cast iron. For high pressures they may be made of cast steel. In some instances cast-iron cases may be lined with steel in order to enable them to withstand the excessive wear to which they are subjected in such services as dredging.

As has already been stated, cases are divided into the circular and the spiral or volute types. The latter is often called a scroll

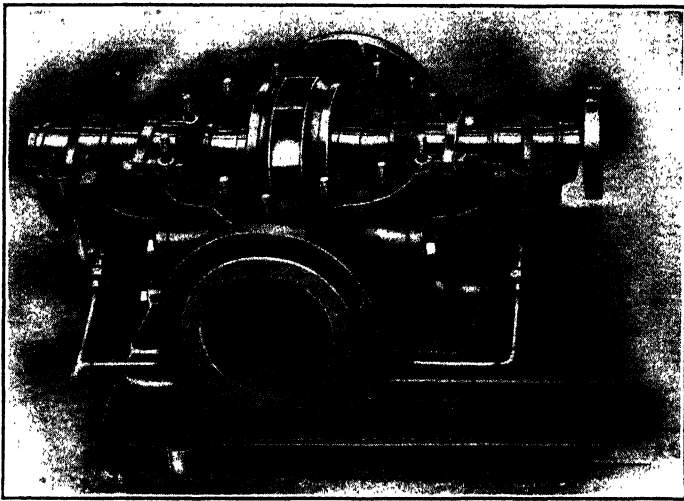

FIG. 27.—Split case volute pump. (*De Laval Steam Turbine Co.*)

case. But a more important distinction is as to how they may be opened up so as to get at the interior of the pump. One type is the horizontally split case such as is shown in Fig. 27. The other is the side plate type shown in Fig. 28 and Fig. 9, page 7. This latter is sometimes called the vertically split case, but obviously the distinctions as to horizontal and vertical are only appropriate in the case of the horizontal shaft pump.

In general the split case makes the pump easier to inspect, take apart or repair. Also it is never necessary to disconnect the piping when it is desired to open up the pump. The side plate type is apt to be a more economical form of construction but it is more difficult to get at the interior, especially in the case of multi-stage

pumps. Also with this type it is usually necessary to disconnect at least the suction piping. But it is possible to have the piping connected to the case proper so that the plates can be readily removed.

With multi-stage pumps of the side plate type we may have either the sectional or the solid construction. The former con-

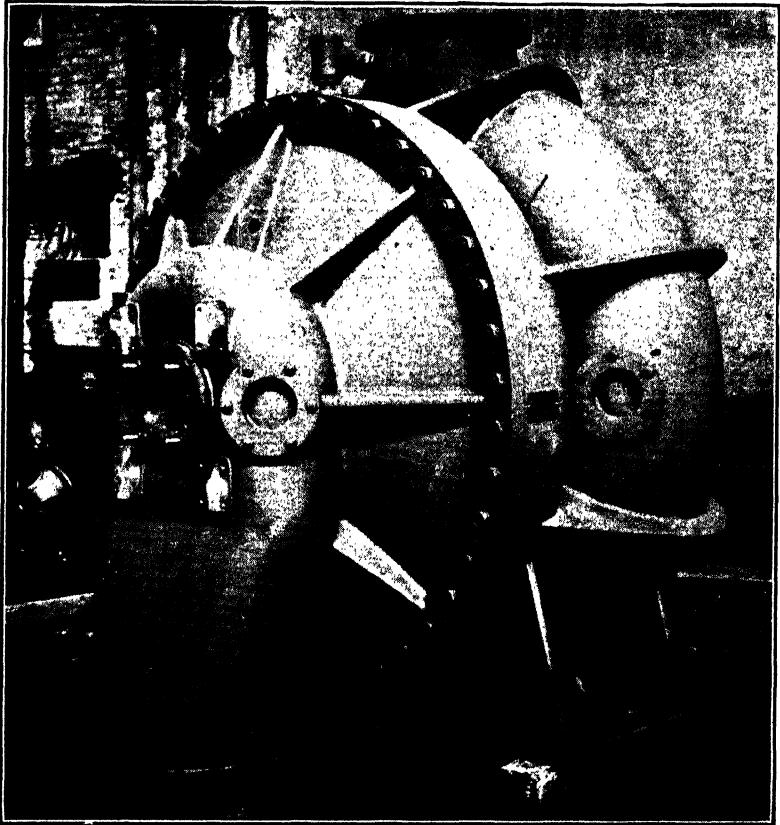

FIG. 28.—Side plate casing. (*R. D. Wood and Co.*)

sists of a number of independent sections bolted together as in Fig. 33 and Fig. 5, page 4. The solid casing is shown in Fig. 63. As is seen, it consists of a shell cast in one piece and long enough to contain all the stages. The impellers and other parts are introduced from the end. The former has advantages in manufacture as any number of stages can be had with a single casing pattern.

However, it is necessary to use great care in lining up all the different sections. It is thought that the latter form might be more difficult to take apart, especially if some of the parts should rust fast together. Also it is difficult to assemble it properly, if there are many stages.

With the multi-stage pump the water is led from the discharge chamber of one impeller to the suction of the next impeller by

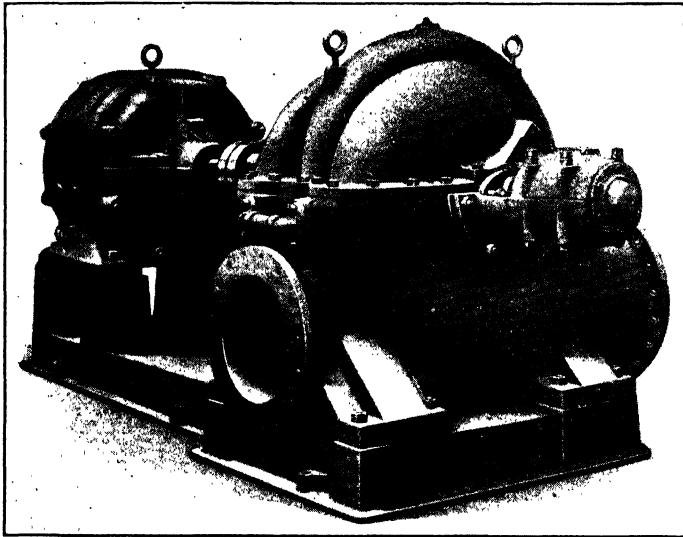

FIG. 29.—Volute centrifugal pump. (*Henry R. Worthington.*)

means of the reversing channels, shown in Figs. 32 and 33. These channels usually have directing vanes in them to guide the water and prevent its rotating. The chamber surrounding each stage, except the last, should be circular, since equal quantities of water flow from it into the reversing channels all around the circumference. But with the last stage the case may be either spiral or circular, just as in the case of a single-stage pump.

The arrangement of impellers in the multi-stage pumps shown in Figs. 30, 31, 32 and 33 is called, from the originator, the Jaeger type. It is the simplest form of construction and has been the most widely used. Another very compact type is the Kugel-Gelpe construction shown in Fig. 34. The latter is made in this country by the Allis-Chalmers Mfg. Co.

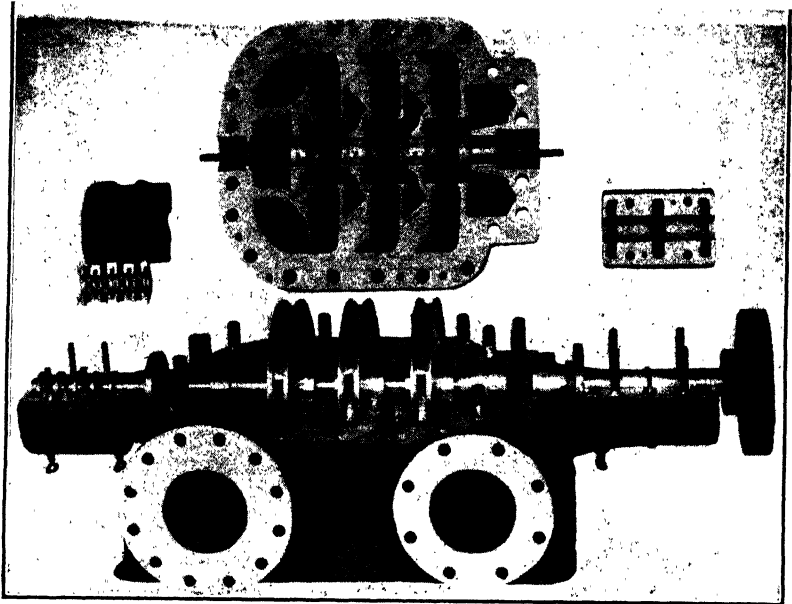

FIG. 30.—Three-stage centrifugal pump without diffusion vanes.
(Platt Iron Works.)

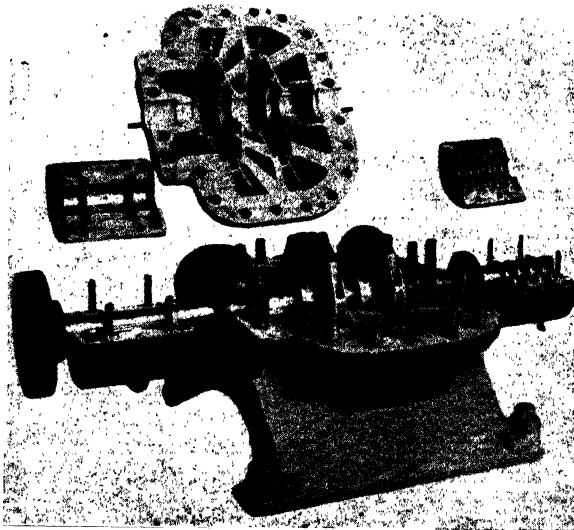

FIG. 31.—Two-stage centrifugal pump with diffusion vanes.
(Platt Iron Works.)

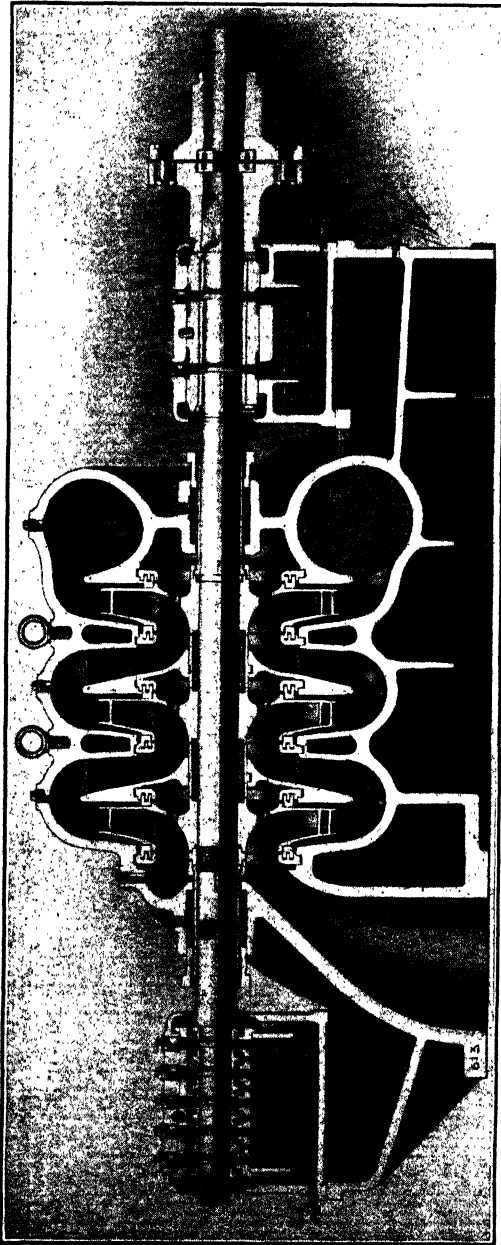

FIG. 32.—Three-stage centrifugal pump without diffusion vanes. (De Laval Steam Turbine Co.)

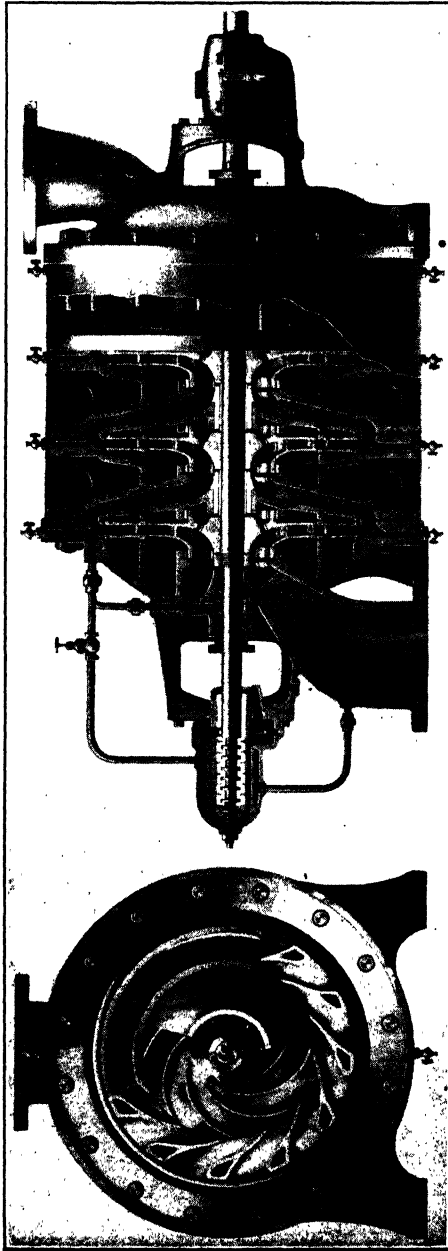

Fig. 33.—Four-stage centrifugal pump with diffusion vanes. (*Alberger Pump and Condenser Co.*)

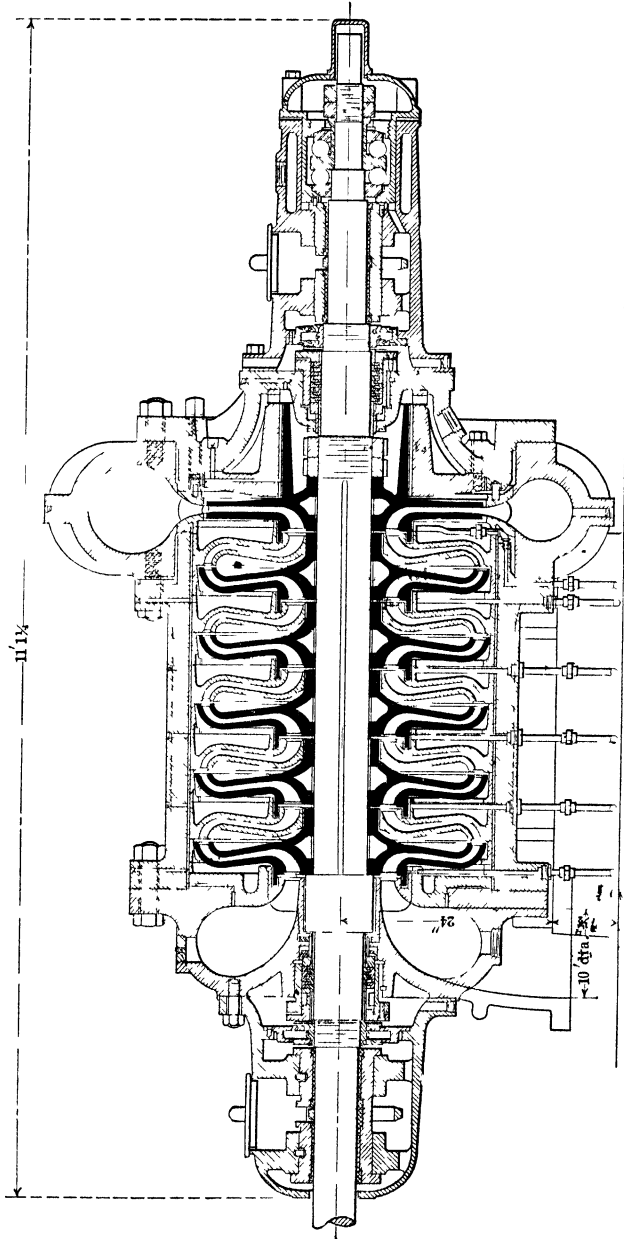

FIG. 34.—Six-stage centrifugal pump of the Kugel-Gelpe type. (Allis-Chalmers Mfg Co)

13. Balancing.—With a centrifugal pump impeller, such as shown in Fig. 35, there will be found an end thrust which must be provided for. This thrust may be taken up entirely by a thrust bearing. Or the thrust can be taken care of by what is called hydraulic balancing. The latter method involves the circulation of a small quantity of water, which may be allowed to escape outside or which is more usually “short circuited” so that it returns to the suction side of the impeller. But the additional work due to pumping this leakage water will usually be far less than that necessary to overcome the friction of a thrust bearing.

With some methods only partial balance is attained and in other cases the balancing must be regulated by hand. In such instances it is necessary to have a bearing to take care of the excess thrust. With other methods complete balance is obtained so that the thrust bearing is practically eliminated. However, even in these cases, it is well to have some thrust bearing in order that a failure of the automatic balancing device should not cause the shut down of the pump.

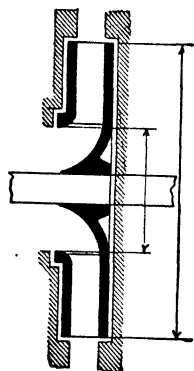

FIG. 35.

This thrust may be caused by two things: (1) It is necessary to change the momentum of the water at entrance to the impeller from an axial to a radial direction. This causes a thrust upon the impeller tending to move it away from the suction side. In Fig. 35 it would tend to move the impeller to the right. The value of the force would be $(W/g)V_1$.*

(2) There will be a pressure on the right-hand side of the web equal in intensity to that existing at the point of exit from the impeller. This pressure may be considered as acting upon two areas, one the portion opposite to the “eye” and the other the annular ring corresponding to the shroud. It is evident that upon the inner portion there will be a resultant thrust equal to the area of the “eye” times the difference between the pressures at exit and entrance to the impeller. Since the water on the left-hand side of the shroud continually escapes through the clearance rings, it is possible that the average intensity of pressure there may be less than that on the corresponding portion of the web,

* For notation, see page 44.

This will certainly be so in case the impeller is equipped with both an outer and an inner set of rings. Thus this thrust, whatever it be in value, must be added to the former. The total thrust from these sources acts toward the suction side, that is toward the left in Fig. 35.

If it is an open impeller, then we do not have the counterbalancing force on the shroud. The pressure within the impeller will be less than that at a similar point in the clearance spaces.

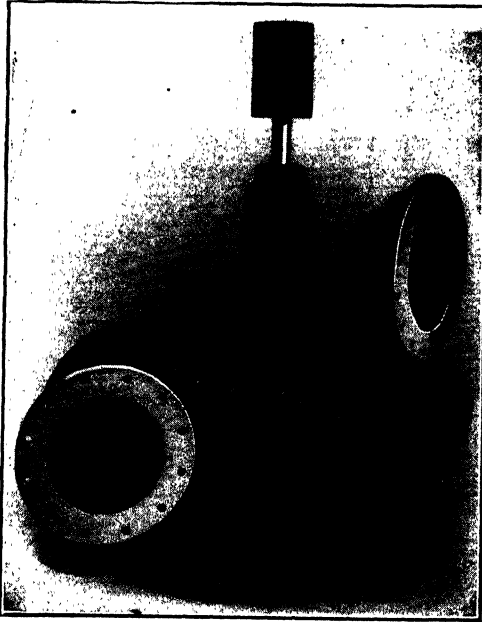

FIG. 36.—Vertical shaft pump with suction above. (*Alberger Pump and Condenser Co.*)

The result will be a greater amount of thrust toward the suction side than would be the case with a shrouded impeller.

It is seen that (1) and (2) oppose each other. However, the latter is, in general, greater than the former so that the total resultant thrust is toward the suction end. For this reason vertical shaft pumps often have the suction on the upper side as in Fig. 36, so that the resultant thrust may aid in supporting the weight of the rotating parts. However, as a good thrust bearing is required in any vertical shaft pump, it is not necessary

to strive for perfect balance. As will be seen later, it may be possible to practically eliminate (2). In such cases we could have the suction on the lower side as in Fig. 102, page 162. In this case, also, the thrust due to (1) alone aids in supporting the weight, but it is probably somewhat less in value than in the former case.

Râteau endeavored to solve the problem for the horizontal pump by making (1) and (2) equal. To do this an annular ring was omitted from the outer part of the web, while the shroud still extended to the tips of the blades. Thus (2) would be decreased, since the area would be decreased. But also the force

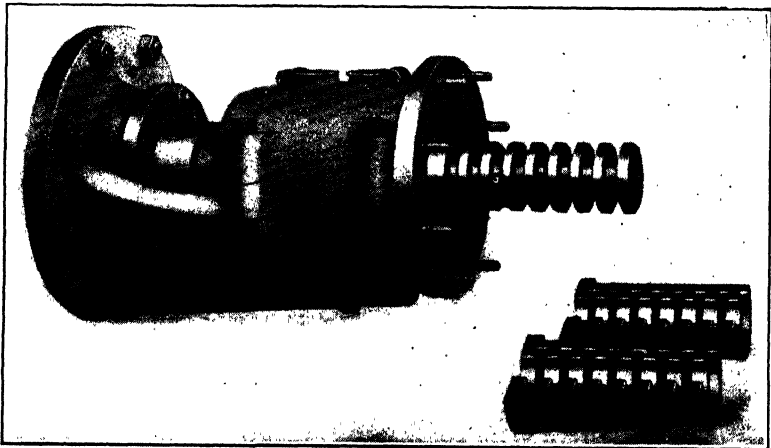

FIG. 37.—Thrust bearing. (*Henry R. Worthington.*)

on the left of the shroud (Fig. 35) opposite the portion of the web that was removed would not be balanced by an equal and opposite force, since the pressure within the impeller would be less than that in the clearance space. Thus there would be a force to be added to that of (1). The defect of this arrangement is that accurate balancing can be determined only by trial, since the forces cannot be calculated with sufficient exactness to enable one to know how much the web should be cut back. Also, since both (1) and (2) vary with the discharge, perfect balance is possible for only one given rate of discharge. It may further be shown that leaving a portion of the impeller open induces greater hydraulic and disk friction losses than would be the case with a completely enclosed impeller.

It is possible to practically eliminate (2) by inserting a clearance ring on the back of the web exactly similar to that on the shroud. Holes are then made through the web near the hub so that the leakage may return to the suction and prevent the pressure on the back from building up. (See Figs. 9, 21, 32.) There is then left only the effect of (1).

In order to eliminate (1) as well, double suction impellers are often used, especially for single-stage pumps. They are also used for multi-stage pumps, but, as may readily be seen, such types of pumps are longer, more costly, and more difficult of design. But aside from eliminating the end thrust, they have the marked advantage that a smaller diameter of impeller is possible than could be had with a single suction impeller of the same capacity. That is, it is possible to secure a lower value of the ratio D/B (Fig. 18). This will be shown later to be desirable from the stand-

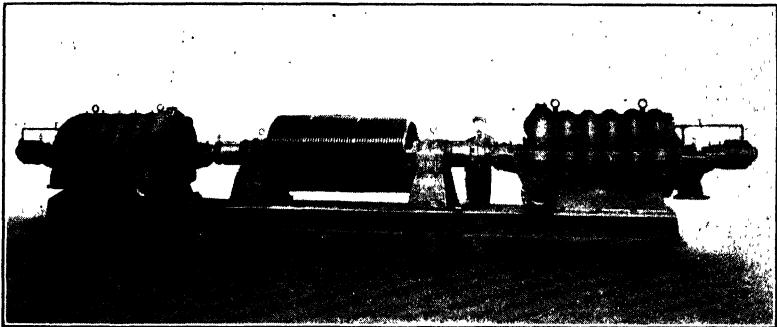

FIG. 38.—Double pumping unit with rope drive. Capacity of each pump = 2,000 G.P.M., $h = 415$ ft., $N = 450$ r.p.m. (*Morris Machine Works.*)

point of efficiency and it will also permit of a higher speed of rotation, which is often a point that is striven for. Though this last type of multi-stage pump is not yet common, it is increasing in popularity. Anything which tends to cause different amounts of water to enter the two sides of the impeller or unequal leakage past the two clearance rings would disturb the equilibrium and produce an end thrust. This must be prevented, as shown further over.

The thrust may also be provided for by dividing the water between a pair of pumps as shown in Fig. 38. These are so arranged that the thrust of one is opposite in direction to that of the other. Often a multi-stage pump may be divided up into two

parts on opposite sides of the driver and the water passed from one to the other in series. Not only does this arrangement eliminate the thrust but it also avoids an extra long shaft between bearings with its attendant vibration troubles.

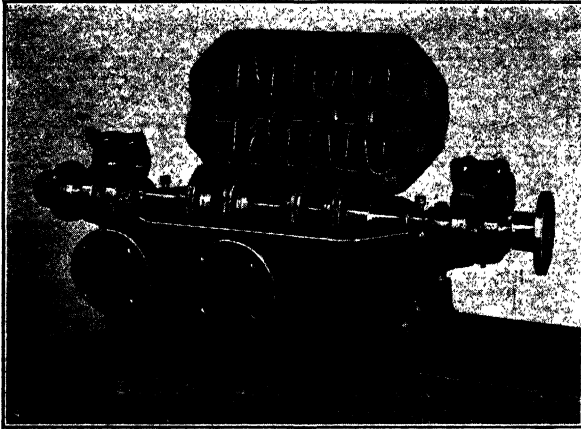

FIG. 39. (a).—Four-stage pump with opposed impellers.
(*Morris Machine Works.*)

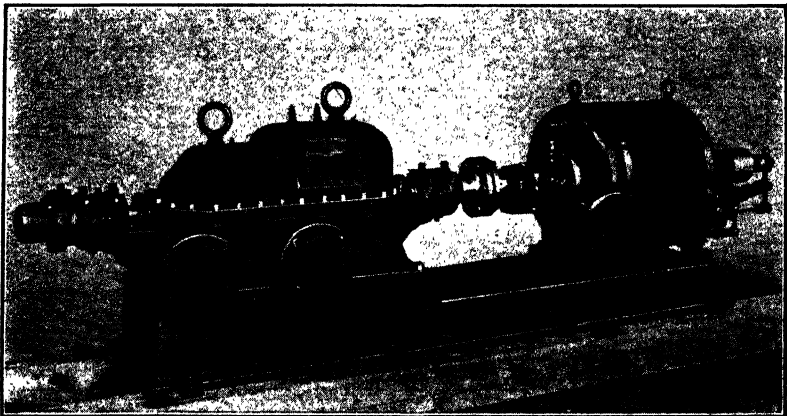

FIG. 39. (b).—Multi-stage pump with opposed impellers.
(*Morris Machine Works.*)

In the construction shown in Fig. 39(a) the suction intake is in the center of the pump. Numbering the impellers from left to right, the water flows through impellers 3, 4, 2 and 1. The water is led from the discharge chamber of 4 to the suction chamber of 2

by a channel contained in the raised part on the right-hand end of the cover of the pump in Fig. 39(b). This arrangement not only provides hydraulic balance, but eliminates the suction stuffing box. Other similar arrangements have been made which bring the high pressure sides together in the center, thereby eliminating the other stuffing box instead of the suction gland.

In Fig. 40 we see a 2-stage pump with the impellers opposed. The discharge of one is led around to the other side of the second. If this had been a pump with diffusion vanes, and more than two stages, these passages would have had to go through the diffuser, using for this purpose the open spaces which may be seen in Fig. 25. (However in this figure these openings are merely left to save

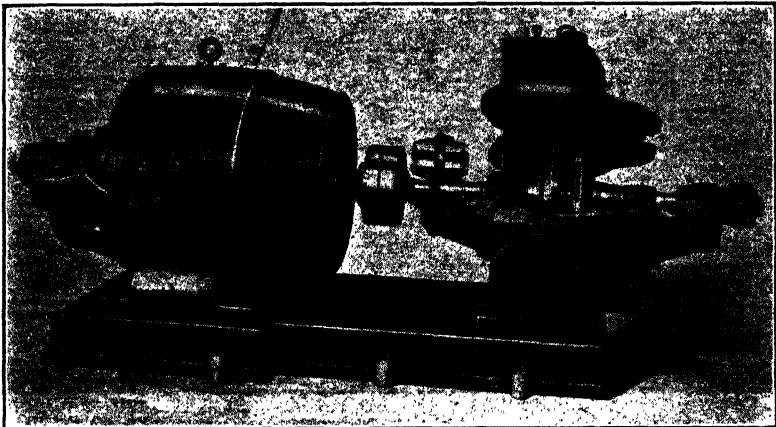

FIG. 40.—Two-stage pump with opposed impellers. (R. D. Wood and Co.)

metal.) The pump with the impellers back to back is known as the Sulzer type. Owing to the somewhat complicated passages, the fact that there must always be an even number of stages and that both right- and left-handed impellers must be built, this type is but little used at present.

All of the above means of eliminating thrust are imperfect. In some of them the thrust is not eliminated entirely, it is merely minimized. In others the thrust is eliminated for one condition of operation only. With the third group perfect balance is only possible with perfect construction. Inaccuracies in workmanship, unequal wear, or other similar causes permit a thrust to be exerted, even with double suction impellers.

Perfect hydraulic balancing can be secured only by balancing pistons or similar devices. The simplest case to consider is that of a double suction impeller such as that in Fig. 24, page 20. Here we find a clearance ring with both axial and radial fissures. If the impeller moves toward the right, for instance, the axial fissures are left unchanged in value but the radial fissure on the left opens up while that on the right closes. The result is that more water escapes from the left-hand clearance space than from the right-hand clearance space. This decreases the pressure on the left, while that on the right increases, thus providing a force to bring the impeller back to the center. The same device may be applied to the single suction impeller as in Fig. 9, page 7.

It is seen that such devices require a certain amount of end play in order to be effective. If it is desired to also use a thrust bearing for emergencies, it is necessary that it should not act until after a certain movement has taken place. This may be accomplished by a marine thrust bearing with collars rotating within a bushing which is held from rotating by a feather key. This key permits it to slide endwise until it strikes a stop, after which it acts.¹

In Fig. 32 each impeller is balanced in itself. In Fig. 41 all the balancing is done by one balancing chamber at the right-hand end of the last stage. The other impellers have no clearance rings on their webs and no holes through which the water could return to the suction. But the last impeller is provided with clearance rings on the web through which water may leak to the balancing chamber. The leakage from this space takes place between two collars, one fixed to the case while the other is attached to the shaft. If the shaft moves toward the right, water is admitted more freely through the labyrinth rings, while the escape is cut off. Thus the pressure builds up and returns the shaft to the normal position. On the other hand, if the shaft moves to the left, the water escapes more freely from this space while admission to it through the labyrinths is restricted. Thus the pressure drops and enables the shaft to move back again. This device is recommended only for clear water as wear would decrease its effectiveness. For gritty water, the arrangement of Fig. 32 is advised.

A special device attached to the shaft for this purpose is called a balancing piston or disk. See Figs. 34, 42 and 43. They are

¹ Loewenstein and Crissey, "Centrifugal Pumps," page 258.

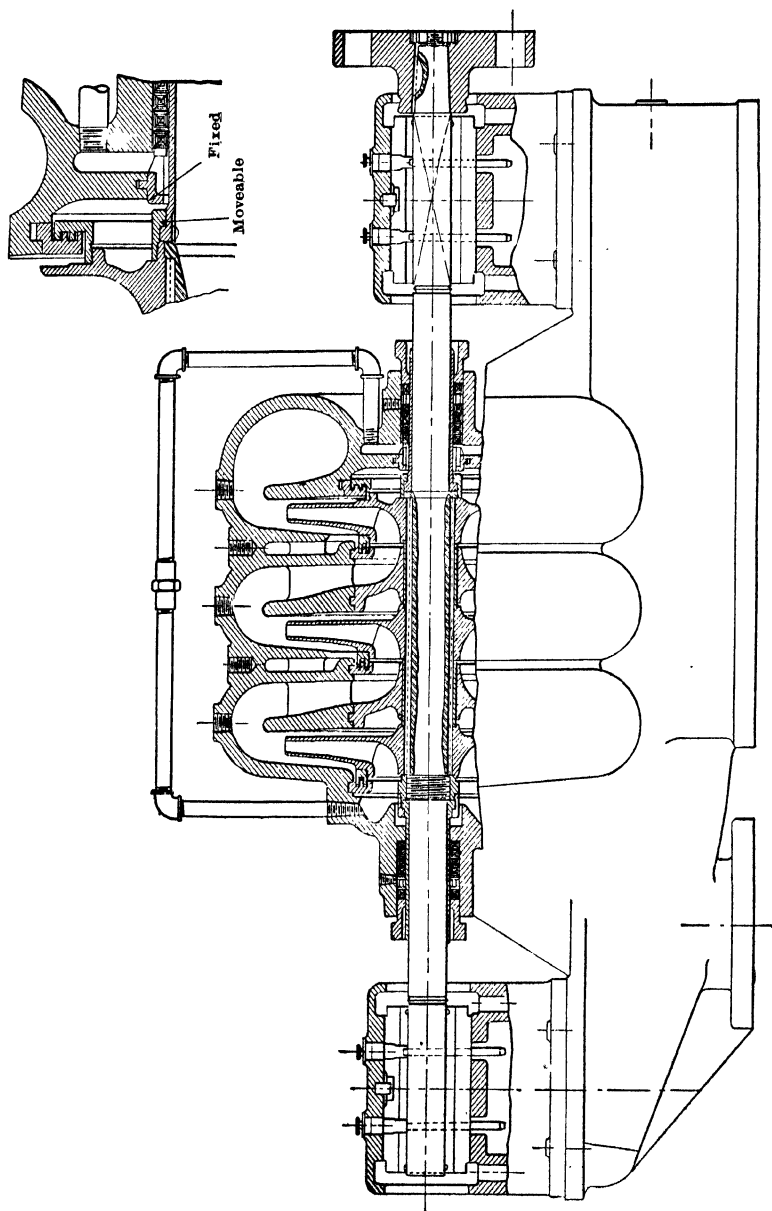

FIG. 41.—Hydraulic balancing piston. (De Laval Steam Turbine Co.)

very similar in principle as all depend upon the combination of two fissures, the area of one remaining unchanged while that of the other varies. The method of operation is the same as that described in the preceding paragraph. If the shaft in Fig. 43(a) moves to the left, the variable fissure, v , closes up. This allows the pressure on the left-hand side of the piston to increase, while that on the right-hand side decreases. The resultant force on the piston is therefore directed toward the right. On

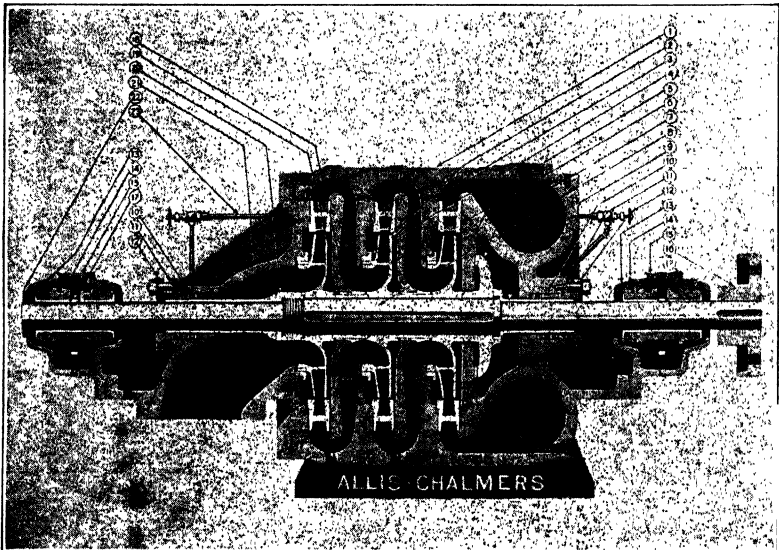

FIG. 42.—Multi-stage pump with balancing piston (No. 7).
(Allis-Chalmers Mfg. Co.)

the other hand, if the shaft moves to the right, the opening of the variable fissure permits the pressure on the left of the piston to decrease and thus allows the shaft to drift back to its normal position. The Sulzer balancing piston may also have the variable fissure precede the constant fissure, c , rather than follow it as shown in this figure.

In Fig. 43(b) another type of balancing piston is shown. It differs from the other in that the variable fissure is located nearer the center. This has the advantage that for the same total leakage area the clearance can be greater, resulting in a longer life and less sensitiveness. If, with this type, the shaft moves to the left, the fissure opens up so as to permit the pressure on the left-

hand side of the piston to become greater than that on the right and thus oppose the movement. The placing of *v* after *c* has certain mechanical advantages as can be seen. But it may be placed first as in the left-hand portion of Fig. 43(c).

For large pumps and those handling gritty water the form shown in Fig. 43(c) is especially desirable. This has a second variable throttling space provided at (2). When new, this space is open too much to be effective. But as wear occurs along the

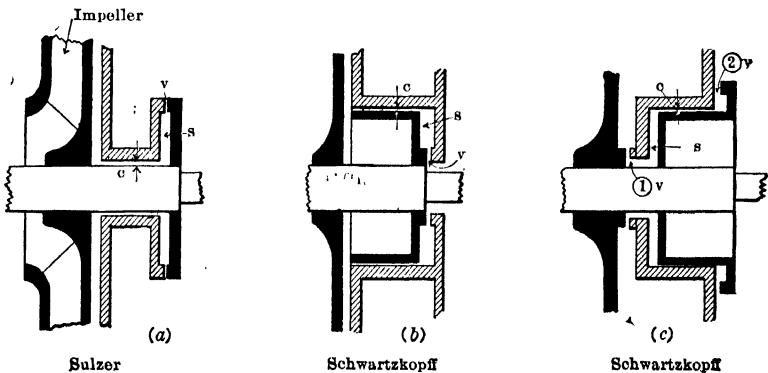

FIG. 43.—Typical hydraulic balancing devices.

constant fissure, the rate of leakage is too great to enable the thrust to be balanced by the pressure on the left of the piston and the shaft drifts further toward the left. But when it does so (2) closes up and permits the pressure to build up, and also provides an increased area upon which it may act. At the same time (1) is left small enough to strain out gritty material.¹

The use of a balancing piston obviates the need for a high pressure packing gland. The water leakage, which is small, may be returned to the suction or may often be used for cooling bearings.

¹ A. V. Mueller, Eng. News, Vol. 70, page 490.

CHAPTER III

INSTALLATION AND OPERATION

14. Priming.—It is impossible for the centrifugal pump to act as an air pump and lift water up to it, as it can create only a slight vacuum. It is therefore necessary to prime it by some means at the start. This may be done either by filling it with water from some other source or exhausting the air and thus drawing water up the suction pipe.

The pump should never be run empty as the packings and certain other parts often depend upon water for their lubrication.

If the bottom of the suction pipe is provided with a foot valve, the pump can be filled with water from some other source. The pet cocks on the top of the pump passages should all be opened in order to let out the air. When water appears from them, they may be closed, the water shut off, and the pump started.

For many small pumps a priming attachment is often provided which consists of a hand pump by means of which the air may be expelled. If this arrangement is employed, it is necessary to have a tight valve on the discharge side of the pump.

Either water is delivered to the case or air exhausted from it by means of steam injectors, compressed air, or other devices according to circumstances. It is necessary with all of these to have a valve of some type on the discharge side of the pump. It is customary to have a foot valve at the bottom of the suction pipe also but in some special cases this may not be necessary.

15. Foot Valves and Strainers.—It is very important to minimize the losses in the suction pipe. Therefore the area through the foot valve should be ample and it should be so constructed that the flaps swing up and out of the way when water is flowing. The area through the foot valve ought to be about twice the area of the suction pipe.

It is often necessary to have a strainer outside the foot valve to prevent trash and large objects from being drawn into the pump. The area through the strainer should be at least twice the area of the suction pipe.

16. Suction Lift.—A centrifugal pump will work under as high a suction lift as any other type of pump, but it is necessary to prime it at starting as has been stated. It has one advantage over the reciprocating pump, which is that the flow is continuous rather than pulsating. This permits of a higher suction lift being employed, since there are no inertia forces to cause the suction pressure to fluctuate below the normal value.

The height to which water may be lifted in any pump depends upon the pressure of the atmosphere and the temperature of the liquid. The higher the temperature of the liquid the lower the pressure at which its conversion into vapor takes place. It is possible to lift water a few feet at a temperature of 150° F., but it is safer to cause all hot water to flow to the pump under positive pressure. If the water is very near 212° F. it should be under considerable pressure at the entrance to the pump. For water at ordinary temperatures it is well to keep its absolute pressure at least 5 ft. of water. Allowing for the usual friction losses and velocity head, this means that the maximum suction lift should not exceed 25 ft. where the pressure of the air is 34 ft. At high elevations the lift must be less than this. While it is possible to lift water 25 ft. in most cases, it is well to keep the suction lift as low as possible.

In order to prevent air from being drawn into the suction pipe by means of a vortex set up at the mouth, it is well to place the entrance of the pipe at least 3 ft. below the surface of the water. If this is not done, the entrance velocity should be kept low. It is needless to say that the entire suction line should be made as nearly air tight as possible. The leakage of air cuts down the capacity of the pump and may even destroy the suction so as to cause the cessation of flow.

A strong reason for keeping the absolute pressure of the water as high as possible is that all water holds air in solution, which may be liberated if the pressure becomes too low. Gases are most readily absorbed by sprays and are easily liberated in an eddy. Thus a check valve, a tee, or sudden change in pipe diameter in the suction line may set this air free. This air is not readily reabsorbed in the flow through the discharge. Water absorbs oxygen from the air more readily than the nitrogen.¹

¹ At 60° F. and a pressure of 34 ft. of water absolute, water may hold in solution 3 per cent. of its volume in oxygen and 1.5 per cent. of nitrogen. Under half this pressure it may hold half of the above.

Thus when this mixture is liberated either by too low a pressure or by an eddy, its corrosive action is greater than that of pure air.

Aside from the question of the liberation of air, if the pressure becomes too low, water vapor is formed. Bearing in mind the fact that the pressure at the suction intake decreases as the flow increases, we see that the following state of affairs might exist. As vapor is liberated and fills part of the space, the rate of discharge decreases. This causes the pressure to rise, the vapor again becomes liquid, the pipe is filled with water and the discharge increases. But as it does so the pressure drops again and thus a pulsation of flow is set up. If there is just about a balance this pulsation will be perceptible to the ear only. If the pressure is further decreased the pulsation is sufficient to cause the suction line and pump to vibrate. If the pressure is made still lower, the flow will finally cease.

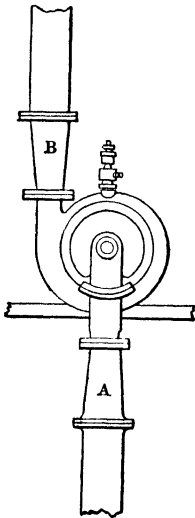

FIG. 44.—Taper pipe connections.

About 90 per cent. of centrifugal pump trouble will be found on the suction side of the pump. The rest of the trouble is largely due to the end thrust.

17. Piping Connections.—In order to minimize the suction-pipe losses, it may be desirable to have it larger than that of the suction-pipe connection. Also it may be desirable to have the discharge pipe much larger than that of the discharge connection in order to reduce the friction head against which the pump has to work. For making these connections so as to prevent losses due to abrupt change of cross section, the taper connections *A* and *B* in Fig. 44 are very desirable.

Not only do the larger suction and discharge pipes reduce the friction head and thus improve the overall pumping efficiency but, as will be seen later, the lower head that the pump will have to develop will enable its efficiency alone to be somewhat higher.

18. Pumps in Series and in Parallel.—Two or more pumps may sometimes be operated in series or in parallel, resulting in great flexibility of service. If two pumps, for instance, with identical characteristics are operated in series the discharge will be the same and the head developed twice as much as with either one of them alone. If they are operated in parallel the head will

be the same and the discharge twice as much with either one alone.

It would seem as if the efficiency should be the same for the pumps combined as that of one of them alone. But for two or more pumps in parallel the efficiency appears to be a few per cent. less than that of the individual pumps.¹ This is undoubtedly due to the fact that no two pumps have precisely the same characteristics, due to necessary variations in workmanship, and thus the water is not equally divided between them. Probably each one is working with a discharge which is not the one for which its efficiency is the highest.

19. Operating a Centrifugal Pump.—In starting up a centrifugal pump the first thing to do is to see that the discharge valve is closed. This is not only necessary in some cases in order to prime the pump but it prevents overloading the motor, since the power at shut-off is less than for normal delivery. After the pump is primed and all the air expelled, the pump may be started and brought up to speed. Then the discharge valve may be slowly opened, so as not to throw a sudden load on the motor, until it is wide open or at least until the desired discharge is obtained. These precautions in starting are not necessary with all types of motors. After the pump is running it is only necessary to see that the bearings are supplied with oil, that the packing glands are properly adjusted so as to neither leak too much nor on the other hand to run hot, that the suction gland is supplied with water for the water seal, and that sufficient water is circulated through the thrust bearing, if there is one, to keep it cool.

When it is desired to shut down the pump, it is best to first close the discharge valve, then to throw off the power. This reduces the amount of power that will be abruptly dropped from the line and also prevents the flow in the discharge pipe from being suddenly stopped. If the pipe line is long this might otherwise create a pressure surge. It is often advisable, in the case of a long pipe line, to protect the pump by means of a check valve on the discharge side.

¹ R. C. Carpenter, "The High-pressure Fire Service Pumps of Manhattan Borough, City of New York," *Trans. A.S.M.E.*, Vol. 31, page 437 (1909).

CHAPTER IV

GENERAL THEORY

20. Notation.—The following notation will be employed:

- V = absolute velocity of water (or relative to earth) (ft. per sec.)
 v = velocity of water relative to impeller (ft. per sec.)
 u = linear velocity of a point of the impeller (ft. per sec.)
 r = radius to any point from the axis of rotation (ft.)
 z = elevation above any arbitrary datum plane (ft.)
 A = angle between V and u (Fig. 45)
 α = angle between v and $-u$ (Fig. 45)
 s = tangential component of V , = $V \cos A$
 F = area of streams normal to the direction of flow in the stationary passages (sq. ft.)
 f = area of streams normal to the direction of flow in the rotating passages (sq. ft.) (Fig. 46)
 D = outer diameter of impeller in inches
 B = width of impeller at periphery in inches
 q = rate of discharge in cu. ft. per sec.
 w = weight of a cu. ft. of water (taken as 62.4 lb.)
 W = pounds of water per sec. = wq
 p = intensity of pressure in feet of water
 H = total head = $z + p + V^2/2g$
 h = head developed by pump
 h' = head lost within the pump
 H' = any other loss of head
 h'' = head imparted to the water by the impeller = $h + h'$
 ϕ = ratio of peripheral speed to $\sqrt{2gh} = u_2/\sqrt{2gh}$
 N = revolutions per minute
 ω = angular velocity = $2\pi N/60 = u/r$ (radians per sec.)
 e = efficiency (Art. 29)
 g = acceleration of gravity = 32.2 ft. per sec. per sec.

Values of quantities at specific points will be indicated by subscripts. (See Fig. 1.) The subscript (_s) will refer to the stream in the suction pipe close to the pump, the subscript (₁) will refer to values at entrance to the impeller, subscript (₂) at exit from the impeller, subscript (₃) in the case, and (_d) in the discharge pipe.

The notation as given in regard to velocities and angles refers to values as determined by the vector diagrams. Whenever the conditions are such that a velocity or direction must be different from that given by the vector diagram, the resulting values will be signified by the use of a prime ($'$). (See Fig. 57.)

21. Relation between Absolute and Relative Velocities.—The absolute velocity of a body is its velocity relative to the earth. The relative velocity of a body is its velocity relative to some other body which may itself be in motion relative to the earth. The absolute velocity of the first body is the vector sum of its velocity relative to the second body and the absolute velocity of

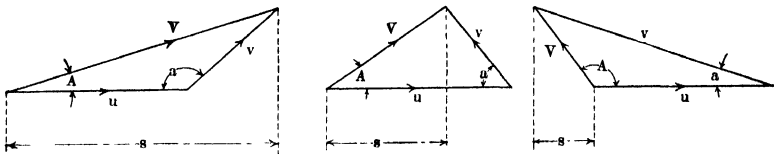

FIG. 45.—Relation between absolute and relative velocities.

the second body. The relation between the three is shown in Fig. 45.^{1,2}

¹ The angle between two vectors is properly the angle between their positive directions. In the author's "Hydraulic Turbines" this convention is adhered to so that a is used to designate the angle between u and v . In such work this angle may be either acute or obtuse, but with centrifugal pumps this angle is almost always greater than 90° . For this reason it has been thought more convenient in this book to use the angle between v and $-u$. Evidently in the left-hand diagram of Fig. 45, $\cos a$ will be negative, while it will be positive in the other two.

² A clearer conception of absolute and relative motion may be had by considering paths traversed. Suppose that a rectangular raft is moving down a stream with a uniform velocity u . After an interval of time Δt the raft may be represented in a second position. Each point on the raft will have traveled a distance $u \Delta t$. Supposed that a man on the raft has moved during this interval of time from one corner of the raft to a diagonally opposite corner. Relative to the raft his path is a straight line which is a diagonal of the raft. But relative to the earth his path will be a different line inasmuch as the corner where he stops is not in the same place that it was when he started. If he moves across the raft with a uniform velocity v relative to it the length of his relative path will be $v \Delta t$. Since u and v are uniform during this time interval, his absolute velocity V is also uniform and his absolute path is a straight line of length $V \Delta t$. Since the velocities are uniform, by dividing by Δt , the lengths of the paths may represent velocities at any instant.

The radial component of the velocity is seen to be

$$V_r = V \sin A = v \sin a \quad (1)$$

The tangential component of V is

$$s = V \cos A = u - v \cos a \quad (2)$$

22. Equation of Continuity.—By F or f is meant the total area of all the streams into which the entire flow may be divided. Thus f_2 , for example, will equal the total area of all the streams leaving the impeller measured normal to v_2 , while F'_2 will denote the total area of all the streams in the diffusion vane channels measured normal to V'_2 .

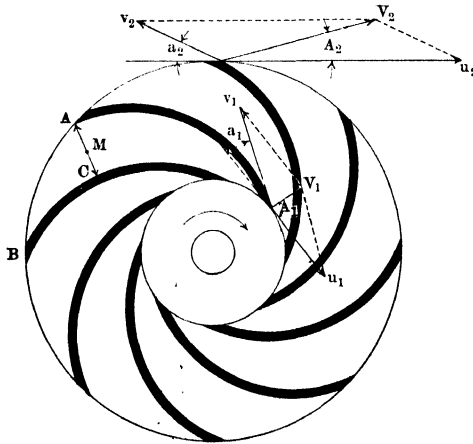

FIG. 46.—Velocity diagrams.

In Fig. 46, if n denote the number of impeller vanes, the area f_2 for example, could be computed as follows:

$$f_2 = n \times AC \times B/144 \quad (3)$$

where AC = the normal distance across the impeller passage in inches and B = impeller width in inches (Fig. 17). Or if the thickness of the vanes in inches be denoted by t , the area could be computed as

$$f_2 = (\pi D \sin a_2 - nt)B/144 \quad (4)$$

The latter method may be slightly more logical but the former is more generally used. In the usual case the two methods give results which differ but little from each other.

If the vane curves are involutes the two methods above will give identical results. This is because the distance between two adjacent vanes remains constant as may be seen in Fig. 108(b), page 172, where A and A' trace involutes as the cord CAA' may be conceived to be wound around the base circle of radius OC . In such event we have in Fig. 46 that

$$AC + t = \text{arc } AB \sin a_2 = (\pi D/n) \sin a_2$$

Therefore,
$$n \times AC = \pi D \sin a_2 - nt$$

If the flow is steady and the rate of rotation uniform, the equation of continuity may be applied. This states that the rate of flow past all sections is constant or that $q = FV = fv = \text{constant}$ and in particular

$$q = f_1 v_1 = f_2 v_2 = F_2 V_2 = F'_2 V'_2 \quad (5)$$

23. General Equation of Energy.—Energy may be transmitted across a section of a flowing stream in any or all of the three forms known as potential energy, pressure energy, or kinetic energy. Head may be defined as the amount of energy per unit weight of water. The total head at any section will be given by

$$H = z + p + V^2/2g \quad (6)$$

There can be no flow without some loss of energy by friction so that the total head must decrease in the direction of flow by the amount of head lost or

$$H_1 - H_2 = H' \quad (7)$$

Subscripts (1) and (2) are here used to designate any two points whatsoever.

In flowing through the impeller of a centrifugal pump, the water loses energy due to various friction losses. The energy lost is dissipated in the form of heat. But the water must receive from the impeller vanes a greater quantity of energy than that which is lost. We denote by h'' the head imparted to the water by the vanes. Thus the preceding equation may be written (since h'' is a negative loss),

$$H_1 - H_2 = h' - h'' \quad (8)$$

Again the subscripts may denote any two points whatsoever as long as h' is understood to mean the total loss of head between the two points. In (7) H_1 must be greater than H_2 unless there is

a pump between the two points. If there is a pump between the two points, then in general H_2 will be the larger. In our notation we always presume that water flows from (1) to (2).

24. Losses of Head in Pipes.—The most important loss in a pipe line of any length is that due to friction along the walls of the pipe and to internal friction of the particles of water against each other.¹ This loss may be given by the formula

$$H' = m(l/d)V^2/2g \quad (9)$$

where m is a friction factor, and (l/d) is the ratio of the length of the pipe to its diameter. Since this ratio is an abstract number, it follows that both l and d must be in the same units.

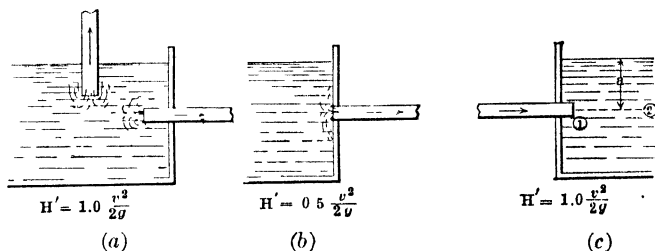

FIG. 47.—Entrance and discharge losses.

The factor m for new clean cast iron pipe may be determined by

$$m = 0.02 + 0.02/d \quad (10)$$

but in the latter formula d must be in inches, otherwise we should have to change the numerator. For old pipe these values need to be increased and may even be twice the value given by the formula. The factor m would also be larger with riveted steel pipe and less with wood stave pipe than would be the case with cast-iron pipe. In any event the choice of a value of m is largely a matter of judgment.

At entrance to a pipe as shown in Fig. 47(a), there is a loss of head of approximately $1.0V^2/2g$. A foot valve or other device on the end of the pipe might increase this value. If the end of the pipe is flush with the side as shown in (b), the loss is approximately $0.5V^2/2g$. By rounding the mouth of the pipe and giving it a taper for a few feet so that there is no abrupt change of velocity at entrance this loss may be reduced practically to zero.

¹ For more complete information on this subject consult Hughes and Safford, "Hydraulics," Chap. XV; Russell, "Hydraulics," Chap. VIII; Hoskins, "Hydraulics," Chap. IX; and other standard works.

At discharge there is a loss of head of $1.0V^2/2g$. This is true whether the pipe projects as shown in Fig. 47(c) or whether it does not. That this is the loss may readily be seen by noting that $H_1 = 0 + a + V^2/2g$ and $H_2 = 0 + a + 0$, where a denotes the pressure at (1) and (2). The body of water is supposed to be so large that the velocity at (2) is negligible. From (7) $H' = H_1 - H_2 = V^2/2g$.

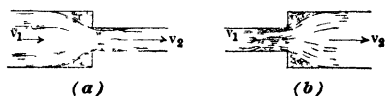

FIG. 48.—Abrupt changes in velocity

Where there is a sudden contraction of the stream as in Fig. 48(a), there is a loss of head of $H' = kV_2^2/2g$, where k is an experimental factor, which increases as the ratio of the two areas departs from unity. The value of k is usually less than unity.

Where there is an abrupt enlargement of the stream as in Fig. 48(b), theory and experiment indicate that the loss may be approximately represented by

$$H' = (V_1 - V_2)^2/2g$$

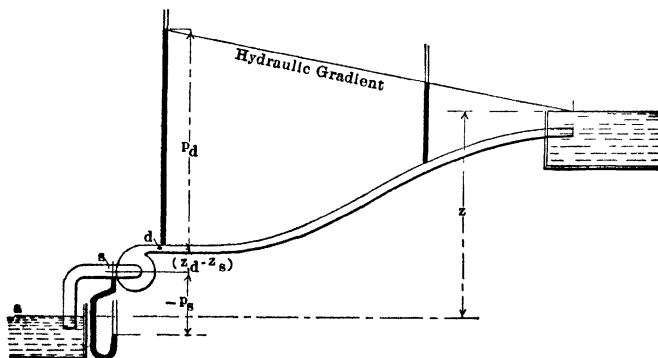

FIG. 49.—Head against which a pump works.

25. Head Developed by Pump.—The head developed by a pump is equal to the actual vertical lift plus all losses in the piping (but not within the pump itself). Thus for Fig. 49

$$h = z + H' \tag{11}$$

If the pipe discharges into the air at a height z above the suction level, the value of the head is the same as for the case shown in the figure. In either event the velocity head at the mouth of the pipe should be included in H' as a discharge loss.

Even in case this velocity head should be useful it is necessary to include it in computing the head, since it represents an expenditure of energy by the pump. But in the latter event the useful work done is proportional to $z + V^2/2g$ rather than z alone.

The vertical lift z is sometimes called static head while the total head against which the pump works, $z + H'$, is called dynamic head.

Evidently the head actually delivered by the pump is equal to the difference between the head with which the water enters and that with which it leaves. Thus

$$h = z_d - z_s + p_d - p_s + (V_d^2 - V_s^2)/2g \quad (12)$$

In general the water enters the pump under a pressure which is less than that of the atmosphere, in which case p_s will be negative in value. Frequently the suction pipe is a size larger than the discharge pipe, but if they are of the same size the velocity head correction drops out of equation (12). In such an event the total value of h may be shown graphically as in Fig. 49, for it is the vertical distance between the summits of the two water columns there represented.¹

26. Centrifugal Action or Forced Vortex.—If a vessel containing a liquid is rotated about its axis, the liquid will tend to rotate at the same speed. If we take an elementary volume whose length along the radius is dr and whose area normal to the radius is dF , we have an elementary mass $w dF dr/g$ moving in a circular path. This mass has an acceleration directed toward the axis of rotation whose value is u^2/r or $\omega^2 r$. Consequently the value of the accelerating force is $(w dF dr/g) \omega^2 r$. The intensity of pressure on the two faces of the elementary volume differs by $w dp_r$ (lb. per sq. ft.). The value of the resultant force is therefore $w dp_r dF$. Consequently

$$\begin{aligned} w dp_r dF &= (w dF dr/g) \omega^2 r \\ dp_r &= (\omega^2/g) r dr \end{aligned}$$

¹The question is often raised as to why $V_s^2/2g$ should be deducted in (12), since the energy represented by it has really been imparted by the pump. Of course (12) is a direct application of (8), but aside from that it may be said that the velocity head affects the value of p_s . Applying (7) between suction level and (s) and with the surface of the suction level as datum,

$$- p_s - V_s^2/2g = z_s + \text{suction pipe losses.}$$

Combining this with (12), $h = z_d + p_d + V_d^2/2g + \text{suction pipe losses}$. It would be as unreasonable to omit $V_s^2/2g$ in (12) as to omit p_s .

But this expression shows only the difference of pressure along the radius and in the same horizontal plane. If we move along a path parallel to the vertical axis of rotation so that the radius is constant, the pressure decreases directly as the elevation increases. Thus

$$dp_z = - dz$$

The variation of the intensity of pressure in *any* direction whatsoever may be found by combining the two preceding equations. Thus, in general,

$$dp = - dz + (\omega^2/g)rdr \quad (13)$$

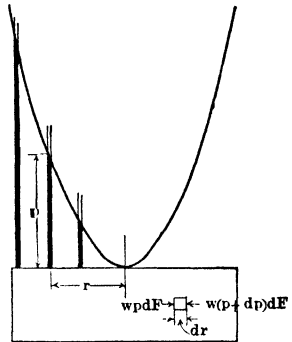

FIG. 50.—Forced vortex.

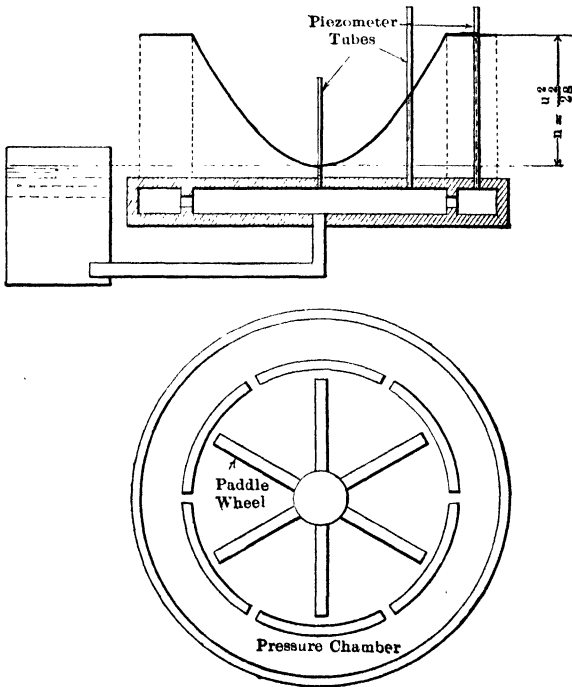

FIG. 51.—Crude centrifugal pump.

To find the equation of the free surface or any surface of equal pressure we need only place dp equal to zero. We then have

$$\int dz = (\omega^2/g) \int r dr$$

$$z = r^2\omega^2/2g + \text{constant}$$

To determine the constant we may assume that $z = 0$ where $r = 0$. Thus the constant = 0. Therefore

$$z = r^2\omega^2/2g = u^2/2g \quad (14)$$

This shows that the free surface or any surface of equal pressure is a paraboloid, since the above is the equation of a parabola.

To find the variation of the pressure between two points at the same elevation take $dz = 0$. Thus as above we get

$$p = r^2\omega^2/2g = u^2/2g$$

or integrating between specified limits

$$p_2 - p_1 = (r_2^2 - r_1^2)\omega^2/2g = (u_2^2 - u_1^2)/2g \quad (15)$$

For the difference in pressure between any two points we must integrate (13) from which we get

$$p_2 - p_1 = z_1 - z_2 + u_2^2/2g - u_1^2/2g \quad (16)$$

If water in a closed chamber is set in motion by a paddle wheel as in Fig. 51, there will be an increase in the pressure from the center to the circumference. By (16) this pressure difference may be seen to be $u_2^2/2g$, where u_2 is the velocity of the tips of the paddle or the velocity of the water at the outer radius. If the water from this chamber is allowed to enter a vertical pipe such as the right-hand piezometer tube in Fig. 51, water will rise in it to such a height that

$$h = u_2^2/2g \quad (17)$$

If the height of the tubes were less than this, water would flow out and we should have a crude centrifugal pump.

The above value of h is commonly said to be the height of a column of water sustained by "centrifugal force." It is more properly the height required to produce the pressure necessary to give the water its centripetal acceleration.

27. Free Vortex.—Where energy is imparted to the water as in the preceding case, we have a forced vortex. Where no energy is imparted, we have a free vortex. We shall first consider a pure radial flow between two parallel plates. In such a case V_r and V are identical. If b = the distance between the plates, by the equation of continuity we have

$$q = 2\pi r_1 b \times V_1 = 2\pi r_2 b \times V_2$$

From this it is seen that V (or V_r) varies as $1/r$, or

$$V_2 = (r_1/r_2)V_1$$

Neglecting losses of energy, $H = z + p + V^2/2g = \text{constant}$ or

$$H = p_1 + V_1^2/2g = p_2 + V_2^2/2g$$

$$p_2 = H - (r_1/r_2)^2 V_1^2/2g$$

The variation of pressure and velocity head with r is shown in Fig. 52.

A free circular vortex consists of a body of water in rotation without any appreciable flow. Thus the stream lines are concentric circles and s and V are identical. In Art. 35 it is shown that torque equals the time rate of change of angular momentum. Since, neglecting frictional resistance, no torque is exerted, it follows that the angular momentum must be constant. But angular momentum is the product of the mass times s times r . Therefore s or V varies as $1/r$. Since no energy is imparted, neglecting frictional resistance, we have throughout the mass $H = z + p + V^2/2g = \text{constant}$. It

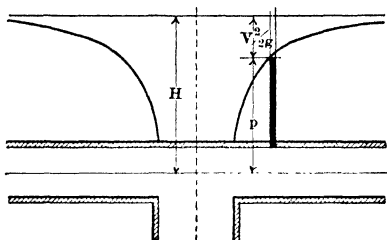

FIG. 52.—Free vortex.

is thus seen that our equations are exactly the same as for a pure radial flow. The only difference between the two is that in the one case $V = V_r$, in the other case, $V = s$.

A free spiral vortex is a combination of the two previous cases. Since $V^2 = V_r^2 + s^2$, it follows that in the case of flow along a spiral path V varies as $1/r$. Also since V , V_r , and s all vary as $1/r$, it may be seen that the angle A is constant for all values of r . Thus the stream line must be a logarithmic spiral, the equation of which is $r = e^{k\theta}$, where $e = 2.7183$, $k = \text{constant}$, and $\theta = \text{angle of the radius vector with an initial position}$.

For a free spiral vortex the equations are the same as those for pure radial flow, except that the actual velocity is not radial. Thus

$$p_2 = H - (r_1/r_2)^2 V_1^2/2g$$

$$= p_1 + [1 - (r_1/r_2)^2] V_1^2/2g \tag{18}$$

The last expression in the above equation is the maximum possible gain of pressure due to a vortex chamber. Actually, owing to

frictional losses and instability of flow resulting in a departure from the stream lines assumed, the pressure increase will be much less.

28. Illustration of Centrifugal Pump Losses.—In order to make clear the exact meaning of certain terms used, a numerical illustration will now be given. Suppose that it takes 80.0 h.p. to run a certain centrifugal pump. This power is commonly called brake horse-power, the reason for this usage being that it is the brake horse-power or developed horse-power of the engine, turbine, or motor that drives the pump. Assume that the friction of the bearings and the drag of the impeller through the water surrounding it is 5.0 h.p. This leaves 75.0 h.p. to be delivered to the water by the impeller. We shall suppose that 11.0 cu. ft. of water per sec. is circulated through the impeller but that the pump actually delivers only 10.0 cu. ft. per sec., the other 1.0 cu. ft. being "short circuited," that is leaking back past the clearance rings, etc. The 75.0 h.p. will then be divided up into 6.8 h.p. for this leakage and 68.2 h.p. for the 10 cu. ft. per sec. actually delivered. But the water actually delivered suffers certain hydraulic friction losses within the impeller and also after leaving the impeller, which we shall take as being 11.4 h.p. This leaves $68.2 - 11.4 = 56.8$ h.p. as the actual useful output of the pump. The latter quantity is commonly called water horse-power.

Since power is a function of rate of flow and of head, it follows that definite values of head must be associated with some of the values of horse-power in the preceding paragraph. Thus to deliver 75.0 h.p. to 11.0 cu. ft. of water per sec. means that the impeller must impart to the water a head of 60.0 ft. And if 10.0 cu. ft. of water per sec. suffers a loss of 11.4 h.p. it can only mean that there is a loss of head of 10.0 ft. Thus the actual head developed by the pump is $60.0 - 10.0 = 50.0$ ft. This last expression in general terms is $h'' - h' = h$.

29. Definitions of Efficiencies.—The word "efficiency" without any qualification will always be understood to mean gross or total efficiency. It is the ratio of the water horse-power to the brake horse-power. That is

$$e = W.h.p./B.h.p. \quad (19)$$

Mechanical efficiency is the ratio between the power actually delivered to (not by) the water and the power supplied to the

pump. If q = actual rate of pump discharge and q' = the rate of leakage,

$$e_m = \frac{w(q + q')h''}{500} / B.h.p. \quad (20)$$

Hydraulic efficiency is the ratio of the power actually delivered by the water to the power imparted by the impeller to the water actually discharged by the pump. That is

$$e_h = W.h.p. / \frac{wqh''}{550} = h/h'' \quad (21)$$

Volumetric efficiency is the ratio of the water actually delivered by the pump to that discharged by the impeller. It is analogous to the "1.00-slip" used in reciprocating pump work.

$$e_v = q/(q + q') \quad (22)$$

Naturally it follows that the total efficiency is the product of these three separate factors. That is

$$e = e_m \times e_h \times e_v \quad (23)$$

In the numerical case given in the preceding article, these various efficiencies are: $e_m = 75.0/80.0 = 0.938$, $e_h = 56.8/68.2 = 50/60 = 0.833$, $e_v = 68.2/75.0 = 10/11 = 0.910$, $e = 56.8/80.0 = 0.938 \times 0.833 \times 0.910 = 0.710$.

30. Duty.—The term "duty" is an expression that has long been used for pumping engines and has been variously defined. First it was the number of foot pounds of work done per bushel of coal burned, then per 100 lb. of coal, then per 1,000 lb. of steam supplied by the boiler, and last per 1,000,000 British thermal units supplied by the boiler. It will be seen that all of these quantities are approximately equivalent to each other. The last term is the most exact but that is even open to the objection that the steam pressure or the quality of the steam must make a difference in operation, even when the total number of heat units is the same.

The term "duty" is sometimes applied to a motor-driven pump, but in such a case it must be noted that there is no fair comparison between it and a steam-driven pump in terms of duty without suitable qualification. For the motor-driven pump we must take the duty as the foot pounds of work done per million B.t.u. supplied to the motor. Thus our base is entirely different from that of the former case.

Since 1,000,000 B.t.u. = 778,000,000 ft. lb., we may write
 $Duty = 778,000,000 \times Pump\ Eff. \times Engine\ Thermal\ Eff.$ (24)
 The thermal efficiencies of the most economical steam engines or turbines usually range from 10 to 20 per cent. For the motor-driven pump we should have to substitute the motor efficiency in place of the thermal efficiency in the above formula. The motor efficiency is usually from 80 to 90 per cent.

Since pump efficiency = W.h.p./B.h.p., and the engine thermal efficiency = (B.h.p. \times 2,545)/lb. steam per hr. \times B.t.u. per lb., we have per 1,000,000 B.t.u.

$$Duty = \frac{W.h.p. \times 1,980,000,000,000}{Lb. steam per hr. \times B.t.u. per lb.} \quad (25)$$

$$Duty = \frac{Pump\ Efficiency \times 1,980,000,000,000}{Lb. steam per b.h.p. per hr. \times B.t.u. per lb.} \quad (26)$$

To obtain duty per 1,000 lb. of steam omit the B.t.u. per lb. in (25) or (26) and divide the numerator by 1,000.

The highest duties attained by centrifugal steam-driven pumping units are slightly above 100,000,000 ft. lb.

31. Abbreviations.—The following abbreviations are commonly employed:

- G.P.M. = gallons per min.¹
- R.p.m. = revolutions per min.
- B.h.p. = brake horse-power.
- W.h.p. = water horse-power.
- K.w. = kilowatts.

32. Conversion Factors.

- 1 U.S. gallon = 0.134 cu. ft. = 8.33 lb. of water.
- 1 Imperial gallon = 1.2 U.S. gallons = 10 lb. of water.
- 1 cu. ft. = 7.48 U.S. gallons = 62.4 lb. of water.
- 1 cu. ft. per sec. = 448 G.P.M.
= 647,000 gal. per 24 hr.
- 1,000,000 gal. per 24 hr. = 1.545 cu. ft. per sec.
= 695 G.P.M.
- 1,000 lb. of water per hr. = 2 G.P.M.
- 1 lb. per sq. in. = 2.308 ft. of water.
- 1 in. of mercury = 1.132 ft. of water.
- 1 h.p. = 550 ft. lb. per sec. = 0.746 k.w.

¹ Throughout this work the U.S. gallon is used. The U.S. gallon = 231 cu. in. = 0.134 cu. ft. = 8.33 lb. of water.

33. Useful Formulas.

$$W.h.p. = \frac{wqh}{550} = \frac{qh}{8.81} \quad (27)$$

$$= \frac{8.33 \times G.P.M. \times h}{33,000} = \frac{G.P.M. \times h}{3,960} \quad (28)$$

If the velocity of flow in a pipe be V in ft. per sec. and the diameter of the pipe in inches be d ,

$$q = \frac{Vd^2}{183.5} \quad (29)$$

$$G.P.M. = 2.443Vd^2 \quad (30)$$

$$h_v = \frac{V^2}{2g} = 523 \frac{q^2}{d^4} = \frac{(G.P.M.)^2}{385d^4} \quad (31)$$

$$V = 8.025\sqrt{h_v} \quad (32)$$

34. PROBLEMS

1. The peripheral velocity of a point on an impeller is 100 ft. per sec. The relative velocity of the water at that point is 20 ft. per sec. and the angle $a = 30^\circ$. What is the magnitude and direction of the absolute velocity?

Ans. $V = 83.3$ ft. per sec., $A = 6^\circ 55'$.

2. What is the radial component of the velocity in (1)? What is the tangential component?

Ans. $V_r = v_r = 10$ ft. per sec., $s = 82.68$ ft. per sec.

3. If the relative velocity $v_2 = 20$ ft. per sec. and the area $f_2 = 0.400$ sq. ft., what must be the value of F_2 if $V_2 = 83.3$ ft. per sec.?

Ans. 0.096 sq. ft.

4. In Fig. 49 suppose the diameter of the pipe is 10 in., the length of the suction pipe is 10 ft., the length of the discharge pipe is 800 ft., and $z = 66.0$ ft. Suppose that $z_d = 8$ ft. and $z_s = 6$ ft. If the pump delivers 6.0 cu. ft. of water per sec., find the total head pumped against, pressure head at s and d , and the water horse-power. (Assume new clean cast-iron pipe.)

Ans. $h = 110$ ft., $p_s = -10.28$ ft., $p_d = 97.72$ ft., 75.0 h.p.

5. The diameter of the discharge pipe of a centrifugal pump = 6 in., that of the suction pipe = 8 in. Pressure gage at d reads 30 lb. per sq. in., vacuum gage at s reads 10 in. of mercury. The pressure gage is 3 ft. above the vacuum gage. If $q = 3.0$ cu. ft. per sec. and the brake horse-power = 36.0, find the efficiency of the pump. (NOTE. A pressure gage reads pressures above that of the atmosphere, a vacuum gage reads the amount by which the pressure is less than that of the atmosphere.)

Ans. $h = 85.8$ ft., $e = 81.2$ per cent.

6. In problem (4) suppose that the mouth of the pipe were 66.0 ft. above the suction water level and that the discharge were free into the air. Would the answers be any different from those in (4)?

7. Suppose that in the above problem a nozzle is on the end of the pipe and the discharge is still 6.0 cu. ft. per sec. If the diameter of the jet is 4 in. and the loss in the nozzle is $0.05V_j^2/2g$, where V_j = jet velocity, solve for head, pressure at (d), and water horse-power of the pump.

Ans. $h = 187.2$ ft., $p_d = 174.92$ ft., 127.5 h.p.

8. What is the efficiency of the pumping plant (including the pipe) in (4) and (7), if the pump efficiency is 70 per cent. in both cases? (Take jet velocity in (7) as useful.)

Ans. 42 per cent., 52.1 per cent.

9. Suppose that in problem (6) the diameter of the pump impeller had been 1.0 ft. and the speed 1,200 r.p.m. Would flow have taken place? (b) How high would water have risen above the suction level? (c) What would be the reading on a pressure gage at d if the center of the gage were 2 ft. above the center of the pipe or 10 ft. above the suction level? (d) What would be the pressure at s ?

Ans. (b) 61.3 ft. (c) 22.3 lb. per sq. in. (d) $p = -6.0$ ft. or a vacuum of 5.3 in. of mercury.

10. How high must the speed be in the above problem to cause water to flow out of the mouth of the pipe?

11. If the inner and outer radii of the whirlpool chamber shown in Fig. 1 are 6 and 10 in. respectively, and water leaves the impeller with a velocity of 70 ft. per sec. at angle $A_2 = 10^\circ$, what will be the values of V , s , and V_r for the water leaving the whirlpool chamber? If there were no loss of energy, what would be the gain in pressure?

12. If the efficiency of a pump is 75 per cent. and the thermal efficiency of a steam turbine driving it is 20 per cent., what is the duty of the set?

13. If the water horse-power of a pump is 500 and the engine consumes 7,000 lb. of steam per hr., each pound of steam containing 1,100 B.t.u., what is the duty of the unit?

Ans. 118,000,000 ft. lb.

14. If the reading of the barometer is 30 in. of mercury, what is the pressure of the atmosphere in ft. of water? In lb. per sq. in.?

15. If a boiler requires 3,000 lb. of feed water per hr. what must be the pump capacity in G.P.M.?

16. A pump discharge 50 cu. ft. per sec. against a head of 40 ft. What is the water horse-power?

17. A pump discharges 3,000 G.P.M. against a head of 70 ft. What is the water horse-power?

18. A pump with a 6-in. suction pipe is to discharge 900 G.P.M. The loss of head at the foot valve and entrance to the suction pipe is $1.5V^2/2g$ and the pipe friction factor, m , is 0.25. If the minimum pressure in the suction pipe is to be -20 ft., what is the allowable height of the pump above the suction well?

Ans. $z = 14.38$ ft.

CHAPTER V

THEORY OF CENTRIFUGAL PUMPS

35. Theorem of Angular Momentum.—In Fig. 53 we will suppose a particle of mass dm to be located at a point whose coordinates are x and y and to be moving with a velocity V . The momentum of this particle will be dmV . The moment of momentum is called angular momentum. For this particle the angular momentum is $dmV \times r \cos A$. Since the moment of any quantity is the algebraic sum of the moments of its components, we may write

$$dmrV \cos A = dmV_y x - dmV_x y$$

Differentiating the above we obtain

$$\begin{aligned} dm \frac{d(rV \cos A)}{dt} &= dm \left(\frac{dy}{dt} \cdot \frac{dx}{dt} + x \frac{d^2y}{dt^2} - \frac{dx}{dt} \cdot \frac{dy}{dt} - y \frac{d^2x}{dt^2} \right) \\ &= dm(a_y x - a_x y) \end{aligned}$$

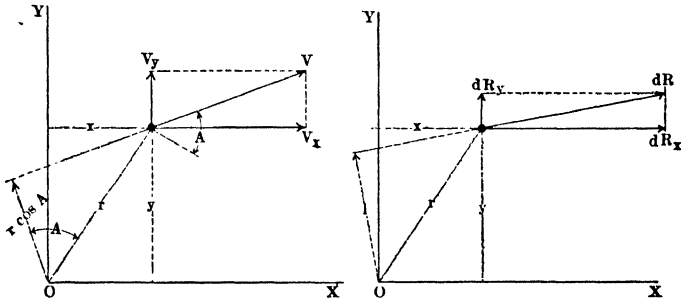

FIG. 53.

where a denotes acceleration with a_x and a_y as its axial components. ($V_x = dx/dt$, $a_x = dV_x/dt = d^2x/dt^2$, etc.). If the resultant force acting on the particle be denoted by dR , $dma_y = dR_y$, and $dma_x = dR_x$. Thus

$$dm \frac{d(rV \cos A)}{dt} = dR_y x - dR_x y$$

The torque exerted upon the particle in Fig. 53 is seen to be $dR \times l$. By the principle of moments

$$dR \times l = dR_y x - dR_x y$$

Thus, if G stands for torque so that $dR \times l = dG$,

$$dG = dmd(rV \cos A)/dt \quad (33)$$

That is, the time rate of change of the angular momentum of any particle with respect to an axis is equal to the torque of the resultant force on the particle with respect to that axis.

36. Torque Exerted by Impeller.—In Fig. 54 let us take an elementary volume of water as shown. If the distance between the web and shroud of the impeller be denoted by b (ft.), the elementary mass, neglecting vane thickness, will be $w \times 2\pi r b dr/g$. Substituting this value of dm in (33) we have

$$\begin{aligned} dG &= \frac{w \times 2\pi r b dr}{g} \times \frac{d(rV \cos A)}{dt} \\ &= \frac{w}{g} \times \frac{2\pi r b dr}{dt} \times d(rV \cos A) \end{aligned}$$

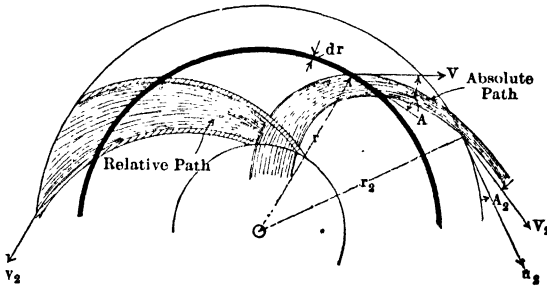

FIG. 54.

But $dr/dt = V_r$, and $2\pi r b =$ the area normal to V_r , so that $2\pi r b dr/dt = q$. Since $w q = W$

$$G = \frac{W}{g} \int_s^2 d(rV \cos A)$$

This should be integrated between the point where the motion of the water is first influenced by the impeller and the point where the impeller ceases to act upon it. The latter is usually taken as (2), the point of exit, though this may be modified slightly as shown later. Since the impeller is capable of exerting some effect upon the water in the eye and even back in the suction pipe a short distance, through the medium of intervening particles of water, we should take the lower limit of integration as the values found at (s) rather than (1). (See Fig. 1.) At (s) the water has no

angular momentum about the axis. Therefore the torque exerted upon the water by the impeller is

$$G = \frac{W}{g} r_2 V_2 \cos A_2 = \frac{W}{g} r_2 s_2 \quad (34)$$

If the water flowed clear up to the inlet edge of the impeller vanes without having any rotation imparted to it we should then have $A_1 = 90^\circ$. In such a case the angular momentum at the impeller entrance would be zero. In the usual design, the impeller angle a_1 is selected so that the flow at entrance will be radial (*i.e.*, $A_1 = 90^\circ$). But this will not be the case when the discharge differs materially from the normal. (See Fig. 56.) In such event there will be a rotation set up in the suction pipe close to the impeller.¹ Thus the water, approaching along helical stream lines, already possesses some angular momentum before it flows into the impeller passages. But this angular momentum has been derived from the impeller and should therefore be credited to it when computing the torque.

In a few cases centrifugal pumps have been built with guide vanes within the eye of the impeller. Since the angle A_1 is now fixed by the form of these guides, we should have to write

$$G = (W/g) (r_2 s_2 - r_1 s_1)$$

If the angle A_1 is not 90° , the value of s_1 would not be zero. The difference between this case and the preceding is that in the former the angular momentum of the water, if any, at entrance to the impeller is all due to the rotating wheel; in the latter case the angular momentum at entrance is due to the stationary guide vanes.²

¹ This has been proven experimentally by Clinton B. Stewart, "Investigation of Centrifugal Pumps," Bulletin of the Univ. of Wis., No. 318, page 119. Readings were taken as far as 18 in. from the impeller but the indications were that the spiral vortex might have extended for 2 or 3 ft.

² This explanation is offered because of the common error made by many writers in applying an equation for the reaction turbine to the centrifugal pump. For the turbine the torque exerted by the water upon the runner is given by $(W/g) (r_1 s_1 - r_2 s_2)$. When the discharge is not radial (A_2 is not 90°), the second term cannot be omitted because the angular momentum at discharge is lost by the action of other bodies than the rotating runner. Thus the turbine runner does not absorb all the angular momentum of the water; but the pump impeller, without guides at entrance, does impart to the water all the angular momentum with which it leaves. The turbine

The advantage of guide vanes within the eye of the impeller is that it is possible to make the angle A_1 less than 90° for the normal rate of discharge without at the same time causing a helical flow in the suction pipe. The latter is undesirable as the water follows a longer path and at a higher velocity than in the case of a straight flow with a resulting increased pipe loss. The advantage of making A_1 less than 90° is that it requires a smaller value of v_1 , thus permitting the use of a larger impeller area at inlet. For some small capacity high-speed pumps this may be desirable as it would materially decrease the friction losses within the impeller passages. On the other hand, these advantages are offset to some extent by the fact that the vanes introduce additional friction losses. Also when the discharge differs materially from that for which a_1 is computed, there will be a shock loss similar to that at the discharge from a turbine pump (Fig. 56).

37. Power Imparted by Impeller.—We may obtain an expression for power delivered to the water by the impeller by multiplying the torque (34) by the angular velocity ω . Thus, in ft. lb. per sec.,

$$\begin{aligned} \text{Power} &= G\omega = (W/g)(r_2s_2)\omega \\ &= (W/g)u_2s_2 \end{aligned} \quad (35)$$

This is less than the power required to run the pump by the amount of the mechanical losses and greater than the power delivered in the water by the amount of the hydraulic losses. Expressed in horse-power it would correspond to the 75.0 h.p. in Art. 28. It is analogous to the indicated power of a reciprocating pump.

38. Head Imparted by Impeller.—The power imparted to the water by the impeller may also be represented by Wh'' . Equating this value to that in (35) we have

$$Wh'' = (W/g)(u_2s_2)$$

From this the head imparted to the water by the impeller may be obtained by dividing out the W . Thus

$$h'' = \frac{u_2s_2}{g} = \frac{u_2(u_2 - v_2 \cos a_2)}{g} \quad (36)$$

equation given can be applied, by reversing signs, only to the centrifugal pump with guides at entrance.

For a pump without entrance guides it is not correct to say that r_1s_1 drops out because the flow is radial, for A_1 is not necessarily 90° , at least it cannot be that for all values of discharge for a given pump. The term r_1s_1 is eliminated by other considerations.

This is not the head actually developed by the pump. From (36) must be subtracted the losses of head to give the actual head developed. (The above corresponds to the 60-ft. head in Art. 28.)

The value represented by h'' is sometimes called the "theoretical head." That does not seem to be a very desirable term, because the quantity h'' is a definite physical quantity in itself and may be determined by test as well as computed by theory. In the same manner the actual head h may be either determined by test or computed by theory. But the two terms represent different things.¹ Equation (36) does not give a "theoretical" value of the head h for any rational theory would also include losses of head.

An inspection of (36) shows that if $a_2 = 90^\circ$, the value of h'' is independent of the rate of discharge. If a_2 is greater than 90° , the value of h'' will increase as q increases providing the pump speed is constant, while, if a_2 is less than 90° , the value of h'' will decrease. For a constant speed, equation (36) is the equation of a straight line. It is often stated that the three cases shown in Fig. 55 for a_2 greater than 90° , equal to 90° , and less than 90° correspond to actual rising, flat or falling characteristics respectively (Fig. 11). This is due to confusing h'' and h . While it is true that pumps with a_2 greater than 90° have given rising characteristics, it is also true that some of them have given falling characteristics. Also an angle of approximately 90° does not insure a flat characteristic as may be seen in Fig. 60. We find that pumps with impeller angles of less than 90° have also given rising characteristics as may be seen in Fig. 66 where $a_2 = 26^\circ$. The fact is that the losses materially modify the conditions, so that all we can say is that the smaller the angle a_2 the more tendency there is for the head to decrease as the discharge increases.

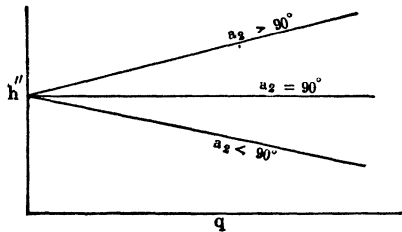

FIG. 55.—Relation between q and h'' at constant speed.

Equation (36) is the most convenient for numerical work,

¹ The difference may be said to be analogous to that between indicated horse-power and developed horse-power.

but for some purposes another form offers some advantages. We may rewrite (36) as

$$h'' = \frac{2u_2^2 - 2u_2v_2 \cos a_2 + v_2^2 - v_2'^2}{2g}$$

From the vector triangle (Fig. 45) we have that

$$V_2'^2 = u_2^2 - 2u_2v_2 \cos a_2 + v_2^2$$

Inserting this value in the above we obtain

$$h'' = \frac{u_2^2 - v_2'^2}{2g} + \frac{V_2'^2}{2g} \quad (37)$$

The first term may be said to be the pressure head imparted within the impeller, while the second term is the velocity head that must be converted in the diffuser.

The equations in this chapter apply directly to a single impeller. For a multi-stage pump it is only necessary to note that the rate of discharge for one impeller is common to all of them, but that values of head or power as computed from the equations must be multiplied by the number of stages to get the proper values for the entire pump.

39. Losses of Head.—In accordance with the usual method in hydraulics, the friction losses in flow through the impeller may be represented as a function of the square of the velocity. The velocity concerned is the relative velocity and, since that varies throughout the flow, we express the loss in terms of its value at one specific point. Thus the hydraulic friction losses may be represented by

$$k \frac{v_2^2}{2g} \quad (38)$$

where k is an empirical factor, whose value can be determined only by experiment.

If we had guide vanes within the eye of the impeller, they would fix the value of A_1 . But the values of u_1 , v_1 , and a_1 , the latter being a fixed impeller angle, would lead to the construction of a vector diagram in which the angle A_1 might not necessarily agree with that determined by the guides. There would thus be an abrupt change of velocity which would cause a loss of head. If no guide vanes were present, we should still have this loss if the water flowed up to the impeller without any rotation being established in it. But such is not the case, as has been pointed

out on page 61. If there is no flow, the water in the eye of the impeller is set into rotation at nearly the same angular velocity as the impeller. Thus for a small rate of discharge it can be seen in Fig. 56, case (a), that there is no abrupt change of velocity as the water flows into the impeller. As the rate of discharge increases, this rotation in the suction pipe decreases. While there is undoubtedly some additional loss at entrance that does not follow the law stated in (38), yet it does not seem of sufficient magnitude to require a separate expression for it. Whatever entrance loss there is may be covered by a suitable value of k . It is hardly probable that k will be constant in value.

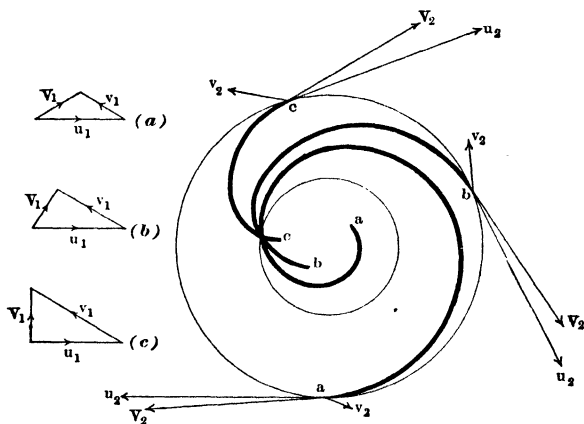

FIG. 56.—Velocity diagrams and stream lines for three rates of discharge.

Where the water leaves the impeller, however, there is an important loss which follows a different law from (38). This loss is due to the fact that there may be an abrupt change of velocity, which will result in a violent turbulent vortex motion. This causes a large internal friction or eddy loss. To this the term "shock loss" is commonly applied, though that is not an exact representation of the actual phenomenon.

For the turbine pump we may consider Fig. 57. The diffusion vane angle A'_2 is fixed by construction. The values of A_2 and V_2 are determined by the vector diagram. If the discharge is such that $v_2 = BD$, then $V_2 = AD$ and $A_2 = A'_2$. In this case there is no shock loss. But if the discharge has any other value such as $v_2 = BC'$, then $V_2 = AC'$ and A_2 is not equal to A'_2 . Therefore

V_2 , the velocity of the water leaving the impeller at angle A_2 , will be forced, as soon as the water enters the diffusion vanes, to abruptly become $V'_2 (= AC)$ at angle A'_2 . The resultant loss may be represented approximately by $(CC')^2/2g$.¹ Since the area of the diffusion ring normal to the radius should equal the area of the impeller outlet normal to the radius, the radial component of V_2 should equal that of V'_2 . Therefore CC' is parallel to u_2 and its value may be found as follows: $V'_2 \sin A'_2 = v_2 \sin a_2$, $CC' = u_2 - V'_2 \cos A'_2 - v_2 \cos a_2$. Substituting in the latter the value of V'_2 from the former we get

$$\begin{aligned} CC' &= u_2 - \frac{v_2 \sin a_2 \cos A'_2 - v_2 \cos a_2 \sin A'_2}{\sin A'_2} v_2 \\ &= u_2 - \frac{\sin (a_2 + A'_2)}{\sin A'_2} v_2 \end{aligned}$$

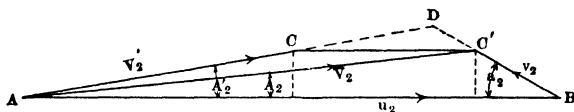

FIG. 57.

If $\sin (a_2 + A'_2)/\sin A'_2 = k'$, the shock loss for the turbine pump may be roughly represented by

$$(u_2 - k'v_2)^2/2g \quad (39)$$

With the volute pump we have a shock loss similar in its nature to the above for the turbine pump, but it will be necessary to express it in different terms. Since the water leaving the impeller with a velocity V_2 enters a body of water in the case moving with a velocity V_3 which, in general, is lower, we may, from the analogy to the pipe in Fig. 48(b), express the loss as $(V_2 - V_3)^2/2g$. But, since these two velocities are not in the same straight line, it will be better to proceed as follows: The velocity V_2 is resolved into its components $V_2 \sin A_2$ and $V_2 \cos A_2$. The mean velocity in the case V_3 is approximately parallel to $V_2 \cos A_2$. Actually there is an angle between them but, being small, it may be neglected without sensible error. Great refinement is unwarranted, since we are unable to formulate a law which will be precisely correct. Therefore we assume that the radial component of the velocity is entirely lost, while the loss with the other component may be represented by $(V_2 \cos A_2 - V_3)^2/2g$. If we

¹ L. M. Hoskins, "Hydraulics," page 237.

write $V_3 = nv_2$, since $V_2 \sin A_2 = v_2 \sin a_2$ and $V_2 \cos A_2 = u_2 - v_2 \cos a_2$, the shock loss for the volute pump may be assumed to be roughly given by¹

$$\frac{(v_2 \sin a_2)^2 + [u_2 - (n + \cos a_2)v_2]^2}{2g} \quad (40)$$

In determining the value of n for use in (40) it would be customary to take it as the ratio of f_2/F_3 , where F_3 is the area of the volute at the section through which all the water passes. (Or if it were taken as the area at any other section, a proportional part of f_2 should be taken.) But this value of n would give a larger value for the loss than is actually the fact. Instead of every particle of water in the case flowing with a velocity determined by q/F_3 , it is probably true that the water near the impeller is moving with a much higher velocity than this mean while the water adjacent to the outer boundary of the case is moving much slower. Thus there is no such abrupt change of velocity as seems to be implied by the formula. We might, therefore, multiply the right-hand member of (40) by a factor less than unity or consider the V_3 that enters into the formula as being greater than the mean velocity. We should thus accomplish the result by making n larger than the actual ratio of the areas. Experimental evidence is lacking as to what this increase should be.

It may be shown that ideally the maximum efficiency of conversion in the volute is approximately attained when $V_3 = 0.5V_2$, the efficiency then being about 50 per cent. It is now thought to be better to make the volute section smaller so that V_3 is greater than $0.5V_2$ and to effect the greater part of the conversion in the "nozzle" shown in Fig. 4. In fact in some designs $V_3 = V_2 \cos A_2$ at the normal discharge so that practically all of the conversion is effected in the nozzle. Experiments indicate² that the best angle of divergence for a circular passage is 6° and that the loss of head is $0.13(V_3 - V_d)^2/2g$. For other angles of divergence and for non-circular sections such as are usual in pumps the factor may be increased to 0.15 or 0.20. When the design is such

¹ A new method is proposed by A. H. Gibson in "The Design of Volute Chambers for Centrifugal Pumps," Proc. of Inst. of Mech. Eng., Apr., 1913, page 519. While the treatment outlined gives much promise yet certain objections must be overcome before it can be accepted, as pointed out by O. A. Price on page 550 of the same paper.

² Trans., Royal Soc. of Edinburgh, 1911, Vol. 40, pages 97 and 104.

that at normal discharge practically all the energy conversion takes place in the nozzle rather than in the volute proper, the pump is said to be analogous to a turbine pump but with only one diffusion vane.

Though the expressions for shock loss for turbine and volute pumps are unlike in appearance, yet it may be seen that the losses in each case follow the same general kind of law. As the discharge of the turbine pump increases from zero, the shock loss decreases until it becomes zero, then with a further increase in the discharge the shock loss increases again. It may be perceived that the right-hand member of (40) does likewise. The total value of (40), however, never becomes zero as does (39), but this is of little significance. With the turbine pump operating without shock there is still a failure to convert velocity head into pressure head without loss, due to the usual frictional resistance of the diffuser passages and the internal friction of the particles of water against each other. But this may be allowed for by a proper increase in the value of k . Equation (39) merely expresses the portion of the loss that is not a simple function of v_2^2 .

It must be borne in mind that none of these assumptions regarding losses can be considered as more than rough approximations to the truth. There are so many factors entering into the total losses that it is not possible to segregate them by ordinary experimental methods. Attempts have been made to compute each separate item but so many assumptions are required, and it is necessary to introduce so many unknown experimental factors, that it seems better to the author to combine all the losses into one term, save these important shock losses, which follow a different law from the others. A great deal of experimental work is necessary before we can have any truly rational theory, which can be successfully applied in detail.

With either the turbine or volute pump there is a loss of energy consequent upon the transformation of kinetic energy into pressure, but it is generally believed that this operation can be more efficiently performed with the diffusion vanes. This is still open to question. While it may have been true with the older types of pumps, yet with proper and careful design of the volute chamber, it may not be true. Since, with modern pumps, from 30 to 50 per cent. of the energy at the point of exit from the impeller is kinetic, it follows that it is desirable to

transform this as efficiently as possible. On account of the difficulty of so doing an effort is usually made to keep the velocity V_2 as low as possible. This has led to the use of impeller vanes with a_2 less than 90° (Fig. 45). Another reason is that it is much easier to lay out smooth vanes with impeller passages free from abrupt changes of area than is the case where $a_2 = 90^\circ$ or more. (Angle a_1 should always be less than 90° .) Both theory and experiment have shown that better efficiencies may be obtained from impellers with backward curved vanes.

40. Head of Impending Delivery.—The head developed by the pump when no flow occurs is called the “shut-off head” or the “head of impending delivery.” We are then concerned only with the “centrifugal head” of Art. 26. This was there shown to be equal to $u_2^2/2g$. The same result may be obtained from the principles of Arts. 38 and 39. In equation (36) if $v_2 = 0$, $h'' = 2u_2^2/2g$. The same is true of (37) for $V_2 = u_2$ when $v_2 = 0$. As to the losses of head, equation (38) becomes zero and by either (39) or (40), $h' = u_2^2/2g$, when $v_2 = 0$. Therefore

$$\begin{aligned} h &= h'' - h' \\ &= 2u_2^2/2g - u_2^2/2g = u_2^2/2g \end{aligned} \quad (41)$$

The explanation of this is that the actual head imparted to the water by the impeller is made up of $z_2 + p_2 = u_2^2/2g$ (as in Fig. 51), and a velocity head $V_2^2/2g$ which is equal to $u_2^2/2g$ since the velocity of a particle of water at the tip of the impeller blade is u_2 if no flow occurs. Thus the actual amount of energy imparted to the water per pound is $2u_2^2/2g$, but, since there is no opportunity to convert any of this kinetic energy into pressure, and since there is no possibility of making use of it otherwise, the useful output is only $u_2^2/2g$. That such a loss does occur can be readily seen, if we suppose an infinitesimal flow to occur. In such event the velocity of water outside the impeller would be practically zero. Therefore a particle of water leaving the impeller with a velocity V_2 and entering this body of water at rest would lose all of its kinetic energy. Since for such a case $V_2 = u_2$, the proposition is evident.

Although the ideal head of impending delivery equals $u_2^2/2g$, we find that various pumps give values both above and below that. This may be accounted for in a number of ways. In any real pump we never have a case of zero discharge through the

impeller, for a small amount of water will be short circuited past the clearance rings, through the suction gland water seal, etc. This will tend to make the measured head greater or less according to whether the pump has a rising or a falling characteristic. With some forms of cases, and especially where the impeller is not surrounded by diffusion vanes, there is a tendency for the water surrounding the impeller to be set in rotation. This tends to increase the head, since the real effective value of r_2 is greater than the outer radius of the impeller. If the water in the eye of the impeller is not set in rotation at the same angular velocity as the impeller itself, there will be a tendency for the head to be decreased. This will also be so in case a shaft passes through the suction intake, since this will prevent the effective value of the inner radius of the vortex from becoming zero. The fewer the number of vanes and the more the vanes are directed backward the less the head will be because of internal eddies that are set up on the rear of each vane tip. That is, the water surrounding the impeller may be said to pulsate, particles on the front side of each vane tip are moved forward and outward until they reach the end of the blade, they flow over this and down into the passage on the rear of the vane. All of these effects together cause the actual measured head for impending delivery to depart somewhat from the value given by (41). In rare cases this departure is quite marked, but ordinarily these various factors offset each other to some extent so that the discrepancy is not great.

It will usually be found that the actual head of impending delivery is

$$h = 0.85 \text{ to } 1.10 u_2^2/2g \quad (42)$$

41. Relation between Speed, Head, and Discharge.—When flow occurs, the above relation no longer holds for other factors besides centrifugal force become important. Due to conversion of velocity head into pressure head, a lift may be obtained which is greater than $u_2^2/2g$. See the "rising characteristic" in Fig. 11, page 9.

The actual lift of the pump may be obtained by subtracting the losses h' from the head imparted to the impeller h'' . Since the expressions for the losses of the turbine and volute pumps are different, we shall have to derive separate equations for each. (See equations 36, 38, 39, and 40.)

For the turbine pump

$$\frac{2u_2^2 - 2u_2v_2 \cos a_2}{2g} - \frac{kv_2^2}{2g} - \frac{(u_2 - k'v_2)^2}{2g} = h$$

After rearranging we have

$$u_2^2 + 2(k' - \cos a_2)u_2 v_2 - (k + k'^2)v_2^2 = 2gh \quad (43)$$

For the volute pump

$$\frac{2u_2^2 - 2u_2v_2 \cos a_2}{2g} - \frac{kv_2^2}{2g} - \frac{(v_2 \sin a_2)^2 + (u_2 - (n + \cos a_2)v_2)^2}{2g} = h$$

After rearranging we have

$$u_2^2 + 2nu_2v_2 - (n^2 + 2n \cos a_2 + 1 + k)v_2^2 = 2gh \quad (44)$$

For the sake of illustration it may be useful to consider equation (37), page 64. If we deduct from the left-hand member the term $k''v_2^2/2g$ to represent the losses within the impeller passages, and multiply the right-hand member by m , a factor less than unity, to give the portion of the velocity head that is not lost, we should have

$$h = \frac{u_2^2 - (1 + k'')v_2^2}{2g} + m \frac{V_2^2}{2g}$$

Replacing V_2 in terms of u_2 and v_2 and reducing we have

$$(1 + m)u_2^2 - 2m(\cos a_2)u_2v_2 - (1 + k'' - m)v_2^2 = 2gh$$

This is easy to derive and is easily explained. The disadvantage is that the factor m varies between wide limits, being 0 when $q = 0$ and ranging as high as about 0.75 for the normal value of q . With equations (43) and (44) the factors are approximately constant for a given pump.

These equations involve the relation between the three variables u_2 , v_2 , and h . If the speed u_2 is constant, the relation between v_2 and h will be the equation of a parabola. If the rate of discharge is constant, the curve between u_2 and h will also be a parabola. If the head h is constant, either (43) or (44) will become the equation of a hyperbola. Actual curves for the three cases cited may be seen in Figs. 61, 73, and 74 respectively.¹

¹ The relation between the three variables N , q , and h may be expressed by a second-degree equation of the form

$$AN^2 + BNq - Cq^2 - h = 0$$

42. Use of Factors.—It may be seen that equations (43) and (44) involve ratios as well as absolute values. Thus we might divide through by $2gh$ and we should have equations between the two variables ($u_2/\sqrt{2gh}$) and ($v_2/\sqrt{2gh}$). We may call these quantities ϕ and c respectively. Thus

$$u_2 = \phi\sqrt{2gh} \quad (45)$$

$$v_2 = c\sqrt{2gh}^* \quad (46)$$

The use of these factors is very convenient in many ways. Thus for a given impeller we may find the relations between c and ϕ regardless of any operating conditions. Then for any fixed conditions such as either speed, discharge, or head the other quantities may be determined. Thus, suppose that for a given pump the values for maximum efficiency are $\phi = 1.10$ and $c = 0.20$. If the peripheral speed of the impeller is given, we may compute h from (45) and thus get v_2 from (46). If the area of the impeller is known, the rate of discharge is thus obtained. Likewise, if the head were specified, we could readily compute the values of u_2 and v_2 .

Even if definite values of two of the three variables are given, the arithmetic involved will be found to be simpler if equations (47) or (48) are used. Also we can tell if the computed factor ϕ or c is unreasonable far easier than we could tell if u_2 , v_2 , or h is unreasonable. After ϕ or c , as the case may be, is determined, (45) or (46) may be employed to get the quantity desired.

Introducing these factors into (43) and (44) they become: For the turbine pump

$$\phi^2 + 2(k' - \cos a_2)\phi c - (k + k'^2)c^2 = 1 \quad (47)$$

For the volute pump

$$\phi^2 + 2n\phi c - (n^2 + 2n \cos a_2 + 1 + k)c^2 = 1 \quad (48)$$

where A , B , and C are coefficients. These could be computed from (43) or (44) by transforming into the proper units, if the theory presented were correct or could be correctly interpreted. Practically the three coefficients could be obtained by inserting values of the variables from three different points from an actual test curve. But, if this method is to have any practical application to design, numerous tests of all types of impellers must be at hand and some means devised for selecting values of A , B , and C in terms of the design.

* It is useful in many cases to note that $h = \frac{1}{v_2^2} \times \left(\frac{u_2^2}{2g} \right)$, $v_2 = \left(\frac{c}{\phi} \right) u_2$.

From actual test data it is found that the general range of these factors, which depend upon the design, is:

For impending delivery

$$\phi = 0.95 \text{ to } 1.09$$

For maximum efficiency (or rated discharge)

$$c = 0.10 \text{ to } 0.30$$

$$\phi = 0.90 \text{ to } 1.30$$

43. Hydraulic Efficiency.—Hydraulic efficiency has been defined on page 55. That is

$$e_h = \frac{h}{h''} = \frac{gh}{u_2(u_2 - v_2 \cos a_2)} \quad (49)$$

In using this equation the values inserted in it must be either determined by test or computed from (43) or (44) as the case may be. (Actually it is better to use (47) or (48) as noted.) If the relation between these three quantities has been determined by test, it is possible to compute the actual hydraulic efficiency directly, if proper values can be inserted in the above expression. The quantity in equation (49) has been termed "manometric efficiency" or more properly "manometric coefficient" by many writers, and treated as if it were essentially different from hydraulic efficiency. Actually its numerical value, as h'' is ordinarily computed and with h determined by test, may be quite different from what the true hydraulic efficiency must really be. In some cases, for instance, its value is less than the gross efficiency, which is absurd. But this is due to the fact that the theory is imperfect as pointed out in Art. 48.

Inserting the relations of (45) and (46) in (49), we obtain

$$e_h = \frac{1}{2\phi(\phi - c \cos a_2)} \quad (50)$$

As in the case above, this expression will give the value of the hydraulic efficiency for any conditions of operation provided ϕ and c are simultaneous values satisfying (47) or (48).

44. Maximum Hydraulic Efficiency.—The values of ϕ and c for which the hydraulic efficiency is a maximum may be found by applying the condition $de_h/d\phi = 0$. The direct method of procedure would be to solve (47) or (48) for c in terms of ϕ and to insert this value of c in (50). We should then have an

equation for efficiency in terms of ϕ only, which would be differentiated. The following method, however, will be found less laborious.¹ Writing (50) as

$$\frac{1}{2e_h} = \phi^2 - c\phi \cos a_2$$

and differentiating, we obtain

$$\frac{1}{2e_h^2} \frac{de_h}{d\phi} = (2\phi - c \cos a_2) - \phi \cos a_2 \frac{dc}{d\phi} = 0 \quad (51)$$

Differentiating (47) and (48) we obtain respectively

$$[\phi + (k' - \cos a_2)c] - [(k + k'^2) c - (k' - \cos a_2)\phi] \frac{dc}{d\phi} = 0$$

$$(\phi + nc) + [n\phi - (n^2 + 2n \cos a_2 + 1 + k)c] \frac{dc}{d\phi} = 0$$

Equating values of $dc/d\phi$ given by each of these equations to that given by (51), we obtain, if $\alpha = c/\phi$,

For the turbine pump

$$[(k + k'^2) \cos a_2] \alpha^2 - 2(k + k'^2) \alpha + (2k' - \cos a_2) = 0 \quad (52)$$

For the volute pump

$$[n^2 \cos a_2 + 2n \cos^2 a_2 + (1 + k) \cos a_2] \alpha^2 - 2(n^2 + 2n \cos a_2 + 1 + k) \alpha + (2n + \cos a_2) = 0 \quad (53)$$

Solving for α from (52) or (53) we obtain the relation between c and ϕ for which the hydraulic efficiency is a maximum. Only one value of α , the smaller, will give positive values of ϕ . Since $c = \alpha\phi$ for maximum efficiency we may substitute the latter expression in place of c in equations (47) or (48) and solve for ϕ . As in any case, the value of the efficiency may be found by substituting in (50).

45. Maximum Gross Efficiency.—The important values of ϕ and c are those for which the gross efficiency is a maximum. As may be seen by an inspection of curves such as those in Fig. 58, the maximum gross efficiency will always be obtained at a higher rate of discharge than the maximum hydraulic efficiency. This is because of the fact that the mechanical losses become of smaller percentage value as the discharge increases. It is not possible to present a simple general equation for the gross

¹ This method of treatment for the turbine pump is that given in Hoskins "Hydraulics," page 238.

efficiency which could be treated as was (50), so that no precise formula can be offered by which the conditions for the maximum gross efficiency may be determined.

It is customary in design to assume that the shock loss is to be zero for the rated discharge. But, as may be seen in Fig. 58, the discharge for which the shock loss is zero is always greater than that for which the hydraulic efficiency is a maximum. This is due to the fact that the other hydraulic friction losses become of greater percentage value as the discharge increases.

If the decreasing percentage of the mechanical losses and the increasing percentage of the other hydraulic friction losses offset each other, the condition for zero shock loss may then give the maximum gross efficiency. It will rarely be found that these two losses offset each other exactly, but in view of the imperfection of the theory, this assumption may be made as a rough approximation.

If the shock loss is to be zero, we should have for the turbine pump $u_2 - k'v_2 = 0$, from which $\phi = k'c$ or

$$c = \frac{\sin A'_2}{\sin (a_2 + A'_2)} \phi \quad (54)$$

With the volute pump we shall equate the right-hand member of (40) to zero. Thus $\phi - (n + \cos a_2) c = 0$ or

$$c = \frac{\phi}{n + \cos a_2} \quad (55)$$

To find the condition for which the shock loss is zero with the turbine pump we may substitute the value of c given by (54) in (47) and solve for ϕ . For the volute pump we may substitute the value of c given by (55) in (48) and solve for ϕ .

46. Experimental Analysis.—In order to illustrate the preceding theory, an analysis has been made of two pumps tested by the author and for which all essential dimensions were obtainable.¹ Curves for a turbine pump are shown in Fig. 58 and for a volute pump in Fig. 59. The test data gave directly for all rates of discharge the head developed, the brake horse-power, the water horse-power, and the gross efficiency. For the turbine pump the bearing friction was also determined by test. The disk friction was estimated from the formulas presented in

¹ Illustrations of these pumps may be seen in Figs. 62, 63, 64, and 65. The test data is recorded in Appendix A.

Chap. VII, and a reasonable leakage loss was assumed. The remainder of the power lost was held to be due to hydraulic friction losses. However, for small rates of discharge there is another source of loss which, for want of a better name, has been termed "churning loss." This loss is due to eddies set up in the water sur-

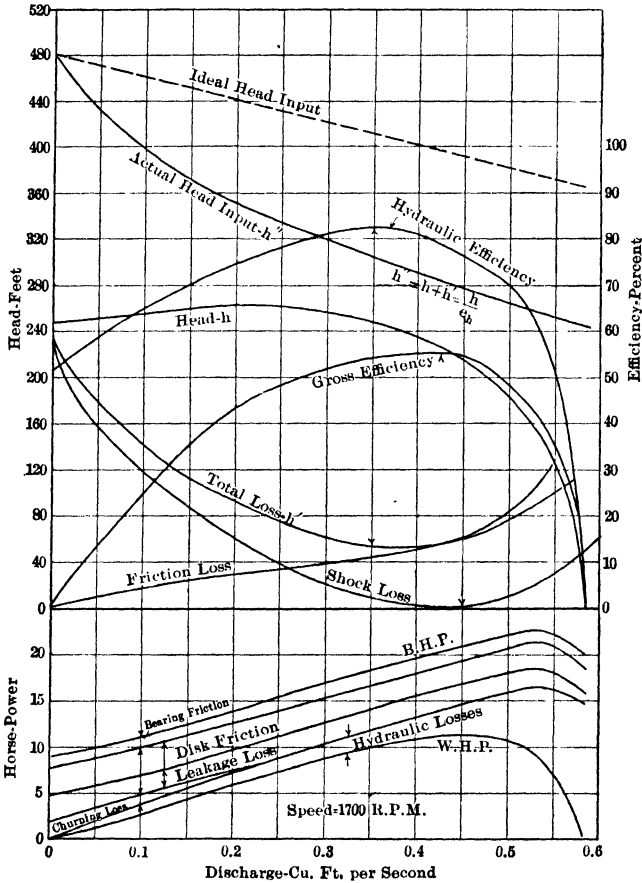

FIG. 58.—Analysis of 2-stage Worthington turbine pump at constant speed.

rounding the periphery of the impeller,¹ This loss is the greatest at zero discharge, but, as the flow is increased, it diminishes and finally ceases when the discharge is great enough to cause the water to flow smoothly away from the impeller. This loss of power is similar to disk friction but it has not been classed as a

¹ R. Biel, Mitteilungen über Forschungsarbeiten, Heft 42.

mechanical loss, as disk friction has been, because it is a function of the discharge and also affects the head developed. Neither has it been classed as a pure hydraulic loss because, though it affects the head as noted on page 70, it is not strictly a function of head as other hydraulic losses are. If it were a function of

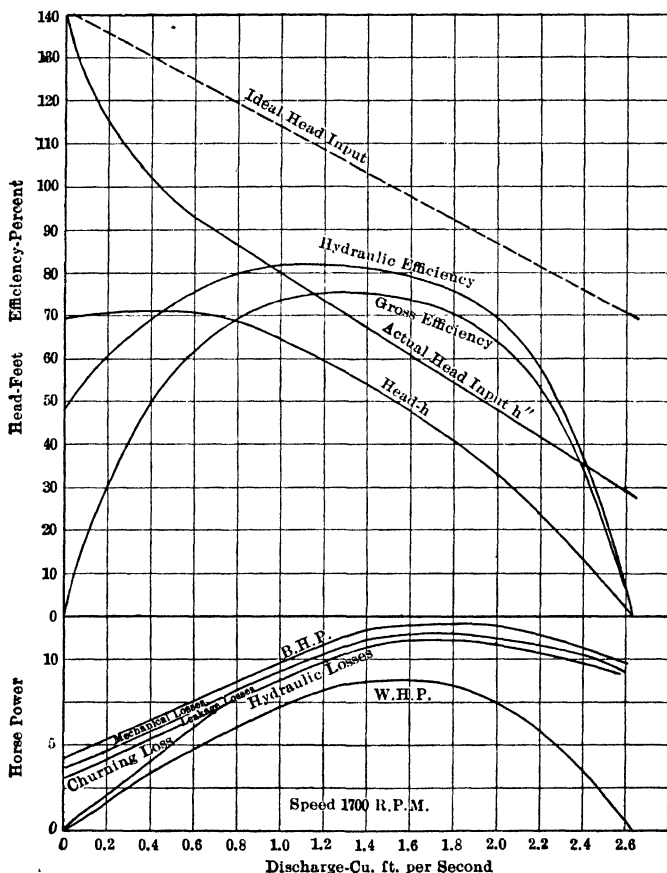

FIG. 59.—Analysis of single-stage De Laval centrifugal pump at constant speed.

head, the loss of power would be zero when q is zero, since power lost equals wqh' . It has, therefore, been left as a separate item. That there is some such additional loss of power for small discharges must be evident from an inspection of test data from many pumps. For instance in Fig. 59 it is seen that at zero discharge the brake horse-power is greater than the total loss

of power (*b.h.p.* — *w.h.p.*) at normal discharge. Since the usual mechanical losses do not vary appreciably with the discharge,¹ while the hydraulic losses increase from zero, it is seen that the brake horse-power at shut-off should be less than the (*b.h.p.* — *w.h.p.*) at any rate of discharge, unless there were some other items.

Although these curves involve assumptions and approximations, they still show very accurately the relative relations between various losses. The author believes also that the absolute numerical values cannot be very much in error. Assuming that they are correct, we can then compute the actual hydraulic efficiency as equal to $w.h.p. / (w.h.p. + \text{hyd. losses})$. It is seen that for zero discharge the hydraulic efficiency does not become zero, as might be expected. The reason is that, as the discharge becomes smaller and smaller, the values in both numerator and denominator of the above expression approach zero. Therefore at zero discharge the hydraulic efficiency is 0/0. This may be evaluated by noting that $(w.h.p. + \text{hyd. losses}) = wqh''/550$. Thus $e_h = wqh/wqh'' = h/h''$. It is seen that the hydraulic efficiency may have some finite value even though q is zero. From a consideration of Art. 40 we should expect the hydraulic efficiency for impending delivery to be 50 per cent. Actually it may differ slightly from this due to the fact that we have a small amount of leakage water that circulates through the impeller. Even when the power output is zero, a finite value of the hydraulic efficiency is reasonable if we regard the mere development of pressure as being a useful result.

If we divide the actual head developed, h , by the actual hydraulic efficiency, we obtain the actual value of h'' , the head imparted by the impeller. This is seen to differ from the curve for h'' as computed by the ordinary methods. The reasons for this discrepancy will be discussed in Art. 48.

Subtracting values of h from h'' we obtain values of h' , the head lost in friction losses within the impeller and diffusion vanes or volute. With our present experimental knowledge any sub-

¹ If the bearing friction losses varied at all they would increase with the discharge due to greater end thrust. The leakage losses will decrease as the discharge increases, but not as much as might be thought. As the flow is increased not only does the pressure at discharge decrease but the suction pressure likewise diminishes. The leakage is a function of the difference between these two, and that difference does not decrease as rapidly as does h .

division of h' is a matter of conjecture. For the turbine pump in Fig. 58, the shock loss was computed by (39) and the rest of the loss taken to be the remaining hydraulic losses. It may be seen that this curve does not represent a loss which varies as v_2^2 as assumed in (38). This may be due to the fact that (39) is not an exact representation of the law by which the shock loss varies. Again the "churning loss" may not have been correctly assumed, thus affecting the value of e_h , h , and h' for the smaller discharges. Also it is highly probable that there are various minor losses which do not follow precisely the law stated in (38). But in the main the curves shown represent the general appearance of the true curves at least.

47. Effect of Number of Vanes.—It is necessary to have a certain number of vanes in an impeller, otherwise proper guidance of the water will not be obtained. On the other hand too many vanes will cause too much frictional resistance to flow. But for a reasonable number of vanes the effect upon the efficiency is slight. This may be seen by the curves in Fig. 60, where the number of vanes was varied from six to twenty-four but without other material changes being made.¹ It cannot be argued from these curves that the efficiency increases as the number of vanes decreases, because with another series having different types of vanes the lowest efficiency was obtained with six vanes. But it can certainly be said that the difference is not material.

The efficiencies shown by these curves are low but that is because the impellers were constructed for experimental purposes and not to give high efficiencies. Also the case was very poor. Substitution later of a good spiral case added 31 per cent. to the efficiency of the same impeller.

For the three impellers with different numbers of vanes the relation between head and discharge varied slightly as may be seen and the maximum efficiency was obtained at different rates of discharge. A general conclusion might be that the fewer the number of vanes the lower the normal head and the larger the normal discharge.

48. Defects of the Theory.—The defects of this theory or any hydraulic theory are as follows: In order to apply simple mathematics to the problem, it is necessary to idealize the conditions of flow by assuming that all particles of water move in

¹ Clinton B. Stewart, "Investigation of Centrifugal Pumps," Bulletin of the Univ. of Wis., No. 173, page 529.

similar paths with equal velocities and angles. We know that this is not in accordance with actual facts, but to undertake to analyze the motions of all the particles would be beyond our

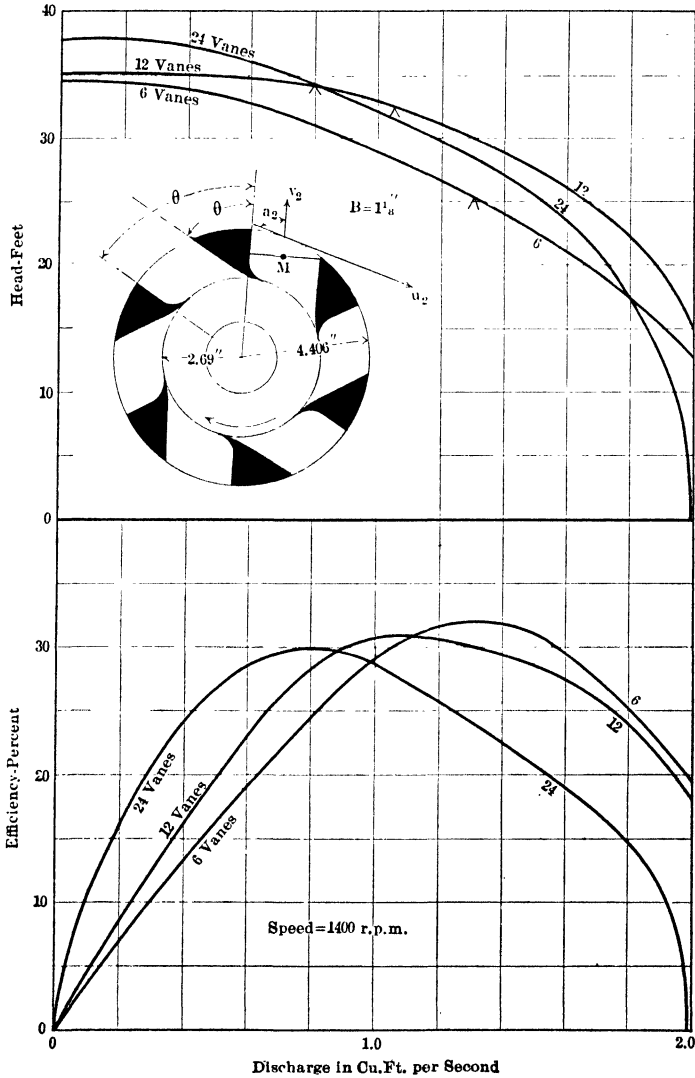

FIG. 60.—Effects of different numbers of vane.

present ability. Thus our equations deal merely with average values of velocities and angles. This is incorrect in principle

as may readily be shown by the following numerical illustration. Suppose we have bodies of equal mass m , one of which moves with a velocity of 10 ft. per sec. and the other is at rest. It is clear that the true kinetic energy of the system is $m \times 10^2/2 + 0 = 50m$. The average velocity of the two bodies is 5 ft. per sec. and the kinetic energy computed on that basis is $(m + m) 5^2/2 = 25m$. This is half of the true value.

But even to determine the average values that should be used in the equations is often a matter of difficulty. Thus, though the direction of the streams leaving the impeller is influenced by the vane angle at that point, it cannot be said that the angle a_2 is exactly equal to the vane angle. In fact the writer has roughly proved by some investigations that the two may differ by from 5 to 10° and that a_2 furthermore varies with ϕ and is not a constant quantity. The same may be said of the area f_2 . Experiments have indicated that there may be a certain amount of contraction of the streams leaving a reaction turbine runner and that this contraction varies with conditions.¹ Thus the true value of f_2 may really be less than the area of the impeller passages. These same observations may be extended to all the angles and areas that enter into the theory. The theory deals with stream lines, but we have to use in it values that we obtain from the construction.

Aside from these considerations, it must be realized that we have yet no absolutely correct expressions for the various losses that affect the head developed.

The fact that there is a discrepancy between the ordinary theory and the actual facts may be seen in Figs. 58 and 59. The actual values of h'' were determined from test data. While there is some uncertainty about the exact values, yet the curves shown cannot be very much in error. The ideal values of h'' were computed from the theory that has been presented, due allowance being made for the flow through the impeller of the leakage water. The difference between these two values of h'' is the cause of the difference between true hydraulic efficiency and "manometric coefficient."

It is found that the greater the number of vanes the better does the theory agree with the facts, the reason for this being that the actual stream lines are compelled to conform more closely to the impeller passages. Thus the values used in the

¹ Zeit. des Vereins deut. Ing., May 13, 1911.

theory are more nearly the true values than otherwise. But a wide departure from the computed results does not mean a loss of efficiency, necessarily, as has just been shown in the preceding article.

49. A Corrected Theory.—Bearing in mind the reasons for the defects of the ordinary theory, an attempt will be made to present several ways of meeting the difficulty.

Equation (35) shows that the power imparted to the water by the impeller is $(W/g) u_2 s_2$. But, as has been pointed out, this can be true only if all particles of water move exactly alike. However this equation may be applied to an infinitesimal mass of water discharging from the impeller so that

$$d(Wh'') = dW u_2 s_2 / g$$

Let dF represent an element of area normal to the radial component of velocity at discharge from the impeller. Then $dW = w V_2 \sin A_2 dF$ and, since $s_2 = V_2 \cos A_2$,

$$\begin{aligned} Wh'' &= (w u_2 / g) \int V_2^2 \sin A_2 \cos A_2 dF \\ &= (w u_2 / 2g) \int V_2^2 \sin 2A_2 dF \end{aligned} \quad (56)$$

If V_2 and A_2 are constant, as ordinarily assumed, this expression may readily be integrated and becomes equation (35). But it is certain that V_2 and A_2 are not constant. They will undoubtedly be found to vary across the section of every stream discharged from each impeller passage. Also it is known that with some cases, at least, unequal amounts of water are discharged around different portions of the circumference. If it were known how V_2 and A_2 varied, so that (56) could be integrated, it is believed that a true value could be obtained for the power imparted to the water by the impeller.¹

In order to evaluate (56) we might represent dF as $r_2 d\theta db$, where $r_2 d\theta$ is a portion of the arc of the circumference and db is a length parallel to the axis or shaft. It would then be necessary to be able to express V_2 and A_2 as functions both of θ and b .

Lacking the knowledge that would enable us to integrate (56), we must fall back upon empirical methods. One method would be to multiply s_2 by some empirical factor. This factor can be determined only by experience and would probably depend upon

¹ This is practically the same method given by C. B. Stewart in Bulletin of the Univ. of Wis., No. 173, page 551.

For a different discussion see "Neue Theorie und Berechnung der Kreisräder" by H. Lorenz.

the vane angle and the number of vanes. With a given impeller it would also vary with the rate of discharge. In Figs. 58 and 59 it is the ratio of the actual h'' to the ideal h'' . In order to obtain the actual head developed we could then subtract computed values of h' from the h'' computed with our empirical factor, or we could multiply the latter by a hydraulic efficiency which experience would lead us to choose. (It may be seen that $h = e_h \times h''$ (actual). But h'' (actual) = empirical factor $\times h''$ (ideal). Therefore $h = e_h \times$ empirical factor $\times h''$ (ideal). Thus the "manometric coefficient" is the product of the actual hydraulic efficiency times this empirical factor.)

Instead of considering the water discharging across the arc AB in Fig. 46, we may consider it at discharge across the line AC and base our computations upon the values there encountered. Since it is clear that the peripheral velocity varies from A to C , we shall take the mean point M and use the values of u_2 and s_2 as obtained for M in equation (36). The only logical reason that may be advanced for this procedure is that the water is no longer confined between the two vanes after it crosses line AC . But it would seem as if the water flowing from C to B would still be receiving energy from the vane, and there are many other reasons against this as being a logical mathematical procedure. However, it has been shown that the value of h'' , as ordinarily computed, is too high and that the fewer the number of vanes the greater the excess over the true value. It is seen that basing computations upon the point M will give smaller values of h'' and that the fewer the number of vanes the greater this reduction will be. But this method can be employed only when water is being delivered. Computations for shut-off must be based upon the outer impeller diameter, and for very small discharges the true value of h'' will be intermediate between that given by either method of computation. By trying this method out with several pumps that differed materially from each other, the author has found that at normal discharge the computed h'' would agree within a few per cent. of the value determined from test results. But he would attribute this close agreement to a coincidence rather than to a logical mathematical relation. But, since this does offer an empirical method of correction that is in the right direction and since it so often fits the actual facts, it may be employed to give values of h'' that will be approximately true.

50. Value of the Theory.—Although the ordinary theory, without empirical modification, is admittedly defective, it is nevertheless of great value. While we may be unable to compute correct numerical values by it, it still serves to indicate relative values. If from tests we know what the actual results are, the theory will enable us to predict the effect of changing various dimensions. Thus the theory indicates that the smaller the vane angle a_2 the steeper the characteristic will be. If we know the actual value of the head developed by an impeller with a certain vane angle, we can estimate the reduction of head caused by a smaller angle or the amount of increase produced by a larger angle. But theory must always work hand in hand with experience, as the number of vanes also affects the head. The theory does not involve this factor.

The theory is also very useful in explaining the actual characteristics obtained from centrifugal pumps and to enable us to understand the principles involved in their design. A rational theory in conjunction with tests will facilitate the development of new designs.

In order to see the application of theory to the general problem of design, let us consider the angles a_2 and A'_2 for the turbine pump. (A similar discussion would apply to the volute pump.) From equation (36) it might appear that it would be desirable to make the angle a_2 about 90° or even greater, as a higher head would be developed with a given pump speed. The undesirable feature of this is that it would result in a higher absolute velocity at exit from the impeller. (See Fig. 45.) The difficulty of transforming this velocity head into pressure is such as to make the resulting efficiency lower. In addition it is difficult to construct vanes with the proper curvature if a_2 is too large. But it is not desirable to make a_2 too small either because it would be necessary to run the impeller at a higher speed to develop a given head than would be the case otherwise. The additional disk friction losses would offset the increased hydraulic efficiency. Also the smaller the angle a_2 the smaller the area of the impeller passages as may be seen from equation (4). This would imply a very small capacity for a given size of impeller, if the vane angle is not given a reasonably large value. And a small capacity pump would have a low efficiency because of the greater percentage value of the mechanical losses. Values of the vane angle a_2 may be

as small as 10° in some cases and as large as 80° in some instances but the more usual values are from 20° to 30° .

By an inspection of Fig. 57, it may be seen that the smaller the diffusion vane angle A'_2 the smaller the rate of discharge at which the shock loss becomes zero. From the curves in Fig. 58, it is clear that the minimum value of the total hydraulic losses is less for such a case and that the minimum value will be found at a smaller discharge. Thus the smaller the angle A'_2 the higher the hydraulic efficiency will be, but the smaller the rate of discharge at which it is found. (This may also be shown by the equations but not so clearly as by the curves.) Therefore as A'_2 approaches zero, h' approaches zero, q approaches zero, while the maximum hydraulic efficiency approaches 100 per cent. But an angle of 0° with a zero discharge would be absurd. In order to secure a reasonable rate of discharge from a given impeller it is desirable to sacrifice hydraulic efficiency to some extent by increasing the value given A'_2 . But this does not really mean a sacrifice of gross efficiency, which is the important practical quantity. In the imaginary case of $A'_2 = 0^\circ$, we find that $e_h = 100$ per cent. But, since the water power output would be zero, the gross efficiency would be zero. Thus for a series of pumps alike in every respect except that of the diffusion vane angle, we should find that as A'_2 increased the maximum hydraulic efficiency would decrease. But since this maximum would be found at higher rates of discharge, the water-power output would be greater and this would be conducive to a higher mechanical and volumetric efficiency. The gross efficiency being the product of a decreasing hydraulic efficiency and an increasing mechanical and volumetric efficiency would at first increase as A'_2 increased from zero, and then later decrease as the hydraulic efficiency became the more decisive factor. It is desirable that such values of A'_2 be used as will lead to the maximum gross efficiency being attained.¹ This can be determined solely by experiment. It is customary to make A'_2 from 5° to 10° for high-head pumps and to use values up to about 30° in some cases of low-head turbine pumps.

¹ The maximum efficiency of a *series* of pumps such as here considered must be clearly distinguished from the maximum efficiency of a *single* pump with values of a_2 and A'_2 fixed. The latter case is treated in Arts. 44 and 45.

51. PROBLEMS

1. The diameter of a centrifugal pump impeller is 20 in., the value of ϕ is 1.053, and the head required is 240 ft. (a) If it is a single-stage pump, what is the necessary rotative speed? (b) What is the necessary speed for a 4-stage pump?

Ans. (a) 1,500 r.p.m., (b) 750 r.p.m.

2. The diameter of a pump impeller is 6 in., the speed is 3,000 r.p.m., and the value of ϕ is 1.093. (a) What will be the head developed by a single-stage pump? (b) What will be the head developed by a 3-stage pump?

Ans. (a) 80 ft., (b) 240 ft.

3. For a turbine pump $a_2 = 15^\circ$, $A'_2 = 7^\circ$, $k = 4.0$ (assumed), $r_2 = 0.50$ ft., $r_1 = 0.25$ ft., $f_2 = 0.20$ sq. ft., $f_1 = 0.18$ sq. ft. For the maximum hydraulic efficiency find ϕ , c , and e_h .

Ans. $\alpha = 0.215$, $\phi = 0.883$, $c = 0.19$, $e_h = 0.808$.

4. If $c = 0.25$, find ϕ for the pump in (3).

Ans. $\phi = 0.929$.

5. If $\phi = 1.00$, find values of c for the pump in (3).

Ans. $c = 0$, and 0.312 .

6. Find values of ϕ and c for zero shock loss for the pump in (3).

Ans. $\phi = 1.030$, $c = 0.336$.

7. When the shock loss at exit is zero, what must be the vane angle with the pump in (3) for the absolute flow at entrance to be radial?

Ans. $a_1 = 47.6^\circ$.

8. For the case in problem (6) find the r.p.m. and the rate of discharge if the head is 100 ft.

Ans. 1,580 r.p.m., 5.40 cu. ft. per sec.

9. Plot curves between head and hydraulic efficiency as ordinates against values of discharge as abscissæ for the pump in problem (3) running at a constant speed of 1,700 r.p.m.

10. For a volute pump $a_2 = 15^\circ$, $k = 5.0$ (assumed), $n = 2.0$. For the maximum hydraulic efficiency, find values of ϕ , c , and e_h .

Ans. $\alpha = 0.198$, $\phi = 0.894$, $c = 0.177$, $e_h = 0.755$.

11. For the pump in (10) with $r_2 = 0.30$ ft. and $f_2 = 0.25$ sq. ft. plot curves of head and hydraulic efficiency against discharge for a constant speed of 1,200 r.p.m.

12. Compute the coefficients A , B , and C for the equation in the footnote on page 71, from the curves in Figs. 58 and 59.

13. Compute the coefficients A , B , and C from the theory, using the dimensions given in Art. 53. Compare with the results in problem (12).

14. For a centrifugal pump running at 1,500 r.p.m., $h = 90$ ft., when $q = 1.5$ cu. ft. per sec. If $r_2 = 0.50$ ft., $a_2 = 30^\circ$, and $f_2 = 0.10$ sq. ft., find the "manometric coefficient." (b) If the actual hydraulic efficiency is 0.850, what is the value of the "empirical factor" of Art. 50?

Ans. (a) 0.563, (b) 0.663.

15. Compute the "manometric coefficients" from the curves in Figs. 58 and 59, at discharges of 0.425 and 1.30 cu. ft. per sec. respectively.

16. Compute the "empirical factors" of Art. 50 from the curves in Figs. 58 and 59.

17. For a turbine pump the vane angle at exit = 30° , and the diffusion vane angle = 7° . If $k = 4.0$ and $c = 0.15$, find ideal values of ϕ and e_h . (b) If the actual value of ϕ is 1.00, find true value of c , manometric coefficient, and the "empirical factor."

Solution: (a) By (47) $\phi = 0.852$ and by (50) $e_h = 0.813$. (b) From (45) and (46) it is seen that $u_2/v_2 = \phi/c$. We are assuming that the values of u_2 and v_2 are fixed and that h is the uncertain element in the theory. Therefore, if the true value of ϕ is 1.00 rather than 0.852, the value of c must be increased in the same proportion, since the ratio of ϕ/c is constant. Thus the true value of c is $(1.00/0.852) \times 0.15 = 0.176$. Introducing $\phi = 1.00$ and $c = 0.176$ in (50), we get $e_h = 0.590$. This is the "manometric coefficient" and is less than the true hydraulic efficiency, because it is based upon actual values of ϕ and c rather than ideal values. The true hydraulic efficiency may be taken as the value determined in (a). Therefore the "empirical factor" is $0.590/0.813 = 0.725$. This treatment assumes that the actual value of h is the same per cent. of the theoretical value as the actual h'' is of the ideal h'' .

18. For the Worthington turbine pump of Art. 53 and for which curves are shown in Fig. 58, the radius of the point " M " (Fig. 46) is 5.314 in. and the angle $a = 28^\circ$. For 1,700 r.p.m. and $q = 0.425$ cu. ft. per sec., compute the value of h'' based upon the velocity diagram at M . Compare with Fig. 59. (To allow for leakage assume that actual discharge through the impeller = $1.10q$.)

19. For the De Laval pump of Art. 53 and for which curves are shown in Fig. 59, the radius of the point " M " (Fig. 46) is 3.81 in. and the angle $a = 22^\circ$. For 1,700 r.p.m. and $q = 1.3$ cu. ft. per sec., compute the value of h'' based upon the velocity diagram at M . Compare with Fig. 59. (To allow for leakage assume that the actual discharge through the impeller = $1.03q$.)

20. Compute coefficients A , B , and C as in problem (13) using the radius r_2 for shut-off only and using the radius of " M " for reasonably large rates of discharge. Values of the radii of M will be found in problems (18) and (19).

CHAPTER VI

CHARACTERISTICS

52. Definition of Characteristics.—The curve expressing the relation between head and rate of discharge of a centrifugal pump running at a constant speed has been called the “characteristic” of the pump. But the curves of brake horse-power and gross efficiency are of equal commercial importance and these three together as in Fig. 61 are called the “characteristics” of the pump. But broadly speaking any of the curves expressing

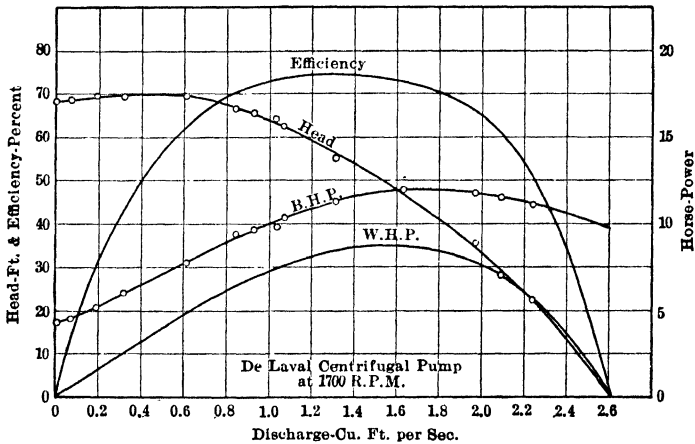

FIG. 61.—Characteristics of a 6-inch De Laval centrifugal pump at a constant speed.

the relations between the head, speed, discharge, and horse-power may be termed pump characteristics regardless of the variable against which they are plotted. From a set of curves such as in Fig. 61, however, one can estimate the performance of the pump under any conditions of operation.

53. Description of Pumps Tested.—The curves shown in this chapter are from actual test data taken by the author upon two centrifugal pumps. It was necessary to test one of these pumps at one speed only but for the other one it was possible to vary

the speed from 700 to 2,000 r.p.m. Sectional views of these two pumps may be found in Figs. 62, 63, 64, and 65. The record of the test data is in Appendix A. The essential dimensions are given in Tables 1 and 2.

TABLE 1.—2.5-IN. TWO-STAGE WORTHINGTON TURBINE PUMP

Outer radius of impeller	$r_2 = 0.500$ ft.
Inner radius of impeller	$r_1 = 0.167$ ft.
Width of impeller passage	$B = 0.250$ in.
Width of impeller passage	$B_1 = 0.500$ in.
Vane angle at exit	$a_2 = 26^\circ$
Vane angle at entrance (approx.)	$a_1 = 15^\circ$
Diffusion vane angle (average)	$A'_2 = 7.5^\circ$
Area of impeller passages	$f_2 = 0.0244$ sq. ft.
Area of impeller passages (approx.)	$f_1 = 0.0260$ sq. ft.
Area of diffuser passages	$F_2 = 0.00895$ sq. ft.
Number of diffusion vanes	= 6
Number of complete impeller vanes	= 5
Number of partial impeller vanes	= 5
Thickness of impeller vanes	= 0.25 in.

TABLE 2.—6-IN. SINGLE-STAGE DE LAVAL VOLUTE PUMP

Outer radius of impeller	$r_2 = 0.380$ ft.
Inner radius of impeller	$r_1 = 0.182$ ft.
Width of impeller passage	$B = 1.10$ in.
Width of impeller passage (total)	$B_1 = 1.75$ in.
Vane angle at exit	$a_2 = 27^\circ$
Vane angle at entrance (approx.)	$a_1 = 10^\circ$
Area of impeller passages	$f_2 = 0.0706$ sq. ft.
Area of impeller passages (approx.)	$f_1 = 0.0400$ sq. ft.
Area of volute	$F_3 = 0.0652$ sq. ft.
Number of impeller vanes	= 6
Thickness of impeller vanes	= 0.187 in.

The value of B_1 is the sum of the widths for both sides in the case of the double suction impeller. The value of F_1 is the area of the volute at the maximum section 360° from the beginning. Exact values of a_1 and f_1 are difficult to estimate.

54. Head-discharge Curves at Constant Speed.—The relation between head and rate of discharge for eight different speeds is shown in Fig. 66. It will be noted that this particular pump has a rising characteristic and that values of head are obtained which are greater than $u_2^2/2g$. While there are variations due to slight irregularities in the test data, the following values will be fair averages. For the shut-off head, $h=1.02$

$u_2^2/2g$; for the maximum head, $h = 1.08u_2^2/2g$; and for the head at the point of highest efficiency, $h = 0.94u_2^2/2g$. For the curves in Fig. 61 the corresponding values of these factors are 0.96, 0.985, and 0.80 respectively.

It will be noticed that for small rates of discharge the curves in Fig. 66 are concave upward and, after passing a point of

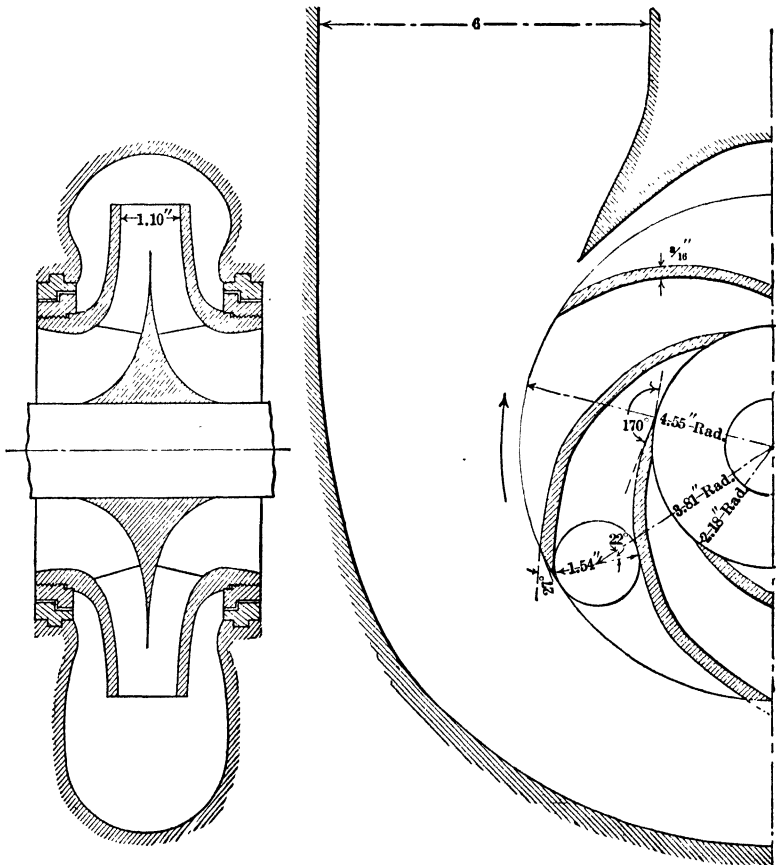

FIG. 62.—Construction of 6-inch De Laval centrifugal pump.

inflection, they assume the customary form of concave downward. The reason for this is that the “churning loss” shown in Fig. 58 prevents the head from rising as it would do otherwise. But this factor drops out as the rate of discharge increases. This feature is very common but is not usually noticed by observers because an insufficient number of points are recorded

for these small flows to enable an accurate curve to be drawn. Thus, if the first point only after shut-off had been omitted from

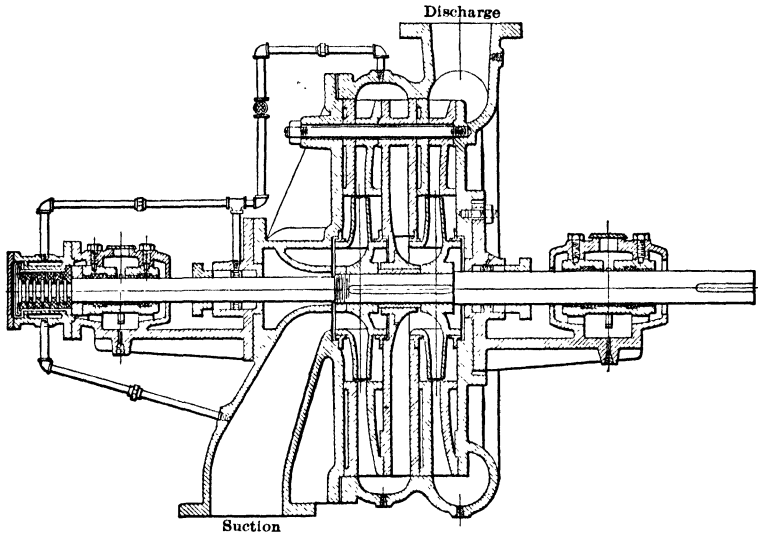

FIG. 63.—Two-stage Worthington turbine pump.

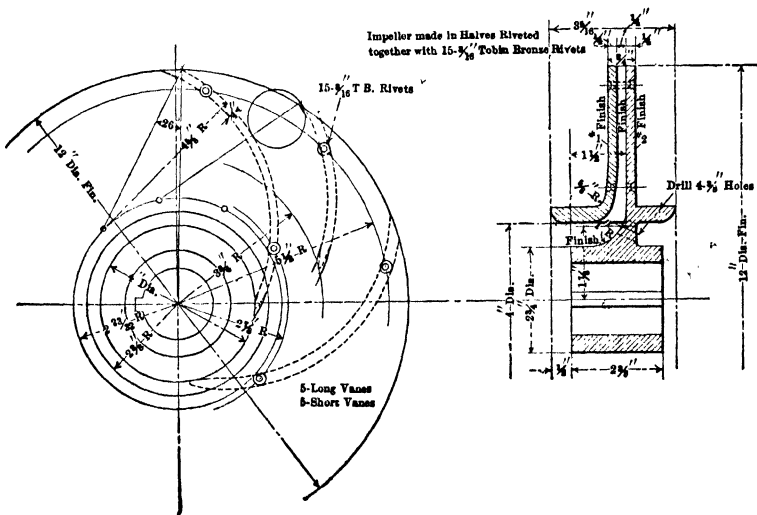

FIG. 64.—Impeller for Worthington turbine pump.

most of the curves in Fig. 66, there would be no indication that the true curve should have a point of inflection. The same is

true in Fig. 11 for an entirely different pump. In many cases, such as Fig. 61, the curvature for this portion of the curve is so slight that no point of inflection could be detected.

Another noticeable feature of the curves in Fig. 66 is that they are all similar in shape until a rate of discharge of about 0.45 cu. ft. per sec. is reached. After that point they become very steep, and the higher the speed the steeper they become. According to the theory we should be able to transfer readings taken at any speed to another speed and obtain the true curve at the latter speed. It is found that this can be done for values of discharge less than 0.45 cu. ft. per sec. but

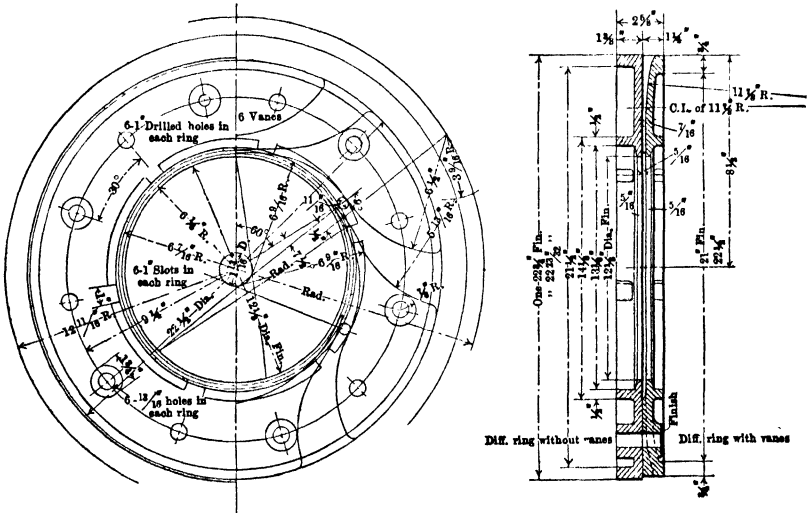

FIG. 65.—Diffuser for Worthington turbine pump.

above that value the curves at different speeds will not agree with each other. It is believed that a series of curves for speeds below 900 r.p.m. would agree with each other if they were reduced to some one common speed. It is thus evident that the cause of the disagreement is a function of an absolute value of the rate of discharge and not a function of the speed. It is believed that the explanation is that, at about the rate of discharge mentioned, the absolute pressure at entrance to the impeller becomes so low, due to the high velocity in the suction pipe with a consequent loss of head, that "cavitation" is set up in the eye of the impeller. That is, the eye of the im-

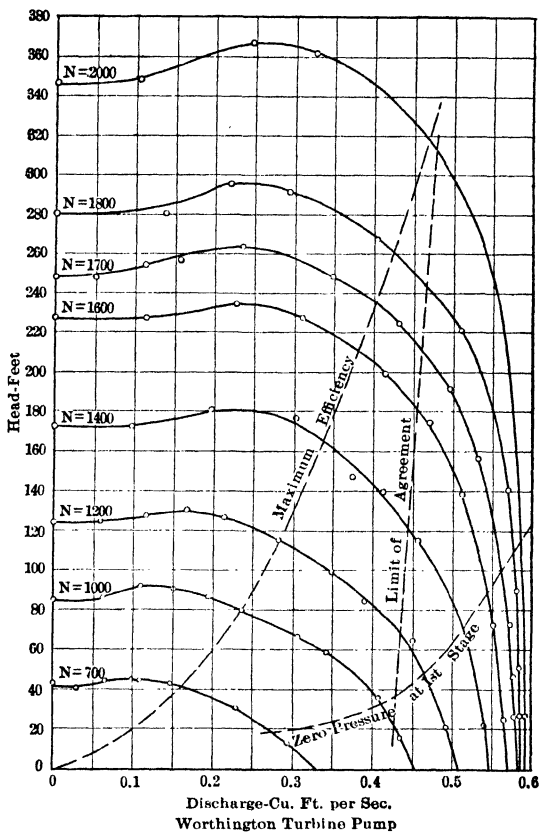

FIG. 66.—Relation between head and discharge at various speeds

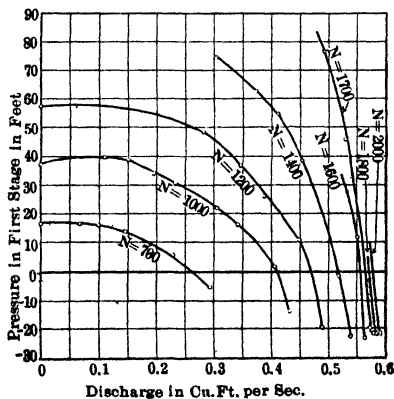

FIG. 67.—Pressures in case between first and second stages.

PELLER, and consequently the impeller passages, is not completely filled with water. Thus the actual rate of discharge of the pump is decreased below the expected amount.

This cavitation may make itself apparent even where the pump is tested at one speed only. It is indicated by an abrupt break in the smoothness of the curve or by a marked increase in the steepness of the curve for the larger discharges.

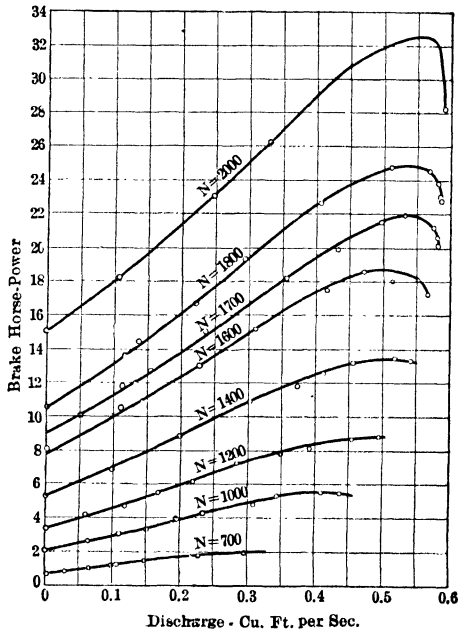

FIG. 68.—Relation between power and discharge for Worthington turbine pump.

Readings were also taken of the pressures at the top of the first stage, where the pipe (Fig. 63) for the suction gland seal and water cooling the thrust bearings is tapped in. These pressures are shown in Fig. 67 and indicate that the velocity head is very high at this point.

55. Power-discharge Curves at Constant Speed.—The relation between brake horse-power and the rate of discharge is shown in Fig. 68. It will be noticed that the power increases as the discharge increases for the smaller speeds but for the higher speeds the power attains a maximum and then decreases. The

explanation for this is involved in the explanation of the rapid drop of head under the same conditions.

It is desirable that the power curve should drop off for the maximum rates of discharge as shown in Fig. 61. This makes it possible to install a motor or other source of power whose maximum capacity is but little more than the power required under normal operation. This is conducive to low cost of the machine and to a better efficiency of the motor. If, due to a break in the pipe line or some other cause, the head becomes very low,

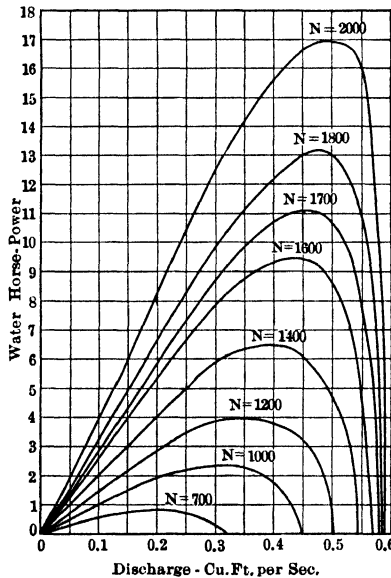

FIG. 69.—Water horse-power of Worthington turbine pump.

the motor will not then be overloaded. This feature can be attained in the design either by “throttling” at the eye of the impeller so as to produce cavitation or by making the angle a_2 small.

56. Efficiency-discharge Curves at Constant Speed.—There are no peculiar features of the curves in Fig. 70 except that the maximum efficiency is not the same for all the speeds. The explanation of this will be taken up later. The dash curve shown is similar to the single efficiency curves and is an envelop of them. It shows that the highest efficiency is obtained at a speed of 1700 r.p.m., when the discharge is about 0.4 cu. ft. per sec.

57. Impending Delivery or Shut-off.—In Fig. 71 will be found values of the head and horse-power for impending delivery as

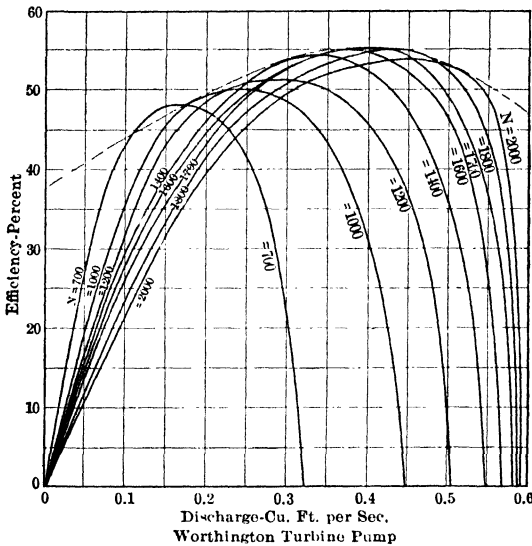

FIG. 70.—Efficiency curves at various speeds.

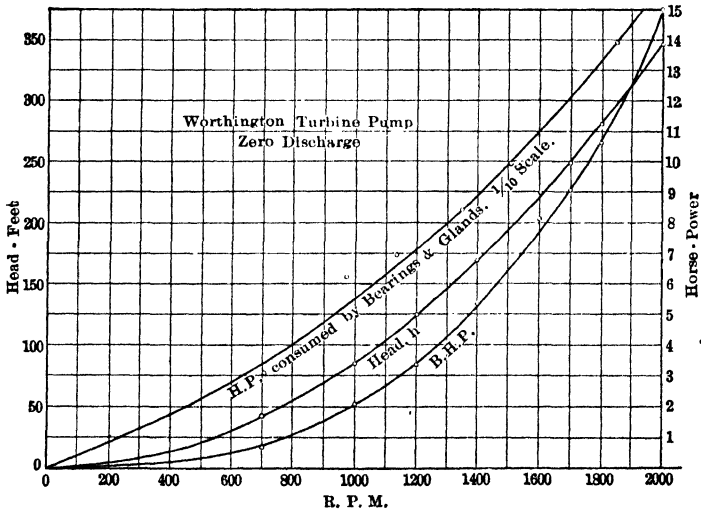

FIG. 71.—Values of head and power for impending delivery.

well as the power consumed in bearing and gland friction for speeds up to 2,000 r.p.m. It will be found that

$$\begin{aligned}
 h &= 0.0000865N^2 \\
 \text{B.h.p.} &= 0.0000000039N^{2.9} \\
 &= 0.0031h^{1.45}
 \end{aligned}$$

58. Maximum Efficiency—Speed.—In Fig. 72 will be found the curve showing the relation between efficiency and speed, the efficiency being the maximum at each speed. This curve shows that the highest efficiency will be found at about 1,700 r.p.m. but that very good results could be obtained with quite a wide range of speeds.

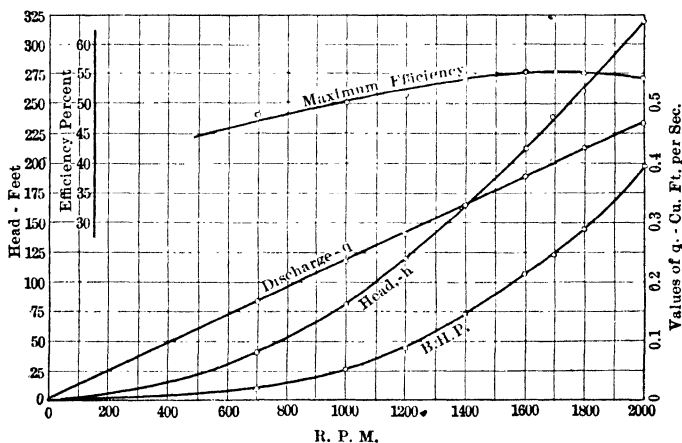

FIG. 72.—Conditions for maximum efficiency of Worthington turbine pump at various speeds.

For each speed the maximum efficiency will be found only for a certain value of head and discharge and values of these other quantities are also plotted. The normal discharge is seen to follow a straight-line law. The following relations will be found:

$$\begin{aligned}
 q &= 0.000235N \\
 h &= 0.000082N^2 \\
 \text{B.h.p.} &= 0.0000000174N^{2.8}
 \end{aligned}$$

Since q varies as N and h varies as N^2 , the water horse-power would vary as N^3 . But the efficiency is not constant for all speeds, therefore the brake horse-power does not vary as the cube of the speed. In the present case the efficiency is increasing for the most part as the speed increases. Therefore the brake horse-power does not increase as rapidly as the water horse-

power. If we had values of these quantities up to about 3,000 r.p.m. we should probably find another law for the brake horse-power to hold above 1,700 r.p.m.

59. Zero Lift and Maximum Discharge.—When the head is zero the rate of discharge is a maximum and the efficiency is zero, since no useful work is done. This case is of no practical importance. The relation between maximum discharge and speed may be seen in Fig. 78 by noting that it is the same as the curve for zero efficiency. It is seen to be a straight line up to about a speed of 900 r.p.m. and a discharge of about 0.4 cu. ft. per sec. This offers some reason for the statement made on page 92. This curve would appear to indicate that the pump

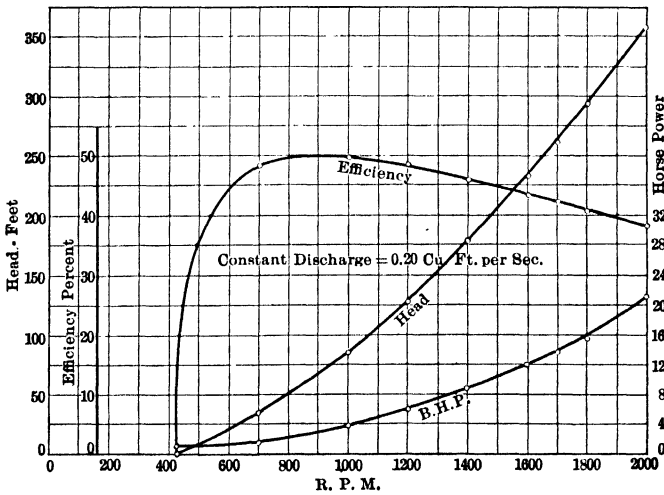

FIG. 73.—Constant discharge and variable speed.

discharge could not exceed a certain value no matter how high the speed. Therefore the equation offered for the normal rate of discharge in Art. 58 would not be true for too large a value of N .

60. Constant Discharge—Variable Speed.—Fig. 73 shows the performance of a pump delivering a constant amount of water under a variable head. In order that it shall do that, the speed must be varied. Such a case might be found where a pump is required to supply a fixed amount of water to a condenser while the level of the source of supply fluctuates within wide limits. (Of course this particular pump is unsuited for condenser pur-

poses as its capacity is too small and the head too high, but the curves will illustrate the case for a pump that is suitable.) It may be seen from the curves that the efficiency varies but little over quite a wide range of head.

In the particular curves shown, the efficiency will be within 5 per cent. of the maximum possible with this rate of discharge while the head varies from 22 ft. to 205 ft. The particular rate of discharge for these curves is 0.20 cu. ft. per sec. Similar curves would be obtained for other discharges. For a larger discharge the speed for zero head would be higher and the first part of the

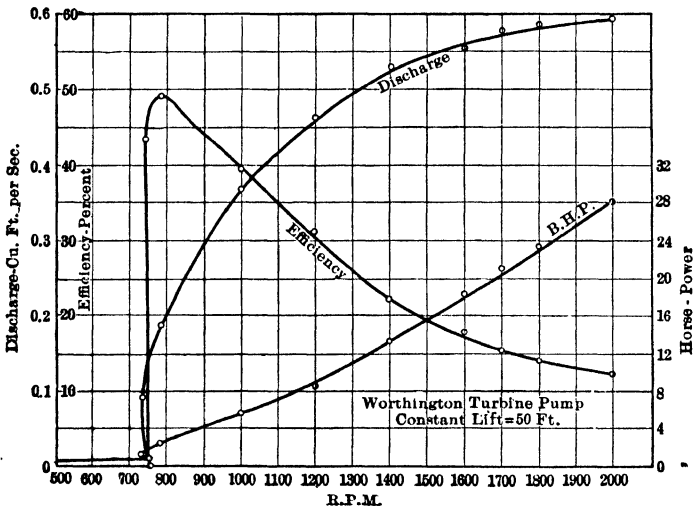

FIG. 74.—Constant head and varying speed.

efficiency curve would not be so steep, also the peak of the efficiency curve would be shifted over to a higher speed.

61. Constant Lift—Variable Speed.—The case of a constant head and a variable rate of discharge is shown in Fig. 74. Such a case might be met with where a pump lifted water vertically through a short stretch of pipe or perhaps discharged directly into a stand-pipe so that friction losses were negligible in comparison with the static lift.

For quantities of water varying from 0.1 to 0.4 cu. ft. per sec. for a head of 50 ft., the range of speed is seen to be small. Also the efficiency does not depart widely from the maximum value possible within that range. But for rates of discharge above 0.4 cu. ft. per sec. the efficiency would fall rapidly,

It will be noted that for small quantities of water (in the present instance anything under 0.13 cu. ft. per sec.), the speed necessary will be less than that required to maintain the static pressure of 50 ft. without discharge. This is due to the characteristic being a rising one.

62. Constant Static Lift with Friction—Variable Speed.—A far more common case than the preceding is one where the pump has to lift water a fixed vertical height and where the pipe line is long enough to add a substantial friction head. In fact it is

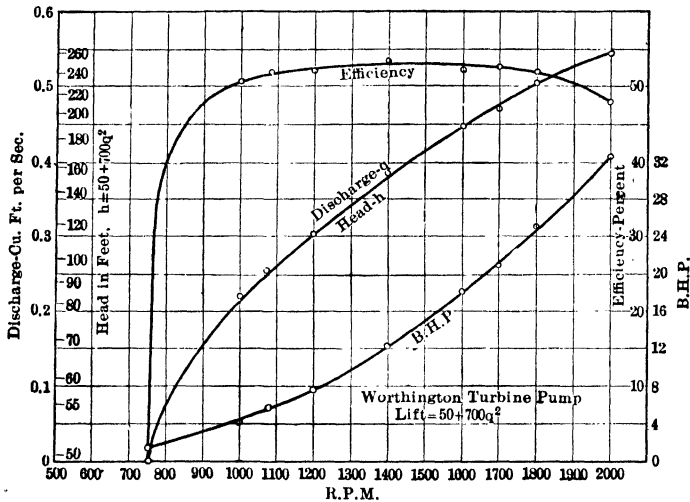

FIG. 75.—Constant static lift with friction head and varying speed.

possible for the friction head to be greater than the vertical lift. Thus both the head and the rate of discharge vary together since the former is a function of the latter.

It will be noted in Fig. 75 that the efficiency curve is very steep at the beginning and very flat for the greater portion up to about 1,800 r.p.m. Thus the average operating efficiency under all conditions shown will be excellent. If the static lift were zero and the friction head were properly proportioned, it would be possible for the relation between h and q to follow the dotted line in Fig. 66 for the case of maximum efficiency. Thus we should obtain the maximum efficiency possible under all conditions of operation.¹ For the particular equation chosen for these curves,

¹ The above discussion is concerned with the efficiency of the pump alone, not with the combined efficiency of the pump and pipe line. For the latter see Art. 64.

$h = 50 + 700q^2$, the relation between h and q is a rough approximation to this dotted curve in Fig. 66. (See Fig. 76.) The two are identical when the flow is about 0.26 cu. ft. per sec. For smaller values of q the values of h are slightly above this dotted curve and for larger values than 0.26 the values of h are below the curve. In either event the efficiency of the pump will be less than the maximum of which it is capable. But for any given pipe line conditions the best average operating efficiency will be obtained when the speed of the pump is varied to suit the head and discharge.

It may be seen that the case taken for these curves is intermediate between the cases of constant discharge and constant lift. With different static lifts and with different friction heads we should have obtained other values either more or less favorable than those shown in Fig. 75.

It might be thought that the portion of the curves of Fig. 74 which is below 760 r.p.m. would be a field of instability as there are two values of the discharge for one value of speed. Such might be the case, if it were not for the balancing effect of friction, however slight the latter might be. It is seen in Fig. 75, where friction is introduced, that there are no double values. It is hardly possible to have a condition where friction is entirely absent. Thus if the discharge tends to increase to the larger value at the same speed, the additional head required prevents the change. Or if the discharge tends to decrease to a smaller value, the resultant diminution of the friction would lower the head and thus prevent the discharge from assuming the lower value. Any real instability would be encountered only where the lift was absolutely constant and totally independent of the discharge.

63. Constant Static Lift with Friction—Constant Speed.—

In the preceding case the speed of the pump was supposed to be varied to meet the demands of the different rates of discharge. In the present case the pump is assumed to run at a constant speed of 1,800 r.p.m., while the conditions of the lift are the same as before. Since the head developed by the pump may be much greater than the head required to produce a certain flow through the pipe line, it will be necessary to throttle it. Thus a great portion of the work done by the pump may be wasted. Therefore the actual efficiency of the pump will be less than the efficiency of which it is really capable.

When the head developed by the pump is equal to the head required to produce that same flow through the pipe line, no throttling is required. It is evident from Fig. 76 that this point also determines the maximum rate of discharge that is possible.

The curve in Fig. 76 designated "pumping efficiency" is the ratio of the actual water horse-power delivered by the pump to the brake horse-power. As may be seen by comparing this with Fig. 70, throttling has caused a considerable decrease in the efficiency for every point except that of maximum discharge, where

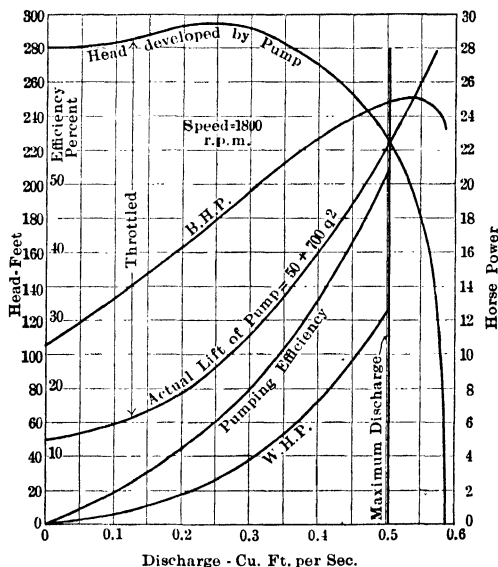

Fig. 76.—Constant static lift with friction head and constant pump speed.

throttling is absent. Thus a pump that delivers widely varying quantities of water must have a low overall pumping efficiency, if it is compelled to run at a constant speed.¹ By comparing this with Fig. 75 it may be seen that it is much more desirable to vary the speed of the pump than to throttle it so far as efficiency is concerned.

This case is not quite so bad as it appears when we consider also the efficiency of the motor or prime mover. Usually the

¹ The difference between the pump efficiency and the overall pumping efficiency is that the head developed by the pump is used in computing the former, while the actual lift of the pump including pipe friction but not the throttling loss is used for the latter.

efficiency of the latter will be somewhat better when it is run at a constant speed. When we consider the additional losses involved in operating the motor or prime mover at a varying speed, we find that the difference in the economy of the set under these two conditions of operation is not so great as for the pump alone.

Whether efficiency is a determining factor or not is open to question. In general the use of a variable speed drive will require a greater investment as it is not as cheap as a constant-speed drive. Also the variable speed device requires more intelligence in its operation and will be more trouble to tend and keep in repair. Thus the cost of labor will be higher. It may be desirable to sacrifice efficiency for cheapness in first cost and simplicity of operation.

64. Efficiency of Pump and Pipe Line.—The preceding discussion has been concerned with the efficiency of the pump alone. If the pipe line is considered along with the pump our results will be somewhat altered. The efficiency of a pipe line may be defined as $\text{static lift} \div (\text{static lift} + \text{friction head})$. In order that the efficiency of a pipe line shall be the maximum possible, which is 100 per cent., it is necessary for the flow to be zero in order that the friction head may be zero. Practically if the pipe is very short in proportion to the vertical height to which water is raised, such as is the case where water is delivered into a stand-pipe close to the pump, this condition would be approached very closely even with a flow of considerable magnitude. The per cent. of friction head allowable depends upon the lift and the length of the pipe. If the pipe is very long and the lift small it would be too costly to make the pipe line efficiency high for the normal rate of flow. The most economical size of pipe could be determined by computing the annual interest on the cost of various sizes of pipe and the annual cost of the power wasted in pipe friction in each size. The most economical size of pipe would be the one for which the sum of these two items is a minimum.

For the case where the efficiency approaches 100 per cent. the combined efficiency of the pump and the pipe line would approach the efficiency curve shown in Fig. 74, since this is where the friction head is zero. For the case where loss of head is considerable, such as in Fig. 75, the combined efficiency of the pump and pipe line would be far below the efficiency curve for the pump alone that is there shown. In fact it would be below the efficiency curve in Fig. 74. Likewise the curve for

pumping efficiency in Fig. 76 is higher than the curve would be if the static lift only were considered as useful work.

65. Characteristic Curves.—All of the relations shown in the preceding sets of curves are involved indirectly at least in what may be called the *characteristic curves*, two forms of

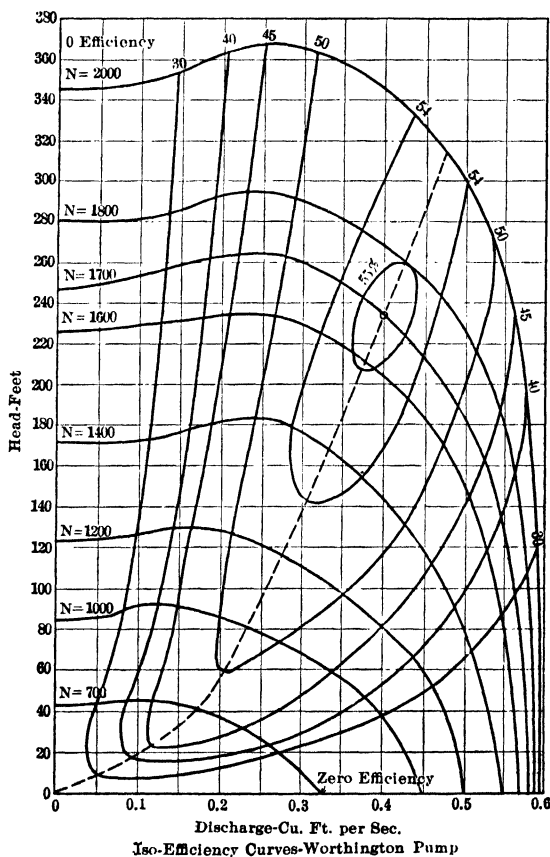

FIG. 77.—Characteristic diagram.

which are shown in Figs. 77 and 78. In Fig. 77 we have the usual head-discharge curves at various constant speeds and upon these are superimposed iso-efficiency curves.¹ In Fig. 78 we have

¹ To plot these curves it is possible to write the value of the efficiency alongside of each experimental point for which the head-discharge curves are drawn. Then the iso-efficiency curves may be drawn by interpolation.

something that is analogous to the characteristic curve for a hydraulic turbine as the coordinates are speed and discharge. (However, these coordinates represent actual values and not values under a unit head.) Upon this diagram we draw iso-head, iso-power, and iso-efficiency curves.

By the use of these diagrams it is possible to tell at a glance what the conditions of operation might be under any circumstances and it is easily seen what is the most economical field of operation. It is clear that, though the maximum efficiency will be found for one point only, a centrifugal pump may be

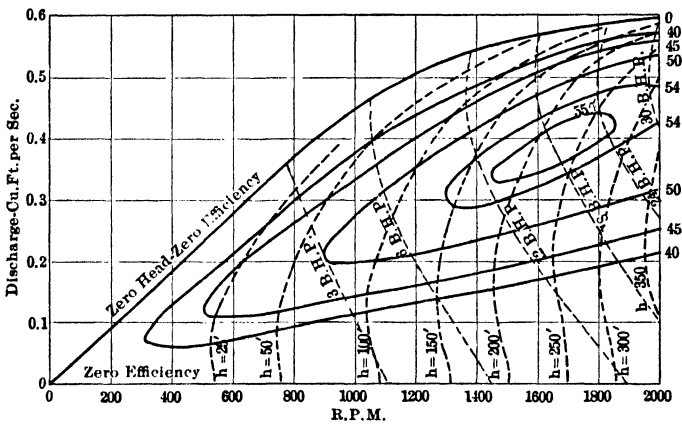

FIG. 78.—Characteristic diagram.

used under quite a range of values of head, speed, and discharge without suffering a big drop in efficiency. Thus for this particular pump the field in which the efficiency is above 50 per cent. or within 5.5 per cent. of the maximum is quite large.

66. PROBLEMS

1. Assuming that ϕ for shut-off in Fig. 11 is 1.0, compute the factors by which $u_2^2/2g$ must be multiplied to give the maximum head with the rising characteristic and values of head for the maximum efficiency with all three of the curves.

The writer believes it is easier, however, to construct the efficiency curves as in Fig. 70. For any value of the efficiency for which a curve is desired in Fig. 77 it is possible to read values of q for the various speeds from Fig. 70. Thus the points are located where each iso-efficiency curve intersects each head-discharge curve in Fig. 77.

2. What are values of ϕ for the above?

Ans. 0.865, 0.900, 1.08, 1.25 respectively.

3. What is the efficiency of the pipe line in Fig. 76 when $q = 0.4$ cu. ft. per sec.?

Ans. 0.312.

4. What is the combined efficiency of the pump and pipe line in Fig. 76 when $q = 0.4$ cu. ft. per sec.?

Ans. 0.103.

5. What would be the combined efficiency of the pump and pipe line in Fig. 75 when $q = 0.4$ cu. ft. per sec.?

Ans. 0.166.

6. For a case of variable speed plot the curve for the efficiency of the pump and pipe line using the same law for the total lift as given.

7. A flow of 2.0 cu. ft. of water per sec. is to be raised 100 ft. If the diameter of the pipe is 6 in. and its length is 120 ft., find the pipe line efficiency. (Assume $m = 0.03$ and neglect all minor losses.)

Ans. 0.896.

8. If the length of the pipe in (7) were 1,200 ft., what would be the efficiency if all other quantities are the same?

Ans. 0.462.

9. If the diameter of the pipe is 8 in. and the length 1,200 ft., what would be the efficiency of the pipe line, all other conditions being the same as in (7)?

Ans. 0.780.

CHAPTER VII

DISK FRICTION

67. Definition.—An important source of loss of power in centrifugal pumps is the drag of the impeller through the water in the clearance spaces. This is termed disk friction.

The results given in this chapter were determined by experiments made by Gibson and Ryan,¹ and are the most accurate and comprehensive tests of which the author is aware. The disks were of 9-in. and 12-in. diameter and with various kinds of surfaces, the speeds were varied from 450 to 2,200 r.p.m., and the side clearance from $\frac{1}{8}$ in. to $2\frac{1}{8}$ in.

68. Theory.—The frictional resistance per sq. ft. of the disk may be taken as equal to fu^n , where u is the velocity of the area in feet per sec. and f and n are experimental factors. The resistance offered by an elementary annular ring will then be equal to $f \times 2\pi r dr \times u^n$. Since $u = r\omega$, the moment of the resistance may be expressed as

$$2\pi f \omega^n r^{n+2} dr$$

The moment of the resistance of the two faces of the disk of radius R (ft.) will be

$$T' = 4\pi f \omega^n \int_0^R r^{n+2} dr$$
$$T' = \frac{4\pi f \omega^n}{n+3} R^{n+3} \text{ (ft. lb.)} \quad (57)$$

If the edge of the disk has an appreciable thickness b (ft.) the moment of the resistance of the edge will be $2\pi b f \omega^n R^{n+2}$. Adding this to the value in (57), the total torque exerted by the water upon the disk is

$$T = 2\pi f \omega^n R^{n+2} \left(\frac{2R}{n+3} + b \right) \text{ (ft. lb.)} \quad (58)$$

From the above it may be seen that, if b is small compared with R , the effective radius is approximately

$$R' = (1 + b/2R)R \quad (59)$$

¹ "Resistance to Rotation of Disks in Water at High Speeds," Proc. of the Inst. of Civ. Eng., 1910, Vol. 179, p. 313.

By effective radius is meant the radius of a disk the friction on whose faces alone is equal to the total resistance of the faces and edge of the actual disk. The power consumed in disk friction will then be

$$\text{H.p.} = \frac{4\pi f(\pi N/30)^{n+1}}{550(n+3)} \times R'^{(n+3)} \tag{60}$$

Equation (60) applies to a solid disk. If it is desired to consider an annular ring it is necessary to integrate between the limits of R_1 and R_2 rather than 0 and R . In equation (59) we should use R_2 for computing R' . With R' thus obtained we should have

$$\text{H.p.} = \frac{4\pi f(\pi N/30)^{n+1}}{550(n+3)} [R'^{(n+3)} - R_1^{(n+3)}] \tag{61}$$

69. Experimental Results.—Numerous experiments were made by Gibson and Ryan to determine values of f and n and to establish the laws by which they vary. The equations in Art. 68 were obtained by integration, treating f and n as constants. Experiment seems to show that they vary as the velocity and hence are functions of r and ω . Since they are functions of r the integration is incorrect and the equations do not express the exact way in which the disk friction varies. But they may be used as empirical equations and will yield correct results providing proper values of f and n are selected.

TABLE 3

Condition of case	Mean vel. ft. per sec.	Disk			
		Polished brass		Rough cast iron	
		f	n	f	n
Smooth, painted.....	10	0.0031	1.85	0.0023	2.00
	20	0.0033	1.84	0.0027	1.96
	30	0.0035	1.83	0.0032	1.91
	40	0.0037	1.82	0.0037	1.86
	50	0.0039	1.80	0.0042	1.81
Rough cast iron.....	10	0.0029	1.92	0.0025	2.00
	20	0.0033	1.89	0.0027	1.98
	30	0.0037	1.86	0.0028	1.96
	40	0.0041	1.83	0.0029	1.93
	50	0.0044	1.80	0.0030	1.91

For the usual clearances encountered with centrifugal pumps the average values in Table 3 may be used. Mean velocity

was taken by the experimenters as being the velocity of a point midway between the inner and outer radii of an annular ring or one-half the peripheral velocity in the case of a solid disk. This is not logical, but it is convenient, and, as long as the equations are really empirical and a strict mathematical integration apparently impossible, it is as good as any other procedure.

70. Summary of Results.—The resistance decreases as the temperature of the water increases. The effect of temperature is negligible when $n = 2.0$ and becomes more important as n becomes smaller.

The value of n is independent of the clearance but the value of f increases as the clearance increases. For the smooth disk in a smooth case the value of f increased about 10 per cent. as the clearance varied from $\frac{1}{8}$ in. to $2\frac{1}{8}$ in. There was very little difference within this range of clearance for the rough disk in a rough case. For extremely small clearances the friction is somewhat higher than the minimum possible. As the clearance is increased the friction decreases slightly. The minimum value is soon reached, however, and after this the friction increases with the amount of clearance.

Both f and n vary according to the nature of the surfaces and the speed. The friction increases as the surfaces become rougher. The friction of a smooth disk in a rough case is about the same as that of a rough disk in a smooth case.

The addition of ribs to one of the disks gave an increase in the power consumed, the loss being greater as the ribs were made deeper. This proves the shrouded type of impeller to be better than the open type.

71. Approximate Formulas.—Equations (60) and (61) are a little tedious to use and for many purposes it may be sufficient to use approximate formulas. Inserting the diameter of the impeller D in inches and taking $n = 2.00$ we have

$$\text{H.p.} = \frac{fN^3D^5}{1,515,000,000,000} \quad (62)$$

Since we have used a value of n that is larger than the average we shall offset this roughly by selecting a value of f that is too small. With $f = 0.002$ we have

$$\text{H.p.} = \frac{N^3D^5}{760,000,000,000,000} \quad (63)$$

Since $u_2 = \phi \sqrt{2gh}$ and also $u_2 = \pi DN/720$, we may insert values of h in (63) and obtain

$$\text{H.p.} = \frac{\phi^3 h^{1.5} D^2}{122,000} \quad (64)$$

$$\text{H.p.} = \frac{27.5 \phi^5 h^{2.5}}{N^2} \quad (65)$$

72. Conclusions.—It is desirable to use a shrouded impeller rather than an open type. The impeller should be polished or made as smooth as is feasible. The interior of the case should also be painted so as to give it a smooth surface. All clearances, either side or radial, should be small.

Either equation (64) or (65) shows that for a given head it is desirable to use a small diameter of impeller at a high rotative speed in order to minimize the disk friction.

An impeller with a steep characteristic must have a higher value of ϕ for a given head. For such a case the disk friction must be greater than that of a corresponding pump with a flat or a rising characteristic.

73. PROBLEMS

1. In the experiments a 12-in. polished brass disk in a rough cast-iron case absorbed 1.11 h.p. at 1,500 r.p.m. See how close you come to this quantity by using values from Table 3 and the various formulas that may be applied. ($b = 0.0167$ ft.)

2. What will be the power consumed by a 6-in. polished brass disk in a rough cast-iron case when running at 3,000 r.p.m.? (b same as in (1)).

3. Assuming $\phi = 1.0$, what is the disk friction of a 12-in. impeller developing a head of 150 ft.?

4. Assuming $\phi = 1.0$, what is the disk friction of an impeller developing a head of 160 ft. when running at 2,000 r.p.m.

* The powers of h may be found very conveniently on the slide rule by noting that $h^{1.5} = h\sqrt{h}$ and $h^{2.5} = h^2\sqrt{h}$.

CHAPTER VIII

FACTORS AFFECTING EFFICIENCY

74. Efficiency of a Single Pump.—The maximum efficiency of a certain pump was found to be different at different speeds as may be seen in Fig. 72. It is now proposed to show why the efficiency of a pump is not independent of the speed. It will probably be true that the hydraulic efficiency will be a constant quantity or at most vary but little. This will be the case, since, as is pointed out in Art. 39, the losses of head are proportional to the squares of the velocities. But the squares of the velocities concerned are in direct proportion to the head developed. Thus both the hydraulic losses and the water-power output of the pump follow the same law, that is they vary as the three halves power of the head developed (the rate of discharge varies as the square root of the head), or as the cube of the pump speed. We might conclude the same thing from equation (50) which is independent of any fixed values of head or speed. If the mechanical losses followed the same law as the hydraulic losses, then the gross efficiency would also remain constant, since the input and output of the pump would vary in the same ratio.

But the mechanical losses do not vary as the cube of the speed. For the Worthington turbine pump for which Fig. 71 was constructed, the power lost in bearing and gland friction will be approximately represented by

$$\text{H.p.} = 0.0000384N^{1.39}$$

Since the bearing and gland friction does not increase as rapidly as the water horse-power with an increase in speed, it will become of less percentage value. By the approximate formula for disk friction, equation (63), it might be thought that the disk friction varied at the same rate as the hydraulic quantities, but the more accurate formula, equation (61), together with the values of f and n in Table 3, will show that the disk friction increases at a lower rate than the cube of the speed. Thus the total mechanical losses will become of less percentage value

as the speed increases. In order to illustrate this point, Table 4 is presented. The pump to which these values apply is the Worthington turbine pump of Chapter VI. (See Fig. 72.)

TABLE 4

Speed	700 r.p.m.	1,700 r.p.m.
Bearing friction.....	0.35 h.p.	1.20 h.p.
Disk friction.....	0.27 h.p.	3.00 h.p.
Hyd. losses and leakage.....	0.29 h.p.	4.40 h.p.
Water horse-power.....	0.75 h.p.	10.70 h.p.
Brake horse-power.....	1.66 h.p.	19.30 h.p.
Hyd. and vol. efficiency.....	0.708	0.708
Mechanical efficiency.....	0.627	0.783
Gross efficiency.....	0.443	0.555

From this it might be inferred that the higher the speed, the higher the efficiency, and that the gross efficiency would approach the hydraulic efficiency as a limit. But experiment shows that the efficiency does not increase for speeds above 1,700 r.p.m. in the case of this particular pump, but falls off slightly instead. The explanation of this drop of efficiency is that cavitation or some other phenomenon affects the operation of the pump. It may be seen in Fig. 66 that the point of maximum efficiency at 1,700 r.p.m. is at a discharge of 0.4 cu. ft. per sec. and the latter value of discharge is the one for which certain departures from assumed laws begin. It is certain that for any given pump the efficiency will begin to decline if the speed be carried high enough.

The general conclusion is that for any single pump the maximum efficiency of which it is capable will increase at a fairly rapid rate as the speed is increased above a very small value. For higher speeds the efficiency will change more slowly as the effect of the mechanical losses becomes of less percentage value. As the speed is still further increased the efficiency will attain a maximum value and then decrease, due to the introduction of some new source of loss.

75. Efficiency of a Series of Pumps.—The preceding discussion has been concerned with a single pump operated under various conditions. The remainder of this chapter will be devoted to a consideration of a series of pumps all alike in every

respect except for the one variable element whose effect upon the efficiency will be studied. By efficiency is meant the maximum efficiency of which any pump in the series is capable.

76. Type of Impeller.—By the term “type of impeller” is here meant the ratio of the diameter of the impeller to its width, that is D/B . (See Figs. 17 and 18.) An impeller for which this factor is large may be seen in Fig. 79, while one with a comparatively low value of the ratio is shown in Fig. 21.

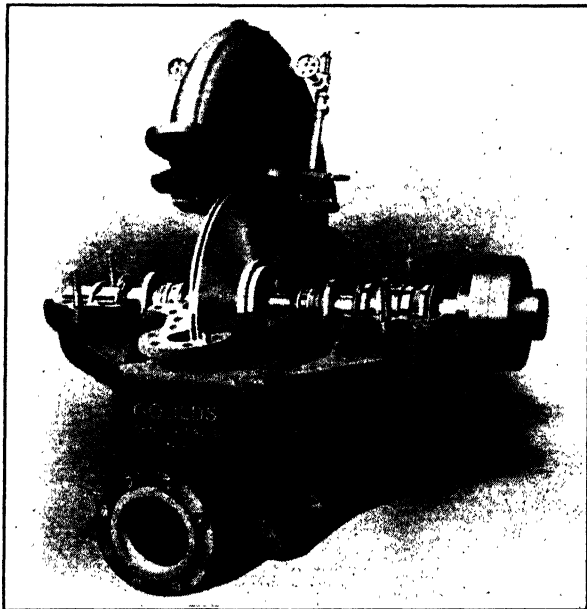

FIG. 79.—Centrifugal pump with narrow type of impeller.
(Goulds Mfg. Co.)

Since the head developed by an impeller is a function of the peripheral speed, it follows that it is possible to obtain a given head by a series of impellers of different diameters but running at different rotative speeds. In order that the discharge shall be the same it will be necessary to vary the width B in inverse proportion to the diameter D , so as to keep the discharge area the same. Thus we may attain a given head and discharge with a series of impellers of different “types.”

In the preceding chapter it is shown that for a given peripheral speed the disk friction will be less in the case of a small

diameter of impeller at a high rotative speed than for a large diameter of impeller at a low rotative speed. Therefore, so far as disk friction is concerned, we should expect the efficiency to be higher the smaller the value of the ratio D/B . That this is so may be seen in Fig. 80. This curve was drawn for a number of pumps of all sizes and styles so that scarcely no two pumps differ only in this one respect. Since the efficiency is also affected by other factors so that the effect of "type" is sometimes offset by other considerations, the points plotted will not all lie on a single curve.

If it is necessary to develop a high head per stage at a low rotative speed, it will be impossible to secure a low value

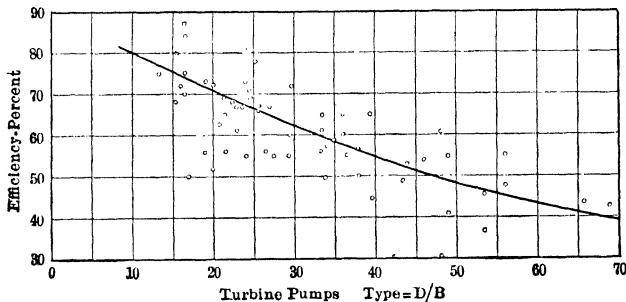

FIG. 80.—Efficiency as a function of impeller type.

of the "type," unless the rate of discharge should also be very large. But even in that event, the type will not be as small as it would if a higher rotative speed could be employed.

77. Efficiency—Capacity.—The efficiency of a centrifugal pump is a function of the capacity, head, and speed but the most important in its effects is the capacity.¹ This is so much so that the efficiency is sometimes given as a function of the capacity to the exclusion of other quantities.

Suppose that a series of impellers of the same diameter are of similar design so that they develop the same head when running at the same speed, but that their widths are different so that their capacities are different. The mechanical losses increase slightly as the capacity increases due to the larger shaft diameter and weight necessary while the disk friction and the leakage losses will be approximately the same for all of them. The hy-

¹ The three factors together really involve the "type."

draulic losses in each case will vary at about the same rate as the quantity of water discharged, therefore the hydraulic efficiency may be said to remain constant. Actually the hydraulic efficiency will increase slightly as the capacity increases, since it is well known that the friction of water flowing through large

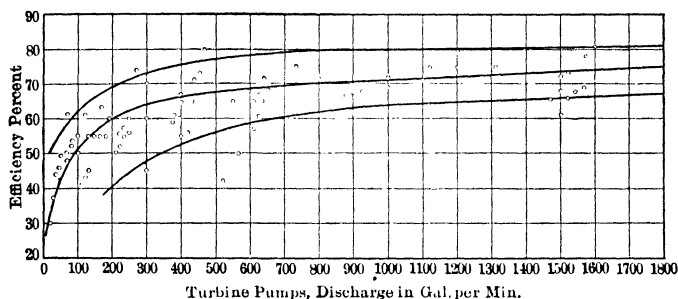

FIG. 81.—Efficiency as a function of capacity.

passages is less than through smaller passages. Thus as the capacity increases the hydraulic efficiency increases slightly, the mechanical and the volumetric efficiency increase considerably.

For an illustration let us consider the Worthington pump for which the curves in Chapter VI were constructed. At 1,700

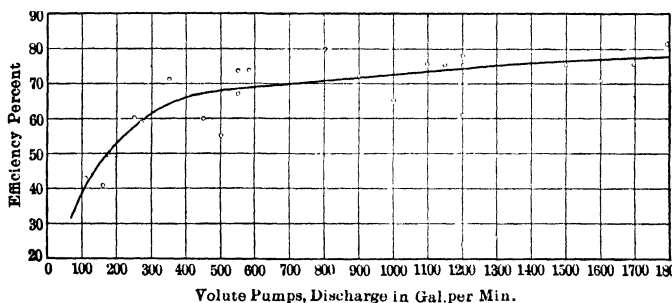

FIG. 82.—Efficiency as a function of capacity.

r.p.m. that pump delivered 0.4 cu. ft. of water per sec. at a head of 237 ft. Let us estimate the efficiency of another pump of similar design but capable of delivering ten times as much water at the same speed and head. This means that the width of the second impeller must be 2.5 in. instead of the 0.25 in. as in the present pump. The comparison is shown in Table 5.

TABLE 5

Discharge, cu. ft. per sec.	0.40	4.00
Bearing friction.....	1.20 h.p.	4.20 h.p.
Disk friction.....	3.00 h.p.	3.00 h.p.
Leakage loss.....	2.00 h.p.	2.00 h.p.
Hydraulic losses.....	2.40 h.p.	23.00 h.p.
Total losses.....	8.60 h.p.	32.20 h.p.
Water horse-power.....	10.70 h.p.	107.00 h.p.
Brake horse-power.....	19.30 h.p.	139.20 h.p.
Hydraulic efficiency.....	0.817	0.823
Volumetric efficiency.....	0.867	0.985
Mechanical efficiency.....	0.782	0.948
Gross efficiency.....	0.555	0.769

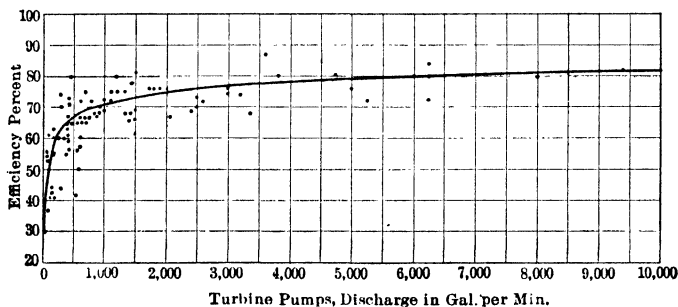

FIG. 83.—Efficiency as a function of capacity.

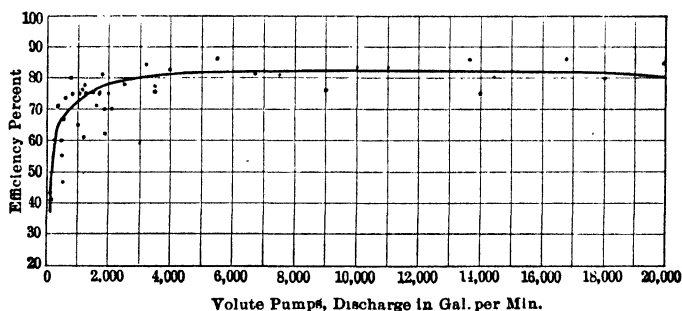

FIG. 84.—Efficiency as a function of capacity.

For a number of pumps of all varieties average efficiency curves against capacity are shown in Figs. 81, 82, 83, and 84. Two scales have been used in order that values of efficiency for the usual moderate discharges may be readily obtained, and on the other hand to show the entire field covered. As there is some

dispute concerning the relative merits of turbine and volute pumps, the efficiency curves for the two have been plotted separately. The points plotted would seem to indicate that the turbine pumps are more generally used for the smaller discharges and the volute pumps for the larger. It may also be seen that the volute pumps run up into much larger capacities than the turbine pumps.

A few values that are off the scales of these curves are: For a turbine pump of 28,530 *G.P.M.* capacity the efficiency was 81 per cent. For volute pumps of 24,000, 26,900, 125,500, and 132,000 *G.P.M.* capacities the efficiencies were 66.0, 72.0, 65.0, and 77.5 per cent. respectively.

78. Efficiency—Head.—For the single pump in Art. 74 the efficiency decreased as the speed, and consequently the head,

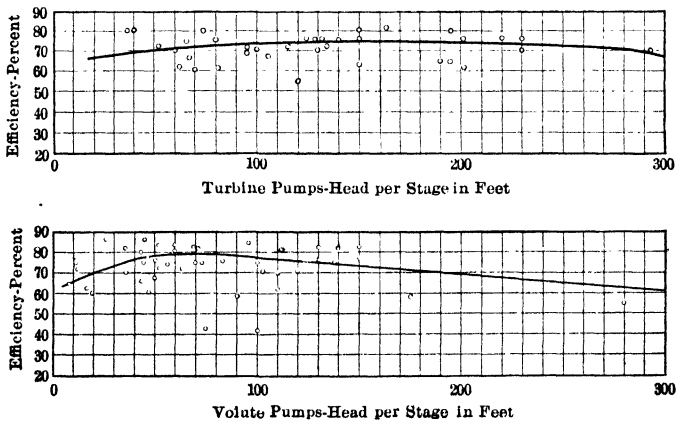

FIG. 85.

decreased. But the rate of discharge decreased also. We wish now to determine the effect of the head upon a series of pumps where the rate of discharge is the same for all of them. We shall assume that the impellers are to be of the same diameter, therefore it will be necessary for the rotative speeds and the impeller widths to be different.

Let us illustrate the case by considering the Worthington pump with 12-in. impellers running at 1,700 r.p.m. and delivering 0.4 cu. ft. of water per sec. against a head of 237 ft. Let us assume that a pump of similar design, but with a wider impeller, is to deliver the same quantity of water against a head of 118.5

ft. From the curves in Fig. 72 the speed will be found to be 1,200 r.p.m. Since the impeller passages are somewhat wider, the hydraulic losses ought to be of a slightly smaller percentage value but we shall assume that they are the same. The two cases may be seen in Table 6.

TABLE 6

Head	237 ft.	118 7 ft.
Speed	1,700 r.p.m.	1,200 r.p.m.
Discharge	0.4 sec. ft.	0.4 sec. ft.
Bearing friction	1.20 h.p.	0.72 h.p.
Disk friction	3.00 h.p.	1.06 h.p.
Leakage loss	2.00 h.p.	0.71 h.p.
Hydraulic friction	2.40 h.p.	1.20 h.p.
Total losses	8.60 h.p.	3.69 h.p.
Water horse-power	10.70 h.p.	5.35 h.p.
Brake horse-power	19.30 h.p.	9.04 h.p.
Gross efficiency	0.555	0.592

This table shows that for the lower head the efficiency is somewhat higher. If the rotative speed had been left unchanged and the diameter reduced to obtain the same rate of discharge we should have obtained a still more favorable result for the "type" of the impeller would have been smaller.

The curves in Fig. 85 indicate that the efficiency tends to decrease as the head becomes higher. This is often offset, however, by the fact that the discharge under a high head is also large. As has been shown, this would improve the efficiency. The curves indicate that the greater number of volute pumps are used for heads per stage of 150 ft. or less, while with turbine pumps many of them run up to 200 ft. per stage or more.

Some values off the scale are: For turbine pumps, heads of 498.6 ft. and 863 ft. showed efficiencies of 81 per cent. and 60 per cent. respectively. For a volute pump an efficiency of 60 per cent. was reached under a head of 700 ft.

Taking these extensions into consideration, the curves indicate that good efficiencies may be obtained even though the head per stage be high.

79. Efficiency—Speed.—In order to vary the speed of a series of pumps for a given head and discharge, it would be necessary to reduce the diameter and increase the width as the speed is increased. This would result in reducing the value of the ratio

D/B , which has already been considered in Art. 76. We should thus see that increasing the rotative speed of a pump for a given head and discharge would tend to improve the efficiency.

It would be possible to illustrate this case with a tabular analysis as in the preceding, but it is hardly worth while. The reason for the change in efficiency is that the disk friction is much less for the smaller diameter of impeller running at the higher speed.

For a given diameter of impeller the speed for a fixed head may also be varied by changing the impeller vane angle and thus changing ϕ . But if the speed is reduced by this method, so as to reduce disk friction and bearing friction, the hydraulic losses tend to become greater, owing to the difficulty of transforming the kinetic energy into pressure energy.

80. Efficiency— $G.P.M./\sqrt{h}$.—The factor $G.P.M./\sqrt{h}$ is a very useful factor in the classification of centrifugal pumps. By

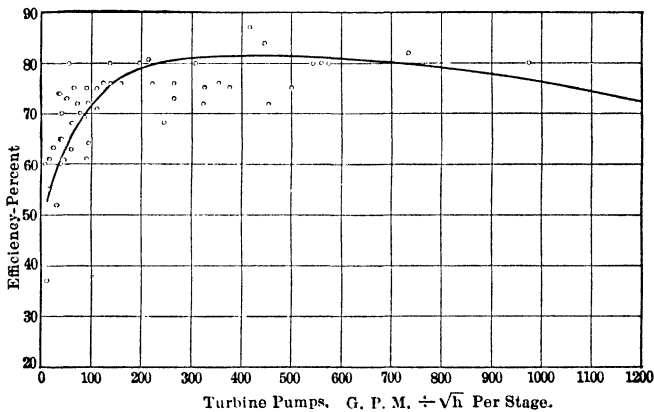

FIG. 86.

$G.P.M.$ is meant the rate of discharge in gallons per min. at which the efficiency is a maximum and h is the corresponding head per stage. It may be perceived that the value of this factor is constant for a given impeller regardless of the actual speed, head, and discharge under which it may be run, providing the head and discharge are the best for that speed.

We have seen that the tendency is for the efficiency to increase with the capacity of the pump and to decrease with the head. Thus we may represent the efficiency as a function of the ratio

of $G.P.M./\sqrt{h}$. We should thus assume that good efficiencies might be obtained even under very high heads per stage if the discharge were large enough to give us a reasonably high value of this factor.

Average curves of efficiency against this factor may be seen in Figs. 86 and 87. It may be seen that higher values of the ratio are found with the volute type of pump. There were numerous values that were off the scale of the curves. For the turbine pump an efficiency of 81 per cent. was had with a value of 1,280. For volute pumps we have values of 2,320, 3,290, 3,660, 6,770, 7,700, 39,800, and 44,400 with efficiencies of 80.0, 86.0, 66.0, 82.0, 72.0, 77.5, and 65.0 per cent. respectively.

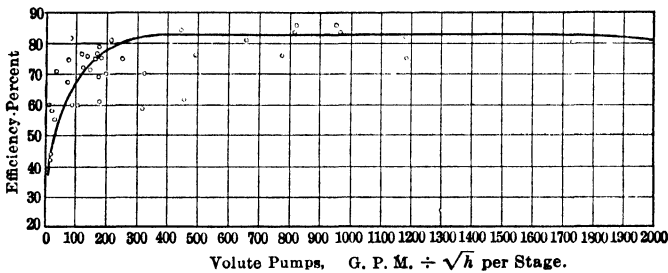

FIG. 87.

81. Efficiency—Specific Speed.—Specific speed will be here merely defined as $N\sqrt{G.P.M.}/h^{3/4}$,* where h = the head per stage. The derivation of this expression and its meaning will be given in Art. 102. This factor is seen to involve all of the three variables of which the efficiency is a function. It will also be found to involve the “type” of the impeller. It will be constant in value not only for a single impeller at any speed but for a whole series of impellers of homologous design, such that each impeller is merely an enlargement or reduction of another, possessing the same proportions and angles.

Efficiency curves against specific speed are seen in Figs. 88 and 89. It may be seen that the volute pumps tend to higher specific speeds than the turbine pumps. It must be borne in mind that a large impeller and a small impeller of the same

* Values of this power of h may be conveniently found on the slide rule by noting that

$$h^{3/4} = h \div h^{1/4} = h \div \sqrt{\sqrt{h}}$$

See table in Appendix C.

homologous series will have the same value of N_s , but we should not expect their efficiencies to be identical. Thus these curves merely show the general tendency of this factor to affect the efficiency without enabling us to pick absolute values. Thus with the turbine pumps a specific speed of 1,000 would give us a range of efficiencies from 50 to 80, depending upon the actual

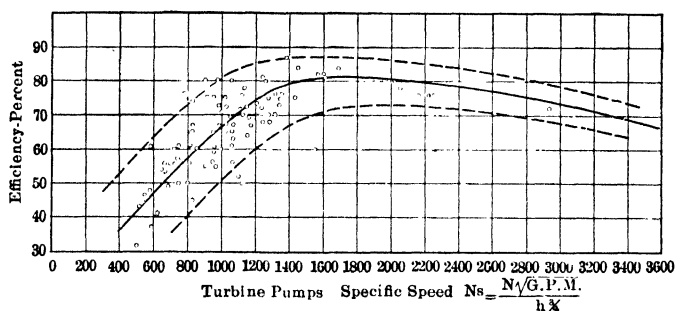

FIG. 88.—Efficiency as a function of specific speed.

capacity of the pump. But of two pumps of identical capacities, for example, one having a specific speed of 1,600 might be expected to have a better efficiency than one whose specific speed was 800.

82. Pumps with High Specific Speeds.—It may be seen that low values of specific speed are obtained with impellers for which the ratio D/B is large, as such an impeller will have either a low

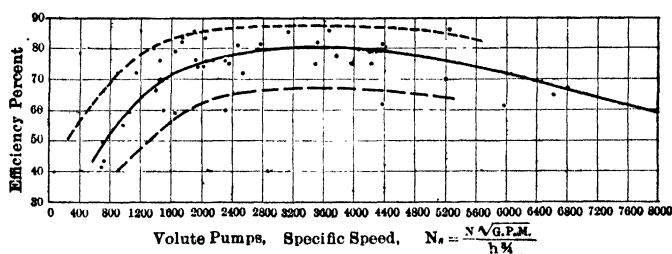

FIG. 89.—Efficiency as a function of specific speed.

rotative speed or a low discharge for a given head. But, as has been shown in Art. 76, such pumps are undesirable from the standpoint of efficiency. The curves in Figs. 88 and 89 also show that low efficiencies are to be expected with very small values of the specific speed. Therefore there is no effort made to produce pumps with low specific speeds.

But an effort is being made to produce centrifugal pumps with high specific speeds as such pumps are desirable for connection to steam turbines and high-speed motors. It may be seen that, if the capacity is large and the head low, a very high value of the specific speed would be necessary unless the rotative speed is very low. Such a combination is often required in pumps for supplying condensing water and similar services. We might conclude that the higher the specific speed, the higher the efficiency, but such is not the case as the curves in Figs. 88 and 89 will show. The reason is that after we pass a certain point it is

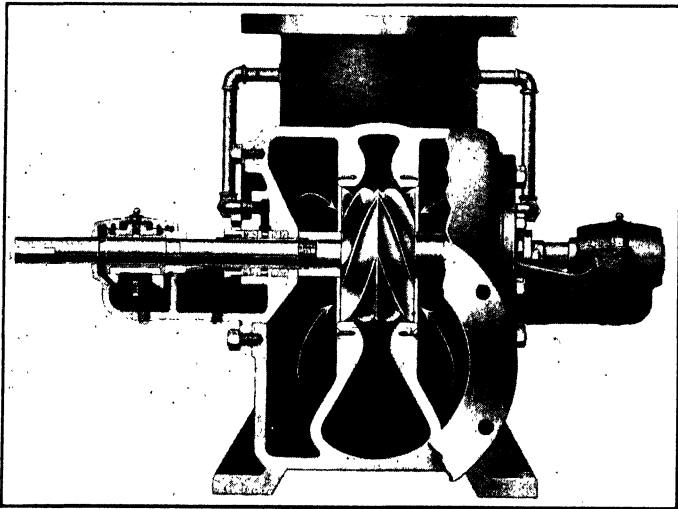

FIG. 90.—Centrifugal pump with a helicoidal impeller. (*McEwen Bros.*)

necessary to sacrifice certain desirable features in design in order to increase the capacity of an impeller without increasing its diameter and hence reducing the speed. But the value of a high rotative speed with a large discharge under a low head is often such as to permit some sacrifice of efficiency.

It may be seen that to increase the specific speed of an impeller we may change the impeller vane angle and we may also decrease the value of the ratio D/B . But this obviously must have some physical limit since the diameter of the eye of the impeller must be less than D with the usual construction and a certain minimum area of the impeller eye is required for a given rate of discharge. For this reason double suction impellers may

have much smaller values of the ratio D/B than single suction impellers and consequently higher specific speeds.

In an effort to produce a high-speed pump the helicoidal impeller shown in Fig. 90 has been developed.¹ The small size of the complete pump may be seen in Fig. 91. By this form of construction the entire diameter of the impeller is available for the admission of water or is equivalent to the eye of the ordinary

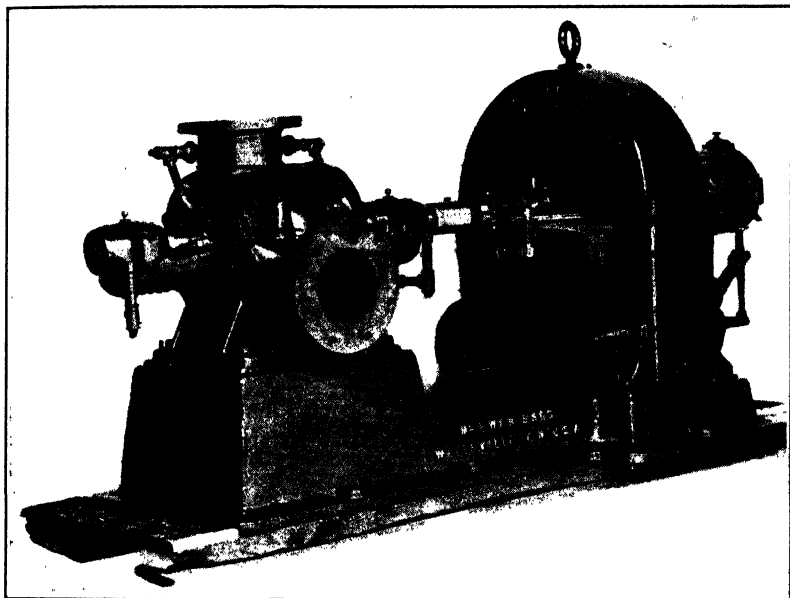

FIG. 91.—Steam turbine driven pump with helicoidal impeller.
(McEwen Bros.)

impeller. An 8-in. pump of this type with an impeller 6 in. in diameter delivered 1,200 *G.P.M.* against a head of 47 ft. at a speed of 3,100 r.p.m. A 30-in. pump with an impeller of 18 in. diameter delivered 24,000 *G.P.M.* under a head of 43 ft. at a speed of 1,500 r.p.m. The specific speeds were 5,980 and 13,850 respectively. The efficiencies were 61 and 66 per cent. respectively. While these values are a little low yet it must be borne in mind that for direct connection to steam turbines, the greater steam economy of the turbine under the higher speeds will compensate for this.

¹ C. V. Kerr, "A New Centrifugal Pump with Helicoidal Impeller," *Journal A.S.M.E.*, Vol. 35, p. 1495, Oct. 1913.

Since the capacity of the usual type of impeller for a fixed rotative speed and head is limited, the conditions of a large discharge under a low head are sometimes met by the multi-impeller type of pump shown in Fig. 92. With this construction we have two or more impellers mounted within the same case so that the total capacity is divided up among them. This makes it possible for the pump as a whole to have a higher value of the specific speed than would be possible with a single impeller.

83. Effect of Number of Stages.—With a multi-stage pump the velocity of the water passing from one stage to the other is kept high. This eliminates the losses that inevitably re-

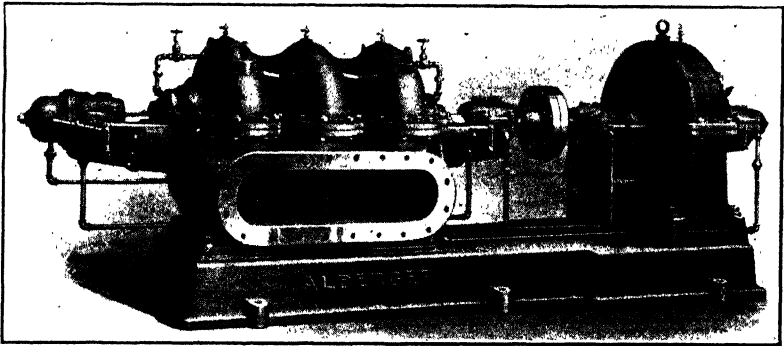

FIG. 92.—Multi-impeller centrifugal pump. (*Alberger Pump and Condenser Co.*)

sult when the velocity is reduced. Thus the loss between stages is less than the loss that accompanies the transformation of kinetic energy into pressure at discharge from the last impeller into the case. Therefore the efficiency of the intermediate stages is higher than that of the last stage. But the efficiency of the last stage is practically that of a single-stage pump. From this it follows that the efficiency of a single-stage pump is less than that of a multi-stage pump with the same speed, discharge, and head per stage. Also it may be seen that the efficiency is higher the greater the number of stages, providing always that the speed and head per stage is the same.

In the preceding paragraph the rotative speed and head per stage were the same for all cases and the total head developed by the pump varied as the number of stages. We shall now consider the more usual case where the capacity and the total

head is fixed and the head per stage and the rotative speed may be varied according to the number of stages employed. This case can be settled only by a consideration of the specific speed, $N\sqrt{G.P.M.}/h^{3/4}$. The curves in Figs. 88 and 89 show that a certain range of values of specific speed is conducive to favorable efficiency. We shall thus divide the total head up among the proper number of stages to get the best value of specific speed, if high efficiency be our primary object. In any event we can determine the relative merits of different numbers of stages by computing values of specific speed and comparing with the average curves shown.

Increasing the number of stages for a given capacity and total head results in a higher value of the specific speed. Thus where the capacity is small and the total head is high a multi-stage pump is more desirable than a single-stage pump. But for the case where the capacity is large and the head very low the specific speed must necessarily be high even for a single stage. If the specific speed is excessively large the only remedy is to resort to some special type of pump as in Art. 82 or to divide the water among several pumps. The latter is what the multi-impeller pump does.

84. Summary.—For a single centrifugal pump the maximum efficiency possible is not quite independent of the speed but increases as the speed increases. However, after a certain value of the speed is reached, the efficiency will begin to decrease.

For a series of centrifugal pumps the efficiency will be higher as the capacity of the pump is greater, providing other conditions are favorable.

The efficiency of centrifugal pumps increases as the head becomes less, the capacity remaining the same. This statement is true only within certain limits.

For a given head and discharge the efficiency is greater as the rotative speed is greater up to a certain limit. This is because the "type" of the impeller is becoming smaller in value. But after a certain point desirable features of design must be sacrificed in order to secure the higher speed.

The variation of efficiency for different pumps may be more properly represented as a function of the factor $G.P.M./\sqrt{h}$ or the factor $N\sqrt{G.P.M.}/h^{3/4}$, where h is the head per stage. The curves in Figs. 86, 87, 88, and 89 will enable us to properly interpret the above statements and to roughly fix the limits

between which they are true. Efficiency may be sacrificed by employing pumps for which these factors are either too high or too low. Thus, although in general the efficiency of a pump increases as the capacity increases, if the speed and head are not suitable the efficiency may suffer, since the specific speed may not have a suitable value.

We thus see that a favorable efficiency may be had even with pumps of small capacity providing the speed is sufficiently high and the head sufficiently low. But a much better efficiency may be had for a large capacity pump with the same specific speed. But to obtain that it is necessary that the speed should be relatively low and the head moderately high. To obtain a large capacity at a high speed under a low head involves difficulties that can be met only by certain special constructions and the efficiency is not likely to be as high as for smaller capacities under the same conditions. The centrifugal pump is not adapted to delivering small quantities under high heads, but a good efficiency may be had under a high head provided the capacity is also large.

In all of this discussion we are concerned with the head developed by a single impeller, not the total head developed by a multi-stage pump. If the value of specific speed is not favorable to good efficiency, we may sometimes improve the conditions by dividing up the total head into various numbers of stages.

85. PROBLEMS

1. At 800 r.p.m. the mechanical efficiency of a certain centrifugal pump is 90 per cent. If the total mechanical losses (bearing friction and disk friction) vary as the square of the speed, what is the mechanical efficiency at 1,600 r.p.m.?

Ans. 0.948.

2. If the gross efficiency of the pump in (1) is 72 per cent. at 800 r.p.m., what will it be at 1,600 r.p.m.?

Ans. 0.758.

3. If the capacity of the pump in Table 5 had been 6.00 cu. ft. per sec., what would its gross efficiency have been?

4. A pump is desired to deliver 500 *G.P.M.* against a head of 150 ft. Will a single-stage or a 2-stage pump give a better efficiency?

5. How many stages are necessary for the best efficiency to be obtained with a pump to deliver 2,000 *G.P.M.* against a head of 600 ft.?

Ans. 6 stages.

6. If a pump is to deliver 30,000 *G.P.M.* at a head of 100 ft., will a better efficiency be obtained with 1 or 2 stages?

7. Would a better efficiency be obtained with a single impeller or with two impellers in parallel for a discharge of 30,000 *G.P.M.* under a head of 100 ft.

8. It is desired to deliver 220 *G.P.M.* against a head of 400 ft. at 3,600 r.p.m. What will be the values of the specific speed for 1 stage and for 2 stages?

Ans. 597 and 1,000 respectively.

9. Which will give the better efficiency in (8)?

10. How many stages would be necessary in (8) for a specific speed of about 2,000? Would this be desirable?

Ans. 5 stages.

11. A single-stage single-impeller pump delivers 6,700 *G.P.M.* at a head of 60 ft. when running at 1,140 r.p.m. Would there be any gain in efficiency by making this a 2-stage pump on the one hand or by dividing the discharge between two impellers, the rotative speed being the same?

12. If it were desired to deliver 6,700 *G.P.M.* at 60 ft. head at 3,000 r.p.m., what type of pump would be used?

13. The efficiency of a single-stage centrifugal pump delivering 1,200 *G.P.M.* against a head of 100 ft. at 1,500 r.p.m. is 70 per cent. Would the efficiency of a 6-stage pump delivering 1,200 *G.P.M.* against a head of 600 ft. at 1,500 r.p.m. be any greater or less than 70 per cent.?

CHAPTER IX

CENTRIFUGAL PUMPS VS. DISPLACEMENT PUMPS

86. Relative Speeds.—As a general proposition displacement pumps must run at slower rotative speeds than centrifugal pumps. In the days of the slow-speed steam engine the former was therefore more suitable for the prime movers then in use. But with the introduction of the electric motor and the small high-speed steam turbine the displacement pump proved to be less suitable for the conditions than the centrifugal pump.

87. Comparative Size.—For the same service the centrifugal pump will be much smaller than the reciprocating pump. Due to its higher speed the motor or prime mover may also be much smaller in size. The only exception to this would be for a pump handling a small quantity of water against a high head. In such event the size of the two types would be about the same, in fact for an extreme case the displacement pump might be smaller.

88. Comparative Efficiency.—For the conditions to which the centrifugal pump is adapted it is probable that its efficiency will be as high as that of the displacement pump, for the same conditions. This will be especially true after some length of service as the efficiency of the centrifugal pump will not deteriorate as rapidly as that of the displacement pump. In other cases that are unfavorable to the efficiency of the centrifugal pump it may still prove to be true that it is preferable on account of overwhelming advantages in regard to characteristics, cost, size, and other factors.

Also when the economy of the pump and motor are considered together, the overall efficiency will be more likely to be better for the direct-connected centrifugal pump than for the slower speed reciprocating pump with intervening gearing or belt drive. An exception to this statement might be found in the case of large pumping engines. For such units the slow-speed steam engines direct connected to displacement pumps will be found to

CENTRIFUGAL PUMPS VS. DISPLACEMENT PUMPS 129

give a greater steam economy. Whether this is of value or not depends upon the relative values of the first costs.

89. Comparative Cost.—The cost of a centrifugal pump will be less than that of a displacement pump except for the case of a very small capacity. In general its cost may be said to be about one-third that of the displacement pump for high lifts and less than one-third for low lifts. Some figures that were compiled for a few cases are given in Table 7.

TABLE 7¹

G.P.M.	Head, ft.	Centrifugal pump and motor		Reciprocating pump and motor	
		H.p.	Cost	H.p.	Cost
167	750	60	\$1,365	55	\$2,480
300	400	52	875	55	2,340
300	100	14	535	20	1,510
700	607	190	1,900	180	7,980

When the total cost of pumping, which includes interest on investment, is considered it may be found that the centrifugal pump will be more economical even though its efficiency might happen to be lower.

90. Comparative Characteristics.—If a centrifugal pump is run at a constant speed the amount of water discharged varies as some function of the head. It is possible to shut off the flow of water entirely without causing the pressure to rise above a certain value. With a displacement pump it is quite different. Neglecting the variation in the slip under various heads, the rate of discharge for a displacement pump must always be the same for a constant speed regardless of the head. If the discharge valve is closed the pump will be stopped or something will burst. If the pump is stopped, the pressure obtained will depend upon the maximum force that the prime mover is capable of exerting on the water piston.

For the centrifugal pump to work efficiently under various heads it is necessary to vary the speed of the pump in direct proportion to the square root of the head. The normal capacity of the pump is also affected when the speed is varied.

With the displacement pump, on the other hand, there is no relation between head and discharge. The head that the pump

¹ Proc. of Inst. of Mech. Eng., 1912, page 7.

is capable of working under depends solely upon the strength of its construction and the power of the prime mover to operate its piston against the pressure applied. The speed has nothing to do with the head. In fact the pump may maintain pressure when it is not moving. But the capacity of a displacement pump varies directly as its speed.

91. Advantages of Centrifugal Pumps.—The centrifugal pump has the great advantage over reciprocating pumps of simplicity, reliability and ease of operation. It is apt to be much more durable than the displacement pump, especially if the water contains sand or grit. The centrifugal pump is able to handle water containing sand or gravel and even fair-sized rocks, an impossibility for the other type of pump.

Another important feature is that the discharge is smooth and continuous and free from the shock and pulsations that are encountered with the reciprocating pump. Since the pump is more free from vibrations itself, it does not require as substantial foundations.

It has already been pointed out that the centrifugal pump usually possesses the merits of a higher speed, occupying less space, being lighter in weight, and costing less. The fact that the discharge from the pump may be shut off by merely closing a valve in the discharge pipe without dangerous pressures being produced or requiring the motor to be shut down is often of great value.

The overall efficiency of a centrifugal pump set is often better than that of a reciprocating pump set. Even in cases where the efficiency is less, the cost of pumping, when interest on the investment is considered, may not be as much as for the displacement type.

92. Advantages of Displacement Pumps.—For very high heads, especially where the capacity is small, the displacement pumps have all the advantages in their favor. For other situations they may have a greater economy in some instances. Also they are able to lift water from below them at starting without being primed. The fact that there is no relation between head and discharge is often an advantage in their favor. Where either the head or the discharge are required to vary within wide limits and where they do not maintain definite relations with each other, the displacement pump will be found to be more flexible and more economical.

93. PROBLEMS

1. Where a pump is required to supply water to a boiler under a constant pressure of 200 lb. per sq. in. and the rate of pumping will vary from 30 to 50 *G.P.M.* which type of pump is more suitable, the displacement or the centrifugal? Why?

2. If a pump is required to supply a constant amount of water while the head may vary from 10 ft. to 80 ft. which type of pump is more suitable?

CHAPTER X

COMPARISON OF TYPES OF CENTRIFUGAL PUMPS

94. Maximum Efficiency of Turbine vs. Volute Pumps.—It is usually stated that the volute pump is very good for low heads but is inefficient under high heads and that for the latter we should resort to the turbine pump. The reason why the value of the head enters the question is that it is necessary to transform a greater per cent. of the kinetic energy of the water leaving the impeller into pressure with high heads than with low heads. It is never all converted into pressure because the water must possess a certain amount of kinetic energy as it flows away from

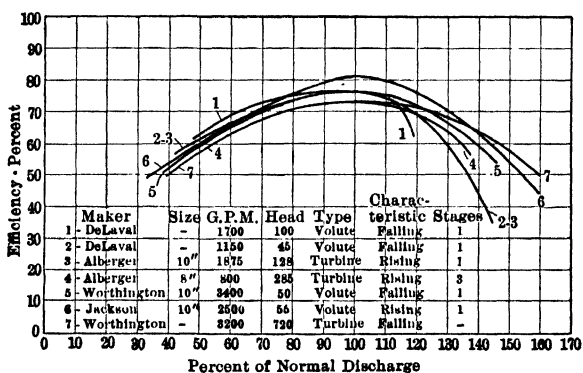

Fig. 93.—Efficiency curves of various types of centrifugal pumps.

the case into the discharge pipe. Since the difference between the two pumps is in the method of converting this energy and since it is held that the turbine pump can do it more efficiently, the above statement is made.

The various efficiency curves in Chapter VIII do not show any material differences between the efficiencies attained with turbine and volute pumps. Heads of 300 and even 500 ft. per stage are sometimes found with volute pumps and the accompanying efficiencies are usually as good as one would have reason to

expect. In Fig. 93 the volute pumps for the most part appear to attain slightly higher efficiencies than the turbine pumps.

The safe conclusion to draw from the evidence at hand would be that there is no marked difference between the maximum efficiencies of the two types of centrifugal pump. With properly proportioned volute passages it may be possible to attain as good results with the volute pump as with the turbine pump. The fact that such has not been the case in past experience may be attributed to the failure of designers to grasp the correct solution since the volute is not so amenable to mathematical analysis as are diffusion vanes.

In view of the marked superiority of volute pumps in regard to size, simplicity, and cheapness, it is evident that, when their design is perfected, they will be more widely used for high-grade installations.

It should be noted, however, that the general tendency of practice, as shown by the points plotted on the various diagrams of Chapter VIII, is to use the volute pump for the lower heads and at higher speeds, in other words with higher values of the specific speed. As has been pointed out, that alone is conducive to improved efficiency. Thus what the volute lacks, if anything, in regard to the conversion of the velocity head at exit from the impeller, it may make up to some extent by being generally designed for more favorable values of specific speed. The curves in Chapter VIII would, therefore, appear to indicate that for certain conditions the turbine pump would have a higher efficiency while for other conditions the volute pump would be superior.

95. Average Efficiency of Turbine vs. Volute Pumps.—It has been stated that the efficiency curve of the volute pump will be flatter than that of the turbine pump. Thus the average operating efficiency may be as good even though the maximum efficiency is less. The curves in Fig. 93 will not bear out this contention. The efficiency curves here are generally a little flatter in the case of the turbine pumps.

It would require a great deal of data to prove this point to be true. Such data are difficult to procure as the pumps should not differ widely in other respects. The only safe conclusion to draw from the evidence presented is that there is very little difference either in the maximum efficiencies or the average efficiencies of turbine and volute pumps.

96. Rising vs. Falling Characteristics.—Since the water horse-power for a pump with a rising characteristic will increase at a more rapid rate as the discharge increases than for a pump with a falling characteristic, it would be expected that the brake horse-power should also increase at a faster rate. Therefore, if a flat brake horse-power curve is desired, one should select a pump with a steep falling characteristic.

A pump with a steep falling characteristic will probably be better for service under conditions where the static head is apt to vary quite widely, while the speed of the pump is kept constant. Such cases might be found with a dry-dock pump or a condenser circulating pump drawing water from a stream whose level fluctuated.

A pump with a rising characteristic is considered better for service where the vertical lift is constant and where there is considerable friction head. When the pump is run at constant speed the head developed by the pump will then conform somewhat better to the demands of the lift than would be the case otherwise. It may be seen that for small discharges less throttling would be required than for a pump with a steep falling characteristic. (See Fig. 76.)

So far as the actual efficiency of the pump itself is concerned, there seems to be no systematic variation in efficiency between pumps with rising and falling characteristics. This would seem to show that the value of h'' dropped as rapidly as the value of h . As to whether a rising or a falling characteristic is secured is solely a question of the vane angle and the number of vanes.

97. PROBLEMS

1. From the various curves in Chapter VIII how do turbine and volute pumps compare as to efficiency for various capacities? For various heads?
2. What are apparently the best values of $G.P.M./\sqrt{h}$ for turbine and volute pumps respectively?
3. What are apparently the best values of specific speed for turbine and volute pumps respectively?
4. If a pump is required to deliver 500 $G.P.M.$ against a head of 100 ft. would a turbine or a volute pump apparently be better?
5. If a pump is required to deliver 10,000 $G.P.M.$ against a head of 100 ft. what type of pump would be better, the turbine or the volute?
6. A 2-stage pump is required to deliver 1,000 $G.P.M.$ under a head of 250 ft. at 1,400 r.p.m. Would a turbine or a volute pump be better?

7. A single-stage pump is to deliver 5,400 *G.P.M.* against a head of 130 ft. at 1,600 r.p.m. Would a turbine or a volute pump give a better efficiency?

8. A pump is required to deliver 5,000 *G.P.M.* approximately under a head which may range from 15 ft. to 25 ft. Would a rising or a falling characteristic be more desirable?

9. A pump is required to deliver water against a constant static head of 60 ft. through a long pipe line. If the rate of flow is to vary from 3,000 to 5,000 *G.P.M.*, would a rising or a falling characteristic be more desirable?

CHAPTER XI

GENERAL LAWS AND FACTORS

98. General Relations.—In the theory in Chapter V we have introduced the factors ϕ and c such that $u_2 = \phi\sqrt{2g\bar{h}}$ and $v_2 = c\sqrt{2g\bar{h}}$. These may also be rewritten as $h = (1/\phi^2)u_2^2/2g$ and $v_2 = (c/\phi)u_2$. It was also shown that for any single pump a certain definite value for ϕ and also for c was necessary for the maximum efficiency to be obtained, the exact values of ϕ and c , however, depending upon the design of the particular pump. But since these values are fixed and constant for any single pump it follows from the above that for the condition of maximum efficiency the speed and discharge of the pump should vary as the square root of the head, the water horse-power varying as the three-halves power of the head. It has been shown that the efficiency will not remain absolutely constant under these conditions, therefore the brake horse-power does not vary in quite the same ratio as the water horse-power. Also for the condition of maximum efficiency the rate of discharge will vary as the first power of the speed, the head as the square of the speed, and the water horse-power as the cube of the speed. The brake horse-power will not vary at the same rate as the water horse-power for the reasons shown elsewhere.

As a matter of fact the above relations need not be restricted to the case of maximum efficiency, but in applying these laws it is only necessary that ϕ and c shall be constant. It is not necessary for them to be the best values. For moderate ranges of speed the change in the gross efficiencies will be slight. Therefore a constant value of ϕ (and c) means an approximately constant efficiency. Thus in Fig. 94, assuming that ϕ and c have the same values for the points A , B , and C , it will be found that these three points are related in the manner given by the laws stated in the preceding paragraph.

Emphasis should be laid upon the fact that these relations may be applied only to points for which ϕ and c are the same, such as A , B , and C . It is frequently stated that the head developed by

a centrifugal pump varies as the square of the speed without its being recognized that the rate of discharge must vary at the same time, if such a law is to apply. If any one of the three factors of speed, head, or discharge is to remain constant or vary in some way so that ϕ and c cannot remain constant in value for a given pump, it is impossible to express the resulting relations in any simple way. For such a case equations (43) and (44) must be applied. The actual relations determined by test may be seen in the curves of Chapter VI.

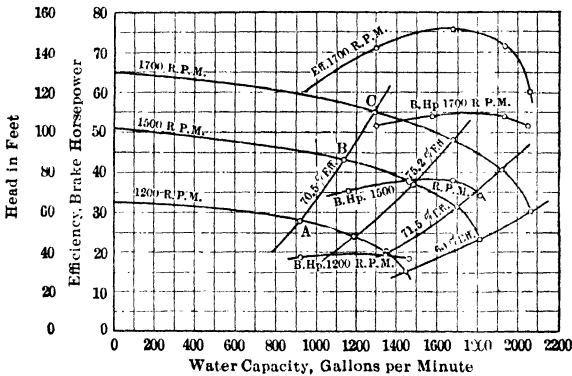

FIG. 94.

If the subscript (1) denotes values under 1 ft. head we may have for constant ϕ and c and approximately constant efficiency:

$$N = N_1\sqrt{h} \tag{66}$$

$$q = q_1\sqrt{h} \tag{67}$$

$$\text{W.h.p.} = (\text{w.h.p.})_1 h^{3/2} \tag{68}$$

If the prime (') denotes values at 1 r.p.m. we may have for constant ϕ and c and approximately constant efficiency:

$$q = q'N \tag{69}$$

$$h = h'N^2 \tag{70}$$

$$\text{W.h.p.} = (\text{w.h.p.})'N^3 \tag{71}$$

99. Values of ϕ and c for Maximum Efficiency.—In practically all the work in this chapter we shall be concerned only with the values of the various factors for which the gross efficiency is a maximum. It will thus be understood that, without any

* For convenience with the slide-rule it may be noted that $h^{3/2} = h\sqrt{h}$.

further qualification, all values of constants and values of head, speed, or discharge will be those for which the efficiency is a maximum under the conditions. (The rated head and capacity or normal head and capacity of a pump will be the values for which the efficiency is a maximum for any given speed. The maximum efficiency of which the pump is capable may be found at some other speed, however. If no speed is specified the values will be those at the speed for which the absolute maximum efficiency is found. Thus for the pump in Fig. 72 we should say that the normal head and discharge are 237 ft. and 0.4 cu. ft. per sec. at 1,700 r.p.m. But if 1,000 r.p.m. had been specified we should then say that the normal head and discharge were 80 ft. and 0.23 cu. ft. per sec. respectively.)

When using any of the factors given in this chapter the value of h should be the head per stage in the case of a multi-stage pump.

For purposes of design the value of $(c \sin a_2)$ is often more useful than the value of c alone. It is therefore given below. With many designs the value of ϕ for the maximum efficiency is usually not far from unity, but the following range may actually be found:

$$\begin{aligned}\phi &= 0.90 \text{ to } 1.30 \\ c &= 0.10 \text{ to } 0.30 \\ c \sin a_2 &= 0.05 \text{ to } 0.15\end{aligned}$$

100. Values of the Ratio D/B.—The points plotted in Fig. 80 show values ranging from 13.0 to 69.0. Double suction volute impellers for very high specific speeds may have even smaller values than this. It is probable that the maximum range that may be expected is

$$D/B = 2 \text{ to } 70$$

101. Impeller Diameter and Discharge.—The rate of discharge is not only proportional to the head developed but also to the outlet area of the impeller. The latter will vary with the design but for a series of homologous impellers, all alike in every respect save in question of size, the proportions and angles being the same, the area will vary with the square of the diameter. We may thus write

$$G.P.M. = K_1 D^2 \sqrt{h} \quad (72)$$

For a series of homologous impellers the value of K_1 would be approximately the same for all of them. As there would be

slight differences in finish and workmanship the results from impellers of the same patterns might not always be identical. Also in a series of all sizes there would be slight variations with the different sizes so that the series would not be strictly homologous. Thus there would be a slight variation in the value of K_1 for a series of impellers of the same general design. For impellers of different designs it may be seen that small values of K_1 are obtained with large values of D/B and vice versa.

For some purposes it may be useful to rewrite equation (72) as

$$G.P.M. = K'_1 D^3 N \tag{73}$$

Average values of these factors may be said to be:

$$K_1 = 0.09 \text{ to } 4.50$$

$$K'_1 = 0.000045 \text{ to } 0.00225$$

102. Specific Speed.—Since $u_2 = \phi\sqrt{2gh}$ and also $u_2 = \pi DN/720$, it may be seen that

$$\phi = 0.000543 \frac{DN}{\sqrt{h}} \tag{74}$$

or

$$N = \frac{1,840\phi\sqrt{h}}{D} \tag{75}$$

Since ϕ is constant for a series of homologous impellers, it follows that DN/\sqrt{h} is constant. This is often very useful, as it enables us to predict the performance of any impeller of a series if the head developed by any one under a given speed is known. Values of DN/\sqrt{h} may range from 1,660 to 2,400.

From (75) we obtain

$$D = 1,840\phi\sqrt{h}/N$$

From (72) we obtain

$$\sqrt{K_1}D = \sqrt{G.P.M.}/h^{3/4}$$

Substituting for the value of D in the second expression we have

$$\sqrt{K_1}1,840\phi\sqrt{h}/N = \sqrt{G.P.M.}/h^{3/4}$$

Letting N_s stand for the constant factors $(\sqrt{K_1}1,840\phi)$ and rearranging we have

$$N_s = \frac{N\sqrt{G.P.M.}}{h^{3/4}} \tag{76}$$

* To find this power of h on the slide-rule note that

$$h^{3/4} = h \div h^{1/4} = h \div \sqrt{\sqrt{h}}$$

See table in Appendix C.

This factor, called in this work the specific speed, will be found to be extremely useful. It serves as an index of the type of pump.¹ Its physical meaning may be seen as follows: If the head be reduced to 1 ft. we have $N_s = N_1\sqrt{G.P.M.}$. By then increasing or decreasing the diameter of the impeller we increase or decrease the capacity. But N_1 always changes in an inverse ratio so that the product of the two is constant and equal to N_s . If the size of the impeller be such that $G.P.M. = 1.0$, then $N_s = N_1$. That is, the specific speed is the actual r.p.m. at which an impeller of the series would run under 1 ft. head if it were of such a diameter as to discharge 1 gal. per min. under those conditions.

The physical meaning of N_s , however, is of little practical value. The important thing is that it is a factor involving the essential quantities with which we are concerned in selecting a centrifugal pump. The average curves of efficiencies that have already been given indicate that a certain range of values of specific speed is more favorable to efficiency than values either above or below that. Thus in selecting the speed, head per stage, or other conditions we may determine what are the best quantities to choose.

Also for a homologous series of pumps the specific speed will have the same value for all the impellers, regardless of their actual size. Thus if the conditions that are given for the pump fix a certain value of N_s , it is easily determined whether some certain impeller of a given series will be suitable or not.

The specific speed is an index of the type of impeller. Speed and capacity are merely relative terms. An impeller with a high rate of rotation is not necessarily a high-speed impeller

¹ A similar expression is given by Greene, "Pumping Machinery," but he uses q instead of $G.P.M.$. It is believed that the latter will be more useful in the formula, since pump capacities are generally given in gallons per min. It may be seen that values given by (76) are 21.2 times the value if q is used.

For a hydraulic turbine specific speed is defined as $N_s = N\sqrt{h.p.}/h^{3/4}$. It is easily seen that the capacity of a turbine or pump is also a measure of its power and that there is a fixed relation between the two. The expression involving horse-power is more useful for the turbine, since hydraulic turbines are rated according to horse-power. For the centrifugal pump the expression given will be found to be of greater value, since pumps are rated according to their capacities, not their power.

Other names applied to this factor for turbines are characteristic speed, unit speed, and type characteristic.

for its capacity may be very small and the head high. We may classify an impeller as a high-speed impeller only when its actual speed is high as compared with other impellers for the same capacity under the same head. All of these relations are covered by $N\sqrt{G.P.M.}/h^{3/4}$. A high-speed impeller will have a high value of N_s , though its actual r.p.m. may be low, while a low-speed impeller will have a low value of N_s , though its actual r.p.m. might happen to be high.

For an impeller, either single suction or double suction, values of specific speed may be found between the following limits:¹

$$N_s = 500 \text{ to } 8,000$$

For a special form such as the helicoidal impeller (Fig. 90) the specific speed may be even higher. The above values apply only to single-stage single-impeller pumps. For a multi-impeller pump it is necessary to divide the total pump capacity by the number of impellers to obtain the proper quantity for use in the formula. Likewise for multi-stage pumps the total head should be divided by the number of stages to obtain the value of h to be used in (76).

103. Illustrations of Specific Speed.—A centrifugal pump running at 465 r.p.m. delivers 16,780 *G.P.M.* at a head of 26 ft. The specific speed is 5,240. It is thus a high-speed pump though the actual r.p.m. is low.

A 5-stage centrifugal pump delivering 500 *G.P.M.* at a head of 1,400 ft. runs at 3,000 r.p.m. The actual speed is high but the specific speed being only 980 shows that it is really a low-speed pump. That is, this same type of impeller, if it were to deliver the same quantity of water at the same head as in the preceding example, would have to run at a much slower speed than the 465 r.p.m. there found.

It is required to pump 20,000 *G.P.M.* against a head of 30 ft. at 1,700 r.p.m. The specific speed is 18,750 which is too high for a single pump. It would be necessary to reduce the speed

¹ If it is desired we may also use a similar factor to that for a hydraulic turbine. That is, $N\sqrt{h.p.}/h^{5/4}$. Its derivation is similar to that given for (76). For w.h.p. it is only necessary to divide the values given by (76) by the number 63. Thus $N\sqrt{w.h.p.}/h^{5/4}$ varies from 8 to 127. If b.h.p. is used assumptions regarding efficiency are necessary. Inserting certain values of efficiency we get the limits to be 10 and 140, if b.h.p. is used in the formula. These values are very similar to those found with hydraulic turbines. See the author's "Hydraulic Turbines," page 104.

for a single pump to about 600 r.p.m. or to divide the capacity up among six impellers. We might have six separate independent pumps running at 1,700 r.p.m. or a less number of multi-impeller pumps.

It is required to deliver 1,600 *G.P.M.* at a head of 900 ft. with a pump speed of 600 r.p.m. For a single-stage pump this would imply the impossible specific speed of 146.3. If a single-stage pump is used its speed would have to be about 2,000 r.p.m. at least. If a speed of 600 r.p.m. is necessary the pump must have at least six stages. This would give a specific speed of 560. For a better efficiency to be obtained the pump might be divided up into 12 stages. This would give a specific speed of 940.

An impeller 8 in. in diameter was found to have a capacity of 900 *G.P.M.* under a head of 40 ft. at 1,700 r.p.m. This would give $D N/\sqrt{h} = 2,150$, $K_1 = 2.22$, and $N_s = 3,200$. Suppose a pump was required to deliver 3,000 *G.P.M.* under a head of 50 ft. at 1,100 r.p.m. The value of N_s for this case is also 3,200. Therefore an impeller of exactly the same design as the first one would satisfy the requirements. However its diameter would have to be 13.8 in.

104. Determination and Use of Factors.—Values of all the factors given in this chapter can be computed by theory, if the essential impeller dimensions are known. For practical use, however, it is better to compute them from test data.

The uses of the factors have already been indicated. They serve to systematize the classification of centrifugal pumps and by their use one can determine the limits between which the choice of certain conditions for a centrifugal pump is possible. By their aid one can choose more wisely and with greater ease the best combination of speed, discharge, and head per stage for given sets of conditions.

105. PROBLEMS

1. At 2,000 r.p.m. a centrifugal pump delivers 1,200 *G.P.M.* at a head of 80 ft. What will be the capacity and head at a speed of 1,000 r.p.m.? What will be the speed and discharge for a head of 60 ft.?

2. The diameter of the impellers of a 3-stage pump is 10 in. At 1,200 r.p.m. the pump delivers 2,000 *G.P.M.* at 300-ft. head. Find values of all the factors.

3. What will be the head and discharge of a 2-stage pump of the same type as in problem (2) but with 14-in. impellers if the speed is 1,500 r.p.m.?

4. A single centrifugal pump under a head of 26 ft. will deliver 16,000 *G.P.M.* when running at 460 r.p.m. If this same type of pump is used

under this head but the total capacity is divided among 2, 4, or 8 units, find the respective speeds that will be attained.

5. What would be the necessary r.p.m. for the pump in problem (4) to have a specific speed of 3,000?

6. If the speed of the pump in problem (4) were kept at 460 r.p.m., into how many units would the capacity have to be divided to give a specific speed of about 2,500?

7. It is required to deliver 1,600 *G.P.M.* at a head of 900 ft. with a pump speed of 1,500 r.p.m. What is the least number of stages that would be required? How many stages would be necessary for the specific speed to be about 2,500?

CHAPTER XII

PUMP TESTING

106. Purpose of Test.—Every centrifugal pump should be subjected to some kind of a test, otherwise the purchaser will have little assurance that the guarantees are being fulfilled. Most builders of centrifugal pumps have facilities for testing in their own plants and test every pump before it is shipped. If desired, they supply the purchaser with an official report of the test. However there are cases where the makers have been guilty of certifying a pump as satisfactory when their actual test has shown it to be very deficient. In any event it is well to test the pump after it is installed, if it is feasible to do so. Also a repetition of the test from time to time is desirable as it will serve to indicate the condition of the pump.

For the purpose of improving pump design, a large amount of testing is essential. It is only by using theory and actual test results together that improvements or radical changes can be made. The successful makers of centrifugal pumps base their designs upon the test records of many pumps.

The method of conducting the test will depend upon the purpose for which the test is to be made. In general there are four main purposes as follows:

(a) *To Determine if Guarantees have been Fulfilled.*—This test will usually consist of determining the efficiency or the duty, as the case may be, of the pump when run under the specified conditions. At the same time it will be established whether the specified head and rate of discharge can be obtained simultaneously under the specified speed. Such a test involves the determination of only one point. In some cases the conditions may be specified at two or more points.

(b) *To Determine Characteristics.*—Such a test will be merely an enlargement of (a). A sufficient number of points will be determined to enable curves to be drawn. In fact this procedure is the most satisfactory way of testing as it takes but little more time and trouble than (a), complete curves are more desirable,

and also the appearance of the curves will serve to indicate the accuracy of the test. Usually such a test as this will be run with one of the three variables, speed, head, or discharge constant. Of these the speed is the one that is most apt to be kept constant. The resulting curves will then be as shown in Fig. 61. From such a set of curves it is possible, by using the principles of Art. 98, to estimate the performance under any other conditions of operation.

(c) *To Determine General Principles of Operation.*—This will be similar to (b) except that it will be more thorough and cover a much larger number of points. All three of the variables of speed, head, and discharge will be varied as was done in the case of the Worthington pump in Chapter VI.

(d) *To Investigate Fundamental Principles.*—This test will be in the nature of research and will be of interest to the pump designer or to one who is making a thorough study of the subject. In addition to the regular test readings a number of secondary readings might be taken in the suction pipe, at various points within the case, or between the diffusion vanes if such are used. These secondary readings might be to determine the pressure, the magnitude of the velocity, the direction of the velocity of the water, or other phenomena. They could be secured by pressure gages or manometers, Pitot tubes, vanes which would indicate direction, or by other special apparatus.

107. Measurement of Head.—To measure the head the pressures should be determined as close to the suction and discharge flanges of the pump as possible to eliminate pipe losses external to the pump. The pressure on the discharge side may be read by a calibrated pressure gage or by a mercury or water manometer if the head is low enough. On the suction side the pressure may be read by a vacuum gage, unless the water is under positive pressure at this point, but a mercury manometer is more reliable and is simpler and cheaper, since the reading will be small.¹

In making connections for any pressure reading it should be

¹ The suction gage should be connected as shown in Fig. 95, so that a pocket of air cannot collect in the tube. Unless there is a solid column of water between the mercury and the pipe, the manometer reading will be incorrect. If it were known that there was no water at all in the tube but that it was entirely filled by air, it would then be known that the manometer reading was the value of p_s direct. But it is difficult to keep all the water out and the conditions are therefore apt to be unknown.

borne in mind that the tube should leave the pipe at right angles to the direction of flow and that the end of the tube should be flush with the walls of the pipe. No tube which projects within the pipe will give a true pressure reading, even though the orifice be parallel to the direction of flow (or the tube be normal to the direction of flow).¹

In computing the head, equation (12) must be employed. That is

$$h = z_d - z_s + p_d - p_s + (V_d^2 - V_s^2)/2g \quad (12)$$

If the suction and discharge pipes are of the same size, the two velocity heads are equal and cancel each other. If the suction

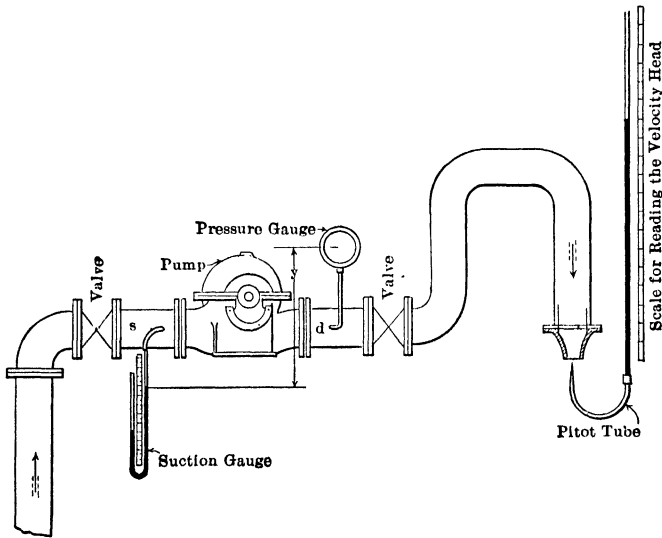

FIG. 95.—Measurement of head.

and discharge flanges are at the same elevation, as in Fig. 95, $z_d - z_s = 0$. But under other circumstances both of these items should be considered.

The pressure gage in Fig. 95 records the pressure at the center of the gage, not at (d). Likewise the mercury manometer reading is the pressure (below the atmosphere or suction) at the top of the right-hand mercury column, not at (s). If the height of the pressure gage above the center of the pipe is x and the gage reads P lb. per sq. in.

$$p_d = 2.308 \times P + x$$

¹ Hughes and Safford, "Hydraulics," page 104.

If the suction gage reading in inches of mercury is S and the distance from the top of the right-hand mercury column to the center of the pipe is $y - x$,

$$p_s = -1.132S - (y - x).$$

Therefore

$$p_d - p_s = 2.308P + 1.132S + y$$

If the water at entrance to the pump is under positive pressure, we should have $p_s = +1.132S - (y - x)$. Thus we should have $p_d - p_s = 2.308P - 1.132S + y$.

Even if the suction and discharge flanges of the pump are not at the same elevation, it may easily be shown that $2.308P \pm 1.132S + y = z_d - z_s + p_d - p_s$. For if our suction and discharge piping in Fig. 95 were so arranged that the center line of the pipe passed through the level of the summit of the right-hand mercury column and through the level of the center of the pressure gage, the gages remaining in their present positions, the gage readings reduced to feet of water would be the values of p_s and p_d . But $z_d - z_s$ would then be y .

Therefore for any setting whatever, the head developed by a pump will be

$$h = 2.308P \pm 1.132S + y + (V_d^2 - V_s^2)/2g \quad (77)$$

The + sign should be used for S whenever the reading is a vacuum such as in Fig. 95. If the suction pressure is greater than that of the atmosphere the - sign should be used. The above formula has been given in this way because the most common instruments are pressure gages, graduated in pounds per sq. in. and mercury manometers. The essential thing is that the term $(2.308P)$ should represent the pressure in feet of the liquid pumped, recorded at the center of the gage or at the surface of the "well" or the lower column of a U tube if a mercury column is used. Likewise the term $(1.132S)$ should be the pressure in feet of the liquid pumped, read by the suction gage or other device.

108. Measurement of Water.—The difficult problem in some pump testing is the measurement of the rate of discharge. The means that may be employed according to circumstances are to weigh or measure the volume of water discharged in a known time interval, to use a weir, a Venturi meter, a Pitot tube, or a calibrated nozzle. In some instances floats or current

meters have been used in the channel leading water to or away from the pump.

To measure the volume of or weigh the water discharged in a certain time interval is feasible only for small capacities, save in exceptional circumstances such as where a pump is to deliver water to a large reservoir. It is a method that may often be found in laboratories.

The weir is a standard device for measuring water but for a large capacity the expense of constructing it might be excessive. It should be remembered that all weir formulas and coefficients are purely empirical in their nature and that the different formulas that are accepted at large do not yield identical results. It is therefore necessary to select the formula based upon actual experiments upon weirs, whose construction and proportions are the nearest to the weir used. The most widely used weir formulas are the Francis and the Bazin formulas. The Francis formula slightly modified is

$$q = 3.33(L - 0.1 nH) (H + \alpha h_v)^{1.5}$$

where L is the length of the weir crest in feet, H is the head on the weir measured in feet, n is the number of end contractions or is zero for a suppressed weir, h_v the velocity head in the weir channel, and α a factor varying from 1.0 to 2.0 according to circumstances.¹ Experiments of Schoder and Turner indicate that for $H = 0.1$ ft. the factor 3.33 should be increased by 7 per cent., for $H = 0.2$ ft. by 3 per cent., and that it is correct when $H = 0.3$ ft.

For small rates of discharge the triangular weir is better than the rectangular weir. Any angle of notch may be employed. For the 90° triangular notch the formula is

$$q = 2.54 H^{2.5}$$

The Venturi meter is very satisfactory and should be permanently installed in many pumping plants as it permits of the measurement of water without any interference in its flow. The extra friction head induced by it is very small.

The Pitot tube may be used to measure the velocity in a closed pipe or in a free jet as in Fig. 95. The impact of the stream against the orifice of the tube produces a pressure which

¹ R. L. Daugherty, "Investigation of the Performance of a Reaction Turbine," Proc. of Am. Soc. of C. E., Oct., 1914, page 2482.



FIG. 96.—Testing a 26-in. centrifugal pump. (*Platt Iron Works.*)

is proportional to the square of the velocity. If h is this pressure reading in feet of water, and K an experimental constant,

$$V = K\sqrt{2gh}$$

The value of K is often, though not necessarily, unity. It is affected by the design of the tube and the manner of determining h . If the water is in a closed pipe, h should be the difference between the actual Pitot tube reading and the pressure head in the pipe, for the Pitot tube reading will be the pressure head plus the velocity head. If h is the difference between the pressure recorded by an orifice facing the stream and another orifice in another tube at the same location in the stream but with the orifice parallel to the stream, the value of h will not be the same as in the former case for the reason given on page 146. Again h may be the difference between the pressures recorded by two tubes, the orifice of one facing up the stream and the other facing down the stream. Such an instrument is called a pitometer and is useful for low velocities since the reading is magnified. For this case the value of K is always less than unity. In using the Pitot tube for any case it must be noted that the velocity is not uniform across a section of the stream. It is, therefore, necessary to take readings at various points in order to compute the total discharge. For a free jet it is probably true that the maximum velocity found across its section is the true ideal velocity determined by $\sqrt{2gH}$ where H is the total head back of the nozzle. This affords a means of determining the constant K .

If a nozzle has been calibrated it may be used for measuring the rate of discharge as shown in Figs. 95 and 96. It is necessary to measure either the pressure back of the nozzle or the velocity head recorded by a Pitot tube in the center of the jet. The rate of discharge of the nozzle will be known as a function of one or the other of these two readings.¹

109. Measurement of Speed.—The most satisfactory way of measuring speed is by means of a reliable and sensitive tachometer. This will serve to indicate not only the speed at a given instant but show if the speed is varying. The ta-

¹ For useful information regarding the methods of measurement here indicated see Hughes and Safford, "Hydraulics," and R. E. Horton, "Weir Experiments, Coefficients, and Formulas," U.S.G.S. Water Supply and Irrigation Paper No. 150, Revised, No. 200.

chometer should be calibrated occasionally. A very good device for measuring speed has been found to be a magneto and a voltmeter. The magneto is belted to the pump shaft and connected to the voltmeter. After calibration it will serve very nicely for a tachometer. By the choice of a suitable voltmeter scale any degree of accuracy in reading may be attained and it will also be sensitive to fluctuations in speed:

Lacking a tachometer a revolution counter may be used for determining speed. Care should be exercised in its use, however, as it will not indicate fluctuations in speed and also, unless the readings are extended over a sufficient time, it will not give an accurate average. A revolution counter, however, is a standard in itself and requires no calibration. That is a valuable point in its favor.

110. Measurement of Power.—For a testing laboratory a transmission dynamometer is a very useful device for measuring the power delivered to the pump. Lacking this the motor or prime mover may be calibrated and such readings taken that the brake horse-power (or developed horse-power) may be known under the conditions of the test. The power output of the motor or prime mover is the power input to the pump.

For some direct connected units it may be difficult or nearly impossible to determine the horse-power delivered to the pump. In such event it is possible to determine only the efficiency of the set.

111. Plotting Curves.—In plotting curves it should be borne in mind that any single point may be in error but that all of them should follow a definite law, unless some factor is introduced which causes an abrupt change from one law to another. Therefore smooth curves should be drawn for the points plotted. Also for a series of curves such as those in Fig. 77, there should be a certain degree of uniformity among them. This often helps to decide what the true curve probably is, when the test points are few in number or are obviously inaccurate.

It is often better to construct such curves as those between head and rate of discharge and between brake horse-power and rate of discharge and to compute the efficiency curve from values read from these curves rather than to attempt to draw efficiency curves through the points computed direct from the test data.

112. PROBLEMS

1. In a pump test the pressure gage read 50 lb. per sq. in. and the suction gage recorded a vacuum of 10 in. of mercury. The center of the pressure gage was 2.0 ft. above the center of the pump shaft while the summit of the upper mercury column of the manometer was 1.0 ft. below the center of the shaft. The suction and discharge pipes were of the same size. What was the value of the head?

Ans. 129.7 ft.

2. In a pump test the pressure gage read 100 lb. per sq. in. while the suction gage recorded a positive pressure of 5 lb. per sq. in. The centers of the two gages were at the same level. The diameter of the suction pipe was 3 in. and that of the discharge pipe 2 in. If the rate of discharge was 100 *G.P.M.*, find the head developed.

Ans. 220.6 ft.

3. A centrifugal pump is equipped with mercury manometers for measuring both discharge and suction pressures. The suction and discharge pipes are of the same size. If the pressure reading is 10 ft. of mercury when the summit of the lower column is 4 ft. below the center of the pump shaft and the suction manometer reads 10 in. of mercury when the summit of the upper column is 1.0 ft. below the center of the pump shaft, what is the value of the head?

Ans. 144.2 ft.

CHAPTER XIII

COSTS

113. Costs of Centrifugal Pumps.—There are so many factors affecting the cost of a centrifugal pump that no simple rule or set of curves can be given by which the cost of a pump can be determined. For any given capacity the cost is affected by the head that is required, by the speed selected, the number of stages, the quality of construction, and commercial conditions.

For similar conditions of head, speed, and construction, the cost may be approximately given as a function of the capacity. The curves in Figs. 97 and 98 will give the average costs of some

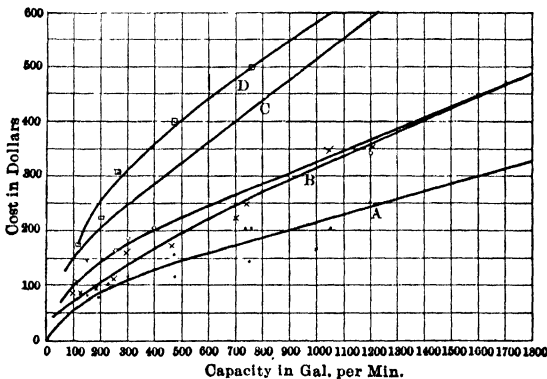

FIG. 97.—Cost of stock centrifugal pumps.

single-stage stock-pumps. Curve (A) applies to very cheaply constructed pumps for low heads. The impellers are of iron and are single suction. The pumps are belt driven. Curve (B) is for pumps similar to (A) but with double-suction impellers. The lower one of the two curves shown for (B) at small capacities is for belt-driven pumps, the upper one for pumps arranged to be direct connected to motors. The pumps of curve (C) are of much better construction than the preceding and are suitable for heads up to 130 ft. They are also to be belt driven.

Curve (D) represents fairly good construction and one suited for direct connection to a motor.

All of the pumps for which these curves are drawn are for moderate heads only and they have iron impellers. To illustrate the effect of the construction upon the cost, Table 8 is presented.

TABLE 8.—COST OF A 6-IN. PUMP

	Iron	Brass	Bronze
Single suction.....	\$200	\$360	\$475
Double suction.....	350	650	785

The cost of a 2-stage pump is about three times the cost of a single-stage pump for the same discharge, speed, and head as

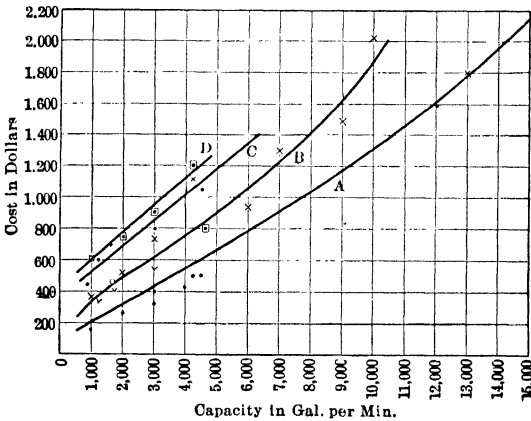

FIG. 98.—Cost of stock centrifugal pumps.

one of the stages. As the number of stages is increased the factor by which the cost of a single-stage pump must be multiplied will approach the number of stages.

When pumps for high heads are considered it will be seen that the curves in Figs. 97 and 98 are entirely inadequate. A few cases to illustrate this may be cited. It will be seen that there is no uniformity among these few cases because the speeds, number of stages, and other features may be quite different. A centrifugal pump with a capacity of 2,500 *G.P.M.* under 600 ft. head cost \$5,000. Another with a capacity of 5,560 *G.P.M.* under a head of 280 ft. cost \$26,000, while a third with a capacity of 27,800 *G.P.M.* under 300 ft. head cost \$55,000. The De Laval

Steam Turbine Co. state that a steam turbine-driven centrifugal pump of the waterworks type for 200-ft. head will cost about \$1,000 per million gallons daily capacity.

The quantity that is the most nearly constant in value is the cost per lb. For a number of small iron pumps this seems to be about 20 cents. For brass or bronze it will be higher. The quality of construction will not affect this very much because better construction usually requires more metal, hence the total weight is greater. As the size of the pump increases, the cost per lb. will become less.

114. Cost of Pumping.—The total cost of pumping is the sum of the fixed charges and the operating expenses. The former consists of interest on the capital cost, insurance, taxes, depreciation, and administration. The latter item includes labor, fuel or electric current, supplies, repairs, and other similar items.

The capital cost covers the cost of the pump, motor or prime mover, and possibly the building, pipe lines, and such other equipment that the pumping makes essential.

The total annual cost consists of fixed charges and operating costs for a period of 1 year. The cost of pumping per water horse-power or per 1,000 gal. per min., or any similar unit is the total annual cost divided by the total capacity of the pump, meaning by total capacity the water horse-power or the number of 1,000 gal. per min., or other units of which the pump is capable. It will be a minimum when the pump is not operated at all as it will then consist of the fixed charges only. It will be a maximum when the pump is operated continuously as that will cause the operating expenses to be a maximum.

For a steam-driven pumping unit the total annual cost of pumping is

$$C = \frac{G \times 8.33 \times h \times S}{D} + L + F(i + d + t) + M \quad (78)$$

in which

C = total annual cost

G = total number of gallons pumped per year

h = head in feet

S = cost of steam per 1,000 lb.

D = duty in foot pounds per 1,000 lb. of steam

L = cost of labor and similar items

F = total investment

i = interest rate on investment

d = rate of depreciation

t = taxes, insurance, etc.

M = administration and similar items.

For a motor-driven pump we should have to consider S as meaning the cost per million B.t.u. supplied to the motor, (1.0 k.w. hr. = 3,412 B.t.u.), and D = duty in ft. lb. per million B.t.u., supplied to the motor. From equation (24) duty = 778,000,000 \times efficiency of set. Therefore the first part of equation (78), if K = cost of power per k.w. hr., is

$$\frac{G \times 8.33 \times h \times K}{2,655,000 \times \text{set efficiency}} \quad (78)a$$

Equation (78) shows that, if the cost of power is high, it may be economical to pay a high price for a high-duty pumping engine. But on the other hand a less expensive centrifugal pump may often effect a saving even though its duty should be somewhat less. Equation (78) would also show that for intermittent service a cheap pump was desirable even though it might be inefficient. But for constant service a high-duty pump is better even though its first cost may be considerably higher.

115. PROBLEMS

1. The City of Youngstown, O., installed a turbine-driven centrifugal pump with a capacity of 5,840 *G.P.M.* at a head of 276 ft. (The 14-in. single-stage pump was built by the Wilson-Snyder Centrifugal Pump Co. The turbine was supplied by the Kerr Turbine Co.) The maximum duty determined by test was 89,000,000 ft. lb. per 1,000 lb. of steam. With coal at \$1.95 per ton and an evaporation of 8.5 lb. of steam per lb. of coal, the cost of steam per 1,000 lb. would be 11.5 cents or \$0.115. The total cost of the installation was \$10,000, the interest, etc., on which will be taken as 14 per cent. Omitting the items L and M , what is the total cost of pumping per year, assuming the pump to run continuously?

Ans. \$10,530.

2. The City of Youngstown also has a triple-expansion reciprocating pumping engine for practically the same conditions as the above. The guaranteed duty is 163,000,000 ft. lb. per 1,000 lb. of steam and the first cost was \$72,000. Assuming interest, etc., to be 14 per cent. as above and adding a total of \$400 for cylinder oil and valves, find the total annual cost of continuous pumping and compare with (1).

Ans. \$15,480.

3. What would be the cost of coal per ton that would make the total costs of pumping equal in (1) and (2)?

4. What would have to be the cost of the reciprocating pumping engine

in (2) for it to be as economical as the turbine-driven centrifugal pump in (1)?

5. What would have to be the per cent. of interest, etc., on the fixed charges to equalize the costs of pumping in (1) and (2)?

6. A motor-driven centrifugal pump with an efficiency of 75 per cent. delivers 1,000 *G.P.M.* during 2,660 hr. per year at a head of 150 ft. If the motor efficiency is 90 per cent. and the cost of power is \$0.04 per k.w. hr., find the annual cost of power for the unit.

Ans. \$4,450.

7. If the above pump is steam driven by a turbine with a thermal efficiency of 8 per cent., what will be the duty? If steam costs \$0.25 per 1,000 lb. and each pound possesses 1,050 B.t.u., what is the cost of power?

Ans. 46,700,000 ft. lb. per million B.t.u., or 49,000,000 ft. lb. per 1,000 lb. of steam, \$1,020.

CHAPTER XIV

ROTARY AND SCREW PUMPS

116. Rotary Pump.—This type of pump is illustrated here because the term is often erroneously understood to mean a centrifugal pump. The true rotary pump is a positive action displacement pump. Its motion, however, is one of rotation and not reciprocation. One form of this pump may be seen in Fig. 99. It consists of a pair of shafts which are maintained in the same relation to each other by a pair of spur gears. Within the case there are a pair of lobe gears which mesh with each other

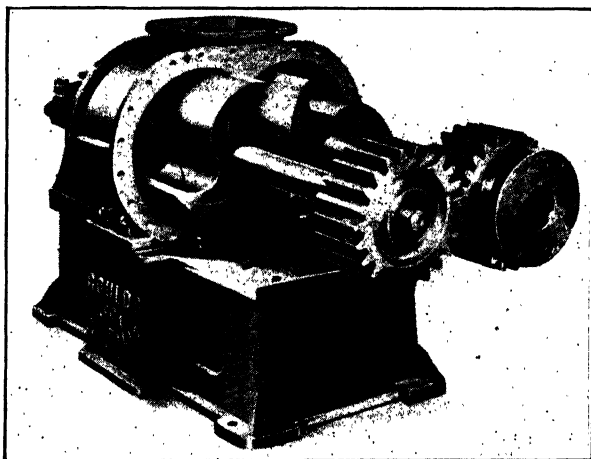

FIG. 99.—The rotary pump. (*Goulds Mfg. Co.*)

and are so arranged that water is admitted to the space between two lobes when this space is open to the suction. As the rotation continues this space is shut off from communication with the suction and the water is carried up to the discharge side. As the lobes mesh with each other there is little opportunity for the water to return to the suction side save by leakage.

This type of pump is suitable for certain classes of service under low head. They are apt to be noisy and inefficient in

operation. As they are continued in service the wear is sufficient to permit considerable leakage and thus the economy decreases.¹

117. Screw or Propeller Pump.—The screw or propeller pump is analogous to the centrifugal pump but the flow of the water is axial rather than radial. The helicoidal impeller (Fig. 90) is an approach to the screw pump. The result obtained with the helicoidal impeller is the ability to handle a large rate of discharge at a low head with a high rotative speed as has already been shown. The same thing is true for the screw pump and to a greater degree. For certain purposes, such as are implied by these conditions, these pumps are useful. But their efficiency is generally low.

¹ For an account of the test of a large rotary pump having a good efficiency see "Test of a Rotary Pump," by W. B. Gregory, *Trans. A.S.M.E.*, Vol. 28, page 963.

CHAPTER XV

APPLICATIONS OF CENTRIFUGAL PUMPS

118. Steam Power Plants.—The centrifugal pump has become practically the standard type for circulating the condensing water. The combination of large capacity and low head that is usually encountered in this work is very favorable to this type of pump. Where the static head varies, as it may where water



FIG. 100.—Multi-stage centrifugal boiler feed pumps. (*Platt Iron Works.*)

is being pumped from a river, it is desirable to operate the pump under a variable speed for the sake of economy. If a constant speed is preferred because of its simplicity, the pump should possess a steep characteristic, in order that the fluctuations of

head should not greatly alter the rate of discharge. If the static head is constant the pump should possess a flat or a rising characteristic so that the discharge may be varied, if desired, without great loss of efficiency.

The centrifugal pump is also becoming very popular for a boiler feed pump. Though the small capacity and high head of such a pump is detrimental to efficiency, that is of small consequence, if the pump is steam turbine driven, since the exhaust steam is all used for heating boiler feed water. However, the steam economy of such a unit is certainly greater than that of

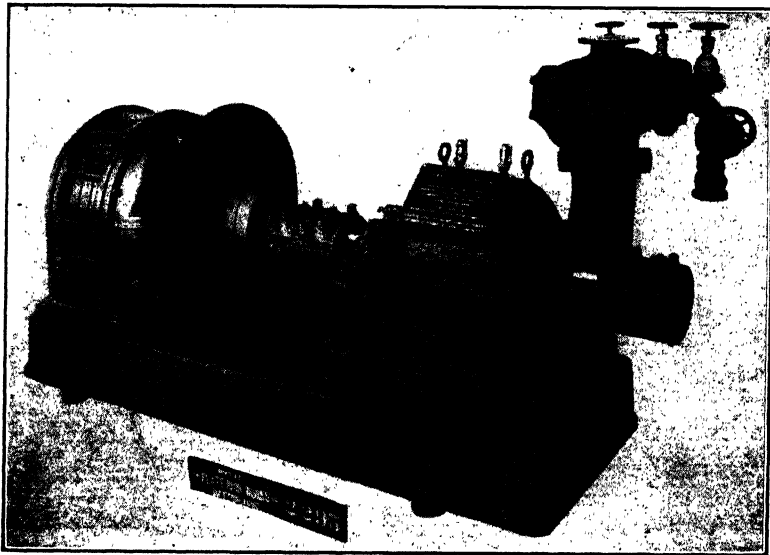

FIG. 101.—Two-stage centrifugal fire pump. (*Platt Iron Works.*)

the direct-acting steam pumps that are often employed for such a purpose. The merits of the centrifugal pump for boiler feeding are found in its operating characteristics. It delivers water smoothly without shock or pulsation.

119. Fire Pumps.—The centrifugal pump offers many attractive features for use as a fire pump, on account of its reliability and comparatively low first cost. Since a pump for fire protection is used but a small portion of the time, the question of first cost and reliability outweighs all others.¹ For this

¹ See "High-pressure Fire Service Pumps of Manhattan Borough" by R. C. Carpenter, *Trans. A.S.M.E.*, Vol. 31, page 437 (1909).

purpose especially rugged construction is demanded and, where the pump is motor driven as in Fig. 101, a shield is usually required to protect the motor from any water that might leak from the pump. A fire pump should have a flat characteristic.

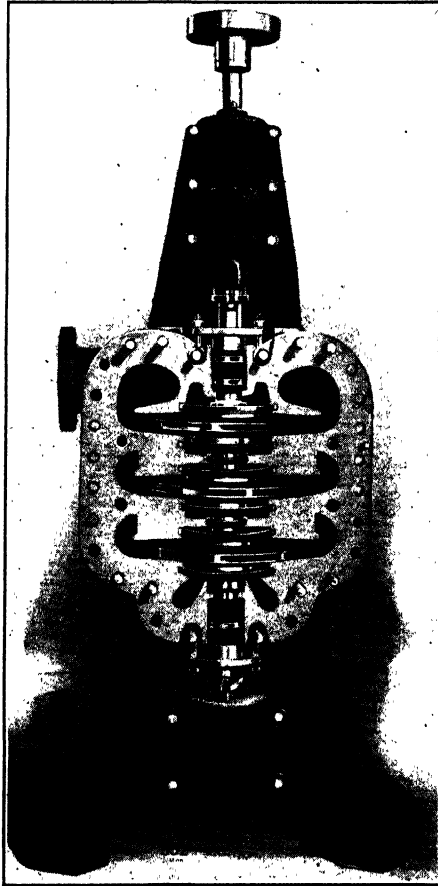

FIG. 102.—Vertical shaft pump. (*De Laval Steam Turbine Co.*)

120. Deep Well Pumps.—For deep well pumps or for mine-sinking pumps the vertical-shaft centrifugal pump is well adapted as it occupies but little space. The motor may be mounted with the pump for mine sinking so that the set can be readily lowered as the water level in the mine shaft falls.

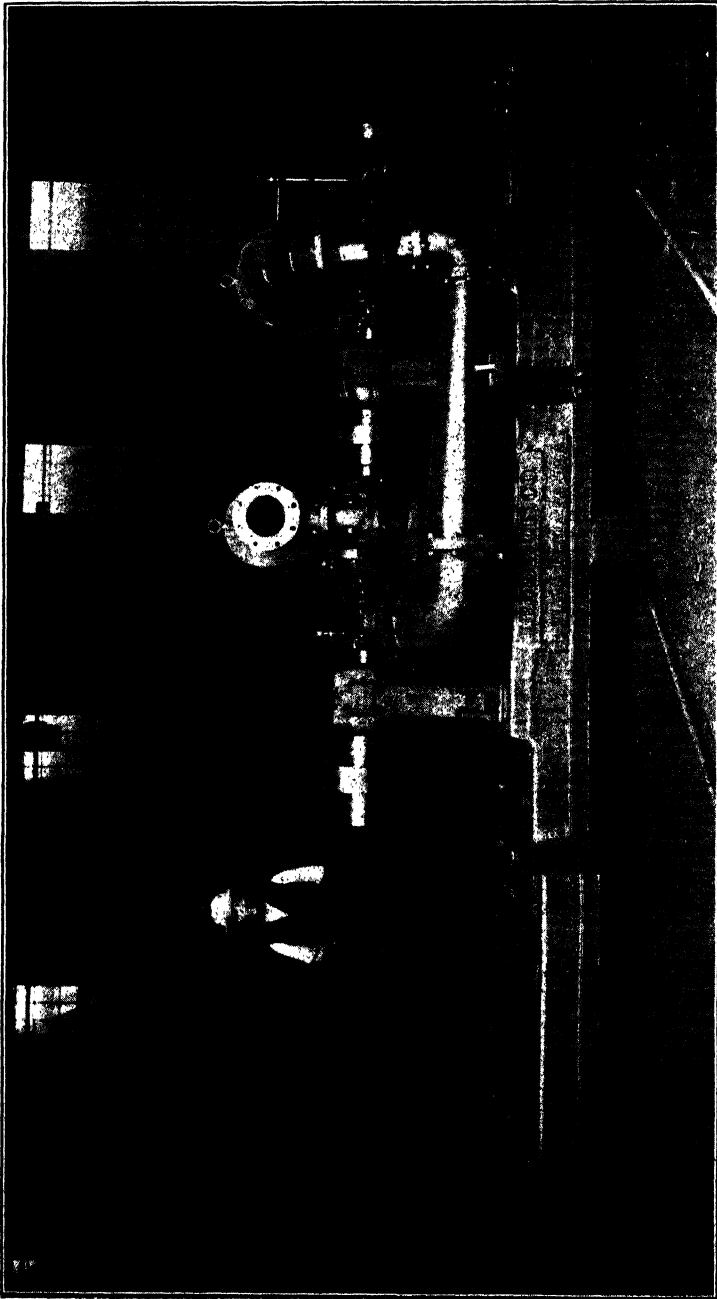

FIG. 103.—Two-stage mine pump. Capacity = 4,000 G.P.M., $h = 330$ ft., $N = 730$ r.p.m. (I. P. Morris Co.)

121. Mine Pumps.—For either temporary use or for permanent installations in mines, the centrifugal pump offers the great advantages of small size and weight and, due to its freedom from vibration, very light foundations are sufficient. Most water encountered in mine pumping is corrosive in its action, due to the presence of various acids. This corrosive action is more detrimental in the case of a displacement pump than in the case of a centrifugal pump. In Fig. 103 is shown a pump for use in a coal mine, where considerable sulfuric acid is present. This

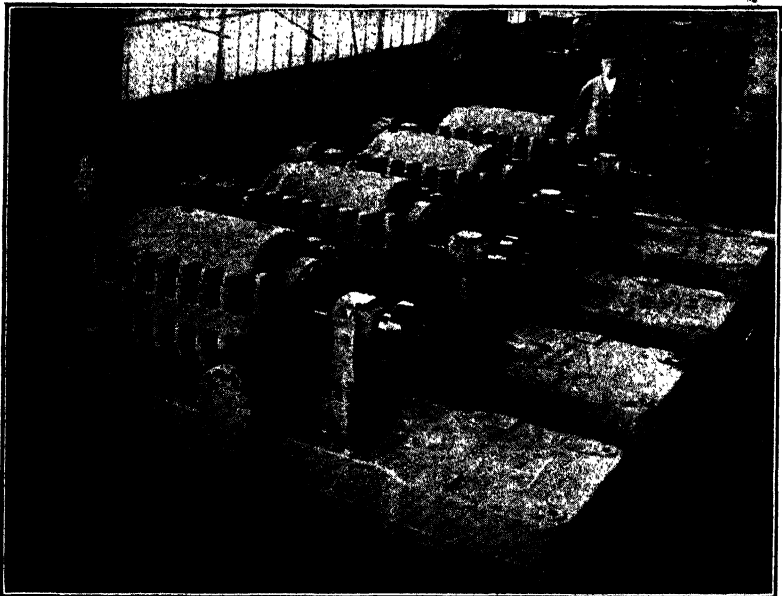

FIG. 104.—Six-stage centrifugal pumps for hydraulic pressure governors of water turbines. Capacity = 1100 G.P.M., $h = 461$ ft., $N = 1170$ r.p.m. (I. P. Morris Co.)

set consists of two single-stage volute pumps connected in series. All the parts which come in contact with the water are made of special acid resisting bronze. The pump was, therefore, made as simple as possible. The case, head covers, and suction elbows are all split on a horizontal plane, so that dismantling for inspection or repairs is readily accomplished. The first of these pumps has now been in service 5 years and shows but little deterioration under the action of the acid.

122. Dredging.—For dredging purposes the centrifugal pump is the only type that can be considered, on account of the large solid materials that have to be handled. Pumps for this service are rapidly worn out and the cases are often lined with steel to resist the erosive action of the grit and gravel that is thrown against them. Cheapness in first cost, ability to withstand abuse, and ease of repair are more important than efficiency.

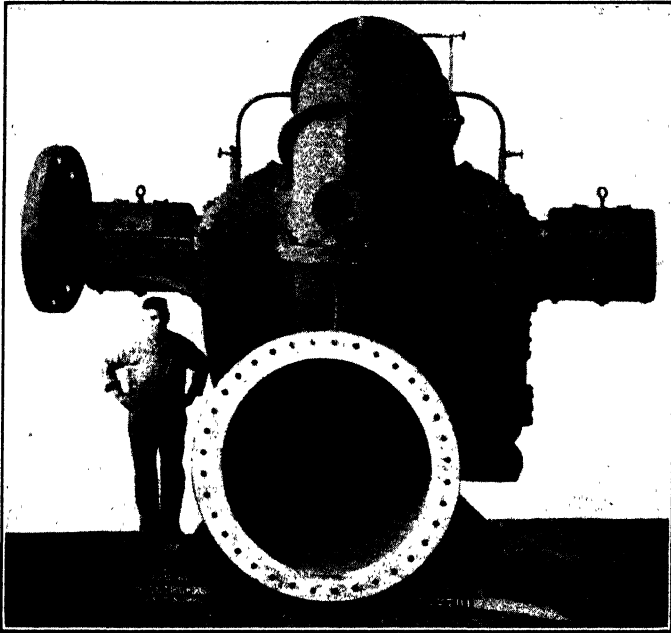

FIG. 105.—Drainage pump. (*Platt Iron Works.*)

123. Waterworks.—In large waterworks we find that conditions of steady load the greater part of the year render it economically possible to install costly pumping machinery with high efficiencies. For such service the triple-expansion pumping engine has been perfected and has given very high duties.

The speed of the usual large reciprocating engine is usually too low for direct connection to the centrifugal pump and the speed of the steam turbine is too high, since the waterworks type of centrifugal pump will not have a very high speed owing to its large capacity. It is therefore necessary to connect the turbine to the pump by means of reduction gears such as are shown in

Figs. 106 and 107. This is the most desirable arrangement for using a centrifugal pump of large capacity.

The duty of the steam turbine-driven centrifugal pump will not be as high, perhaps, as that of the very efficient pumping

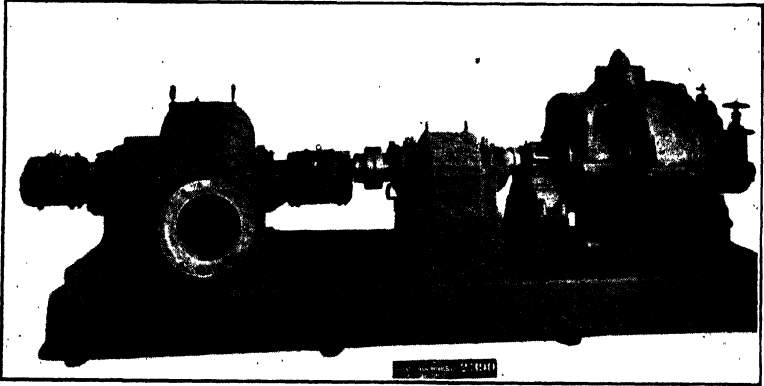

FIG. 106.—Steam turbine-driven centrifugal pump for waterworks. Capacity = 6,950 *G.P.M.*, $h = 200$ ft., $N = 1100$ r.p.m. Turbine speed = 3600 r.p.m. (*Platt Iron Works.*)

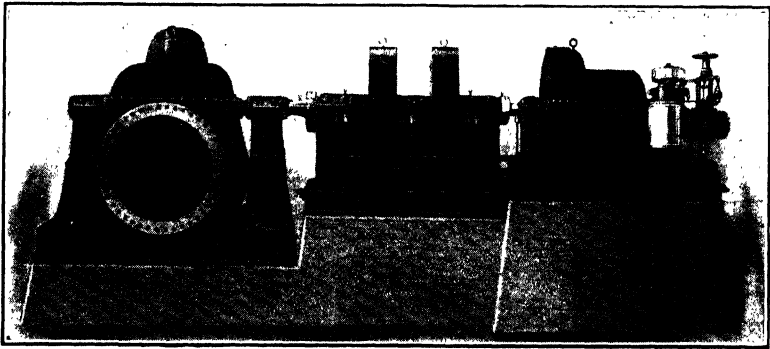

FIG. 107.—Steam turbine-driven centrifugal pump for waterworks. Capacity = 71,260 *G.P.M.*, $h = 58.7$ ft., $N = 345$ r.p.m., discharge = 48 inches. (*De Laval Steam Turbine Co.*)

engine. But its lower first cost may enable it to be more economical than the pumping engine, as is shown by the problems in Art. 115. This is not always the case as, where the cost of fuel is high, the high-duty pumping engine may give a greater economy despite its greater first cost.

In comparing the capital costs of the two types of pumping units, it is well to note that the turbine-driven centrifugal pump requires less room than the triple-expansion pumping engine, the foundations may be much lighter, and a smaller crane need be installed to handle the parts of the machine. This means a much cheaper building.

In comparing operating costs it must be noted that, though the fuel economy of the pumping engine may be much higher, more labor is often needed to attend to it and the cost of cylinder oil, renewing valves, and other repairs is greater. Frequent attention is also needed, otherwise the slip will become excessive so that the rated duty will not be attained. With the centrifugal pump the economy will change very slowly.

The pumping engine is more difficult to repair in case of a breakdown than the centrifugal pump. All of these factors tend to show that the turbine-driven centrifugal pump is well worthy of consideration for waterworks pumping plants. The choice between the two types can be made only by carefully estimating all the separate items that affect the result.

124. Miscellaneous Uses.—The preceding classes of service are typical of the field that can be covered. Thus drainage and irrigation are often comparable with waterworks service, while sewage pumping requires features that may be intermediate between this and dredging work. The development of hydraulic pressure for elevators and similar purposes will require a pump of the type suitable for boiler feed. For marine use the merits of the centrifugal pump are the small space occupied, the light weight, light foundations required, and freedom from vibration.

For handling all kinds of corrosive liquids and material which is likely to clog small passages, the centrifugal pump is better adapted than any other type.

CHAPTER XVI

DESIGN OF A CENTRIFUGAL PUMP

125. Empirical Procedure.—In this chapter only the determination of such dimensions as are involved in the hydraulics of the pump will be considered. The design of mechanical details such as bearings, shafts, and other features will not be treated, as such may be found in general works on machine design.

Owing to the inherent defects of the theory of the centrifugal pump, any method of design must involve the use of empirical factors determined by experience. This is true of practically all engineering work, but in some cases the factors are reasonably constant or are known to vary as definite functions of other quantities. The determination of numerical values for these factors is not so certain in the case of the centrifugal pump.

The design of a centrifugal pump impeller is ultimately based upon the performances of other impellers. The theory indicates what would be the general effect of altering certain dimensions. Hence successful design consists of modifying or changing the design of impellers which have been tested out rather than the creation of entirely new patterns. After a number of impellers of different types have been constructed and their performances properly recorded, the designer will then be in a position to develop new designs and to predict results with some assurance.

As an illustration, suppose that it is required to design a centrifugal pump of a certain capacity under a given head. The number of stages and the r.p.m. might be arbitrarily assumed for non-technical reasons. But more scientifically they might be determined in accordance with the material given in Chapter VIII, due regard being shown commercial conditions at the same time. But it is seen that the experimental data shown in the curves of Chapter VIII will be necessary before even this much can be done.

Having now the values of N , $G.P.M.$, and h per stage, the desired form of impeller characteristic may be selected. That is we may decide whether a rising, a flat, or a steep characteristic is more suitable for the particular work this pump is to do.

Having chosen this, it will be necessary to select the angle of the impeller vane at exit. Again experience will be necessary for this to be done, since it cannot be determined by the solution of any mathematical equation. The theory, however, indicates that the smaller the angle α_2 the steeper the characteristic. Experience also points to the fact that the fewer the number of vanes the steeper the characteristic. Also the theory (or more plainly the curves in Fig. 58) will show that the angle of the diffusion vanes or the area of the volute case, if vanes are lacking, has an effect upon this. The larger the diffusion vane angle A'_2 or the larger the case of a volute pump, the higher the discharge and the lower the head at which the maximum efficiency will be found. Only by the study of the performances of other pumps for which these quantities are known can the proper values of α_2 and A'_2 or F_3 be chosen.

The next step is the selection of the factors ϕ and c , whose values may normally range from 0.90 to 1.30 and from 0.10 to 0.30 respectively. The steeper the characteristic the larger the value of ϕ . Therefore ϕ is some function of the quantities in the preceding paragraph, as is c also. If the theory were capable of exact application, we might compute values of ϕ and c from the equations given in Chapter V, but even those equations involve the selection of a factor k which is a matter of experience again. We shall, therefore, have to choose a value for ϕ according to our best judgment or according to values obtained by test upon a pump similar in design to the one we are attempting. The value of c may be determined in the same manner as ϕ .

As a check upon the rationality of our values of α_2 , ϕ , and c we may substitute them in equation (50), and see if the value of the expression is in accordance with the customary values for the line of pumps whose data we may have. If our theory were exact the value of (50) would be the true hydraulic efficiency, a value for which might reasonably be estimated. As our theory is defective, that is, since the computed value of k'' is higher than the true value as shown in Figs. 58 and 59, this value will not be any definite physical quantity and is called simply "manometric coefficient."¹ Or we might assume a

¹ For a large number of pumps ranging from capacities of 50 to 6,250 G.P.M. the author has found values of this coefficient ranging from 0.543 to 0.762 as extremes, though the usual values were from 0.56 to 0.65. The gross efficiencies in most cases were higher than these values.

value of the "manometric coefficient" and compute c from (50).

With values of ϕ and c determined, we can compute the essential impeller dimensions as follows:

From (75)

$$D = 1,840 \phi \sqrt{h}/N \quad (79)$$

The required impeller area may be computed as

$$f_2 = q/v_2 = G.P.M./448 c\sqrt{2gh}$$

Combining the value of f_2 given by equations (3) or (4) with this we obtain

$$B = \frac{0.04 \times G.P.M.}{n \times AC \times c\sqrt{h}} \quad (80)$$

or

$$B = \frac{0.04 \times G.P.M.}{(\pi D \sin a_2 - nt) \times c\sqrt{h}} \quad (81)$$

We should employ (80) or (81) according to whether we have used (3) or (4) respectively for computing values of f_2 , in order to calculate the values of c for previous pumps. As has been pointed out, these two values will be identical if the vanes are involute curves. (The *G.P.M.* here used should also include the estimated leakage loss.)

It is customary to make the diameter of the vanes at entrance D_1 equal to about $0.5D$, though this ratio may vary from 0.3 to 0.6 or even extend beyond these limits. The essential thing is to see that the eye of the impeller is sufficiently large in diameter so that cavitation will not be produced due to too high a velocity head at this point with a consequently low value of pressure.

The width of the impeller at entrance B_1 is usually from 1.0 to $2.0B$. For a given D_1 both this width and the angle a_1 are usually so chosen that the absolute velocity at entrance may be radial for the normal rate of discharge. Before proceeding further it will be necessary to consider the suction pipe. A size will be chosen for that that will give a reasonable velocity of flow for a given suction head. By properly proportioning the intake to the pump case and the eye of the impeller it will be possible to gradually accelerate the water as it approaches the entrance to the impeller vanes. With the amount of acceleration determined, we can compute the value of V_1 , since the velocity in the suction pipe has been chosen. The value of V_1 is usually not much different from $v_2 \sin a_2$. The area $F_1 = q/V_1 = G.P.M./448 V_1$.

But the area $F_1 = (\pi D_1 B_1 / 144) - \text{vane thickness}$. Since the velocity diagram at entrance is a right-angled triangle for the case of radial flow, we know that $v_1 \sin a_1 = V_1$ and $v_1 \cos a_1 = u_1$. Dividing one of these by the other we can determine the angle since V_1 and u_1 are known. Thus

$$\tan a_1 = V_1 / u_1 \quad (82)$$

The essential dimensions of the impeller are thus determined. If the results lead to poor proportions, some of the assumptions can be altered and new solutions found.

If we wish to choose the diffusion vane angle for a turbine pump so that no shock loss is occasioned at this speed and rate of discharge we can make the angle $A'_2 = A_2$. Therefore

$$\tan A'_2 = \frac{v_2 \sin a_2}{u_2 - v_2 \cos a_2} = \frac{c \sin a_2}{\phi - c \cos a_2} \quad (83)$$

For a volute pump we may make the area of the volute at its maximum section $F_3 = f_2 / n$.¹ The value of n may be determined from equation (55) as

$$n = \frac{u_2 - v_2 \cos a_2}{v_2} = \frac{\phi - c \cos a_2}{c} \quad (84)$$

The main dimensions which affect the hydraulic features of the pump are thus determined. The question may be raised as to what assurance we have that the maximum efficiency will be attained under the conditions of speed, head, and discharge for which these computations were made. The only explanation is that the values of ϕ and c , upon which the computations hinge, were selected according to values obtained with previous pumps for their points of maximum efficiency. Furthermore all dimensions and angles computed were determined upon the supposition that the flow specified would be the normal flow and provisions

¹ If the velocity throughout the case is uniform, the area of the volute should increase directly as the angle measured from the "cutwater." If the cross-section of the case is circular, as in Fig 9, the outer boundary curve is a parabolic spiral whose equation is $r = \sqrt{c\theta} + K$, where θ is the angle measured from the "cutwater," K is the radius to the "cutwater," and c is a constant. If the cross-section of the case is rectangular, the outer boundary curve should be a volute the diameter of whose base circle is $2K \sin A$, where K has the same meaning as in the former instance, and A is the angle with the tangent made by the stream lines entering the case. The smaller diameter of the "nozzle" will be π times the diameter of the base circle. The actual cross-sections of cases are rarely rectangular and often not even circular.

were made to minimize all the losses at the flow. However the actual point of maximum gross efficiency is affected by the mechanical losses as well as the hydraulic losses. It might be necessary to allow for this if it were not for the fact that it has also entered into the previous pumps for which our values of ϕ and c were experimentally determined.

126. Layout of Impeller Vanes.—The theory does not prescribe any definite curve for the vanes but the common forms are circular arcs and involutes or rather curves with involute tips.

To lay out a circular arc the following procedure may be employed:¹ If the outer and inner radii are OA and OB respect-

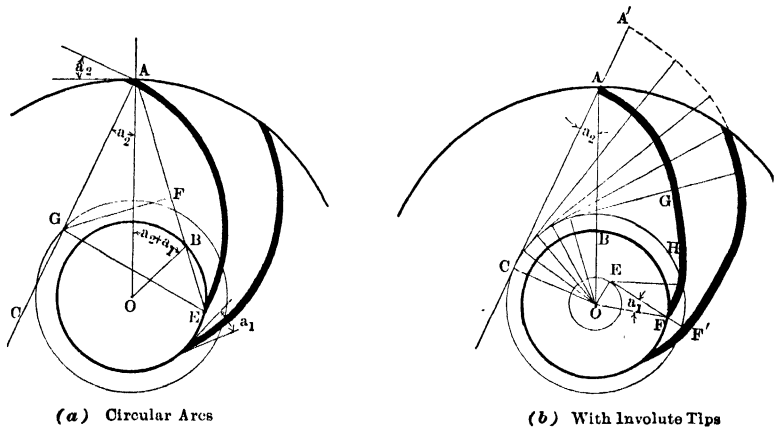

FIG. 108.—Layout of impeller vanes.

ively in Fig. 108(a), lay off the angle $OAC = a_2$. Lay off the angle $AOB = a_2 + a_1$. Through A and B draw the line intersecting the circle of the inner diameter at E . Erect FG as a perpendicular bisector of AE . Through G , which is the point of intersection of this bisector and the line AC , draw a circle with center at O . With the point G as a center and radius GA describe the arc AE . This is the vane desired. Other centers may be located on the circle through G according to the number of vanes. The circular arc thus constructed will be found to make the required angles a_2 and a_1 at exit and entrance respectively.

The layout of vanes with involute tips is shown in Fig. 108(b). With O as a center, a circle may be described whose radius $OC = OA \sin a_2$, where OA is the outer radius of the impeller. Thus

¹ C. G. De Laval, "Centrifugal Pumping Machinery."

the angle a_2 is the angle OAC . With this circle as a base circle the involute AG may be drawn. The involute is the curve traced by the point A as the imaginary cord CA is wound around a cylinder of which the base circle is a trace. Thus we merely decrease the length of CA by the length of the arc from C to the point of tangency of the line on which we are to lay off a new radius. If the involute were produced until it reached the base circle, the angle which it would make with a tangent to the circle at that point would be 90° . It is impossible, in general, to draw a complete involute for the entire vane as the angle a_1 would not be the proper value. Therefore only AG is drawn as an involute.

For entrance the same process is followed. The base circle is drawn with a radius $OE = OF \sin a_1$, where OF is the inner radius of the vanes. With this base circle the involute FH is drawn. H and G are then connected by a smooth curve. It is necessary to start the involute at the proper point F so that the two tips may be properly joined by a smooth curve HG . This is a matter of trial, but can be easily accomplished by drawing FH on a piece of thin paper or tracing cloth first.

While the point A traces one involute a second point A' may trace a second involute which will be at a constant distance from the first, hence the two curves are parallel. Likewise the distance between the two involutes at entrance is FF' until the end of the second involute tip is reached.

The author does not believe that one form of vane offers any material advantage over another so far as the efficiency of the impeller is concerned. The involute vanes have the advantage that it is easier to determine the angles and area that should be used in the formulas, since the two curves are parallel. The fact that they are parallel makes it more reasonable to assume that the stream lines are of the same form and, therefore, impellers with involute tips are more amenable to mathematical analysis.

127. Layout of a Mixed Flow Impeller.—The same demands that led to the development of the mixed flow reaction turbine from the pure radial type first employed¹ have also led to the use of the mixed flow type of centrifugal pump; that is the desire to obtain a high specific speed.

For the radial flow type of pump the impeller vanes may be laid out as in Fig. 108, since the curves are plane curves. But

¹ See the author's "Hydraulic Turbines," page 28.

with the mixed flow impeller we have surfaces of double curvature. It should be noted first that points in the plan view of Fig. 109 are actual projections of the points upon that plane. But the elevation view shows each point as it would be if it were rotated about the axis until it lay in the plane of the paper, and does not show actual projections.

The procedure is as follows:¹ The impeller passage is divided up into parts by stream lines such as NN' , QQ' , etc., in the elevation

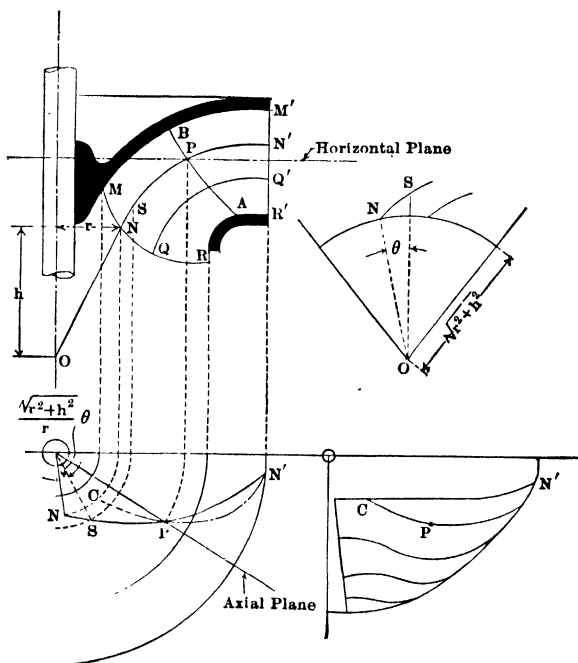

FIG. 109.—Layout of a mixed flow impeller.

view. The ends of the blades such as NS (in the elevation view) are regarded as lying on the surface of a cone whose vertex is at O . For Q there will be another cone whose vertex is determined by producing the stream line through Q until it intersects the axis of rotation. The ends of the blades are then drawn in the customary manner but upon the surfaces of these developed cones, such as that at the right for the point N . Since u varies with r it will be necessary for a to also vary with r if the entrance

¹ This is an abridgment from Loewenstein and Crissey, "Centrifugal Pumps," page 146.

flow is to be radial at all points. We should thus lay out a different curve for Q from the one for N as well as have it on the developed surface of another cone. The manner of transferring NS from the developed cone to the two views is readily seen. The location for N in the plan view is selected at will and then S is located in reference to it.

In the plan view NSN' is drawn as a smooth curve making the required angle a_2 at N' . To determine if NSN' in the plan is a proper curve, we may take *axial* sections by passing planes parallel to the axis, and containing the axis if the entrance arc is in a radial plane. If the entrance arc is not in a radial plane, these axial planes should be parallel to the plane of the entrance arc. Where the axial plane cuts the curve in the plan view, such as P , it is possible to locate a corresponding point P in the elevation. A number of such points for this one axial plane and other vane curves such as QQ' , etc., will determine a line APB . This process may be repeated for other axial planes until the elevation view is covered with curves similar to APB . If proper curves had been assumed for all the lines such as NSN' in the plan view, APB and all the others of the same kind in the elevation would be smooth curves. If they are not smooth, the curves NSN' , etc., in the plan should be altered, but always in such a way that they are also smooth.

The more useful curves are the "pattern-maker's curves" which are obtained with horizontal planes. In the elevation a single horizontal plane is shown which cuts the various lines such as NSN' at P . This locates P on the curve NSN' in the plan view. If the curve MM' were drawn in the plan view, the point C could be located on it from the intersection of this horizontal plane with MM' in the elevation. With a sufficient number of such points the curve CPN'' could be drawn. This is the actual curve cut by the one horizontal plane. For other horizontal planes similar curves could be obtained. For practical use the curves would be obtained for planes which would cover the entire height of the impeller blade or from M' in the elevation to the bottom of the blade below R . If these planes are equidistant from each other, or at least at definite distances apart, the curves may be laid out on boards the thicknesses of which are exactly equal to the distances between planes. After the curves are sawed out the boards may be assembled in the proper order and, after smoothing down, the exact surface

of a blade is obtained. In order to properly match up the boards it is well to lay out each curve with reference to a right-angled corner. It is then only necessary to match up the corners of the boards. A projection of a set of pattern-maker's curves is shown in the lower right-hand portion of Fig. 109. With this impeller the outlet edge $M'R'$ is taken as being parallel to the axis. It is frequently inclined, in which event M' , N' , Q' , R' , etc., would not coincide in the plan view.

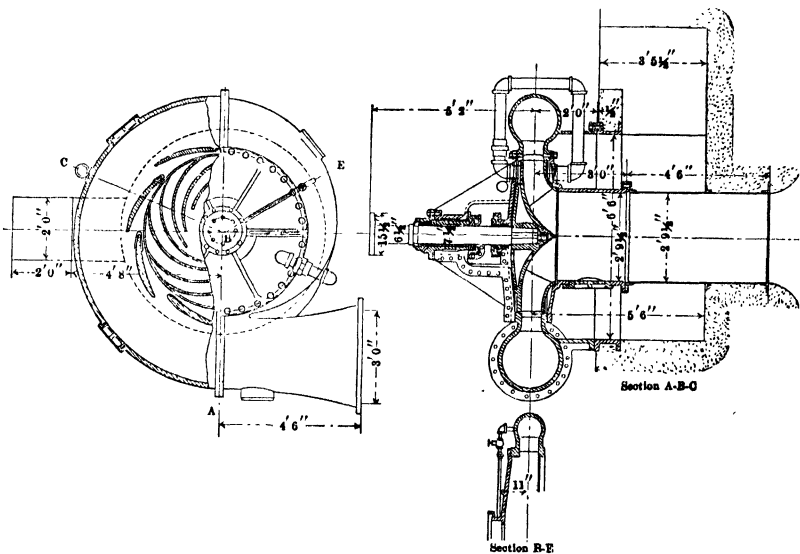

FIG. 110.—Centrifugal pump for irrigation. Capacity = 31,500 G.P.M.,
 $h = 59$ ft., $N = 292$ r.p.m. (*I. P. Morris Co.*)

128. Rating Chart.—When a company is requested to supply a centrifugal pump for a specified speed, head, and capacity, the following procedure could be employed. The value of the specific speed, N_s , for the desired pump could be computed from equation (76). It would then be known at once whether any one of their standard lines of pumps would be suitable for this service. If they did build a pump or a line of pumps having approximately this same value of the specific speed, that type would fulfill the conditions. To determine the exact size of impeller that would be required, equation (72) would be employed, using the value of K_1 that was known to apply to the standard line. Since pumps are rated according to

the diameter of the discharge flange, and not according to the impeller diameter, it would be necessary to select the nominal pump size. This could be done either by having an established relation between the diameter of the discharge flange and the diameter and width of the impeller or by using a certain definite value of the velocity of the water through the discharge flange. Since the capacity of the pump is given, the size would be directly determined by the latter procedure. (See Art. 6.)

The selection of a certain pump to fulfill these conditions can be more readily accomplished by means of a rating chart, such as that in Fig. 111.¹ This diagram may be laid out on

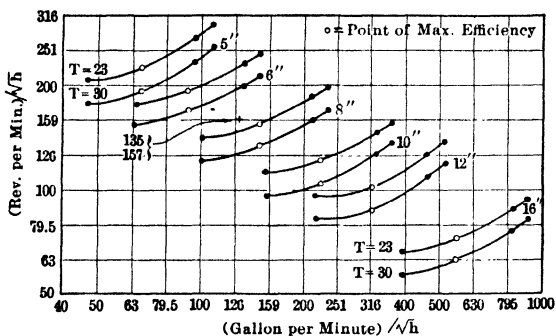

FIG. 111.—Rating diagram for centrifugal pumps.

logarithmic cross-section paper or on regular cross section paper. In the latter event logarithmic scales should be used. The data for constructing such a chart should be determined by actual tests of various sizes of pumps so as to secure the exact head, speed, and capacity at which the maximum efficiency is found.

For a given size of pump (by which is here meant the diameter in inches of the discharge flange) a point of maximum efficiency can be located for values of N/\sqrt{h} and $G.P.M./\sqrt{h}$. Three other points are also usually located, one for a smaller capacity at 90 per cent. of the maximum efficiency, and two for larger capacities at 95 and 90 per cent. of the maximum efficiency. The "type" of the impeller, that is the ratio D/B , is also marked on this curve. In the sample chart in Fig. 111 only two "types" are shown.

Suppose that it is required to supply a pump for 1,500 *G.P.M.* at 1,760 r.p.m. under a head of 125 ft. per stage. The value of

¹ L. J. Bradford, Eng. News, Vol. 72, No. 8, page 382.

N/\sqrt{h} is 157 and that of $G.P.M./\sqrt{h}$ is 135. This point is shown on the chart. If this point fell on one of the curves, the pump for which that curve was constructed would be the one required. If the maximum efficiency does not occur here, it simply means that the head and capacity of the pump is a trifle different from the values specified. The efficiency under the exact conditions specified would be a certain per cent. of the maximum efficiency, which could be estimated. In the figure shown, this point does not fall on one of the curves, though it might do so, if other "types" had also been plotted. But suppose these two lines of pumps are all that are available. It is seen that an 8-in. pump of type 23 is a trifle too large for the conditions. It could be made to fit the case by cutting the vanes back a little, as this would reduce the effective diameter of the impeller. Under the conditions shown, it is seen that the pump would operate at about 98 per cent. of its maximum efficiency.

This chart is constructed for single-stage pumps only. It would be possible to add other curves similar to these but on other parts of the field for various numbers of stages.

129. PROBLEMS

1. Design a centrifugal pump to deliver 900 *G.P.M.* at a head of 40 ft. when running at 2,000 r.p.m. (The data for the pumps described in Art. 53 will serve as guides in this.)
2. Construct the curve for the Worthington pump of Art. 53 in the rating chart, Fig. 111.
3. Using the rating chart of Fig. 111, select the size of pump to deliver 4,000 *G.P.M.* at a head of 100 ft. when running at 1,000 r.p.m. If the maximum efficiency of the pump selected is 72 per cent., what will its efficiency probably be under the required conditions? What would the capacity have to be under this head and speed for the maximum efficiency of this pump to be attained?

APPENDIX A

TEST DATA

The test data of the pumps for which the characteristics in Chapter VI were plotted will be found in Tables 1 and 2. This data is from careful tests performed by the author with the assistance of F. G. Switzer upon two centrifugal pumps in the hydraulic laboratory of Sibley College. The water was measured by weirs, which had been thoroughly calibrated with the aid of a large weighing tank. Pressures were read by mercury manometers or by pressure gages of suitable scales which were calibrated by comparison with a dead weight gage tester. The pumps were driven by electric motors, the losses of which were determined, so that the brake horse-power could be computed from the electrical readings.

The test data in Tables 3 and 4 was supplied by the Platt Iron Works Co.

TABLE 1.—TEST OF A 2.5-IN. TWO-STAGE WORTHINGTON TURBINE PUMP
(By R. L. Daugherty)

Run	R.p.m.	Discharge, cu. ft. per sec.	Total head, ft.	B.h.p.	Efficiency, per cent.
1	700	0.000	43.6	0.705	00.0
2	700	0.028	40.5	0.788	16.4
3	700	0.067	44.7	0.990	34.3
4	700	0.100	44.8	1.190	42.7
5	700	0.108	44.8	1.246	44.0
6	700	0.148	42.3	1.490	47.9
7	700	0.230	30.3	1.760	45.2
8	700	0.295	13.1	1.950	22.5
9	1,000	0.000	85.1	2.06	00.0
10	1,000	0.062	86.2	2.60	23.5
11	1,000	0.110	92.2	3.00	38.3
12	1,000	0.150	91.2	3.39	45.9
13	1,000	0.196	86.2	3.92	49.0
14	1,000	0.233	80.1	4.27	49.7
15	1,000	0.308	66.3	4.83	48.0
16	1,000	0.343	59.7	5.28	44.0
17	1,000	0.408	35.8	5.57	29.8
18	1,000	0.436	15.5	5.53	14.2

CENTRIFUGAL PUMPS

TABLE 1.—TEST OF A 2.5-IN. TWO-STAGE WORTHINGTON TURBINE PUMP
(By R. L. Daugherty).—Continued

Run	R.p.m.	Discharge, cu. ft. per sec.	Total head, ft.	B.h.p.	Efficiency, per cent.
19	1,200	0.000	124.1	3.38	00.0
20	1,200	0.060	124.2	4.11	20.6
21	1,200	0.117	127.7	4.65	36.6
22	1,200	0.167	130.9	5.43	45.7
23	1,200	0.215	126.7	6.22	49.7
24	1,200	0.283	115.2	7.22	51.4
25	1,200	0.348	99.5	7.85	50.2
26	1,200	0.390	84.8	8.15	46.2
27	1,200	0.450	64.0	8.78	37.2
28	1,200	0.494	20.3	8.87	12.9
29	1,400	0.000	172.8	5.41	00.0
30	1,400	0.097	173.1	6.88	28.6
31	1,400	0.198	180.5	8.90	45.6
32	1,400	0.302	176.5	10.85	55.8
33	1,400	0.373	146.8	11.95	52.2
34	1,400	0.412	140.1	12.64	51.7
35	1,400	0.455	115.5	13.27	45.1
36	1,400	0.518	67.3	13.50	29.4
37	1,400	0.541	23.3	13.40	10.7
38	1,600	0.000	226.8	8.18	00.0
39	1,600	0.112	227.2	10.44	27.8
40	1,600	0.226	235.3	12.95	46.7
41	1,600	0.310	228.5	15.22	52.8
42	1,600	0.415	200.5	17.51	54.0
43	1,600	0.470	175.1	18.60	50.2
44	1,600	0.512	139.4	18.08	45.0
45	1,600	0.550	72.2	18.15	24.9
46	1,600	0.565	25.2	17.35	09.3
47	1,700	0.000	248.5	9.13	00.0
48	1,700	0.049	248.6	10.12	13.7
49	1,700	0.112	254.7	11.78	27.6
50	1,700	0.155	257.5	12.70	35.8
51	1,700	0.236	264.1	15.08	47.1
52	1,700	0.348	248.8	18.15	54.3
53	1,700	0.429	225.0	20.06	55.0
54	1,700	0.494	192.3	21.60	50.0
55	1,700	0.531	157.3	22.00	43.2
56	1,700	0.573	73.1	21.25	22.4
57	1,700	0.578	47.0	20.60	15.0
58	1,700	0.580	26.3	20.15	08.6
59	1,800	0.000	280.8	10.58	00.0

TABLE 1.—TEST OF A 2.5-IN. TWO-STAGE WORTHINGTON TURBINE PUMP
(By R. L. Daugherty).—*Continued*

Run	R.p.m.	Discharge, cu. ft. per sec.	Total head, ft.	B.h.p.	Efficiency, per cent.
60	1,800	0.137	281.3	14.43	30.4
61	1,800	0.221	297.2	16.70	44.7
62	1,800	0.293	292.1	19.38	50.2
63	1,800	0.403	268.4	22.65	54.3
64	1,800	0.510	221.2	24.80	51.8
65	1,800	0.568	140.9	24.60	36.9
66	1,800	0.580	90.0	23.90	24.8
67	1,800	0.584	51.4	23.00	14.8
68	1,800	0.585	22.0	22.90	07.8
69	2,000	0.000	346.8	15.00	00.0
70	2,000	0.105	349.4	18.20	22.9
71	2,000	0.247	368.1	23.00	44.8
72	2,000	0.327	362.6	26.30	51.2
73	2,000	0.590	27.4	28.30	06.5
74	708			0.31
75	964			0.62
76	1,132			0.69
77	1,344	Pump free from water		0.84
78	1,512			0.99
79	1,846			1.76

TABLE 2.—TEST OF A 6-IN. SINGLE-STAGE DOUBLE-SECTION DE LAVAL
VOLUTE CENTRIFUGAL PUMP
(At a Constant Speed of 1,700 r.p.m.)

Run	Discharge, cu. ft. per sec.	Total head, ft.	B.h.p.	Efficiency, per cent.
1	0.000	68.5	4.3	00.0
2	0.068	68.4	4.5	11.8
3	0.188	69.6	5.2	28.6
4	0.320	69.3	6.0	42.0
5	0.606	69.2	7.8	61.1
6	0.840	66.7	9.4	67.7
7	0.933	65.5	9.7	71.6
8	1.063	62.7	10.3	73.3
9	1.315	55.7	11.3	73.7
10	1.632	47.3	12.0	73.3
11	1.968	35.7	11.8	67.7
12	2.090	28.1	11.5	58.0
13	2.240	22.3	11.2	50.7

CENTRIFUGAL PUMPS

TABLE 3.—TEST OF AN 18-IN. SINGLE-STAGE DOUBLE SUCTION PLATT
CENTRIFUGAL PUMP

(Volute Type. Impeller Diameter = 15.5 in.)

R.p.m.	G.P.M.	Head, ft.	B.h.p.	Efficiency, per cent.
1,135	7,700	24.0	94.5	50.0
1,140	7,670	33.0	107.0	60.0
1,140	7,610	41.0	111.0	71.0
1,135	7,320	49.5	120.0	76.5
1,140	6,700	59.5	124.0	81.0
1,140	5,950	66.5	124.0	80.5
1,140	5,050	72.5	120.0	77.5
1,135	3,775	77.5	110.0	67.5
1,140	3,260	78.0	100.0	64.2
1,140	2,550	79.0	91.0	56.0
1,145	0	80.0	57.5	00.0

TABLE 4.—TEST OF A 26-IN. SINGLE-STAGE DOUBLE SUCTION PLATT
CENTRIFUGAL PUMP

(Volute Type)

R.p.m.	G.P.M.	Head, ft.	B.h.p.	Efficiency, per cent.
465	16,460	25.8	127.5	84.0
465	16,780	26.0	127.5	86.0
465	15,850	26.8	127.0	84.5
465	14,850	27.9	124.0	84.0
470	13,750	29.1	123.0	82.0
472	12,400	32.5	122.5	81.0
480	9,220	36.0	117.5	71.0
550	0	48.0	101.5	00.0
450	0	30.0	45.0	00.0

APPENDIX B

REVIEW QUESTIONS

1. What is a centrifugal pump? Why is it so called?
2. How are centrifugal pumps classified?
3. What is a whirlpool chamber?
4. What is a rising characteristic?
5. What is a flat characteristic?
6. What is a steep characteristic?
7. Why is the modern centrifugal pump a recent development?
8. To what heights may water be lifted by centrifugal pumps?
9. How large may be the capacities of centrifugal pumps?
10. What rotative speeds are commonly found?
11. How many stages may be employed with centrifugal pumps?
12. What is the usual range of head per stage?
13. What "size" of centrifugal pump would be required to discharge 900 *G.P.M.*?
14. What is meant by "normal discharge?"
15. What types of impellers are there?
16. How are impellers constructed?
17. What is meant by the "type" of an impeller?
18. What is the function of the diffuser?
19. How is velocity converted into pressure in a volute pump?
20. What are labyrinth rings?
21. How is air prevented from leaking in around the shaft at the suction end?
22. What types of cases are there? What are their relative merits?
23. What is the Jaeger type of pump? The Kugel-Gelpe type? The Sulzer type?
24. What are the relative merits of the four types of pumps (adding the Rateau to the above named)?
25. What causes end thrust?
26. What is hydraulic balancing?
27. What are balancing pistons? How do they operate?
28. How are pumps primed?
29. Of what use are foot valves?
30. Of what use is a check valve on the discharge side?
31. Of what use is a gate valve on the discharge side?
32. What limits the allowable suction lift?
33. What is the effect of slight air leakage in the suction pipe upon the operation of the pump?
34. What is the effect of the liberation of air that may be in solution in the water in the suction pipe?

35. What is the effect of the formation of water vapor due to too low a pressure in the suction pipe?

36. What kind of piping connections are desirable? Why?

37. What will be the effect of placing two pumps in series? In parallel? How does this affect the efficiency? Why?

38. What procedure would you follow in starting up a centrifugal pump?

39. Given $u = 50$ ft. per sec., $V = 40$ ft. per sec., $A = 20^\circ$, find v and a .

40. Given $V = 100$ ft. per sec., $A = 30^\circ$, what is the value of s ?

41. If $u = 60$ ft. per sec., $v = 20$ ft. per sec., what is the value of s if $a = 20^\circ$? (b) If $a = 90^\circ$? (c) If $a = 120^\circ$?

42. In what ways may the area of the impeller passages be computed? Do these two methods give identical results?

43. What is "head?" What is its energy meaning?

44. How would the head against which a pump must work be computed from the pipe line specifications?

45. How would the head against which a pump works be computed from data taken at the pump?

46. What is the distinction between a forced vortex and a free vortex?

47. What is the difference between the variation of the pressure with the radius of rotation in the cases of a free and a forced vortex?

48. What is "brake horse-power?" Why is it so called?

49. What is water horse-power?

50. What is the physical meaning of the "power imparted to the water by the impeller?"

51. What is gross efficiency? Mechanical efficiency? Volumetric efficiency? Hydraulic efficiency?

52. What is meant by duty?

53. What are the advantages of guide vanes at entrance to a centrifugal pump impeller?

54. What is the difference between h'' and h ?

55. What is the difference between hydraulic efficiency and manometric coefficient?

56. Why does not the maximum hydraulic efficiency occur when the shock loss is zero?

57. Why does not the maximum gross efficiency occur where the hydraulic efficiency is a maximum?

58. What effect has the number of vanes upon the characteristics of an impeller?

59. What are the defects inherent in the ordinary hydraulic theory?

60. Is the vane angle necessarily the value that should be used for α_2 in the theoretical equations?

61. Is the area of the impeller passages the actual effective area of the streams?

62. What can be done to overcome the defects of the theory?

63. Of what value may a theory be that does not yield numerically exact answers?

64. What considerations affect the selection of a value for α_2 ? For A'_2 ?

65. If the dimensions of a pump are given, what equations would you use to find by theory the values of ϕ and c for the maximum hydraulic efficiency?

66. What equations would you use to find the values of ϕ and c for which the shock loss in the turbine pump is zero?

67. Given all the essential dimensions and a specified value of ϕ (not necessarily the best), what equations would you use to find the hydraulic efficiency by theory?

68. What causes a point of inflection in the head-discharge curves of some pumps at constant speed for small values of the rate of discharge?

69. Why is it desirable that the b.h.p. curve for a pump at constant speed reach its maximum before the maximum value of the rate of discharge is attained?

70. The water horse-power of a pump at maximum efficiency varies as what power of the speed?

71. Why does not the b.h.p. of a pump at maximum efficiency vary as the cube of the speed? When will the power be less than the cube? When higher?

72. Is there any limit to the capacity of a given centrifugal pump if its speed be indefinitely increased?

73. What practical cases might be found where a pump was required to deliver approximately a constant rate of discharge under a varying head? How can this be accomplished with a centrifugal pump? Which way is most economical?

74. For an ordinary pipe line with friction what is the most efficient way to operate a centrifugal pump for a varying rate of discharge? Which way is simpler and cheaper in first cost?

75. What is meant by efficiency of a pipe line?

76. Why may a pipe 300 ft. long elevating water a height of 200 ft. have a higher efficiency than another one 3,000 ft. long delivering water at a height of 50 ft? Would it be a physical possibility for them to have the same efficiency?

77. Assuming the friction factor to be 0.03 for all cases and neglecting minor losses, what would be the diameter of pipe necessary for an efficiency of 90 per cent. in each case in (76)? For an efficiency of 60 per cent.?

78. Which gives the greater amount of disk friction for a given peripheral velocity, a small diameter of impeller at a high rotative speed or a large diameter of impeller at a low rotative speed?

79. Is the shrouded type of impeller more desirable than the open type so far as disk friction is concerned?

80. To reduce the disk friction of an impeller is it desirable to have the clearance large or small?

81. Should the interior of the pump case be smooth? Why?

82. Will the test of a centrifugal pump at a certain speed determine the efficiency for another speed?

83. Why is the efficiency of a large capacity pump higher than that of a small capacity pump?

84. How may a high specific speed be attained in the construction of a centrifugal pump?

85. Of what advantage may a high specific speed be?

86. What determines the number of stages into which a pump is to be divided?

87. What are the natures of the characteristics of the displacement pump? How do they compare with those of the centrifugal pump?
88. What are the relative merits of displacement and centrifugal pumps?
89. What seems to be the difference in the efficiencies of turbine and volute pumps?
90. Is there any difference between the efficiencies of pumps with rising and falling characteristics?
91. When would a turbine pump be preferable to a volute pump? When would the volute pump be preferable?
92. When is a pump with a steep characteristic desirable?
93. What uses may be made of the specific speed factor?
94. For a given total head and capacity, how does the value of the specific speed change as the number of stages is varied?
95. For what purposes would a pump be tested?
96. What precautions should be observed in attaching a gage to a pipe for the measurement of pressure?
97. Why should the connections between the pipe and the gage be filled with water?
98. Why should the difference between the velocity heads at suction and discharge be considered in computing the head developed by a pump?
99. How should a weir formula be chosen?
100. For a uniform rate of pumping, which type of pump may be more economical, the centrifugal or the reciprocating?
101. For intermittent service, which type is more economical, the centrifugal or the reciprocating?
102. Which type of pumping unit, centrifugal or reciprocating, is apt to be better where fuel is cheap?
103. What are the advantages of a screw pump?
104. What conditions are favorable to the use of a centrifugal pumping unit?
105. What conditions are favorable to the use of a reciprocating pumping unit?

APPENDIX C

TABLE OF THE 34 POWERS OF NUMBERS FROM 1 TO 300
(For Example $16^{34} = 8.00$)

	0	1	2	3	4	5	6	7	8	9
0	0.00	1.00	1.68	2.28	2.83	3.34	3.83	4.30	4.75	5.20
1	5.62	6.03	6.45	6.85	7.24	7.62	8.00	8.38	8.73	9.09
2	9.45	9.80	10.15	10.50	10.83	11.18	11.50	11.85	12.18	12.50
3	12.82	13.14	13.45	13.78	14.10	14.38	14.70	15.01	15.30	15.63
4	15.90	16.20	16.50	16.80	17.08	17.38	17.65	17.95	18.25	18.54
5	18.80	19.19	19.38	19.64	19.91	20.20	20.45	20.75	21.00	21.30
6	21.65	21.80	22.10	22.36	22.62	22.90	23.17	23.42	23.70	23.92
7	24.20	24.45	24.71	25.00	25.24	25.47	25.75	26.00	26.22	26.47
8	26.77	27.00	27.25	27.50	27.75	27.98	28.23	28.50	28.74	28.99
9	29.23	29.45	29.70	29.98	30.20	30.44	30.67	30.90	31.13	31.40
10	31.6	31.9	32.1	32.3	32.6	32.8	33.0	33.2	33.5	33.7
11	33.9	34.2	34.4	34.6	34.8	35.0	35.3	35.5	35.8	36.0
12	36.2	36.5	36.7	36.9	37.1	37.4	37.6	37.8	38.1	38.3
13	38.5	38.7	39.0	39.2	39.4	39.6	39.8	40.0	40.2	40.4
14	40.6	40.8	41.0	41.3	41.6	41.8	42.0	42.2	42.4	42.6
15	42.8	43.0	43.2	43.5	43.7	43.9	44.1	44.4	44.6	44.8
16	45.0	45.2	45.4	45.7	45.8	46.0	46.2	46.4	46.7	46.9
17	47.1	47.2	47.4	47.7	47.9	48.1	48.3	48.5	48.7	49.0
18	49.2	49.3	49.5	49.7	49.9	50.2	50.4	50.6	50.8	51.0
19	51.2	51.4	51.6	51.8	52.0	52.2	52.4	52.6	52.8	53.0
20	53.2	53.4	53.6	53.8	54.0	54.2	54.4	54.6	54.7	54.9
21	55.1	55.3	55.6	55.8	56.0	56.2	56.4	56.6	56.7	56.9
22	57.1	57.3	57.5	57.7	57.9	58.1	58.3	58.5	58.6	58.8
23	59.0	59.3	59.5	59.6	59.8	60.0	60.2	60.4	60.5	60.8
24	61.0	61.2	61.4	61.6	61.8	62.0	62.1	62.4	62.5	62.7
25	62.9	63.1	63.3	63.4	63.6	63.8	64.0	64.2	64.4	64.6
26	64.8	65.0	65.2	65.4	65.6	65.8	66.0	66.1	66.2	66.4
27	66.6	66.8	67.0	67.2	67.4	67.6	67.7	67.9	68.0	68.2
28	68.4	68.6	68.8	69.0	69.2	69.4	69.6	69.8	70.0	70.1
29	70.2	70.4	70.6	70.8	71.0	71.2	71.4	71.5	71.6	71.8
30	72.0

INDEX

A

- Abbreviations, 56
- Absolute path of water, 2, 60
 - velocity, 45
- Air in suction, 41
- Analysis of centrifugal pumps, 75
- Angles a_2 and A'_2 , 85
- Angular momentum, 59
- Annual cost of pumping, 155
- Appold, 10
- Average efficiency, 133
- Axial thrust, see Thrust.

B

- Balancing, 30
 - pistons, 36
- Blade, see Vane.
- Boiler feed pumps, 161
- Brake horse-power, 54

C

- Calculation of impeller, 170
- Capacities, 11
- Capacity, effect on efficiency, 114
 - factor, 138
- Capital cost, 155
- Cases, 23
 - form of, 171
- Cavitation, 92
- Centrifugal action, 50
 - head, 69
- Centrifugal pump, action of, 1
 - advantages of, 130
 - crude, 52
 - definition of, 1, 6
- Characteristic, classification as to, 8
 - curves or diagram, 104
 - definition, 88
 - rising vs. falling, 134
- Churning loss, 76

- Circular arc vanes, 172
- Classification, 1
- Clearance rings, 22
- Condenser circulating pumps, 160
- Conditions of use, 11
- Construction of vane curves, 172
- Continuity, equation of, 46
- Conversion factors, 56
- Cost of cheap stock pumps, 153
 - pumping, 155
- Curved vanes, introduction of, 10

D

- Defects of theory, 79
- De Laval pump, dimensions of, 89
- Design of impeller, 169
- Development of centrifugal pump, 9
- Diameter of impeller and capacity, 139
- Diffusion vanes, advantages of, 68
 - angle of, 85
 - description of, 21
 - introduction of, 10
 - use of, 1
- Directing vanes, see Diffusion vanes,
see Guide vanes.
- Discharge, diagram, 66
 - losses of impeller, 66
 - losses of pipe, 49
 - measurement of, 139
- Disk friction, 107
 - approximate formulas for, 109
 - experimental results, 108
- Displacement pumps, advantages of, 130
 - characteristics of, 129
 - comparison with, 128
- Drag of impeller, see Disk friction.
- Double suction, 16
- Dredging pumps, 165
- Duty, 55

E

- Efficiency, definition of, 54
 as a function of capacity, 114
 of head, 117
 of number of stages, 124
 of specific speed, 120
 factors affecting, 125
vs. discharge curves, 95
 hydraulic, 55, 73
 maximum, 97
 mechanical, 54
 of pump and pipe line, 103
 of pumping, 102
 of a series of pumps, 112
 of a single pump, 111
 total, 55
 volumetric, 55
- Empirical design, 168
 modification of theory, 82
- Enclosed impeller, 16
- End thrust, 30
- Energy, equation of, 47
- Entrance diagram, 65
 losses in pipe, 49
- Euler, 9
- Exit losses of impeller, 66
- Experimental analysis, 75
- Eye of impeller, 2

F

- Factors, 72, 136
- Falling characteristic, 7, 63
- Fire pumps, 161
- Fixed charges, 155
- Flat characteristic, 7, 63
- Foot valve, 40
- Friction in pipe, 48
 losses in pump, 64

G

- Gland cage, 22
- Gross efficiency, see Total efficiency.
- Guide vanes at exit, see Diffusion vanes in eye, advantages of, 62

H

- Head, computed by theory, 71
 developed by pump, 49
 discharge curves, 89
 effect on efficiency of, 117
 imparted by impeller, 62
 of impending delivery, 69
 losses in pipe, 48
 losses in pump, 54, 64
 meaning of, 47
 shut-off, 69
- Heads of pumps, 11
- Helicoidal impeller, 123
- Historical development, 9
- Horse-power, largest, 13
- Hydraulic balancing, 36
 efficiency, 55

I

- Impeller, 16
 helicoidal, 123
- Impending delivery, 69, 96
- Imperfections of theory, 79
- Involute vanes, construction of, 172
- Iso-efficiency curves, 104

J

- Jaeger type, 25
- Jordan, 9

K

- Kugel-Gelpe type, 25

L

- Labyrinth rings, 22
- Leakage of air, effect of, 41
 losses, 30, 54, 78
- Lift, see Head.
- Losses of head in pipes, 48
 pumps, 54, 64

M

- McCarty pump, 10
- Manometric coefficient, 73
 values of, 169

- Massachusetts pump, 10
 Maximum efficiency, conditions for,
 125
 of turbine *vs.* volute pumps, 132
 Measurement of head, 146
 speed, 150
 water, 147
 Mechanical efficiency, 54
 losses, 54, 111
 Mine pumps, 164
 Mixed flow impeller, 173
 Multi-impeller, 124
 Multi-stage, introduction of, 10
 meaning of, 7
- N
- Normal discharge, 15
 Notation, 44
 Nozzle, 3
 Number of pump, 15
 of vanes, 79
- O
- Open impeller, 16
 Operating expenses, 155
 Operating a pump, 43
 Opposed impellers, 35
- P
- Packing, 22
 Papin, 9
 Parallel operation, 42
 Pattern maker's curves, 175
 Pipe efficiency, 103
 friction, 48
 Pitot tube, 148
 Plotting curves, 151
 Power-discharge curves, 94
 measurement of, 151
 Pressure, negative, 1
 positive, 1
 transformation, 2, 53
 Priming, 40
 Propeller pump, 159
 Pulsation of flow, 42
- R
- Rateau, 32
 Rated capacity, 15
 discharge, 15
 head, 15
 Rating chart, 176
 Reaction turbine, comparison with,
 8
 Reciprocating pump, comparative
 cost of, 129, see Displace-
 ment pump.
 Reduction gears, 166
 Relative velocity, 45
 Reversing channels, 25
 Rings, clearance, 22
 Rising characteristic, 7, 63
 Rotary pump, 158
- S
- Screw pump, 159
 Scroll case, 22
 Sectional cases, 24
 Series operation, 42
 Series of pumps, efficiency of, 112
 Shock loss, 65
 Short circuited water, 30, 54, 78
 Shroud, 16
 Shut-off head, 69, 96
 Side plate type, 7
 merits of, 23
 Side suction, 16
 Single suction, 16
 stage, 7
 Size of pump, 15
 Solid case, 24
 Specific speed, derivation of, 139
 efficiency a function of, 120
 high values of, 122
 values of, 141
 Speeds, 14
 effect on efficiency, 118
 measurement of, 150
 Split case, 7
 advantages of, 23
 Stages, number of, 14
 effect of number of, 124
 Static head, 50

Steam power plant, pumps for, 160
 turbine driven centrifugal, 12,
 123, 165
 Steep characteristic, 7
 Strainers, 40
 Stuffing boxes, 22
 Suction, double, 16
 gland, 22
 lift, 41
 rotation in, 61
 side or single, 16

T

Tachometer, 150
 Test data, 179
 Testing, purpose of, 144
 Theoretical head, 63
 Theory, corrected, 82
 defects of, 79
 discrepancy of, 78
 value of, 84
 Thrust, 30
 bearing, 36
 Torque exerted, 60
 Total efficiency, 55
 Turbine pump, definition of, 1
 introduction of, 10
 Type of impeller, 18
 effect on efficiency, 114
 values of, 138

V

Vane angle, values of, 84
 Vanes, backward curved, 69
 construction of, 172
 curved, 10
 effect of number of, 79
 half, 18
 of mixed flow impeller, 174
 Venturi meter, 148
 Velocity, absolute, 45
 relative, 45
 Volumetric efficiency, 55
 Volute pump, 2
 Vortex, forced, 50
 free, 52

W

Water horse-power, 54
 Water seal, 22
 Water vapor, effect of, 42
 Waterworks, 165
 Wearing rings, 22
 Web, 16
 Weir, 148
 Whirlpool chamber, 3
 Worthington pump, dimensions of,
 89

DATE OF ISSUE

This book must be returned
within ~~3, 7, 14~~ days of its issue. A
fine of ONE ANNA per day will
be charged if the book is overdue.

**This book is issued for
SEVEN DAYS ONLY.**