

Birla Central Library

PILANI (Jaipur State)

Class No :- 668.5

Book No :- N294N

Accession No :- 31249

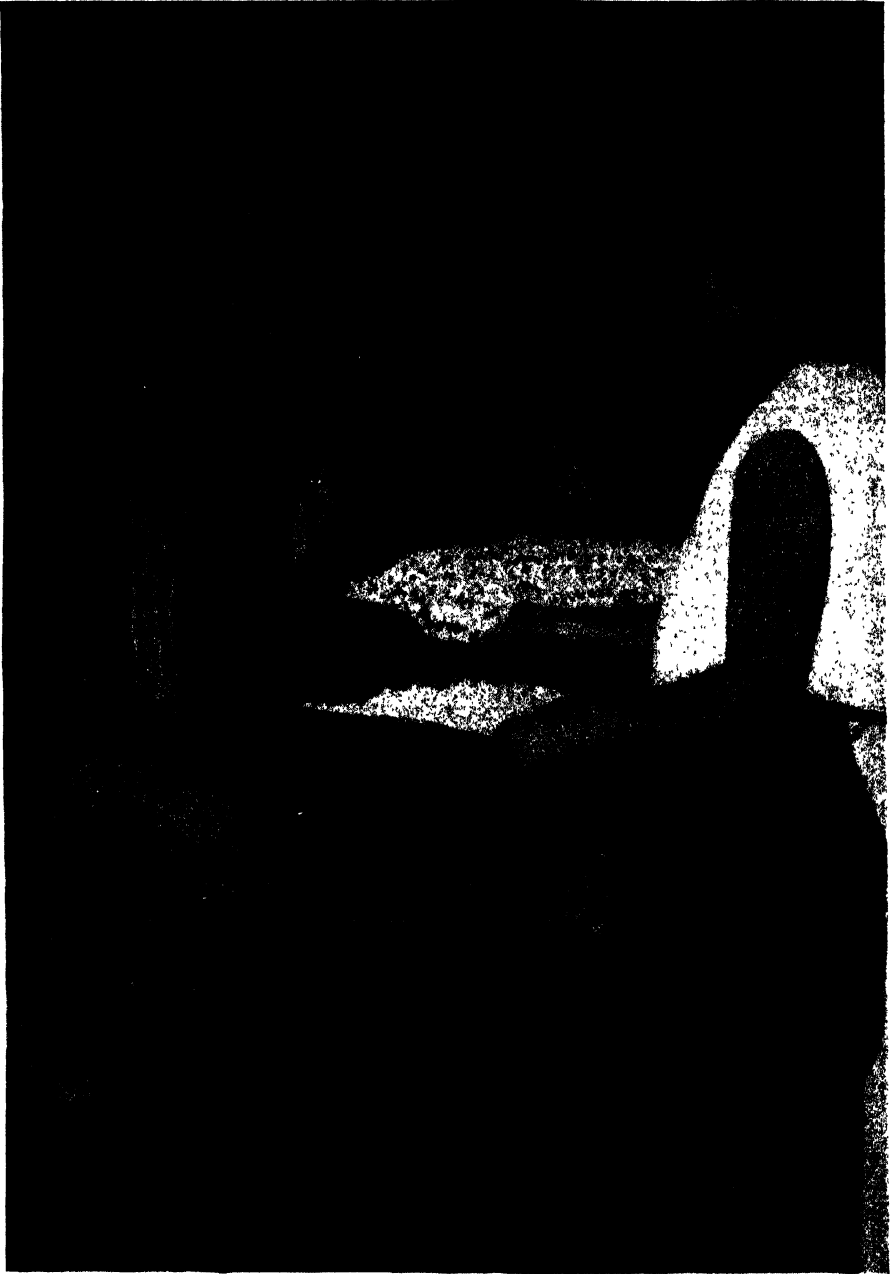

Etablissements Antoine Chiris, Grasse

Production of the flower oil from jasmin by the enfleurage process in France.

NATURAL PERFUME
MATERIALS

*A Study of Concretes, Resinoids, Floral Oils
and Pomades*

by
Dr. Y. R. Navés and G. Mazuyer

*with a preface by Professor H. Gault
of the Faculty of Sciences of the University of Paris*

Translated from the First French Edition by
Edward Sagarin

REINHOLD PUBLISHING CORPORATION
330 West Forty-Second St., New York 18, U. S. A.
1947

Copyright 1947 by
REINHOLD PUBLISHING CORP.

All rights reserved

J
N 295
31249
1/81

Printed in the United States of America by
THE HADDON CRAFTSMEN, INC., SCRANTON, PA.

PREFACE

From time immemorial, humanity has sought to use the resources of Nature for nourishment, for defense and for protection, in all climates and all seasons, against the sun, the storm and the cold. Little by little, man's crude and purely animal-like instincts of simple conservation became refined, and the peoples who were separated into various lands on the surface of the earth—of whom the Orientals were the first—sought in the three reigns any and all things that Nature may have provided, which could aid in ameliorating and embellishing the sad fate of man on earth. There was awakened in man the desire to satisfy his most highly refined senses; he listened to the chirping of the birds and the chant of the winds through the palm trees and through the cedar leaves; he contemplated the changing colors of the sky, of the waters of sea and of rivers, of fruits and of flowers; and he breathed of the smooth perfumes exhaled by a luxurious vegetation.

But there came a day when the birds were silenced, when the skies were darkened, when the flowers closed their petals. Man, sensitive to all the manifestations of beauty, sought to reproduce the sounds, so that he might harmonize them, and to draw out from the plants their color and their perfume, so that once the flower had withered, the color and the perfume might remain, to be sent from the Orient to less fortunate regions of the earth, where the lights were shining less brightly, where the tints were less exciting, and the flowers less odorous.

Man discovered that the woods and the foliage of trees, of herbs and of flowers would give up their color and their aroma to waters, to oils and to fats; later, when he had learned about the fermentation of honey and of the juices of fruits, he converted them to "spirits."

Benefiting by the progress made in the utilization of fire for the preparation of food, for the manufacture of pottery and enamel, for the making of bronze and brass, the Chinese, the Persians, the Egyptians and the Arabs acquired a knowledge of the treatment of plants to extract tinctures, perfumes and remedies. They practiced expression, maceration, digestion, and then initiated the distillation of woods, plants and flowers, giving the essential oils. The fumes of frankincense and of myrrh gave

a light and odorous aura which enveloped the religious sacrifices and rites, and the balsams, unguents, pomades and cosmetics began to serve the needs of mankind for maintenance of the beauty of the human body.

The aromatics, the extracts of precious woods, the perfumed oils and the distilled waters of roses were developed, partly as a result of the great voyages and of the trading from Persia and Egypt to Greece and Rome, and then to the Empires of the Far East and the West. Methods of extraction of odorous principles were modified and perfected during the early Egyptian and Arabian civilizations, and then were transmitted to the European peoples inhabiting the shores of the Mediterranean. None of these methods has today been abandoned by the modern natural perfume industry which, with all the powerful means at its disposal, still employs the techniques of antiquity and of the Middle Ages in the treatment of odorous plants.

The most widely used process, when it is applicable, of course, is steam distillation. However, side by side with its advantages, chief of which is its simplicity, it presents in many cases the rather serious drawback that it *simultaneously* calls into play a physical agent, heat, and a chemical agent, water; and the combined action of these two agents unfavorably affects the quality of the main constituents of the odorous plants.

On the other hand, the treatment of freshly gathered plants, and particularly flowers, by extraction agents, fats or volatile solvents, which act only by their solvent power, without any risk of chemical alteration, conserves in the extracted odorous material all the fullness and delicacy of the natural aroma. If the solvent is properly chosen, the complex formula of the chemical constituents which make up the odor character should be practically unchanged in the extracted product—that is, if it is not modified by a selective separation or by a more or less profound degradation of one of the constituents. It will therefore be understood that, despite the technical progress of steam distillation, the ancient methods of maceration, digestion and diffusion have been conserved and their practice modernized, and they constitute today the true *art* of the extraction of natural perfumes.

The numerous works dealing with the many techniques of the perfume raw material industry have not sufficiently discriminated between the merits and the disadvantages of the respective production methods. It is fitting that a work should have been written by specialists with training in the French natural perfume industry, a work limited to the ancient processes of extraction of natural odorous materials and to the

related preparation of essences, tinctures, oils and perfumed pomades. For it is in France and in the French Empire that *jasmin*, *violet*, *lavender*, *tuberose*, *mimosa*, *rose*, *orange flower*, *vanilla* and *nutmeg*, among others, are grown. It is to this work that Y. R. Naves and G. Mazuyer have dedicated themselves; one a well-informed chemist, the other an able perfumer; both known and held in high esteem in the art of extracting and blending perfumes.

The work which I have been asked to present to the public contains, in the first place, a history—as well documented as it is pertinent—of the methods of extraction and the agents employed in the course of the centuries. It is followed by a second part, a technical description of the raw materials used in extraction; the choice, purification and recovery of volatile solvents; the preparation of tinctures and infusions; the treatment of concretes, resins and balsams; the extraction of the aromas of fruits and distilled flower waters; the manufacture of pomades and perfumed oils by the use of vegetable and animal fats and mineral oils, properly chosen and prepared; the processes of digestion and enfleurage on solid and liquid absorbents; and finally, the extraction of decolorized absolutes and pomades from the diffused products.

In a third section of the book, the authors have assembled information on the chemical composition and analytical examination of the products of extraction by volatile solvents, enfleurage and digestion.

Finally, the last part of this book is extremely important; it is made up of a series of monographs of plant and animal raw materials that are subjected to extraction by one or several of the methods described in the earlier chapters, in order to obtain and subsequently treat their odoriferous principles.

By the importance and scope of the documents here assembled, by the very number of significant references, by the critical and certainly independent spirit which the authors have displayed, the study of Y. R. Naves and G. Mazuyer is deserving of wide success. Because of the choice and the diversity of the materials treated, it will be read with satisfaction by all those interested in the perfume industry and in the art of the perfumer, whose activities so clearly influence the purely scientific as well as the industrial world. It will be consulted by chemists and by technicians, as well as by those who will seek in the history of the methods practiced by the perfumers of Persia and of Egypt the foundations of the modern organic chemical industry.

I was particularly pleased by the honor of having been asked to write a preface for this book, not only because of the high esteem in which I hold the authors, but also because the name which I can place at the end

of this preface is now inscribed on the first pages of the two great works dealing with perfume raw materials, that of *Gildemeister and Hoffmann*, which has long become the classic in perfumery, and now a second, that of *Y. R. Naves and G. Mazuyer*, which too will become a classic in the very near future.

Paris, 1939.

H. Gault

FOREWORD TO THE FIRST AMERICAN EDITION

In bringing forth the present volume, the authors were seeking to present a new and useful work. Although the knowledge of essential oils has been assembled in a few fundamental works, our knowledge of perfume materials extracted by digestion, by enfleurage and by volatile solvents, is reported in the general treatises dedicated to odorous materials only in a fragmentary fashion, and sometimes with an insufficient familiarity with the subject. It seemed opportune to fill this gap in our scientific and industrial literature.

We have briefly reviewed the history and the present status of the industry engaged in the extraction of perfume raw materials by means of fats or volatile solvents. We have therefore excluded from our volume all information concerning essential oils obtained by the steam distillation of plant material.

In translating this work so carefully and competently, Edward Sagarin has made it possible to bring it before a public wider than it has heretofore reached, and I warmly thank him.

It is well-nigh seven years since the French edition of "Les Parfums Naturels" made its appearance. During these critical years, the efforts of mankind, in France and elsewhere, were directed toward the horrible struggle for life and death. These were unhappy years for France, the world center of the natural perfume industry, and it is therefore not surprising that relatively little time has been devoted by that industry to further research since 1939. As a result, its technical orientation was hardly modified, and the book which is now being presented to its American audience is fully up to date.

There were a few people who evidently misunderstood our purpose in writing this book. Our work was not intended to be a collection of technical recipes, to be compared to the instructions and formulas found in other works, just as one compares the recipes of culinary books. Such a comparison cannot be made, for our book was principally intended to open the road of experimental progress to the flower-oil industry, uniting both interpretation and aims. This significance will become clearer as there appear in America studies similar to those which have been published in Europe in recent years.

Looking back today on the experiments of my late collaborator, Gabriel Mazuyer, and myself, in the course of our activity in Grasse, and comparing these experiences with that resulting from other forms of activity in the manufacture, control and use of perfume raw materials during the intervening years, I can state that the aim pursued in this volume is correct and valuable.

Furthermore, the contents of this book have been discussed with my students in the course of my lectures at the University of Geneva, and I may say that the students have assimilated the material with ease.

The French edition of this book was received with enthusiasm. For this reason, I can foresee that future editions will bring to the reader the development of further chapters which adhere to the original idea.

February, 1946.

Y. R. Naves

INTRODUCTION

The most frequently used method for the isolation of natural odorous products is undoubtedly steam distillation, which gives *essential oils* or *essences*.

This technique has several drawbacks, of which the most important are: the modification or the creation of odorous bodies by the chemical action of water; the difficulty of extracting odoriferous substances which are not very volatile or which are appreciably soluble in water; and the inability to employ steam distillation for the isolation of the perfume of certain flowers, among others the *jasmin*. These defects and shortcomings are overcome by several other methods of extraction, which are the subject of this book.

From the dawn of recorded history, the capacity of fatty bodies to absorb perfume has been noted. The preparation of perfumed fats has long been practiced and used as a form of cosmetics. After man learned how to separate the odorous substances from the fats, with the aid of alcohol, this technique became a means of extracting perfume from flowers.

By the *digestion* of flowers in a mixture of fats (a pomade) or in oils, at a temperature of between 40 and 70°C, which is best suited for extraction and manipulation, there are prepared *flower pomades* (*pommades aux fleurs*) and *flower oils by digestion* (*huiles aux fleurs par digestion*).

It is remarkable that certain flowers continue to generate large quantities of perfume after they have been cut. To treat these flowers, one utilizes the *enfleurage* process; the flower is kept at ordinary temperature, under conditions which simulate its life, for about a day or more, while it is in contact with pomades and oils which absorb the perfume. There are obtained in this manner the *pomades* and the *oils of enfleurage*.

Ethyl alcohol has the property of extracting almost all the perfume from these pomades, in a concentration in which only a minimum of fats goes into solution. Utilizing this property of alcohol, there are prepared *alcoholic washings of pomades* (*lavages alcooliques de pommades*) and the distillation of the alcohol leaves as residue the *pomade concentrates* (*concentrés de pommades*).

The direct extraction of odoriferous plant substances by means of

alcohol has been known for a long time. Depending on whether one works with or without heat, it results in *tinctures* or *infusions*. By distilling off the alcohol from the infusions, there are obtained the *infusion concentrates* (*concentrés d'infusions*) also called the *alcoholic resinoids* (*les résinoïdes alcooliques*), either because of the predominance of resins in the extracts, or because their appearance resembles that of resins.

In the presence of fresh vegetable matter, the alcohol would be diluted by the vegetable water, and would lose its solvent powers. Extraction with ether or with other volatile solvents, such as benzene or petroleum ether, overcomes this difficulty, permitting isolation of the odorous products from fresh as well as dried plants. The extracts from fresh plants are particularly rich in waxy substances; they are often solids, and they are called *concrete oils* or *concretes* (*essences concrètes*), while the extracts from dried products, rich in resins, are the *resinoids*.*

Alcohol dissolves the odorous products in the concrete, and to a small degree the waxes. Utilizing this property of alcohol, there are obtained the *washings from concretes* (*lavages de concrètes*); and upon eliminating the alcohol from the washings by distillation, one obtains the *absolute oils from concretes*, frequently called simply *the absolutes*.

Other terms are used by producers or traders, but we shall not use them here, for those mentioned above are generally accepted and constitute a clear and logical system of nomenclature.

All the products extracted by the methods of digestion, enfleurage and extraction by volatile solvents, including alcohol, reflect the odor of the vegetable matter more genuinely and more faithfully than do the essential oils. And since the term "essential oil" is accepted by all and suffices for its purpose, we feel justified in reserving the term "natural perfumes" for the products extracted by the techniques which are described in detail in this book.

* The name "concrete" is applied to the essential oils of orris and ambrette because of their butter-like consistency.

TRANSLATOR'S NOTE

This authorized translation of "Les Parfums Naturels" has been reviewed in full by the senior author of the volume, Dr. Y. R. Naves, and the translator wishes to express his thanks to Dr. Naves for his aid in the preparation of the English version.

Many of the terms in common use in the French perfume industry either have no English equivalents at all, or are more widely used in American and British perfume circles in their original. It has seemed wise, as far as possible, to preserve the French version of these terms. To cite a few examples, we have preferred to speak of the *enfleurage* process, rather than *inflorescence*; we have kept intact such words as *châssis* and *corps*, which are defined by the authors in this volume, and we have preferred not to use the literal English equivalent, *wheel*, for the equipment widely known in France as *roue*.

On the other hand, several of the flowers described in this volume are well-known among perfumers in this country under the French name, but are referred to in chemical and botanical literature in their English version. Such words as *cassie*, *cassis*, *verveine*, *immortelle*, *gênet* and *réséda*, we felt had to be replaced, for the sake of scientific accuracy, with the corresponding *acacia*, *black currant*, *verbena*, *everlasting*, *broom* and *mignonette*. There are ample botanical identifications, and wherever we thought confusion might arise, we have cited the French equivalents as well as the English words.

The translator wishes to thank all those who have aided in the preparation of this translation for publication. He wishes to thank his colleagues at Givaudan-Delawanna, Inc., who have been extremely helpful in the search for proper chemical and perfumery terms. He wishes particularly to thank Miss Amy Geliebter for her studious and painstaking library work in checking the hundreds of bibliographical references contained in this volume. The translator is also indebted to Miss Mary Reid for her careful and untiring secretarial work, and to Mr. George Klinger, for his aid through many long hours of proofreading.

February, 1946.

Edward Sagarin

Abbreviations Used in Bibliographical References

<i>Am. J. Pharm.</i>	<i>American Journal of Pharmacy</i>
<i>Am. Perfumer</i>	<i>American Perfumer</i>
<i>Ann.</i>	<i>Annalen der Chemie</i>
<i>Ann. chim.</i>	<i>Annales de chimie</i>
<i>Ann. chim. anal. chim. app.</i>	<i>Annales de chimie analytique et de chimie appliquée</i>
<i>Ann. chim. phys.</i>	<i>Annales de chimie et de physique</i> (before 1914)
<i>Ann. fals.</i>	<i>Annales des falsifications et des fraudes</i>
<i>Apoth. Zt.</i>	<i>Apotheker Zeitung</i> (since Jan. 1934 <i>Standeszeitung Deutscher Apotheker</i> and since Oct. 1934 <i>Deutsche Apotheker-Zeitung</i>)
<i>Arch. Gewerbepath. Gewerbehyg.</i>	<i>Archiv für Gewerbepathologie und Gewerbehygiene</i>
<i>Arch. Pharm.</i>	<i>Archiv der Pharmazie und Berichte der deutschen pharmazeutischen Gesellschaft</i>
<i>Ber.</i>	<i>Berichte der deutschen chemischen Gesellschaft</i>
<i>Ber. Schimmel & Co. Akt. Ges.</i>	<i>Berichte der Schimmel & Co. Aktiengesellschaft</i>
<i>Biochem. J.</i>	<i>Biochemical Journal</i>
<i>Biochem. Z.</i>	<i>Biochemische Zeitschrift</i>
<i>Boll. chim.-farm.</i>	<i>Bollettino chimico-farmaceutico</i>
<i>Boll. ufficiale staz. sper. ind. essenze e deriv. agrumi</i>	<i>Bollettino ufficiale della regia stazione sperimentale per l'industria delle essenze e dei derivati dagli agrumi</i>
<i>Botan. Centr.</i>	<i>Botanisches Centralblatt</i>
<i>Bull. Imp. Inst.</i>	<i>Bulletin of the Imperial Institute</i>
<i>Bull. sci. pharmacol.</i>	<i>Bulletin des sciences pharmacologiques</i>
<i>Bull. soc. chim.</i>	<i>Bulletin de la société chimique de France</i>
<i>Bull. soc. chim. biol.</i>	<i>Bulletin de la société de chimie biologique</i>
<i>Can. Chem. Met.</i>	<i>Canadian Chemistry and Metallurgy</i>
<i>Chem. Industries</i>	<i>Chemical Industries</i>
<i>Chem. Weekblad</i>	<i>Chemisch Weekblad</i>
<i>Chem. Zentr.</i>	<i>Chemisches Zentralblatt</i>
<i>Chem.-Zt.</i>	<i>Chemiker-Zeitung</i>
<i>Compt. rend.</i>	<i>Comptes rendus hebdomadaires des séances de l'Académie des Sciences</i>

<i>Deut. Apoth. Zt.</i>	<i>Deutsche Apotheker Zeitung</i>
<i>Deut. Essigind.</i>	<i>Deutsche Essigindustrie</i>
<i>Deut. Parfüm.-Zt.</i>	<i>Deutsche Parfümerie-Zeitung</i>
<i>Documentation sci.</i>	<i>Documentation scientifique</i>
<i>Drug Cosmetic Ind.</i>	<i>Drug and Cosmetic Industry</i>
<i>Helv. Chim. Acta</i>	<i>Helvetica Chimica Acta</i>
<i>Ind. Eng. Chem.</i>	<i>Industrial and Engineering Chemistry</i>
<i>Indian J. Agr. Sci.</i>	<i>Indian Journal of Agricultural Science</i>
<i>J. Am. Chem. Soc.</i>	<i>Journal of the American Chemical Society</i>
<i>J. Am. Pharm. Assoc.</i>	<i>Journal of the American Pharmaceutical Association</i>
<i>J. Chem. Soc.</i>	<i>Journal of the Chemical Society (London)</i>
<i>J. Chem. Soc. Japan</i>	<i>Journal of the Chemical Society of Japan</i>
<i>J. Ind. Hyg. Toxicol.</i>	<i>Journal of Industrial Hygiene and Toxicology</i>
<i>J. pharm. chim.</i>	<i>Journal de pharmacie et de chimie</i>
<i>J. prakt. Chem.</i>	<i>Journal für praktische Chemie</i>
<i>J. Proc. Roy. Soc. N. S. Wales</i>	<i>Journal and Proceedings of the Royal Society of New South Wales</i>
<i>J. Roy. Soc. W. Australia</i>	<i>Journal of the Royal Society of Western Australia</i>
<i>J. Russ. Phys.-Chem. Soc.</i>	<i>Journal of the Russian Physical-Chemical Society (After 1930, Zhurnal Obshchei Khimii)</i>
<i>Kolloid-Z.</i>	<i>Kolloid-Zeitschrift</i>
<i>Parfums France</i>	<i>Parfums de France</i>
<i>Perfumery Essent. Oil Record</i>	<i>Perfumery and Essential Oil Record</i>
<i>Pharm. Acta Helv.</i>	<i>Pharmaceutica Acta Helvetiae</i>
<i>Pharm. J.</i>	<i>Pharmaceutical Journal</i>
<i>Pharm. Monatsb.</i>	<i>Pharmazeutische Monatshefte</i>
<i>Pharm. Weekblad</i>	<i>Pharmaceutisch Weekblad</i>
<i>Pharm. Zentralhalle</i>	<i>Pharmazeutische Zentralhalle für Deutschland</i>
<i>Pharm. Zt.</i>	<i>Pharmazeutische Zeitung</i>
<i>Philippine J. Sci.</i>	<i>Philippine Journal of Science</i>
<i>Recherches</i>	<i>Recherches, published by Roure-Bertrand fils et Justin Dupont, Grasse</i>
<i>Rec. trav. chim.</i>	<i>Recueil des travaux chimiques des Pays-Bas</i>
<i>Rev. botan. appl. agri. trop.</i>	<i>Revue de botanique appliquée et d'agriculture tropicale</i>
<i>Rev. chim. ind.</i>	<i>Revue de chimie industrielle</i>

<i>Rev. marques parfum. savon.</i>	<i>Revue des marques de la parfumerie et de la savonnerie</i>
<i>Riechstoff Ind. Kosmetik</i>	<i>Riechstoff Industrie und Kosmetik</i>
<i>Riv. ital. essenze profumi piante offic.</i>	<i>Rivista italiana delle essenze, dei profumi e delle piante officinali</i>
<i>Roure-Bertrand fils, Sci. Ind. Bull.</i>	<i>Bulletin scientifique et industriel de la maison Roure-Bertrand fils</i>
<i>Seifensieder-Zeit.</i>	<i>Seifensieder-Zeitung</i>
<i>Vierteljabresschr. prakt. Pharm.</i>	<i>Vierteljabresschrift für praktische Pharmazie</i>
<i>Wein u. Rebe</i>	<i>Wein und Rebe</i>
<i>Z. allgem. österr. Apoth.-Ver.</i>	<i>Zeitschrift des allgemeinen österreichischen Apotheker-Vereines</i>
<i>Z. exper. Path. Therap.</i>	<i>Zeitschrift für experimentelle Pathologie und Therapie</i>
<i>Z. physiol. Chem.</i>	<i>Zeitschrift für physiologische Chemie</i>
<i>Z. Untersuch. Nabr. u. Genussm.</i>	<i>Zeitschrift für Untersuchung der Nahrungs- und Genussmittel sowie der Gebrauchsgegenstände (since 1926, Zeitschrift für Untersuchung der Lebensmittel)</i>

PRINCIPAL ABBREVIATIONS

M.P.	Melting point
C.P.	Congealing point
B.P. ₁₂ . . . B.P. _{<i>n</i>}	Boiling point under 12 mm . . . under <i>n</i> mm.
d ₁₅ . . . d _{<i>n</i>}	Specific gravity at 15° C. . . at <i>n</i> ° C
α_D	Optical rotation for D wave length
$[\alpha]_D$	Specific rotation for light of $\lambda = D$
n_D^{20}	Refractive index for light of $\lambda = D$ at 20° C.
n_D^n	Refractive index for light of $\lambda = D$ at <i>n</i> ° C.
A.V.	Acid value
E. V.	Ester value
S. V.	Saponification value
M. V.	Methoxy value (Zeisel)
E.V. ac.	Ester value after acetylation
E.V. cf.	Ester value after cold formylation
I. V.	Iodine value
% Esters	Ester content expressed, unless otherwise indicated, in esters of molecular weight of 196.16
% Free alc.	Free alcohol content expressed, unless otherwise indicated, in alcohols of molecular weight of 154.14
Tot. alc.	Total alcohol content, calculated in the same way
Sol. 80 . . . Sol. <i>n</i>	Soluble in 80% alcohol . . . in <i>n</i> % alcohol

WEIGHTS, MEASURES AND ANALYTICAL DATA

All data regarding weights, measures, temperature readings, and similar information, are reported here in the metric system. Our readers will be thoroughly familiar with all such standards, except possibly the hectare, which is the equivalent of 10,000 square meters or 2.471 acres.

LIST OF ILLUSTRATIONS AND GRAPHS

FIGURE	PAGE
	<i>Frontispiece</i>
1. <i>Jasmin enfleurage</i>	11
2. <i>Perfumers of the sixteenth century</i>	12
3. <i>Cultivation of orange trees</i>	13
4. <i>Directions for enfleurage, from Liébaut</i>	13
5. <i>Directions for enfleurage, from Cortese</i>	25
6. <i>Panorama of Grasse</i>	74
7. <i>Vapor tension curves</i>	76
8. <i>Activated carbon adsorption</i>	86
9. <i>Garnier-type extractor</i>	87
10. <i>Garnier-type extractor</i>	88
11. <i>Bondon-type extractor</i>	89
12. <i>Solvent recovery with carbon</i>	89
13. <i>Rotating extractors</i>	90
14. <i>Apparatus for solvent recovery</i>	91
15. <i>Solvent extraction room</i>	92
16. <i>Garnier apparatus for rose extraction</i>	92
17. <i>Bondon-Dumont extractor</i>	93
18. <i>Jasmin flowers in extractor</i>	94
19. <i>Removal of exhausted jasmin</i>	95
20. <i>Volatile solvent extraction</i>	108
21. <i>Water baths and hydraulic presses</i>	109
22. <i>Solvent extraction room</i>	115
23. <i>Production of oils by maceration</i>	116
24. <i>Removal of alcohol from jasmin pomade</i>	117
25. <i>Removal of jasmin flowers from frames</i>	118
26. <i>Removal of jasmin flowers from frames</i>	119
27. <i>Preparation of alcoholic washings</i>	120
28. <i>Apparatus for maceration</i>	146
29. <i>Naves apparatus to determine yield of absolute</i>	149
30. <i>Naves apparatus for distillation under pressure</i>	150
31. <i>Head of Naves apparatus</i>	153
32. <i>Periods of year for treatment of flowers</i>	160
33. <i>Map of Grasse and its environs</i>	189
34. <i>Gathering of jasmin</i>	191
35. <i>Variation of jasmin yield during season</i>	192
36. <i>Variation of jasmin absolute yield, during day</i>	192
37. <i>Variation of jasmin absolute yield, during season</i>	208
38. <i>Cultivation of lavender</i>	210
39. <i>Cultivated lavandin</i>	222
40. <i>Variation of orange flower yield</i>	224
41. <i>Orange groves</i>	226
42. <i>Picking orange blossoms</i>	236
43. <i>French roses in factory</i>	247
44. <i>Gathering of tuberoses</i>	253
45. <i>Cultivation of violets</i>	255
46. <i>Victoria violets</i>	255

TABLE OF CONTENTS

	PAGE
<i>Preface by Professor H. Gault</i>	iii
<i>Foreword</i>	vii
<i>Introduction</i>	ix
<i>Translator's Note</i>	xi
<i>Abbreviations for References</i>	xii
<i>Principal Abbreviations, Weights and Measures</i>	xv
 I. A BRIEF HISTORY OF NATURAL PERFUME MATERIALS 	
<i>The Documents and the Iconography</i>	1
<i>Evolution of the Natural Perfume Industry</i>	2
<i>Bibliography of Sources and Works Consulted</i>	16
<i>History of Techniques of Extraction</i>	18
 II. MODERN PROCESSES OF MANUFACTURE 	
<i>Concrete Essences and Resinoids</i>	59
<i>Pomades and Floral Oils</i>	104
<i>Absolute Essences and Concentrates from Products of Enfleurage and Digestion</i>	121
<i>Decolorized Concretes, Resinoids, Absolutes and Concentrates from Pomades</i>	126
<i>Separation of Odorous Fractions by Distillation</i>	132
 III. CHEMICAL COMPOSITION AND ANALYTICAL EXAMINATION OF PRODUCTS OF EXTRACTION, ENFLEURAGE AND DIGESTION 	
<i>Chemical Composition</i>	137
<i>Analytical Examination</i>	141
 IV. MONOGRAPHS ON NATURAL PERFUMES 	
<i>General Remarks</i>	161
<i>Monographs of Floral Oils</i>	165
<i>Monographs of Plant Resinoids</i>	262
<i>Monographs of Animal Resinoids</i>	295
 <i>Index of Latin Botanical Names</i>	 301
<i>Author Index</i>	305
<i>Subject Index</i>	314

SECTION I

A BRIEF HISTORY OF NATURAL PERFUME MATERIALS

THE DOCUMENTS AND THE ICONOGRAPHY

We possess no testimonial of the invention of the first process for the manufacture of perfume; it was the common result of all the great technical processes which are at the origin of our civilization.

Progress in the creation of the natural perfume industry developed slowly. The first manipulation of perfumes was as *therapeutic* remedies, utilizing the immediate resources of Nature; then, as time passed and the experience of mankind accumulated, they became the basis of the then secular employment of incense. The latter established the first forms of perfume, and contributed to the knowledge which has led to the evolution of the technique of *the perfumer*. This knowledge was then applied to flowers, whose cultivation became centered in spots where the climate and land were favorable.

In the course of the centuries, and until very recent times, progress in the knowledge of perfumes was the possession of anonymous artisans; all such progress, when it was published, was linked with the past. Thus much was lost, but it was later to be recovered.

We are familiar with the work of the encyclopedists who, by recording the state of knowledge at various periods, made the contribution of gathering information on contemporary technical processes.

For many centuries the great minds, prepared by study and meditation, by the acquisition of general knowledge, and by a critique of the experimental method, were diverted from this field of work by the practice of alchemy, a religious and philosophical science, the ideal of their dreams, which bestowed upon experimentation only a mystical character. Thus the learned men of the Middle Ages, upon the development of the science of distillation, maintained that the methods for the extraction of natural perfume, digestion and expression, for example,

were accessories of negligible importance. They were just the common practices "of vulgar people," wrote Conrad Gessner.

Upon the efforts of Paracelsus, of Bernard Palissy, of Nicolas Houel, of the rationalism of Descartes and of Roger Bacon, the modern experimental method was built. The interest of men of science was directed more to the products of distillation than to those of dissolution—a technique less new, and they felt less scholarly, which was not to be understood again until our day. Perhaps it is for these reasons that today we are engaged in recording the examination and the study of natural perfumes, as compared with the products of distillation, or the process of their distillation.

More exact knowledge concerning perfumes came later; in the beginning, such information was known only among the Gnostics, and had no meaning except for the initiated; the knowledge was rare, because the source of the materials and the general experimental processes were surrounded by an aura of mystery. For a long time, we were reduced to the use of sources that were scanty and fragmentary, until the seventeenth century, when the first treatises appeared in which the processes were described for the artisan and written by those in the art. For the artisan, that is saying a great deal, for it can be seen that it was frequently the aim of these volumes to arouse the curiosity of the nobility.

The iconographic documents are also few in number; those that are relatively abundant and that date back to the first printed books, concern the process of distillation. From the sixteenth century on, the iconography of odorous plants developed, but not until the eighteenth century does one encounter illustrations of technical processes of the perfumed fatty *corps*.

However, general documents do exist which illustrate the paths—ethnic, climatic and commercial—along which these processes have developed, to culminate in recent centuries in the artistic and later the industrial center of the manufacture of natural perfumes: the town of *Grasse* and its environs.

EVOLUTION OF THE NATURAL PERFUME INDUSTRY

The history of natural perfume materials is identified in the first instance with the history of perfumery; well-described technical forms appeared with the first products of distillation; the waters, in the era of Byzantium; then the essential oils, in the Arab period; the fatty preparations and the alcoholic solutions during the Middle Ages; and during the Renaissance there was formed the industry of the perfumed fatty *corps*.

In the first part of this book, we shall describe the framework and

the roads along which the science and industry of natural perfume developed, and then show how each element in the manufacture became integrated into the whole and how it attained its present form.

Ancient Civilization. The primitive perfumes were natural aromatics. They constituted one of the earliest media of exchange because they were rare, precious in a small volume, and could be carried by caravan along the routes of commerce. In the ancient civilizations, perfumes were used as an expression of the animist and cosmic conceptions, responding above all to the exigencies of a cult.¹ In China, the first evidence of the use of perfume dates back to a little before the first thousand years before our era. In two rituals, the Li-ki and the Tcheou-Li, the forms of this cult have been preserved.

In India the Sutras, a body of elaborate precepts collected during several centuries and transmitted by word of mouth, correspond to the ritual represented by perfume sacrifices. In the Vedic literature there was already apparent a broader significance to perfume; in the Indo-Aryan tongue, *Atar* means wind, smoke, odor and essence, and among the Indo-Iranians, perfume was no longer confined to odors created by fire, but was also a product made by the manipulation of vegetable material for the compounding of sacrificial liquors. The Buddhist liturgy later prescribed that statues of the gods be washed with perfumed electuaries. Similar rites were found in the religious customs of ancient Egypt.

Associated at first with theophanies and incantations, the perfumes made by *fumigation*, *libation*, and *ablution*, grew directly out of the ritual, and became an element in the art of therapy. By the very nature of things, the juices expressed from succulent flowers and plants, the pulp of fruits, the meal of oleaginous seeds, honey and oils were the basis of the first remedies and at the same time of the first perfumes of the Egyptians, who were the earliest to create certain methods for adornment of the body.

The civilization of the Nile transmitted on the stones of its monuments a complete iconography of the processes for the preparation of oils, balsams and fermented liquors, but it was not until the epoch of the Saïte era, the 7th to 4th centuries before our time, that we find proof of the existence of a method of expression of flowers, represented by a bas-relief of the *Gathering and Pressing of the Lily*, now in the possession of the Louvre.²

The bas-reliefs of the chambers of Edfu mentioned, under the name of *Ami*, 14 kinds of perfumes, and by the name of *Ab* designated 8 kinds of aromatics,³ of which we actually have only conjectural data. The

materials of the aromatic Pharmacopoeia of Egypt are known to us. The murals of the temples and later the medical papyri written in the Egyptian demotic, cite more than 500 names of plants which were passed down by the Greek writers, particularly by Theophrastus of Eresus, on Lesbos; but this documentation is replete with an entirely Oriental disorder, which mistakes the whole for the part, confusing origins, characters and properties.

There was known in the Egypt of Ptolemy an aromatic vegetable preparation called *Kyphi* which was distributed after the conquest of Egypt in the Greek and Roman world. Many hieroglyphics are extant which refer to *Kyphi*, notably on Philæ.⁴ In the age of Ptolemy, *Kyphi* was used not only as a religious aromatic, but as an antidote and as a perfume; thus two centuries before our era, we find the entry of perfume into the life of man outside his temple.

Asia Minor: The ancient civilization of the Chaldeans and the Assyrians improved the mental tools of mankind, especially in languages and mathematics; it contributed less to the cultivation of the arts; it knew the worship of fire and built huge ones but nothing, strictly speaking, could be a sacrilege to fire, which explains why there is left today no vestige of the times which evidences the ritualistic use of perfumes.

A legal reprobation struck the many professional men, who were charged with tampering with fire, and even with water and earth; that is why, in the "Laws of the Hittites" one finds that these *mixers of ingredients* were among the lowest classes of society, which meant that their profession was reserved only for slaves.

In the five books which are the foundation of the history of Israel, numerous references to perfumery are made⁵; the Ishmaelites of Gilead transported aromatics; there was one perfume reserved for holy anointing oil, and others for secular usage; according to Exodus, the Lord transmitted to Moses the formula of the anointing oil, in which olive oil was used, among other substances. For perfume for secular use, the perfumers do not seem to have been held in high esteem among the Israelites, although they were free men.⁶

Navigators and traders, the Phoenicians brought to Carthage the gums from Arabia, which one finds together with the coal of the Dead Sea in the Punic sarcophagi; they were the first to bring to Rome the camphor from China, cinnamon from India, which they received from Eziongaber, their port on the Red Sea to the east of the Sinai peninsula.⁷ It was a rule among the Phoenicians to keep their trade routes secret, and for that reason the western peoples for a long time did not know the true origins of aromatics and perfumes.

Greek and Roman Civilization. Herodotus and Hippocrates, who summarized the state of knowledge of their times, transmitted what the Greeks knew about perfumery; Herodotus furnished the first information about designated perfumes, and numerous details on vegetable oils and odorous plants⁸; regarding aromatics, Herodotus cited many curious legends that emphasize the diligent care exercised in Greek times for the severe defense of the sources of materials as precious as perfumes.⁹

Hippocrates prescribed *perfumed fumigations* and *fomentations*¹⁰; from Greek medical practice there is derived the term *Iatralypte*, from the physician who cured by the use of aromatic unctions. Under Pericles, the preparation of perfumed oils was important; special vases of Athenian ceramic, the *aryballus* and the *lecythus*, were for aromatic oils.

At the same time, the Greek colonial islands reached a high cultural level; Cyprus, particularly, exploited its raw materials and developed the industries for their use. Cyprus became one of the first *lands of perfumery*.

Roman civilization intensified trade relations, developed agriculture, and thus permitted the liberal arts which depend on these industries to gain a stable footing and to develop. Dioscorides made a study of the sources and the uses of drugs and odorous vegetable materials in which the Greeks and Romans specialized; known among the latter as the *Herbarius*, the former as the *Rhizotomos*.

Pliny, who borrowed his perfume terminology from Theophrastus, clarified and detailed the work of his predecessor and indicated processes for obtaining perfumes by means of extraction with fats.

At the zenith of the Empire, under the first Caesars, the knowledge of perfumery already covered many subjects, as shown by the complete vocabulary that has survived. Much of this knowledge still relates to the *Materia Medica*; Criton, physician from Trojan, placed 25 types of odoriferous oils among the medicaments.¹¹ Little by little, the luxury of perfumery spread in the Roman world, diffused particularly by the Orientals,¹² and by such writers as Juvenal and Martial.¹³ Horace tells us that the wealthy Romans conserved the precious oils in Arrentive earthenware vases; in the murrhine vases of Sidon, and in rhinoceros horns.¹⁴ The Romans, wrote Pliny, considered the use of perfumes as one of the most honest of the pleasures of man.¹⁵

The Byzantine Epoch. Under the influence of the immediate successors of the Alexandrian School, a regrouping of scientific forces occurred, and there was founded a movement which was then called by the new name of *Khimeutika*. What has come down to us of this civilization has been recovered in Greek manuscripts, of interest primarily in deter-

mining the state of knowledge between the third and sixth centuries before our era. The basis of this knowledge includes liberal art procedures, chimeric processes, or clear and positive descriptions of a still unshaped technology. There is little knowledge of perfumery in the manuscripts of the Greek alchemists, either because these were among the lost sections of their work, or because the austerity of Christianity in birth saw in perfume oils an accessory to idolatry. None the less, a sort of odor symbolism made its appearance. We find the term *pneumata* to define whatever volatilizes and evaporates under fire, from sublimable bodies to alcohol; translated into modern language as *esprits*, or *spirits*, it was to be used to designate odorous alcoholic substances.

The first classification of perfumery operations is found in the work of the Greek alchemists; they define the disaggregation or separation (*analysis*); the fixation, decantation, extraction, fusion (*elaiosis*: passage into oil); the decoction, ceration (*kerotakis*: fusion analogous to that in waxy bodies); sublimation and digestion; and finally in these same documents there appears the first graphic representation of distillation apparatus, to which perfumery owes so much.

At the end of the Byzantine empire, Nicholas of Alexandria, also known as Myrepsos, the maker of unguents—he had invented a cinnamon pomade—as well as Actuarius, Aetius and Oribasius, who wrote on distillation, transmitted to the Arabs the knowledge which here interests us.

The Arab Civilization. With Mohammed, the empire of Islam extended from the Tokhars of the Gobi desert to Maghrebins on the Atlantic coast, where there arose the Crusades, which had so profound an influence on Oriental culture. It was long known that the Arabs were traders in the aromatics of the Hadramaut and the treasures of Ophir, a name used to designate the entire eastern coast of Africa; but it was not known that their navigators, as familiar with the compass as they were with the monsoon, frequented Zanzibar, the Persian Gulf, the coast of India, Ceylon and Sumatra. In fact, through the control of maritime trading routes, they held a monopoly in spices, and the Mediterranean peoples showed fear of their might, though they hardly knew these Arab traders. Finally, the Arabs also controlled the land trading routes in aromatics with China and India.

Arab hegemony brought with it the material basis for the growth of large cities; and at the same time, the preoccupation with cultural developments necessitated translation into the Arab tongue of the books of the Persians, the Syrians and the Alexandrians. Thus was transmitted to us the sum total of all previous knowledge. From the 7th to the 9th centuries, Arab civilization flourished under the Califs, the Ommeaides

and then the Abassides, all friends of science, protectors of the savants, founders of educational institutions and of libraries.

The Arabs were more interested in exact sciences than in applied arts and sciences. They assembled the first collections of pharmaceutical knowledge, which they called *Science of Misan*—science of the balance—which is truly a collection of galenicals, close to our own in origin. If they were not the inventors of distillation, they improved it and spread its uses. From the 7th to the 13th centuries, they produced the elite men of science: Geber, Rhazès, Avicenna, Aboul Quassim, Sérapion, Mesuë, whose works were translated into Latin. Geber was the encyclopedist of his times. One of the most important of his books, *Summa Perfectionis*, deals with various methods of distillation, sublimation and digestion. Mesuë left for posterity his *Antidotaire* in 12 books, a capital work republished by the Pharmacopoeias up to the 17th century, of which two chapters on unguents and oils pertain to perfumery.

The Salerno and Montpellier Schools. Masters of half of the Mediterranean coast, with its advanced posts in southern Italy, in Sicily to which they brought the Agrumes, in Sardinia and the Balearic Islands, the Moslems soon carried to the West their Saracen civilization, under the form of teachings of a didactic character; the contact was established at Salerno, in the shadows of Naples, and at Toledo, which had again become Christian in the 11th century.

At Salerno, a port frequented by navigators during the Crusades, a Benedictine foundation professing to follow Greek science gathered around it the Arabian scientific teachings, particularly in medicine, which it disseminated among the clerics. Europe of the 11th and 12th centuries needed such instruction; the contact with the Orient in the Holy Land had enlarged its horizons and established certain trends of thought; and the school of Salerno became a spiritual rallying ground, through which the science of the Arabs penetrated throughout the West.

The teachings of Salerno were repeated for three centuries in the outstanding universities of Christendom; from a later date, we possess texts inspired by these teachings; among others the *Antidotarium Nicolai* of Nicolas Praepositus, which became a compulsory possession of every apothecary under the laws of 1353; the *Liber de Simplici Medicina* of Platearius; the *Compendium Aromatariorum* of Saladin, all of which are treatises on drugs and plants, the majority odorous. It was then that Europe knew the terrible fear of the great pestilence, and anything that was aromatic took on the aspect of a panacea in the hands of the *Aromataires*, so that the use of aromatics spread. They were experimented

with, they were studied, they were the subjects of endless learned writings until the days of Paracelsus.

At the same time, Toledo had become another pole of learning. In contact with Cordova, capital of the Occidental Califate, Toledo attracted Gerbert d'Aurillac, later to become leader of Christianity, and Gérard de Crémone founded in that city a school of translators who rendered an immense service by the circulation they gave to a wide variety of studies. Thus the light of Moslem culture and tolerance was shining simultaneously in Italy and in Spain, bringing changes in technique, building the foundations of new industries, and affecting the art of perfumery primarily by making known the art of distillation. Thus they developed spirits of wine, destined to become, with the abandonment of the use of oil, the vehicle of perfumes.

From Catalonia, following the travelers and merchants who there enjoyed trading privileges, the savants of Spain, ruled by the Almoravides, and of the Balearic school of the learned Jews, migrated to southern France, where they founded the faculty of Montpellier, in its beginnings a genuinely Mozarabic university. It was a school that shone with a brilliant light, spreading its influence to all other centers of learning in Europe; it was frequented by the great humanists. With Arnould de Villeneuve, Raymond Lulle and Jean de Roquetaillade, the domain of distillation was enriched; the apothecary-spicers learned to prepare medicines, essential oils, perfumed oils, to which the Languedocian flora lent itself. This was the first activity of importance to French perfumery, which was to plant its roots deep in the soil of that land, for on the threshold of the 18th century, the French were still teaching the methods of the *Senteurs en odeur de Montpellier*, the odor blenders of the Montpellier school.

Venice and the Great Exploration. One important page in the history of perfumes is the history of spices, linked as it is with the grandeur of Venice. The Venetians, whose future could be only at sea, for many years had close relations with the Orientals. Venice was already the center of active trading, when the Crusades offered it an opportunity to establish itself in a powerful position in the Levant.

In Mediterranean commerce, this was of capital importance, for it was there that the precious commodities from India and China arrived for the Occident, and Venice succeeded in establishing quite a monopoly in this trade. The products of this commerce included young deer, fabrics of silk and cotton, carpets and rugs, ivory, precious stones, glassware, exotic fruits, together with such drugs as amber, alum, aloes, and rhubarb; then sugar and spices—pepper, cinnamon, camphor, nutmegs,

cloves, musk, sandalwood and incense; and balsams and gums; in a word, all the commodities of a luxury which many Crusaders, who had left their homelands frustrated and bloodthirsty, but who had become artistic and tolerant, found for the development of a cultured taste.

During the 14th and 15th centuries, Venice became one of the great powers of Europe, with 3,000 ships and 30,000 sailors, with ambassadors as far away as Cathay, with the oldest known banks and with flourishing industries. At one time Venice punished by death a worker who exported or disclosed any knowledge of use to the nobility. The competition of the Genoans, followed by the discovery of America and of a route to the Indies, contributed to bringing about the decadence of Venetian commerce, which had spread among the Europeans benzoin, balsam, civet, as well as the old remedy, treacle, and porcelain.

In 1498, the Portuguese under Vasco da Gama landed at Calicut to the frank and unashamed cry: *Christos e espiciarias!* Calicut is a land of tropical plants; all the drugs, the spices and the perfumes of Asia pass through its markets. The travels of Vasco da Gama led him to Goa, to Malacca, and to the great commercial ports of East Africa, Mombasa and Mogadoxo. He returned to Lisbon, with galleons laden with cinnamon, pepper, incense, cloves . . . and with a project for the destruction of the entire navy of the Moors! In 1523, he sold 700,000 cruzados of aromatic drugs and spices in a single day in Lisbon—the like of which had never before been seen. The road pioneered by the Portuguese had completely changed the course of world trade; the war of spices had begun, destined to continue for two centuries.

Renaissance and Sixteenth Century. The revival of the Byzantine savants following the Ottoman conquest, the invention of movable type by Gutenberg, and the flowering of humanism—these were the forces that developed the road of progress, that encouraged the birth of new trends of thought, that multiplied voyages of exploration and trade, creating a standard for the exchange of moneys, brought forth coins of pure alloys, and sponsored contracts and credits.

Centers of learning and culture multiplied; the foundations of the system of knowledge were modified, and a critical spirit replaced a narrow dogmatism. There developed the idea of combatting speculation with logic: "To attain the truth, one must consult experience," taught Bernard Palissy.¹⁰

Alchemy gave way to iatrochemistry, a form of technical chemistry whose aim was the positive study of nature; through this learning, the knowledge of perfumes was related to the other manifestations of man's intellect. Because the merchants always came back from the Orient carry-

ing the plague among their merchandise, perfume was considered as a remedy, only to become the object of a deeper curiosity. At the head of his *Trésor des Remèdes*, Conrad Gessner stated, in an old French that almost defies translation, "the chemical art is the extraction of juices and good things."¹⁷

In Florence, Venice, and Rome, eminent centers of the revival of the plastic arts, the applied sciences were also progressing, and the administrative society encouraged the magnificent arts. In France, the taste for perfumed oils and pomades, for soaps and perfumed gloves, was maintained by the Court, but soaps and *axunges pérégrines* (foreign salves), as they called these materials at the time, were manufactured abroad. In 1565, there was established at Chaillot, near Paris, the first factory for the production of soap, which hitherto had come from Genoa, Bologna and Alicante. The Statutes of 1582 contributed toward the formation of a guild of *parfumeurs-gantiers*, which was to become independent of the society of *spicers-apothecaries*.

From the period date a large number of collections of the *Marvels of Nature* and of *Formularies* and *Recipes* of the art of perfumery, all ingenious in their techniques. From 1530 to 1590 there appeared in Italy and in France, in quick succession, the works of Le Fournier, Luigini, Cortese, Marinello, and Filareto, in numerous editions. In 1553, there was published the *Critique des distillations et décoctions chymiques* of Placotomus (Breitschneider); and in the first half of the 16th century, both Symphorien Champier in his *Myrouel* and du Boys (Sylvius) in his *Méthode* were largely preoccupied with perfumes and odorous drugs.

Thus perfumes were becoming a part of the fashions. Montaigne entitled a chapter of his *Essays*, "Des senteurs,"¹⁸ and Fioravanti stated that "the art of the perfumer should be practiced by ingenious and noble men, more for pleasure than for profit, as it is by several in Venice and in Paris, who have rare things in their shops."¹⁹

In the 16th century, all Europe passionately embraced the study of botany. It was the age of the *Herbolayre* and of the *Kraeuterbuch*; botanical gardens sprang up in Padua in 1545, Pisa in 1549, Leiden in 1577, and Montpellier in 1598, while Sully cultivated the mulberry tree and perfumery plants. Travelers and botanists came to satisfy their curiosity, developed their knowledge of exotic plant life, aided their acclimatization, their cultivation, and their use. The industry of perfumery and that of distillation flourished, attracting the illustrious names of the day: Matthiole, Caesalpin and Prosper Alpin in Italy; Charles de l'Écluse, Dalechamps, Belon and Thevet in France and in Flanders; Nicolas Monard, Garcia da Orta and Acosta in Spain and in Portugal;

Brunfels, Rauwolff, Cordus and Conrad Gessner in Germany and in Switzerland.

In the northern countries of Europe, and then in France, were founded flourishing commercial enterprises, of which we need mention only the Hanseatic League. The traders in spices and in perfumed drugs were also the shipowners and the bankers. It was in a Europe enriched by trade that the development of the luxury and comfort industries became imperative.

Zu den vierden wie man die composita vnd simplicia zusam
men vermischen soll/nach rechter Kunst vnd art/off das sie zu vollkommender werckung
vollbringen mögen/nach dem die alten Philosophi darvon schreiben.



G. Mazuyer Collection

FIGURE 1. *Perfumers of the sixteenth century, as depicted in the book by Brunschwig, "Liber de arte destillandi," Strasbourg, 1516.*

Seventeenth Century. Guiding the forces of the nation toward the development of production and trade, Colbert rose to power in France. His Ordinance of Commerce of March 1673, regulating the apprentice masters and the professionals, inspired a general activity which enabled the manufacturers of perfumes to prosper and to group themselves into an industry.

This new industry was at first dependent on the spicers-apothecaries society, two groups which had been reunited under the Statutes of 1638.

They were part of the famous *Six-Corps*, that is of the six most powerful commercial societies, supported by tremendous financial interests sponsoring the purchase of foreign raw materials—not only the official and the aromatic types, but also the waxes, fats, certain oils, soaps, and caustic soda.

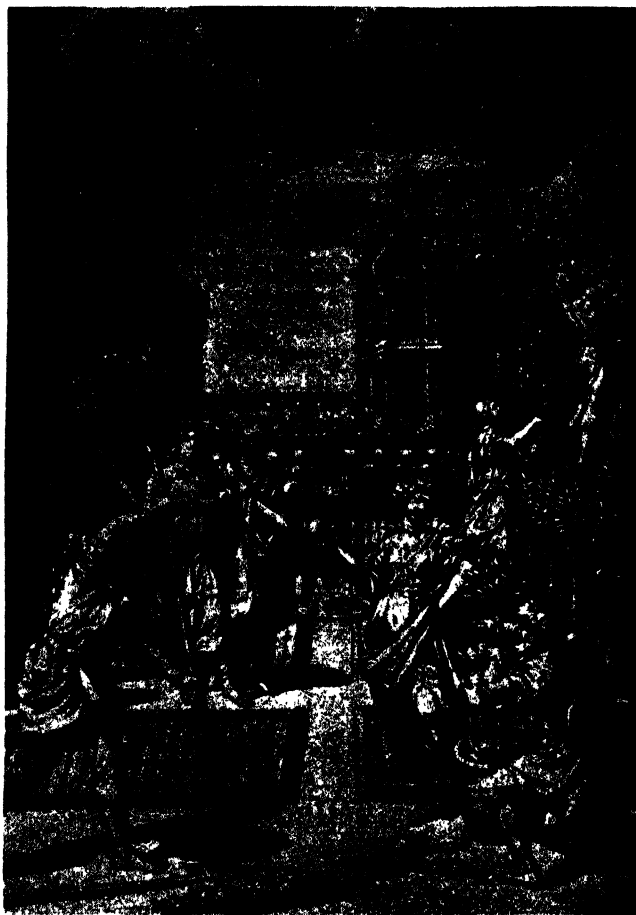

G. Mazuyer Collection

FIGURE 2. *Allegory depicting cultivation of orange trees, from the fresco of Guido Reni in Aldobrandini's Villa, in Frascati, seventeenth century.*

Whereas in Paris the society of *gantiers-poudriers-parfumeurs* was primarily a commercial organization of many years' standing, which had been revived by the Statutes of 1656,²⁰ in Provence, at Grasse, a few artisans, grouped around several families, at the end of the seventeenth

century created a floral perfume industry, choosing a spot that was favored by climatic conditions, and dedicating themselves to the production of fine oils and the cultivation of several perfume plants.

In its beginnings, this activity was linked to the industrial enterprises in which perfume was an accessory item: there were the gloves; there

Huile de fleurs d'oranges.

Prenez femences de melon bien fort , pilez telle quantité qu'il vous plaira , mettez vne partie d'icelles dans vn vaisseau vitré , & par dessus des fleurs d'oranges, couutez derechef ces fleurs d'oranges , d'autres femences de melon: cela fait laissez les reposer vn iour entier & le lendemain ietrez hors les fleurs, au lieu delquelles mettés d'autres recentes sur les femences de melon que disposerés à la mesme façon qu' auparauant , ainsi par chacun iour changez les fleurs : A la parfin les semences de melon abbrenuees des facultés & odeur des fleurs d'oranges soient exprimees par vn sac de lin arroufé d'eau rose, & l'huile en soit gardee.

FIGURE 3. *Directions for the treatment of orange flowers by enfleurage, from the work of Liébaut, "Quatre livres de secretz," 1616.*

were hides prepared from myrtle and mastic, soaps from Bologna, tobacco which had recently been coming from Spain, and the powdered wigs, imposed by the fashions of the Court of Versailles. Simon Barbe, in *Le Parfumeur François*, published in 1693, showed that these industries had common techniques for the preparation of flower oils and

Oglio di naranze.

Pigliate scorcia di naranze , e pestatele con le mandole , e lasciate cosi vn giorno , e dipoi farete oglio a torcolo , e datteli poco fuoco , e premetelo ben senza fuoco, e ponetelo nella bozza al Sole .

FIGURE 4. *Directions for the treatment of orange flowers by enfleurage, from the book, "I Secreti della signora Isabella Cortese," Venice, 1665.*

pomades, but Grasse became the center of all these local activities, when the leather-dressing industry of Grenoble and the tobacco industry of Avignon began to decline.

The community of commercial interests between the spice dealers and the apothecaries would explain why the seventeenth century pharma-

copoeias of Jean de Renou, Bauderon and Charas, and the chemical treatises of Beguin, Nicolas Le Febvre and Crollius, deal to a considerable extent with the preparation of perfumes. None the less, the profession of perfumery broke away from the allied fields, and became independent, due to the very nature of the production problems. Thus, in the collection of de Blégnny,²¹ gathered in 1689 on the order of Daquin, leading physician to Louis XIV, perfumes were no longer treated in the same way as medicines, except where they had some rather doubtful medicinal properties. As a matter of fact, de Blégnny explicitly separated the distilled liquors, such as the Hungary waters; the tinctures of amber and cinnamon, the perfumes of decoction, such as the *eau d'Ange*; the fatty essences or flower oils of infusion, the pomades, and the odorous balsams. Upon the authority of the royal commission, he thus grouped all the materials of the perfumer, which were liberated from the trusteeship of the apothecaries.

Eighteenth Century. It was in the 18th century that the industries of artistry, and minor arts as well, found among the nobility a support, an enthusiasm which gave wide fame to the products of its manufacture. "For the French," wrote Necker, "taste is the most fruitful of businesses."

Together with a few *Fonderia* in Italy, that of St. Mark in Florence and St. Jerome in Verona, the people of Provence were the sole suppliers of pomades, floral powders, perfumed oils, and under the name of *quintessences*, of alcoholic solutions of ambergris, musk and vanilla. These constituted at the time all the natural perfume materials in which interest was sufficient, as early as 1730, to stimulate the foundation of a society of Grasse perfume suppliers.

Following publication of *Le Parfumeur Royal*, ideas were still confused on the origin of many foreign raw materials. It was the task primarily of the drug merchants to recognize and to evaluate the rare and frequently unobtainable drugs. At the head of his treatise, Lémery proudly proclaimed: "The knowledge of drugs is a beautiful and exalted thing." Soon after, the Indian firms began to send useful and regular information. In 1755, under Poivre, commissioner for the Iles de France and the then Bourbon Island, the plantations of spices for perfumery were started.

At the same time, the work of the producers was being enriched by new processes, new and better conceived applications, and the manufacture of alcohol was developing, improved with the creation of the society of brandy testers, who date back to 1703. By the end of the 18th century, high-proof alcohol was a very common commodity, and

it brought to perfumery a new means of expression for a wider and more refined public.

Further writings of the period, particularly the works of Dejean, Poncelet and Fargeon, contributed to making perfumery a more exact science. In 1778, Baldinus published his *Catalogus Odorum* in Naples.

In the preceding century, a solution of benzoin in alcohol, called the *Magistère de Benjoin*, had been known. One of the clearest minds of his original times, Antoine Baumé, prepared with vitriolic ether an extract of aromatics; this was the first resinoid. The evolution of human knowledge is seen in the works of Glaser, Macquer, Fagon, Rouelle. Then Geoffroy published his *Mémoires*, probably the first book in modern Europe which had as its sole objective a description of the extraction of flowers, whose purpose was to stimulate interest in the production of a natural perfume industry.

Grasse was becoming a trading town, commercial and prosperous, its reputation and industrial development constantly growing; it was beginning to create the positive conditions of scientific invention, of which more will be said later.

References

1. Salles, G., "Bronzes Chinois des Dynasties Tchéou," Paris, 1924.
2. Benedite, G., "Mémoires Piot," 25, 1-28 (1921-22).
3. *Bulletin de l'Institute Egyptien* (1883).
4. Dumichen, "Geographische Inschriften Altaegyptischer Denkmäler," Leipzig, 1865.
5. The Holy Scriptures, *Genesis*, 37, 25; *Exodus*, 25, 30, 36, 37.
6. The Holy Scriptures, *The Book of Samuel*, 13.
7. de Rosemont, Dr. Reutter, *Bulletin de la Société d'Historie de la Médecine*, 15 (1914).
8. Herodotus, "Histories," II-94, III-113, IV-169, VI-119, VIII-138.
9. Herodotus, "Histories," III-107, III-112.
10. Hippocrates, "Aphorisms," V-28, VI-31.
11. Fabricius, "Bibliotheca Graecica," XII-690.
12. Suetonius, "History of the Twelve Caesars," Galba, III.
13. Juvenal, "Satires," II, IV, V, VI.
Martial, "Epigrams," I-73, 78, 88; II-29, 41, 59; III-2, 12, 43, 45, 53, 55, 82; IV-4, 13, 36; V-36, 64; VI-55, 93; VII-54, 74.
14. Horace, "Satires," I-2.
15. Pliny, "Natural History," XIII-2.
16. Palissy, Bernard, "Discours admirable de la Nature," Paris, 1580.
17. Gessner, Conrad, "Trésor des remèdes secretz," Lyon, 1558.
18. Montaigne, "Essais," Book I, Chap. LV, edition of 1580.
19. Fioravanti, "Miroir Universel des Arts et des Sciences," p. 214, Paris, 1584.
20. "Statuts de la Communauté des Marchands Gantiers-Parfumeurs," Paris, 1772.
21. "Secrets," collected by M. de Blégny, Vol. I, p. 683, Paris, 1689.

Bibliography of Sources and Works Consulted

Archaeology and Art

- Cordier, P., "Traité médicaux sanscrits," Louvain, 1930.
 Delaporte, L. J., "Les Hittites," Renaissance du Livre, Paris, 1936.
 Diehl, C., "Manuel d'art byzantin," Picard, Paris, 1910.
 Dussaud, R., "Notes de mythologie syrienne," Leroux, Paris, 1903.
 Gobineau, J. A., Comte de, "Les Religions et les philosophies dans l'Asie centrale," 2nd ed., Didier, Paris, 1866.
 Grousset, R., "Sur les traces du Bouddha," Plon, Paris, 1929.
 Loret, V., "L'Égypte au temps des Pharaons," Leroux, Paris, 1889.
 Malet, A., "Histoire des peuples de l'Orient," Hachette, Paris, 1918.
 Masson-Oursel, P., "L'Inde antique," Renaissance du Livre, Paris, 1933.
 Reinach, S., "Histoire générale des arts plastiques," Hachette, Paris, 1918.

History of Knowledge

- Berendes, J., "Das Apothekenwesen," Enke, Stuttgart, 1907.
 Berendes, J., "Die Pharmazie bei den alten Kulturvölkern," Tausch and Grosse, Halle, 1891, 2v.
 Berthelot, M. P. E., "Introduction à l'étude de la chimie des anciens et du moyen-âge," Steinheil, Paris, 1889.
 Campbell, D. E. H., "Arabian Medicine and its Influence on the Middle Ages," Paul, French, Trubner & Co., London, 1926.
 Choulant, J. L., "Handbuch der Bücherkunde für die ältere Medizin," Voss, Leipzig, 1841.
 Daremberg, C. V., "Histoire des sciences médicales," Baillière, Paris, 1870.
 Darmstaedter, L., "Handbuch zur Geschichte der Naturwissenschaften und der Technik," Springer, Berlin, 1908.
 Dujardin, J., "Recherches retrospectives sur l'art de la distillation," published by the author, Paris, 1900.
 Ferguson, J., "Bibliotheca chemica: A Catalogue of the Alchemical, Chemical and Pharmaceutical Books in the collection of the Late James Young of Kelly and Durris," Maclehose, Glasgow, 1906, 2v.
 Fluckiger, F. A., and Hanbury, D., "Histoire des drogues d'origine végétale," Dain, Paris, 1878.
 Gmelin, J. F., "Geschichte der Chemie seit dem Wiederaufleben der Wissenschaften bis an das Ende des achtzehnten Jahrhunderts," Rosenbusch, Gottingham, 1787-99.
 Hoefler, J. C. F., "Histoire de la chimie," Hachette, Paris, 1842-43.
 Hoefler, J. C. F., "Histoire de la botanique, de la minéralogie, et de la géologie depuis les temps les plus reculés, jusqu'à nos jours," Hachette, Paris, 1872.
 Houdard, M. S., "Histoire de la médecine grecque," Baillière, Paris, 1856.
 Leclerc, L., "Histoire de la médecine arabe," Leroux, Paris, 1876.
 Pouchet, F. A., "Histoire des sciences naturelles au moyen-âge," Baillière, Paris, 1853.
 Sachs, J. von, "History of Botany," Oxford, 1890, authorized translation by H. E. F. Garnsey, rev. by I. B. Balfour, Clarendon Press, Oxford, 1890.
 Saintyves, P., "Les Origines de la médecine," Nourry, Paris, 1920.
 Schelenz, H., "Geschichte der Pharmazie," Springer, Berlin, 1904.
 Schelenz, H., "Zur Geschichte der pharmazeutisch-chemischen Destilliergeräte," Springer, Berlin, 1911.

- Schmidt, A., "Drogen und Drogenhandel im Altertum," Barth, Leipzig, 1924.
 Sprengel, Kurt, "Histoire de la médecine depuis son origine jusqu'au dix-neuvième siècle," translated by A. J. L. Jourdan from the German and reviewed by E. F. M. Bosquillon, Deterville, Paris, 1815-20.
 Sudhoff, K., "Handbuch der Geschichte der Medizin," S. Karger, Berlin, 1922.

History of Commerce and Explorations.

- Bonvalot, G., "Les Chercheurs de routes, Marco Polo," Cres & Cie., Paris, 1924.
 Chastin, J., "Les trusts et les syndicats de producteurs," Alcan, Paris, 1909.
 Diehl, C., "Venise," Flammarion, Paris, 1915.
 Heyd, W. von, "Histoire de commerce du levant au moyen-âge," Harrassowitz, Leipzig, 1885-86.
 Huet, P. D., "Histoire du commerce et de la navigation des anciens," Duplain, Lyon, 1763.
 Ibn Batoutah, "Voyages," Paris, 1859. Arab text accompanied by the French translation of C. Defremery and B. R. Sanguinetti, Paris, 1853-79.
 Lespinasse, R. de, "Les Métiers et corporations de la ville de Paris," Imprimerie nationale, Paris, 1886-97.
 Meunier, M., "Apollonius de Tyane," Grasset, Paris, 1936.
 Micard, Etienne, "L'Héroïque inquiétude de Vasco de Gama," Roger, Paris, 1930.
 Niebuhr, C., "Description de l'Arabie," Baalde, Amsterdam, 1774.
 Robertson, W., "Recherches historiques sur l'Inde ancienne," Janet et Cotelte, Paris, 1821.
 Savary des Bruslons, Jacques, "Dictionnaire universel de commerce," Paris, 1760.

Local History and Documentation

- Astruc, J., "Mémoires pour servir à l'histoire de la Faculté de médecine de Montpellier," Cavalier, Paris, 1767.
 Figuiet, L. "L'alchimie et les alchimistes," 3rd ed., Hachette, Paris, 1860.
 Franklin, A., "Les Médicaments," Plon, Nourrit & Cie., Paris, 1891.
 Gautier, E. F., "Mœurs et coutumes des musulmans," Payot, Paris, 1931.
 Grasset-Morel, L., "Histoire de Montpellier," Montpellier, 1908.
 "Li Chi...Li Ki; ou, mémoires sur les bienséances et les cérémonies." (Chinese text with a double translation in French and Latin by S. Couvreur)...Ho Kien Fou, Impr. de la mission catholique, 1899, 2v.
 Massa, "Histoire de Grasse," Cannes, 1878.
 Redgrove, H. S., "Alchemy; ancient and modern," Rider, London, 1911.
 Senequier, P., "Histoire de Grasse," Grasse, 1902.

HISTORY OF THE TECHNIQUES OF EXTRACTION OF
NATURAL PERFUME MATERIALS

Extraction with Fats

The Various Techniques. The recognition of the affinity of fatty bodies for odor was made in ancient times. Extraction by infusion was from its beginnings and almost to our day an empirically developed technique, in the narrowest meaning of the phrase. It was subject to little improvement and perfection, and resulted in products that were ill-defined and poorly classified.

The very meaning of the word "oil" was the subject of considerable confusion for a long time. For many centuries, the word was understood to mean oils of expression, of maceration, of distillation and of pyrogenous treatment. Among the ancient writers, "oil" denoted the products of decoction¹ or of expression of oleaginous seeds, as well as of the digestion of plant matter.² The confusion was accentuated when essential oils appeared. Thus, for Conrad Gessner in 1558, the oils of expression were the common oils, while the oils of distillation were the true oils³; while Nicolas Monard, in 1619, wrote of his astonishment that extraction by decoction, the method of Dioscorides, was still in use.⁴

At about the same time, Liébaud drew a clear distinction between oils obtained by expression of fruits and pulverized seeds, and those derived by impression of flowers digested or immersed in oil and then exposed to the sun⁵; but Sylvius⁶ also used the word *oil* for the oils of expression, of maceration, and those "drawn by the force of fire," both essential and pyrogenous.

Brice Bauderon⁷ differentiated between the natural and artificial oils. The former, he contended, were the oils created "by the heat of the sun," the styrax, the American liquidambar—these are our balsams; and among the artificial oils he distinguished between simple oils, made by expression or by ascending or descending distillation, and the compound oils, which are our products of maceration.

When the practice of distillation became widespread, solutions of essential oils in fixed oils were called *huiles factices* (*unnatural oils*). The ignorance of the methods of preparation was responsible for this confusion of nomenclature. Thus, Simon Barbe wrote that the flower essences used for the hair were not true essences, but oils.⁸

In the eighteenth century, the systematization of logic led to a classification based on the properties of these materials, and resulted in a more logical definition of oils. Macquer, for instance, established that the common property of vegetable, mineral and animal oils was their in-

flammability, which he related to the phlogiston theory. Among the vegetable oils, he distinguished between *the fatty oils of expression*, "which have no odor or taste, which are soft, unctuous and congealing, and which, with an alkali salt, give a truly neutral salt"; *the essential oils of expression*, "which are tenuous, volatile, have a bitter taste and conserve the odor of the plant"; *the essential oils of distillation*, "which rise to the heat of boiling water and become resinous with the passage of time," and finally, the *pyrogenous oils*, "black, with a burned, fetid and empyreumatic odor."⁹ These definitions confirm the distinctions between fixed oils and essential oils.

At the time of the preparation of the essential oils, it had been noted that distillation did not produce an oil in certain vegetation, some of whose species were among the richest in odor in the plant kingdom. Nicolas Lémery noted this in treating *jasmin* and *violet* flowers: "It would be wrong," he stated, "to attribute this to the evaporation of subtle particles, or to state that the fire causes a mixture and confusion of the volatile substances of these flowers with their viscous parts."¹⁰ This observation, to this day true for several flowers, came to justify the techniques of digestion and *enfleurage*; the latter process, which does not date back earlier than the seventeenth century, utilizes fats and oils on cotton cloths.

At the beginning of the nineteenth century, the production of alcohol on a commercial scale enabled investigators to isolate perfume from the fatty corps, an important invention which opened the road to entirely new applications of the principle of absorption of perfume by fatty bodies. The first *pomade washings* were called *spirits* and *spirits of odor*, and then *pomade extracts*,¹¹ and were obtained by brewing with spirits of wine 3/6, that is 85°/86° proof.¹² Successive washings, called *infusions*, were also developed. Spirits of wine 3/8, or 92°/93° proof, was later made available.

It was probably toward 1860 that the industry began to define with numbers the concentration of the pomades and likewise the washings. Just after 1870, there appeared the *pomade concentrates*, corresponding to a concentration first of 50, then 100 kilograms of washings. The term *absolute of pomade* is more recent, and arose from an assimilation with the absolutes of volatile solvent extraction.

At the end of the nineteenth century, Jacques Passy noted that certain flowers continue to produce their perfume after they have been cut.¹³ This was a new justification for the technique of extraction of perfume by cold *enfleurage*, which was responsible for an important development in the production of perfumed fats. We will show later that *enfleurage*

utilizes the survival of the flower, and furnishes more oil, giving the total perfume exhaled, and not merely the odorous reserve.

References

1. Dioscorides, "De Materia Medica," I-30.
2. Pliny, "Natural History," XIII-1.
3. Gessner, Conrad, "Trésor des Remèdes Secretz," p. 265, Lyon, 1558.
4. Monard, Nicolas, "Histoire des Simples Médicamens apportés de l'Amérique," p. 10, Lyon, 1619.
5. Liébaut, "Quatre Livres de Secrets de la Médecine et de la Philosophie Chymique," p. 106, Rouen, 1616.
6. Sylvius, "La Pharmacopée divisée en Trois Livres," p. 590, Paris, 1625.
7. Bauderon, "Pharmacopée," p. 363, Lyon, 1628.
8. Barbe, Simon, "Le Parfumeur François," p. 4, Paris, 1693.
9. Macquer, "Elemens de Chymie Théorique," p. 178, 186, Paris, 1756.
10. Lémery, Nicolas, "Cours de Chymie," p. 528, Paris, 1701.
11. Bertrand, C. F., "Le Parfumeur Impérial," p. 70, Paris, 1809.
12. Celnart, Mme., "Manuel du Parfumeur," p. 170, Paris, 1854.
13. Passy, J., *Compt. rend.*, 121, 783 (1897).

The Materials. *The Odoriferous Plants.* Treatment with oils has been applied to a large number of odorous plants, either by a simple or a complex maceration.

The Greek and Roman writers, Theophrastus, Dioscorides, and Pliny¹ gave names to perfumes according to their origin: *Cyprinum*, *Mendesium* and *Susinum*; or according to their constituents: *Amaracus*, *Crocinum*, *Oenanthe*. They were familiar with an abundance of aromatic botanical products, particularly the Labiatae and Umbelliferae, and many odoriferous roots of great interest. The most frequently cited plants include the calamus, cardamom, cumin, cypress, elecampane, fennel, fenugreek, marjoran, mastic, melilot, myrtle, origanum, orris, thyme, savory; a costus whose exact species has not been determined; the *Schoenos*, which is believed to have been *Andropogon Schoenanthus* L.; the *Aspalathe*, which has been identified with *Lawsonia inermis* Lam. or *henna*, whose flower has a most agreeable odor; the vine flower; and the Celtic nard, associated by some authors with valerian, by others with spike. The Romans also knew camphor and cinnamon.

The Arab authors, Avicenna, Rhazès, and Mesuë² cite the oleaginous digestion products of dill, chamomile, pennyroyal; the resins and the balsams, galbanum, myrrh, olibanum, sagapenum, and styrax. The Arab navigators brought to the western world ambergris, ambrette, benzoin, clove, mace and vetivert.

In the age of Salerno, rosemary was used; Saladin mentions oakmoss,

under the name of *Usnea*³; it came from Cyprus, and for a long time it was a cure-all throughout the Orient. Pierre Belon noted that it was still to be found in the shops of the Levant in the 16th century.⁴

The Middle Ages brought the three *Santaulx*, or the three types of sandalwood. Nicolas Praepositus⁵ and Platearius⁶ cite among their oils the mastic, musk and spikenard. During the following years, Europe began to receive the aromatic productions from America: balsams tolu⁷ and Peru, cascarilla, liquidambar.⁸ Sylvius prepared the oils of wormwood, elecampane, galangal, mint and rue.⁹

For many centuries, aromatic materials filled the pharmacopoeias. Perfumed oils were primarily remedies. It was only after the 16th century that a distinction was made between perfumes and the aromatics that had become part of the domain of the apothecary and the distiller, particularly in the northern countries. In southern Europe there was founded the genuine perfume industry, utilizing essentially the odorous substances not coming from the alembic, that for the most part give no perfume at all or only an insignificant quantity by distillation or alcoholic infusion; the majority of the flowers are in this category.

Along the border of the Mediterranean, as long ago as the days of Pliny, the process of maceration in oils of the flowers of hyacinth, lily, narcissus, and rose was known¹⁰; Salerno prepared those of jasmin, rose, and violet, and this was likewise cited by Ibn el Beithar.¹¹ In the 17th century, the perfumed oil industry became stabilized; in Tuscany, the oils of Damascus rose, jasmin, orange blossom, violet, white lily and honeysuckle were prepared¹²; in Languedoc were made those of jasmin, lily, rose, single violet, broom and the yellow violet that the Greeks called *Leucoïon*.¹³ By the end of the 17th century, Grasse was producing oils of *cassie* (acacia), hyacinth, jasmin, jonquil, narcissus, orange blossom, rose, tuberose and double violet,¹⁴ and was experimenting with enfleurage as a process for certain flowers.

But the natural perfume industry could develop only with abundant and frequent harvests. The first cultivation of a perfume-bearing plant recorded in Provence was that of the bigarade tree, *Citrus bigaradia* Risso. According to Galesio, this citrus plant was known in the Mediterranean countries before the lemon or even the orange trees. Its presence was recorded in Rome,¹⁵ Palermo, Sevilla, and Pampelune¹⁶; by the end of the 14th century, it was growing in Liguria in the valleys of Rapallo, on the Riviera near Nice,¹⁷ and in Provence. During the 16th century, it was cultivated at Grasse¹⁸ and at Hyères, where rather large plantations were visited by Charles IX in 1564.¹⁹ In the years following, the well-known orange groves of the Aldobrandini at Frascati, of Louis XIII at Saint-Germain and of Helliburi at Gend²⁰ contributed to the develop-

ment of the production of orange pomade and orange flower water. The 17th century writer, Olivier de Serres, pointed out that *bigarat* was highly prized in Provence for its easy growth²¹ and began to be used for grafting. The historians of the era describe the grave damage brought to the plantations by the vigorous winters of 1709²² and 1768.²³ At the time of Pomet, all the products of the bigarade were commercially manufactured.²⁴

The *Jasminum grandiflorum* L. was not known in Europe until the 16th century. It came to Provence from Spain, via Catalonia, where it was known by its former designation of *Jasminum Catalonicum*.²⁵ In the 17th century, Olivier de Serres was responsible for the first plantations, which had difficult beginnings before they were set up at Grasse.²⁶ By the end of the 17th century, the harvests yielded a regular supply of oils and pomades.²⁷

The *Jasminum Sambac* Ait. or *Nyctanthes Sambac* L. is the Arabian jasmín which is so abundantly referred to in Oriental poetry. Its leaf is oval-shaped, and it has flowers similar to those of *Jasminum grandiflorum* but with 8 lobes, with few flowers on the plant. A perfect description of this plant was made by Prosper Alpin.²⁸ There exists a variety with a large double flower, opening only partly, and which originates from cross-pollination; its odor is slightly different from that of the other jasmíns—one might say, more sugary. This variety was known for the first time in Europe when it was brought from Goa to the Medici and was guarded jealously in the gardens of the villa Castello in Florence.²⁹ It was then called *Mugherino*, an appellation still used in Tuscany.³⁰ It has been held in high regard for many years in the Indies³¹; it is the same plant that is known as the *Foul* in Cyprus and *M'lati* in Java. The cultivation of this species is difficult, and no experimental work has taken place in Grasse.

The *Polyanthes tuberosa* L. is said to have originated in Mexico; none the less, Simon de Tovar, physician of Sevilla, who seems to have had the first seeds of the flower to reach Europe, received them in 1594 from the East Indies and not America. The first description of the flower was made by Charles de L'Ecluse³²; after this it was described by Bauhin, Raÿ, Barrelier and Tournefort. At first it was named *Hyacinthus indicus*, or *Tuberosa flore Hyacinthi orientalis*. It soon became a favorite, and it was noted that the tuberose exhaled its best perfume at twilight. Rumphius named it *Amica nocturna*.³³

The cultivation of the tuberose was described by La Quintinye³⁴; on a commercial scale, it was cultivated at the end of the 17th century in Basse-Provence, and it was mentioned by Simon Barbe among the flowers then used for perfumery. Le P. d'Ardène also wrote with ex-

perience of this cultivation, stating that the "East Indies gave the tuberose to Italy, who passed it on to us."³⁵ Papon mentions it among the exotic plants acclimated in his time in Provence.³⁶

The shrub which produces the acacia, better known in American and English perfume circles by its French name, the *cassie*, does not have an impressive appearance. It protects itself with sharp needles and has globulous flowers in the capitulum, that were sought in ancient times for their delicious odor. The *Acacia farnesiana* Willd. is without doubt an African plant; however, it cannot be found among the numerous Mimosaceae cited or described by Ibn el Beithar and later by Prosper Alpin. Europe is indebted for this flower to the Saracens. It was cultivated toward the end of the 16th century in the Farnesa Gardens of Rome, but was not cultivated in Grasse until a century later, less perhaps for its flowers than for its pods, then utilized by the leather tanneries of Grasse. At the end of the 17th century, Simon Barbe cited the acacia,³⁷ which, it seems, was not found before him in the Italian formulary books. It is probable that the harvests of acacia were very small at that time. In 1780, Papon described this shrub, which he called *Acacia indica farnesiana*, as growing in exposed spots, and useful for its flowers, which were employed by perfumers for oils and pomades.³⁸

The first rather important cultivation of the acacia shrubs was toward 1792 in Cannes,³⁹ then at Vallauris. Later plantations of a closely related species, *Acacia Cavenia* Hook, were developed; this was more rustic and yielded more flowers.

Herodotus had known in Persia the "sixty-petaled" rose⁴⁰; it was evidently a cultivated flower, that of Chiras, Ispahan, and of the Mogul Indian. The Arab botanist, Ibn el Awam, was the first to distinguish in the *Rosa canina* L. the 2 principal types of roses known in his time: the white-flowered, "with 50 petals, 40 at the least," and the red-flowered, "which contains more than 100 petals."⁴¹ He described the grafting, the pruning, and the methods of reproduction, principally by shoots in layers. They were the progenitors of the two types cultivated in Bulgaria since the 17th century: *Rosa alba* L. and *R. damascena* Mill. The latter, said to have been brought to southern France by the Crusaders, may have cross-bred with the native rose to give the *R. gallica* L.

In the 17th century, Olivier de Serres recommended the cultivation of the rose.⁴² La Quintinye cites the hundred-leafed rose, called the "rose à cent feuilles," and the rose of Damas or "rose muscade," literally the "nutmeg rose." Barbe⁴³ states that there were used in perfumery the common rose, the musky rose, and the rose de Provins, probably the denominations, respectively, of *Rosa centifolia* L., *R. damascena* Mill., and *R. gallica* L. The cultivation of the rose for perfumery developed on a

large scale in Provence at the beginning of the 19th century; today, the plantations for the Grasse factories consist in the main of "rose de mai."

The planting of the violet was recommended at an early date by Varron.⁴⁴ In Saladin, who extolled its essence in the *confections*,⁴⁵ forerunners of the crystallized violets; in the *Antidotaire* of Nicolas⁴⁶; and in the words of Jean de Garlande, it was no longer being used only as cut flowers, even at the time of Lémery.⁴⁷ However, the double violet was already known, and was harvested in Grasse in the 18th century. But the violet did not really become the rage until the founding of the empire; it was the flower under Napoleon I, the perfume under Napoleon III. The cultivation traveled from Liguria to Provence on a practical scale during the second half of the 19th century.

At first, the cultivation was of *Viola odorata* L., var. *pallido plena*, called the violet of Parma or the violet of Naples.⁴⁸ The cultivation of the cut flowers was developed in Italy, at Villanova d'Albenga and at Arma di Taggia, near San Remo, then at Menton and Nice; after 1860, some plantations of the violet of Parma were developed in the Maritime Alps, at Vence.⁴⁹ It was around 1875 that the variety known as the Victoria violet or Russian violet, with its large dark-violet corolla, developed as a bouquet flower at Toulon and at Hyères, was used on a large scale for perfumery; its cultivation was centered in the valleys around Grasse. Shortly after 1900, the leaf of the Victoria violet, cited centuries earlier by Mesuë⁵⁰ and Saladin⁵¹ as being one of the useful parts of the plant, was successfully treated by extraction.

In the 18th century, there is found evidence of the cultivation of the jonquil and the carnation, but the development of the lily, narcissus, mimosa and mignonette is more recent. Among the cut flowers, the acacia robinia, the broom and the blue hyacinth were harvested for maceration as early as the 16th century. The *Helichrysum stoechas* D.C., the everlasting or *immortelle*, was gathered only recently. Later we shall see the extension of the cultivation of perfume-bearing plants, as a result of the extraction process, outside of Provence into tropical lands.

During the course of centuries, it was necessary to make a choice of odorous materials. As early as Pliny,⁵² the different odors of the various parts of the same plant were noted: "For the lily, the odor, like the color, is a double one; one for the petals, another for the stamens." Mesuë indicated⁵³ that the oil of orris flowers should be made "taking care to remove all the yellow." Macer Floridus and Platearius recommended cutting the mitre of the roses, to keep only the petals. Later, Baumé called attention to the localization of the oil⁵⁴: "There are many flowers in which the odoriferous principle is in the calyx, particularly

among the flowers of the Labiatae; and the odor is in the petals for the Liliaceae—lily, hyacinth, tuberose, and narcissus.” At Grasse, for the preparation of clear-colored pomades, the flowers must be selected, or at least winnowed.

The *time of harvest* was taken into account even in ancient days. Arnaud de Villeneuve declared that, to be effective, the plants must be harvested in conformity with the signs of the zodiac. Saladin d’Ascoli was less speculative in his remarks on the subject, addressed primarily to the perfumers, with respect to violet and jasmin.⁵⁶ Paracelsus called



Parfums de France

FIGURE 5. *Panorama of the city of Grasse.*

the hour preceding the rising of the sun *balsamiticum tempus*; among our perfumers, Simon Barbe noted: “It should be observed that the flowers must be gathered in the morning and in the evening; in the morning, an hour or two after the sun has been shining; in the evening, two hours before the sun has set; that the orange blossoms should be opened and not burgeoning, and they should not be wet in any spot.”⁵⁶ More exactly, Dejean stated that “a flower cut in the midst of the day’s heat has less odor than the flower cut in the morning.”⁵⁷ Baumé noted: “It is in the time of fecundation, just before their expansion, that the flowers have the greatest odor,” while Poncelet said: “Many people

imagine that the flowers become more odorous as they expand, but experience teaches us just the opposite."⁵⁸

The *influence of the soil*, finally, did not escape the observations of the ancients. "The genuine rose, for the most part, is indebted for its qualities to the nature of the soil," wrote Pliny. "That of Cyrène is the most odorous of all, and hence it is that the unguents of that place are so remarkably fine . . . in some years, we find the roses much less odorous than in others; in addition, their smell is always more powerful when grown in dry soils than in humid ones."⁵⁹ These observations were common to all odorous species, and have since been continually confirmed. They are observations that touch on most complex problems.

It was precisely at Grasse that the warm sun and the proper climate united; Grasse, with its ancient, time-honored experience in the cultivation and handling of flowers, as we shall show for each individual flower. However, modern economic conditions are tending to cause a rupture with the judicious customs of the past, and are imposing the necessity of gathering the flowers late in the day, without being able to make a daily choice of the best materials, as was done at the time when men and women in the country listened before dawn for the sound of the *greïle* calling to the harvest.

References

1. Theophrastus, "De Odoribus," p. 39, 43, 50, 64, 78.
Dioscorides, "De Materia Medica," I-24, 56, 67.
Pliny, "Natural History," XII-2, XIII-4, XV-7.
2. Mesuë, "Antidotarium," Book XII.
3. Saladini de Asculo, "Compendium Aromatariorum," 459-III, 465-II.
4. Belon, Pierre, "Les Observations," Paris, 1555, p. 76.
5. "L'Antidotaire," edited by Dr. Dorveaux, p. 32 and 33.
6. "Le Livre des Simples Médecines," edited by Dr. Dorveaux, p. 193.
7. Lopez de Gomara, "Historia General de las Indias," Medina, 1553.
8. Monard, "Histoire des Simples Medicamens apportés de l'Amérique," 1619, p. 23.
9. Sylvius, "La Pharmacopée," Paris edition, 1625, p. 598.
10. Pliny, "Natural History," Bks. XII, XIII.
11. Ibn el Beïthar, "Traité des Simples," III-470.
12. "Ricchetario Fiorentino," Florence, 1623, p. 260.
13. Bauderon, "Pharmacopée," Lyons, 1628, p. 386.
14. "Le Parfumeur Royal," 1699, p. 172 and 182.
15. Ferrari, "Hespérides," Rome, 1646, p. 33.
16. Saurel, "Culture de l'Oranger en Provence," Marseilles, 1873, p. 8.
17. Gallesio, "Traité du Citrus," Paris, 1829, p. 277; *see also* 16, p. 9.
18. Massa, "Histoire de Grasse," 1878, p. 164.
19. *See* 16, p. 25.
20. *See* 15, p. 138.
21. de Serres, Olivier, "Théâtre d'Agriculture," Geneva, 1639, p. 632.

22. See 18, p. 206.
23. Papon, "Voyage de Provence," Paris, 1780, p. 196.
24. Pomet, "Histoire générale des Drogues," Paris, 1735, I-267.
25. See 23, p. 359.
26. de Serres, Olivier, "Théâtre d'Agriculture," Lyons, 1675, p. 490.
27. Barbe, "Le Parfumeur François," 1639, p. 52.
28. Alpin, Prosper, "De Plantis Aegypti," Leyde, 1735, p. 39.
29. See 17, p. 311.
30. Raggioneri, "Gelsomino," San Remo, 1925.
31. Sawer, "Odorographia," London, 1892, Vol. 1, p. 92.
32. Clusius, "Historia Plantarum," Anvers, 1601.
33. Rumphius, "De Amboinsche Rariteitkamer," Amsterdam, 1705, plate 285.
34. La Quintinye, "Instructions sur les Jardins," Paris, 1690, vol. 2., p. 523.
35. "Traité sur la Connoissance des Jacinthes," Avignon, 1765, p. 111.
36. See 23, p. 358.
37. See 27, p. 6.
38. See 23, p. 355.
39. Rolet, "Plantes à Parfum," Paris, 1918, p. 266.
40. Herodotus, VIII-138.
41. Ibn el Awam, "Le Livre de l'Agriculture," Paris, 1864, I-VI-281.
42. See 26, p. 490.
43. See 27, p. 6.
44. Varron, "De Re rustica," I-16.
45. See 3, 459-III.
46. See 5, p. 5.
47. Lémery, Nicolas, "Traité des Drogues Simples," Paris, 1698, p. 812.
48. See 31, I-105.
49. See 39, p. 244.
50. See 2, VIII, 263.
51. See 3, 465-II.
52. See 10, XXI, 11.
53. See 2, Book XII-415.
54. Baumé, "Elémens de Pharmacie," Paris, 1769, p. 53.
55. See 3, 459-II.
56. See 27.
57. Dejean, "Traité des Odeurs," Paris, 1753, p. 55.
58. "Nouvelle Chymie du Goût et de l'Odorat," Paris, 1800, I, p. 5.
59. See 10, XXI-10.

The Oils and Fats. The invention of the grindstone, one of the great accomplishments of man's genius, simultaneously enabled man to obtain feculent meal and oils which, together with mucilaginous and honey materials, constituted the first vehicles for cosmetics and perfumes.

The oil to which the most ancient reference is extant is sesame oil, *Sesamum indicum* D.C., cited on the stones engraved by the Assyrians,¹ and mentioned by Herodotus.² In the age of Pliny, this oil came from India, via the Red Sea, to Europe, just as sesame seed does today. Mesuë indicated that the oil should be cooked to remove its odor before its use

in the maceration of perfumes.³ In the Middle Ages, the plant was known to be cultivated in Egypt; under the name of *Sempsen*, descriptions of it are found in the works of Prosper Alpin.⁴

No exact knowledge is available as to the use of walnut oil, *Juglans regia* L., the old *Caryinon* or *Carginium* of Pliny. According to Matthiöle, walnuts were in current use among the old perfume sellers, the *myropolists*.⁵ We know still less of the Egyptian palm oil, the *Adipoos* of the ancients, of which Pliny says only that it is usable for perfumery.⁶ Cottonseed oil was known much later. Alpin mentions that the *Gossypium* gives a mucilage, as did the sesame, but mentions no oil.⁷ On the other hand, the oil of the laurel, the *Laurus nobilis* L., the *Laurinum* of the Romans, was described by the writers of antiquity. It was obtained by boiling the berries. This mixture of fatty oil and essential oil was in current cosmetic usage. Laurel oil appeared in the early pharmacopoeias, and at the beginning of the twentieth century became, with the balsam of Father Tranquille (*Balsamum tranquillans*), a Grasse preparation. The Romans also utilized the oil obtained from an oak gland, the *Glans unguentaria*, a name which was later to be given to oil of ben.

Castor oil, *Ricinus communis* L., was well known in antiquity. The *Kikaion* of the Egyptians, the *Sillicyprion* of Herodotus,⁸ is clearly identifiable with the characteristics ascribed to castor oil by Theophrastus⁹ and Dioscorides.¹⁰ This oil was used in funeral lights and for unguents. The oldest reference to its botanical name, *Ricinus*, is found in Pliny.¹¹ The castor bean was introduced into Spain by the Arabs, and from Spain its renown spread throughout the western world. For many years, it was called *Palma Christi*; Nicolas Monard stated that in his time it was being brought from America under this name.¹² Castor oil was then used for external purposes, for maladies of the skin. It was abandoned a long time ago for the maceration process.

In various ages, lesser known oils of limited production have been used, the oils of earth-nut, the *Arachine* of Mesuë,¹³ of fir-cone kernel, of hazel-nut, and of melon seeds.¹⁴ But the fixed oils that the ancients used by preference and on a large scale for maceration were almond oil, ben oil, and olive oil.

Almond oil, *Amygdalus communis* L., is the base of the *Metopium* of Dioscorides.¹⁵ It was originally prepared from sweet almonds which were dried, pulverized, and then moistened with boiling water; later the bitter almonds were also used, and the extraction process was similar to that used for other oleaginous seeds. Pliny noted that odors were better preserved in almond oil, because of its fattiness.¹⁶ The oil was cited, among other places, in the *Compendium aromatariorum* of Saladin

d'Ascoli,¹⁷ and in the Italian recipes, as serving for the extraction of orange flower perfume by maceration "in a hot sun."¹⁸ In the eighteenth century, Pomet indicated that true almond oil was "made without fire."¹⁹ Both almond oil and apricot-nut oil were used at one time for enfleurage in Grasse, but were abandoned as being too fragile.

Ben oil, behen oil, ben-nut oil or horseradish oil, the *Moringa pterigosperma* Gaertn., is the *Balanos* of the Greek writers.²⁰ For many centuries, it was a prized vehicle for perfumes; today it is no longer of any use.

Known by Dioscorides, by Pliny,²¹ by the Alexandrians and the Arabs under the name of *Myrobalan*, the oil of ben was for a long time surrounded by a veil of obscurity, because the term *myrobalan* for many years designated both the vehicle and the aromatic product. In its origin, the term is believed to have referred to macerations of variable compositions, in which myrrh was evidently one ingredient.

In the sixteenth century, Matthias de Lobel²² gave a description of myrobalan conforming to the true oil of ben, since known and excellently described by Guibourt.²³ The iconography of Garcia da Orta and of Christophe d'Acosta,²⁴ among others, reproduced as myrobalans five altogether different types of fruits, among which are included the Indian cardamom, *Elletaria cardamomum* Mat., and the large Ethiopian cardamom, *Amonum angustifolium* Son. These documents have made it possible to reconstruct the constituents of the ancient Myrobalanum, a maceration of myrrh and cardamom in oil of ben.

Furthermore, the Arabs introduced, under the name of Myrobalans,²⁵ fruits of various Combretaceae or Anacardiaceae,²⁶ which had only a superficial similarity in size. One can recognize, for instance, among the five figures of Garcia da Orta, two of these Combretaceae, the *Myrobalamus chebula* Gaertn. and the *M. bellerica* Gaertn., which have no aromatic properties, all of this adding to the confusion.

Finally, another nut oil that is analogous to the belleric *Myrobalan*, imported by the Arabs from the Malayan peninsula, was again a cause of confusion. This nut, which has no botanical relationship to the *moringa* of ben oil, nor to the Combretaceae of the myrobalans, seems to have been the *Aleurites triloba* Forst.²⁷ It contains an abundant amount of fatty matters, known as oil of bancoul or of k'miri, from which the ancients made a cosmetic oil. This was the base of the genuine oil of Macassar, so much in vogue only a century ago. The oil of bancoul, which has led us away from oil of ben, deserves to be given new consideration.

As a fixed oil, ben oil was in great favor not very long ago: "It has no odor, does not corrupt, does not rancidify," said Ruscetti²⁸; "it does

not smell itself, so that it picks up even the weakest and most delicate odor," stated Simon Barbe²⁹; and Lémery indicated that it could be pressed out easily, without the aid of fire.³⁰ These were precious assets. But the disappearance of oil of ben from the scene is explicable only by its rarity at the time of the industrial development of Grasse. Pomet noted that in his day olive oil had already replaced ben oil, because the former was cheaper.³¹ Chaptal stated that on second pressing, the ben nut gave an oil, part of which would not congeal, and this made it particularly valuable for perfumers.³² It was cited as late as 1873,³³ and then disappeared. During the last few years, there has been a tendency to revive interest in this oil.

The oil that could be obtained easily and in abundance from the pulpy fruit of the olive tree, *Olea europea* L., was considered very precious at an early date. It was the oil *par excellence*; the terms "oil" and "olive oil" became synonymous. The process for the preparation of olive oil has been transmitted to us in great detail by the ancient writers, so that it can be easily understood; the *Omphancium* was obtained from unripe and bitter-tasting olives, considered the best for perfumery.³⁴ Pliny tells us³⁵ that the olives were gathered from the ground the very moment they fell, washed if dirty, dried for three days, then pressed and heated in water, the floating oil washed and poured off several times during the day. Another method consisted in crushing the olives in a grinder or mill-stone. The *Omphancium* was then bleached by a fenu-greek solution and exposed to the sun; the oil thus prepared rancidified only with difficulty.

For the maceration of perfumes, Pliny stated that the oil had to be as newly prepared as possible, very fluid, and have a good odor³⁶; before Pliny, Lucretius wrote: "When you compound an essence, give it the least odorous oil for its base, so that the heated vapor shall not corrupt the flower perfume."³⁷ To have a fresh odor, these oils for perfumery were later prepared by those who took care not to bruise the olive pits; then, the fine oil which floated on the paste of the olives crushed in the mill was chosen, because it had so little odor, and was extremely stable.

Soon man was to learn what experience alone could teach, that a material which exacts so much care seems to have been created precisely for flowers. The production of olive oil for perfumery—the activity of artisans—was at first confined to Languedoc; then it spread to Provence, and out among the olive groves, where the air spreads over a limited territory, olive oil first became known as the oil of the flowers. The oil held in highest esteem was that of Grasse, wrote Pomet in the

eighteenth century, adding: "And it is a trade in which there is considerable cheating."³⁸

Soon the minds of many men were preoccupied with the problem of producing perfume from flowers: Baumé,³⁹ then Fourcroy and Chaptal.⁴⁰

The materials for aromatic digestion, which were oils in *Unguentum*, the significance of which has come down to us, were the animal fats in the *Myron* of the Greek authors.⁴¹ As its name indicates, myron is essentially odoriferous. The fats associated with myron are found in Aesop: the wool grease from the sheep,⁴² in the bones of various animals, in the waxes, to which were sometimes added what were known as *résines limbées*,⁴³ that is, resins heated to the point where the volatile substances were driven off. The fats were used at an early age as materials for liniments and salves, the invention of which, as is well known, is attributed to Galen. These preparations, under the name of *Malagmata*, *Cataplasmata*, and *Epithemata*, in the writings of Nicolas Myrepe Avicenna and Paul Aegynète, differed from one another only in their consistency; they were macerations of herbs and flowers, used primarily for medicinal purposes, as were the pomades originally, and the juices of various fruits, particularly the apple and the quince, as in the *Melinum* of the Romans. The ancient Egyptian Pharmacopoeia contained data on the pulp of cassia, carob, pomegranate and date, all somewhat similar to the animal fats.

The fats used for extraction of perfume are, in the main, lard from the hog and tallow from the ox. The English word "lard" is derived from the Latin and Greek, where *λαρινος* means "fattened." The French equivalent, *axonge*, has an even more interesting derivation. It was used by the Greeks, who at first employed this material to grease the axles of wheels; hence, the words *axis* and *axle*. Pliny indicated that ox tallow was prepared by washing in sea water, and then exposing the fat to the sun to be bleached.⁴⁴ In this way, the ancients treated the greases from the bull, the goat, the panther and the camel, and therapeutic virtues were attributed to these products.

In the course of the centuries, the preparation of fats was perfected only in details, principally in order to assure better conservation.

In the sixteenth century, one finds the fats being used in distinct perfumery preparations. Under the name of *Pomata*, a Venetian recipe, dating to 1561, used ox and goat fats, to the exclusion of apple pulp,⁴⁵ the fats being carefully washed in rose, myrtle and orange flower water. Lard is also found, washed in the wine of Malvoisie.⁴⁶

Sylvius recommends choosing the fat of an animal "in the flower

of youth, melting the fat in ashes, and mixing it in pots made of tin or white lead."⁴⁷

Bauderon passed on his instructions for washing the fat so that it might lose its entire scent and more easily receive that of the flower.⁴⁸ Ruscelli conceived the plan of associating in the pomade the hog lard and the veal grease, purged in rose water⁴⁹; and Barbe preferred the fat of the male hog,⁵⁰ because, Charas explained, it was more firm.⁵¹

Nicolas Le Febvre improved the fine qualities of the *corps* of goat and hog grease by adding his *washed nutmeg oil*; this washing consisted in treating the melted nutmeg butter with tartarized wine spirits until it became white and had lost all but the slightest odor.⁵²

For a long time the fats were colored; in ancient days, a process for imparting a red tint with the alkanet *Anchusa* was known; then yellow with the anatta, and later green with the leaves of newly picked *Solanum*, the nightshade.⁵³

The use of alum for the washing of fats was known by the ancient Egyptians; it has been practiced at all times, and we shall return to it again later.

In the course of the eighteenth century, the simultaneous use of lard and beef tallow became a general practice; for a firm pomade, 75 parts of lard were mixed with 25 parts of a beef fat, and sometimes even equal parts were used; in warm climates, a small quantity of white wax was added.⁵⁴

At the opening of the nineteenth century, the practitioners in the art gradually came to approach a few processes similar to those used today, and which we will describe presently.

References

1. Thomson, R. Campbell, "The Assyrian Herbal," London, 1924.
2. Herodotus, "Histories," I-193.
3. Mesuë, "Antidotarium," XII-405.
4. Alpinus, "Historia Naturalis Aegyptia," Leiden, 1735, II-47.
5. Matthiöle, "Commentaires," Venice, 1554, p. 147-26.
6. Pliny, "Natural History," XII-57.
7. *See* 4, II-181.
8. *See* 2, II-94.
9. Theophrastus, "Historia Plantarum," I-18.
10. Dioscorides, "De Materia Medica," I-38, IV-64.
11. *See* 6, XV-7.
12. Monard, Nicolas, "Histoire des Simples Medicamens," p. 12, Lyons, 1619.
13. *See* 3, XII-409.
14. Liébaud, "Quatre Livres des Secrets," p. 159, Rouen, 1616.
15. *See* 10, I-60.
16. *See* 6, XII-46.

17. Saladini de Ascoli, "Compendium Aromatariorum," 465-I.
18. Cortese, I., "Secreti della Signora Isabella Cortese," p. 291, Venice, 1665.
19. Pomet, "Histoire Générale des Drogues," Vol. I, p. 264, Paris, 1735.
20. See 9, 97-I.
21. See 6, XII-46.
22. De Lobel, in the "Commentaire de Théophraste," Vol. 4, p. 299, 1644.
23. Guibort, "Histoire Naturelle des Drogues Simples," Vol. 3, p. 385, Paris, 1869.
24. "Histoire des Drogues et Epicerics qui naissent ès Indes." Vol. I, p. 181, 1619.
25. Ibn El Beithar, "Traité des Simples," Paris, 1883, Vol. 3, p. 2261.
26. See 23, v. 3, p. 282.
27. Heyne, "De Nuttige Planten van Nederlandsch Indie," Vol. 2, p. 932, Buitenzorg, 1927.
28. Piémontois, A., "Les Secrets d'Alexis Piémontois," p. 109, Lyons, 1657.
29. Barbe, S., "Le Parfumeur François," 1693 (the foreword).
30. Lémery, "Cours de Chymie," p. 500, Paris, 1701.
31. See 19, Vol. 1, p. 261.
32. Chaptal, "Elemens de Chymie," Vol. 3, p. 45, Paris, 1796.
33. Pradal and Malepeyre, "Manuel du Parfumeur," p. 103, Paris, 1873.
34. See 9, Vol. 1, p. 313.
35. See 6, XV-6.
36. See 6, XIII-1.
37. Lucretius, "De Natura rerum," Book 2.
38. See 19, I-276.
39. Baumé, "Elemens de Pharmacie," p. 182, Paris, 1769.
40. Baudoin, "Traité théorique de l'Art du Savonnier," p. 120, Paris, 1808.
41. See 9, p. 1027, edition of 1644.
42. Ovid, "De Artis Amatoriae," Bk. III-213.
43. See 10, VI-60.
44. See 6, XXVIII, 37-38.
45. "Secreti dell' Arte Profumatoria," Folio 47, Venice, 1561.
46. "Riccetario Fiorentino," p. 260, Florence, 1623.
47. Sylvius, "La Pharmacopée," 3 volumes, Paris, 1625, p. 137 and 387.
48. Bauderon, "La Pharmacopée," p. 414, Lyons, 1628.
49. See 28.
50. Barbe, S., "Le Parfumeur Royal," p. 183, Paris, 1699.
51. Charas, "Pharmacopée Royale," p. 364, Lyons, 1753.
52. Le Febvre, N., "Traité de Chymie," p. 369, Paris, 1660.
53. See 33, p. 47, 1863 edition.
54. Bertrand, "Le Parfumeur Impérial," p. 3, Paris, 1809.

Digestion. The process of digestion was known by Dioscorides,¹ Nicolas of Alexandria, Aetius, Paul d'Egine, Pliny and Mesuë. Pliny distinguished between various materials: the *Hedysmata* and such aromatics as *Stymma*; he differentiated between the macerated product, *Diaspermata* and the dregs, *Magmata*.² The oleaginous materials were sometimes mixtures; in the early days of perfumery, resins and pitch were added to the original material with the idea of giving it what was considered a more favorable consistency.

Oils were prepared by successive or simultaneous digestions of several substances; certain roots, as orris, and calamus, were first of all macerated in water, a process which contributed toward the hydrolysis of the glucosides; and the gum resins were then soaked in spirits of wine, whose solvent power was well known.

For the *Unguentum rosatum*, it was prescribed that there be added to the oleaginous macerated product of the flowers one part of juice obtained from the petals, which had been bruised with salt and then allowed to ferment; this practice, and decoction until the aqueous parts were consumed, gave nothing of any interest for perfumery. The oils of rose, of violet and of lily came later, both for the pharmaceutical emollients and for perfumes, and it seems that the decoction was prescribed for the Pharmacopoeia preparations, whereas digestion with a small amount of heat was used for odorous oils.

Libavius described digestion in a closed chamber; Jean Béguin used salt to prevent "putrefaction" in the digested mixtures.³

Following the Greek alchemists, who were so much wedded to the search for operative methods, the aromatic compounders took constant care to obtain for the digestion an equal and well-regulated heat. Successively, there was known the sea-water bath, the sand bath, the ashes bath; the *Botarion*, a vase for digestion; the *Diplom*, a double vessel, our water-bath; the *Oenum*, about which Martial wrote, and which designated for the Romans a cauldron of bronze, the receptacle of the water-bath used in aromatic macerations.

Insolation was a process invented by Rhazès for flowers and herbs immersed in oils.⁴ The Arabs, also, utilized the heat of the burning mirror,⁵ created by refraction, by reflection and by repercussion, to maintain the fluidity of the maceration oils. As it is not equally applicable to all climates and in all seasons, it was thought advisable to have recourse to the heat of horse dung, the *fen de cheval*, which for a long time had been considered extremely useful for digestion, coagulation and circulation.

On the threshold of the eighteenth century, Charas was still using it: "The heat," he wrote, "can be so great from this source that the hand is unable to stand it,"⁶ whereas boiling water, heated *per aquam ferventem*, never became too hot for the fingers. At any rate, different alchemical symbols were used to designate the various degrees of heat.

In early times, a form of digestion with evaporation was practiced, necessitating a high temperature. Oils and plants were heated over a direct flame, and the condensation of the essential oils from the plant materials collected over a layer made of a floc of wool. It is a process of great historical interest in the development of distillation, but nevertheless it led directly toward the process of enfleurage with linen.

The digestion of successive charges of flowers is very old; there is even a suggestion of it in Dioscorides. Pliny wrote that the roses were charged up to seven times.⁷ Rhazès, in his *Antidotaire*, says that one part of roses should be treated in four parts of oil, and exposed to the sun for three days, and then the flowers renewed three times. No doubt there was considerable guess-work involved, until "the oil was imbued with the odor."⁸ In addition, it was necessary to make adjustment, depending on the irregularity of the quality of the harvest.

Little by little, particularly under the influence of apothecaries, a little order was put into these operations. As early as Bauderon, it was said that, for the compounded oils and pomades, it was advisable to place the flowers "which cannot endure a long decoction" into the oils a long time after the roots.⁹

The clarity of progress begins to show itself with Baumé; he treated oils for a long time by decoction and by infusion: he showed that the oil is a menstruum which has the property of extracting from the material only oily and resinous substances¹⁰; he indicated that the oils perfumed with the pale rose, the violet and the broom were obtained by treating the infused material two or three days in the sun, or over a water-bath, and then going over it with strong expression; the infusion had to be renewed after 12 or 15 days for the tuberose or the jasmin.

At an early date, the gum-resins and the spices were associated with the flowers of digestion, for the preparation of "oils mixed for the grace of their odor," as Philiatrus wrote. Cardan explained that this was "the only hope of retaining the subtle odors," and was above all a method of obtaining oils powerful for their perfume, which had become necessities. In the seventeenth century, clove buds and benzoin were used to reinforce and to fix the odor of jasmin flowers,¹¹ the forerunner of a use to which benzoin is still devoted—a use necessary to free the odor from the fats of the pomade corps.

Later, it was found advisable to enhance the quality of digested perfume materials by mixing therein several drops of essential oils. With oils of a citric character, such as lemon or bergamot, there was made the *pomades of Italian odor*; after which the preparation of flower oils and flower pomades began to develop on a large scale.

The documents dating from the beginning of the nineteenth century indicate that the pomade corps had to be made of two parts of lard for one part of mutton tallow and two of beef tallow. The fats were melted in a tin receptacle; there was then added their weight in flowers. The flowers were kept immersed in the fats for four hours over a water-bath. The flowers were then gathered in a linen, and these exhausted flowers ground in a press. Five or six charges of flowers give the double pomade.¹²

It will be seen later on, in studying the industry as it functions today, that the techniques have changed but little, but with the passage of time, the digestion in fixed solvents has been relegated to the role of extraction and conservation of odors. In a word, no other branch of the manufacture of the raw materials of perfumery has so many antique and respectable roots.

Techniques of Separation. The exhaustion of odorous matter in the fatty corps by immersion or by bruising in the presence of fats or oils made necessary the development of practical techniques of separation.

Decantation, the first means used, involved considerable losses, so that it was soon found necessary to substitute expression for this process. Nevertheless, decantation was seen as a means of perfecting the product of expression by separating the water from the vegetable matter or from the alcohol, the latter sometimes being added as a complementary raw material for oleaginous digestions. Thus there were used for this purpose the decantation ampoules employed in the separation of small quantities of essential oils floating on distilled waters.

Conrad Gessner indicated¹³ the use "of a glass vessel, broken by a thread of hot iron from which is a narrow opening for all the water to flow through." Jacques Besson made a drawing of an "earthenware vessel punctured in the base with a small opening,"¹⁴ and he described the siphon "for the suction of the water from the receptacle, which will leave the oil in the bottom." The treatise of Porta gives a design of a siphon, of a decantation funnel and of two receptacles with a double opening.¹⁵

The primitive mode of *expression* is exemplified by a handle of fabric being twisted with sticks; this scene is depicted in an Egyptian bas-relief in the Louvre. Such a process was applied for a long time to limited quantities of perfume plants, whereas the pressing of oleaginous seeds gave a much more attractive yield with the invention of the *scourtin*, a press-bag of coarse material, which combined pressure and sifting. The sieve, according to Pliny, was known by the Egyptians, who made it with papyrus filament and with very thin rattan, while the Gauls were the first to use for that purpose the mane of horses, he reported.¹⁶ The *scourtin* of bristles, or the *scouffin* of *esparto*, is directly derived from it. Bauderon called it an *esportin*.¹⁷ Sylvius said that it was made of a tissue of goat-hair.¹⁸ Later, the plants were pressed by placing them between two heated metal plaques.

The technical importance of the expression of oleaginous matter grew. The Grasse industry of digestion for a long time used hand-presses, and only some sixty or seventy years ago was the hydraulic press first used there.

The invention of filtration seems to be due to the Arabs; the word

itself comes from *feltre*, which means *felt*. No doubt it is a word of Tuscan origin, although the importation of the felt industry into Europe seems to have come from central Asia via the Arabians. The first filtration was an application of the principle of capillarity; it is depicted in a wood engraving in the work of Geber,¹⁹ entitled *Distillation*, which conceives the primitive Arab science of thinning out a substance, understood by the Arabs to be a function of distillation. Commentary on this technique is found in the *Summa perfectionis*.²⁰ Geber's distillation *per descensum*, without fire, is actually decantation, useful for the separation of the oils from other liquid materials, through the lower parts of the vase; the distillation *per filtrum* was for a long time assimilated in the distillation *per descensum*, and no doubt an equal merit was ascribed to it.

Brunschwig, in the eighth chapter of his treatise, showed how "one should distill with the filter."²¹ Conrad Gessner depicted a subtle distillation which is a filtration "in a still with a band of distilling cloth."²² At the time, this separation with the filter of the aqueous parts of the oils from the juices and the waxes was a most marvelous process.

However, Liébaud rose up against the confusion: "The expression," he wrote, "of some liquids through felt, sponge, sieves or by pots of raw earth, should not rightly be called distillation."²³ At the same time, the felt was being used to determine the strength of alcohol: imbibed with *eau ardente*, it should burn without being entirely consumed. However, among the chemical characters shown on the pages of the Encyclopedia of 1763, filtration was again represented by the symbol of distillation. Finally, filtration by gravity, with a felt band, soon replaced the capillarity decantation.

Perfumery again had recourse to *distillation* for the elimination of the water from macerations, no doubt to the great harm of the products. Such distillation was carried out over ashes, with a small fire, a sort of slow evaporation, and had the advantage of coagulating the vegetable matter in suspension and of facilitating its precipitation; it eliminated the alcohol from the spirits of wine, added to perfect the extraction. The entire process was related to the operation which consisted of "rectification in the sun."

Finally, in all times, various subterfuges were employed to clarify the perfumed oils: the ancients smeared the inner walls of the receptacles with honey, an ingenious method for the separation of the aqueous parts²⁴; with the use of fats, the difficulty naturally became much greater. Later, Baumé applied himself to the problem; he recommended for the desiccation of the pomade, the addition of 10 to 12 ounces of starch for every five pounds of pomade, to melt it after three days, and then separate the solid starches.²⁵ Thus, in all ages, care has been taken to ameliorate the methods

of separation in order to perfect the quality of the products of extraction with fixed solvents.

References

1. Dioscorides, "De Materia Medica," Book II-69.
2. Pliny, "Natural History," Book XII-2, Book XIII-3.
3. Béguin, Jean, "Les Elemens de Chymie," 1624, p. 57.
4. Mesuë, "Antidotarium," Book XII, p. 411.
5. Geber, "Summa perfectionis," Danzig, 1682, p. 83.
6. Charas, "Pharmacopée Royale," Paris, 1753, p. 22 and 47.
7. *See* 2, Book XIII-2.
8. Gessner, Conrad, "Trésor des Remèdes Secretz," Lyons, 1558, p. 364.
9. Bauderon, "Pharmacopée," Lyons, 1628, p. 385, 387.
10. Baumé, "Elements de Pharmacie théorique," Paris, 1769, p. 781 and 786.
11. "Secreti nobilissimi dell' Arte Profumatoria," Venice, 1678, p. 169.
12. "Nouvelle Chimie du Goût et de l'Odorat," Paris, 1819; p. 216.
13. *See* 8, p. 268.
14. Besson, Jacques, "L'Art et Moyen parfaict de tirer Huyles et Eaux de tous Médicemens oléagineux," Paris, 1571, p. 6 and 8.
15. Porta, "De Distillatione," Book IX, Rome, 1608, p. 71 and 72.
16. *See* 2, Book XVIII-11.
17. *See* 9, p. 366.
18. Sylvius, "La Pharmacopée," Paris, 1625, p. 296.
19. Geber, "Works," edited by E. Darmstaedter, Berlin, 1922, p. 53.
20. *See* 5, p. 83.
21. Brunschwig, "Das neuwe Distillier Buch," Strasbourg, 1531, folio 15.
22. *See* 8, p. 97.
23. Liébaut, "Quatre Livres des Secrets," Rouen, 1616, p. 2.
24. *See* 2, Book XV-7.
25. *See* 10, p. 826.

Enfleurage. Cold fat extraction, by contact without immersion, was one of the first methods used with the exclusive aim of perfumery in mind. It was developed, empirically at first, as a technique which restores most faithfully the odor of the flowers.

A trace of this method is found as an artisan technique of the eighteenth century in southern France, where the manufacture of the raw materials of perfumery was developing into an industrial form. The advantage of enfleurage over digestion was not fully appreciated until the end of the last century. Enfleurage has been known under several forms.

Enfleurage of oleaginous fruits combines the method of expression of the oil of the seed, without heat, with the process of immersion of fresh odorous flowers. In Persia, at the time of Mesuë, the enfleurage of rose flowers over sesame seeds was known; the process was renewed until the seeds ceased to increase in size from the humidity of the petals. In the

sixteenth century, Conrad Gessner described the enfleurage of violet flowers over almonds:¹

"The almond must be peeled and roasted a little, so that the oil is less subject to corruption; layers of processed almonds are alternated with flowers, which are kept as long as the odor of the flowers is given off, and then new flowers are placed in their stead; as many times until the almonds are satiated with the odor; the almonds are then pressed."

Jean Liébaut described the preparation with almonds of the oils of jasmin flowers, violet flowers, rose of Damas, and the preparation with melon seeds of the orange blossom oil.² Ruscelli reported the same technique.³ Among the Florentine perfumers, triturated and flowered almonds were used in the preparation of *pommes de senteur*, the *pastenôtres*, then the almond cakes (*les pains d'amandes*) for the hand toilet, soon to be an honor in the court of Louis XIII. At the time of Simon Barbe, orris powder was added to the jasmin *pâtes de Provence*, giving the perfumer at the same time an oil and paste.⁴ Dejean described enfleurage with almonds,⁵ as did Pomet,⁶ Baumé⁷ and then Fargeon.⁸

At the opening of the nineteenth century, enfleurage with almond was still being practiced and with the four grains (barley, wheat, oats, rye);⁹ the oils of enfleurage were developed, and the production of almond oil increased, followed by the perfumers' usage in his essences of the pastes of pressed cakes.

The *enfleurage of oils* was known from the seventeenth century. The flowers were placed on wooden frames, furnished with hooks on which were held cotton veils imbibed in oils; they were removed and renewed each day; later the cloths were detached, folded in four, and pressed.¹⁰ The technique, which has hardly changed, was described by Dejean, Lémery,¹¹ and Fargeon; later a rigid metallic grill was substituted for the hooks.

A virgin olive oil, sweet almond oil, and then ben oil were used for this process, and the flowers included orange blossom, jasmin, violet, white and blue hyacinth, tuberose, acacia, and on rare occasions rose and jonquil, although the greater part of these two flowers was treated by infusion.¹² Bertrand indicated 10 or 12 enfleurages for the jasmin, and four or five for the orange flower.¹³ At one time, the oils of enfleurage with ben oil were called essences,¹⁴ to distinguish them from the oils of infusion. Barbe called *essence de millefleurs* (oil of a thousand flowers) the mixture of various flower oils, and under the names of *huile au bouquet* and *huile au pot-pourri*, oils of enfleurage were prepared, reinforced with oils of bergamot, clove and thyme.

More recently, cottonseed oil and earthnut oil, which the industry furnishes free from odor, have been used in enfleurage. Finally, the

paraffin oils, or as they are called in Europe the neutralin oils, give an enflourage of enhanced fineness; but the use of these oils has been little developed because of the limited absorptive power of Vaseline and other paraffin products.

Enflourage with fats, a monopoly of the Grasse industry, is a more recent technique. In its beginnings, purified lard was used, "the thickness of a finger in two tin plates; the flower is put into one plate, and recovered from the other."¹⁵ Glazed pottery plates—the *tiames*—were used and "only the pomades of jasmin, orange blossom and tuberose will keep," it was said at the time. "The others are too weak to give an odor that lasts." In 1809, according to Bertrand, frames or *châssis* were used, and the pomade corps was made up of a mixture of hog and beef fats, spread on the surface of the glass in the frames, in two lines of thickness; little grooves were made in the fat, to increase the surface contact. In the middle of the operation, the fat was turned around.¹⁶

To the prepared corps, cakes of benzoin or storax were added, sometimes of both, or of styrax or balsam Peru for the pomades of composition. The pomades were then mixed, except for the rose and orange flower; to 10 pounds of jasmin pomade, there were added 1½ pounds of pomade of acacia, and other conventional mixtures were made for the pomades of jonquil, tuberose, acacia, mignonette and even of violet.

These pomades were mixed with the aid of heat, receiving only 5 or 6 enflourages. The pomade was finished by the addition of amber, musk or vanilla. This was then the finished perfume preparation; it was not until the middle of the nineteenth century that the enflourages of the Grasse industry became raw materials for perfumes.

The technical literature of 1854¹⁷ gave minute details of the separation of the enflourage in usage at the time: the pomade corps was prepared with heat from burning wood; with lards and fats chosen and cleaned by hand, not by machine. The literature of 1863¹⁸ indicated a method of pneumatic enflourage, developed by Piver. For certain usages, pomades richer in beef tallow, called *corps durs* or hard fats, were prepared.

Later it became clear that the costly process of enflourage was advantageous only for jasmin and tuberose, the infusion method being justified for the other flowers.

Even in our day, enflourage remains a delicate technique, requiring a considerable quantity of material, a large and highly specialized personnel, bringing forth economic problems of the first order in an extremely seasonable industry.

The process of *enflourage des poudres*, the manufacture of powders perfumed by flowers, is very ancient. The process takes place by simple

contact, in a closed receptacle, and the flowers are removed and replaced with carefully chosen and sorted ones.

Powders treated in this manner included the plant powders, orris, ambrette, oakmoss; amylaceous matter, starch and faecula;¹⁹ and minerals, crayon and talc;²⁰ the flowers used included jasmin, hyacinth, jonquil, orange flower, nutmeg rose,²¹ mignonette, tuberose,²² and even wallflower and lily-of-the-valley.²³ By an analogous process, hides and gloves²⁴ have been perfumed with the same flowers, and also with violet and crimson carnation.²⁵

It is to these long-abandoned methods that we trace the modern experiments with enfleurage with pulverized solid adsorbents, to which we shall devote a special chapter of this book.

References

1. "Trésor des Remèdes Secretz," Lyons, 1558, p. 365.
2. Liébaud, "Secrets de Médecine," Rouen, 1616, p. 159.
3. Ruscelli, "Les Secrets d'Alexis Piemontois," Lyons, 1657, p. 114.
4. "Le Parfumeur François," Amsterdam, 1693, p. 40.
5. Dejean, "Traité des Odeurs," Paris, 1763, p. 453.
6. Pomet, "Histoire Générale des Drogues," Paris, 1735, vol. 2, p. 265.
7. Baumé, "Elemens de Pharmacie," Paris, 1759, p. 181.
8. Fargeon, "L'Art du Parfumer," Paris, 1801, p. 225.
9. Bertrand, "Le Parfumeur Impérial," Paris, 1809, p. 204.
10. See 4, p. 35 and 49.
11. Lémery, "Cours de Chymie," Paris, 1753, p. 665.
12. "Nouvelle Chimie du Goût et de l'Odorat," Paris, 1819, p. 238.
13. See 9, p. 195 and 201.
14. Celnart, "Manuel du Parfumeur," Paris, 1854, p. 39.
15. See 4, p. 51.
16. See 9, p. 6-19.
17. See 14, edit. of 1854, p. 39.
18. Pradal and Malepeyre, "Manuel du Parfumeur," Paris, 1863, p. 52.
19. See 4, p. 4.
20. Le Camus, "Abdeker," Paris, 1756.
21. "Le Parfumeur Royal," Paris, 1761, p. 125.
22. "Nouvelle Chimie du Goût et de l'Odorat," Paris, 1811, p. 233.
23. See 9, p. 137-144.
24. De Blégny, "Secrets," gathered by M. Daquin, Paris, 1689, v. 2, p. 380.
25. See 21, p. 3.

The Perfumed Oils of Distillation. Long before the essential oils, the first products coming from distillation were obtained by the dry distillation of animal products, balsams and resins. In this process, a large part of the products of pyrogenation, which condensed with difficulty or were carried away in the gases, was lost.

It should be considered as progress, whether it had been reasoned out

or had happened by chance, that there was developed the practice of receiving the distillate in an oil. The operation was well described by Conrad Gessner, based upon the work of Aetius and Nicolas of Alexandria. This process gave what the French called *huiles capnistes*, or smoked oils; it was a distillation *par descens*, just as was practiced for the wood oils, but in which the lower vessel contained an oil. Gessner wrote that it was used for frankincense, styrax, the gum-resin bdellium, and costus.¹

This process was particularly useful for therapeutic preparations. "We most frequently perfume our medicaments," wrote Sylvius a little later, "and this consists merely in permitting them to receive some vapors which arise from the heat, when we prepare or burn them."² In the eighteenth century, these oils, because of "their acrimony," fell from favor.³

Particular mention should be made of the process which consisted in receiving the aqueous distillate in the oil; the water of distillation is then drained from the oil, resulting in a complete distillate frequently differing to a great extent from the usual essential oil.

References

1. Gessner, Conrad, "Trésor des Remèdes Secretz," 1558, p. 284.
2. Sylvius, "La Pharmacopée," Paris, 1625, p. 428.
3. Macquer, "Elemens de Chymie théorique," Paris, 1756, p. 192.

The Stabilization of the Perfumed Fatty Bodies. The primitive methods of extraction by boiling imparted a certain robustness to the oils; but when they were prepared in the hot sun, or in a cold medium, necessity imposed on the industry a study of the conditions and methods for their better conservation.

Pliny noted the desirability of keeping the perfumed oils in well-closed containers, free from heat; he recommended the addition of salt to the oil for its conservation, and adding resin, which could have the effect of rendering it less easily alterable.¹

The practice of salting was observed for a long time; it was noted at an early age that salt aided in the resolution of aqueous emulsions, and Béguin² observed that it created a milieu in the water that was bacteriologically almost inert.

The necessity of decantation was affirmed by early observers. Dioscorides wrote that great care was necessary in the separation of the oil from the aqueous parts, or it would alter,³ and Pliny noted that digestion should be carried out in the shade, in lead receptacles, so that the perfumes would improve with age, whereas the sun caused them to deteriorate.⁴

When the materials were cooked or baked, the resulting oils contained

the 'juices.'⁵ The Geber decantation method was an improvement.⁶ At the time of Gessner, glass ampoules were available for decantation.⁷ Deleboe repeated that it was necessary "to cause the consumption of the superfluous juices which are in the oils, or they will cause corruption," and he indicated a method of control: "If some oil is placed on the hand, the juice separates and the oil floats." And later: "To know whether juice remains, the oils should be boiled without sparkling on the flame or in the cauldron."⁸

The use of alum for the conservation of the oils, still employed in the preparation of the corps for enfleurage, is cited in the *Secreti* of Isabella Cortese: 2 ounces of rock alum for 3 pounds of oil;⁹ in the *Secreti* of Filareto, for laurel oil¹⁰ and also for the orange flower oil.¹¹ Ruscelli gives a recipe for oils which will never rancidify: "Take for each pound of oil, 2 grains of salt, 1 grain of brass filings, 2 grains of rock alum, and make all these boil a little together; then complete the oil without fear that it will ever rancidify or become corrupt."¹²

The addition of benzoin, styrax, musk or spices to the fatty corps of the digestions was not merely because of the need for odoriferous constituents, but had the practical aim of protecting them from the causes of rancidity.¹³ In Porta, one can read that a small quantity of musk contributes to avoiding deterioration;¹⁴ Nicolas Le Febvre had recourse to a nutmeg butter for the conservation of unctuous balsams.¹⁵

In the following years, special efforts were made not to soil the oils; to separate with care the fats from the corruptible tissues; to wash them; and to protect the corps and the pomades from contact with light and air. Empiricism taught the use of benzoin. More recently, with the innovation of antioxidant bodies, new attention has been given to the important problem of the stabilization of the fatty corps.

References

1. Pliny, "Natural History," XIII-2.
2. Béguin, Jean, "Les Elemens de Chymie," Paris, 1624, p. 58.
3. Dioscorides, "De Materia Medica," I-XLII.
4. See 1.
5. Mesuë, "Antidotaire," XII-338.
6. See preceding chapter, *Decantation and Filtration*.
7. *Ibid.*
8. "La Pharmacopée de Sylvius," III-X.
9. "I Secreti dell' Arte Profumatoria," Venice, 1561, p. 77.
10. Filareto, "Breve Raccolti di Bellissimi Secreti," Florence, 1573, Ch. 54.
11. Cortese, I., "I Secreti della Signora Isabella Cortese," Venice, 1665, p. 291.
12. Ruscelli, "Les Secrets d'Alexis Piemontois," Lyons, 1657, p. 116.
13. See 9, p. 47.

14. Porta, "Magia Naturalis," Leiden, 1644, p. 452.
15. Le Febvre, Nicolas, "Traicté de Chymie," Paris, 1660, I, p. 369.

Extraction with Volatile Solvents. Extraction with volatile solvents consists in dissolving the odorous product in a solvent and isolating the perfume from the solution, either by precipitation or by concentration. Thus there would be excluded from consideration under this heading the hydrolates and the alcoholates, which are obtained by the distillation of the extracts.

The first solvent used for this purpose was no doubt alcohol; then came ether. Then, with the progress of the chemical industry, much later, work was done with carbon disulfide, benzene and petroleum ether, followed by chlorinated volatile solvents.

For the treatment of fresh vegetable matter, alcohol presents the difficulty of becoming diluted by the water of vegetation, thus diminishing its solvent power for the perfume, and increasing it for other substances. Alcohol has been used for the extraction of concentrated odorous substances—balsams and resins; or for dry vegetable matter or for the extraction products of fresh vegetable matter obtained by oils, fats or by solvents not miscible with water.

The use of alcohol was an innovation of extreme importance for perfumery, and it resulted in enabling the perfumer to use the perfumes from the flowers extracted by digestion or by enfleurage, in the same way as he utilizes the essential oils. Its introduction into the production of perfumes marks a decisive turning point in the history of the development of the techniques of the industry. Let us first examine chronologically the conceptions concerning the extraction of odorous products by solvent power.

History of Dissolution and of Extracts. It should be noted that for a long time there was confusion—and it still persists to a certain extent in the current terminology—between extracts obtained by dissolving in alcohol, and the products isolated by distillation of the alcoholic solution.

The distinction, however, was made by Béguin,¹ by Charas,² and by Johannès Segerus of London who, in 1685, wrote of the various uses of alcohol as a solvent; later it was made by Macquer, who stated: "In submitting to distillation the tinctures of the aromatic plants in spirits-of-wine, one recovers the spirits filled with the odorous principle and with the most volatile part of the essential oils, deprived of all extractive or coloring matter, because the latter are not sufficiently volatile to rise with the spirits-of-wine." The spirits-of-wine were also called by the name of "aromatic distilled spirituous water."³

The pharmaceutical extracts obtained by the concentration of medicinal solutions were already well known—Adrian⁴ places their first mention in the sixteenth century⁵—so that one hesitated to use the same technique to produce aromatic extracts. Lémery⁶ advised against the extraction of the aromatic materials “because of the dissipation of their volatile parts in the evaporation;” as did Quincy a little later.⁷

In the eighteenth century, odor was attributed to the *esprit recteur*, a concept different from the extractive, and tending to separate from it. These errors, and the imperfections of the processes for concentration by evaporation, retarded by a century, one can say, the invention of the concrete floral essences.

Thus Baumé wrote: “The spirit-of-wine is a menstruum which easily takes up the essential oil, or the odor of flowers which cannot be obtained by distillation . . .”⁸ He utilized ether to purify the resins, preparing from them a kind of resinoid, but he did not think of using ether for the extraction of the perfume from the flowers.

Elsewhere, he adds: “Certain authors seem to have claimed that one can, by means of ether, extract the essential oils from the clove” . . . but he believed that this was a solution of the clove resin in a wine oil, which contained poorly rectified ether.⁸ And the notion of the *extractive*, which is traced to Vauquelin,⁹ only increased the confusion.

According to Vauquelin, the extractive, composed of carbon, hydrogen, nitrogen and oxygen, was the same for all vegetation, and the apparent differences were due to impurities. Fourcroy rallied to the support of these notions, but by 1801,¹⁰ he admitted that the extractive was not the same for all vegetation, and the particular characteristics were due to the presence of certain substances, to which he later devoted his attention.¹¹ Parmentier also supported the notion of the extractive.¹²

In 1809, Schrader¹³ expunged the extractive from the chemical commentaries. The following year, Fourcroy—and even Vauquelin himself—cast some doubt on its existence;¹⁴ it disappeared from the scientific conceptions following the works of Chevreul on the so-called extractive of woad. By 1823, the term was no longer to be found in the French edition of Gmelin’s treatise on organic chemistry.¹⁵

The first works on essential oils were then pursued in an effort to link the odor to the existence of individual chemical components. The *esprit recteur* passed on to the ranks of the myths, and the isolation of odorous products was to follow reasoned and logical paths.

But all progress in the extraction with alcohol has been linked to the industrial production of a commodity of high purity, the only type usable, because the odorous products are frequently soluble only in highly concentrated spirits.

References

1. Béguin, "Les Elemens de Chymie," Paris, 1624, p. 186.
2. Charas, "Pharmacopée Royale," Lyons, 1753, p. 41.
3. Macquer, "Dictionnaire de Chymie," Paris, 1778, II-19.
4. Adrian, "Etude historique sur les Extraits," Paris, 1889, p. 7.
5. Wecker, J. J., "Le Grand Thésor ou Dispensaire," Geneva, 1610, the first German edition of which appeared in Basel in 1577.
6. Lémery, "Cours de Chymie," Paris, 1701, p. 631.
7. Quincy, "Pharmacopeia Officinalis et Extemporanea," London, 1727.
8. Baumé, "Elemens de Pharmacie Théorique," Paris, 1769, p. 249, 283.
9. *Journal de la Société des Pharmaciens de Paris*, 1797-1799, p. 133.
10. Fourcroy, "Système des Connaissances Chimiques," 1801, VII, p. 125.
11. Fourcroy, "Philosophie Chimique," Paris, 1806, p. 314.
12. Parmentier, *Ann. chim.*, (1) 43, 19, (1802).
13. Schrader, *Ann. chim.*, (1) 72, 290 (1809).
14. Vauquelin, *Bulletin de Pharmacie*, 2, 241 (1810).
15. Gmelin, "Chimie Organique," Paris, 1823.

Alcohol, Its Industrial Production and Its Proof. The invention of the *retentorium*, or the vessel used to retain products of distillation, has been attributed to Raymond Lulle, working in the first half of the fourteenth century, and to this apparatus the Liebig fractionating column is related. On the other hand, the preparation of the *aqua mirabilis* of Lulle for a long time remained a secret jealously guarded by the alchemists and the apothecaries.

In the fifteenth century, distillation began to be carried out in important quantities. Michael Savonarola noted that not all the alcohols distilled were worthy of being called *quintessences*; he cited the necessity of increasing the number of distillations; and he spoke of a distillation apparatus "of which the furnace is at the bottom of the house and the head on the roof."¹ Ullstadt,² then Brunschwig³ and Gautier Ryff, in the course of the sixteenth century, described and depicted large numbers of distillation apparatuses which could give an alcohol of better purity, a testimonial to the importance of the distillation of alcohol already being shown in Germany.

At the same time, rectification was being currently practiced in Italy. Jérôme Rubée utilized the apparatus of Raymond Lulle,⁴ and Biringoccio published a chapter on distillation, well illustrated, showing an alembic with a flat tray and an aerial coil.⁵ Alcohol at the time was still being obtained only from wine, and was employed for medicinal purposes.

Instructions for the enrichment of the alcohol from distillation are found in the works of Gessner, Liébaut,⁶ and Porta,⁷ among others.

Libavius described⁸ the production of alcohol from grain and from fruits rich in sugar or starch, by fermentation followed by distillation

with peculiar deflegmators, at right angles. In the seventeenth century, Angelo Sala also wrote about the fermentation of grain.⁹

Nicolas Le Febvre, Glauber,¹⁰ and Glaser¹¹ perfected the distillation apparatus; Robert Boyle, in order to purify alcohol, distilled it over calcined white tartar (anhydrous potassium carbonate) or over quicklime, as did Le Febvre,¹² following the teachings of Rhazès. Later Khunrath,¹³ and then Kunckel,¹⁴ showed the development of the production of grain alcohol in the Low Countries of Europe. Kunckel seems to have been the first to succeed in separating the fusel oils without recourse to lime.

Alcohol, however, was still not of high purity. Saint-Simon wrote that during the rigorous winter of 1709 the violence of the cold caused the bottles of Hungary water to break in the cupboards of several apartments in Versailles.

The study of alcohol was progressing; Charas¹⁵ and Nicolas Lémery,¹⁶ taking up the conceptions of Libavius, adapted to the *alambic rosaire*, used in the distillation of rose water, a raised condenser which enabled them to obtain a concentrated alcohol. This apparatus, utilized in Languedoc and in Provence, gave quite a regular production of alcohol, although on a small scale. Geoffroy Le Jeune, who for a time lived in Grasse, published his studies on distillation at the same time as those on essential oils. From the information which he gave,¹⁷ it can be assumed that he had at his disposal at the least an 86 per cent alcohol. Baumé contributed some very pertinent writings on the subject of alcohol, from the fermentation to the proof.¹⁸ At the end of the eighteenth century, a strong alcohol, known in France as *esprit-de-vin alkoolisé*, was in current usage in that country in pharmacy laboratories and in industry generally.

We are indebted to Baumé for the first practical suggestions on the production of alcohol on a large scale, but it was through the efforts of Chaptal, under Napoleon I, that there was created in southern France a distillation industry,¹⁹ which had so great an influence on the evolution of the Grasse perfume production. The invention of a continuous distillation process and the application of steam, were decisive steps, and little by little small improvements in the domain of rectification enabled the industry to produce a neutral and odorless alcohol, so indispensable to perfumery.

All progress in the rectification of alcohol is linked with the tests for purity. From the time of the first alchemists, studies had been pursued for methods of determining the purity of alcohol. Several methods involving combustion were known: tests with linen, with oil, with cannon

powder; then there were the gravimetric tests from which the aerometer was derived.

Basile Valentin,²⁰ Ulstadt,²¹ and Conrad Gessner suggested the use of combustion tests: "*Eau-de-vie* is absolute, when it burns without leaving a water of residue, or if the burning consumes the linen impregnated in it." This method was in operation for quite some time; it was described in detail by Porta and Nicolas Le Febvre.²² In 1760, one such method was still being used in Languedoc under the name of proof-stick (*épreuve de la sonde*).²³

The Holland proof of alcohol was one of the first standards in commerce. This alcohol was a 47 to 50 per cent product; it was of known density, and when agitated in a test-tube, rolling pearls formed on the surface of the liquid. This was an experiment easy to perform, but the results were not always conclusive.

The cannon powder method was popularized by Moïse Charas toward the end of the seventeenth century. Some dry, fine cannon powder was soaked in alcohol; a flame was put to the powder, and if it crackled the alcohol was concentrated; if not, "it is proof that the over-flegmatic spirits have moistened the powder."²⁴ Baumé²⁵ correctly criticized this test, which gave varying results, according to the relative proportion of the powder and the alcohol.

The gravimetric tests can be traced to the Ulstadt test for oil. One drop of olive oil is deposited in alcohol. If it falls to the bottom and stays there, it is a sign that the alcohol has been properly rectified.²¹ After Boyle, Musschenbroek, Fahrenheit, and the Abbé Nollet, it was Baumé who devised a practicable form of the gravimetric test, with the invention of the aerometer, which remains to this day the classic instrument.

In 1816, the Cartier aerometer was chosen as the standard for the measurement of alcohols; then in 1824, there appeared the centesimal alcoholometer of Gay-Lussac, more simple in its use and more exact in its results; it became the official alcoholometer, which it still is today.

References

1. Savonarola, Michael, "Libellus de Aqua Vitae," Basel, 1561, p. 272.
2. Ulstadt, "Coelum Philosophorum," Paris, 1544, folios 3, 20.
3. Brunschwig, "Das neuwe Destillier Buch.," Strasburg, 1507.
4. Rubeus, "De Distillatione Liber," Basel, 1585, p. 13.
5. Biringoccio, "Li diece Libri della Pirotechnia," Venice, 1558, p. 128.
6. Liébaut, "Quatre Livres des Secrets," Lyons, 1593.
7. Porta, "De Distillatione," Lib. IX, Rome, 1608.
8. Libavius, "Alchemia recognita," Frankfort, 1597, Lib. II, Chapt. XXVI.
9. Sala, "Opera Medicochymica quae extant omnia," Frankfort, 1647.

10. Glauber, "Furni novi philosophici," Amsterdam, 1651.
11. Glaser, "Traité de la Chymie," Paris, 1663.
12. Le Febvre, "Traité de la Chymie," Paris, 1669, II-8.
13. Khunrath, "Medulla Destillatoria et Medica," Frankfort, 1703.
14. Kunckel, "Laboratorium chymicum," Hamburg, 1716.
15. Charas, "Pharmacopée Royale," Lyons, 1704.
16. Lémery, "Cours de Chymie," Paris, 1701.
17. Geoffroy, *Mémoires de l'Académie des Sciences*, 517 (1707).
18. Baumé, "Elemens de Pharmacie," Paris, 1769, p. 434, 479.
19. Chaptal, "L'Art de faire le Vin," Paris, 1801.
20. Valentin, Basile, "Offenbahrung der verbogenen Handgriffe," Erfurt, 1624.
21. Ulstadt, "Coelum Philosophorum," Paris, 1544, fo. 23.
22. Le Febvre, "Traité de Chymie," Paris, 1669, II-8.
23. Dujardin, "Recherches sur l'Art de la Distillation," Paris, 1900, p. 205.
24. Demachy, "Dissertations Physico-Chimiques," Paris, 1774.
25. Baumé, "Elemens de Pharmacie," Paris, 1769, p. 462.

The Invention of Resinoids, Washings and Pomade Absolutes. The simplest method for the purification of resins—by means of water—was applied in the first instance to the gum resins. The idea dates back to the Arabs, and was handed down without improvement. For example, in Liébaut,¹ there is a description of the "manner of extracting myrrh, by resolution and distillation with a filter." It was actually a digestion over warm ashes in several charges of water, each time decanted by capillarity, until the water was no longer colored.

In the first pharmacopoeias, and in the *Guydon des Apotiquaires* of Valérius Cordus,² the use of rose spirits and of distilled rainwaters was prescribed; the water no doubt answered the needs of the day for the purification of juices, but was less appropriate for the purification of *galbanum*, *sagapenum* and *asafoetida*, among others.

The use of a weak alcohol, called *eau-de-vie*, was a step forward. Adrian cites the appearance of *eau-de-vie* in the preparation of extracts in 1587.³ Béguin,⁴ and later Jean de Renou,⁵ advanced arguments to prove the necessity of varying the solvents according to the materials to be treated. The invention of resinoids came at a later date, when a more concentrated alcohol was available.

Nicolas Le Febvre described the preparation of the benzoin product, then known as the *magistère de benjoin*. He dissolved benzoin in alcohol, filtered it, precipitated it with the addition of water, distilled off the alcohol, decanted the water, and dried the residue. This method of operation is not satisfactory, because the concentration of the aqueous alcohol causes some of the odorous principles to be carried over to the distillate;⁶ had he concentrated the alcohol, he would have obtained a better product, corresponding to the alcoholic resinoid of today.

Charas claimed⁷ "that chemistry has nothing better than spirits of wine at its disposal for the extraction of substances, particularly the resinous ones, whereas water should be reserved for the gummy parts," thus drawing a clear distinction between the conditions necessary for the extraction of resins and of gums.

With the same objection in view, Baumé⁸ contended that resins should be extracted with well rectified spirits of wine, treating the resin two or three times with 6 or 8 times its weight in spirits of wine, then filtering, and concentrating half or two-thirds of the alcohol. But Baumé also precipitated by the addition of water, which he decanted after a suitable waiting period. He insisted on the necessity of repeating the purifications. At another time, Baumé, better informed, was to become the champion of vitriolic ether extraction.

With Macquer,⁹ the form of our resinoids clarified itself. He distinguished, as a matter of fact, between two different types—the precipitation of tincture of resins, and the complete concentration of the tinctures, to give the plant extracts. None the less, another century was required, bringing with it an abundance of new raw materials and new solvents, for the resinoid to take on its present role in the perfume industry.

Many investigators were occupied with the analysis of plant life. They included Boulduc, Louis Lémery (Junior) and Rouelle, but it was Geoffroy the younger who for thirty years pursued his studies of the principles causing color and odor in certain plants. From 1707 to 1738, he presented numerous papers on spirits of liquors, on essential oils and on plant extracts,¹⁰ and all the evidence continued to mount, showing that the odorous principles were soluble in concentrated alcohol.¹¹

Geoffroy the younger studied the extracts from balsam Peru and benzoin and the so-called essential salt of the distilled waters of aromatic plants. He sought a means of conserving the odor of violets, roses and carnations. This was the point of departure for the work which was destined to separate the study of odorous materials from that of pharmaceutical substances. The perfumers of Provence were soon to take part in this work.¹²

Soon after, Marot de la Garaye published his method for the extraction of the essential salts from plant material. His aim was "to separate from the mixtures the medicinal parts." He seems to have obtained rather poor results, judging from his description of the "salt of red carnation flowers."¹³ However, it is to his credit that Garaye, in the course of his research, invented a pulverizing machine, the forerunner of Grasse's own pomade *batteuse*.

At the dawn of the nineteenth century, there were available in Grasse

some high-purity alcohol, the means for carrying out the enfleurage, and the mechanical equipment for preparing pomade washings. Under the First Empire, spirits or extracts of flowers were prepared from the oils and the pomades, with two extractions, which gave the first and second infusion. The first was made from four pounds of oil or of pomade with four pints of alcohol, remaining in contact for two weeks; the second with only three pints of alcohol. The residual oil and pomade were used in cosmetic preparations.¹⁴

Not long after, it was proposed that the fatty *corps* remaining in the enfleurage washings could be congealed by contact with ice,¹⁵ and from this followed the important progress of freezing, which became widespread with the invention of the refrigerator. The application of a vacuum pump improved the methods of evaporation of the alcohol, and led to the first production of pomade absolutes.

References

1. Liébaut, "Quatre Livres des Secrets," Rouen, 1616, p. 317.
2. "Le Guydon des Apotiquaires," Lyons, 1572.
3. Schvenskfeldt, Caspar, "Thesaurus Pharmaceuticas," 1587.
4. Béguin, "Les Elements de Chymie," Paris, 1624, p. 186.
5. de Renou, Jean, "Les Oeuvres Pharmaceutiques," Lyons, 1631.
6. Le Febvre, "Traité de la Chymie," Paris, 1669, p. 83.
7. Charas, "Pharmacopée Royale," Lyons, 1753, p. 564.
8. Baumé, "Elemens de Pharmacie," Paris, 1769, p. 346.
9. Macquer, "Dictionnaire de Chymie," Paris, 1778, II, p. 19.
10. Geoffroy the younger, *Mémoires de l'Académie des Sciences*, 517 (1707); 37 (1718); 147 (1721); 114 (1727); 88 (1728); 193 (1738).
11. de la Garaye, "Chymie Hydraulique," Paris, 1746, p. 97.
12. Demachy, *Journal de la Société des Pharmaciens de Paris* (1797).
13. See 11, p. 188.
14. Bertrand, C. F., "Le Parfumeur Impérial," Paris, 1809, p. 70, 72.
15. "Nouvelle Chymie du Goût et de l'Odorat," Paris, 1819, p. 181, 206.

Neutral Solvents. At almost the same time that the practice of purifying resins by means of alcohol was becoming general among apothecaries, the use of ether for this purpose was first proposed. Ether, though known for many years, had been produced in quantities only since the time of Baumé, who published his *Dissertation sur l'éther* in Paris in 1757. After having studied the solvent power of ether on various drugs, Baumé felt he could separate the resins "without touching the gummy, extractive and soapy principles."¹ He dissolved the resins in cold ether, and concentrated the tincture in a still. Thus Baumé, almost 150 years before the reinvention of the solvent extraction process by the Grasse industry, had prepared "resinoids" without the use of alcohol.

But Baumé never imagined that it was possible to extract the aromatic spirits from the plant,² and he interpreted the ethereal extraction of clove as simply a solution of "clove resin" in an "oil of wine" which incidentally contained poorly rectified ether.

It was not until 1835 that a pharmacist, who had already achieved success with an important contribution to the pharmaceutical extract industry, applied ether to the extraction of the perfume of fresh flowers, long after the incredible theory of the extractive had been discarded.

First Experiments of Robiquet. It is a fact that the first experiments of Robiquet are inseparable from the evolution of the manufacture of pharmaceutical extracts, a description of which is found in the work of Adrian.³

In 1835, Robiquet⁴ reported on his experiments with the extraction of jonquil perfume by the use of ether. He purified the extract, eliminated the alcohol-insoluble substances, and thus prepared an absolute oil. We have already noted on page 19 that this treatment with alcohol had been applied for some time to the concentration of the perfume preparations from enfleurage and digestion.

The following year Buchner⁵ applied the Robiquet technique to the extraction of the perfume of syringa, linden and mignonette, and in 1838, Favrot⁶ treated the false acacia (robinia) and lilac flowers. During the succeeding years, as work on the fatty raw materials progressed and became industrialized, only silence surrounded the research on this new method of extracting perfumes.

As a matter of fact, the extraction of fats and oils by means of ether, which had been noted by Baumé, was applied by Robiquet and Boutron Charlard to the treatment of almonds.⁷ In England Jesse Fisher of Birmingham used carbon disulfide to extract oleaginous fats.

The Work of Millon and Ferrand. In 1856, Millon, the head of the Laboratoire de Chimie of Algiers, was seeking a rational method of exploiting the aromatic resources of Algeria.⁸ He worked out a method for extracting the perfume of the flowers of acacia, rose, jasmin, néroli, tuberose, heliotrope, wallflower, narcissus, carnation, and of the branches of verbena, by means of ether or carbon disulfide, which he preferred to chloroform, to the volatile fractions of "wood spirits," to benzene, and to alcohol. Millon's collaborator, Ferrand, patented the industrial application of the "invention."⁹ In this patent, the flowers were put in a displacement apparatus, and remained in contact with the solvent for ten minutes. The ether was concentrated in an ordinary distillation apparatus.

The work of Millon attracted considerable attention. The industrial

application of the process was ready to be tried, but it depended above all on the choice of an appropriate solvent, and it had to follow the progress of industrial extraction of the fatty *corps*. It is important to note that the difficulties were greater in the extraction of flowers, which give weak yields of perfume; the impurities of the solvents were concentrated, and exerted a great influence on the quality of the extracted products.

Progress in the Choice of Solvents. Ether being expensive, carbon disulfide was the next choice as solvent; but it is dangerous, highly toxic, and even when mixed with air is highly inflammable and explosive. In addition, it alters quite easily, and contains loathsome impurities that are difficult to remove. Despite the numerous efforts made to purify this solvent,* it was used by only a few workers, Lemettais and Bonnière,¹¹ Deiss,¹² Piver,¹³ Chiandi,¹⁴ Vitcau and Mazure,¹⁵ Dombain and Trumper,¹⁶ and is no longer in use today.

Methyl chloride was used by C. Vincent,¹⁷ G. Ville,¹⁸ Naudin and Schneider,¹⁹ Massignon,²⁰ and Naudin.²¹ But this solvent is expensive, and has a low boiling point, which makes it rather impractical. Approximately the same thing can be said of ethyl chloride, which Naudin found useful.

The employment of petroleum ether and of benzene, today so widespread, appeared in 1863 in a patent of Richardson, Lundy and Irvine, relating to the extraction of fats.²² The authors recommended the use of fractions of petroleum, or other earth oils, and "similar volatile hydrocarbons obtained from asphaltum oil, coal oil, or shale oil," distilling below 100°. In 1864, Hirzel patented in France, England and Austria, and in several German states, an apparatus for a petroleum ether extraction, despite the fact that Naudin²¹ used butane, pentane and "the light fractions of American petroleum distilling after pentane."[†]

The nascent petroleum refining industry made possible the development of these fractions on an industrial scale. Among the most important patents to be found concerning the use of petroleum ether, one should mention those of Naudin and Schneider,²³ of Schneider and Naudin,²⁴ of Massignon,²⁵ and of the Société des Parfums Naturels of Cannes.²⁶

* See particularly the works of Cloez, Millon, Commaille, Wittstein, Kern, Friedeburg, Allary, Obach, Macquart, Chenevier, Hunrich, Delachanal, Mercuet.¹⁰

† In the following years, the fat and oil industry had recourse to a petroleum oil, d_{15} approximately 0.700, distilling from 110 to 120°, because it was less expensive, more easily recoverable, and it dissolved less resins and gummy material than does petroleum ether. But the latter alone is still used for the extraction of perfumes sensitive to heat, and also because it is very easy to "deodorize."

The Industrialization of the Process. As early as 1870, a Grasse industrialist, Louis Maximilien Roure, was studying the extraction of the perfumes of several flowers. In 1873, he presented several concrete oils to the Vienna Exposition, and interest in these products was manifested, in 1875, in the *Momiteur de Quesneville*.²⁷

A tremendous advance was recorded when, in 1879, Naudin patented an apparatus which permitted extraction and distillation with greatly reduced losses.²⁸ In 1882, in his publication in the *Bulletin de la Société Chimique de France*, he described in even greater detail his equipment, the principle of which continues to be applied in the apparatus in use today.

He reduced the losses and the dangers from fire by working in a closed chamber, and he improved the quality of the products by operating at a low temperature and under reduced pressure.

The Naudin apparatus consisted essentially of the following:

A digester, which can be removable, to carry out a methodic exhaustion;

A decanter, for the separation of the perfumed solution from the water;

A concentrator, composed of an evaporator and a refrigerant, connected to a refrigerator;

A vacuum pump, serving to concentrate at a low temperature, and to recover the solvent held by the exhausted materials.

The truth is that the use of each of these parts was not new. The pharmaceutical extract industry, in particular, had for a long time been using a closed extractor. As Adrian pointed out, methodic lixiviation had been practiced as early as the eighteenth century, and had been used for a long time with success in the Scotch breweries for the washing of saltpeter materials.²⁹ The use of a vacuum for evaporation had been suggested by Henry^{30, 31} and Barry.³²

The contribution of Naudin consisted in his application of these advances to the problem of the extraction of perfumes. Furthermore, he utilized, for the elimination of waxes from concretes, the process of treating the pomades with alcohol, which had been done by Robiquet in 1835, but he reduced the temperature to 15 or 20° below zero, before filtration, and this increased the degree of insolubility of the waxes.

Soon after the progress of Naudin, Massignon studied the extraction of perfumes from flowers, and took out several patents. His processes were acquired by Léon Chiris, who in 1898 built a large extraction factory at Grasse, which for many years remained the model of its kind. Pursuing with tenacity the work he had begun toward 1870, Louis Maximilien Roure, and later his son, Louis Roure, and his son-in-law, Jean Amic, placed on the market concrete essences, and toward 1900 absolute

essences and liquid essences, the latter being alcoholic solutions of absolute essences. Thanks to the new processes of extraction, he introduced to perfumery the perfumes of mimosa, narcissus, hyacinth, broom, hay and violet leaf,⁸³ the resinoids of styrax, of balsam Peru and of opopanax,⁸⁴ and in 1905 he brought forth the decolorized absolute essences.⁸⁵

The difficulties of stationary apparatus, in which the extracted material is submerged in a solvent, brought forth many corrective efforts.

A swinging or circulating apparatus was tried as an extractor (*essoreuse* of Sourdat in France, apparatus of Schulze in Germany⁸⁶) but this type of equipment is very expensive. A greater success greeted the apparatus of Garnier, and the similar apparatus which followed. The Garnier machinery was patented in 1902.⁸⁷

Extension of the Process. In Grasse, center of the floral perfume production, the industrial movement begun by the houses mentioned above spread rapidly. In 1914, there were 14 factories engaged in this type of extraction; after 1918, there were more than 20.

In 1903, Ch. Garnier experimented in the treatment of Bulgarian rose; in 1904, he installed in Kara Sarli a *batterie* of 6 rotating extractors. In 1919 and the years that followed, 6 more factories were installed, and in the course of the best years, the Bulgarian factories produced more than 1,000 kilograms of rose concrete annually.

In 1904, Garnier installed an extractor at Haifa, in Palestine, for the treatment of acacia. Several years later, this apparatus was transported to Egypt. At Beirut, a Grasse house built a factory for the treatment of acacia and orange flower, and this factory is still functioning. In 1922, an installation for the extraction of jasmin was built near Tel-Aviv. In Egypt, a factory was installed by Garnier at Nawa, near Cairo, in 1910, and ten years later another one at Shubra. A third installation, set up around 1925 by a well-known Egyptian, was dedicated to the treatment of jasmin.

On the Italian Riviera, toward 1920, several extraction installations were created, but the greatest Italian development of extraction was in Sicily and in Calabria, particularly in the course of the years after the First World War. There are installations at Reggio in Calabria, and in Sicily there are three centers of jasmin extraction—at Messina, Avola and Milazzo.

In the French colonies, extraction equipment was installed at Boufarik, near Algiers, which is almost as old as the first Grasse installations. Several years ago a French firm set up an installation at Seba Aïoun, near

Meknès, in Morocco; this is devoted particularly to the treatment of rose and oakmoss.

In 1911, Ch. Garnier equipped the Usine du Bois Rouge in Réunion, and toward 1920, the apparatus was transported to the Piton factory, near Saint-Paul, on the same island. More recently, the Pères Missionnaires set up an extraction factory for the treatment of ylang ylang at Nosse-Bé, and another installation was established in the Comores by the Société Coloniale de Bambao.

An Australian company produces the concrete essence of *Boronia megastigma* Nees. by petroleum extraction.

Finally, extraction installations are now being built, or have recently been built, in Guiana, Brazil, and California.

References

1. Baumé, "Elémens de Pharmacie théorique et pratique," 2nd ed., Paris, 1769, p. 283, 346, 354, 356.
2. *Loc. cit.*, p. 356.
3. Adrian, "Étude historique sur les extraits pharmaceutiques," Paris, 1889.
4. Robiquet, *J. pharm. chim.*, 21, 335 (1835).
5. Buchner, *ibid.*, 23, 157 (1837).
6. Favrot, *J. chim. médic.*, 221 (1838).
7. Robiquet and Charland, B., *Compt. rend.*, 44, 352 (1830): *J. pharm. chim.*, 17, 144 (1831) and 21, 113 (1835).
8. Millon, *J. pharm. chim.*, (4) 36, 407 (1856).
9. Ferrand, French Patent 22,404 (1855).
10. See bibliography in Naves, Y. R., *Riechstoff Ind. Kosmetik*, 11, 136, 137 (1936).
11. Lemettais and Bonnière, French Patent 35,499 (1858).
12. Deiss, French Patent 54,126 (1862).
13. Piver, "Rapport du jury de l'Exposition de 1862," Paris.
14. Chiandi, French Patent 153,198 (1883).
15. Viteau and Mazure, French Patent 170,388 (1885).
16. Dombrain and Trumper, French Patent 202,918 (1890).
17. Piesse, "Chimie des Parfums," 1903, p. 69.
18. Ville, G., French Patent 47,285 (1860).
19. Naudin and Schneider, French Patent 130,873 (1879).
20. Massignon, French Patent 130,967 (1879) and 145,958 (1881).
21. Naudin, *Bull. soc. chim.* (2) 38, 582 (1882).
22. Lundy and Irvine, English Patent 2315 (1863).
23. Naudin and Schneider, French Patent 130,873 (1879).
24. Schneider and Naudin, French Patent 130,127 (1879).
25. Massignon, French Patent 139,693 (1880) with additions of February 10, 1882 and September 13, 1882.
26. *Société des Parfums Naturels*, Cannes, French Patent 204,199 (1890).
27. Roure-Bertrand fils, *Sci. Ind. Bull.*, (1) 2, 25, (1900).
28. Naudin, French Patent 130,137 (1879).
29. Vauquelin and Trusson, "Instruction sur la fabrication du salpêtre," 1795.
30. *J. pharm. chim.*, 302 (1819).

31. Tenant, *Repert. für Pharm.*, Buchner, 6, 94 (1819).
32. Barry, *Ibid.*, 11, 316.
33. Roure-Bertrand fils, *Sci. Ind. Bull.*, (1) 2, 25 (1900); (1) 3, 22 (1901); (1) 6, 36 (1902); (1) 8, 50 (1903); (2) 5, 50 (1903).
34. *Ibid.*, (1) 5, 44 (1902).
35. *Ibid.*, (2) 1, 50 (1905); (2) 2, 48; (2) 6, 49 (1907).
36. Schulze, German Patent 41,772 (1887).
37. Belgian Patent, 169,929 (April 23, 1903).

SECTION 2

MODERN PROCESSES OF MANUFACTURE

CONCRETE ESSENCES AND RESINOIDS

General Remarks. Odoriferous raw materials treated by volatile solvents can be divided into three groups:

(1) Fresh plant materials, treatment of which gives concrete essences or concretes.

(2) Dried plant materials, resins, balsams, gum-resins, and animal products, from which the resinoids are prepared.

(3) Plant juices and distilled waters.

The processes of extraction (nature of the apparatus, choice of solvent, conduct of the extraction) differ depending on which of these three groups the product to be treated falls into. Let us examine the reasons for this choice, before studying the various types of apparatus and the proposed solvents.

Raw Materials of the First Group. The parts of perfume-bearing plants treated in the fresh or semi-solid state, because the perfume cannot survive complete desiccation, contain a considerable amount of water, and a very small percentage of perfume.

The fresh flowers have a water content of 80 to 90 per cent, the leaves 60 to 80 per cent, the herbaceous stems 50 to 65. Their desiccation results in a considerable loss of perfume by volatilization, even if this drying is carried out at ordinary temperature, and whether it be in the sun or in the shade. The drying process produces various alterations, due particularly to the rupture of cells and to the exaggeration of diastasic activities.

The yield in concrete by extraction of fresh flowers varies between 0.08 per cent for tuberose flowers and 0.95 per cent for ylang ylang flowers, and the yield from extraction of the summits varies between

0.06 per cent for the mignonette and 2.5 per cent for semi-dried lavandin.

Usually no treatment is used preliminary to the extraction (contusion, pulverization, hashing); and even the crumbling of certain flowers must be avoided in order not to provoke any injurious diastasic action.

The dominant features of the processes adapted to the treatment of these raw materials are therefore the following: the use of apparatus which does not injure the flower; the employment of solvents not miscible with water and usable in large quantities, as compared with the mass of products extracted in small yields.

Inasmuch as the process involves treatment of fresh plant material, generally in bloom—which means it must be carried out in the course of a very short period—it is necessary to use extractors in such a way that the time of charging and removing the flowers is very brief.

The fragility and the small quantity of the perfume extracted make absolutely necessary the use of solvents that are very pure and stable. The most frequently employed solvents are benzene and petroleum ether.

Raw Materials of the Second Group. This group includes the roots, rhizomes, woods, leaves, fruits, seeds, mosses, resins, balsams and gum-resins. The perfume is protected against evaporation by the structure of the plant material, or the perfume is not created except during desiccation. Among these products, disastasic reactions are either non-existent or very unimportant.

The desiccation of the parts of the plant is only partial, an equilibrium being established with the surrounding atmosphere. It can, however, reach as high as 70 to 90 per cent of the initial water content. In the roots and rhizomes, it varies between 60 and 75 per cent, in the woods between 40 and 50 per cent, in the seeds 5 to 10 per cent.

The majority of the cellular membranes are not permeable by solvents except to the extent that the plant is impregnated with water. It therefore follows that to extract the dried plants (mosses, for example) it is necessary to moisten them well; or in order to compensate for the difficulty of penetration, the raw material is finely divided (by cutting or processing).

The extraction can be carried out at a cold or a warm temperature, and the solvents that are miscible in water can be utilized in the majority of cases; to the benzene or petroleum ether, for instance, alcohol or acetone is added. The duration of the extraction can be prolonged without any ill effects. The yields vary between 3 to 15 per cent (oakmoss) and 20 to 30 per cent (tonka beans). The possibility of compressing the divided materials into a pile enables the ex-

traction to be pushed to its end, and the number of extractions is increased.

In the case of resins, balsams and gum-resins, and of the animal products, ambergris, musk, castoreum and civet, the yields are generally high. But the nature of the materials, extracted frequently at a high temperature, demands a careful mixing to assure a complete extraction. The possibility for good contact thus enables the number of extractions to be reduced to three, and sometimes even two.

Raw Materials of the Third Group. In this group, we would include the fruit juices and the distilled waters of aromatic plants (particularly the orange flower water, rose water, etc.). It is clear that solvents immiscible in water are used, and the dissolved fraction must be easily recoverable by partial distillation. The apparatus utilized must be highly specialized, and permit an extraction pushed to the end, aided by a low proportion of solvent. The yields are generally very low.

Tinctures and Infusions. In the alcoholic extraction of the products of the second group, there are obtained, by processing in the cold, the tinctures, and with heat the infusions. These forms are best suited for direct use in perfumery, and their development was a limited application of the process of manufacture of concentrated perfumes, which we shall consider here.

Choice and Preparation of the Raw Materials. We will leave aside for the moment the choice of the time for the cutting of the flowers; this will be taken up in the separate study of each plant.

Desiccation. Various plants are partially dried, so as to reduce the weight and the bulk of the material to be extracted, and thus increase the yield of the extract. Besides, in certain cases diastasic reactions modify the odor and develop, for instance, coumarinic notes in the Labiatae—lavender, clary sage and the gramineous “hays.”

A complete desiccation makes possible the stabilization or the perfecting of the artificial processes of elaboration of the perfume (tonka bean, vanilla pod, etc.); it permits, in addition, a generally economic conservation and transportation of the various odorous materials (roots, leaves, fruits, seeds, etc.). The chemical modifications are, in general, much more marked if the desiccation is carried on slowly. Such modifications can be completely stopped only with the absolute dryness of the material. The attractive note of these products can thus be regulated, and their nature selected, by proceeding with the drying period

more rapidly or less so, with alternating periods of forced rehumidification.

Very frequently, the desiccation is effected under bad conditions, and the ensuing undesirable alterations are very important. Thus, when it is too slow, perhaps because of poor ventilation, or because the plant material has been compressed too tightly, it is accompanied by injurious fermentations; colored substances are created, which have a bad influence on the appearance of the extracted perfume. If it is too rapid, it gives a material less permeable to the solvents used to extract the perfume.

In order to reduce the diastasic actions, one of the classic processes of "stabilization" can be utilized (action of dry heat at 80°, the vapors of boiling water or of alcohol, or the use of pressure, as in the processes of Bourquelot, Perrot and Goris, etc.). Such processes are used in the treatment of vanilla pods. There are also conditions under which one expressly seeks to bring about fermentation before desiccation (for instance, in the preparation of tea leaves, patchouli leaves, etc.).

In order to facilitate the treatment of flowers, it has been proposed that their water be absorbed by drying agents, for example by sodium sulfate.¹ This practice seems to be superfluous and even injurious, for the absorption necessitates a previous bruising. It is not instantaneous, as are the harmful diastasic reactions, which, accelerated or provoked by the liberation of the cellular juices, are very rapid. The penetration of the non-dehydrated plant cells is theoretically acceptable, and it is satisfactory from a practical point of view. The research carried out in the Reed Laboratories of the Citrus Experiment Station, at Riverside, California, has shown that even the paraffin oils, pulverized on the green organs, infiltrate the membranes of the living cells. Much more generally, Overton has shown, in the course of his classic studies the vegetable cells are permeable by the most varied organic solvents, which is explained by the equally classic hypothesis of Gibbs. Benzene is particularly penetrating on humid material; this explains why it is so generally favored for the extraction of the oleaginous substances. In the extraction of lichens by means of benzene, or even with petroleum ether, it is advantageous to restore a partial permeability by soaking the lichens in tepid water for several hours before the extraction, and allowing them to swell with the water, and then drying the plant material before placing them in the extractors.

Division of the Raw Material. In appearance, the division of the raw material facilitates contact with the solvent, and permits an increased amount of flowers to be placed in the apparatus. But the com-

factness that is entailed paralyzes the circulation of the solvent, and prevents homogeneity of the solution. A favorable compromise must therefore be worked out.

In the case of fresh vegetable plants, bruising, cutting or chopping of the plant is conducive to diastasic activity of the juices. Among the flowers, any attack on the physiological integrity of the cells before the extraction is harmful to the quality of the product obtained. Oddo and Fondard² have shown that the yield in the extraction of *jasmin* and *rose* is augmented by one third if, before the extraction, the flowers are crushed, triturated and pressed. The house of *Lautier Fils of Grasse* made a similar study.³ But this increase of yield carries with it a greater extraction of the "waxes", and furthermore the quality of the perfume is poorer.

It was for good reason that, prior to the war of 1914, it was required that *jasmin* flowers be "carried" to the factories intact, and not drawn by peasant carts that are more or less poorly balanced.

The products extracted from bruised or crushed flowers are more highly colored than the normal products. The contact of the juices rich in oxidases generates melanic pigments. The formation of these pigments is quite apparent in the darkening of the damaged flowers and of the dried plants.

Many of the flowers are treated rapidly, right after they have been cut; these include *jasmin*, *rose*, *acacia*, *mimosa*, *carnation*, *jonquil*, *narcissus*, *hyacinth*, *tuberose* and *ylang ylang*.

As well as can be done, the vegetable parts are separated; for example, the flower-stalks of the *jonquil*, *narcissus*, and *hyacinths*, which contain no perfume, would only encumber the extractors and diminish the yield.

When a delay of several hours before treatment of the flowers is unavoidable, either because of irregularity of the supply of raw materials, or because there are insufficient pieces of apparatus, the flowers must be spread out on a thin bed and moved around from time to time. The loss in perfume by evaporation in this manner will no doubt increase, but it is a necessary step to inhibit the detrimental chemical action which is activated by the close contact and the warmth. During the waiting period, it is necessary to place these flowers in a fresh and moderately ventilated spot.

The treatment of the orange flower blossoms involves a special case. It is necessary to split them into pieces so that the solvent can penetrate them effectively, yet injure the petals and the sepals as little as possible. This is accomplished by means of an apparatus consisting of two channelled cylinders, turning in opposite directions, and at the same circum-

ferential speed. The spacing is regulated in such a manner as not to crush the petals, but simply to break them off the flower. It is recommended that the flowers be dropped into the apparatus in smaller quantities than can be absorbed, instead of feeding with a charge that will remain on the cylinders where the flowers should not accumulate. This type of apparatus is analogous to the rammer of the vintner.

The flourishing herbs, lavender, lavandin, clary sage, etc., are treated as they come out of the chaff-cutter, to augment the capacity of the extractors and to reduce the quantities of the solvents used. The division of the plant is continued until the fragments are from 4 to 5 cm. in height. Several houses also treat the mimosas in this way.

The dried products are treated in an entirely different manner. Cellular chemical activity is very feeble, even after the plant has been crushed. Pulverization therefore permits an increase of the capacity of the apparatus and a saving of the solvent employed. But on the other hand, penetration and circulation of the solvent are made more difficult; this is remedied by dividing the charge, prolonging the time of contact, or utilizing apparatus with alternating soaking and draining. Agitation of the product in the solvent cannot be envisaged, for there is used at most only enough solvent to soak the product.

With regard to the various methods of construction of the extractors and the techniques for the conduct of the extraction, for the purpose of enhancing the contact with the solvent, one should consider the degree of pulverization of the product. The pulverization should be sufficiently homogeneous, without having sections that are too finely ground, and which would compress, and cause the formation of plugs preventing the circulation of the solvent.

Vetivert roots are cut in a chaff-cutter into pieces one to two centimeters in length. The yield is not substantially increased by treatment of the roots with a pounding machine or a blow-disc machine. On the other hand, the tubercles and the rhizomes (orris, costus, etc.) are usefully treated in such apparatus by pressure and then pulverization. Seeds, fruits and cloves are treated by simple crushing.

Woods and ligneous roots are first reduced to pieces by a planing machine, and these pieces are either extracted directly or first treated; this treatment can be in musket pulverizers, pounding machines, or blow-disc machines.

For the crushing of seeds, fruits or clove buds, one should use disc machines or toothed cylinders; in general there need be hardly any fear of adherence of the products to the surface of the crushing machine. The disc machine includes two channelled discs, one mobile and the other stationary. The toothed cylindrical apparatus is more

frequently employed for treating tonka beans or for preparing vanilla pods for finer pulverization, although cutting the vanilla pods in a sort of chaff-cutter is preferable. Pulverization in a mill-stone should be avoided, because of the heating of the products.

The disintegrators are very useful. They include an interior envelope in which revolve one or more discs furnished with stationary bearings or joined hammers. The material introduced is beaten with great speed, and pulverized and projected across a sieve which covers the outlet of the apparatus. This type of apparatus is supplied with small cutting bars when fibrous material, such as wood, is treated.

Rather than precipitate the product in a narrow-spaced grill, it is preferable to send it through a sieve, and return the material that is too large to a pulverizer, the finer product being collected through cyclones or filtering bags. As the appearance of the crushed material is of little import, other than for easy penetration by the solvent, sheet iron with elongated perforations, arranged in shelves, or veil sheets with a rectangular mesh are used for pulverization by disintegration, instead of sheet-iron sieves with round holes, which reject too many of the larger particles produced by the shock-discs, and centrifugal hammer machines. To facilitate removal from the extraction apparatus, and to avoid obstructing the outlets, the crushed products are placed in jute or cotton sacks.

The Solvents. *General Conditions for Use.* The solvents must be inexpensive, and this involves not only their purchase price, but also the possibilities of their recovery and the cost of distillation. These latter conditions play a major role in the treatment of fresh vegetable matter, because large quantities of the solvent must be used to obtain a small quantity of extract.

The solvents must obviously dissolve the odorous material easily and rapidly, a matter involving cellular penetration and selectivity. They must be inert toward the perfume and the material out of which the apparatus is made, and in this connection one must consider not only the solvents, but also their impurities, and the substances produced by chemical alteration.

It would be most advantageous to use only non-inflammable solvents, those which give no explosive mixtures with air, and which are not toxic.

It is evident that the majority of these conditions are interdependent, and that there exists no solvent which meets all of them perfectly. In general, the choice of solvent rests on the consideration of several favorable factors of importance, and on the empirical approach. Furthermore, the recovery of the solvents must be perfected, research on inert material

of apparatus pursued, the most reactive impurities eliminated, and security in the face of incendiary and toxic dangers enhanced.

Logic and empiricism have placed the following in the front rank of solvents:

Petroleum ether
Benzene, and less frequently toluene
Methyl and ethyl alcohol
Acetone

For the extraction of perfumes, the following solvents are almost never used:

Chlorinated solvents, derivatives of methane,
ethane or ethylene
Ethyl ether

and even more rarely:

Propyl and butyl alcohols
Isopropyl ether
Methylal (formaldehyde dimethyl acetal).

Chlorinated solvents have the great advantages of being relatively inexpensive and of being non-inflammable. But their complete purification is indispensable for the treatment of perfumes; and in the face of the weak yields of extracted products, this is difficult and costly. In contact with water, they liberate hydrochloric acid, which attacks the apparatus. They dissolve in the water, in the form of chlorohydrates, the bases which frequently exist in the perfumes in only the weakest proportion, but which play a very important role from the point of view of the odor of the material. The extracted products always contain very small quantities of organic chlorinated substances whose injurious influence on the olfactory stability and the coloration of the perfume is well known. Furthermore, the metallic chlorides which are produced by the attack on the apparatus are carried into the solvents and left in the concentrated residues, and have a notorious influence on the rancidification of the perfume and on other methods of alteration of the extracted product. In a word, these solvents are hardly ever employed, except for the manufacture of flavoring aromatic extracts, such as from the vanilla pods.

Ethyl ether is costly, its recovery is difficult, it is very inflammable and very toxic. It peroxidizes easily in the air, and the presence of

these peroxides renders its distillation dangerous. It is too general a solvent, insufficiently selective. For all these reasons, its use for the extraction of perfumes has by now been almost entirely abandoned.

The propyl and butyl alcohols, isopropyl ether and methylal are products which have appeared only in recent years on an industrial scale. Their use has not been sufficiently studied to warrant any general remarks. It must be recorded, however, that it is most difficult for the perfume raw material industry to launch new products, because of the difficulties and costs involved in the creation of new and important outlets within a short enough period of time for the rapid amortization of the costs of initiating the manufacture. The use of new solvents generally furnishes extracts different from the traditional ones, particularly because of the selective solubilities occurring in the complex mixtures of the odorous constituents.

Perhaps methylal could replace acetone without involving any great modifications in the odoriferous note of the extracts. Its use, cited quite some time ago,⁴ was patented in 1928.⁵

We are therefore going to confine ourselves to the study of the usual solvents, and to their employment. We shall examine successively:

- (a) their dissolving power
- (b) their purification
- (c) their distillation and regeneration
- (d) the necessary protection against fire, explosion and poisoning.

We shall treat this last matter quite summarily, as the data are not very specific for the industry with which we are here concerned.

Solvent Power. Only petroleum ether, benzene and toluene are employed in the treatment of fresh vegetable matter, of the juices from the expression of fruits, and of distilled waters. Alcohol and acetone can be added to them for the treatment of desiccated raw materials, but these solvents become enriched in water during the course of the extraction.

The varying solvent powers of these substances are used to advantage in the concentration of the perfume, by the successive utilization of two solvents. Thus the treatment with alcohol of the products already extracted by means of petroleum ether or benzene give the absolute essences, or absolutes.

The chemical action of the solvent is not always undesirable. Partly as a result of such action, alcoholic tinctures or infusions are improved

by aging. As a result of the alcoholysis of the depsides in lichens, in making an alcoholic extraction of these plants, some valuable products are obtained. Certain alcoholizable products being rather insoluble in benzene, a mixture of benzene and of alcohol can be used in the extraction, in preference to the treatment of the benzene-extracted product with alcohol. Or, when the price of alcohol permits, the alcoholic extract is treated with benzene.

The solubilities of the different vegetable elements vary considerably. These solubilities are not appreciably modified by the presence of other categories of constituents for, as we have already said, the extraction of perfumes is carried out in great dilution. On the other hand, certain mutual influences must be taken into account; for instance, in the purification processes, which call into play the recovery of the perfume by a small quantity of a second solvent, as in the preparation of the absolutes.

Solvent Power

Legend: +, very easily soluble; °, soluble only with heat;
 —, difficultly soluble or insoluble; ± rather soluble;
 ", soluble in the solvent diluted with water.

Constituents	Petroleum Ether	Benzene and toluene	Ethyl Alcohol	Acetone	Ether
Paraffins	+	+	—	—	+
Sugars	—	—	"	"	—
Heterosides	—	—	"	"	—
Saponins	—	—	°	—	—
Natural dyestuffs	—	—	°	+	°
Fatty acids	+	+	°	+	+
Glycerides	+	+	°	±	+
Waxes	±	+	°	±	+
Etholides	—	+	°	+	°
Sterols	+	+	°	+	+
Carotenoids	+	+	+*	+	+
Chlorophylls	—	+	+	+	+
Alkaloids	+	+	+°	+	+
Oxygenated terpene derivatives	+	+	+	+	+
Aromatic (benzenoid) odorous materials	±	+	+	+	+

* The oxygenated carotenoids only.

Let us emphasize the solubility of the paraffinic elements in petroleum ether, benzene and toluene, and the rather poor solubility of the etholides, the lactones, depsides, sterols and chlorophyll derivatives in

petroleum ether. This explains why the extracts obtained by means of benzene are generally darker in color and poorer in odorous substances than the petroleum ether extracts. The use of petroleum ether would seem to be preferable, except when plants containing coumarins or depsides (lavender, lavandin, hays, tonka beans, oakmoss) are concerned.

By the use of alcohol or acetone, the paraffins, the glycerides (particularly the glycerides of saturated fatty acids), and the cerides—all substances which are hardly soluble in acetone, particularly when cold—can be eliminated.

Purification and Analysis of Solvents: PETROLEUM ETHER.

The petroleum ether used for the extraction of perfumes is the fraction of the saturated hydrocarbons from petroleum which distills almost in its entirety between 60 and 80°. The small fraction of the industrial product which distills before 60° is negligible, and its loss in recovery is therefore greatly exaggerated. The fraction remaining undistilled at 85° should be very small and absolutely odorless. In general, 80 per cent of the product distills between 60 and 75°, these points of distillation being determined by means of the standard Engler flask (Standards of the ASTM, D.86-30).

This petroleum ether is made up for the most part of *n*-hexane, diisopropylmethane (2,4-dimethylpentane) and dimethylpropylmethane (2-methylpentane). Its specific gravity varies between 0.682 and 0.701 (at 15°/4°) and its refractive index n_D^{20} between 1.3826 and 1.3920, the heaviest ethers being the most refractive.

The sulfuric heat (Maumené test) is generally lower than 2.7°; the elimination of the ethylenic hydrocarbons is therefore quite complete. The presence of such products is undesirable because they are very easily susceptible to auto-oxidation and polymerization (gummage), causing very profound alterations in the quality of the extracted products. The special refineries give excellent products for the perfume industry.

In addition to the determination of the physical characteristics cited above, the following tests can be made:

One cc of petroleum ether is mixed with 1 cc of concentrated sulfuric acid. The acid should not become appreciably colored.

Five cc of petroleum ether are added to 2 cc of ammoniacal silver nitrate solution, and the mixture is heated to 50° in a five-minute period. It is protected from light, and no yellow or brown coloration should be observed.

Two cc of petroleum ether are treated with 2 cc of a solution of mercuric acetate. No precipitate should appear.

The petroleum ether should be neutral; 2 cc agitated with 2 cc of water should not cause the water to show an acid reaction with litmus paper.

The odor of the petroleum ether should be clear-cut and fugitive. This is not always the case, and if the odor quality is deficient, the petroleum ether can be corrected by distillation over 5 to 10 per cent of paraffin or of a neutral Vaseline oil.

BENZENE. The benzene utilized for this purpose is the commercial quality, known as the crystallizable. It should distill between 80 and 81.5°, be free from thiophene and diolefinic hydrocarbons. Frequently the benzene contains a small amount of cyclopentadiene and cyclohexadiene, both inseparable by the usual industrial methods of rectification; but the majority of the processes for the removal of the thiophene bring about polymerization of these dienes.

To test for the absence of thiophene, 10 cc of benzene are agitated with 1 cc of concentrated sulfuric acid. To the separated acid layer, there is added 1 cc of sulfuric isatin solution, obtained by dissolving 0.4 gm of isatin in 100 cc of concentrated sulfuric acid. The mixture is agitated, then allowed to rest. The presence of traces of thiophene is betrayed by a yellow-greenish coloration, and the solvent is not usable. The sensitivity of the reaction approaches 0.04 mg of thiophene.

TOLUENE. The toluene used in the industry should distill between 109 and 111°. It should be free from homologs of thiophene. The same test as used for thiophene is applicable for its homologs.

METHYL ALCOHOL. The methanol used today is a synthetic substance. It should be neutral, free from reducing substances, from alcoholic homologs, from empyreumatic impurities, and from the salts of heavy metals.

It should distill between 64 and 65°. By the alkaline liquor and the phenolphthalein tests, its acidity, calculated as formic acid, should be less than 0.01 per cent. In addition, the same test methods for impurities as are used in the analysis of ethyl alcohol are employed for methyl alcohol.

ETHYL ALCOHOL. The ethyl alcohol should not be denatured, and should possess a very neutral odor. In France, either a well-rectified grain alcohol, or a synthetic alcohol is used; no other is acceptable from the olfactory point of view. The alcohol analyzes 95 to 96 per cent. It should distill between 77 and 78.5°, and be free from acid products,

reducing substances, empyreumatic substances, alcoholic homologs, and salts of heavy metals. Its purity is controlled by means of the following reactions:

Test for the Presence of Methyl Alcohol. In a ground-stoppered tube, 0.2 cc of alcohol and 0.4 cc of water are agitated; then 5 cc of a 1.5 per cent potassium permanganate solution and 0.2 cc of concentrated sulfuric acid are added. The mixture is agitated and allowed to stand two to three minutes. Then add, agitating after each addition, 1 cc of a 6.3 per cent oxalic acid solution, 1 cc of concentrated sulfuric acid, and 5 cc of a Schiff reagent. The mixture, after 30 minutes, should not show a bluish-violet nor a red coloration.

To prepare the Schiff reagent, 0.2 gm of fuchsine are dissolved in 140 cc of warm water, and then, after cooling, 5 gms of crystallized sodium sulfite, 3 cc of concentrated hydrochloric acid and sufficient water to make 200 cc, are added. After two hours, the mixture is filtered. The reagent is kept in well-stoppered bottles, protected from the light.

Test for Reducing Agents. Mix 5 cc of alcohol and 1 drop of a 1.5 per cent potassium permanganate solution, and keep the mixture at 20° for 10 minutes. The mixture should remain a clear violet-red color.

Test for Acetone. Mix 1 cc of alcohol and 9 cc of water, 0.01 gm of finely powdered vanillin, and 1.5 gms of potassium, then heat for 15 to 20 minutes to 70 or 75° in a water bath, without agitating. The surface of the potassium can be slightly yellowish, but should not turn red or orange-red.

Test for Furfurol. Mix 10 cc of alcohol, 1 cc of crystallizable acetic acid, and 0.5 cc of freshly distilled aniline. The mixture should not produce a red coloration while standing for 5 minutes after it has been prepared.

Test for Heavy Metals. Two cc of alcohol and 1 cc of water are mixed, and 3 drops of 10 per cent acetic acid and 3 drops of a 12 per cent sodium sulfide solution (in a mixture of 25 per cent water and 75 per cent glycerin) are added. At the most, a slight opalescence, due to the presence of colloidal sulfur, is permissible. The addition of ammonia until an alkaline reaction is produced should not cause an accentuation of the opalescence or a formation of a precipitate.

Measurement of Acidity. Fifty cc of the alcohol should require

at the most 0.25 cc of a *N*/10 alkaline solution for neutralization in the presence of phenolphthalein.

Test for Fixed Substances. Fifty cc evaporated on a water bath should leave no residue which can be detected on a balance or by its odor.

ACETONE. The acetone utilized in the industry is generally produced synthetically, and analyzes 99 per cent. It should distill between 55 and 56.5°, and should meet the following tests:

Mix 1 cc of acetone with 1 cc of water; the mixture should be neutral to litmus paper.

Mix 5 cc of acetone with 1 drop of a 1.5 per cent potassium permanganate solution; the mixture should remain rose-colored after 15 minutes.

Test for Reducing Agents. Mix 5 cc of acetone with 3 cc of water and 2 cc of ammoniacal silver nitrate solution. Heat over a water bath for 15 minutes at 50°, protected from direct light. The mixture should not form a brown or yellow color.

The silver reagent is prepared as follows: Dilute ammonia is added, drop by drop, to a decinormal solution of silver nitrate until the originally formed precipitate is dissolved.

Fifty cc of acetone, evaporated over a water bath, should leave no measurable residue.

Distillation and Recovery of the Solvents. The cost of the distillation and of the recovered solvent depends on the intrinsic properties of the solvent, notably on its specific heat, on its latent heat of vaporization, and on the modality of vaporization.

In order to reduce as much as possible the utilization of heat, which is detrimental to the quality of the perfume, the major part of the solvents is distilled under reduced pressure. The choice of the pressure of distillation depends entirely on the modality of vaporization of the solvent, on the temperature of the condenser and its activity, and on the possibility of recovering the uncondensed substances.

In examining the accompanying table, the thermal advantage of the use of hydrocarbon solvents is seen to be considerable in comparison to the use of alcohols.

On the accompanying graph, the curves show the vapor tensions as a function of the temperature. They are based on the results of

Properties of Common Solvents

	Benzene	Toluene	Methanol	Ethanol	Acetone
d_{20}^4	0.878	0.866	0.793	0.791	0.793
B.P. (760 mm)	80-81.5°	110-111°	65.5°	78.5°	56.5°
n_D^{20}	1.5014	1.4962	1.3290	1.3610	1.3591
Dilution coefficient from 10 to 30°	0.00124	0.00107	0.00118	0.00108	0.00134
Vapor pressure at 30°	118 mm	26 mm	160 mm	78 mm	277 mm
Sol. in 100 g. water at 20°	negligible	negligible	—	—	—
Sol. of water in 100 g. of solvent at 20°	0.19	0.065	—	—	—
Ignition point	inf.-15°	6.5°	11°	18.5°	17.7°

Note: Constants covering methanol, ethanol and acetone refer to the anhydrous materials. For more general information, see T. H. Durrans, "Solvents," New York, 1933; O. Jordan, "Chemische Technologie der Lösungsmittel," Berlin, 1932; K. B. Lehmann and F. Fleury, "Technologie u. Hygiene der technischen Lösungsmittel," Berlin, 1938.

Regnault, except in the case of *n*-hexane, which was studied by Y. R. Naves. These curves show that, with the usual waters of refrigeration, at 13 to 14°, the solvents can be classed as follows, according to the difficulty of their condensation: acetone, hexane, methanol, benzene, ethanol.

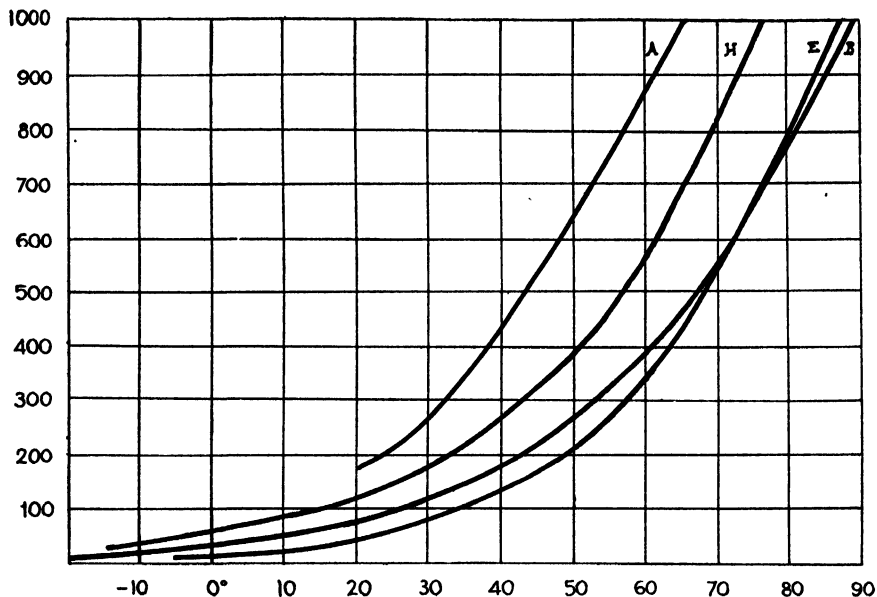

FIGURE 6. Vapor tension curves for acetone (A), ethanol (E), hexane (H), and benzene (B).

The thermal constants (specific heat and latent heat of vaporization) are taken from the literature, and are as follows:

Solvents	Specific Heat	Temp. (° C)	Latent Heat of Vaporization	Temp. (° C)
Petroleum ether	0.500 to 0.520	20 to 70	Approx. 90.0	70
Benzene	0.340	10	92.9	80
	0.423	40		
	0.482	65		
Toluene	0.364	10	86.0	111
	0.490	65		
	0.534	85		
Methanol	0.590	0 to 10	267.0	64.5
	0.601	15 to 20	289.0	0
Ethanol	0.548	0	205.0	78.1
	0.648	40		

The reduction of the heat employed is one of the essential conditions for the good quality of extracted products, an observation that has often been expressed in this form: The quality of the perfume is in inverse ratio to the number of calories necessary for its extraction. Later, in the study of extraction and concentration processes, we will see what artifices are used to minimize the action of heat on perfumes, independently of the characteristics of the solvent itself.

The recovery of the uncondensed solvent by the use of a refrigerant is a necessity in contemporary extraction installations. The industrial processes, the practical details of which we will describe presently, can be divided into three categories:

- (1) Compression and refrigeration processes.
- (2) Washing and dissolving processes.
- (3) Processes of adsorption on porous bodies.

Recovery by compression is effectuated at the outlet of the pump that maintains the necessary pressure in the concentrator. This pump evacuates, either at atmospheric pressure or, in the more perfected installations, at a higher pressure. Assuming that the gaseous mixture which is at the base of the refrigerant, in contact with the condensed liquid, is drawn out and compressed at twenty times its initial pressure, the temperature remaining constant due to a satisfactory refrigerant, then 19/20ths of the solvent will be condensed. If the extracted gaseous mixture increases in volume with a production of work, it cools itself and a new condensation is obtained. On these principles are based the recovery installations which work by a vacuum compressor pump, and then expand, the work of expansion being recovered. This is a utilization of the well-known principle of Claude and Norton for the liquefaction of gases.

Recovery by washing in contact with heavy oils is applied to benzene and to petroleum ether. Substances used include glycol, glycerin or water, for the recovery of alcohol. But this process is less frequently used than recovery based on porous adsorbents. However, an economic application of this method consists in combining the production of the vacuum and the recovery of the solvent, by the use of condenser-pumps, consisting of a tube in which the vector liquid is carried into a closed circuit by a pump. The liquid is separated periodically, and regenerated by distillation, which separates the dissolved solvent.

Recovery by adsorption is based upon a relationship between the partial vapor pressure and the quantity of vapor adsorbed. Freundlich expressed this as follows:

$$W = a \times P^{\frac{1}{n}}$$

and Patrick empirically established that the following modified equation more closely corresponds to the facts:

$$W = k \left[\frac{p^\sigma}{P} \right]^{\frac{1}{n}}$$

where: W is the volume of condensed vapor, measured in the liquid state, and related to the unity of weight of the adsorbing agent;

p is the partial vapor pressure in equilibrium with the adsorbent;

P is the vapor pressure of the liquid;

σ is the surface tension of the liquid;

(the last three constants are expressed at the same temperature)

k and n are constants which depend on the physical properties of the adsorbent;

n is of value only for adsorption due to capillary condensation.

It has been established that for mixtures of vapors and air, the Patrick equation is sufficiently exact for industrial application. The presence of air has no practical effect on the proportion of vapor adsorbed, but the speed of adsorption is weaker.

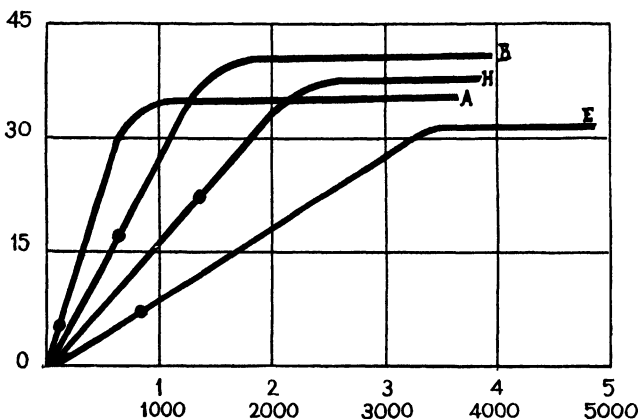

FIGURE 7. Diagram of adsorption for a granulated activated carbon of $d: 470 \pm 10$, this dry carbon being in a layer of 10 cm., in contact with dry air charged with solvent at 8 to 9 per cent of the saturating pressure, and traveling at the speed of 500 meters an hour. The ordinates represent grams of solvent retained for 100 gs. of dry virgin carbon, rupture at 85% of saturation. The abscissae represent the duration of the adsorption in hours and liters of dry vitiated air passed through 100 gs. of carbon. A, acetone; E, ethanol; H, heptane; B, benzene.

The adsorbed solvent is recovered, being carried over by means of a gas or steam. Under industrial conditions, which we shall describe in detail later, recovery can reach 90 per cent of the solvent expelled

by vacuum pumps, whereas in practice it does not surpass 45 to 55 per cent by compression and expansion, and 70 per cent by washing.

For further details, the following works should be consulted:

F. Krczil, "Untersuchung und Bewertung Technischer Adsorptionsstoffe," Leipzig, 1931, Chapt. III E: *Adsorptionsstoffe zur Wiedergewinnung flüchtiger Lösungsmittel*.

E. Schwartz, "Wie setzen wir die Verluste an flüchtigen Lösungsmitteln herab?" Berlin, 1934.

C. S. Robinson, "The Recovery of Volatile Solvents," New York.

L. Patti, "Die Wiedergewinnung flüchtiger Lösungsmittel," Berlin, 1932.

Danger of Fire, Explosion and Poisoning. The dangers of fire in the use of these solvents are of an ordinary industrial nature, and the usual precautions are taken to reduce them in the majority of cases, except those involving inflammability due to the accumulation of static electrical charges.

Whereas carbon disulfide, almost completely discarded by the perfume extraction industry, presents an extreme danger, since the eutectic mixture of air with the vapor of CS_2 ignites upon contact with steam, the solvents actually used industrially do not spontaneously burn at the usual temperatures. The fields of explosion of the mixtures of the vapors of benzene and air, and of petroleum ether and air, are respectively considered to lie between 2 and 6 per cent, and 2.5 and 4.8 per cent; it therefore suffices to remove the causes of ignition: flames, incandescent filaments and sparks.

In the conception and the construction of apparatus in which anhydrous hydrocarbon solvents circulate, the dangers of fire due to static electricity, to the friction of the liquids in pipes or on the inner walls of the vessels, or to free drainage, have been overlooked. The liquids generally carry a negative charge, the apparatus a positive one and the potentials can reach and sometimes exceed 1,000 volts. To minimize these dangers, there must be a reduction in the speed of the flow of solvents, as well as reduction of the speeds of distillation and of the lengths of canalizations, increase in the diameter of the pipes, avoiding of clogged passages, and of clamps and sluices that are not strictly indispensable. The entire apparatus should rest on the earth, and the resistance of the stakes to the earth, measured by an earthohmmeter, should not surpass a few score ohms. We emphasize these points only because this danger is not well understood by the majority of technicians in the perfume extraction industry, nor has the actual toxicity of benzene and toluene been realized. One of the authors can speak of the results of chronic benzene poisoning from his personal experience.

Benzene has been the cause of numerous accidents, many of them fatal. The first symptoms of poisoning are dizziness, headaches, visual difficulties and nausea. Later appear blood changes, calcium metabolism trouble, and the presence of hematin in the urine. According to Smyth,⁶ the phenomena of acute poisoning are the extravasation of blood into the lungs and later hepatic and renal degeneration. Blood trouble is manifested quite some time after poisoning,^{7, 8} and shows itself by periodic variations, often drastic, of the number of leucocytes. A sudden fatal poisoning shows itself by a ventricular fibrillation, due to a discharge of adrenalin and to the sensitivity of the myocardium.

To prevent poisoning, the most important thing is the reduction of the contact of the solvents with the atmosphere in the workrooms (1) by operating in closed systems; (2) by rendering as perfect as possible a recovery of the solvents retained by the exhausted raw materials; (3) by dilution of the gases evacuated from the vacuum pumps and the recovery apparatus, eliminating them in the open air, as far away as possible; (4) by excellent ventilation of the shops, particularly in the neighborhood of soil; and (5) by a frequent change of personnel employed in these shops, through rotation with the workers in other activities.

Extraction. *Preparation of Tinctures and Infusions.* The preparation of tinctures and infusions is accomplished by simple processes, and is applicable to dry plant material as well as to products of animal origin. These products constitute excellent forms for the manufacture of perfumery extracts. As a matter of fact, the concentration of the solutions is accompanied by a loss in perfume. The preparation of tinctures and infusions is generally practiced on a small scale by the consumer, but it can be related to the manufacture of alcoholic resinoids.

At any rate, the difficulty of procuring small quantities of raw materials of good quality and of known purity has inspired an important part of the smaller consumers either to purchase tinctures and infusions from the large producers of raw materials, or even more frequently to make these tinctures and infusions by dissolving the resinoids in alcohol.

The principal tinctures and infusions made are those from ambergris, castoreum, civet and musk, and balsam Peru, balsam tolu, styrax, opopanax, benzoin, tonka bean, vanilla pod, labdanum, orris, patchouli and oakmoss. Some of these products are partially concentrated, while others undergo a natural or accelerated aging.

The tinctures are prepared by maceration, percolation, or as stated above, by dissolving the extracts. The usual concentrations are given in the following table:

Percentage of Raw Material Used, Based on the Finished Product

Material	Per Cent
Ambergris, musk, civet and castoreum	2
Labdanum, myrrh and opopanax	12.50
Ambrette, balsam Peru, styrax, balsam tolu, benzoin, elemi, tonka bean, oakmoss, vanilla	25
Orris	50

For maceration, a closed receptacle is used; it can be made of glazed sandstone, porcelain, or dark-colored glass; the material is well divided, and is placed in the receptacle with part of the alcohol and agitated frequently; then it is filtered and the residue expressed. The same procedure is repeated at least twice on the residue, and the filtrates united. The united filtrate is allowed to stand at a cool temperature and shaded from direct light; it is then filtered again, and sufficient solvent added to make the desired volume.

Percolation is a continuous extraction, utilizing the force of gravitation. The material to be extracted is placed in a filtering bag or in a receptacle with a porous bottom; it is moistened with alcohol and the extract allowed to run slowly to the base, constantly feeding an equal quantity of fresh alcohol. Treatment in the well-known Soxhlet apparatus or in similar equipment exposes the tincture to prolonged heat, for which reason it acquires characteristics different from those of tinctures produced in the other ways which we have already described.

The infusions are generally prepared in the same concentration as the tinctures. In the treatment of aromatic raw materials, infusion is frequently confused with digestion and maceration. *Digestion* is generally carried out at 40 to 50°; *infusion* is an extraction made by refluxing in the presence of alcohol. In both cases, it is wise to treat several times, and to agitate. But in general, for infusion immediate filtration will suffice.

The aging of the alcoholic tinctures and infusions is often extolled. It is accompanied by certain modifications of the perfume, enhancing its qualities, making it more homogeneous, more mellow. These phenomena can be related to the processes of alcoholysis, hydrolysis, esterification and acetalysation,⁹ and the bottles which contain the tinctures and infusions in dilute alcohol must be protected from the light, because of the photolysis of the glucosides, particularly in the case of orris.

There have been many attempts to improve the quality of the tinctures more rapidly, but without any marked success. The systems that have been used include alternate heat and cold, ultraviolet radiation, the "catadynic" action of silver or silver sulfate, etc. The absence of

any generally conclusive results justifies our dealing no further with these studies.

Manufacture of the Resinoids from Resins, Gum Resins, Balsams and Animal Products. In small-scale manufacture, and for the alcoholic extracts, one can group together the tinctures and infusions obtained in the manner just described. On a more important scale, one places the manufacture of resinoids, consisting of extraction at 40 to 50°, or at the boiling point, with alcohol, acetone, benzene, and sometimes petroleum ether. When, very rarely, this treatment is carried out without heat, movable mixing apparatus is employed, as it is also in the manufacture of absolutes; or apparatus of the classic type is used, with a double base heated with steam, an agitator, and reflux refrigerant.

In the case of civet, rich in low-melting lipoids, the process of preparation of alcoholic and acetone extractions is similar to the methods employed in the transformation of concretes into absolutes, details of which are found in the section dealing with this process.

In the other cases, the extraction is repeated once, and often twice. After a suitable cooling, the extract is separated by decantation. At the end, the exhausted material is either drained by filtration, or pressed. The united extracts are filtered and concentrated. The yields of extraction are generally high. Based on the usual quality of raw material, which frequently consists of products of only average appearance but having good odor, the yields can be estimated as follows:

Product	Origin	Solvent	Per Cent Yield
			Varying with Types
Benzoin	Tonkin, Laos, Siam, Sumatra	Alcohol	80-95
		Benzene	40-50
Galbanum	Persia, Turkestan	Alcohol	45-60
		Benzene	20-30
Myrrh	Somaliland, Arabia	Alcohol	25-30
		Benzene	50-74
Olibanum	Soudan, Abyssinia, Arabia	Benzene	50-74
Opopanax	Arabia, Persia	Benzene	15-25
		Alcohol	20-35
		Alcohol	60-75
Styrax	Asia Minor	Benzene	55-70
		Acetone	65-70
		Benzene	55-70
Tolu	Venezuela, Brazil	Benzene	55-70
		Alcohol	60-66
Ambergris	Atlantic and Indian Oceans, Australian coasts	Alcohol	80-90
Castoreum	Canada, Siberia	Benzene	20-25
		Alcohol	45-80
Civet	Abyssinia, Malaya	Acetone	55-75
		Alcohol	45-65
Musk	China (Tibet, Yunan)	Alcohol	10-12

On the other hand, because of the low yields, different types of processes must be used for the treatment of fresh and dried vegetable matter.

Manufacture of Concretes and Resinoids.

As we have already noted, the treatment of these materials is characterized by the following factors:

First group: The materials must be treated in the fresh state, and rapidly.

Second group: The materials can be divided, and their treatment prolonged at leisure; it is carried out in the off-season of the treatment of the products in the first group.

The common trait—the poor yields—makes it necessary to have a completed extraction, with a minimum of solvent and a minimum of manipulation, so as to reduce the loss of solvent, the duration of heat of the products at the time of the concentration of the solutions, and the cost of the entire operation.

The yields are as follows:

Flowers	Origin	% Yield (Petroleum Ether)	
		Normal	Extreme Limits
<i>Acacia Cavenia</i>	Provence, Algeria	0.60 to 0.86	0.47 to 0.93
<i>Acacia farnesiana</i>	Provence, Algeria	0.50 to 0.70	0.30 to 0.82
<i>Boronia megastigma</i>	Australia	approx. 0.40	—
Broom	Provence	—	0.09 to 0.18
Carnation	Provence	0.23 to 0.29	0.23 to 0.33
Champac	Réunion	—	0.16 to 0.20
Everlasting	Provence	—	0.90 to 1.15
Gardenia	Réunion	—	0.04 to 0.05
Hyacinth	Provence, Holland	0.17 to 0.20	0.13 to 0.22
Jasmin	Provence, Algeria, Sicily, Calabria, Egypt	0.28 to 0.34	0.24 to 0.38
Jonquil	Provence	0.39 to 0.45	0.38 to 0.51
Lilac	Provence	—	0.60 to 0.95
Mimosa	Provence	—	0.70 to 0.88
Narcissus	Provence	0.24 to 0.28	0.21 to 0.45
Orange flower	Provence, Algeria	0.24 to 0.27	0.20 to 0.40
Robinia (False acacia)	Provence	—	0.15 to 0.20
Rose	Provence	0.24 to 0.265	0.17 to 0.27
Rose	Bulgaria	—	0.22 to 0.25
Tuberose	Provence	0.08 to 0.11	0.08 to 0.14
Violet (Parma)	Provence	0.09 to 0.13	0.09 to 0.17
Violet (Victoria)	Provence	0.07 to 0.10	0.07 to 0.20
Ylang ylang	Réunion, Comores	—	0.80 to 0.95

Herbs	Origin	Solvent	% Yield
Clary sage	Provence	Petroleum ether	0.60 to 0.80
Geranium	Provence	Benzene	0.20 to 0.25
Lavandin	Provence	Petroleum ether	1.40 to 2.50
Lavender	Provence	Petroleum ether	1.50 to 2.20
Mignonette	Provence	Petroleum ether	0.07 to 0.15 (0.26)
Verbena	Provence, Algeria	Petroleum ether	0.25 to 0.30
Drugs	Origin	Solvent	% Yield
Clove Bud	Netherland Indies, Madagascar, Comores, Zanzibar	Benzene	18 to 22
Oakmoss			
Mousse d'arbre*	Yugoslavia, Czechoslovakia, Italy, France	Petroleum ether	2.0 to 4.0
Mousse de chêne*	Yugoslavia, Czechoslovakia, Italy, France, Morocco	Petroleum ether	1.5 to 3.0
		Benzene	2.0 to 4.0
Orris rhizome	Provence, Tuscany		2.0 to 3.5
		Petroleum ether	1.0 to 1.9
Patchouli (leaves)	Netherland Indies, Malay	Benzene	4.5 to 5.8
Sandalwood	Mysore	Benzene	6.0 to 8.5
Tonka Bean	Venezuela, Brazil, Guiana	Benzene	20 to 30
Vanilla Bean	Tahiti, Comores, Réunion, Antilles, Mexico	Benzene	approx. 6.0
		Acetone	9.2 to 15.0
		Alcohol	10 to 12
Vetivert (roots)	Java, Réunion	Petroleum ether	3.0 to 5.5
Violet Leaf	Provence	Petroleum ether	0.05 to 0.13
Zdravets	Bulgaria	Petroleum ether	0.30 to 0.45

* See page 275 for botanical description of these two types of lichens, both of which are known in America under the name of *oakmoss*.

In all these cases, particularly in the treatment of the fresh materials, the extraction is carried out by the use of a large quantity of solvent as compared to the quantity of extract. It seems that, in the majority of cases, almost all the odorous materials pass into the solution at the time of the first extraction; but the quantity of solution retained by the materials subjected to the extraction is very high. Recovery of this perfume is therefore indispensable. This is done by successive dilutions with several charges of solvent (washings). But in general the practice of a third washing is not economically justified, and only on rare occasions are there more than three charges of solvent.

In the laboratory, one can use a percolator, or continuous solvent recovery equipment, such as the Soxhlet apparatus which works at a low temperature, or the apparatuses of Kumagawa and of Forster, which require heat.

An excellent improvement over the Soxhlet apparatus, permitting rigorous working at a low temperature, and under reduced pressure—

conditions that make its use interesting for the treatment of fragile products—has been described by A. Macheboeuf and N. Fethke.¹⁰

Industrially, in certain factories, apparatuses that closely copy the above-described equipment are used for the treatment of dried drugs. Such equipment can be of several types. In some, the solvent recovered by distillation streams through the refrigerant across the material to be extracted, and runs into the alembic in a continuous fashion; in others, the solvent vapor freely crosses the material of extraction, on which the condensed solvent runs down; in still others, there are successive macerations, as in the Soxhlet and Kumagawa apparatuses. The solvent recovered by distillation, which comes through the extractor, is periodically siphoned and returned to the still. In this case, an intermediary reservoir is installed between the extractor and the still; this reservoir periodically feeds the still, making it possible to avoid severe modifications of the conditions of distillation. Such apparatus can function under reduced pressure. An industrial apparatus somewhat related to that of Kumagawa was patented some half century ago by J. Merz for the extraction of fats and oleaginous fruits.¹¹

To extract the perfume from fresh vegetable matter, extractors are generally used that are not connected with the distillation apparatus. As a matter of fact, the separation of the water carried over and of the various impurities, before the concentration, is indispensable, and this separation frequently requires a considerable length of time. This concentration of the extracts which contain very volatile odorous products must be conducted prudently and rationally. Finally, this type of apparatus lends itself to the reduction of the quantities of solvent necessary to be distilled, thanks to the methodic circulation of the solvent in the extractors grouped together in a "batterie."

The extractors currently in use can be classed in two categories:

(1) The apparatus in which the materials of extraction are motionless and submerged in the solvent. These are called "static" or "stationary" extractors.

(2) The apparatus in which the materials of extraction are in motion and periodically become soaked in a quantity of the solvent proportionally much smaller than that used in the stationary apparatus. This is called a "mobile apparatus."

The first industrial equipment was of the static type, and resembled the machinery used a long time before in the pharmaceutical extract industry. Massignon used an apparatus of this type.

The first mobile equipment, the extractor of Ch. Garnier, appeared in 1902. At about the same time, the fatty corps industry created its first rotating extractors; the first patent seems to have been the one of

Ed. Bataille date 1904. It was about this time that O. Wilhem of Stralsund was using a horizontal rotating apparatus, to treat fish and stumps of resinous trees.

Stationary Apparatus. The stationary apparatus has the advantage of being very simple in construction. The extraction proceeds well if the material is distributed in such a manner as to enable the solvent to circulate freely. It is essential to avoid a piling up of the material.

This equipment usually consists of a cylindrical envelope, at the ends of which are two spherical valve-caps, the cylinder being placed vertically.

At the upper part is a lid, movable at the joint, and held in equilibrium by a counterweight. The lid is closed on a plastic joint (asbestos braid) by means of bolts put together on joints and furnished with eared-screws, or by means of vise-presses.

The material to be extracted is placed in a removable cylindrical basket, made of perforated sheet-iron, with an interspersed crown. In the center of the lower tray there is a column, erected in the usual manner, on which the intermediary trays are placed. At the top of the column, there is a ring or hook by means of which the entire contents of the extractor can be discharged by a simple leverage.

The solvent is injected at the bottom, to avoid compression which would result from its introduction at the top.

These extractors are grouped into *batteries*. The solution is enriched in extract by a methodical circulation in several extractors grouped together and having contact with one another. The virgin solvent arrives at the first extractor, where it is discharged, and the liquid containing the extract and ready for concentration leaves the last extractor to be charged. If the extraction has to be stopped, the incompletely used washings are placed in the intermediary receptacles, which can be the non-charged extractors.

The number of extractors in one *batterie* depends on the number of passages of the solvent on one charge, and the length of time for the recovery of the solvent retained by the raw material, for the discharging and the recharging processes. In general, for three extractions totaling 60 minutes, a *batterie* of 9 extractors should be used.

The most commonly used extractors have a capacity of 500 to 1200 liters. In a 1,000-liter extractor, the following amounts of plant material can be placed:

Jasmin flower	140 kilograms
Rose de mai (May rose)	150
Orange flower	230

Lavender	300
Oakmoss	60

The drainings, generally numbering three, last for 30, 20 and 10 minutes, the difference in time being accounted for by the dripping. About three hours are necessary to complete one extraction. However, for oakmoss, this period of time is surpassed, the duration for cold extraction being 9, 6 and 3 hours, while for warm extraction the duration is uniform, one hour each.

Mobile Apparatus. The mobile equipment used in the perfume industry is called a *roue* or wheel, because of its structure. There are two models, the Garnier *roue*, dating back to 1902, and the Bondon *roue*, which appeared in 1929, and which is a perfection of the first.*

Both types of apparatus are comprised essentially of an air-tight mangle, more or less cylindrical, and constructed on one side of a cylinder. In the interior there is a cylindrical machine, moving around an axis, and forming a cage. In the Garnier *roue*, this cage supports, in its interior and all around it, cylindrical removable trays which receive the raw material for extraction. In the Bondon *roue*, the cage directly contains the materials, thanks to a metallic veil or perforated sheet-iron covering.

The mangle of the Garnier apparatus has a circular opening, which closes on a movable plug around a clamp. This opening is constructed in such a way that by the rotation of the mobile section of the equipment, the trays are successively put in place or removed.

The mangle of the Bondon apparatus has two openings opposite which the corresponding openings of the tray are placed. The opening for the charging is generally placed on the higher level of the mangle; that for discharging on the lower level of one of the bases of the cylinder.

The distribution of the charge of the Bondon extractor is maintained by hooks placed in the manner of baffle plates on regularly spaced generators. Despite this artifice, some of the material does pile up, making the

* In 1923, Charles Garnier (French Patent No. 585,199) patented a new type of equipment in which the trays were omitted. There is a movable mangle around a horizontal axis, in which the flowers are directly enclosed; these flowers are divided into 4 separate compartments by perforated sheet-iron, each containing an opening for charging and discharging.

This apparatus has several inconvenient features, the most important of which is the difficulty of charging, and even more of discharging.

Despite the greater mechanical complication, the Bondon extractor presents a better solution. Today there are seldom seen any mobile extractors other than the Garnier "tray type," found in a large number of the old factories, and the Bondon *roues*.

entire operation troublesome and causing deterioration of the flowers; for example, it gives the odor of foliage to the jasmín products, which are thus less highly valued.

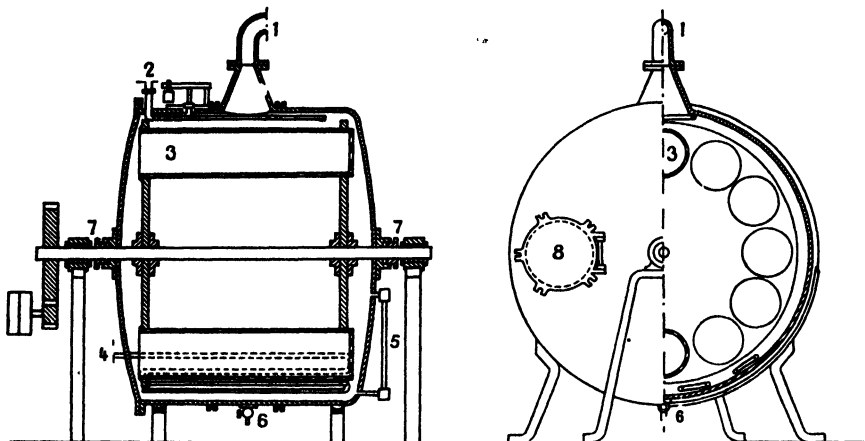

FIGURE 8. A schematic division of the Garnier-type tray-extractor. 1, goose neck; 2, solvent feed-valve; 3, removable tray; 4, worm condenser; 5, liquid-level gauge; 6, drain valve; 7, pressure bearing; 8, manhole cover, for the loading and unloading of trays.

The models currently in use have a capacity of 3 cubic meters, and external dimensions of 2.120×1.300 meters. The Garnier extractor of this size consists of 12 trays, but larger ones have been made, containing 24 trays, and smaller ones, having from 6 to 8 trays. The trays are of uniform size. On each tray there is loaded:

Jasmin flower	30 kg
Rose de mai (May rose)	32 kg
Orange flower	45 to 50 kg
Oakmoss	13 to 15 kg
Lavender	60 to 65 kg

The *Bondon roue* of the above-mentioned dimensions can accommodate a load about twice that of the 12-tray Garnier equipment. The first charge of solvent consists of about 800 liters for the Garnier apparatus, about 600 for the Bondon, the latter containing more material for extraction. Two or three drainages suffice under current conditions.

The movement of the *roue* is maintained by a low-powered motor having a transmission belt and endless screw reaching an axis cogwheel. For certain products that are difficult to extract, such as acacia flowers,

the movement is conducted by hand, as slowly as desired, in a pendulum motion if necessary.

The mangle of these machines has pipes for the inflow and outlet of the solvent, for the inflow of vapor, and a goose-neck linked to a con-

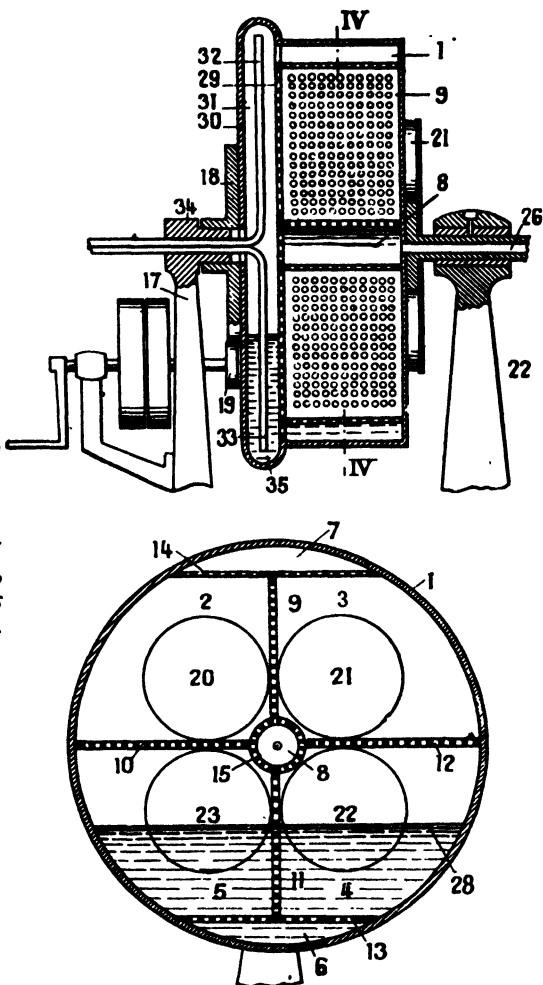

FIGURE 9. *Extractor of the Garnier-type, French Patent 585,199 (1923).* 1, rotary drum; 2 to 8, compartments; 9 to 15 and 29, perforations; 16, rotary axis; 17, stationary bearing supporting column; 18, 19, transmission gears; 20 to 23, manhole covers for charging and discharging of corresponding compartments (2 to 5); 32, 33, stationary pipes; 32, gas entrainment tube; 33, siphon; 26, steam inlet.

denser destined for the recovery of the solvent retained by the plant material. It is crossed by the junctions of a coil which serves for heating the charged solvent to its vapor state, if required.

It is only in the fat and oil extraction industry that a system of heating the rotating apparatus by a circulating vapor in a double envelope has

been adopted; examples can be found in the equipment of C. Schlotterhose, Börsig, Hoffmann, Wilhem and Lamy-Torrilhon.

Forced draining apparatus. There have been efforts to render the extraction more efficient by reducing the amount of solvent retained by the plant material. One such effort consisted in equipping each tray of the

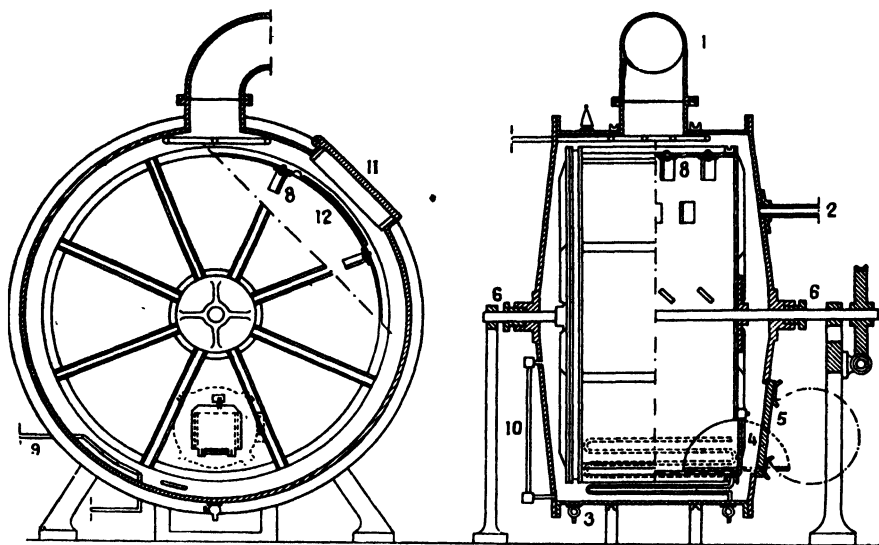
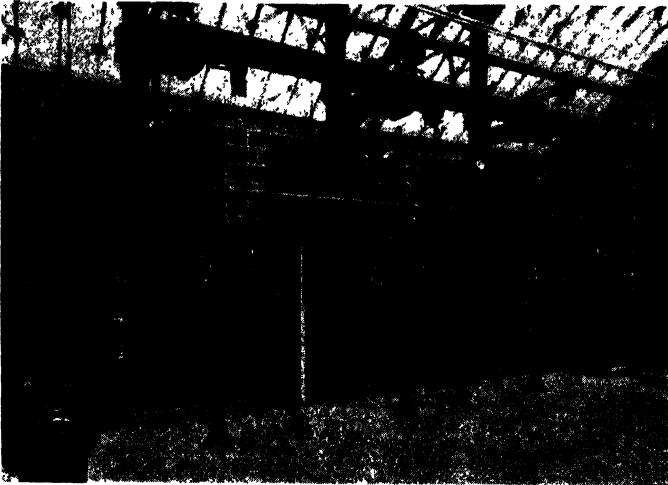

FIGURE 10. A schematic division of the Bondon-type extractor. 1, goose neck, attached to condenser; 2, solvent entry; 3, drain valve; 4, opening for discharging; 5, movable trap door; 6, pressure bearing; 8, clamps for anchoring partitions; 9, coil condenser; 10, liquid-level gauge; 11, 12, manhole covers for charging.

Garnier *roue* with a movable piston, all the pistons being manipulated from the exterior. But this system has been abandoned, as costly, complicated, long and difficult to maneuver.

It seems that, in this respect, it is better to make an effort to render more practical two models, the filter-press and the drying-machine. Efforts have been made to construct apparatus applying the principle of the filter-press, but we know of none in use. As for apparatus based upon the centrifugal drying machine, there were efforts to build such at an early date; in France, there was the equipment of Sourdat, and in 1887 the Schulze apparatus appeared in Germany.¹² To cite only the most recent efforts along this line, there have been the extractor of L.-J. Simon¹³ and that of Steinmann.¹⁴ These machines present great construction difficulties in respect to being water-tight, and furthermore they are very costly.



Société Carbonisation et Charbons Actifs, Paris

FIGURE 11. *Installation for solvent recovery with activated carbon.*

None the less, for the perfume extraction industry, it is quite likely that the autoclave drying machine with a horizontal axis is the apparatus of the future.



Etablissements Antoine Chiris, Grasse

FIGURE 12. *Batteries of rotating extractors.*

Continuous Extraction Apparatus: Efforts have also been made to construct continuous extraction apparatus, based either on the U-tube equipment or on the Archimedes spiral. In such equipment, the plant material

and the solvent circulate in opposite directions. A continuous apparatus for the extraction of fatty matter was patented in 1901 by Ed. Bataille, and since then other machines have been studied in France by J. A. Hughes, and in Germany by Hildebrandt, Böhm and Fauth. To our knowledge, the perfume industry is not using any machine of this type at the present time.

Recovery of the Retained Solvent.

The exhausted plant material retains an important quantity of solvent. With the normal load of a 1,000-liter static extractor, this quantity varies

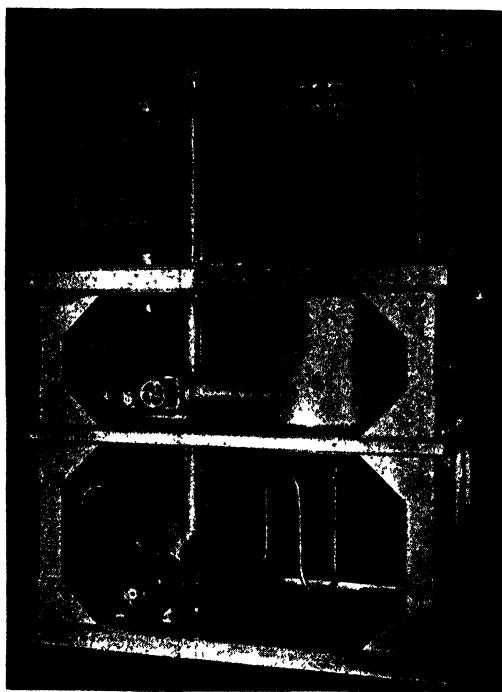

*Société Carbonisation et Charbons
Actifs, Paris*

FIGURE 13. *Standard apparatus for solvent recovery.*

between 150 and 180 liters. It is of the same order for mobile apparatus. The exact quantity depends, as a matter of fact, on the nature of the material of extraction, and is very little influenced by the type of apparatus.

Experimentation has been conducted for the distillation of the solvent by heat sufficient to compensate for the heat of vaporization, aided by a reduction of the pressure. But even on agitating the charge, the heat has only a poor and irregular penetration and the operation is either incomplete or interminable.

It has therefore been found preferable to steam-distill the solvent. But the penetration of steam is irregular, and it creates "chimneys." Agitation increases the rapidity of the recovery, but during the process the material piles up. The mobile extractors seem to present an advantage over the static ones, in the course of this phase of extraction.

The recovery of the solvent currently reaches about 90 per cent of the quantities retained. After blasting, water is injected to cool the extractor, and is immediately removed.



Etablissements Antoine Chiris, Grasse

FIGURE 14. *Room for extraction of perfume by volatile solvents.*

In certain static batteries, where a vapor blasting is effected *per descensum*, there is obtained, in concentrating the products carried over by distillation, a residue rich in waxy materials and somewhat odorous. It is used by the soapmakers, or transformed into an absolute of inferior quality. This practice of recovery of the waste has been dying out.

Comparison of the Yield Obtained with Various Apparatuses.

We shall limit this study to the types of apparatus in current usage, that is, to the static extractors and to the Garnier and Bondon extractors.

It is difficult to say with certainty which equipment gives the best yield in valuable products. For comparison, the yield in absolute oil, based on the plant material, is usually studied.

G. Dumont, constructor of the Bondon apparatus, gives the following yields of concretes for the extraction of jasmin by petroleum ether:

Static extractor	0.28%
Garnier extractor	0.30%
Bondon extractor	0.35%

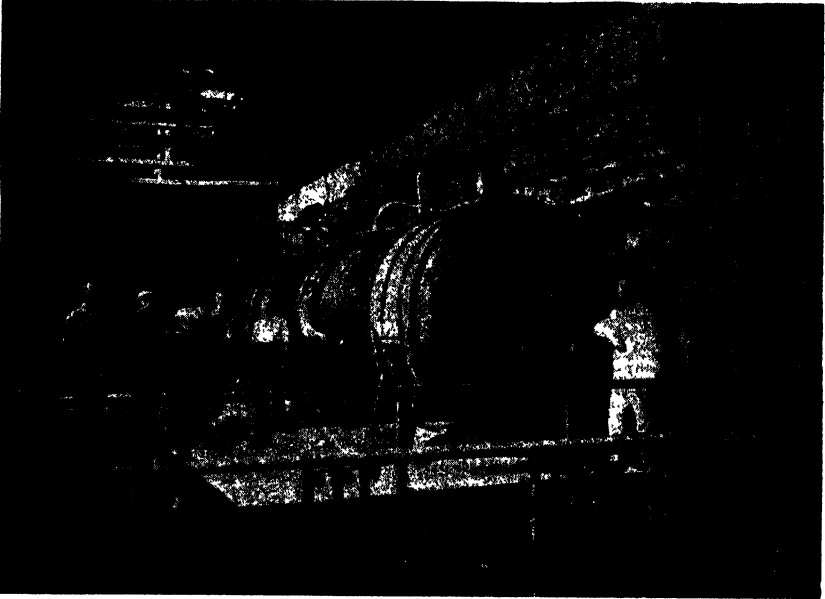

Robert Garnier's works near Kara Sarli, Bulgaria

FIGURE 15. *Garnier apparatus for the extraction of rose concrete.*



FIGURE 16. *Parts of a Bondon-Dumont extractor.*

G. Dumont, Grasse

The yield in absolute is constant, that is about 50 per cent of the concrete in all cases. But the majority of opinions differ; in general the technicians estimate that the yields by the Garnier and Bondon extractors are approximately identical, and only slightly higher than the yield of the static equipment.

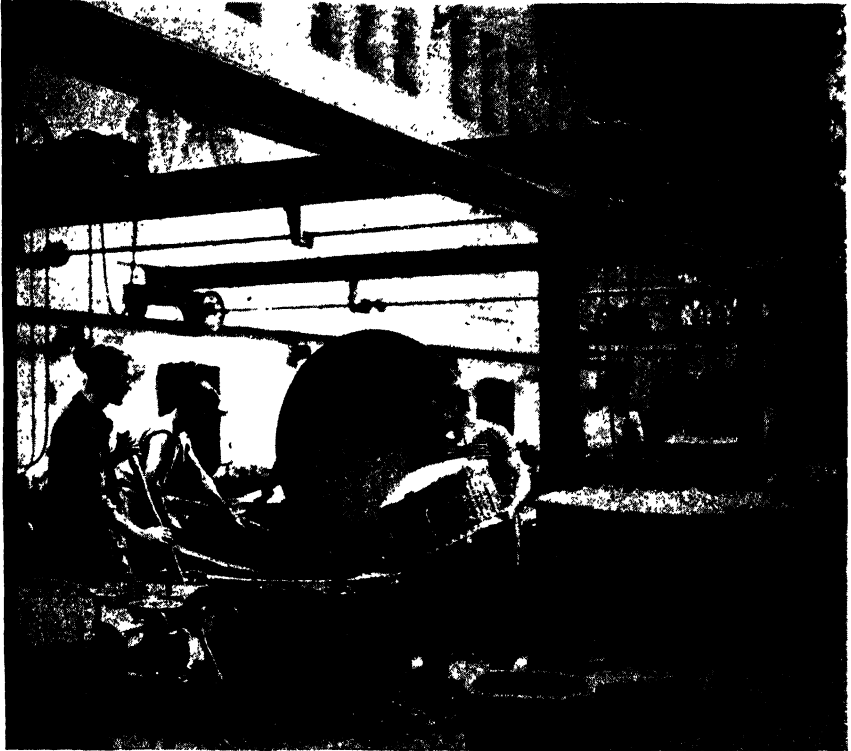

Etablissements Antoine Chiris, Grasse

FIGURE 17. *Placing the jasmin flowers in a stationary extractor.*

But the products obtained by mobile equipment are better, from an olfactory point of view, for a smaller amount of solvent is used, and the concentration, from which the perfume quality suffers, is less prolonged, the quality of the perfume improving in proportion to the decrease of solvent employed.

The quantities of petroleum ether used in the treatment of 100 kilograms of jasmin by methodical circulation are:

Static extractor	600 liters
Garnier extractor	240 liters
Bondon extractor	140 liters

The losses in petroleum ether, including losses in the course of extraction, concentration and rectification of the recovered solvent, and without taking into account the recovery of the non-condensed solvent by condensation (a recovery which is often neglected) are about as follows:

Static extractor	60 to 100 liters
Garnier extractor	23 to 40 liters
Bondon extractor	13 to 22 liters



Etablissements Antoine Chiris, Grasse

FIGURE 18. *Removal of exhausted jasmin from stationary extractor*

The treatment of one load on a 3 cubic meter Bondon *roue* required four hours of hand work; the treatment of an equivalent charge of flowers would require 6 hours of hand work with the Garnier apparatus, and 12 hours with the static *batterie*.

The unloading of the Garnier apparatus is rather troublesome, because of the weight of the trays filled with humid material, particularly at a time of intense work, when it is necessary to remove the trays while they are hot.

The circular grills of the static *batteries* and the trays of the Garnier *roue* are burdensome in their maintenance. The mobile apparatus, particularly in the Bondon *roue*, is economical in comparison with the static *batterie*, because of the saving in the necessary quantity of solvent, in the expenses of concentration of the solutions and rectification of the solvents, in the cost of the hand work, and also because of their large capacity for

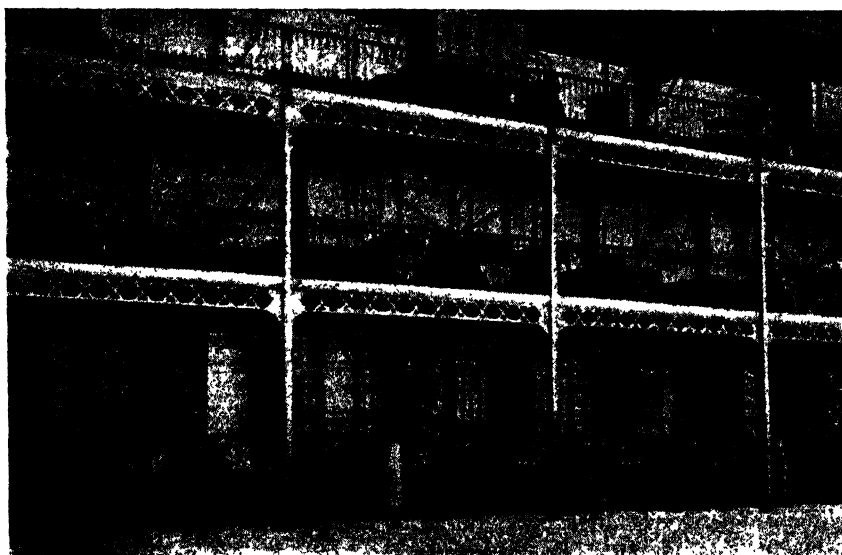

Etablissements Roure-Bertrand Fils et Justin Dupont, Grasse

FIGURE 19. *Volatile solvent extraction with stationary extractors.*

treatment of flowers, which permits a considerable reduction in the cost of equipment, despite the high initial construction cost.

The expenses in supplementary material (reservoirs, pumps, evaporators, condensers, and solvent recovery equipment) in comparison with the cost of exploitation, are in the ratio of 1.0 for the Bondon *roue*, 1.7 for the Garnier *roue*, and 3 for the static equipment.

The amortization of the mobile apparatus and of a part of the accessory installations can be accelerated if the equipment is used for distillation purposes when it is not being used for the solvent extraction of flowers.

It lends itself particularly well to distillation under reduced pressure and superheat.

In Bulgaria, this equipment is used for the distillation of the otto of rose. It requires 150 to 180 kg of vapor for the treatment of 100 kg of roses, instead of the 300 kg in the case of the usual alembic. The oil of rose obtained includes less "stearoptene," is finer in odor, more flowery, and the yield is 10 per cent higher than that of ordinary stills.

Extraction of the Aroma of the Juices of Expressed Fruits and of the Perfume of Aromatic Distilled Waters

The concentrated fruit juices are relatively more stable than the expressed juices, and the packaging and transportation more economical. The concentration is carried out by evaporation or vacuum distillation. More and more, the tendency is to continue this process until solid products are obtained; to attain this end, frequent use is made of pulverization driers (often also called atomization driers), which date back to the invention of Percy in 1872.¹⁵

The concentration is always accompanied by at least a partial loss of the odorous substances. Instead of remedying this loss by the use of artificial materials more or less resembling the aroma of the naturals, it would be judicious to separate the aromatic substances before concentration, by extraction of the juices with a suitable volatile solvent. Finally, having eventually eliminated the colored or insert materials, the extract can be incorporated into the concentrated product.

A certain number of aromatic distilled waters can be replaced by simple saturated aqueous solutions of the essential oils. But others include aromatic substances, present or liberated in small quantities, soluble in distilled water, which do not exist in the decanted essential oil, or which are found in the oil in only very small quantity, even when the oil contains a certain amount of water. The most important of these distilled waters are those of orange flower and *rose de mai* (May rose).

In view of the importance of the cost of packing, transportation, customs duties, and the relative instability of these waters, efforts have been made for a long time to extract their aromatic substances by means of a volatile solvent. After dilution with a suitable amount of water, the extracted product gives a reconstituted distilled water, which is a better product than the true distilled water.

Furthermore, the extracts obtained can be used in perfumery, and these are raw materials which have found a growing favor in the industry. They are generally known under the name of *essences des eaux*; in

English they are called *rose-water oils*, *orange-water oils*, *néroli-water oils*, etc.

Conduct of the Extraction. In the two cases, in the treatment of both fruit juices and aromatic waters, the technical problem of extraction is the same.

The old process of the circulation of the aqueous liquid in a layer of the solvent contained in a Florentine flask (several Florentine flasks can advantageously be placed in a row) has been forsaken by the profit of treatment in emulsifiers. The emulsion obtained is separated by simple gravity or by a centrifugal separator.

For the dispersion apparatus, either a turbine placed at the separation surface of the solvent-in-water phase is used, or preferably a circulating homogenizer. The best models are the rotators which turn at a speed of between 4,000 and 10,000 revolutions per minute, bringing about a suitable mixture of the liquid of extraction and the solvent (one volume of the former for two of the latter). The space where the rotator is connected is a slit 0.125 to 0.500 mm wide. In one of the best pieces of equipment (the Hurrel homogenizer) the stator covers the periphery of the rotor and the evacuation of the mixture is accomplished through holes pierced in the stator, following the axial plane of the entire apparatus. The feeding is done through two sides of the rotor, which are in equilibrium.

Industrially, hardly any waters of distillation are produced in Provence except those from the orange and *rose de mai*. The solvent used is either petroleum ether, benzene or toluene. The yields obtained by petroleum ether treatment of the freshly distilled waters are as follows:

Orange Bigarade Flower (kg water/kg)	0.325 to 0.450% ¹⁶
<i>Rose de mai</i> (May rose)	0.325 to 0.450%

To a very small extent, the waters obtained from the distillation of the young stems and leaves of the orange bigarade (petitgrain) are treated; this gives orange sprouts water oil, known as *l'essence des eaux de brout d'oranger*.¹⁷ The yield varies from 0.250 to 0.380 per cent.

These yields diminish rapidly, and in very strong proportion, according to the age of the distilled waters. Attempts have been made to extract industrially the distilled waters of lavender, clary sage, rosemary, mint, and geranium,¹⁸ but those efforts have been without success.

Concentration of the Solutions. The concentration of the solutions, often extremely diluted, containing many different odorous substances (some of which are relatively highly volatile and constitute the deter-

minants of the quality of the perfume) is a delicate operation. Its realization always leaves something to be desired in the way of the choice of solvent and the working of the apparatus, for frequently elementary knowledge and even the teachings of simple common sense are overlooked.

Preparation for the Concentration. The product which is evacuated from the extractors, either by gravity, by the use of compressed air, or by the use of circulation pumps, is sent into a decanter (when fresh vegetable matter is involved) where it separates from the water, goes through a filter, and then generally into the concentrator.

As a matter of fact, the treatment of the fresh vegetable matter liberates an important quantity of aqueous juices which are carried over, suspended in the extraction solvent. The aqueous phase is frequently acid, because of the acidity of the vegetable juices, due to the action of esterases and lipases. It includes diastases and peroxidases which react, particularly on phenolic products, and which generate colored substances. The water carries in suspension fermentizable materials. Finally, the water-solvent emulsion adsorbs, at the interface, some colored products and some other insoluble products which cause sedimentation, leaving muddy deposits as the emulsion separates.

This aqueous phase should generally be separated by simple gravitation, before the emulsion is completely separated, or even before a prolonged waiting period. The aqueous phase which has been arbitrarily separated contains in suspension a fraction of the perfumed solution. There is frequently joined to this phase an intermediary layer, sometimes quite large, and rich in odorous products.

There is therefore a great advantage on the one hand of not prolonging the decantation, and on the other of speeding the pace. Liquids are treated by supercentrifugation; no doubt because of the importance of the processes for the recovery of the fatty oils, a large number of water-tight supercentrifugal models is available. With a centrifuge making 17,000 to 19,000 revolutions per minute, and having a basin 11 cm in diameter and 70 cm high, some 1500 liters of liquid can effectively be treated per hour. The use of apparatus which permits considerable aeration at the contact of the liquid should be avoided. The separation is rapid; the dryness of the organic phase (dissolved water not included) is almost perfect; and the yield in odorous products is at a maximum. Thus a perfectly purified product is prepared for concentration.

Principles of concentration. In the course of concentration, it is essential to reduce to the minimum the losses in odorous products.

The most volatile products are, in general, quite easily sacrificed by the majority of technicians, who accuse the harvest of having yielded flowers weak in aroma, and they blame these flowers for the flatness of their products. Their critical voices are heard over and over again every year. More information will be available in the near future as to the importance and the gravity of these losses, thanks particularly to the progress in the isolation of chemical imponderables, such as by the use of the aldehyde and ketone reagents suggested by Girard and Sandulesco.

The concentrators should always be furnished with efficient fractionating columns. If it is theoretically impossible to recover a pure solvent, it is at least possible to reduce considerably the amount of odorous products retained, for instance by repeated distillation in a plated column.

In effect, during at least a large part of the concentration processes, the technician is dealing with a mixture of perfectly miscible products. The system then consists of two phases, one the liquid, the other gaseous and homogeneous, and the phase rule determines that the system is bi-variant. The free factors are the boiling temperature, the pressure and the composition of the vapor. At a given temperature or pressure, several different compositions of the vapor are therefore possible, and the retrogradation will change the composition of the gaseous phase, which becomes enriched in a lighter product. Toward the end of the concentration, the insolubility of certain constituents may reduce the number of free conditions to one, causing an entrainment; but in general when the first plates are reached, the entrained constituent will dissolve, the zone of miscibility having been reached. The column will make another distillation on the higher plates.

It is evident that the use of a column makes necessary the limitation of the speed of the distillation, and increases the duration of the period when heat is applied to the product. However, for economy of operation and for the sake of the quality of the perfume, it is important to reduce this period of application of heat. For this purpose, advantage is taken of concentrators of small capacity, fed in a continuous fashion. Another advantage is that in this way the heating equipment (coil and double base) is immersed in water during almost the entire operation, and superheating is thus reduced. The use of carefully studied concentration equipment permits a reduction of the importance of solvent rectifications. Such rectifications are necessary to obtain a solvent of neutral odor, when the quantity of solvent disposable is reduced in comparison with the variety of products to be extracted, and when one wishes to avoid reporting solvent stocks from one season to the next; they considerably affect the cost of production.

In general, the concentrations are made for 80 per cent of the solvent

at ordinary pressure; then, for the remainder, at a reduced pressure of 140 to 160 mm of mercury. Therefore, there are few installations in which the entire concentration is carried out under vacuum.

The concentration is rarely continued to its end in the first apparatus; with the perfume extracted, two to three parts of solvent are left; the concentrated solution is removed by a sluice or tap situated at the base of the concentrator, and the concentration is then finished in a glass flask. When the concretes obtained are not to be transformed into absolutes by the manufacturer, the last traces of petroleum ether or benzene are eliminated by adding a small quantity of absolute alcohol, which is then removed by distillation. As early as 1892, Ch. Garnier¹⁹ proposed a method for eliminating the last traces of a solvent of disagreeable odor, by finishing the concentration in the presence of ethyl ether.

Purification of the Recovered Solvent. At the end of the extraction, the recovered solvent is used to wash the extraction apparatus, and then it is rectified. This operation is repeated, and the rectification is also repeated once or twice over Vaseline oil (5 per cent). Thus a total of at least 4, and sometimes 6, rectifications are made. The perfumed Vaseline is sometimes discarded, but more often it is sold for industrial use. It can be deodorized by distillation with superheated steam, followed by filtration with activated carbon, and then re-utilized.

Recovery of the Non-Condensed Solvents. Importance of the Losses. The losses of solvent, evaluated on the basis of the quantity of solvent gathered at the base of the refrigerant of the concentrator, are very great.

It can be said that, in the course of the treatment of 100 kg of jasmin flowers by the use of a static *batterie*, 100 liters of petroleum ether can be lost. The loss is proportional to the quantity of solvent originally used. Losses can be reduced by concentrating the solutions to the greatest possible extent, at ordinary pressure, but the perfume extracted suffers thereby.

Including rectifications, the losses in petroleum ether reach 12 to 16 per cent of the quantities employed, when waters at 16 to 20° are used as condensing agents, and when the waters are as low as 12 to 14°, the losses are 9 to 13 per cent. Losses of 20 per cent are sometimes cited for petroleum ether, but they are exaggerations, as are the low figures of 3 to 5 per cent.

Recovery of the uncondensed solvent. The application of the principles described above (page 75) makes possible a recovery of 40 to 90 per cent of the uncondensed solvent.

Utilizing the principle of compression, and keeping the temperature constant, recovery amounts to from 40 to 55 per cent of uncondensed material. An attempt has been made to interpolate a vacuum pump between the concentrator and the condenser. This is only aggravating the difficulty; it is better to place the vacuum pump after the condenser, and to evacuate the recovered solvent into a small auxiliary condenser.

Recovery by dissolution consists in evacuating the gases at cross-currents, across a packed tower or a plated column, or to steam down some Vaseline oil, some tetraline or some cresols, or to treat the gases in a rotatory centrifugal washer (examples: Theisen, Ströder or Feld apparatuses). The dissolved solvent is recovered by distillation. The yield can be as high as 90 per cent.

The condenser-air pump makes possible a combination of the production of the vacuum and the washing operation. It is made up of an ejector fed by a liquid coming from a circulation pump. For the ejector-liquid, a product miscible with the solvent, easily liberating it by distillation, can be chosen. This apparatus is the simplest and most economical mixed condenser.

Recovery by porous adsorbents gives yields higher than 90 per cent; it has the disadvantage of requiring rather costly installations. The most frequently employed adsorbent is activated carbon; on rare occasions, silica gel, alumina gel or ferric hydrate gel is used.

The carbon is generally used in the form of cylinders 4 mm in diameter and 5 to 6 mm long; 1 gram of carbon can reach, considering the degree of porosity, 300 to 400 square meters of surface.

The uncondensed solvents are drawn to the base of the condenser by means of a ventilator, and mixed with air in such a way as to bring about the concentration of whatever vapors there may be, without producing a dangerous situation, even though there may be a spark due to the accumulation of static electric charges.

The mixture is compressed into the adsorption column, the gases are freed of the dust, and evacuated. The adsorption is accompanied by a rise in temperature, the measurement of which makes it possible to follow the course of the operation.

It can be said that, for a carbon of good quality, the economic saturation is reached when it absorbs 30 to 40 per cent of its weight of solvent. The advantage of porous over liquid adsorbents is the slight degree of sensitivity of the former to the extent of dilution of the vapors, whereas the latter act in accordance with Henry's law.

After the carbon is saturated, it is regenerated by passing vapors through it; the steam displaces the adsorbed solvent and carries it over into a cooled condenser. The carbon is dried and cooled by an inde-

pendent gaseous current, and the adsorber is ready to be placed back on the adsorption circuit. The continuous apparatus therefore has an even number of adsorbers.

The carbon should be carefully chosen, as some overactivated carbons require a greater quantity of steam for the elution of the adsorbed solvent. Their use results in an increase in the expenses of regeneration, as well as increased losses of solvent.

There is a great advantage in furnishing all solvent reservoirs with a permanent respiration collector, linked with an adsorber. As a matter of fact, the alternate heating and cooling cause atmospheric movements in the reservoirs and bring about an expulsion of the solvent vapors in considerable quantities.

Installations of the Acticarbone type used by the French perfume raw material industry require per liter of solvent recovered:

K.W.H.	0.06 to 0.10
Saturated vapor, lowest pressure	3 to 5 kg
Condensation water	40 to 60 liters

The carbon used amounts to 0.5 to 1 kg per ton of solvent recovered.

Construction of the Extraction Apparatus. *Materials.* Possible corrosion of the extraction apparatus should be avoided with the greatest care. The presence of metallic salts, it should be remembered, is prejudicial to the quality of the manufactured product, to its appearance and to its stability.

The first extraction apparatuses were constructed in black sheet-iron, in galvanized iron, or in plated copper, with the tap system in bronze. Later, copper plates replaced the sheet-iron, because of their better resistance to corrosion. In recent years, *batteries* have been constructed that were protected by *brauthitage*.

For the construction of concentrators, copper plating was at first used; then aluminum became popular, both in a pure form and as an alloy mixed with small quantities of manganese and other metals, such as the skleron, the aeron and the aludur. Still later, the industry felt that such apparatus was costly, and that the aluminum was causing certain alterations in the perfume, and there was a return to plated copper at least for the construction of the stills, which were being made in small quantities and of a rather complicated and specialized structure.

Among the metals used have been special steels, particularly of the type of the classic austenite steel known as 18/8. These steels are costly, difficult to work with, and some of them present to a large extent the problem of fission corrosion. Their mechanical qualities are frequently

mediocre. The disadvantage of their poor thermal conductivity is not an important factor in considering their use for this purpose. The lichen products, such as oakmoss, attack steel. In short, even where the use of steel is indispensable, it must nevertheless be curtailed.

There has been advantageous use of vitreous sheet-iron in the manufacture of decanters and stock receptacles.

Circulation of the Liquids. In the old installations, there were duplex steam pumps, that could be easily regulated, and through which the solvent could be injected slowly and uniformly, without the use of an intermediate reservoir. Today rotatory pumps of the Mouvex type and centrifugal pumps are in use, and they have been improved upon considerably. Gravitation and compressed air are used wherever possible.

Production of the Vacuum. For the lack of air-pumps, which are highly advantageous, rotatory or piston pumps can be used, the vacuum being limited by a by-pass, generally of the clack-valve pilot type. This stabilizes the vacuum at the pressure chosen to obtain a good efficiency of the condensers. The disoiling of the parts in movement is compensated for by an abundant greasage, and the vacuum pump is connected with an oil-regeneration unit that functions by distillation.

References

1. Lautier Fils Company, cited by W. Poucher, "Perfumes, Cosmetics and Soaps," 5th ed., v. 2 p. 47, London, 1936.
2. Lindet, *Acad. Agr. de France*, February 20, 1924.
3. W. Poucher, *loc. cit.*
4. Wurtz, "Dictionnaire de Chimie," 2nd suppl., v. 3, p. 545.
5. French Patent 673,703 (1928).
6. Smyth, *J. Ind. Hyg. Toxicol.*, 13, 87 (1931).
7. Dimmel, H., *Arch. Gewerbepath. Gewerbehyg.*, 4, 414 and 464 (1933).
8. Nahum, L. H., and Hoff, H. E., *J. Pharm.*, 50, 536 (1934). For more general information on the subject of intoxication by industrial solvents, see "Toxicity of Industrial Organic Solvents" by E. Browning, Report No. 80, Medical Research Council, London, 1937; on the subject of the effect of traces of solvents in the atmosphere of shops, see "Nachweis und Bestimmung von Lösungsmitteldampf," by L. Patti, Dresden, 1937.
9. Naves, Y. R., *Parfums France*, 13, 103 (1935).
10. Macheboeuf, M. A., and Fethke, N., *Bull. soc. chim. biol.*, 16, 229 (1934).
11. Fritsch, "Fabrication et raffinage des huiles végétales," p. 178 and 181, Paris, 1931.
12. Schulze, German Patent 41,772 (1887).
13. Simon, L. J., English Patent 255,923 (1926).
14. Steinmann, German Patent 574,144 and English Patent 388,966 (1931).
15. Percy, U. S. Patent 125,406 (1872).
16. Naves, Y. R., *Parfums France*, 12, 60 (1934).

17. Naves, Y. R., *loc. cit.*, p. 68.
18. Naves, Y. R., *loc. cit.*, p. 179.
19. Garnier, Ch., French Patent 223,119 (1892).

POMADES AND FLORAL OILS

General Remarks. In the first part of this book, we traced from ancient times the evolution of the processes for extraction of perfume, which have given us pomades and oils. Today, with a few exceptions, these methods are no longer applicable, except for extracting the perfume of the most fragile flowers. Thus jasmin and tuberose are treated by cold-fat extraction, this method assuring the capture of the perfume, which the cut flower continues to secrete. The rose, orange flower, acacia, jonquil, narcissus, hyacinth and violet are subjected to digestion in liquid fats, at a suitable heat, or in oils.

For enfleurage, the Vaseline oils (or so-called neutralin oils) are also used, but the industry has weighed the relative merits and demerits of this process, and has practically abandoned it. Due to the higher cost of the classic cold-fat extraction, the antique process of *criblage* or screening has been revived (see page 114).

We have also shown the reasons why the enfleurage and maceration extraction industry centered at Grasse. It is there that these processes must be studied in order to know them.

Raw Materials. Pomade or Prepared Corps. The pomade is made up of a mixture of suitably purified lard and suet. For cold enfleurage, a mixture is generally used at Grasse consisting of 65 to 70 parts of lard, and 30 to 35 parts of suet; and for digestion, the percentage of lard is cut approximately in half.

The composition of the enfleurage pomade should be adapted to the particular enfleurage factory, and to the seasonal characteristics, particularly the temperature in the factory during the operation. The pomade should be hard enough so that the flowers should adhere, and soft enough so that the surface can easily be "combed" and so that it shows a proper absorptive power. Too soft a pomade "runs," is difficult to manipulate, soils with ease and alters without difficulty, and the losses by adherence to the flowers become considerable.

The choice and the purification of the lard and suet are delicate processes.

Lard. The lard is prepared from the fat of healthy pigs, carefully selected. A part of the hog fat employed in Grasse is of Italian origin.

The prepared product should be pure white, soft and homogeneous

in consistency, and should not have the least odor of rancidity. Melted and placed in layers 1 cm thick, it should appear limpid and colorless.

High-quality lard has the following characteristics: M.P.: 33 to 41° (after fusion, mixing and resting for 5 hours at 10 to 12°, or 24 hours at the temperature of the canalization water); solidification point: 24 to 34° (most frequently between 28 and 29°); n_D : -6 to -12.5° and most frequently -7 to -11° on the oleorefractometer of Amagat-Jean, at 45°, on the OB scale.

The following additional properties have been reported by various authors:

n_D^{45} :	1.464 to 1.468
A.V.:	1.2 or less
S.V.:	193 to 198
I.V.:	52 to 57 (Wijs)

Unsaponifiable material: Not more than 0.5%.

The lard that is purchased all prepared and ready for use should also be examined to see that it is free from sesame oil, cottonseed oil and chlorinated compounds. Bleached or otherwise altered lard can be detected by means of the following test:

Agitate for 1 minute a mixture of 1 cc of melted lard and 1 cc of concentrated HCl. Then add 1 cc of resorcinol solution in benzene (0.15%) and continue to agitate. No violet-red coloration should be produced.

For other analytical details, special studies on the subject should be consulted.

Suet. The suet is extracted from the renal conjunctive tissue of the bull. It is a white mass of firm, grainy texture, with a weak but not rancid odor. It should contain not more than 0.5% of water, determined by heating to 110°. It has the following characteristics:

M.P.:	44 to 50°
n_D^{60} :	1.449 to 1.451
A.V.:	2.0 or less
S.V.:	192 to 195
I.V.:	33 to 43 (Wijs)
Dalican test:	43.5 to 45.5°

To test for bleached or otherwise altered suet, proceed as for lard. For other details, see special works on the subject.

In general, the manufacturers of perfume raw materials prepare their own fats in the off-season for perfumery, making up as much as they expect to need. To prepare the lard, the hog fats must be picked very carefully, and only those of best appearance and freshest odor are chosen.

The slightly defective material can be kept, if one wishes, for use in the digestion process.

The fats are minced, then washed in water, interrupted during the course of the washing by passage to the cutter-rover, thus eliminating blood and other débris. They are then placed in a plated basin, heated by a double-bottom steam bath, in quantities of about 100 kg. They are melted and then decanted into another basin.

To each 80 kg of lard, there are added 200 to 250 grams of bruised alum and 3 to 5 liters of distilled water. This is melted down and allowed to stand for 10 to 15 minutes at the boiling point of water. The froth is skimmed off with a hand colander. The foam is set aside and allowed to cool; the usable fraction is recovered, reheated and reskimmed.

The fat is melted and passed through a fine bristle sieve. It is dropped through a conical vase, decanted and put back into the boiler. Three liters of rose water and three liters of orange flower water are incorporated, or 5 liters of the orange water alone, and then it is melted, brought up to the boiling point of water, and then skimmed again.

From 80 to 200 grams of benzoin powder are then sifted into the lard. For this, there can be used—and opinion is divided—either benzoin of Siam or of Sumatra. The Sumatra would seem to be preferred, as it has the most acid qualities (A.V. 160 to 178) which are utilized. An excellent method of amelioration consists in using an alcoholic benzoin resinoid in place of the crude benzoin.

After the addition of the benzoin, and as soon as the scum has completely ceased forming, the heating is stopped, the entire mixture covered and left to cool slowly (4 to 5 hours) until it begins to congeal at the edges. It is then poured into wooden cases lined with tin plates, having a capacity of 300 to 400 kg, which were previously washed with tincture of benzoin. The lard thus prepared is white and homogeneous, whereas if it had been drawn off as soon as the fat had been purified and melted, it would have taken on a granular aspect. It is kept in cellars until wanted.

The preparation of suet is similar, except that the suet is washed after wringing over a sieve, to avoid entrainment by water.

The lard is the soft corps, the suet is the hard corps. The lard and suet are frequently mixed in the proper proportions at the last fusion, and then the process is terminated in the manner described above. Or they can be mixed before being run onto the *chassis*.

Some companies incorporate a little white wax in the prepared corps.

The greatest degree of cleanliness is absolutely indispensable in the course of all these manipulations. It is also necessary to avoid the introduction of any salts of heavy metals. The fresh pomades should be conserved away from light, so as to avoid rancidification. A prepared

corps which presents the slightest evidence of alteration should be rejected for perfumery purposes, and turned over to the soap industry without hesitation.

Vegetable Oils. Vegetable oils are today rarely used for digestion.

The olive oil used is the first-pressed; it is yellowish or greenish-yellow in color, and has a sweetish odor and taste. The oil should not be bleached or altered, and should have the following characteristics:

Beginning of turbidity at 10°, concretizing at 0° into a buttery mass

d_{15}^{15} :	0.915 to 0.918
n_D^{20} :	1.4620 to 1.4652
A.V.:	2.0 or less
S.V.:	188 to 196
I.V.(Wijs):	79 to 88

The sweet almond oil is light in color, and has a fresh and characteristic odor and taste. Its properties are as follows:

It should remain limpid after being exposed for three hours to a temperature of -10°.

d_{15}^{15} :	0.916 to 0.919
n_D^{20} :	1.4640 to 1.4666
A.V.:	4.2 or less
E.V.:	189 to 196
I.V.(Wijs):	93 to 100

In order to protect these oils and the perfumed oils from rancidifying, 2 to 5 grams of benzoin or 3 to 4 grams of benzyl salicylate are added, per kilogram of oil.

Vaseline oils, "neutralin" oils or paraffin oils. The so-called "neutralin" oils are utilized less and less in perfumery. They have the advantage of not turning rancid and not acidifying, but their absorption power for perfume is less than that of the fats and vegetable oils.

The Vaseline oils are heavy oils, generally extracted from American petroleum, purified by washing over sulfuric acid and sodium. They distill between 330 and 345°. They are colorless, non-fluorescent, and hardly soluble in water. They do not absorb bromine; they turn very pale yellow under the action of sulfuric acid, which does not dissolve them to any great extent, even with agitation. These oils volatilize without leaving any residue. They do not show turbidity at 0°, and have the following other characteristics:

d_{15}^{15} :	0.878 to 0.893
-----------------	----------------

Absolute viscosity at 20°: 0.1 to 0.2 poise.

5 cc of the neutralin oil, when agitated with 5 cc of sulfuric acid (specific gravity 1.84) and heated over a water bath for 10 minutes, should not color the acid any darker than a pale yellow.

When 5 cc of the oil and 20 cc of almost boiling water are agitated for 1 minute, and the aqueous fraction filtered, it should not show any color in the presence of phenolphthalein; 1 drop of a decinormal sodium solution should color it red.

The saponification value is nil.

Practice of Enfleurage. The jasmine or tuberose flowers destined for the enfleurage process should be perfectly healthy and dry. As a matter of fact, water seems to accelerate the rancidification of the fats, probably by providing a vehicle for the metallic salts, which are the rancidification catalysts, where the lipase actions and bacterial changes occur.



Lautier Fils, Grasse

FIGURE 20. *Water baths and hydraulic presses used in the digestion or maceration processes.*

The flowers should not be damaged; otherwise, they undergo very quick alteration, and produce pigments and colors which run from an ordinary brown to a blackish brown. Years ago, the Grasse producers accepted only flowers which had been carried to their factories either on the heads of the workers or by saddle-packed asses or mules. Flowers which came over bad roads, or in badly constructed carts, were rejected. The flowers had to be gathered with sufficient care to avoid the necessity of screening at the factory, a process which tends to damage them. All these precautions, which had already been abandoned in Grasse even before the outbreak of the Second World War, because of the difficulty of procuring flowers and because of the changed outlook of the French peasant, were perhaps a bit exaggerated, but they gave to the manufacture of pomades a security which it has since lost.

The quantity of flowers used varies according to the factory. For jasmín, 1.500 to 3 kg of flowers are used for each kilo of prepared corps; in general, the figure is 2 kg or 2.500 kg, and for tuberose the most generally used quantity is 2.500 kg.

The absorption power of fat is very limited, and what is more important, is qualitatively limited. It is well known that the olfactory quality of a pomade that has been treated with 2 kg, for instance, is different from one treated, during the same period, with 2.500 kg. The odor of the former is more fatty, more homogenous, more tenacious than that of the latter, and the yield in extracted odoriferous products based on the quantity of flowers is higher in the first case, as we shall describe in detail later on.



Etablissements Antoine Chiris, Grasse

FIGURE 21. *Volatile solvent extraction room, with stationary extractors.*

Technique of Enfleurage. For enfleurage, glass plates about 0.50×0.60 meters, symmetrically encased in wooden frames about 60 to 70 mm high, are formed and adjusted. In its entirety, this is known as a *châssis*. On the face of the glass plate, a layer of prepared corps is spread, stopping 15 to 20 mm from the frame, so as not to impregnate the wood. The face of each frame holds 200 to 250 grams of fat. The *châssis* is piled up in columns, and each set of two plates constitutes a closed chamber in which the flowers are to be kept.

Let us make a close examination of the enfleurage of jasmín.

Each *châssis* receives the flowers, which are spread on the upper face. The charge varies between 30 and 80 grams. It is higher toward the end of the operation of renewing the charges, when the pomade is very soft

and the flowers are not as rich in odorous products. The quantity placed on each *châssis* is called the *taux journalier d'enfleurage*, or the daily rate of enfleurage. The size of this daily charge is a function of the temperature, of the state of the pomade, and of the quality of the flowers. On the correctness of the judgment in deciding the rate depend the quality and the outcome of the manufacture.

After 24 to 48 hours of contact (or 48 to 72 hours, in the case of tuberose) the flowers are taken off. This is the *défleurage* process. To do this, the *châssis* is turned over, which eliminates the major part of the flowers; then, the frame held vertically with both hands, is tapped in short and steady blows on the table, and most of the remaining flowers fall down. The last ones adhering are lifted off one by one, using little sticks or pens. If the enfleurage has been conducted properly, and the pomade is in good condition, that is, if it is not too soft, this *défleurage* should not present any difficulties. It does require attention, for the flowers, or their débris, if left on the pomade, can become the seat of putrid fermentation.

There have been efforts to modernize the *défleurage* process, which is long and costly hand labor, by incorporating talc into the prepared corps. This is an efficient process, but the addition of talc diminishes the absorptive capacity of the fat for perfume.

An effort was also made to facilitate the *défleurage* by pneumatic suction of the adherent flowers. This process does not seem to be practiced generally.

Finally, there have been efforts to separate the flowers from the pomade by a silk veil, which facilitates the *défleurage*, but lowers the yield of perfume. It seems that a fuller contact of the flowers with the fats is indispensable.

Soon after the *défleurage*, the charge of flowers is renewed, but this time the *châssis* is turned around. Thus each layer of fat alternates in coming into contact with the flowers.

About once a week, the absorption surface of the fat is renewed by successive combing and levelling. The combing, or *rayage*, consists in drawing lines along the width and length of the fat, by means of a wooden or aluminum comb; the following week, the surface is leveled with a wooden spatula, a process known as *pâtage*.

When the enfleurage is over, the pomade is taken off by *racle* or scraping; all the pomades from the various *châssis* are brought together, melted at a mild temperature, filtered through a veil, and allowed to cool in the same type of containers as were used to store the prepared corps, with the same precautions concerning conservation.

The flowers taken off the *châssis* are still odorous, and have some

pomade adhering to them. In order to obtain their perfume and recover this pomade, these flowers are treated either with benzene or petroleum ether, and a yield is obtained on the average of 3 to 3.5 per cent of the flowers. This material is known as the *essence concrète des châssis*, and is usually known in English, if prepared from jasmin flowers for instance, simply as *jasmin châssis*. It is rich in fats, and we will take up a little later its other characteristics.

Enfleurage requires a considerable amount of material and of trained personnel. Assuming that 2 kg of flowers are treated on a *châssis* containing 0.500 kg of prepared corps, the treatment of one ton of jasmin flowers therefore requires 1000 *châssis*, the service for which in turn requires, in the course of the manufacturing season, some 5 to 8 workers. Thirty to 40 *châssis* are known as *une pile*; the corresponding English words, pile or heap, have not been used in the literature or in the industry. Fifty to 100 *piles* form one *atelier* or work-shop.

A yield of 85 to 90 kg of pomade is obtained from 100 kg of prepared corps.

Yield of Perfume from Enfleurage. As Passy was the first to note, the jasmin and the tuberose continue to secrete their perfume after the flower has been cut. It was noted, in fact, that the enfleurage process makes it possible to obtain a much higher quantity of perfume than can be secured by direct volatile solvent extraction.

Hesse and his collaborators studied the problem between 1899 and 1904,^{1, 2} as did E. Erdmann,³ P. Jeancard and C. Satie,⁴ v. Soden,⁵ M. Viard,⁶ and chemists of Antoine Chiris.⁷ For further data and bibliographical references, see Y. R. Naves.⁸

It seems that the first experimenters had no knowledge of the preparation of the pomade with distilled waters and with benzoin, which bring to it some odorous elements, and for this reason their conclusions were somewhat false. None the less, the importance of this omission should not be exaggerated. The quantity of steam-distillable products obtained in treating the soluble fraction in alcohol (pomade concentrate) from 100 kg of an ordinary non-enfleurated corps is about 12 grams. Perhaps the action of the air on the pomade during the course of the enfleurage might increase this quantity a little, but probably by very little. Based on 100 kg of jasmin flowers for a 2-kg enfleurage, this would be 0.006 per cent, or on an average 6 per cent of the yield of enfleurage. It seems almost superfluous to discuss this matter further.⁹

Several authors have based their comparison of the yield from the various processes of extraction of perfume on the yield in pomade concentrate (for enfleurage) as against yield of absolute essence (for volatile

solvent extraction). Two unlike things cannot be compared. And inasmuch as we do not wish to anticipate the description of the pomade concentrates and the absolutes, we refer the reader to the section on *j*asmin, starting on page 188, for a description of these products.

The only comparable things are the yield in steam-distillable products, which represent almost the total amounts of odoriferous products, and (approximately speaking) only these. Furthermore, only results obtained in treating flowers from the same season and the same harvest period should be accepted. This was probably not done by Hesse, who applied his processes at different periods, and to a limited extent over an interval of several years. This reason alone would suffice to explain the difference between the results of Hesse and of those who later studied the same question.

In addition, Hesse obtained some yields of distillates from the concretes which are quite variable. Initially, in the course of his study, he isolated 0.01785 per cent of distillate (1901), and later (1904) he first obtained 0.195 per cent of concrete and 0.0447 per cent of distillate (23 per cent of the concrete); secondly, 0.426 per cent of concrete, and 0.0442 per cent of distillate (10.6 per cent of the concrete), all yields based on the weight of the flowers.

These yields in concretes are out of line with the data of current manufacturers (a yield of 0.28 to 0.34 per cent of petroleum ether concrete is obtained, *see* page 81). It should be noted that the experiments of Hesse were not followed up with figures of yields of volatile products.

Hesse arrived at the following yields:

Quantity of Steam-Distillable Products Obtained
from One Ton of Flowers

From the:

Flowers	194 grams
Petroleum ether concrete	445 grams
Pomade	1784 grams
Neutralin oil	1053 grams
Flowers after enfleurage	195 grams

Enfleurage, followed by steam distillation of the flowers, gave Hesse 1979 grams of essence, against 445 grams obtained by petroleum ether extraction, or 4.45 times as great a quantity.

The quantity of oil obtained by petroleum ether extraction is generally between the limits of 300 and 550 grams; but the quantity obtained by enfleurage is not as great as reported by Hesse, for in enfleurage one rarely obtains more than 1350 grams of essence. As for the recovery of the

perfume from the *châssis* concrete, it amounts to about 80 to 140 grams of distillable essence, for 1,000 kilograms of flowers.

While v. Soden mentions a ratio of 2.5, the chemists of Antoine Chiris have indicated that this varies between 2.1 and 2.65, a value which was confirmed by one of the authors in 1930.¹⁰

Composition of the Perfume of Enfleurage. The composition of the perfume of enfleurage is a little different from that extracted by volatile solvents. The perfume of enfleurage contains odorous products introduced into the pomade corps, whether it be the odorous products of rose water, of orange flower water or the odorous elements of benzoin. In addition, it includes the products soluble in alcohol, which may be volatile and odorous, which come from the fats themselves and from the modification of these fats during the course of the enfleurage.

Hesse¹¹ was of the opinion that indole and methyl anthranilate, both of which have been found in the products of enfleurage, were products of the activity of the cut flower, but v. Soden found indole in the concrete, and we can today state that the indole content is particularly high in the concretes manufactured in Algeria and Egypt. It amounts to some 250 to 330 mg per kilogram of concrete, analyzed by colorimetric quantitative determination of the dimethylaminobenzaldehyde. Cerighelli¹² noted that the flowers begin to give off indole, and to accumulate it, from the time of the blooming. The maximum yield of indole is reached at dawn. Like Hesse, Cerighelli confirmed that the flowers kept in a confined atmosphere give off three to four times as much indole as they can accumulate. The products of enfleurage are therefore richer in indole than the concretes.

Aside from the yield of indole and of methyl anthranilate, there are no marked differences between the composition of the perfume of extraction and that of the perfume of enfleurage. The continued life of the flower is accompanied by all sorts of generative phenomena of the oil; this is the process of the manufacture of oil of jasmin.¹³

Enfleurage with oils. Cotton cloths, impregnated with oil and folded two or four times, are supported in general by a wide-meshed trellis in a wooden frame 0.80 by 1 meter. These *châssis* are placed in a pile, like those containing fats. The flowers are placed above the cotton cloth, and to the greatest possible extent the petals are placed against the cloth. The chalice therefore is exposed to the air. To remove the flowers, two workers, usually women, hold the cloth by the ends, and turn it over. The flowers fall down, the cloth is unfolded, and the last flowers are removed. After the enfleurage, the cloths are sent to the presses to

remove the greater part of the oil, and then the remainder of the oil is extracted with volatile solvents.

The conduct of oil enfleurage differs but little from enfleurage with fats, but the yields are poorer. Rarely does one obtain more than 2 kg of jasmin.

Enfleurage with Solid Adsorbents. This method of treatment, regardless of the nature of the adsorbent, presents *a priori* certain great advantages:

- (1) The adsorption surface is very large.
- (2) The flowers do not adhere, their life is prolonged, and separation is simple.
- (3) The work can be done in factories that are not well ventilated.
- (4) The extraction can be mechanized.

Unfortunately, the adsorption itself is mediocre, the yield in perfume extracted is low, and the nature of the perfume is different from that regularly obtained by the usual enfleurage.

The contact of the flower with an adsorption agent acting by dissolution is indispensable. It is also possible that this direct contact may bring about the dissociation of complex products, generators of odorous substances, a dissociation which is impossible or at least limited in the case of evaporation.

It is because this situation has not been corrected that the experiments of Piver and his imitators with a "pneumatic" enfleurage have not found industrial application. Piver utilized two chambers in which the flowers were prepared on metallic screens, and glass or silver-plated copper trays held the sheet, forcefully divided across a perforated sheet-iron plating. The screens and the plants alternate, vertically, and are placed like baffle plates. To increase the passage of air, a series of pipes alternate from one chamber to the other.¹⁴

The enfleurage on paraffin plaques, patented by Chardin and Massignon, is not a process of interest, because of the rapid superficial saturation. However, in Syria, according to A. Ruppin,¹⁵ the jasmin flowers are placed in contact with spermaceti plaques which are then sent to France and from which the perfume is there isolated.

The ancient process of screening was revived in 1928 by J. Meunier.¹⁶ The flowers are mixed with solid hydrocarbons melting at not less than 60°, such as the paraffins, the ceresins, ozocerite, etc., coarsely pulverized. They are then separated by shifting. The perfumed powder is extracted with alcohol, and the powder is then reused. Meunier has claimed, in addition to the advantages quoted at the beginning of this section, that the hydrocarbons are practically odorless and very slightly soluble in

alcohol; that a single freezing of the alcoholic extracts gives a usable pomade concentrate; and that, in addition, the complementary treatment of the flowers by petroleum ether gives a better product than the classic *châssis* absolute. But it is our opinion that the absorption is only mediocre, the yield in perfume is low, and the olfactory qualities quite different from those of the perfume isolated by the usual enfleurage.

Enfleurage with adsorbent powders has for a long time been one of the phases of the manufacture of toilet powders in France, and it has recently been used on an experimental scale for the manufacture of the raw materials for perfumery.



Etablissements Antoine Chiria, Grasse

FIGURE 22. *Production of flower oils by maceration or digestion.*

Verley has used as the adsorbent a pulverized wood charcoal, or even better, a mixture of activated carbon and silica gel, and he has isolated the perfume from the adsorbent by means of petroleum ether. He claims that his process, when used with *jasmin* flowers, gives 20 per cent more perfume than the classic enfleurage process. However, the process has not been utilized industrially, and all hopes that have been placed in analogous processes by many inventors have apparently been in vain. The most interesting patents along this line are those of the I. G. Farbenindustrie A.G.,¹⁷ of the Urbain Corporation,¹⁸ and of E. E. Reid.¹⁹ Extraction has been tried under reduced pressure, in an inert gaseous atmosphere (hydrogen, nitrogen, carbonic gas, purified combustion gas, etc.) and the perfume itself has been isolated by steam distillation or by dissolving in alcohol, benzene or petroleum ether.

I. G. Farbenindustrie A.G. has claimed a yield of 750 grams of hya-

cinth oil for 1000 kg of flowers. This result is surprising to us, as the petroleum ether extraction, followed by steam distillation of the concrete, gives at best 60 grams of oil from 280 grams of absolute, and the experiments with enfleurage have not given better results than the extraction process.

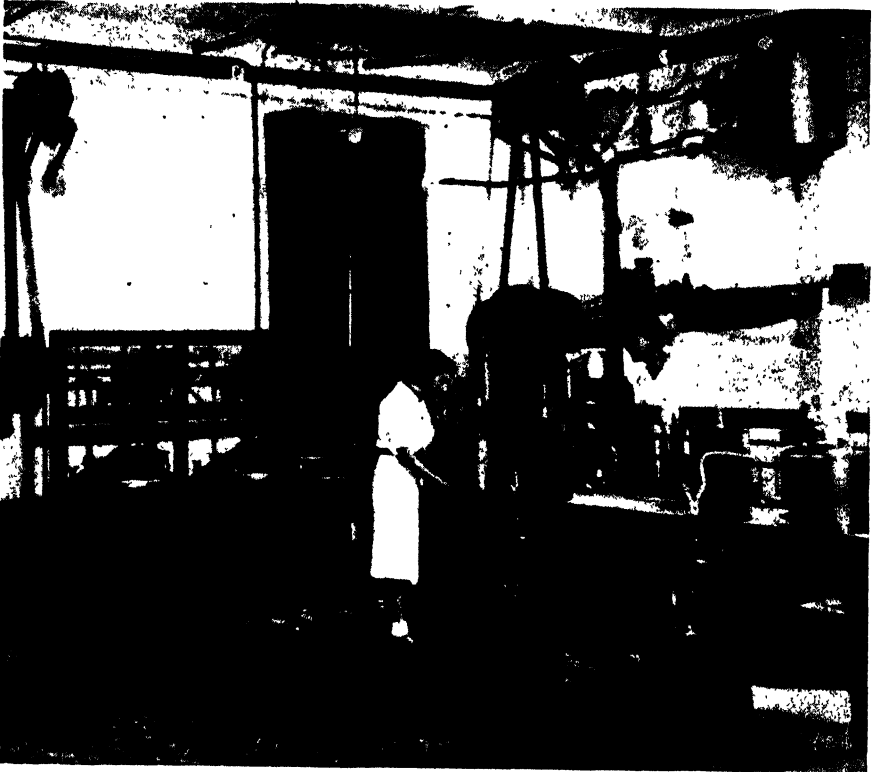

Parfumerie Jean Niel, Grasse

FIGURE 23. *Removal of alcohol by vacuum distillation in the purification of jasmin pomade.*

Besides, by enfleurage of the jasmin flower in contact with activated carbon (NORIT), we have obtained a yield corresponding to 250 grams of oil for 1000 kg of flowers, whereas the usual enfleurage enables one to isolate 1350 grams. The extracted perfume was a greatly modified reflection of the true odor of jasmin, and had no practical value.

Practice of Digestion. Digestion consists in immersing the plant material in melted fats or in oils heated over a water-bath, to about 50 to

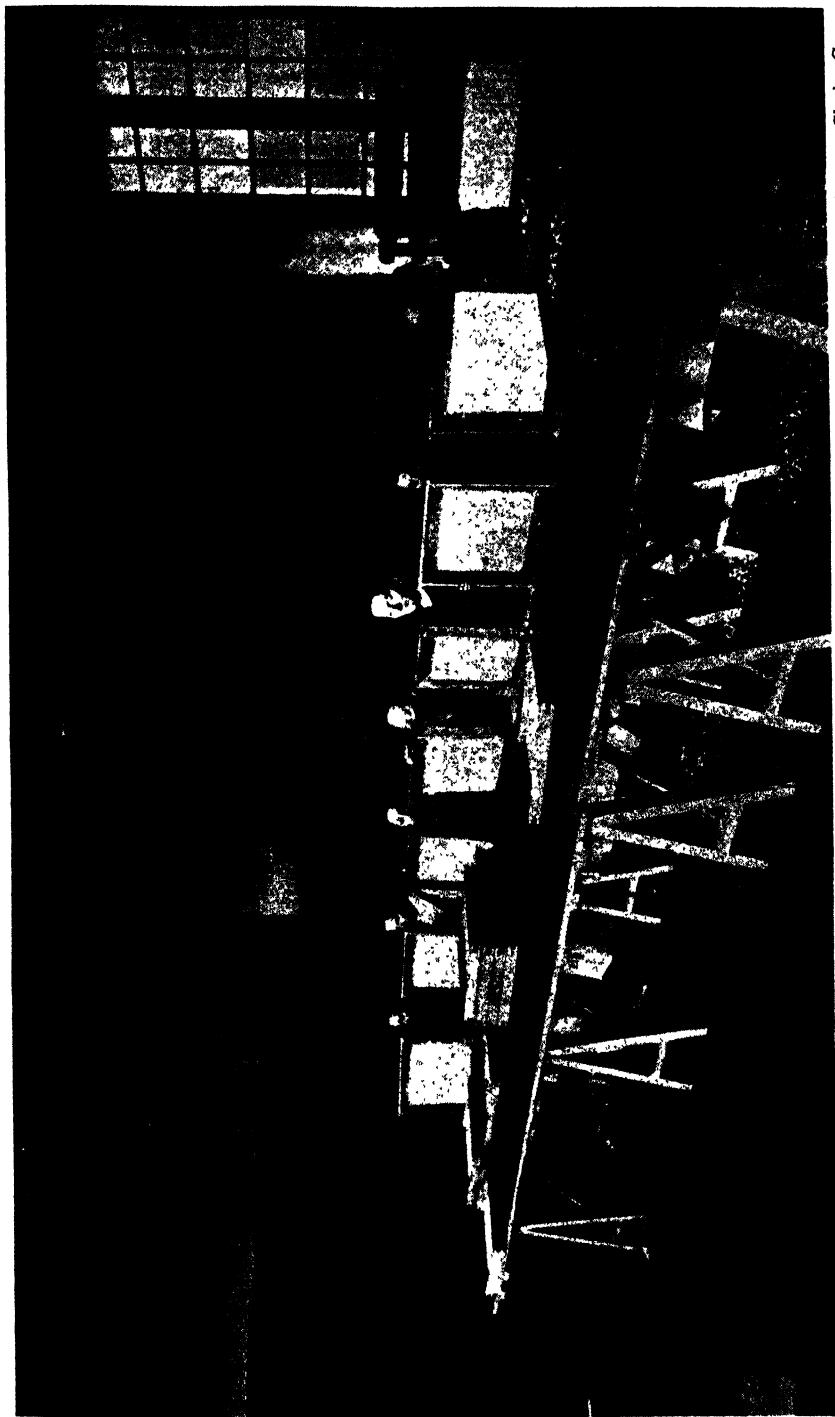

Etablissements Antome Chris, Grasse

FIGURE 24. *Removal of the jasmine flowers from the frames, a process known as defeurage.*

70°, in a copper-plated vat. The fat mixture generally consists of 40 to 50 per cent of lard, and the remainder suet.

The perfume is extracted by immersion for 1 or 2 hours at the most; the intervals between the digestions vary according to the flowering and the supplies, but in general the interval is about 48 hours. There are



Parfumerie Jean Niel, Grasse

FIGURE 25. *Jasmin flowers being removed from the frames. The exhausted flowers are seen under the table.*

usually 10 to 15 immersions, and the total weight of the flowers treated varies between 5 to 10 times that of the fat; any undue increase in the charge will affect the complete extraction of the perfume.

For *rose de mai* or May rose, the charge generally consists of 7 kg of flowers for 1 kg of pomade, in 12 to 15 operations. For the orange flower, only 7 to 8 digestions are made, with 8 to 10 kg of flowers per kilo of pomade.

During the entire time of digestion, the mass is verily slowly moved around. The flowers are separated from the pomade or the oil, either

by a centrifuge or by filtration with a perforated iron sheet. The last quantities of pomade or of oil carried over by the flowers are recovered by placing the flowers in sacks made of *scourtin* or press-bag cloth, and placed, luke-warm, in a hydraulic press; or they may be treated with volatile solvents.

The almost complete absence of volatility of the fats makes for excellent fixation and good conservation of the perfume. The ease of obtaining supplies and the comparatively low price of the fats have favored wider use of this ancient process, particularly when it is con-



Etablissements Antoine Chiris, Grasse

FIGURE 26. *Room for the preparation of alcoholic washings or lavages.*

sidered that its application—if perfection is not being sought—is within the reach of almost every factory, even those rather indifferently equipped.

Treated in this manner are the orange flower, the May rose, the true acacia or *cassie*, the hyacinth, jonquil, narcissus and violet; the perfumes obtained are smoother, much more rounded out and harmonious than the extracts obtained by volatile solvents. Most frequently the pomades, which lend themselves rather well to the concentration of perfume by alcohol, are used; more rarely, the vegetable oils, and on exceptional occasions—because of their poor absorptive power for perfume—the neutralin oils. In the case of the latter, the amounts of enfleurage are even lower than for pomade; for instance, 2 kg for jasmin and 4 to 5 kg for May rose are seldom surpassed. The designation of oils by the numbers

36, 24 and 12, signifying that 1 kg corresponds to 3.6, 2.4 and 1.2 kg of flowers, is therefore not correct.

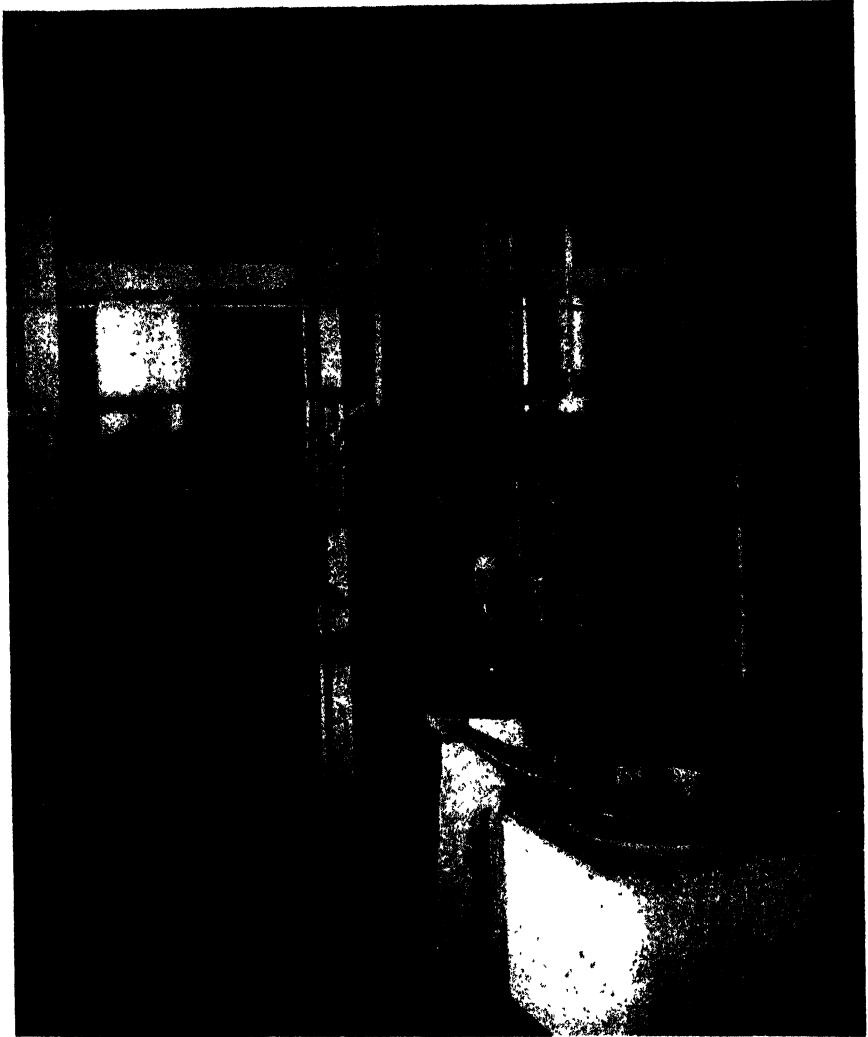

Loutier Fils, Grasse

FIGURE 27. *Apparatus for the preparation of flower oils by maceration or digestion.*

There are also prepared "infusions on oils" from musk, civet, ambergris, vanilla, balsam Peru, tonka bean, etc., in oil, agitating for 10 days with sand or with pieces of glass in a shaker, and filtering. For 100 cc,

10 grams of ambergris or of musk, and 4 grams of civet are generally used.

References

1. Hesse, A. and Müller, F., *Berliner Berichte der Chemie*, 32, 565 and 765 (1899).
2. Hesse, A., *Berliner Berichte der Chemie*, 32, 2611 (1899); 33, 1565 (1900); 34, 2916 (1901); 37, 1457 (1904).
3. Erdmann, E., *Berliner Berichte der Chemie*, 34, 2281 (1901).
4. Jeancard, P., and Satie, C., *Bull. soc. chim.*, 555-600 (1900).
5. v. Soden, H., *J. prakt. Chem.*, (II) 69, 227 (1904); *Deut. Parfum Zt.*, 11, 149 (1925).
6. Viard, M., *Parfums France*, 4, 35 (1926).
7. Les Laboratoires des Établissements Chiris, *Ibid.*, 6, 229 (1928).
8. Naves, Y. R., *Ibid.*, 8, 296 (1930).
9. For comparison, see Louveau, G., "Le jasmin," p. 14-15, published in 1936 by *Rev. marques parfum. savon.*, Paris.
10. Les Laboratoires des Établissements Chiris, *Parfums France*, 8, 296 (1930).
11. Hesse, A., *Berliner Berichte der Chemie*, 30, 295 (1901).
12. Cerighelli, *Compt. rend.*, 179, 1193 (1924).
13. Naves, Y. R., *Parfums France*, 8, 294 (1930).
14. Turgan, "Grandes Usines de France," v. 4, 1932.
15. Ruppin, A., *Ber. Schimmel & Co. Akt. Ges.*, 66 (1917).
16. Meunier, J., French Patent 673,328 (1928).
17. I. G. Farbenindustrie A.G., English Patent 255,346 (1926); 292,668 (1928); French Patent 610,734 (1926).
18. Urbain Corporation Ltd., French Patent 623,002 (1927).
19. Reid, E. E., U. S. Patent 1,786,630 (1930); see *Perfumery Essent. Oil Record*, 312 (1931).

ABSOLUTE ESSENCES AND CONCENTRATES FROM THE PRODUCTS OF ENFLEURAGE AND DIGESTION

General Remarks. The resins, gum-resins, balsams and animal products are most frequently extracted by means of alcohol. The alcoholic resins, redissolved in alcohol, produce the modern successors of the old and classic alcoholic infusions.

On the other hand, alcohol has never been used for the extraction of fresh plant matter, because of the high water content. The industry has therefore had recourse to petroleum ether and to benzene. The extracted products contain a greater or smaller quantity of odorless products, of little importance for the retention of the perfume, and hardly soluble in alcohol.

Starting from the concretes, alcoholic treatment therefore gives on the one hand *insoluble waxes*, and on the other *alcoholic washings* which, after the distillation of the alcohol, become the *absolute essences*, commonly called the *absolutes*.

As for the separation of the odorous, alcohol-soluble fraction of the pomades obtained by enfleurage or by digestion, we have already noted that the perfumers of Provence have practiced this for a long time. They obtain *washings of pomades*, which become the *pomade concentrates* after distillation of the alcohol.

Naudin seems to have been the inventor of the happy improvement, which consists in separating the insoluble fraction after cooling the alcoholic solution to a low temperature (12 to 15° below zero). This technique was taken up by Ch. Garnier in the French patent 223,119 of July 20, 1892. Garnier indicates that the product is to be extracted in alcohol, with or without heat, as the case may be, and filtered; after the filtrate is recooled, it is then refiltered. He offers an excellent innovation in his partial concentration of the alcoholic solution after the first filtration.

Modern Processes for the Preparation of Absolutes and Concentrates from Pomades. *Extraction with Alcohol.* Extraction with alcohol is carried out either in the presence of heat (45 to 60°) or at room temperature. In general, the concretes which soften only at a high temperature are treated with heat; there is no fear of any alcoholysis with these products. Such concretes include, for instance, the rose, and according to information from several manufacturers, jasmin concrete, mimosa concrete and carnation concrete. Also treated with heat, and sometimes refluxed with alcohol, are the concretes of oakmoss; with these products, alcoholysis is frequently desirable (see page 68). Products which contain aldehydes that are acetalizable should be treated at a lower temperature.

Alcoholic treatment can be effected in a kneader of the current Werner type, or in specially adapted apparatus, heated with steam in a double boiler, turning on an axis, and including bruising balls or gravel. This type of apparatus is very good for products of hard consistency, whose waxes are of a greater specific gravity than the alcoholic solution.

Cold treatment is practiced in kneaders. At Grasse, moving mixers, of a special type, known as *batteuses*, are used. These machines are cylindrical; they have a vertical shaft and horizontal paddles whose diametrically opposed surfaces are inclined in opposite directions. The pot itself is capable of rotation in the opposite direction from the movement of the shaft. The circular movement of the shaft is superimposed by a vertical movement, brought about by a cam.

Kneaders with paddles producing epicycloidal movement, of medium speed (80 to 300 revolutions a minute) are used successfully.

It is indispensable to assure a good drainage, but in the majority of cases, it is necessary to avoid too great a division, so that separation of the

greater part of the liquid of extraction can be assured by simple decantation.

In general, there are three successive extractions, with 3, then 2, then 1 part of alcohol. The extracts are decanted by pouring or by siphoning, or by means of a hand dipper, and they are then filtered through a cloth or filter paper. Sometimes there is a fourth extraction with 3 parts of alcohol, but this washing, in place of being united with the first three, is used for the first extraction of the next operation.

When the extraction is made in the presence of heat, the insoluble fraction generally congeals and is separated; it is precipitated by substituting cold water for steam in the base of the double boiler.

The alcoholic extracts are united and then iced at 12 to 15° below zero for several hours, so that the insoluble fractions should come through and be ready for separation. It is then filtered through a rather thick filter paper, frequently adding filtration aids (pulp, silica or colloidal silicates). After that, recooled Büchner funnels are used, or the extract is drawn into refrigerated vats by means of porous glass filters mounted at the ends of suction pipes. Porosity 3 on the Jena scale is suitable.

In modern installations in large factories, the precipitated products are separated by centrifugal action, by means of an apparatus with a cooled basin, and the action is terminated by passage into a supercentrifuge equipped with a separator bowl. The efficiency of the operation is a function of the maintenance of the low temperature.

The amount of materials precipitated and the efficiency of the separation can be enhanced by concentrating the alcoholic solution by partial distillation before freezing, or by diluting the alcohol with water.

These treatments give washings of the concretes and washings of the pomades. These washings can be obtained at a higher concentration, by substituting for the extraction described above a methodic extraction, in which the third washing serves for a second washing in the treatment of a second charge, then for a first washing in the treatment of a third charge. The methodic extraction is generally applied to the treatment of pomades in which the proportion of perfume to be extracted is much smaller than in the concretes, and also because the fats are appreciably soluble in alcohol, even at low temperature.

Concentration of the Washings by Distillation. When the odoriferous product is subjected to alcoholysis, the washing is diluted with salted water and extracted with petroleum ether and benzene, and the extract thus obtained is concentrated by distillation. This is an excellent practice for enhancing the quality of the perfume; furthermore, it reduces

the volume of the solvent to be distilled and it substitutes for alcohol a solvent whose latent heat of vaporization is much lower. However, it is costly, as the recovery of the alcohol is made more difficult, and losses are high.

The industry, however, has recourse to a mixed treatment. The alcohol is concentrated under reduced pressure, utilizing a very efficient column. The distillation is stopped when the remaining liquid becomes heterogeneous (turbidity point), to avoid carrying over any odoriferous substances. The residue is diluted with salted water and is extracted as described above. It is never advisable to continue distillation of the alcohol until it is totally eliminated, because it becomes enriched with water, and odorous substances are distilled.

Despite all precautions, the distilled alcohol always contains small quantities of odorous substances. In order not to lose these products, the alcohol is used in the manufacture of a new quantity of absolute.

It is advisable to use these washings and not the pomade absolutes or concentrates in the preparation of alcoholic perfume solutions. The relative costs of the use of concentrated products and of washings should be studied, the latter being burdened with expenses of packaging and transportation, customs duties and the cost of tying up the alcohol for a period of time. In studying the frequent losses and the deterioration of the perfume in the manufacture of concentrated products, the influence of the alcohol, during the course of long storage, on the perfume of the washings should be considered.

A step forward in the use of the perfume concentrates consists in distilling only a fraction of the alcohol, and utilizing these concentrated washings directly, after having standardized them to a given content of perfume by the addition of highly concentrated alcohol.

Yields in Absolutes and Pomade Concentrates. The table of functional solubilities reproduced on page 68 shows the nature of the separation of constituents by means of alcohol. It is thus that the treatment of the concretes obtained by petroleum ether enables the paraffins, the fatty acids, the fats, the cerides, and a portion of the non-oxygenated carotenoids, of the alkaloids and of the hydrocarbon terpenes to be eliminated. It should here be noted that the concretes from flowers are almost free from terpenes and sesquiterpenes; these substances are met only in the oils from buds and other plant materials.

The functional solubilities have major exceptions. Thus, the glycerides of saturated acids are, in general, hardly soluble in cold alcohol, but those of unsaturated acids are quite soluble. Separation is often complicated by the phenomenon of reciprocal solubility, and it is there-

fore necessary to avoid too great a concentration of the alcohol in washings before freezing. This phenomenon of reciprocal solubility explains the enormous disagreements in the findings of investigators on the entrainment of the glycerides by alcohol, and they justify efficient removal of the fats from the pomade concentrates.

The yields of the most important concretes, in absolutes, are shown in the table below. They are based on extraction by means of three washings with 96 to 97 per cent alcohol. We would consider it an error to push the concentration of the perfume any further, for general usage, for it deprives the absolute of a part of its fixative elements and increases the losses of odorous substances in the course of manufacture.

Flower Absolutes from Concretes

	Per Cent
Acacia Cavenia (<i>Cassie romaine</i>)	about 33
Acacia farnesiana (<i>Cassie ancienne</i>)	about 33
Broom	30 to 40
Carnation	9 to 12
Everlasting	60 to 70
Gardenia	about 50
Hyacinth	10 to 14
Jasmin	45 to 53
Jonquil	40 to 55
Mimosa	20 to 25
Narcissus	27 to 32
Orange flower	36 to 55
Robinia	35 to 40
<i>Rose de mai</i> (French)	55 to 65
Rose (Bulgarian)	50 to 60
Tuberose	18 to 23
Violet (Parma)	35 to 40
Violet (Victoria)	35 to 40
Wistaria	40 to 50
Ylang ylang	75 to 80

Absolutes from Herbs, Leaves and Flowering Stalks

Clary sage	80 to 85
Geranium	70 to 80
Labdanum	45 to 65
Lavandin	45 to 55
Lavender	50 to 60
Mignonette	30 to 35
Verbena	50 to 60
Violet leaf	35 to 40
Zdravets	40 to 45

Indirect Alcoholic Resinoids

Petroleum ether resinoid from orris rhizome	50 to 60
Benzene resinoid from orris rhizome	70 to 80
Petroleum ether resinoid from oakmoss	40 to 60
Benzene resinoid from oakmoss	35 to 50
Benzene resinoid from patchouli leaf	70 to 80
Benzene resinoid from tonka bean	10 to 15
Benzene resinoid from vanilla	60 to 70

Use of solvents other than ethyl alcohol. Efforts have been made to prepare an absolute by means of methyl, propyl and butyl alcohols, but these experiments have not led to commercial application. The solubilities of the constituents of the concretes and the pomades are very different in other solvents than in ethyl alcohol, and in the case of the propyl and butyl alcohols, the solubilities of the waxes and fats are appreciable.

Nomenclatures. The absolutes are also called *produits naturels sans cires* (natural products without waxes) or *parfums naturels sans cires* (natural perfumes without waxes). The fractions of the concretes that are insoluble in alcohol are called *cires résiduaires* (residual waxes), *paraffines résiduaires* (residual paraffins) and *concrètes résiduaires* (residual concretes).

DECOLORIZED CONCRETES, RESINOIDS, ABSOLUTES AND
CONCENTRATES FROM POMADES

General Remarks

The colorless (or to be more exact, the decolorized) concretes, resinoids and absolutes appeared in the perfume raw material market at the end of the last century. Their importance has continuously increased, as the processes of manufacture were improved.

It is possible that their interest for perfumery has been exaggerated. Color is not removed without a loss of useful products, nor without a more or less marked break in the equilibrium of the odorous complex. Products should therefore not be deprived of their color unless necessary, and in many cases it is undesirable to continue the process until decoloration is complete. A compromise must be reached between the inconveniences of highly colored material and the best safeguards for the olfactory note. It should also be taken into account that decolorized products are frequently much more susceptible to alteration than the raw material from which they are made.

These decolorized materials are prepared by adsorption of the colored constituents by means of reagents chosen as specifically for the particular product as is possible. The intensity of the decoloration is a function of the nature of the colored products, of the proportion and the method of application of the adsorbent.

Nature of the Colored Products. *Colored Products from Raw Materials which Undergo Extraction.* These are natural colored products; they belong to several classes, their quantity and their nature depending on the solvent used for extraction. They are:

Chlorophyll Pigments: Various investigators¹ have claimed that these pigments are radically modified in the course of the extraction, and that there develops a complex ensemble of oxidations, dehydrogenations and isomerizations, bringing about brown or blackish-brown pigments.

Carotenoid Pigments: These are the carotenes and xanthophylls which accompany the chlorophylls, and are the pigments existing in the flower in the absence of chlorophyll. These products are very sensitive to oxidation: flavonic, xanthonic and anthocyanic pigments (genestein of broom, quercetagenine of carnation, anthocyanines of rose, hyacinth, saffron, etc.).

These pigments exist either in a free state, or in combination with sugars. If the latter is the case, they are not extracted by petroleum ether or benzene. The same is true of the yellow glucosides of the Convolvulaceae.

Colored Products Generated by Alteration of the Extracts: The products that are created in the course of the alteration of the extracts are not numerous. The best known are: (1) brown chlorophyllanes, derived from chlorophyll; (2) oxidation products of the phenols, dark brown to black brown in color (examples: melanic pigments, phlobaphene derivatives of the tanoids), frequently generated under the influence of oxidases and peroxidases; and (3) alteration products of the nitrogen bases, created by photochemical oxidation or condensation, for example, from indole.

The most frequent causes of the formation of colored products are the following: (1) direction oxidation, for example, of phenolic compounds; (2) diastasic hydrolysis, which liberates alterable aglycones, by oxidation or by hydrolysis.

An important part of the direct oxidations is provoked by diastasic oxidants. Therefore, the reduction of diastasic action by the treatment of the fresh plant material, unaltered, by limiting the contact of the cellular sugars and of the extracts, in turn reduces the coloration of the

products, without the necessity and importance of decoloration treatment.

The metals from which the industrial apparatus is constructed frequently cause the formation of colored salts, or act as catalysts in the genesis of colored products. It is therefore to the producers' interest to select unreactive metals and thus reduce the importance of corrosion factors.

Measure of Coloration

When two products of a similar tint are to be compared, or when the progress of decoloration is to be measured, without a change in the nature of the color, the well-known Dubosq colorimeter can be used. But such cases are rare; it is often necessary to compare products of different colors. For such purpose, one can use photometers, with photoelectric cells, which establish the equality of the luminous flux independently of the color; but it must be remembered that the sensitivity of the cell can vary with the wave length. The use of filters makes possible the approximate monochromatization of the light, and solves this problem.

Direct-vision colorimeters are also frequently employed, most general of which is the Lovibond colorimeter (tintometer). The use of seemingly more perfect apparatus, such as the equipment of Exton, Adler, Vernes, Bricq and Yvon, and the photometer of Pulfrich-Zeiss or the gradual photometer, is less practical and less widespread.

We do not feel it necessary to describe the Lovibond tintometer or the method of its use; it suffices to report on the literature distributed by the manufacturers.

The use of colorimeters makes it possible to follow the treatment of decoloration and to standardize the manufacture of partially decolorized products.

Decoloration by Adsorption

Principles. This method of decoloration is widely used because of its apparent simplicity. It has nevertheless caused many difficult after-effects.

This process consists in placing the product in contact with a porous, solid adsorbent with a large surface, to eliminate the adsorbed material from the colored body and from the excess of adsorbent, by filtration or centrifugal action.

N. Chilow and B. Nekrassow² have studied the relationship between

adsorption with carbon and chemical constitution. Adsorption of stereoisomers has been examined by W. R. Brodi and R. Adams.⁸

The fact that the adsorbents have a tendency to retain substances other than the colored materials is frequently overlooked; a good example is the deodorization of water by adsorption with wood charcoal.

The adsorption of odorous products frequently modifies the perfume note. The damage is considerable when the bouquet character is due to traces of substances, whether it be indole and its homologues or coumarin derivatives, which play such a great role in many natural perfumes, and which are nevertheless found in very small proportions. Yet they are frequently completely eliminated by active adsorbents.

These facts in themselves justify the opinion we have expressed at the opening of this section; namely, that perfumes should be decolorized only when absolutely essential, and only to the extent that is necessary.

However, a section of the adsorbed odoriferous products can be recovered and restored to the decolorized complex. The colored products are not very volatile, and therefore in desorbing by steam distillation, the odorous products are carried over. But frequently the products in question have undergone profound modifications in contact with the adsorbents.

The adsorbents utilized for decoloration (carbon, earths, silica gels) are actually very active catalysts for condensation and oxidation. They provoke polymerization of unsaturated substances. Gurwitsch⁴ has even claimed that these unsaturated substances are first of all polymerized, and then adsorbed. Some technicians have found a relationship between the capacity for decoloration and the power of oxidation,^{5, 6} for the adsorbents are, in effect, active promoters of oxidation. When the decolorization earths are separated from the organic solutions, the filters can actually go up in flames. This oxidation potentiality affects not only the adsorbed body, but also the products in solution.

Specificity. The specificity of the adsorption depends on the nature of the adsorbent, the temperature, the solvent, the composition of the odorous mixture, the time of the reaction, and all the conditions of contact—occlusion of gases, initial humidity of the adsorbent, and agitation.^{7, 8, 9}

The carbons easily eliminate the chlorophylls and the xanthophylls from the alcoholic solutions, but the concentration of the aqueous alcohol plays an important role, determining the optimum of activity. They are also effective in eliminating the chlorophylls from the benzene or petroleum ether solutions, but not the carotenes, which are adsorbed by alumina. It is therefore of value to use several adsorbents, either

simultaneously or successively. Thus, for the treatment of crude perfumes obtained from green plants, a small proportion of decolorizing earths or of alumina is added to the activated carbons.

Other Elements in the Choice of Adsorbents. Carbons are usually to be preferred to decolorizing earths; they are easier to purify, more active, more selective, and they retain lesser amounts of odorous substances. To our knowledge, silica gels are employed only on rare occasions, for their activity is low, and they produce decolorizing products that have been greatly altered by oxidation.

It is absolutely essential that the adsorbent should not impart an odor to the treated product, and should not acidify it. The absence of iron in the activated carbon is a necessity. As a matter of fact, the carbons which contain some iron possess a catalytic activity conducive to oxidations,¹⁰ and they provoke residual colorations. The absence of iron should therefore be controlled.^{11, 12, 13}

The choice of the carbon can be made only empirically. The adsorption capacity for colored products can be measured by one of the following tests:

*Diphenylguanidine Method.*¹⁴ Two grams of diphenylguanidine are dissolved in 1000 cc of alcohol; 50 cc of this solution are agitated for 2 hours with 1 gram of the sample under study. The solution is filtered and 25 cc of the filtrate is titrated with a decinormal hydrochloric acid solution, using a mixture of bromophenol blue and methyl red as indicator. At the same time, a blank is tested. The activity of the carbon is in proportion to the quantity of diphenylguanidine adsorbed, and this quantity corresponds to the difference between the volumes of the hydrochloric acid solution used.

*Methylene Blue Method.*¹⁵ The adsorption capacity of methylene blue is measured with carbon. This method has been studied by L. Pelet and L. Grand. Several methods of operation have been described, of which the most reliable measure colorimetrically the unadsorbed methylene blue. The following is a description of this method: one-tenth gram of carbon is agitated for 30 minutes, at ordinary temperature, in a ground-stoppered flask, with 50 cc of a 0.20 per cent aqueous solution of methylene blue. The mixture is centrifuged; then 0.5 cc diluted with water to make 50 cc, and 0.5 cc of the original solution are compared with 50 cc of the diluted mixture on the colorimeter.

Decoloration Techniques. For a given adsorbent, the temperature, agitation, nature of the solvent, concentration of the solution, and duration of the action must be taken into consideration.

The optimum of adsorption must be sought empirically, to the extent desired, and with the least possible denaturation of the perfume. Such considerations generally lead to working at ordinary temperature, in a fairly dilute solution (5 to 10 per cent of concrete, 2 to 5 per cent of pomade concentrate).

To restrict recoloration to a minimum, the zone of desorption should be kept as far away as possible, and there is an advantage in dividing the action of the adsorbent into successive charges, when the adsorbent is immersed in the solution in which it is to be treated. Another method is to decolorize by percolation in an adsorbent column. This method, of which chromatography is an application, is by far the longest and requires the largest quantity of adsorbent. It is a process that requires some 40 times as long a time, but it brings about a practical decoloration, and lends itself particularly well to the use of mixed adsorbents.

In order to reduce oxidation, and at the same time facilitate the decoloration, the adsorbent is de-aired by immersing it in a pure solvent, which is then brought to its boiling point. The adsorbed decolorized product is removed, not with the classic Büchner funnel, but by filtering through a vacuum or pressure filter, in an inert gaseous atmosphere. A filter-press is also used. The last traces of solids are removed by ultra-filtration in an inert atmosphere. Many decolorized products owe their sensitivity to oxidation to the presence of colloidal carbon, invisible to the naked eye, and which ultra-filtration eliminates.

Decoloration by Oxidation

The carotenoids are, for the most part, difficult to extract by adsorption, without an appreciable loss of perfume. Attempts have been made to eliminate them by oxidation. This takes place at a low temperature, in the air, under strong ultraviolet radiation. The application of this process to the decolorization of perfume has been little studied as yet. It might prove interesting in the "bleaching" of certain concretes, particularly those of rose and jasmin.

Elimination of Colored Metallic Salts

It is frequently interesting to remove iron and manganese salts. The alcoholic, petroleum ether or benzene solutions are filtered with oxalic, citric or tartaric acids or the solutions washed with these acids. The processes have been developed empirically, and constitute a "sleight-of-hand" which we must be excused for not divulging.

References

1. Hilpert, *Ber.*, **64**, 2570 (1931).
2. Chilow, N., and Nekrassow, B., *J. Russ. Phys.-Chem. Soc.*, **60**, 103-112 (1928).
3. Brodi, W. R., and Adams, R., *J. Am. Chem. Soc.*, **46**, 2032-2043 (1924).
4. Gurwitsch, *Petroleum*, **20**, 903 (1924).
5. Benedict, *Seifensieder-Zeit.*, 243 (1926).
6. Rideal and Thomas, *J. Chem. Soc.*, 2119 (1922).
7. Freundlich, H., "Kapillarchemie," 2nd ed., Akademische Verlagsgesellschaft m.B.H., Leipzig.
8. Hückel, E., "Adsorption und Kapillarkondensation," same publisher.
9. Krczil, "Untersuchung und Bewertung Technischer Adsorptionsstoffe," same publisher.
10. Dorochevski, A., and Bar dt, A., *J. Russ. Phys.-Chem. Soc.*, **46**, 754 (1914).
11. Warburg, A., *Biochem. Z.*, **119**, 134 (1921).
12. Heide, *Wein u. Rebe*, **4**, 359 (1922).
13. Roques, X., *Ann. fals.*, **17**, 215 (1924).
14. Wiegard, W. B., and Snyder, J. W., *Can. Chem. Met.*, **15**, 157-160 (1931).
15. Pelet, L., and Grand, L., *Kolloid-Z.*, **2**, 41 (1907).

SEPARATION OF THE ODOROUS FRACTIONS BY DISTILLATION

General Remarks

The odorous constituents are almost entirely found in the most volatile fractions of the concretes, resinoids and pomades.

These substances can therefore be concentrated, either by simple distillation or by distillation with steam or other suitable vapor. The odorous substances are in this way obtained in a much higher state of concentration than that reached in the manufacture of the pomade absolutes and concentrates. The colored products, with few exceptions, remain in the non-volatile fractions.

An olfactory comparison of the distillates with the pomade absolutes and concentrates shows that the distillates have a hard note, less stable, a little artificial, and are not well conserved. It seems that their relative commercial success is not entirely merited; a close examination would frequently restore to the absolutes an interest which has been diverted in the direction of the more concentrated products.

The volatile fractions are, in general, soluble in alcohol. Therefore, when alcoholysis is not useful, and when the structure of the substances permits, the concretes are treated directly, rather than the absolutes. As for the pomades, their poor perfume content makes necessary the concentration before distillation. An alcoholic concentration is therefore made, without freezing.

Simple Distillation

Simple distillation of these products is a difficult process to carry out. It is necessary to work at a low temperature, so as to avoid pyrolysis, the products of which can damage the perfume. However, it is very difficult to isolate the heavy odorous products; they are energetically retained by the residue, and are difficult to "sweep out" toward the flask. It is therefore necessary to have a good vacuum and to have only a short distance for the vapors to travel, working with very small charges. So as not to lose the constituents of the first fractions (the heads), the distillation is started, according to the efficiency of the condensing agent, at a pressure of 5 to 10 mm, and ended, if possible, under a cathodic vacuum.

Flat-bottomed flasks with large evaporation surfaces are used; they should have short necks, or better, the neck can be a tube which projects into the interior and goes out at the bottom.

Even more delicate to put into operation, although preferable from another point of view, is a distillation with a thin film, continuously fed by a special apparatus of the Watermann type, manufactured by the glass works of Jena.

Simple distillation carries over, in quite a number of cases, a certain proportion of paraffins (for example, rose concrete). The yield by weight is often higher than that of vapor distillation, because of the inevitable pyrolyses, but the residues remain strongly odorous.

Steam Distillation

This method, utilizing steam, was proposed by Ch. Garnier in 1892,¹ at the same time as the process described above. To reduce the importance of chemical modifications, which are related to the temperature, and to increase the speed of distillation and the proportion of odorous substances carried over by the water, the operation is conducted with superheated steam and under reduced pressure. The steam in this case acts like a gas.²

Entrainment with a gas has sometimes been advised, but it presents certain disadvantages. The loss of the uncondensable material is not permissible, and the proportion of losses is a function of the temperature of the source of cooling. It is therefore necessary to recycle the gas; this practice is detrimental in those cases where the substances in the distillate are sensitive to the heat, and where the bouquet is made up of small quantities of volatile products. The condensation of a vapor permits, on the other hand, the almost integral recovery of the distillate.

In the chapter devoted to the analysis of natural perfumes, data concerning a laboratory apparatus invented by Y. P. Naves, actually an adaptation of industrial equipment on a laboratory scale, are given.

The alembic should be tall. The vapor should be divided, so as to favor bubbling and complete distillation, but without excess, which would encourage the formation of cloudiness. The vapor is distributed by means of a steam-coil, supplied with holes, and the passageway of vapor is increased by immersing, in the product to be distilled, some fillers (little balls, stones, coils from washing or distillation columns). The alembic has a double base, heated with steam. The vapor admitted is distended by means of a sluice and circulates in a re-heater (double-concentric coil, whose shaft is fed with vapor under the initial pressure), before paddling in the product.

The head of the gooseneck should be insulated and should contain a valve guarding against the carrying over of sludge. The condensation arrangement should be very effective.

The re-entry of the air should be carefully avoided, for it causes losses of odorous materials by distillation. For this reason, the vapor should be produced in a special generator, from water that is completely free from air. The apparatus should function under the originally established vacuum, without continuous extraction, but this is almost impossible to realize industrially. The pressure should be regulated to furnish the pump with a limited vacuum by-pass, and automatic functioning apparatus that is simple and sure. This apparatus can be advantageously used for a pressure of 35 to 40 mm, with steam of 115 to 120° and a refrigerant whose tank is maintained at 0°.

Other liquids, not miscible in the majority of odorous constituents, can be substituted for water, if they are chemically unreactive, like ethylene glycol and glycerin.

The odorous products are extracted from the distillate by means of benzene or petroleum ether. The approximate yields are shown on pages 151 and 152.

It is not without interest to recall here that the industry of deodorization of oils which is, in the final analysis, an extraction of odorous products, utilizes this process of steam distillation under a vacuum. In 1890, Ed. Bataille patented a super-deodorizer which he claimed would work under a pressure of 5 mm, at 20°.³ A patent for the same type of equipment was taken out in 1893 by the Société des Parfums Naturels at Cannes.

Thanks to this separation of the odorous products, part of the inconveniences of decoloring absolutes by adsorption can be overcome. The non-volatile fraction can be decolorized, and then added to the decolor-

ized product of the distillate, thus reconstituting a decolorized absolute which is a better product than that obtained by the direct decoloration of the absolute.

References

1. Garnier, Ch., French Patent 223,119 (1892); 278,755 (1898).
2. Naves, Y. R., *Documentation sci.*, 59, 269-274 (Nov. 1937).
3. Fritzsche, J., "Fabrication et raffinage des huiles végétales," Paris, 1931, p. 273.

SECTION 3

CHEMICAL COMPOSITION AND ANALYTICAL EXAMINATION OF THE PRODUCTS OF EXTRACTION, ENFLEURAGE AND DIGESTION

CHEMICAL COMPOSITION

Research Studies

The composition of a small number of concrete essences and products of enfleurage has been studied, for the most part since the beginning of this century. A few chemists, most of whom were not in the employ of the Grasse houses, were in the forefront of this work. Illustrating the little interest that has been shown by the Grasse industry for such studies, it is sufficient to recall the words of Louis Roure,¹ one of the leaders and creators of this industry: "It is to be infinitely regretted that we are today obliged to recognize the error committed by Grasse in having neglected the vigorous application of chemical research to the study of flowers . . . Grasse has left to others the honor and the advantage of determining the composition of numerous floral products. It is, however, thanks to the perfected knowledge of these materials that current technical problems have been solved and that new processes for extraction of perfume can be imagined."

Independently of the problems of production, the study of these products is of interest to the consumers. The consumers have had to display confidence in the producers whose trademarks were known to them as representing a given quality, just as the origin covers the quality of wines of good vintage. It is only recently that these purchasers have undertaken any research to create guarantees of their own through an analytical examination of the products they were buying.

This research work has been conducted particularly by the synthetic aromatic chemical industry, despite the tremendous handicaps of the workers who, in a majority of cases, have had great difficulties in obtaining workable quantities of natural products of known purity and quality.

The products of extraction are not used, except in very rare cases,

as raw materials for the preparation of synthetics; they include few constituents that are not obtainable less expensively by the treatment of essential oils. But the synthetic aromatic chemical industry has sought among these products chemicals not discovered in the essential oils, for models or inspirations of their own work. The synthesis of these substances, and the extension of the synthesis to their homologs or to other related products, has been a fruitful work, which has enriched the arsenal of the perfumer with unexpected resources. Let us only recall the discovery of methyl anthranilate and of phenylethyl alcohol in the products of orange flower and rose, a discovery which led to their use in perfumery; and it is interesting also to recall the studies in the structure of jasmone, and of the violet leaf aldehyde, during more recent years.

It is extremely rarely that one can count on such studies to lead to the replacement of natural perfumes with synthetic. The thought of possible rivalry could be entertained only by those who are ignorant of the history and the potentialities of perfumery.

Composition of the Odorous Fractions

In general, the study of the composition of odorous fractions extracted by means of volatile solvents, or by enfleurage or digestion, has been preceded by their separation by steam distillation. It is possible, but not certain, that all the substances discovered had already existed in the original plant raw material, or even in the product of extraction. The investigator examining the results obtained in the analysis of floral concretes is immediately struck by the frequent repetition of aromatic constituents, and by the almost complete absence of terpenes and sesquiterpenes. It should be noted that, in the extraction process, the petals are not separated from other parts of the flower.

These aromatic constituents are the following:

Benzyl alcohol and related esters and ethers (benzyl acetate, benzyl benzoate, methyl benzoate);

Phenylethyl alcohol and phenylethyl isothiocyanate;

Cinnamic alcohol, cinnamyl acetate and cinnamyl aldehyde;

Cuminic aldehyde;

Methyl salicylate and benzyl salicylate;

Methyl anthranilate;

Paracresol, dimethyl hydroquinone, eugenol, isoeugenol, methyl eugenol, vanillin, heliotropin;

Indole.

In the fourth section of this book we shall study in detail the nature of the substances obtained from each product subjected to extraction.

Composition of the Non-Volatile Fraction

The composition of the non-volatile fraction of floral concretes is generally complex. The concretes obtained from flowers and leaves, and the resinoids from peels and barks, are rich in waxes. This is due to the extension to the surface of these plant materials of the lipidic membranes that are impermeable to water, or of "mosaic" membranes, with a predominant lipidic domain.

The chemistry of plant waxes was studied, particularly between 1910 and 1917, by Keegan, and this work was recently taken up again and interpreted by E. Chibnall and his collaborators,² while the waxes of peels and rinds have been the object of remarkable work by C. Feinberg, J. Hermann, L. Roeglesperger and J. Zellner,^{3, 4} and of Bougault and Cattelain.⁵

The waxes separated from the concretes have been studied in a more or less profound manner, by d'Ambrosio⁶ (wax from rose), H. Prophète⁷ (wax from rose), J. F. Stramm⁸ (rose, hyacinth, jasmin, mimosa and violet waxes), Radcliffe and Allen⁹ (jasmin wax), Tsuchihaschi and Tasaki¹⁰ (jasmin wax), L. S. Glichitch¹¹ (carnation wax), and Y. R. Naves¹² (wax from *Geranium macrorrhizum* or Zdravets). Finally, G. Louveau¹³ has described several of the analytical characteristics of the waxes of May rose, jasmin, acacia, mimosa, and violet.

The characteristics (analytical constants) published to date are shown in the accompanying table. From an examination of these characteristics, it can be seen that the waxes contain a large proportion of hydrocarbons, some of them almost as much as 75 per cent. The free acids are the higher fatty acids, for the most part probably hydroxy-acids. Finally, the waxes include a small quantity of glycerides.

The waxes also retain a small quantity of odorous products, usually a few per cent.¹⁷

One of the hydrocarbons generally encountered is triacontane, $C_{30}H_{62}$, m.p. 65°. J. F. Stramm identified it in the waxes from rose, jasmin, violet and hyacinth. Y. R. Naves believed, in 1929, that he had isolated triacontane from the Zdravets concrete. However, from the works of Chibnall and his collaborators, it would seem that the paraffins containing an even number of carbon atoms are rarely found in vegetable waxes. It is likely, therefore, that this was not triacontane, but homologs or mixtures of homologs. In a new study, Naves demonstrated that the Zdravets paraffin was hentriacontane. L. S. Glichitch found heptacosane (m.p. 63 to 64°) in the carnation concrete, of which it constitutes about 31 per cent. H. Prophète has indicated his belief that various paraffins exist in the May rose waxes, but A. C. Chibnall,

	d_{15}	M.P.	C.P.	A.V.	S.V.	I.V.	Acetylation Value	Reichert-Meissl Index	Hegner Index	% of Hydrocarbons
Radcliffe and Allen										
Jasmin, Grasse	—	—	—	—	65.8	52.53	—	—	—	—
Fargeaud ¹⁴	—	—	—	2.6	67.1	52.6	27	1.1	98.4	—
Jasmin	—	—	—	5.5	67.9	25.2	34.8	0.85	98.1	—
Monnery ¹⁴	—	—	—	24.1	26.7	9.4	28.5	0.73	98.9	—
Mimosa	—	—	—	6.4	100.5	77.1	—	0.78	92.4	—
Guérin ¹⁴	—	—	—	3.15	29.8	13	31.9	1.35	97.9	—
Carnation	—	—	—	—	—	—	—	—	—	—
Moriset ¹⁴	—	—	—	—	—	—	—	—	—	—
Orange Flower	—	—	—	—	—	—	—	—	—	—
H. Prophète	—	55–58°	58.5–59°	—	—	—	—	—	—	—
<i>Rose de mai</i> (May rose)	—	—	—	3.4	27.4	—	—	—	—	74.2
J. F. Stramm	—	—	—	2.2	104.8	45.76	—	—	—	25.4
<i>Rose de mai</i> (May rose)	0.930	57.5°	—	—	—	—	—	—	—	—
Hyacinth	0.956	48°	—	—	—	—	—	—	—	—
G. Louveau										
<i>Rose de mai</i> (May rose)	0.988	60°	—	39.4	78.8	—	—	—	—	50.0
<i>Rose de mai</i> (May rose)	0.970	59°	—	38.5	77	—	—	—	—	52.8
Jasmin, Grasse	0.950	60°	—	6.0	62.8	—	—	—	—	44.0
Jasmin, Grasse	0.971	64°	—	7.6	67.6	—	—	—	—	40.8
<i>Acacia Cavenia</i>	0.946	54.5°	—	6.3	58.1	—	—	—	—	29.8
<i>Acacia Cavenia</i>	0.946	53°	—	7.0	59.5	—	—	—	—	28.0
Mimosa	0.962	61°	—	24.8	113.8	—	—	—	—	49.6
Mimosa	0.969	59°	—	25.2	104.1	—	—	—	—	47.2
Violet (Parma)	0.962	58°	—	12.2	67.2	—	—	—	—	44.0
Violet (Parma)	0.966	61°	—	14.4	67.6	—	—	—	—	45.8

Note: Analytical techniques: Iodine value by Hübl method (Prophète). Acetylation value by Leys method (Prophète). Specific gravity by the Fréssinus and Schulze method, modified by Chattaway and Helen (G. Louveau). Hydrocarbons determined by insoluble fraction in acetic anhydride.¹⁶

S. H. Piper, A. Pollard, E. F. Williams and P. N. Sahai² have established that this wax is actually nothing but a mixture of paraffins.

J. F. Stramm has identified cerotic acid in the waxes of rose, jasmin, mimosa, violet; palmitic acid and stearic acid in the mimosa wax; palmitic and stearic, together with another higher fatty acid, in the hyacinth wax.

In the wax of the rose Druschky, d'Ambrosio separated a hydroxystearic acid, $C_{18}H_{36}O$, m.p. 73° , which he called rosolic acid. Under the action of hydriodic acid, this rosolic acid gives an iodine derivative, m.p. 57° , which is transformed by zinc powder into stearic acid. Chromic oxidation of rosolic acid in an acetic acid medium gives azelaic acid.

In the separated neutral part, after saponification, of the wax of May rose, H. Prophète has identified the following alcohols constituting 20 per cent of the wax: pseudocerylic alcohol, m.p. 77° , (acetate, m.p. 61.5°); an alcohol, m.p. 62° (acetate, m.p. 57°), identical with the alcohol found by Kessel in carnauba wax;¹⁸ an isocerylic alcohol, m.p. 58.5° (acetate, m.p. 42° ; acid by chromic oxidation, m.p. 52.5 to 53°); two alcohols of the molecular formula $(C_{10}H_{20}O)_n$, one having m.p. 49.5° (acetate, m.p. 28°), the other m.p. 43° (acetate liquid); an unsaturated alcohol, m.p. 16° (acetate liquid).

Uses of the Waxes: The tons of waxes from the floral concretes each year find use in high-grade soaps, because of their still powerful odor and their excellent stability. They are also used in cosmetic products.

Variation of the Composition of Concretes

The proportion of odorous products in the concretes varies according to the time of harvest and even, it has been shown for various flowers, according to the hour of harvest (*see* monographs on jasmin, p. 192, and orange flower, p. 222). The nature of the perfume also varies, a fact that has been known for a long time (*see* p. 26). The results obtained in the study of the evolution of the composition of essential oils should be studied and examined in the light of the period of vegetation.

ANALYTICAL EXAMINATION*

Relative Infrequency of Analytical Studies

Few studies have been made concerning the methods of analysis of the products of extraction, enfleurage and digestion, and the published

* This section is the development of a study published by Y. R. Naves, S. Sabetay and L. Palfray, in *Perfumery Essent. Oil Record*, 28, 327 ff. (1937). The translator is indebted to the study in question for aid in the translation of this part of the book.

results of the analytical examination of these products are rare. The experiments of H. Walbaum and A. Rosenthal¹⁹ and of Y. R. Naves, S. Sabetay and L. Palfray²⁰ constitute the only works of any scope that have been made. In addition to these, there are the works of Hesse and his collaborators, v. Soden, Treff, Werner, Wittrisch, and G. and M. G. Igolen, who have published a considerable amount of information that will be summarized a little later.

Analysis for commercial purposes is but little practiced. Contrary to the frequently accepted opinion, the generally high prices of natural perfume materials do not constitute a valid reason for dispensing with the analytical examination. Just the contrary; these high prices justify a sacrifice of raw materials in order to establish controls over the concentration and quality of odorous products. This concentration, though it varies little for the concretes, varies considerably, on the other hand, for the absolutes, and for the products of enfleurage and digestion.*

The olfactory examination, to which the large majority of consumers limit themselves, is an indispensable factor, insufficient though it is. No one would dream of judging the vintage of a wine solely by its alcohol content, its extractives, etc. The same is true of the raw materials of perfumery; and we say this particularly for the official laboratories, as well as for the professional laboratories who must arbitrate commercial controversies, as they frequently neglect the olfactory characteristics.

But an olfactory examination, like any organoleptic examination, requires a consummate knowledge of the entire class of products under study, and also, since a perfect olfactory memory is a very rare gift, it requires authentic control samples for comparison. However, such an olfactory knowledge is not frequently encountered, and good control samples often have their shortcomings; finally, the products in question are very easily alterable. Furthermore, an olfactory examination makes possible an appreciation of the entire tone-value but does not establish an olfactory yield with the necessary exactitude, except after costly and fatiguing tests.

On the other hand, the other analytical studies to which the olfactory examination can look for support and for specific data, are mathematically definite, and they have a permanent value, unchanging with the passage of time.

Difficulties of Analytical Examination. The analysis of natural per-

* It would also be desirable for customs duties to be based on the content of odoriferous substances.

fumes is a delicate matter. It is hampered by difficulties of interpretation due to the presence of a large proportion of olfactorily inert substances which possess a variety of chemical functions analogous to those of the odorous constituents themselves. Finally, the products that are marketed are frequently diluted, either by odorless materials, or by odorous substances taken from a wide variety of essential oils, or by artificial or synthetic substances.

First of all, it is necessary to carry out the principal analytical examination upon the odorous fraction. If any considerable amount of hydrolysis is avoided, this fraction is identical with the steam-distillable fraction. The analytical difficulties are then of the same order as in the examination of essential oils. Furthermore, the knowledge of yield in odorous products is an analytical tool of the first importance.

Before this, however, there are certain analyses which can and should be made on the crude product. We shall point these out in studying successively the analysis of concretes, of absolutes, of pomades, of pomade concentrates, and of the steam distillates obtained from these different classes of products. We shall also return to the various information given in this chapter and supplement it, when we deal with altered and adulterated products.

The analysis should include the examination of the original or crude material as well as of the distillates. The olfactory examination is made on the alcoholic solution (or extract) in a 2, 5 or 10 per cent concentration, and on the distillate. The examination of the distillate is generally more revealing than that of the original product, provided that the distillation does not correct certain defects due to alteration or to fraud (see page 155). The successive olfactory notes come off more easily, and lend themselves better to analysis.

Examination of the Concretes and Non-Alcoholic Resinoids

The appearance and the consistency of these products are generally characteristic factors. Some are soft and almost liquid; others are very hard, not softening until they reach 50 or 60°. The color varies from a light green (rose concrete, for example) to a very dark green (lavender) and from a very light brown (mimosa) to the dark brown of the majority of the resinoids.

As a rule, the commercial products contain small quantities of solvents, which must be eliminated before the analysis can be pursued, and it is useful to make a quantitative determination of these solvents. To do this, a known quantity of the product, 5 or 10 grams, for instance,

is placed in a small tared distillation flask, and the solvent is distilled off under a mercury pressure of 30 to 50 mm, heating the water-bath to 40 to 50°. It is not wise to add a small quantity of alcohol, an addition which is of value only from an olfactory point of view, in the preparation of commercial absolutes and resinoids; for it is just as difficult to eliminate the alcohol by distillation as it is the products in question; but the addition of from 1 to 2 cc of freshly rectified and dry ether is useful. Evaporation takes place without the entry of air, so as not to carry over any odorous products.

For a quantitative determination of small amounts of alcohol which might come from the distillation, in the course of industrial manufacture (see page 100), the reader is referred to the section on examination of absolutes.

The presence of 2 to 5 per cent of solvent in the concretes and resinoids, which are not to be used directly as such, can be considered normal. The other products should be free from solvents.

The product which has been freed of the solvent should be examined, after allowing it to rest for several hours, for determination of the melting point. The determination of this constant should be made in the standard Ubbelohde apparatus, or if this not available, by the Bensemann method.²¹ The specific gravity is determined in a pycnometer.

The determinations of rotatory power and refractive index are not of outstanding interest. The former is taken in a 5 or 10 per cent carbon tetrachloride solution, in which practically all concretes are completely soluble, and the latter at the proper temperature, corresponding not to the melting point but rather to the point of complete liquefaction.

It is not advisable to determine the percentage of volatile products by heating over a water-bath or on a stove. A long time is required to obtain a rather constant weight. This determination is merely a duplication of the determination of products that are volatile in steam, their results presenting certain deviations which are approximately proportional to the absolute values found.

The acid value and the saponification value are determined in the usual manner. In the rather frequent cases in which the product is not entirely or is incompletely dissolved in alcohol, this is carried out in a mixed alcohol-benzene solution.

There are cases where other functional determinations can be fruitfully made—those in which the waxy fraction does not include the functional groups considered; determinations are thus made for aldehydes and ketones. The quantitative oximation of the concrete itself offers very interesting results, and as the aldehyde or ketone content of the

volatile fraction varies only between strict limits, it gives an idea of the percentage of volatile products. In the same way, it is interesting to determine directly the percentage of phenylethyl isothiocyanate by the sulfur determination of mignonette concrete; the direct determination of the indole and the methyl anthranilate content of the products of jasmin and orange flower is also of interest.

Determination of the Yield of Absolute

Absolutes are seldom prepared from petroleum ether and benzene resinoids. In general, the alcoholic resinoids are manufactured directly. But the transformation of the concretes into absolutes is a general process, and is indispensable for industrial use. It is frequently useful to determine the value of a concrete from the point of view of its yield of absolute.

The analytical process closely follows the method of manufacture; there are several alcoholic extractions, which are reunited, dried, iced and filtered; finally the alcohol is removed by distillation. The laboratory determination involves certain experimental difficulties that are not properly solved by the majority of workers. These difficulties concern the insolubility at low temperature and filtration. It is indispensable:

(1) To maintain the alcoholic solution for several hours between -12 and -15° , so that the insoluble products precipitate and leave the tincture, which facilitates the drying and washing.

(2) To filter in an isothermal apparatus.

(3) To wash the insoluble products with a little cold alcohol, and to dry the cake in contact with cold air. If these conditions are followed, the analytical yield of absolute closely corresponds to the industrial yield.

The apparatus devised by Y. R. Naves²² to effectuate these separations includes, as the filter, a plaque of porous glass, porosity 3 of the Jena scale (15 to 40μ) generally being chosen; it is only in the presence of small quantities of metallic soaps coming from a reaction with the apparatus that use is made of porosity 4, with rapid filtration (5 to 15μ). It is constructed by Schott and Gen., of Jena.

The apparatus is shown on page 146. The alcoholic solution comes from the successive extraction by 3, then 2, then 1 part of 96 per cent alcohol, at a low temperature with a mortar, or with heat, mixing it with a glass rod, and is filtered on a fluted filter paper, which is then washed with a minimum of alcohol. The washing is united with the filtrates. The reunited liquids are cooled in the upper receptacle for at least 4 hours, then allowed to run on the filter while the glass stopper which closes the receptacle at the base is lifted. A light vacuum suction

assures rapid filtration. The precipitate should not be completely dried, but should be washed twice with a little cooled alcohol. The drying is perfected by passage of air, or better of carbonic gas, cooled by circulation in a small-diametered tin tube, rounded into a cylinder and placed in the refrigerant mixture. The glass stopper having been taken away, this tube is bound to the neck of the apparatus, with the aid of a rubber stopper. The following are the dimensions of an apparatus in which 10 grams of concrete are to be tested: the upper section has a capacity

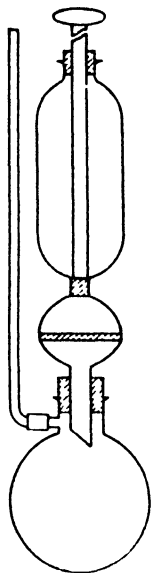

FIGURE 28. *Naves apparatus for the analytical determination of the yield of absolute.*

of 70 cc, the receiving flask of 135 cc. The apparatus is placed in a cooling mixture contained in a d'Arsonval (Dewar) bowl, or in a refrigerant. For the yields, see page 125; they are dependent on the processes described above.

Examination of the Absolutes

A rather large number of analyses of absolutes have been published. These results have a relative value, for the methods of preparation of the absolutes vary with the strength and the quantity of the alcohol employed, the number and the successive series of extractions, the completeness of the successive separations, and finally with the degree of care used in all

these delicate operations and in the separation of the alcohol and the absolutes.

The large number of these factors explains the great variations in the analytical characteristics attributed to the absolutes by the various authors.

The interest in the analysis of functional groups, when applied to absolutes, is the same as in the examination of the concretes. In addition, analysis affords a means of controlling the uniformity of manufacture.

The solubility of the essences in alcohol should be verified. The solution in 3 volumes of 95.6 per cent alcohol should remain clear for several hours at 0°. On the subject of the examination of the altered or adulterated products, see page 156.

The majority of the absolutes contain some alcohol. From 2 to 5 per cent can be tolerated, particularly since the complete elimination of alcohol is accompanied by notable odorous losses. To determine the amount of alcohol, the Thorpe method is used; the absolute is washed, after being dissolved in a light petroleum ether and after eventual filtration of the insoluble products, which would hinder washing; or in the absence of other interfering products, the quantity of alcohol is determined by the Zeisel method.

Examination of the Pomades

The sole interest in examining pomades is to determine the extent of their alteration (see page 155) and their yield in pomade concentrates and in odorous products.

To determine their yield in concentrates, the same method as used in the determination of absolutes from concretes is employed, but since the yield varies between 1 and 2 per cent, it is necessary to treat a rather large quantity of pomade. For the same reason—that is, the low yield—an analytical steam-distillation of the pomade itself should not be made, but only of the pomade concentrate, or a concentrate prepared without refrigeration, with this distillation particularly in mind.

Examination of the Pomade Concentrate

The nature of the important fraction of the fats included in the pomade concentrates is rather variable, changing with the composition of the prepared corps, the conduct of the enfleurage or digestion, and the details of the preparation of the concentrate.

Other than for research or for the study of the measurement of alteration, all analytical work should be done on the distillable section of the natural perfume.

Isolation of the Steam-Distillable Fraction

Isolation by steam distillation has been used since the beginning of this century, for the study of the perfume of extraction or enfleurage, but only recently have there been efforts to study the specific conditions which will give dependable results.

Walbaum and Rosenthal Technique. Walbaum and Rosenthal were the first to outline such conditions,²³ and their method is summarized as follows: 10 grams of concrete (or 5 grams of absolute) are distilled in the presence of 10 grams of sea salt and 100 grams of water. The distillate is extracted with ether and the aqueous fraction is cohobated continuously. The flask is heated in an air-bath, in an oven of boiling tetraline (b.p. 182°). After 5 hours of distillation, the ethereal solution is decanted into a tared flask, and the ether removed by distillation.

In the opinion of the authors of this volume, the separation of the volatile fraction and of the waxes is far from being complete. The degrees of separation are comparable only under identical conditions of operation. We should add that the conduct of this operation is difficult; the formation of mounds and the frequent frothing and bumping require uninterrupted attention. Furthermore, 5 hours seems to be an insufficient time to carry out the operation. There is considerable uncertainty as to the completeness of the separation, even under the same conditions. Finally, the high temperature causes hydrolysis and other chemical modifications.

Because of these difficult operating conditions and the uncertainties, the operation cannot be put into the hands of any worker, and even under ideal conditions, the final results cannot always be guaranteed.

Y. R. Naves Technique. A technique has been described by Y. R. Naves, which he believes is more accurate, more reliable, more practical and more certain; it utilizes distillation by superheated steam under reduced pressure.²⁴

The distillation is effected in a special double-coated flask. Between the two walls there circulates steam coming from a separated generator, the excess of steam escaping at the base through a slender tube, and condensing in a small Florentine flask fed with running water. The steam being carried over has previously been taken from this circuit and its rate of flow is regulated by a tap.

The dimensions of the splash head should be as small as possible. This splash head is carefully insulated, as is the ascending branch of the evacuation tube, as for instance with cotton wool. Thorough insulation is indispensable to prevent condensation and retrogression of the vapors,

which would diminish the yield of the operation and could provoke hydrolytic reactions.

A rapid-acting and efficient condenser is chosen. With a good condenser, fed with iced water, pressures of 30 to 35 mm of mercury can be

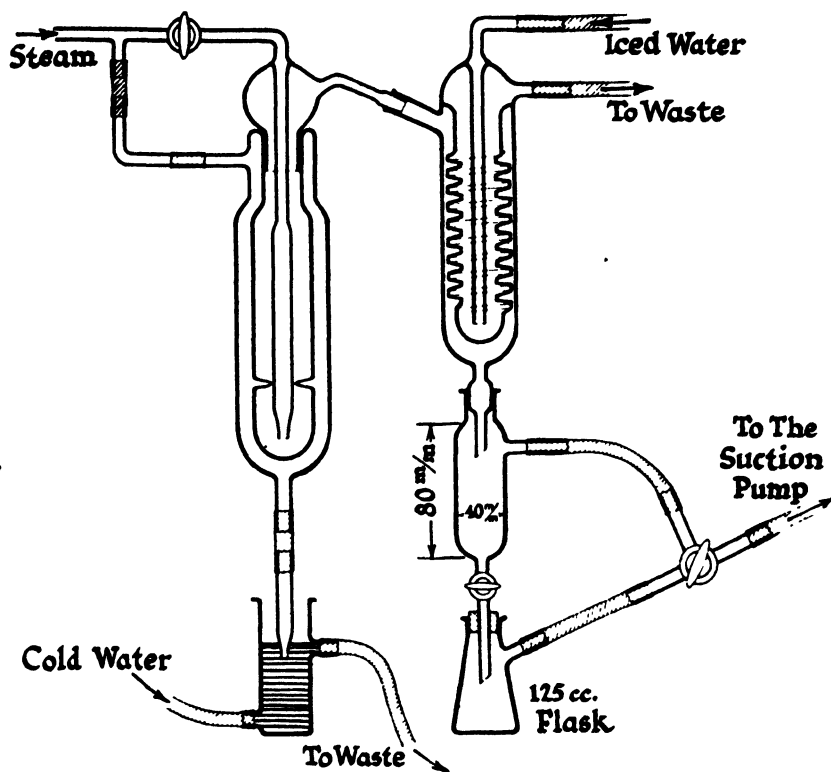

FIGURE 29. Naves apparatus for distillation under reduced pressure with superheated steam.

used. The pressure is established by a water-pump, and is regulated by any appropriate apparatus, such as that invented by Cherbuliez.²⁵

An entrainment apparatus of the same order enables the operation to be conducted on a very small quantity of material. It is an adaptation of an apparatus manufactured by Bruère for the determination of volatile acidity.²⁶ The tube, which contains the product being treated, is heated in the same atmosphere as the steam-generating flask. The introduction of steam is regulated by a tap or by a pincer with parallel screws and blades. The same precautions are taken against primage and premature condensations.

The steam should be generated from perfectly deaerated water. The generator and the jacket should be carefully freed of air by sweeping with steam, before admitting the steam into the distilling flask. The fact is that this air is susceptible of provoking losses in distilled products, and this consideration is very important when dealing with complex aromatic products, whose olfactory value is particularly associated with the presence of small proportions of the lower-boiling constituents.

As soon as the flask and its contents have reached the temperature of the vapor, and the refrigerant is functioning, the vacuum is established, and the release tap opened so as to admit the maximum quantity of steam compatible with the efficiency of the condenser and with the absence of priming in the splash head. An excellent practice consists in providing the socket of the joint supporting this head with a glass cotton buffer.

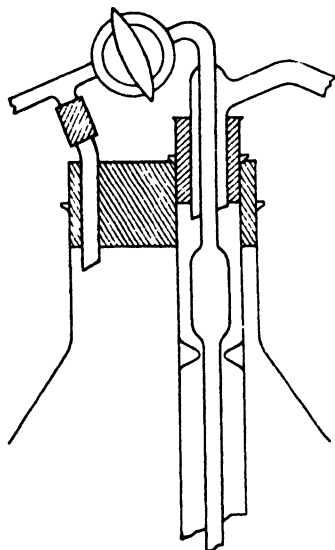

FIGURE 30. *Head of the Naves apparatus for steam distillation of very small quantities of a substance.*

The distillation requires 30 to 50 minutes, and at its end, the recooled residue should be practically odorless. The distillation is considered finished when no oil particles are observed in the distillate, or when there is no separation if the flow into the lower receptacle is interrupted.

Certain products leave a deposit of odorous constituents in the splash head, no matter how well insulated it may be. Thus, during the distillation of the products of the tonka bean, of the *Liatris* (deer's tongue), of the melilot vine and the lavender, all of which contain some coumarins, a large proportion of these coumarins is deposited. In the course of the

distillation of the products extracted from lichens, which are already more or less alcoholized, everminic and divaricatinic esters are deposited.

The distillate is extracted by means of pentane or ether, or a mixture of both, according to the results obtained by preliminary experiments. The solvent is first of all utilized for rinsing the condenser, the separator and, in the case of deposits such as mentioned above, the splash head. The aqueous phase is saturated with sodium chloride and the solvent utilized in several fractions.

The apparatus, which is manufactured in France by Société Le Pyrex, and in Germany by Schott and Gen. of Jena, is about 300 mm high (distillation vessel). A maximum of 15 to 30 grams of a product can be treated at one time. Usually the volume of the distillate varies between 60 and 80 cc, and it is extracted successively with 30, 20 and 20 cc of solvent. In the case of distillates that are rich in water-soluble materials (rose, jasmin, orange flower, ylang ylang, etc.) the number of extractions is increased to 5. In general, pentane is suitable, ether being added or substituted only in case of necessity.*

The extract is desiccated over anhydrous sodium sulfate (free from the carbonate) and then concentrated on the water-bath. Evaporation of the solvent is completed, without application of heat, in a small tared distillation flask, under vacuum; a pressure of 16 to 18 mm is suitable in the majority of cases, and is reduced to 4 to 6 mm for viscous products free from volatile constituents. Utilization of a capillary air inlet to facilitate the separation should be avoided, as this air inlet may cause considerable losses.

In the case of very volatile products, the distillate is salted until saturated, then cooled and extracted with ethyl chloride (b.p. 14 to 15°) or with methyl ethyl ether (b.p. 11°). The dried extract is reheated to room temperature in a tared extraction flask, where the solvent leaves the essential products.

The usual yields, based on concretes or pomade concentrates, are as follows:

<i>Concretes from Flowers</i>	<i>% Oil Obtained from Concretes</i>
<i>Acacia Cavenia</i> , Provence	7 to 10.4
<i>Acacia farnesiana</i> , Egypt	6.5 to 9
Carnation, Provence	1 to 3.6
Everlasting, Esterel	3.6 to 7
Hyacinth, Provence	1.8 to 3
Jasmin, Provence	10 to 19

* Note—See modifications in *Helv. Chim. Acta.*, 27, 1103-1108 (1944) for rose, jasmin and ylang ylang products.

<i>Concretes from Flowers</i>	<i>% Oil Obtained from Concretes</i>
Jonquil, Provence	3 to 7
Karokarounde, Guiana	17.2
Mimosa, Provence	4.1 to 6.2
Narcissus, Provence	2.2 to 3.5
Orange Flower, Provence	22 to 36
May Rose, Provence	25 to 32
Rose, Bulgaria	35 to 41
Tuberose, Provence	3.3 to 4.1
Ylang Ylang, Réunion	51 to 63
<i>Concretes from Flowering Summits or Herbs</i>	<i>% Oil Obtained</i>
Black Currant, Burgundy	15.7
Clary Sage, Provence	7 to 13.5
Geranium, Provence	60 to 68
Labdanum, Esterel	3.2 to 5
Lavandin, Provence	40 to 48
Lavender, Provence	37 to 54
Mignonette, Provence	3.8 to 5.5
Verbena, Algeria	30 to 36
Verbena, Provence	30
Violet Leaf, Provence	4 to 12
Zdravets, Bulgaria	6 to 7

These concretes are obtained by petroleum ether extraction, with the exception of the concretes of black currant buds and of geraniums, which are manufactured by benzene extraction.

<i>Resinoids</i>	<i>% Oil Obtained</i>
Cedar root from Morocco (benzene)	28.5
Orris rhizome, Tuscany (petroleum ether)	3 to 7
Oakmoss, Czechoslovakia:	
benzene	3 to 4.8
ethyl alcohol	8 to 13.4
<i>Products of Enfleurage and of Digestion (Grasse)</i>	<i>% Oil Obtained</i>
Jasmin pomade concentrate, yield approx.	
1.2 to 1.8%	26.1 to 15.5
Tuberose pomade concentrate, yield approx.	
1.2 to 1.5%	14.8 to 11.4
Orange flower pomade concentrate, by digestion	6.1 to 10.2
May rose pomade concentrate, by digestion	31.0

Analysis of Distillates. The weight of the aromatic distillate obtained varies, according to the material under study, between 0.5 and 12 grams. The distillate is analyzed, utilizing techniques appropriate to the analysis

of essential oils. As often as possible, use is made of sensitive methods—that is, those in which the experimental error is small in relation to the limits of the constants observed.

Interpretation of Analytical Results

The characteristics of the concretes and particularly of their volatile fractions vary only between the narrowest limits. In the case of floral

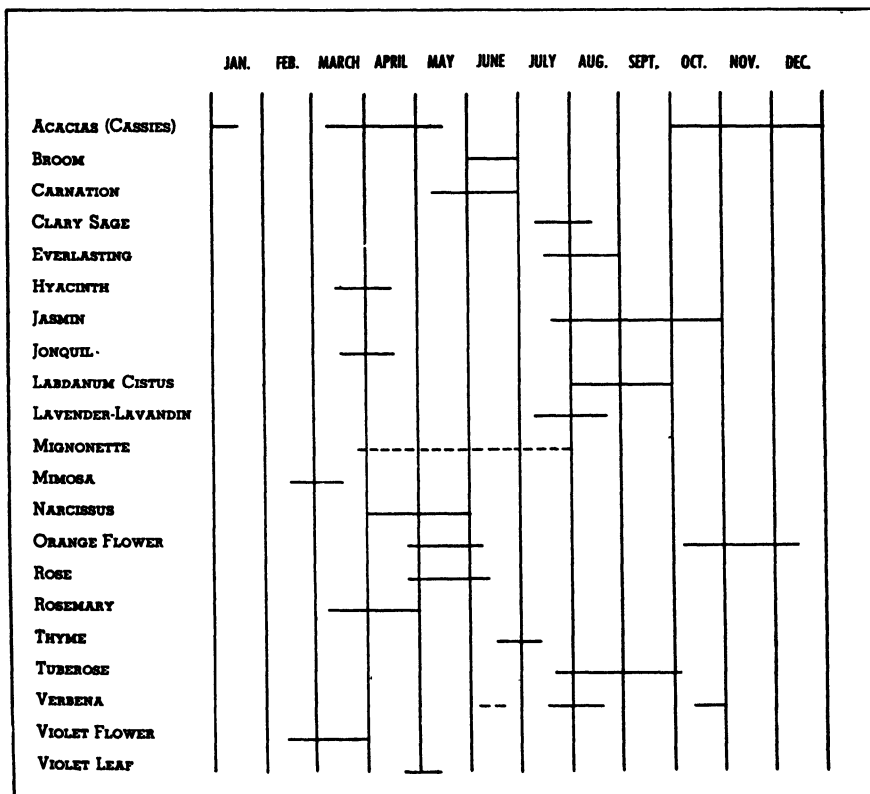

FIGURE 31. *Periods of the year for the treatment of various flowers produced in Provence.*

products, several observations can be cited to support this statement:

(1) Flowering is a well-determined physiological period of the year, and the flowers therefore constitute a perfectly homogeneous raw material. The manufacturers of natural perfumes are few in number, and they utilize rather similar material and techniques. Their manufacturing processes are somewhat uniform.

(2) Each producer generally gathers in the production from the entire countryside, in order to have a homogeneous product for marketing. The seasonal influences, which are rather marked when the olfactory characteristics are considered, have only a slight influence on the variation of physical and chemical properties. On the other hand, the influence of the length of the period of treatment can be detected, and it is known that the beginning and end of the harvest are fixed each year by taking into account the quantitative needs of the market.

Carry-over of stocks from one year to another is frequent, and these stocks are "refreshed" by being blended with fresh material; this tends to cancel the influence of seasonal variations on the products delivered to the market.

(3) The analytical characteristics of the volatile fractions of the concretes of a given geographical origin show little variation.

The products of enfleurage present an entirely different picture. The fact is that the techniques—the nature and preparation of the corps, the charge of the enfleurage, the number and the duration of the enfleurages, and the attention given to the entire operation—are all divergent factors in the influence of the character of the perfumed product.

If, for instance, the influence of the variation of the charge of enfleurage of *jasmin* is examined, all other conditions being equal, it will be seen that the yield in odorous products, based on the weight of the flowers, diminishes as the daily charge is increased. While this yield is about 0.20 per cent of the flowers for an enfleurage charge of 1500 grams per kilogram of fat, it falls to about 0.12 per cent for a charge of 2500 grams. This factor, which hardly influences the yield in pomade concentrates, of which the major part consists of fats, explains the large differences in yield given by the pomade concentrates when they are steam-distilled. The characteristics of the distillates vary at the same time as the quantities.

Altered Products

Concretes. The waxy concretes are hardly alterable. As a matter of fact, they are subject to contact with air and eventually with light, only on an unchanging surface, and they are not permeable to air or transparent to light, except in an unusually thin layer. Furthermore, they seem to contain rather efficient quantities of oxidation inhibitors; their absolutes are remarkably stable, and rancidify only with difficulty. Finally, favorable to their conservation, particularly when compared with the essential oils, is the absence of terpenes and sesquiterpenes from most of these products.

Certain concretes and their corresponding absolutes (jasmin, acacia, karokaroundé, orange flower, tuberose, etc.) turn dark red on standing, and this discoloration is frequently attributed to the presence of indole among the constituents. The distillates obtained by steam distillation are colorless. It is therefore opportune to note the alteration in examining the original product.

Products of Enfleurage and Digestion. Pomades are much more susceptible to alteration than concretes and absolutes. Like the latter, they darken, only more rapidly. But above all they acidify (acetification) and rancidify.

Acidification is a very frequent form of alteration, particularly in the pomade concentrates. The altered product contains acetic acid, ethyl acetate, etc. It has an acidic, vinegar-like odor. Examination of the distillation product only infrequently shows the degree of alteration, for the acetic acid and the ethyl acetate are partly dissolved in the water. Steam distillation, in fact, permits the partial regeneration of these greatly altered products.

The acid value of the jasmin pomade from enfleurage should not surpass 2.0, and the ester value should be between 192 and 198. The acid value of the pomade concentrate should reach 80.0 at the most. For normal products, this acid value is due almost entirely to the higher acids.

Alteration by acidification is easily recognizable by the determination of the acid and ester values of the aqueous distillate. In the case of well conserved products, the acid value is very small, lower than 10.0, and the ester value is practically zero.

A moderate degree of rancidification is scarcely ever revealed by examination of the distillate. The most that the nose can determine from the distillate is the presence of the characteristic ketones, derived from the degradation of the oxidation products of the fats. The analytical confirmation and estimation of the degree of rancidification are determined by an examination of the initial product. It is preferable to use the methods of Kreis,^{27, 28, 29} and of Stamm^{30, 31} rather than the potassium iodide method^{32, 33} and as it is known that to a large extent the degree of rancidity can be related to the degree of peroxidation, it is possible to measure it by the quantitative determination of peroxides, for example by the method of the salts of trivalent titanium.³⁴

Falsified Products

A great many commercial products are placed on the market after having been falsified. It is worthwhile to examine the causes of falsifica-

tion, the methods of the falsifiers, and the research to determine falsification.

Causes. The causes of falsification are to be found essentially in the ignorance of the consumers, their efforts to find low prices, and the practically universal absence of official control in the quality of commercial products.

The ignorance of the majority of the consumers is amply demonstrated by the state of the market and the superabundance of forms under which commercial products are placed on the market and sold. This ignorance is in part excusable because products of a known purity are difficult to procure, because the appropriate analytical methods have been offered only recently, and because documentary analytical reports are still very rare.

During certain periods, falsification was practically imposed on the industry by the establishment of very low prices, which left only a very small margin, insufficient even for the most favored manufacturers to cover normal costs of manufacture and still give an interesting return.

There have even been times when the producers were selling materials at prices below the costs of the fresh plants. The market in acacia concretes, for several years during the thirties, was an illustration of this aberration. In a period of continuous low prices or of stagnation of the market, the carry-over of stocks maintains or aggravates this condition.

It is very difficult to calculate a standard cost price based on the price of the plant material and on the average manufacturing costs, as the latter vary considerably, often doubling from one manufacturer to another, as the manufacturing techniques differ, because their preparation is more or less successfully practiced, and because the care that must be taken to condition the quality—and proper care is very expensive—is more respected in one company than in another. Taxation may also be a cause of injustice. It is good commercial practice to pay for genuine merchandise at its price, and the knowledge of materials demonstrates that falsified products are actually very expensive.

Means of Fraud and Search for Fraud. There are two main types of falsification:

- (1) The substitution of foreign products that are less costly, and that can at the same time be a fraud on the origin and on the quality.
- (2) The diluting of natural products with artificial or synthetic materials, or the presence of abnormal quantities of solvents.

Substitution by products of foreign origin, such as the cutting of a Grasse jasmin with an Algerian, Sicilian or Egyptian jasmin, can hardly

be detected, except by an olfactory examination. Any analytical differences in the characteristics that are linked to the point of origin are still too little known to be of value.

The presence of abnormal quantities of solvent, particularly of alcohol, is a fraud on the quantity of merchandise delivered.

Dilution with artificial or synthetic products can take many different forms. Let us try to systematize its various aspects.

If the added materials are not volatile (waxes, etc.) the yield of steam-distillable products is lowered, and conversely it is raised by the addition of volatile products, but it is maintained within acceptable limits by the double addition.

Certain odorous products that are added are only slightly volatile, and remain in the distillation residue, such as the nitrated musks, which are occasionally added to clary sage, ambrette, etc.

The addition of volatile products can be studied on the crude materials when these fraudulent substances present specific and sensitive reactions, such as diethyl phthalate. This material is frequently found in large proportions in commercial products. Certain producers declare that it is added to render facile for handling products that are otherwise too consistent, such as the resinoids. It can be demanded that these producers state the percentage of such materials that is present. Others, to explain its presence in absolutes and pomade concentrates, say they have added it to standardize the utilization of the product, but the consumer can demand that no general guarantee be given for the purity of such a product. This is a poor explanation which throws into doubt the reputation of a commercial house.

The determination of the presence and quantity of diethyl phthalate is simple.³⁵ If its preliminary determination is neglected, the formation of a precipitate of insoluble potassium salts when saponifying with a potassium solution in strong alcohol, an increase in the acid value in comparison to the normal result, and a rise above the usual density of the distillates—these are among the indications that should motivate an attentive determination of the presence of diethyl phthalate.

The difficulty in the determination of other adulterants is the same as in the analysis of essential oils.

Fraud is simple when extraction products that contain large proportions of common substances are concerned. This is the case with the addition of phenylethyl alcohol to the extraction products of rose, or of benzyl acetate or benzyl alcohol to the extraction products of jasmin. Such frauds impose some very arduous analytical problems on the chemist who is seeking to determine and prove them. The same is true when there are added to the products of extraction or of enfleurage or digestion

the corresponding essential oils, or conveniently chosen fractions of the essential oils. Examples are easy to find; the fraud of the concretes and absolutes of lavender and of geranium, of clary sage and ylang ylang. Here is an entire domain for facile fraud, favored by the high prices of the products, and challenging the sagacity of the chemist.

But it is here that olfactory examination can be brought into play with great success. If it cannot be a formal argument in the hands of the legal chemist, it nevertheless is a weapon in the hands of the consumer in his negotiations with the seller. The olfactory examination of the sophisticated product shows a rupture in the equilibrium by comparison with the odor of the natural complex. The efficacy of the examination is increased when the steam-distillable fraction is examined; but let us repeat: this examination necessitates a knowledge, as precious as it is rare, of the pure product, the fruit of years of training and experience.

References

1. Roure, L., *Recherches*, 4, 128 (Dec. 1937).
2. Chibnall, A. C., *Chem. Industries*, 55, 259 (1936); Chibnall, A. C., Piper, S. H., Pollard, A., Williams, E. F., and Sahai, P. N., *Biochem. J.*, 28, 2189 (1934); Chibnall, A. C., and Piper S. H., *Ibid*, 2209; Chibnall, A. C., Williams, E. F., Latner, A. L., and Piper, S. H., *Ibid*, 27, 1881; Blount, B. K., Chibnall, A. C., and Mangoni, H. A., *Ibid*, 31, 1375 (1937).
3. Feinberg, C., Hermann, J., Roegelsperger, L., and Zellner, J., *Mon. für Chem.*, 44, 261 and 277 (1926).
4. Zellner, J., *Ibid.*, 46, 610 (1926).
5. Bougault and Cattelain, *Compt. rend.*, 186, 1746 (1928).
6. d'Ambrosio, *Ann. chim. anal. chim. app.*, 16, 1600 (1926).
7. Prophète, H., *Bull. soc. chim.*, (4) 39, 1600 (1926).
8. Stramm, J. F., *Pharm. Weekblad* (January 1927) and *Dissert.*, Delft (1926).
9. Radcliffe and Allen, *J. Soc. Chem. Ind.*, 28, 227 (1909).
10. Tsuchihashi and Tasaki, *J. Chem. Soc. Japan*, 21, 1117 (1918).
11. Glichitch, L. S., *Parfums France*, 47 (Nov.-Dec. 1923).
12. Naves, Y. R., *Parfums France*, 7, 308 (1929).
13. Louveau, G., *Rev. marques parfums savon.*, Jan. to Mar. 1931.
14. See 7, p. 1602.
15. Leys, *J. pharm. chim.* (8) 25, 49 (1922).
16. Lewkowitsch-Bontoux, "Huiles, Graisses et Cires," v. 1, p. 852, Paris, 1929.
17. Louveau, G., *loc. cit.*
18. Kessel, *Berliner Berichte der Chemie*, 11, 2114 (1878).
19. Walbaum, H., and Rosenthal, A., *Ber. Schimmel & Co. Akt. Ges., Jubil. Ausgabe*, 187 (1929), and *J. prakt. Chem.*, N. F. 124, 67 (1929).
20. Naves, Y. R., Sabetay, S., and Palfray, L., *Ann. chim. anal. chim. app.*, (3) 19, 201 and 227 (1937); *Perfumery Essent. Oil Record*, 28, 327 (1937).
21. See 16, p. 484.
22. Naves, Y. R., *Documentation sci.*, 61, 25 (1938).
23. See 19.

24. Naves, Y. R., *Documentation sci.*, **48**, 303 (Dec. 1936); *Ibid.*, **59**, 269 (1937); *see also* 20.
25. Cherbuliez, *Helv. Chim. Acta*, **19**, 734 (1936).
26. Bruère, *J. pharm. chim.*, (8) **13**, 79 (1931).
27. Richardson, A. S., *Oil and Fat Industry*, **8**, 269 (1931).
28. Jones, F. W., *J. Soc. Chem. Ind.*, **43**, 1268 (1924).
29. Lea, C. H., *Proc. Roy. Soc.*, (B) **108**, 175 (1931); and *Soap*, **83** (Dec. 1931).
30. Stamm, *Bull. soc. pharm. Esthonie*, **5**, 181 (1925).
31. Korpaczy, S., *Zeit. Unt. Lebensm.*, **67**, 75 (1934).
32. See note by Wheeler, H., *Oil and Soap*, **9**, 89 (1932).
33. See 29.
34. Naves, Y. R., *Parfums France*, **12**, 322 (1934).
35. Naves, Y. R., and Sabetay, S., *Perfumery Essent. Oil Record*, **29**, 22 (1938), and *Bull. soc. chim.*, (5) **5**, 102 (1938).

SECTION 4

MONOGRAPHS ON NATURAL PERFUMES

General Remarks

The following pages are devoted to monographs of the natural perfumes extracted by means of volatile solvents or fatty materials.

In each monograph, we have given the botanical or zoological identity of the raw material. In so doing, we have utilized the data supplied in the *Index Kewensis* and in the *Syllabus of Engler-Gilg*. With a few exceptions, we have eliminated botanical synonyms, which can be found in special treatises on botany.

The production of various plant materials subjected to extraction is here studied, with a view to evaluating the mutual dependencies existing between the agricultural production and the manufacture of odorous products. We have only briefly summarized the information regarding those plants from which essential oils, balsams, resins and gum-resins are obtained. Our work should be considered a complement to the classic literature on odorous materials, a literature which is well developed in the domain of essential oils, balsams, resins and gum-resins.

The analytical characteristics given here represent all the data that have come to our attention in the scientific and technical literature. Some readers may consider this information superfluous; however, the limits of analytical properties can be established only by a study of dozens of analyses; the knowledge of the general relationships among these properties, and between the analytical properties and the system of production, requires a large number of observations. While awaiting a further development of this work, we are obliged to accumulate the information available in the literature, which we have done.

These monographs also present a large number of hitherto unpublished analytical or economic data. Literature references of all information previously published, however, have been faithfully given.

In principle, we have limited ourselves to citing only the odorous constituents of these materials. For more information on the totality of the extracted substances, the reader is referred to C. Wehmer's "Die Pflanzenstoffe," second edition, Jena, 1929, "Supplement," Jena, 1935.

No doubt the value of the present work has been enhanced by the reservations which have from time to time been necessary regarding the correctness of identification of several constituents; these reservations were based on a critical examination of the original publications, which in certain cases were unfortunately all too brief. Thus we must state that G. Louveau, author of numerous works on the constituents of natural products, has only on exceptional occasions justified his results. We have also omitted the results obtained by Sadgopal on the composition of the pandanus absolute, as they are quite unconvincing.

The products studied are divided into three classes, according to the method of treatment:

- (1) Fresh plant materials, concretes, pomades and flower oils.
- (2) Dried plant materials and resinoids.
- (3) Animal products.

In each category, we have followed an alphabetical arrangement, except in certain cases where we have grouped together products that are analogous from the point of view of production or characteristics.

All commercially available products have not been listed. The manufacture of many of them is the speciality of a single producer, and in such cases we frequently do not possess reliable information on the production. Other products have never had, and do not today have, any real commercial importance.

We have systematically omitted those products obtained by techniques foreign to the industry and the art of natural perfumes, such as the innumerable extracts produced with ether, alcohol or acetone, for purposes other than the examination of the odorous constituents.

Finally, there are a certain number of commercial products about which the published information was insufficient, and our knowledge uncertain, at the time of the preparation of this book. We are listing these products below, and hope to introduce descriptions of many of them in the monographs of future editions of this work.

LIST OF PRODUCTS NOT INDIVIDUALLY DESCRIBED

Products Treated in the Fresh State (Or Summarily Desiccated)

<i>Product</i>	<i>Exact Identity</i>	<i>Section Treated</i>
Bitter Orange	<i>Citrus bigaradia</i> Risso (Rutaceae)	Leaf
Celery	<i>Apium graveolens</i> L. (Umbelliferae)	Leaf, stem

Products Treated When Dry

<i>Product</i>	<i>Exact Identity</i>	<i>Section Treated</i>
Acaroid gum	I. Red resin: <i>Xanthorrhoea quadrangulata</i> F.v.M. (Liliaceae) II. Yellow resin: <i>X. bastilis</i> R. Br.	Gum-resin
Ammoniac gum	<i>Dorema ammoniacum</i> Don. (Umbelliferae)	Gum-resin
Angelica	<i>Archangelica officinalis</i> Hoffm. (Umbelliferae)	Seed, root
Angostura	<i>Cusparia trifoliata</i> Engl., <i>Galipea officinalis</i> Hanc. (Rutaceae)	Bark
Arnica	<i>Arnica montana</i> L. (Compositae)	Root, flower
Asarbacca	<i>Asarum Europaeum</i> L. (Aristolochiaceae)	Rhizome
Asafoetida	<i>Ferula foetida</i> Regl. and related species (Umbelliferae)	Gum-resin
Buchu	<i>Barosma serratifolium</i> Willd. and related species (Rutaceae)	Leaf
Calamus	<i>Acorus calamus</i> L. (Araceae)	Rhizome
Carlina	<i>Carlina acaulis</i> L. (Compositae)	Root
Carrot	<i>Daucus Carota</i> L. (Umbelliferae)	Seed
Cascarilla	<i>Croton eluteria</i> Benn. (Euphorbiaceae)	Bark
Cedar	<i>Cedrus Atlantica</i> Man. and <i>C. deodora</i> (Roxb.) Loud. (Abietineae)	Wood, root
Celery	<i>Apium graveolens</i> L. (Umbelliferae)	Seed
Chamomile	<i>Anthemis nobilis</i> L. (Compositae)	Flower
Cinnamon Ceylon	<i>Cinnamomum Zeylanicum</i> Nees (Lauraceae)	Bark
Coriander	<i>Coriandrum sativum</i> L. (Umbelliferae)	Seed
Cumin	<i>Cuminum cyminum</i> L. (Umbelliferae)	Seed
Curcuma	<i>Curcuma longa</i> L. (Zingiberaceae)	Rhizome, root
Cypress	<i>Cupressus sempervirens</i> L. (Cupressineae)	Wood, root

<i>Product</i>	<i>Exact Identity</i>	<i>Section Treated</i>
Elecampane	<i>Inula Helenium</i> L. (Compositae)	Rhizome
Fern	<i>Aspidium Filix-mas</i> (L.) Swartz. (Polypodiaceae)	Rhizome and base of fronds
Fokiena (pe-mou)	<i>Fokiena Hodginsii</i> Henr. and Th. (Cupressineae)	Wood, root
Galangal	<i>Alpinia officinarum</i> Hance (Zingiberaceae)	Rhizome, root
Guaiaic	<i>Guajacum officinale</i> L. (Zygophyllaceae)	Wood, root
Imperatoria	<i>Peucedanum Ostbrutium</i> Koch. (Umbelliferae)	Root, resin
Juniper	<i>Juniperus communis</i> L. (Cupressineae)	Berry
Liquorice	<i>Glycyrrhiza glabra</i> L. (Leguminosae)	Root
Mate	<i>Ilex paraguarensis</i> St. Hil. (Aquifoliaceae)	Leaf
Wild ginger (Canadian serpentaria)	<i>Asarum canadense</i> L. (Aristolochiaceae)	Rhizome, root
Zedoary	<i>Curcuma Zedoaria</i> Rosc. (Zingiberaceae)	Rhizome
<i>Product of Animal Origin</i>		
Muskat	<i>Ondatra Zibethica</i>	Scent gland

Before drawing this lengthy introduction to our monographs to its close, we should like to cite those works which we believe can be advantageously consulted for data complementary to the present volume:

- Andès, "Die Harzprodukte," Vienna and Leipzig, 1905.
 Czapek, "Biochemie der Pflanzen," Jena, 1923.
 Dieterich, "Analyse der Harze, Balsame und Gummiharze," Berlin, 1930.
 Engler-Prantl, "Natürliche Pflanzenfamilien," Leipzig, 1936.
 Gildemeister and Hoffmann, "Die Aetherischen Oele," Leipzig, 1929-31.
 Gilg-Brandt, "Pharmakognosie," Berlin, 1922.
 Moeller, "Lehrbuch der Pharmakognosie," Vienna, 1906.
 Planchon and Collin, "Les drogues simples d'origine végétale," Paris, 1896.
 Pöschl, "Grundzüge der wissenschaftlichen Drogenkunde," Berlin, 1927.
 Schweizer, "Die Destillation der Harze," Vienna and Leipzig, 1905.
 Thoms, "Handbuch der praktischen und wissenschaftlichen Pharmazie," Berlin and Vienna, 1924-1930.
 Tschirch, "Handbuch der Pharmakognosie," Leipzig, 1932.
 Tschirch, "Die Harze und die Harzbehälter," Leipzig, 1906.
 Wehmer, "Die Pflanzenstoffe," Jena, 1929 and 1935.
 Wiesner, "Die Rohstoffe des Pflanzenreiches," Leipzig, 1921.
 Wolf, "Die natürlichen Harze," Stuttgart, 1928.

Acacia Cavenia

The *Acacia Cavenia* Hook. and Arn. is harvested in Provence and in Algeria, and is known in perfumery under the name of *cassie romaine*. The appearance of the flower is very much like that of *Acacia farnesiana*,¹ but its perfume is not as suave and as well blended. The perfume of the *Cavenia* is not as highly prized as the *farnesiana* and the flowers of the former are worth less than half the value of the latter.

The culture of the two species is similar, but the blooming of *Acacia Cavenia* takes place mainly in the springtime, and the flowers are gathered until May. The October harvest is much less important. Before the 1920 frost, the annual harvest was from 20 to 30 tons; in 1924, it was still 15 tons; and it had decreased, up to the outbreak of the Second World War, to between 5 and 8 tons, depending on the year.

Extraction. The average annual yield of concrete by petroleum ether extraction in Provence is generally understood to be between 0.60 and 0.84%, and in exceptional cases extends to the low and high limits of 0.55 and 0.88%. The flowers gathered in October give a better yield than those of the spring (0.60 to 0.92% as against 0.49 to 0.56%). In Algeria, the yield of concrete varies between 0.46 and 0.63%.

The concrete furnishes about one-third of its weight in absolute, and 7 to 10.4% of steam-distillable products.

Very little pomade is made from this species of acacia.

Characteristics of the extracts. One of the authors has examined a sample of French concrete. It was a waxy mass, hard, maroon-colored, melting at 52 to 53°, and having an acid value of 32.4 and an ester value of 46.2. A sample of an absolute of the same origin, almost liquid, very dark in color, had the following characteristics:

d_{18° :	0.984
α_D :	+8° 20'
$n_D^{20^\circ}$:	1.5037
A.V.:	33.6
E.V.:	49.

Two distillates from concretes were described by Y. R. Naves, S. Sabetay and L. Palfray:²

	1	2
d_{18° :	1.031	1.028
α_D :	inactive	+0° 14'
$n_D^{20^\circ}$:	1.5120	1.5140
A.V.:	11.2	22.0
E.V.:	96.0	112.0

Composition of the extracts. H. Walbaum³ has studied two distillates of concretes. One included (percentages based on weight of concrete) 5.5% of phenols, 8.8% of non-phenolic bodies and 1.1% of salicylic acid; the other 3% of phenols, 4.5% of non-phenolic bodies and 1.66% of salicylic acid.

The phenols consisted of at least 90% of eugenol. The salicylic acid was esterified, in the form of methyl salicylate. The neutral fraction contained benzaldehyde (8%), benzyl alcohol (20%), some geraniol, some anisaldehyde, some methyl eugenol, a ketone of a violet odor, and probably some linalool and decyl aldehyde.

References

1. It has been admitted that this is only a variety of *A. farnesiana*. See Wehmer, C., "Die Pflanzenstoffe," second ed., vol. 1, Jena, 1929, p. 492 and Mazuyer, G., *J. parf. savon.*, 21, 254 (1908).
2. Naves, Y. R., Sabetay, S., and Palfray, L., *Perfumery Essent. Oil Record*, 28, 336 (1937).
3. Walbaum, H., *J. prakt. Chem.*, N. F. 68, 235 (1903); *Ber. Schimmel & Co. Akt. Ges.*, 14 (Oct. 1903).

Acacia Farnesiana

The true acacia, known in perfumery by its French name, *cassie ancienne*, is the *Acacia farnesiana* Willd. (Leguminosae). It is a bushy plant which grows spontaneously in tropical Africa, in the West Indies,¹ on the southerly spurs of the Himalayas, in Australia and New Caledonia. It is cultivated for industrial extraction of the perfume in Provence, Algeria, Egypt and Syria. In France, it is still called *cassie Farnèse* or *cassie du Levant*.

Acacia farnesiana is propagated by seedlings. At the end of three years, the shrub begins to yield flowers. The quantity of flowers harvested during one year, on a plant in full production, usually varies between 500 and 600 grams, but can reach 1000 grams. The acacia flower is produced in Provence on the outskirts of Cannes, Cannet, Vallauris and Saint-Laurent-du-Var. The harvest begins in the last days of September, and continues actively until the end of November, continuing to a small extent into January. The flowers harvested in October are the most valuable. Flowers are gathered twice weekly, one by one; this gathering is difficult, for the plant has a great number of long and sharp thorns. The blooming is affected considerably by climatic conditions. A high wind, a rather violent storm, or several brisk mornings, arrest the flowering. In Algeria and in Egypt, the principal harvest also takes place in October and November.

In 1850, four tons of flowers of *Acacia farnesiana* were treated, and in 1900, 35 tons. After 1920, the year of the great frost, the annual production fell to 10 to 12 tons and even lower after 1930. In Algeria, about 5 to 6 tons are annually treated, and some 2 to 3 tons in Egypt and in Syria. According to L. Trabaud,² the acacia plant was imported into French Guiana from France. The first quantities of petroleum ether concrete produced have a value resembling that of the concrete of Provence.

Extraction. The acacia is extracted with petroleum ether, or by maceration in melted pomade.

The yield in concrete usually varies between 0.50 and 0.70%, exceptionally rising as high as 0.82%. The flowers gathered at the end of the season usually give a higher yield than those of the autumn. The concrete gives about one-third in absolute, which furnishes 6.5 to 9% of steam-distillable products. It is of a soapy consistency, dark brown in color, becoming lighter on contact with light and air. The distillate is colorless and very refractive.

The acacia pomade is prepared by maceration, at a temperature of 35 to 50°. It is very dark brown.

Characteristics of the extracts. Walbaum and Rosenthal³ have observed a concrete having the following properties:

C.P.:	46.5°
S.V.:	103.6

One of the writers has observed an absolute of Grasse origin:

d_{18}° :	0.988
A.V.:	62.8
E.V.:	33.5

G. Rovesti⁴ has given the following characteristics for an absolute prepared in Liguria in 1923-1924:

d_{18}° :	1.020 to 1.070
α_D :	0° to -3°
n_D :	1.514 to 1.521
A.V.:	18 to 55
E.V.:	97 to 243

The following are the analytical findings of the products obtained by steam distillation, which have been published:

Origin and % yield	C.P.	d_{15}	α_D	n_D^{20}	A.V.	E.V.
France:						
0.084 of flowers ⁵	18-19	1.040 (27°)	-0° 40'	—	42.50	114.0
5.65 of concrete ⁸	liq.	1.0575	-0° 30'	1.5158	25.40	229.0
Egypt ⁷	liq.	1.032	+0° 55'	1.5045	5.60	154.0
Egypt ⁷ } 6.5 to 9	liq.	1.037	+0° 20'	1.5082	3.70	148.0
Egypt ⁷ } of concrete	liq.	1.029	+1° 10'	1.5018	4.20	166.0
Egypt ⁷ }	liq.	1.043	-0° 15'	1.5120	6.30	182.0
Egypt ⁷ (a) 26.4 of abs.	liq.	—	inact.	1.5212	30.50	169.0

(a) Prepared from a commercial product of guaranteed purity.

The distillate from the pomade concentrate prepared in India was obtained by the chemists of Schimmel & Co., with a yield of 0.171%, based on the pomade.⁸ This distillate was a pale yellow color, and had the following characteristics:

d_{15} :	1.0475
α_D :	$\pm 0^\circ$
n_D^{20} :	1.5133
S.V.:	176.0

Composition of the extracts. The odorous constituents of the distillate prepared from the pomade have been investigated.⁹ The well-defined products found were methyl salicylate (11%), p-cresol, benzaldehyde, benzyl alcohol, a ketone of minty odor (b.p., 200 to 205; d_{15} , 0.9327; α_D , -3°50'; semicarbazone, m.p. 177-178°), anisaldehyde, decyl aldehyde, cuminic aldehyde, and a ketone with a violet odor (b.p.^{15mm} 133°; p-bromophenylhydrazone, m.p. 103-107°). These products were probably accompanied by some geraniol and linalöl.

In the heavy fractions of the distillate, Haarmann and Reimer found farnesol.¹⁰

References

- Engler-Prantl, "Die Natürlichen Pflanzenfamilien," v. 3, sec. 1, part 3, p. 112.
- Trabaud, L., *Riechstoff Ind. Kosmetik*, 13, 250 (1938).
- Walbaum and Rosenthal, *Ber. Schimmel & Co. Akt. Ges., Jubil. Ausgabe*, 193 (1929).
- Rovesti, G., *Profumi Italici*, 3, 277 (1925).
- Soden, H. v., *J. prakt. Chem.*, N.F. 69, 270 (1904).
- Ber. Schimmel & Co. Akt. Ges.*, 18, (Apr. 1907).
- Naves, Y. R., Sabetay, S., Palfray, L., *Perfumery Essent. Oil Record*, 28, 336 (1937).
- Ber. Schimmel & Co. Akt. Ges.*, 21 (Apr. 1904).
- Ber. Schimmel & Co., Akt. Ges.*, 58 (Oct. 1899); 16 (Apr. 1901); 16 (Apr. 1903); Walbaum, H., *J. prakt. Chem.*, N.F. 68, 235 (1903); *Ber. Schimmel & Co. Akt. Ges.*, 21 (Apr. 1904); German Patents 139,135 and 150,170.

10. Haarmann and Reimer, German Patent 149,603; Helfenberg, K. D., *Chem. Zentr.*, 2, 975 (1904).

Asparagus Sprengeri

The *Asparagus Sprengeri* Regl. (Liliaceae), widespread on the Riviera, is cultivated in European greenhouses. It has very small rosy flowers, with a strong and agreeable odor. F. Elze¹ has prepared the concrete and the absolute. The odor of these products is powerful and recalls that of the fatty aldehydes. Distillation of the flowers corrupts the perfume. The nature of the constituents is unknown.

Reference

1. Elze, F., *Chem.-Zt.*, 41, 842 (1917).

Boronia Megastigma

The *Boronia megastigma* Nees (*Rutaceae*) or brown boronia of western Australia, is a bushy plant about two meters high. It is found in abundance in the districts of Mount Barker, Albany, Bridgetown and Greenbushes. In favorable localities, almost three pounds of flowers are gathered in an hour.¹

According to information communicated to the authors by one of the producers of the concrete, Plaimar Ltd. of Perth, the flowers are harvested from August to October; they are immediately immersed in petroleum ether, and the drums containing the flowers and the solvent are transported to the factory. The absolute is prepared in the usual manner.

For several years, 75,000 pounds of flowers were treated, giving 300 pounds of concrete, and the major part of the absolute was consumed by the domestic perfume industry.

Characteristics of the extract. The concrete has been studied by A. R. Penfold.² It is of buttery consistency, and is colored green. The following characteristics have been observed on four samples:

Year	M.P.	$d_t/15^\circ$	n_D	A.V.	E.V.	E.V. ac.
1924	35°-36°	0.8989/15°	1.4752/38°	27.5	106.7	139.5
1925	40°-41°	0.9189/40°	1.4842/39°	22.8	109.3	149.0
1926	40°	0.9091/40°	1.4826/40°	24.2	95.9	136.5
1926	39°-40°	0.9173/40°	1.4852/38°	30.5	107.3	147.8

Y. R. Naves, S. Sabetay and L. Palfray³ obtained from a concrete of known purity, 20.4% of products carried over by steam distillation, which had the following characteristics:

d_{40}^20 : 0.896 α_D : $-3^{\circ} 20'$ n_D^{20} : 1.4737

A.V.: 22.4

E.V.: 67.2

and which contained 40.1% of ketones (expressed as ionones, and calculated by oximation).

Composition of the extract. The composition of the concrete essence of *Boronia megastigma* has been studied by A. R. Penfold.²

The fraction insoluble in alcohol, separated at 15°, represents 15% of the concrete. It is composed of triacontane (m.p. 64°). The soluble fraction includes small quantities of glycerides, of formic acid and of caprylic acid, both in free state, a phytosterol $C_{27}H_{46}O$, m.p. 162°, $[\alpha]_D^{20}$: +60° (c=0.723 chloroform), whose acetate melts at 120 to 130°, and of β -ionone. The ionone was characterized by its odor and by the formation of the semicarbazone (m.p. 145-146°), and the mixture of this semicarbazone with that of synthetic β -ionone (m.p. 148-149°) did not depress the melting point.

The presence of β -ionone was confirmed by S. Sabetay,⁴ who formed the semicarbazone (m.p. 149°) and the *p*-bromophenylhydrazone (m.p. 120°), whose mixed melting point was studied. Finally, Penfold also found in the concrete about 5% of ethyl alcohol and a small quantity of ethyl formate.

References

1. Penfold, A. R., *J. Proc. Roy. Soc. N. S. Wales*, 70, 30 (1936).
2. Penfold, A. R., *J. Roy. Soc. W. Australia*, 14, 2 (1937).
3. Naves, Y. R., Sabetay, S., and Palfray, L., *Perfumery Essent. Oil Record*, 28, 336 (1937).
4. Sabetay, S., *Compt. rend.*, 189, 808 (1929).

Broom

The flowers of Spanish broom, *Spartium junceum* L. (Papilionaceae) are treated in Grasse by volatile solvents and on rare occasions by maceration in a pomade.

The broom is a shrub which grows wild in the stony, argellous claylands of Provence and Languedoc. It is cultivated in certain regions, particularly around Lodève, for its textile fibers, which are drawn from its stems and stalks. It covers large sections of the grassy mountainside, and a few score tons are treated annually (50 tons in 1926).

The fragrance of the broom is powerful and delicious on the plant, but although care is taken to treat the flowers rapidly, since their odor changes quickly after the flowers are cut, the concrete has a waxy aroma, reminiscent of the Provence honey. (It is true that the bees pilfer the

broom.) However, the extraction products of the broom are among the precious raw materials of perfumery.

Characteristics of the extract. The yield of petroleum ether concrete varies between 0.09 and 0.18% and this concrete gives 30 to 40% of absolute.

Walbaum and Rosenthal¹ have analyzed a sample:

C.P.:	49.8°
S.V.:	44.8

and an absolute:

A.V.:	33.6
E.V.:	85.9

and they have obtained a distillate, in a yield of 5%, and having an E.V. of 101.1.

The constituents are unknown.

Other Species of Broom. The flowers of *Genista tinctoria* L. have furnished 0.161% of a petroleum ether concrete to W. Treff, F. Ritter and H. Wittrisch,² and this concrete gave 53% of absolute, and contained 2.26% of steam-distillable products. The distillate had a yellowish color, a green and heavy odor:

d_{15}^0 :	0.9335
α_D :	-9.10°
A.V.:	18
E.V.:	35
E.V.ac:	156.0

References

1. Walbaum, H., and Rosenthal, A., *Ber. Schimmel & Co., Jubil. Ausg.*, 193 (1929).
2. Treff, W., Ritter, F., and Wittrisch, H., *J. prakt. Chem.*, N.F. 113, 355 (1926).

Buddleia Variabilis

Y. R. Naves has obtained 0.46% of a petroleum ether concrete from the fresh flowers of *Buddleia variabilis* (Hemsl. (Loganiaceae). The concrete is yellowish brown and has a very strong odor reminiscent of aquatic mint and official sage.

Carnation

The carnation, *Dianthus caryophyllus* L. (Caryophyllaceae) is cultivated in the entire region of the Antibes, in Provence around Hyères, and also in Holland, for sale as a cut flower.

Extraction. The perfume of the carnation is extracted by volatile solvents, both in Grasse and in Holland. The last flowers to bloom appear in June, when the sales of the cut flowers diminish, and it is at that time that the carnation is treated. They are gathered after the sun goes down, for then they have the greatest amount of perfume.

The carnations are treated without separation of the types and qualities. The most ordinary species, and the lightest in color, give the best yields.¹

About forty or fifty years ago, some 200 tons of carnations were treated annually at Grasse. By 1920, the requirements of the perfumers had diminished, but the production still surpassed 100 tons a year. By 1938, this had decreased to a few tons.

The concrete is obtained in Grasse by petroleum ether extraction, in a yield of 0.23 to 0.29%, sometimes rising as high as 0.33%. This concrete gives 9 to 12% of an absolute, and includes 1 to 3.6% of steam-distillable products.

W. Treff, F. Ritter and H. Wittrisch² treated carnations cultivated at Riesa (Germany) and obtained 0.282% of a petroleum ether concrete, giving 32.9% of absolute and 7.7% of distillate. A few years later, Treff and Wittrisch³ obtained a yield of 0.289% of a concrete, from carnations of the same origin; this concrete gave 31.3% of absolute and 5.25% of distillate.

Characteristics of the extraction products. The concrete prepared at Grasse has a more or less deep brown-green color, a hard consistency, and strong, spicy, characteristic odor. The absolute is sirupy, and has a dark brown color.

A concrete of Grasse origin was analyzed by one of the writers, and had the following properties:

M.P.:	56° to 62°
C.P.:	58° to 54°
α_D :	0
A.V.:	15.2
E.V.:	23.8

and gave a 9.4% yield of absolute.

Mme. H. S. Sabetay and G. Mane⁴ have described a concrete prepared by petroleum ether extraction of flowers grown in the Maritime Alps. The concrete was obtained in a yield of 0.21 to 0.26%, had a yellowish color, and gave 20 to 25% of a dark greenish absolute, d_{15° : 0.8966; n_D^{20} : 1.4708.

Steam distillation of the absolute, utilizing the Naves apparatus, gave 7% of an oil (or 1.40 to 1.75% of the concrete) with a powerful odor,

which turned green on contact with ferric chloride, and which had the following characteristics:

d_{15}° :	0.9726
n_D^{20} :	1.4908
$[\alpha]_D$:	-4°
Phenol content (by 4% KOH solution):	43%
Methoxy content:	7.2%

This distillate included no nitrogen-containing compounds, but sulfur-containing products were detected. The non-phenolic fraction had the characteristics:

A.V.:	7.9
E.V.:	153
Carbonyl value:	18.6

G. Rovesti⁵ studied a concrete prepared in 1924 in Liguria, in a yield of 0.2514%. It had a maroon color, melted at 32 to 35°, and gave 8.35% of an absolute, having the properties:

d_{15}° :	0.951
α_D :	-2.6°
n_D :	1.5101
A.V.:	6.7
E.V.:	58.3
Phenol content:	57.2%

A concrete was prepared from white carnations, of the type used for garden borders, in a yield of 0.282%, and gave the same author 8.7% of an absolute having the following characteristics:

d_{15}° :	0.949
α_D :	-0.82°
n_D :	1.5209
A.V.:	7.9
E.V.:	15.1

The distillates examined by Treff and his collaborators had these characteristics:

	A ²	B ³
d_{15}° :	1.010	1.0375
α_D :	$-0^{\circ} 36'$	$-0^{\circ} 39'$
A.V.:	0.28	16.8
E.V.:	132	131.6
E.V.ac:	249	247.8

Composition of the extracts. W. Treff and H. Witttrisch³ identified the following constituents: 30% of eugenol, 7% of phenylethyl alcohol,

40% of benzyl benzoate, 5% of benzyl salicylate, 1% of methyl salicylate. Mme. Sabetay and G. Mane⁴ confirmed the identification of eugenol.

References

1. Roure-Bertrand fils, *Sci. Ind. Bull.*, (4) 1, 89 (1920).
2. Treff, W., Ritter, F., and Wittrisch, H., *J. prakt. Chem.*, N.F. 113, 357 (1926).
3. Treff, W., and Wittrisch, H., *J. prakt. Chem.*, N.F. 122, 332 (1929).
4. Sabetay, Mme. H., and Mane, G., *Rev. chim. ind.*, 48, 39 (1930).
5. Rovesti, G., *Profumi Italiani*, 3, 141 (1926).

Champac

The true champac, an orange yellow flower, is the *Michelia Champaca* L., *M. rufinervis* DC., *M. aurantiaca* Wall. (Magnoliaceae). The white flowered champac, *M. longifolia* Blume and, in Java, the pale yellow flower, *M. montana*, are also exploited. Brooks¹ cites the *M. fuscata* and *M. nigalirica* Zenk.

The champac is of Indian origin, being found principally in Nepal, Assam, Bengal and right up to the foot of the Himalayas. It is cultivated in Java and the Philippines. The Philippine flowers are said to be more odorous than those of Singapore, Penang and Colombo.

In India, Java and the Philippines, the natives prepare the perfumed oils and fats by maceration. In the Philippines and Java, a mixture of champac and ylang ylang flowers is frequently treated.²

Extraction. In Réunion, the champac flowers are extracted with petroleum ether, and a concrete is obtained in a yield of 0.16 to 0.20%, of which about 50% is separable as the absolute.

R. F. Bacon³ has extracted the champac perfume with a paraffin oil, renewing the charge of flowers ten times, and each time allowing them to have contact with the oil for 24 hours. He prepared the absolute, in a yield of 0.2% based on the flowers. This absolute, separated by filtration from a crystallized product, m.p. 165-166°, which settled with ease, had the following characteristics:

d_{30}^{30} :	0.9543 to 1.020
n_D^{30} :	1.4550 to 1.4830
S.V.:	160 to 180

This absolute was neutral, and soluble in 70% alcohol. It had a very fine odor, resembling that of the flower.

Composition of the extract. R. F. Bacon has identified in the champac absolute 3% of phenols, for the most part isoeugenol, 30% of esterified acids, and 46% of neutral substances having an odor of oil of bay. Saponification almost completely destroys the champac odor.

References

1. Brooks, B. T., *Philippine J. Sci.*, A. 6, 333 (1911); *J. Am. Chem. Soc.*, 33, 1763 (1911).
2. See *Perfumery Essent. Oil Record*, 22, 272 (1931).
3. Bacon, R. F., *Philippine J. Sci.*, A. 4, 131 (1909) and A. 5, 262 (1910).

Chimonanthus Fragrans

The *Chimonanthus fragrans* Lindle, *Calycanthus praecox* L. (Calycanthaceae) is a shrub originating in China and Japan, and which blooms in winter. It was introduced to France in 1766 and has been cultivated for ornamentation. Its flowers have an odor suggestive of jasmin, orange peel and jonquil.

Extraction. G. Louveau¹ has obtained 0.615% of a concrete by petroleum ether extraction, having an odor which, he states, recalls the jasmin, champac, orange and jonquil. The absolute is more fluid than a jasmin absolute.

By enfleurage (*Ibid.*, p. 632), Louveau has obtained a pomade concentrate in a yield of 1%, based on the weight of the flowers. It was brownish-yellow in color, thick, and had the odor of the flowers in bloom, while the absolute prepared from the concrete kept the odor of the buds.

Composition of the extracts. The concrete contains 27% of a paraffin, m.p. 65-66°, 14% of a white wax, m.p. 61-62°, 12% of a yellow wax soluble in alcohol at a moderate temperature, but separating from the alcohol at -15°. It gives 19% of an absolute, which is liquid at 20°.

The pomade concentrate has the following characteristics:

d_{15}° :	0.9243
$[\alpha]_D$:	+1° 45'
n_D :	1.4714
A.V.:	85.1
E.V.:	90.3
E.V.ac:	198.1

and is soluble in 0.2 to 9 volumes of 80% alcohol.

It was reported to contain 6% of benzyl alcohol, free and esterified, 8% of linalool, almost entirely esterified, 6% of terpenic alcohols (for the most part terpineol), 3% of sesquiterpenic alcohols, most of which was free farnesol, 0.8% of aliphatic aldehydes, among which was decyl aldehyde, 1% of terpenes, 2% of sesquiterpenes, 0.2% of acetamide, and a little indole.

Reference

1. Louveau, G., *Rev. marques parfum. savon.*, 9, 531, 573, 622 (1931); (See note on page 162).

Citrus Peel Oils

The generally high price of hand labor in North America has made the process of expression of these oils relatively costly. In California, studies have been made to extract the citrus fruit peels by volatile solvents, and to manufacture lemon and orange "oleoresins."

The oleoresins are distinguished from the essential oils by their dark color and their relatively high yield of non-volatile materials.

R. T. Will¹ has described these experiments. The peel is placed in a paste, then treated with a solvent, the latter divided into three parts. Lemon gave 1.9% of a resinoid which had a very dark yellowish green color, and orange 2.2% of a dark red resinoid. The latter contained 88.36% of terpenes, 1.28% of aldehydes, and 10.36% of non-volatile products.

Characteristics of the resinoids. The lemon resinoids had the following characteristics:

d_{20}^4 : 0.8730 to 0.8836
 α_D : +57° 30' to +60° 30'
 α_D of the first 10%: +54° 11' to 69° 40'
 Residue of evaporation: 14.2 to 15.4% (having an A.V. 25.4 and E.V. 102.1)
 Citral content: 6%

The orange resinoids:

d_{20}^4 : 0.8535 to 0.8723
 α_D : Approximately +75° to +89°
 α_D of the first 10%: +90° 54' to 96° 21'
 Residue of evaporation: 11.0 to 14.7% (of which the A.V. 13.5 and E.V. 107.0 to 112.0).

References

1. Will, R. T., *Ind. Eng. Chem.*, **8**, 8 (1916).

Clary Sage

The clary sage or musky sage, *Salvia sclarea* L. (Menthaceae) grows wild in North Africa and southern Europe. It is cultivated for distillation at Langeudoc, in the valley of the Rhone, the Var, the Basses-Alpes, and the Maritime Alps, and cultivations were also developed in Germany, Hungary, Roumania and Russia.

In France, under usual conditions, the essential oil is obtained in a yield of 0.05 to 0.09%. The localization of the oil and its evolution in the course of the plant vegetation have been thoroughly studied.¹

Some time ago, it was noted that the typical musk-like and amber-like odor is found in the relatively non-volatile fractions, and that the distillation residue is highly odorous. This observation led to the preparation of the concretes by petroleum ether and benzene extractions.

Extraction. Only the upper extremities of the stems are used, and they must be chosen at the very moment when the seeds are beginning to turn brown. The yield by petroleum-ether extraction, obtained from sage that had been dried in the shade (with a loss of 25% to 35% of the weight of the fresh plant) varies between 0.60 and 1.25%. This concrete gives a yield of 80 to 85% of absolute. The 50% yield reported by E. S. Guenther² is low. The concrete contains from 7 to 13.5% of steam-distillable products.

Characteristics. The concrete is a heterogeneous, semi-solid product, the greater part of which consists of flaky, colorless crystals, surrounded by a light green pasty mass. This crystalline mass consists of an odorless product, sclareol.

Y. R. Naves, S. Sabetay and L. Palfray³ have described a distillate having these characteristics:

d_{40}° :	0.932
α_D :	-17° 20'
n_D^{20} :	1.4692
A.V.:	2.4
E.V.:	196.0

Composition of the extracts. Y. Volmar and A. Jermstad⁴ studied a commercial concrete having these properties:

C.P.:	35° to 36°
d:	0.9826
$[\alpha]_D^{18}$:	+4° 12' (alcoholic solution)
n_D^{20} :	1.5038
A.V.:	4.81
E.V.:	49.30
E.V.ac:	81.6
Evaporation residue over water-bath:	73 to 74%

They identified in the concrete acetic acid, a small proportion of an ester $C_7H_{12}O$, some linoleöl (of which 4/5 was in the form of the acetic ester), a substance which they falsely identified as cedrene,⁵ a sesquiterpene alcohol $C_{15}H_{26}O$ (d_{15} : 0.9841, α_D : +24° 47'; n_D^{20} : 1.5138), and a crystallized substance which they called sclareol. The exact nature of sclareol was later recognized by M. M. Janot⁶ and by L. Ruzicka and Janot.⁷ The concrete studied by Ruzicka and Janot contained 42% of sclareol.

Sclareol is the typical constituent of the clary sage concrete. It is a diterpenic glycol, $C_{20}H_{36}O_2$, m.p. 105.5 to 106°, not distillable in steam, very soluble in benzene; the dihydrogenated derivative melts at 114 to 115°, and dehydrogenation gives 1,5,6-trimethylnaphthalene.

Sclareol is localized in the blossoming summits and in the seeds.

References

1. *Parfums France*, 7, 149-154 (1929).
2. Guenther, E. S., *Am. Perfumer*, 27, 479 (1932).
3. Naves, Y. R., Sabetay, S., and Palfray, L., *Perfumery Essent. Oil Record*, 28, 336 (1937).
4. Volmar, Y., and Jermstad, A., *Compt. rend.*, 186, 517 and 783 (1928).
5. See 1, p. 153.
6. Janot, M. M., *Compt. rend.*, 191, 847 (1930); *Ann. chim.*, 17, 5-127 (1932).
7. Ruzicka, L., and Janot, M. M., *Helv. Chim. Acta*, 14, 645 (1931).

Currant

The black currant, *Ribes nigrum* L. (Saxifragaceae) grows wild in the temperate regions of Europe. It is cultivated on 3,000 hectares in France, in the Côte-d'Or, le Loir-et-Cher, l'Oise, and on 600 hectares in Holland. Its dried leaves are used as medicinal herbs, and its fresh buds and fruits are employed by the liquor industry.

The fresh buds contain oil glands which impart to the plant a very fine perfume. It is used by the liquor trade in the form of an alcoholic maceration, known in France under the name of *essence de bourgeon*. The essential oil has been examined by the chemists of Schimmel & Co.¹

It is obtained in a yield of 0.75%. For several years, a benzene extracted product has been used. This product has been studied by L. S. Glichitch and Mme. M. G. Igolen.²

Extraction. The benzene extraction gives 2.4 to 3% of a semi-crystalline concrete, dark green in color and intense in odor. This concrete contains 16 to 17% of steam-distillable products.

Composition of the extract. The volatile part has the following characteristics:

d_{15}° :	0.879
α_D^{25} :	+1° 35'
n_D^{20} :	1.4870
A.V.:	1.12
E.V.:	7.0
E.V.ac:	30.16
E.V.cf:	40.7

The volatile portion included no nitrogen-containing compound, nor did it have any aldehyde or ketone.

Glichitch and Mme. Igolen have determined the presence in the oil of 85% of terpenes and sesquiterpenes (nopinene, sabinene, caryophyllene, *d*-cadinene), 6% of alcohols (probably sabinol, some terpineols, and a sesquiterpene alcohol), 0.25% of phenols (phenol, β -naphthol), and some acetic acid esters. The non-volatile fraction is made up of a C₁₈ hydroxy-acid (m.p. 148°).

References

1. *Ber. Schimmel & Co. Akt. Ges.*, 114 (Apr. 1907).
2. Glichitch, L. S., and Igolen, Mme. M. G., *Parfums France*, 15, 241 (1937).

Cyclamen

The *Cyclamen europaeum* L., *C. clusii* Lindl. (Primulaceae), sweet of odor, is widely found in the Alps and at Jura.

F. Elze¹ has treated the cyclamen flowers by maceration. The absolute, a colored product, has the following characteristics:

d_{15}° :	0.94467
α_D :	0

The author has identified nerol and farnesol, and also found present some ketones, aldehydes, phenols and esters.

Otto Gerhardt² has obtained from *C. europaeum* 0.18% of a petroleum ether concrete, greenish yellow in color, and of a strong odor.

References

1. Elze, F., *Riechstoff Ind. Kosmetik*, 3, 91 (1928).
2. Gerhardt, O., *Perfumery Essent. Oil Record*, 20, 317 (1929).

Elder

On several occasions, experimental extractions of rather sizable quantities of the elder, *Sambucus nigra* L. (*S. vulgaris* Lam.) and *S. Ebulus* L. (*Ebulus humile* Gcke.), a caprifoliaceous shrub, have been made. The plant grows in Europe, western Asia and North Africa.

L. Labaune¹ reported that the fresh flowers of *Sambucus Ebulus* L., treated with hydrocarbon solvents, gave a good yield of a concrete. It had a green note, somewhat salicylic, and very persistent.

Reference

1. Labaune, L., *Riechstoff Ind. Kosmetik*, 13, 195 (1938).

Everlasting

The everlasting or the *immortelle* of the Grasse perfumers, also known as the herb of St. John, is the *Helichrysum angustifolium* DC., *H. italicum* G. Don. (Compositae), while the everlasting of the florist shops is *H. arenarium* Moench. Also treated for perfumery is the *H. stoechas* Moench. These species are very polymorphous, and are widely found in North Africa, Portugal, Spain, Languedoc, Provence and Italy.

In Grasse, the plant is gathered in the Esterel, from the end of June to August, during which time it is allowed to dry. Up to fifteen tons are treated annually.

In Liguria, and in the Abruzzas, *H. angustifolium* and *H. stoechas* have been treated.

Extraction. In Grasse, a petroleum-ether extraction is made, giving a hard, waxy concrete in a yield of 0.90 to 1.15%. It has a yellow-brown color, and a characteristic and tenacious odor. This concrete gives 60 to 72% of an absolute, and contains 3.6 to 7% of products volatile in steam.

Characteristics of the extracts. *H. angustifolium* gathered at the beginning of August in the Abruzzas gave P. Rovesti¹ 0.92% of a petroleum

ether concrete, m.p. 35°, and 1.13% of a benzene-extracted concrete, with a soft and buttery consistency.

The characteristics of these extraction products were:

	Concrete	
	Petroleum-ether	Benzene
Yield in Absolute	68.3%	78.7%
<i>Characteristics of the absolute:</i>		
d_{15}°	0.9814	0.9862
$[\alpha]_D$ (C=0.10 alcohol)	+1° 44'	+1° 21'
Color	maroon	olive-green
<i>Steam Distillate:</i>		
Yield from absolute	21.8%	15.8%
d_{15}°	0.8874	0.9061
α_D^{20}	+2° 53'	+3° 42'
n_D	1.4815	1.4791
E.V.	89.60	35.47
E (%)	31.36	12.41
E.V.ac.	136.27	112
Sol. 90	1.5	7

The petroleum ether absolute had the finer odor, with a rosy note. From *H. stoechas* Moench., P. Rovesti² obtained, in Liguria, a petroleum ether concrete giving 76.8% of an absolute, with the following characteristics:

d_{15}° :	0.9962
$[\alpha]_D^{20}$:	-2° 41' (C=10.0 alcohol).

This absolute yielded 17.9% of products volatile in steam, characterized as follows:

d_{15}° :	0.9178
α_D :	-3° 17'
n_D^{20} :	1.4749
E.V.:	169.87
Sol. 90:	3 vol.

Y. R. Navcs, S. Sabetay and L. Palfray³ have described two distillates obtained from the concretes from Grasse, greenish yellow in color, and having the following characteristics:

	1	2
d_{15}°	0.939	0.935
α_D	+5° 35'	+7° 40'
n_D^{20}	1.5021	1.4968
A.V.	20.2	13.1
E.V.	33.6	42.0

The constituents of these products have not been described.

References

1. Rovesti, P., *Riv. ital. essenze profumi piante offic.*, 23 (1935).
2. Rovesti, P., *Ibid.*, 149 (1930).
3. Naves, Y. R., Sabetay, S., and Palfray, L., *Perfumery Essent. Oil Record*, 28, 336 (1937).

Fruit Juices

The extraction of the aromatic substances of fruit juices by means of volatile solvents seems to be one phase of a careful and judicious process of concentrating these juices, but hardly a means of preparing commercially practicable aromatics (*see page 96*). None the less, what magnificent aromatic models the fruit juices contain, as against the mediocre synthetic substitutes which enjoy such a large market!

The yields in odoriferous extractable products are very poor, ranging from 0.001 to 0.004%. These products, very costly, have scarcely been studied, for the industries engaged in the exploitation of fruit juices, almost always having only distant connections with the perfume raw material industries, do not have at their disposal chemists specializing in the very delicate study of this type of mixture.

Almost all the studies have been made on the odorous substances isolated by the distillation of the juices. There are very few odorous products which can be detected directly in the juice; methyl anthranilate is one of them.¹ Salicylic acid has frequently been identified, but it is not certain whether it pre-exists, as has often been claimed, in the form of methyl salicylate, in the juice of the grape (*Vitis vinifera* L., Vitaceae);² the apple (*Pyrus Malus* L., Rosaceae);² strawberry, (*Fragaria eliator* Ehrh., Rosaceae);³ raspberry (*Rubus idaeus* L., Rosaceae);² cherry (*Prunus avium* L., Prunaceae);^{2, 5} plum (*Prunus domestica* L., Prunaceae).⁴

The aromas of the following juices have been isolated by distillation, frequently preceded by fermentation:

Apples of various varieties: *Pyrus Malus* L., var.⁶

Bananas: *Musa paradisiaca* L. and *M. sapientum* L. (Musaceae).⁷

Pineapples: *Ananas sativus* Schult., *Ananassa sativa* Lindl. (Bromeliaceae).⁸

Orange: *Citrus aurantium* Risso (Aurantiaceae).⁹

Peach: *Prunus persica* Sieb. and Zucc., *Persica vulgaris* DC. (Prunaceae).¹⁰

Power and Chesnut¹¹ have studied the oil obtained by distilling the ethereal extract of apples, this oil representing 0.0035 to 0.0043% of the fruit, according to the variety, and possessing a very pronounced odor

of fresh apple. They have identified therein acetaldehyde, furfural, a paraffin hydrocarbon, and some constituents which were likewise identified in the apple distillate: the amyl esters of formic, acetic and caproic acids, with a small quantity of caprylic esters. The proportions of these constituents vary according to the varieties, and this accounts for the differences in odor. In 1922, they identified geraniol,¹² in addition to the constituents mentioned above.

F. Elze¹³ has studied the odorous constituents of the ethereal extract of ripe raspberries, separated by steam distillation. He found a paraffin, m.p. 43° to 54°, anisaldehyde, irone and nerol.

Absolutely nothing is known of the aromatic constituents of several fruits whose juices are well-known articles of commerce:

pear (*Pyrus communis* L., Prunaceae)

apricot (*Prunus Armeniaca* L., Prunaceae)

the red or white currant (*Ribes rubrum* L., Saxifragaceae)

the black currant (*Ribes nigrum* L., Saxifragaceae)

the gooseberry (*Ribes grossularia* L., Saxifragaceae)

the bilberry or whortleberry (*Vaccinium myrtillus* L., Ericaceae),
etc.

References

1. Power, F. B., *J. Am. Chem. Soc.*, 43, 377 (1921).
2. Traphagen, F. W., and Burke, E., *J. Am. Chem. Soc.*, 25, 242 (1903).
3. Traphagen, F. W., and Windisch, Z. *Untersuch. Nahr. u. Genussm.*, 6, 447 (1903).
Truchon and Claude, *Ann. chim. anal. chim. app.*, 6, 85 (1901).
Portes and Desmoulières, *Ibid.*, 401.
4. Lampitt and Hughes, *Analyst*, 53, 32 (1928).
5. Jablin and Gonnet, *Ann. chim. anal. chim. app.*, 8, 371 (1903).
6. Power, F. B., and Chesnut, V. K., *J. Am. Chem. Soc.*, 42, 1509 (1920).
7. Rothenbach and Eberlein, *Deut. Essingind.* 9, 81 (1905).
Kleber, C., *Am. Perfumer*, 7, 235 (1912).
8. Sullivan, *Ind. Eng. Chem.*, 6, 919 (1914).
9. Hall, A. J., and Wilson, C. P., *J. Am. Chem. Soc.*, 47, 2575 (1925).
10. Nelson, E. K., *J. Am. Chem. Soc.*, 46, 2337 (1924). Power, F. B., and Chesnut, V. K., *J. Am. Chem. Soc.*, 43, 1725 (1921), and 44, 2966 (1922).
11. Power, F. B., and Chesnut, V. K., *J. Am. Chem. Soc.*, 42, 1509 (1920).
12. Power, F. B., and Chesnut, V. K., *Ibid.*, 44, 2938 (1922).
13. Elze, F., *Riechstoff Ind. Kosmetik*, 4, 72 (1929).

Gardenia

The gardenias belong to the Rubiaceae family, and are widely found in India. One species, *Gardenia florida* L., *G. jasminoïde* Ell. or Cape

jasmin, is of Chinese origin, and serves to flavor tea in China. *Gardenia grandiflora* Lour., *G. calyculata* Roxb., found in Japan and in Indochina, is also used for the same purpose. Among the aromatic species, mention should be made of *G. citriodora* L., whose flower exhales a perfume having the distinct scent of orange flower, and *G. deromiana* of the West Indies, whose flower has a fragrance suggestive of the jasmin. The white or creamy white flowers have the most agreeable odor. A variety, botanically ill-defined, is cultivated in Réunion, where its exploitation has been experimented with since 1912 by Ch. Garnier.¹

About 7,000 plants are cultivated per hectare, and a stalk that has been well developed gives 100 to 260 grams of flowers per year. Harvesting takes place in November and December.

Gardenias are also cultivated in Florida and in California, where a pomade has been prepared.

Extraction. R. Garnier has indicated, in a communication to Y. R. Naves, that from 2 to 2.6 tons of flowers are needed to produce 1 kilogram of concrete. This concrete gives about 50% of an absolute.

E. Parone² has treated with Vaseline the gardenia flowers (*Gardenia Brasiliensis* Spreng.), fresh and in full bloom, and he obtained 0.0704% of a yellow concrete:

d_{20}^20 :	1.009
α_D^{20} :	+2.94°

distilling, under a pressure of 12 to 15 mm, in the main between 84 and 150°.

Composition of the extract. The product obtained by Parone contained, according to that author, some benzyl acetate, secondary phenylethyl acetate (methylphenylcarbonyl acetate), linalool, linalyl acetate, terpineol and methyl anthranilate. The percentage of benzyl acetate was high; the fragrance was due particularly to the methylphenylcarbonyl acetate.

References

1. Guenther, E. S., *Am. Perfumer*, 29, 558 (1935).
2. Parone, E., *Boll. chim-farm.*, 41, 489 (1902).

Garland Flowers

The garland flowers or butterfly lilies, *Hedychium flavum* Roxb. (Zingiberaceae) are of Indian origin, and are today cultivated in Mada-

gascar; the flowers are treated in Nossi-Bé for the production of the concrete.

Extraction. The production and the extraction product have been described by L. Trabaud and S. Sabetay.¹

The blooming takes place in February-March. The flowers are gathered early in the morning, and give 0.049% of a petroleum-ether concrete. This product has a consistency reminiscent of the concrete of orange flower. It is dark brown in color. The authors mention a melting point of about 37°, and a drop point (Ubbelohde apparatus) of 46.5 to 47°.

This concrete gives about 50% of an absolute, thick and oily, very dark orange-brown in color.

Analytical Characteristics of the Extracts

(Analytical results converted into usual forms)

	Distillates from	
	the concrete	the absolute
Yield (%)	22	29.6
d_{15}°	0.9153	d_{15}° 0.9666
α_D	-7° 20'	-10° 40'
n_D^{20}	1.4872	1.5002
A.V.	5.1	11.2
E.V.	54.6	94.1
E.V.cf.	188	---
Phenols (4% KOH) (%)	20	---
Methoxy, OCH ₃ (Zeisel) (%)	3.05	3.5
Aldehydes and Ketones as C ₁₀ H ₁₆ O (%)	2.73	---

The residual waxes from the preparation of the absolute are dark brown-black in color. They melt at between 43 and 44°; have an acid value of 29.4, and ester value of 75.8.

It should be emphasized that the treatment of the concrete has given many volatile products other than the absolute. This rather rare phenomenon merits study for confirmation and explanation by further work.

Composition of the perfume. The authors claim to have identified indole among the perfume constituents; however, their proof (presence of nitrogen, positive reaction to the fir-shaving test) is insufficiently characteristic.

Reference

1. Trabaud, L. and Sabetay, S., *Perfumery Essent. Oil Record*, 29, 142 (1938).

Heliotrope

The heliotropes originate in tropical and semi-tropical countries, some varieties being acclimated to southern Europe. The best known species is *Heliotropum peruvianum* L. (Borraginaceae), which has a characteristic and agreeable odor.¹ The winter heliotrope, *Tussilago fragrans* Vill., *Petasites fragrans* Presl. (Compositae), native of southern Europe, and its white-flowered variety, *Petasites albus* Gaertn., have a less agreeable odor.

A very small amount of the flowers of *Heliotropum peruvianum* are treated by digestion in Provence, right after they are cut.

Reference

1. On the perfume of the heliotrope, see: Glenk, *J. Am. Pharm. Assoc.*, 13, 913 (1924).

Honeysuckle

In Provence, the flowers of *Lonicera caprifolium* L. and of *L. etrusca* Santi, *L. gigantea* L. (Caprifoliaceae), are treated. They have a heavy, warm, jasmin-like and citric odor, with a light suggestion of vanilla. The odor of the concrete is only a fair approximation of that of the flower.

Extraction. G. Igolen¹ has treated the flowers of *L. gigantea*, in mid-June, by petroleum-ether extraction. He obtained 3.30% of a dark green concrete, giving 23.8% of a sirupy absolute, olive green in color, and 2.14% of a steam-distillable product, yellowish in color, of fluid consistency, whose top note is rather unpleasant, and which has the following characteristics:

d_{15}° :	0.9012
α_D :	0°
n_D^{20} :	1.4613
A.V.:	25.20
E.V.:	145.60

The constituents are unknown.

Reference

1. Igolen, G., *Parfums France*, 15, 299 (1937)..

Hyacinth

The hyacinth, *Hyacinthus orientalis* L., which is classed in the Liliaceae family, is said to be of Syrian origin. It is cultivated in the Grasse

region at Vence, Tournettes, le Bar, Callian, Mouans-Sartoux, and Valbonne, and in Holland, on 4,000 hectares, between Haarlem and Leyden, around Noorduyk, Katuyk and Alkmar, for the production of the bulbs and the cut flowers, and for perfumery. The blossoming lasts only a short time.

At Grasse there is also treated the wild blue hyacinth (*Hyacinthus non scriptus* L., *Scilla nutans* Sm.). This variety grows among the olive groves and in the open plains. Its perfume is more fresh, more flowery, but less powerful, than that of cultivated hyacinth.

From 1920 to 1928, about 70 to 80 tons of hyacinth were treated annually in Grasse. In 1926, one Dutch house treated 85 tons.¹

Extraction. In Grasse, the cultivated hyacinth yields, on petroleum-ether extraction, 0.17 to 0.20% of a concrete, frequently reaching the limits of 0.13 to 0.22%. The concrete gives 10 to 14% of absolute, and 1.8 to 3% of products volatile in steam. The wild hyacinth gives a higher yield (0.19 to 0.23%). The pale-colored flowers contain more oil than the highly colored ones.

In Holland, an extraction is made with benzene. An industrial experiment to extract with petroleum ether gave 0.098% of concrete.

Characteristics of the extracts. The concrete has a waxy consistency, and its color is more or less pronounced, varying from a greenish brown to a dark brown.

The characteristics of the distillates, A and B, from two concretes of Provence origin, were described by Y. R. Naves, S. Sabetay and L. Palfray,² and those of a distillate, C, from a Dutch concrete, by L. Hoejenbos and A. Coppens:³

	A	B	C
d_{15}°	1.037	1.029	1.0423
α_D^{20}	-0° 44'	-1° 12'	-0° 12'
n_D	1.4998	1.5021	1.4981
A.V.	3.6	2.8	3.0
E.V.	152.1	136.1	143.0
E.V.ac.	-	-	272.0

Composition of the extracts. Spalteholtz and C. J. Enklaar⁴ have identified in the absolute: benzyl benzoate, a substance with a vanilla odor, and a basic substance, fluorescent, not containing any nitrogen. They suspected the presence of benzyl alcohol and cinnamic esters.

L. Hoejenbos and A. Coppens (*loc. cit.*) have identified in the above-mentioned distillate benzyl alcohol, phenylethyl alcohol, cinnamic al-

cohol, cinnamic aldehyde, benzaldehyde, dimethyl hydroquinone, eugenol and methyl eugenol, benzyl acetate, probably accompanied by *n*-heptanol and *n*-heptaldehyde, *o*-methoxy methyl benzoate, benzyl benzoate, and *N*-methyl methyl anthranilate (dimethyl anthranilate).

References

1. *Chem. Industries*, 167 (1928).
2. Naves, Y. R., Sabetay, S., and Palfray, L., *Perfumery Essent. Oil Record*, 28, 336 (1937).
3. Hoejenbos, L., and Coppens, A., *Rev. marques parfum. savon.*, 588 (1931).
4. Spalteholtz and Enklaar, C. J., *Chem. Weekblad*, 7, 1 (1910).

Jasmin

Among the numerous odorous species of jasmin, there are cultivated for perfumery the Spanish jasmin, *Jasminum grandiflorum* L., *J. hispanicum* Hortex D.C., *J. aureum* Don., *J. italonicum* Hort., also called the large-flowered jasmin, the Italian jasmin or the royal jasmin. The jasmin is included in the Oleaceae family. It is grafted on the common jasmin, *J. officinale*, introduced from Persia in 1548, and has since grown spontaneously in the high lands of the Maritime Alps.

Spanish jasmin was introduced in 1560 by Spanish navigators, and has been cultivated at Grasse for approximately two centuries. The cultivation of the plant and the extraction of the perfume were determining factors in the development and orientation of the Grasse industries.

For perfumery, the jasmin is cultivated in the Maritime Alps and the department of Var, from Vence to Seillans; in Algeria, on the plains of Boufarik; on the Italian Riviera, in Calabria and in Sicily; in Egypt, in the Cairo region; in Palestine, near Tel-Aviv; and in Syria, near Beirut.

In India, in the region of Ghazipur (Benares Division of the united provinces of Agra and Outh) there is an active perfume industry. Several jasmin species (*Jasminum grandiflorum* L., *J. sambac* Sol., or Foul, which we shall discuss a little later, and *J. auriculatum* Vahl.) are cultivated for the perfume. Jasmin plantations have also been created in French Guiana, by the aid of plants coming from the Grasse region. These plantations are to be found in the Nadel and Sala regions.¹

In 1939, P. Rovesti² presented his studies of the possibilities for jasmin production in the East African colonies then under Italian domination. In the native gardens of Eritrea and Ethiopia he found *Jasminum abyssinicum* R. Br., *J. floribundum* R. Br., *J. mauritianum* Boer, *J. bogosense* Becc., some *J. sambac* Sol., and in Asmara there were experimental cultivations of *J. grandiflorum* L., grown from Ligurian plants.



Etablissements Antoine Chiric, Grasse

FIGURE 33. *Gathering of jasmmin on the plantations of Provence.*

In Provence, the flowers generally begin to bloom between July 25 and July 30, and the florescence generally continues until the first days of November. The season can be more or less short, depending on the time of cutting and picking. The blossoms of the first weeks are quite unimportant; but toward August 20 the highest daily production figures begin to be reached. The August flowers are the heaviest; eight to ten thousand flowers weigh about one kilogram, whereas in October this figure rises to 14,000.

Generally 100,000 to 150,000 stalks are planted in one hectare; a single plant, known as a *jasmineraie*, well established and well cared for, can last from 8 to 15 years; some have been known to be 20 years of age.

The first year, 12 to 15 kg of flowers are obtained from every 1,000 stalks; the next year, this becomes 30 to 40 kg, a figure that is maintained thereafter. This means that, per hectare, 1,200 to 2,000 kg are obtained the first year, and 3,000 to 4,000 kg for the years that follow, in the course of which the saplings disappear.

The most delicious perfume is given off by the flower at twilight and at daybreak. Each morning at dawn, the flowers are gathered, as quickly as possible. A good worker, usually a woman, gathers up to 3 kg of flowers in 6 hours.

The quantity of flowers delivered annually to the factories of Grasse and its environs, just before the First World War, was about 600 to 700 tons; during the period of heavy collection, deliveries amounted to 7 to 8 tons a day. This production was divided as follows:

Region of Grasse, Montauroux, Seillans	400 tons
Region of Mouans, Mougins, Valbonne	170 tons
Region of Pégomas, Cannes	80 tons

The production varied considerably between the First and Second World Wars. From 800 tons in 1925, it shot up to 1500 in 1927, declined to 750 tons in 1929, went into a serious eclipse from 1930 to 1933, and then was stabilized at 600 to 700 tons just before the recent war.

But in the face of the high market prices of the privileged period of 1926 to 1927, a production foreign to Grasse was organized. In Algeria, jasmin was planted, particularly in the easily irrigable region in the high valley of the Mitidja. The plantings are made by direct cuttings, without any earthing up. Full production was reached in the third year, and the yield per hectare was sometimes double that of Provence; the same is true of the plantings in Syria and in Egypt. In Syria, production is stabilized at 10 to 12 tons per year; in Egypt, it has reached as high as 100 tons in some years, the industry being localized in the region around Cairo. In Italy, production seems to have reached,

in 1939, 400 to 500 tons; the cultivation is in the neighborhood of the two Calabrian centers, Branca Leone and Reggio, and the Sicilian centers of Messina, Avola and Milazzo. In these regions, the fields are generally irrigated, the yields in weight of flowers harvested being very high, but the yield of concrete, and to an even greater extent of absolute, being low.

Distillation of the jasmin gives a very poor yield of an essence of a sour odor, extremely unlike that of the flower. The perfume is extracted by volatile solvents (petroleum ether or benzene) and by enfleurage (pomade, neutralin).

Extraction by Volatile Solvents. *Manufacture of concretes and absolutes:* We have already described this type of manufacture in another part of this volume, and will not return to it now. (See pp. 84-96 and 122.)

The concrete has a more or less dark maroon color; the product manufactured in Algeria and Egypt, and the concrete produced in the heart of the season in Sicily and Calabria, are dark red-brown in color. However, the concretes made at the beginning and at the end of the

FIGURE 34. *Diagram showing the variation in yield from a jasmin plantation having an annual production of 1000 kg., in 1927 in Liguria. From the results published by G. Ro-vesti, Riv. ital. essence profumi piante offic., 187 (1928).*

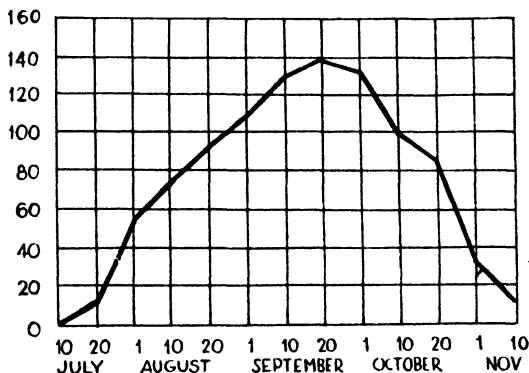

season have a rather pronounced brownish-green tint. The color of the surface is always more or less accentuated. The consistency is rather firm and waxy. Benzene extraction gives a more highly colored concrete, of harder odor, than petroleum ether extraction. It has been noted, particularly in Algeria, Egypt and Italy, that the first harvests of new plantations give more deeply colored products, containing a greater amount of indole. These characteristics progressively disappear in the years that follow, as the quality of the products approaches that of the Grasse concretes.

The yields are rather similar in the various centers of production. They vary from 0.28 to 0.34%; exceptionally these limits are extended to 0.24 and 0.38%. There is a 45 to 53% yield of absolute, and a 10 to 19% content of steam-distillable substances.

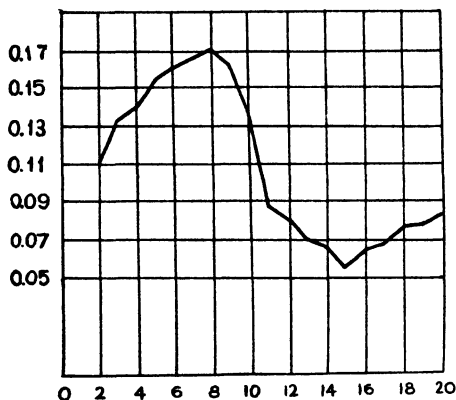

FIGURE 35. Graph showing the variation in yield of absolute, per 100 kg. of jasm-in flowers, according to the hour of harvest. The graph reads from midnight (0) to 8 P.M. (20). From the results published by G. Rovesti, Riv. ital. essenze profumi piante offic., 188 (1928).

The yield varies with the time of harvest.³ According to Rovesti, it reaches a maximum in the course of the second half of August and the beginning of September, and another maximum for the flowers gathered from 6 to 10 o'clock in the morning, when it is double the yield of flowers gathered in the afternoon, and one and a half times as great

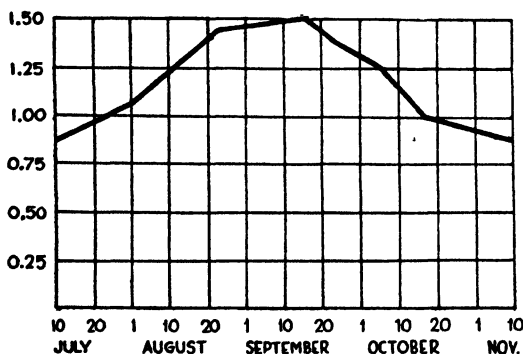

FIGURE 36. Graph showing the variation in the yield of absolute from concrete of the Ligurian jasm-in, during the 1927 season. The yields are based on 1000 kg. of flowers. From the results of G. Rovesti, Riv. ital. essenze profumi piante offic., 187 (1928).

as the yield of the flowers gathered at daybreak, although the perfume of the daybreak collection is the finest.

G. Louveau⁴ has reported a yield of concrete of 0.284 to 0.312%, and of absolute of 40 to 45%. E. Guenther⁵ has indicated a yield of absolute of 0.143 to 0.147%, based on the flowers, and G. Rovesti (*loc. cit.*) of 0.080 to 0.145% for the flowers of the Italian Riviera.

In French Guiana,¹ the flowers are harvested from July 15 to the end of October. In 1937, 2 tons of flowers gave 0.26% of petroleum ether concrete, and this concrete furnished 42% of absolute. The quality is inferior to the corresponding concretes and absolutes produced in Grasse.

Analytical characteristics of the concretes. H. Walbaum and A. Rosenthal⁶ have offered the following limits:

C.P.:	48 to 51°
S.V.:	90 to 123

and G. Louveau (*loc. cit.*):

M.P.:	49 to 51°
E.V.:	95 to 110

The following limits should be acceptable:

C.P.:	47 to 51°
M.P.:	49 to 52°
A.V.:	9.8 to 12.6
E.V.:	68 to 105

and a 10% alcoholic solution has a $[\alpha]_D$ of about +5° to +12°.

No important analytical differences have been found between the products of Provence, of Sicily, Algeria and Egypt, on the basis of these constants.

Analytical characteristics of the absolutes. Freshly prepared, the absolutes are limpid, viscous, and possess a reddish brown color. They rapidly become cloudy, depositing a grayish, waxy sediment; their color darkens, becoming a deep red. This coloration proceeds very quickly in the absolutes prepared from Algerian and Egyptian concretes. G. Louveau⁷ indicates the following characteristics for the absolutes prepared from Grasse concretes between 1928 and 1930, by special processes, in a yield of 28 to 30%:

d_{20}^4 :	1.018 to 1.032
A.V.:	13.5 to 38.0
E.V.:	148 to 175
Free volatile acids (as acetic acid):	0.8 to 2.5%
Methyl anthranilate:	less than 0.2%
Indole:	approximately 0.2%

These values should be modified if one wishes to include the general Grasse production and particularly the so-called *classic* absolutes, which are obtained in a yield of 45 to 53%:

d_{15}° :	0.962 minimum
n_D^{20} :	1.4860 to 1.4920
A.V.:	25 to 30 average
E.V.:	124 to 194

G. Rovesti³ has published the following characteristics for Ligurian absolutes:

d_{15}° :	0.931 to 0.970
α_D :	+0.5° to 2.8°
n_D :	1.4807 to 1.525
E content (as benzyl acetate):	41 to 65%
Indole content:	0.3 to 0.7%
Methyl anthranilate content:	0.2 to 0.8%

and for an absolute prepared at Reggio de Calabria:

d_{15}° :	0.9830
α_D :	+2.5°
E. content (as benzyl acetate):	28.8%

Distillates from concretes and absolutes. By steam distillation, the volatile products are easily separable from the concretes, in a yield of 10 to 16%, on exceptional occasions reaching up to 19% of the concrete. A small yield, about 8%, was reported by J. Viard.⁸

A. Hesse⁹ has steam-distilled several concretes or their absolutes. The first product gave him the very low yield, based on the weight of the flower, of 0.01785%. The analytical characteristics of the distillate were also abnormal:

d_{15}° :	0.940
α_D :	±0°
S.V.:	151.2

In 1904 (ref. 9, p. 1549) Hesse studied two other concretes:

	1	2
Yield of flowers in concrete (%)	0.195	0.426
Yield of concrete in distillate (%)	23	10.6
Yield of distillate based on flowers (%)	0.0447	0.0442
Characteristics of the distillate:		
d_{15}°	1.015	1.001
α_D	+1° 45'	—
S.V.	222.04	199.3

The distillates included approximately 0.4% of methyl anthranilate and 0.2% of indole.

H. v. Soden¹⁰ has studied the distillates from the concretes prepared

industrially in Grasse during the first half of the harvest (I) and the second half (II), and his findings are interesting:

	1	2
Yield per 100 kg of flowers (%)	0.0777	0.0718
d_{15}°	0.9955	0.967
α_D	-1°	Not readable
A.V.	2.5	3.5
E.V.	190.0	161.5

Walbaum and Rosenthal (*loc. cit.*) have briefly described the distillates that they obtained from three concretes:

	% Yield	A.V.	E.V.
1.	15.4	2.7	196.4
2.	14.0	1.4	208.0
3.	13.5	2.4	203.5

Y. R. Naves, S. Sabetay and L. Palfray¹¹ have described the characteristics of distillates obtained from petroleum ether concretes from Provence, in a yield of 10 to 19%.

d_{15}°	α_D	n_D^{20}	A.V.	E.V.
0.996	$+3^{\circ} 30'$	1.4971	2.24	193.0
0.989	$+2^{\circ} 34'$	1.4982	2.80	204.2
1.004	$+3^{\circ} 16'$	1.4956	3.1	216.1
0.988	$-0^{\circ} 40'$	1.4949	3.5	194.1
0.998	$+0^{\circ} 12'$	1.4938	2.7	224.2

Extraction by Enfleurage. *Manufacture of the products of enfleurage.* The manufacture of products of enfleurage makes it possible to obtain a higher quantity of perfume than extraction with volatile solvents, as we have already described (pages 111 to 113).

The pomade obtained by enfleurage is rarely used as such. By extraction with alcohol (as described on page 122), the pomade washings are obtained; the perfumer uses these washings, as well as the products of the partial concentration of the washings, obtained by the elimination of alcohol; or the products obtained by the almost total elimination of the alcohol, by distillation (pomade concentrates, "concretes" or absolutes.) The manufacturers usually designate each of these products by a number, which is more or less in accord with the perfume concentration, depending on the producer. But we should look more thoroughly into this method of nomenclature before justifying such appellations.

The pomade "absolutes" or "concentrates" obtained by the methodic extraction of the pomade, with 95 to 96% alcohol, and by the separation of the materials that are insoluble at -12 to -15° , represent anywhere

from 1.500 to 1.800 kg per 100 kg of pomade, depending on the size of the enfleurage charge and the quality of the work in the enfleurage process. By partially concentrating the alcoholic washing by distillation, before freezing, and then by subsequently diluting the concentrated washing with water to lower the alcoholic content, and finally isolating the products that remain in solution, concentrates are obtained that contain a minimum of fats, and which attain a concentration as high as 500 to 700 grams from 100 kg of pomade.

Following a technique which is related to the enfleurage methods practiced in France as early as the seventeenth century, the Indian perfume industry treats large quantities of jasmin by enfleurage in contact with sesame seeds. The industry was well described in 1919 by J. P. Srivastava,¹² and more recently was the object of an interesting report by S. Banerjee.¹³ The perfumed oil is obtained by expression of the seeds, which had been decorticated and washed, and then placed, for 12 to 14 hours or 24 hours at a time, in contact with renewed charges of the jasmin flowers.

The characteristics of the absolutes described by Louveau,⁷ obtained at Grasse from 1927 to 1929, the concentrations of which were not reported, are as follows:

d_{15}° :	0.994 to 1.008
α_D :	+2° 30' to +3° 50'
A.V.:	5.5 to 8.0
E.V.:	170 to 208

P. Rovesti² has described the characteristics of the absolutes obtained from East African flowers, following the usual process of enfleurage, and the transformation of the pomade into the absolute. The characteristics are given below:

Species	Yield in absolute based on flowers	d_{15}°	Characteristics of absolute		
			$[\alpha]_D^{20}$	n_D^{20}	S.V.
<i>J. abyssinicum</i>	0.256%	0.9981	+3.63°	1.4953	123.9
<i>J. floribundum</i>	0.198	1.016	+1.71°	1.4854	131
<i>J. mauritianum</i>	0.221	0.9913	+2.44°	1.4814	116.9
<i>J. bogosense</i>	0.186	0.9503	+6.53°	1.4915	181.4
<i>J. sambac</i>	0.291	1.024	+2.41°	1.5061	153.3
<i>J. grandiflorum</i>	0.239	1.009	+2.34°	1.4938	131.6

From an olfactory point of view, the absolute from *J. grandiflorum* is comparable to that of commercial products. *J. abyssinicum* and *J. mauritianum* gave absolutes with interesting and particularly delicate odors; *J. sambac* had an odor somewhat less fine, but nevertheless worthy of attention; and *J. floribundum* and *J. bogosense* gave absolutes of inferior quality.

Characteristics of the "distillates" of pomade concentrates. A. Hesse steam-distilled the odorous products of the pomade of enfleurage, and obtained 0.395 to 0.595% of a distillate, based on the pomade, or 0.17%, based on the flowers.

Y. R. Naves, S. Sabetay and L. Palfray (*loc. cit.*) have reported values of 15.5 to 26.1%, corresponding to the concentrate, which in turn was obtained in a yield of 1.500 to 1.800 kg from 100 kg of pomade.

The limits of the characteristics reported by Hesse and Muller on products manufactured in 1896 and 1897 are given in columns 1 and 2; under 3, the characteristics are given of a product examined by Hesse several years later; under 4 to 10, the data published by Y. R. Naves, S. Sabetay and L. Palfray:¹¹

	1	2	3	4	5	6	7	8	9	10
d_{15}°	1.006 to 1.018	1.009 to 1.015	1.015	1.047	1.001	1.004	1.005	0.993	1.012	1.008
α_D	+2° 30' to +3° 30'	+3° 10' to +3° 30'	+3° 20'	+2° 10'	+3° 40'	+2° 15'	+3°	+3° 30'	+3° 03'	—
n_D^{20}	—	—	—	1.4960	1.4946	1.4953	1.4966	1.5015	1.4944	1.4960
A.V.	—	—	—	6.4	7.5	2.2	3.1	2.8	6.1	6.6
E.V.	—	—	268.8	268.0	234.0	254.8	264.8	249.2	268.8	252.1
E. content (as benzyl acetate) (%)	69.1 to 73.0	71.0 to 73.0	71.6							
Indole content (%)	2.5	2.5	2.5							
Methyl anthranilate content (%)	0.5	0.5	0.5							

Neutralin Oils. As we have already pointed out (p. 107), the neutralin oils have less absorption power for perfume than have the fats. Their use for jasmin enfleurage is constantly diminishing. Some Grasse houses treat the fresh flowers by maceration in these oils, at a temperature of between 30° and 35°.

By steam distillation, Hesse isolated the volatile substances of a neutralin oil extract.⁹ The yield was 0.1053%, based on the flowers, and the distillate had the following characteristics:

d_{15}° :	0.975
α_D :	+2°
E. content (as benzyl acetate):	58%

The Chassis Concretes and Absolutes. The flowers that have been removed from the *châssis* still contain a considerable portion of their perfume, and also have some pomade adhering to them. The pomade and the perfume are recovered by volatile solvent extraction (*see* p. 111).

The isolated perfume is powerful and tenacious, but less "indoley" than the perfume obtained by direct extraction or by enfleurage.

The volatile fraction obtained by the steam distillation of a *châssis* concrete had the following characteristics:

d_{40}^{20} :	0.962
α_D :	+2° 42'
n_D^{20} :	1.4902
A.V.:	4.9
E. content (as benzyl acetate):	47.8%

Odoriferous Constituents of the Jasmin Products. The chemical composition of the jasmin perfume was the subject of attentive study by A. Hesse,⁹ who devoted his work particularly to the essence obtained from the enfleurage pomade. He reported the following approximate analysis of the oil:

Benzyl alcohol	6%
Benzyl acetate	65
<i>d</i> -Linalool	15.5
Linalyl acetate	7.5
Jasmone	3
Methyl anthranilate	0.5
Indole	2.5
Bases with a narcotic odor and phenols	traces

To these constituents, Elze¹⁴ added para-cresol and geraniol.

Jasmone seems to be one of the characteristic constituents of jasmin. Its structure, established through the works of W. Treff and H. Werner on the one hand, and Ruzicka and Pfeiffer on the other, indicates that it is 3-methyl-2-(2-pentenyl)- Δ -2-cyclopenten-1-one. The same ketone has also been found in the oil of orange flower,¹⁵ and in jonquil absolute.¹⁶

The presence of indole in jasmin products has been the subject of lively discussions. At first, Hesse contended that indole does not exist in the free state in jasmin flowers, but only in the odoriferous vapors emitted by the flowers.¹⁷ The presence of indole in jasmin concrete was observed by v. Soden,¹⁰ who later confirmed his findings.¹⁸

R. Cerighelli¹⁹ has tried to clear up this question. He found that the flowers contain no indole in the evening when they bloom, but contain an average of 5 mg per 100 grams by morning. The flowers left on the plant lose their indole during the course of the day. Those gath-

ered under the usual conditions contain, at the moment of treatment, 3.5 to 5 mg. of indole, which remains in the atmosphere of the pile of flowers or of the extractors, and goes into the concrete. In the free air, it evaporates, leaving only 0.9 to 1.5 mg. At the time of blooming, the flowers give off their indole at the rate of 0.6 to 0.8 mg per 100 grams per hour. In a confined atmosphere, they give off 14.5 to 19 mg in 24 hours, which explains the high indole content in the products of enfleurage.

The existence in the flower of odorous constituents combined in the form of glucosides, which has been claimed by Nivière,²⁰ remains to be proved.

References

1. Trabaud, L., *Riechstoff Ind. Kosmetik*, 13, 250 (1938).
2. Rovesti, P., *Riv. ital. essenze profumi piante offic.*, 51 (1939).
3. Rovesti, G., *Riv. ital. essenze profumi piante offic.*, 185 (1928).
4. Louveau, G., "Le Jasmin," Paris, Les Editions de la Revue des Marques, 1936.
5. Guenther, E., *Am. Perfumer*, 29, 399 (1934).
6. Walbaum, H., and Rosenthal, A., *Ber. Schimmel & Co. Akt. Ges., Jüb. Ausgabe*, 192 (1929).
7. Louveau, G., *loc. cit.* and *Rev. marques parfums savon.*, 402 (1931).
8. Viard, J., *Parfums France*, 4, 37 (1926).
9. Hesse, A., and Muller, F., *Berliner Berichte der Chemie*, 32, 565 and 768 (1895). Hesse, A., *Ibid.*, 32, 2619; 34, 2916; 37, 1549 (1904); *Z. für angew. Chem.*, 25, 363 (1912). Erdmann, A., *Berliner Berichte der Chemie*, 34, 2282 (1901).
10. Soden, H. v., *J. prakt. Chem.*, N.F. 69, 268 (1904).
11. Naves, Y. R., Sabetay, S., and Palfray, L., *Perfumery Essent. Oil Record*, 28, 336 (1937).
12. Srivastava, J. P., *Perfumery Essent. Oil Record*, 10, 190 (1919); also Rakshit, J. N., *Ibid.*, 38, 241 (1937).
13. Banerjee, S., *Indian Soap Journal*, (July 1938).
14. Elze, F., *Chem. Zt.*, 34, 12 (1910).
15. Elze, F., *Riechstoff Ind. Kosmetik*, 30 (1926). Naves, Y. R., *Parfums France*, 12, 66 (1934).
16. Elze, F., *Riechstoff Ind. Kosmetik*, 181 (1926).
17. Hesse, A., *Berliner Berichte der Chemie*, 34, 2929 (1901).
18. Soden, H. v., *Berliner Berichte der Chemie*, 37, 1458 (1904).
19. Corigelli, R., *Compt. rend.*, 179, 1193 (1924).
20. Nivière, J., *Bull. soc. chim.*, (4) 27, 862 (1920).

Jasmin of Formosa

The *Jasminum odoratissimum* L. (Oleaceae) grows spontaneously in Madeira and in the Far East. It is cultivated for the flavoring of tea in Formosa, where it is known as the Schuei flowers.

Extraction. A petroleum-ether extraction, conducted by R. Tsuchihaschi and S. Tasaki,¹ gave a concrete in a yield of 0.277%; an alcoholic extraction of the concrete gave 0.116% of absolute and 0.116% of waxes, the absolute thus representing 42% of the concrete. Enfleurage experiments gave no favorable results.

Characteristics of the absolute. The absolute, reddish-brown in color, had the following constants:

d_{18}° :	0.9309
α_D^{15} :	+5.64°
n_D^{15} :	1.4845
A.V.:	5.85
S.V.:	92.25
E.V. ac.:	186.20

Composition of the absolute. The authors have identified in the absolute 6% of linaloöl, 6% of *d*-linalyl acetate, 1.6% of benzyl alcohol, 6% of benzyl acetate, 10% of methyl anthranilate and some indole. In the highest-boiling fraction, there is a sesquiterpene or a diterpene alcohol, making up the major part (57%) of the product.

Also used for the flavoring of tea is the Foul, *Jasminum sambac* L., as well as *Nyctanthes sambac* L., *Mogorium sambac* Lam., or Arabian jasmin, which is very widespread, particularly in India. Several efforts to extract the perfume have brought no results (see monograph below).

Reference

1. Tsuchihaschi, R., and Tasaki, S., *J. Chem. Ind. Tokyo*, 21, 1117 (1918); *J. Soc. Chem. Ind.*, A, 38, 117 (1919).

Jasminum Sambac (Foul)

The *Jasminum sambac* Sol. (Oleaceae) or Arabian jasmin, is a bushy plant cultivated in tropical Asia and in the Orient and frequently referred to in French perfumery literature as *le foul*. The flowers are used to flavor tea, together with the flowers of other oleaceous-jasminoid plants, such as *J. odoratissimum* L. and *Nyctanthes Arbor Tristis* L.

According to information supplied by R. Garnier, he has made experimental plantings in Egypt, but the climate does not seem to be suitable, for the plants perish rapidly, and the production of the flowers reaches only an insignificant quantity at the end of several years.

By petroleum-ether extraction, R. Garnier has obtained an average of 0.2% of a concrete giving about 50% of absolute. The odor of this

absolute is at the same time reminiscent of the jasmin and the orange flower, being extremely warm and powerful. The color is intense red, similar to that of an aged orange absolute.

Jonquil and Narcissus

The narcissus belongs to the Amaryllidaceae and, among the numerous species, three are of particular importance to perfumery:

Narcissus jonquilla L. or jonquil, has a violent and very original odor, finer than that of the true narcissus species.

Narcissus tazetta L., or the bouquet narcissus, known as the *Done* of the Provence, grows widely on the plains and in the clear woods of Provence. Its perfume is violent, crude, savage.

Narcissus poeticus L., the white narcissus with the golden heart, is cultivated in southern France and in Holland. Its odor is powerful, very characteristic, clearly fecal.

Also treated sometimes is the *Narcissus odorus* Willd., which is very similar to the jonquil, whose perfume it also resembles, although it is less pronounced.

Jonquil. The floral stalk of the jonquil, almost cylindrical, is 30 to 40 cm high, and contains three to eight beautiful golden yellow flowers. The pappus is of essentially the same color as the corolla.

The cultivation of the jonquil is difficult, and requires great care. The terrain of the jonquil must be changed every three or four years. It is cultivated in the Tanneron-Peymenade-Grasse region. The greatest annual production since 1919 was 30 to 40 tons, decreasing as low as 5 tons just before the Second World War.

*Extraction of the perfume.*¹ A petroleum-ether extraction gives a yield of concrete varying between 0.35 and 0.45%, the limits on rare occasions extending to 0.25 and 0.51%. The concrete gives 40 to 55% of absolute, and includes 3 to 7% of steam-distillable products. The concrete has a waxy texture, and a dark maroon-yellow color. The color of the absolute is very dark brown.

Digestion generally is accomplished in a mixture of 65 parts of a soft and 35 parts of a hard corps, at a temperature which can vary between 50 and 70°. The quantity treated is from 2 to 3 kg of flowers, divided into ten charges, each digested for 30 to 60 minutes.

The pomade has a dark brown-yellow color. The concentrate is obtained by the classic processes, in a yield of 1.55 to 1.80%, based on the weight of the pomade.

Although the jonquil flower does not seem to secrete any perfume after being cut, contrary to the biological processes of the jasmin and

the tuberose, it is nevertheless treated, on very rare occasions, by enfleurage, with the aim of preparing a pomade less highly colored than that obtained by digestion. The duration of the enfleurage is about 24 hours, and the charge varies from 2 to 2.500 kg. The flowers separated from the fats are extracted with petroleum ether.

The manufacture of neutralin oil products from the jonquil has practically been abandoned.

Characteristics of the extracts. The principal analytical characteristics of the concrete can vary between the following limits:

M.P.:	48° to 52°
A.V.:	30 to 44.2
E.V.:	88.6 to 106.8

An absolute from Provence, studied by Y. R. Naves, had the following characteristics:

$d_{15^{\circ}}$:	0.992
n_D^{20} :	1.5044
A.V.:	42.4
E.V.:	132.6

Distillates obtained from the concretes were examined and had the following properties:

	1	2
$d_{15^{\circ}}$:	1.047	1.038
α_D :	-2° 12'	-1° 37'
n_D^{20} :	1.5175	1.5120
A.V.:	2.4	5.6
E.V.:	216.0	196.0

By steam distillation of a concrete manufactured in Grasse, v. Soden² obtained a distillate having the following characteristics:

$d_{15^{\circ}}$:	1.064
$[\alpha]_D$:	-2° 45'
A.V.:	0
E.V.:	250.0

whose alcoholic solution possessed a strong blue-violet fluorescence. The oil rapidly turns brownish yellow on exposure to the air.

Constituents of the extracts. H. v. Soden identified the following substances in the distillate by their olfactory characters and their boiling points: methyl and benzyl benzoates, esters of cinnamic acid (among others, methyl cinnamate), linalool, and by fluorescence he identified methyl anthranilate. By means of the picrate derivative, he isolated indole.

F. Elze³ has identified jasmone in a jonquil absolute.

Narcissus. In former times, *N. tazetta*, *N. multiflorus* Lam. was treated in Grasse; it was cultivated in the Tanneron-Peymeinade-Auribeausur-Siagne region, as well as in the region of Hyères. Today, there is hardly any treatment of narcissus except the *N. poeticus*, from the hills of Maures, and also the wild flowers that are gathered on the plateau of Caussols, in the regions of Castellane, Comps and Moustiers in the mountainous territory known as the Basses-Alpes. In Holland, this same *N. poeticus* is cultivated and treated.

In 1924, 80 tons of narcissus were treated at Grasse, as compared to the 40 or 50 tons in the years before the First World War.

The floral stalk of *N. tazetta* is 30 to 50 cm high. At its end are four to twelve flowers, each with six divisions; they are creamy white in color, with an orange-yellow pappus. The perfume is more violent than that of the jonquil.

The cultivated flowers are gathered during the month of March. The gathering of the wild flowers begins when the harvest of the cultivated ones reaches its end. Each flower is cut with the nail, at a spot about one-third above the ovary. In a well cultivated field, a worker can gather from 0.400 to 1 kg of flowers per hour.

The plantations last from three to four years. During the first year, they yield 300 to 400 kg per hectare; by the third year, this has increased to from 900 to 1200 kg.

The wild flowers growing in abundance in the Maritime Alps and the Basses-Alpes, at rather high altitudes, 1,000 meters and higher, are gathered in March, April and sometimes even in May.

Extraction. The narcissus flowers are treated in Grasse, particularly by petroleum-ether extraction and, to a lesser extent, by digestion, in the same way as the jonquil flowers. In Holland, a benzene extraction is made.

The yield in concrete usually varies between 0.25 and 0.28%. It sometimes falls as low as 0.21%, and on very rare occasions rises as high as 0.45%. The concrete gives 27 to 32% of absolute, and includes 2.2 to 3.5% of steam-distillable products. The *N. poeticus* gives a smaller yield than *N. tazetta* (0.20 to 0.26% against 0.25 to 0.28% of concrete.)

Characteristics of the extraction products. The concrete is waxy, firm, and much less highly colored than the jonquil concrete:

M.P.:	about 50°
A.V.:	24
E.V.:	60 (1 determination).

The absolute is fluid, sirupy and is colored maroon-brown:

d_{15}° :	0.960
n_D^{20} :	1.4884
A.V.:	38
E.V.:	88.6

H. v. Soden⁴ obtained a distillate having the following characteristics, from a Grasse concrete:

d_{20}° :	0.985
α_D :	slightly dextrorotatory
A.V.:	7
E.V.:	202.0

which congealed at between 20 and 22°.

Y. R. Naves, S. Sabetay and L. Palfray¹ have described a distillate which was completely liquid, even at 10°, and which had the following characteristics:

d_{15}° :	0.994
α_D :	+0° 40'
n_D^{20} :	1.4988
A.V.:	5.6
E.V.:	184.0

Constituents. The constituents of the perfume are still unknown.

References

1. Naves, Y. R., Sabetay, S., and Palfray, L., *Perfumery Essent. Oil Record*, 28, 336 (1937).
2. Soden, H. v., *J. Prakt. Chem.*, N.F. 110, 277 (1925).
3. Elze, F., *Riechstoff Ind. Kosmetik*, 181 (1926).
4. Soden, H. v., *loc. cit.*, p. 278.

Karokarounde

A karokarounde concrete has been prepared for several years by a colonial house in French Guiana. The name of the plant comes from the Fouta language. The plant is called the Fara Koronte or the Cayou by the Malinkas. According to A. Chevalier,¹ it is a Rutaceae, *Lep-tactina senegambica* Hook. fil. The shrub is very common in the region of Fouta Djalon, at an altitude of between 1,000 and 1,400 meters, particularly on the acid ferruginous plateaux, the so-called "bowels." It has not been seen except in Guiana, in Sierra-Leona and in the Sudan. The shrub is separated at the bottom; it reaches a height of 1.50 to 2 meters. At the end of October, after the end of the rainy season,

and during the dry season, it is covered with large, white, very odorous flowers.

In the environs of Kinda and Mamou, the *L. densiflora* Hook. fil., with highly perfumed flowers, is found. *L. manii* Hook. fil., whose flowers are equally odoriferous, is found in Gabon. However, these two species are not commercially exploited.

Extraction. The flowers are distilled for the production of the essential oil. A concrete, obtained by petroleum-ether extraction, is dark brown in color, sometimes even a mahogany brown. The color and consistency are analogous to the North African jasmin concrete. The odor is characteristic, successively recalling jasmin, orange flower and acacia, with a benzyl cyanide top-note.

Characteristics of the concrete. Y. R. Naves, S. Sabetay and L. Palfray² have obtained 17.2% of steam-distillable products from a concrete. The distillate had the following characteristics:

n_D^{20} :	1.5174
A.V.:	16.0
E.V.:	32.1

According to S. Sabetay, L. Palfray and L. Trabaud, petroleum-ether extraction gave a concrete of 0.1333%, from which 60 to 65% of absolute was extracted.³ The color of the concrete was orange red; one lot melted at 44°, and contained 1.2 to 1.3% of nitrogen. The absolute is a sirupy liquid, dark orange-red in color. Steam distillation of the concrete gives an average yield of 15.1% of volatile products, and the authors have determined the following characteristics of this distillate:

d_{15° :	0.9944
α_D :	-20°
n_D^{20} :	1.5150
A.V.:	17.3
E.V.:	38.1
E.V. ac.:	138
E.V.cf.:	174.5
Methoxy (%):	3.1 (Zeisel)
Phenols plus acids (%):	32 (cold absorption in 3% caustic soda solution)
Carbonyl index:	8.6
Nitrogen (%):	4.6

Constituents. Isoeugenol and benzyl cyanide have been identified in the distillate. Benzyl cyanide constituted about 38%.⁴

References

1. Chevalier, A., *Rev., botan. appl. agr. trop.*, 831 (1931).
2. Naves, Y. R., Sabetay, S., and Palfray, L., *Perfumery Essent. Oil Record*, 28, 336 (1937).
3. Sabetay, S., Palfray, L., and Trabaud, L., *Perfumery Essent. Oil Record*, 29, 345 (1938); *see also* Trabaud, L., *Riechstoff Ind. Kosmetik*, 32, 249 (1938).
4. Sabetay, S., Palfray, L., and Trabaud, L., *Compt. rend.*, 207, 541 (1938).

Labdanum

On the subject of Spanish labdanum, *see also* the chapter on Resinoids, page 273.

The labdanum, or ladanum, *Cistus ladaniferus* L., *C. polymorphus* Willk. (with three sub-varieties, *albiflorus* Dun., *stenophyllus* Dun., *maculatus* Dun.) belongs to the family of Cistaceae. It grows wild in the Mediterranean regions, and thickly in the Esterel mountains of Provence. It also grows abundantly in Spain, in the provinces of Zamora, Leon and Andalusia. On Cyprus and Rhodes, *Cistus cyprius* Lam. is found. In France, the *C. monspeliensis* L. and *C. salvifolius* L., *C. salviaefolius* Boiss. are also treated, but only on rare occasions. These species furnish extraction products which are of second-grade quality.

The leaves and the branches of labdanum are rich in oil and in resin. Benzene and petroleum-ether extractions are made in Spain and France, but in the former country, as on Cyprus and Crete, the gum-resin is usually collected directly.

The labdanum treated in Grasse comes from the thick growths of the Esterel, and consists of shrubs 2 to 4 meters high. The flowers appear in June, and last only a few hours. The leaves have secreting bristles formed by two or three cells, and which become extremely viscous in summer.

The quantity treated in Grasse reached 150 to 200 tons in 1937, due to the Spanish War.

Extraction. The resinous extremities are gathered at the end of July and during the entire month of August. They are then left to dry in the shade, after which they are extracted with petroleum ether or benzene. The concrete has a very dark color, semi-hard consistency, and it stretches out from the fingers, to which it adheres. The yield obtained by petroleum-ether extraction varies between 3 and 6%, and this concrete gives 45 to 65% of an absolute, which contains 3.2 to 5% of steam-distillable products. The yield by benzene extraction varies from 4 to 7%. The benzene concrete has a darker green color, a harder

consistency, and is frequently brittle, with characteristic appearance of the cracks.

By direct distillation of the resinous extremities, there is obtained 0.1 to 0.2% of an essential oil, whose odor is different from that of the products of extraction, but less persistent, less "animal-like," and less valuable.

The absolute is made by "circulating" the concrete, which has been softened by heat, in warm agitated alcohol. It is well to help the separation of the insoluble products by adding a certain amount of paraffin. The odor of the absolute is amber-like, powerful, and very tenacious.

Characteristics of the extracts. *Concrete.* E. S. Guenther¹ has made observations on two concretes, one prepared in the province of Zamora, in Spain, the other in Provence, having the following characteristics:

	Zamora concrete	Provence concrete
A.V.	71.4	72.8
S.V.	167.1	167.1
E.V.	95.6	94.3

which were soluble to the extent of 85 to 95% in 95% alcohol.

One of us has observed an absolute prepared in Provence:

A.V.:	61.6
S.V.:	146.5
E.V.:	84.9

Distillates. Y. R. Naves, S. Sabetay and L. Palfray² have given the characteristics for the distillates of two petroleum-ether concretes from Provence, shown under columns 1 and 2. By comparison, we are reporting under 3 and 4 respectively the characteristics for the essential oils of the dried labdanum and of the freshly harvested labdanum:³

	1	2	3	4
d_{18}°	0.987	1.003	0.9450 and 0.9443	0.917
α_D	$-4^{\circ} 42'$	$-5^{\circ} 50'$	$-2^{\circ} 36'$ and $-3^{\circ} 08'$	$-9^{\circ} 52'$
n_D^{20}	1.4971	1.4936	1.4900 and ?	1.4878
A.V.	31.0	46.2	16.8 and 14.56	3.73
E.V.	56.6	59.2	22.4 and 32.9	30.8

Samples 1 and 2 were soluble, 1 volume in 90% alcohol; 3, 0.5 volume in 90% alcohol, with cloudiness above 5 volumes; 4, 0.2 volume in 90% alcohol.

Composition of the extracts. The constituents of the extraction products are unknown. H. Masson⁴ has identified acetophenone and 1,5,5-trimethylcyclohexanone-6, in addition to phenols, esters and sesquiterpene products, in the distilled oil.

References

1. Guenther, E. S., *Am. Perfumer*, 27, 479 (1932).
2. Naves, Y. R., Sabetay, S., and Palfray, L., *Perfumery Essent. Oil Record*, 28, 336 (1937).
3. Igolen, G., *Parfums France*, 15, 170 (1937).
4. Masson, H., *Compt. rend.*, 154, 517 (1912).

Lavender and Lavandin

For many years lavender, *Lavandula officinalis* Chaix. *subspec. fragans* and *Delphinensis* Jordan (Labiatae) has been treated by distillation, but the different olfactory note of the plant and the essential oil, as well as the obvious loss of the heavy and tenacious odorous products in the distillation residue, have motivated work on the volatile solvent extraction of lavender. This process gives a product having a faithful and tenacious odor. Today large quantities of lavender and lavandin are treated either by petroleum ether or benzene.

This process is little practiced outside the Grasse region. Treatment is confined to plants easily accessible and inexpensive, usually from the Maritime Alps or the Basses-Alpes, or to the cultivated lavandin of Grasse origin. The herb is semi-dried, and extracted after it has lost 30 to 45% of its weight by exposure to the air, in the shade. This desiccation, which is frequently not pushed as far with lavender that is to be distilled, brings a considerable loss of the most volatile aromatic substances.

It is difficult to give data on the tonnage of lavender and lavandin extracted with volatile solvents, for the simple reason that many houses simultaneously make the essential oil by distillation and the natural perfume essence by solvent extraction.

Extraction. The herb is cut in a chaff-cutter, so as to permit a larger charge in the extractor. Usually benzene is used, rather than petroleum ether, as the latter is a poor solvent for the heavier perfume substances. The benzene concrete is dark green, almost black, and the petroleum ether concrete almost as highly colored.

Lavender gives 1.5 to 2.2% of a concrete, based on plant material that has been desiccated by exposure to the air. This concrete gives 50 to 60% of absolute, and contains 37 to 54% of steam-distillable products.

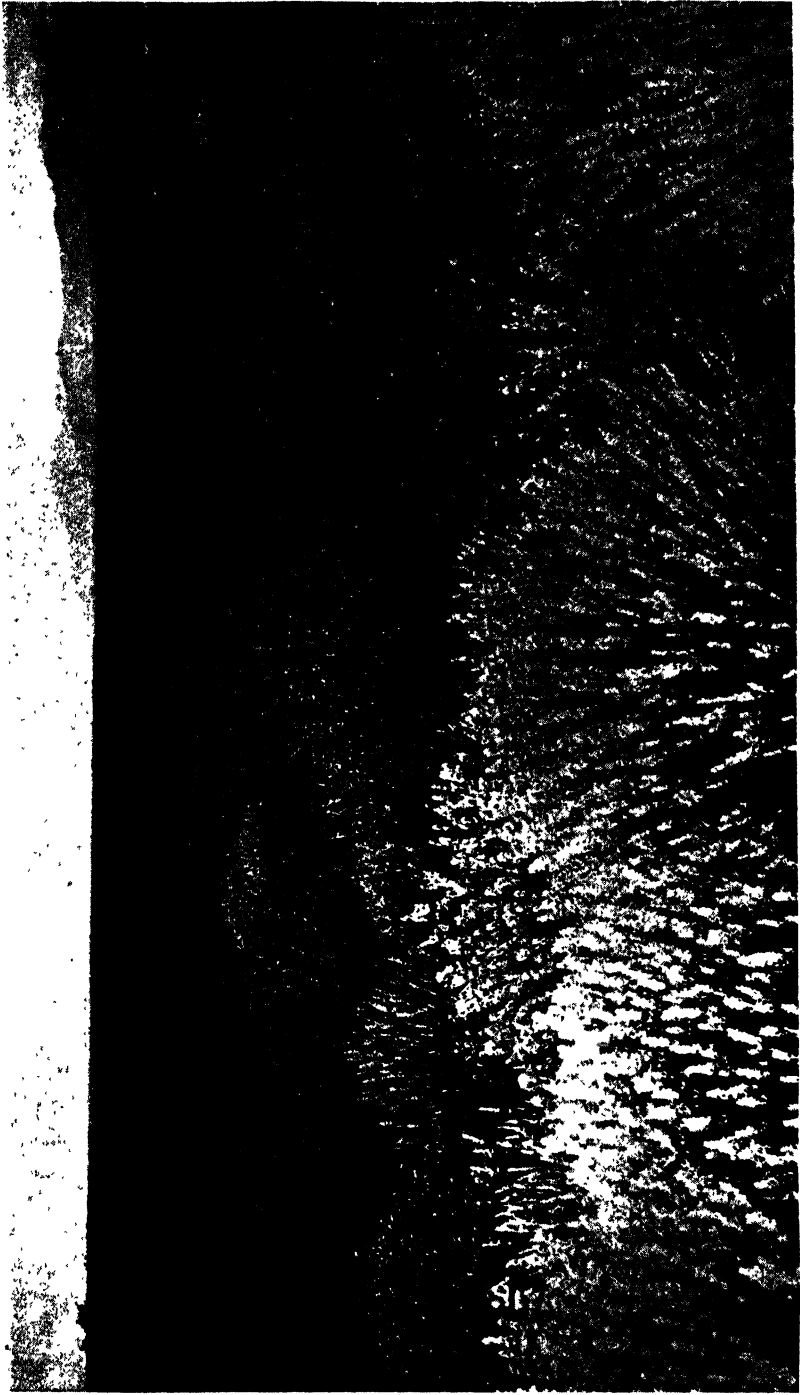

Etablissements Antoine Chiris, Grasse

FIGURE 37. *Cultivation of lavender in France.*

Selected lavandins are generally treated. They give 1.4 to 2.5% of a concrete. This yield is therefore slightly higher than that obtained from the lavenders. This is explained by the generally higher content of extractible products, and also by the fact that, to overcome the crowding of the extractors, which seems to be more serious for the lavandin because of the rigidity of its stems, these stems are cut very short, the cut off stems then being subjected to distillation. A lavandin concrete gives 45 to 55% of absolute, and contains 40 to 48% of steam-distillable constituents.

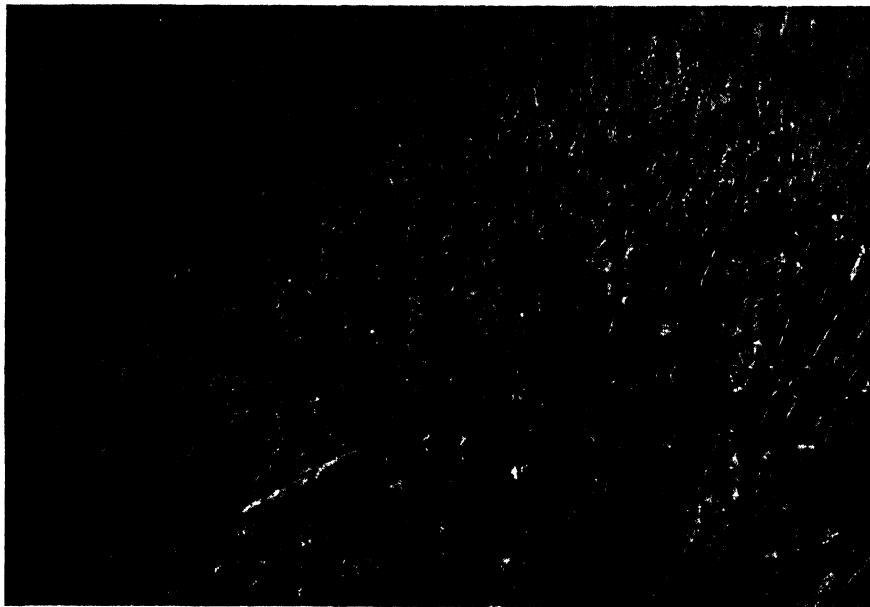

FIGURE 38. *Cultivated lavandin in Provence.*

Characteristics of the extracts. The concretes of lavender and lavandin have a soapy appearance; they are more or less consistent. Sometimes the concretes and the absolutes are mixed with some of the essential oil, so as to reduce the cost of the marketable products. The normal absolutes are very thick and viscous.

By the use of activated carbon, absolutes are prepared that are partially or "almost completely" decolorized. These "almost completely" decolorized products are actually reddish-brown, due to the presence of carotenoid pigments whose total elimination is accompanied by the corruption of the perfume, for odoriferous substances are adsorbed at the same time by the large proportions of activated carbon that must be used.

The odor of the concrete is full, mellow, free from the rapid gradation of the odors that can be observed in following the evaporation of the essential oil. The odor is extremely tenacious.

The usual characteristics of the concretes are as follows:

M.P.:	32 to 39°
A.V.:	5.6 to 28.0
E.V.:	76 to 124

The absolutes have the following characteristics:

d_{15}° :	0.939 to 0.968
n_D^{20} :	1.467 to 1.486
A.V.:	4.8 to 15.0
E.V.:	76 to 136

P. Rovesti and I. Cantamessa¹ have obtained, from the Ligurian lavender flowers, 1.963% of a concrete, m.p. 35-36°, giving 48% of an absolute having the characteristics:

C.P.:	10 to 12°
d_{15}^{50} :	0.9725
α_D^{24} :	-2.68°
n_D^{20} :	1.4897
A.V.:	0
E.V.:	153.07

A. Muller² has made the following observations:

	Concretes	Absolutes
d_{15}°	0.925 to 0.930	0.9715 to 0.973
α_D^{20}	-6° to -8°	-2.3° to -2.8°
n_D^{20}	—	1.491 to 1.492
% E	42 to 43	42.5 to 45
Free alc.	45 to 48	50 to 52

The analysis of the distillates obtained by steam distillation of a number of concretes was made by Y. R. Naves, S. Sabetay and L. Palfray.³

	d_{15}°	α_D	n_D^{20}	A.V.	E.V.	E.V. cf.
Lavender concretes	0.895	-8° 30'	1.4640	2.24	116.2	—
	0.898	-7° 26'	1.4643	2.80	124.1	—
	0.893	-7° 44'	1.4670	1.96	143.1	—
Lavandin concretes (Non-borneol and non-camphor type)	0.888	-7° 40'	1.4598	0.7	142.0	242.0
	0.891	-6° 56'	1.4582	1.1	136.0	247.0
	0.896	-7° 12'	1.4602	0.6	116.0	256.0
	0.892	-7° 34'	1.4594	1.4	131.0	252.0
Lavandin concretes (Borneol and camphor type)	0.903	-4° 20'	1.4660	1.4	76.6	—
	0.904	-5° 32'	1.4671	1.96	77.0	—
	0.898	-5° 04'	1.4684	1.86	74.2	—

Constituents of the extraction products. The extraction products contain free linalool, linalyl acetate and coumarin,⁴ the methyl ether of umbelliferone⁵ and some coumaric acid.⁶ The presence of cedrene, announced by Volmar and Turkhauf, is not certain, for the derivative mentioned by the authors, cedrene glycol, should melt at 167.5 to 168°, and not at 150°, as found by them.

A. Kaufmann and F. Kjelsberg,⁷ who studied the relationship between the linalyl acetate, butyrate and isobutyrate in the essential oil, came to the conclusion that the concrete contains considerably more butyrate than isobutyrate. According to Ellmer,⁸ the proportion of methyl umbelliferone can be as high as 5% in certain lavender concretes. The same author found 3.4% of coumarin in the extraction product, as against 0.8% in the essential oil.

References

1. Rovesti, P., *Profumi Italici*, 4, 208 (1926).
2. Muller, A., *Seifensieder-Zeit.*, 56, 95 (1929).
3. Naves, Y. R., Sabetay, S., and Palfray, L., *Perfumery Essent. Oil Record*, 28, 336 (1937).
4. Kleber, C., *Am. Perfumer*, 21, 680 (1927) and 22, 275 (1928).
5. Pfau, A. St., *Perfumery Essent. Oil Record*, 18, 205 (1927).
6. Volmar, Y., and Turkhauf, O., *J. pharm. chim.*, (Ser. 8), 10, 199 (1929).
7. Kaufmann, A., and Kjelsberg, F., *Riechstoff Ind. Kosmetik*, 171 (1927).
8. Ellmer, *Riechstoff Ind. Kosmetik*, 206 (1927).

Lilac

The common lilac, *Syringa vulgaris* L. (Oleaceae), is of Persian origin; it was introduced into Spain some 350 to 400 years ago. It usually blooms in France during the second half of April. A part of the cultivated flowers was once used for the manufacture of pomades, but this production in recent years was drastically curtailed. An attempt was made to utilize *S. persica* L. or Persian lilac, but several species introduced into Europe from China between 1900 and 1910 seem to be more interesting. These are *S. affinis Giraldui* Schneid., *S. Julianae* Schneid., *S. pinnatifolia* Hemsl., *S. Sweginzowii* Kochne and Ling., *S. tomentella* Bur. and Franch.

Extraction: The extraction of *S. vulgaris* with petroleum ether gives approximately 0.4% of a concrete, the aroma of which is considerably different from that of the flower, and particularly lacks its freshness.

G. Igolen¹ has obtained a petroleum ether concrete, dark green in color, in a yield of 0.24 to 0.36%. Benzene gave him a yield of 0.6%, the concrete being blackish green in color and of hard consistency. The odor of these products had no resemblance to that of the flower; in fact it was disagreeable.

The petroleum ether concrete gave the same investigator 38% of a green-colored absolute, which included 8.72% of steam-distillable products. The distillate had an odor of linseed oil, and had the following characteristics:

d_{40} :	0.9594
α_D :	4° 20'
n_D^{20} :	1.4876
A.V.:	16.8
E.V.:	59.92

The carbonyl index was 39.2, and there was no indole in the distillate.

Composition: The lilac waxes were studied by Favrot.² In the perfume, Kerschbaum³ identified farnesol.

References

1. Igolen, G., *Parfums France*, 16, 117 (1938).
2. Favrot, *J. chim. med.*, 14, 212 (1838).
3. Kerschbaum, *Ber.*, 46, 1733 (1913).

Lily

The lily, *Lilium candidum* L. (Liliaceae), is of Oriental origin. It has large flowers, very odorous, arranged in rows along a stem.

Before 1914, up to three tons of the lily flowers were treated annually at Grasse. The yield of petroleum ether concrete varies between 0.22 and 0.24%.

The constituents are unknown.

Lily-of-the-Valley

The lily-of-the-valley or the perfumer's *muguet*, *Convallaria majalis* L., *C. Linnaei* Gärtner (Liliaceae), has four or five pediculed and reversed flowers, forming a unilateral row, and which bloom in May at the summit of a slender stalk. It grows in the humid woods of southern Europe.

The lily-of-the-valley gives a petroleum ether concrete in a yield of 0.42 to 0.55%, based on the flowers and stalks, or 0.9% to 1.05%, on the flowers alone.

In 1836, B. Herberger¹ made a study of the flower, and isolated a very odorous crystalline substance. Farnesol was identified in the perfume by Kerschbaum.²

References

1. Herberger, B., *Répert. pharm.*, 2, 397 (1836).
2. Kerschbaum, *Ber.*, 46, 1732 (1913).

Linden

The dried flowers of the following species of linden, belonging to the Tiliaceae family, and very widespread in Europe, are extracted:

Tilia cordata Mill., *T. parvifolia* Ehrh., *T. ulmifolia* Scop.;

T. platyphyllos Scop., *T. grandifolia* Ehrh.;

T. tomentosa Moench., *T. argentea* Desf.

G. Igolen¹ has described the preparation and the characteristics of the concrete. The flowers are gathered in June or July, when the corolla is wide open. Properly dried, they should have an amber-yellow color, with the bracts being decidedly yellowish. Treating the fresh flowers coming from the Rhone valley, Igolen obtained 0.33% of a petroleum ether concrete, whereas the dried flowers of the same origin gave a yield of 0.915%. Both products are hard and brittle, dark green in color, having the herbaceous odor of dry hay, hardly at all characteristic of linden. The absolutes, obtained in yields of 32 and 19% respectively, are greenish viscous products.

The absolute derived from the concrete of the fresh flowers gave 5.7% (or about 1.1% of the concrete) of a yellowish distillate, semi-congealed, having these characteristics:

d_{18}° :	0.913
α_D^{28} :	$-3^{\circ} 20'$
n_D^{20} :	1.4736
A.V.:	44.8
E.V.:	112.2
E.V.ac:	163.9
Carbonyl value:	25
Sol. 90% alc.:	2 vols.

It had a vague odor of the flowers, perceptible only on strong dilution.

The fresh flowers of *Tilia argentea* Desf. gave Y. R. Naves an orange-yellow petroleum ether concrete, in a yield of 0.32%. It was a soft product, with an odor suggestive of hydroxycitronellal, with a greenish back-note. Selected flowers gave a rather fluid concrete, in a yield of 0.34%, and the bracts produced a concrete, with the yield 0.29%. This product was firmer in its consistency, had a rough-grained structure, was greenish-yellow in color, and had the specific odor note of green plant life.

The linden concretes are very rich in waxes, which were studied by T. Klobb, J. Garnier and R. Ehrwein.² They isolated a hydrocarbon, $C_{20}H_{38}$, melting at 54 to 56°. The concrete had a powdery note, a little sharper than the scent of the flower, and seems to be of little interest, particularly in view of its high price.

The only constituent known is farnesol.³

References

1. Igolen, G., *Rev. marques parfum. savon.*, 111 (1938).
2. Klobb, T., Garnier, J., and Ehrwein, R., *Bull. soc. chim.* (4) 7, 948 (1910).
3. Kerschbaum, *Ber.*, 46, 1732 (1913).

Lupine

The yellow lupine, *Lupinus luteus* L. (Papilionaceae) or odorous lupine, is cultivated as fodder and also as an ornamental plant, particularly because of the agreeable odor of the flowers. These flowers are grouped in a terminal bunch; they are pale yellow in color, strong in odor. The lupine is widely cultivated in Germany, and has been treated by W. Treff, F. Ritter and H. Wittrisch.¹

A petroleum ether extraction of the calyx and peduncle, separated from the stalk, gave them 0.205% of a concrete, 0.124% (60.4% of the concrete) as absolute, and 0.00195% (0.95% of the concrete) as distillate.

The distillate had a yellow color, a very green odor, and the following characteristics :

d_{15}° :	0.900
α_D :	+7° 30'
A.V.:	38
E.V.:	31
E.V.ac.:	143

The constituents are unknown.

Reference

1. Treff, W., Ritter, F., and Wittrisch, H., *J. prakt. Chem.*, N.F. 113, 359 (1926).

Magnolia

The *Magnolia grandiflora* L. (Magnoliaceae) originated in South Carolina, and was brought to Europe in the eighteenth century. The essential oil was described by G. Tommasi.¹

G. Igolen² has described the flowers that were harvested in Provence in June and again in July. They were treated immediately after being cut, and gave 0.12 and 0.163% respectively of a petroleum ether con-

crete, greenish-yellow in color, of hard consistency, M.P.: 58-60° (Pohl method); A.V.: 28; E.V.: 84.

Steam distillation gives 9.57% and 10.1% of semi-solid distillates, with a pale greenish-yellow color, having these characteristics:

	d_{25}^20 :	0.900	0.903
$[\alpha]_D^{20}$ (benzene, c.:25):		+0° 50'	+4° 36'
n_D^{20} :		—	1.5143
A.V.:		11.04	9.33
E.V.:		11.2	13.07

The odor of the distillates is just like that of the flowers. The non-volatile residue of the first concrete melted at 42 to 44°.

References

1. Tommasi, G., *Riv. ital. essenze profumi piante offic.*, 10, 156 (1928).
2. Igolen, G., *Rev. marques parfum. savon.*, 33, (1938).

Marigold

The flowers of the marigold, *Calendula officinalis* L., *C. officinalis* L. var. *hortensis* Fiori (Asteraceae), a wild plant growing on the entire border of the Mediterranean, and cultivated in European gardens, gave a petroleum ether concrete to G. Igolen.¹ The concrete was obtained in a yield of 0.12%, and had a characteristic herbaceous odor.

No constituent has been identified.

Reference

1. Igolen, G., *Parfums France*, 14, 272 (1936).

Mastic

The mastic or lentisk, *Pistacia lentiscus* L. (Anacardiaceae), is a bushy plant that is widespread in the Canary Islands, around the border of the Mediterranean, and in the Greek archipelago. One variety, *P. lentiscus* L. var. *Chia* D. C., furnishes the resin known under the name of Chio mastic (see page 283).

The concrete has been prepared commercially in Liguria, and was studied by P. Rovesti.¹

The leafy stalks (35% stalks and 65% leaves), gathered in May, gave the following yields of extraction products:

	Benzene	Petroleum Ether	Carbon Tetrachloride
Yield in concrete	0.560%	0.488%	0.512%
Yield of concrete in absolute	53.6%	51.8%	56.4%
Analysis of the absolutes			
d_{15}	0.9776	0.9655	0.9874
α_D^{20}	+0° 54'	+2° 08'	+1° 31'
n_D^{20}	1.4723	1.4708	1.4713
A.V.	3.73	1.87	5.60
E.V.	70.93	80.27	76.78
E.V.ac.	97.07	113.87	106.4
% E.	24.82	28.09	26.78
Tot. Alc.	26.82	31.55	29.44
Free Alc.	7.32	9.48	8.40
Analysis of steam distillates			
Yield from absolute	18.3%	20.7%	21.2%
d_{15}	0.8882	0.8852	0.8876
α_D^{20}	+3° 52'	+5° 18'	+4° 15'
n_D^{20}	1.4728	1.4702	1.4712
E.V.	26.13	18.67	16.80
E.V.ac.	50.40	46.67	42.93
% E.	9.14	6.53	5.88
Tot. Alc.	13.97	12.99	11.94
Free Alc.	6.79	7.86	7.32

The absolutes are quite viscous, and have a light green color. All of these products have a characteristic, green and rustic odor.

Reference

1. Rovesti, P., *Riv. ital. essenze profumi piante offic.*, 357 (1932).

Mignonette (Reseda)

According to Louveau,¹ the following varieties of mignonette are treated for their perfume:

Reseda odorata var. *gigantea*;

Reseda odorata var. *grandiflora*;

Reseda odorata var. *pyramidalis*;

belonging to the Resedaceae family.

The plant seems to be of Egyptian origin. It is cultivated in the plains of Siagne, near Grasse, at Roquette-sur-Siagne, Pégomas and Mandelieu. The flowers are cut from March to July, the yield being about 4,000 kg. per hectare. The flowers are whitish in color, with brick-colored anthers, and have a perfume that is sweet and fresh. Distillation destroys this perfume, and even extraction alters it considerably. A small quantity of mi-

ignonette is treated by digestion, but enfleurage has been completely abandoned. A suitable process which would conserve this beautiful perfume remains to be worked out.

Before 1914, up to 20 tons of mignonettes were treated with solvents annually; by 1927, this had dropped to only 8 or 10 tons, and by 1939, only a few hundred kilograms were still being treated.

Extraction: By petroleum ether, 0.07 to 0.15%, and sometimes up to 0.26% of a concrete is obtained. This in turn contains 30 to 35% of an absolute and includes 3.8 to 5.5% of steam-distillable products.

Characteristics of the extracts: The concrete is dark brown, and has a heavy and tenacious odor, quite unlike that of the fresh flower. It has a waxy and rather homogeneous appearance.

Two concretes, prepared in Grasse in 1936, had the following characteristics:

M.P.:	46° and 49°
A.V.:	66 and 84.2
E.V.:	48.6 and 66.0

A semi-solid absolute was prepared from a bulking of these concretes:

A.V.:	92.4
E.V.:	76.3
Sulfur content:	2.24%

H. v. Soden² steam-distilled a mignonette absolute, and obtained a distillate in a yield of 0.003%, based on the flowers. It was a yellow, non-fluorescent essence, solidifying on cooling, with a strong odor and the following characteristics:

d_{15} :	0.961
α_D :	+31° 20'
A.V.:	16.1
E.V.:	85

Y. R. Naves, S. Sabetay and L. Palfray³ have described two distillates:

	1	2
d_{15}	0.972	0.966
α_D	27° 42'	37° 16'
n_D^{20}	1.4944	1.4886
A.V.	2.8	3.9
E.V.	76.6	84.1

Composition of the extracts: The typical known constituent is phenylethyl senevol, identified by H. Walbaum and A. Rosenthal,⁴ and which today is better known under the name of phenylethylisothiocyanate. This substance had previously been detected in the essential oil of

mignonette roots by J. Bertram and H. Walbaum.⁵ Kerschbaum⁶ noted the presence of farnesol in the mignonette perfume.

References

1. Louveau, G., *Rev. marques parfum. savon.*, 139 (1930).
2. Soden, H. v., *J. prakt. Chem.*, N.F. 69, 264 (1904).
3. Naves, Y. R., Sabetay, S., and Palfray, L., *Perfumery Essent. Oil Record*, 28, 336 (1937).
4. Walbaum, H., and Rosenthal, A., *Ber. Schimmel & Co. Akt. Ges., Jubil. Ausg.*, 221 (1929).
5. Bertram, J., and Walbaum, H., *J. prakt. Chem.*, N.F. 50, 555 (1894).
6. Kerschbaum, *Ber.*, 46, 1732 (1913).

Mimosa

About 30 species of mimosa, among the several hundreds enumerated by botanists, have been cultivated in Grasse. But for perfumery, there is seldom used any species but *Acacia dealbata* Lk. and, on very rare occasions, *A. floribunda* or *retinoïdes*. The mimosa with durable flowers, preferred by horticulturists, is *A. floribunda* Willd. Both species were introduced from Australia around 1835.

Most mimosa species are calcicolous, and in the Grasse region they are therefore cultivated in the primary terrain of the Esterel, where they reproduce and spread spontaneously. They are to be found from Tanneron to Vallauris, in Auribeau, Pégomas, Théoule, La Bocca, La Croix des Gardes and Supercannes.

The first flowers are sold as cut flowers. Then, toward the end of March, and in April, the flowers in full bloom, much more highly scented, are treated for their perfume. In some years, nearly 80 tons of the flowers were extracted.

Extraction: The mimosa is treated exclusively by petroleum ether extraction. The yield in concrete is from 0.70 to 0.88%. The perfume is found in the flowers. Picked off and sorted from the rest of the plant, they have given 1.06% of a concrete, as against 0.77% for the crude material, under the same conditions. The yield in benzene concrete is about the same as obtained with petroleum ether. The latter gives a concrete which yields 20 to 25% of absolute, and contains 4.1 to 6.2% of steam-distillable products. In the humid season, the yield in absolute is lower.

The concrete is waxy, hard, yellowish-white. Its odor is in no way reminiscent of that of the flower; it is quite flat, and is particularly suggestive of the scent of beeswax. However, it has been recommended for the compounding of a mimosa note. A satisfactory process for the extraction of mimosa, that would retain the fine and exalting aroma of

the flower, remains to be found. The note of the concrete from *A. dealbata* is somewhat violet-like; that of *A. floribunda* more phenolic, suggesting the note of ylang ylang.

Characteristics of the extracts: H. Walbaum and A. Rosenthal¹ have analyzed a concrete and obtained the following results:

C.P.:	48.2°
A.V.:	28
E.V.:	44.8

A distillate, obtained by them in a yield of 6.2%, had these characteristics:

A.V.:	26.4
E.V.:	84.5

Three products analyzed by one of the writers had the following characteristics:

M.P.:	48°, 51°, 54°
A.V.:	12.4, 16.1, 9.8
E.V.:	32.4, 26.2, 38.8

and the absolute, prepared from the three samples, after bulking, had these properties:

d_{40} :	1.002
α_D :	+22° 40'
n_D^{20} :	1.5184
A.V.:	8.9
E.V.:	60.4

H. v. Soden² has described an essence obtained in a yield of 0.018%, based on the flowers, from a concrete prepared at Grasse in 1904. It was greenish-yellow in color, and solidified toward 0° into a flaky crystalline mass:

d_{20} :	0.816
α_D :	inactive or slightly laevo-rotatory
A.V.:	12
E.V.:	20.5

A distillate described by Y. R. Naves, S. Sabetay and L. Palfray³ had these characteristics:

α_D :	+0° 35'
n_D^{20} :	1.4812
A.V.:	3.6
E.V.:	22.0

Composition of the extracts: The nature of the constituents of the mimosa perfume is entirely unknown.

References

1. Walbaum, H., and Rosenthal, A., *Ber. Schimmel & Co. Akt. Ges., Jubil. Ausg.*, 193 (1929).
2. Soden, H. v., *J. prakt. Chem.*, N.F. 110, 146 (1925).
3. Naves, Y. R., Sabetay, S., and Palfray, L., *Perfumery Essent. Oil Record*, 28, 336 (1937).

Orange Flowers

The fresh flowers of the bigarade or bitter orange fruit, generally known in perfume circles as the *néroli bigarade*, *Citrus bigaradia* Risso, *Citrus aurantium* L. *subspec. amara* L., *C. bigaradia* Dun. (Rutaceae), gives on steam distillation néroli or orange flower oil and the orange flower distilled water. An orange flower concrete is also prepared by petroleum ether extraction, and the pomades and paraffin oil derivatives by digestion. The extraction of the distilled water with volatile solvents gives oil of néroli waters.

The oil of néroli is prepared in Provence, in Algeria, on the Italian Riviera, in Calabria, in Egypt and on Comores, but the concrete is made only in Provence, Algeria and Italy, and the digestion products only in Grasse. The quantity of extraction products prepared other than in Grasse is negligible.

The production of orange flowers in Provence varies between one and two thousand tons. A maximum of 2000 tons was reached in 1927. By the latter 1930's, production had reached a stable level of 1300 to 1500 tons.

It is very difficult to say what percentage of this is distilled, and how much is set aside for each of the other extraction processes. No satisfactory documentation is available. In the years of highest production, some 250 tons may have been treated by volatile solvents.

In the Maritime Alps, there are two zones of cultivation of these flowers. They are the littoral region which ranges from Vallauris-Golfe-Juan to St. Laurent-du-Var, and the mountainous region that ranges from Gattières to Bar-sur-Loup, through Vence and Tourettes. In the former region, the blooming begins and ends at an earlier date than in the other. There are in fact two blooming periods, one in May and June, and a second, of irregular importance, in autumn. The products obtained from the flowers in each of the two zones are considerably different from the olfactory point-of-view.

The Concrete. *Extraction:* The orange flower is extracted by petroleum ether. Details of the extraction process are given in the section on modern methods of manufacture (see pages 84 and ff.).

The yield in concrete for an entire year averages 0.20 to 0.40%, and usually 0.24 to 0.27%. The concrete gives 36 to 55% of absolute, and includes 22 to 36% of steam-distillable products.

It is commonly observed that the yield of concrete in Autumn is 30 to 60% higher than in the Spring. In general, the Fall yield is between 0.36 and 0.40%.

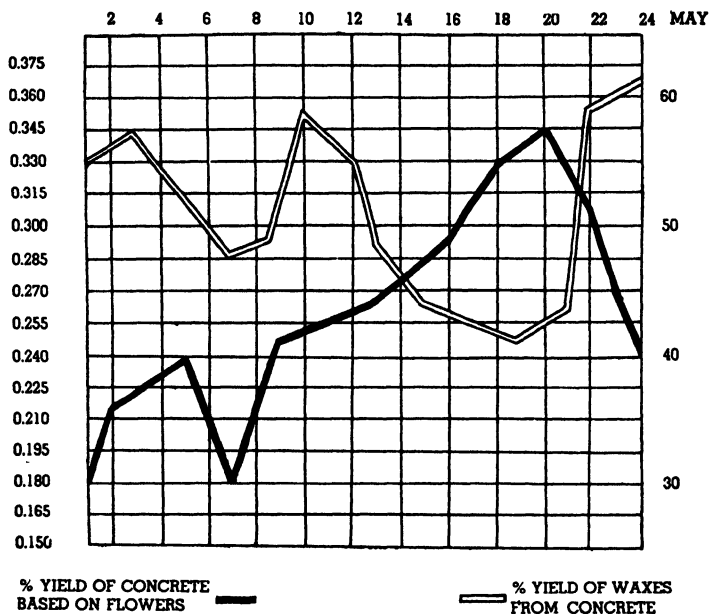

FIGURE 39. Diagram showing the variation of yield of orange flower concrete and absolute, during the 1923 season at Vallecrosia, in Liguria. From G. Rovesti, Riv. ital. essenze profumi piante offic., 54 (1931).

G. Rovesti¹ studied the variation in the yield of concrete during the Spring campaign on the Italian Riviera, and also the variation in the yield of absolute from concrete. According to this author, the Ligurian concrete is obtained in a yield of 0.23 to 0.29%, and it gives 45 to 55% of an absolute.

Compared to the yield of the essential oil, the yield of volatile products obtained by extraction is low. The essential oil of néroli is usually obtained in an average yield of 0.11 to 0.15%, including the orange water essences, whereas the distillate from the concrete averages only 0.06 to 0.09%, or about half as much. Digestion gives only 0.035 to 0.045% of an essence, and enfleurage, utilized only under the most exceptional circumstances, gives only 0.01 to 0.015% of the essence.²

A distillate was obtained from the concrete by Elze³ in a yield of only 0.0235%, based on the flowers; this is abnormally low.

Characteristics of the extraction products: The orange flower concrete is a product of a soapy texture and dark brown color. The absolute is a very dark brown liquid.

H. Walbaum and A. Rosenthal have observed on the concretes:

S.V.: 85.2 to 106.4

G. Rovesti gives the characteristics of absolutes prepared in Liguria:

d_{15} :	0.9105 to 0.9228
α_D :	-0.74° to -5.48°
n_D :	1.4658 to 1.4729
S.V.:	105 to 137.8
Ester content:	36.7 to 48%
Sol. 1 vol. in 95% alcohol.	

The characteristics of several distillates are shown in the table below:

1. The limits given by Gildemeister and Hoffmann,⁴ based on the works of Hesse and Zeitschel, of the Schimmel chemists, and of Calone;
2. The work of Elze (*loc. cit.*);
- 3 to 7. The work of Y. R. Naves, S. Sabetay and L. Palfray;⁵
8. The work of Walbaum and Rosenthal.⁶

	1	2	3	4
d_{15}	0.889 to 0.929	0.922	0.934	0.923
α_D	-0° 48' to -4° 06'	-4° 10'	-3° 55'	-2° 44'
n_D^{20}	—	—	1.4740	1.4768
A.V.	—	2.1	2.4	3.7
E.V.	—	(Ester %: 45.6)	147	84.1
S.V.	55 to 118	—	—	—
Methyl Anthranilate content	2.7 to 15%	—	—	—

	5	6	7	8
d_{15}	0.907	0.905	0.905	0.8902
α_D	-5° 12'	-5° 34'	-2° 20'	-0° 40'
n_D^{20}	1.4788	1.4727	1.4790	1.471
A.V.	1.8	1.9	4.5	—
E.V.	99.6	110.6	88.8	—
S.V.	—	—	—	—
Methyl Anthranilate content	—	—	—	—

The chemists of Roure-Bertrand fils have made a comparative study of the characteristics of the volatile fractions from concretes prepared in Spring and Fall.⁷ The yields are based on 1,000 kg. of flowers. The



FIGURE 40. *Orange groves at Vallauris.*

soluble and insoluble fractions in the distillation water were examined separately, and then united (total essence):

	Insoluble Fraction	
	Spring	Fall
Yield	0.6590	0.6115
d_{45}	0.8883	0.8866
α_D	$-0^{\circ} 40'$	$-4^{\circ} 28'$
n_D^{15}	1.474	1.469
Sol. 80% alc.	1 plus	1 plus
A.V.	0.7	0.7
S.V.	71.4	96.6
% Esters	25.0	33.8
E.V.ac.	172.2	185.9
Tot. Alc.	54.4	59.3
% Methyl Anthranilate	2.43	1.57

	Soluble Fraction	
	Spring	Fall
Yield	0.0773	0.0521
d_{15}	0.9434	0.9124
α_D	-1° 46'	-3° 20'
n_D^{15}	1.498	1.483
Sol. 80% alc.	1 plus	1 plus
A.V.	0.7	1.05
S.V.	61.6	58.8
% Esters	21.5	20.6
E.V.ac.	164.7	173.7
Tot. Alc.	51.6	54.8
% Methyl Anthranilate	13.2	12.4

	Total Essence	
	Spring	Fall
Yield	0.7363	0.6636
d_{15}	0.8899	0.8887
α_D	-0° 48'	-4° 3'
n_D^{15}	1.478	1.476
Sol. 80% Alc.	1 plus	1 plus
A.V.	0.73	1.0
S.V.	70.2	95.8
% Esters	24.6	33.4
E.V.ac.	161.1	179.5
Tot. Alc.	51.0	57.0
% Methyl Anthranilate	3.53	2.74

The residual waxes of the distillation are described below:

	Spring	Fall
Percentage of flowers	0.2272	0.1794
Concrete % of flowers	0.30083	0.24576
M.P. of waxes	46° to 50°	46° to 50°
S.V. of waxes	80.1	77.2

The yields in concrete are contradictory to our own results (see p. 222) which are based on the statistical observations over several years.

Luisi Sorgona⁸ has recently described the characteristics of concretes and absolutes prepared in Calabria.

The concrete had the following properties:

M.P.:	32°
A.V.:	11.4
E.V.:	72.5
Yield of absolute:	40 to 45%

The following characteristics were observed on four lots of the absolute:

	1	2	3	4
d_{20}^4	0.924	0.928	0.901	0.933
α_D^{25}	inact.	inact.	inact.	inact.
n_D^{25}	1.4830	1.4830	1.4700	1.4905
A.V.	24.08	29.47	24.36	15.95
E.V.	73.50	73.32	92.30	68.85
% Esters	25.72	26.25	32.30	24.10
Free Alc.	36.46	37.71	10.06	29.94
Tot. Alc.	56.66	58.34	35.43	43.89
Sol. 80% Alc.	2 vol.	1 vol.	0.9 vol.	0.8 vol.

Composition of the extraction products: Schimmel chemists⁹ have found in the orange flower concrete: some traces of benzaldehyde; a basic substance with a nicotinic odor, which distills above 110° under

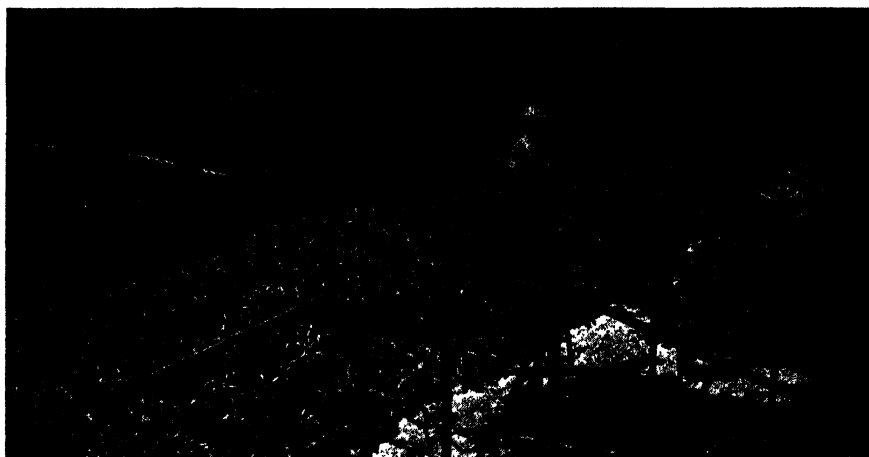

Parfums de France

FIGURE 41. *Picking the orange blossoms at Saint Jeannet, near Grasse, in the Maritime Alps.*

6mm. pressure; a nitrogen-containing compound, melting at 159° which had already been discovered by Hesse and Zeitschel in the orange waters; a product which on saponification gives phenylacetic acid and ammonia, and which probably is benzyl cyanide; and finally a ketone (semi-carbazone, m.p. 205 to 206°) which might be jasmone.

Elze (*loc. cit.*) has detected the following products in the distillate of a Provence concrete: pinene, *l*-camphene, diptentene, *l*-linaloöl, nerol,

phenylethyl alcohol, phenylacetic acid, jasmone, *p*-cresol, indole, methyl anthranilate, and in the distillation residue, indole and farnesol.

Oil of Neroli Waters. Although the constituents of this oil, at least in part, are undoubtedly created by hydrolysis in the course of the distillation, we are including in this volume a study of the oils obtained industrially by the volatile solvent extraction of the distillation waters, both because of the extraction process employed and because these products are generally overlooked in the standard treatises on essential oils.

Extraction: A detailed description of the extraction process is given on page 96. Solvents used are petroleum ether, benzene or toluene. The use of toluene is more advantageous than benzene; for the former is less soluble in water. The petroleum ether extraction of the water, kilogram/kilogram, that is of the water obtained by distilling one kilogram of water per kilogram of flowers charged, gives a yield varying between 0.0325 and 0.0450%, for recent distillation waters. This yield is substantially lowered when the waters are kept for some time before extraction. E. Guenther¹⁰ has indicated a yield varying between 0.0286 and 0.0333%. Waters obtained in distilling one kg of water per two kg of charged flowers are also extracted. They are richer in methyl anthranilate, in proportion to their content of extractible products, since this ester distills over for the most part at the beginning of the distillation. The first waters are known in Grasse as the *eaux bleues* or blue waters, because of their characteristic fluorescence, due to the methyl anthranilate content.

The extracted products in general are deep red-brown in color. Simple or steam distillation will decolorise them.

Characteristics of the néroli-water oils: The characteristics of the oils of néroli waters are considerably different from those of the oils decanted from the waters (the essential oil) because of the relatively high solubility of several constituents in the water, and because the yield of these constituents is insufficient to saturate the water. It follows, then, that these néroli-water oils find uses in perfumery different from those of the oil of néroli itself. They are widely used in flavoring compounds, and they enable the perfumer to recapture rather faithfully, by dissolving these products in water, the character of orange flower water.

The table on page 228 summarizes the published analytical data on these oils.

1. From Hesse and Zeitschel;¹¹
2. E. S. Guenther;¹⁰
3. to 8. Y. R. Naves.¹²

	Water			
	2 kg. 1	kg./kg. 2	2 kg. 3	2 kg. 4
d_{15}	0.945–0.968	0.921	0.9470	0.9482
α_D	+1° 47' to +2° 30'	+1° 10'	inactive	not readable
n_D^{20}	—	1.4814	—	—
A.V.	—	3.3	4.2	4.4
E.V.	—	36.9	41.3	44.8
S.V.	49 to 100	—	—	—
E.V.cf.	—	—	—	268.2
% Methyl Anthranilate	11.6 to 16.0*	—	—	12.0

* Note: According to Hesse.

	Water			
	2 kg. 5	2 kg. 6	kg./kg. 7	kg./kg. 8
d_{15}	0.9462	0.9193	0.9171	0.9344
α_D	not readable	not readable	inactive	+0° 35'
n_D^{20}	—	1.5116	1.4836	1.4928
A.V.	5.0	3.9	2.0	4.2
E.V.	44.1	27.7	35.0	32.2
S.V.	—	—	—	—
E.V.cf.	223.3	301.7	296.8	277.2
% Methyl Anthranilate	12.0	22.0	8.0	8.1

Composition of the water oils: A. Hesse and O. Zeitschel (*loc. cit.*) identified in a 2 kg. water product, originating in Grasse, appreciable quantities of phenols, as well as methyl anthranilate, geraniol, nerol, linalool, phenylethyl alcohol and, in the wash waters from the saponification of the extract, some phenylacetic acid.

Y. R. Naves studied two oils, one a kg./kg. water product, the other a 2 kg. water product. The composition of these two essences is given below, together with the findings of Hesse and Zeitschel for the essential oil of néroli:

Constituents	% Neroli oil	% 2 kg. product	% kg./kg. product
Pinene, camphene, dipentene, paraffins	35	Traces	Traces
<i>l</i> -Linalool	30	32	54
<i>l</i> -Linalyl acetate	7	Traces	Traces
<i>d</i> -Terpineol	2	13	18
Geraniol and nerol	4	8	6
Geranyl and neryl acetates	4	Traces	Traces
<i>d</i> -Nerolidol	6	1	1
Methyl anthranilate	0.6	22	8
Indole	<0.1	Traces	Traces
Free acids and phenols	0.1	1	Traces
Phenylethyl alcohol	identified	8-10	1-2
Benzyl alcohol	—	2	Traces

The same author has also identified in the oil of néroli water eugenol, benzaldehyde and jasmone, and was able to assume the presence of benzyl cyanide, phenyl acetaldehyde and of a bisabolol.

Oils from the sprout waters: The orange flower waters are frequently diluted with sprout waters known as the *eaux de brouts*, which are obtained by distilling the leaves and the young shoots of the bigarade orange tree. These waters, freshly treated, give 0.250 to 0.380% of an oil upon extraction.

One of these oils was analyzed by Y. R. Naves (*loc. cit.*) and had the following characteristics:

d_{16} :	0.8988
n_D^{20} :	1.4682
A.V.:	1.12
E.V.:	4.9
E.V.cf.:	286.3

and contained only traces of methyl anthranilate.

The oil (oil of petitgrain bigarade) that was decanted from the treated water, contained 62% of esters, calculated as linalyl acetate.

Pomades and Neutralin Oil Products. *Manufacture:* The pomades and neutralin oil products are manufactured in the usual manner (*see p. 107*). They are treated at 50 to 70°; six to eight charges are made, for an average total of 5 kg., and, in the case of pomades, sometimes as much as 8 or 10 kg.

The concentrate is obtained in a yield of 1.8 to 2 kg. per 100 kg. of pomade. It is a very dark colored liquid.

Characteristics of the pomade concentrates: The pomade concentrate contains 6.1 to 10.2% of steam-distillable products.

In column 1, we show the results of an analysis of a distillate obtained by Hesse and Zeitschel,¹¹ and in columns 2 and 3 an analysis of two distillates, described by Y. R. Naves, S. Sabetay and L. Palfray:⁵

	1	2	3
d_{16}	0.913	0.904	0.897
α_D	-5°	-6° 20'	-5° 50'
n_D^{20}	—	1.4710	1.4682
A.V.	—	5.6	3.8
E.V.	78.1	102.2	97.1
% Methyl Anthranilate	9.2	—	—

Composition of the pomade concentrates: P. Engels¹⁸ has found indole in the pomade.

References

1. Rovesti, G., *Riv. ital. essenze profumi piante offic.*, 54 (1931).

2. Hesse, A., and Zeitschel, O., *J. prakt. Chem.*, N.F. 64, 245 (1901).
3. Elze, F., *Riechstoff Ind. Kosmetik*, 29-30 (1926).
4. Gildemeister and Hoffmann, "Die Ätherischen Öle," 3rd edit., v. 3, p. 125.
5. Naves, Y. R., Sabetay, S., and Palfray, L., *Perfumery Essent. Oil Record*, 28, 336 (1937).
6. Walbaum and Rosenthal, *Ber. Schimmel & Co. Akt. Ges., Jüb. Ausg.*, 201 (1929).
7. Roure-Bertrand fils, *Sci. Ind. Bull.*, 43 (Apr. 1910).
8. Sorgona, L., *Boll. ufficiale staz. sper. ind. essenze e derio argumi*, 43 (Mar.-Apr. 1938).
9. *Ber. Schimmel & Co. Akt. Ges.*, 52 (Oct. 1903).
10. Guenther, E., *Am. Parfumer*, 28, 653 (1933).
11. See 2, p. 250.
12. Naves, Y. R., *Parfums France*, 12, 63 (1934).
13. Engels, P., *J. prakt. Chem.*, N.F. 66, 504 (1902).

Orchid

Crouzel¹ was unable to obtain an oil by the steam distillation of *Orchis militaris* L. (Orchidaceae). By petroleum ether or alcohol extraction, he was able to get a small amount of a yellowish oil, having a strong, agreeable odor. Coumarin has been identified in this plant, as it has in a large number of related species, *Orchis simia* L., *O. purpurea* Huds., *O. fusca* Jacq., *O. galeata* Poir., *O. cariophora* L. (*O. fragrans* Pall.), *O. odoratissima* L.,² and *Angraecum fragrans* Thonard.³

References

1. Crouzel, *Apoth. Zt.*, 16, 6 (1901).
2. Lojander, *Z. allgem. österr. Apoth.-Ver.*, 25, 438 (1887).
Bertheraud, *J. Pharm.*, 406 (1888).
Wittstein, *Vierteljahresschr. prakt. Pharm.*, 7, 19.
Poulsen, *Botan. Centr.*, 15, 415 (1883).
3. Goble, M., *J. pharm. chim.*, (3), 17, 348 (1850).
Paschkis, *Z. allgem. österr. Apoth.-Ver.*, 490 (1879).
Planchon, *Medical Thesis*, Montpellier (1892).

Pandanus

The *Pandanus odoratissimus* L.¹ (Pandanaeae) has extremely odoriferous flowers. The tree grows in Arabia, in southeastern Iran, in India and in the Malayan peninsula around Singapore. In India, the flowers are known under the name of Kewda. Their color ranges from creamy yellow to white; they are large and have an average weight of almost 120 g. The flowers blossom from the end of July to the end of December, and become particularly abundant from mid-August to mid-September. According to Śadgopal, their odor is suggestive at the same time of

lilac, honeysuckle and ylang ylang, with a predominant topnote of hyacinth and tuberose.

The pandanus seems to be the basis of the most important production of perfume materials in India.

The same author has stated that the flowers are treated with volatile solvent, and the absolute is distilled under reduced pressure, giving an essence with the following characteristics:

d_{18} :	1.0880 to 1.0884
α_D :	$\approx 0^\circ$
n_D^{20} :	1.5220 to 1.5224

We do not feel justified in reporting the composition of the extract, as given by Sadgopal, as we feel it should first be supported by guarantees of authenticity.

A perfumed oil, prepared by maceration of the pandanus in sesame oil, and a perfumed pomade prepared by the usual methods employed at Grasse, are also made in India.

References

- Holmes, E. M., *Pharm. J.*, (III), 10, 653 (1880).
Dymock, Warden and Horper, *Pharmacopoeia India*, IV, 531.
Sadgopal, *Soap, Perfumery and Cosmetics*, 396 (1937).

Plumiera

The flowers of *Plumiera acutifolia* Poir. (Apocynaceae), a tree growing in the Philippines, in India and Central Asia, have a sweet odor reminiscent of frangipane and of an odorous complex of tuberose and gardenia.

R. Bacon¹ made a petroleum ether extraction and obtained a concrete having an agreeable odor. Even better results were obtained by digestion of the flowers in a paraffin oil.

The constituents are unknown.

The flowers of *Plumiera alba* L., or frangipane, and of *P. alba* Hort.² have also been treated for perfumery.

References

- Bacon, R., *Philippine J. Sci.*, (A) 4, 131 (1909).
- Roure-Bertrand fils, *Sci. Ind. Bull.*, 28-29 (Apr. 1909).

Poplar Buds

The fresh buds of the balsam of tacmahac, *Populus balsamifera* L. (Salicaceae), a large tree introduced from southern America in the seventeenth century, were extracted with ether by A. Goris and H. Canal.¹

The concrete was very dark green, and had an agreeable odor. It contained some free acids, some phenols, phenylcinnamate and cinnamic esters, together with 2,6-dihydroxy-4'- β -methoxypropioiphenone, $C_{16}H_{16}O_4$ which melts at 168°.

Later the same authors² isolated propionic acid, butyric acid, cinnamic acid, an acid $C_{24}H_{48}O_2$, m.p. 71°, 4-hydroxybenzoic acid, 2,3-dihydroxybenzoic acid, 3,4-dihydroxycinnamic acid, a methyltrihydroxyanthraquinone, m.p. 218°, and an unidentified phenol, m.p. 224°. The neutral fraction contained phenylethyl and cinnamyl cinnamates, a sesquiterpene alcohol $C_{15}H_{26}$ (phenylurethane m.p. 150°), acetophenone, 2,6-dihydroxy-4'- β -methoxypropioiphenone, pentacosane (m.p. 54.5°), heptacosane (m.p. 59.5°) and nonacosane (m.p. 63.5°).

References

1. Goris, A., and Canal, H., *Compt. rend.*, 201, 1435 and 1520 (1935).
2. Goris, A., and Canal, H., *Bull. soc. chim.*, (5) 3, 1982 (1936).

Privet

The privet is a shrub of extremely pleasing appearance, growing widely in woods and among hedges in the temperate regions of Europe, Asia, Africa and America. The white flowers are grouped in thick bouquets, and are very odorous. They begin to blossom in Provence toward the middle of July.

The petroleum ether concrete of the common privet, *Ligustrum vulgare* L. (Oleaceae), has been studied by Mme. M. G. Igolen.¹

Extraction: Petroleum ether extraction gave a light green concrete, in a yield of 0.4%; this concrete gave 17 to 22% of a dark green, viscous absolute, and included 9.4% of steam-distillable products.

Characteristics of the absolute: The analytical characteristics of an absolute studied by Mme. Igolen were:

d_{15}° :	0.979
A.V.:	48.5
E.V.:	76.5

and of the corresponding distillate:

d_{15}° :	0.9481
α_D^{20} :	+4°
n_D^{20} :	1.4919
A.V.:	37.8
E.V.:	57.51
E.V.ac.:	123.1
E.V.cf.:	164.13
Sol. 90% alc.:	20 vol.

Composition of the distillate: The distillate contained no aldehyde or ketone, but gave a positive reaction for sesquiterpene azulenes.

Reference

1. Igolen, Mme. M. G., *Parfums France*, 15, 143 (1937).

Rhododendron

The young shoots of the "rose laurel of the Alps," the *Rhododendron ferrugineum* L. (Ericaceae), were dried in the open and treated by the chemists of Roure-Bertrand fils,¹ who obtained a petroleum ether concrete, which in turn gave a steam-distillate in a yield of 0.17%, based on the plant. The distillate was light green, had a balsamic odor, and the following characteristics:

d ₄ :	0.840
A.V.:	0
E.V.:	63.47

The constituents are unknown.

Reference

1. *Roure-Bertrands fils, Sci. Ind. Bull.*, 34 (Apr. 1920).

Robinia

The acacia or robinia, or to be more exact, the false acacia, *Robinia pseudacacia* L., (Papilionaceae) is a large tree of North American origin. It was introduced into France around 1615. Its flowers, very odorous, are grouped in white bunches. There have been several efforts to make an ether extraction of these flowers, which are today almost entirely, and unjustifiably, ignored by perfumery. Production efforts were carried on in Hungary, particularly because of the blockade of the First World War.¹ According to E. Gorokhoff,² the robinia is cultivated in Russia, where the flowers are gathered in the morning, before the morning dew, and they are treated by enfleurage, 3 kilograms of flowers for one kilogram of pomade.

Extraction: The yield of concrete obtained by petroleum ether extraction, calculated on the basis of the fresh flowers, usually varies between 0.15 and 0.20%.

Composition of the extract: F. Elze³ has studied the composition of the petroleum ether concrete. The volatile fraction distilling between 60 and 150° C. under 5 mm. mercury pressure, had a density of 1.05 at 15°

and contained 9% of esters, calculated as methyl anthranilate. Elze has identified the following constituents: methyl anthranilate, indole, traces of pyridine bases, heliotropin, benzyl alcohol, linalool, α -terpineol, traces of aldehydes, some ketones of a peach odor, and probably some nerol. According to Haarmann and Reimer,⁴ farnesol is found in the oil of the flowers of various acacias.

References

1. Folsch, M., *Riechstoff Ind. Kosmetik*, 123 (1928).
2. Gorokhoff, E., *Parfumerie moderne*, 32, 439 (1938).
3. Elze, F., *Chem.-Zt.*, 34, 814 (1910).
4. Haarmann and Reimer, German Patent, 149,603; *Chem. Zentr.*, 2, 975 (1904); see also Kerschbaum, *Ber.*, 46, 1732 (1913).

Rose

In France, the chief production of a flower oil from the rose is based on the May rose or *rose de mai*, *Rosa damascena* Mill., supplemented by such garden roses as the Ulrich Brunner, van Houtte, tea rose, etc.

In the Balkans, the *Rosa damascena* Mill., var. *trigintipetala* Dieck., is treated, and in Bulgaria there is also used, in addition, *Rosa alba* L., a flower of lesser value. According to some botanists, *Rosa damascena* Mill. seems to be the progenitor of the species now exploited in Bulgaria and in North Africa, whereas in Provence, the *Rosa centifolia* L. was propagated [see *Parfums France*, 4, 161 (1926)].

In France, only a small amount of the essential oil is produced, distillation being practiced mainly to obtain the rose water; a small quantity of flowers is used to produce pomades and oils by digestion, and the major part is utilized in the manufacture of the concrete; whereas in Bulgaria, the greater part of the flowers is used in the essential oil production.

Before 1914, the annual production of May rose in Provence reached 2500 to 3000 tons. Immediately after World War I, this production fell to about 1500 tons, and by the middle nineteen thirties had collapsed to only four to five hundred tons.

The rose bush plantations in Provence are cultivated for an average life of ten years, although some bushes last as long as twelve to fifteen years. The maximum production is realized toward the fourth or fifth year, and it reaches 2000 to 5000 kg. per hectare. The plantations are to be found from the region of Vence up to Peymeinade, and the centers of cultivation are La Colle-sur-Loup, Valbonne, Grasse, Peymeinade, and Mouans-Sartoux. The blossoming is at its height in May, as the name

would suggest. Precocious flowers in some years begin to appear in April, and last right into June. Considerable quantities of flowers are delivered to the factories on certain days, as much as 15 to 20 tons, which must be treated without delay.

In Bulgaria, the volatile solvent treatment of the rose was innovated by Ch. Garnier in 1904. He installed a factory at Kara Sarli, containing six 12-tray extractors (the *roue type*). After 1919, six more factories were built, all but one equipped with stationary extractors, and three of which were still in use in 1939. Large quantities of flowers have been treated, particularly from 1922 to 1930. In some years, production of the concrete reached as high as 1000 kg., only to fall to two to three hundred kg. between 1932 and 1935.

The Bulgarian roses that are extracted come from the regions of Kazanlik, Brezovo, Karlovo, Kalofer and Klissoura. Production per hectare varies between 1800 and 2000 kg. About 8 to 10% of the harvest is extracted with volatile solvents.

Small quantities of concrete have been produced on the Italian Riviera, and at Boufarik in Algeria. In Morocco, the Seba Aïoun factory, near Meknès, has extracted with petroleum ether considerable quantities of fresh rose and of a dried "button rose."¹

There is an industry of increasing importance in Turkey. According to C. Erhardt,² a factory for the preparation of a petroleum ether concrete from *Rosa damascena* Mill. has been installed at Burdur.

Concrete. Extraction: The rose is extracted with petroleum ether or benzene. The latter gives a slightly higher yield, and the concrete varies in color from light green to greenish brown, while the former produces a concrete ranging from a light brown to dark brown.

The yield in petroleum ether concrete in Provence varies between 0.17 and 0.27%, and is usually between 0.24 and 0.265%. This concrete gives 55 to 65% of an absolute, and includes 25 to 32% of steam-distillable products. Rovesti³ has reported a yield in Liguria of 0.18 to 0.317% of concrete prepared from the May rose; this concrete gives an average of 48% of absolute.

The benzene concrete is obtained in a slightly higher yield, but it contains less absolute.

The roses cultivated at a higher altitude seem to yield more concrete.⁴ The increase in yield seems to be around 30 to 35% for the roses gathered at 1150 meters in the Grasse region, as compared with the roses harvested on the plains of Grasse, where the average altitude is 100 to 250 meters.

The treatment of the Brunner rose gives 0.10 to 0.14% of a concrete, and on exceptional occasions a little more, rising as high as 0.19%. This

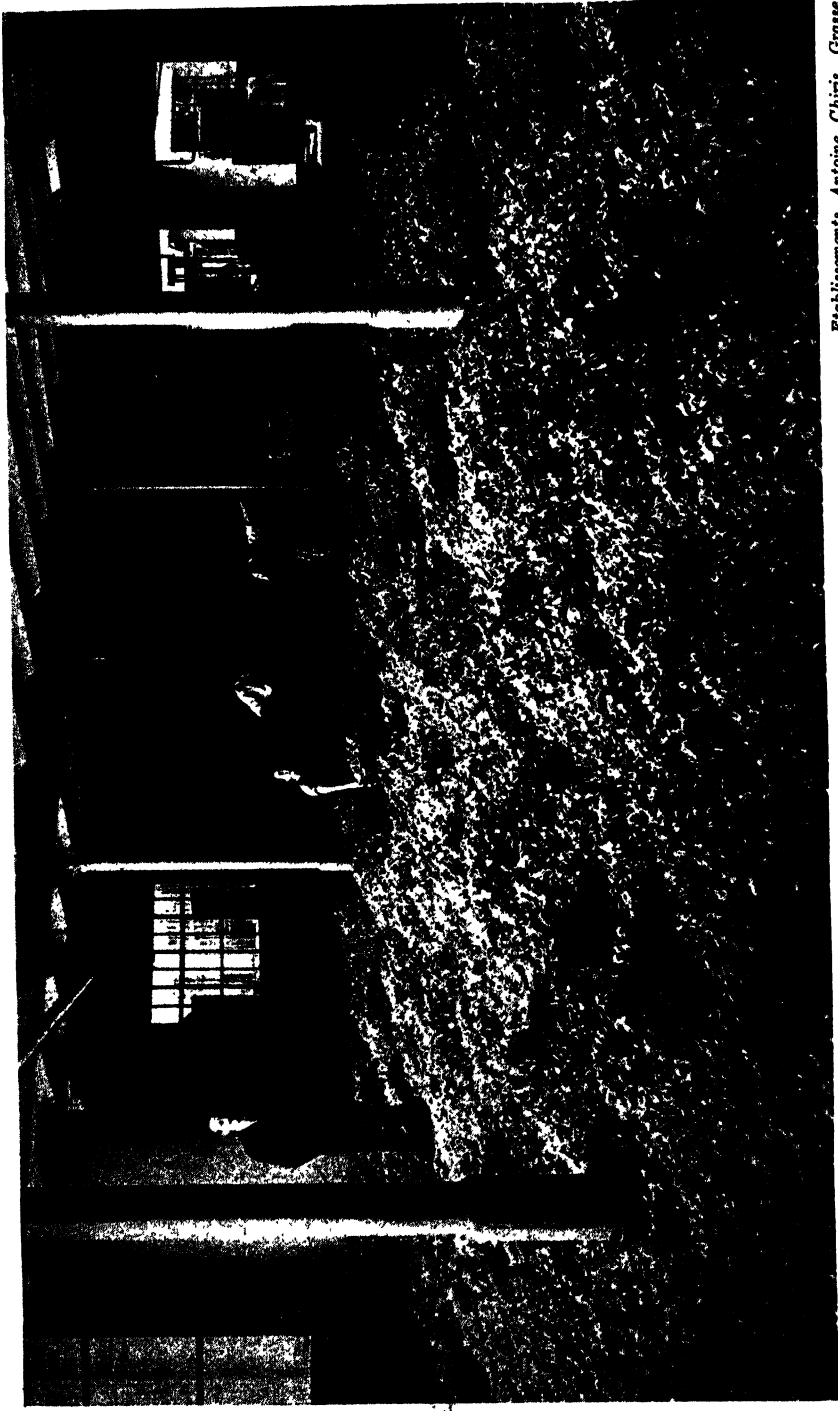

Etablissements Antoine Chiris, Grasse

FIGURE 42. French roses stocked in a factory, ready to be extracted for perfume.

concrete gives 30 to 35% of absolute. Rovesti⁵ reports, for the Ligurian production, 0.114 to 0.165% of concrete, and 41% of absolute.

In Bulgaria, the petroleum ether concrete is obtained in a yield of 0.22 to 0.25%, and gives 50 to 60% of absolute, including 35 to 41% of steam-distillable products.

In Italy, V. Massera and G. Monti⁶ obtained 0.2118% of a concrete from *Rosa centifolia*; 0.1158% from Brunner rose; and 0.0068% of absolute from Druschki rose.

In Morocco, the dried roses give 1.0 to 1.12% of concrete.

Characteristics of the products: Concretes: The petroleum ether concrete prepared from the May rose in Provence has the following characteristics:

C.P.:	43° to 48°
M.P.:	49° to 54°
A.V.:	9.8 to 14.4
E.V.:	19.6 to 25.2

H. Walbaum and A. Rosenthal reported the following characteristics for the Bulgarian concrete:

C.P.:	41° to 46.5°
S.V.:	31 to 56

and for the concretes prepared at Miltitz, Germany, from *Rosa damascena*:

C.P.:	40° to 46.5°
S.V.:	44.8 to 50.4

They report that commercial products frequently contain a considerable amount of petroleum ether. (They encountered samples containing as much as 25%). The presence of petroleum ether depresses the congealing point. Thus, a concrete congealing at 44.5%, will congeal at 41.5° when 3% of petroleum ether is added; at 37° with 15%, and 34° with 25%.

Absolutes: Several analyses of absolutes have been published, and are summarized below. To them, we have added the unpublished studies of Y. R. Naves.

Product and origin	d_{15}	α_D	n_D^{20}	A.V.	E.V.	E.V.ac.	Tot. Alc.
1. <i>R. centifolia</i> , Italy	0.9696.	-0° 31'	1.4754	0.81	—	—	91.2
2. R. Bulgarian	0.9729	+13° 10'	1.50808	9.3	29.9	217.5	71.5
R. Bulgarian	0.9682	+14° 25'	1.50633	9.3	30.9	211.9	69.3
R. Bulgarian	0.9916	+14° 20'	1.51556	11.2	27.1	218.4	71.8
R. German, Miltitz	0.9820	+10° 25'	1.50781	20.5	28.9	225.9	74.8
R. German, Miltitz	0.9556	+5° 20'	1.50158	14.1	33.6	210.0	68.5
May rose, France	0.9640	+13° 55'	1.50873	9.3	29.0	220.3	72.6
Various garden roses	0.9059	+0° 50'	1.48286	13.1	9.3	123.2	37.3

Product and origin	d_{15}	α_D	n_D^{20}	A.V.	E.V.	E.V.ac.	Tot. Alc.
3. R. Druschky, Italy	0.9151	-0° 39'	1.4701	—	—	—	81.4
R. Brunner, Italy	0.951	-0° 19'	1.4905	—	—	—	90.5
4. R. Bulgarian	0.983	+9° 40'	1.5078	4.8	22.4	216.1	—
R. Bulgarian	0.991	+10° 24'	1.5072	3.5	19.6	243.2	—
R. Bulgarian	0.973	+11° 10'	1.5081	4.34	23.1	231.7	—
May rose, Var, France	0.988	+12° 28'	1.5096	7.56	23.4	229.9	—
May rose, Var, France	0.993	+10° 41'	1.5104	6.86	17.5	236.6	—
May rose, Var, France	0.981	+13° 10'	1.5122	3.4	26.6	231.2	—

1. V. Massera and G. Monti;⁶ to the above characteristics, add a congealing point of +8.1° and a 5.1% citronellol content;
2. Schimmel;⁷
3. V. Massera and G. Monti (*loc. cit.*);
4. Y. R. Naves, unpublished studies.

These absolutes are generally brownish green; they are limpid and sirupy. They have a remarkable dextrorotatory power (particularly *Rosa damascena*); whereas the essential oils and the distillates are laevorotatory. The substance or substances responsible for the dextrorotation are non-volatile.

Distillates: The distillates from the concretes and absolutes are colorless and limpid. If the distillation is carried too far, particularly at atmospheric pressure, some paraffins are distilled. Characteristics of several distillates are summarized below:

	C.P.	d_{15}	α_D	n_D^{20}	A.V.	E.V.	E.V.ac.	10° A° H
1. R. France	5 to 7°	0.967	-1° 55'	—	5.5	4.6	295.0	—
R. Germany	12°	0.987*	+0° 9'	—	3.0	4	313.5	—
2. R. <i>centifolia</i>	13°	0.9934*	+0° 6'	—	3.15	2.9	317.5	—
3. May rose (petroleum ether)—liquid		0.976	-2° 24'	1.5038	0.8	7.2	292.6	—
May rose (benzene) —liquid		0.989	—	1.5145	2.8	5.25	—	—
R. Bulgarian (petroleum ether)—liquid		0.951	-2° 42'	1.5046	2.1	8.8	298.0	—
R. Bulgarian (petroleum ether)—liquid		0.948	-1° 54'	1.5056	3.1	10.4	284.9	—
R. Bulgarian (petroleum ether)—liquid		0.956	-2° 16'	1.5071	2.8	9.6	278.6	—
R. Bulgarian (petroleum ether)—liquid		0.992	-1° 12'	1.5184	2.24	6.3	305.2	—
R. Bulgarian (petroleum ether)—liquid		0.974	-1° 50'	1.5065	2.8	8.4	296.1	—

	$d_{15^{\circ}}$	α_D	n_D^{20}	A.V.	E.V.	E.V.ac.	E.V.cf.
R. Bulgarian (petroleum ether)—liquid	0.966	-1° 44'	1.5071	3.2	5.6	286.1	—
R. Bulgarian (petroleum ether)—liquid	0.989	-0° 54'	1.5190	5.1	9.8	302.0	—
4. R. Bulgarian (petroleum ether)—liquid	0.9713	-1° 36'	1.5098	—	8.4	320.6	313.6

* Calculated by Y. R. Naves for values at 15°.

1. H. v. Soden;⁸
2. F. Elze;⁹
3. Y. R. Naves, S. Sabetay and L. Palfray;¹⁰
4. L. S. Glichitch and Y. R. Naves.¹¹

Composition of the extracts: The composition of the volatile fraction of the concrete differs from that of the essential oil, as is also the case with orange flower products. The rose contains a considerable proportion of phenylethyl alcohol, which is relatively highly soluble in water. This alcohol remains in the distillation water and in the still. An experiment conducted by the Schimmel chemists⁷ amply demonstrates this fact. An absolute having the characteristics:

$d_{15^{\circ}}$:	0.982
α_D :	+10° 25'
n_D^{20} :	1.5078
A.V.:	20.5
E.V.:	28.9

and containing 74.8% of total alcohols (expressed as geraniol) was distilled. The characteristics of the direct essence are shown in column 1; those of the essence obtained by extraction of the water, in column 2:

	1	2
$d_{15^{\circ}}$	0.9183	0.9977
α_D	-0° 48'	inactive
n_D^{20}	1.48344	1.51745
A. V.	3.4	7.5
E.V.	15.9	7.5
E.V.ac.	258.5	317.2
Total alc.	88.2	—

Identification of phenylethyl alcohol in the concrete is credited to H. v. Soden and W. Rojahn¹² and to H. Walbaum;¹³ v. Soden and Rojahn also detected it in the rose water and in the pomade distillate.

The essential oil hardly contains more than 1% of this alcohol.¹²

Rhodinol has been extracted, in a pure state, from a Bulgarian concrete.¹⁴ A distillate from the concrete, obtained by steam distillation, contained about 63.7% of phenylethyl alcohol, some 13% of geraniol-nerol,

and 21% of rhodinol. The rhodinol, purified by benzylation, according to the Barbier-Bouveault technique, had these characteristics:¹⁵

B.P. _o :	99° to 104°
d ₄ ₂₀ :	0.8618
[α] _D :	-4° 14'
n _D ²⁰ :	1.4570

The concrete also contains small quantities of eugenol and acetyl eugenol, as well as traces of a ketone with a minty odor (Y. R. Naves).

Nerol and farnesol have been identified in the concrete by Elze.⁹

The optical activity of rhodinol, corresponding to the maximum rotatory power of this alcohol, constitutes an interesting analytical fact. By isolating and examining this alcohol by means of the technique utilized by L. S. Glichitch and Y. R. Naves, the purity of an oil containing the usual percentage of rhodinol can be controlled.¹⁴

Oil of Rose Waters. The distilled water of the May rose is prepared on a large scale in Grasse. It can be estimated that one-fourth of the annual harvest is set aside for this purpose. Part of the rose water produced is extracted with volatile solvents, exactly as is done with orange flower water. The product obtained is the oil of rose water, having different uses in perfumery than the essential oil, and which can be used as the base for the reconstitution of a rose water, having the advantages of an economy of storage expense, packing, transportation, and an assurance of better conservation.

The yield by petroleum ether extraction is from 0.200 to 0.280% for the so-called "single" water manufactured at Grasse. This product consists mainly of phenylethyl alcohol.

The data concerning the characteristics of oils of rose water published by v. Soden, H. Walbaum and their collaborators, cannot be taken as the basis for a study of these products, as they worked under conditions quite dissimilar from those at Grasse.

Jeancard and Satie¹⁶ have reported on the extraction product from a water prepared on the basis of 1 kg. for 1 kg. of flowers (single water):

C.P.:	+25.9°
A.V.:	2.24
E.V.:	14.70
Tot. Alc.:	32%
Citronellol (by formylation):	15.10%
Stearoptenes:	58.88%

The high content of stearoptenes would indicate that this was an oil that had not been purified by decantation and filtration.

Pomades and Paraffin Oil Derivatives. May rose pomade is usually prepared at a temperature of from 50 to 70°, with 5 to 7 kg. of flowers for each 1 kg. of prepared corps, the treatment being in 12 or 15 operations. The digestion lasts 30 minutes to 2 hours, with agitation. The average yield in pomade concentrate is 1.8%, based on the pomade.

The paraffin or neutralin oil derivatives are no longer being manufactured.

The composition of the pomade perfume was studied by H. v. Soden and W. Rojahn.¹⁷ There is nothing characteristic about these products, as distinct from the concretes. The flowers that are removed from the pomades are extracted with volatile solvents.

Y. R. Naves, S. Sabetay and L. Palfray¹⁰ described a distillate obtained in a yield of 31% from a pomade concentrate. The characteristics were as follows:

d_{15}° :	0.952
α_D :	+1° 42'
n_D^{20} :	1.5010
A.V.:	3.6
E.V.:	7.2

References

1. Trabaud, L., *Drug Cosmetic Ind.*, **40**, 183 (1937).
2. Erhardt, C., *Seifensieder-Zeit.*, **31**, 594 (1938).
3. Rovesti, P., *Profumi Italiani*, **3**, 108 (1925).
4. Ellmer, *Riechstoff Ind. Kosmetik*, **5**, 193 (1930).
5. Rovesti, P., *Riv. ital. essenze profumi piante offic.*, **221** (1932).
6. Massera, V., and Monti, G., *Riv. ital. essenze profumi piante offic.*, **2**, 8 (1920).
7. *Ber. Schimmel & Co. Akt. Ges.*, **104** (1926).
8. Soden, H. v., *J. prakt. Chem.*, N.F. **69**, 265 (1904).
9. Elze, F., *Chem.-Zt.*, **43**, 747 (1919).
10. Naves, Y. R., Sabetay, S., and Palfray, L., *Perfumery Essent. Oil Record*, **28**, 336 (1937).
11. Glichitch, L. S., and Naves, Y. R., *Parfums France*, **11**, 163 (1933).
12. Soden, H. v., and Rojahn, W., *Berliner Berichte der Chemie*, **33**, 1720 and 3065 (1900).
13. Walbaum, H., *Berliner Berichte der Chemie*, **36**, 2299 (1903).
14. Glichitch, L. S., and Naves, Y. R., *Parfums France*, **11**, 162, 163 (1933).
15. See 14, p. 156.
16. Jeancard and Satie, *Bull. soc. chim.*, (3) **31**, 934 (1904).
17. See 12, **33**, 3063 (1900); **34**, 2803 (1901).

Rose Geranium

The rose geranium is cultivated, particularly for the production of its essential oil, in Provence, Algeria, Morocco, Calabria, Crimea and

Réunion. A succinct but complete monograph, written by one of the authors, covers the essential oil.¹

In Grasse, the concrete is produced by petroleum ether or benzene extraction. In 1937, more than 50 tons of the herb were treated. The benzene concrete, the more common, gives a yield of between 0.20 and 0.25%.

This concrete is a pasty mass, dark green in color, and which gives a thick limpid absolute, in a yield of 70 to 80%, dark in color, and containing 60 to 68% of steam-distillable products. The yield of odorous material is therefore higher than that obtained by direct distillation, which gives only 0.06 to 0.12% of oil.

The odor of the absolute is more rosy than that of the essential oil, and has a green note, slightly amber, and very tenacious.

These products have not been described analytically.

Essences from the Waters. The distillation waters of geranium are extracted by benzene or toluene, and give an oil poor in isomenthone but rich in alcohols. This water extract is an important by-product in the manufacture of the essential oil. One of us (*loc. cit.* p. 179) has described the analysis of the essences prepared from the Algerian waters:

d_{25}°	0.8971 to 0.9016
α_D^{20}	-2° 50' to -5° 35'
n_D^{20}	1.4711 to 1.4756
A.V.:	1.4 to 2.1
% esters:	3.1 to 4.42
% free alcohols (by cold formylation):	85.1 to 87.2
Total alcohols:	88.0 to 89.2
Apparent rhodinol (by warm formylation):	29.0 to 31.2
Primary alcohols (by pyridinic phthalization):	44.2 to 46.1
Sol. in 68% alcohol:	1 to 3 vol.

Reference

1. Naves, Y. R., *Parfums France*, 12, 168 (1934).

Rosemary

At Grasse and in Italy, small quantities of a concrete are made from the rosemary, *Rosmarinus officinalis* L., *Salvia rosmarinus* Spenner (Menthaceae), using semi-dried flowery summits. The extraction is made either with benzene or petroleum ether, according to the process of the individual manufacturer.

G. Rovesti¹ made a petroleum ether extraction of the Ligurian summits, gathered in April and mixed with not more than 20% of stems, and

obtained 2.3% of a green concrete, of pasty consistency, having the true odor of the plant, and whose absolute had the following characteristics:

d_{4}^{is} :	0.9567
α_{D} :	+1.74°
n_{D}^{15} :	1.4791
S.V.:	28.32

Reference

1. Rovesti, G., *Riv. ital. essenze profumi piante offic.*, 249 (1933).

Rue

As reported by Louveau,¹ extraction of the European garden rue or *Rue officinale*, *Ruta graveolens* L. (Rutaceae), with benzene gives a concrete with a less violent odor than that of the corresponding essential oil, but more herbaceous, more tenacious, and of real potential interest to perfumers.

Reference

1. Louveau, G., *Rev. marques parfum. savon.*, 591 (1930). See the excellent monograph on *Ruta graveolens*: "Anatomie und Chimie d. *Ruta graveolens*," by Brandt, Berlin, 1915, eg. *Arb. Pharm. Inst.*, 11, 82 (1914).

Sweet Orange

A variety of sweet orange grows in abundance in Guiana, and the exploitation of its fruit is the basis of an important essential oil production. It is the *Citrus Sinensis* Osb. var. *Djalomis* A. Chev.¹ The petroleum ether concrete obtained from the flowers was described by Trabaud.² Blossoming takes place from the end of April to the beginning of June. The yield in concrete is 0.2228%, and this in turn furnishes 52% of absolute. The olfactory note of these products is sweeter than that of the bitter orange flower products.

References

1. Chevalier, A., *Rev. botan. appl. agri. trop.*, 15, 658 (1935); see also Naves, Y. R., *Parfums France*, 13, 299 (1935).
2. Trabaud, L., *Riechstoff Ind. Kosmetik*, 13, 248 (1938).

Syringa

The syringa, *Philadelphus coronarius* L. (Saxifragaceae) or German jasmin, is native to the French Midi. It is a bushy plant, common in central and southern European woods, and cultivated as an ornamental

flower. The flowers are white, they have a powerful odor, lacking however in smoothness.

In addition to this species, some twenty others are cultivated, and as many varieties and hybrids, the majority of which have very odorous flowers. The only odorless flowers are those of *P. gordonianus* Lindl., *P. inodorus* L. and *P. latifolius* Schrad.

Extraction: W. Treff, F. Ritter and H. Wittrisch¹ made a petroleum ether extraction of the flowers of various *Philadelphus** species gathered in Saxony. They obtained 0.237% of a concrete and 0.124% (52.2% of the concrete) of an absolute. The absolute gave them 2.5% (of the concrete) of a yellowish distillate, having a powerful and characteristic odor, which had these properties:

d_{15}° :	0.974
α_D :	inactive
A.V.:	28
E.V.ac.:	224

and which probably contained some methyl anthranilate.

Cartwright Farmiloe² obtained 0.25% of a petroleum ether concrete, which gave him 38.2% of an absolute.

G. Igolen³ obtained 0.144 to 0.179% of a petroleum ether concrete, reddish-brown in color, of hard consistency, and 0.215% of a benzene concrete, having a green and rather disagreeable odor. From the petroleum ether concrete, the same author prepared 25 to 27.2% of a reddish-brown absolute of thick consistency, with a penetrating, fruity odor, suggestive of the syringa flowers. The absolute gave 9% of a steam distillate, having the following characteristics:

d_{15}° :	0.912
α_D :	+3° 45'
n_D^{20} :	1.4668
A.V.:	25.2
E.V.:	95.2
Carbonyl value:	39.6

References

1. Treff, W., Ritter, F., and Wittrisch, H., *J. prakt. Chem.*, N.F. 113, 358 (1926).
2. Farmiloe, Cartwright, *Perfumery Essent. Oil Record*, 20, 321 (1929).
3. Igolen, G., *Parfums France*, 16, 92 (1938).

* Mixture of the flowers of *Philadelphus coronarius* L., *P. Lemoinei* Lem., *P. pubescens* Loisl., *P. floribundus* Schrad., *P. "Mont Blanc"* Lem., *P. "Avalanche"* Lem., *P. coronarius* L. *forma Keteleiri* Carr., *P. latifolius* Schrad., *P. Falkoneri* Jarg., *P. microphyllus* A. Gr.

Tagetes

The tagetes are a genus of the Asteraceae family. They are annual shrubs or herbs, and originated in Africa or America. The most common is the Indian carnation of the French horticulturists, *Tagetes patula* Schrank., *Tagetes minuta* L.¹ They are cultivated for their grain, in Provence, in the region of Saint-Rémy.

The essential oils of a number of species have been described by G. Igolen,² who also treated *Tagetes glandulifera* by volatile solvent extraction.

T. glandulifera Schrank. is of South American and South African origin. It is an annual plant, has an extremely vigorous development, and in France grows to a height of nearly 3 meters.

The flowers are yellow; they are grouped together in a cluster, and when extracted with petroleum ether, give 0.278% of a concrete. This concrete yields 56.7% of a semi-solid, very dark green absolute, rather viscous at ordinary temperature. The odor of the concrete is less warm, less herbaceous, than that of the essential oil.

Benzene gives a higher yield than petroleum ether, but the odor of the concrete is less flowery, more green, than that of the petroleum ether concrete.

The odoriferous constituents are unknown.

The waxes of *Tagetes glandulifera* were studied by Kuhn, Winterstein and Lederer,³ and by A. C. Chibnall, S. H. Piper, A. Pollard, E. F. Williams and P. N. Sahai.⁴ They contain *n*-hentriacontane, the dipalmitic ester of luteine (helenine), and palmitone, C₁₅H₃₁COC₁₅H₃₁.

References

1. Kew's "Handlist of Herbaceous Plants," 1925.
2. Igolen, G., *Parfums France*, 14, 6-11 (1936).
3. Kuhn, Winterstein and Lederer, *Z. physiol. Chem.*, 197, 141 (1931).
4. Chibnall, A. C., Piper, S. H., Pollard, A., Williams, E. F., and Sahai, P. N., *Biochem. J.*, 28, 2189 (1934).

Thyme

Small quantities of a petroleum ether or benzene concrete of thyme, *Thymus vulgaris* L. (Menthaceae), have been produced at Grasse. The heads of the flowering branches are semi-dried and then subjected to extraction. The yield of benzene concrete, which is the more common of the two, is in the neighborhood of 2.6%. It is used as such in soap-making, and seems to warrant more attention on the part of perfume raw material consumers.

Tuberose

The tuberose, *Polyanthes tuberosa* L. (Liliaceae), said to be of Mexican origin, was introduced into France in the sixteenth century. It is grown in Provence for its perfume; cultivation in the region of Grasse is at Auribeau, Pégomas, Mandelieu, Cannes, with the cultivation most highly developed at Pégomas. The single-flower variety is used in perfumery, and the double-flower variety sold as a cut flower.¹

The flowers are grouped in a spike-shaped cluster, 15 to 20 cm. in length. Blossoming begins in July, becomes more important toward August 5 to 15, and continues until the last days of September, when a second growth of flowers appears.

The corollas are gathered each morning, at the moment when the flowers are just beginning to open a little. They are detached by breaking at the top of the stem.

The plantations are renewed every year by changing the site. It is rare to find one that can be conserved for a second year. The bulbs are gathered in November and placed in the earth in April. The offshoots of the bulbs, or bulbils, detached from the principal bulbs and placed in the nursery, do not blossom until the third year. It is therefore impossible to have a rapid variation in the tonnage of flowers produced.

It can be said that 1000 saplings give an average of 25 to 30 kg. of flowers. During the years immediately following World War I, the quantity of tuberose flowers used by the perfume industry reached 75 tons. It fell to 30 tons in 1926, then to 17 tons in 1927, and was almost wiped out completely in the ensuing years. In 1939, it was just about beginning to be revived with a certain vigor, when World War II broke out.

Extraction: Distillation of the tuberose gives only a small quantity of a perfume oil, greatly altered in character.

The perfume must therefore be extracted by volatile solvents, fats and paraffin oils. Like the jasmin, the tuberose flower that has been cut continues to generate its perfume, and the extraction of this perfume by enfleurage is therefore a suitable process.

A. Hesse² has studied the yields of steam-distillable products obtained by several processes of extraction. He obtained from 1000 kg. of tuberose:

By petroleum ether, 56 gs. of distillate (at the beginning of the harvest, only 36 gs.), and the residual flowers gave another 10 gs. of oil by distillation.

By enfleurage, 801 gs. of distillate, and the residual flowers gave another 78 gs. of oil.

It can therefore be seen that, industrially, if it is considered that nothing is recovered from the residual flowers after the petroleum ether extraction, whereas the residual flowers from enfleurage are treated with volatile solvents, enfleurage thus gives about 15 times as much perfume as petroleum ether extraction. In the latter process, the yield of concrete



Charabot & Cie., Grasse

FIGURE 43. *Gathering of the tuberoses.*

is 0.08 to 0.11%, on exceptional occasions reaching 0.14%. This concrete gives 18 to 23% of an absolute, and contains 3.3 to 4.1% of steam-distillable products. This yield is lower than that reported by Hesse, who probably worked with specially chosen flowers.

Extraction of the double flowers gives 0.15% to 0.18% of concrete.

The enfleurage process is carried out with closed flowers, which open up on the fats. A charge of 2.500 kg. to 3 kg. is made, and the flowers are left in contact with the fat for 48 hours. For the rest, the treatment is the same as for jasmin.

The yield of "normal" pomade concentrate is 1.500 to 1.800 kg. Two samples of concentrates that were examined gave 11.4 and 14.8% of distillates,³ respectively, and this corresponds approximately to the findings of Hesse.

The flowers that are removed from the frames give 1.20 to 1.50% of concrete.

The perfumers generally prepare and sell a mixture of absolute from concrete and of pomade concentrate.

Characteristics of the extracts: The tuberose concrete varies in color from a pale brownish yellow to a light maroon. It is waxy and rather hard. H. Walbaum and A. Rosenthal⁴ found these properties in a concrete:

C.P.:	56.9°
S.V.:	117.6

G. Rovesti⁵ reported the characteristics of three absolutes prepared in Liguria, in 1922, 1923 and 1924 respectively:

	1	2	3
d_{20}^{20}	1.1211	0.988	1.061
α_D	-5° 41'	-1° 07'	-3° 15'
E.V.ac.	168	156	217

These absolutes contained 4 to 5% of methyl anthranilate (analyzed by the Hesse-Zeitschel technique).

A sample of concrete of known purity was examined by Y. R. Naves and S. Sabetay, and had these characteristics:

C.P.:	49 to 50°
A.V.:	52.2
E.V.:	76.4

The absolute is deep red, semi-liquid and pasty. From the concrete mentioned above, an absolute was obtained having these properties:

C.P.:	21 to 22°
d_{20}^{20} :	0.982
n_D^{20} :	1.4916
A.V.:	84.6
E.V.:	138.2

Several analyses of distillates have been described in the literature, and are summarized below:

1. A. Hesse:² A. Distillate from the pomade; B. Distillate from the concrete.
2. F. Elze:⁶ Distillate from the concrete (6% of the concrete).

3. and 4. Y. R. Naves, S. Sabetay and L. Palfray:⁸ Distillates from the pomade concentrate.

	1A	1B	2	3	4
d_{15}	1.009–1.035	1.007	1.003	—	—
α_D	–2° 30'	–3° 45'	–3° 15'	—	—
n_D^{20}	—	—	—	1.5352	1.5136
A.V.	32.7	22.0	25.0	10.6	29.3
E.V.	243–280	224.0	230.0	243.0	205.0
% Methyl Anthranilate	3.2 and 5.4	1.13	1.4	—	—

Composition of the extracts: A. Verley⁷ reported that he had isolated 10% of a so-called "tuberone," $C_{13}H_{20}O$, but no chemist has confirmed the presence of such a substance.

The Schimmel⁸ chemists have had reason to assume the presence of methyl anthranilate and methyl benzoate.

A. Hesse (*loc. cit.*) found the following constituents common to the products of extraction and enfleurage: esters of benzoic acid (among which was benzyl benzoate), methyl anthranilate, other unidentified aromatic esters, benzyl alcohol (free and esterified), some unsaturated alcohols, butyric acid, and probably phenylacetic acid. In the enfleurage product only, he found methyl salicylate.

F. Elze (*loc. cit.*) has also found eugenol, methyl benzoate, geraniol and nerol, both free and acetylated, and probably also esterified in the form of the propionates, and farnesol.

According to the calculations of Hesse, enfleurage gives 56 times as much methyl anthranilate as does extraction with volatile solvents.

References

1. Mazuyer, G., *J. parf. et savon.*, 21, 195 (1908).
2. Hesse, A., *Berliner Berichte der Chemie*, 36, 1459 (1903).
3. Naves, Y. R., Sabetay, S., and Palfray, L., *Perfumery Essent. Oil Record*, 28, 336 (1937).
4. Walbaum, H., and Rosenthal, A., *Ber. Schimmel & Co. Akt. Ges., Jubil. Ausg.*, 193 (1929).
5. Rovesti, G., *Profumi Italici*, 3, 243 (1925).
6. Elze, F., *Riechstoff Ind. Kosmetik*, 154 (1928).
7. Verley, A., *Bull. soc. chim.*, (3) 21, 307 (1899).
8. *Ber. Schimmel & Co. Akt. Ges.*, 74 (Apr. (1903).

Verbena

The plant known as verbena or verbain, *Lippia citriodora* H. B. and Kunth., *Verbena triphylla* Lam. (Verbenaceae), is cultivated for the perfume industry at Grasse. It is said to have come from Peru in 1784, and today is found in the Antilles and in India. It should not be confused

with the Indian verbena, which is lemongrass, or with official verbena, which is *Verbena officinalis* L.; or with the verbena or *verveine* of the Provence liquors, which is the dried flower of a Menthaceae, *Dracocephalum moldavici*, or with the Spanish verbena, which is *Thymus hyspanicus* Lange.

The true verbena is cultivated in the Grasse region, on the slopes of Valbonne and on the plain of Siagne. It is also cultivated for its perfume at Boufarik, near Algiers. It is a shrub which grows to a height of 1.20 to 1.50 meters.

The plant is cut in July, as soon as the first blossoms appear, and a second time in October, before it is earthed up. Sometimes there are three harvests, at the end of June, in mid-August, and at the end of October. It is cut 10 cm. from the soil, and must be treated immediately. The harvest varies from 4 to 6 tons per hectare. The stalks are delivered to the factory, still containing their leaves, and tied together in little bundles. The major part of the harvest is distilled, but a small percentage, both at Grasse and in Algeria, is treated with volatile solvents.

Extraction: The yield of petroleum ether concrete varies from 0.25 to 0.30%, the concrete giving 50 to 60% of absolute, and including 30 to 36% of products volatile in steam.

This concrete is waxy, though solid. Its color ranges from light to dark green. It melts between 40 and 52°, and has an A.V. of around 30; E.V. 24.1 to 38.4.

The absolute is dark green, thick and sirupy.

The distillate is either colorless or is a very light greenish yellow, and has properties close to those of the essential oil. Y. R. Naves, S. Sabetay and L. Palfray¹ have described four distillates coming from an Algerian concrete:

	1	2	3	4
d_{15}^15 :	0.898	0.904	0.894	0.907
α_D :	-4° 40'	-5° 20'	-4° 52'	-6° 16'
n_D^{20} :	1.4772	1.4794	1.4784	1.4741
A.V.:	3.8	7.2	5.6	4.5
% Citral (By hydroxyl-amine method):	40.0	39.5	42.1	41.3

Composition: The composition of the natural verbena products has not been studied. It can be assumed that it contains at least some of the constituents of the essential oil.

Reference

1. Naves, Y. R., Sabetay, S., and Palfray, L., *Perfumery Essent. Oil Record*, 28, 336 (1937).

Violet

Two varieties of violets, *Viola odorata* L. (Violaceae), are cultivated in Provence for perfumery; they are the Parma violet and the Victoria violet.

The Parma variety has been preferred for a long time. In 1900, nearly 200 tons of these flowers were treated, and this figure remained almost as high during the years that followed, while in addition about 100 tons of the violet leaves were being treated, for both leaves and flowers are strong in odor and have different odor notes. At the same time, large quantities of the flowers were being sold for confectionery purposes, and also as an ornamental flower.

The production of interest to the perfumer is localized in two spots, around Grasse and in the region of Hyères.

Cultivation is generally developed in the shadows of the olive groves, extending from Vence to Spéracédès, through La Colle, Tourette, Le Bar, Magagnosc and Le Tignet. Between 1895 and 1900, from the hamlet of Magagnosc alone there came 45 tons of flowers for the perfume industry.

A production center has been created in Italy, principally in the valley of Taggia, in such places as Arma di Taggia, San Remo, and Villanova d'Albenga, supplying the Ligurian factories.

But then there came over-production, the abandonment of the fashion for violet perfumes, and attacks of all sorts of mysterious ailments. The cultivation of the Parma violet was replaced by the Victoria. But the latter was less highly valued by perfumers, though it resists the plant diseases to which the Parma was subject. Today, there are hardly any Parma violets being produced, except on a small scale at Tourette, Le Bar, Magagnosc and around Hyères. It is used by the perfume industry only when its sale for bouquets is no longer remunerative, particularly in February and March. It is cut twice a week, without the peduncle; 1,000 flowers weigh 250 grams, and the yield per hectare, for an entire season in full production, reaches 800 kg. of flowers (for 140,000 tufts).

The double-flowered violet, cultivated around Toulouse for bouquets and confectionery, has little odor.

By 1926, only 1500 kg. of Parma violets were being treated for their perfume in the Maritime Alps.

While it takes four years for the Parma violet plantations to produce, there is production by the second year with the Victoria, and the plant, much more resistant to disease, lasts six or seven years. The Victoria has therefore been coming into greater and greater preference among cultivators, even though the perfume industry will pay only one-fourth or

one-fifth as much as it would for the Parma. From February on, production is devoted to perfumery. In April the leaves are cut and sent to the factories. The yield in flowers can reach, for an entire season, 1200 to 1600 kg. per hectare.

Violet Flower Products. *Extraction:* The yield of petroleum ether concrete from the Victoria flowers varies from 0.09 to 0.13%, on exceptional occasions rising to 0.17%. The yield from the Parma varies between 0.07 and 0.12%, on very rare occasions reaching 0.17%, and in 1920 went to 0.20%. The yield of absolutes from concentrates is approximately the same for both varieties, 35 to 40%.

H. v. Soden¹ obtained an essence from the violet flowers, in a yield of 0.0031%, which corresponds to about 1.6 to 4.3% of the concrete, utilizing the extreme limits mentioned above. According to information supplied by this author to one of the writers, the Parma variety was used.

Digestion is carried out, at a temperature of 50 to 60°, in a total charge of 3 kg., divided into 10 to 20 operations.

Characteristics of the extracts: The concrete from the Parma violet is a not very pronounced green-yellow product; the Victoria concrete is slightly darker in color. The pomade is light green. The odor of these products is very close to that of the flower. The perfume of Victoria violet is the harder, the more penetrating of the two.

H. Walbaum and A. Rosenthal² have reported the following characteristics of a Victoria concrete:

C.P.:	45.5°
A.V.:	11.2
E.V.:	95.2

A Victoria concrete of Italian origin, examined by one of the writers, had these properties :

C.P.:	36° to 38°
A.V.:	64.4
E.V.:	49.8

The distillate of the Parma concrete was studied by v. Soden (*loc. cit.*) who reported the following constants:

d_{4}^{20} :	0.920
α_D^{20} :	+104° 15'
A.V.:	10
E.V.:	37

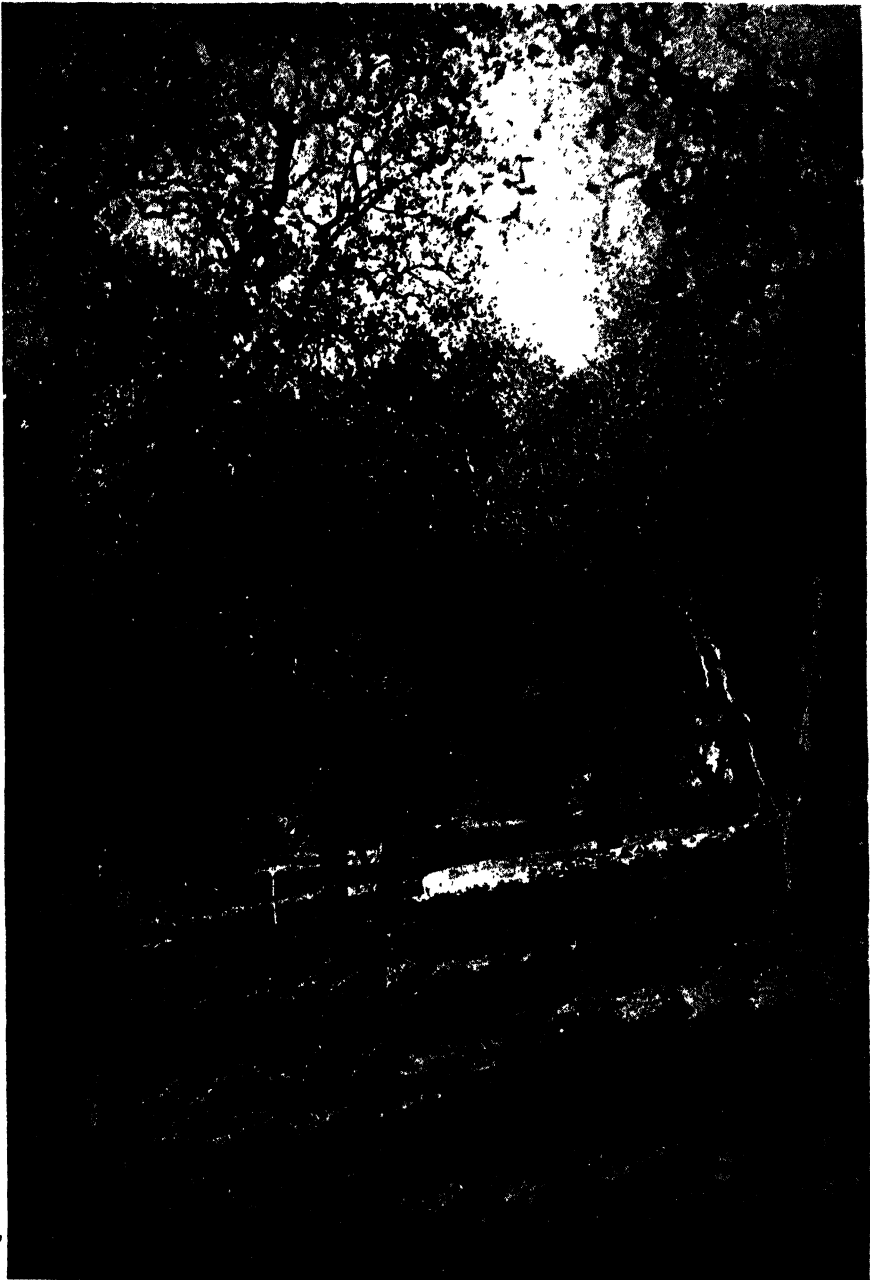

Parfums de France

FIGURE 44. *Cultivation of violets in the olive groves.*

A Victoria distillate examined by Ruzicka had these properties:

d_4^{20} : 0.896

$[\alpha]_D$: +7.6°

and corresponded to 7.1% of the absolute.

Composition: L. Ruzicka (*loc. cit.*) found the following compounds in the flower oils: nonadienal, which had already been identified in the leaf oil, but which is found in the flower oil in only one-tenth as great a proportion; a ketone isomeric with the ionones, having the fine odor of the violet, called parmone; *n*-hexyl alcohol; a tertiary heptenol; a tertiary octadienol; 2,6-nonadienol-1; and benzyl alcohol. Parmone has the molecular formula of $C_{13}H_{20}O$, its phenylsemicarbazone melts at 166 to 168°, and the *p*-bromophenylhydrazone melts at 132 to 133°.

Violet Leaf Products. *Extraction:* The petroleum ether extraction furnishes an average of 0.09 to 0.12%, reaching the wider limits of 0.055 to 0.13%, of concrete. The latter gives 35 to 40% of absolute, and includes 4 to 12% of steam-distillable products. The yield in extraction products is quite variable, depending on the strength of vegetation.

For the digestion process, 6 to 8 kg. of leaves are charged per kilogram of fats, at a temperature of 60 to 70°, and in 10 to 20 charges.

The products obtained are highly colored, but an entire gamut of products are prepared for perfumers, ranging from the partially to the completely decolorized, which are sold in a solution of ethyl alcohol, phenoxyethyl alcohol, diethyl phthalate, benzyl laurate or benzyl benzoate.

Characteristics of the extracts: A concrete had the constants:

M.P.:	54-55°
C.P.:	about 50°
A.V.:	78.2
E.V.:	42.6

v. Soden⁴ described the distillate obtained from a concrete, corresponding to 0.002% of the weight of the fresh leaves. The distillate was greenish-yellow, had an odor that was described as "staggering," and had these characteristics:

d_{20} :	0.909
$[\alpha]_D$:	+2° 20'
A.V.:	20
E.V.:	75

H. Walbaum and A. Rosenthal⁵ obtained a brown oil, corresponding

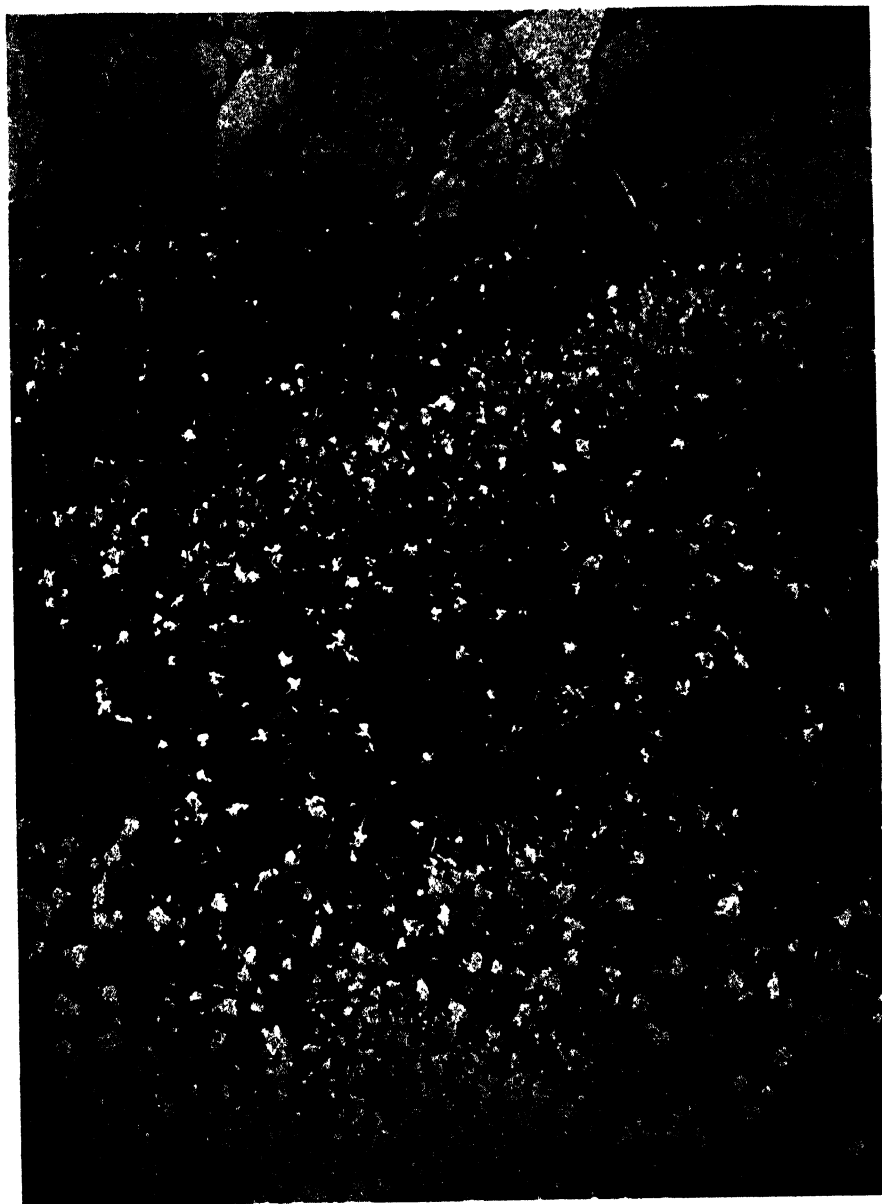

Etablissements Antoine Chiris, Grasse

FIGURE 45. *Victoria violets, which give a highly valued oil.*

to 3.08% of the concrete, with a strong odor and having the following properties:

d_{15} :	0.9270
n_D^{20} :	1.47642
A.V.:	20
E.V.:	108.3

Y. R. Naves, S. Sabetay and L. Palfray⁶ described two distillates from the concrete:

	1	2
d_{15}	0.913	0.925
α_D	+18° 12'	+16° 40'
n_D^{20}	1.4944	1.4808

The second product had an A.V. of 12.4, and included by volumetric oximation, 52.0% of aldehydes, calculated as nonadienal.

W. Treff, L. Ritter and H. Wittrisch⁷ made an extraction of the leaves of *Viola rossica*, Queen Charlotte variety, cultivated in Saxony. They obtained 0.159% of concrete, giving 68.5% of absolute and 1.045% of a yellowish distillate. The distillate had a strong odor, and the following constants:

d_{15} :	0.912
$[\alpha]_D$:	Inactive
A.V.:	52
E.V.:	76.1
E.V.ac.:	172

Composition of the extracts: The nature of the odoriferous principle, nonadienal, was suggested by Walbaum and Rosenthal (*loc. cit.*), worked out more precisely by E. Spaeth and F. Keszler,⁸ and by L. Ruzicka and H. Schinz,⁹ who reproduced nonadienal by synthesis.

The odor of this aldehyde is powerful and characteristic. The double bonds are in the 2 and 6 positions. The semicarbazone melts at 158 to 159°. Nonadienal constitutes approximately from one-third to one-half of the distillate.

Ruzicka and Schinz studied the non-aldehydic fraction, after saponification. They identified propionic acid, oenanthic acid, palmitic acid, salicylic acid, an octylic acid, an octenoic acid, and in the neutral fraction a *n*-hexenol, a heptenol and an octenol (both optically active), *l*-2,6-nonadienol-1, a tertiary octenol, and probably some benzyl alcohol, *n*-hexanol and *n*-2-octenol-1.

References

1. Soden, H. v., *J. prakt. Chem.*, N.F. 69, 261 (1904).

2. Walbaum, H., and Rosenthal, A., *Ber. Schimmel & Co. Akt. Ges., Jubil. Ausg.*, 191 (1929).
3. Ruzicka, L., *Comptes rendus du XVII Congrès de Chimie industrielle*, Paris, 1937.
4. Soden, H. v., *J. prakt. Chem.*, N.F. 110, 273 (1925).
5. See 2, p. 211.
6. Naves, Y. R., Sabetay, S., and Palfray, L., *Perfumery Essent. Oil Record*, 28, 336 (1937).
7. Treff, W., Ritter, F., and Wittrisch, H., *J. prakt. Chem.*, N.F. 113, 357 (1926).
8. Spaeth, E., and Keszler, F., *Ber.*, 67, 1496 (1934).
9. Ruzicka, L., and Schinz, H., *Helv. Chim. Acta*, 17, 1602 (1934).
10. *Ibid.*, 18, 381 (1935).

Wallflower

The wallflower, *Chiranthus Cheiri* L., *Ch. fruticosus* L. (Brassicaceae), flourishes in abundance. The flowers are striking yellow, with a mixture of brown or red, or they are white. About a dozen varieties of French origin are known, and in that country they are generally called *violiers* (from the Old French, *viole* for violet).

Extraction: By extraction with petroleum ether, a concrete is obtained, deep in color and soapy in consistency. An experiment to extract white wallflowers gave a yield in concrete of 0.12%.

E. Kummert¹ has prepared the absolute, and has also steam-distilled it. The yield of the distillate was 0.06%, based on the flowers.

Characteristics of the distillate: The odor of this distillate was strong, agreeable, and when diluted recalled the scent of the flower. The constants were:

d ₄ :	1.001
A.V.:	0.35
E.V.:	20.0

and the distillation took place under 3 mm. pressure, between 40 and 150°.

Composition of the extracts: Kummert has identified nerol, geraniol, linalool, benzyl alcohol, indole and methyl anthranilate. The saponification washings contained acetic acid, salicylic acid, anthranilic acid, and traces of bases of a pyridine odor, some phenols (probably *p*-cresol), some lactones (probably coumarinic), some carbonyl bodies having an aubepine and violet odor, and which were isolated by the formation of their semi-carbazones.

Reference

1. Kummert, E., *Chem.-Zt.*, 35, 667 (1911).

Wistaria

The Chinese plant, *Wistaria Sinensis* Sweet., (Papilionaceae), is a

climbing shrub, alternately spelled *wistaria* and *wisteria*. It is cultivated for the beauty of the flowers. The flowers bloom in the spring, before the early leaves, first in March and April, and then again in autumn. The powerful perfume of the wistaria, peppery and rosy, has not attracted the attention of the manufacturers of perfume raw materials.

The flowers give, by petroleum ether extraction, 0.60 to 0.95% of a concrete, with a powerful and characteristic odor, and which yields 40 to 50% of absolute.

Wistaria macrostachya Nutt., originating in Carolina, was introduced into France in 1824. It is a sarmentaceous shrub, cultivated for its beautiful bunches of purplish blue, yellowish or purple flowers. It has not been given serious consideration for perfumery.

Ylang Ylang

The ylang ylang, a tree of the Annonaceae family, is characterized as *Cananga odorata* Hook. fil. and Thomson, *Unona odorata* Dunn., *Unona odoratissima* Blanco., *Uvaria cananga* Vahl., *Uvaria odorata* Lam., *Uvaria axillaris* Roxb., and *Artabotrys odoratissima* R. Br.

The production of the essential oil, formerly almost entirely confined to the Philippines, has practically become a monopoly of the French colonies of the Indian Ocean (Comores, Nossi-Bé, Madagascar and Réunion). The production of the essential oil of ylang ylang in these colonies, the characteristics of the oil and its composition, were described by L. S. Glichitch and Y. R. Naves.¹

Extraction: The concrete is manufactured close to the place where the flowers are harvested, for the flowers are very fragile, and must be treated without delay. For the extraction, petroleum ether is found to be preferable to benzene.

To our knowledge, there are three industrial installations for volatile solvent extraction: the Piton factory near St. Paul, on Réunion, which is owned by the Société Aroma; the factory of the Société Coloniale de Bambao, on Comores; and the factory of the Pères Missionnaires at Nossi-Bé.

The yield in concrete varies between 0.80 and 0.95%. The concrete gives 75 to 80% of absolute, and includes 51 to 63% of products volatile in steam.

According to E. S. Guenther,² the production of ylang ylang concrete reaches several hundred kilograms a year. This production was initiated by Ch. Garnier on Réunion in 1912. The yield is 0.7 to 1%, based on the flowers.

Characteristics of the extracts: The odor of the products of extraction

is strong, has a more cresylic note and is more pungent than that of the essential oil. The concrete is dark brown, it is semi-liquid; the absolute is very dark amber-colored, thick and limpid; the distillate is colorless and highly refractive.

Bacon³ prepared a concrete in the Philippines, in a yield of 0.7 to 1%. The chemists of the Antoine Chiris Company⁴ have described two concretes coming from the Comores Islands (A and B) and the corresponding absolutes (C and D), obtained in a yield of about 75% of the concretes. Four distillates (I, II, III and IV) were described by Y. R. Naves, S. Sabetay and L. Palfray.⁵

	A	B	C	D
d_{15}	1.0317	1.024	1.0436	1.0369
α_D	—	—	-7°	-5° 15'
n_D^{20}	—	1.5200	1.5255	1.5227
A.V.	17.68	10.08	9.8	8.1
E.V.	148.4	177.45	189	200
E.V.ac.*	201.95	244.2	—	289.6
% Phenols	4	10	—	12.5

	I	II	III	IV
d_{15}	1.017	1.022	1.019	1.026
α_D	-6° 30'	-5° 54'	-6° 04'	-6° 16'
n_D^{20}	1.5112	1.5008	1.5106	1.5143
A.V.	28.8	3.2	1.9	2.4
E.V.	216.4	226.2	231.4	212.5
% Phenols	21.5	17.0	19.6	24.0

Note: Solubility in alcohol: A and B, partially soluble in 95% alcohol; C and D: soluble 1.2 volumes in 80% alcohol, with cloudiness above that.

* Determined on the material without its phenols, but calculated on the entire product.

Composition of the extracts: The nature of the constituents of the flower oil has not yet been described. It can be assumed that the concrete contains most of the oxygenated constituents of the essential oil. L. S. Glichitch and Y. R. Naves (*loc. cit.*) have noted that the concrete does not contain the sesquiterpenes, which make up 60 to 65% of the total essential oil. Now, the latter is obtained in an average yield of 2%. Therefore, 0.7 to 0.8% remains for the oxygenated products. Extraction gives 0.5 to 0.6% of volatile oxygenated products. The authors therefore concluded that the sesquiterpenes were formed during the distillation, and this viewpoint was confirmed experimentally by L. Trabaud.⁶

Confirming the contention is the information supplied by Guenther,⁷ who stated that the ylang ylang flowers were steam-distilled by Garnier and Defaud after petroleum ether extraction. They obtained an oil which

is very similar to the third oil of a normal distillation (which, as is known, is made up almost entirely of sesquiterpenes).

References

1. Glichitch, L. S., and Naves, Y. R., *Parfums France*, 8, 350 (1930); 10, 7 and 36 (1932).
2. Guenther, E. S., *Am. Perfumer*, 37, 42 (Dec. 1938).
3. Bacon, R. F., *Philippine J. Sci.*, A4, 127 (1909).
4. *Parfums France*, 8, 359 (1930).
5. Naves, Y. R., Sabetay, S., and Palfray, L., *Perfumery Essent. Oil Record*, 28, 336 (1937).
6. Trabaud, L., *Perfumery Essent. Oil Record*, 28, 406 (1937).
7. See 2, Nov. 1938, p. 44.

Zdravets (*Geranium Macrorrhizum*)

The Zdravets of the Balkans, *Geranium macrorrhizum* L., is a small lively plant, growing wild above a certain altitude on the entire North shore of the Mediterranean basin. It blooms from May to July. It has been cultivated for some time in central and southern Europe, and particularly in Bulgaria, as an ornamental and medicinal plant.

An essential oil is prepared, and also a concrete by petroleum ether extraction. The products were studied by P. Rovesti in 1927, by the Schimmel & Co. chemists in the same year, and by Y. R. Naves in 1929.¹

Extraction: The fresh plant, treated by petroleum ether extraction, gives 0.30 to 0.45% of a concrete, which includes an accumulation of paraffins side by side with leafy colorless crystals, surrounded by a soft pasty mass of greenish color. From the concrete, 40 to 45% of a blackish green absolute, thick and limpid, is obtained. By steam distillation, 6 to 7% of a colorless or slightly bluish distillate is produced. The odor of these products is warm and extremely tenacious, reminiscent somewhat of clary sage.

Characteristics of the extracts: The table (p. 261) gives the characteristics of two concretes and their respective absolutes (Y. R. Naves, *loc. cit.*). It will be noted that there is a great difference between the ester values after acetylation and after cold formylation, which would indicate the formation of esters from non-alcoholic constituents.

Composition of the extracts: The fraction insoluble in 95% alcohol is made up almost entirely of hentriacontane, M.P. 66°-66.5° (see page 139).

The absolute includes small quantities of caproic and caprylic acids; some geraniol; some monocyclic and bicyclic dextrorotatory sesquiterpenes, which on dehydrogenation give an azulene; some tertiary sesquiterpene alcohols which give the same azulene, and which were identified

by A. St. Pfau and P. Plattner² as being the S-gaïazulene; and a very large proportion of germacrol, M.P. 56-56.5°, B.P.₁₀: 150-151°, C₁₅H₂₂O.³

	Concretes		Absolutes	
	I	II	I	II
d ⁵⁵ :	0.9080	0.9135	—	—
d ¹⁵ :	—	—	0.9831	0.9998
[α] _D c=0.10 CCl ₄ :	+8° 40'	+4° 10'	—	—
[α] _D c=0.10 alcohol:	—	—	+15° 50'	+21° 10'
n _D ⁵⁵ :	1.4859	1.4905	—	—
n _D ²⁰ :	—	—	1.51097	1.51798
M.P.:	53°	55°	liq. 0°	liq. 0°
C.P.:	52°	48°	—	—
A.V.:	25.2	30.1	7.0	6.72
E.V.:	22.4	23.05	42.3	46.5
E.V.ac.:	62.5	106.75	139.7	143.1
E.V.cf.:	31.85	70.7	69.8	132.1
Aldehyde & ketone content (Oximation, determ. of CO):	0.3	0.5	0.6	1.1

Note: Solubility of the concretes in 3 vols. of 95% alcohol, I: 45%, II: 42%; absolutes, I: in 0.8 to 2.8 volumes 90% alcohol; II: in 0.8 to 5.8 volumes 90% alcohol.

References

1. Naves, Y. R., *Parfums France*, 7, 304 (1929).
2. Pfau, A. St., and Plattner, P., *Helv. Chim. Acta*, 19, 863 (1936).
3. Naves, Y. R., *Parfums France*, *loc. cit.*, 306.

PLANT RESINOIDS

Before we begin the monograph studies of resinoids of plant origin, it is worthwhile to emphasize a few specific points with reference to resinoids of products of secretion, and the commercial presentation of certain resinoids.

The manufacture of resinoids from resins, gums and gum-resins is usually practiced by using raw materials of mediocre appearance, generally considered low-quality commodities. These raw materials are broken and are mixed with lignous products or with mineral substances. But such a classification takes into consideration only the visual appearance, whereas the products used frequently have the finest odor.

The manufacture of resinoids has as its aim the utilization of these depreciated qualities, by eliminating the foreign matter and the colored products. In addition, this manufacture makes possible the separation of the gums. It gives concentrated products, more convenient for use, more consistent in properties even than the plant drugs, and whose analytical control is greatly facilitated. Finally, the majority of these resinoids are completely soluble in alcohol.

There frequently are offered resinoids already diluted with neutral solvents; diethyl phthalate, benzyl benzoate, β -phenoxyethyl alcohol, for instance, or with essential oils, in order to facilitate their manipulation. Most resinoids, the fact is, have a rather hard consistency. However, the resinoid content should be mentioned whenever a diluted product is offered on the market. Such information aids in the proper use of the commercial product, and honest traders would find an advantage in offering such information.

Ambrette Seed

The seed of the ambrette, *Abelmoschus moschatus* Moench., *Hibiscus Abelmoschus* L. (Malvaceae), and also called the abelmosk seed, on steam distillation gives an oil with a musky odor, due principally to the presence of ambrettolide.

Distillation is generally carried out in Europe, from seeds coming from Java, the Seychelles, or Martinique.

Extraction of the seeds with petroleum ether, benzene or alcohol, of which benzene is the most frequently used, gives a resinoid. In addition to the odorous products, there is extracted at the same time a large amount of fatty oil, which is eliminated in the course of the preparation of the absolute.¹

The yield in petroleum ether resinoid is from 10 to 14% of the seeds, and about 80% of the resinoid is soluble in alcohol.²

These extraction products are of little interest in comparison with the so-called "absolutes" of good quality, which consist of the neutral fraction of the essential oil, the latter being very rich in fatty acids.

References

1. For a study of the fatty oil: Braun, K., *Deut. Parfum-Zt.*, 15, 473 (1929).
2. Naves, Y. R., *Parfums France*, 9, 35 (1931).

Balsam Resinoids

Purified Balsams Peru and Tolu, and Styra. The crude balsams that have been exuded are contaminated with plant debris, with products of polymerization and oxidation, colored or colorless, but either insoluble or little soluble in volatile solvents. Thus it is the current practice to purify the balsams, and use them in the form of resinoids (purified balsams of the Pharmacopoeias). The chemical affinity between styrax and balsams Peru and tolu, their similar physical appearance and texture, and the resultant analogous methods of examination and treatment, are the reasons for grouping these products together.

Balsam Peru. Balsam Peru comes from a Papilionaceae, *Myroxylon balsamum* (L.) Harms. var. β *Pereira* (Royle) Baillon. The largest production is from the San Julian region of San Salvador.

The balsam is a viscous liquid, dark brown when thick, reddish brown and transparent in a thinner layer. Its odor is balsamic and vanillinic, its flavor is tart and slightly bitter.

Purification and characteristics of the purified product: The balsam used in perfumery and in medicine is obtained by treating the crude balsam with alcohol or benzene. The purified product is a thick, reddish-brown liquid. The alcoholic resinoid has these characteristics:

d_{15} :	1.140 to 1.170
α_D :	up to $+2^{\circ} 20'$
n_D^{20} :	1.590 to 1.599
A.V.:	55 to 84
E.V.:	168 to 220
S.V.:	230 to 286

The benzene resinoid, obtained in a yield of 80 to 86%, has the following properties:

d_{20} :	1.103 to 1.126
α_D :	up to $+2^\circ 44'$
n_D^{20} :	1.568 to 1.582
A.V.:	22.4 to 48.6
E.V.:	198 to 260

By washing the benzene solutions with an alkaline solution, the so-called *neutral* resinoid of balsam Peru is obtained.

Treatment of the solutions with activated carbon gives the colorless resinoids.

The balsam Peru that has been purified by alcohol and prepared for medicinal use, is generally judged by its *cinnamein* content, this being a mixture of benzyl benzoate and benzyl cinnamate. For the quantitative determination of cinnamein, 1 g. of balsam is treated with 20 c.c. of ether. The ethereal extract is agitated with 10 c.c., then 5 c.c. of a 5% sodium solution. The alkaline solution is washed with 10 c.c. of ether. The united ethereal solutions are washed twice with 5 c.c. of water each time. The ether is distilled off, and the extract dried for 30 minutes at 103 to 105°, and then weighed. The yield is generally between 53 and 66% of the weight of the balsam. The saponification value of the extract varies between 235 and 260 (saponification in 20 c.c. of a demi-normal alcoholic potassium solution, refluxing for 30 minutes), and the refractive index varies between 1.575 and 1.582.

For the tests for adulterants, the Pharmacopoeias and special treatises should be consulted.

Composition: The major part of balsam Peru is made up of the mixture of benzyl benzoate and benzyl cinnamate, known as *cinnamein*. The benzyl cinnamate was discovered by Thoms,¹ the benzoate by Tschirch and Trog.² Thoms also found an alcohol, peruviol, associated with a dihydrobenzoic acid; this alcohol was shown by the Schimmel chemists to be *d*-nerolidol.³ It is accompanied by farnesol.⁴

The balsam also contains a small amount of vanillin.⁵

References

1. Thoms, H., *Arch. Pharm.*, 237, 271 (1899).
2. Tschirch and Trog, *Arch. Pharm.*, 232, 70 (1894).
3. *Ber. Schimmel & Co. Akt. Ges.*, 75 (April 1914).
4. Elze, F., *Chem.-Zt.*, 34, 857 (1910).
5. Schmidt, E., "Tagebl. d. Naturforscher-Vers," Strasburg, 1885, p. 377.

Balsam Tolu. Balsam tolu is obtained from a Papilionaceae, *Myroxylon (Toluifera) balsamum* (L.) Harms. var. *α -genuinum* Baill., which grows in South America. The color of the balsam ranges from brownish to reddish brown. It is of hard consistency, and begins to soften toward

30° and melts between 60 and 65°. It adheres to the fingers, hardens upon storage, and becomes brittle. Pressed between two pieces of glass, it shows the characteristic crystals of cinnamic acid.

Purification and characteristics: Upon treatment with alcohol, it gives 60 to 66% of a resinoid; with benzene 50 to 70%:

A.V.:	112 to 154
E.V.:	53 to 72
S.V.:	155 to 198

These resinoids include 2.5 to 12% of the essential oil, which has a hyacinth and vanilla odor.

By alkaline washing of the benzene extract, the *neutral* resinoids are prepared.

Composition: These products contain benzyl benzoate and cinnamate, identified in the balsam by E. Busse,¹ free benzoic and cinnamic acids, which frequently crystallize in the resinoids, some vanillin, and probably farnesol, identified by Elze² in the oil.

References

1. Busse, E., *Berliner Berichte der Chemie*, 9, 830 (1876).
2. Elze, F., *Chem. Zt.*, 34, 857 (1910).

Styrax. Styrax is obtained by treating with boiling water and then expressing the bark of *Liquidambar orientale* Mill., *Liquidambar imberbe* Ait., *Platanus occidentalis* Pococke (Hamamelidaceae). It is extracted in Asia Minor and refined at Smyrna, where water and foreign bodies are removed.

Styrax is grayish and semi-liquid, with a characteristic balsamic odor and a tart and spicy flavor.

Method of treatment: A good quality balsam gives 60 to 75% of an alcoholic resinoid, 55 to 70% of a benzene resinoid, 35 to 55% of a petroleum ether resinoid, and 65 to 70% of an acetone resinoid. These resinoids are prepared with heat. Yields are frequently lower, because of the excessive humidity of the styrax, which can reach 20 and even 30%. In such a situation, treatment with alcohol or acetone should be in the presence of dry sodium sulfate. The alcoholic resinoid is the purified styrax of the Pharmacopoeias.

Neutral resinoids are prepared, by alkaline washings of the benzene or petroleum ether solutions.

The styrax resinoids have the consistency of honey, they are a more or less dark brown, limpid in a thin layer, and have an odor suggestive of benzoin and of balsam Peru. They have a sharp taste, similar to that of balsam tolu.

According to Ahrens, the petroleum ether resinoid has:

A.V.:	36 to 63
S.V.:	194 to 199

The styrax purified with alcohol has these characteristics:

A.V.:	68 to 94
E.V.:	105 to 154
S.V.:	171 to 234

Composition: The styrax resinoids probably contain the constituents of the essential oil, ethyl cinnamate, cinnamyl cinnamate (Styracine), and phenylpropyl cinnamate;¹ probably some benzyl cinnamate;² the components of these esters, and finally some vanillin.³

References

1. Miller, W. v., *Ann. chim.*, 188, 184 (1877).
2. Laubenheimer, H., *Ann. chim.*, 164, 289 (1872).
3. Dietrich, K., *Pharm. Zentralhalle*, 37, 425 (1896).

Benzoin

There are two principal types of benzoin, the Siamese and the Sumatra products.

Benzoin Siam comes from *Styrax Tonkinense* Pierre, *S. macrothyrsus* Perk. (Styraceae).¹ The tree is found at Laos, and in the upper basin of the Black River and the Red River, at Tonkin. Some of the resin goes to the embarkation ports through Siam (Thailand), and the rest is exported via Haiphong and Saigon. Annual production in normal times averages about 60 tons. The crude resin is classified according to the appearance and thickness of the grains, into *Tears* No. 1, 2, 3, 4, amygdaloids and lumps. Tears No. 1 have the finest odor, generally followed by amygdaloids.

The Sumatra benzoin is derived from *Styrax benzoin* Dryand., *S. benzoides* Craib. It is generally less highly valued than the Siamese benzoin. Another type, *Northern benzoin* or *benzoin of Penang*, according to Heyne, is a mixture of the resins of *S. benzoin* Dryand. and *S. Sumatrana* Heyne, *S. Sumatrana* J. J. Smith.²

The Sumatra product is divided at the origin into several groups, and classified into three for export. The benzoin of each lot is crushed and amassed. The best quality contains little mass at the base and many white grains; the second, more mass and considerably fewer white grains; the third only a few isolated grains in a brown and brittle mass, rich in bark débris.

In the manufacture of the resinoids, the benzoin of inferior appearance is used, but such products generally possess the finest odor.

Extraction: For extraction, either alcohol or benzene is used. Treatment is conducted in the presence of heat, with two or three successive extractions. The first is genuinely an extraction, and the next two, conducted with very limited quantities of solvent, are rather washings.

The yield depends in the first place on the humidity of the product. It is low for the first qualities (0.6 to 2%) but reaches 10 to 12% for the lower qualities. The yields reported below are based on the dry products (analytical determination by desiccation of the pulverized resin, placed in a vacuum exsiccator, over sulfuric acid.)

The average yields in alcoholic resinoid vary between the following limits:

	Percentage
Benzoin Siam Tears No. 1 to 4	92-98
Benzoin Siam Amygdaloid	85-94
Benzoin Siam Lumps	82-88
Benzoin Sumatra, Quality No. 1	90-94
Benzoin Sumatra, Quality No. 2	80-86
Benzoin Sumatra, Quality No. 3	65-76

Benzene extraction gives yields approximately identical in the case of benzoin Siam, and slightly lower with benzoin Sumatra.

Neutral benzene resinoids are prepared by alkaline washing.

The products prepared from the higher quality materials are amber colored, while the other qualities give more or less dark reddish products. Treatment with activated carbon corrects the color and lightens it.

Analytical characteristics: The resinoids have analytical characteristics between the following limits:

SIAM

A.V.	134 to 166, and usually 142 to 166
E.V.	44 to 86, and usually 52 to 76
S.V.	212 to 244, and usually 220 to 240
% Total aromatic acids (according to British Pharmacopoeia, 1932)	38 to 64

SUMATRA

A.V.	112 to 170, and usually 122 to 146
E.V.	64 to 110, and usually 70 to 84
S.V.	176 to 232, and usually 200 to 225
% Total aromatic acids (according to British Pharmacopoeia, 1932)	30 to 60

Composition: The main difference between the Siam and Sumatra benzoin, from the chemical point-of-view, resides in the percentage of their benzoic and cinnamic acids and their esters. The benzoic derivatives are dominant in the benzoin Siam (an average of four to six against one) and the cinnamic derivatives in the Sumatra product (from two to ten against one). The two benzoin both contain vanillin (up to 1.5%) and, when they are old, some traces of benzaldehyde. For bibliographical references, the reader should consult studies on the subject of resins.

References

1. Cardot, J., "Industrie et commerce des essences et parfums d'Indo-Chine," Publication of Agence économique de l'Indo-Chine, No. 22, 1929, p. 9-11.
2. Reinitzer, F., *Arch. Pharm.*, 5, 1 (1926).

Cacao (Cocoa)

The fruit and the seeds of the cacao tree, more frequently but less properly called cocoa, *Theobroma cacao* L. (Sterculiaceae), have been distilled for the production of the essential oil.¹

Expression in the presence of heat, or extraction with volatile solvents, of the cacao-nut, gives cacao butter. For perfumery, the Venezuelan earth cacao is preferred.

Extraction of the roasted, decorticated and pulverized seeds, by the use of petroleum ether, which dissolves little of the theobromine, gives 45 to 60% of a maroon-brown solid and brittle mass, having the characteristic cacao odor, and the constants:

C.P.:	22 to 22.5°
M.P.:	29 to 34°
I.V.:	34 to 38

By treatment with luke-warm alcohol, followed by freezing and filtration, a dark brown absolute of buttery consistency, used in perfumery, is prepared.

The odorous constituents are unknown.

References

1. Sack, *Landb. West-Indie*, Bull. 10, 10 (1908).
Müller, F., *Pharm. Zt.*, 53, 57 (1908).
Bainbridge and Davies, *J. Chem. Soc.*, 101, 2209 (1912).

Coffee

Coffee, *Coffea arabica* L. (Rubiaceae), is cultivated in the tropical regions of all parts of the world. It is imported into Europe in three forms: the coffee bean, or the seed enveloped in the pericarp; the roasted coffee, in which the seed has been recovered by a yellow endocarp and parchmented; and the decorticated coffee.

The roasted seed, upon treatment with water, benzene or petroleum ether, gives aromatic extracts. The yield in petroleum ether extract, practically free from caffeine, varies between 11 and 16%. It is treated with alcohol to eliminate the major part of the fatty oil and the waxes.¹

The leaf of the coffee tree has a very aromatic odor. Fermented or not, and slightly roasted, it acquires a most agreeable odor, somewhat in-between the scents of coffee and tea. In fact, it is frequently used in China to add to tea. It is extracted with benzene, petroleum ether or alcohol, giving some resinoids that are very interesting for perfumery; these extracts have a warm note, slightly amber, recalling the Oriental tobaccos. The most frequently used solvent is alcohol; the yield varies between 8 and 9%.

The perfume of roasted coffee was studied by Staudinger and Reichstein,¹ whose results are cited in the patents of the *Internationale Nahrungs- und Genussmittel A.G.* This work was completed by the works of Prescott and his collaborators,² of W. R. Johnston and C. N. Frey.³ The reader should also consult an article in the publication *Flavours*.⁴

The following products were identified by Staudinger and Reichstein: hydrogen sulfide, furfuryl mercaptan, dimethyl sulfide, acetaldehyde, furfuraldehyde, diacetyl, acetyl-propionyl, furfuryl alcohol, acetic acid, guaiacol, vinyl guaiacol, pyridine, pyrazine, N-methylpyrrole, to which Prescott and his collaborators added formic acid, diethyl ketone, kahweol, vanillone, *p*-vinylcatechol, eugenol, sylvestrene, and Johnston and Frey added furan and methylacetylcarbinol.

References

1. English patents 241,454 and 260,960; Swiss patents 119,456, 130,605, 130,606, 130,607 and 130,608.
2. Prescott, Emerson, and Peakes, *Food Research*, 2, 1 (1937); Prescott, Emerson, Woodward, and Heggie, *Ibid.*, 165.
3. Johnston, W. R., and Frey, C. N., *J. Am. Chem. Soc.*, 60, 1624 (1938).
4. Anonymous, *Flavours*, 1, 16 (June, 1938).

Costus

The root of the costus, *Saussurea lappa* Clarke, *Aplotaxis lappa* De-caise, *A. auriculata* D.C., *Aucklandia costus* Falc. (Asteraceae), is pro-

duced in India, in the regions of Cachemire and Punjab. It is generally slightly roasted.

For quite some time, benzene or alcohol extractions have been made, and resinoids highly valued in perfumery thus prepared. These products have a warm, envelopping and characteristic note, and are incredibly tenacious. The yield of benzene resinoid is between 4 and 6.5%.

The odorous constituents are unknown.

Coumarin-containing Plants*

In general, coumarin is found in the fresh plant in the form of complex combinations, from which it is liberated in the course of certain phenomena which accompany desiccation. The perfume is extracted by means of alcohol or benzene.

Lacinaria. The leaves of the lacinaria or liatris, (deer's tongue or hound's tongue) *Liatris odoratissima* Willd., *Trilisia odoratissima* (W.) Cass. (Asteraceae), are gathered in the savanna-land from North Carolina to Florida. When fresh, they have little odor; dry, they acquire an odor of coumarin and vanilla. The vanilla note is particularly strong in the *Liatris scariosa* (L.) W.¹ The leaves are used for perfuming tobacco. T. L. Wood² has extracted from the leaves 0.78 to 0.98% of coumarin. For a long time these leaves served as a raw material for the production of coumarin, before the popularization of the synthetic product.

The leaves have a dark color; they are 15 to 20 cm. long. They arrive in Europe via Le Havre or Hamburg, and are extracted by means of benzene. From 3 to 4% of a solid resinoid is obtained; it is partially crystallized, of light green color, and almost entirely soluble in 96% alcohol. The odor of the resinoid is coumarinic and very powdery, suggestive of dry hay.³

References

1. Hoffmann, in Engler-Prantl, "Pflanzenfamilien," IV, v. 5, p. 142.
2. Wood, T. F., *Pharm. J.*, 12, 764 (1882).
Procter, *Am. J. Pharm.*, 31, 556 (1859).
3. Igolen, G., *Parfums France*, 14, 223 (1936).

Melilot. Of the melilot species, there are treated for perfumery *Melilotus arvensis* Wallr., *M. officinalis* Desr., *M. bungeana* Boiss., *Trifolium melilotus officinalis* α. L. (Papilionaceae).

For information on this subject, see H. Simonis, "Die Cumarine," Stuttgart, 1916, p. 54 ff.

This is a wild plant that grows in abundance in the humid prairies. The flowers are grouped in clusters, in the axil of the leaves; the corollas, usually yellow, are sometimes white. The dry flowers were distilled by Haensel,¹ who extracted coumarin.

When treated with benzene, the dry flowers give 2 to 3% of a very dark green, semi-liquid resinoid, with the consistency of honey. When the absolute is being prepared, there is a separation of the soluble product into two layers; the lower, solid, is composed almost entirely of coumarin; the upper, liquid, extremely perfumy, has an intense tobacco odor and has the following analytical properties:²

d ₁₅ :	1.043
A.V.:	about 56.1
E.V.:	140

References

1. Haensel, *Apoth. Zt.*, 15, 516 (1900).
Fontana, *Gazz. Eclett.*, 13, 196 (1833).
Guillemette, *J. Pharm.*, 11, 481 (1825); and 21, 172 (1835).
Cadet de Gassicourt, *Pharm. Zentralhalle*, 332 (1835).
Clausen, *Pfaffs. Mitteil.*, fasc. 748, 77 (1837).
Bleibtreu, *Ann.*, 59, 177 (1846).
Zwenger and Bodenbender, *Ibid.*, 126, 257 (1863).
2. Igolen, G., *Parfums France*, 14, 225 (1936).

Tonka Bean. The tonka bean is the seed of *Dipterix odorata* Willd., *Coumarona odorata* Aubl., *Baryosma tongo* Gaertn. (Papilionaceae), which grows in Venezuela, the Guianas and northern Brazil. Also harvested and designated as tonka bean are the seeds of *Dipterix oppositifolia* Willd. and *D. pteropus* Taub.¹

The fruit falls on the ground upon ripening, is gathered, dried, and the shells broken. The extracted beans are dried in the shade, and then immersed in a vat of 65% alcohol for a half day. The alcohol is decanted, and the beans left to dry for five to six days in the shade, so as to have a beautiful "frost", that is to recover the bean with numerous little coumarin crystals.

The Venezuela beans known as *Angostura* are the most highly valued. The Guiana and Paraguay beans are smaller.

Extraction: Infusions in 96% alcohol, and alcohol, benzene and acetone resinoids are prepared. These products are rich in fats, waxes and odorous materials, the latter being represented primarily by coumarin.

The benzene resinoid is obtained in a yield of 20 to 30%. Treatment of this resinoid with alcohol eliminates the major part of the fats and

waxes. The yield in absolute is then from 10 to 15% of the weight of the beans. A benzene resinoid examined by Y. R. Naves had these characteristics:

d ₄₀ :	0.940
A.V.:	28.4
E.V.:	128

and contained 15% of coumarin.

Reference

1. Hartwich, C., "Die neuen Arzneidrog. aus dem Pflanzenreich," 1897, p. 1117.

Fenugreek

The seeds of the fenugreek, *Trigonella foenum graecum* L., *Follicigera graveolens* Pasquale, *Foenumgraecum officinale* Alef. (Fabaceae), are gathered in India, Persia, Arabia and Greece. They are yellowish, have a prismatic form, are 2 to 3 mm. wide and 3 to 4 mm. long. Deodorized, they are useful for therapeutic purposes.

The odor of fenugreek is very characteristic, and its merits have been described by G. Igolen.¹ It is tenacious and powerful, is related to the odor of celery and the true opopanax, with nonetheless a flat and nauseating mustiness. The odor is similar to that of the ethyl ether of β -methylumbelliferone.²

The fenugreek extracts are used in America, in association with vanilla and coffee extracts. They find their way into numerous tobacco flavors.

Extraction: Benzene and petroleum ether extract, together with the aroma, a fatty oil (8 to 9% of the weight of the seeds), which was studied by E. Fleurent. The major part of this oil is eliminated in the manufacture of the absolute. Alcohol is used for direct extraction; it extracts, over and above the aroma and a part of the waxes and fats, about 10% of resins.

References

1. Igolen, G., *Parfums France*, 14, 154 (1936).
2. Pfau, A. St., *Riechstoff Ind. Kosmetik*, 10, 57, (1935).

Henna

The henna, *Lawsonia inermis* L., *L. alba* Lam. (Lythraceae), is cultivated in Arabia, Persia, India and Ceylon, and in the eastern and north-eastern sections of Africa. The leaves and roots are highly valued for the production of a dyestuff that is important in Oriental and Arab cosmetics (Henna, Alhenna, Tamr-el-Hinna).

By extraction of the dried flowers with benzene or alcohol, a resinoid is obtained; it has a very agreeable odor, somewhat phenolic and very tenacious.

The essential oil has been prepared by Holmes.¹

Reference

1. Holmes, E. M., *Pharm. J.*, (3) 10, 635 (1880).

Hop

The hop, *Humulus lupulus* L. (Moraceae), is cultivated in England, Holland, Belgium, in northern and eastern France, in Germany, Czechoslovakia, Hungary and also North America, for the manufacture of beer. The fruit is harvested.

Alcoholic extraction of the dry drug gives 12 to 15% of a thick, dark brown resinoid, having a strong, aromatic odor.

F. B. Power, Fr. Tutin and H. Rogerson¹ identified ceryl alcohol, hentriacontane, a phytosterol, some fatty acids, and a phenolic compound, humulol, the hydrolysis of which liberates an acid (C₁₅H₁₄O₅) and para-hydroxy benzaldehyde, as well as another phenol, a crystalline substance called xanthohumol (C₁₃H₁₄O₃) and some resins.

Reference

1. Power, F. B., Tutin, Fr., and Rogerson, H., *J. Chem. Soc.*, 103, 1267 (1913).

Labdanum

On page 206, we have described the extraction products of the resinous branches of the labdaniferous cistus.

The Cretan gum-resin is today hardly more than a picturesque memory; on the other hand, the Spanish product is today still on the market, 15 to 20 tons being produced annually, of which 12 to 15 tons are from the province of Zamora.

In Spain, the summits of the cistus are gathered in the off-season of the agricultural workers, and they are then dried in the sun. The branches, tied in small bundles, are immersed in boiling water, and a dark resin gathers and comes to the surface. It is decanted and as great a quantity as possible of the water is expressed from it. It is then moulded into blocks of about 10 kg. each, and the water continues to evaporate, while the resin hardens and becomes porous.

Spanish gum labdanum is of very irregular quality, because of the

very little care given to this treatment. The most volatile of the odorous principles are more or less lost.

The rather fresh loaves range in color from dark green to brown-green; these loaves are generally rough, on rare occasions brittle, and almost always contaminated with large quantities of foreign matter of an unpredictable nature.

Purification: The gum is purified by treatment with alcohol, benzene or on rare occasions petroleum ether. The product, softened by heat, is poured into the heated solvent and agitated.

Decoloration by activated carbon gives light yellow-brown products. The best qualities give 70 to 85% of an alcoholic resinoid:

A.V.:	76 to 112
E.V.:	136 to 188

having a powerful, amber-type odor, and being an extremely tenacious odorant.

References

For a description of labdanum and its production, see Gérardin, *Bull. Sci. pharmacol.*, 6, 289 (1919); Camus, G., *Roué-Bertrand fils, Sci. Ind. Bull.*, 3, (Oct. 1920).

Lovage

The lovage, *Levisticum officinale* Koch., *Angelica levisticum* All. (Umbelliferae), is a hardy plant whose exact origin is unknown. It was cultivated in the days of the Romans, and is today grown in Provence, in the Dauphins, in Thuringia, and in Belgium.

Extraction of the roots of the lovage gives a resinoid whose powerful and aromatic note suggests the warm celery odor, with a tenacious animal mustiness. The yield varies between 4 and 7.5%, according to the state of freshness of the roots.

The composition of this resinoid has not been studied. Sommer¹ seems to have established that the umbelliferone found in the products of distillation does not exist in the roots.

Reference

1. Sommer, *Arch. Pharm.*, 148, 1 (1859).

Oakmoss

Origin: The lichens that make up the so-called "oakmoss" sold commercially are, for the most part, *Evernia prunastri* Ach. and *E. furfuracea* Ach. Other species that are sometimes found mixed with the better

lichens in smaller or greater proportions, are *Sticta pulmonacea* Ach., *Usnea ceratina* Ach., and some *Ramalina* (*R. farinacea*, *R. fraxinae*, *R. pollinaria*), as well as some *Alectoria* and *Parmelia*.¹

The supplies for the Grasse factories come from the environs of Paris, particularly from the forest of Fontainebleau, from the Cévennes and Ardèche, from Piémont, Calabria, Bohemia and Yugoslavia.

Apparatus for the extraction of oakmoss has been installed in Yugoslavia, whereas in Bulgaria, some of the installations dedicated to the treatment of rose are used for oakmoss.

In France, it is generally agreed that products obtained from *E. prunastri* be called *oakmoss* or *mousse de chêne*, and derivatives of *E. furfuracea* and *Usnea barbata* be called *tree moss* or *mousse d'arbre*. This distinction is not made in the United States, where the only term in use is *oakmoss*.

The lichens gathered from the oak tree are actually rich in *E. prunastri*, and they are light green in color; those gathered from the Conifera are grayish, and generally possess a resinous odor, *E. furfuracea* being dominant.

A French organization undertook the task of exploiting the green oak and cedar forests of the Berber country of Morocco, between Azrou and Timrhadit,² about 60 km. south of Meknès and at an altitude of 1200 to 1300 meters. The types gathered are *E. prunastri* and *E. furfuracea*. Side by side with the *E. prunastri*, small quantities of *Ramalina calicaris* are found.

Extraction: The lichens are always treated after desiccation. The perfume develops during the course of storage.

The extraction processes should be divided into two classes, according to whether or not the solvent is chemically reactive. In the first class, the solvents that intervene chemically, there is alcohol; and in the second class, benzene, petroleum ether and acetone. But of these acetone is used only in exceptional cases.

Benzene or petroleum ether extraction: Petroleum ether extraction gives a finer product than benzene extraction, but the yield is lower. Petroleum ether gives 1.5 to 3% of resinoid, when *E. prunastri* is used, and benzene 2 to 4%. Higher yields, 2 to 4%, of the petroleum ether resinoid, and about 5% of the benzene resinoid, are obtained from the so-called *mousse d'arbre*.

L. Trabaud (*loc. cit.*) reported that in Morocco, the petroleum ether yield is only one-third to one-half of the benzene yield.

Benzene extracts more colored materials and resins than petroleum ether, but also more perfume. Its use is generally preferred. As we have

already pointed out, on page 62, an excellent practice consists in moistening the moss with warm water 24 hours before the extraction, so as to enhance the permeability of the cells, and then draining or drying in the air before treating it with benzene. This solvent is better at penetrating into the tissues than is petroleum ether. Extraction is generally carried out in the presence of heat, the solvent being kept at its boiling point from the beginning of the operation.

Acetone Extraction: Extraction with acetone gives a yield of 5 to 8% of a resinoid with remarkable aromatic qualities. Unfortunately, this solvent is hardly practicable, because losses increase the cost.

Alcoholic extraction: Extraction is carried out by means of alcohol alone, a little below its boiling point, or a mixture of alcohol and benzene is used. Certain manufacturers replace ethyl alcohol by methyl alcohol.

These alcohols cause a considerable alcoholysis of the depsides, which are generally odorless and only slightly soluble in petroleum ether and in benzene. This alcoholysis generates odorous, soluble esters. The note of the product obtained varies according to the nature of these esters, and also depending on whether methyl or ethyl alcohol is used. Methanol generates products having a sweet and anisy odor, and ethanol generates sharper-smelling esters.

The yield in alcoholic resinoid varies between 8 and 12%, when alcohol alone is used, and between 4.5 and 6% when mixtures of alcohol and benzene are used.

Purification of the products of first extraction: The benzene resinoids are consumed in great quantities by the soapmakers, who use them either as such or partially decolorised, finding value in their strong odorant power and in their fixative qualities.

But a certain proportion of the alcoholic and petroleum ether resinoids is transformed into absolutes. They are treated over the water-bath with alcohol, almost at the boiling point, or refluxed with alcohol, while agitating. Separation of the insoluble products is effected after cooling, but without freezing. The resinoids of the *E. prunastri* give about 35 to 60% of absolute, those of the *mousse d'arbre* 60 to 70%.

The resinoids prepared by direct alcoholic extraction include a large proportion of inert materials, gums and mucilages. Thus, to enrich these resinoids in odoriferous materials, they are agitated in benzene or petroleum ether over the water-bath; there are three extractions, which are bulked, filtered and concentrated by distillation. The alcoholic resinoid, extracted with petroleum ether, gives 22 to 35% of a purified product, and with benzene, 40 to 69%. By the initial extraction with alcohol and the subsequent purification with petroleum ether or benzene, a greater quan-

tity of product is obtained than by direct extraction with these solvents, due to the alcoholysis of the depsides.

Absolutes that are more concentrated in perfume are obtained but at the price of considerable losses, by diluting the alcoholic solution with water, so that the alcohol is brought down to 80%. The solution is separated, and the insoluble products are washed twice with the 80% alcohol. The bulked alcoholic solutions are concentrated by distillation until cloudiness appears, and then brought down to 30% alcohol with brine. The products are then extracted with benzene, and the concentration of the benzene solution gives the desired product.

In certain cases, an effort has been made to obtain neutral concentrated products, by proceeding with the extraction of the raw material in the presence of lime. But this is difficult to carry out in a practical manner.

Concentration by distillation: The distillation of the resinoids in the "molecular" vacuum is very delicate. Small charges are used, or a continuous film process employed, so as to avoid pyrolysis. Products with little color and very powerful odor are thus obtained. But considering the operating difficulties, the following process is generally preferred:

Concentration by vapor distillation: In view of the weak volatility of most of the constituents of these products, distillation of the resinoids is difficult and long. Use is made of superheated water, ethylene glycol or glycerol, under reduced pressure. In the case of ethylene glycol or glycerol, the distillate is diluted with water and extracted with petroleum ether. The use of ethylene glycol and glycerol makes it possible to operate the extraction more rapidly, and with the least alteration. The yield obtained is from 15 to 20% higher than by the use of steam.

The following yields are obtained by steam:

From benzene resinoids	3.0 to 4.8%
From petroleum ether resinoids	3.9 to 5.6%
From alcoholic resinoids	8.0 to 13.2%

The distillates are colorless and semi-crystalline.

Characteristics of the extraction products: The petroleum ether and benzene resinoids have a waxy and soapy consistency. They include a smaller or larger proportion of crystallized products. The benzene resinoid is dark green and deeply colored.

The absolutes obtained from the petroleum ether resinoids are more fluid than those extracted from the benzene products, the latter being very rich in crystalline substances.

All these products are difficult to decolorize by the use of adsorbent

carbons. They retain a more or less dark amber tint, which deepens with the passage of time. Decoloration by absorption brings with it a considerable loss in odorous products. Therefore, it is generally preferable to decolorize by distillation, as described above.

The alcoholic resinoids are generally highly colored, and very rich in crystalline products. Their perfume is more powerful and well rounded out than that of resinoids prepared with hydrocarbons. The characteristics of several samples of these products are as follows:

	M.P.	A.V.	E.V.
Petroleum ether resinoids	48° and 50°	68.2 and 56.8	74.2 and 78.5
Benzene resinoids	50° and 52°	16.1 and 22.4	42.0 and 38.1
Alcoholic resinoids	semi-liquid	32.6 and 72.3	82.7 and 62.9

Y. R. Naves, S. Sabetay and L. Palfray³ have described four distillates, obtained by steam distillation under reduced pressure.

Source of Distillate	A.V.	E.V.
Petroleum ether resinoids	21.5 and 31.4	82.3 and 90.6
Benzene resinoids	16.1 and 22.4	42.0 and 38.1

Composition of the products of extraction: The composition of the extraction products of oakmoss has been the subject of several works of Stenhouse,⁴ Hesse,⁵ A. St. Pfau,⁶ Walbaum,⁷ Spaeth⁸ and Stoll and Scherrer.⁹

Great progress has been made in the chemistry of these constituents, thanks to the work of several of the authors mentioned above, particularly A. St. Pfau, and of Y. Asahina, E. and H. L. Fischer, H. Curd, A. Robertson, R. J. Stephenson, G. Köller and K. Pöpl. Bibliographical references can be found in the review articles of Y. R. Naves¹⁰ and A. St. Pfau.¹¹

Evernia prunastri contains mainly evernic acid, *d*-usnic acid, some atranorine and chloratranorine.

Evernia (Parmelia) furfuracea contains atranorine, physodic acid, furfuracinic acid, and chloratranorine.

Usnea ceratina consists primarily of usnic acid and barbatinic acid.

The structures of the chief constituents mentioned above are as follows:

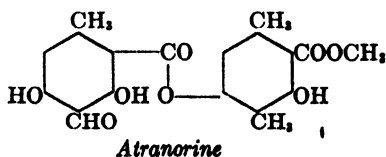
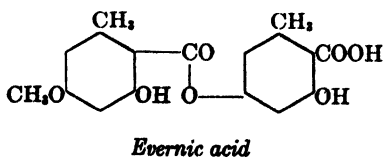

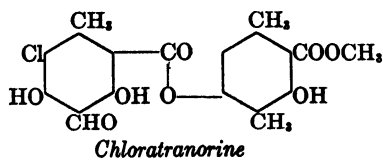
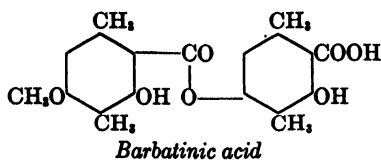

According to A. St. Pfau, *Evernia prunastri* contains 2 to 3% of evernic acid, 0.1 to 0.3% of atranorine, and 0.1 to 0.2% of chloratranorine.

The rupture of the depsidic bond of the compounds shown above is provoked by water, methanol and ethanol. Thus, hydrolysis generates:

Orsellinic and evernic acids from evernic acid. These two acids decarboxylate and give, respectively, orcine and the monomethyl ether of orcine.

Methyl β -orcine carboxylate, and atranol, product of the decarboxylation of the hematommic acid generated from atranorine.

Methyl ether of β -orcine and β -orcine, produced by the decarboxylation of the hydrolysis products of barbatinic acid.

Chloratranol, from the decarboxylation of chlorhematommic acid, and methyl β -orcine carboxylate, generated from chloratranorine.

By alcoholysis, the following products are obtained:

Evernic esters in place of evernic acid.

Hematommic esters in place of atranol.

Rhizoninic esters in place of the methyl ether of β -orcine.

Chlorhematommic esters in place of chloratranol.

The structural formulae of the products of scission can be derived from the formulae given above by the rupture of the depsidic bonds:

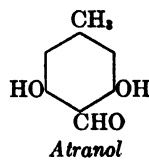
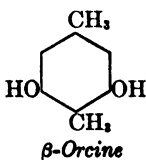
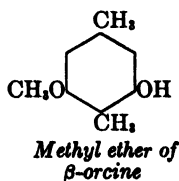
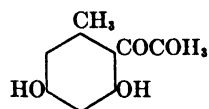
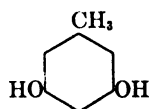
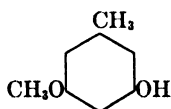
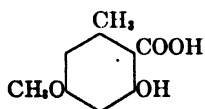

M. Stoll and W. Scherrer (*loc. cit.*) studied the composition of the ethereal extracts of oakmoss, and particularly the composition of the fractions volatile in steam.

The ethereal extracts were in turn extracted by a light petroleum ether. The fraction insoluble in the latter solvent was made up for the most part of evernic acid, together with β -orcine and 5% of the mono-methyl ether of orcine. The volatile fraction contained formic and acetic acids. By washing the petroleum ether solution with water, these authors separated acetic acid, a little formic acid, and some resins rich in orcine.

By treating this petroleum ether solution with a sodium bicarbonate solution, they separated some fatty acids, about one-third being saturated (stearic and palmitic) and two-thirds unsaturated (oleic). These acids constitute 0.25% of the ethereal extract. Extraction with a 2% sodium washing gave 0.05 to 0.1% of a mixture of phenols, in which the following were identified: phenol, β -orcine, methyl β -orcine carboxylate, and a large proportion of evernic acid and of orcine monoether.

Washing of the petroleum ether solution with a 2% hydrochloric acid solution resulted in the isolation of small quantities of bases with a pyridine-like odor.

In the most volatile neutral fraction, Stoll and Scherrer identified α - and β -thujone, the principal substances, and camphor, borneol, cineol, and variable proportions (depending on the origin of the oakmoss) of naphthalene, of a dimethylcyclohexenone identical with the substance found by Béhal in the heavy wood oil, probably accompanied by methylonylketone and other unidentified ketones, as well as geraniol, citronellol, nonanol and other alcohols, and vanillin.

The less volatile neutral fractions contain a lactone ($C_{12}H_{20}O_2$ or $C_{13}H_{22}O_2$), stearic alcohol, a little stearic aldehyde, some hydrocarbons $C_{20}H_{32}$, some esters of saturated fatty acids (principally palmitic acid) and of unsaturated acids.

References

1. For a general point-of-view, the reader should consult Naves, Y. R., *Parfums France*, 6, 34 (1928).
Trabaud, L., *Perfumery Essent. Oil Record*, 27, 161 (1936).
Pfau, A. St., *Riechstoff Ind. Kosmetik*, 12, 179 and 208 (1937).
2. Trabaud, L., *loc. cit.*
3. Naves, Y. R., Sabetay, S., and Palfray, L., *Perfumery Essent. Oil Record*, 28, 336 (1937).
4. Stenhouse, *Ann.*, 68, 83 (1848).
5. Hesse, *Ann.*, 117, 312 (1861).
6. Pfau, A. St., *Ber.*, 57, 468 (1924); *Helv. Chim. Acta*, 9, 650 (1926); 11, 864 (1928); 17, 1319 (1934).
7. Walbaum, *Ber.*, 57, 770 (1924).
8. Spaeth, *Ber.*, 57, 417 (1924).
9. Stoll, M., and Scherrer, W., "Communication au XVII^e Congrès de Chimie industrielle," Paris, 1937, No. d'ordre 29.

10. Naves, Y. R., *Parfums France*, 6, 34 (1928).
11. Pfau, A. St., *Riechstoff Ind. Kosmetik*, 12, 179 and 208 (1937).

Orris

For perfumery, the *Iris pallida* Lamk. (Iridaceae) is cultivated; it is alternately called orris or iris, the latter after the principal place of production, the *iris* of Florence.

Under cultivation in Italy one also finds *I. florentina* and *I. germanica*. The most important cultivations are in the neighborhood of Verona and Florence in Italy, and around Ollioules (Var) and near Grasse in France.¹

The fresh rhizomes have practically no odor. The odor develops during the desiccation and in the course of months of storing. Utilizing fresh rhizomes, two years old, 100 kg. gives 40 kg. of the dry product.

Steam distillation gives an oil rich in fatty acids that are solid at ordinary temperature, and particularly myristic acid. For this reason, the essential oil is called a concrete. The neutral liquid portion, separated by alkali treatment, is called the absolute. These products should not be confused with the products of extraction, which we shall call exclusively by the name of resinoids.

Extraction: The tincture of orris is prepared by maceration of the orris powder in 95% alcohol. The alcoholic resinoid results upon concentration of the tincture by distilling off the alcohol. The yield varies from 14 to 22.8%.

Petroleum ether furnishes 1 to 1.9% of a brown-yellow to red-brown resinoid, having the consistency of honey, and the warm and tenacious odor of orris roots. Benzene gives a higher yield, 2 to 3.5%, but the resinoid contains more resins and gums.

The petroleum ether resinoid contains 50 to 60% of alcohol-soluble products, and this proportion rises to 70 to 80% in the benzene resinoids.

By steam distillation, the petroleum ether resinoid gives 3 to 7% of volatile products.

Y. R. Naves, S. Sabetay and L. Palfray² reported the following characteristics for this distilled fraction:

	α_D	n_D^{20}	A. V.	E. V.	% Iron (by oxidation)
1. Liquid at +20°	+24° 16'	1.4780	50.4	63.0	68.1
2. Liquid at +18°	+20° 22'	1.4756	42.0	71.6	70.6

References

1. Mazuyer, G., *Am. Perfumer*, 31 (1911); *Parfums France*, 6, 126 (1908).
2. Naves, Y. R., Sabetay, S., and Palfray, L., *Perfumery Essent. Oil Record*, 28, 336 (1937).

Patchouli

The distillation of the leaves of patchouli, *Pogostemon patchouly* Pell., *P. cablin* Benth., *P. suavis* Hook., (Menthaceae), gives oil of patchouli, with its warm, heavy and characteristic odor. This is the Singapore patchouli. In Java and Sumatra, an oil of patchouli of inferior quality is produced from the leaves of *P. heynamus* Benth.

Generally the leaves are dried and partially fermented before distillation.

The distillation proceeds with difficulty, and it modifies the perfume of the patchouli leaves. Efforts have therefore been made to prepare resinoids from patchouli leaves, by the use of volatile solvents.

The solvent most frequently used is benzene, and the yield of resinoid reaches 4.5 to 5.8%. The odor note of this resinoid is rounder and more tenacious than that of the essential oil, and it is free of its camphoraceous top-note and of its mustiness.

The resinoid is being used more and more by perfumers and soap-makers. Unfortunately, it is often adulterated with oakmoss resinoids, with cloves and with coumarin, and diluted with the essential oil of patchouli.

Resins and Gum Resins

Elemi. The elemi resinoid is prepared from the Manila elemi. Its odor is green and pungent, with the phellandrene note dominant at the beginning of the evaporation. It has powerful fixative qualities.

Elemi has the appearance of a waxy mass, yellowish white to yellowish brown in color. E. D. Merrill reported its origin from *Canarium luzonicum* (Miq.) A. Gray, *C. album* Bl., *C. commune* Vill. (Balsaminaceae).¹ It is produced in the Philippines. Steam distillation gives 20 to 30% of an oil rich in *d*-phellandrene.

Elemi is usually extracted with benzene; on rare occasions, with alcohol.

After quite some time, one can recognize, among elemi resinoids of good quality, rich in elemol, the characteristic sublimation of this alcohol in fine white needles, at the surface of the resinoid and in the empty section of the packing.

Reference

1. Gray, A., according to Gildemeister and Hoffmann, "Die Ätherischen Öle," 3rd edit., vol. 3, p. 177.

Galbanum. Galbanum is derived from various Umbelliferae which grow in Persia and Asia Minor, among which the most important are: *Ferula galbaniflora* Boissier and Buhse, *Peucedanum galbaniflorum* Baillon, *F. rubricaulis* Boiss., *P. rubricaulis* Baillon, *F. erubescens* Boiss., *F. gummosa* Boiss., and *F. shair* Boiss.

On the subject of the production of the gum-resin, see Buhse.¹

It arrives in Europe in two forms, the Levantine or soft, and the Persian or hard galbanum.

The first is in the form of round, sticky tears, sometimes dull and sometimes shiny, slightly yellowish or reddish in color. The tears are more or less bunched together and mixed with plant débris.

The Persian or hard galbanum has the appearance of slightly yellowish dry tears.

The odor of galbanum is aromatic, powerful and tenacious, and it has a bitter taste.

Extraction: Extraction of the usual commercial product with 96% alcohol gives 45 to 60% of resinoid; with benzene, 40 to 50%. These products contain umbelliferone. When they are boiled with water and ammonia is added, a product having a marked fluorescence of a characteristic blue is formed. The essential oil yield varies between 12 and 19%.

References

1. Buhse, "Aufzählung der Transkaukasien und Persica gesammelten Pflanzen," Moscow, 1850 and 1860.
Hirschsohn E., *Pharm. J. and Trans.*, 369 ff. (1876).

Mastic. The mastic comes from an Anacardiaceae, *Pistacia Lentiscus* L. or lentisk, which grows on the Mediterranean islands and the Canary Islands. One variety grows in abundance on Chio Island, *P. lentiscus* var. *Chia*. It is noted for its exceptional development.

Two qualities are found on the market, the seed and the bloc mastic. The former appears in the form of tears or globulous piles, from 0.5 to 2 cm. in diameter, lightly greenish in color when the product is fresh. The second variety, the bloc, has a yellowish or brownish color, and is frequently mixed with earth, sand or plant débris.

The odor of mastic is very balsamic, and recalls the odor of savin.

Extraction: Extraction with alcohol or benzene gives resenoids having little color. With petroleum ether, a resinoid is obtained in a yield of 30 to 55%.

Myrrh. The bitter or male myrrh is the oleogum-resin of a Burseraceae, *Commiphora myrrha* Holmes, which grows in Somaliland and southeastern Arabia.¹

The bisabol myrrh, or female myrrh, the opopanax of the perfumers, is the product of *Balsamodendron erythreum* var. *Glabrescens* Engler, *Commiphora kataf* Engler.

The two myrrhs can be distinguished by the Bonastre test (the ethereal extract of the bitter myrrh turns violet under the action of bromine vapors), by the Tucholka test, or by the Dezani reaction.²

The bisabol myrrh is preferred in perfumery. Myrrh appears in the form of little spherical heaps or irregular tears, brown-yellow, reddish-yellow or brown-red, strewn with whitish occlusions, having an aromatic odor and a tart flavor. The male myrrh has a bitter taste.

There are two categories of bisabol myrrh, the chosen and the sorted.

Extraction: From the sorted myrrh, extraction with 96% alcohol gives 25 to 30% of reddish brown resinoid, resinous and hard, having the following characteristics (Y. R. Naves, *loc. cit.*):

A.V.:	12 to 38
E.V.:	47 to 70.0
S.V.:	67.0 to 94.0

Benzene gives 20 to 30% of a resinoid having similar properties. The yield from chosen myrrh, extracted with 96% alcohol, is 48 to 56%.

The yield in oil, obtained by steam distillation, varies between 16 and 28%; the characteristics of this oil are analogous to those of the oil obtained from the drug itself.³

References

1. On the botanical origin of myrrh, see Gildemeister and Hoffmann, "Die Ätherischen Öle," 3rd edit., v. 3, p. 152.
2. For these tests, see for example Naves, Y. R., *Parfums France*, 12, 234 (1934).
3. See 1, p. 152 and 156.

Opopanax. The true opopanax (the opopanax of the perfumers) seems to come from an Umbellifera, *Commiphora chironium* Koch. or *Opopanax chironium* Koch., which grows in the northern regions of Persia. According to Polak, it is furnished by *Diplotoenia cachrydifolia* Boiss., and according to other authors, by some *Ferula*, *Laserpitium* or *Herculeum*.¹

G. Igolen² describes opopanax as appearing in regular, compact tears, having the form of a cacao bean, and possessing a rather lively characteristic reddish color. These rather soft tears can be agglomerous; they are polished, brilliant and rather fragile, and are reduced to the form of powder quite easily. They have a very lively aromatic odor, resembling

that of swamp smallage and of fenugreek, with an animal note suggestive of the odor of lovage and costus roots.

Extraction: With 96% alcohol, a resinoid yield of 20 to 35% is obtained; and with benzene, 15 to 25%, utilizing rare commercial qualities which are found on the market, and which are mixed with large proportions of lignous débris.

The resinoid is dark reddish brown, its consistency resinous and hard.

References

1. Holmes, E. M., *Perfumery Essent. Oil Record*, 2, 241 (1910).
Cordenoy, J. de, "Les Plantes à gommes et résines," p. 257.
2. Igoen, G., *Parfums France*, 14, 303 (1936).

Olibanum (Frankincense). According to Birdwood and Fluckiger, the Somali and Arabian incense or olibanum comes from three Balsaminaceae:¹ *Boswellia carterii* Birdwood of Somaliland and Arabia; *B. frereana* Bird. and *B. Bhan Djiana* Bird., from the Somaliland.

The first two species give the most highly valued resins. The *B. carterii* is a pale resinoid found in globular, piriform tears; the *B. frereana* is a transparent yellow or orange.

On the "frankincense" or incense of other origins, see Y. R. Naves.²

Extraction: The true olibanum is frequently mixed with lignous débris to which it adheres, and with stones and earth. Separated from these impurities, it includes 27 to 35% of gum, 4 to 7% of essential oil (on the average), and 66 to 70% of resin.

Benzene usually extracts 62 to 74% of selected olibanum, though these limits can extend from 50 to 74%; the soluble fraction represents 24 to 33%.

The characteristics of the resinoid are as follows:²

A.V.:	34.0 to 51.0
E.V.:	31.0 to 64.0

Its color is a more or less reddish brown, its consistency hard and resinous.

The quality of the resinoid can be estimated by steam distillation. The yield varies between 6 and 9%, sometimes rising as high as 11%.

Characteristics of the distillate: Y. R. Naves² reported:

d_{15}° :	0.876 to 0.894
α_D :	+10° to +33°, and rarely -9° 39' to +34° 30'
n_D^{20} :	1.4720 to 1.4816
A.V.:	up to 3.0
E.V.:	4.2 to 32.2

The odorous substances are unknown.

References

1. Holmes, E. M., *Perfumery Essent. Oil Record*, 7, 78 (1916).
2. Naves, Y. R., *Parfums France*, 12, 230-232 (1934).

Saffron (Crocus)

The Saffron, *Crocus sativus* L., *C. officinalis* Pers. (Iridaceae), grows wild in Attica and on the islands of Syros and Tenos.¹ The "Russian" saffron from the Caspian region and northern Persia is obtained from other varieties.² The plant is cultivated in France, in Gâtinais and Angoumois; in Spain, Bavaria, Austria and Turkey. The drug is derived from the extremity of the stylus and the stigmata.

Saffron blooms in September and October; the blossoming lasts about three weeks. The flowers are gathered daily, early in the morning, and the next day they are cleaned, that is separated from the stigmata. The latter are then desiccated over a charcoal fire. The conservation of the aroma depends on the proper conduct of these operations.

About 15,000 flowers are needed to produce 1 kg. of fresh saffron, and preparation then reduces this weight to a fifth. In the Gâtinais section, an average of 10 kg. of prepared saffron are obtained per hectare under cultivation.³ The commercial drug is a deep red, elastic to the touch, and frequently sold as a powder. Saffron is often adulterated; on this subject, the reader should consult special works.⁴

Steam distillation gives a small quantity of an essential oil, that has been little studied.

Extraction with benzene or alcohol gives resinoids, having aromatic value of great use to the manufacturers of liquors and food products, and they can be recommended in de luxe perfumery. At any rate, the substance to which saffron owes the major part of its odor quality, safranal, is readily available through synthesis.⁵

The greater part of safranal exists in the saffron in the form of a glucoside, as Kuhn and Winterstein have shown.⁶ This glucoside, known as picrocrocine, is split by acids. The exploitation of the saffron products must take into consideration the existence of this glucoside, of which fresh saffron contains about 4%.

References

1. Heldreich, "Nutzpflanzen Griechenlands," Athens, 1862, p. 8.
2. Tichomirow, *Arch. Pharm.*, 656 (1903).
3. Pierlot, G., *Chimie & industrie*, 14, 809 (1925).
- Urnat, J., "Le safran du Gâtinais," Paris, 1913.
4. Molisch, "Gundriss einer Histochemie der Pflanzlichen Genussmittel," Jena, 1891, p. 57.

- Meyer, A., "Die Grundlagen und Methoden für die Mikrosk. Untersuchung von Pflanzernpulvern," Jena, 1901, p. 223.
- Hanausek, T. F., "Die Safranverfälschungen," in Kronfeld, "Geschichte der Safran," Vienna, 1892, p. 68-110.
- Vogl, "Nahr. und. Genussmittel," p. 359 ff.
- Moeller, *Ibid*, 2nd edit., 1905, p. 102 ff.
5. Kuhn, R., and Wendt, G., *Ber.*, 69, 1549 (1936).
6. Kuhn, R., and Winterstein, *Ber.*, 67, 346 (1934).

Sandalwood

Sandalwood from India or Mysore, *Santalum album* L. (Santalaceae), is sometimes extracted with benzene. It gives, in a yield of 6 to 8.5%, a reddish-brown resinoid, with a characteristic odor note that is strong and tenacious, which has not been elsewhere described.

Spices: Clove, Ginger, Nutmeg, Pepper

The spices, clove, ginger, nutmeg and pepper, are all treated with benzene, petroleum ether or alcohol. The products obtained are of great tenacity and of excellent fixative value, with an odor note appreciably different from that of the corresponding essential oils.

Clove. The floral buds, prepared and desiccated, of *Eugenia caryophyllata* Thunb., *Caryophyllus aromaticus* L., *Jambosa caryophyllus* (Spreng) Ndz. (Myrtaceae), are treated. These cloves come from Réunion, Madagascar, Zanzibar or the Malayan States.

The solvent used is benzene or alcohol. The yield in resinoid varies between 18 and 22%. Alcohol gives an extract very rich in resins, which is put to little use. The yield varies between 27 and 40%.

Ginger. The decorticated rhizomes of *Zingiber officinale* Roscoe, *Amomum zingiber* L., (Zingiberaceae), originating in China, Japan, India or Jamaica, are treated, giving a resinoid having an odor that is aromatic, sweet and very tenacious. Alcohol and benzene are most frequently used as the extraction solvent. The yield in alcoholic resinoid, based on the weight of the dry material, is between 5.5 and 9%, while the benzene yield varies between 5 and 8.2%.

Nutmeg. The dried seed of the nutmeg tree, *Myristica fragrans* Houtt., *M. officinalis* L. fil., *M. aromatica* Lam. (*Myristicaceae*), is treated, after the seed has been separated from the tegument and the aril.

The drug is produced in the Dutch Indies, the Malayan States, the Moluccas, and Brazil, and is treated in Europe. It is extracted by benzene,

the resinoid yield varying between 31 and 37%. The extract is rich in fatty materials, the major part of which is separated by alcoholic treatment.

Pepper. The gray pepper, also called black pepper, being the unripe and desiccated berry of *Piper nigrum* L. (Piperaceae), from India and Indochina, is treated with benzene or alcohol. The alcoholic resinoid is produced in a yield varying between 11 and 14%. The white pepper, rarely treated, under the same conditions gives 9 to 10.5% of a resinoid.

Sumbul

In India, there is known under the name of sumbul root, the roots of several aromatic plants, notably of two Valerianaceae, *Nardostachys jatamansi* D. C., *Valeriana spica* Vahl., *Sumbul Hindi*, and *V. celtica* L., *S. Ekleti*, *S. Kumi*.¹

The true sumbul root is that of *Ferula sumbul* Hook. f., *Euryangium sumbul* Kaufmann (Umbellifereae), which grows in Central Asia, particularly in Turkestan.

Extraction: Sumbul root gives 5.5 to 9% of a benzene resinoid, having a warm, musky and resinous characteristic odor.

F. W. Heyl and M. C. Hart² studied the ether, ethyl acetate and alcoholic extraction. Cold extraction of the roots with 95% alcohol gave them 20% of an extract; and at the boiling temperature of alcohol, 27.4%. In the products of hydrolysis of the extract, they identified umbelliferone and vanillic acid.

References

1. *Pharm J.*, (1) 7, 546 (1848).
2. Heyl, F. W., and Hart, M. C., *J. Am. Chem. Soc.*, 38, 432 (1911).

Tea

The dried leaves of tea, *Thea sinensis* L., *Camellia thea* Lmk. (Theaceae), gave to G. J. Mulder¹ one of the first resinoids ever to be described. The yield was from 0.6 to 0.98%. The product had a lemon-yellow color, and congealed upon freezing.

The essential oil from the tea has been mentioned several times, and its study has been rather thorough.

The commercial drug consists of the leaves of *Thea sinensis*, which is frequently used in Chinese tea in combination with the leaves of *T. bohea* L., *T. viridis* L., *T. stricta* Heyne, and with various aromatic species, among which are *Chloranthus inconspicuus* Sa. (Chloranthaceae), *Gar-*

denia florida L. (Rubiaceae), *Olea fragrans* (Oleaceae), *Jasminum sambac* Sol. (Oleaceae) and *Aglaiia odorata* Lour. (Meliaceae).

The Ceylon tea comes from another variety, *T. sinensis* var. *Assamica*.

Distinction is made between the green teas and the black teas. The former are obtained essentially by direct desiccation of the leaves after the harvest, and rolling them out by rubbing on a table; they are then lightly scorched and sifted. The black teas are first slightly dried and then—and this is the essential difference—fermented. Their preparation is completed with the same series of operations as used for the green teas.

The aroma of tea is due to a large number of odorous products, as has been shown in the study of the essential oils of green tea² and of black tea.³

The teas are classified under more or less well-known trademarks, according to their origin and method of preparation. The falsifications are numerous. For specific details, the reader is referred to special works on the subject, namely:

Leprince and Lecoq, "Guide partique d'analyses alimentaires et d'expertises chimiques usuelles."

Gérard and Bonin, "Traité pratique pour l'analyse des denrées alimentaires."

Villiers, A., Colin, E., and Fayolle, M., "Traité des falsifications et altérations des denrées alimentaires."

Extraction: The manufacture of extracts for the use of the perfumer is generally accomplished by means of alcohol or petroleum ether, neither of which will appreciably dissolve the caffeine. On very rare occasions, benzene is used. The products prepared from black teas are very highly colored.

The alcoholic resinoid is obtained in a yield of 8.3 to 13.5%, usually varying between 10 and 11%.

The benzene resinoid is obtained in a yield of 0.9 to 2.4%, and generally between 1.2 and 2%.

The petroleum ether resinoid is obtained in a yield of 0.9 to 1.2%, and gives 24 to 35% of an absolute.

The preparation and purification of tea resinoids, with a view to their use for food, have been described by O. Strobach and P. A. Wickmann.⁴

Characteristics of the extraction products: The products of extraction were described by G. Igolen.⁵ They have a slightly flowery herbaceous note, and a warm and amber-like tone that suggests the fragrance of Oriental tobaccos.

They are generally sophisticated with coumarinic extracts and with oil of guaiac.

References

1. Mulder, G. J., *Ann.*, 28, 314 (1838).
2. Takei, S., Sakato, Y., and Ono, M., *Bull. Inst. Phys. Chem. Research, Tokyo*, 15, 626 (1936) and 16, 3 (1937).
3. Yamamoto, R., and Ito, K., *Bull. agro. Chem. Soc. Japan*, 13, 74 (1937).
4. Strobach, O., and Wickmann, P. A., English Patent 335,901 (1919).
5. Igolen, G., *Parfums France*, 14, 102 (1936).

Tobacco

The tobacco drug is made up of the leaves of several species of the genus *Nicotiana* (Solanaceae).¹

Tobacco is cultivated in the temperate zone of America, Europe, Africa and Asia. The drug is prepared by fermentation, in this way acquiring its characteristic odor. Alcoholic and benzene resinoids have been prepared, their odor due principally to nicotine and to *tobacco camphor* or nicotianine $C_{23}H_{32}N_2O_3$ and to related bases.

W. Halle and E. Pibram² treated a Hungarian tobacco (*Nicotiana rustica*) with a volatile (?) solvent, using heat, and obtained 0.047% of a yellow oil, having a strongly aromatic odor, acid reacting, and distilling between 71 and 100° under a pressure of 26 mm. It contained isovalerianic acid and a hydrocarbon $C_{10}H_{18}$ or $C_{11}H_{20}$.

References

1. Comes, O., Monograph on the genus *Nicotiana*, including the botanical classifications of industrial tobaccos, Naples, 1899; "Delle razze dei tabacchi filogenesi," Naples, 1905.
Preissecker, "Der Tabakbau und die Ausbildung des Tabaks zum industrielle Rohstoffe," v. 1, Vienna, 1914.
Rouant, E., "Le Tabac, culture et industrie," Paris, 1901.
2. Halle, W., and Pibram, E., *Berliner Berichte der Chemie*, 47, 1394 (1914).

Vanilla

Vanilla beans came to Spain from Mexico toward 1500, at the same time as cacao was being introduced to Europe. They were commodities that commanded high prices up to the time that their cultivation was extended to the Antilles, and then to the Dutch, British and French colonies.

At the present time, the beans are produced mainly in Tahiti and the neighboring archipelago, in the French islands of the Indian Ocean, in Java, the Antilles and Mexico.

In 1929 and 1935, the production was divided as follows, in tons:

	1929		1935	
	Tons	%	Tons	%
Madagascar and its dependencies	730	73	395	75.6
Réunion	80	8	15	2.88
Tahiti	55	5.5	40	7.65
Guadeloupe and the neighboring islands	20	2	7	1.34
Mexico	90	9	45	8.64
Java	25	2.5	20	3.82
	1,000		522	

The vanilla plant belongs to the Orchidaceae family; there are about 40 species. *Vanilla planifolia* Andrews is cultivated in Mexico, Madagascar, Réunion and the neighboring islands, and in Java. It is also found in Tahiti,¹ together with *Vanilla planifolia* var. *Augusta* Const. and Blois, and a third variety, *V. tiarei* Const. and Blois, which has very large fruit. On Guadeloupe, *V. pompona* Schiede. is cultivated; its fruit is known in French as the *vanillon*, or the big vanilla. In South America, *V. simarona*, *V. sylvestris* grows, and gives a bastard vanilla, a short plant, with little pulp, rather sour, and hardly any rind.

Details of the cultivation of vanilla are found in the works of the following authors:

Mexican vanilla: C. Cunningham² and C. A. Smeltzer,³

Guadeloupe vanilla: C. A. Smeltzer;⁴

Javanese vanilla;⁵

and a general study of vanilla in the work of W. L. Utermark.⁶

The aroma is developed artificially in several fashions:⁷

- (1) The maturation of the vanilla is halted and the tissues modified, so as to permit the diffusion of cellular juices and diastases:
 - (a) by dry heat (Mexico, Guadeloupe, Java, Tahiti);
 - (b) by lime-washing in water, at 60-65°, or by scalding (the cask process, in the islands of the Indian Ocean);
- (2) A partial fermentation is provoked by humid heat;
- (3) The plant is desiccated to halt diastasic activity.

Following such treatment, the aroma develops, the pods soften, darken, and then shrivel up.

The treated parts are classified for commercial purposes, according to the fineness of their aroma, into several categories. The French colonies where vanilla is grown have regulated the harvest, transportation, preparation, evaluation and packing of the pods.

The beans which do not fall into one of the categories are reduced to powder for vanilla extract. The same is done with any categories that prove difficult to sell.

Extraction: The extracts include almost all the aromatic substances

of the vanilla. They have been carefully studied for use in the food industry (pastries, confectionery, biscuits, chocolates, liquor) and for pharmaceutical purposes. They alter less easily than do the pods, and are easily measurable.

The vanilla extract industry has particularly flourished in the United States.⁸

Liquid extracts are prepared, which are tinctures or infusions in dilute alcohol of the products of maceration in water to which sugar or glycerol has been added. They are often "strengthened," as are the soft extracts, with vanillin, ethylprotocatechuic aldehyde (ethylvanillin), coumarin or with traces of tincture of castoreum.

The soft and the solid extracts are obtained by means of 60 to 80% alcohol, isopropyl alcohol, acetone, methylal, trichlorethylene or benzene. There seems to be an advantage in having a first extraction with trichlorethylene or benzene, and a second with dilute alcohol or dilute acetone.

The extracts prepared with dilute alcohol or acetone are delicate to manufacture, for a concentration that is effected without great precautions is accompanied by serious losses in aromatic products.⁹

According to J. B. Wilson and J. W. Sales,¹⁰ the Bourbon vanillas give the greatest quantity of extract; then come the Tahitian vanillas, followed by the Mexican. According to these authors, 65 to 95% alcohol, and isopropyl alcohol, give 18 to 30% of soft extract; carbon tetrachloride and acetone, 7 to 16% of an extract which is much less aromatic.

In France, the powders are treated with 5 parts (volume-weight) of 60 to 80% alcohol, and in general 10 to 12% of solid concentrated extract is obtained. Benzene gives an average of 6% of extract, and the use of alcohol makes possible the separation of 60 to 70% of an absolute from the benzene resinoid.

Characteristics of the extracts: The aroma of the vanilla pods seems to be rather complex, and we are far from knowing all the principal substances, particularly those which contribute the warm and animal-like note so characteristic of the choice products.

A. Goris¹¹ has asserted that the green fruit of the vanilla plant includes three glucosides: glucovanillin, glucovanillic alcohol, and a glucoside whose cleavage frees an ester with a strong and suave odor note.

In 1909, H. Wallbaum¹² found in the Tahitian vanilla anisic alcohol and the corresponding aldehyde and acid. G. B. Gnadinger¹³ confirmed this in 1925, and announced that the Bourbon vanillas contain cinnamic acid and cinnamic esters.

The presence of heliotropin (piperonal) in the vanilla pods has been the subject of heated discussion. T. v. Fellenberg¹⁴ identified it in the

vanilla and claimed it to be the principal aromatic constituent of the *vanillons*.

G. B. Gnadinger¹⁵ found heliotropin in the Tahitian *vanillons* and vanillas, but not in Mexican, South American, Javanese and Réunion vanillas. But the identification of heliotropin by phloroglucine and gallic acid color reactions is of doubtful value.

The most important constituent is vanillin. The quantity existing in pods of various origins was determined by Tiemann and Busse,¹⁶ Doherty,¹⁷ L. Amoretti,¹⁸ S. Pritzker and R. Jungkunz,¹⁹ and S. Isermann.²³

The average content varies between 2 and 3%.

The method for the determination of vanillin that can be recommended for the analysis of pods, extracts and resinoids, consists in placing the vanillin in solution in a solvent not miscible with water, and then isolating it by an ammoniacal combination soluble in water. The technique of clarification, introduced in several analytical methods, brings forth errors of default.²⁰

Ponderal methods can also be used, by treatment of the semi-oxamamide (technique of R. Eder and E. Schlumpf)²¹ or of the *m*-nitrobenzyhydrazide (J. Pritzker and R. Jungkunz).²²

The vanillin content of the alcoholic resinoids prepared in France is about 10%, a testimonial to the great losses brought about by extraction and concentration.

References

1. Constantin and Blois, *Compt. rend.*, 161, 196 (1915).
2. Cunningham, C. H., "Commerce Reports" of Nov. 20, 1920, from *Am. J. Pharm.*, 93, 272 (1921).
3. Smeltzer, C. A., *Perfumery Essent. Oil Record*, 17, 413 (1922); *Chem. Industries*, 50, 1215 (1927).
4. Smeltzer, C. A., *Perfumery Essent. Oil Record*, 16, 197 (1921).
5. *Handelsbericht*, The Hague, 12, 374 (1918); *Indische Mercur* (July 5, 1919).
6. Utermark, W. L., *Kolonial Instituut*, Amsterdam, Mededeeling No. 17 (1922).
7. Chalot, C., *Parfumerie moderne*, 64-70 and 84-92 (1923).
8. Pontillon, C. H., *Rev. botan. appl. agri. trop.* (Apr. 1930).
9. *Jour. Ind. Eng. Chem.*, 15, 782 (1923); 19, 342 (1927).
10. Armstrong, A. D., *Drug Markets*, 19, 2123 (1926).
11. Bayle, F. M., *Am. Perfumer*, 17, 207 (1922).
12. Gnadinger, G. B., *J. Ind. Eng. Chem.*, 19, 342 (1927).
13. Wilson, J. B., and Sales, J. W., *J. Ind. Eng. Chem.*, 15, 782 (1923); *Am. Perfumer*, 18, 301 (1923); 19, 24 (1924); 20, 155 (1925).
14. Goris, A., *Compt. rend.*, 179, 70 (1924).
15. Behrens, *Tropenpflanzer*, 3, 299 (1899).
16. Busse, *Z. Untersuch. Nabr. u. Genussm.*, 3, 21 (1900).
17. Walbaum, H., *Ber. Schimmel & Co., Akt. Ges.*, 240 (Oct. 1909); "Otto Wallach Festschrift," Göttingen, 1909, p. 649.

13. Gnadinger, J. B., *J. Ind. Eng. Chem.*, 17, 303 (1925); *Am. Perfumer*, 20, 26 (1925).
14. Fellenberg, T. v., *Mitt. Lebensm. u. Hyg.*, 6, 269 (1915).
15. Gnadinger, G. B., *J. Ind. Eng. Chem.*, 18, 588 (1926).
16. Tiemann and Busse, *Ber. Schimmel & Co., Akt. Ges.*, 72-85 (Apr. 1900).
17. Doherty, J., *Proc. Roy. Soc. N. S. Wales*, 57, 157.
18. Amoretti, L., *Profumi Italiani*, 2, 251 (1924).
19. Pritzker, S., and Jungkunz, R., *Zeit. Unters. Lebensm.*, 55, 424 (1928).
20. *Ber. Schimmel & Co. Akt. Ges.*, 106 (1922).
21. Eder, R., and Schlumpf, E., *Pharm. Acta Helv.*, 3, 65 (1928) and 4, 65 (1929).
22. Pritzker, J., and Jungkunz, R., *Pharm. Acta Helv.*, 4, 15 (1929).
23. Isermann, S., *Am. Perfumer*, 5, 89 (1910).

Vetivert

The root of the vetivert, *Vetiveria zizanoides* Stapf, *V. muricata* Griseb, *Andropogon squarrosus* Hack., *A. muricata* Retz, *Anatherum muricatum* Beaus. (Gramineae), gives an essential oil with a warm, deep and powerful note, and with great tenacious power.

A certain number of extraction products have been prepared: alcoholic and benzene resinoids, which possess these same characteristics to an acute degree, and to which the perfume and soap industries are turning with increased attention.

The roots utilized in Europe for the manufacture of these products are usually from Java, and only rarely come from Réunion.

The benzene concrete yield varies between 3 and 4.8%. The resinoids are reddish-brown. They have not been described elsewhere.

ANIMAL RESINOIDS

The animal products that are currently being manufactured are: *ambergris*, *castoreum*, *civet* and *musk*. The manufacture of the resinoids answers the need of the consumer to have these products in a finished, concentrated and eventually alcohol-soluble form.

Ambergris

Ambergris is a pathological secretion from a common species of whale, *Physeter macrocephalus* L. (Cetaceae). The whale frequently expels the ambergris from its body, or liberates it after death, but the whale-hunt also results in an important quantity of this perfume material being found.

Taken right out of the body of the whale, or freshly expelled from it, the ambergris has a very deep black color, a nauseating odor and a soft consistency.

However, under the simultaneous exposure to sea-water and air, its color becomes lighter and lighter, first turning grayish, and then almost white. The odor becomes refined, somewhat suave and very agreeable, finally taking on the characteristic note associated with this product.

Ambergris that comes from a whale-hunt must be conserved for several years for favorable aging. Efforts have been made to accelerate this process.

For a description of ambergris, see references 1 to 6.

In perfumery, ambergris is generally used in the form of a tincture, and on rare occasions an infusion. The alcoholic solutions become more refined after a long storage in a fresh place. Before using the tincture, it is filtered.

Ultraviolet radiation, properly regulated and used in an inert atmosphere, will ameliorate the odor of the tinctures.

The concentration of the tinctures and the infusions gives ambergris resinoid, in a yield of 80 to 90%, based on the raw material.

J. Lund⁷ made an ethereal extraction of ambergris, separating 26% of insoluble products. The soluble fraction had these properties:

M.P.:	52°
n_D^{20} :	1.5028
A.V.:	24
I.V.:	78
Acetylation index:	25

The content of free acids was approximately 3%.

J. Schmidt-Nielsen and A. Flood⁸ prepared the alcoholic resinoid. The insoluble fraction represented 1.5 to 5% of the raw material. The characteristics of the dissolved fraction were as follows:

n_D^{20} :	1.5011
A.V.:	2
S.V.:	17.1
I.V.(Hübl):	125
E.V.ac.:	21.5
% C.:	83.03
% H.:	12.07
% N.:	0.05

Steam distillation of the ambergris gave them 0.65% of an oil with a characteristic odor.

Composition: The composition of ambergris is almost unknown. The major part is made up of ambreine, which has been studied by Pelletier and Caventou, then by Riban, and more recently by Makoto Suzuki.⁹ It seems to have the formula $C_{26}H_{44}O$. S. Sabetay and G. Sandulesco have isolated the ketonic fraction of ambergris, by means of the hydrazide reagent of Girard-Sandulesco.¹⁰ They have given no report on the proportion.

References

1. Zell, Th., *Kosmos, Handweiser Naturfreunde*, 14, 324 (1917).
2. Stull, D. C., *American Magazine*, 52 (1923).
3. Holmes, E. M., *Pharm. J.*, 112, 491 (1924).
4. Morrison, *Technological Museum, Sydney*, Bull. No. 15 (1929).
5. Redgrove, S. H., *Perfumery Essent. Oil Record*, 21, 205 (1930).
6. Sterling, A. C., *Chem. Drugg.*, 294 (1934).
7. Lund, J., *Apoth. Zt.*, 33, 27 (1918).
8. Schmidt-Nielsen, J., and Flood, A., *Chem. Zentr.*, (II), 4019 (1936).
9. Suzuki, M., *Japanese J. Med. Sci.*, 1, 31 (1925).
10. Sabetay, S., and Sandulesco, G., *Riechstoff Ind. Kosmetik*, 12, 161 (1937).

Castoreum

Castoreum is a secretion of an amphibious rodent, the beaver, *Castor fiber* L. (Castoridae). This animal is widely encountered, and trapped, in Canada and Siberia. The commercial castoreum comes from both these regions.

The scent glands are found between the anus and the genitals of both male and female beavers; these glands secrete an oily product which serves

as a coating to protect the animal's fur and tail, preventing them from becoming soaked in water.

The name *castoreum* is used to designate the glands that have been dried in the sun, and sometimes smoke-dried over burning wood. In its fresh state, the content of the pouch has a yellowish color; has the consistency of butter, and an odor that is fetid, sharp and aromatic. Once prepared, castoreum becomes dark brown and hard. Its appearance is then resinous, and it is lined with whitish partitions which are the remains of the recesses of the epithelium.

The Canadian pouches are piriform, almost always flattened out, and are from 5 to 13 cm. long and 3 to 5 cm. wide, weigh from 50 to 100 gs. each, and their surface is wrinkled and brownish black.

The Siberian pouches are ovoid and smooth. They are from 6 to 12 cm. long and have a circumference of 6 to 9 cm. Their content is earthy, and they are less valued than the Canadian product.

Method of extraction and characteristics of the extraction products: Alcoholic and benzene resinoids are prepared. Alcohol extracts 45 to 75% of the drug,¹ although A. Rosenthal has reported 70 to 80%.² The benzene resinoid is obtained in a yield of 18 to 25% (on the entire pouches).

A. St. Pfau³ identified the following compounds in the steam-volatile fraction: acetophenone, benzyl alcohol, benzoic acid, *p*-ethylphenol, and he assumed that the most important odoriferous principle was a lactone.

H. Walbaum and A. Rosenthal⁴ obtained 2.1% of a distillate, in which they also found acetophenone, benzyl alcohol, *p*-ethylphenol, and in addition *l*-borneol, *o*-creosol, and a methoxy-phenol (guaiacol or creosol). In the aqueous distillate, they detected ammonia, benzoic acid and traces of organic bases.

References

1. Naves, Y. R., *Parfums France*, 12, 126 (1934).
2. Rosenthal, A., *Riechstoff Ind. Kosmetik*, 30 (1928).
3. Pfau, A. St., *Perfumery Essent. Oil Record*, 18, 206 (1927).
4. Walbaum, H., and Rosenthal, A., *J. prakt. Chem.*, N.F. 117, 225 (1927).

Civet

The civet cat is a mammal of the Viverridae family, widely encountered in Africa, from Zambèze and the Sahara to Ethiopia, and in India, Malay, Indochina and Indonesia.

In Africa, the species found is the *Viverra civetta* (and var. *V. orientala*,

V. Portmani, etc.); in Asia, *V. zibetha* (India, Malay, Indochina), *V. tangalunga* (Indonesia), *V. megaspila* (Malay, Indochina, Sumatra), *V. civettina* (Malabar coast), and *V. malaccensis*, or Rasse (India, Ceylon, China, Indonesia).

The drug is secreted by an odoriferous apparatus that exists in both sexes. The major part of the civet imported into Europe comes from the civet cats raised in Ethiopia. It is obtained by a weekly draining of the gland. When fresh, the civet is pale yellow, almost limpid, but darkens on exposure to the air and takes on the consistency of a pomade.

The Indian civet comes to Europe in lead or steel containers; the Ethiopian arrives in the hollowed-out horns of the male zebu, which can contain from 800 to 2000 g. each.

On the subject of the analysis of civet, the reader is referred to the study of Bennett and Seaber.¹

Civet contains a large proportion of fatty materials, and frequently some foreign bodies. It is purified and the major part of the fats eliminated by extraction with various solvents; the most frequently prepared products are the alcoholic and the acetone resinoids.

Extraction and characteristics of the resinoids: For laboratory and analytical purposes, the extraction is made in a Soxhlet or a Kumagawa apparatus; industrially, however, it is accomplished at ordinary temperature, usually in the presence of anhydrous sodium sulfate, with agitation, so as to obtain a concentrated product whose quality is not affected by the initial content of humidity (which can be as high as 30%). The extracts are cooled to at least 15° and filtered, so as to increase the amount of fats eliminated.

Under these conditions, high-quality civet gives between 55 and 75% (usually 55 to 63%) of an acetone resinoid, and 45 to 65% (usually 45 to 56%) of an alcoholic resinoid. The former is the more fluid, has a deep brown-red color; and holds together faithfully the *ensemble* of odorous products in civet; the alcoholic resinoid is buttery, sometimes has the consistency of lard, and in its preparation there are some losses of odorous products.

These resinoids have the following properties:

Acetone resinoid

M. P. (Ubbelohde)	19° to 25°
A.V.	88 to 112 on rare occasions up to 130
E.V.	25 to 35 on rare occasions up to 42
S.V.	118 to 144 on rare occasions up to 152
I.V. (Hübl)	55 to 66 on rare occasions up to 72

. *Alcoholic resinoid*

M. P. (Ubbelohde)	20° to 34° on rare occasions up to 39°
A.V.	110 to 150 on rare occasions up to 156
E.V.	24 to 40 on rare occasions from 19 to 57
S.V.	148 to 176 on rare occasions up to 192
I.V. (Hübl)	64 to 88 on rare occasions up to 94

The determination of the yield and the examination of the product obtained by steam distillation of the volatile fractions (*see* p. 148) seem to furnish precious information on the quality of commercial civets.

Composition: The composition of civet was studied first by Boutron Charlard,² and then by Schutzensberger, who found olein and margarine in the fatty part.

H. Walbaum³ isolated 0.1% of skatole from African civet. Schimmel and Co.⁴ at first believed that civet contained muscone, but this was refuted by L. Sack,⁵ who isolated and characterized civetone, and Ruzicka⁶ extracted this ketone by distillation of a previously saponified civet. According to Ruzicka, the properties of civetone are:

M.P.:	31°
B.P. _a :	158°-160°
B.P. _{o.s} :	145°
d ₂₀ ²⁰ :	0.9135
n _D ²⁰ :	1.4820

and he established its chemical structure as that of a macrocyclic ketone:

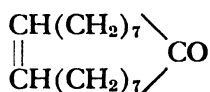

Civetone is found in association with the corresponding alcohol, civetol, which is convertible into civetone by chromic oxidation.⁷

References

1. Bennett, C. T., and Seaber, W. M., *Perfumery Essent. Oil Record*, 19, 14 (1929).
2. Boutron-Charlard, *J. pharm. Chim.*, 10, 537 (1843).
3. Walbaum, H., *Berliner Berichte der Chemie*, 33, 1903 (1900).
4. German patent 198,660, cited by Sack.
5. Sack, L., *Chem. Zt.*, 39, 538 (1915).
6. Ruzicka L., *Helv. Chim. Acta*, 9, 238 (1926).
7. Naef, S. A., et Cie., German Patent 482,762 (1927).

Musk

Musk is produced by the musk deer, *Moschus moschiferus* L. (Moschidae), a small wild ruminant about the size of a goat. The musk deer

lives in central Asia, in Chinese Turkestan, Tibet, Altai, northern India and China, in the mountains as high as the clouds. The male adult has an internal pouch, 6 to 7 cm. long, 3 to 5 cm. wide, and 2 to 3 cm. thick, situated between the navel and the penis. Among the young deer, the pouch is empty and contracted, but that of an adult contains 15 to 20 gs. of musk, which diminishes to 8 or 9 gs. in the old animals. Fresh musk has a honey-like consistency, brownish-red color, and hardens rapidly when the pouch is cut, taking on a blackish-brown color. The commercial pouches, known as musk pods, are sold under several names, Tonquin, Peau Bleue (blue skin), Yunnan or Sawko, Cabardin, Nepal, Assam.¹

Musk grains are obtained by emptying the pouches. When the musk dries, it assumes the form of irregular grains; if the pods are humid, the grains become black. High quality musks are soft to the touch, have a blackish-brown color, and a sour and astringent taste. The good pods should give about 70% of their weight in musk grains, while the mediocre pods give only 40 to 60%.

Extraction: From musk grains, tinctures are made, using 96% alcohol; on rare occasions, infusions are prepared. These products improve as they age. Concentration of the tinctures and infusions gives musk resinoid, in a yield of 10 to 12% of the pods.

Composition: The odorous product in musk was isolated by H. Walbaum² in 1906. Known as muscone, it was identified by L. Ruzicka as being 3-methylcyclopentadecanone.

References

1. Lueders, G., *Proceedings of the Association of Perfumers in Am. Perfumer*, 42 (1909).
Chenet, *Bulletin de la Chambre de Commerce Française en Chine*, June 2, 1917.
Schmuck, L., *Parfumerie moderne*, 180 (1919); see also *Parfums France*, 2, 44 (1924); 4, 393 (1926).
2. Walbaum, H., *J. prakt. Chem.*, N.F. 73, 488 (1906); *Ber. Schimmel & Co. Akt. Ges.*, 96 (Oct. 1906).
3. Ruzicka, L., *Helv. Chim. Acta*, 9, 715 and 1008 (1926).

INDEX OF LATIN BOTANICAL NAMES

- A**
Abelmoschus moschatus, 262
Acacia Cavenia, 23, 165
Acacia dealbata, 219, 220
Acacia farnesiana, 23, 165, 166
Acacia floribunda, 219, 220
Acacia indica farnesiana, 23
Acacia retinoides, 219
Acorus calamus, 163
Aglaiia odorata, 289
Alectoria spec., 275
Aleurites triloba, 29
Alpina officinarum, 164
Amomum angustifolium, 29
Amomum zingiber, 287
Amygdales communis, 28
Ananas sativus, 182
Ananassa sativa, 182
Anatherum muricatum, 294
Andropogon muricata, 294
Andropogon Schoenanthus, 20
Andropogon squarrosus, 294
Angelica levisticum, 274
Angraecum fragrans, 230
Anthemis nobilis, 163
Apium graveolens, 162, 163
Aplotaxis auriculata, 269
Aplotaxis lappa, 269
Archangelica officinalis, 163
Arnica montana, 163
Artabotrys odoratissima, 258
Asarum canadense, 164
Asarum Europaeum, 163
Asparagus Sprengeri, 169
Aspidium Filix-mas, 164
Aucklandia costus, 269
B
Balsamodendron erythreum var. *Glabrescens*, 284
Barosma serratifolium, 163
Baryosma tongo, 271
Boronia megastigma, 169
Boswellia Bhan Djiana, 285
Boswellia carterii, 285
Boswellia frereana, 285
Buddleia variabilis, 171
C
Calendula officinalis, 216
Calendula officinalis var. *bortensis*, 216
Calycanthus praecox, 175
Camellia thea, 288
Cananga odorata, 258
Canarium album, 282
Canarium commune, 282
Canarium luzonicum, 282
Carlina acaulis, 163
Caryophyllus aromaticus, 287
Cedrus Atlantica, 163
Cedrus deodora, 163
Chimonanthus fragrans, 175
Chiranthus Cheiri, 267
Chiranthus fruticosus, 267
Chloranthus inconspicuus, 288
Cinnamomum Zeylanicum, 163
Cistus cyprius, 206
Cistus ladaniferus, 206
Cistus monspeliensis, 206
Cistus polymorphus, 206
Cistus salviaefolius, 206
Cistus salvifolius, 206
Citrus aurantium, 182
Citrus aurantium subsp. *amara*, 21, 162, 221
Citrus bigaradia (see *Citrus aurantium* subsp. *amara*)
Citrus Sinensis var. *Djaloniis*, 243
Coffea arabica, 269
Commiphora chironium, 284
Commiphora kataf, 284
Commiphora myrrha, 284
Convallaria Linnaei, 213
Convallaria majalis, 213
Coriandrum sativum, 163
Coumarona odorata, 271
Crocus officinalis, 286
Crocus sativus, 286
Croton eluteria, 163
Cuminum cyminum, 163
Cupressus sempervirens, 163
Curcuma longa, 163
Curcuma Zedoaria, 164
Cusporia trifoliata, 163
Cyclamen clusii, 179
Cyclamen europaeum, 179, 180
D
Daucus Carota, 163
Dianthus caryophyllus, 171
Diplotoenia cactrydifolia, 284
Dipterix odorata, 271
Dipterix oppositifolia, 271
Dipterix pteropus, 271
Dorema ammoniacum, 163
Dracocephalum moldavici, 250

- Ebulus humile**, 180
Elletaria cardamomum, 29
Eugenia caryophyllota, 287
Euryangium sumbul, 288
Evernia furfuracea, 274, 275, 278
Evernia prunastri, 274, 275, 276, 278, 279
Ferula erubescens, 283
Ferula foetida, 163
Ferula galbaniflora, 283
Ferula gummosa, 283
Ferula rubricaulis, 283
Ferula shair, 283
Ferula spec., 284
Ferula sumbul, 288
Foenumgræcum officinale, 272
Fokiena Hodginsii, 164
Follicigera graveolens, 272
Fragaria eliator, 182
Galipea officinalis, 163
Gardenia Brasiliensis, 184
Gardenia calyculata, 184
Gardenia citriodora, 184
Gardenia deroniana, 184
Gardenia florida, 183, 288
Gardenia grandiflora, 184
Gardenia jasminoïde, 183
Genista tinctoria, 171
Geranium macrorrhizum, 260
Glycyrrhiza glabra, 164
Guajacum officinale, 164
Hedychium flavum, 184
Helichrysum angustifolium, 180
Helichrysum arenarium, 180
Helichrysum italicum, 180
Helichrysum stoechas, 24, 180, 181
Heliotropum peruvianum, 186
Herculeum spec., 284
Hibiscus Abelmoschus, 262
Humulus lupulus, 273
Hyacinthus indicus, 22
Hyacinthus non scriptus, 187
Hyacinthus orientalis, 186
Ilex paraguayensis, 164
Inula Helenium, 164
Iris florentina, 281
Iris germanica, 281
Iris pallida, 281
Jambosa caryophyllus, 287
Jasminum abyssinicum, 188, 196
Jasminum aureum, 188
Jasminum auriculatum, 188
Jasminum bogosense, 188, 196
Jasminum Catalonicum, 22
Jasminum floribundum, 188, 196
Jasminum grandiflorum, 22, 188, 196
Jasminum hispanicum, 188
Jasminum italonicum, 188
Jasminum mauritianum, 188, 196
Jasminum odoratissimum, 199, 200
Jasminum officinale, 188
Jasminum Sambac, 22, 188, 196, 200, 289
Juglans regia, 28
Juniperus communis, 164
Laserpitium spec., 284
Laurus nobilis, 28
Lavandula officinalis sub-spec. *Delphinensis*, 208
Lavandula officinalis sub-spec. *fragrans*, 208
Lawsonia alba, 272
Lawsonia inermis, 20, 272
Leptactina densiflora, 205
Leptactina manii, 205
Leptactina senegambica, 204
Levisticum officinale, 274
Liatris odoratissima, 270
Liatris scariosa, 270
Ligustrum vulgare, 232
Lilium candidum, 213
Lippia citriodora, 249
Liquidambar imberbe, 265
Liquidambar orientale, 265
Lonicera caprifolium, 186
Lonicera etrusca, 186
Lonicera gigantea, 186
Lupinus luteus, 215
Magnolia grandiflora, 215
Melilotus arvensis, 270
Melilotus bungeana, 270
Melilotus officinalis, 270
Michelia aurantiaca, 174
Michelia Champaca, 174
Michelia fuscata, 174
Michelia longifolia, 174
Michelia montana, 174
Michelia nigalirica, 174
Michelia rufinervis, 174
Mogorium sambac, 200
Moringa pterigosperma, 29
Musa paradisiaca, 182
Musa sapientum, 182
Myristica aromatica, 287
Myristica fragrans, 287
Myristica officinalis, 287
Myrobalanus bellerica, 29
Myrobalanus chebula, 29
Myroxylon balsamum var. α -*genuinum*, 264
Myroxylon balsamum var. β -*Pereira*, 263
Narcissus jonquilla, 201
Narcissus multiflorus, 203
Narcissus odoratus, 201
Narcissus poeticus, 201, 203
Narcissus tazetta, 201, 203
Nardostachys jatamansi, 288
Nicotiana rustica, 290
Nicotiana spec., 290
Nyctanthes Arbor Tristis, 200
Nyctanthes sambac, 22, 200
Olea europea, 30
Olea fragrans, 289

- Opopanax chironium*, 284
Orchis cariophora, 230
Orchis fragrans, 230
Orchis fusca, 230
Orchis galeata, 230
Orchis militaris, 230
Orchis odoratissima, 230
Orchis purpurea, 230
Orchis simia, 230
P
Pandanus odoratissimus, 230
Parmelia furfuracea (sec *Evernia furfuracea*)
Parmelia spec., 275
Persica vulgaris, 182
Petasites albus, 186
Petasites fragrans, 186
Peucedanum galbaniflorum, 283
Peucedanum Osthrutium, 164
Peucedanum rubricaulis, 283
Philadelphus "Avalanche," 244
Philadelphus coronarius, 243, 244
Philadelphus coronarius forma *Keteleira*, 244
Philadelphus Falkoneri, 244
Philadelphus floribundus, 244
Philadelphus gordonianus, 244
Philadelphus inodorus, 244
Philadelphus latifolius, 244
Philadelphus Lemoinei, 244
Philadelphus microphyllus, 244
Philadelphus "Mont Blanc," 244
Philadelphus pubescens, 244
Piper nigrum, 288
Pistacia Lentiscus, 216, 283
Pistacia Lentiscus var. *Chia*, 216, 283
Platanus occidentalis, 265
Plumiera acutifolia, 231
Plumiera alba, 231
Pogostemon cablin, 282
Pogostemon heymanus, 282
Pogostemon patchouly, 282
Pogostemon suavis, 282
Polyanthes tuberosa, 22, 246
Populus balsamifera, 231
Prunus Armeniaca, 183
Prunus avium, 182
Prunus domestica, 182
Prunus persica, 182
Pyrus communis, 183
Pyrus Malus, 182
R
Ramalina calicaris, 275
Ramalina farinacea, 275
Ramalina fraxinae, 275
Ramalina pollinaria, 275
Reseda odorata var. *gigantea*, 217
Reseda odorata var. *grandiflora*, 217
Reseda odorata var. *pyramidalis*, 217
Rhododendron ferrugineum, 233
Ribes grossularia, 183
Ribes nigrum, 178, 183
Ribes rubrum, 183
Ricinus communis, 28
Robinia pseudacacia, 233
Rosa alba, 23, 234
Rosa canina, 23
Rosa centifolia, 23, 234, 237, 238
Rosa damascena, 23, 234, 235, 237, 238
Rosa damascena var. *trigintipetala*, 234
Rosa gallica, 23
Rosmarinus officinalis, 242
Rubus idaeus, 182
Rue officinale, 243
Ruta graveolens, 243
S
Salvia rosmarinus, 242
Salvia sclarea, 177
Sambucus Ebulus, 180
Sambucus nigra, 180
Sambucus vulgaris, 180
Santalum album, 287
Saussurea lappa, 269
Scilla nutans, 187
Sesamum indicum, 27
Spartium junceum, 170
Sticta pulmonacea, 275
Styrax benzoides, 266
Styrax benzoin, 266
Styrax macrothyrsus, 266
Styrax Sumatrana, 266
Styrax Tonkinense, 266
Sumbul Ekleti, 288
Sumbul Hindi, 288
Sumbul Kumi, 288
Syringa affinis Giralddii, 212
Syringa Julianae, 212
Syringa persica, 212
Syringa pinnatifolia, 212
Syringa Sweginzowii, 212
Syringa tomentella, 212
Syringa vulgaris, 212
T
Tagetes glandulifera, 245
Tagetes minuta, 245
Tagetes patula, 245
Thea bohea, 288
Thea sinensis, 288
Thea sinensis var. *Assamica*, 289
Thea stricta, 288
Thea viridis, 288
Theobroma cacao, 268
Thymus hyemalis, 250
Thymus vulgaris, 245
Tilia argentea, 214
Tilia cordata, 214
Tilia grandifolia, 214
Tilia parvifolia, 214
Tilia platyphyllos, 214
Tilia tomentosa, 214
Tilia ulmifolia, 214
Trifolium melilotus officinale, 270
Trigonella foenum graecum, 272
Trilisia odoratissima, 270
Tuberosa flore Hyacinthi orientalis, 22
Tussilago fragrans, 186

- U***nona odorata*, 258
Unona odoratissima, 258
Usnea barbata, 275
Usnea ceratina, 275, 278
Uvaria axillaris, 258
Uvaria cananga, 258
Uvaria odorata, 258

V*accinium myrtillus*, 183
Valeriana celtica, 288
Valeriana spica, 288

Vanilla planifolia, 291
Vanilla planifolia var. *Au-*
gusta, 291
Vanilla pompona, 291
Vanilla simarona, 291
Vanilla sylvestris, 291
Vanilla tiarei, 291
Verbena officinalis, 250
Verbena triphylla, 249
Vetiveria zizanooides, 294
Viola odorata, 24, 251

Viola rossica, 258
Vitis vinifera, 182

W*istaria macrostachya*, 258
Wistaria Sinensis, 257

X*anthorrhoea hastilis*, 163
Xanthorrhoea quadrangulata, 163

Z*ingiber officinale*, 287

AUTHOR INDEX

- A**
Aboul Quassim, 7
Acosta, Christophe d', 10, 29
Actuarius, 6
Adams, R. (Brodi, W. R. and), 129
Adrian, 45, 49, 52, 54
Aegynète, Paul, 31
Aesop, 31
Aetius, 6, 33, 42
Ahrens, 266
Allary, 53
Allen (Radcliffe and), 139, 140
Alpin, Prosper, 10, 22, 23, 28
Ambrosio, d', 139, 141
Amic, Louis, 54
Amoretti, L., 293
Andès, 164
Ardène, Le P. d', 22
Armstrong, A. D., 293
Arnauld de Villeneuve, 8, 25
Asahina, Y., 278
Astruc, J., 17
Aurillac, Gerbert d', 8
Avicenna, 7, 20, 31
- B**
Bacon, R. F., 174, 175, 231, 259
Bacon, Roger, 2
Bainbridge and Davies, 268
Baldinus, 15
Banerjee, S., 196
Barbe, Simon, 13, 18, 22, 23, 25, 27, 30, 32, 39
Barbier and Bouveault, 240
Bardt, A. (Dorochevski, A. and), 132
Barrelier, 22
Barry, 54
Basile, Valentin, 48
Bataille, Ed., 84, 90, 134
Bauderon, Brice, 14, 18, 26, 32, 35, 36
Baudoin, 33
Bauhin, 22
Baumé, Antoine, 15, 24, 25, 35, 37, 39, 45, 47, 48, 50, 51, 52
Bayle, F. M., 293
Beguin, 14, 34, 42, 44, 49
Belon, Pierre, 10, 21
Bénédict, 132
Bénédite, G., 15
Bennett, C. T., and Seaber, W. M., 298
Bensemann, 144
Berendes, J., 16
Berthelot, M. P. E., 16
Bertheraud, 230
Bertram, J., and Walbaum, H., 219
Bertrand, C. F., 19, 33, 39, 40, 41, 51
Besson, Jacques, 36
Birdwood and Fluckiger, 285
Biringoccio, 46
Bléigny, de, 14, 41
Bleibtreu, 271
Blois (Constantin and), 293
Blount, B. K., Chibnall, A. C., and Mangoni, H. A., 158
Bodenbender (Zwenger and), 271
Böhm, 90
Bonastre, 284
Bondon, 85, 86, 88, 91, 93, 94, 95
Bonin (Gérard and), 289
Bonnière (Lemettais and), 53
Bontoux (Lewkowsch-), 158
Bonvalot, G., 17
Börsig, 88
Bougault and Cattelain, 139
Boulduc, 50
Bourquelot, 62
Boutron-Charlard, 299
Boutron-Charlard (Robiquet and), 52
Bouveault (Barbier and), 240
Boyle, Robert, 47, 48
Boys, du (*see* Sylvius)
Brandt, 243

- Brandt (Gilg), 164
 Braun, K., 263
 Breitschneider, 10
 Brodi, W. R., and Adams, R., 129
 Brooks, B. T., 174
 Browning, E., 103
 Bruère, 149
 Brunfels, 11
 Brunschwig, 11, 37, 46
 Buchner, 52
 Buhse, 283
 Burke, E. (Traphagen, F. W. and), 183
 Busse, E., 265
 Busse (Tiemann and), 293

C
 Cadet de Gassicourt, 271
 Caesalpin, 10
 Calone, 223
 Campbell, D. E. H., 16
 Campbell Thomson (*see* Thomson)
 Camus, G., 274
 Camus, Le, 41
 Canal, H. (Goris, A. and), 231, 232
 Cantamessa, I. (Rovesti, P. and), 211
 Cardan, 35
 Cardot, J., 268
 Cartier, 48
 Cartwright Farmiloc (*see* Farmiloc)
 Catrelain (Bougault and), 139
 Caventou (Pelletier and), 296
 Celnart, Mme., 20, 41
 Cerighelli, R., 113, 198
 Chalot, C., 293
 Champier, Symphorien, 10
 Chaptal, 30, 31, 47
 Charas, 14, 32, 34, 44, 47, 48, 50
 Chardin and Massignon, 114
 Charlard, Boutron- (*see* Boutron-Char-
 lard)
 Chastin, J., 17
 Chattaway and Helen, 140
 Chenet, 300
 Chenevier, 53
 Cherbuliez, 149
 Chesnut, V. K. (Power, F. B. and), 182,
 183
 Chevalier, A., 204, 243
 Chevreul, 45
 Chiandi, 53
 Chibnall, A. C., 139
 Chibnall, A. C. (Blount, B. K., —, and
 Mangoni, H. A.), 158
 Chibnall, A. C., Piper, S. H., Pollard, A.,
 Williams, E. F., and Sahaj, P. N., 139,
 141, 158, 245
 Chibnall, A. C., Williams, E. F., Latner,
 A. L., and Piper, S. H., 158
 Chilow, N., and Nekrassow, B., 128
 Chiris, Etablissements Antoine, 111, 113,
 259
 Chiris, Léon, 54
 Choulant, J. L., 16
 Citrus Experiment Station, 62
 Claude and Norton, 75
 Claude (Truchon and), 183
 Clausen, 271
 Cloez, 53
 Clusius, 27
 Colin, E. (Villiers, A., — and Fayolle,
 M.), 289
 Collin (Planchon and), 164
 Comes, O., 290
 Commaille, 53
 Constantin and Blois, 293
 Coppens, A. (Hoejenbos, L. and), 187
 Cordemoy, J. de, 285
 Cordier, P., 16
 Cordus, 11
 Cordus, Valérius, 49
 Cortese, Isabella, 10, 13, 33, 43
 Couvreur, S., 17
 Crémone, Gérard de, 8
 Criton, 5
 Crollius, 14
 Crouzel, 230
 Cunningham, C., 291
 Curd, H., 278
 Czapek, 164

D
 D'Acosta, Christophe (*see* Acosta)
 Dalechamps, 10
 d'Ambrosio (*see* Ambrosio d')
 Daquin, 14, 41
 Daremberg, C. V., 16
 Darmstaedter, L., 16
 d'Aurillac, Gerbert (*see* Aurillac, Gerbert
 d')
 Davies (Bainbridge and), 268
 de Blégnay (*see* Blégnay)
 Defaud (Garnier and), 269
 de Garlande, Jean (*see* Garlande)

- Deiss, 53
 Dejean, 15, 25, 39
 Delachanal, 53
 de la Garaye (*see* Garaye)
 Delaporte, L. J., 16
 Deleboe, 43
 de l'Ecluse (*see* Ecluse)
 Demachy, 49, 51
 Descartes, 2
 Desmoulières (Portes and), 183
 Dezani, 284
 Diehl, C., 16, 17
 Dietrich, K., 164, 266
 Dimmel, H., 103
 Dioscorides, 5, 18, 20, 28, 29, 33, 35, 42
 Doherty, J., 293
 Dombraïn and Trumper, 53
 Dorochevski, A., and Bardt, A., 132
 Dorveaux, Dr., 26
 du Boys (*see* Sylvius)
 Dujardin, J., 16, 49
 Dumichen, 15
 Dumont, G., 91
 Durrans, T. H., 73
 Dussaud, R., 16
 Dymock, Warden and Horper, 231
- E**
 Eberlein (Rothenbach and), 183
 Ecluse, Charles de l', 10, 22
 Eder, R., and Schlumpf, E., 293
 Egine, Paul d', 33
 Ehrwein, R. (Klobb, T., Garnier, J., and), 214
 Ellmer, 212, 235
 Elze, F., 169, 179, 183, 198, 199, 202, 223, 226, 233, 239, 248, 249, 264, 265
 Emerson (Prescott, —, and Peakes), 269
 Emerson (Prescott, —, Woodward and Heggie), 269
 Engels, P., 229
 Engler-Gilg, 161
 Engler-Prantl, 164, 168, 270
 Enklaar, C. J. (Spalteholtz and), 187
 Erdmann, 111, 199
 Erhardt, C., 235
- F**
 Fabricius, 15
 Fagon, 15
 Fahrenheit, 48
 Fargeaud, 140
 Fargeon, 15, 39
- Farmiloe, Cartwright, 244
 Fauth, 90
 Favrot, 52, 213
 Fayolle, M. (Villiers, A., Colin, E., and), 289
 Feinberg, C., Hermann, J., Roeglesperger, L., and Zellner, J., 139
 Feld, 101
 Fellenberg, T. von, 292
 Ferguson, J., 16
 Ferrand, 52
 Ferrari, 26
 Fethke, N. (Macheboeuf, A. and), 83
 Figuier, L., 17
 Filaretto, 10, 43
 Fioravanti, 10
 Fischer, E. and Fischer, H. L., 278
 Fischer, H. L. (Fischer, E. and), 278
 Fisher, Jesse, 52
 Fleurent, E., 272
 Fleury, F. (Lehmann, K. B. and), 73
 Flood, A. (Schmidt-Nielsen, J. and), 296
 Fluckiger (Birdwood and), 285
 Fluckiger, F. A., and Hanbury, D., 16
 Folsch, M., 234
 Fondard (Oddo and), 63
 Fontana, 271
 Forster, 82
 Fourcroy, 31, 45
 Franklin, A., 17
 Frésénius and Schulze, 140
 Freundlich, H., 75, 132
 Frey, C. N. (Johnston, W. R. and), 269
 Friedeburg, 53
 Fritzsck, 103, 135
- G**
 Galen, 31
 Galesio, 21
 Garaye, de la, 50
 Garcia da Orta (*see* Orta, Garcia da)
 Garlande, Jean de, 24
 Garnier, Ch., 55, 56, 83, 85, 86, 87, 88, 91, 93, 94, 95, 100, 122, 133, 184, 235, 258
 Garnier, R., 184, 200
 Garnier and Defaud, 259
 Garnier, J. (Klobb, T., —, and Ehrwein, R.), 214
 Gautier, E. F., 17
 Gay-Lussac, 48
 Geber, 7, 37, 38
 Geoffroy, 15, 47, 50

- Gérard and Bonin, 289
 Gérardin, 274
 Gerbert, d'Aurillac (*see* Aurillac, Gerbert d')
 Gerhardt, Otto, 180
 Gessner, Conrad, 2, 10, 11, 18, 35, 36, 37, 39, 42, 43, 46, 48
 Gildemeister and Hoffmann, 164, 223, 282, 284
 Gilg-Brandt, 164
 Girard and Sandulesco, 99, 296
 Glaser, 15, 47
 Glauber, 47
 Glenk, J., 186
 Glichitch, L. S., 139
 Glichitch, L. S., and Igolen, Mme. M. G., 179
 Glichitch, L. S., and Naves, Y. R., 239, 240, 258, 259
 Gmelin, J. F., 16, 45
 Gnadinger, G. B., 292, 293
 Gobineau, J. A. de, 16
 Goble, 230
 Gomara, Lopez de, 26
 Gonnet (Jablin and), 183
 Goris, 292
 Goris, A., and Canal, H., 231, 232
 Goris (Perrot and), 62
 Gorokhoff, E., 233
 Grand, L. (Pelet, L. and), 130
 Grasset-Morel, L., 17
 Gray, A., 282
 Grousset, R., 16
 Guenther, E. S., 177, 184, 192, 207, 227, 258, 259
 Guérin, 140
 Guibourt, 29
 Guillemette, 271
 Gurwitsch, 129
H
 Haarmann and Reimer, 168, 234
 Haensel, 271
 Hall, A. J., and Wilson, C. P., 183
 Halle, W., and Pibram, E., 290
 Hanausek, T. F., 287
 Hanbury, D. (Fluckiger, F. A. and), 16
 Hart, M. C. (Heyl, F. W. and), 288
 Hartwich, C., 272
 Heggie (Prescott, Emerson, Woodward and), 269
 Heide, 132
 Heldreich, 286
 Helen (Chattaway and), 140
 Henry, 54
 Herberger, B., 213
 Hermann, J. (Feinberg, C., —, Roeglesperger, L., and Zellner, J.), 139
 Herodotus, 5, 23, 27, 28
 Hesse, A., 111, 112, 113, 142, 194, 197, 198, 199, 228, 246, 247, 248, 249, 278
 Hesse, A., and Müller, F., 121, 197
 Hesse, A., and Zeitschel, O., 223, 226, 227, 228, 229, 230, 248
 Heyd, W., 17
 Heyl, F. W., and Hart, M. C., 288
 Hcync, 33, 266
 Hildebrandt, 90
 Hilpert, 131
 Hippocrates, 5
 Hirschohn, E., 283
 Hirzel, 53
 Hoefler, J. C., 16
 Hoejenbos, L., and Coppens, A., 187
 Hoff, H. E. (Nahum, L. H. and), 103
 Hoffmann, 88, 270
 Hoffmann (Gildemeister and), 164, 223, 282, 284
 Holmes, E. M., 231, 273, 285, 286, 296
 Horace, 5
 Horper (Dymock, Warden and), 231
 Houdard, M. S., 16
 Houel, Nicolas, 2
 Hüffel, E., 132
 Huet, P. D., 17
 Hughes, J. A., 90
 Hughes (Lampitt and), 183
 Hunrich, 53
 Hurrel, 97
I.
 I. G. Farbenindustrie, 115
 Ibn Batoutah, 17
 Ibn el Awam, 23
 Ibn el Beïthar, 21, 23, 33
 Igolen, G., 142, 186, 208, 212, 214, 215, 216, 244, 245, 270, 271, 272, 284, 289
 Igolen, G., and Igolen, M. G., 142
 Igolen, M. G. (Igolen, G. and), 142
 Igolen, Mme. M. G., 232
 Igolen, Mme. M. G. (Glichitch, L. S. and), 179
 Internationale Nahrungs- u. Genussmittel A. G., 269

- Irvine (Richardson, Lundy and), 53
 Isermann, S., 293
 Ito, K. (Yamamoto, R. and), 290
- J**
 Jablin and Gonnet, 183
 Janot, M. M., 178
 Janot, M. M. (Ruzicka, L. and), 178
 Jeancard, P., and Satie, C., 111, 240
 Jermstad, A. (Volmar, Y. and), 177
 Johnston, W. R., and Frey, C. N., 269
 Jones, F. W., 159
 Jordan, O., 73
 Jungkunz, R. (Pritzker, J. and), 293
 Juvenal, 5
- K**
 Kaufmann, A., and Kjelsberg, F., 212
 Keegan, 139
 Kern, 53
 Kerschbaum, 213, 214, 219
 Kessel, 141
 Kestzler, F. (Spaeth, E. and), 256
 Khunrath, 47
 Kjelsberg, F. (Kaufmann, A. and), 212
 Kleber, C., 183, 212
 Klobb, T., Garnier, J., and Ehrwein, R., 214
 Köller, G., 278
 Korpaczy, S., 159
 Krczil, F., 77, 132
 Kreis, 155
 Kronfeld, 287
 Kuhn, R., and Wendt, G., 287
 Kuhn, R., Winterstein and Lederer, 245
 Kuhn, R., and Winterstein, 286
 Kumagawa, 82, 83, 298
 Kummert, E., 257
 Kunckel, 47
- L**
 Labaune, L., 180
 Lampitt and Hughes, 183
 Lamy-Torrilhon, 88
 Latner, A. L. (Chibnall, A. C., Williams, E. F., —, and Piper, S. H.), 158
 Laubenheimer, H., 266
 Lautier Fils, 63, 103
 Lea, C. H., 159
 Le Camus, 41
 Leclerc, L., 16
 Lecoq (Leprince and), 289
 Lederer (Kuhn, Winterstein and), 245
- Le Febvre, Nicolas, 14, 32, 43, 47, 48, 49
 Le Fournier, 10
 Lehmann, K. B., and Fleury, F., 73
 Lémery, 14, 19, 24, 30, 39, 45, 47
 Lémery, Louis (Junior), 50
 Lemettais and Bonnière, 53
 Le P. d'Ardène (*see* Ardène)
 Leprince and Lecoq, 289
 Lespinasse, R., 17
 Lewkowitsch-Bontoux, 158
 Libavius, 34, 46, 47
 Liébaut, 13, 18, 32, 37, 39, 46, 49
 Lindet, 103
 Lobel, Matthias de, 29
 Lojander, 230
 Loret, V., 16
 Louveau, G., 121, 139, 140, 162, 175, 192, 193, 196, 217, 243
 Lucretius, 30
 Lueders, G., 300
 Luigini, 10
 Lulle, Raymond, 8, 46
 Lund, J., 295
 Lundy (Richardson, —, and Irvine), 53
- M**
 Macer Floridus, 24
 Macheboeuf, A., and Fethke, N., 83
 Macquart, 53
 Macquer, 15, 18, 42, 44, 50
 Malepeyre (Pradal and), 33, 41
 Malet, A., 16
 Mane, G. (Sabetay, Mme. H. S. and), 172, 174
 Mangoni, H. A. (Blount, B. K., Chibnall, A. C. and), 158
 Marinello, 10
 Marot de la Garaye (*see* Garaye)
 Martial, 5, 34
 Massa, 17, 26
 Massera, V., and Monti, G., 237, 238
 Massignon, 53, 54, 83
 Massignon (Chardin and), 114
 Masson, H., 208
 Masson-Oursel, P., 16
 Matthiole, 10, 28
 Mazure (Viteau and), 53
 Mazuyer, G., 166, 249, 281
 Mercuet, 53
 Merrill, E. D., 282
 Merz, J., 83
 Mesuë, 7, 20, 24, 27, 28, 33, 38, 43

- Meunier, J., 114
 Meunier, M., 17
 Meyer, A., 287
 Micard, Etienne, 17
 Miller, W. v., 266
 Millon, 52, 53
 Moeller, 164, 287
 Molisch, 286
 Monard, Nicolas, 10, 18, 26, 28
 Monnery, 140
 Montaigne, 10
 Monti, G. (Massera, V. and), 237, 238
 Moricet, 140
 Morrison, 296
 Mulder, G. J., 288
 Muller, A., 211
 Müller, F., 268
 Müller, F. (Hesse, A. and), 121, 197
 Musschenbroeck, 48

Nahum, L. H., and Hoff, H. E., 103
 Naudin, 53, 54, 122
 Naudin and Schneider, 53
 Naves, Y. R., 56, 74, 103, 104, 111, 113, 134, 135, 139, 145, 148, 159, 171, 172, 184, 199, 202, 214, 227, 228, 229, 237, 238, 239, 242, 260, 261, 263, 272, 278, 280, 284, 285, 297
 Naves, Y. R. (Glichitch, L. S. and), 239, 240, 258, 259
 Naves, Y. R., and Sabetay, S., 248
 Naves, Y. R., Sabetay, S., and Palfray, L., 141, 142, 165, 168, 169, 177, 181, 187, 195, 197, 204, 205, 207, 211, 218, 220, 223, 229, 239, 241, 249, 250, 256, 259, 278, 281
 Necker 14
 Nekrassow, B. (Chilow, N. and), 128
 Nelson, E. K., 183
 Nicholas of Alexandria, 6
 Nicolas, 24, 33, 42
 Nicolas Praepositus, 7, 21
 Niebuhr, C., 17
 Nivière, J., 199
 Nollet, Abbé, 48
 Norton (Claude and), 75

Obach, 53
 Oddo and Fondard, 63
 Ono, M. (Takei, S., Sakato, Y. and), 290
 Oribasius, 6

 Orta, Garcia da, 10, 29
 Overton, 62
 Ovid, 33

Palfray, L. (Naves, Y. R., Sabetay, S. and), 141, 142, 165, 168, 169, 177, 181, 187, 195, 197, 204, 205, 207, 211, 218, 220, 223, 229, 239, 241, 249, 250, 256, 259, 278, 281
 Palfray, L. (Sabetay, S., —, and Traubaud, L.), 205
 Palissy, Bernard, 2, 9
 Papon, 23, 27
 Paracelsus, 2, 8, 25
 Parmentier, 45
 Parone, E., 184
 Paschkis, 230
 Passy, Jacques, 19, 111
 Patrick, 76
 Patti, L., 77, 103
 Paul d'Egine (*see* Egine)
 Peakes (Prescott, Emerson and), 269
 Pelet, L., and Grand, L., 130
 Pelletier and Caventou, 296
 Penfold, A. R., 169, 170
 Percy, 96
 Pères Missionnaires, 56
 Perrot and Goris, 62
 Pfau, A. St., 212, 272, 278, 279, 280, 297
 Pfau, A. St., and Plattner, P., 261
 Pfeiffer (Ruzicka and), 198
 Philiatrus, 35
 Pibram, E. (Halle, W. and), 290
 Pierlot, G., 286
 Piesse, 56
 Piper, S. H. (Chibnall, A. C., —, Pollard, A., Williams, E. F. and Sahai, P. N.), 139, 141, 158, 245
 Piper, S. H. (Chibnall, A. C., Williams, E. F., Latner, A. L. and), 158
 Piver, 40, 53, 114
 Placotomus (Breitschneider), 10
 Plaimar, Ltd., 169
 Planchon, 230
 Planchon and Collin, 164
 Platearius, 7, 21, 24
 Plattner, P. (Pfau, A. St. and), 261
 Pliny, 5, 18, 20, 21, 24, 26, 27, 28, 29, 30, 31, 33, 35, 36 42
 Polak, 284

- Pollard A. (Chibnall, A. C., Piper, S. H., —, Williams, E. F., and Sahai, P. N.), 139, 141, 158, 245
- Pomet, 22, 29, 30, 39
- Poncelet, 15, 25, 38, 41, 51
- Pontillon, C. H., 293
- Pöpl, K., 278
- Porta, 36, 43, 46, 48
- Portes and Desmoulières, 183
- Pöschl, 164
- Poucher, William, 103
- Pouchet, F. A., 16
- Poulsen, 230
- Power, F. B., 183
- Power, F. B., and Chesnut, V. K., 182, 183
- Power, F. B., Tutin, Fr., and Rogerson, H., 273
- Pradal and Malepeyre, 33, 41
- Praepositus, Nicolas, 7, 21
- Prantl (Engler-), 164, 168, 270
- Preissecker, 290
- Prescott, Emerson, Woodward and Heggie, 269
- Prescott, Emerson and Peakes, 269
- Pritzker, J., and Jungkunz, R., 293
- Procter, 270
- Prophète, H., 139, 140, 141
- Ptolemy, 4
- Q**uassim (*see* About Quassim)
- Quincy, 45
- Quintinye, La, 22, 23
- R**adcliffe and Allen, 139, 140
- Raggioneri, 27
- Rauwolff, 11
- Ray, 22
- Redgrove, H. S., 17, 296
- Reed Laboratories, 62
- Regnault, 74
- Reichstein (Staudinger and), 269
- Reid, E. E., 115
- Reimer (Haarmann and), 168, 234
- Reinach, S., 16
- Reinitzer, F., 268
- Renou, Jean de, 14, 49
- Reutter de Rosemont (*see* Rosemont)
- Rhazès, 7, 20, 34, 35, 47
- Riban, 296
- Richardson, A. S., 159
- Richardson, Lundy and Irvine, 53
- Rideal and Thomas, 132
- Ritter, F. (Treff, W., —, and Wittrisch, H.), 171, 172, 173, 215, 244, 256
- Robertson, A., 278
- Robertson, W., 17
- Robinson, C. S., 77
- Robiquet, 52, 54
- Robiquet and Boutron-Charlard, 52
- Roeglesperger, L. (Feinberg, C., Hermann, J., —, and Zellner, J.), 139
- Rogerson, H. (Power, F. B., Tutin, Fr. and), 273
- Rojahn, W. (Soden, H. v. and), 239, 241
- Rolet, 27
- Roques, X., 132
- Roquetaillade, Jean de, 8
- Rosemont, Reutter de, 15
- Rosenthal, A., 297
- Rosenthal, A. (Walbaum, H. and), 142, 148, 167, 171, 193, 195, 218, 220, 223, 237, 248, 252, 254, 256, 297
- Rothenschach and Eberlein, 183
- Rouant, E., 290
- Rouelle, 15, 50
- Roure-Bertrand Fils, 224, 233
- Roure, Louis Maximilien, 54, 137
- Rovesti, G., 167, 173, 191, 192, 194, 222, 223, 242, 248
- Rovesti, P., 180, 181, 188, 196, 217, 235, 237, 260
- Rovesti, P., and Cantamessa, I., 211
- Rubée, Jérôme, 46
- Rumphius, 22
- Ruppin, A., 114
- Ruscelli, 29, 32, 39, 43
- Ruzicka, L., 254, 299, 300
- Ruzicka, L., and Janot, M. M., 178
- Ruzicka, L., and Pfeiffer, 198
- Ruzicka, L., and Schinz, H., 256
- Ryff, Gautier, 46
- S**abetay, Mme. H. S., and Mane, G., 172, 174
- Sabetay, S., 170
- Sabetay, S. (Naves, Y. R. and), 248
- Sabetay, S. (Naves, Y. R., —, and Palfray, L.), 141, 142, 165, 168, 169, 177, 181, 187, 195, 197, 204, 205, 207, 211, 213, 220, 223, 229, 239, 241, 249, 250, 256, 259, 278, 281

- Sabetay, S., Palfray, L., and Trabaud, L., 205
 Sabetay, S., and Sandulesco, G., 296
 Sabetay, S. (Trabaud, L. and), 185
 Sachs, J. von, 16
 Sack, 268, 299
 Sadgopal, 162, 230, 231
 Sahai, P. N. (Chibnall, A. C., Piper, S. H., Pollard, A., Williams, E. F. and), 139, 141, 158, 245
 Saint-Simon, 47
 Saintryves, P., 16
 Sakato, Y. (Takei, S., —, and Ono, M.), 290
 Sala, Angelo, 47
 Saladin, 7, 20, 24, 25, 28
 Sales, J. W. (Wilson, J. B. and), 292
 Salles, G., 15
 Sandulesco (Girard and), 99, 296
 Sandulesco, G. (Sabetay, S. and), 296
 Satie, C. (Jeancard, P. and), 111, 240
 Saurel, 26
 Savary des Bruslons, Jacques, 17
 Savonarola, Michael, 46
 Sawyer, 27
 Schelenz, H., 16
 Scherrer (Stoll and), 278, 279, 280
 Schimmel & Company, 168, 178, 223, 226, 238, 239, 249, 260, 264, 299
 Schinz, H. (Ruzicka, L. and), 256
 Schlotterhose, 88
 Schmidt, A., 17
 Schmidt, E., 264
 Schmidt-Nielsen, J., and Flood, A., 296
 Schlumpf, E. (Eder, R. and), 293
 Schmuck, L., 300
 Schneider (Naudin and), 53
 Schrader, 45
 Schulze, 55, 88
 Schulze (Frésenius and), 140
 Schutzenberger, 299
 Schwenskfeldt, Caspar, 51
 Schwartz, E., 77
 Schweizer, 164
 Seaber, W. M. (Bennett, C. T. and), 298
 Ségérus, Johannès, 44
 Sénéquier, P., 17
 Sérapion, 7
 Serres, Olivier de, 22, 23
 Simon, L.-J., 88
 Simonis, H., 270
 Smeltzer, C. A., 291
 Smyth, 78
 Snyder, J. W. (Wiegard, W. B., and), 132
 Société Aroma, 258
 Société Coloniale de Bambao, 56
 Société des Parfums Naturels, 53, 134
 Soden, H. v., 111, 113, 142, 168, 194, 198, 202, 204, 218, 220, 239, 240, 252, 254
 Soden, H. v., and Rojahn, W., 239, 241
 Sommer, 274
 Sorgona, Luisi, 225
 Sourdat, 88
 Soxhlet, 82, 83, 298
 Spaeth, 278
 Spaeth, E., and Kestzler, F., 256
 Spalteholtz and Enklaar, C. J., 187
 Sprengel, Kurt, 17
 Srivastava, J. P., 196
 Stamm, 155
 Staudinger and Reichstein, 269
 Steinmann, 88
 Stenhouse, 278
 Stephenson, R. J., 278
 Stirling, A. C., 296
 Stoll and Scherrer, 278, 279, 280
 Stramm, J. F., 139, 140, 141
 Strobach, O., and Wickmann, P. A., 289
 Ströder, 101
 Stull, D. C., 296
 Sudhoff, K., 17
 Suetonius, 15
 Sullivan, 183
 Sully, 10
 Suzuki, M., 296
 Sylvius (du Boys), 10, 18, 21, 31, 36, 42, 43
 Takei, S., Sakato, Y., and Ono M., 290
 Tasaki, S. (Tsuchihashi, R. and), 139, 200
 Tenant, 57
 Theisen, 101
 Theophrastus, 4, 5, 20, 28
 Thévet, 10
 Thomas (Rideal and), 132
 Thoms, H., 164, 264
 Thomson, R. Campbell, 32
 Thorpe, 147
 Tichomirow, 286
 Tiemann and Busse, 293
 Tommasi, G., 215

- Tournefort, 22
 Tovar (Simon de), 22
 Trabaud, L., 167, 199, 206, 241, 243, 259, 275, 280
 Trabaud, L., and Sabetay, S., 185
 Trabaud, L., (Sabetay, S., Palfray, L., and), 205
 Traphagen, F. W., and Burke, E., 183
 Traphagen, F. W., and Windisch, Z., 183
 Treff, W., Ritter, F., and Wittrisch, H., 171, 172, 173, 215, 244, 256
 Treff and Werner, 198
 Treff, Werner and Wittrisch, 165
 Treff, W., and Wittrisch, H., 172, 173
 Trog (Tschirch and), 264
 Truchon and Claude, 183
 Trumper (Dombrain and), 53
 Trusson (Vauquelin and), 56
 Tschirch, 164
 Tschirch and Trog, 264
 Tsuchihaschi, R., and Tasaki, S., 139, 200
 Tucholka, 284
 Turgan, 114
 Turkhauf, O. (Volmar, Y., and), 212
 Tutin, Fr. (Power, F. B., —, and Rogerson, H.), 273
- U**bbelohde, 144, 185, 298, 299
 Ullstadt, 46, 48
 Urbain Corporation, 115
 Ursat, J., 286
 Utermark, W. L., 291
- V**alentin, Basile (*see* Basile Valentin)
 Valerius Cordus (*see* Cordus)
 Varron, 24
 Vauquelin, 45
 Vauquelin and Trusson, 56
 Verley, A., 115, 249
 Viard, 111, 194
 Ville, G., 53
 Villeneuve, Arnauld de (*see* Arnauld de Villeneuve)
 Villiers, A., Colin, E., and Fayolle, M., 289
 Vincent, C., 53
 Viteau and Mazure, 53
 Vogl, 287
 Volmar, Y., and Jermstad, A., 177
 Volmar, Y., and Turkhauf, O., 212
- W**albaum, H., 166, 168, 239, 240, 278, 292, 299, 300
 Walbaum, H. (Bertram, J. and), 219
 Walbaum, H., and Rosenthal, A., 142, 148, 167, 171, 193, 195, 218, 220, 223, 237, 248, 252, 254, 256, 297
 Warburg, A., 132
 Warden (Dymock, —, and Horper), 231
 Watermann, 133
 Wecker, J. J., 46
 Wehmer, C., 162, 164, 166
 Wendt, G. (Kuhn, R., and), 287
 Werner (Treff and), 198
 Werner (Treff, —, and Wittrisch), 165
 Wickmann (Strobach and), 289
 Wiegard, W. B., and Snyder, J. W., 132
 Wiesner, 164
 Wilhem, O., 84, 88
 Will, R. T., 176
 Williams, E. F. (Chibnall, A. C., Piper, S. H., Pollard, A., —, and Sahai, P. N.), 139, 141, 158, 245
 Williams, E. F. (Chibnall, A. C., —, Latner, A. L., and Piper, S. H.), 158
 Wilson, C. P. (Hall, A. J., and), 183
 Wilson, J. B., and Sales, J. W., 292
 Windisch, Z. (Traphagen and), 183
 Winterstein (Kuhn, R., and), 286
 Winterstein (Kuhn, —, and Lederer), 245
 Wittrisch (Treff, Werner and), 165
 Wittrisch, H. (Treff and), 172, 173
 Wittrisch, H. (Treff, Ritter and), 171, 172, 173, 215, 244, 256
 Wittstein, 53, 230
 Wolf, 164
 Wood, T. F., 270
 Woodward (Prescott, Emerson, —, and Heggie), 269
 Wurtz, 103
- Y**amamoto, R., and Ito, K., 290
- Z**eisel, 147
 Zeitschel, O. (Hesse, A., and), 223, 226, 227, 228, 229, 230, 248
 Zell, Th., 296
 Zellner, J. (Feinberg, C., Hermann, J., Roeglesperger, L., and), 139
 Zwenger and Bodenbender, 271

SUBJECT INDEX

(Main entry for each perfume raw material is indicated by bold-face type.)

- Ab**, Egyptian aromatic, 3
Abelmosk seed (*see* Ambrette seed)
Ablutions, 3
Absolute essences (*see* Absolutes)
Absolutes, analysis, 146
 decolorized, 126
 definition, x, 67, 121
 determination of yield, 145
 introduction, 55
 preparation, 122
Absorption of water, 62
Acacia, compared to karokaroundé, 205
 concrete, discoloration, 155
 extraction, 55, 63
 falsification, 156
 history, 21, 23, 39, 40
 solvent extraction, 52
 warm fat extraction, 104, 119
 wax, 139, 140
Acacia Cavenia, monograph, 165
 solvent extraction yields, 81
 yield of absolute, 125
 yield of distillate, 151
Acacia, false (*see* Robinia)
Acacia farnesiana, monograph, 166
 solvent extraction yields, 81
 yield of absolute, 125
 yield of distillate, 151
Acaroid gum, 163
Acetaldehyde (apple juice), 183
 (coffee), 269
Acetamide (*Chimonanthus fragrans*), 176
Acetic acid (clary sage), 178
 (coffee), 269
 (oakmoss), 280
 (wallflower), 257
Acetic acid esters (currant), 179
Acetone, extraction with, 60, 66, 67
 purification and analysis, 72
 solvent power, 68, 69
 test for, in ethyl alcohol, 71
 vapor tension, 74
Acetophenone (castoreum), 297
 (labdanum), 208
 (poplar buds), 232
Acetyl eugenol (rose), 240
Acetyl-propionyl (coffee), 269
Acid, liberated by hydrolysis of humulol,
 273
 (poplar buds), 232
Acidification of concretes, 155
Acids, esterified (champac), 175
 fatty (hop), 263
 (poplar buds), 232
Acid value determination, 144
Adipos, 28
Adsorbents, enflourage with, 114
 of colored bodies, 130
Adsorption, decoloration by, 128
 solvent recovery by, 75, 101
 specificity of, 129
Aerometer, invention, 48
Aeron, 102
Aging of tinctures and infusions, 79
Aglycones, 127
Alambic roseaire, 47
Alcohol, extraction with, 44, 52, 60, 67
 fresh plant extraction with, 121
 industrial production of high-proof, 46
 in rose wax, 141
 quantitative analysis in absolutes, 147
 quantitative analysis in concretes, 144
 unsaturated, in rose wax, 141
 in tuberose, 249

- Alcohol (*Continued*)
used as solvent, 69
used to prepare resinoids, 121
(*see also* Ethyl alcohol, Methyl alcohol)
- Alcoholic extraction of pomade products, 122
- Alcoholic resinoids, indirect, 126
- Alcoholic washings, 121
- Alcoholic washings of pomades, ix
- Alcohololysis, 68
- Aldehydes (citrus peel oils), 176
(cyclamen), 179
(robinia), 234
- Aldehydes, aliphatic (*Chimonanthus fragrans*), 176
(*see also* Decyl aldehyde, Heptaldehyde, etc.)
- Aldehydes, not found in currant, 179
- Alexandria school, 5
- Algeria, extraction installations in, 55
- Alhenna, 272
- Aliphatic aldehydes (*see* Aldehydes, aliphatic)
- Alkaloids, extraction, 124
solubility in various solvents, 68
- Alkanet, 32
- Almond cakes, 39
- Almond oil, enflourage over, 39
extraction, 52
history, 28
- Altrachine*, 28
- Alteration of natural perfumes, 154
- Aludur, 102
- Alum, fats washed with, 32
for conservation of perfumed fats, 43
- Alumina, adsorption with, 129
- Alumina gel, 101
- Aluminum in extraction apparatus, 102
- Amaracus*, 20
- Amber, added to powder, 40
- Ambergris, history, 14, 20
infusion on oil, 120, 121
monograph, 295
resinoid yield, 80
tincture and infusion, 78, 79
yield, 61
- Amber-like odor of clary sage, 177
of labdanum, 274
- Ambreine (ambergris), 296
- Ambrette concrete, x
falsification of, 157
history, 20
tincture and infusion, 79
- Ambrette powder, 41
- Ambrette seed, monograph, 262
- Ambrettolide (ambrette seed), 262
- Ammonia (castoreum), 297
orange compound saponification product, 226
- Ammoniac gum, 163
- Amyl acetate (apple juice), 183
- Amyl caproate (apple juice), 183
- Amyl caprylate (apple juice), 183
- Amyl formate (apple juice), 183
- Analysis, interpretation, 153
of distillates, 152
of natural perfumes, 137 and ff.
- Analytical examination of extraction products, 141 and ff.
- Anatta, 32
- Anchusa*, 32
- Angelica, 163
- Angostura, 163, 271
- Animal fats, 31, 32
(*see also* Fats, Lard, Suet)
- Animal products, alcoholic extraction, 121
infusions on oil, 120, 121
resinoid yields, 80
tinctures and infusions, 78
yields, 61
(*see also* Ambergris, Civet, Musk, Castoreum)
- Animal resinoids, monographs, 295 and ff.
- Anisaldehyde (*Acacia Cavenia*), 166
(*Acacia farnesiana*), 168
(raspberries), 183
(vanilla), 292
- Anisaldehyde odor in wallflower, 257
- Anisic acid (vanilla), 292
- Anisic alcohol (vanilla), 292
- Anthocyanic pigments, 127
- Anthocyanines, 127
- Anthranilic acid (wallflower), 257
- Anthraquinone, methyltrihydroxy (popular buds), 232
- Anti*, Egyptian aromatic, 3
- Antidotaire* of Mesuë, 7

- Antidotaire* of Nicolas Praepositus, 7
Antidotaire of Rhazès, 35
 Apparatus of Bataille, 90
 Böhm, 90
 Bondon, 85 and ff.
 Börsig, 88
 Bruère, 149
 Cherbuliez, 149
 Fauth, 90
 Forster, 82
 Garnier, 55, 85 and ff.
 Hildebrandt, 90
 Hoffmann, 88
 Hughes, 90
 Hurrel, 97
 Kumagawa, 82, 83
 Lamy-Torrilhon, 88
 Macheboeuf and Fethke, 83
 Massignon, 83
 Merz, 83
 Naudin, 54
 Naves, 134, 145 and ff.
 Schlotterhose, 88
 Schulze, 55, 88
 Simon, 88
 Sourdat, 55, 88
 Steinmann, 88
 Walbaum and Rosenthal, 148
 Watermann, 133
 Wilhem, 88
 Apparatus for extraction, construction,
 102
 metals used, 102
 types, 84
 Apple juice, 31, 182
 Apple pulp, 31
 Apricot juice, 183
 Apricot-nut oil, 29
Aqua mirabilis, 46
 Aquatic mint odor of *Buddleia variabilis*,
 170
 Arabian incense (*see* Olibanum)
 Arabian jasmin, 200
 Arabs and perfumery, 6
 Arnica, 163
 Aroma of fruit juices, 96
 Aromatic esters, unidentified (tuberose),
 249
 Aromatic waters (*see* Waters, Rose
 water, Orange flower water, etc.)
- Aryballus*, 5
 Asafoetida, extraction, 163
 history, 49
 Asarabacca, 163
Aspalathe, 20
Asparagus Sprengeri, monograph, 169
 Asphaltum oil fractions, 53
 Assyrians and perfumery, 4
Atar, 3
Atelier, 111
 Atranol (oakmoss), 279
 Atranorine (oakmoss), 278, 279
 Aubepine (*see* Anisaldehyde)
 Austenite steel, 102
 Australia, extraction installations in, 156
Axonge, 31
Axunges pérégrines, 10
 Azulene, Zdravets sesquiterpene deriva-
 tive, 260
 Azulenes, sesquiterpene (privet), 233
- Balamos**, 29
Balsamiticum tempus, 25
 Balsam of tacmahac, 231
 Balsam Peru, history, 21, 40
 infusion on oil, 120
 monograph, 263
 odor of, in styrax, 265
 resinoid, 55
 tincture and infusion, 78, 79
 Balsam resinoids, monographs, 263
 Balsams, alcoholic extraction of, 121
 yield of, 61
 Balsam tolu, history, 21
 monograph, 264
 resinoid yield, 80
 taste of, in styrax, 265
 tincture and infusion, 78, 79
Balsamum tranquillans, 28
 Banana juice, 182
 Bancoul, oil of, 29
 Barbatinic acid (oakmoss), 278, 279
 Barley, used for enflourage, 39
 Bases with narcotic odor (jasmin), 198
 with pyridine odor (oakmoss), 280
 (robinia), 234
 Basic substance (hyacinth), 187
 with nicotinic odor (orange flower),
 226

- Batteries, 84
Batteuse, 50
 Bay-oil odor of champac compounds, 175
 Bellium, for perfuming oils, 42
 Beaver (*see* Castoreum)
 Behen oil (*see* Ben oil)
 Beirut, Syria, extraction installations at, 55
 Ben oil, for enfleurage, 39
 history, 28 and ff.
 Benzaldehyde (*Acacia Cavenia*), 166
 (*Acacia farnesiana*), 168
 (benzoin), 268
 (hyacinth), 188
 (orange flowers), 226, 229
 Benzene, color elimination with, 129
 distillate extraction, 134
 extraction with, 44, 52, 60, 62, 66
 fresh plant extraction, 121
 glucoside extraction, 127
 pigment extraction, 127
 pomade washings extraction, 123
 purification and analysis, 70
 recovery by washing, 75
 solvent power, 67 and ff.
 thermal constants, 74
 toxicity, 77
 vapor tension, 74
 water-oil extraction, 97
 Benzenoid compounds, solubility in various solvents, 68
 Benzoic acid (balsam tolu), 265
 (benzoin), 268
 (castoreum), 297
 Benzoic acid esters (benzoin), 268
 (tuberose), 249
 Benzoin, added to lard, 106
 fats stabilized with, 43
 first extraction product, 15
 for enfleurage, 113
 history, 15, 49
 magistère dc, 15
 monograph, 266
 odor of, in styrax, 265
 pomades prepared with, 35, 40
 resinoid yield, 80
 tincture and infusion, 78, 79
 Benzyl acetate, 138, 157
 (gardenia), 184
 (hyacinth), 188
 Benzyl acetate (*Continued*)
 (jasmin), 194, 197, 198
 (jasmin of Formosa), 200
 Benzyl alcohol, 138, 157
 (*Acacia Cavenia*), 166
 (*Acacia farnesiana*), 168
 (castoreum), 297
 (*Chimonanthus fragrans*), 176
 (hyacinth), 187
 (jasmin), 198
 (jasmin of Formosa), 200
 (orange flowers), 228
 (robinia), 234
 (tuberose), 249
 (violet), 254
 (violet leaf), 256
 (wallflower), 257
 Benzyl benzoate, 138, 254, 262
 (balsam Peru), 264
 (balsam tolu), 265
 (carnation), 174
 (hyacinth), 187
 (jonquil), 202
 (tuberose), 249
 Benzyl cinnamate (balsam Peru), 264
 (balsam tolu), 265
 (styrax), 266
 Benzyl cyanide (karokaroumé), 205
 (orange flower), 226, 229
 Benzyl esters (*Chimonanthus fragrans*), 176
 Benzyl laurate, 254
 Benzyl salicylate, 138
 (carnation), 174
 Bergamot, added to enfleurage oils, 39
 used in pomades, 35
 Bigarade, history, 21, 22
 (*see also* Orange flower)
Bigarat, 22
 Bilberry juice, 183
 Bisabol (*see* Myrrh)
 Bisabolol (orange flower), 229
 Bitter orange, 162
 (*see also* Orange flower)
 Black currant (*see* Currant)
 Black currant juice, 183
 Bleaching of concretes, 131
 Blue hyacinth (*see* Hyacinth)
 Borneol (castoreum), 297
 (oakmoss), 280

- Borneol-type lavandin, 211
Boronia megastigma, extraction, 56
 extraction yields, 81
 monograph, 169
Botarion, 34
 Bouquet narcissus, 201
Bourgeon, essence de, 178
Brauthitage, 102
 Brazil, extraction installations in, 56
 Bronze, for extraction apparatus, 102
 Broom, extraction, 55
 extraction yields, 81
 history, 21, 24
 monograph, 170
 yield of absolute, 125
 Brown boronia (*see Boronia megastigma*)
 Bruising, effect on perfume, 63
 Brunner rose (*see Rose*)
 Buchu, 163
Buddleia variabilis, monograph, 171
 Bulgaria, extraction installations in, 55
 Bull grease, 31
 Butane, extraction with, 53
 Butterfly lilies, 184
 Butyl alcohol, 66, 67
 for absolutes, 126
 Butyric acid (poplar buds), 232
 (tuberose), 249
 Byzantine epoch, 5

Cacao, monograph, 268
 Cacao bean, shape of, 284
 Cadinene (currant), 179
 Calabria, extraction installations in, 55
 Calamus, extraction, 163
 history, 20, 34
 California, extraction installations in, 56
 Camel fat, 31
 Camphene (orange flower), 226, 228
 Camphor, history, 4, 20
 (oakmoss), 280
 Camphor, tobacco (*see Nicotianine*)
 Camphor-type lavandin, 211
 Canadian serpentaria, 164
 Cannon powder test for alcohol, 48
 Capacity, of extractors, 84
 of trays, 86
 Caproic acid (Zdravets), 260
 Caprylic acid (*Boronia megastigma*), 170
 (Zdravets), 260

 Caprylic acid esters (apple juice), 183
 Carbon, activated, enfleurage with, 115
 adsorption with, 129
 jasmin yield with, 116
 solvent recovery with, 101
 Carbon disulfide, extraction with, 44, 52,
 53
 fire hazard, 77
 Cardamom, history of, 20, 29
Carginium, 28
 Carlina, 163
 Carnation, enfleurage on powder, 41
 extraction, 52, 63
 history, 24, 41, 50
 Indian (*see Tagetes*)
 monograph, 171
 wax of, 139, 140
 yield of absolute, 125
 yield of distillate, 151
 yields by solvent extraction, 81
 Carnauba wax, 141
 Carob pulp, 31
 Carotenes, 127, 129
 Carotenoid pigments, 127
 Carotenoids, extraction of, 124
 solubility in various solvents, 68
 Carrot, 163
Caryinon, 28
 Caryophyllene (currant), 179
 Cascarilla, extraction, 163
 history, 21
 Cassia pulp, 31
Cassie ancienne (*see Acacia farnesiana*)
Cassie du Levant, 166
Cassie Farnèse, 166
Cassie romaine (*see Acacia Cavenia*)
 Castoreum, added to vanilla extract, 292
 monograph, 296
 resinoid yield, 80
 tincture and infusion, 78
 yield, 61
Castor fiber, 296
 Castor oil, 28
 Catadynic action for aging, 79
Catalogus odorum of Baldinus, 15
Cataplasmata, 31
 Catechol, vinyl (*see Vinyl catechol*)
 Cayou, 204
 Cedar, 163
 Cedar root resinoid, 152

- Cedrene, falsely identified in clary sage, 178
 (lavender), 212
 Celery, 162, 163
 odor of, in lovage, 274
 Centesimal alcoholometer, 48
 Ceresins, for screening, 114
 Cerides, elimination of, 69
 extraction of, 124
 Cerotic acid, 141
 Ceryl alcohol (hop), 273
 (see also Isoceryl alcohol, Pseudoceryl alcohol)
 Chaldeans, perfumery among, 4
 Chamomile, extraction, 163
 history, 20
 Champac, extraction yields, 81
 monograph, 174
 odor of, in *Chimonanthus fragrans*, 175
 Charcoal, enfleurage with, 115
 Châssis, concretes of, 111
 description, 109
 of enfleurage, 40
 Chemical composition of natural perfumes, 137 and ff.
 Cherry juice, 182
Chimonanthus fragrans, monograph, 175
 China, perfumery in, 3
 Chio mastic, 216, 283
 Chloratranol (oakmoss), 279
 Chloratranorine (oakmoss), 278, 279
 Chlorhematommic acid (oakmoss), 279
 Chlorhematommic esters (oakmoss), 279
 Chlorinated solvents, 44, 66
 (see also Chloroform, Methyl chloride, etc.)
 Chloroform, 52
 Chlorohydrates, 66
 Chlorophyllanes, 127
 Chlorophyll pigments, 127
 Chlorophylls, 129
 solubility in various solvents, 68
 Chromatography, 131
 Cineol (oakmoss), 280
 Cinnamon (balsam Peru), 264
 (balsam tolu), 265
 Cinnamic acid (benzoin), 268
 (poplar buds), 232
 (vanilla), 292
 Cinnamic acid esters (benzoin), 268
 (jonquil), 202
 (poplar buds), 232
 (vanilla), 292
 Cinnamic alcohol, 138
 (hyacinth), 187
 Cinnamic aldehyde, 138
 (hyacinth), 188
 Cinnamic esters (hyacinth), 187
 (vanilla), 292
 Cinnamon, history, 4, 20
 Cinnamon Ceylon, 163
 Cinnamyl acetate, 138
 Cinnamyl cinnamate (poplar buds), 232
 (styrax), 266
 Circulating extractor, 55
 Circulation of liquids, 103
Cires résiduaires, 126
 Cistus (see Labdanum)
 Citral (lemon peel), 176
 (verbena), 250
 Citric odor of heliotrope, 186
 oils, added to pomades, 35
 Citronellol (oakmoss), 280
 (rose), 240
 Citrus peel oils, monograph, 176
 Civet, infusion on oil, 120, 121
 manufacture of resinoid, 80
 monograph, 297
 resinoid yield, 80
 tincture and infusion, 78, 79
 yield, 61
 Civetol (civet), 299
 Civetone (civet), 299
 Clary sage, extraction, 64
 falsification of, 157, 158
 monograph, 177
 odor of, in Zdravets, 260
 pretreatment of, 61
 water oil, 97
 yield of absolute, 125
 yield of distillate, 152
 yields by solvent extraction, 82
 Cloves, adulterant for patchouli, 282
 crushing of, 64
 extracted with ether, 45, 52
 fixative, 35, 39
 history, 9, 20
 monograph, 287
 yields by solvent extraction, 82

- Coal oil fractions, 53
 Cocoa (*see* Cacao)
 Coffee, monograph, 269
 Color, created during desiccation, 62
 generated by alteration, 127
 nature of, 127
 of concretes, 143
 removal of, 126
 Colorimeters, 128
 Combustion tests for alcohol, 48
 Comores, extraction apparatus on, 56
Compendium Aromatariorum of Saladin, 7, 28
 Composition of enfleurage products, 113
 Compression, 101
 Compression recovery, 75
 Concentrates, definition, 121
 preparation of, 122
 (*see also* Pomade concentrates)
 Concentration of extraction products, 97
 preparation for, 98
 principles of, 99
 Concentration of natural perfumes, 132
 Concentration of pomadę washings, 123
 Concretes, alteration, 154
 analysis, 143
 color of, 143
 decolorization, 126
 discoloration, 155
 introduction at Vienna, 54
 invention, 45
 manufacture, 59
 variations in composition, 141
 yields, 59
 yields of distillates, 151
*Concrètes résiduaire*s, 126
 Continuous extraction, 89
 Copper plating for extraction apparatus, 102
 Coriander, 163
 Corps, raw materials for, 104
 Costus, history, 20
 monograph, 269
 odor of, in opopanax, 285
 perfumed oil of, 42
 pretreatment, 64
 Cottonseed oil, 28, 39
 Coumaric acid (lavender), 212
 Coumarin, added to vanilla extract, 292
 adulterant for patchouli resinoid, 282
 Coumarin (*Continued*)
 containing plants, choice of solvents
 for, 69
 containing plants, monographs, 270
 and ff.
 isolation of distillates containing, 150
 (lacinaria), 270
 (lavender), 212
 (melilot), 271
 (orchid), 230
 (tonka bean), 271, 272
 Coumarinic extracts, used to sophisticate
 tea resinoids, 289
 Coumarinic lactones (wallflower), 257
 Coumarinic notes, developed by diastasic
 reactions, 61
 Crayon, used in enfleurage, 41
 Creosol (castoreum), 297
 o-Cresol (castoreum), 297
 p-Cresol, 138
 (*Acacia farnesiana*), 168
 (jasmin), 198
 (orange flower), 227
 (wallflower), 257
Crocinum, 20
 Crocus (*see* Saffron)
 Crushing, effect on perfume, 63
 Cumin, extraction, 163
 history, 20
 Cuminc aldehyde, 138
 (*Acacia farnesiana*), 168
 Curcuma, 163
 Currant, black, red and white, 183
 monograph, 178
 yield of distillate, 152
 Cyclamen, monograph, 179
 Cyclohexadiene, in benzene, 70
 Cyclohexanone, trimethyl (*see* Trimethyl
 cyclohexanone)
 Cyclohexenone, dimethyl (*see* Dimethyl
 cyclohexenone)
 Cyclopentadecanone, methyl (*see* Meth-
 ylcyclopentadecanone)
 Cyclopentadiene, in benzene, 70
 Cyclopentenone, substituted (*see* Jas-
 mone)
 Cypress, extraction, 163
 history, 20
Cyprinum, 20
 Cyprus, perfumery in, 5

- Daily rate of enfleurage, 110, 154
Damascus rose, 21
Date pulp, 31
Decanal (*see* Decyl aldehyde)
Decantation, history, 36
Decoloration, general observations, 126
 oxidation method, 131
 techniques, 130
Decolorized absolutes, general observations, 126
 introduction, 55
 process of manufacture, 134
 reconstitution of, 134
Decolorized products, 126
Decyl aldehyde (*Acacia Cavenia*), 166
 (*Acacia farnesiana*), 168
 (*Chimonanthus fragrans*), 176
Deer's tongue (*see* Lacinaria)
Défleurage, 110
Deodorization of oils 134
Deposides, choice of solvent, 69
 solubility in various solvents, 68
Desiccation, 60, 61
Diacetyl (coffee), 269
Diaspermata, 33
Diastasic reactions, 61
Diethyl ketone (coffee), 269
Diethyl phthalate, 157, 254, 262
Digestion, contrasted with infusion, 79
 defined, 116
 fat mixture, 118
 history, 33
 practice of, 116
Dihydrobenzoic acid (balsam Peru), 264
2,3-Dihydroxybenzoic acid (poplar buds), 232
3,4-Dihydroxycinnamic acid (poplar buds), 232
2,6-Dihydroxy-4- β -methoxypropionophenone (poplar buds), 232
2,6-Dihydroxy-4'- β -methoxypropionophenone (poplar buds), 232
Di-isopropylmethane, in petroleum ether, 69
Dill, history, 20
Dimensions of extractors, 86
Dimethyl anthranilate (hyacinth), 188
Dimethylcyclohexenone (oakmoss), 280
Dimethyl hydroquinone, 138
 (hyacinth), 188
2,4-Dimethylpentane, in petroleum ether, 69
Dimethylpropylmethane, in petroleum ether, 69
Dimethyl sulfide (coffee), 269
Dipalmitic ester of luteine (tagetes), 245
Dipentene (orange flower), 226, 228
Diphenylguanidine test for adsorption capacity, 130
Diplom, 34
Discoloration of concretes, 155
Disintegrators, 65
Dissolution, history of, 44
 recovery by, 101
Distillates, analysis, 152
 isolation, 148 and ff.
 olfactory value, 138
 yields, 151, 152
Distillation, in desiccation of oils, 37
 of extraction products, 132
 of odorous fractions, 132
 of pomade washings, 123
 per descensum, 37, 42
 per filtrum, 37
 perfumed oils of, 41
 with steam, 133, 148 and ff.
Distilled waters, 61
Diterpene or sesquiterpene alcohol (jasmin of Formosa), 200
Diterpenic glycol, sclareol, 178
Divaricatinic esters, isolation of distillates containing, 151
Division of plants, 62
Done of Provence, 201
Double violet (*see* Violet)
Drainage, 88
Drugs, solvent extraction yields, 82
Druschky rose, 141
Drying (*see* Desiccation)
Drying agents, 62
Dyestuffs, from henna, 272
 solubility in various solvents, 68
Earth-nut oil, 28, 39
Earths, for adsorption, 129
Eau-de-vie, 49
Eaux bleues, 227
Eaux de brouss, 229
Egypt, extraction installations in, 55
 perfumery in ancient, 3

- Elaiosis*, 6
 Elder, monograph, 180
 Elecampane, extraction, 164
 history, 20, 21
 Electricity generated in movement of solvents, 77
 Elemi, monograph, 282
 tincture and infusion, 79
 Elemol (elemi), 282
 Enfleurage, by screening, 114
 composition of perfume, 113
 concentrates (*see* Pomade concentrates)
 fats used, 104
 history, 21, 38
 labor required, 111
 of oleaginous fruits, 38
 of powders, 40, 115
 on solid adsorbents, 41, 114
 pneumatic, 114
 pomade of, defined, ix
 practice of, 108
 theory of, 111
 with oils, 39, 113
 yields, 111
 (*see also* Jasmin, Tuberose)
Epithemata, 31
Epreuve de la sonde, 48
Espiritin, 36
Esprit-de-vin alcoolisé, 47
Esprit recteur, 45
Essence de bourgeon, 178
Essence des eaux, 96
Essence des eaux de brout d'oranger, 97
 Essential oils, used for falsification, 157
 Essential salt, so-called, 50
Essoreuse, 55
 Ester $C_6H_{12}O$ (clary sage), 178
 Esterified acids (champac), 175
 Esters (cyclamen), 179
 (labdanum), 208
 (robinia), 234
 unidentified (tuberose), 249
 Esters of acetic acid (currant), 179
 Esters of benzoic acid (tuberose), 249
 Esters of fatty acids (oakmoss), 280
 Ethane, chlorinated derivatives of, 66
 Ethanol (*see* Ethyl alcohol and Alcohol)
 Ether, distillate extracted with, 151
 extraction with, 44, 45, 50-53, 66
 Ether (*Continued*)
 solvent power, 68
 (*see also* Petroleum ether)
 Etholides, solubility in various solvents, 68
 Ethyl alcohol, 66, 254
 (*Boronia megastigma*), 170
 purification and analysis, 70
 thermal constants, 74
 vapor tension, 74
 (*see also* Alcohol)
 Ethyl chloride, distillate extracted with, 151
 extraction with, 53
 Ethyl cinnamate (styrax), 266
 Ethylene, chlorinated derivatives of, 66
 Ethylene glycol, distillation with, 134
 Ethyl ether (*see* Ether)
 Ethyl ether of β -methylumbelliferone, odor of in fenugreek, 272
 Ethyl formate (*Boronia megastigma*), 170
 Ethyl ketone (*see* Diethyl ketone)
p-Ethylphenol (castoreum), 297
 Ethylprotocatechuic aldehyde, 292
 Ethylvanillin, 292
 Eugenol, 138
 (*Acacia Cavenia*), 166
 (carnation), 173, 174
 (coffee), 269
 (hyacinth), 188
 (orange flower), 229
 (rose), 240
 (tuberose), 249
 Everlasting, history, 24
 monograph, 180
 solvent extraction yields, 81
 yield of absolute, 125
 yield of distillate, 151
 Evernic acid (oakmoss), 278, 279, 280
 Evernic acid (oakmoss), 279
 Evernic esters, 151
 (oakmoss), 279
 Expenses, comparison for various extractors, 95
 Explosion, danger from solvents, 77
 Expression, history, 36
 Extraction apparatus, general observations, 83 and ff.
 materials used, 102
 (*see also* Apparatus, Extractors)

- Extraction of aromatic distilled water, 96
 of fruit juice aroma, 96
 of steam-distillate, 151
 with fats, 18
 with solvents (*see* Volatile solvents)
- Extractive, theory of, 45
- Extractors, continuous, 89
 filter press, 88
 forced drainage, 88
 mobile, 85 and ff.
 stationary, 84 and ff.
 (*see also* Apparatus)
- Extracts, history of, 44
- F**
- Faecula, used in enfleurage, 41
- False acacia (*see* Robinia)
- Falsification of natural perfumes, 155
 causes of, 156
 means of, 156
 search for, 156
- Fara Koronte, 204
- Farnesol (*Acacia farnesiana*), 168
 (balsam Peru), 264
 (balsam tolu), 265
 (*Chimonanthus fragrans*), 176
 (cyclamen), 179
 (lilac), 213
 (lily-of-the-valley), 213
 (linden), 214
 (mignonette), 219
 (orange flowers), 227
 (robinia), 234
 (rose), 240
 (tuberose), 249
- Fat extraction, history, 18
- Fats, extraction of, 124
 hard and soft, 40, 106
 prepared, 104
 used in perfumery, 35
 (*see also* Lard, Suet)
- Fatty acids (hop), 273
 (oakmoss), 280
- Fatty acids, extraction of, 124
 solubility in various solvents, 68
- Fennel, history, 20
- Fenugreek, history, 20
 monograph, 272
 odor of, in opopanax, 285
 solution as bleach, 30
- Fermentation, provoked during desiccation, 62
- Fern, 164
- Ferric hydrate gel, 101
- Fien de cheval*, 34
- Filtration, history of, 36
- Fir-cone kernel, 28
- Fire, danger from various solvents, 77
- Flavonic pigments, 127
- Floral oils, process of manufacture, 104
- Flower oils by digestion, defined, ix
- Flower pomades, defined, ix
- Flowers, influence of soil on perfume, 26
 storage before treatment, 56
 time of harvest, 25
 water content, 59
- Flower-water oils, extraction of, 96
 yields, 97
- Fokiena (pe-mou), 164
- Fomentations, perfumed, 5
- Foreign products, use for fraud, 156
- Formaldehyde dimethyl acetal, 66, 67
- Formic acid (*Boronia megastigma*), 170
 (coffee), 269
 (oakmoss), 280
- Formosan jasmin (*see* Jasmin of Formosa)
- Foul (*see* *Jasminum sambac*)
- Frangipane, 231
- Frankincense, 42
 (*see also* Olibanum)
- Fraud of extraction products (*see* Alteration, Falsification)
- Fruit juices, extraction of aroma, 96
 monograph, 182
- Fruits, crushing of, 64
- Fumigations, perfumed, 3, 5
- Furan (coffee), 269
- Furfuracinic acid (oakmoss), 278
- Furfuraldehyde (*see* Furfurol)
- Furfurol (apple juice), 183
 (coffee), 269
 test for in ethyl alcohol, 71
- Furfuryl alcohol (coffee), 269
- Furfuryl mercaptan (coffee), 269
- G**
- Gaiiazulene (Zdravets), 261
- Galangal, extraction, 164
 history, 21

- Galbanum, history, 20, 49
 monograph, 283
 resinoid yield, 80
- Gardenia, monograph, 183
 odor of, in plumeria, 231
 solvent extraction yields, 81
 yield of absolute, 125
- Garland flowers, monograph, 184
- Gas, entrainment with, 133
- Genestein, 127
- Geraniol (*Acacia Cavenia*), 166
 (*Acacia farnesiana*), 168
 (apple juice), 183
 (jasmin), 198
 (oakmoss), 280
 (orange flower), 228
 (rose), 239
 (tuberose), 249
 (wallflower), 257
 (Zdravets), 260
- Geranium, falsification of, 158
 solvent extraction yields, 82
 water oil, 97
 yield of absolute, 125
 yield of distillate, 152
- Geranium macrorrhizum* (see Zdravets)
- Geranium, rose (see Rose geranium)
- Geranyl acetate (orange flower), 228
 (tuberose), 249
- Geranyl propionate (tuberose), 249
- Germacrol (Zdravets), 261
- Gibbs, hypothesis of, 62
- Ginger, monograph, 287
 (see also Wild ginger)
- Glans unguentaria*, 28
- Gloves, enfleurage of, with powders, 41
- Glucosides, claimed to exist in jasmin, 199
 extraction of, 127
 (vanilla), 292
- Glucovanillic alcohol (vanilla), 292
- Glucovanillin (vanilla), 292
- Glycerides (*Boronia megastigma*), 170
 elimination of, 69
 extraction of, 124
 in waxes, 139
 solubility in various solvents, 68
- Glycerin, distillation with, 134
 used in solvent recovery, 75
- Glycol, used in solvent recovery, 75
- Goat fat, 31
- Gooseberry juice, 183
- Gramineous hays, pretreatment of, 61
- Grape juice, 182
- Grasse, development of, 15, 26
 extraction apparatus in, 55
- Gravimetric test for alcohol, 48
- Greece, perfumery in, 5
- Guaiac, extraction, 164
 sophistication with, 289
- Guaiacol (castoreum), 297
 (coffee), 269
- Guaiacol, vinyl (coffee), 269
- Guiana, extraction apparatus in, 56
- Gum-resins, alcoholic extraction of, 121
 monographs, 282 and ff.
 yields of, 61
- Gutenberg, 9
- H**aifa, Palestine, extraction apparatus at, 55
- Harvest, period of, in Provence, 153
- Hay, choice of solvent, 69
 desiccation, 61
 extraction, 55
 odor of, in lacinaria, 270
- Hazel-nut oil, 28
- Hedysmata*, 33
- Helenine (tagetes), 245
- Heliotrope, monograph, 186
 solvent extraction, 52
- Heliotropin, 138
 (robinia), 234
 (vanilla), 292, 293
- Hematommic acid (oakmoss), 279
- Hematommic esters (oakmoss), 279
 (see also Chlorhematommic esters)
- Henna, history, 20
 monograph, 272
- Henry's law, 101
- Hentriacontane, 139
 (hop), 273
 (tagetes), 245
 (Zdravets), 260
- Heptacosane, 139
 (poplar buds), 232
- Heptaldehyde (hyacinth), 188
- Heptanoic acid (see Oenanthic acid)
- Heptanol (hyacinth), 188
- Heptenol (violet leaf), 256

- Heptenol, tertiary (violet), 254
 Heptyl alcohol (*see* Heptanol)
 Herb of St. John, 180
 Herbaceous stems, water content of, 59
Herbarius, 5
 Herbs, solvent extraction yields of, 82
 Heterosides, solubility in various sol-
 vents, 68
 Hexane, in petroleum ether, 69
 vapor tension, 74
 Hexanol (violet), 254
 (violet leaf), 256
 Hexenol (violet leaf), 256
 Hexyl alcohol (*see* Hexanol)
 Hides, enflourage of, with powders, 41
 Hittites, laws of the, 4
 Hog lard, 31
 Holland proof of alcohol, 48
 Homogenizer of Hurrel, 97
 Honeysuckle, history, 21
 monograph, 186
 odor of, in pandanus, 231
 Hop, monograph, 273
 Horseradish oil, 29
 Hound's tongue (*see* Lacinaria)
Huile au bouquet, 39
Huile au pot-pourri, 39
Huiles aux fleurs par digestion, ix
Huiles capistes, 42
Huiles factices, 18
 Humulol (hop), 273
 Hurrel homogenizer, 97
 Hyacinth, enflourage on powder, 41
 extraction, 55, 63
 history, 21, 24, 25, 39
 monograph, 186
 odor of, in balsam tolu, 265
 in pandanus, 231
 solvent extraction yields, 81
 treated with warm fats, 104, 119
 wax, 139-141
 yield claimed by I. G., 115
 yield of absolute, 125
 yield of distillate, 151
 Hydrocarbon, $C_{20}H_{42}$ (linden), 214
 Hydrocarbon, $C_{10}H_{18}$ or $C_{11}H_{20}$ (tobac-
 co), 290
 Hydrocarbons, $C_{20}H_{42}$ (oakmoss), 280
 Hydrocarbons in waxes, 139
 Hydrochloric acid, 66
 Hydrogen sulfide (coffee), 269
 Hydroxy-acid (currant), 179
p-Hydroxy benzaldehyde, 273
 4-Hydroxybenzoic acid (poplar buds),
 232
 Hydroxycitronellal, odor of, in linden,
 214
 Hydroxystearic acid, 141
 Iatralypte, 5
Immortelle, 180
 Imperatoria, 164
 Incense, history, 9
 (*see also* Frankincense, Olibanum)
 India, perfumery in ancient, 3
 Indian carnation (*see* Tagetes)
 Indian verbena, 250
 Indole, 138
 alteration products of, 127
 (*Chimonanthus fragrans*), 176
 content in enflourage products, 113
 determination, 145
 effect on color of concretes, 155
 (garland flowers), 185
 (jasmin), 191, 194, 197-199
 (jasmin of Formosa), 200
 (jonquil), 202
 not found in lilac, 213
 (orange flowers), 227-229
 (robinia), 234
 (wallflower), 257
 Influence of soil, 26
 Infusions, aging, 79
 concentrates of, x
 contrasted with digestion, 79
 definition, x, 19, 61
 on oil, 120
 preparation of, 78
 Insolation as means of heating, 34
 Insoluble waxes, 121
 Interpretation of analytical results, 153
 β -Ionone (*Boronia megastigma*), 170
 Ionone isomer (violet), 254
Iris (*see* Orris)
 Iron, for extraction apparatus, 102
 in adsorption, 130
 Irone (orris), 281
 (raspberries), 183
 Isoceryl alcohol, 141

- Isoeugenol, 138
 (champac), 175
 (karokarouiné) 205
- Isomenthone, in rose geranium water, 242
- Isopropyl ether, 66, 67
- Isovalerianic acid (tobacco), 290
- Israel, perfumery in land of, 4
- Italian jasmine, 188
- Italian Riviera, extraction apparatus on, 55
- J**
- Jasmin, biological process, 201
 châssis, 111, 198
 cold-fat treatment, 104
 concrete, analysis, 145
 decoloration, 131
 discoloration, 155
 distillate from, 151
 indole in, 113
 invention of, 52
 conduct of extraction, 91
 enfleurage, 108 and ff.
 in Syria, 114
 on powder, 41
 on wood charcoal, 115
 with oil, 114
 with solid adsorbents, 114, 115
 examination of altered products, 155
 of sophisticated products, 155
 falsification of, 157
 history, 21, 22, 25, 35, 39, 40
 indole content, 113
 influences on products, 154
 methyl anthranilate content, 113
 monograph, 188
 odor of, change during extraction, 86
 compared to karokarouiné, 205
 in *Chimonanthus fragrans*, 175
 in gardenia, 184
 in honeysuckle, 186
 pomade, acid value, 155
 alteration of, 155
 distillate from, 152
 from digestion, 119
 from enfleurage, 109
 from neutralin oils, 197
 pretreatment, 81
 proportions to fats, 109
 quality by various extractors, 93
 size of charge, 84
- Jasmin (*Continued*)
 solvent employed, 93
 solvent extraction, 52, 55, 63
 solvent extraction yield, 63, 81
 solvent lost, 94, 100
 technique of extraction, 81
 tray load, 86
 treatment in Egypt, Italy, Palestine, 55
 wax, 139-141
 yields, of absolute, 93, 125
 by various extraction methods, 111
 from various extractors, 91
 with activated carbon, 116
- Jasmin of Formosa, monograph, 199
- Jasminum sambac*, history, 21
 monograph, 200
- Jasmone (jasmin), 198
 (jonquil), 202
 (orange flower), 226, 227, 229
 research studies of, 138
- Jonquil, enfleurage on powder, 41
 extraction, 52, 63
 history, 21, 24, 39, 40
 monograph, 201
 odor of, in *Chimonanthus fragrans*, 175
 solvent extraction yields, 81
 treated by warm fats, 104, 119
 yield of absolute, 125
 yield of distillate, 152
- Juices, fruit, extraction of, 61
 (see also Fruit juices)
- Juniper, 164
- K**
- Kahweol (coffee), 269
- Kara Sarli, Bulgaria, 55
- Karokarouiné, concrete, discoloration, 155
 monograph, 204
 yield of distillate, 152
- Kerotakis*, 6
- Ketone isomeric with ionones, 254
- Ketone (orange flower), 226
- Ketone with minty odor (*Acacia farnesiana*), 168
 (rose), 240
- Ketone with violet odor (*Acacia Calycina*), 166
 (*Acacia farnesiana*), 168

- Ketones (ambergis), 296**
 (cyclamen), 179
 Ketones, not found in currant, 179
 unidentified (oakmoss), 280
 with peach odor (robinia), 234
Khimeutika, 5
Kikaion, 28
 K'miri, oil of, 29
Kyphi, 4
- Labdanum cistus, monograph of concrete, 206**
 monograph of resinoid, 273
 tincture and infusion, 78, 79
 yield of absolute, 125
 yield of distillate, 152
 Labor for enfleurage, 111
 for various extractors, 94
Lacinaria, monograph, 270
 (see also *Liatris*)
 Lactone (castoreum), 297
 (oakmoss), 280
 Lactones, solubility in various solvents, 68
 (wallflower), 257
 Lard, history of use in perfumery, 31, 35, 40
 origin and preparation, 104
 physical and chemical properties, 105
 test for purity, 105
 use for enfleurage and digestion, 104
 Laurel oil, history, 28, 43
 Laurel, rose (see *Rhodendron*)
Laurinum, 28
Lavages de concrètes, x
 Lavandin, choice of solvent, 69
 extraction, 64
 monograph, 208
 preparation for extraction, 64
 yield of absolute, 125
 yield of concrete, 59, 82
 yield of distillate, 152
 Lavender, choice of solvent, 69
 color of concrete, 143
 desiccation, 61
 extraction, 64
 extraction of waters, 97
 falsification, 158
 isolation of distillate, 150
- Lavender (*Continued*)
 monograph, 208
 pretreatment, 61
 size of charge, 85
 solvent extraction yields, 82
 tray load, 86
 water oil, 97
 yield of absolute, 125.
 yield of distillate, 152
 Leaves, water content of, 59
Lecythus, 5
 Lemongrass, 250
 Lemon, history, 21
 Lemon oil, added to pomades, 35
 Lemon peel, 176
 Lentisk (see *Mastic*)
Leucoïon, 21
Liatris, isolation of distillate, 150
 (see also *Lacinaria*)
 Libations, 3
Liber de Simplici Medicina, of Platearius, 7
 Lichens, extraction, 62, 68
 isolation of distillates, 151
 (see also *Oakmoss*)
 Lignous roots, planing of, 64
 Li-Ki, 3
 Lilac, history, 52
 monograph, 212
 odor of, in pandanus, 231
 solvent extraction yields, 81
 Lilies, butterfly, 184
 Lily, history, 21, 34
 monograph, 213
 Lily-of-the-valley, enfleurage on powder, 41
 monograph, 213
 Linaloöl (*Acacia Cavenia*), 166
 (*Acacia farnesiana*), 168
 (*Chimonanthus fragrans*), 176
 (clary sage), 178
 (gardenia), 184
 (jasmin), 198
 (jasmin of Formosa), 200
 (jonquil), 202
 (lavender), 212
 (orange flower), 226, 228
 (robinia), 234
 (wallflower), 257

- Linalyl acetate (clary sage), 178
 (gardenia), 184
 (jasmin), 198
 (jasmin of Formosa), 200
 (lavender), 212
 (orange flower), 228
 (petitgrain bigarade), 229
 Linalyl butyrate (lavender), 212
 Linalyl esters (*Chimonanthus fragrans*), 176
 Linalyl isobutyrate (lavender), 212
 Linden, history of extraction, 52
 monograph, 214
 Linseed oil odor of lilac product, 213
 Liquidambar, 18, 21
 (see also *Styrax*)
 Liquid essences, 55
 Liquorice, 164
 Losses of solvent, 100
 Louis XIII, court of, 39
 Lovage, monograph, 274
 odor of, in *opopanax*, 285
 Lupine, monograph, 215
 Luteine dipalmitic ester (tagetes), 245
- M**ace, history, 20
 Maceration (see *Digestion*)
Magistère de benjoin, 49
 (see also *Benzoin*)
Magmata, 33
 Magnolia, monograph, 215
Malagmata, 31
 Manganese, 102
 Margarine (civet), 299
 Marigold, monograph, 216
 Marjoran, history, 20
 Mastic, history, 20, 21
 monographs, 216, 283
 Mate, 164
 Maumené test, 69
 May rose (see *Rose*)
 Measurement of color, 128
 Melanic pigments, 63, 127
 Melilot, history, 20
 isolation of distillate, 150
 monograph, 270
Melinum, 31
 Melon seed oil, used for perfumery, 28
 Melon seeds, enflourage with, 39
 Melting point determination, 144
- Mendesium*, 20
 Metals used in extraction apparatus, 102
 Metallic salts, cause of color, 128
 elimination of colored, 131
 Methane, chlorinated derivatives of, 66
o-Methoxy methyl benzoate (hyacinth), 188
 Methoxy-phenol (castoreum), 297
 Methylacetylcarbinol (coffee), 269
 Methylal, 66, 67
 Methyl alcohol, 66
 for absolutes, 126
 purification and analysis, 70
 test for in ethyl alcohol, 71
 thermal constants, 74
 vapor tension, 74
 Methyl anthranilate, 113, 138, 145
 (fruit juices), 182
 (gardenia), 184
 (jasmin), 194, 197, 198
 (jasmin of Formosa), 200
 (jonquil), 202
 (orange flower), 223-225, 227, 228
 (orange sprout water oil), 229
 (robinia), 234
 (syringa), 244
 (tuberose), 248, 249
 (wallflower), 257
 Methyl benzoate, 138
 (jonquil), 202
 (tuberose), 249
 Methyl chloride, for extraction, 53
 Methyl cinnamate (jonquil), 202
 3-Methylcyclopentadecanone (musk), 300
 Methylene blue test for adsorption capacity, 130
 Methyl ether of β -orcine (oakmoss), 279
 Methyl ether of umbelliferone (lavender), 212
 Methyl ethyl ether, extraction of distillate with, 151
 Methyl eugenol, 138
 (*Acacia Cavenia*), 266
 (hyacinth), 188
N-Methyl methyl anthranilate (hyacinth), 188
 Methylonylketone (oakmoss), 280
 Methyl β -orcine carboxylate (oakmoss), 279, 280

- 2-Methylpentane, in petroleum ether, 69
 3-Methyl-2-(2-pentenyl) Δ -2-cyclopenten-1-one (see *Jasmone*)
 Methylphenylcarbinyl acetate (*gardenia*), 184
N-Methylpyrrole (coffee), 269
 Methyl salicylate, 138
 (*Acacia Cavenia*), 166
 (*Acacia farnesiana*), 168
 (carnation), 174
 (fruit juices: grape, apple, strawberry, raspberry, cherry, plum), 182
 (tuberose), 249
 Methyltrihydroxyanthraquinone (poplar buds), 232
 Methyl umbelliferone (lavender), 212
 Methylumbelliferone ethyl ether, odor of, in fenugreek, 272
Metopium, 28
 Mignonette, analysis, 145
 history, 24, 40, 52
 monograph, 217
 solvent extraction yields, 82
 yield of absolute, 125
 yield of concrete, 59
 yield of distillate, 152
Millefleurs, essence de, 39
 Mimosa, color of concrete, 143
 enfleurage on powder, 41
 extraction, 55, 63
 history, 24
 invention of concrete, 55
 monograph, 219
 preparation of absolutes, 122
 solvent extraction yields, 81
 wax, 139-141
 yield of absolute, 125
 yield of distillate, 152
 Mint, history, 21
 odor of, in acacia ketone, 168
 in *Buddleia variabilis*, 170
 in rose ketone, 240
 water of, 97
 Mirror, heat of burning, 34
 Misan, Science of, 7
M'lati, 22
 Mobile apparatus, 85
 Monomethyl ether of orcine (oakmoss), 279, 280
 Montpellier, influence of on perfumery, 8
Moringa, 27
 Morocco, extraction apparatus in, 56
Moschus moschiferus, 299
 Mosses, moistening of, 60
 (see also *Lichens*, *Oakmoss*)
Mousse d'arbre (see *Oakmoss*)
Mousse de chène (see *Oakmoss*)
Muguet, 213
 Muscone, falsely reported in civet, 299
 (musk), 300
 Musk, added to pomade, 40
 history, 9, 14, 21
 infusion on oil, 120, 121
 monograph, 299
 odor of, in clary sage, 177
 resinoid yield, 80
 tincture and infusion, 78, 79
 used in fats, 43
 yield, 61
 Muskrat, 164
 Musks, nitrated, used for falsification, 157
 Musky sage (see *Clary sage*)
 Myristic acid (orris), 281
Myrobalan, 29
Myron, 31
 Myropolists, 28
Myrouel of Symphorien Champier, 10
 Myrrh, extraction, 49
 history, 20, 29
 monograph, 284
 resinoid yield, 80
 tincture and infusion, 79
 Myrtle, history, 20
 water, 31
 Naphthalene (oakmoss), 280
 β -Naphthol (currant), 179
 Narcissus, extraction, 52, 55, 63
 history, 21, 24, 25
 monograph, 201
 solvent extraction yields, 81
 warm fat treatment, 104, 119
 yield of absolute, 125
 yield of distillate, 152
 Narcotic-smelling bases (jasmin), 198
 Nard, Celtic, 20
 Natural perfumes without waxes, 126

- Natural products without waxes, 126
- Nerol (cyclamen), 179
 (orange flower), 226, 228
 (raspberries), 183
 (robinia), 234
 (rose), 239, 240
 (tuberose), 249
 (wallflower), 257
- Néroli bigarade* (see Orange flowers)
- Néroli, solvent extraction of, 52
- Nerolidol (balsam Peru), 264
 (orange flower), 228
- Néroli-water oils, 97, 227
 (see also Orange-flower water)
- Neryl acetate (orange flower), 228
 (tuberose), 249
- Neryl propionate (tuberose), 249
- Neutralin oils, for digestion and enfleurage, 40
 (see also Vaseline oils, Paraffins)
- Nicotianine (tobacco), 290
- Nicotine (tobacco), 290
- Nicotinic-smelling substance (orange flower), 226
- Nightshade, 32
- Nitrogen compound (orange flower), 226
- Nitrogen compounds, not found in carnation, 173
 not found in currant, 179
- Nomenclature of absolutes and residues, 126
- Nonacosane (poplar buds), 232
- Nonadienal (violet), 254
 (violet leaf), 256
 (see also Violet leaf aldehyde)
- 2,8-Nonadienol-1 (violet), 254
 (violet leaf), 256
- Nonanol (oakmoss), 280
- Non-volatile fractions, composition of, 139
- Nonyl alcohol (see Nonanol)
- Nopinene (currant), 179
- Nossi-Bé, installations for extraction, 56
- Nutmeg, butter, 32, 43
 monograph, 287
 oil, 32
 rose, 41
- Oak gland oil, 28
- Oakmoss, adulterant for patchouli resinoid, 282
 choice of solvent, 69
 extraction, 85
 extraction yield, 60
 history, 20
 monograph, 274
 preparation of absolute, 122
 size of charge, 85
 solvent extraction yields, 82
 steel attacked by, 103
 tinctures and infusions, 78, 79
 treatment in Morocco, 56
 tray load, 86
 used for enfleurage, 41
 yield of distillate, 152
 yields of resinoid, 126
- Oats, used for enfleurage, 39
- Octadienol, tertiary (violet), 254
- Octenoic acid (violet leaf), 256
- Octenol (violet leaf), 256
- Octylic acid (violet leaf), 256
- Odorous fractions, separation by distillation, 132
- Oeanthe*, 20
- Oenanthic acid (violet leaf), 256
- Oenanthal (see Heptanol)
- Oenum*, 34
- Official verbena, 250
- Oils, bouquet, 39
 compound (Bauderon), 18
 definitions, 18
 deodorization, 134
 enfleurage with, 113
 essential, of distillation (Macquer), 19
 expression (Liébaud), 18
 fatty, of expression (Macquer), 19
 floral, altered, 154
 floral, general observations, 104
 natural (Bauderon), 18
 of digestion, ix
 of enfleurage, ix
 of impression (Liébaud), 18
 perfumed, of distillation, 42
 pot-pourri, 39
 pyrogenous (Macquer), 18
 simple (Bauderon), 18
 smoked, 42

- Oils (*Continued*)
 used in enflourage and digestion, 107
 vegetable, for digestion, 107
 Oleic acid (oakmoss), 280
 Olein (civet), 299
 Olfactory analysis, value of, 142
 Olfactory examination, 158
 Olibanum, history, 20
 monograph, 285
 resinoid yield, 80
 Olive oil, history, 4, 28, 39
 properties and tests, 107
Omphancium, 30
Ondatra Zibethica, 164
 Opopanax, monograph, 284
 of perfumers, 284
 resinoid, 55, 80
 tincture and infusion, 78, 79
 Optical rotation determination, 144
 Orange (*see also* Bitter orange)
 history, 21, 22
 Orange flower, analysis of concrete, 145
 compared to karokaroundé, 205
 discoloration of concrete, 155
 discovery of constituents, 138
 enflourage on powder, 41
 extraction, 55, 63
 extraction of distillate, 151
 history, 21, 25, 29, 39, 40, 43
 monograph, 221
 odor of, in gardenia, 184
 in *Jasminum sambac*, 201
 size of charge, 84, 118
 solvent extraction yields, 81
 tray load, 86
 treatment by digestion, 104, 119
 treatment in Syria, 55
 wax, 140
 yield of absolute, 125
 yield of distillate, 152
 Orange-flower water, 31, 61, 96
 extraction of perfume, 97
 monograph, 227
 use in enflourage, 113
 yield, 97
 Orange juice, 182
 Orange leaf, extraction of distilled water,
 97, 227
 extraction of leaf, 162
 Orange peel, 176
 odor of, in *Chimonanthus fragrans*, 175
 Orange-sprouts water, 97
 Orange, sweet (*see* Sweet orange)
 Orchid, monograph, 230
 Orcine (oakmoss), 279, 280
 β -Orcine (oakmoss), 279, 280
 β -Orcine carboxylate, methyl (oakmoss),
 279, 280
 Orcine monomethyl ether (oakmoss),
 279, 280
 Organic bases (castoreum), 297
 Origanum, history, 20
 Orris, concrete, x
 effect of light on tincture, 79
 enflourage on powders of, 41
 history, 20, 24, 34
 monograph, 281
 pretreatment, 64
 solvent extraction yields, 82
 tincture and infusion, 78, 79
 used in Provence *pâtes*, 39
 yield of distillate, 152
 yields of resinoid, 126
 Orsellinic acid (oakmoss), 279
 Otto of rose (*see* Rose)
 Oxidation, decoloration by, 131
 Oximation of concretes, 144
 Ox tallow, 31
 Oxygenated terpene derivatives, solubil-
 ity in various solvents, 68
 Ozocerite, for screening, 114
- P**
Pains d'amandes, 39
 Palestine, extraction apparatus in, 55
Palma Christi, 28
 Palmitate (di), of luteine (tagetes), 245
 Palmitic acid, 141
 (oakmoss), 280
 (violet leaf), 256
 Palmitic acid esters (oakmoss), 280
 Palmitone (tagetes), 245
 Palm oil, 28
 Pandanus, monograph, 230
 Panther fat, 31
 Paraffin (*Chimonanthus fragrans*), 175
 (raspberries), 183
 Paraffin hydrocarbon (apple juice), 183
*Paraffines résiduaire*s, 126

- Paraffins in simple distillation, 133**
 elimination of, 69
 enfleurage on plaques, 114
 extraction of, 124
 for digestion and enfleurage, 40
 (orange flowers), 228
 residual, 126
 screening, 114
 solubility in various solvents, 68
- Parfumeur royal, Le, 14*
Parfums naturels sans cires, 126
 Parma violet (*see* Violet)
 Parmone (violet), 254
Pastenôtres, 39
Pâtage, 110
Patchouli, monograph, 282
 resinoid yields, 126
 solvent extraction yields, 82
 tincture, 78
- Pâtes de Provence, 39*
 Peach juice, 182
 Peach odor of ketones (robinia), 234
 Pear juice, 183
 Peel oils, 176
 Peel waxes, 139
 Pe-mou (*see* Fokiena)
 Pennyroyal, history, 20
 Pentacosane (poplar buds), 232
 Pentane, extraction of distillate with, 151
 for extraction, 53
Pepper, monograph, 288
 Percolation, 79
 Period of year for flowering, 153
 Permeability of plant cells by solvents, 62
 Peru (*see* Balsam Peru)
 Peruvial (*see* Nerolidol)
 Petitgrain, 97
 Petitgrain bigarade, 229
 Petroleum ether, elimination of colored
 products, 129
 extraction of distillate, 134
 extraction of glucosides and pigments,
 127
 extraction of perfume, 44, 53, 60
 fresh plant extraction, 121
 losses of, 100
 purification and analysis, 69
 quantities employed, 93
 quantities lost, 94
 recovery by washing, 75
- Petroleum ether (*Continued*)
 solvent power, 67-69
 thermal constants, 74
 use for isolation from adsorbents, 115
 use for water-oil extraction, 121
 washings of pomades, 123
- Phellandrene (elemi), 282
 Phenol (currant), 179
 (oakmoss), 280
 unidentified, in poplar buds, 232
- Phenols (*Acacia Cavenia*), 166
 (carnation), 173
 (champac), 175
 (currant), 179
 (cyclamen), 179
 (jasmin), 198
 (labdanum), 208
 (oakmoss), 280
 (orange flower), 228
 oxidation products of, 127
 (poplar buds), 232
 (wallflower), 257
 (ylang ylang), 259
- Phenoxyethyl alcohol, 254, 262
 Phenyl acetaldehyde (orange flower), 229
 Phenylacetic acid, 226
 (orange flower), 228
 (tuberose), 249
- Phenylacetic nitrile (*see* Benzyl cyanide)
 Phenylcinnamate (poplar buds), 232
sec.-Phenylethyl acetate (gardenia), 184
 Phenylethyl alcohol, 138, 157
 (carnation), 173
 (hyacinth), 187
 (orange flower), 226, 228
 (rose), 239, 240
- Phenylethyl cinnamate (poplar buds), 232
 Phenylethyl isothiocyanate, 138
 determination of, 145
 (mignonette), 218
- Phenylethyl senevol (*see* Phenylethyl iso-
 thiocyanate)
- Phenylpropyl alcohol (styrax), 266
 Phenylpropyl cinnamate (styrax), 266
 Phlobaphene derivatives, 127
 Phoenicians, traders in perfumes, 4
 Photometers, 128
Physeter macrocephalus, 295
 Physodic acid (oakmoss), 278

- Phytosterol (*Boronia megastigma*), 170
 (hop), 273
 Picrocrocine (saffron), 286
 Pigments, nature of, 127
Pile, 111
 Pineapple juice, 182
 Pinene (orange flower), 228
 Piperonal (see Heliotropin)
 Plumiera, **monograph**, 231
 Plum juice, 182
Pneumata, 6
 Pneumatic enflourage, 114
 Pomade absolutes, 51
 concentrates, decolorized, 126
 defined, ix
 examination, 147
 invention, 19
 manufacture, 122
 extracts, 19
 preparation, 111
 Pomade washings, 51
 defined, ix
 invention, 19
 manufacture, 122
 Pomades, acidification, 155
 alteration, 155
 analysis, 147
 composition, 104
 defined, ix
 history, 31, 33 and ff.
 manufacture, 104
 rancidification, 155
 steam distillation, 148
 yields of distillates, 152
Pomata, 31
 Pomegranate pulp, 31
Pommades aux fleurs, ix
Pommes de senteur, 39
 Poplar buds, **monograph**, 231
 Portuguese, traders in perfumery, 9
 Powders, enflourage with, 40, 115
 Presses, history of use, 36
 Pretreatment of flowers, 60, 61
 Privet, **monograph**, 232
Produits naturels sans cires, 126
 Proof-stick for alcohol, 48
 Propionic acid (poplar buds), 232
 (violet leaf), 256
 Propiophenone (2,6-dihydroxy-4- β -
 methoxy) (poplar buds), 232
 Propyl alcohol, 66, 67
 for absolutes, 126
 Pseudoceryl alcohol, 141
 Pulfrich-Zeiss photometer, 128
 Pulverization of plants, 64
 Purification of recovered solvent, 100
 Pyrazine (coffee), 269
 Pyridine (coffee), 269
 Pyridine odor of bases (oakmoss), 280
 (robinia), 234
 (wallflower), 257
 Pyrrole (N-methyl-) (coffee), 269
Q
 Quercetagenine, 127
 Quince juice, 31
Quintessences, 14, 46
R
Râclage, 110
 Rancidification of concretes, 155
 Raspberries, 183
 Raspberry juice, 182
Rayage, 110.
 Recoloration, 131
 Recovery of solvents, 75, 90
 Red currant juice, 183
 Refractive index determination, 144
 Renaissance, evolution of perfumery dur-
 ing, 9
Réséda (see Mignonette)
 Residual concretes, 126
 Residual paraffins, 126
 Residual waxes, 126
Résines limbées, 31
 Resinoids, analysis, 143
 decolorized, 126
 definition, x, 121
 invention, 49, 51, 55
 manufacture, 59, 80
 monographs, 262 and ff.
 steam distillation of, 152
 yields, 80
 yields of distillates, 152
 Resins, alcoholic extraction of, 121
 (hop), 273
 monographs, 282 and ff.
 yields, 61
Retentorium, 46
 Réunion, extraction installations in, 56

- Rhizomes, 64
 water content of, 60
- Rhizonic ester (oakmoss), 279
- Rhizotomos*, 5
- Rhodinol (rose), 239, 240
 apparent, in rose geranium water, 242
- Rhododendron, monograph, 233
- Rinds, waxes of, 139
- Robinia, history of, 24, 52
 monograph, 233
 solvent extraction yields, 81
 yield of absolute, 125
- Rome, perfumery in ancient, 5
- Roots, planing of, 64
 water content of, 60
- Rose, concrete, color of, 143
 discoloration of, 131
 distillation of, 133
 distillation in extractor, 96
 extraction, 52, 55, 56, 63
 extraction of distillate, 151
 falsification, 57
 history, 21, 23, 24, 26, 34, 38-40, 50
 indole in, 138
 methyl anthranilate in, 138
 monograph, 234
 otto of, distillation, 96
 pomade by digestion, 118, 119
 pretreatment, 63
 size of charge, 84, 118
 spirits, 49
 tray load, 86
 treatment, by warm fats, 104, 119
 in Bulgaria, 55
 in Morocco, 56
 waxes, 139-141
 yield by extraction, 63, 81
 yield of absolute, 125
 yields of distillates, 152
- Rose de mai* (see Rose)
- Rose geranium, monograph, 241
- Rose laurel (see Rhododendron)
- Rosemary, history, 20
 monograph, 242
 water oil, 97
- Rose, May (see Rose)
- Rose, nutmeg, enfleurage on powder, 41
- Rose water, 31, 61, 96
 extraction of perfume, 97
 monograph, 240
- Rose water (*Continued*)
 use in enfleurage, 113
 yield of, 97
- Rosolic acid, 141
- Rotation determination, 144
- Roué*, 85
- Royal jasmin, 188
- Rue, history, 21
 monograph, 243
- Rye, used for enfleurage, 39
- S**
- Sabinene (currant), 179
- Sabinol (currant), 179
- Saffron, monograph, 286
- Safranal (saffron), 286
- Sagapenum, history, 20, 49
- Sage, odor of, in *Buddleia variabilis*, 170
- Sage (see Clary sage)
- Saint-John, herb of, 180
- Salerno school, influence on perfumery, 8
- Salicylic acid (*Acacia Cavenia*), 166
 (fruit juices), 182
 (violet leaf), 256
 (wallflower), 257
- Salicylic odor of elder, 180
- Salts, essential, 50
- Sandalwood, history, 9, 21
 monograph, 287
 solvent extraction yields, 82
- Santaulx*, 21
- Saponification value determination, 144
- Saponins, solubility in various solvents, 68
- Savin odor of mastic, 283
- Savory, history, 20
- Schoenos*, 20
- Schuei flowers, 199
- Sclareol (clary sage), 178
- Scourin*, 36, 119
- Screening, 114
- Seeds, crushing of, 64
 water content of, 60
- Sempsen*, 28
- Serpentaria (see Canadian serpentaria)
- Sesame oil, used in perfumery, 27
- Sesame seeds, enfleurage over, 38
- Sesquiterpene alcohol $C_{15}H_{26}O$ (clary sage), 178
 (poplar buds), 232
- Sesquiterpene alcohol or diterpene alcohol (jasmin of Formosa), 200

- Sesquiterpene alcohols (*Chimonanthus fragrans*), 176
(currant), 179
(Zdravets), 260
- Sesquiterpene azulenes (privet), 233
- Sesquiterpene products (labdanum), 208
- Sesquiterpenes, absence of, in concretes, 138
(*Chimonanthus fragrans*), 176
(currant), 179
extraction, 124
(ylang ylang), 259
(Zdravets), 260
- S-gaiazulene (Zdravets), 261
- Shale oil fractions, 53
- Sheep grease, 31
- Sicily, extraction apparatus in, 55
- Silica gel, 101
enfleurage with, 115
for adsorption, 129
- Silicyprion*, 28
- Simple distillation, 133
- Single violet (*see* Violet)
- Skatole (civet), 299
- Skleron, 102
- Societies of perfumers in France, 10, 12
- Sodium sulfate, used for desiccation, 62
- Soil, influence of, 26
- Solanum*, 32
- Solvents, choice of, 53
conditions for use, 65
dilution with as fraud, 157
distillation and recovery, 72
fire, explosion and poisoning from, 77
for absolutes, 126
latent heat of vaporization, 74
physical properties, 73
presence in concretes, 143, 147
purification after recovery, 100
quantities employed, 94
quantities lost, 94
recovery, 75, 82
recovery of non-condensed, 100
solvent power of, 67, 68
specific heat, 74
thermal constants, 74
vapor tension, 74
volatile (*see* Volatile solvents, Petroleum ether, Benzene)
- Somali incense (*see* Olibanum)
- Sophistication (*see* Falsification)
- Soxhlet apparatus, 82
- Spanish broom (*see* Broom)
- Spanish jasmin, 188
- Spanish verbena, 250
- Specific gravity determination, 144
- Specific heat of common solvents, 72, 74
- Specificity of adsorption, 129
- Spices, monographs, 287
stabilization of fats with, 43
- Spikenard, 20, 21
- Spirits, definition, 6
- Spirits of odor, 19
- Sprout water oil, 229
- Stabilization, of harvested plants, 62
of perfumed fats, 42
- Starch, used in enfleurage, 41
- Stationary apparatus, 55, 84
- Steam-distillates, yields compared, 112
- Steam distillation, 133
- Stearic acid, 141
(oakmoss), 280
- Stearic alcohol (oakmoss), 280
- Stearic aldehyde (oakmoss), 280
- Stearic (hydroxy) acid, 141
- Stearoptenes (rose), 240
- Steel for extraction apparatus, 102
- Stems, water content of, 59
- Sterols, solubility in various solvents, 68
- Storax, 40
- Strawberry juice, 182
- Stymna*, 33
- Styracine (styrax), 266
- Styrallyl acetate (*see* sec.-Phenylethyl acetate)
- Styrax, history, 20, 40, 42
monograph, 265
resinoid, 55, 80
tinctures and infusions, 78, 79
used to stabilize fats, 43
- Suet, extraction with, 104
origin and preparation, 105
physical and chemical properties, 105
test for purity, 105
- Sugars, solubility in various solvents, 68
- Sulfur-containing products (carnation), 173
- Sumbul, monograph, 288

- Summa perfectionis* of Geber, 7
Susimum, 20
 Sweet orange, monograph, 243
 Swinging extractor, 55
 Sylvestrene (coffee), 269
 Synthetic aromatic chemical industry, 137
 Synthetics, use for fraud, 156
 Syria, extraction apparatus at Beirut, 55
 Syringa, history, 52
 monograph, 243
- T**
 Tacmahac balsam, 231
 Tagetes, monograph, 245
 Talc, used in enfleurage, 41
 Tallow, 31, 35
 Tamr-el-Hinna, 272
 Tannins, solubility in various solvents, 68
 Tanoids, 127
Taux journalier d'enfleurage, 110
 Tchéou-Li, 3
 Tea, monograph, 288
 Tea rose (*see* Rose)
 Technique of decoloration, 130
 Tel-Aviv, Palestine, extraction apparatus at, 55
 Terpene alcohols (*Chimonanthus fragrans*), 176
 (currant), 179
 Terpene derivatives (oxygenated), solubility in various solvents, 68
 Terpenes (*Chimonanthus fragrans*), 176
 (citrus peel oils), 176
 (currant), 179
 Terpenes, absence of, in concretes, 138
 Terpenes (hydrocarbon), extraction of, 124
 Terpeneol (*Chimonanthus fragrans*), 176
 (gardenia), 184
 (orange flower), 228
 (robinia), 234
 Terpeneols (currant), 179
 Thiophene, test for, in benzene, 70
 Thujone (oakmoss), 280
 Thyme, added as fixative, 39
 history, 20
 monograph, 245
Tiames, 40
 Time of harvest, 25
- Tinctures, aging, 79
 definition, 61
 preparation, 78
 (*see also* Infusions, and individual products, as Ambergris, Vanilla, etc.)
 Tintometers, 128
 Tobacco, monograph, 290
 Tobacco camphor (*see* Nicotianine)
 Tobacco, odor of, in melilot, 271
 in tea resinoids, 289
 Toledo, role in evolution of perfumery, 8
 Tolu (*see* Balsam tolu)
 Toluene, 66
 for flower-water oils, 97
 purification and analysis, 70
 solvent power, 67, 68
 thermal constants, 74
 toxicity, 77
 Tonka bean, choice of solvent, 69
 desiccation, 61
 extraction yields, 60, 82
 infusion on oil, 120
 isolation of distillate, 150
 monograph, 271
 pretreatment, 65
 resinoid yields, 126
 tincture and infusion, 78, 79
 Toxicity of solvents, 77
 Tree moss (*see* Oakmoss)
Trésor des remèdes of Conrad Gessner, 10
 Triacontane (*Boronia megastigma*), 170
 in flower waxes, 139
 1,5,5-Trimethylcyclohexanone-6 (labdanum), 208
 1,5,6-Trimethylnaphthalene, from scareol, 178
 Tuberculès, 64
 Tuberone, claimed to be found in tuberose, 249
 Tuberose, biological process, 202
 concrete, discoloration of, 155
 yield of distillate, 152
 enfleurage, 104, 108 and ff.
 enfleurage on powder, 41
 extraction, 52, 63
 history, 21, 22, 25, 39, 40
 monograph, 246
 odor of, in pandanus, 231
 in plumiera, 231

- Tuberose** (*Continued*)
 pomade, yield of distillate, 152
 proportions to fats, 109
 solvent extraction yields, 81
 yield of absolute, 125
 yield of concrete, 59
- Ultraviolet radiation for aging**, 79
- Umbelliferone** (galbanum), 283
 not found in lovage root, 274
 (sumbul), 288
- Umbelliferone methyl ether** (lavender), 212
- Unguentum**, 31
- Unguentum rosatum**, 34
- Unsaturated alcohols** (tuberose), 249
- Usnea**, 21
- Usnic acid** (oakmoss), 278
- Vacuum**, production of, 103
- Valerian**, 20
- Valerianic (iso) acid** (*see* Isovalerianic acid)
- Vanilla**, desiccation, 61
 extraction, 66
 history, 14
 infusion on oil, 120
monograph, 290
 odor of, in heliotrope, 186
 in hyacinth, 187
 pretreatment, 65
 resinoid yields, 126
 solvent extraction yields, 82
 tincture and infusion, 78, 79
- Vanillic acid** (sumbul), 288
- Vanillin**, 138, 292
 (balsam Peru), 264
 (balsam tolu), 265
 (benzoin), 268
 (oakmoss), 280
 (styrax), 266
 (vanilla), 293
- Vanillon**, 291, 293
- Vanillone** (coffee), 269
- Vapor tensions of common solvents**, 72, 74
- Vaseline oils**, 40, 104
 properties and tests, 107
- Veal grease**, 31
- Vegetable oils, for digestion**, 107
- Venice, role in perfumery**, 8
- Verbain** (*see* Verbena)
- Verbena, monograph**, 249
 solvent extraction, 52
 solvent extraction yields, 82
 yield of absolute, 125
 yield of distillate, 152
- Verveine**, 250
- Vetivert, history**, 20
monograph, 294
 pretreatment, 64
 solvent extraction yields, 82
- Victoria violet** (*see* Violet)
- Vine flower**, 20
- p-Vinylcatechol** (coffee), 269
- Vinyl guaiacol** (coffee), 269
- Violet, history**, 21, 24, 25, 34, 38, 40, 50
monograph, 251
 odor of, in acacia ketones, 166, 168
 solvent extraction yields, 81
 treated by warm fats, 104, 119
 wax, 139-141
 yield of absolute, 125
- Violet leaf, aldehyde from**, 138
monograph, 288
 solvent extraction, 55
 solvent extraction yields, 82
 yield of absolute, 125
 yield of distillate, 152
- Violiers**, 257
- Viverra civetta and other Viverra species**, 297, 298
- Volatile solvent extraction, extension of processes**, 55
 history, 44 and ff.
 industrialization, 54
 modern manufacture, 59
- Wallflower, history**, 41
monograph, 256
 solvent extraction, 52
- Walnut oil**, 28
- Washings, alcoholic**, 121
 from concretes, definition, x
 of pomades, 122
 with heavy oils, 75
- Water content of plants**, 59, 60

- Waters, aromatic, extraction of, 96
- Waxes, in *Chimonanthus fragrans*, 175
insoluble, 121
of concretes, 139
of flowers, peels, plants, 139
removal, 124
residual, 126
solubility in various solvents, 68
white, added to pomades, 106
- Whale product (*see* Ambergris)
- Wheat, used for enfleurage, 39
- White carnation (*see* Carnation)
- White currant juice, 183
- White lily (*see* Lily)
- White narcissus, 201
- White wax (*Chimonanthus fragrans*), 175
- Whortleberry juice, 183
- Wild ginger, 164
- Wistaria, monograph, 257
yield of absolute, 125
- Wisteria (*see* Wistaria)
- Woad, extractive of, 45
- Wood charcoal, adsorption with, 129
- Wood spirits fractions, for extraction, 52
- Woods, planing of, 64
water content of, 60
- Wool grease, 31
- Wormwood, history, 21
- Xanthohumul (hop), 273
- Xanthonic pigments, 127
- Xanthophylls, 127, 129
- Yellow violet (*see* Violet)
- Yellow wax (*Chimonanthus fragrans*), 175
- Yields, compared for various extractors, 91
compared for various processes, 112
from enfleurage, 111
of absolutes, 124
of concretes, 59, 60, 81
of flower-water oils, 97
of pomade concentrates, 124
- Ylang ylang, extraction of, 56, 63
extraction of distillate, 151
falsification of, 158
monograph, 258
odor of, in pandanus, 231
yield of absolute, 125
yield of concrete, 59, 81
yield of distillate, 152
- Zdravets, monograph, 260
solvent extraction yields, 82
wax, 139
yield of absolute, 125
yield of distillate, 152
- Zedoary, 164

