

CENTRAL LIBRARY

**Birla Institute of Technology & Science
PILANI (Rajasthan)**

Call No 711
 T 771 T

Accession No. 55076

Acc. No... ..

ISSUE LABEL

Not later than the latest date stamped below.

2 Apr 75

**TOWN PLANNING
AND
ROAD TRAFFIC**

By the same Author

**ROAD TRAFFIC
AND ITS CONTROL**

*(Volume VII in "The
Roadmakers' Library")*

EDWARD ARNOLD & Co.

TOWN PLANNING AND ROAD TRAFFIC)

By

SIR ALKER TRIPP

C.B.E. —

Assistant Commissioner of Police, Scotland Yard

Author of "Road Traffic and its Control"

Foreword by

SIR PATRICK ABERCROMBIE

M.A., F.R.I.B.A.



LONDON

EDWARD ARNOLD & CO.

*Copyright in all countries signatory to the
Berne Convention*

First published 1942

Reprinted 1943 (twice), 1944, 1946 and 1951

*Printed in Great Britain by
Butler & Tanner, Ltd., Frome and London*

FOREWORD

By

PROFESSOR PATRICK ABERCROMBIE

The science of Road Design to meet the requirements of motorised traffic is still in its infancy ; few people, whether those who use roads for the purpose of getting about, those who use buildings facing on to roads or those who plan roads as one aspect of the arranging of our physical environment, have as yet fully grasped the implications of the internal combustion engine on the land ; and while we are still struggling to adapt ourselves to this minor revolution we shall soon be faced with the effect on our daily lives of the internal combustion engine in the air. In war we have had a glimpse at its possibilities ; in peace we shall find ourselves still groping in the dark. This is one of the major difficulties of civilisation, namely, the length of time which it takes to adapt general human existence to individual human inventions.

With roads, of course, the vested interest, both public and private, of existing relics of the past prevents any complete realisation of a new Design, even when bombing and fire have given some opportunity. But impossibility of realisation should not preclude clarity of thought, upon which a plan of action can be based, tending towards the full conception. And yet I venture to say that the majority of people are still mentally biassed, unconsciously perhaps, by the old vision of the pony-trap, the cart-horse, the waggon or the hansom cab. Though some of the younger members of our generation may have never seen a hansom, they too are like dogs whose more numerous life-periods have not yet accustomed them to the speed of cars ; *we* may have grasped their speed (though the Police might dispute even that), but certainly have not grasped their more remote implications. It is still possible to find shopkeepers who think that it is an advantage to have a ceaseless stream of through-traffic—motor lorries, train-catching taxis, etc.—passing their

FOREWORD

plate-glass windows and making crossing the street by shoppers a perilous enterprise—Lord Street, Liverpool, Market Street, Manchester, The Moor, Sheffield, Oxford Street, London, are all grotesque survivals of the horse-drawn vehicle age. Are steps being taken to render them more satisfactory as shopping streets, making use of destruction where this has occurred? Are the shopkeepers asking for less through-traffic and wider pavements and are the authorities considering how these things can be done?

It is still possible to find mothers of families who declare that they prefer to live in houses directly facing on to motor-tracks compared with which an unfenced railway is like a country lane; so lovely and lively, they say, until one of the children is killed crossing the road on the way to school. It is still possible to hear an official advise against canalising through-traffic in streets planned for the purpose and advocate the continuance of the fortuitous filtering of through-traffic along streets in which people live and doctors work. It is still possible to hear an enterprising housing reformer advocate using the street for children's playgrounds; (even when the street is freed from through-traffic, the motor milk and other vans scatter their play and may imperil their lives).

It was still possible, a year or two ago, to hear some members of Parliament describing the ideal of trunk-roads as running from one end of England to the other ribboned by cycle-tracks and footpaths, as though any pedestrian wished to walk from Newcastle to Southampton, though his tour was by stages, within a few feet of the sight, sound and smell of motor lorries. A few years before that, it was still possible for short-sighted officials to prevent the purchase of enough land to control the development of the frontages of the arterial roads of London which were then being made, with the results which can be seen to-day on the Great West Road. About the same time the Italian planners (more backward than ours) were constructing those new towns for Mussolini in which the central civic and shopping square is placed exactly at the intersection of national traffic routes. But Italy must be given the credit of being one of the pioneers, with the U.S.A. and Germany, of the conception of a modern motor-

FOREWORD

road in the country, which should be treated very much like a main-line railway. And yet there are still people in this country who oppose a similar treatment here, urging that we are too small and thickly populated a country, that these motor-roads would desecrate rural England, whereas they would be the best means of preserving the historic beauty of our existing roads and villages.

All these are examples, selected at random, which illustrate how slowly our minds adapt themselves to new conditions of environment. The legal position is yet more antiquated than technical practice or public instinct. We are still labouring under a street invented by the Bye-laws under the 1875 Public Health Act ; it is a street that is practically never used, as it is too narrow for arterial and too wide and expensive for local roads, but it still exists as a sort of ghost of the past used to frighten people who build a house into doing something to be let off having to make a "bye-law road", for the use of the public. The incidence of road charges encourages a developer to build narrow-fronted deep and dark houses instead of wide, shallow and sunny ones. These charges still favour ribbon building on existing roads (in spite of the Act to prevent it), they are still based upon the Victorian idea that the size of a man's income is indicated by the size of the house he lives in ; the man in a small house who owns two cars is much better treated than the man with a family in a larger house who walks to his work. But I am in danger of straying from the subject of road traffic into the wider one of public and private responsibilities which, none the less, require complete overhauling.

In the midst of this rather gloomy backward-looking scene, it is pleasant to find the Police, instead of performing the negative role so often assigned to them of the prevention of wrongdoing, are our most progressive positive reformers. Their interest in road traffic may appear to the ordinary person limited to giving a personal touch to mechanical traffic lights and road-signs (now lamentably non-existent) and to enforcing speed limits. A wider conception would be that their interest is in the safety and comfort of human beings and in the convenience and economy of road communications : Human Life and Business. They see at first

FOREWORD

hand the danger and delay due to the maladjustments to which I have alluded. But it has been left to Mr. Alker Tripp, Assistant Commissioner of Police at Scotland Yard, to turn his experience into the practical form of a system of modern Traffic Planning. He realises that however much the disadvantages of traffic can be ameliorated by personal effort in its midst—and the work of the London Police must be acknowledged to be, by a combination of skill, imperturbability and human kindness, the best in the world—it is only by planning that a radical improvement can be found ; nor is the planning only of the nodal points—the roundabout, the flyover, the clover-leaf—sufficient. Perhaps Mr. Tripp's most original contribution to planning in general is his development of the idea of the "Precinct." It was implicit in the by-pass ; Mr. Tripp has given it a more positive and especially an urban significance. If I were to try to sum up Mr. Tripp's theory in a single phrase (which, of course, would be inadequate) I would say it was this : " The nondescript Traffic Road must go." He himself puts it rather more fully :

" Roads and road layouts cannot, with complete success, be projected and designed by people who think mainly in terms of physical survey, construction, architecture, finance—or even town planning ; it is necessary also to think, and to think accurately, in terms of traffic control."

I can speak personally for one town and country planner who has benefited enormously from Mr. Tripp's accurate and, may I add, intrepid thinking on the subject of Road Design for the Motor Age.

PATRICK ABERCROMBIE

UNIVERSITY OF LONDON,
March, 1942.

AUTHOR'S PREFACE

It has been said that the town-planning of our great cities is governed by their sewers. This is truthful caricature, for the town planner finds himself encompassed on every hand by the works of other people, and his task is everywhere conditioned by the technique of enterprises which are not his own. Among the most formidable of his conditioning factors is that of modern road traffic: hence the importance of co-ordinating the technique of town planning and of road traffic control.

I believe I am right in saying that, when I wrote my book on "Road Traffic and its Control," I was writing the first comprehensive study of the subject. The object of the book was to review in outline the whole field of traffic direction, its supervision and control, the making and enforcement of traffic law, and the relevant problems of public opinion and psychology, of road layout and equipment, and of town and country planning. A reviewer opined that it was "perhaps too much to ask that any one man should have expert knowledge on matters ranging from public psychology to the planning of towns"; but that, *pace* the reviewer, is in reality the very essence of the case. Few, if any, of us can master the whole of our fellow technicians' fields of enterprise, but each of us *must* learn such details of their technique as impinge upon our own.

To try to work in water-tight compartments is fatal. If anyone thinks for example that the use-zoning in the town plan can be left entirely to one party and the communications entirely to another, he is on the high road to failure. The whole structure must be intimately knit and truly balanced. The object of the present book is to convey some of the major demands which road traffic control must make upon the town and country planner.

There are two points in this connection which have a certain importance of their own. First, transport and traffic are different matters, though most people seem to use the terms as if they

AUTHOR'S PREFACE

were interchangeable. Road transport relates to the science and art of portage and haulage, whereas road traffic relates interchange and passage, and includes the whole interplay as "give-and-take" between public and private vehicles, goods vehicles, pedestrians, driven animals and everything else. In the design of town and country road systems, the approach must be from the point of view of traffic, and not merely from that of transport. The transport operators have their own viewpoints, as also have the pedestrian, the pedal cyclist and the private car driver. When all of these classes are to be catered for on the same road systems, the problem becomes predominantly a traffic problem.

Secondly, it is necessary in planning to think in terms of complete road systems, and not merely of major roads. A plan is of little use which merely gashes great highways through the landscape or townscape and leaves it at that. The great highways, present and future, must be accurately and sagaciously linked with the whole plan; and the latter task is likely to be the stiffer problem of the two.

I should perhaps apologise to any readers who are disappointed at the complete absence of designs for ambitious flyover junctions, like those favoured in America. This book is written primarily for readers at home, and our problem is not parallel to that of America. Our density of population to the square mile is nearly twenty times as great as theirs, the proportion of motor vehicles to population in this country is only one-fifth of that in the United States, and the number of pedal cycles here is very high in relation to the total population, whereas in the United States it is very low. It is not, however, wholly on account of these differences, and certainly not through lack of knowledge or experience of American conditions, that I neglect the big flyover junction; it goes deeper than that. We must get our fundamentals right before we deal in elaborate top-hammer, and we can't afford to spend money in frills as long as the fundamentals are all wrong. This last consideration I would respectfully offer to my many friends in America as well as to readers at home. Even the comparatively modern cities of

AUTHOR'S PREFACE

America were not designed for fast motor traffic, while our own cities, from that point of view, are merely an unplanned muddle.

Post-war reconstruction will not enable us to create new and utopian townships throughout England's green and pleasant land, but it will register a fresh starting-point, where possibilities are reviewed, ideas marshalled and general lines of policy established. Upon the accuracy of the *approach* the results of post-war planning will depend ; and if the opportunity is great, so also is the responsibility of using it to the best advantage. Where mistakes are made now, future generations will have to pay the price.

H. A. T.

NOTE

In his official capacity as the Assistant Commissioner of Police at Scotland Yard in charge of traffic, the author has had considerable experience in all phases of traffic control ; though, however, he writes in the light of that experience, the statements and views put forward in this book are entirely his own ; they are in no way official pronouncements.

CONTENTS

	PAGE
I TOWN PLANNING AND TRAFFIC CONTROL	15
II THE SCIENCE OF TRAFFIC CONTROL	18
Division of Function. The Police. The Engineer. Restriction and Construction. Education. The Psychological Factor. The Pedestrian. The Pedal Cyclist. General Vehicular Movement. Other Traffic Problems. Road Traffic and Town Planning.	
III THE SCIENCE OF TOWN PLANNING	35
Communications. Importance of the Roads in the Town Plan. Classical Layouts. Drawing-Board Plans. The Road System.	
IV STATE CONTROL OF PLANNING	38
A Nation-wide Scheme. Private Interests. Development or Dispersal.	
V THE DESIGN OF ROADS FOR TRAFFIC REQUIREMENTS	40
Space for Circulation. Separation of Opposed Streams. Classification of Roads. Arterial Roads. Sub-Arterial Roads. Local Roads. Parkways. Junctions and Intersections. Layout for a New Town. Application of Principles to Existing Town Layouts.	
VI SURVEY OF EXISTING TOWN LAYOUT	58
Nondescript Roads. Existing Road Space. Road User.	
VII REFORM OF EXISTING TOWN LAYOUT.	60
New Road Plan for an Old Town. Ring Roads. The Central Area. Effective Compromise. Standing Vehicles. The Plan Takes Shape. Isolation of Arterial Grid. Linkage with Local Roads. Precincts. Insulation. Frontages. Separation of Levels. Road Widths. One-Way Working. Resultant Layout. The Smaller Towns. A Cross Check on the Town Plan. Priority of Treatment.	
VIII SUBURBAN LAYOUT	89
General Arrangement. A Practical Example. New Building.	

CONTENTS

	PAGE
IX IN THE COUNTRY AND THE VILLAGES	95
Local Roads. Main Roads. By-Pass Roads. New Building. The General Picture.	
X TRAFFIC SIGNALS IN TOWN PLANNING	104
Detached Installations. Co-ordinated Systems. Speed Control. Turning Traffic. Pedestrian-Operated Signals. "Deterrent" Signalling. The General Plan of Campaign.	
XI CONCLUSION	111
INDEX	115
FOLDING PLATE	<i>at end</i>

TOWN PLANNING AND ROAD TRAFFIC

I

TOWN PLANNING AND TRAFFIC CONTROL

Town planning, as we now know it, is a science of quite recent origin. During the centuries there were many examples of deliberate planning of the centre of towns, but the surrounding development was generally confused and even chaotic. In the case of continental cities the walls and fortifications imposed a certain degree of discipline, but in our own country even that restraint long ago ceased to obtain. Modern science, which sets out to tidy up the confusion and to achieve real order and design, addresses itself to an up-hill task. But the beginnings of that task are now well in hand.

In the science of town planning the road communications play an important part, and it is with this aspect that the present book is concerned.

Exponents of town planning have always, and with good reason, insisted that the communications must be adequate. There is, however, another aspect more vital still, which has not yet received the full attention which it deserves, namely that the communications must also be *safe*. During the ten years preceding the war 68,248 persons were killed and 2,107,964 injured on the roads of Great Britain. Casualties on that scale are at battle level.

There has been a good deal of argument, to no great profit, as to whether it is the roads or the road users that are responsible for the casualties. The answer is that both are to blame. The roads were not designed, nor are they fitted, for modern traffic conditions ; but, the roads being at this moment what they are, proportionate care ought to be exercised by road users. As

TOWN PLANNING AND ROAD TRAFFIC

such care is *not* exercised, and as it becomes quite clear that we shall not alter human nature, we must alter the roads.

The whole trouble originates in unsuitable layout; the problem is fundamentally one of design and planning. On the railways the toll of casualties is not comparable to that of the roads because the railways were from the outset designed for mechanical transport. The roads were not so designed. On the railways proper layout came first and high speeds afterwards; on the roads high speeds were introduced on primitive and unprotected tracks; and now, after more than a generation, the right kind of layout both in our towns and in the country at large is still awaited. All this will have to be changed. It is in the towns and built-up areas, which are the special field of the town planner, that the great majority of casualties are occurring.

Many efforts towards greater safety have already been made. Since the beginning of the present century the provision of refuges and islands for pedestrians crossing the road has been greatly increased; valuable work has been done by the Town Planning Institute in regard to the general principles of the layout of cross-roads, junctions and corners,¹ and the design and layout of principal roads,² the aim being to secure safer and better vehicular circulation. Important memoranda on the subject have been issued by the Ministry of Transport³ with the same end in view. The problem, however, remains.

Of the persons killed in road accidents in London 60 per cent are pedestrians—or, in other words, mostly the local inhabitants. *Any town so planned that its citizens are killed and injured in vast numbers is obviously an ill-planned town.* The town plan may have a thousand virtues, but on the very highest level it has failed. This matter is one that has to be faced and settled.

It is easy enough to take a drawing-board and to lay out in plan the roads that will be necessary for traffic circulation; it is equally straightforward to survey lines for new roads and

¹ *Report on the Layout of Cross Roads, Junctions and Corners.* The Town Planning Institute, 1928.

² *The Design and Layout of Principal Roads.* The Town Planning Institute, 1936.

³ cf. *Memoranda on the Layout and Construction of Roads, 1930, 1938, etc.*

TOWN PLANNING AND TRAFFIC CONTROL

to chalk them in upon a map. But that is no solution of the major problem, because new roads on the old lines will only produce more casualties still. If town and country planning is to succeed, it must cope effectively with the problem of death and danger on the road.

To say this is not to suggest of course that the town planner is the only party concerned in the problem ; there are the Government Departments over all, and then also there are the Police. The Police in the ordinary course of their duty, however, can only deal with the disastrous effects of unsuitable layout, whereas the town planner can cope with the trouble at source ; he can so plan as to abolish the conditions which produce the casualties.

Again and again we are brought back to the matter of planning. It is wrong to have the local groups of population clustering about conduits that carry high-speed traffic ; it is equally wrong to lead the heavy traffic-flows through places where shopping crowds congregate ; and these things must not be allowed to go on happening just because they have happened for years and years past. Replanning is the only cure. The town planner is anxious, and most rightly anxious, to establish a calculated balance between the industrial, business and residential areas, and between built-up areas and open spaces ; but the balance will have to be so struck that real safety is achieved. The entire layout of all newly developed areas must, if necessary, be made dependent on that safety factor ; it would be rather futile to plan, by means of layout, for hygiene and amenity, but at the same time to overlook that this same layout is likely, daily and hourly, to cause death or maiming. If the town planner will exploit his opportunities to the full, orderly arrangements will replace the present cross-currents and confusion.

Sound and rapid circulation by road must of course also be promoted, and careful investigation of traffic control leads definitely to the conclusion that a high safety factor is necessary if traffic-flows are to be both rapid and orderly ; those two problems are in fact one.

TOWN PLANNING AND ROAD TRAFFIC

The control of road traffic is a somewhat tangled and difficult affair, but, when we come to study it, we begin to find some important underlying principles. Equally with the town planner the traffic specialist has his own science and technique. Sound planning can only be achieved by pooling the resources of the two sciences—town planning and traffic control.

II

THE SCIENCE OF TRAFFIC CONTROL

Division of Function

In road traffic control the present stage is transitional. On road systems intended for horse-drawn traffic railway speeds have suddenly developed, and drastic redesign is wanted. That is a truly colossal task, not to be settled in a day—or in a generation, for that matter. In the meantime, until the roads can be made to fit the traffic, the traffic must be made to fit the roads. This means that, during the present phase, the traffic must be disciplined by means of laws and regulations, often complex and always tiresome. Traffic control proceeds in fact simultaneously along two parallel lines, viz.

(1) Restrictive measures, the aim of which is to maintain public safety by legal prohibitions until such time as the roads have been made structurally safe and adequate. These measures are devised by the legislature and implemented by the Police.

(2) Constructive work, the ultimate aim of which is to make the vehicle-tracks as well adapted, fenced and arranged for high speed, without danger to the general public, as the railways are; and at the same time to provide adequate road space for the vastly increased number of vehicles. These works are implemented by the engineer, but the town planner can play a very important part in devising them.

THE SCIENCE OF TRAFFIC CONTROL

Constructive work represents the path to complete solution of the whole problem, restrictive measures are only the provisional safeguards which in the meantime are indispensable. The more that can be done on the constructive side the less will restriction be necessary. The process is continuous, and the aim of the traffic specialist is to establish an accurate balance, at every given time and place, between restrictive and constructive measures. To this we will return in a moment.

Traffic science may be divided into two principal branches :

- (a) the "Dynamic," which is the study of the movement and habits of traffic, and
- (b) the "Static," which is the study of road layout and construction, with a view to facilitating and safeguarding the movement of traffic.

Broadly speaking, the first is the province of the people who have the day-to-day control of the traffic, the second is the province, not only of the engineer, but also of the town planner.

Clearly the first must condition the second. It would be a great mistake if road layout were designed save in the fullest possible light of experience of the actual handling of traffic. That being so, the town planner will first of all want to gather as much as he can of the practical knowledge of the people who actually handle the traffic, for they can speak from experience.

The Police

When William Phelps Eno, the first modern-minded writer on road traffic problems, compiled his first volume, he began his opening chapter with this simple sentence : " The Police regulate traffic on the highways." Very many people now interest themselves in the traffic problem, and are sometimes quite dogmatic about it ; but few of them really possess that intimate knowledge which is needful. It is the Police who, being the persons on the spot, have the first-hand knowledge. From their reports and figures, casualty maps and graphs can be worked out by others and statistics can be compiled, but the whole main fund of basic knowledge, as well as of practical experience, remains

TOWN PLANNING AND ROAD TRAFFIC

and can only remain with the Police. This applies not only in regard to accident location, but to the behaviour, habits and vices of road users which the Police are able to observe with a trained eye. They can say where and why the traffic difficulties and delays occur : they know in fact just where the shoe pinches. In the light of their knowledge the town planner can often be guided to a solution which might otherwise be reached only after a long and costly process of trial and error.

The Engineer

The contribution made by the engineer and surveyor is an equally important one. He is a constructive worker in the whole science of road design and is himself continually engaged on the planning and improvement of roads and road layout. In addition, it is he who gives effect to the general plans which the local authority or town planner may conceive.

Restriction and Construction

All too often in the past, authorities have relied upon regulation by law and by Police when the situation could have been regulated much more effectively by means of layout and construction. When trouble arises at a particular point, it is easy and cheap to get a regulation made and to toss it over to the Police for enforcement. But that is not the best method. Nothing should ever be done by means of legal restrictions which it is practicable to effect by layout ; this principle must be regarded from the outset as an axiom of traffic science. To restrict movement by law and Police is likely to be both irksome and inefficient, whereas guidance by layout and mechanical equipment is efficient and, generally speaking, congenial.

A couple of very simple examples taken from fact will make the point much better than theoretical argument ; the first is one where the problem was of the control of vehicles, the second concerned the control of pedestrians.

The first example is shown in Fig. 1. A new arterial road A was built roughly parallel (at this point) to the existing road B ;

THE SCIENCE OF TRAFFIC CONTROL

other existing roads were C and D. Then, as so often happens and ought not to happen, a series of residential roads was built, E, F, G, H and J, opening directly upon the new artery, thus

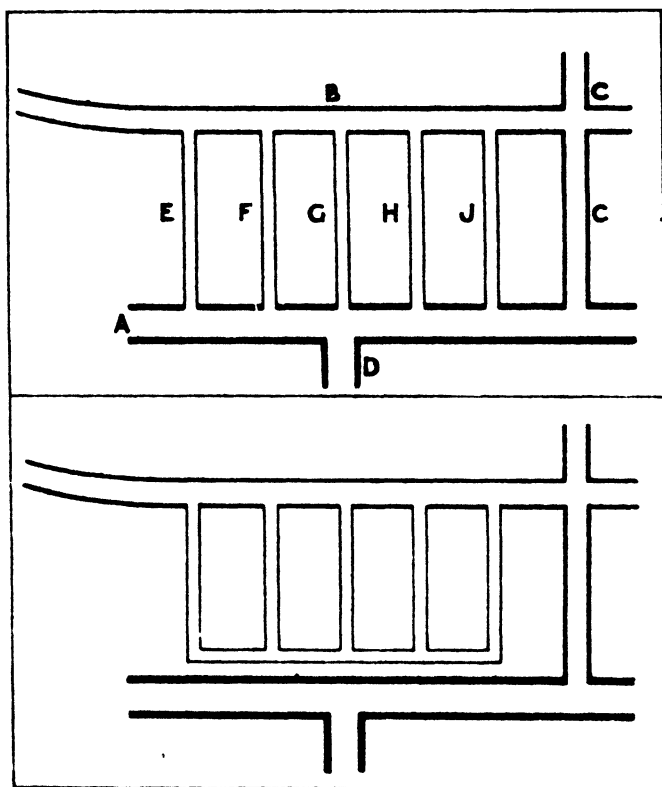

FIG. 1.—Prevention of casualties by road layout, not by law. If there had been proper planning, the residential roads E to J would never have been built communicating directly with the traffic artery A. A great amount of lorry traffic from the important road D percolated through these residential roads and caused many casualties there; a regulation excluding lorries was therefore demanded by the local authority. Bad planning, however, must be cured by better planning, and nothing that can be achieved by layout should be left to law and Police. The proper layout is shown in the lower plan.

creating a most undesirable layout. Concurrently, the road D was greatly improved and made to provide a through route for heavy traffic from another district. Lorries were soon running

TOWN PLANNING AND ROAD TRAFFIC

through the new residential roads, and numerous casualties ensued. Thereupon the local authority asked for an order, to be enforced by the Police, excluding lorries from these residential roads. The view of the Police was that the situation, which had been created by bad layout, should be corrected by proper layout and not by regulations ; they therefore asked either that a service road connecting the ends of the roads E to J should be built (there was space for it), thus isolating these roads from the artery, or, if this were too costly, that the ends of the roads should merely be closed. The upshot was that the road ends were closed up by a series of posts ; the cure was complete, the residential roads being made quiet and *safe*.

The second example is shown in Fig. 2. A railway station had been moved from a back street and rebuilt at A beside a new arterial road, the latter having dual carriageways, with a central strip BB. Large numbers of people arrived and left by omnibus at the point D. The road bridge over the railway at C was hump-backed, thus creating a blind bend on the vertical plane. Deaths and injuries became exceedingly frequent, the road being a derestricted one, and speed on it high. To help pedestrians, a footbridge DA had been erected, but that was no cure—because nearly everyone boycotted it and crossed on the level. Requests were thereupon made by local residents for a speed limit. That however would have been quite wrong, as the road had been built as a traffic artery, and anyway such a limit could never have been fully enforced. Here again, as always, it was necessary to apply the principle that nothing must ever be done by restriction which can be effected by construction. The solution put forward by the Police was that the road-gaps in the central reserve should be closed up and a continuous spiked fence 300 yards in length erected along the central reserve itself. This was done ; the people had to go over the bridge (as they do without demur on every railway system), and the casualties just disappeared. A very simple case, but quite a good example. We will return to these examples later on.

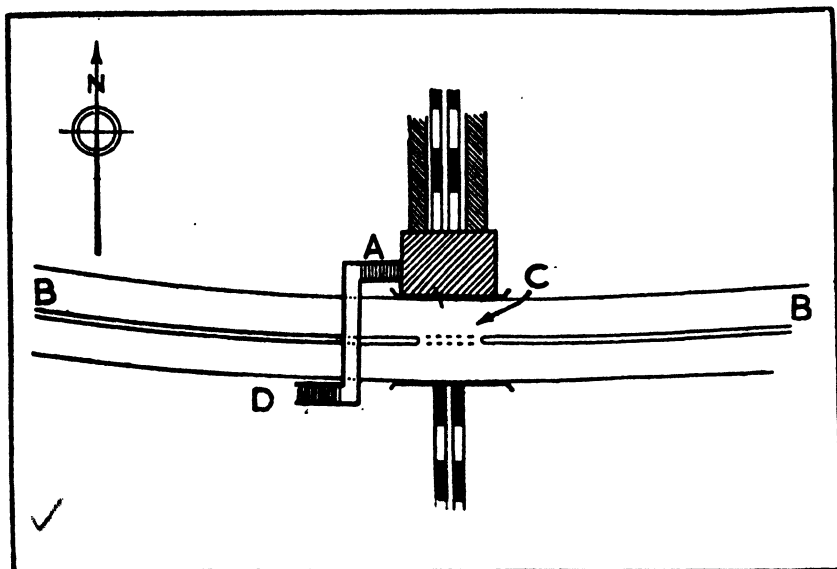

FIG. 2.—Protection of pedestrians, not by law, but by road equipment. Though a bridge had been erected for pedestrians to cross a high-speed arterial road from the bus stop D to the railway station A, the bridge was totally neglected, and many pedestrians crossing on the level were killed or injured. Application was made for a 30 m.p.h. limit on the arterial motor traffic, but that would have been no real solution, and would moreover have been wrong in principle on a road newly built to attract and canalise the fast through-traffic. Instead, spiked railings were erected along the central reserve BB for an unbroken length of 300 yards; the pedestrians were thus forced to use the bridge, and the casualties were completely stopped.

Education

In coping with the general problem, education and propaganda are important items during the present transitional phase. These items are, however, purely ancillary, and can never effect a cure for the shortcomings in layout and mechanical control.

It would of course have been possible to leave all our railways unfenced and to rely upon education and propaganda to prevent people being killed and injured. On the railways we are not content to take that casual line; nor can we afford to do so on our roads for one moment longer than we need. This applies in particular to the major roads where speeds are often as high

TOWN PLANNING AND ROAD TRAFFIC

as on the railways, and the moving units are so very much more numerous.

None the less, education in road safety will always be of real value, because all roads can never be shut off as completely as the railways are. Among children education is fruitful, but adults are much less susceptible, and therein lies an aspect very relevant to the present subject, viz., the psychological factor.

The Psychological Factor

The psychological factor is of great importance. To the adult pedestrian and to those of us who are practised drivers, the functions of walking and driving have become automatic, without our focusing any conscious attention upon them. When another pedestrian or another vehicle looms on the horizon, our response is automatic, and we avoid the comer by reflex action rather than by conscious volition.

We know perfectly well (and no amount of propaganda can make it more clear to us) that the penalty of careless walking or careless riding or driving may be death. The pedestrian is naturally anxious to escape death, but, as one eminent pedestrian has said, "We cannot *all* the time be thinking about being killed." When, for example, the pedestrian sees his omnibus just starting away on the opposite side of the road, he forgets everything except the one fact that he wants to catch that bus ; and very likely he plunges at speed into a vortex of traffic, regardless of danger. If a man in that mood is to be stopped, an obstruction must be put in his way ; nothing less will stop him. The only sure way of protecting the pedestrian is in fact to fence off the perils and to guide him, willy-nilly, into the safe path ; and the town planner and road planner—if this casualty problem is to be solved at all—must plan accordingly. The ideal is of course complete segregation, a subject which we will consider under the next heading.

The driver too may have the very best intentions, but when he is in a hurry, he will often take risks which he would strongly condemn at any other time—or in any other driver. On the main roads, where the vast majority of casualties occur, we must

THE SCIENCE OF TRAFFIC CONTROL

therefore make sure that the driver is provided with conduits of a type which will reduce to a minimum the amount of harm which he can do to himself or others. He must be headed off, by a discouraging type of layout, from places where he is not wanted, and must be coaxed into the right channels by means of attractive and acceptable conduits. It is all very well for optimistic planners to draft layouts in which people are "supposed" or "expected" to do this or that. If a driver, pedestrian or pedal cyclist spies a short cut (in which, unknown to him, may lurk dangers to himself or others) he is pretty sure to make for it at once. We must seek every opportunity to make our traffic regulation entirely self-enforcing.

All of this, the student will perhaps say, is quite obvious, and is accepted by us all. So also, it may be answered, is the law of gravity. But the difference is that, whereas the inventor does not put forth propositions that ignore the law of gravity, town planners, engineers and surveyors have all been known to devise schemes which quite ignore the factor of human nature. The traffic specialist, if he is a police officer, is much less likely to forget that factor, because he has been well schooled in human perversity. He approaches his whole problem largely, and indeed mainly, from that angle.

We now come to the direct question of control, dealing separately with the pedestrian, the pedal cyclist and general vehicular movement.

The Pedestrian

More than 200 pedestrians (about one-third of the casualty total) are killed or injured on the roads of Great Britain every day. In some large towns no less than two-thirds of the persons who are killed outright are pedestrians. Here then is a problem and an opportunity for the town planner.

If we could segregate pedestrians completely from the wheeled traffic, we should of course abolish pedestrian casualties. Complete segregation cannot however be achieved; and indeed, in minor and residential roads, where statistics show that risks are as a rule very low, segregation need not be seriously thought of

at the present stage—if ever. We must fasten first of all upon the main problem, viz., that of the major roads ; there it is that the majority of casualties occur, and there the problem is definitely soluble. Prohibitions or propaganda will never effect a cure ; the solution lies in sound planning on a broad scale, and in layout.

First of all, looking at the country as a whole, one point is very clear. Great streams of high speed traffic have suddenly invaded age-old towns and villages, in the streets of which people on foot continue to pursue their lawful occasions—just as they have for generations past. If that local populace cannot be completely withdrawn from the main streams of fast traffic which have invaded its haunts (and it cannot, unless the villages are pulled down and re-erected elsewhere), then the main streams of motor traffic must be withdrawn from the local populace. This means that, instead of tinkering with the old coach roads which are our present trunk road system, we shall have to build new roads exclusively for motor traffic, so as to drain that traffic as much as possible out of those centres of population. It will probably be cheaper in the long run ; the matter is dealt with at greater length on pages 96–99.

Secondly, in places (and these are bound to be numerous) where pedestrians and heavy streams of traffic must still use the same main thoroughfares, resort must be had to local segregation. Such segregation is possible in all the main thoroughfares of our towns and cities : it can be effected either in relation to place or time.

(i) *Place-segregation*. This can be achieved—as we all know—by operating the two classes of traffic at different levels (Fig. 3) or by fenced footways connected by pedestrian subways or bridges. Where expedients of that kind are too costly, the less straightforward plan of time-segregation will have to be invoked.

(ii) *Time-segregation*. By means of a co-ordinated system of automatic traffic signals, separate time periods are provided for vehicles and pedestrians respectively. The result is that vehicles do not run in a continuous stream : the stream is broken up into platoons with a time-interval between them, and pedestrians—

THE SCIENCE OF TRAFFIC CONTROL

protected by the traffic signals—are able to cross in safety between the platoons. To make the segregation complete, pedestrians should not be permitted to cross the road except at the signalled

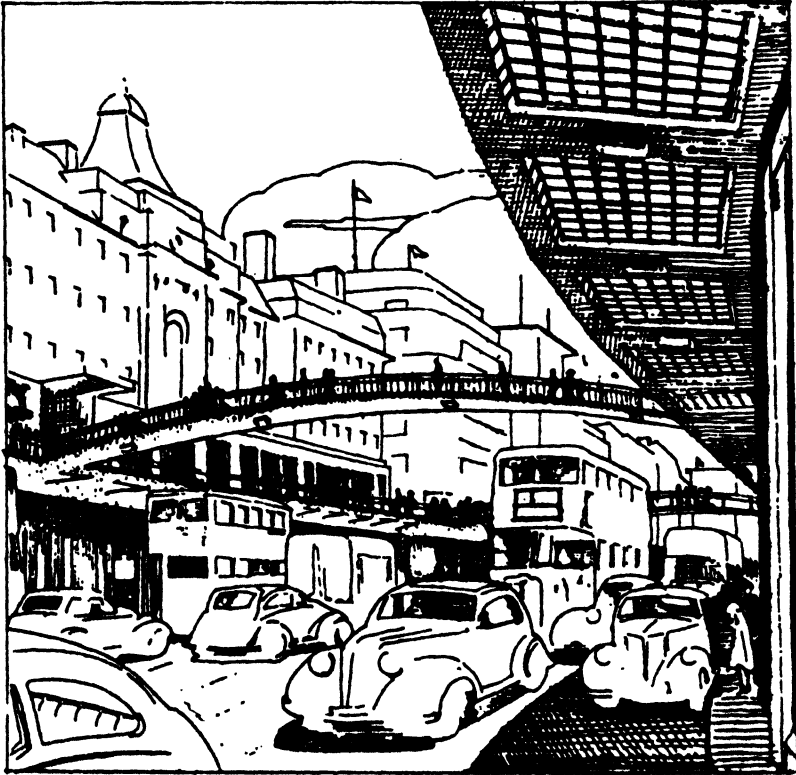

FIG. 3.—Place-segregation of vehicular and pedestrian traffic. This is achieved by separation of levels. The footways and shop fronts are at first floor level, with frequent bridges between footway and footway. The ground level is reserved for vehicles, the passengers from which reach the footway and shop frontages by stairs or lifts. Accommodation for waiting vehicles and bays for loading and unloading clear of the highway should be provided on the ground floor level of the buildings. (This illustration is based—by permission—upon a picture which appeared in the *Autocar* on the 27th November, 1936.)

crossings, and when the signals are in their favour. The subject is developed on pages 105–6.

Under such arrangements ordered and controlled pedestrian movement will be achieved for the first time, and when those

first steps have been negotiated, further stages will follow, to the great advantage of the pedestrian.

The Pedal Cyclist

The case of the pedal cyclist is far less simple. The cyclist has vehicle-speed without vehicle-stability, and has the same vulnerability as a pedestrian without a footway. This indeed is the most intractable problem of all.

The first fact is that the average pedal cyclist is not nearly as good and efficient a traffic unit as he might be. When he comes to harm, the fault is more often his own than somebody else's.¹

As in the case of the pedestrian, segregation of the pedal cyclists from motor traffic would be the cure. If therefore in the country at large, the main streams of fast motor traffic can be drawn away into motor-roads, the pedal cyclist—like the pedestrian—will be proportionately safeguarded.

On existing roads complete segregation is not possible. The use of cycle-tracks, as in Holland and Denmark, is regarded by many people as the main hope. Unfortunately, cycle-tracks break off at all road junctions, which are just the spots where accidents are most frequent and protection is most needed. Nor are the cycle-tracks themselves as good as they sound. At the entry of every minor road, the cyclist finds he has to bump over the gutter and camber of the minor road ; motor vehicles trying to emerge from those roads pull up right athwart his track ; tradesmen delivering goods to houses pass to and fro across it ; mothers and nursemaids with perambulators use the ramps at the road junctions and thus obstruct the cyclists ; passengers for omnibuses must cross the track, and while waiting they are apt (when numerous) to spread over the track and block it.

There is of course another difficulty about cycle-tracks, and it is a major one. Cycle-tracks cannot be successfully incorporated in busy town roads. And on those roads the casualty

¹ In London, in the last two completed years before the war, the percentages of accidents to pedal cyclists which were attributed to the cyclists themselves were 57·7 per cent in 1937 and 56·2 per cent in 1938. Report of the Commissioner of Police of the Metropolis for the year 1937, page 50 ; for the year 1938, page 46.

THE SCIENCE OF TRAFFIC CONTROL

rate is much the highest. Even if street parking were prohibited, omnibuses, cabs and other vehicles would still be constantly drawing in and out from the kerb to take up and set down passengers or goods, thus cutting across, and often standing upon, the cycle-tracks. A cycle-track between the footway and the building line is not practicable ; a dual track along the central reserve of a dual-carriageway road would obviate the kerb-side difficulties, but the junctions might then prove even more difficult for the cyclist than at present.

An incidental point not to be forgotten is that the number of casualties caused through cyclists colliding with pedestrians is by no means negligible : in some places the accidents of this class have been more than 5 per cent of the total accidents of all kinds.

Cycle-tracks, in the comparatively few roads where they can be installed, are a help, and they are well worth having ; but they do not provide a solution. For real improvement we must look elsewhere, namely to traffic control generally. If vehicular circulation as a whole can be managed upon more logical and self-regulating lines, the pedal cyclist will share the benefit ; but the cyclist himself *must* become an efficient traffic unit. The club member who takes a pride in his cycling very seldom indeed comes to grief ; the majority of cyclists, however, are not of that calibre, so very many of them being young, venturesome and casual ; that, however, is a matter outside our province here.¹

Another point not immediately relevant to the task in hand must also be mentioned, viz., that existing road surfaces in towns are often extremely dangerous to the cyclist, and cause very many accidents for which he is *not* to blame. Wood blocks, for example, when worn smooth by the traffic, and lubricated by moisture and a film of oil dropped by motor vehicles, are a menace to the motor traffic and a real death-trap for cyclists. The cyclist suffers not only from his own skids, but from the skids of other people's vehicles. If public safety is to be served, the use of wood, and any other material which cannot successfully

¹ In the case of motor vehicles, registration and licensing were an initial and fundamental measure for ensuring orderly and lawful use of the road.

TOWN PLANNING AND ROAD TRAFFIC

retain a non-skid surface, will have to be ruled out. Furthermore the nearside portions of all roads should be of merit equal with that of the crown, otherwise—and he cannot be blamed for it—the cyclist will ride well away from the kerb, although the risk is greater ; and there must be no sunken gullies, to avoid which the cyclist will always swerve outwards into the traffic.

Elementary safeguards of that kind are of course essential. Apart from them, the cyclist, provided that he becomes an efficient traffic unit himself, can best be protected if vehicular traffic as a whole is controlled and guided by means of layout. Vehicular control is in fact the main problem.

General Vehicular Movement

Vehicular movement has been governed by statute law for more than a century, and special laws and regulations for the control of mechanical traffic have since been introduced. First of all, general speed limits were imposed ; and a limit of 4 m.p.h. on heavy locomotives in 1865 was reasonable enough, because the roads themselves, not to speak of public opinion, could not have withstood higher speed. Then came the light motor car. The general speed limits of 14 m.p.h. (1896) and 20 m.p.h. (1903) were repressively intended, and both failed. The abolition of all general speed limits in 1930 (following a recommendation of a Royal Commission based on the theory that road casualties were mainly due to dangerous and careless driving) failed also, and fatalities began to mount up very steeply.

At that stage traffic science was able to lend a hand, and a real appreciation of the case was for the first time obtained. Investigation established that only 15 per cent of the total casualties were due to dangerous or careless driving of a prosecutable order. Of the remaining 85 per cent a small proportion were due to vehicle defects and other miscellaneous causes ; the vast majority (more than 75 per cent of the total) were due to human errors on the part of pedestrians, pedal cyclists and drivers of vehicles. The lethal effect of each of those errors was increased, it was found, as vehicle-speed was increased and was reduced as vehicle-speed was reduced. In other words, the higher the

THE SCIENCE OF TRAFFIC CONTROL

vehicle-speed, the shorter is the time-interval for the protective reaction on either side. This meant that vehicle-speed ought to be kept down at places where pedestrians and pedal cyclists were numerous ; and the 30 m.p.h. speed limit in built-up areas was therefore the logical outcome. In practice that limit produced the precise effect which had been forecast : the lethal effect of human error was reduced. The fatalities in the Metropolitan area were in fact brought down by nearly 25 per cent, an improvement which has since been maintained.

Here therefore a definite line for reducing casualties was given. We must, however, continue to apply the principle already set out ; nothing ought to be effected by restriction which can be effected by construction (a term which covers the use of mechanical appliances as well as of stone and concrete). Where therefore it is necessary to apply a speed limit on a stretch of main road, this can most accurately and effectively be done by mechanical means. A local 30-mile speed limit imposed merely by law on such a road, in response to pedestrian clamour, leaves us with an unbroken stream of vehicles proceeding at a speed which—though reduced—is still capable of doing serious harm ; it affords no opportunity for really safe crossing by the pedestrian, and it is regarded with aversion by the motorist. No party is in fact as well served as he might be. The self-same limit, imposed by means of co-ordinated traffic signals, can produce a traffic stream broken into platoons, thus affording opportunities for pedestrians to cross in complete safety—an arrangement congenial to pedestrian and motorist alike (pages 105-6).

That, as far as it goes, is good, but it is only a very small beginning. On the main roads, moreover, it is not desirable to reduce speeds unduly, because low speed neutralises the high value of motor transport. The aim must on the contrary be to develop and encourage speed, an end which can only be achieved by the removal of present dangers and obstructions.

The first steps towards constructive improvement were as unsuccessful as the earlier efforts at control by restriction, and much has been learned from experience. Many of the roads built to relieve the pressure in towns (*viz.* the by-passes) were

TOWN PLANNING AND ROAD TRAFFIC

carried from end to end through virgin fields and the opportunities were therefore superlative. Yet they produced vice after vice. They were ribbon-developed; they became, in places, shopping and amusement centres, thus creating pedestrian circulation where pedestrians were least wanted; they admitted scores of junctions with building estate roads, each of which is a danger, and their casualty records soon became very serious indeed. Traffic arteries are of course the very last place for shopping centres, and some of the building estate roads were so laid out as to create actual *intersections* on the artery, a very serious blunder. When the inevitable casualty record began to mount up, traffic signals were sometimes installed, so operated that a single cyclist could stop the whole arterial flow at will,

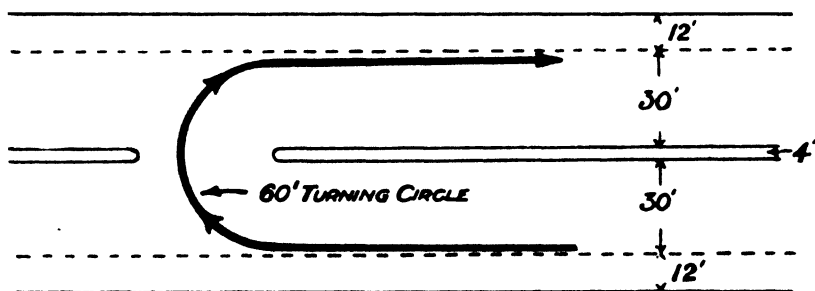

FIG. 4.—A breach in the central reserve between dual carriageways, for purposes of access to ribbon-developed buildings. The result is that large vehicles make turns such as that shown, cutting sharply across the middle and fast tracks of *both* dual carriageways. This, as a traffic manoeuvre, is just as bad as it can be. In properly planned areas central reserves must be carried inexorably from roundabout to roundabout on any artery created to carry fast through-traffic. On such roads riparian development cannot be allowed to upset and endanger the arterial stream. Detours along to the nearest roundabout must be made, or back-access to the premises must be provided from back roads.

an arrangement which—taking the long view—is obviously quite wrong. Things must be better arranged than that.

The introduction of dual carriageways, to prevent head-on collisions, marked a very definite advance. Vehicles could thus be given an unbroken run, moving on parallel lines without cuts and with very little jockeying for position (which is a continual source of accidents). Even that valuable layout was, however,

subverted in consequence of ribbon development. Confronted with continuous lines of houses on each side of the new road, the local road authority made breaches in the central reserve for access purposes. Fig. 4 shows the result, viz. isolated right-hand turns of a particularly dangerous character. At a point where speeds are high, a lorry with a 60-ft. turning circle has to manœuvre, without control by signals or roundabout, from the slow track clean across the middle and fast tracks on both carriage-ways. Railway operators would be aghast at such an idea ; and discipline like that of the railways will have to be imposed on main road traffic, not by laws but by layout, if railway safety and railway smoothness of circulation are to be achieved. The artery was created to carry an arterial stream of through-traffic, and riparian development should not be allowed to imperil and upset the arterial stream.

What is wanted on a main road is an uninterrupted flow of fast traffic, with the fewest possible junctions or turning movements. When vehicles turn to the left into other roads there is little trouble, because no traffic-stream is cut. When however vehicles turn to the right to enter other roads, the whole opposite traffic-stream must be cut ; and the chances of confusion and danger are therefore proportionately high.

If the number of right-hand turns upon major thoroughfares can be reduced, the safety factor will be greatly enhanced ; those turns will cease to be sporadic and uncontrolled, because the vehicles requiring to make the turn will be collected, and the turns will then be made at a few controlled points only. This arrangement can only be achieved by reducing to quite a drastic minimum the number of minor roads opening upon the main arteries ; in the country it will be effected mainly by means of separation of levels, in towns by closing up superfluous entries. That is a very big programme, and we shall have to see later on how best it can be approached.

Next, as to the junctions themselves. These, as already seen, must be reduced to an absolute minimum. When that has been effected, the object must be to avoid stoppages altogether, because, by maintaining perpetual movement on the artery, we

TOWN PLANNING AND ROAD TRAFFIC

shall produce traffic streams of more or less consistent density, without undue thickness in any part of them ; and that is always one of the chief aims of traffic control. Bunching leads to congestion. At the junctions, however, it is necessary to slow everything down sufficiently to allow the sorting-out to be done with safety. From that point of view the roundabout is excellent, and it is cheap ; the full clover-leaf flyover junction is nearly ten times as costly and is therefore a luxury which in any event can seldom be afforded (page 50).

When passing from theory to practice, the difficulties, as always, begin to mount up. The pedestrians must be accommodated somewhere, and all those complex webs of minor roads in the towns and suburbs must be brought into some sort of orderly plan and linked up adequately, but not too freely, with the arteries. In towns the multiplicity of junctions and intersections looks almost hopeless ; and all are productive of accident and delay.

In practice, these problems of detail are indeed the real crux. When replanning a town, the task of projecting and surveying lines for new and ambitious systems of main roads will be found to be child's play as compared with the detailed application of the scheme. The new roads—unless properly spliced into the present layout—will create a still further crop of accident-producing junctions throughout their whole length. We have before us the examples already quoted : those by-pass roads of the nineteen-twenties were sound enough in broad idea and in general line ; it was upon the detail that they fell down so badly. Nor need we wonder at it. Road survey and road making are a hereditary science—handed down to us from the Romans and even earlier, while those various details, which are as difficult as they are unspectacular, are a new problem. A town plan which ignores the awkward details and consists mainly in fine new roads with fine architectural façades will be rather in the nature of a whited sepulchre. That town, by reason of its bad layout, will continue to kill its inhabitants quite unnecessarily, and will thus remain an ill-planned town.

Roads and road layouts cannot with complete success be

THE SCIENCE OF TRAFFIC CONTROL

projected and designed by people who think mainly in terms of physical survey, construction, architecture, finance—or even town planning; it is necessary also to think, and to think accurately, in terms of traffic control.

Other Traffic Problems

The science of traffic control embraces quite a wide range of subjects not mentioned in this brief survey, such as the problems of driving standards, braking efficiency, accident-proneness, horse-drawn traffic, commercial traffic, peak load periods, street trading and much else. These items, however, need not be considered here.

Road Traffic and Town Planning

The entire road system must be so designed as really to control movement, an end which has as yet been very seldom achieved. The whole of the detail will have to be brought under review, the line of approach in every case being precisely the same as that adopted in the two simple examples on pages 20–23. The wider the scale upon which that rational type of treatment can be applied, the more the present toll of casualties will be brought down. Town and country planning is planning on the really grand scale, and the opportunities thus presented are immense.

III

THE SCIENCE OF TOWN PLANNING

This is not, of course, the place for any general essay on town planning; the respective specialists on road traffic and town planning must pursue their separate sciences, each invoking the other where functions overlap. The traffic specialist is not an inspired town planner, nor is the town planner a fully qualified traffic expert.

TOWN PLANNING AND ROAD TRAFFIC

For the sake of completeness, however, it is necessary to set out a general statement of the scope of the science of town planning, as culled from the writings of its own exponents. This can be done in little more than a paragraph. First of all the town planner makes a complete survey of the district concerned, in order that a general plan may be prepared. In this general plan certain regions, or "zones" as they are called, are set apart respectively for (a) industrial and business accommodation, and (b) residential accommodation (with areas allotted for residences of different character and class, such as tenements, terrace houses and garden suburb houses). This general allocation is called "use-zoning." There are also "reservations" such as open spaces, cemeteries, allotments, aerodromes, car parks, etc. The object is to achieve a well-balanced distribution of buildings and open spaces, and a convenient disposition, in relation to one another, of industrial, business and residential areas. In practice, the scheme is very flexible, because places of business and even small factories may sometimes be allowed in zones that are predominantly residential, and so forth. In existing towns, moreover, the so-called "zones" may in reality be a multiplicity of small patches, rather like a patch-work quilt. Account is also taken of density, height of buildings and site coverage.

Next, communications (by road, rail, etc.) between all parts of the town plan must be established, or, where they already exist, they must be adapted and improved.

And finally, provision must be made for orderly future development in areas not as yet designated.

Communications

In his general layout and in his use-zoning, the town planner will base his plans upon very many factors other than communications. Very often the use-zoning will govern the communications, but sometimes the communications will have to govern the use-zoning and general arrangement.

In view of the daily toll of death and injury, the essential conditions for town-planned roads are that they shall be adequate and convenient, but above all things they must be *safe*.

THE SCIENCE OF TOWN PLANNING

Importance of the Roads in the Town Plan

Any town plan is on inspection found to be defined mainly in terms of road layout. The road layout becomes—so to speak—the skeleton of the body. If it is ill designed, the whole town plan is permanently deformed : the new layouts, once built, are hopelessly rigid, and a great opportunity has then been lost.

Classical Layouts

It is usual, and very right, to revere the architecture and design of the great ages of the past. In the matter of road layout, however, classical layouts are nothing but a snare. The designs required for the necessities of modern transport are of a totally different character.

Drawing-Board Plans

From a traffic point of view there can be no inherent value in any town plan which is symmetrically perfect, if that symmetry can only be seen from the clouds. Such town plans are attractive on the drawing-board, but are not really useful in practice.

A town built for space and dignity, upon symmetrical lines, can be excellent on the drawing-board but can yet be full of defects as a traffic layout. L'Enfant's design of Washington D.C. is deservedly held in esteem, but its combination of rectangles and diagonals is bad from the traffic standpoint. The rectangular layout of New York, which originated in 1811, is another drawing-board design, and it proves very awkward in these modern days of fast traffic, because it consists of a multiplicity of intersections. The 1811 plan has since been supplemented by layouts of a totally different character (e.g. Riverside and East River Drives and the Tri-Borough Bridge approaches), the object of which is to obviate intersections instead of creating them.

The Road System

The road layout of any town, however large, is an item in the general communications of the whole country ; the road system of the country is one, and as such is a matter of direct concern to the central Government.

IV

STATE CONTROL OF PLANNING

A Nation-wide Scheme

The ideal of town and country planning has always been a co-ordinated scheme on a national scale. The good work done during the past twenty years by the regional planning movement has not been in vain, nor has that of the joint committees of various adjacent local authorities which that movement produced. The statutory joint committees which appeared in many parts of the country (though not in all) in the years that followed the passing of the Act of 1932 have continued to develop the broad layout of the problem. While, however, ideas have broadened, the difficulties and delays of complex negotiation on all manner of details have not been overcome. This in turn brings into relief the fact that there are very many gordian knots which can only be cut by the central Government itself.

It has been stated on behalf of the Government that "planning must be a partnership between central and local authorities, the centre being responsible for the application of national policies on such matters as agriculture, industrial development and transport."¹ In the same statement it was indicated that local authorities would plan in regional groups.

Finally, a Ministry devoted exclusively to town and country planning has been created.

Private Interests

As post-war reconstruction will have the full force of the Government behind it, private interests will be handled—it may be hoped—with the same firmness as during wartime itself. An earnest has already been given in the matter of inflated land values, the principle having been accepted that the compensation payable in public acquisition or control of land shall not exceed sums based on the standard of values at some particular date.²

¹ *Hansard*, 1940-1 (House of Lords), Vol. 119, Column 854.

² cf. *Expert Committee on Compensation and Betterment Interim Report*. H.M. Stationery Office. Cmd. 6291. The date suggested in the Report is 31st March, 1939.

STATE CONTROL OF PLANNING

That will destroy one of the greatest bugbears of pre-war days, when, the moment any road improvement was officially mooted, there was a rocketing upwards of the values of the lands or buildings affected.

Many other aspects remain. Nobody will dispute that it has been wrong in the past to allow large new buildings to be erected beside cramped and congested thoroughfares, when everyone knew beforehand that those buildings would bring large numbers of waiting vehicles for which no accommodation had been provided in the plan. It was equally wrong to allow snack bars, the plan of which included no standing accommodation for vehicles, to be erected beside broad new arterial roads, with the result that the 9-inch concrete which had been laid at great public expense to carry the through traffic came to be used as a parking place to swell the private profits of the snack bar. No less wrong was it to allow groups of shops to be built facing new arterial roads, where the shoppers are bound to be endangered by fast through-traffic ; yet we know that, if owners and builders were able to get better prices by developing such sites for shop property, they were allowed to do so. Developments such as these have not been due to any deliberate policy, but to a natural disinclination in a free country to interfere with or shackle private enterprise. The result, however, has been unfortunate, because where private and public interest have been in conflict, the latter has all too often gone to the wall. It is largely through the freedom allowed to private interests that we are in the real muddle in which we now find ourselves. Large-scale planning, with Government backing, should be able to produce quite a different perspective.

Development or Dispersal

The vexed question of development versus dispersal is another problem marked out for State control.¹ Whether, however, in the case of any particular town, continued growth is to be encouraged or separate satellites are to be created, the road problem

¹ cf. *Royal Commission on the Distribution of the Industrial Population Report*. H.M. Stationery Office. Cmd. 6153.

TOWN PLANNING AND ROAD TRAFFIC

will be equally vital. In the case of the satellites there should be opportunities for really modern layouts for traffic circulation (the lines of which will be considered in Chapter V), while at the same time the existing town itself will have to be replanned on lines better suited to modern needs.

THE DESIGN OF ROADS FOR TRAFFIC REQUIREMENTS

We now proceed to the design of roads and road layouts for traffic requirements. The traffic requirements are two in number, viz., to provide (1) for free and convenient circulation, (2) for safety, not only of the wheeled traffic itself, but of all persons who have access to the roads.

First we consider the component items, and then we piece together the layout of a town.

Space for Circulation

[It is obvious that, if sufficient road space is provided, traffic can circulate.] And that was the simple idea underlying the design of some of the roads constructed immediately after the war of 1914-18. In its original state, the Great West Road, Middlesex, was a good example—a fifty-foot carriageway without central reserve or refuges. The idea was that, as there is a tidal movement of traffic towards London in the morning and a similar movement outwards in the evening, it would be uneconomical to split up the road-space into two separate channels. [In the single conduit, two-thirds of the space could be used by incoming traffic in the morning, and two-thirds for outgoing traffic in the evening.] And so the road was built—an unregulated wilderness of space.

[That wide space induced very high speeds, which in turn led to many deaths and very serious injuries, not only at the numerous

THE DESIGN OF ROADS FOR TRAFFIC REQUIREMENTS

intersections, but also on the open road. High speed should certainly be possible on a road of this class, but mere speed which is likely to land the vehicle in the ditch or in collision with other vehicles is no use to anyone. Before speed can be safe, orderly and controlled movement must be achieved.]

Separation of Opposed Streams

[Where dual carriageways are provided, head-on collisions can be written off at once.] But, as already noticed (pages 32–33), accidents of other kinds are fostered unless the principle is correctly and strictly applied. No liberties must be taken; the traffic must have an unimpeded run from junction to junction, and [all junctions must be controlled.] That must be our aim on all the great arteries.

Next, we classify our roads.

Classification of Roads

From a traffic point of view, it is of the utmost importance that there shall be three generic types of road and three only, viz., (1) arterial, (2) sub-arterial and (3) local, i.e. minor.

The local roads can be divided up into as many categories as the town planner may desire, but generically—for traffic purposes—those roads all have the same status, viz., that of a local road.

The traffic classification will thus work out as under :¹

- | | | | |
|------------------|------|--|--|
| (1) Arterial | | | |
| (2) Sub-arterial | | | |
| (3) Local | TOWN | { Shopping
Business
Industrial
Amusement
Residential | COUNTRY { Village streets
Country lanes |

¹ Roads are already classified, on the basis of present user, by the Ministry of Transport, for administrative purposes of maintenance and grant. The important main roads rank as Class I (or A) roads, and the second grade roads, which are important roads of a more local character, rank as Class II (or B). All other roads rank as "unclassified" roads.

In very many cases this system will be found to correspond with the traffic classification for future user, but the extent of that correspondence will only emerge when the general outline of Town and Country Planning is developed.

TOWN PLANNING AND ROAD TRAFFIC

In classes (1) and (2) the interests of the traffic will be regarded as absolute; in the case of (3) traffic considerations must be entirely subordinated to the needs of the frontagers, local population and pedestrians.

Arterial Roads

These are the roads for long distance movement through the country, and for the heavy main traffic-flows in towns. When a new road of this class is constructed, every other consideration must give way to the single aim of free and rapid flow. The artery must be dedicated to transit first, last and all the time. The carriageways must be kept clear of obstructions of every sort; there must be no frontages, no loading and unloading, no standing vehicles—and no pedestrians. *Any new traffic artery either in country or town which admits of contact between the ordinary pedestrian and the moving traffic can be classed at once as a faultily designed road.*

The number of junctions will be reduced to an absolute minimum and each junction will be controlled by a roundabout of generous dimensions (incorporating where necessary a flyover bridge as in Fig. 9, page 51).

The only premises directly accessible from the artery will be repair depots and places where meals are served; both should provide (at their own proprietors' cost) ample space off the highway for their standing vehicles. All bus stops should be embayed, and passenger bridges or subways provided at all stopping points.

When existing roads are adapted (Chapter VII), it may not be possible to live up to the whole of these requirements, but the aim must always be to approach them as nearly as possible.

[*Sub-Arterial Roads*

The sub-arterial, an intermediate class of road, is required to link up the main arteries with the various webs of minor roads. The sub-arterial road will be designed, as far as may be, on the lines of the arterial.

THE DESIGN OF ROADS FOR TRAFFIC REQUIREMENTS

Local Roads

The local roads are of quite a different category. In the country they are the lanes and byways : in towns they are the roads for residence, business and shopping. They will be so designed as to discourage through traffic of any kind from entering them at all. The only traffic to be coped with in these roads will be the traffic having business in the particular locality.

Parkways

“Parkways,” a new type of road developed principally in America, are finding considerable favour among planners in this country. Whereas in America commercial traffic is usually excluded, the parkways projected in this country are intended for all types of traffic. Park-strips on each side of the road are laid out or afforested, views and surroundings being alike made pleasant. The park-strips that border the road need not be public property ; in regionally planned areas it is sufficient if they are zoned for agricultural or forestry purposes.

The parkway makes as little contact as possible with ordinary roads, crossing them wherever possible at a different level. From a traffic point of view, the parkway is therefore classed with arterial roads.

Junctions and Intersections

(i) *On Arterial and Sub-Arterial Roads*

Science was first applied to junctions and intersections by the American specialist whose name has already been mentioned, William Phelps Eno ; he realised that the chief difficulty of traffic movement as a whole was the intersection and turning movements of the traffic streams. Working largely on the spacious layouts of Paris, he laid down the principle that a “dead area” should, where possible, be created in the centre of each intersection or junction, round which the traffic movement would be in one direction only. This led to the development of the roundabout as we know it, in which a weaving movement is created, all direct cuts being eliminated.

TOWN PLANNING AND ROAD TRAFFIC

The first roundabouts built were much too small. Their narrow dimension enabled vehicles, when traffic was light, to take the roundabout at too high a speed ; and the vehicles which entered from the several roads crossed one another's tracks so sharply that the movements amounted to a very definite cut.

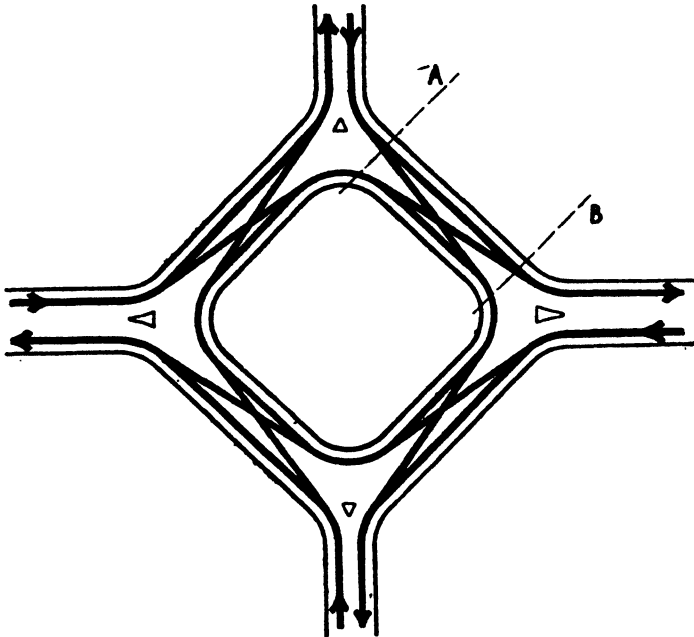

FIG. 5.—The course followed by vehicles in negotiating a roundabout, as established from photographs of vehicle-tracks taken from the air. The combination of the movements shown, involving as they do overtaking from either side, is known as "weaving." For purpose of computation, the distance A—B can be regarded as the "weaving length." The weaving lengths required depend upon the volume of traffic which may be expected, now and hereafter.

When traffic was heavy, moreover, the traffic streams—having insufficient space—simply locked, and everything came to a standstill.

Much has been learned about roundabouts in the past twenty years, but finality of design has by no means been achieved. Experiment and development continue.

The early fault was that the "weaving lengths" were too short for those interlacing movements which should take place

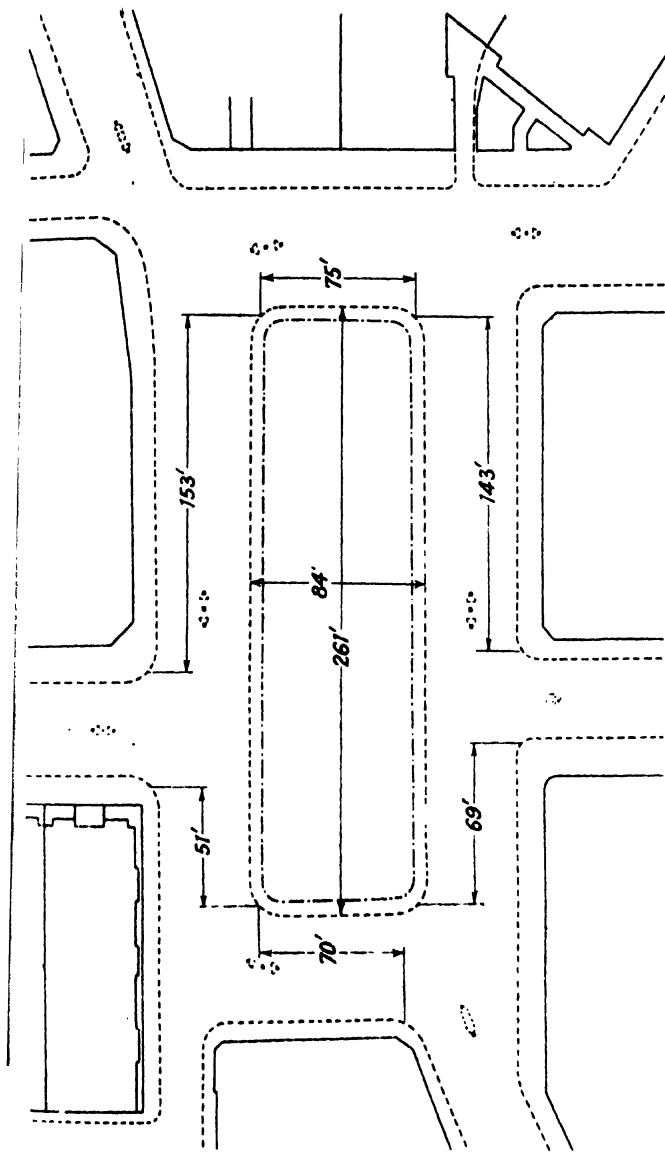

FIG. 6.—Sloane Square, London ; an example of a roundabout where existing layout has been adapted for this type of control. The six weaving lengths in this roundabout are measured in the manner shown. Some of the lengths are so short that "scissor-cuts" are produced instead of proper weaving ; and when traffic is really heavy the roundabout is therefore liable to jam. It has been necessary to retain the refuges in the roundabout itself because there are no subways and pedestrians therefore cross on the level ; from the vehicular point of view these refuges restrict still further weaving lengths which are already inadequate. The refuges in the mouths of the approach roads are sound and valuable.

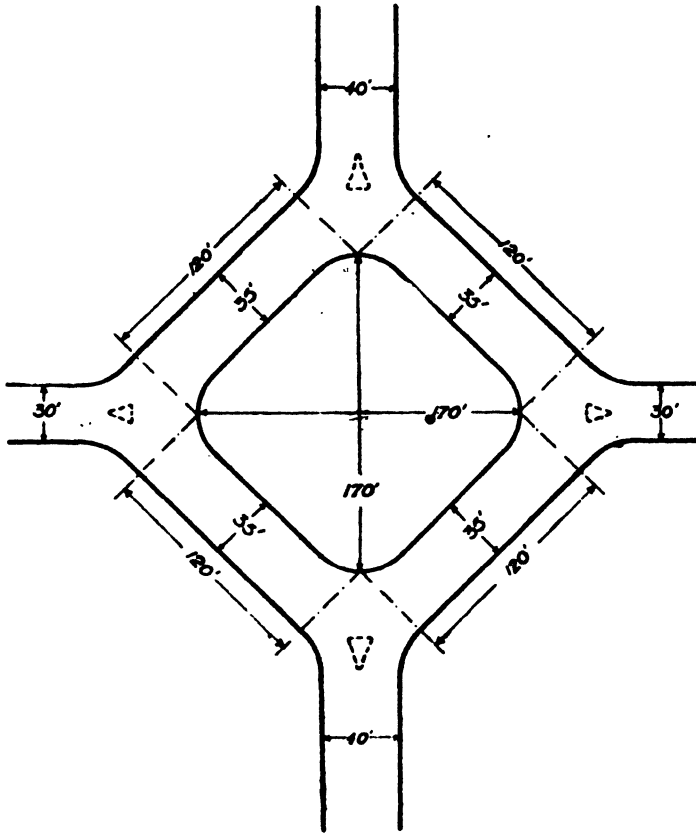

FIG. 7A.—A roundabout at an intersection of a 40-ft. and a 30-ft. road in the country, with weaving lengths of 120 ft. The width of the road round the island will be one-fourth of the total width of the approach roads, viz. 35 ft., and the breadth of the central island itself works out at about 170 ft.

TOWN PLANNING AND ROAD TRAFFIC

freely along each of the limbs of a well-dimensioned roundabout. The essential feature in roundabout construction is, in fact, the weaving length. [Fig. 5 shows the normal course followed by vehicles, and the distance between A and B can be regarded, for purposes of computation, as the weaving length.] [In cases of roundabouts of irregular design, e.g. those in which existing layouts have been adapted for this type of control, the weaving lengths are worked out as indicated in the example shown in Fig. 6.

[In designing any new roundabout, allowance must of course be made for the greatly increased traffic likely to accrue in the future, and weaving lengths such as those set out below seem therefore to be indicated :

[At intersection of two main roads in the country, well away from large towns	120 ft.
At intersection of two heavily trafficked arterial roads in a suburban area	180 ft.
At similar intersection in centre of towns	300 ft. ¹

[As regards the width of the carriageway surrounding the island, a working rule has been to take the aggregate width of all the carriageways of all the converging roads and to divide the result by the number of those roads.] If, for example, a roundabout is to be created in the country at an intersection of a 40-ft. road and a 30-ft. road, the width of the road round the island will be 35 ft., as shown in Fig. 7A, and the diameter of the central island will be found to work out at about 170 ft. When dealing with a multiple junction the size of the roundabout will be increased, in a country layout, by units of at least 120 ft. for each additional weaving length, the dimensions of the central island thus becoming proportionately greater. In congested areas, with weaving lengths of at least 300 ft., a central island of 500-600 ft. may be expected (Fig. 7B), and in places where traffic is really heavy islands up to 1000 ft. will be none too large.

¹ In order to give a definite idea of this dimension in practice, it may be mentioned that the weaving length on the north side of Trafalgar Square, London, computed on the basis of Figs. 5 and 6, works out at 390 ft.

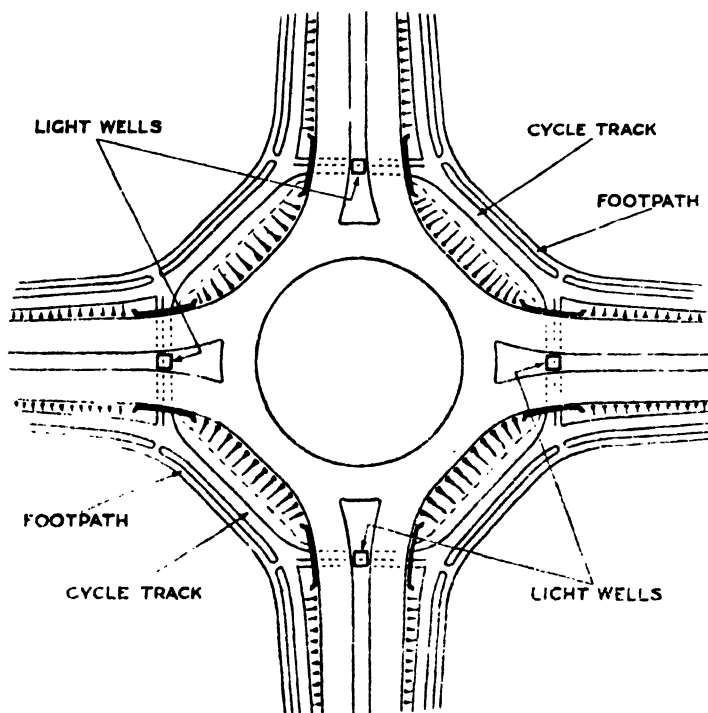

FIG. 8.—A roundabout for areas not closely built up, which provides subways, following the periphery of the roundabout, for pedestrians and pedal cyclists; the carriageway is carried over the subways by means of embankments. Alternatively, the roundabout can be designed with the carriageway below, instead of above; but usually it will be better to send the pedestrians and cyclists below the carriageway, because this will eliminate gradients for them, while the up-gradients imposed upon vehicles approaching the roundabout will tend to retard their speed. The subways can conveniently be lighted by means of open wells situated in the central reservations or islands dividing the carriageways, as shown in the diagram. The design is taken from the paper by Mr. A. J. Lyddon, C.B.E., M.I.C.E., on "Road Junction Design in Relation to Safety" (National Safety Congress, 1939). It is to be hoped that roundabouts of this character will become standard practice, being peculiarly suited to the needs of our own densely populated country, with its very numerous pedestrians and pedal cyclists.

⌊ The central island can be in the shape of a square, oblong, polygon, circle or oval. At all corners, including those of the approach roads, a radius of 30 ft. is required; nothing less is sufficient, and anything much greater conduces to speed and is therefore not desirable. For the guidance of traffic, islands or refuges should be provided in the mouth of the approach roads, and each of those roads should be so led into the roundabout as to make the junction as nearly as possible a right-angled one.

These details are very important. Even the most reckless of drivers, in order to save his own skin, is compelled to slow down at any properly designed roundabout; the accident rate is therefore low, and such accidents as do occur are seldom serious.

Where pedestrians are admitted to an artery or sub-artery, pedestrian subways at roundabouts are essential, and subways for pedal cyclists are very desirable also, as in Fig. 8.

When pedestrians can reach the central island by subway or overbridge, and it is made physically impossible for them to cross on the level, the island itself can be built up and used for business purposes. There is no need for sight lines for drivers *across* a roundabout.

⌊ Intersections can also be dealt with by means of flyover junctions. These have been developed chiefly in America, at places where there are no pedestrians (and pedal cyclists are few, if any), and in Germany, on the Autobahnen, from which all pedestrians and pedal cyclists are excluded. These "flyovers," which enable high speeds to be maintained, are not really manageable on roads like our own where pedestrians and pedal cyclists are accommodated, because (1) the layout becomes unduly complicated, and (2) cyclists, and particularly pedestrians, must be required to make quite unreasonable detours. As, moreover, the full flyover junction is extremely expensive, costing about ten times as much as a roundabout, it is much better to have ten roundabouts at ten dangerous junctions than a single flyover at a single junction, thus leaving nine danger points undealt with.

While, however, the full flyover junction is seldom likely to be worth while in this country, a combination of roundabout and flyover bridge can be of extreme value; this combination is a

THE DESIGN OF ROADS FOR TRAFFIC REQUIREMENTS

native product, peculiarly suited to our own needs. Fig. 9 shows the arrangement, which is particularly useful upon an arterial road such as a ring road in a town where—in order to attract traffic—an unbroken run is essential, but intersections are numerous. When the junction is in a built-up area, the central island can be used for building, provided that access to the premises is from the sub-arterial road only, not from the arterial, also that pedestrian access to the building is by subway or overbridge.

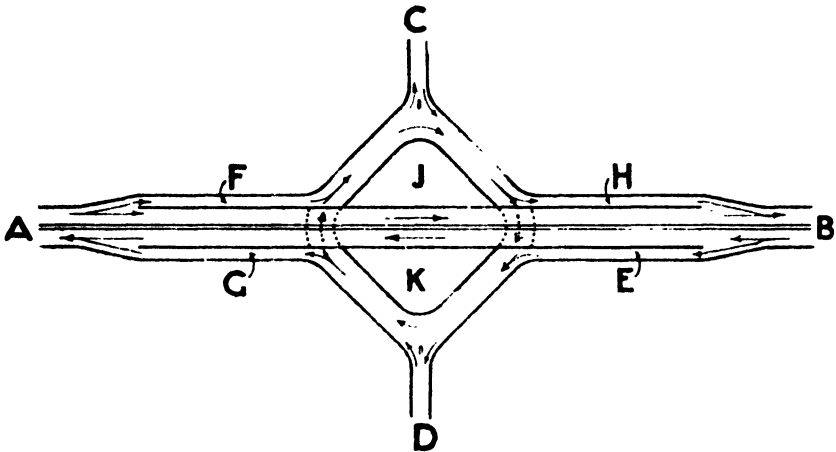

FIG. 9.—A combination of roundabout and flyover bridge. An arterial road AB intersects a sub-artery CD. Traffic from the artery reaches the roundabout by the ramps E and F, and traffic from the roundabout reaches the artery by the ramps G and H. In urban areas there is no objection to the central island being “built up,” provided that pedestrian access to the buildings is on a level separate from that of the road. Either there can be twin buildings at J and K on each side of the artery (but without access to it), or a single building can be erected, through which the artery is carried by means of a tunnel.

This design is not a scale plan: the ramps (the gradient of which would probably be 1 in 30 to 1 in 20) would be longer than shown, and the approach from the ramps to the elevated road would be tapered much more gradually.

On sub-arterial roads intersections and junctions can be controlled by automatic traffic signals, but it is essential that the signals should be operated in accordance with a master scheme for general traffic circulation (see page 109). Controlled pedestrian crossing on the level (pages 105–6) can thus be arranged.

(ii) On Local Roads

(The method of traffic control at junctions of local roads, especially in towns, is a problem apart. For whole systems of these roads the idea of a general one-way system is attractive at first sight, a unidirectional flow at junctions being thus created, but there are great disadvantages in practice. It is true that one-way workings are extremely useful in making the best of a bad job where cramped layouts are now carrying three or four times the amount of traffic for which they were built.¹ But the great drawback to a general system of that character, more especially in networks of minor roads, is that, even after a multiplicity of notices has been provided, the whole affair becomes a regular Chinese puzzle for the stranger. Incidentally it is not always easy to site the notices at the spots where they will hit the eye of the driver; police officers notice that, even after one-way streets have been in operation for several years, many drivers still mistake their way, and thus cause confusion, as well as danger to themselves and other people. On the whole, a system of one-way workings, though often a useful remedy, is not a sound idea for original layout.

There is, moreover, another point. One-way workings, while conducing to speed, at the same time violate the pedestrian's ordinary instincts in crossing the road; not only therefore will the chances of pedestrian accidents be increased, but their gravity will also be enhanced on account of the speed factor. Furthermore, whereas the object in view on the arterial road is to encourage speedy transport by banishing all obstructions, including pedestrians, the object of design in these minor roads is just the opposite, viz. to render excessive speeds impossible—so that pedestrians can be free to circulate.

On the whole a two-way system in minor roads seems clearly to be indicated, devised on lines that (1) provide no short cuts for through traffic (page 76), and (2) have no direct intersections. The junctions will therefore be T junctions; and if it is necessary for two roads to cross one another in one of these minor systems,

¹ It is for that reason that one-way workings have been adopted on a wide scale on the major roads of Birmingham. London also has, in the aggregate, quite a number of one-way streets.

THE DESIGN OF ROADS FOR TRAFFIC REQUIREMENTS

the crossing will be staggered. It should, however, be added that, while staggered junctions are sound design in the back roads, they are very dangerous on roads where speed is high ; intersections on high-speed roads—until such time as they can be dealt with by a simple separation of levels or by roundabouts—should be converted into straight-cuts, controlled by signals.

Layout for a New Town

Next we come to the general road plan for a town : the road system must afford rapid circulation, and the whole system must be as accident-proof as possible.

Three generic types of town plan, as expressed in terms of road layout are shown in Fig. 10, viz. (i) the rectangular, (ii) the

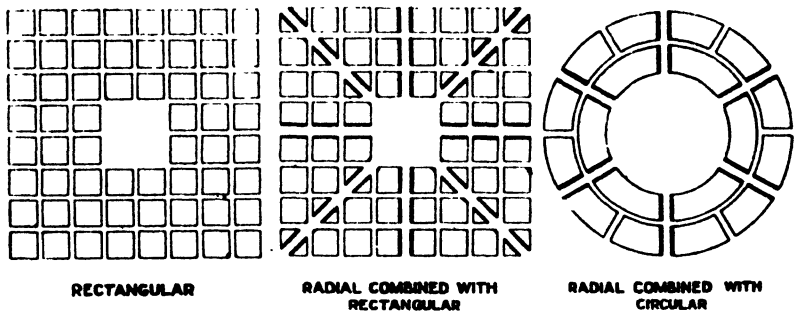

FIG. 10.—Three generic types of town plan expressed in terms of road layout. These are merely diagrams, not scale-plans.

radial in conjunction with the rectangular, and (iii) the radial in conjunction with the circular ; these layouts are well known to the town planner. We have already seen that the first two are unsatisfactory from a traffic point of view ; the first is a mass of intersections, and the second has the same malady developed in a more acute form. From a traffic point of view the radial plus circular is by far the best. The space between the circles will have to be determined in such a way as to fit the general conception of the town plan ; and the radials should terminate in a circle of fairly generous dimensions. In a town of 100,000 inhabitants, for example, the radius of this circle would probably be something between a quarter and half a mile.

TOWN PLANNING AND ROAD TRAFFIC

It has already been remarked (page 36) that sometimes the use-zoning will govern the communications, and sometimes the reverse will be the case. The town planning expert will probably agree that, broadly speaking, his use-zoning should be so devised as to fit in with the arterial road plan; the sub-arterial and minor roads should, on the other hand, be made to subserve the town planner's intentions as to general layout. Not until the town planner's intentions are known in some detail can a traffic specialist attempt to design the whole road-system for a particular town.

For present purposes it will be sufficient to indicate a layout on general lines. The main features will work out somewhat as shown in Fig. 11, which is a diagram and not a scale plan. Rapid circulation is induced by allowing complete freedom of movement on the arteries and sub-arteries, despite very slow speeds on the minor roads. The speed of travel would in fact be very much like that of the railway passenger from point to point. From house or office he takes a comparatively slow journey to the railway station by cab or bus, and thence his main journey is made at railway speed. In just the same way there will be a slow drive through the minor roads, but, once the arterial road is reached, speed will be high. This in turn will induce the driver to keep out of the local roads as much as possible—which is precisely what is wanted.

In the case of a new town, the essential features of the layout, from a traffic point of view, can be summarised as under:

1. The general plan should be on the radial *plus* circular system, but perfect symmetry is of no practical value so long as the general idea is followed.

2. A circular road of extreme merit must surround the centre and heart of the city.

3. The traffic arteries must be roads dedicated to transit, first, last and all the time. There must be no frontages, no loading and unloading, no standing vehicles and no pedestrians.

4. The main arterial system will communicate, by means of large roundabouts, with a system of sub-arterial roads.

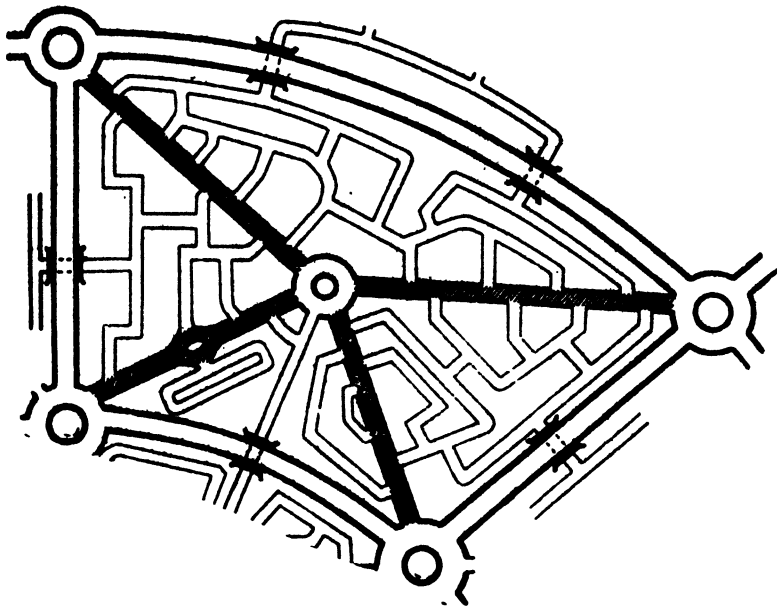

KEY



- ARTERIAL ROADS 
- SUB-ARTERIAL ROADS.. 
- LOCAL ROADS..... 

FIG. 11.—A portion of a city planned upon a system of radial and circular roads. This is a diagram only and not a scale plan ; in reality, the proportion of local roads to sub-arterials would be considerably higher. The general arrangement can be applied, though not in this symmetrical pattern, when replanning existing towns. The points to be noted are (1) the arterial roads communicate only with one another and with sub-arterials, never directly with local roads ; (2) the local roads are linked up with the whole arterial system *via* the sub-arterials ; (3) the local roads are so laid out as to offer no inducement to any driver not having local business to enter them at all : they provide no short cuts ; (4) systems of local roads communicate with each other by subway or bridge without touching the arterials at all ; the daily town life is thus isolated from the arterial traffic movements. Application of these principles to existing layouts is shown in Fig. 21 (see folding plate at end) and Fig. 22 (see page 78).

TOWN PLANNING AND ROAD TRAFFIC

5. The local roads will communicate with one another and with the sub-arterial roads—never directly with the main arteries. Where local roads have to cross a traffic artery they must do so by bridge or tunnel.

6. All road junctions in the system of local roads will be staggered.

7. Business, shopping, industrial and amusement centres will be in places where there is no through-traffic.

This plan will harmonise perfectly with that pleasant idea of the town planner, whereby parkways are provided leading to the centre of the town, and wedges of green land are created, as shown in Mr. G. L. Pepler's conception in Fig. 12.

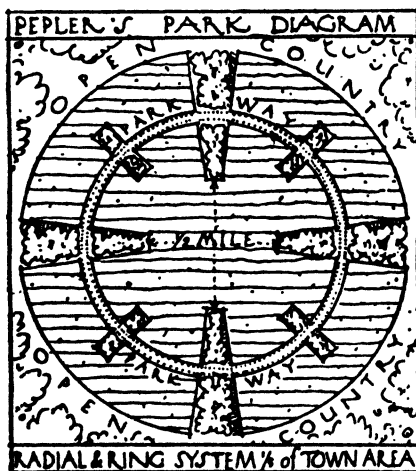

FIG. 12.—The park system of a town as designed by Mr. G. L. Pepler. This diagram is reproduced, by his permission, from *Town and Country Planning*, by Professor Patrick Abercrombie, Oxford University Press. Connected by a circular parkway, parks and wedges of park-land are laid out in such a way as will harmonise with a radial road system. By means of parkways laid through the park-wedges people desiring to reach the open country from the centre of the town will be enabled to do so in rural surroundings for practically the whole of the way. It will be noted that this layout accords excellently with the general road layout shown in Fig. 11.

It is to be hoped that these broad principles will be followed in the layout of all the post-war satellite towns, it being under-

THE DESIGN OF ROADS FOR TRAFFIC REQUIREMENTS

stood that, so long as the principles are meticulously honoured, symmetrical drawing-board plans are of no practical consequence. In the linked systems of local roads, people will live, shop and do their business without making any contact at all with the through-traffic. Under such an arrangement, the fatalities on the roads can be reduced to half their present level, or even lower. If pedestrians are admitted to the arteries and sub-arteries, pedestrian subways will be necessary at all roundabouts. Linked traffic signals should also be provided on the sub-arteries (page 110). This whole scheme, which applies equally to redeveloped existing layouts, is pursued in further detail in Chapter VII.

Application of Principles to Existing Town Layouts

New towns, of course, are the exception and not the rule. True, there have been Canberra and New Delhi, and there has also been the very valuable development of the garden cities. The more immediate problem—as the town planner so well knows—is that of replanning existing towns. The ideas set out in the preceding paragraphs (some of which are beginning now to obtain recognition as a matter of theory) do look rather remote when the task in hand is that of reorganising some stubborn, bad, confused city layout that is generations old. Let us therefore now take a survey of a city or town of that kind, and note a few salient features.

VI

SURVEY OF EXISTING TOWN LAYOUT

Concerning ourselves only with the road system, our object here is twofold, to find out what is wrong and to establish the cure.

Nondescript Roads

One of the chief troubles is that in our existing towns most of the more important roads are nondescript in character. The traffic arteries have become trading centres cumbered with standing vehicles, and many residential roads that ought to be secluded and safe have become conduits for fast through-traffic. The result is familiar to us all ; we have a jumble of through-traffic, local traffic, pedestrians and pedal cyclists, and a really shocking daily toll of casualties.

All this needs to be drastically sorted out. Every road should have its own character and ticket ; there must be no nondescripts. The arterial and sub-arterial traffic routes will have to be definitely dedicated to through-traffic, and all obstructions and hindrances cleared out of the way ; shopping streets, business centres and residential roads must be respectively dedicated to shopping, business or residence, and the through-traffic cleared out of them. This may seem to be rather a far cry, but it should not be as difficult as it sounds. The great thing is to grasp the nettle and to make a real start. For some time to come a good many nondescript roads will remain, but once we have really sorted out our roads, and have determined what interest is to have absolute priority on each, the rest will gradually follow. We will come down to the practical details in the next chapter.

Existing Road Space

The idea is widely held that great numbers of road widenings and new roads, at fabulous expense, would be essential to any

SURVEY OF EXISTING TOWN LAYOUT

effective replanning of towns. It is not really quite as bad as that, though some new roads will certainly be wanted. The fact is that traffic-space in very many roads which are now badly congested would be quite adequate for present needs if the space available were properly exploited. The chief enemies are the standing vehicle and the fixed-rail tramway. The latter, a railway which uses for its passenger-platforms the "running road," is clearly out of date in these days of fast traffic; and is already disappearing; but the former is becoming a more serious factor than ever, increasing as the number of vehicles increases.

Æsthetically, as well as from the practical point of view, the standing vehicle is a great incubus. More and more of the open spaces in the world's great cities are spoiled by the "cluttering" effect of masses of parked cars. Vehicles out of use ought to be out of sight.

From the practical point of view, the matter is even more serious. First, standing vehicles beside a busy road unsight persons about to cross the carriageway, and deaths and injuries result. Secondly, they choke the traffic-flow. Thirdly, it is on roads where the value of ground space is highest that the standing vehicles are generally thickest. Traffic cannot be poured smoothly through a conduit the walls of which are irregular and jagged. A town planner who sits down to work out his own communications would be horrified at the idea of roads of ragged widths, with kerb lines jutting 10 ft. into the road here and there at irregular intervals. But precisely the same effect is produced upon the moving traffic if standing vehicles are allowed to cumber the carriageway. The cure will be found along two lines.

First, in any plan of reconstruction, good accommodation for standing vehicles, in places off the highway at very frequent intervals, is essential, and it must be easily accessible. If parking at these places is free of charge up to (say) fifteen or even thirty minutes, the proposition is not likely to be financially unsound from the point of view of the township. The arrangement is very much cheaper than allowing cars to park on street space of exorbitant value.

TOWN PLANNING AND ROAD TRAFFIC

Secondly, all new buildings should be required (i) to provide for vehicles loading and unloading goods to stand in their own premises, and (ii) to accommodate off the highway all the vehicles which they attract. Suburban cinemas, as a result of police pressure, already provide accommodation in increasing numbers for the parking of cars which they attract. Many of them advertise the fact of a "Private Car Park" as an attraction. Businesses, stores, theatres and every other undertaking will have to be made to do the same.

This whole problem is one of immediate importance for the town planner, because sites for standing vehicles must be earmarked at an early stage in the town plan. Many suitable sites have been cleared by enemy action, and many others may be found under buildings or under open spaces. The town plan must not only provide adequate and well-connected arteries, but it must make such physical provision as will prevent road space being abused, now and hereafter.

Road User

The final step in the survey of the existing town layout is to review the user of all roads, and to classify *in regard to intended future user*. Every road must fall into one or another of the three mutually exclusive categories, viz. arterial, sub-arterial or local (page 41).

VII

REFORM OF EXISTING TOWN LAYOUT

New Road Plan for an Old Town

Coming now to our replanning, it may be well to repeat yet once again the main objects : viz. to produce a road system that will be adequate and convenient, but above all things *safe*.

The main reason why present layouts are so very unsafe is

REFORM OF EXISTING TOWN LAYOUT

that pedestrians and fast motor traffic will never, and can never, safely mix. A town plan which admits of this is a bad town plan.

At present the chief factors of traffic control in towns are restrictive laws and appeals to better nature. What is wanted instead is road planning on a rationalised basis whereby the layout itself will guide and control all road users ; or, where actual rebuilding is not possible, the provision, by means of traffic signals, of a dependable cycle of automatic guidance. We want to give the fast traffic a free run, and we want to keep all other parties clear of it, and safe from it. This is not in the least a fanciful proposition, but a severely practical one.

Ring Roads

The general road plan, which will give effect to these ideas, must therefore now be sketched. To begin with, there are two obvious points. First of all a by-pass road is desirable to keep all main-road " through " traffic clear of the town, and the best by-pass of all is one which forms a complete " outer circle," encompassing the whole town. Secondly, at least one good circular road is, in addition, required within the confines of the town itself, to enable the town's own traffic to by-pass the centre as much as possible. These ideas are so generally accepted that they need not perhaps be further elaborated here ; but the point must be stressed over and over again that the integrity of such roads must be established and strictly maintained. To serve its purpose adequately, the inner ring road, as well as the by-pass, must be given full arterial status, *refusing all contact save with a very few roads of high importance*, for unless a free and really fast run is given to the traffic, drivers will resort to short cuts through the centre, and the ring road will have failed to achieve its object. By far the best plan will be to carry the ring road on a level separate from that of the general road plan (see Separation of Levels, pages 81-82), because the local roads on each side of it must be enabled to communicate with one another, and some of the sub-arterials may also have to be crossed without contact. Equally clearly, the best type of junction will be that shown in

TOWN PLANNING AND ROAD TRAFFIC

Fig. 9, page 51, the ring road being conveyed across the junction without interruption while the roundabout at separate level is left to deal with the cross traffic and turning movements.

The radial arteries leading to the town should be regarded as terminating at the inner ring road ; beyond that point they become sub-arterials (see Fig. 24, page 84). While, in a city of 100,000 inhabitants the radius of the inner ring road would probably be a quarter to half a mile, in a city with a population of a million or over, the radius might be a mile or more.

The Central Area

So far, the problem is straightforward. The real tussle commences when we deal with the town itself, and especially the centre. On wide roads the architect has always wanted noble buildings and splendid vistas ; it has been said that "great roads demand buildings on a grand scale." The traffic specialist has quite other ideas. The proper use for wide and strongly built roads is to carry heavy flows of traffic, and such places are the very last spots for view-gazing. Æsthetically, it can be justly contended, the use of a busy thoroughfare as a viewpoint is wrong, because the prospect from the pavement is continually interrupted by the movement of large vehicles close at hand. From the practical point of view, the idea is even more misguided, because sightseers and promenaders, when drawn to these show roads, are exposed to serious risks. Noble buildings are of extreme value, but they should be isolated, like most of our cathedrals, thus giving the buildings their proper atmosphere of dignity and repose, and promoting public safety at the same time. Handsome business buildings will be in handsome business streets ; a traffic artery is no place for any of them. In that artery we shall be wanting over-bridges and other structures and equipment which would be quite out of the picture. A traffic artery is a thing strictly utilitarian and had better be kept in the background, just as the railways are. Wide traffic arteries can very usefully be exploited as "slits" through which to command a view of some important feature or building (such as St. Paul's Cathedral) from safe and selected points of vantage,

REFORM OF EXISTING TOWN LAYOUT

properly laid out. But the artery itself must be for movement only.

Architects seem to be inclining nowadays more and more towards grouped buildings rather than a scattering of important individual buildings over wider areas ; and, in their pursuit of effective silhouette, their opportunities no doubt are thereby enhanced. This inclination of theirs is in harmony with the foregoing ideas. The grouped buildings should be duly recessed from the business and bustle of the arteries, and the general traffic layout must be such as to ensure their "insulation" (page 79) from the danger and noise.

On the main traffic arteries where it has hitherto been assumed that there must be fine frontages, the traffic specialist must ask for "packages" instead. Buildings should not only turn their backs upon the traffic arteries but should be securely walled away from them without direct access of any sort. Even the backs of buildings, however, can afford the architect excellent opportunities ; it is true that backs and back-yards are usually ugly, but there is no reason why they should continue to be so. The sole access to a main traffic artery should be (*a*) for vehicles, at major junctions at long intervals, and (*b*) for persons on foot, at bus stations which have platforms and bridges like railway stations. No pedestrian must set foot in the carriageway.

There need be no traffic objection to frontages which are completely shut off from direct access to the artery. Service roads can run parallel with the artery either for short or long distances, provided always that there is an effective fence (without openings of any kind either for pedestrians or vehicles) between the artery and the service road ; the service road will be linked only with local roads. Such an arrangement is shown in Fig. 13. Service roads of this kind must not be led direct into one of the roundabouts on the artery ; the best course will be to link them up with a sub-artery, whence the nearest roundabout on the artery itself can be reached (Fig. 14).

Such frontages, however, are quite unnecessary, and, if—on an arterial or sub-arterial road—widening is undertaken whereby building lines are set back and new buildings erected, it

TOWN PLANNING AND ROAD TRAFFIC

is infinitely better, from the point of view of orderly town planning, that the new buildings should *not* face the widened road but should be turned about so as to face roads of their own. This is of especial importance when the premises concerned are shop premises.

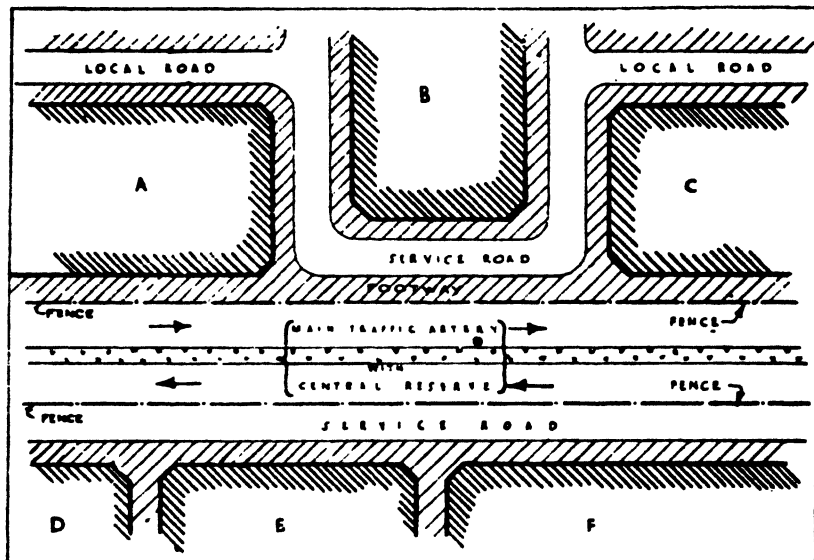

FIG. 13.—An arrangement which, though admissible, is better avoided. When new arteries are created in towns by setting back the existing building lines, the old prejudice in favour of frontages will die hard, even though the carriageways of a properly planned main traffic artery will be shut off completely from frontages, service roads and pedestrians. Buildings *can*, if desired, be erected facing the artery as at A—F, but the only access to them will be by way of service roads linked up, not with the artery, but with other local roads. Linkage with the main artery will be by way of the nearest roundabout only, as shown in Fig. 14.

The problem of the shopping centres has to be faced ; it has already been mentioned more than once and we will now try to find what can be done about it. In every town and village, shopping centres have for generations clustered round the main traffic routes. That arrangement has never been a matter of deliberate design, and it cannot continue to exist in any town that aspires to call itself a planned area. To compel drivers to

REFORM OF EXISTING TOWN LAYOUT

force their way through shopping crowds, and to allow shopping crowds to be exposed to traffic dangers (were such a thing deliberately perpetrated) would be pretty near the acme of bad design. Oxford Street in London has a most serious casualty record, despite a system of traffic signals at short intervals throughout its length. It is necessary to replan.

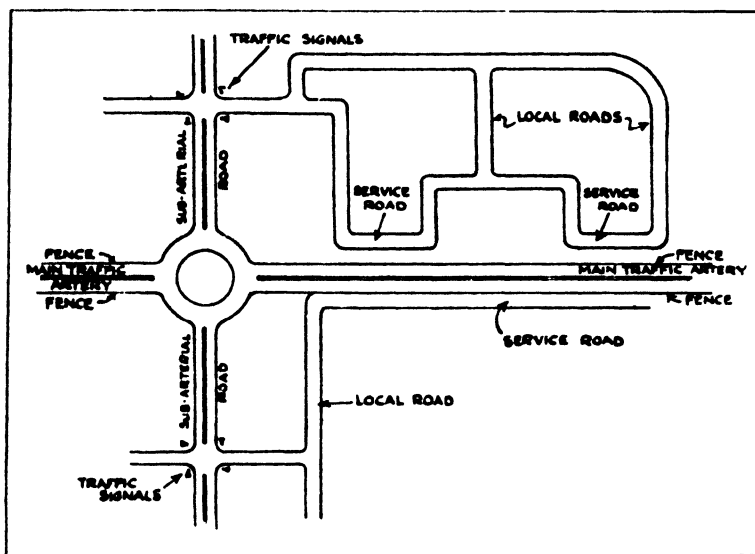

FIG. 14.—Linkage of service roads with a main traffic artery. No direct connection is admissible, as the artery must run unbroken from roundabout to roundabout, without other junctions of any kind. Linkage is effected with a sub-arterial road, whence the main artery is in turn reached.

If the shop premises cannot be moved because the shopping interests are too deeply entrenched, then the through traffic must be drawn away to other conduits. Pedestrians *ought* to be able to circulate freely, and traffic *ought* to be able to travel fast even in towns, because otherwise the value of the speedy motor vehicle is neutralised. Both the authorities and the population value handsome shop frontages, and we must of course have them. But we must also isolate them from the heavy traffic-flows, remembering that the ideal shopping or business centre is upon roads that

TOWN PLANNING AND ROAD TRAFFIC

lead nowhere else. A plan for a shopping centre is shown in Fig. 15 ; various other arrangements could give equally good effect to the end in view.

This obviously is common sense but it is not likely as yet to be popular either with shopkeeper or shopper. The shopkeeper thinks that, if his premises face a main artery, the through-traffic will bring him trade, and he feels that this traffic-flow imparts an air of prosperity to the whole road. The shopper, too, likes the bustle and life. A different outlook is required if a safe and orderly township is to be achieved.

The best plan, when practicable, will almost certainly be to leave the existing main thoroughfares with their existing frontages severely alone and to provide new isolated conduits of such outstanding traffic-merit as to draw all the through-traffic away from the old main streets. We may thus hope to see some new town streets of modern design ; and we must remember once again that any conduit designed for through-traffic, if it allows any contact at all between pedestrians and vehicular traffic, is a faultily designed thoroughfare. Often, however, it may be necessary merely to adapt an existing parallel road. In either event, these new arteries will have to be isolated from the casual incursions of local traffic, a proposition which is entirely practical : the ends of numerous minor roads which debouch on the artery will have to be relentlessly closed, access being had at a few main junctions only.

The whole problem, however, is full of pitfalls, and here are three points that must never be forgotten :

First, the more ample we make the layout in the centre, the more we may aggravate our traffic problem, because good accommodation inevitably attracts more traffic.

Secondly, if ring roads are created to relieve congestion in the centre, these roads will be a failure unless they are so attractive, by virtue of width and of absence of checks, as to *induce* traffic to use them, despite any additional mileage. If we make a brand new road and then instal disconnected traffic signals all along it which check the traffic in a long series of jerks, we have spoiled our scheme. Strangers may, by means of good

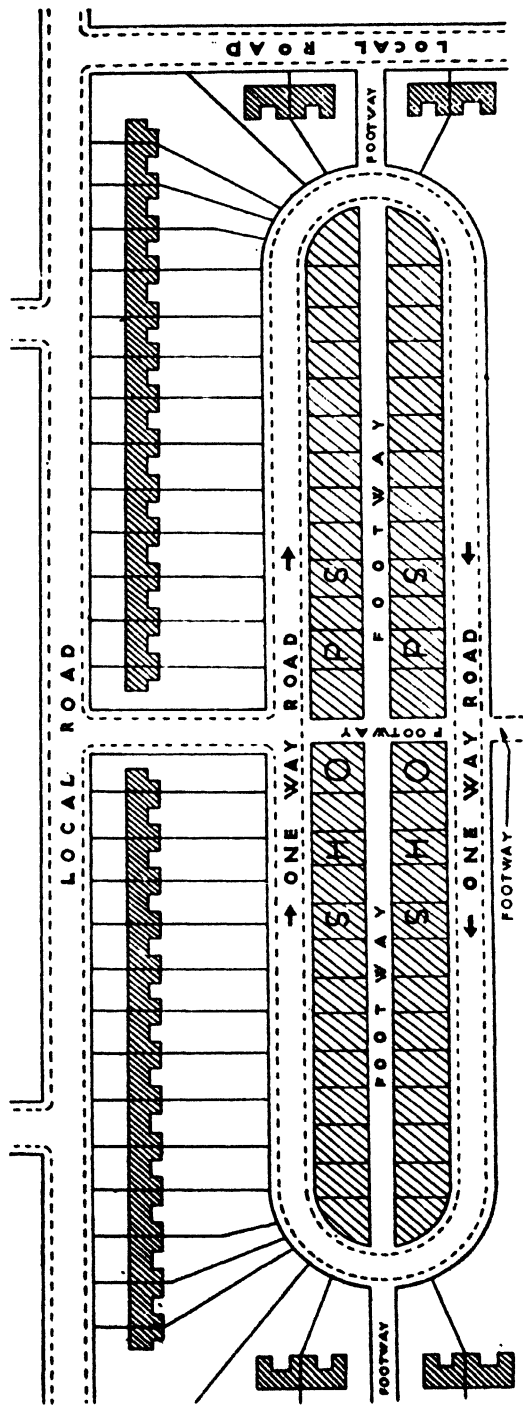

FIG. 15.—A main shopping centre in a new town. This is so designed that no vehicular traffic will have any inducement to enter the area unless it has actual business there. The shops are erected on both sides of a central footway on an island site; each shop has a frontage upon the central footway and also upon the road. There is a cross footway in the centre; and access for foot passengers to and from the adjacent roads is provided. On the road surrounding the shops, there are waiting spaces and parking spaces. The houses that are shown as built facing the ordinary roads of the locality have no direct access to the road surrounding the shops.

TOWN PLANNING AND ROAD TRAFFIC

sign-posting, be kept on the by-pass, but the habitués will almost certainly go back to shorter routes through the centre.

Thirdly, if, by means of any road or combination of roads, accidental short cuts are created through any district where through-traffic is not wanted (whether it is a business centre or a housing estate), the traffic at once finds its way through these short cuts. They must be eliminated.

Effective Compromise

With the best will in the world it will not be possible for town planning authorities, when dealing with existing cities, to live up to all the principles which could so profitably govern new construction. Where nearly all the main traffic arteries in the centre of the city have continuous frontages of shops and business premises, the position may seem well-nigh hopeless. Funds would never permit of the paralleling of *all* these roads. In that event there must be compromise.

A courageous policy of two-deck arcading would isolate the traffic artery pretty effectively both from the shoppers and the shoppers' vehicles. The lower arcade would be used for vehicles waiting or engaged in loading or unloading, and the upper deck arcade would accommodate, at first-floor level, the footway and shop frontages. The footways on the two sides of the road would be linked by bridges at reasonably frequent intervals. The existing carriageway *plus* the existing footways would thus be available for a wide traffic artery with dual carriageways at a cost very much smaller, no doubt, than that of hewing out a new road of similar width. There is, of course, the difficulty that floor levels on existing frontages are not likely to be uniform; that trouble, however, is not one that should daunt a resourceful architect. Another fly in the ointment is that the approach ramps for pedestrians would probably have to be 70 yards long—if the gradient were not to be unduly steep. Even if four equal ramps were used, returning on themselves (with half-spaced landings), some 20–25 yards of ground floor frontage would be masked, unless of course the ramps were constructed at right angles to the frontage and set into the building. Escalators might some-

REFORM OF EXISTING TOWN LAYOUT

times be possible. This, however, is another problem for the architect.

Going still lower in the scale of compromise, ordinary arcading on ground level can be used. By that means the available space will be widened sufficiently to give a free run to the traffic in dual carriageways, all standing vehicles being swept into special reservations provided at frequent intervals off the highway. The arcaded footways will be fenced by means of guard rails, and traffic signals working on the flexible progressive system will platoon the traffic, thus enabling foot passengers to cross with safety from footway to footway on the level. The fact that the ends of the minor roads will have been closed up should enable us to produce a favourable time-distance diagram for the traffic signals, affording a traffic speed up to 30 m.p.h. if desired (see page 105).

Even without arcading, this system of signalling will provide the required segregation of pedestrian and vehicular traffic, but pedestrian subways or over-bridges at the big junctions will be essential in both cases, on account of the turning movements of the wheeled traffic.

The point must again be stressed that, in any plan for main roads in towns, segregation of pedestrian and vehicular traffic is *essential*, either (a) by means of place-segregation, which means separation of levels, or (b) by means of time-segregation, effected by systems of linked traffic signals.

Arrangements such as those outlined above, though far from ideal, will at least provide a planned scheme of main highways as part of the general town plan. In that way pedestrian casualties in the main thoroughfares should be well-nigh abolished, and inter-vehicular accidents greatly reduced.

The broad principle is that the traffic artery must be a traffic artery, and the shopping street a shopping street. The two must never be *mixed up* in any thoroughfare. As a make-shift arrangement, the same thoroughfare may have to be used for both purposes, but in that event each element must be segregated from the other. The traffic artery must be given the whole of the existing ground space, and the entire shopping centre sent

TOWN PLANNING AND ROAD TRAFFIC

upstairs. In the case of a sub-artery the shopping centre and the shoppers can be railed off completely from the road, pedestrians being only allowed to cross the carriageway at regular intervals of time and place, under the protection of traffic signals. There will be no standing vehicles.

Standing Vehicles

It may be contended that this high-handed banishment of standing vehicles will not be possible, because vans and cars will have to be perpetually calling at the shops. The answer is that conditions will be precisely the same as those obtaining in certain busy shopping streets when tramways were operating with their nearside rails within 4 ft. of the kerb. As tramcars were passing every minute or two, vehicles simply could not wait beside the kerb; vehicles therefore *did* not wait beside the kerb. Access from the back is of course the solution, and arrangements of that kind will no doubt be embodied in the plans.

Arteries and sub-arteries are so obviously not the place for standing vehicles that the point ought not to need further stressing. But the old prejudice will die hard. As shown on pages 59-60, it is needful

- (1) to provide good and accessible accommodation, in places off the-highway, at very frequent intervals;
- (2) to ensure, in all building plans
 - (a) that all loading and unloading is carried out in loading bays on private property,
 - (b) that all premises attracting vehicles shall provide accommodation off the highway for those vehicles.

The Plan Takes Shape

Reform on the foregoing lines should have produced an effective arterial grid. If several good new routes, carved out through the existing bricks and mortar, have been found possible, so much the better; if not, suitable roads will have been selected for adaptation. The aim will be to approximate as closely as possible to the ideas conveyed in Fig. 11, on page 55, using

REFORM OF EXISTING TOWN LAYOUT

that general conception as a master plan. So far as the town-dwellers, business people and shoppers are concerned, *the heavy streams of arterial traffic must be regarded as sheer poison, never to be touched, because contact is deadly.* In a really well-designed town, no pedestrian should be able to set foot on the carriageway of the arteries, nor on that of the sub-arteries save under compulsory control by traffic signals. By means of link roads between the various groups of minor roads, as shown in the diagram already quoted (Fig. 11), it should be possible for the daily life of the town to be carried on without any contact at all with the arteries. At the same time, for vehicular purposes, we have to splice on to that arterial system the whole of the roads of the hinterland. Great care and judgment are here wanted.

The junctions are the places with the biggest crop of accidents. Up to the present, however, no limit has ever been set upon the number of minor roads which debouch upon town arteries. There is no sense at all in general layouts of the present character ; the whole thing is an unplanned muddle which calls for replanning on a town-wide scale. Our development survey must therefore not be confined to plans for new and problematical roads intended to improve circulation : its first aim must be to rationalise the whole road system. We must have our arteries, and we must have our systems of local roads ; at present the linkage between them is grossly overdone, there being too much of it either for safety or order. First of all then we will isolate our arterial grid, and then we will link up with the minor roads on some basis more reasonable than the present one.

Isolation of Arterial Grid

The arteries will connect with the sub-arteries, the sub-arteries with selected local roads. The majority of the local road-ends will have to be sealed up, both along the arteries and sub-arteries.

This, of course, will be opposed ; it will be contended that great inconvenience will arise, and that local drivers will have to make quite big detours. In the case of the railways, however, similar detours are accepted as a matter of course : for purposes

TOWN PLANNING AND ROAD TRAFFIC

of comparison, two actual layouts are shown in Figs. 16 and 17. The railways are properly planned ; and the roads, now that they carry traffic more lethal than railway traffic, will have to follow suit.

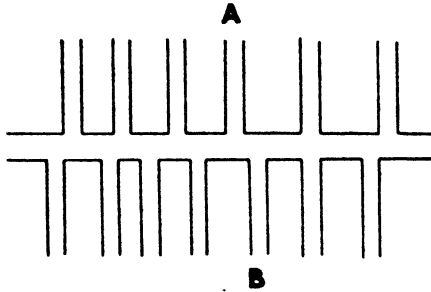

FIG. 16.—A portion of an old main road upon which numerous by-roads open. The result is that pedestrians cross the main road at correspondingly numerous points : a person desiring to cross from A to B assumes, and is still allowed to assume, that he can follow a direct line across.

The road-ends need not be closed up with bricks and mortar : a row of posts will be just as effective. The pedestrian guard rails along the artery or sub-artery will, of course, be continued unbroken across these road-ends.

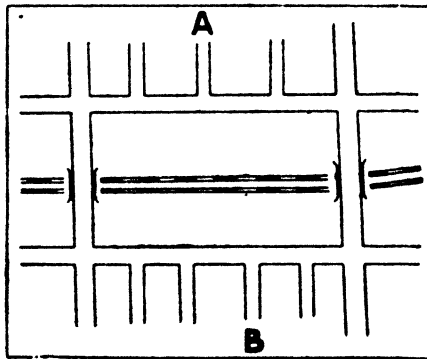

FIG. 17.—A system of by-roads surrounding a railway. Here, in contrast to the case in Fig. 16, sporadic crossing is prevented, and people wanting to cross from A to B make the necessary detour without demur.

When the junctions along the artery are large roundabouts, separation of levels will be necessary for pedestrian circulation

REFORM OF EXISTING TOWN LAYOUT

at those points ; and, that being so, a system of raised footways and first-floor frontages at the roundabouts and along the artery itself will probably be the most economical arrangement when the artery is an old town road which, without actual rebuilding, is being adapted to modern conditions.

Linkage with Local Roads

The local roads will communicate with the sub-arterials only and never with the main arteries direct.

As already mentioned, it is all-important from a traffic point of view that the three classes of road, viz. artery, sub-artery and local road, should be regarded as absolute. The local roads can be sub-classified to any extent desired, but for traffic purposes they still remain "local." If a road which is now a shopping street is to be used as a sub-artery, it must be regarded as a sub-artery without reserve or compromise, shops and shoppers being fenced off from the road completely (page 69).

Selection of the local roads which are to be allowed access to the sub-arteries is the next task. Their number and position will have to be decided in relation to the method of traffic control on those main roads themselves.

If the sub-artery is to be of wholly modern type, with raised footways and large roundabouts at junctions, the number of minor inlets can be reduced to zero. Entry will be provided at one or more of the roundabouts, and the latter will be able, without becoming overloaded, to handle all the traffic from all the neighbouring systems of local roads.

Junctions at roundabouts will be architecturally planned, but a layout which is sound from the traffic point of view must be mapped out before the architect is invoked.

If the sub-arterial traffic is not controlled by roundabouts but by a system of automatic signals, the utmost care will have to be taken not to overload the junctions ; otherwise queues of vehicles may build up from junction to junction, and, when that happens, movement on the sub-artery will be brought to a standstill. The roads which are to be granted entry will therefore be selected in regard to position rather than importance, because the inlets

TOWN PLANNING AND ROAD TRAFFIC

must be as evenly spaced as possible, and not too close together. This will enable the signalling scheme in the sub-artery to give the through-traffic a free run at a reasonable speed (see Chapter X).

Sometimes it may be necessary to redesign road junctions where the layout is irregular ; and always, where there is a pronounced right-hand turn, the main carriageway should if possible be splayed, so as to give an additional traffic lane for a short distance, thus affording a little reservoir space. The idea is shown in Fig. 18. This will ease the situation considerably,

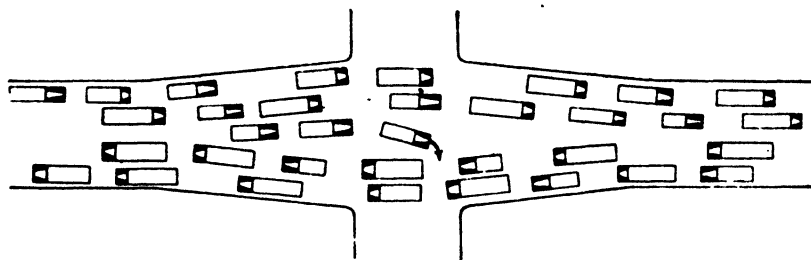

FIG. 18.—A method of preventing the delay to other traffic caused by vehicles waiting to make a right-hand turn. The carriageway is splayed so as to give an additional traffic lane for a short distance. Vehicles wanting to make the right-hand turn are thus able to wait without impeding the through-traffic. Unless that reservoir space is provided, one of the lines of traffic is completely held up until the right-hand turns have been made.

more especially as the right-hand turn is, as a rule, preponderantly on one side only, as shown in the diagram, and not on both sides.

At all junctions, whatever the character of the roads entering the sub-artery, special provision will have to be made for pedestrian safety. Traffic signals at a junction only afford complete safety when the pedestrians are given a separate all-red period ; without that period the turning traffic is a danger.

Where, however, traffic is heavy and congested the time simply cannot be spared for an all-red period, because this would bring traffic circulation to a standstill. In such cases pedestrian subways, with ramp approaches, will have to be provided ; the most suitable design for a four-way junction is shown in Fig. 19,

REFORM OF EXISTING TOWN LAYOUT

this arrangement providing for diagonal as well as direct crossing. The main traffic streams must not be delayed.

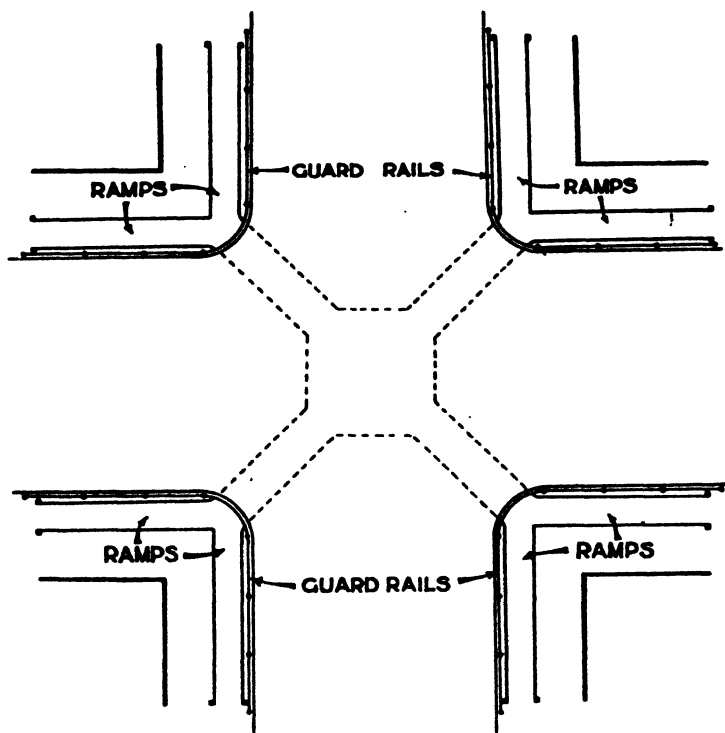

FIG. 19.—A suitable arrangement for pedestrian subways at a cross-road, the intention being to facilitate diagonal, as well as direct, crossings. At major junctions where traffic is heavy and turning movements to the right or left are continuously happening, separation of levels is the only real means of safeguarding pedestrians, even in roads where traffic is controlled by co-ordinated systems of traffic signals. Crossing on the level under the protection of the signals at other points along the roads is safe enough, but not at those major junctions.

Precincts

Under the system outlined, a great number of pockets will have been created, each of which will consist of a little local system of minor roads, devoted to industrial, business, shopping or residential purposes.

These pockets will be a leading feature of the whole town

TOWN PLANNING AND ROAD TRAFFIC

plan ; from a traffic point of view they are merely pockets, but each will be a centre of life and activity, and they will thus require a more ornamental name. Each pocket represents in its way a separate little community. The words "precinct," "close," "purlieu," "pale," "circuit," are all possible ; the French word "enclave" is descriptive ; perhaps even the word "zone" might serve. The best term on the whole seems to be "precinct" ; let us therefore for present purposes adopt it.

Where entry is afforded to any of these precincts from more than one sub-artery, great care must be taken that no accidental short-cut through the precinct is created, for all traffic not having actual business there must be rigorously discouraged. Road layout may have to be altered in such a way as to make it deliberately obstructive.

In Fig. 20¹ an existing street layout is shown. In Fig. 21¹ the same layout is revised in relation to the neighbouring sub-arteries, thus developing precincts of the kind desired.

Each of these precincts will require a separate name or number of its own for directional purposes, and in particular for sign-posting. It is to be hoped that each precinct will have its own proper name.

An outstanding example of a real precinct, with all its abounding virtues, is already to be found in the Inns of Court in London, which remain as secluded as no doubt they were when Spenser wrote "Prothalamion" :

". . . those bricky towers
The which on Thames' broad agèd back do ride
Where now the studious lawyers have their bowers."

Within quiet confines from which the general traffic has been totally excluded, lie those ordered precincts, adorned with buildings that are architecturally fitting, and relieved and softened by grass plots and growing trees. In preserves of that kind all men, and not only a favoured few, should be able to spend their working hours, and town dwellers their lives. While the lawyers' precincts will keep their own dignity and reserve, the

¹ See folding plate at the end of the book.

REFORM OF EXISTING TOWN LAYOUT

shopping precincts will revel in colour and display, and in each business precinct the stockbrokers and merchants will be able to move freely without dodging between masses of buses and cabs—a horribly inefficient arrangement. The residential precinct will have its own space and repose, equally sequestered from the rush and the peril of the through-traffic.

All of this is logical development, and it is bound to come—if not now, in later centuries. The streets in the various precincts will then become town streets of the old-fashioned type. They will cease to be maelstroms of noise and confusion, and become companionable places, with an air of leisure and repose; such streets will provide a real promenade for the town dweller and a rest for jaded nerves. We shall be getting back to Merrie England.

The objection will perhaps be raised that strangers will have difficulty in finding their way about these blind and rather intricate layouts. That may be so. It is difficult to-day to find one's way about in municipal housing estates and in garden suburbs; and they are the better for it, because the short-cut motor driver is kept out.

The layout or adaptation of each precinct must be carefully designed on its own merits; no two will be exactly alike (Fig. 22). The degree of alteration required in the existing local roads will be determined by the number of casualties at present occurring both in the precinct itself and in the sub-arteries with which it is connected.

The precise nature of the access to the precincts, as already seen, will depend upon the nature of traffic control in the neighbouring arteries.

The precincts should be so arranged that no part of any of them is more than a quarter of a mile (at most) from an arterial or sub-arterial road which can carry an omnibus service.

Shopping centres will cease to be known by the names of streets; the name of the precinct will confer the distinction instead. The practice of locating shopping centres in main streets was not the result of a deliberate plan; it grew up under conditions totally different from our own. Anyone seriously bent

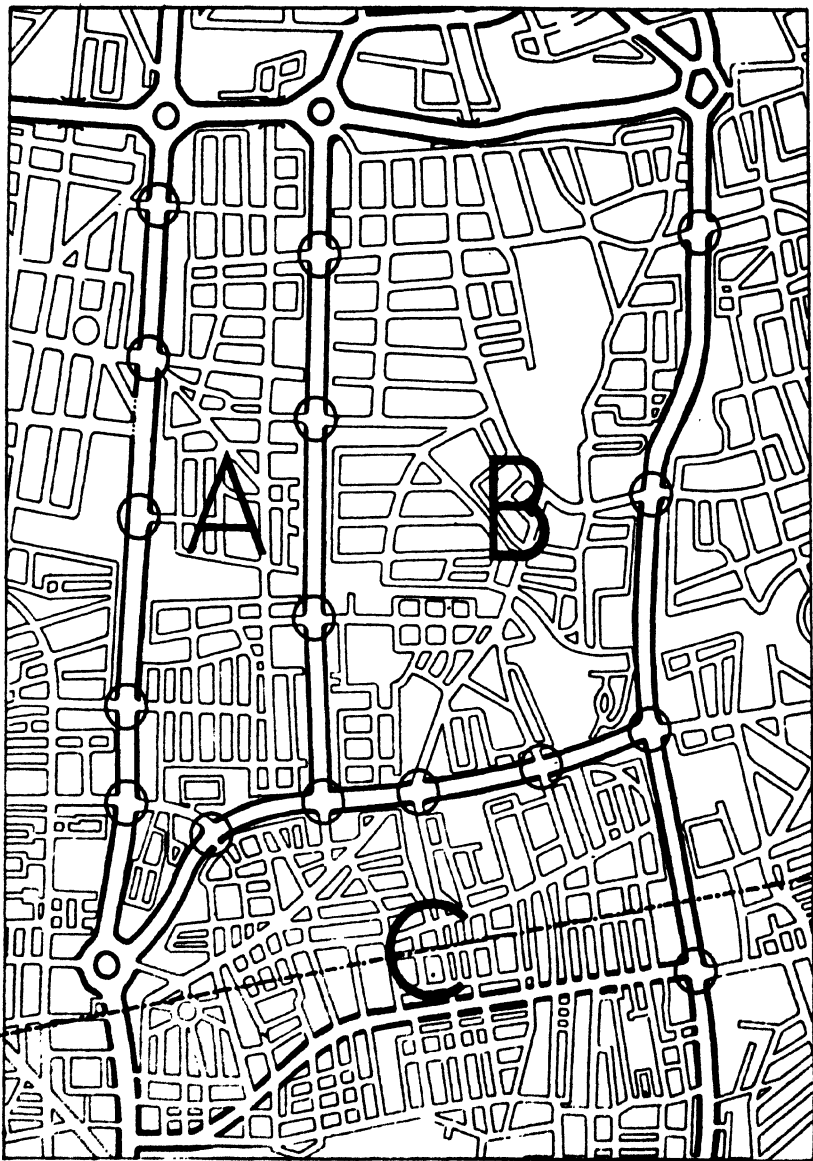

SUB-ARTERIAL ROADS... 

ROUNDBABOUTS..... 

TRAFFIC SIGNALS... 

FIG. 22.

REFORM OF EXISTING TOWN LAYOUT

on real planning therefore will have to alter it. We *must* break from a bad tradition. Shops must have their own secluded precincts.

Where road-ends have been closed, but pedestrian traffic is still allowed on fenced footways beside the artery or sub-artery concerned, pedestrian access to the main road footways should still be allowed at points at present available, or at all events a high proportion of them.

Insulation

As already suggested on page 63, the town plan should be so arranged that notable buildings, in a designed setting no doubt, will be insulated from the bustle and the danger of the traffic. The main traffic routes will be looped away from them, and any main roads cutting directly between neighbouring buildings of public and architectural importance will be diverted. In cases where diversion of a main traffic route is really impossible vehicular access to such buildings will be afforded from side roads, and not directly from the main road. This "insulation" will be another feature of the new town plan.

An example is shown in Fig. 23. It is an example only, not

FIG. 22.—Separation of existing residential, shopping or business areas from the lethal main traffic-streams. The ideal of planning is that people should be able to lead their daily lives without any contact at all with the through-traffic routes, save when they use the latter for purposes of transport. Daily life is lived in the precincts (three separate precincts, A, B and C, are shown in the diagram); it is there that shops and places of amusement should be located, *not* on the main roads. Where precincts are separated by a main artery (on which traffic is controlled by roundabouts) pedestrians and vehicles pass from one precinct to the other by means of subways; where, however, precincts border sub-arterial roads controlled by traffic signals, crossing is effected under protection of the signals. The main traffic routes are thus treated much as if they were railways. Every opportunity should be taken of converting shopping and amusement centres into precincts, and—as a gradual process—of "turning round" the buildings on the main roads so that their frontages are towards the precincts. In the diagram, the upper part has been replanned on safety lines; in the extreme lower part (below the dotted line) the present unplanned condition is retained for purposes of contrast.

Road-ends need not be closed up with bricks and mortar; a row of posts will suffice for the present. Where pedestrians are admitted to arteries or sub-arteries, the footways will be guard-railed throughout, and sporadic crossing *entirely* prevented.

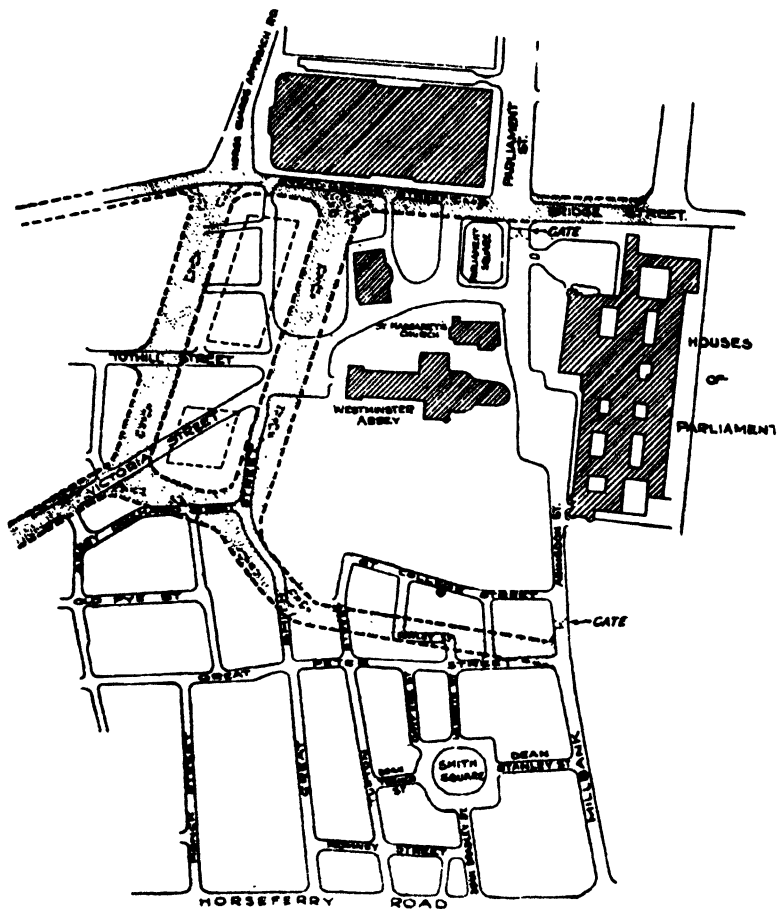

TOWN PLANNING AND ROAD TRAFFIC

a suggestion ; a recast of layout on a wider scale can afford a better solution.

The same principle applies in the case of important shopping

FIG. 23.—A case for "insulation" from traffic. Grouped buildings of public importance and architectural merit should not be invaded, and cut through, by traffic routes. The area should rather be a reserve where people can in tranquillity appreciate the buildings and all that they connote. Taking the case of the Houses of Parliament and Westminster Abbey as an example, the traffic of Abingdon Street should be diverted by means of some such layout as that shown by the dotted lines, and no traffic except that having business in the precinct would be admitted to it. This is an example only, not a suggestion ; the same result can be better produced by a recast of layout on a wider scale.

REFORM OF EXISTING TOWN LAYOUT

or business centres : they too must be “insulated” from the main traffic streams.

Frontages

Even at the cost of repetition, the position in regard to frontages had better be summarised :

(i) *On new arterial and sub-arterial roads.* There should be no frontages at all. The assumption that “great roads demand buildings on a grand scale” is unsound because, if the roads are properly designed, there will be no one to see these buildings except persons boxed up in fast-moving vehicles, who can get no adequate impression of the merits of any building whatever. Architectural effort on these roads can best be devoted to achieving an effective perspective which leads to some building of distinguished design, so set in relation to the artery as to produce its maximum effect from a selected point of vantage at the other end of the vista.

(ii) *On existing arteries or sub-arteries where frontage lines are set back and buildings re-erected.* The new buildings should, so to speak, be turned about so as to face a precinct road. There will be no direct access to the artery or sub-artery from these buildings.

(iii) *On existing arteries or sub-arteries which are not widened or rebuilt.* The frontages will remain, but pedestrians will be isolated from the carriageway by means of separation of levels or by fencing (pages 68—69).

(iv) *In the precincts.* This is the place for planned architectural work, and this is where the frontages should be ; there people can not only do their business, but can linger in safety and appreciate the quality and beauty of gracious buildings. Fit settings for such buildings can also here be provided, to the great advantage of the whole community.

Separation of Levels

Naturally enough, for practical reasons, architects and planning authorities are often inclined to shy when separation of carriageway levels is demanded. Frontage levels become

awkward, and the cost is very high when compared with that of a simple crossing.

Nevertheless separation of levels is in certain cases essential. In order to obtain really effective ring roads, for example, levels will have to be separated at very many points, in addition to the closing of all minor road-ends. The case of ring roads has already been mentioned, and the same considerations apply to any arterial road in a built-up area. An elevated road, 16' 6" above ground level, is in most cases best ; the same results can, however, be achieved by means of a sunken road : this has been successfully used, for example, in a portion of the Express Highway in the city of St. Louis, U.S.A. For arterial roads through a built-up area, tunnels would be equally efficient, but they are more problematical : we know that drivers will use tunnels under a river, *when they have no alternative* ; but where overground alternatives are available it is possible that any long tunnel might be neglected. This does not, of course, apply to tunnels which are incidents on a long-distance arterial road ; on the 160 miles of the Pennsylvania Turnpike between Pittsburgh and Harrisburg there are 7 tunnels.

Separation of levels must not be regarded as a sort of additional feature that can be discarded if costs begin to run too high. It must be taken as one of the basic factors in the town plan.

Two-level roads in towns, the one being an artery and the other a local road for shopping and business, have been sometimes suggested, but from the point of view of planning the idea is definitely unsound. Shopping and business should be isolated from the noise,¹ vibration and exhaust fumes of the arterial traffic ; the artery should be treated like a railway and kept in the background. The proper place for shopping and business is in the precincts, not along a traffic artery.

Major junctions, i.e. junctions of one arterial road with another,

¹ Lord Horder has said that there is no more need to put up with expenditure of nerve energy through needless exposure to noise than to put up with bad housing, tainted food or impure water. He has also said that resistance to noise costs the individual something that he cannot afford to pay, and that many of us are "over-drawn" already.

REFORM OF EXISTING TOWN LAYOUT

will as a rule be dealt with by means of roundabouts, not flyover junctions.

Road Widths

Arterial and sub-arterial roads in towns must be wide enough to carry a really heavy traffic-flow ; not less than 64 ft. between kerbs will be required. In time past, when road traffic problems were approached solely from the point of view of circulation, the idea was to spread the traffic ; that old contention has recently been revived,¹ viz. to supplement single routes with two or three parallels. These parallels would unfortunately be nondescripts of the worst type, and would create a triple contingent of casualty-causing intersections. Safety demands that every main traffic-flow be concentrated where it can be given absolute priority, and all comers can be duly safeguarded from it.

The width of local roads will not exceed 44 ft. between kerbs, because in those roads the dominant feature will be shopping, business, amusement or residence, as the case may be, and traffic will be of quite minor account.

One-way Working

If in some of the main streets in existing layouts, one-way workings would materially assist the general task, those workings should be introduced without hesitation.

Though in minor roads a one-way system is, as a rule, neither sound nor necessary (page 52), it may be of great value in a controlled main thoroughfare, because (1) it is equivalent, when two complementary one-way streets are created, to an important road widening ; (2) the speed of traffic, under signal control, can be increased ; (3) junctions can be more readily controlled by signals, and with less loss of time to the through-traffic than on two-way roads (page 106) ; and (4) pedestrians can more easily be given safety at one hundred per cent level (page 108.)

¹ *Britain Must Rebuild. A Policy for Regional Planning*, p. 31, by Frank Pick (Kegan Paul).

TOWN PLANNING AND ROAD TRAFFIC

The drawback, and it is a serious one, is that these workings so often puzzle and confuse the stranger.

Resultant Layout

The town (Fig.24 is an example) will now be served by

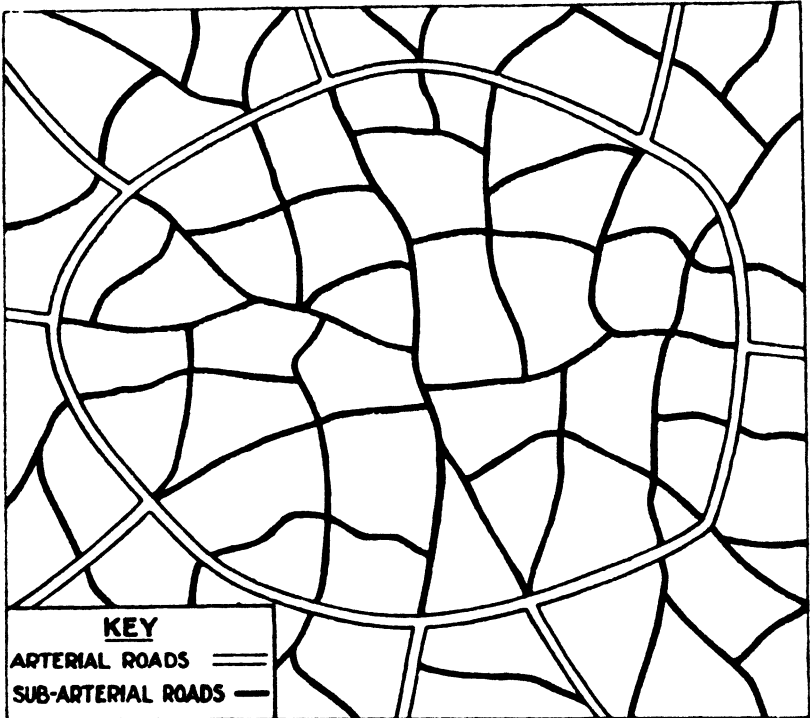

FIG. 24.—General road layout where an existing town has been adapted to modern traffic conditions but not drastically rebuilt. A ring road has been provided, and at that ring road the radial arterials are regarded as terminating; within it they become sub-arterials. An adequate sub-arterial system has been created by the selection of suitable roads conveniently spaced to serve the whole area: these sub-arterials are selected not on a basis of present, but intended, user. The blank spaces between the major roads represent the precincts, all the roads within which are merely local, to be kept clear of all through-traffic. (Examples of precincts are shown in Figs. 21 and 22.) In addition, the entire town will be encompassed by a circular by-pass (not shown in the diagram), thus enabling through-traffic from whatever quarter to keep clear of the town altogether.

a system of protected and isolated arterial roads, and of sub-arterial roads, protected and isolated as much as possible. The

REFORM OF EXISTING TOWN LAYOUT

minor or local roads will form series after series of pockets or "precincts," which offer no inducement to through-traffic. The local road system may be displeasing in plan, because many roads will have been violently truncated ; as, however, so few of us make a practice of looking at our home town from the clouds, we can probably make shift to endure it.

When any city or town is replanned upon these lines many traditional prejudices will be violated. It is necessary therefore to review the justification—and indeed the necessity—for such a break. The main idea is to let people work and live in an atmosphere like that of the Inns of Court in London, instead of amid a hurly-burly of traffic-noise and traffic-danger.

"Look here, upon this picture, and on this,"

On the one hand is the picture of town life in an ordered series of safe and sequestered precincts wherein every avocation is peacefully pursued in safety, and on the other is the present picture of those same activities mixed up with a jumble of traffic, which means exposure to sudden death everywhere.

The Smaller Towns

Apart from the great cities, the various towns in the counties (which have their shopping and business premises ribboned along their main traffic routes) demand replanning on the same lines. Even after the arterial traffic has been diverted from these towns by means of by-pass roads, there is still much local through-traffic, and casualties will continue to be numerous until the shopping and business centres are isolated from it.

An example is generally the best means of exposition. Fig. 25 shows the layout of an existing county town, which has already been relieved of arterial traffic by a by-pass. The casualty record of the road AB is, however, really serious ; that road constitutes the main shopping centre, but (i) the bus and trolley-bus services run through it, not to speak of lorries and multitudes

TOWN PLANNING AND ROAD TRAFFIC

of private cars, and (ii) its footways are too narrow to accommodate the shopping crowds. The road CD is also a shopping street and is an amusement centre too, having upon it a theatre and three cinemas. Fig. 26 shows a sound new plan.

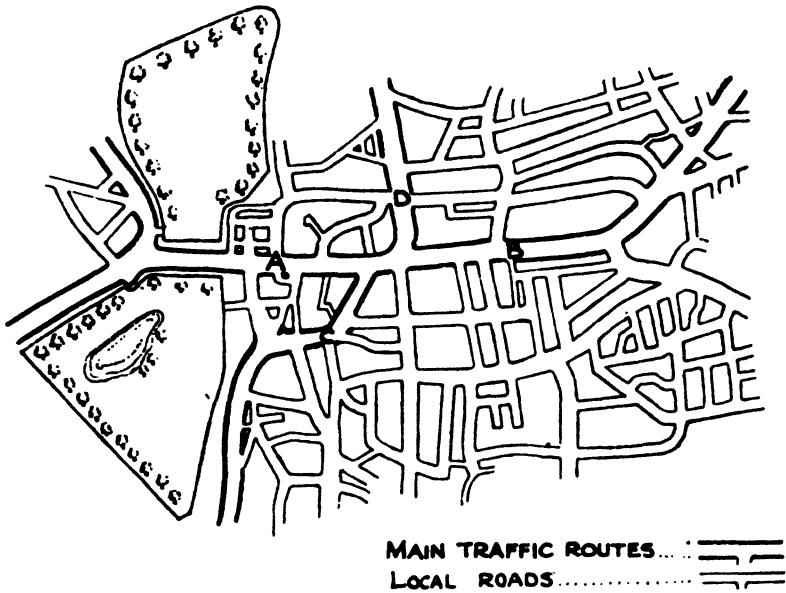

FIG. 25.—An existing town layout. This is the centre of a county town where the shopping and amusement centres, as so often happens, are upon the main traffic routes (AB and CD), and a serious casualty record is in consequence incurred. A town plan which permits of such cause and effect is a bad town plan. Replanning is called for, alike from the point of view of safety, convenience and amenity.

A Cross Check on the Town Plan

For the sake of convenience, four main pitfalls may be briefly re-stated :

- (1) provision of too liberal road layout in the centre is bound to draw unwanted traffic there ;
- (2) ring roads will not serve their purpose unless they afford a faster and freer run than short cuts through the centre ;

REFORM OF EXISTING TOWN LAYOUT

(3) if short cuts through the centre exist, the traffic will use them, with proportionate danger to the masses of people who are daily working, shopping, etc. in that centre ;

(4) traffic routes are not the place for shopping centres.

The town planner will do well to look back at his draft plan, using those four points as a yardstick to size up its merit.

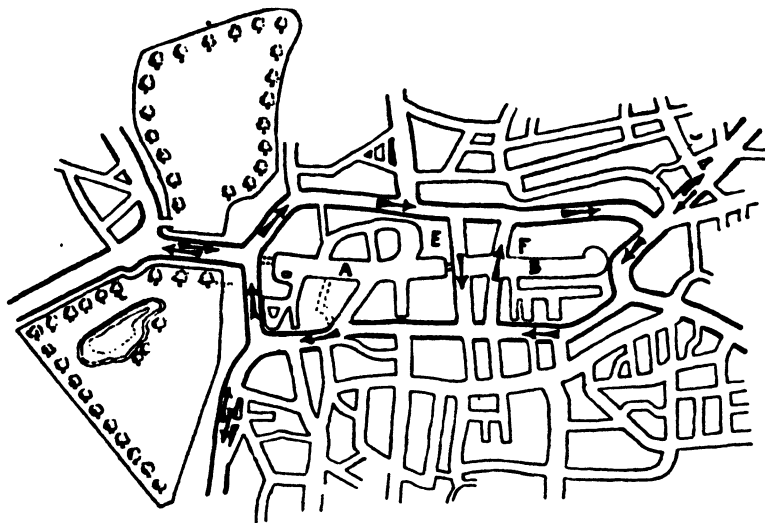

FIG. 26.—A sound new plan for the town layout shown in Fig. 25. By adaptation of existing roads, the through-traffic is drawn away from the shopping and amusement centre, thus allowing people to shop in safety. On account of the restricted widths of the roads into which the through-traffic is diverted, resort is had to a one-way circular working ; and, for protection of pedestrians, a system of traffic signals, linked on the flexible progressive system, should be incorporated in the plan. Two additional one-way roads, E and F, are provided so that there may be access to the centre without undue detours.

Priority of Treatment

For implementing the town plan, a priority table is sure to be wanted. Even as between the main arteries themselves some scheme of precedence will have to be established.

The main guiding line will be the present factors of (a) congestion and (b) danger, those factors being thought of both separately and in combination.

TOWN PLANNING AND ROAD TRAFFIC

Congestion is put first, not because it is a more serious matter than danger (which obviously it is not), but because remedy may be more difficult. Where congestion is serious, and cannot be sufficiently relieved by the removal of standing vehicles into proper parking spaces, by the sealing of unnecessary road-ends and so on, the only cure will be additional road space, which means either arcading or new construction. The congestion factor will, no doubt, have obtruded itself forcibly enough, but if a mathematical comparison as between streets is required, this can be obtained by means of a traffic census at peak load periods *taken in relation to the road width* reckoned in "lanes"; or more simply still the factor can be assessed in direct terms of actual delay.

Danger can in many cases be combated with weapons less costly than wholesale reconstruction, viz. by signal-systems, guard rails and subways, also by removal of all standing vehicles. The present degree of danger will be shown in the casualty maps kept by the Police; the casualty coefficient of every road or portion of a road can be found there. The casualty flags or pins are in point of fact always heavily concentrated along the main traffic routes, and the most lethal of these will be put highest on the list.

At the same time, of course, account will be taken of quick returns, for reform is wanted as rapidly as possible. If half a dozen arteries could be effectively adapted by means of arcading and traffic signals for the same cost as the widening of a single artery and the construction of ambitious roundabouts, and if that cost would exhaust the first year's budget, the six roads would no doubt be chosen, and the one would wait over.

SUBURBAN LAYOUT

VIII

SUBURBAN LAYOUT

General Arrangement

In suburban layout the principles are much the same as in the town itself. All residential estates will have to be isolated from arterial roads on the lines already laid down. Where residential or shopping development along arterial roads has already occurred, the residences or shops (and the footways themselves also) will have to be protectively isolated from the through-traffic in the same way, viz. by means of guard rails and signalling systems. Schools, like the shops, business premises etc., should be in dead ends or other roads which afford no inducement to through-traffic of any kind. And, above all, there must be no nondescript roads; every road must serve a particular office.

The town planner will no doubt be desirous of creating self-contained communities in place of ragged building estates and mere dormitory areas. So much the better; that is well suited to the traffic layout which is intended.

As in the town itself, suburban layout will resolve itself into a series of pockets, or precincts. If shopping, social and amusement centres are intended to serve several residential precincts, there should be communication between all these precincts by subways or bridges, with easy ramps, across the arterial or sub-arterial roads. The suburban population should thus be able to carry on its daily life just as if the traffic arteries did not exist. And that is as it should be.

A Practical Example

In traffic matters, a pinch of practical work is generally worth a bushel of theory. Let us therefore look at one actual design for suburban development, and note the alterations deemed necessary to make the layout a safe one. These altera-

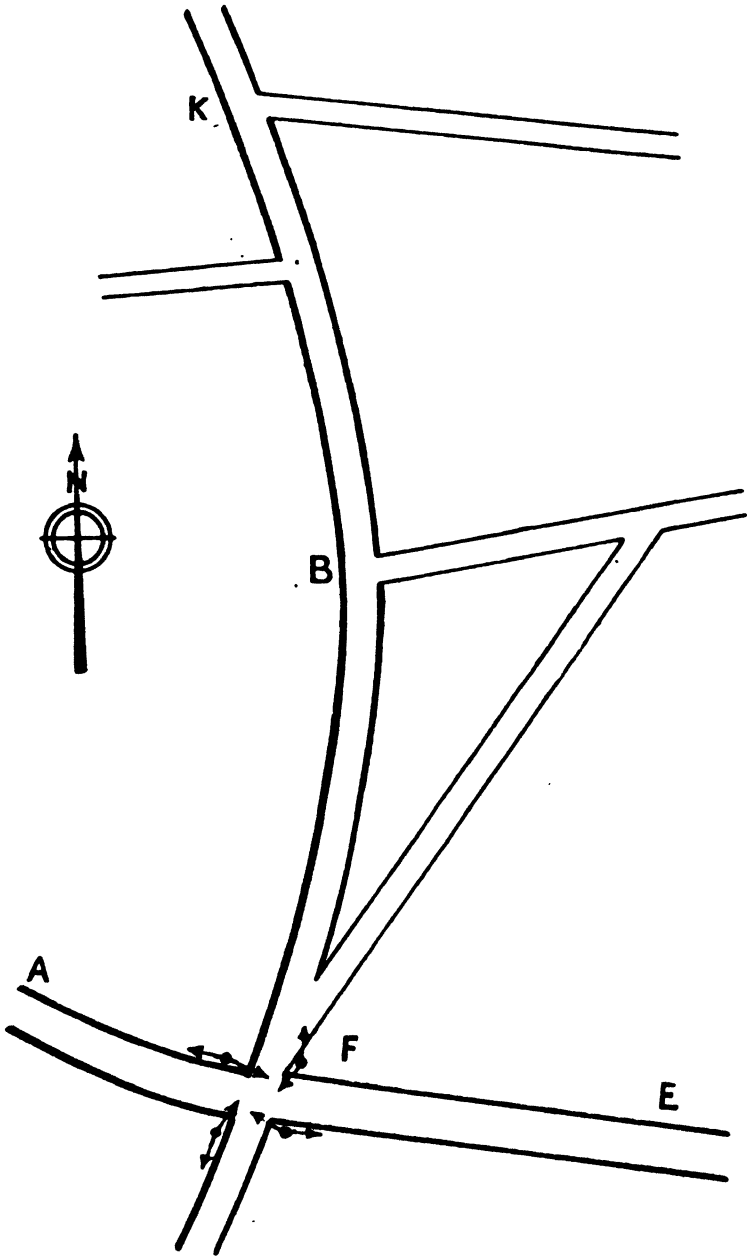

FIG. 27.—A small estate, at the junction of an arterial and a sub-arterial road, which had been acquired for suburban development. See also Figs. 28 and 29.

SUBURBAN LAYOUT

tions, it was found, could be incorporated in such a way as not to disturb the proposed building arrangements. At the same time, had the problem been that of the road layout for a virgin building estate of the same dimensions, the layout might of course have been upon quite different lines.

Fig. 27 shows the original layout and Fig. 28 shows the layout contemplated by the designers of the building estate. Let us follow the process through.

The site, as these sites so often are, is an unsatisfactory one : it straddles a sub-arterial road (KBF) and abuts on a main artery (AFE). First, we shall have to live up to our principles by isolating the estate entirely from the traffic artery, and arranging that vehicle approach to the estate roads shall be from the sub-arterial road only, and preferably at a single point. In cases like this, we may be forced, for reasons of safety, to make vehicles travel slightly greater distances ; but pedestrian-distances must never be increased unless the necessity is absolute.

Next, still following out our basic principles, we must decide what purpose each of our roads is to serve. The two main roads are already classified ; the others, we decide, are all wanted as secluded estate roads, and not as short cuts for fast traffic. From a traffic point of view they will be local roads.

We effect then the necessary changes as follows. The features calling for attention from the safety point of view are marked by letters on Fig. 28 ; the reasons for suggesting alteration are shown in the following paragraphs, and the altered layout which results is shown in Fig. 29.

A. The road AB is intended as an estate road, and not for through-traffic. Nevertheless three features at once strike the eye : (1) a new point of entry to an arterial road is created, (2) a short cut is provided which can be used by "signal-dodgers," and those folk are people who are in a hurry, and (3) this induced traffic will be passing a school (for which special police protection will probably have to be asked later on unless the road layout is altered). The solution is to seal up the end of the road, providing a 60-ft. turning circle for vehicles and a footpath to the main road for pedestrians, see Fig. 29.

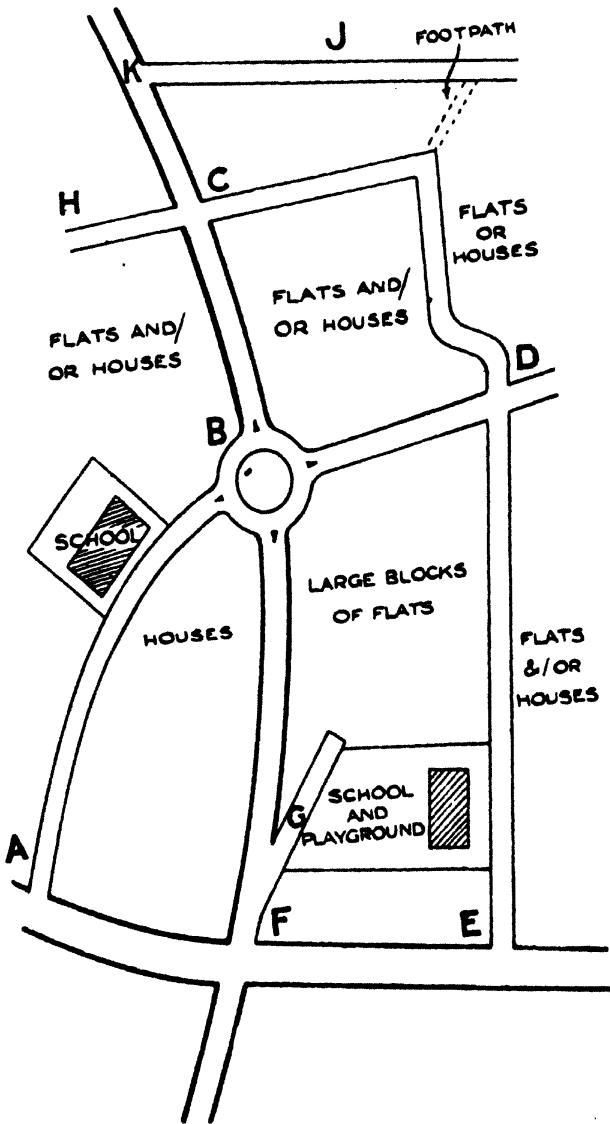

FIG. 28.—The layout drawn up by the parties developing the estate shown in Fig. 27. For reasons explained in the text, this layout is defective from a traffic point of view at the points A, B, C, D, E and G.

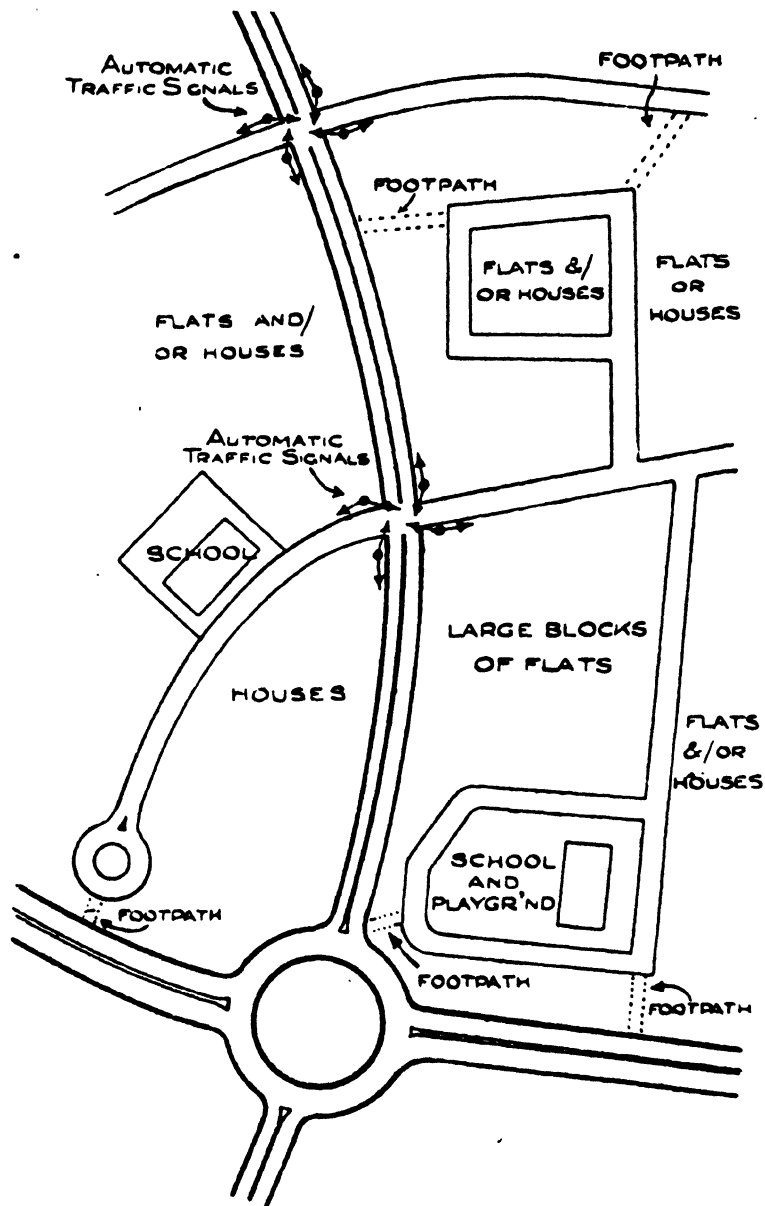

FIG. 29.—The proposed layout shown in Fig. 28 is here re-planned. As a result the safety factor will probably be increased by three or four hundred per cent, while at the same time the architectural layout of the estate is left quite undisturbed. The opportunity has been taken of improving both the arterial and sub-arterial roads themselves.

TOWN PLANNING AND ROAD TRAFFIC

B. The designers of the estate contemplated a roundabout here. Now a roundabout admits of an unbroken traffic-flow, and there is therefore no opportunity for people to cross in complete safety from one side of the estate to the other. We must either have a roundabout *plus* subways with long ramps (for perambulators) or a signalled crossing. As we are now making this junction in effect only a T junction, signals will suffice.

The road CBF. This sub-arterial road must be treated as an unwanted intruder, except at the one junction. We will isolate it from pedestrians by means of guard rails, and allow crossing only at the signalled junction. The opportunity must also be seized of improving the sub-arterial road itself. Our general policy of preventing indiscriminate access to main roads will put a stop to a great many short cuts through back streets, and will throw a greater volume of traffic on to the main roads. The main roads must therefore be improved at every opportunity. We provide dual carriageways, with a 4-ft. central reserve, and we instal a spiked fence along the centre of the reserve in order forcibly to prevent all promiscuous crossing.

C. Here a new point of entry has been made to the sub-arterial road. That will not do at all ; it provides moreover a route for " dodging " the major junctions at B and F. We must keep out the intruders who would endanger residents and their children. We reduce the road to a footpath for pedestrians and deal with the road itself as shown in Fig. 29.

D. Here a direct cut has been designed between two local roads. Accidents are sure to result ; we therefore stagger the roads as shown.

E. Here again a new point of entry to the traffic artery has been contemplated and the case is a parallel to case A, there being again a school facing the road.

F. This being the junction of a sub-arterial with an arterial road, a roundabout should be provided, with pedestrian subways.

G. An acute-angled junction is always awkward and generally dangerous ; and this particular junction is a singularly bad specimen. While retaining a portion of the metalled road at G, we will link it with the road ED. The outlet of the road ED to

IN THE COUNTRY AND THE VILLAGES

the traffic artery will have been sealed, as in case A, and a foot-path substituted.

H. This road, in conjunction with the road J, now creates a staggered crossing on a sub-arterial road. It will be best to "square up" the junction, and to control the cross traffic by means of automatic signals, which will be linked up with the signals at the junction B on the flexible progressive system, in order to obviate jerky stoppages of the main-road traffic.

In the whole of this process we have not disturbed the architectural layout of the building estate, but we have probably increased the safety factor by three or four hundred per cent.

For a new estate the principles would be just the same, the points of entry for vehicles being very few, and the junctions in the estate roads being all T junctions.

New Building

All new building in suburban areas will be upon precinct roads ; none will be upon the arterials and sub-arterials.

IX

IN THE COUNTRY AND THE VILLAGES

In the country and villages the present road communications are ample so far as road mileage is concerned, but they are deficient in quality and arrangement. Here again every road must have its own character and its own office. As in the towns, furthermore, the object must be to keep the fast traffic on the main roads, where its own passage can be made safe and the general public can be protected from it.

Local Roads

There can be no question of applying a uniform standard of improvement to all country roads alike. Improvement must always be selective and cautious. Country lanes that are narrow

TOWN PLANNING AND ROAD TRAFFIC

and winding can as a rule best remain narrow and winding ; they are safer so. Their office is to serve the needs of the countryside, and every " hazard " in their course steadies the speed of vehicles and discourages invasion by the fast driver. So-called improvements will often build up an accident record on a road that had been virtually accident-free ; the road had previously been so dangerous as to be safe. The sound plan in most cases is to label the dangers quite clearly and to allow them to remain as a standing check upon undue speed.

The first step, therefore, is to find out from the Police the points at which casualties are actually occurring. If these are flagged upon a map, the points at which improvement or control by signals is essential will be brought into relief at once. Everything else should be left severely alone. Complete adaptation of these local roads for fast traffic is neither necessary nor desirable.

Main Roads

Roads that already carry a good deal of through-traffic are quite another matter. The chief consideration as always must be safety : and on safety grounds the first thing to do is to drain the lethal fast traffic by every possible means from the small roadside towns and villages, and to separate it completely from pedestrians and pedal cyclists.

A few years ago, the general idea was that all the great main roads would in course of time be provided with dual carriageways, footways and cycle-tracks. But the drawbacks are serious. The policy of accommodating all three classes (vehicular, pedestrian and cycle) in separate partitions on the same thoroughfare would be excellent if there were no cross-roads or crossing ; the three classes would run in eternal parallels and would never clash. Unfortunately, there are many junctions in all existing main roads where cyclists want to turn right or left, and the pedestrians on their part frequently have occasion to cross the main carriageway. It is in this way that the majority of casualties on these roads are sustained, and this must somehow be altered ; footways and cycle tracks afford no cure.

In order to bring layouts up to date, flyover junctions are

IN THE COUNTRY AND THE VILLAGES

generally envisaged, but it is not sufficiently realised that these flyovers (though—as already noted—excellent in America where there are practically no pedal cyclists, or on the German Auto-bahnen to which neither pedestrians nor pedal cyclists are admitted) are not really manageable on roads where pedestrians and pedal cyclists are accommodated. The estimated cost of a single clover-leaf flyover junction, in which an effort has been made to accommodate all three classes, has been quoted as about £80,000, and even then all the traffic-streams are not completely separated. Funds are not unlimited, and it is in any case a mistake to spend thousands of pounds in unravelling a tangle which need not have been allowed to occur. Exclusion of pedestrians and pedal cyclists from any new main roads is thus most clearly indicated.

Whether on adapted coach-roads or on new motor-ways, the main junctions should be roundabouts (or roundabouts with flyover bridge), the saving in cost being devoted to still more mileage of protected motor-ways.

As between the two types of road, the question turns, not solely upon the safety factor, but also upon cost and practicability. In the matter of cost, it is pointed out that the old roads cannot be effectively widened save by drastic destruction of high-priced roadside properties, and that this would probably be much more costly than driving a new road through virgin land to be acquired at agricultural values. On the score of practicability, however, it has been objected that the country is so evenly populated that satisfactory lines for new roads could not be found, and that in any event the new roads would encounter other roads, on average, at about every half-mile. Neither of these two objections is convincing; one cannot imagine a surveyor sent out (for example) to suggest a line for a new railway between any two big towns coming back and saying that the project must be dismissed as impracticable. The second objection, moreover, is a strong argument in favour of the motor-way, which can negotiate all these minor roads by simple bridging, whereas the adapted main road obviously cannot refuse all contact with the existing local road systems *of which it is already a part*; innumerable

TOWN PLANNING AND ROAD TRAFFIC

roundabouts or elaborate six-track flyovers would therefore be required. From the safety point of view, the separate motorways, which would drain the fast traffic away from the country towns and villages, can be the only sound choice. It is to be hoped that the claims of safety will outweigh all other considerations. The main traffic-streams will then run through fields and woodlands, the former having been dedicated in perpetuity to agriculture and the latter created (where not already existent) by afforestation.

The alternative to that attractive scheme, when studied in detail, looks less and less practicable. First there is the process of adaptation, which would inevitably be spread over a long period of years ; it has been pictured as under :

“The roads proposed to be dealt with are roads in constant daily use. They could only be ‘ adapted ’ half a road at a time. (Else the villages, hamlets, farms, fields and residences served by them could not subsist.) To have 4,500 miles of our roads (selected as the busiest) closed half by half in disjointed snippets for long periods, during which they would operate in spasms at double traffic density, would slow our industries, impede commerce, injure agriculture, and bid fair to ruin the industry of road transport if this state persisted for long.”¹

A second aspect is almost equally disturbing. However well in course of time the existing main roads may be adapted, it is agreed on all hands that by-passes must be provided where large towns are encountered. Not only the larger towns, however, but very small towns are now feeling the need for a by-pass, and these demands will grow more and more. The by-pass means a loop, and in course of time there may be more loops than old main roads.

Even when numerous loops have been provided, moreover, a very uncomfortable item remains. The fast through-traffic, after being given free and fast travel along those stretches of by-pass, is poured back on to the old road to surge like a great lethal wave through the old ribbon-developed roadside villages

¹“A Plan to Reduce Accidents.” Lt. Col. Mervyn O’Gorman, C.B. D.Sc., M.Inst.C.E., M.I.Mech.E. (the *Autocar*, 2nd May, 1941).

IN THE COUNTRY AND THE VILLAGES

which have not as yet been "by-passed." That is a very ugly picture.

A scheme which was quite seriously envisaged by local planners a few years ago affords a good example. The old road is shown in Fig. 30 as AB. C and D are towns already by-passed as shown, and E is a smaller town; F and G are villages of some dimensions. The proposal was to by-pass the small town E and one of the villages F. A scheme for by-passing the village G was only required to make the picture complete.

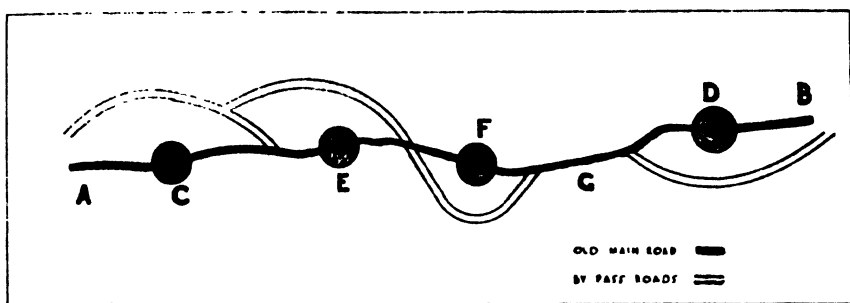

FIG. 30.—A stretch of old main road, and a scheme produced by local planners for adapting it to modern needs. AB represents a 20-mile stretch of the old road; C and D are towns already by-passed, E is a smaller town, and F and G are villages of some dimensions. The proposal of the local planners was to by-pass the small town E and one of the villages, viz. F. A further scheme for by-passing the village G would have made the picture complete. Each by-pass means a loop, and, with this piecemeal policy, there might easily in course of time be more loops than old main road. A more comprehensive scheme of planning is clearly called for.

It is hardly possible that necessity should ever demand that the line of an existing main road should be slavishly followed; should it do so, however, a layout such as that shown in Fig. 31 would probably be by far the best. The old and new roads would only be linked at very occasional roundabouts; the new road would thus in effect be an isolated motor-way, and the old road would become a local road. The widening of the existing main road would of course destroy a great amount of beautiful roadside property, not to speak of the roadside trees. The effect of this upon existing villages does not bear thinking about.

TOWN PLANNING AND ROAD TRAFFIC

By-Pass Roads

Of the quite numerous by-pass roads which have already been constructed a certain proportion are serving their original purpose excellently : without frontages, and with all their main junctions controlled by roundabouts, they represent sterling achievement. They would be better still if they had dual

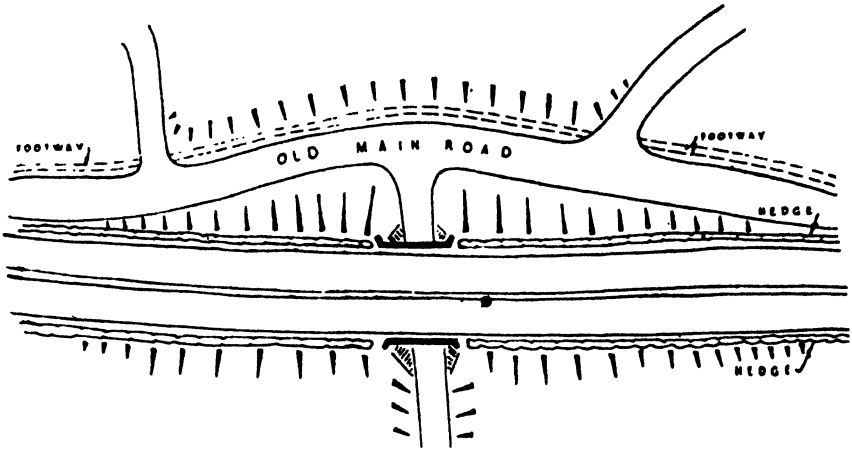

FIG. 31.—A new traffic artery paralleling an old main road. This is not to be recommended ; but if in providing the trunk road system for future needs, the line of the existing main roads *should* have to be slavishly followed, an arrangement as shown above would be the soundest form of planning. The diagram is a rough sketch conveying the idea ; it is not a scale plan. Instead of attempting to widen the existing road, the idea would be to construct a new dual carriageway road beside it, the old road being left just as it is—for two reasons : first, the old road will carry all the traffic until such time as the new road is available, and secondly, when the work is finished, the old road will become a *local* road which, completely separated from the new artery, will absorb all the old minor junctions, thus keeping the new road free from junctions except at big roundabouts at long intervals. At those occasional roundabouts, and there only, the old and the new road will be linked. The whole affair would be costly and troublesome, and a new motor road through land acquired at agricultural values is definitely to be preferred.

carriageways, but that can wait—for years and years, if need be. They are good as they are.

But not all the by-passes have retained their character, and some of them have been so shockingly subverted by ribbon development that the gibe about “by-passing the by-pass”

IN THE COUNTRY AND THE VILLAGES

becomes nothing less than the bare truth. Private enterprise had free play before the case for Government control had become manifest, and this has been the result.

In town and country planning, whatever the long-term policy for the road communications of the country may be, these unfortunate failures will have to be cleaned up. As already noted, the situation cannot effectively be met by imposing speed limits or installing pedestrian-operated signals. The absolute priority of the fast motor traffic has to be re-asserted ; and the pedestrians must be sent over or under the artery. From end to end of a by-pass there should be no traffic signals at all ; every really main junction should be controlled by a roundabout (with flyover bridge, if possible, as in Fig. 9, page 51), and all other roads sent over or under the by-pass, or stopped up altogether. The original object of the road will thus be re-established.

New Building

If one thing has been established in regard to town and country planning, it is that the town must be the town and the country the country. During the last two or three decades, new buildings, largely of the suburban villa type, have been scattered broadcast, anywhere and everywhere ; the country lanes are out-raged by them, and the whole countryside increasingly marred.

Both from the point of view of traffic and of planning, this has to be stopped. In the case of classified roads (which are broadly speaking the arterials and sub-arterials), the required prohibition is already inherent in the Restriction of Ribbon Development Act, and there is every indication that the principle will be applied more and more stringently as the need is increasingly recognised to abolish ribbon development altogether. A setting-back of the ribbon development by means of service roads paralleling the principal road is—from the point of view of planning—as bad as ribbon development itself, while from the traffic aspect the arrangement gives rise to the defects in layout referred to on pages 32–33, and also to multiplication of junctions.

From a planning point of view no new building, either

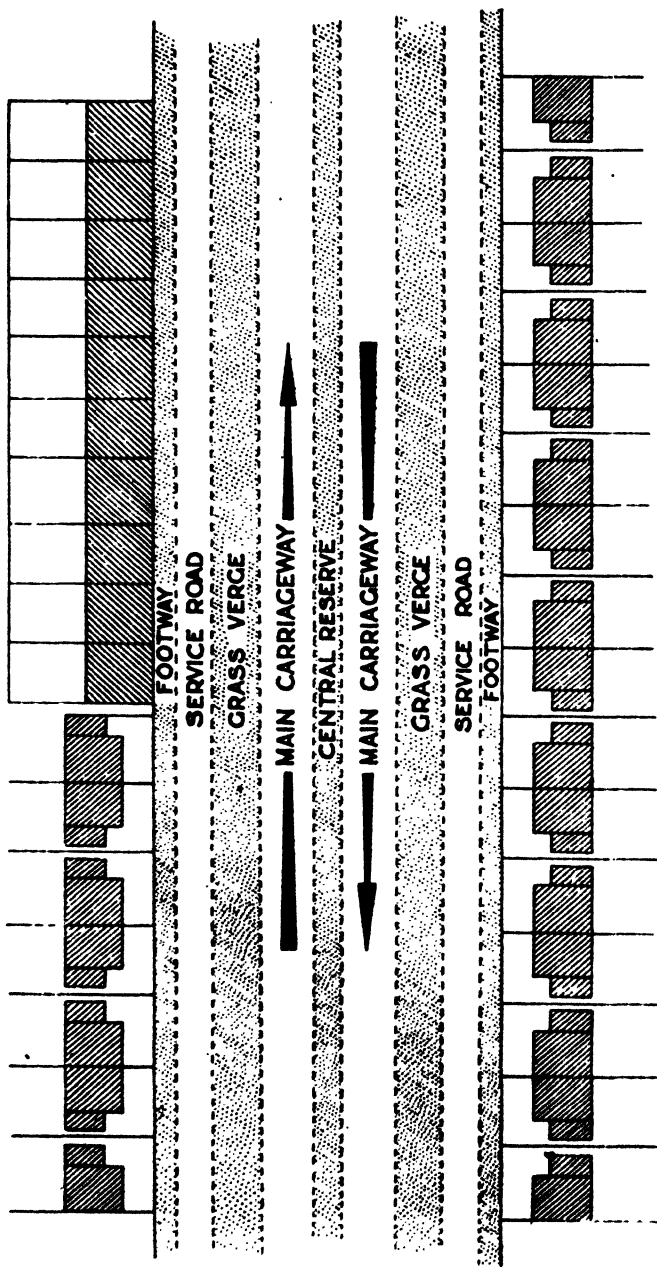

FIG. 32.—A case of faulty planning. Here, beside an arterial road with dual carriageways, houses and shops have been erected. This is ribbon development, despite the fact that the buildings are upon service roads. From a planning point of view the arrangement loses none of its vice when the buildings are merely set back in this way. The incurable evil of the arrangement is that people are brought to live and to shop at the *worst possible place*, viz. beside a high speed arterial road. This is bad planning. Not only must ribbon development be abolished, but new residences and shops must be located only in properly designed precincts, where they would face local roads of their own.

IN THE COUNTRY AND THE VILLAGES

immediately fronting or set back, should be permitted upon any arterial or sub-arterial road, *because that is the wrong place for people to live or do business*, seeing that they are thereby exposed in their daily goings and comings to serious and quite needless dangers. In Fig. 32, a layout is shown of a kind which gives rise to those pitiful cases where children, given by their parents a penny for sweets, rush joyfully out to spend it, and never return. From the point of view of planning, not only must ribbon development be entirely abolished, but no new building should be permitted on any local road not already dedicated deliberately to ordered building development, and that building development should be upon precinct roads, *clear of all the old roads which lead from place to place*.

The General Picture

For the whole country, there will be an arterial grid, supplemented by the entire network of sub-arterial and local roads. If new arteries, reserved solely for motor traffic, are developed, a logical and sound road system will be built up.

In the meantime, and so long as the old main roads have to be used for fast through-traffic, the arterial stream will have to be given the freest and safest passage that can be managed on all open lengths, other interests being subordinated. Where any village or roadside town is encountered, the arterial stream must be slowed down and platooned by means of linked traffic signals (pages 105-6).

Sub-arterial roads require to be of such merit as to keep the through-traffic away from the local roads, and the former will be correspondingly improved and safeguarded. Local (i.e. minor) roads will be left as they are, save that real hazards of every sort will be duly labelled, and individual spots possessing a bad accident record will be redesigned or controlled by signals. A single fatality cannot be regarded as a bad accident record; such a thing may happen anywhere.

From the country as from the towns, the nondescript road must disappear. Every road will be of definite status, arterial, sub-arterial or local. The local roads will be sub-divided into

TOWN PLANNING AND ROAD TRAFFIC

village streets and country lanes. Erection of new buildings¹ fronting the arteries or sub-arteries will be prohibited, and new housing will be concentrated in newly made village streets, not on roads that lead from place to place.

X

TRAFFIC SIGNALS IN TOWN PLANNING

The Town and Country Planner who has been following up the idea that, in his planning, safety must be the first aim, will want to form some exact measure of the possibilities of automatic traffic signals. The scientific use of these signals can play an important part in town planning, and sometimes may obviate the need for new roads. The planning of new roads and the adaptation of old ones are not matters to be kept in water-tight compartments; the possibilities of signalling may thus have quite an important bearing upon the whole road plan.

It is only with these possibilities that we are here concerned; the technique of the mechanism, lenses, location of signal lamps, exact siting of signal posts, and so on, need not detain us at all.

Signals, as is well known, are sometimes installed as isolated units and sometimes in co-ordinated groups.

Detached Installations

Detached installations are of great value at the occasional, and often unexpected, cross-road. At places, however, where there is a great deal of wheeled traffic and there are few pedestrians, roundabouts are much better than signals, especially when a heavy right-hand turn has to be provided for. When on the other hand pedestrians are numerous, signals—by stopping the traffic periodically—give the people their chance of crossing the road.

¹ Subject to the exceptions on page 42 in favour of motor service stations and places of refreshment, both having private road space for standing vehicles.

TRAFFIC SIGNALS IN TOWN PLANNING

If traffic is not heavy, signals are particularly useful at places where the cost of a roundabout would not be justified. The vehicle-actuated type, which is now too familiar to need description, is of singular value.

On by-pass roads or motor-roads there should be no signals at all, the object there being an unobstructed run without any stoppage at all.

On roads where speeds are high, the staggered junction, which was favoured in the nineteen-twenties, can now better be squared up and signalled—until such time as bridges or roundabouts can be provided.

Co-ordinated Systems

Broadly speaking, there are three main methods of co-ordination :

(1) *The Synchronised System.* All the signals of a whole series change from red to green and from green to red simultaneously. The best known example is the system in New York City, where the uniform rectangular layout is well suited to it. The disadvantage is that, the volumes of cross-traffic at the various junctions not being equal, the period of stoppage at all junctions must correspond with that of the busiest, with the result that—at the less important crossings—the traffic on the main avenues is held for some time after the minor road traffic has cleared.

(2) *Limited Progressive System.* All the signals of the series are operated from a central control. Along the line of route the signals are divided into groups, and when one group changes from red to green, the next group changes from green to red and so on. The system can be usefully applied to some, layouts of regular rectangular type, but—for purposes of expediting vehicular traffic—it is seldom, if ever, suited to the needs of this country.

(3) *Flexible Progressive System.* This is by far the most useful and satisfactory system of co-ordination, but even it is greatly handicapped by our irregular layouts. The signalling system is so arranged that, if the driver, on being admitted

TOWN PLANNING AND ROAD TRAFFIC

to the controlled thoroughfare by the green lights, will conform to a certain set speed which can be advertised on the signal posts, he will find that each signal will turn green in his favour as he approaches it. In that way, if he is travelling at the correct speed, he will go through the whole section, which may be some miles in length, without being stopped at all. A platoon of vehicles, of which this driver's car is only one, will in fact be moving with him ; and between each platoon there will be an empty space. On these empty spaces the pedestrians can cross in complete safety, and without impeding the traffic-stream. All the signals in the system are governed by one master controller which can be so adjusted that, within limits, the speed of the traffic will be varied according to the peak or slack periods of the day.

The system has the great advantage that it discourages racing, because any driver travelling beyond the prescribed speed is at once brought up by a red signal. In order to make the system function at its best all standing vehicles should be removed, and all bus stops embayed. Promiscuous crossing by pedestrians should be prevented by means of guard rails ; pedestrians must cross nowhere save at the signalled points, and then only when the signals are in their favour.

It is easy to apply this system upon a road (if such a road exists) where the road junctions occur at regular and equal distances. Where the junctions are irregularly placed, certain adjustments will be required, seeing that the same signal phases will have to govern the traffic in both directions ; for example, some minor roads may have to be closed up, worked in one direction only, or even ignored altogether. The phasing is worked out on a time-distance diagram, details of which are unnecessary here. The speed in town areas is generally between 15 and 20 m.p.h. ; that speed can however be greatly increased upon roads where crossings are few, or in one-way systems.

TRAFFIC SIGNALS IN TOWN PLANNING

Speed Control

As already mentioned (page 31), traffic signals co-ordinated on the flexible progressive system can be used to control speed automatically, and this is by far the best method of enforcing a speed limit upon a main road. Enforcement by observation and prosecution is not satisfactory; mechanical control is more effective as well as being more acceptable to all parties.

Turning Traffic

Vehicles turning to left or right are of course always a complication; those turning to the left endanger the pedestrian walking parallel to the main traffic-stream, and vehicles turning right impede the general traffic-flow by holding up vehicles

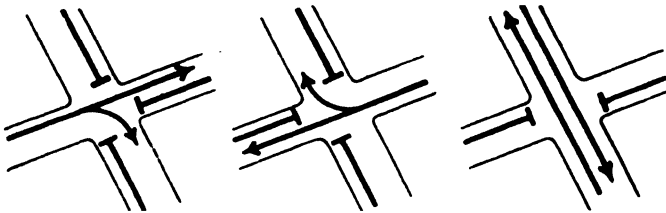

FIG. 33.—A square intersection controlled on the three-phase system, with separate phases to allow of two right-hand turns. The traffic-streams which are in motion and at rest at each of the three phases are indicated respectively by use of arrows and stop lines.

behind them while awaiting an opportunity to make the turn, and then by cutting the course of those approaching in the opposite direction. A three-part timing¹ is necessary where a right-hand turn is heavy (Fig. 33). The turning traffic is slow and casualties are therefore not likely to be numerous or serious. For full pedestrian safety, an all-red period is to be desired; but this slows up traffic movement, and is therefore not always possible. In that case, pedestrian subways are essential.

¹ Fuller details as to the phasing of signals both at simple and multiple junctions, as well as instructions for the preparation of a time-distance diagram for signals linked on the flexible progressive system, will be found in the author's *Road Traffic and its Control*, Chapter XII.

TOWN PLANNING AND ROAD TRAFFIC

In a one-way street, hundred per cent safety can be achieved on one side of the junction, as shown in Fig. 34.

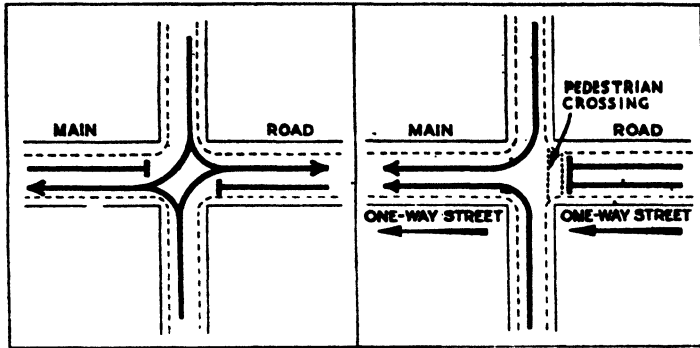

FIG. 34.—The manner in which, when a main thoroughfare is made a one-way street, completely safe passage across that thoroughfare can be given by traffic signals. In the diagram on the left the main thoroughfare is a two-way street; and when traffic is stopped the pedestrians crossing are still endangered by turning traffic. In the right-hand diagram the main thoroughfare is a one-way street; and hundred per cent safety is given to pedestrians at one crossing, because at that point there is no turning traffic at all.

Pedestrian-Operated Signals

Signals fitted with buttons to be pressed by pedestrians (or operated when the pedestrian interrupts an electric ray or beam), are sometimes used (a) at cross-roads in conjunction with signals controlling vehicular traffic, or (b) on long unbroken stretches of road where there is no protected crossing place. These installations should be used on local roads only; it is quite wrong to allow the individual pedestrian to upset the traffic-stream on a traffic artery; on the artery, the pedestrian (if admitted at all) must be protected by separation of levels or by signals on the flexible progressive system.

“Deterrent” Signalling

It has been seen on page 68 that, if the layout is such as to offer short-cuts through residential or shopping precincts, those short-cuts will be used, with resultant casualties. In applying modern principles of town planning to old-fashioned layouts, it may not be possible always to eliminate those short-cuts. In

TRAFFIC SIGNALS IN TOWN PLANNING

that event, signalling arrangements can be used which, while safeguarding movements inside the precinct, will slow down the short-cut so much that it will cease to be worth while. This can be done in various ways, the simplest plan being to give the cross-traffic a very marked preference. Alternatively, in a shopping street which is being converted from a traffic artery or sub-artery into a local road in a precinct, the signals can be arranged on the synchronised system. If, as may well happen, a widening of the pavements is wanted in order to give the shoppers better scope, and the consequent narrowing of the carriageway necessitates one-way vehicular movement, measures may be necessary to prevent undue speed. In that event the periods for pedestrian crossing must be sufficiently prolonged to slow down the wheeled traffic, and to discourage and keep out the short-cut driver.

The General Plan of Campaign

The full possibilities of traffic signals have not yet been really exploited ; it is necessary to reduce the whole matter of control to a regular system. There must be no haphazard sprinkling of isolated signals along nondescript roads.

The general principles will work out as under :

(1) Arterial and sub-arterial roads.

(i) Roads in the centre of towns. Here the needs of the wheeled traffic must be given first place, because—if perpetual checks are put on the traffic (for pedestrian crossing, and so forth)—vehicular circulation will become so congested that it will probably be brought to a standstill. The case of each town must be taken on its own merits. In many instances the flexible progressive system will be possible upon the main traffic routes, but the system upon each must always be related to the signalling of all the other arteries or sub-arteries which are encountered. Where that system is practicable, pedestrians can cross on the level ; where it is not practicable and there is not sufficient time for pedestrian periods without unduly clogging the traffic movement, subways or overbridges for pedestrians are *essential*.

TOWN PLANNING AND ROAD TRAFFIC

It must be always remembered that when any main city street is made "one-way" the chances are doubled of getting pedestrians across on the level without unduly impeding the traffic. As already pointed out, however, a "one-way" system is a puzzle to a stranger.

In all cases where the flexible progressive system is used, it will be found in practice that the higher the vehicular speed is set, the further apart the pedestrian crossings will have to be.

(ii) Radial arteries or sub-arteries leading from the town centre, and arteries or sub-arteries passing through outlying or isolated built-up areas. Here the flexible progressive system is at its best. The traffic is given an assured and uniform run and pedestrian safety is established.

(iii) By-pass roads and motor-ways. Traffic signals should not be used at all. All junctions should be regulated by roundabouts (with or without flyover bridges). The traffic should never be stopped. Pedestrians must cross by bridge or subway.

(2) Local (or minor) roads. Detached installations can be used, or systems

(i) based upon vehicular needs with button (or ray) operation for pedestrians when required, or

(ii) based upon pedestrian needs, with vehicle-operated pads for the wheeled traffic.

CONCLUSION

XI

CONCLUSION

The science of traffic control is a vital element in the science of town and country planning.

A total of road casualties which approaches a quarter of a million every year is a very stern fact indeed ; and planning, or lack of planning, which admits of such slaughter is bad ; this calls for radical reform.

In the town and country planning of the future, life itself must be the first consideration : it is needful to seek safety above all things. Convenience and amenity, highly important though they are, are not enough. The whole problem of planning requires to be re-approached from the safety angle. Road safety cannot be regarded merely as an important item ; it must become a dominant factor, governing, if need be, all else in town and country planning.

The first necessity is to establish concord between the principles of traffic control and the principles of town and country planning ; and the initial step towards that end will be to harmonise ideas in the matter of classification of road user.

From a traffic point of view there are three classes of road and three classes only : the artery, the sub-artery and the local road. The last-named class can be sub-divided as much as may be desired (page 41) for town planning purposes, but the category must always be "local" or minor. There must be no nondescript roads. If a road already built up is used as an artery or sub-artery, it must be treated as an artery or sub-artery pure and simple. In such arteries and sub-arteries the needs of the through-traffic must be absolute, any existing roadside development being effectively isolated from it. In the local roads, on the other hand, the local daily life will be all important, and through-traffic must therefore be totally excluded. All these objects will have to be achieved by layout and road equipment, not by legal prohibitions.

TOWN PLANNING AND ROAD TRAFFIC

The arrangement thus outlined will result in an arterial grid isolated from frontages and from all chance comers, and having very few road junctions. Those few junctions will link up with a sub-arterial grid, which is itself isolated in the same way as much as possible. The sub-arteries will communicate with selected local roads, which in turn will afford access to whole systems of other local roads. No local roads at all should de-bouch upon the arteries, the sub-arteries being the sole link between the arterial and local roads. The arrangement is shown diagrammatically in Fig. 11 on page 55. The application of these ideas to existing layouts is a perfectly practical move; the lines of approach are set out in Chapters VII, VIII and IX.

The effect will be that series upon series of "pockets" of local roads will be created; the fast through-traffic will be kept entirely clear of those pockets because it will have no inducement to enter. The pockets, or "precincts" as they may better be called, will in the towns be little systems of shopping, business, industrial and residential streets; in the country they will be village streets, clear of the main roads. The country lanes will retain their status of local roads—and their rural character.

The main traffic flows should always be regarded as sheer poison, to be completely isolated and on no account to be allowed to seep into the precincts.

New building will be confined to precinct roads dedicated entirely to that purpose; in the towns these will be new or existing local roads, in the country they will as a rule be new village streets, off the main highways, laid out and planned in such a way as to maintain the rural character. The curse of ribbon development will automatically disappear.

The general result will be an ordered system, which will be profoundly valuable alike to traffic control and to town planning. The ordinary daily life in the town and village can be *completely* separated from the lethal through-traffic; daily life can carry on as if the through-traffic did not exist. Only when a journey by vehicle is undertaken need there be any contact at all with the major traffic-streams. That is a simple and sane arrange-

CONCLUSION

ment ; it is indeed a logical development which is bound to materialise, if not now, in later centuries.

All this is perfectly straightforward. Here, however, comes the main danger. In order to secure the great end in view, a vast mass of detail will have to be handled and decided. If that detail is handled in a spirit of easy compromise, the desired results will not accrue ; the pursuit of safety must be unyielding, and in the long run the boldest measures will almost certainly be the cheapest.

In particular, liberties must not be taken with traffic details by designers not possessing sound traffic knowledge. The abiding trouble is that everyone in these days thinks himself a born traffic expert, and if the foregoing pages induce in others a little of the specialist's more cautious habit of mind, they will not have been written wholly in vain. The long tale of past errors is most instructive. Similar errors will inevitably occur in the future, but the margin of error will be continually reduced if traffic matters are in the hands of the traffic specialists.

For the prevention of road casualties there is no panacea, because human nature, which has changed so remarkably little in the few thousand years of which record remains, is not likely to change over-night at the present juncture. Casualties will continue, but the casualty total can be cut down to a fraction of its present bulk by means of Town and Country Planning, resolutely undertaken on a principle of " first things first." The body is more than raiment. It is futile to plan (let it be repeated) for hygiene and amenity while at the same time forgetting the ever-present risk of sudden death. There then is the task ; and the present time affords the golden opportunity.

INDEX

- Accidents, *see* "Road casualties"
- Adaptation of existing roads and layout, 34, 57, 58, 60
- Effective compromise, 68
- In the country, 95, 98
- In the suburbs, 89
- In the towns, 68, 85
- Main roads, 96
- Priority of treatment, 87
- Resultant layout, 70, 84, 103, 112
- Arcading, 68, 88
- Arterial roads, 41, 42 (*see also* "By-pass roads" and "Main roads")
- Buildings on, 62, 81
- Isolation of, 71
- Junctions on, *see under* "Junctions"
- Linkage with other roads, 71, 73, 112
- Pedestrians on, 57, 63, 71, 79
- Traffic signals on, 32, 109
- Autobahnen, 50
- Automatic traffic signals, *see* "Traffic signals"
- "Backages," 63
- Bays for standing omnibuses, 42, 106
- Betterment, 38
- Birmingham, 52
- Buildings (*see also* "Frontages")
- Accommodation for vehicles attracted to, 39, 60, 70
- "Insulation" of, from traffic, 62, 79, 101
- New, 39, 95, 101, 112
- Bus stations, 63
- Bus stops, embayment of, 42, 106
- By-pass roads, 31, 61, 98, 100
- Canberra, 57
- Casualties, road, *see* "Road casualties"
- Casualty maps, 19, 88, 96
- Central area, adaptation of, 62
- Circulation of traffic, *see under* "Road traffic"
- "Classical" road layouts, 37
- Classification of roads, 41, 60, 111
- Communications in town planning, 15, 36, 54
- Congestion, remedial measures, 88
- "Construction" and "Restriction," 18, 20
- Country roads and lanes, treatment of, 95
- Cycle tracks, 28
- Cyclists, *see* "Pedal cyclists"
- Dangerous and careless driving in relation to accident causation, 30
- Design of roads for traffic requirements, 40
- "Deterrent" signalling, 108
- Detours, 71
- Development *v.* dispersal, 39
- "Drawing-board" plans, 16, 37
- Dual carriageways, 32, 41
- "Dynamic" function of traffic science, 19
- Education as means of accident prevention, 23
- Elevated footways, 27, 68, 73
- Elevated roads, *see* "Separation of levels"
- Engineer, responsibilities of the, 20
- Eno, William Phelps, 19, 43
- Existing towns, re-planning of, *see* "Adaptation of existing roads and layout"

INDEX

- Flexible progressive system of traffic signals, *see under* "Traffic signals"
- Flyovers and flyover bridges, 34, 42, 50, 61, 83, 96, 101, 110
- Frontages, 63, 81
- Great West Road, 40
- Guard rails, 69, 70, 72, 79, 81, 88, 89, 106
- Human factor in road behaviour, 24
- Inns of Court, London, 76, 85
- "Insulation" of buildings from traffic, 62, 79, 101
- Intersections, *see* "Junctions"
- Junctions :
 Flyover, *see* "Flyovers and flyover bridges"
 On arterial and sub-arterial roads, 32, 33, 42, 43, 71, 73, 97
 On local roads, 52
 Staggered, 53, 56, 105
 Subways at, 50, 69, 74, 107, 109
 " T " junctions, 52
 Turning traffic at, 69, 74, 107
- Layout of roads, *see* " Road layout "
- L'Enfant, 37
- Limited progressive system of traffic signals, 105
- Linkage of roads, *see under* " Roads "
- Loading and unloading space, 60, 70
- Local roads, 41, 43, 103
 Closing of ends of, *see under* " Roads "
 In the country and villages, 95
 Junctions on, 52
 Linkage with, 71, 73
 Traffic signals on, 110
- Main roads, 96
- Minor roads, *see* " Local roads "
- Motor roads, 97, 110
- National planning, 38
- New buildings, *see under* " Buildings "
- New Delhi, 57
- New towns, layout for, 53
- New York, 37, 105
- Noise, 82
- " Nondescript " roads, 58, 89, 103
- Obstruction, 59
- One-way systems, 52, 83, 108, 110
- Overbridges, 27, 68, 69, 89, 109
- Oxford Street, London, 65
- Parking places, 59
- Parkways, 43, 56
- Pedal cyclists, 28
 Registration and licensing of, 29
- Pedestrian-operated signals, 108, 110
- Pedestrian subways, *see* " Subways "
- Pedestrian traffic :
 At junctions, 74
 Casualties to, 16, 25
 Control of, 25
 On arterial or sub-arterial roads, 57, 63, 71, 79
- Pennsylvania Turnpike, 82
- Place segregation of traffic, 26, 69
- " Platooning " of traffic, 26, 31, 69, 106
- Police, responsibilities of, 17, 19
- Precincts, 75, 85, 112
 In the suburbs, 89
- Private interests, 38, 101
- Psychological factor in accident prevention, 24
- Railways and roads compared, 16, 23, 33, 72
- Ramps, 68
- Regional planning, 38
- Regulation of traffic by Police, 19

INDEX

- Re-planning of roads and towns,
see "Adaptation of existing roads and layout"
- "Restriction" and "Construction," 18, 20
- Ribbon development, 32, 33, 39, 100, 101
- Right-hand turns, 33
 Splaying of carriageway for, 74
- Ring roads, 51, 53, 61, 66, 82, 84, 86
- Road casualties :
 Causation, 15, 30
 Effect of speed upon, 30
 Prevention of by road layout, 20
 Statistics, 15, 16, 25, 28, 29, 111
- Road layout, 16, 37, 40
 Adaptation of existing, *see* "Adaptation of existing roads and layout"
 As means of regulating traffic, 20
 For new towns, 53
 In the country, 95
 Suburban, 89
- Road safety, 16, 111
- Road surfaces, 29
- Road traffic :
 Circulation, 17, 40
 Control of, 18
 "Platooning" of, 26, 31, 69, 106
 Regulation of, 19, 20
 Segregation of, 24, 25, 26, 28, 69
- Road widths, 83
- Roads :
 Adaptation of existing, *see* "Adaptation of existing roads and layout"
 Arterial, *see* "arterial roads"
 By-pass, 31, 61, 98, 100
 Classification of, 41, 60, 111
 Closing of ends of minor, 22, 33, 66, 69, 71, 72, 79, 82, 88
 Design of, for traffic requirements, 40
- Roads—*continued.*
 Elevated, *see* "Separation of levels"
 Importance of in town plan, 37
 In the country, 95
 In the towns, 60
 Linkage of, 71, 73, 112
 Local, *see* "Local roads"
 Main, 96
 Minor, *see* "Local roads"
 Motor, 97, 110
 "Nondescript," 58, 89, 103
 One-way, 52, 83, 108, 110
 Re-planning of, *see* "Adaptation of existing roads and layout"
 Service, 63, 101
 Sub-arterial, *see* "Sub-arterial roads"
 Suburban, 89
 Sunken, *see* "Separation of levels"
 Two-level, 82
v. Railways, 16, 23, 33, 72
 Widths of, 83
- Roundabouts, 34, 43, 97
 Separation of levels at, 49, 50, 72
 With flyover bridge, 42, 51, 61, 97, 101, 110
- Schools, 89
- Segregation of pedestrian, cyclist, and vehicular traffic, 24, 25, 26, 28, 69 (*see also* "Separation of levels")
- Separation of levels, 26, 33, 61, 68, 81
 At junctions, 74
 At roundabouts, *see under* "Roundabouts"
- Service roads, 63, 101
- Shopping centres, 64, 69, 77, 82, 109
- Signals, *see* "Traffic signals"
- Sloane Square, London, 45
- Speed control by means of traffic signals, 31, 107

INDEX

- Speed, effect of on road casualties, 30
- Speed limits, 30
- Splicing of carriageway, 74
- Staggered crossings, 53, 56, 105
- Standing vehicles, 59, 70, 88
- Accommodation for, off the highway, 39, 42, 59, 70
- State control of planning, 38
- "Static" function of traffic science, 19
- Streets, *see* "Roads"
- Sub-arterial roads, 41, 42, 103
- Buildings on, 81
- Junctions on, 43
- Linkage with local roads, 73
- Pedestrians on, 79
- Traffic signals on, 51, 57, 109
- Suburban layout, 89 (*see also* "Town layout")
- Subways, 69, 74, 88, 89, 107, 109
- At roundabouts, 50
- Sunken roadways, *see* "Separation of levels"
- Synchronised system of traffic signals, 105
- "T" junctions, 52
- "Time segregation" of traffic, 26, 69
- Town layout (*see also* "Suburban layout")
- Existing, survey of, 58
- New, 53
- Re-planning of, *see* "Adaptation of existing roads and layout"
- Town planning, 15, 35
- "Classical layouts," 37
- In relation to road safety, 15-17, 111
- On regional and national basis, 38
- State control of, 38
- Town Planning Institute, 16
- Town plans, generic types of, 53
- Town roads, 60
- Trafalgar Square, London, 48
- Traffic, *see* "Road traffic"
- Traffic, control of, 18
- Traffic problems, 35
- Traffic science, 19
- Traffic signals, 104
- "All red" period, 74, 107
- As deterrent, 108
- Co-ordinated systems, 26, 105
- Detached installations, 104
- Flexible progressive system, 26, 69, 105, 107, 109
- Limited progressive system, 105
- Misuse of, 32, 66
- On arterial and sub-arterial roads, 32, 51, 57, 109
- On local roads, 110
- Pedestrian-operated, 108, 110
- Speed control by, 31, 107
- Synchronised system, 105
- Tramways, 59, 70
- Transport, Ministry of, 16
- Tri-Borough Bridge, 37
- Tunnels, 82
- Turning movements :
- At signalled junctions, 69, 107
- In dual carriageways, 32, 33
- Splicing of carriageway for, 74
- Two-level roads, 82
- Vistas and viewpoints, 62, 81
- Waiting vehicles, *see* "Standing vehicles"
- Washington, 37
- "Weaving" lengths in roundabouts, 44-48
- Widths of roads, 83
- Wood block road surfaces, 29
- Zoning, 36, 54



