CENTRAL LIBRARY
Sri Lanka Institute of Tech. & Science
KILIANI (Rajapathana)

Call No. 621.183

E803M

Accession No. 59346

MODERN FURNACE TECHNOLOGY

OTHER BOOKS OF INTEREST

REFRACTORY MATERIALS: Their Manufacture and Uses.

By A. B. Searle, Cantor Lecturer on Brickmaking.
Third Edition. Revised and Enlarged. Medium 8vo. 895 pages. 176 illustrations. 45s.

The standard volume on the subject of refractories, dealing with every type of brick, etc., and with all materials used. All phases of manufacture, testing and analysis, as well as full specifications are given. Refractory cements and mortars are also dealt with.

MAGNESITE AS A REFRACTORY.

By A. W. Comber, F.I.C., A.I.M.M.
No. 8 "Industrial Textbooks" Crown 8vo. 112 pages. 16 illustrations. 4s. 6d.

A monograph on the newly-introduced material for bricks and linings (high-temperature) of steel, re-heater and electric furnaces; also for Bessemer and copper converters. Details of the production of this refractory from "ground to lining" are given, and the various applications are considered. This is a book of very real value to furnace designers and operators.

FLOW AND MEASUREMENT OF AIR AND GASES.

By Alec. B. Eason, M.A., A.M.I.E.E.
Second Edition. Revised. Medium 8vo. 254 pages. 22s.

The subject of gas flow is of the utmost importance in furnace design, and the Author of *Modern Furnace Technology* refers to this book in his general considerations on gas flow and friction losses. The data and practical information given will be found indispensable, and obtainable from no other source.

METHODS OF MEASURING TEMPERATURE.

By Ezer Griffiths, D.Sc., F.R.S.
Second Edition. Revised. Medium 8vo. 203 pages. With 99 illustrations. 12s.

A volume written for all concerned with the measurement of temperature, and also of particular interest to furnace designers and operators. Attention is given to the various methods applied in different circumstances, and to the calibration of instruments; and all details of manipulation are set out.

CHEMISTRY FOR ENGINEERING STUDENTS. (Also of particular service to the Engineer in practice.)

By R. Hum, B.Sc.(Hons.), Lond., A.I.C.
Demy 8vo. 832 pages. With 171 illustrations. 20s.

A practical text-book of applied chemistry written from the Engineer's point of view and with his requirements in mind. There is, in fact, very little that the average civil, mechanical or electrical engineer needs to know about chemistry which is not fully and efficiently discussed.

PHYSICAL CHEMISTRY.

By J. Newton Friend, D.Sc., Ph.D., F.I.C.
In Two Volumes. Medium 8vo. Sold separately. Each 26s.

Vol. I. *General Properties of Elements and Compounds.* 501 pages. Frontispiece, 3 plates, 198 illustrations.

Vol. II. *Principles Involved in Chemical Reactivity.* 483 pages. Frontispiece, 3 plates, 117 illustrations.

THERMOSTATS AND TEMPERATURE-REGULATING INSTRUMENTS.

Roosevelt Griffiths. 2nd Edn. 12s.

CALCAREOUS CEMENTS: Their Nature, Manufacture and Uses.

Redgrave and Spackman. 3rd Edn. 25s.

CONCRETE ENGINEERING. Singleton-Green. Vol. I. Practical Concrete.

Vol. II. Properties of Concrete. (Sold separately.) Each 9s.

MATERIALS AND THEIR APPLICATION TO ENGINEERING DESIGN.

Ailcut and Miller. 2nd Edn. 20s.

PULVERISED FUEL. Goodrich. 12s.

BOILER FIRING. Armstrong and Lewis. 6s.

BOILER MANAGEMENT, MAINTENANCE AND INSPECTION.

Armstrong and Lewis.

PROBLEM OF FLUCTUATING LOADS ON BOILERS. Hider. 8s. 6d.

STEAM GENERATORS. Rudorff. 12s.

CONTROLLED HUMIDITY IN INDUSTRY. Marsh. 7s.

CARBONISATION TECHNOLOGY AND ENGINEERING. Armstrong. 40s.

TREATISE ON ELECTRO-METALLURGY. McMillan and Cooper. 24s.

4th Edn.

Prices net, postage extra.

CHARLES GRIFFIN & CO. LTD.

42 DRURY LANE, LONDON, W.C.2

MODERN FURNACE TECHNOLOGY

BY

H. ETHERINGTON, B.Sc., A.R.S.M.

SECOND EDITION REVISED

With 64 Illustrations, Many Useful Tables
and 2 Folding Plates



LONDON
CHARLES GRIFFIN AND COMPANY, LIMITED
42 DRURY LANE

1944

[All Rights Reserved]

*Printed in Great Britain by
Bell and Bain, Limited, Glasgow.*

PREFACE

IN this volume it is my purpose to explain the scientific principles underlying the various phases of modern furnace design and operation, and to show how these principles may be applied to achieve operating improvement. Special effort has been made to present the more complex aspects of the subject in the simplest possible manner, and more particularly to provide simplified yet accurate methods of calculation. It is believed that the facility with which many of these methods may be applied will appeal to busy technical men who cannot find time to use the customary more complicated formulæ and methods.

The semi-technical furnace operator will experience no difficulty in following either the explanations of principles or, with very few exceptions, the methods of calculation, these having been developed in terms of elementary mathematics. In addition to serving directly these readers, as well as students, it is hoped that this book will assist in achieving a better appreciation of the specialised papers and bulletins published by technical and scientific societies.

Where numerical examples have been given, so far as practicable these have been made perfectly general in character, in order that the methods illustrated may be applied more readily to any type of practice. In a few cases only, it has been found desirable, in order to preserve logical sequence, to use a specific furnace operation in developing certain ideas and calculations. Most readers, being already familiar with some particular phase of metallurgical or other furnace practice, will find it a simple matter to apply the principles to their own particular problems. Small type has been used to elaborate on certain topics, and also to refer to matters of subsidiary importance. Such sections may be omitted without interfering with the continuity.

I wish to thank Dr. L. Reeve of the United Steel Companies, Sheffield, England, and Mr. H. G. Thomson, Ceramic Engineer, Milwaukee, U.S.A., for their valuable suggestions, Dr. Reeve

particularly with reference to the Chapters on Heat Transfer, and Mr. Thomson particularly with reference to the Chapter on Refractories. I wish to thank also another friend for his comments and suggestions concerning the Chapter on Physical Chemistry; and R. Etherington, B.Sc., for assistance rendered throughout the preparation of the manuscript. Finally, I must thank the various publishers and professional societies who have so kindly given me permission to use certain illustrations; detailed acknowledgments are made in the text.

H. ETHERINGTON.

MILWAUKEE, WISCONSIN,
April, 1938.

PUBLISHERS' NOTE TO SECOND EDITION.

THE insistent call for copies of this book has necessitated immediate preparation of a new edition. A few corrections and minor alterations have been received from the Author, who is at present abroad, and these have been incorporated.

CHARLES GRIFFIN & CO., LTD.

CONTENTS

	PAGE
CHAPTER I.—Introduction	1
General	1
Elementary Use of Atomic Weights	4
CHAPTER II.—Combustion—Available Heat	8
* I. Use of the Chemical Equation for Calculation of Gas Quantity	8
II. Heat of Combustion	25
III. Specific Heat and Sensible Heat	35
IV. Available Heat	40
V. Combined Effect of Factors Affecting Available Heat	51
VI. Control of Combustion Conditions—Flue Gas Analysis	59
VII. Flame Temperature	67
VIII. Characteristics of Industrial Fuels	73
Summary of Useful Data and Formulæ	75
CHAPTER III.—Process Balance Sheets	79
I. The Material Balance	79
II. Heat Balance	86
CHAPTER IV.—Theory of Gas Flow	124
I. Volumetric Gas Laws	125
II. Types of Gas Flow	132
III. Energy of Gases	134
IV. Mechanism of Energy Losses due to Disturbance	145
V. Friction	151
VI. Buoyancy	159
VII. Draught	172
VIII. Gas Leakage	178
IX. Pressure Calculation of a Furnace System	186
X. Measurement of Gas Pressure and Flow	190
Summary	207
CHAPTER V.—Principles of Heat Transfer	212
I. Conduction	212
II. Convection	219
III. Radiation from Surfaces	228
IV. Total Heat Loss from Hot Surfaces	236
V. Gas Radiation	237
VI. General Case of Heat Flow	251
VII. Applications of the Theory of Heat Transfer to Pyrometry	259
Summary	261

CHAPTER VI.—Practical Solution of Heat Transfer Problems	265
I. Heat Transfer through a Wall	265
II. Heat Loss by Gas Leakage	281
III. Unsteady Heat Flow—Heat Storage	282
IV. Heat Loss in Foundations	288
V. Heat Loss by Water Cooling	292
VI. Heat Loss through Openings	296
VII. Heat Transfer to Charge or Stock in a Direct Fired Furnace	299
Summary	310
CHAPTER VII.—Heat Exchangers	314
I. Factors Governing Heat Transfer in Recuperators and Regenerators	318
II. Recuperators	324
III. Regenerators	341
IV. Pressure Considerations	357
V. Possible Improvements in Heat Exchanger Practice	369
VI. Minor Devices for Return of Heat	372
Summary	374
CHAPTER VIII.—Refractory Materials	379
I. Melting Point	380
II. Expansion and Contraction	388
III. Texture	395
IV. Failure under Load at High Temperatures	397
V. Spalling	402
VI. Slag Action	406
VII. Other Properties	410
VIII. Less Common Refractories	411
IX. Refractory Plastics	421
X. Cements	424
XI. Insulating Materials	426
Summary	432
CHAPTER IX.—Physico-Chemical Considerations	437
I. Mass Action	444
II. Velocity of Reaction	461
III. Oxidation and Reduction	472
IV. Reactions between Slag and Metal	488
Summary	498
Index	507

FOLDING PLATES

Plate I. Conversion Scales	<i>Facing p. 504</i>
Plate II. Heat Loss through Furnace Walls Chart	„ „ 504

IMPORTANT DATA FOR USE IN CALCULATIONS

GENERAL.		PAGE
Table I.	Approximate Atomic Weights	5
Table XXVI.	Full List of International Atomic Weights	504
Plate I.	Temperature Conversion Scales, etc.	<i>Facing</i> 504
THERMAL.		
Table II.	Thermo-Chemical Data for Fuel Gases	30
Table III.	Sensible Heat of Gases	36-37
Fig. 1.	Specific Heats of Gases	38
Table IX.	Sensible Heat of Materials	90-105
Table X.	Other Specific and Sensible Heat Data	108
Table XI.	Heat of Formation of Binary Compounds	113
Table XII.	Heat of Reaction from Combination of Oxides	115
GAS FLOW.		
Fig. 5.	Temperature-Pressure Relation of Gases (Nomogram)	131
Fig. 7.	Pressure Equivalent (p.e.) of Gas Movement (Nomogram)	140
Fig. 8.	Energy (Pressure) Loss Factors	142
Fig. 11.	Pressure Loss Factors for Sudden Change of Section	148
Table XIV.	Friction Coefficient for Gases	154-155
Fig. 19.	Gas Leakage through Openings	178
HEAT FLOW.		
Fig. 26.	Thermal Conductivity of Refractories	215
Fig. 29.	Coefficient of Forced Convection (Nomogram)	222
Fig. 31.	Heat Loss from a Hot Surface	227
Table XVI.	Emissivity of Surfaces	230
Fig. 32.	Radiation from Surfaces (Nomogram)	232
Fig. 33.	Correction Nomogram for Radiation Coefficient (for use with Plate I, Scale 6)	233
Fig. 35.	Coefficient of Gas Radiation (Nomogram)	241
Table XVII.	Standard Brick Equivalents	266
Plate II.	Heat Loss through Furnace Walls	<i>Facing</i> 504
Table XVIII.	Steam Radiation at Low DP Values	323
HEAT EXCHANGERS.		
Fig. 48.	Heat Exchanger Factor (<i>f</i>)	327
Table XIX.	Resistance of Checkers to Heat Flow	343-344
PHYSICO-CHEMICAL.		
Table XXIV.	Equilibrium Constants for Gaseous Reactions	451-452
Table XXV.	Oxygen Decomposition Pressures	475

PRINCIPAL ABBREVIATIONS

PRINCIPAL ABBREVIATIONS USED IN THE TEXT

<i>A</i>	Area.	<i>L</i>	Length.
<i>a</i>	Heat transfer coefficient.	<i>n</i>	Diameter ratio (for a Venturi meter).
<i>a_c, a_r,</i> <i>a_g.</i>	Heat transfer coefficients for convection, radiation and gas radiation, respectively.	<i>P</i>	Absolute or total pressure.
B.Th.U.	British Thermal Unit.	<i>p</i>	Gauge pressure, Partial pressure (physical chemistry).
<i>c</i>	Specific heat (at constant pressure).	<i>p.e.</i>	Pressure equivalent.
C.H.U.	Centigrade heat unit, or pound-calorie.	<i>Q</i>	Heat quantity.
<i>D</i>	Diameter.	<i>q</i>	Heat rate.
<i>d</i>	Thickness.	<i>S</i>	Sensible heat.
<i>DP</i>	Diameter × per cent.	<i>T</i>	Absolute temperature.
<i>E</i>	Emissivity, Energy.	<i>t</i>	Temperature.
<i>f</i>	Friction coefficient, Heat exchanger factor.	<i>t_a</i>	Atmospheric temperature.
<i>g</i>	Acceleration due to gravity (32.2 ft. per sec. per sec.).	<i>t₁, t₂, t₃,</i> <i>etc.</i>	Temperatures in decreasing order (<i>i.e.</i> <i>t₁</i> is the highest).
<i>H</i>	Height.	<i>V</i>	Velocity.
<i>h</i>	Inches water gauge (pressure), Time in hours.	<i>v</i>	Volume, Volume rate of flow.
<i>K</i>	Equilibrium constant, Over-all conductivity.	<i>V_n, v_n</i>	As above, in terms of <i>normal</i> cu. ft. (<i>i.e.</i> under standard conditions).
<i>k</i>	Coefficient of thermal conductivity (heat units per hour per sq. ft. per degree per inch of thickness).	<i>W</i>	Weight.
		<i>w</i>	Weight per cu. ft. (under actual conditions).
		<i>w_n</i>	Density (wt. per cu. ft. under standard conditions).

Where confusion is not possible, these and additional symbols are also used with local significance as explained in the text.

MODERN FURNACE TECHNOLOGY

CHAPTER I.

INTRODUCTION.

WITHIN a particular metallurgical industry there will usually be found considerable diversity of furnace construction and operation as practised not only in different countries, but also within the same country. Some of these differences are due to differences in local conditions; some are due to differences of opinion. Differences of opinion, radical or otherwise, always will exist, and an understanding of the principles involved will assist the operator in using scientific fact in the formulation of his opinions. Every good furnace operator or designer is continually testing his views by making minor changes in furnace operation or construction. Thereby progress is achieved; thereby also, costly mistakes are made. The directive influence resulting from a scientific background cannot but increase the number of successful attempts and decrease the number of failures.

The Value of Calculations.—The modern furnace designer makes more or less free use of calculation. On the other hand, many furnace operators do not make proper use of the very simple calculations which can shed so much light on errors and possible improvements in operation and construction. The notion that the furnace operator has no time nor use for mathematics is based on a misconception. Certainly he, in common with the designer, has no use for the higher mathematics by which the physicist and the physical chemist arrive at their conclusions. But just as certainly he is directly interested in these conclusions, many of which can be applied very simply to furnace problems.

The data used in calculations have been accurately determined in the laboratory where all disturbing factors can be eliminated.

Arithmetical application of these data to furnace problems will indicate what may reasonably, if not confidently, be expected to result from a proposed furnace change. It will also, in some instances, indicate possible difficulties which might not otherwise be apparent. If calculation indicates the advisability of proceeding with a test, then the final answer is of course obtained in actual practice. Just as chemical analysis indicates whether a new material is likely to be suitable for use, so calculation indicates whether a proposed test is reasonable or not. A special effort has been made in this book to present rapid and simplified methods of calculation. It is worthy of note, however, that even though several days are spent on a few computations, the cost involved will in most cases be quite insignificant compared with the cost of the structural or operating changes which the calculations are designed to control.

Presentation of Material.—In some chapters a few pages of elementary theory are included in order to make the book as self-contained as possible. Such sections have been made concise and have been segregated so that readers who desire to do so can omit them. In other cases, the theory is of a less elementary nature and its development occupies considerable space. Here also, the same plan has been adopted, the related facts and theory being first explained, and then practical applications and methods being given separately.

Certain of the calculations have been worked on a theoretical basis, either in order to establish some conclusion, or as an illustration of the use of given data. In many cases these calculations, although simple, are tedious and consequently are not suitable for everyday use. Owing, moreover, to uncertainties met with in practice, furnace calculations, invaluable though they are, are necessarily approximations, and complicated figuring is therefore not warranted. In recognition of this, in nearly all cases, unnecessary refinements may be eliminated by simplified methods of calculation recommended for general use. The object has been to provide methods which will give sufficient accuracy with a minimum expenditure of time and trouble. In cases where solution is dependent on complicated formulæ, nomograms (see p. 130) are given to permit instant evaluation. It may be pointed out that where calculation is used merely to compare two given conditions, inaccuracies in data or assumptions are of even less importance if the same assumptions are applied to both conditions. Such comparative calculations may be likened to a measuring instrument which gives readings which are consistently high or

consistently low. If a correction factor is not available, the value of the instrument for absolute measurement is impaired; but for comparative measurements on routine work, it still retains much of its value.

In those cases where a full study of a problem would involve a departure from the set policy of using only simple mathematics, merely the general trend and conclusions of such investigations are here offered.

Units Used.—Different systems of measurement are used in different English-speaking countries, and also in different branches of an industry within the same country. Amongst the unfortunate complications which arise may be mentioned the use of the long (or gross) ton of 2,240 lb. and the short (or net) ton of 2000 lb. in America for weighing different materials used in a single process; the use of such measures as the hundredweight (cwt. = 112 lb.) and the quarter (28 lb.) in Britain; the use of the °F. and the °C. in different industries and sometimes within the same industry; the occasional use in Britain of the °C. almost in the same breath with the B.Th.U.—units totally foreign to each other.

With these complications, and others of less importance, the selection of units for calculations must be to some extent a compromise. It is hardly possible to refrain from comparing such a muddled and inconvenient set of units with the delightful simplicity of the metric system which is used in almost all non-English-speaking countries.

The long ton (2240 lb.) has been adopted as the unit of weight, because it is more widely used than the short ton. The pound is of course the unit for small quantities.

The foot is used as the unit of length excepting in a few cases where the inch is a more convenient measure. In dealing with gases, the cubic foot is used as the measure of quantity in preference to the pound.

Both Fahrenheit and Centigrade scales have been used for temperature, with their related heat units, the B.Th.U. and the C.H.U. The balance of usage being in favour of the °F. and the B.Th.U., taken as a combination, these units are given first in the text. The °C. and C.H.U. are usually given in parentheses. In this connection, equivalent temperatures have generally been given to within 5°. For example, if an illustration is based on a temperature of 2900° F., the Centigrade temperature given in parentheses would be 1590° C. instead of the closer equivalent of

1593° C. This is thought quite close enough in view of the fact that readers who use the Centigrade system will ignore the Fahrenheit figures entirely, and will find it more convenient to follow round numbers. Conversion charts for °F. and °C. and for B.Th.U's. and C.H.U's. will be found in Plate I, Scales 1 and 2 (end of book).

Data Used.—The latest reliable data available have been used, wherever possible weighted averages by recognised authorities having been adopted. Since, however, it is useless to employ constants worked out with great accuracy for calculations which involve large probable errors, the actual figures have been rounded off in order to simplify the work.

Information for Reference.—As is usual with technical books, the tables and curves fall into two main categories :—

- (a) Those used to illustrate some point in the discussion.
- (b) Those containing information essential for making calculations.

Those in the first class are of value only in connection with the text. Those in the second class will be referred to continually by readers in making their own calculations. On page ix will be found a list of the tables and curves containing basic data, in order that the information can be found quickly. The most frequently used of these sheets are listed in bold-face type.

Other Material.—A list of the abbreviations used in this book will be found on page x. These are as far as possible in keeping with common usage, except that Greek letters have been practically eliminated.

Points of major practical importance are collected together in the form of summaries concluding the chapters.

References to work mentioned in the text are given as foot-notes. In addition, at the end of each chapter will be found a short list of books covering the scope of the chapter. The general references at the end of the present chapter are concerned with furnace operation in general, and therefore have a bearing on the subject matter of many of the chapters of this book.

ELEMENTARY USE OF ATOMIC WEIGHTS.

Since the next two chapters are based largely on the use of atomic weights and chemical equations, it may not be out of place to give here a brief review of the most elementary phases

of this subject. Table I gives the atomic weights of the elements which are of most metallurgical importance. At the end of the book will be found a full list of the elements with their exact atomic weights.

TABLE I.—APPROXIMATE ATOMIC WEIGHTS OF SOME IMPORTANT ELEMENTS.

Element.	Symbol.	Atomic Weight.	Element.	Symbol.	Atomic Weight.
Aluminium, .	Al	27	Manganese, .	Mn	55
Calcium, .	Ca	40	Nickel, .	Ni	59
Carbon, .	C	12	Nitrogen, .	N	14
Chromium, .	Cr	52	Oxygen, .	O	16
Copper, .	Cu	64	Phosphorus, .	P	31
Fluorine, .	F	19	Silicon, .	Si	28
Hydrogen, .	H	1	Sulphur, .	S	32
Iron, .	Fe	56	Tin, .	Sn	119
Lead, .	Pb	207	Zinc, .	Zn	65
Magnesium, .	Mg	24			

The atomic weights show only the relative weights of the atoms of the elements; but, it is convenient to suppose that one atom of hydrogen weighs one pound, and the figures for the other elements will then represent the weight per atom in pounds. The fact that scientifically the atom is an extremely small quantity is of no practical importance in this connection; but the quantity of an element represented by the atomic weight in pounds is usually called the **pound-atom** in recognition of the very large quantity represented as compared with the true atom.

Use of Atomic Weights to Determine the Composition of a Compound.—The formula of a compound shows the number of atoms of each of the constituent elements in one molecule of the compound. The weight of compound represented by the formula is the sum of the weights of the elements, and the pound being the unit of weight, the quantity of compound under consideration is called the **pound-molecule**. Since the formula gives the weights of the different elements in a known weight of compound, the per cent. composition is easily calculated.

Example.—To Investigate the Composition of Ferric Oxide (Fe_2O_3).

1 lb.-molecule of Fe_2O_3 contains $56 \times 2 = 112$ lb. of iron and $16 \times 3 = 48$ lb. of oxygen, the total weight of the molecule

being $112 + 48 = 160$ lb. These basic quantities may be expressed in a number of ways to suit our convenience.

1. 160 lb. of ferric oxide contains 112 lb. of iron, therefore 100 lb. contains $112/160 \times 100 = 70$ lb. iron (70%).

2. 112 lb. of iron combines with 48 lb. of oxygen to form 160 lb. of ferric oxide, therefore 1 lb. of iron combines with $48/112 = 0.428$ lb. of oxygen and yields 1.428 lb. of ferric oxide.

3. 48 lb. of oxygen combines with 112 lb. of iron to produce 160 lb. of ferric oxide, or 1 lb. of oxygen is sufficient to oxidise 2.33 lb. of iron to produce 3.33 lb. of ferric oxide.

The Chemical Equation.—A chemical change may be represented by an equation, which shows all the substances originally present, and all the substances present in the final distribution. The same number of atoms of each element must occur on each side of the equation.

Example.—Under certain conditions magnetic oxide of iron (Fe_3O_4) will oxidise the element phosphorus and yield metallic iron and phosphorus pentoxide (P_2O_5). It is required to write an equation representing this reaction.

Step 1.—Write down the formulæ of the original and final materials on the two sides of the equation, without attempting to write in the numbers of the reacting molecules.

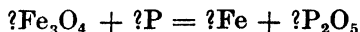

Step 2.—Assume that there is only one molecule of one of the more complex materials.

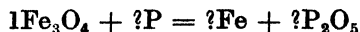

Step 3.—There are 3 atoms of iron on the left, therefore there must be 3 atoms on the right, and this may be written in immediately. The left side contains 4 atoms of oxygen, so the right must also contain 4 atoms, and this is possible only by having $\frac{2}{5}$ of a molecule of phosphorus pentoxide on the right. This contains $\frac{2}{5} \times 2 = \frac{4}{5}$ atoms of phosphorus, so the equation may now be written



Step 4.—The equation is somewhat inconvenient in this form, and it is desirable in this case to get rid of fractions by multiplying the equation right through by 5, giving

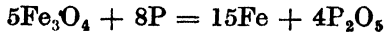

Step 5.—Checking, we find on the left side $3 \times 5 = 15$ atoms of iron, $4 \times 5 = 20$ atoms of oxygen, and 8 atoms of phosphorus. On the right we also have 15 atoms of iron, 20 atoms of oxygen and 8 atoms of phosphorus, showing that the equation balances correctly.

Weights of Reacting Substances.—When an equation has been balanced, the molecular weights may be written below the formulæ to show the relative weights of the reacting substances. For example,

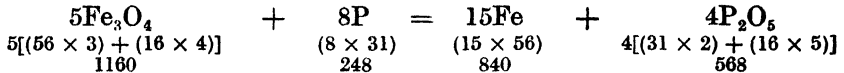

As a check, we may test whether the total weight on the left side of the equation is equal to that on the right.

From the figures given, it follows, for example, that the oxidation of 1 lb. of phosphorus requires $1160/248 = 4.68$ lb. of iron oxide and yields 3.39 lb. of iron and 2.29 lb. of phosphorus pentoxide.

Additional uses of the chemical equation will be referred to later.

General References :—

1. A. Hermansen : *Industrial Furnace Technique.*
2. M. H. Mawhinney : *Practical Industrial Furnace Design.*
3. J. W. Richards : *Metallurgical Calculations.*
4. W. Trinks : *Industrial Furnaces.*

CHAPTER II.

COMBUSTION—AVAILABLE HEAT.

SATISFACTORY combustion conditions are essential to the economic success of most furnace operations. It is necessary, before considering the effect of various factors on furnace performance, to review certain fundamental principles governing the quantities, material and thermal, involved in combustion. The relation between fuel and air quantities will be considered first.

I.—USE OF THE CHEMICAL EQUATION FOR
CALCULATION OF GAS QUANTITY.

Gas quantity is more conveniently measured in cubic feet than in pounds. The volume of a gas changes with temperature and pressure; but if, when referring to volume, we understand that volume which the gas would occupy at a temperature of 60° F. or 15° C. and under standard atmospheric pressure of 30 inches of mercury, then the amount specified is as much a fixed quantity as if it were stated in pounds. The term one **normal cubic foot**, borrowed from the German, is expressive and will be used to indicate the quantity of gas which, at standard temperature and pressure, would occupy 1 cu. ft.

The complete combustion of carbon, in oxygen, to carbon dioxide is represented by the equation—

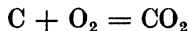

The first information conveyed by this equation is that one atom of carbon combines with one molecule of oxygen giving one molecule of carbon dioxide; or, if the pound be used as the unit of weight,

12 lb. of carbon combines with $16 \times 2 = 32$ lb. of oxygen
giving $12 + (16 \times 2) = 44$ lb. of carbon dioxide.

The equation gives us yet further information. It is an experimental fact that under the same conditions of temperature

and pressure the volume occupied per molecule is the same for all gases, and if the pound-molecule be taken as unit, that volume will be nearly 380 normal cu. ft.¹

Consequently, the equation also tells us that to burn completely one lb.-atom (or 12 lb.) of carbon, 380 normal cu. ft. of oxygen is required, and that the combustion produces 380 normal cu. ft. of carbon dioxide. The weights or volumes for one pound of carbon are obtained by dividing these quantities by 12 (the weight of an atom of carbon). In calculating volumes from equations, it is essential to express the molecular formulæ correctly. For example, it would be wrong to write $C + 2O = CO_2$, because this would imply that a molecule of oxygen contains only one atom and that in this equation, two molecules, or 380×2 cu. ft. of oxygen would be required instead of one molecule, or 380 cu. ft., which we know to be sufficient. The combustion of hydrogen is represented by the equation—

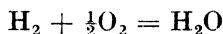

indicating

(a) That $1 \times 2 = 2$ lb. of hydrogen requires $\frac{1}{2} \times 16 \times 2 = 16$ lb. of oxygen, forming $(2 + 16) = 18$ lb. of water (or steam), and

(b) That the quantities under standard conditions represent 380, 190 and 380 normal cu. ft. respectively; or, if we are not concerned with weights, that 1 cu. ft. of hydrogen requires $\frac{1}{2}$ cu. ft. of oxygen and yields 1 cu. ft. of steam, the latter being considered to remain in the gaseous state.

Again, from the equation for the combustion of methane,

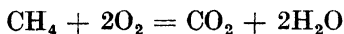

we learn

(a) That $12 + 4 = 16$ lb. of methane combines with $2 \times 16 \times 2 = 64$ lb. of oxygen and yields $12 + 32 = 44$ lb. of carbon dioxide plus $2(2 + 16) = 36$ lb. of steam, and

¹ The value is not quite the same for all gases. At standard pressure (approximately 30 inches of mercury) the actual values are as follows.—

	O ₂ , N ₂ , H ₂ , CO	CH ₄	H ₂ O	CO ₂	C ₂ H ₄	C ₂ H ₆
60° F.	379.2	378.7	378.2	376.7	376.2	374.7
15° C.	378.5	377.9	377.4	376.0	375.4	374.0

These actual figures have been used in calculating data tables presented in this chapter—a refinement which is perhaps scarcely justified. In calculations, differences should be entirely disregarded. The figure 380 is quite close enough; but, if desired, 379 may be taken as a mean figure for 60° F., and 378 for 15° C.

(b) That the quantities of gases represent 380, 760, 380 and 760 cu. ft. respectively (assuming the H_2O to be in the gaseous state); or 1 cu. ft. of methane requires 2 cu. ft. of oxygen and yields 1 cu. ft. of carbon dioxide plus 2 cu. ft. of steam.

The Air.—In commercial combustion, air is used instead of oxygen; but the equations given above are valid for combustion in air provided that a separate calculation is made to determine the amount of nitrogen accompanying the oxygen required for combustion. By volume, the air is composed of 20.9 per cent. oxygen and 79.1 per cent. nitrogen, so that 1 cu. ft. of oxygen is accompanied by $79.1/20.9 = 3.78$ cu. ft. of nitrogen (or 1 molecule by 3.78 molecules, molecules of all gases occupying equal volumes). The volume of air required is therefore 4.78 times that of the oxygen necessary. For the combustion of carbon in air, we could, if we preferred, write

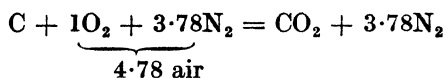

showing in one equation the amount of air required and the products of combustion when one atom of carbon is burnt.

Occasionally, it is necessary to know the composition of the air by weight. It has been shown that

1 molecule of O_2 is accompanied by 3.78 molecules of N_2

therefore (16×2) lb. of O_2 is accompanied by $(14 \times 2) \times 3.78 = 106$ lb. of N_2

whence, 1 lb. of O_2 is accompanied by $106/32 = 3.31$ lb. of N_2 , and the composition of the air by weight is

$$O_2 = \frac{1}{1 + 3.31} \times 100 = 23.2\% \text{ and } N_2 = \frac{3.31}{1 + 3.31} = 76.8\%$$

Chemical Analysis of a Fuel.—Perhaps the most important information concerning a fuel is its chemical analysis. It will now be shown how the analysis can be used to determine the quantity of air required for the combustion of a given amount of fuel, and to determine the quantity and composition of the products of combustion.

Air Required for Combustion, and Products of Combustion.—These combustion data are calculated from the chemical analyses and the simple combustion equations given earlier.

(1) **Gaseous Fuel.**—For gases, calculation is simplified if we remember that the molecules of all gases occupy the same volume ; hence, if all the substances are gases, we may write a molecular equation and may consider the quantities to represent cubic feet. For example, the equation,

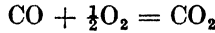

really refers to molecules of the gases, but it is also correct if we understand

$$1 \text{ cu. ft. of CO} + \frac{1}{2} \text{ cu. ft. of O}_2 = 1 \text{ cu. ft. of CO}_2$$

Similarly, from the equations

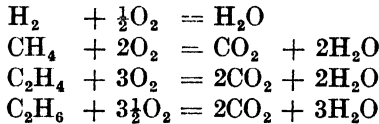

are determined the oxygen requirement and the products of combustion of one cubic foot of each of the combustible gases. These basic figures are tabulated on the left of the accompanying table. The right side of the table shows how these values are applied to investigate the combustion of producer gas.

Combustion of Constituent Gases.				Combustion of 100 cu. ft. of Producer Gas.				
Gas.	O ₂ Required for Combustion of 1 cu. ft.	Products of Combustion from 1 cu. ft.		Constituent of Gas.	Amount of Constituent per 100 cu. ft. of Dry Producer Gas.	O ₂ Required.	Products of Combustion.	
		CO ₂ .	H ₂ O.				CO ₂ .	H ₂ O.
		Cu. ft.	Cu. ft.			Cu. ft.	Cu. ft.	Cu. ft.
CO ₂	—	1	—	CO ₂	3.0	—	3.0	—
C ₂ H ₄	3 cu. ft.	2	2	C ₂ H ₄	0.2	0.6	0.4	0.4
CO	$\frac{1}{2}$ "	1	—	CO	28.0	14.0	28.0	—
H ₂	$\frac{1}{2}$ "	—	1	H ₂	12.0	6.0	—	12.0
CH ₄	2 "	1	2	CH ₄	2.5	5.0	2.5	5.0
C ₂ H ₆	3 $\frac{1}{2}$ "	2	3	C ₂ H ₆	—	—	—	—
H ₂ O	—	—	1	H ₂ O	4.0	—	—	4.0
				Total,		25.6	33.9	21.4

Data : The gas analysis shown in the above table is

CO ₂	C ₂ H ₄	O ₂	CO	H ₂	CH ₄	N ₂	Total.
3.0%	0.2%	0.2%	28.0%	12.0%	2.5%	54.1%	100%

In addition to the constituents shown by analysis, the gas contains moisture, the amount of which can be determined only by separate analysis. Suppose the *moisture to be 4.0 per cent. by volume, based on 100 volumes of dry gas* of the above composition. For convenience, this same analysis is used in subsequent calculations. The total oxygen required for theoretically perfect combustion is 25.6 cu. ft.; but as the gas already contains 0.2 cu. ft. of oxygen, only 25.4 cu. ft. needs to be supplied by the air. This will bring with it $25.4 \times 3.78 = 96.0$ cu. ft. of nitrogen which, together with the 54.1 cu. ft. of nitrogen present in 1 cu. ft. of producer gas, will appear in the waste gas, giving a total of 150.1 cu. ft. of nitrogen.

Summarising this, we find that 100 cu. ft. of the gas requires 121.4 cu. ft. of air (25.4 cu. ft. of oxygen and 96.0 cu. ft. of nitrogen), and yields 205.4 cu. ft. of waste gas consisting of 33.9 cu. ft. carbon dioxide, 21.4 cu. ft. water vapour and 150.1 cu. ft. of nitrogen.

Thus 1 cu. ft. of the gas requires 1.21 cu. ft. of air (0.25 cu. ft. of oxygen and 0.96 cu. ft. of nitrogen) and yields 2.05 cu. ft. of waste gas consisting of 0.34 cu. ft. carbon dioxide, 0.21 cu. ft. water vapour and 1.50 cu. ft. of nitrogen. The true per cent. composition of this gas would be,

$$\text{CO}_2 = \frac{0.34}{2.05} \times 100 = 16.6\%, \quad \text{H}_2\text{O} = \frac{0.21}{2.05} \times 100 = 10.2\%,$$

$$\text{N}_2 = \frac{1.5}{2.05} \times 100 = 73.2\%.$$

The laboratory determination gives the analysis on a dry basis, as though all the moisture were first removed from the sample. Consequently, for theoretically perfect combustion of 1 cu. ft. of the producer gas, the products reported by the laboratory would be only 0.34 cu. ft. of carbon dioxide and 1.50 cu. ft. nitrogen, equal to 1.84 cu. ft. total volume. The carbon dioxide determination returned by the laboratory would be $\frac{0.34}{1.84} \times 100 = 18.5\%$. This figure, which is the maximum carbon dioxide content theoretically obtainable after condensation of the steam, is called the *ultimate CO₂*, and should be known for whatever fuel is being used.

There are other ways of arriving at this combustion information.

Another method is to write a direct equation for the combustion of 100 cu. ft. (or 100 molecules) of the gas as follows:—

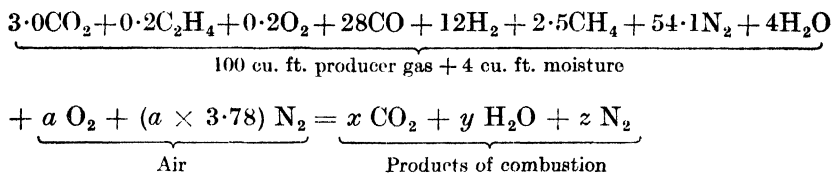

For the unknown quantities, the symbols a , x , y and z have been used, and the problem is to find the values of these quantities. There must be exactly the same number of carbon atoms on the right of the equality sign as on the left. On the left there are $3 + (0\cdot2 \times 2) + 28 + 2\cdot5 = 33\cdot9$ atoms of carbon, therefore x equals 33·9, and this should be written into the equation immediately in place of x . In the same way, the total number of hydrogen atoms on the left is $(0\cdot2 \times 4) + (12 \times 2) + (2\cdot5 \times 4) + (4 \times 2) = 42\cdot8$. This must be equal to $2y$, from which $y = 21\cdot4$. From the values of x and y it is seen that the number of oxygen atoms on the right of the equation equals $(33\cdot9 \times 2) + 21\cdot4 = 89\cdot2$. The number of oxygen atoms accounted for in the producer gas on the left of the equation is $(3 \times 2) + (0\cdot2 \times 2) + 28 + 4 = 38\cdot4$. The oxygen atoms to be supplied by the air must be $89\cdot2 - 38\cdot4 = 50\cdot8$, from which $a = \frac{50\cdot8}{2} = 25\cdot4$. The nitrogen from the air accompanying this must be $25\cdot4 \times 3\cdot78 = 96\cdot0$ molecules. This, added to the 54·1 molecules of nitrogen from the gas gives 150·1 molecules, which must be the value of z . The full equation now becomes:—

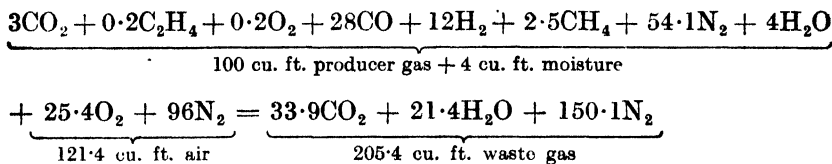

Advantages of this method are speed, since most of the figures may be inserted by inspection, and ease of checking the correctness of the solution by seeing that each element does actually balance on both sides of the final equation.

For natural gas, coke oven gas, or mixed gases, the calculation is similar.

(2) **Liquid Fuels and Coals.**—As an example, a fuel oil having the following analysis by weight is taken :—13 per cent. hydrogen, 85 per cent. carbon, 1 per cent. oxygen, 1 per cent. nitrogen. This time the problem is a little more complicated because we are dealing with weights of fuel, but wish to determine air and products of combustion in cubic feet. The calculation will first be made for 100 lb. of fuel; it is necessary to convert the percentage figures to lb.-atoms per 100 lb. For hydrogen, carbon, oxygen and nitrogen the weights per lb.-atom are 1 lb., 12 lb., 16lb., and 14 lb., respectively; therefore

$$13 \text{ lb. of hydrogen} = 13 \text{ lb.-atoms}$$

$$85 \text{ lb. of carbon} = \frac{85}{12} = 7.08 \text{ lb.-atoms}$$

$$1 \text{ lb. of oxygen} = \frac{1}{16} = 0.06 \text{ lb.-atom}$$

$$1 \text{ lb. of nitrogen} = \frac{1}{14} = 0.07 \text{ lb.-atom}$$

From the equation $\text{H}_2 + \frac{1}{2}\text{O}_2 = \text{H}_2\text{O}$, we know that 1 molecule (2 atoms) of hydrogen requires $\frac{1}{2}$ molecule (1 atom) of oxygen, and produces 1 molecule of water; therefore, 13 atoms ($6\frac{1}{2}$ molecules) of hydrogen requires $3\frac{1}{4}$ molecules of oxygen and produces $6\frac{1}{2}$ molecules of steam. Also from the equation $\text{C} + \text{O}_2 = \text{CO}_2$, we see that 1 atom of carbon requires 1 molecule (2 atoms) of oxygen, and yields 1 molecule of carbon dioxide; therefore 7.08 atoms of carbon requires 7.08 molecules of oxygen and yields 7.08 molecules of carbon dioxide.

For theoretically perfect combustion 100 lb. of the fuel oil would require $7.08 + 3.25 = 10.33$ molecules of oxygen and would yield 7.08 molecules of carbon dioxide and 6.5 molecules of steam; but the oil already contains 0.06 atom = 0.03 molecule of oxygen per 100 lb., and therefore only $10.33 - 0.03 = 10.3$ molecules has to be supplied by the air. This amount of oxygen would be accompanied by $10.3 \times 3.78 = 38.93$ molecules of nitrogen which would be added to the waste gas, and the amount of air to be supplied per 100 lb. of fuel oil would be $10.3 + 38.93 = 49.23$ molecules. But, in addition, the fuel contained 0.07 atom = 0.04 (approximately) molecule of nitrogen, and this would also appear in the waste gas, giving a total of 38.97 molecules of nitrogen. Finally, if steam were used for atomising the oil,

this would have to be added to the products of combustion. Supposing the atomising steam to be 30 per cent. of the weight of the fuel (about $2\frac{1}{4}$ lb. per gallon) for 100 lb. of fuel, this would represent 30 lb. or $\frac{30}{18} = 1.7$ molecules of steam, which, added to the 6.5 molecules of steam from combustion, gives a total of 8.2 molecules. Additional moisture present in the air or fuel may also be added to the calculated products of combustion.

All the quantities involved in the combustion of 1 lb. of oil are summarised below in tabular form, and are given separately in molecules, in pounds, and in cubic feet.

COMBUSTION OF ONE POUND OF FUEL OIL.

	Steam for Atomising.	O. Required for Combustion.	N. Accompanying O ₂ .	Air for Combustion.	CO ₂ in Waste Gas.	H ₂ O in Waste Gas.	N ₂ in Waste Gas.
Molecules, .	0.017	(0.103)	(0.389)	0.492	0.071	0.082	0.390
Lb., . . .	0.30	(3.3)	(10.9)	14.2	3.1	1.5	10.9
Cu. ft., . .	6	(39)	(148)	187	27	31	148

The quantities expressed in pounds are obtained by multiplying the numbers of molecules by the molecular weights of the various gases—the weight of air is obtained by adding together the weights of oxygen and nitrogen, but it may also be obtained by assuming the “molecular weight” of air to be 29. The values expressed in cubic feet are obtained by multiplying the numbers of molecules by 380. Thus 1 lb. of this fuel requires 187 cu. ft. (14.2 lb.) of air and gives 206 cu. ft. (15.5 lb.) of waste gas containing 27 cu. ft. (3.1 lb.) of carbon dioxide, 31 cu. ft. (1.5 lb.) of water vapour and 148 cu. ft. (10.9 lb.) of nitrogen. The true percentage composition, by volume, of the waste gas would be :—

$$\text{CO}_2 = \frac{27}{206} \times 100 = 13.1\%$$

$$\text{H}_2\text{O} = \frac{31}{206} \times 100 = 15.1\%$$

$$\text{N}_2 = \frac{148}{206} \times 100 = 71.8\%$$

The ultimate CO_2 analysis with the steam removed, as reported by the laboratory, would in this case show

$$\text{CO}_2 = \frac{27}{27 + 148} = 15.4\%$$

If preferred, the equation method can conveniently be applied to solve the problem for 100 lb. of fuel, as follows:—

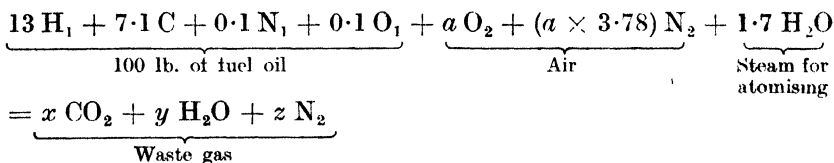

This being a true molecular equation, to balance the carbon atoms x must equal 7.1, and this value may be substituted immediately. Similarly for hydrogen $y \times 2$ must equal $13 + (1.7 \times 2) = 16.4$, therefore $y = 8.2$, and this value is also written into the equation. We now know that the right side has $(7.1 \times 2) + (8.2 \times 1) = 22.4$ oxygen atoms. On the left side 0.1 atom of oxygen is supplied by the fuel and 1.7 by the atomising steam, therefore $22.4 - 1.8 = 20.6$ atoms must be supplied by the air, whence $a = 20.6 \div 2 = 10.3$. The nitrogen brought in with this oxygen is $3.78 \times 10.3 = 38.93$ and z must be 39.03 in order to balance the nitrogen. The full equation now becomes

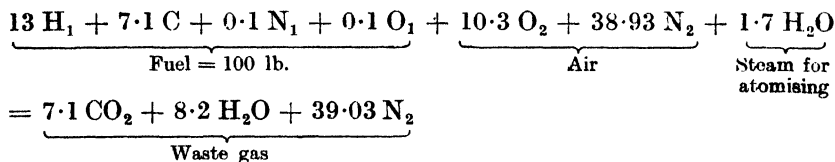

which leads to the same quantitative results concerning the air and the products of combustion as the other method.

The calculation for coal, tar, etc., is similar.

For coal gasified in producers an additional explanation is necessary. The amounts of carbon dioxide and nitrogen in the dry waste gas, and hence the ultimate CO_2 , are the same as if the coal had been burnt directly, because the steam used and decomposed in the producers is reconverted to steam during combustion, and is removed from the waste gas before the gas analysis is made. To estimate the moisture content of the waste gas without making an actual laboratory analysis (rather a difficult determination), it is necessary to add together the amount of

moisture calculated as above from the complete coal analysis, the amount of steam blown into the producers, and the amount of moisture present in the coal. For example, if the weight of steam used in the producers were 25 per cent. of the weight of coal gasified, and if the coal contained 5 per cent. of moisture, for 100 lb. of coal $\frac{30}{8} = 1.67$ molecules (30 lb. or 635 cu. ft.) of steam would be added and this additional quantity would be found in the waste gas. However, as part of the air for combustion of the coal is supplied in the gas producers, it is generally more convenient to consider the producer gas to be the fuel and to solve problems from the gas analysis as shown on pages 11-13, rather than from the coal analysis.

Excess Air.—Calculation, as described, gives the air and waste gas quantities for perfect combustion with no excess of air over the theoretical requirement. In practice this condition represents an ideal which can only be approached.

Combustion can take place only when gas and oxygen molecules meet. At the point of initial contact between fuel and air in a furnace, the large proportion of free oxygen and gas molecules results in a large number of contacts of gas and oxygen molecules, and consequently a rapid initial combustion; but further combustion depends on making of further contacts between unused oxygen molecules and the remaining gas molecules. In most large industrial furnaces the mixing of fuel and air is more or less imperfect, and some portions of the air stream may never mingle completely with the gas stream. In order to make sure that no fuel remains unburnt, some excess air is nearly always necessary, while in actual practice a large and undesirable excess is too frequently used.

In calculating the air requirement and flue gas quantity for a given per cent. of excess air, it is convenient to calculate for theoretically perfect combustion, and then to add the excess air quantity.

Calculation from Operating Data.—Previous calculations have assumed a given fuel, burnt with the theoretically necessary quantity of air, or with a known excess of air. In calculating from routine data, the amount of excess air is not known, and a somewhat different procedure must be followed.

Calculations from operating data fall naturally into two classes—

(a) Percentage or ratio calculations based on the flue gas analysis alone.

(b) Calculations of gas volumes from the weight of fuel burnt and the analyses (partial or complete) of fuel and flue gas. If any element passes completely from a given quantity of fuel to the waste gas, *the resulting quantity of waste gas must contain the same weight of the element as the fuel*—this constitutes the basis for calculations of the second class. The weight of carbon, for example, is known from the weight and analysis of the fuel. The quantity of carbon present in 1 cu. ft. (or other volume) of the gas is obtainable from the gas analysis. Therefore the volume of gas containing the entire weight of carbon is easily calculated. Metering this gas volume would be difficult.

It will be shown later that the percentage and quantity data obtainable are extremely valuable. In general, a series of calculations will determine the characteristics of the fuel employed, and then charts or tables may be made for instant interpretation of operating conditions. The methods employed will be explained by means of examples.

Example 1.—To Find the Per Cent. Excess Air from the Flue Gas Analysis.—The analysis of the flue gas (from combustion of pulverised coal) is

$$\text{CO}_2 \text{ 15.0\%, O}_2 \text{ 4.3\%, N}_2 \text{ 80.7\%}.$$

Solution.—The 4.3 of the flue gas analysis represents excess oxygen over the theoretical requirement.

4.3 by volume of O₂ in the air is accompanied by $4.3 \times \frac{79.1}{20.9}$
(or 4.3×3.78) = 16.2 of N₂.

Nitrogen in theoretically unnecessary air	= 16.2
.. air utilised	= 80.7 - 16.2
	= 64.5

The small quantity of nitrogen present in the coal is negligible; for fuels such as blast furnace gas and producer gas, however, it would be necessary to allow for the nitrogen in the fuel.

Excess of air over theoretical requirement (the same ratio as the corresponding nitrogen figures) = $\frac{16.2}{64.5} = 0.25$, or 25%.

Example 2.—To Find the Ultimate CO₂ of a Fuel from the Flue Gas Analysis.—The flue gas analysis is again CO₂ 15.0%, O₂ 4.3%, N₂ 80.7%.

Solution.—As found in Example 1, the 4.3 of unwanted oxygen is accompanied by 16.2 of nitrogen. For theoretically perfect combustion, this excess air would not have been admitted, and the 15.0 of carbon dioxide would have been accompanied by only

64.5 of nitrogen, giving a total of 79.5 instead of 100. Converting to percentages,

$$\text{CO}_2 = 15.0 \times \frac{100}{79.5} = 18.9\%$$

$$\text{N}_2 = 64.5 \times \frac{100}{79.5} = 81.1\%$$

$$\text{Total} \quad . \quad . \quad . \quad \underline{\underline{100.0\%}}$$

$$\text{Ultimate CO}_2 = 18.9\%$$

Example 3.—To Find the Approximate Moisture Content of the Flue Gas from its Analysis.—This is important in heat transfer problems as well as in calculation of the gas volume. The gas analysis from the combustion of fuel oil (analysis unknown) is:—CO₂ 12.0%, CO 0.4%, O₂ 4.0%, N₂ 83.6%.

Solution.—Basing the calculation on 100 cu. ft. of dry waste gas, we find that 83.6 cu. ft. of nitrogen must have been accompanied by

$$83.6 \times \frac{20.9}{79.1} \text{ or } \left(83.6 \times \frac{1}{3.78} \right) = 22.1 \text{ cu. ft. of oxygen.}$$

The other gases account for 12.0 (in CO₂) + $\frac{0.4}{2}$ (in CO) + 4.0 (free O₂) = 16.2 cu. ft. of O₂.

The unaccounted for 5.9 cu. ft. of oxygen must be present as moisture, which would require 11.8 or approximately 12 cu. ft. of moisture to every 100 cu. ft. of dry gas.

For determining the volume of waste gas, the result would conveniently be left in this form. For other purposes the gas analysis may be recalculated to a percentage basis, on the total volume, by multiplying the original figures by $\frac{100}{112}$, giving CO₂ 10.7%, CO 0.4%, O₂ 3.6%, N₂ 74.6%, H₂O 10.7%.

Limitations of this Method.—The calculation neglects the one per cent. or so of nitrogen, of oxygen, and of sulphur ordinarily present in this type of fuel, but this does not result in any significant error, as the weight of fuel is only about 5 per cent. of the total weight of products of combustion. If the oil were atomised with steam, the amount of moisture introduced might result in an increase of as much as 60 per cent. over the calculated value—the actual amount could of course be determined if the steam were metered. The amount of moisture ordinarily present in solid or liquid fuels is not important. The moisture entering with the air could, if necessary, be found and added.

Owing to possible errors of analysis, the method is open to objection if the fuel is burnt with a very large excess of air. In such cases the gas analysis may show 19 per cent. or more of free and combined oxygen; thus the unaccounted-for oxygen cannot be much greater than 2.0, and errors of analysis may cause serious percentage error in the moisture calculation. For a fuel having a high ultimate CO_2 , the calculated moisture may, for the same reason, show a large error when expressed as a proportion of the amount actually present—the amount of hydrogen present in the fuel will, however, be small, making the absolute error in the moisture calculation also small in this case. Allowance must be made for any large moisture addition, such as occurs in the manufacture of producer gas.

Again, if the waste gas contains a considerable amount of carbon monoxide, there must also be free hydrogen present (see p. 454), and the latter in a normal flue gas analysis would be reported as nitrogen. The hydrogen content of the waste gas is likely to vary from a quantity expressed by $(\% \text{ CO}) \times \frac{(\% \text{ H}_2\text{O})}{(\% \text{ CO}_2)}$ to one-half of this value (p. 455). For the waste gas in the above example the hydrogen will therefore lie between 0.2% and 0.4%.

The method for calculating moisture must be used with caution for gaseous fuels of high unknown oxygen content (for solid and liquid fuels this is much less important), and should not be used at all for gases, such as blast furnace gas and water gas, which have been enriched in oxygen to a large but unknown extent (blast furnace gas by oxygen from ore, and water gas by oxygen from steam).

Example 4.—To Determine the Approximate Carbon : Hydrogen Ratio of the Fuel from the Flue Gas Analysis.—The data and deductions of Example 3 are used.

Solution.—Subject to the provisions specified in Example 3, the carbon : hydrogen ratio of the fuel will be the same as in the waste gas. Using the per cent. figures of the solution to Example 3 as molecular quantities, we find that $10.7 + 0.4 = 11.1$ atoms of carbon were associated with $10.7 \times 2 = 21.4$ atoms of hydrogen in the flue gas. (Added moisture must not be included in determining the hydrogen of the fuel.) Multiplying these quantities by the atomic weights, we get 133.2 lb. of carbon and 21.4 lb. of hydrogen. The approximate weight composition of the fuel oil, omitting small unknown quantities of oxygen, nitrogen, and sulphur, is :—

$$\text{C} = \frac{133.2}{133.2 + 21.4} \times 100 = 86.2\%$$

$$\text{H} = \frac{21.4}{133.2 + 21.4} \times 100 = 13.8\%$$

Example 5.—To Find the Volume of Waste Gas from the Weight of Fuel.—A furnace is fired with (pulverised) coal containing 80 per cent. carbon. The flue gas analysis is CO_2 15.0%, O_2 4.3%, N_2 80.7%. To calculate the volume of waste gas per 100 lb. of dry coal.

Solution.—Carbon entering the waste gas per 100 lb. of coal = $\frac{80}{12} = 6.67$ lb.-atoms. From the gas analysis, 1 lb.-molecule (380 cu. ft.) of flue gas contains 0.15 lb.-atom of carbon.

0.15 lb.-atom of carbon is present in 380 cu. ft. of dry flue gas

\therefore 1 atom of carbon is present in $\frac{380}{0.15}$ cu. ft of dry flue gas

\therefore 6.67 atoms of carbon are present in $\frac{380}{0.15} \times 6.67$ cu. ft. of dry flue gas

= 16,900 cu. ft. of dry flue gas.

To this should be added the volume of moisture which, according to the method shown in Example 3, must be present. The 80.7 of nitrogen was associated in the air with $\frac{80.7}{3.78} = 21.3$ of oxygen.

The carbon dioxide and oxygen of the flue gas analysis account for 19.3 of this, leaving 2.0 unaccounted for. The 2.0 of oxygen is present in 4.0 of moisture, showing 4 per cent. of moisture on the dry gas quantity, or nearly 700 cu. ft. of moisture.

The total flue gas volume is $16,900 + 700 = 17,600$ cu. ft.

Example 6.—To Find the Volume of Air Used in Example 5.—This determination involves some approximations which are the subject of comment in the next example.

Solution.—From the flue gas analysis, 15 atoms of carbon are associated with 80.7 molecules of nitrogen. From Example 5, 100 lb. of coal contains 6.67 lb.-atoms of carbon ; then by proportion

6.67 lb.-atoms of carbon are associated with $80.7 \times \frac{6.67}{15}$

-- 35.8 lb.-molecules of nitrogen in the flue gas.

The volume of nitrogen in the air supplied is therefore

$35.8 \times 380 = 13,600$ cu. ft.

(Or, using Example 5, $16,900 \times 80.7\% = 13,600.$)

The oxygen accompanying this in the air is $13,600 \times \frac{20.9}{79.1} = 3,600$ cu. ft.

∴ Volume of air per 100 lb. of coal = 17,200 cu. ft.

Example 7.—To Show the Effect of Using the Complete Coal Analysis in Examples 5 and 6.—The full analysis of the pulverised coal as used is:

C 80%, H 4%, O 4%, N 1%, S 1%, ash 10% (Total 100%).
Moisture 1%.

The volume of dry flue gas obtained in Example 5 was based on the carbon quantity and the flue gas analysis and therefore remains as before, irrespective of the amounts of other substances in the coal.

It is the purpose of the present example to show that the amounts of elements other than carbon have little effect on other calculations made in Examples 5 and 6. It is convenient therefore to treat each element separately.

(a) *Moisture in the Flue Gas.*—This can now be calculated directly. 100 lb. of coal (dry basis) contains 4 lb.-atoms of hydrogen and $\frac{1}{8}$ lb.-molecule of moisture, yielding a total of $\frac{4}{2} + \frac{1}{8} = 2.06$ lb.-molecules of hydrogen or $2.06 \times 380 = 780$ cu. ft. of water vapour. Direct calculation is of course much better than the indirect method used in Example 5.

(b) *Nitrogen in the Fuel.*—Combustion of 100 lb. of coal will yield $\frac{1}{14 \times 2} \times 380 = 14$ cu. ft. of nitrogen from the 1 per cent. of nitrogen in the coal. The 16,900 cu. ft. of dry waste gas includes this 14 cu. ft. of nitrogen from the coal—0.083 per cent. of the waste gas volume. This 0.083 per cent. should be subtracted from the 80.7 per cent. of nitrogen in the waste gas to determine how much of the nitrogen was supplied by the air. The volume of oxygen accompanying nitrogen from the air will also be less than the value calculated in Example 6 by $\frac{0.083}{3.78} = 0.022$ per cent. of the waste gas volume. Similarly, it is found that the moisture content of the waste gas is 7 cu. ft. less than the 700 cu. ft. calculated in Example 5—a discrepancy of one per cent. The recalculated quantity of air used for combustion of 100 lb. of dry coal is 18 cu. ft. less than the original value of 17,200 cu. ft.—a discrepancy of one-tenth of one per cent.

The effect of nitrogen in the quantities commonly present in solid and liquid fuels is therefore negligible.

(c) *Oxygen in the Fuel.*—In burning 100 lb. of coal, $\frac{4}{16 \times 2} \times 380 = 48$ cu. ft. of the total oxygen of the waste gas is supplied by the 4 per cent. of oxygen in the fuel. In calculating the moisture, this additional oxygen input shows as an increase in the "unaccounted for" oxygen of the waste gas. The extra 48 cu. ft. of "unaccounted for" oxygen must be present as 96 cu. ft. of moisture, showing an approximate increase of one-seventh on the 700 cu. ft. of moisture calculated in Example 5.

In Example 6, the volume of air was calculated on the nitrogen basis and the calculation will therefore not be affected by the oxygen content of the fuel.¹

Again it may be concluded that a moderate percentage of oxygen does not materially affect the calculations, the indirect moisture calculation being, in any case, rather uncertain.

¹This refers to the air actually used according to the given data—the theoretical air requirement will naturally be lower for a fuel high in oxygen.

(d) *Sulphur in the Fuel.*—Owing to the smaller quantity and much higher solubility of sulphur dioxide in water, compared with carbon dioxide, in ordinary analyses¹ sulphur dioxide present in the flue gas will not be included in the dry gas analysis or calculated gas quantity.

The combustion of sulphur requires oxygen, but even assuming that all of the sulphur is burnt to sulphur dioxide, 1 per cent. of sulphur in the fuel would produce only $\frac{1}{8} \times 380 = 12$ cu. ft. of sulphur dioxide, and would require an equal volume of oxygen. (The relatively small amount of oxygen required to oxidise iron associated with sulphur in the fuel is neglected.) Where part only of the sulphur is in a combustible form the discrepancies will be correspondingly smaller. Besides the volumetrically negligible addition of 12 cu. ft. (0.07 per cent. of the total volume of dry flue gas), there will be an effect on the moisture content as calculated on the missing oxygen basis. The effect will be to decrease the calculated moisture by 24 cu. ft. on the 700 cu. ft. calculated, or approximately $\frac{1}{30}$ of the latter volume.

Unless sulphur is present in very large quantities, its effect may be neglected. Each 1 per cent. by weight of sulphur burnt neutralises exactly, so far as flue gas analysis and air requirements are concerned, 1 per cent. by weight of oxygen of the fuel.

Example 8.—To Find the Volume of Producer Gas from the Weight of Coal.—A producer gasifies 2,400 lb. of coal per hour = 40 lb. per minute.

Coal analysis.—71% C, 5% H, 9% O, 1% N, 1% S, 9% ash, 4% moisture. Total 100%.

Producer gas analysis.—CO₂ 3.0%, C₂H₄ 0.2%, O₂ 0.2%, CO 28.0%, H₂ 12.0%, CH₄ 2.5%, N₂ 54.1%. The gas contains in addition 4% of moisture.

Step 1.—Carbon Entering Gas.—Some of the carbon from the coal will not appear in the gas, due to the formation of tar, and loss of carbon in ash, soot and dust. The quantity of carbon accounted for by these substances should be known from direct determination. It will be assumed that this carbon is 6 per cent. of the weight of coal.

$$\begin{aligned} \text{Carbon entering the gas per minute} &= \frac{(71 - 6)}{100} \times 40 = 26 \text{ lb.} \\ &= 26/12 = 2.17 \text{ lb.-atoms.} \end{aligned}$$

Step 2.—Carbon in 1 lb.-mol. of Gas.—From the gas analysis, 1 lb.-molecule (380 cu. ft.) of gas contains:—

$$\begin{array}{cccc} \text{CO}_2 & \text{C}_2\text{H}_4 & \text{CO} & \text{CH}_4 \\ 1/100 (3 + 2 \times 0.2 + 28 + 2.5) & & & = 0.339 \text{ lb.-atom of carbon.} \end{array}$$

¹ In carbon dioxide recorders, the wash water may, unless precautions are taken, become saturated with sulphur dioxide. If this occurs, sulphur dioxide will be recorded as additional carbon dioxide, introducing an appreciable error for high sulphur coals.

Step 3.—Volume of Gas.—

0.339 lb.-atom of carbon is present in 380 normal cu. ft. of gas
(Step 2)

1 lb.-atom of carbon is present in $380/0.339 = 1120$ normal
cu. ft. of gas

∴ 2.17 lb.-atoms of carbon are present in $1120 \times 2.17 = 2430$
normal cu. ft. of gas.

The gas volume is 2430 normal cu. ft. per minute (dry basis).

*Example 9.—To Find the Volume of Primary Air used in the Above Problem.—*The volume of nitrogen in the producer gas is obtainable from the gas analysis and the gas quantity as determined in Example 8.¹ This volume of nitrogen has been supplied by the primary air; consequently the volume of primary air can be calculated.

It is not possible to work on the basis of oxygen content alone unless the weight of injected steam is known.

Volume of nitrogen in producer gas = $54.1/100 \times 2430$
= 1310 normal cu. ft. (approx.).

*Volume of Air Used.—*In the atmosphere 79.1 cu. ft. of nitrogen is accompanied by 20.9 cu. ft. of oxygen.

Volume of oxygen used = $1310 \times 20.9/79.1$
= 350 normal cu. ft. per min.

Volume of primary air = $1310 + 350$
= 1660 normal cu. ft. per min.

*Other Bases for Volume Calculation.—*Theoretically, any other element can be used in the same way as carbon or nitrogen. Practically, the other elements are likely to prove less satisfactory.

There are two objections to the use of a hydrogen basis. Firstly, the moisture content of gases is always a rather uncertain quantity—water contains $\frac{1}{8}$ of its weight of hydrogen. Secondly, the more important source of hydrogen is the fuel itself, and since the percentage of hydrogen in most fuels is small, any error of analysis may lead to serious error in calculated results. (Incidentally a check on the hydrogen basis will show that the coal and gas analyses in the preceding producer gas problems are inconsistent with practice, unless an abnormally small quantity of steam were

¹ The amount of nitrogen contributed by the coal, and the small quantities of nitrogen compounds in the gas, are ignored.

used in the producer). The hydrogen content of the fuel is used, of course, to calculate the amount of water vapour in the products of combustion as explained earlier.

Oxygen is imperfect as a basis, also because of the uncertainty of the moisture content. Sulphur is quite unsuitable owing to its small quantity and the fact that it is not reported in gas analyses.

Adjustments Necessary in Preceding Calculations.—Variations in gas volume and ratio calculations are almost endless. The examples given illustrate the principles, but in specific cases certain adjustments may be necessary. The most important of these are due to

(a) loss of fuel ;

(b) changes in gas composition on account of chemical reactions taking place in the furnace charge.

Loss of fuel has been mentioned with regard to producer gas manufacture. The major fuel losses to be allowed for are losses through the grate and unburnt carbon carried from the furnace as soot. Laboratory control will indicate the normal extent of these losses.

Changes in gas composition due to the furnace charge may cause considerable variation in the flue gas analysis. These disturbances include addition of oxygen to the gas (from reduction of ore), removal of oxygen from the gas (due to oxidation of the charge by furnace gas), addition of carbon dioxide to the gas (by calcining of limestone or other carbonates), and addition of large quantities of sulphur (from sulphide ores). The extent of these changes may be calculated (see Chapter III, " The Material Balance Sheet ").

II.—HEAT OF COMBUSTION.

Heat Units.—The units of heat used in practical furnace work are the British Thermal Unit (B.Th.U.) and the Centigrade Heat Unit (C.H.U.). The B.Th.U. is the amount of heat required to raise 1 lb. of water 1° F. The C.H.U. is the amount of heat required to raise 1 lb. of water 1° C. In America, this unit is commonly called the pound calorie.

The amount of heat required to raise one pound of water 1° F. (or 1° C.) varies slightly with the temperature of the water. In modern scientific work the heat unit is generally expressed as the amount of heat required to raise unit weight of water from

14.5° to 15.5° C.—the scientific unit of weight is the gram, and the scientific heat unit is the calorie, expressed more precisely as the 15° C. calorie or cal₁₅. All recent scientific thermal data are expressed in 15° C. calories, and the practical units adopted in this book are the 15° C. C.H.U. and the B.Th.U. corresponding to this unit.

For practical work, thermal units sometimes used are the "mean B.Th.U.," which is $\frac{1}{180}$ part of the heat required to raise one pound of water from 32° to 212° F., and the "mean C.H.U.," which is $\frac{1}{180}$ part of the heat required to raise one pound of water from 0° to 100° C. From determinations by Osborne, Stimson and Fiock,¹ it is calculated that the mean heat unit is greater than the 15° C. unit by less than one part in one thousand (1 mean cal. = 1.0007 cal₁₅).

There is little in favour of using the mean heat unit. From a scientific point of view this unit is extremely difficult to measure accurately in terms of other heat or energy units. From a practical point of view, the difference between the mean unit and the 15° C. unit is so small as to be negligible; in any case, the heat values which we obtain from physico-chemical tables are understood to be in 15° C. units, and we introduce a nominal error when we interpret these values as representing mean units.

The advantage of the C.H.U. lies principally in the fact that calorific values per pound of a substance, when measured in this unit, are numerically equal to those of the metric system, which is used in technical work in practically all non-English speaking countries and in scientific work everywhere. The C.H.U. is the larger unit in the ratio of the °C. to the °F., so that to convert C.H.U's. to B.Th.U's. multiply by $\frac{9}{5}$; and to convert B.Th.U's. to C.H.U's. multiply by $\frac{5}{9}$. Plate I, Scale 2, may also be used for conversion.

It is essential that in all calculations involving B.Th.U's., the °F. be used as the measure of temperature; and for C.H.U's., the °C. Particularly in the steel industry of Great Britain there is likelihood of confusion of units, because most other furnace engineers have adopted the °F. and the B.Th.U. This has led, in many cases, to the use of the B.Th.U. in the steelworks as a unit of heat (especially in referring to the calorific value of fuels and the thermal requirements of making one ton of steel), while the °C. is still retained as the unit of temperature. In this book, calculations have been made in B.Th.U's., and in most cases in C.H.U's. also. The result and all data pertaining to the C.H.U., including temperatures in °C., are placed in parentheses to avoid confusion.

Calorific Value.—The calorific value is the number of heat units generated by combustion of unit quantity of a fuel. The unit of quantity is usually the pound, except for gaseous fuels,

¹ Osborne, N.S., Stimson, H. F., and Fiock, E. F.: "A Calorimetric Determination of Thermal Properties of Saturated Water and Steam from 0° to 270° C.," *Bureau of Standards, Journal of Research*, 1930, vol. 5.

where the cubic foot is more conveniently used ; and the calorific value is given in B.Th.U's. or C.H.U's., according to the system used, per pound of solid or liquid fuel, or per cubic foot of gaseous fuel at 60° F. (15° C.). For fuels containing hydrogen (*i.e.* nearly all fuels used in furnace work), there are two calorific values, one called the *gross* or *higher* calorific value and the other called the *net* or *lower* calorific value. The higher value is that obtained experimentally ; it is based on the assumption that all moisture formed during combustion is condensed to water. In general furnace practice, the waste gas is above the boiling point of water, so that no condensation of steam can take place. In technical calculations it is therefore somewhat simpler to use the lower calorific value, in which the heat required to evaporate the water to steam has been deducted from the higher calorific value, thus giving the amount of heat which is ordinarily developed in metallurgical processes. The alternative is to use the higher value and calculate separately the heat which has been required to evaporate the water in the products of combustion.

It is, after all, only a matter of arithmetic, and in this book the lower value has been used throughout, so that for data taken entirely from this book, it is not possible for confusion to arise. Where other combustion data are used, it is only necessary to take care to ascertain which calorific value is intended, and to convert to the lower value in cases where only the higher value is given.

Lower value (B.Th.U.) = Higher value (B.Th.U.) - 1050 (9H + H₂O)

Lower value (C.H.U.) = Higher value (C.H.U.) - 585 (9H + H₂O)

where H is the weight of hydrogen and H₂O is the weight of water, both expressed as a decimal of a pound, in 1 lb. (or 1 cu. ft.) of the fuel.

For coal or other solid fuel, the laboratory determination of higher calorific value is nearly always based on the dry fuel, moisture being reported separately. It is quite common to calculate the lower calorific value also on the dry basis ; but by so doing we lose most of the mathematical advantage of using the lower value. All of the moisture, whether derived from combined hydrogen of the fuel or from moisture present in the fuel as used, has to be converted into steam ; and to be logical in the matter, we must deduct all of the heat necessary to effect the vaporisation. The procedure recommended is therefore first to convert the laboratory determinations, both analyses and higher calorific value, to the wet basis, and then to convert to

the lower calorific value as illustrated in the following example. In this book, unless otherwise stated, the lower or net calorific value is understood to mean the calorific value of the fuel as supplied to the furnace, after deducting the heat necessary to convert all water (from hydrogen and from combined and uncombined water) to vapour at 60° F. (15° C.).

In gaseous fuels, particularly hot producer gas, uncombined moisture is already in the gaseous state. In this case, no deduction is necessary for vaporisation of this moisture; but the usual deduction from calorimeter determinations must be made for water resulting from combustion.

Example.—A coal, as used, has the following composition by weight: C 71%, H 5%, O 9%, N 1%, S 1%, Ash 9%. Uncombined moisture 4%, and has a higher calorific value, based on the wet coal, of 12,600 B.Th.U's. (7000 C.H.U's.).

The lower calorific value will be

$$12,600 - 1050\{(0.05 \times 9) + 0.04\} = 12,100 \text{ B.Th.U's.} \\ \text{(approx.)}$$

$$\text{or } 7,000 - 585\{(0.05 \times 9) + 0.04\} = 6,700 \text{ C.H.U's.} \\ \text{(approx.)}$$

For natural gas the net value is about 9 per cent. less than the gross, for coke oven gas about 11 per cent. less, for producer gas about 6 per cent. less, for fuel oil about 6 per cent. less, for bituminous coal containing a normal quantity of moisture 3 to 5 per cent. less, for tar about 4 per cent. less, and for blast furnace gas about 2 per cent. less than the gross value.

The existence of two different calorific values has been explained only in case data from other sources be used in conjunction with this book. It is important also that the laboratory should report the net, not the gross, value. Here, we need concern ourselves only with one calorific value—the lower value.

Heats of Formation and Combustion.—It has been shown that the equation

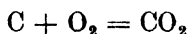

gives complete information of the relative quantities of the substances taking part in the reaction. The heat generated when carbon dioxide is formed from its component elements is called the heat of formation. The heat of formation of 1 lb.-molecule

of carbon dioxide from carbon¹ and oxygen is 169,630 B.Th.U's. (94,240 C.H.U's.), and this may be indicated by writing this heat quantity under the equation thus :—

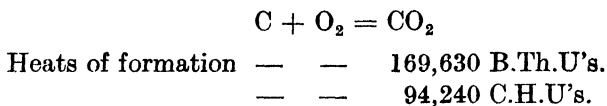

The heats of formation of carbon and oxygen, these being elements, are zero. The net heat generated in a reaction is the sum of all the heats of formation on the right side of the equation, minus the sum of the heats of formation on the left side. In this case there is only one heat quantity involved. By a useful convention, the equation is written,



When the equation represents a combustion process, the net heat of reaction is called the heat of combustion. The last equation therefore indicates, directly, the heat of combustion of 1 lb.-atom (12 lb.) of carbon, and it follows that the heat of combustion of 1 lb. of carbon is 14,140 B.Th.U's. (7,850 C.H.U's.).

The heat of formation of 1 lb.-molecule of steam under standard conditions is 104,130 B.Th.U's. (57,850 C.H.U's.),² so we write the equation,

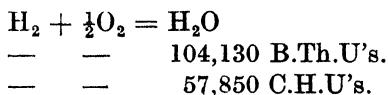

which could in this case also be written,

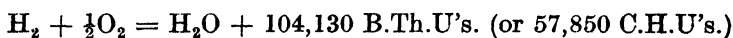

indicating that in burning 2 lb. (more accurately 2.016 lb.) or 380 cu. ft. of hydrogen, 104,130 B.Th.U's. (57,850 C.H.U's.) are liberated, giving as the calorific value of hydrogen 51,660 B.Th.U's. (28,700 C.H.U's.) per lb., or 275 B.Th.U's. (153 C.H.U's.) per normal cu. ft.

The equation for combustion of methane is

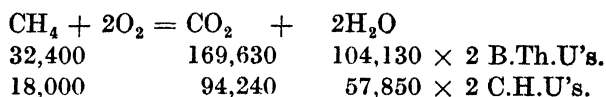

¹ See "Notes on Table II, No. 3."

² This figure represents the lower heat of combustion, it being assumed that the steam formed remains in the gaseous state.

The figures 32,400 B.Th.U's. (18,000 C.H.U's.) represent the heat of formation of the hydrocarbon methane. The total heat generated according to the equation is

$$169,630 + (104,130 \times 2) - 32,400 = 345,490 \text{ B.Th.U's.}$$

$$\text{or } 94,240 + (57,850 \times 2) - 18,000 = 191,940 \text{ C.H.U's.}$$

and the equation may therefore be written,

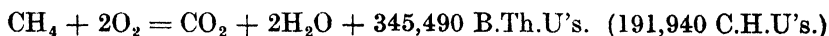

indicating that 16 lb. or 380 cu. ft. of methane has a lower heat of combustion of 345,490 B.Th.U's. (191,940 C.H.U's.), giving approximately a calorific value of 21,500 B.Th.U's. (12,000 C.H.U's.) per lb. or 910 B.Th.U's. (510 C.H.U's.) per normal cubic foot.

Heats of formation and heats of combustion used in this Chapter are given in Table II.

TABLE II.—THERMO-CHEMICAL DATA FOR FUEL GASES.*

1.—HEATS OF FORMATION PER POUND-MOLECULE OF COMPOUND.

B.Th.U's.				C.H.U's.			
CO	47,950	CH ₄	32,400	CO	26,640	CH ₄	18,000
CO ₂	169,630	C ₂ H ₄	-33,300	CO ₂	94,240	C ₂ H ₄	-18,500
H ₂ O (steam)	104,130	C ₂ H ₆	36,860	H ₂ O (steam)	57,850	C ₂ H ₆	20,480

2.—HEATS OF COMBUSTION.†

B.Th.U's.				C.H.U's.			
	Per lb - molecule.	Per pound of fuel.	Per cubic foot of fuel. (At 60° F.)		Per lb.- molecule.	Per pound of fuel.	Per cubic foot of fuel. (At 15° C.)
H ₂ (to steam)	104,130	51,660	275	H ₂ (to steam)	57,850	28,700	153
CO (to CO ₂)	121,680	4,350	321	CO (to CO ₂)	67,600	2,410	179
C† (to CO ₂)	169,630	14,140	—	C† (to CO ₂)	94,240	7,850	—
CH ₄	345,490	21,550	912	CH ₄	191,940	11,980	508
C ₂ H ₄	580,820	20,720	1,544	C ₂ H ₄	322,680	11,510	860
C ₂ H ₆	614,790	20,470	1,641	C ₂ H ₆	341,550	11,370	913
C† (to CO)	47,950	4,000	—	C† (to CO)	26,640	2,220	—
S (to SO ₂)	127,620	3,980	—	S (to SO ₂)	70,900	2,210	—

* At constant pressure.

† Lower values.

‡ See "Notes on Table II," Note 3.

Notes on Table II.—The combustion data for carbon monoxide, hydrogen, methane, and ethane are based on recent determinations by Rossini,¹ the value for sulphur dioxide (from rhombic sulphur) is due to Eckman and Rossini²; that for carbon dioxide, to Roth and Naeser³; and that for ethylene is a mean of the values found by Berthelot and Mixter.

Necessary adjustments of the experimenters' values have been made to render the data consistent with standards adopted in this book. In particular:

Note. 1.—For compounds containing hydrogen, the heats of combustion have been calculated to give the lower value, water remaining in the gaseous state.

Note. 2.—Values have been adjusted to conform with the temperature standard, 15° C. (60° F.), adopted.

Note. 3.—The heat of formation of a particular carbon compound depends on the physical variety of carbon from which the compound is considered to be formed. The variety of carbon known as " β -graphite" has been generally adopted in calculating heats of formation, and this standard has been adhered to in this book. For the heat of formation of carbon dioxide from β -graphite, the value 94,240 C.H.U's. is accepted generally. This value is obtained by adjusting the value of Roth and Naeser (94,270 C.H.U's.) to represent the heat of combustion of one pound-molecule of carbon weighed *in vacuo*, i.e. the true weight as distinct from the apparent weight; other small adjustments are also included in the recalculation. For use in calculations dealing with heats of formation and combustion of gases, use of the true weight is mathematically more accurate, because the weight of a quantity of gas is always understood to mean the weight *in vacuo*.

Thermo-chemical calculations are affected by the form of carbon adopted as standard only in those cases where the uncombined element carbon appears as an initial reactant or as an end product of the reaction. Thus, calculations involving the combustion of fuel gases are not affected, as neither the fuel gases nor the products of combustion contain free carbon. On the other hand, if it were required to calculate, without experiment, the heat produced in burning one pound-molecule of the uncombined element carbon, it would be necessary to know the form of carbon, and the heat of combustion should be based on the weight of one pound-atom of carbon in air. The heat of combustion of "amorphous carbon" to carbon dioxide is 176,040 B.Th.U's. (97,800 C.H.U's.⁴) per pound-atom (weight in air) of carbon.

The carbon of industrial fuels is not, in general, either amorphous or graphitic—the physical form being usually ill-defined; consequently, direct experiment is applied for accurate determination of the calorific value of fuels containing solid carbon.

It is concluded, therefore, that the form of carbon (β -graphite) adopted as the scientific standard, and the practically insignificant adjustment for weight *in vacuo*, are acceptable for technical application. The advantage of adhering to this standard

¹ Rossini, F. D.: "The Heat of Formation of Water," and "The Heats of Combustion of Methane and Carbon Monoxide" (with a recalculation of the latter research), *Bureau of Standards, Journal of Research*, 1931. "Calorific Determination of the Heats of Combustion of Ethane, Propane, Normal Butane, and Normal Pentane," *op. cit.*, 1934.

² Eckman, J. R., and Rossini, F. D.: "The Heat of Formation of Sulphur Dioxide," *Bureau of Standards, Journal of Research*, 1931.

³ Roth, W. A., and Naeser, W.: "Über weissen und schwarzen Diamanten und ihr Verhältnis zum Kohlenstoff," *Ztschr. Electrochem.*, vol. 31, 1925, p. 461.

⁴ Roth, W. A., and Naeser, W., *op. cit.*

is that in physico-chemical tables, the heats of formation of all carbon compounds are based on β -graphite.

Note. 4.—Values given in the table are for constant pressure (i.e. the values required for practical work).

Note. 5.—In calculating the table, the exact values for atomic weights and volumes of the pound-molecule have been used.

Determination of Calorific Value Without Direct Experiment.—

From the chemical analysis of a coal and the heats of combustion of the elements it is possible to make a close estimate of the calorific value, while for gaseous fuels the analysis provides the simplest way of arriving at the calorific value.

The following methods of calculation may be used when accurate laboratory determinations are not available.

(1) *Producer gas and other gaseous fuels*.—The gas analysis used is that given on page 11. From the analysis, 1 cu. ft. of dry gas at 60° F. (15° C.) and 30 inches of mercury pressure contains 0.03 cu. ft. of CO₂, 0.002 cu. ft. of C₂H₄, 0.002 cu. ft. of O₂, 0.28 cu. ft. of CO, 0.12 cu. ft. of H₂, 0.025 cu. ft. of CH₄, and 0.541 cu. ft. of N₂. Of these constituents only C₂H₄, CO, H₂ and CH₄ are combustible, and to determine the calorific value, we multiply the heats of combustion of each of these by the amount present in 1 cu. ft. of producer gas, and add.

Constituent.	Heat of Combustion of one cu. ft. of Constituent.		Cu. ft. of Constituent present in 1 cu. ft. of gas.	Heat Contributed per cu. ft. of Producer Gas.	
	B.Th.U's.	C.H.U's.		B.Th.U's.	C.H.U's.
C ₂ H ₄ , .	1544	(860)	0.002	3.0	(1.7)
CO, . .	321	(179)	0.28	89.9	(50.1)
H ₂ , . .	275	(153)	0.12	33.0	(18.4)
CH ₄ , . .	912	(508)	0.025	22.8	(12.7)
	Lower Calorific Value per cu. ft. of producer gas			148.7	82.9

For other gaseous fuels the calculation is precisely similar.

(2) *Coal*.—Dulong found that if all the oxygen present in coal is assumed to be combined with hydrogen as water, then the calorific value is equal to the heating value of the carbon¹ plus

¹ Dulong's formula, which is of course empirical, requires that the heat of combustion of carbon be taken as 14,800 B.Th.U's. (8100 C.H.U's.) per pound, corresponding approximately to the value for amorphous carbon.

the heating value of that part of the hydrogen not required by the oxygen. The heating value of sulphur present is also added.

Dulong's formula was given for the higher calorific value, but for the lower calorific value the formula may be re-arranged as follows :—

$$\begin{aligned} \text{Lower calorific value} &= 146C + 517H - 76O + (40S) - (11H_2O) \\ &\quad \text{in B.Th.U's.} \\ \text{or} \quad &81C + 287H - 42O + (22S) - (6H_2O) \\ &\quad \text{in C.H.U's.} \end{aligned}$$

where C, H, O, S and H₂O represent the percentages of these substances in the coal as supplied to the furnace.

Example.—The composition of a gas coal, as used, is 71% C, 5% H, 9% O, 1% N, 1% S, 9% ash and 4% moisture.

$$\begin{aligned} \text{Lower calorific value} &= (146 \times 71) + (517 \times 5) - (76 \times 9) \\ &\quad + (40 \times 1) - (11 \times 4) \\ &= 12,250 \text{ B.Th.U's. (6,810 C.H.U's.)} \end{aligned}$$

It is noticeable that the effects of sulphur and moisture are quite small and that they tend in opposite directions. In view of the approximate nature of the formula it is therefore not worth considering the last two terms of the lower calorific value formula given above.

Dulong's formula gives excellent results for all coals not exceptionally high in volatile matter, the error rarely being greater than 2 per cent. and usually much less. For lignites (black and brown) and cannel coals the error is likely to be greater. More complicated methods of computation have been suggested, but they yield results only slightly better than those given by the simpler formula.

There are several formulæ, varying in accuracy and complexity, for estimation of calorific value of coals from the proximate analysis (*i.e.* from the percentage of volatile matter, fixed carbon, ash, and moisture).

(3) *Fuel Oil and Tar.*—Dulong's formula for the calorific value of coal is based on the assumption that the heat of formation of coal is zero, and the close agreement between experimental and calculated results indicates this to be fairly near to the truth. For liquid fuels this method cannot be used because the heat of formation of these substances varies widely. For an oil containing 14 per cent. of hydrogen the positive heat of formation might be 8 per cent. of the actual calorific value, while an oil containing 11 per cent. of hydrogen might have a negative heat of formation

amounting to 4 per cent. of the total. Nor is it safe to assume that the heat of formation varies regularly with the hydrogen content.

For mineral oil fuels Sherman and Kropff¹ give a formula based on the density,

Higher calorific value in B.Th.U's. per lb. = $18,650 + 40(\text{Baumé} - 10)$

With no increase of inherent inaccuracy, the expression may be replaced by:—

Lower calorific value in B.Th.U's. per lb. = $17,000 + (40 \times \text{Baumé})$

The value of a formula of this type depends on the manner in which it is used. The very close agreement generally found between calculated and experimental values is remarkable, Sherman and Kropff having investigated a wide range from heavy oils of 15.2° Bé (0.9642 sp. gr.) to very light oils of 67.2° Bé (0.7100 sp. gr.) and having found that the agreement was in over 90 per cent. of the oils tested within 1 per cent., while in no case was an error exceeding 3 per cent. found. It happens, however, that the Mexican fuel oils, of which mention was not made in the paper, constitute an exception, and usually show calculated values up to, or even more than, 3 per cent. higher than the true calorific value.

Formulae derived in a more recent study by Cragoe² may be expressed approximately as:—

Lower calorific value in B.Th.U's. per lb. = $20,000 + 1350d - 3800d^2$

where d is the specific gravity of the fuel. This formula is based on the ash-, water-, and sulphur-free fuel; it is stated to be accurate in almost all cases to within 1 per cent., the investigation covering 630 petroleum oils from eleven different countries.

For works use it would be more satisfactory to establish from a number of density and calorific value determinations a table of densities with the corresponding calorific values. Such a table could be used with a confidence which it would not be reasonable to repose in a general formula covering a wide range of different kinds of oil of varying origin.

¹ Sherman H. C., and Kropff A. H.: "The Calorific Power of Petroleum Oils and the Relation of Density to Calorific Power," *Journal of the American Chemical Society*, October, 1908.

² Cragoe, C. S.: "Thermal Properties of Petroleum Products," *Bureau of Standards, Miscellaneous Publication No. 97* (1929).

III.—SPECIFIC HEAT AND SENSIBLE HEAT.

Specific Heat.—Heat is required to raise the temperature of any substance, whether solid, liquid or gaseous. The specific heat of a substance is the amount of heat required to raise the temperature of unit quantity (the pound for solids and liquids, and usually the cubic foot for gases) 1° F. where the B.Th.U. is used, or 1° C. where the C.H.U. is used.¹ In the latter case the amount of heat required is $\frac{9}{5}$ times greater than in the former; but since it is measured in a unit which is $\frac{9}{5}$ times larger, the numerical values are the same in both cases for the same actual temperature. Where the pound is the unit of quantity, the specific heat is also the same as in the metric system.

It follows from the definition that, if W lb. of a substance of specific heat c be heated from temperature t_2 to temperature t_1 , the amount of heat required is given by

$$Q = W \times (t_1 - t_2) \times c \quad . \quad . \quad . \quad (1)$$

Actually the specific heat is not a constant quantity for a given substance, but varies with the temperature, so that it is necessary to use the average specific heat, between temperatures t_1 and t_2 .

Sensible Heat.—In problems involving specific heat, it is convenient to select as a base line some temperature at which the total heat content of all substances is assumed to be zero. The base line temperature frequently used is 60° F., or 15° C.—common atmospheric temperatures, which happen to be almost identical. Naturally the heat content at this base temperature is not really zero, and in order to preserve this convention, at lower temperatures, substances must be considered to have negative heat content. Sensible heat may be defined as the total heat content of a given quantity of a substance, the heat content at 60° F. or 15° C. being taken as zero. According to this definition, the sensible heat Q_t of W lb. (or cu. ft.) of a substance at temperature t is obtained from the formula,

$$Q_t = W \times (t - 60) \times c \text{ B.Th.U.'s. } (t \text{ being } ^\circ \text{ F.})$$

$$Q_t = W \times (t - 15) \times c \text{ C.H.U.'s. } (t \text{ being } ^\circ \text{ C.})$$

As explained, c is itself dependent on temperature, so we can simplify by writing,

$$Q_t = W \times S_t \quad . \quad . \quad . \quad . \quad . \quad . \quad (2)$$

¹ In physics, a distinction is made between "specific heat" and "heat capacity per unit quantity"—analogous to the distinction between specific gravity and density. Technically the term "specific heat" is usually used even when the longer term would be more accurate, as when referring to the "specific heat" of a gas by volume.

TABLE IIIA.—HEAT CONTENT OF GASES * IN B.Th.U's. PER
NORMAL CUBIC FOOT ABOVE 60° F.

Temp. °F.	O ₂ , N ₂ , Air, CO.	H ₂ .	CO ₂ .	H ₂ O.	CH ₄ .	C ₂ H ₄ .	C ₂ H ₆ .
60	0	0	0	0	0	0	0
100	0.7	0.7	1.0	0.9	0.9	1.1	1.3
200	2.6	2.4	3.4	3.1	3.5	4.0	4.5
300	4.4	4.1	6.0	5.3	6.3	7.0	8.1
400	6.3	5.8	8.6	7.5	9.4	10.3	11.8
500	8.1	7.5	11.3	9.7	12.7	13.7	15.8
600	10.0	9.3	14.1	12.0	16.3	17.3	20.0
700	11.8	11.1	16.9	14.2	20.2	21.0	24.3
800	13.7	12.9	19.9	16.5	24.3	25.0	29.1
900	15.6	14.7	22.8	18.8	28.7	29.1	34.0
1000	17.5	16.5	25.9	21.1	33.4	33.5	39.1
1100	19.4	18.4	29.0	23.5	38.3	38.0	44.5
1200	21.3	20.2	32.1	25.8	43.5	42.6	50.1
1300	23.2	22.1	35.3	28.2	49.0	47.5	55.9
1400	25.2	24.0	38.6	30.7	54.7	52.5	61.9
1500	27.1	26.0	41.9	33.2	60.7	57.8	68.2
1600	29.1	27.9	45.2	35.7	67.0	63.2	74.7
1700	31.0	29.9	48.6	38.2	73.5	68.8	81.4
1800	33.0	31.8	52.0	40.8	80.3	74.5	88.4
1900	35.0	33.8	55.4	43.4	87.4	80.5	95.6
2000	37.0	35.8	58.9	46.1	94.7	86.6	103.0
2100	39.0	37.8	62.4	48.8	102.3	92.9	110.6
2200	41.1	39.9	65.9	51.6	110.2	99.3	118.5
2300	43.1	41.9	69.4	54.4	118.3	106.0	126.5
2400	45.2	44.0	72.9	57.3	126.7	112.9	135.0
2500	47.3	46.1	76.5	60.2	135.4	119.9	143.5
2600	49.4	48.2	80.1	63.2			
2700	51.6	50.3	83.7	66.3			
2800	53.7	52.5	87.3	69.4			
2900	55.9	54.6	90.9	72.6			
3000	58.1	56.8	94.6	75.9			
3100	60.3	59.0	98.1	79.2			
3000	58	57	95	76			
3500	69	68	113	93			
4000	81	80	131	113			
4500	94	92	150	134			
5000	107	104	169	159			
5500	122	117	188	186			
6000	137	130	208	216			
6500	153	144	228	250			

* At constant pressure.

where S_t is the sensible heat of 1 lb. of the substance at the temperature t . This is only another way of saying if 1 lb. contains S_t heat units, W lb. must contain $S_t \times W$ heat units.

In referring to specific and sensible heats, the unit quantity has hitherto been assumed to be the pound. Other units may be used, such as the pound-molecule (*i.e.* the molecular weight in pounds); and in dealing with gases the normal cubic foot is frequently a more convenient unit.

Tables IIIA and IIIB give the sensible heat of 1 normal cubic foot of the principal gases with which we are here concerned.

TABLE IIIB.—HEAT CONTENT OF GASES * IN C.H.U.'s. PER
NORMAL CUBIC FOOT ABOVE 15° C.

Temp. °C.	O ₂ , N ₂ , CO, Air,	H ₂ .	CO ₂	H ₂ O.	CH ₄ .	C ₂ H ₄ .	C ₂ H ₆ .
15	0	0	0	0	0	0	0
100	1.6	1.4	2.1	1.9	2.1	2.4	2.8
200	3.4	3.1	4.7	4.1	5.1	5.6	6.4
300	5.3	4.9	7.4	6.3	8.5	9.1	10.5
400	7.1	6.7	10.3	8.6	12.4	12.9	15.0
500	9.0	8.5	13.3	10.9	16.8	17.0	19.9
600	10.9	10.3	16.3	13.2	21.7	21.4	25.1
700	12.9	12.2	19.5	15.6	27.0	26.2	30.8
800	14.8	14.1	22.8	18.1	32.9	31.3	37.0
900	16.8	16.1	26.1	20.6	39.2	36.8	43.5
1000	18.7	18.1	29.5	23.2	46.0	42.5	50.5
1100	20.7	20.1	33.0	25.8	53.2	48.6	57.8
1200	22.8	22.1	36.5	28.6	61.0	55.0	65.6
1300	24.9	24.2	40.1	31.5	69.2	61.8	73.8
1400	27.0	26.3	43.6	34.4	77.9	68.8	82.4
1500	29.1	28.4	47.2	37.5			
1600	31.3	30.6	50.8	40.6			
1700	33.5	32.8	54.4	43.9			
1800	35.7	35.0	58.1	47.4			
1800	36	35	58	47			
2000	40	40	65	55			
2200	45	45	73	63			
2400	50	49	80	71			
2600	55	54	88	80			
2800	61	59	96	90			
3000	67	64	103	101			
3200	73	69	111	113			
3400	79	74	119	126			
3600	87	80	127	139			

* At constant pressure.

The variation of specific heat of these gases with temperature is shown in Fig. 1.

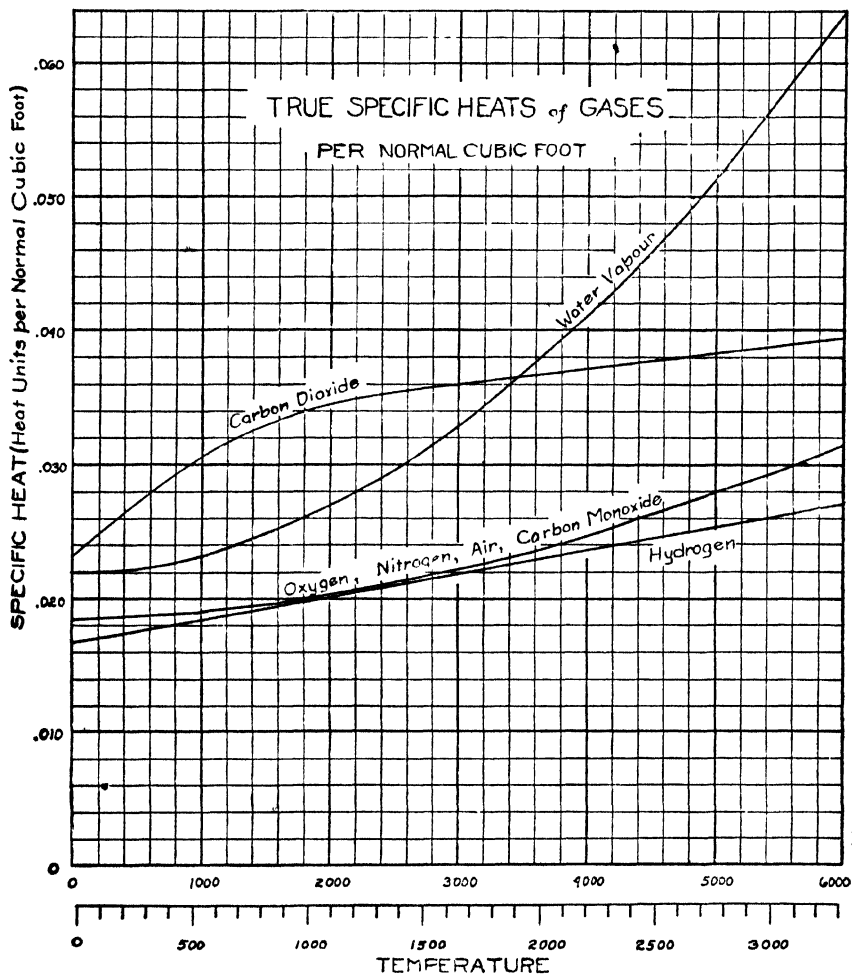

Fig. 1.—True Specific Heats of Gases (at Constant Pressure).

The sensible and specific heats of the gases have been calculated from formulæ developed by Goodenough and Felbeck.¹

¹ Goodenough, G. A., and Felbeck, G. T., "An Investigation of the Maximum Temperatures and Pressures Attainable in the Combustion of Gaseous and Liquid Fuels," *Bulletin No. 139, Engineering Experimental Station, University of Illinois, 1924.*

These equations are devised to include extremely high temperatures. The results show fairly good agreement with the later values of Eastman for the range up to 3100° F. (1700° C.).

If, instead of the total sensible heat of v cu. ft. of a gas, we require to know how much heat is needed to raise this volume from temperature t_2 to t_1 , we may use either the sensible heat tables or the specific heat curves. If the sensible heat tables are to be used, and if q_1 and q_2 are the sensible heats of 1 cu. ft. of gas at temperatures t_1 and t_2 respectively, then the heat required is given by

$$vq_1 - vq_2 \text{ or } v(q_1 - q_2)$$

If the specific heat curves are used, the specific heat, c , at the average temperature $\frac{t_1 + t_2}{2}$ must be found. Then the heat is given by

$$(t_1 - t_2) cv$$

Example.—To find the heat required to raise 1000 normal cu. ft. of air from 1100° F. to 2200° F. (600° C. to 1200° C.).

(i) Using the sensible heat tables :

Sensible heat per cubic foot of air at the higher temperature :—

$$q_1 = 41.1 \text{ B.Th.U's. (22.8 C.H.U's.)}$$

Sensible heat per cubic foot of air at the lower temperature :—

$$q_2 = 19.4 \text{ B.Th.U's. (10.9 C.H.U's.)}$$

$$q_1 - q_2 = 21.7 \text{ B.Th.U's. (11.9 C.H.U's.)}$$

Heat required = $v(q_1 - q_2) = 1000 \times 21.7 = 21,700 \text{ B.Th.U's.}$
 or = $1000 \times 11.9 = 11,900 \text{ C.H.U's.}$

(ii) Using the specific heat curves :

Average temperature $\frac{t_1 + t_2}{2} = 1650^\circ \text{ F. (900}^\circ \text{ C.)}$.

Specific heat at average temperature : $c = 0.0198$.

Heat required = $(t_1 - t_2) cv = (2200 - 1100) \times 0.0198 \times 1000$
 = $21,800 \text{ B.Th.U's.}$

or $(1200 - 600) \times 0.0198 \times 1000 = 11,900 \text{ C.H.U's.}$

For most purposes, calculation from the sensible heat data (method (i)) is preferable and is just as convenient. The use of the specific heat at the average temperature (method (ii)) is inaccurate for some gases if the temperatures t_1 and t_2 are far apart. This difficulty is sometimes overcome by using tables of mean specific heat between 60° F. (15° C.) and the temperature under consideration ; but then additional complication occurs when we require to know the heat to raise the temperature of a gas from

one specified temperature to another. Formulæ are sometimes used to express specific heats as a function of temperature, but unfortunately a single simple expression is inadequate in the case of carbon dioxide and steam for the wide temperature range with which it is sometimes necessary to deal. The advantages of using the cubic foot as the unit of quantity, instead of the pound, are that gases are usually measured by volume, and that the values for carbon monoxide, oxygen, nitrogen, and air, are identical when presented on a volume basis, while on a weight basis only carbon monoxide and nitrogen would have the same values, as only these gases have the same molecular weight. On a volume basis, the values for hydrogen are also so near to the figures for oxygen, etc., that they may frequently be taken as identical, while on a weight basis they would be widely different.

The figures given for the gases are known as sensible heats at constant pressure. In ordinary low pressure furnaces, the effect on sensible heat of pressure variations in the system are entirely negligible. Even where the pressure changes considerably, as in blast furnaces, the tables should still be used, and if desired a correction may be made for heat absorption during expansion of the gases.

IV.—AVAILABLE HEAT.

When a fuel is burnt, much of the heat supplied is utilised in raising the temperature of the products of combustion. The rest of the heat is transferred from the flame and hot gas to the furnace, or lost in other ways. If the temperature at which the burnt gas leaves the furnace is known, its heat content can be calculated, and by subtraction from the heat supplied, it is possible to find how much heat has been transferred in the furnace. A concrete example will be given as the best means of showing the effect of various factors on the quantity of heat which can be transferred in a furnace. The example is used only in an endeavour to illustrate principles. From a practical point of view inconsistencies will be apparent—some of these will be mentioned later.

Illustrative Example.—The working temperature of a batch ¹

¹ A furnace in which the material is charged (usually cold) in one operation, brought up to temperature, and removed from the furnace also in one operation. In this type of furnace the waste gas must escape at a temperature somewhat higher than the furnace temperature.

The other important type of furnace is the continuous furnace, where cold material is continuously entering one end of the furnace and being discharged at the other end. Combustion takes place at the hot end and the products of combustion leave the furnace at the cold end. The escaping gas therefore leaves at a temperature higher than that of the cold charge, but usually much lower than the average furnace temperature.

type furnace is such that the waste gas leaves the furnace at 2200° F. (1200° C.). The heat losses through the walls of the furnace, etc., total 180 B.Th.U's. (100 C.H.U's.) per second. These two conditions are regarded as fixed, irrespective of changes in the following additional assumptions. This hypothesis may not appear at the present time to be justified, but the laws of heat transfer to be considered in a later chapter show that for a given furnace temperature, the waste gas temperature and heat losses from the furnace may be but little affected by slight modification of the other combustion conditions.

The furnace is fired with producer gas having the composition given on p. 11. The quantity of gas consumed is 10 normal cu. ft. per sec. (dry basis), and the quantity of air is 20 per cent. more than the theoretical requirement. The gas enters the furnace at 1100° F. (600° C.).

Information Conveyed by Data.—Previous calculations and methods are used in interpreting the information given in the problem. The effect of deviation from these basic data can then be considered. All quantities are based on 10 cu. ft. of producer gas, and therefore on a time of 1 second.

(a) *Air Quantity.*—The theoretical air requirement for 10 cu. ft. of producer gas is $1.21 \times 10 = 12.1$ cu. ft. (p. 12). With 20 per cent. excess air the total air requirement is 14.5 cu. ft.

(b) *Products of Combustion.*—With theoretical air the products of combustion of 10 normal cu. ft. of producer gas consist of

CO ₂	H ₂ O	N ₂	Total.
3.4	2.1	15.0	20.5 cu. ft.

With 20 per cent. excess air (2.4 cu. ft., containing 0.5 cu. ft. O₂, and 1.9 cu. ft. N₂), the products of combustion consist of

CO ₂	H ₂ O	N ₂	O ₂	Total.
3.4	2.1	16.9	0.5	22.9 cu. ft.

(c) *Heat of Combustion of Producer Gas.*—The heat of combustion of 10 cu. ft. of producer gas is 1487 B.Th.U's. (829 C.H.U's.).

(d) *Sensible Heat of Producer Gas.*—The sensible heat of the producer gas at 1100° F. (600° C.) is obtained from the gas analysis and Table III, A or B. For example, the analysis shows 1 cu. ft. of the gas to contain 0.03 cu. ft. of carbon dioxide and Table III shows the sensible heat of 1 cu. ft. of carbon dioxide at 1100° F. (600° C.) to be 29.0 B.Th.U's. (16.3 C.H.U's.). The sensible heat of the carbon dioxide in 1 cu. ft. of producer gas is therefore 29.0 B.Th.U's. (16.3 C.H.U's.) \times 0.03 = 0.87 B.Th.U's. (0.49

C.H.U's.). The sensible heats of the other constituents are similarly calculated and the results added. The calculation is tabulated as follows :—

Constituent Gas.	Cu Ft.	Sensible Heat per cu. ft. of constituent. From Table III.		Sensible Heat per cu. ft. of producer gas.	
		B.Th.U's.	(C.H.U's.)	B.Th.U's.	(C.H.U's.)
CO ₂ , . . .	0.03	29.0	16.3	0.87	0.49
H ₂ , . . .	0.12	18.4	10.3	2.21	1.24
O ₂ +CO+N ₂ , . . .	0.823	19.4	10.9	15.97	8.97
CH ₄ , . . .	0.025	38.3	21.7	0.96	0.54
C ₂ H ₄ , . . .	0.002	38.0	21.4	0.08	0.04
H ₂ O (water vapour), . . .	0.04	23.5	13.2	0.94	0.53
TOTAL, . . .	1.040	—	—	21.0	11.8

Sensible Heat of 1 cu. ft. of Producer gas at 1100° F. (600° C.).

For 10 cu. ft. of producer gas, the sensible heat is 210 B.Th.U's. (118 C.H.U's.).

(e) Total Heat Supplied by Producer Gas.—

	B.Th.U's.	C.H.U's.
Heat of Combustion (from (c)), . . .	1487	829
Sensible Heat (from (d)), . . .	210	118
	1697	947

(f) Sensible Heat of Products of Combustion.—At the exit temperature, the heat content of the waste gas from 10 cu. ft. of producer gas is—

Constituent Gas.	Cu. Ft.	Sensible Heat per cu. ft. of constituent.		Sensible Heat	
		B.Th.U's.	C.H.U's.	B.Th.U's.	C.H.U's.
CO ₂ , . . .	3.4	65.9	36.5	224	124
H ₂ O, . . .	2.1	51.6	28.6	108	60
O ₂ + N ₂ , . . .	17.4	41.1	22.8	715	397
			TOTAL, . . .	1047	581

Sensible Heat of Products of Combustion at 2200° F. (1200° C.) from 10 cu. ft. of Producer Gas with 20 per cent. excess air.

(g) Heat Loss through Walls.—180 B.Th.U's. (100 C.H.U's.).

1. Cold Air (60° F. or 15° C.) Used for Combustion.—

	B.Th.U's.	C.H.U's.	Per cent. of heat supplied.*
Heat supplied by producer gas (from (e)),	1697	947	100
Sensible heat carried out by waste gas (from (f)),	1047	581	61.7
Heat transferred to furnace,	650	366	38.3
Heat loss through furnace walls,	180	100	10.6
Heat transferred to stock,	470	266	27.7

* The per cent. figures are based on the B.Th.U. values. Owing to slight differences between the Centigrade and Fahrenheit temperatures, the per cent. figure based on the C.H.U. values are very slightly different.

The heat transferred in relation to the heat supplied is depicted in Fig. 2 (a).

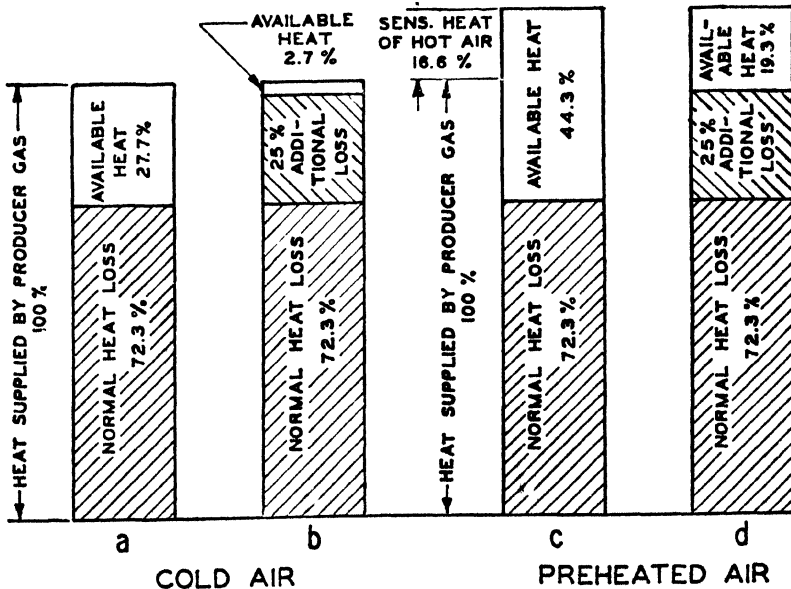

Fig. 2.—The Effect of Additional Heat Loss on the Available Heat. With cold air, the available heat in (b) is 10 per cent. of that in (a); with air preheated to 1100° F. (600° C.), the available heat in (d) is 44 per cent. of that in (c).

2. Air Preheated to 1100° F. (600° C.).—If, instead of using air at 60° F. (15° C.), a heat exchanger be used to preheat the air to 1100° F. (600° C.), each cubic foot of air will bring into the furnace an additional 19·4 B.Th.U's. (10·9 C.H.U's.). Multiplying this by the 14·5 cu. ft. of air used, we find the additional heat input to the furnace is 281 B.Th.U's. (158 C.H.U's.). According to the explanation given earlier that the heat losses will remain the same as for cold air, practically the whole of this extra heat will enter the charge, and may therefore be added to the 470 B.Th.U's. (266 C.H.U's.) transferred when cold air is used.

	B.Th.U's.	C.H.U's.	Per cent. of heat supplied.
Heat supplied by producer gas,	1697	947	100
Heat transferred to stock,	751	424	44·3

It is seen, Fig. 2 (c), that preheating the air results in a big relative increase in utilisation of the heat supplied. The sensible heat of the hot air entering the furnace must not be classed as "heat supplied" in calculating the per cent. utilised, because this heat is merely extracted from the waste gas with no additional fuel expenditure, *i.e.* the improvement is achieved by a more efficient furnace arrangement. A change of preheat of 180° F. (100° C.) results in a change of heat absorption by the stock equal to 2·9 per cent. of the heat supplied by the producer gas.

3. Excess Air.—An increase in the amount of excess air used will result in removal from the furnace of the sensible heat contained by the extra air at 2200° F. (1200° C.). If preheated air is used, the loss will be diminished by the sensible heat entering with the additional air.

For 10 cu. ft. of producer gas, 10 per cent. of excess air (1·21 cu. ft. based on the theoretical requirement) contains

$$1\cdot21 \times 41\cdot1 = 49\cdot7 \text{ B.Th.U's. (27}\cdot6 \text{ C.H.U's.) at } 2200^\circ \text{ F. (1200}^\circ \text{ C.).}$$

$$1\cdot21 \times 19\cdot4 = 23\cdot5 \text{ B.Th.U's. (13}\cdot2 \text{ C.H.U's.) at } 1100^\circ \text{ F. (600}^\circ \text{ C.).}$$

(a) *Cold Air.*—When cold air is used, a variation of 10 per cent. in the excess air (based on the theoretical air requirement)

will cause a variation in heat transferred to the stock of 49.7 B.Th.U's. (27.6 C.H.U's.) per sec., or 2.9 per cent. of the heat input. This is about 10 per cent. of the heat received by the stock according to the original assumptions, so that with an additional 100 per cent. of excess air over that assumed, no heat would be available to the stock because furnace losses and the sensible heat of the waste gas would account for the entire heat input.

(b) *Preheated Air.*—When air at 1100° F. (600° C.) is used, a 10 per cent. variation in the excess air results in a net loss of transferable heat equal to $49.7 - 23.5 = 26.2$ B.Th.U's. (14.4 C.H.U's.) per sec. This is 1.5 per cent. of the heat supplied by the producer gas, the loss therefore being only a little over half that found for cold air. Moreover, as the percentage utilisation of heat is much greater with hot air, this figure represents a still smaller proportion, based on the heat transferred to the stock.

For similar types of furnace, it is concluded that the evil of unnecessary excess air is much greater if cold air is used. For very high temperature furnaces, preheating may be a necessity rather than a mere economy. Notwithstanding its preheat, a large excess of air may, in such furnaces, entirely rob the system of its narrow margin of available heat.

4. Air Infiltration.—A certain amount of cold air enters hearth type furnaces through the doors, and through defective brickwork. The causes of this infiltration are discussed in Chapter IV. Any air so entering must leave the furnace at the usual exit temperature, and therefore carry out sensible heat which the stock would otherwise have received. The infiltrating air cannot be used to assist combustion or to replace excess air normally admitted, because it usually enters under conditions which are unfavourable to mixing, most of the infiltration occurring at the flue end of the furnace.

For a furnace using cold air for combustion, the loss of heat to the stock caused by infiltration is the same as if additional excess air had been used. For a furnace using preheated air, it was shown in Section 3 that the effect of excess air was less serious than for the same furnace using cold air. When infiltration is in question, there is no such difference, the cold air resulting in identical loss in the two cases.

Air entering through the brickwork may receive a preheat, slightly mitigating the bad effect.

5. Incomplete Combustion.—In many cases, combustion in a furnace is far from complete, owing firstly to the time necessary

for combustion, and secondly to imperfect mixing of fuel and air.¹ Suppose, in the illustration, that 10 per cent. of the calorific value (not including the sensible heat) of the fuel remained undeveloped due to incomplete combustion. This is by no means an unlikely condition, as it would represent only about 2 per cent. of carbon monoxide plus hydrogen in the escaping gas.

The loss of available heat would be

$$1487 \times 10/100 = 148.7 \text{ B.Th.U's. (82.9 C.H.U's.)}$$

This is 8.8 per cent. of the total calorific and sensible heat of the hot producer gas.

When cold air is used, the loss of 8.8 per cent. of the heat input would reduce the 27.7 per cent. of available heat to 18.9 per cent. With hot air the actual reduction is the same, but the proportionate reduction is less drastic, the change being from 44.3 per cent. to 35.5 per cent.

6. Gas Temperature.—A 180° F. (100° C.) change of producer gas temperature, the composition remaining as before, would cause a change of 38 B.Th.U's. (21 C.H.U's.) in the heat input. The change in heat received by the stock is 2.2 per cent. of the original heat input, this figure to be added to or subtracted from the 27.7 per cent. for cold air or 44.3 per cent. for hot air.

7. Gas Composition.—The effect of a small decrease in the calorific value due to a greater degree of oxidation of a producer gas is quite noticeable. Suppose, for example, that due to less perfect producer operation the same quantity of coal and steam (but with slightly more air) yielded the gas indicated below :

	CO ₂	C ₂ H ₄	CO	H ₂	CH ₄	N ₂	O ₂	Total.	Heating Value for 1 (or 1.019) cu. ft.	
									Cu. Ft.	B.Th.U's.
Original Gas, .	0.03	0.002	0.28	0.12	0.025	0.541	0.002	1	148.7	82.9
Slightly Inferior Gas, .	0.04	0.002	0.27	0.12	0.025	0.56	0.002	1.019	145.5	81.1

¹ In this connection it may be noted that in most furnaces used for reheating metal for forging, rolling or heat treating processes, a so-called "reducing" or "neutral" atmosphere is frequently maintained in the furnace. Such an atmosphere serves to decrease scaling, i.e. oxidation of the metal, and it may be attained by an actual deficiency of the air supplied for combustion. Here, considerations of quality of the product and cost of oxidation loss place fuel economy in a position of secondary importance, and the presence of up to 5 per cent. of carbon monoxide in the flue gas is not uncommon.

The heat supplied by combustion, based on 10 cu. ft. of the original gas, will be 32 B.Th.U's. (18 C.H.U's.) lower, while the sensible heat supplied to and removed from the furnace will not be very different in the two cases. Expressed in per cent. of the total heat input, the loss to the stock is 1.9 per cent., and this has to be subtracted from the 27.7 per cent. and 44.3 per cent. for cold and for hot air respectively.

8. Moisture.—An influence over which the operator has no control is the condition of the atmosphere. The water vapour carried in the air may vary from 4 per cent. or more on a hot, humid day to a negligible quantity in frosty weather. On the quantity of air used, 4 per cent. of water vapour (0.58 cu. ft.) would, at 2200° F. (1200° C.), carry from the furnace 30 B.Th.U's. (17 C.H.U's.). This is 1.8 per cent. of the heat input, and this represents the loss to the stock if cold air is used. If hot air is used, after deducting the heat brought in by the moisture at 1100° F. (600° C.), we find a loss to the stock equal to 0.9 per cent. of the heat input.

The quantity of moisture in the producer gas is likely to be greater (usually 3-8 per cent. by volume) but allowance has already been made in this case for heat brought in by the moisture. Appreciable quantities of water vapour will also be introduced when steam is used for atomising a liquid fuel.

9. Losses Through Walls.—The 180 B.Th.U's. (100 C.H.U's.) per sec. lost through the walls represents 10.6 per cent. of the heat input. Any reduction of this heat loss is accompanied by an equivalent increase in the quantity of heat available to heat the stock.

10. Loss of Gas from the Furnace.—The amount of heat leaving a furnace as flame and hot gas escaping through openings is likely to be considerable; but the heat actually lost to the furnace hearth (*i.e.* the loss of available heat) is the difference between the heat carried out by this gas (both chemical heat due to incomplete combustion and sensible heat at the temperature of escape), and the sensible heat which they would in any case have carried from the furnace at the flue gas temperature. At the best, the escaping gas may carry no more heat than it would at 2200° F. (1200° C.), in which case there is no reduction in the heat transferred to the stock. At the worst, the loss of available heat would be $100 - 61.7 = 38.3$ per cent. (Section 1) of the total heat of that portion of the gas which escapes.

Of course the practical objection to escaping hot gas on account

of damage to the furnace structure is not at present under consideration.

11. Effect of Chemical Changes in the Batch.—The chemical changes taking place in the batch exert an influence which is generally very much underestimated. The two-fold effect on gas composition and heat requirement is referred to in Chapter III.

12. Furnace Temperature.—The furnace temperature is important mainly in its effect on the waste gas temperature, although it will also have some effect on the other losses. If, due to a change in the furnace temperature, the temperature of the waste gas leaving the furnace increases or decreases by 180° F. (100° C.), the change of sensible heat carried from the furnace will be 96 B.Th.U's. (53 C.H.U's.), which is 5.7 per cent. of the total heat input. The operating temperature of a furnace is evidently of primary importance in determining how much heat is left in the stock, but this was outside the scope of the problem as enunciated.

In the given example, all other conditions being ideal, the furnace could theoretically still operate with cold air at a temperature such that the escaping gas was 800° F. (450° C.) higher, giving an exit temperature of 3000° F. (1650° C.); but the rate of heat transfer to the stock would be reduced to an insignificant quantity. In practice, the furnace would not operate economically at a temperature very much higher than that assumed. With hot air, on the other hand, the loss of heat transferred would be less serious.

In the highest temperature direct-fired furnaces, much higher air preheats than assumed in the example must be obtained, and when a low calorific value fuel such as producer gas is used, it is usual to preheat this also to a high temperature in order to increase the quantity of sensible heat supplied to the furnace. Higher preheats are rendered possible by the higher temperature of the escaping gas. In furnaces of this type the available heat is frequently a small percentage, corresponding approximately to the value for cold air in the illustration. The seriousness of any condition resulting in loss of heat transfer might be approximately the same as in the illustrative example with cold air, notwithstanding that the high temperature furnace used highly preheated air and gas.

Similarly, with furnaces operating at a temperature lower than assumed in the illustration, the effect of many of the factors on heat loss to the stock is reduced in absolute quantity, while in all cases the effect is reduced relatively, on account of the larger margin of available heat.

In a batch type furnace, as the stock is brought up to temperature, the available heat and the effect of varying the conditions will naturally change. Also if the furnace itself is heated up from cold, the furnace lining will absorb heat which would otherwise have been received by the stock.

The calculations cannot be used in quite the same way for continuous type furnaces. The same general principles apply; but the margin of available heat under ideal conditions is greater, and the effect of some of the deviations from the ideal case is less. The problem is, however, complicated by other considerations.

13. Gas Quantity.—This for a given furnace temperature, must be considered the most important variable of all. By control of fuel quantity, while maintaining the same proportion of air, the heat supply to the furnace is readily adjusted to the needs of the furnace—perhaps a little too readily, because it is so easy to cover the various sources of heat loss merely by pumping more fuel into the furnace, at a price which, due to lack of comparative figures, is frequently not appreciated.

Each additional 10 per cent. of gas, with the same fuel-air ratio as before, will bring in (p. 42) 169.7 B.Th.U's. and will carry as sensible heat from the furnace 104.7 B.Th.U's., giving a net gain to the batch of 65 B.Th.U's. (37 C.H.U's.) per sec. This is 3.8 per cent. of the total heat input with cold air, and (due to heat brought in by the additional air) 5.5 per cent. with hot air. These quantities are subject to change with variation in any of the other factors which have been considered. Moreover, the calculated effect of increased fuel and air input is probably too great, because secondary influences are particularly important on account of the shorter time of passage through the furnace, resulting in greater probability of incomplete combustion and higher exit temperatures.

Review of Various Effects.—In Table IV the various tendencies are summarised. The true measure of a change in operation is the change of heat received by the stock expressed as a per cent., not of the total heat input, but of the heat originally received by the stock. For example, the change in Section 5 (Table IV) shows for cold air a change of 8.8 per cent. on the heat input. The figure 8.8 per cent., taken by itself, belittles the bad effect of incomplete combustion. Based on the 27.7 per cent. of available heat, there is a reduction in the latter figure of no less than 32 per cent. However, the figures as calculated previously, and repeated in Table IV, are in some respects more satisfactory, provided that

it is constantly borne in mind that these figures are to be directly added to or subtracted from the 27.7 per cent. for cold air or 44.3 per cent. for preheated air. Figs. 2 (b) and (d), representing a 25 per cent. increase (based on the heat supplied by the fuel)

TABLE IV.—EFFECT OF CHANGING CONDITIONS ON AVAILABLE HEAT.*

Section.	Variable	Cold Air 60° F. (15° C.)	Preheated Air 1100° F. (600° C.)
1 & 2	Basic assumptions (Sections 1 and 2)—Available Heat,	27.7%	44.3 %
2	Air preheat—180° F. (100° C.) change of temperature,	2.9%	2.9%
3	Excess air—10% change,	2.9%	1.5%
4	Infiltration—for each 10%,	2.9%	2.9%
5	Incomplete combustion—for each 10% of the total heat of combustion,	8.8%	8.8%
6	Gas temperature—180° F. (100° C.) change,	2.2%	2.2%
7	Gas composition—1% change of calorific value,	0.9%	0.9%
8	Moisture—for each 1% moisture in the air,	0.4%	0.2%
9	Loss through walls—10% change,	1.1%	1.1%
10	Loss of gas through openings—for 10% of total volume of products of combustion,	0-3.8%	0-3.8%
11	—	—
12	Exit temperature—180° F. (100° C.) change,	5.7%	5.7%
13	Gas quantity—10% change,	3.8%	5.5%

* This table refers to the Illustrative Example used in the preceding pages. The figures give changes of available heat in per cent. of the total heat input.

over the normal losses depicted in (a) and (c), illustrate this principle; the figure also shows the greater stringency when cold air is used. It has been assumed in all of the calculations that the exit temperature is invariable and, except in Section 9, that the heat loss through the walls is also constant. It has been stated that these assumptions are approximately correct. Actually, there must be a slight change of exit temperature and radiation loss with change in the other factors, sometimes the tendency being to intensify the direct effect of the change and sometimes to mitigate the effect. An example of the former case is found when combustion is incomplete—incomplete combustion is usually the result of poor mixing and implies delayed combustion in the furnace, resulting in poorer opportunity for heat transfer to the charge and a higher exit temperature of the gases, which therefore carry away more sensible heat as well as chemical heat. An example of

the latter case is found with higher air preheat—the higher initial temperature may result in a higher exit temperature, so that the stock may not receive quite all of the extra heat brought in; or, due to more rapid combustion, it may even have the reverse effect. These and similar effects are disregarded as secondary influences, which merely modify the main conclusions. Reasoned analysis will readily indicate which way these tendencies operate.

V.—COMBINED EFFECT OF FACTORS AFFECTING AVAILABLE HEAT.

The chief factors influencing heat utilisation have been given separately. In practice, all these influences must be considered. It is only necessary to add the losses due to deviation from the best obtainable conditions to show that many furnaces are at present operated without sufficient attention to combustion conditions, and that some must be burning twice or more than twice as much fuel as the operation warrants.

A large part of the technology of furnace construction and operation is devoted to increasing the available heat in furnace processes. Naturally then, it is not possible to discuss all the variables at this stage, since the underlying principles have yet to be considered in later chapters. Certain features, involving combustion principles only, may be conveniently treated in this chapter.

It will be noted that in making direct addition of the separate effects, we assume each change to be independent of the others. In most cases this is not quite true owing to secondary effects; but for the sake of simplicity these are ignored. There are, however, some cases in which the effects are interdependent. The first relates to completion of combustion and excess air—as a rule variation in one of these factors directly affects the other. There are two major causes of incomplete combustion in furnaces—imperfect mixing and inadequate air supply.

Imperfect Mixing.—The temperature of the mixture of combustible gases or vapours with air is raised sufficiently, at least locally, for combustion to commence at or near the burner. Assuming that the gas and air are perfectly mixed at the burner, an interval of time is required for combustion to extend from a point of ignition through the entire mixture. This time interval, under normal furnace conditions, is only a fraction of a second,

so that given perfect mixing, combustion may be practically complete within a few feet of the burner. On the other hand, when mixing is not perfect, the rate of flame propagation¹ is no longer the controlling factor in the time required for completion of combustion or its dependent quality, length of flame.

The degree of mixing attainable is in a large measure dependent on the type of fuel. Cold gas fuels can be premixed with air before projecting into the furnace. When this is done, using the full air quantity for combustion, the mixture must be carried to the furnace at a higher velocity than the rate of flame travel, otherwise the mixture will backfire and burn in the pipe. It is the actual speed of projection into the furnace that will then control the length of flame.

For a burner of circular cross-section, if combustion of a *perfect mixture* of fuel gas and air be considered to commence at the edges of the burner, the flame tends to be approximately conical in shape. Active combustion occurs at the outer surface of the cone, the gas mixture within the cone being unburnt; and the length of the cone is determined by the distance which the gas at the centre of the stream can travel before it is ignited by flame propagation from the periphery. From this it follows that:

(a) For a given burner, the higher the gas velocity (*i.e.* the greater the rate of fuel consumption) the longer will be the flame. If a steady flame could be maintained with a gas velocity only slightly greater than the velocity of flame propagation, this flame would form a very flat cone with the burner opening as its base.

(b) For a given rate of fuel consumption, the larger the burner diameter the lower will be the gas velocity and the shorter the flame.

(c) For a given fuel rate, a number of smaller burners will give flames which are shorter than the flame produced by one burner of equivalent cross-section.

When perfect mixing is obtained, there is not much likelihood of incomplete combustion. To accelerate still further the combustion of a perfect gas-air mixture, the principle of *surface combustion* may be employed. Here, the gas mixture is passed through, or projected on to, a bed of broken refractory material or a refractory surface. The material rapidly heats up and flameless

¹ The speed at which flame, starting from a point of ignition, will sweep smoothly through an explosive mixture is called the speed or rate of flame propagation. The value is determined experimentally, and depends on the composition of the gas mixture, and on the physical conditions of the experiment.

combustion proceeds on the refractory surface. This may be illustrated by directing a torch flame (with sufficient oxygen) through a small pile of coarse granular refractory. The material soon becomes hot and combustion continues in the pile without visible flame.

In the majority of large furnaces, mixing at the burner is imperfect. This may be because the nature of the fuel does not permit mixing; or because additional expense would be involved in attaining good mixing; or because mixing would be undesirable by reason of the intense local heat which would be produced.

With gaseous fuels, the gas pressure is frequently used to inspirate a part of the air necessary in a way similar to that employed in a bunsen burner or domestic gas burner. This mixture of "primary" air and gas then inspirates additional air ("secondary air") through the burner opening in the furnace wall. The original mixture will burn in a cone as already explained, but combustion will be partial only, because the mixture is deficient in air. Subsequent combustion will depend on the rate of mixing between the secondary air and the products of primary combustion.

When hot producer gas is used, it is usual to dispense with primary air in order to avoid the pre-combustion which must always take place, irrespective of speed of flame propagation, when any part of a combustible mixture is above its ignition temperature. Efficiency of mixing in the furnace again becomes the controlling factor. This applies also to the mixing of secondary air with volatile matter produced when the fuel is coal—the primary air of course enters through the grate. The rate of combustion of pulverised coal is also determined mainly by the rate of mixing of the stream of primary air and coal with the secondary air.

For oil fuel and tar, in addition to satisfactory mixing between the secondary air and the fuel mist, the efficiency of atomisation is a major factor. Neither the various methods of atomisation nor the numerous oil burners and systems will be considered here.

When a mixture of combustible gas and air is brought to the ignition temperature, combustion is, if not instantaneous, at least extremely rapid. The reaction between a carbon particle and air, on the other hand, depends on the rate at which oxygen can get to the particle to replace films of carbon oxides which have formed on the surface from previous combustion. Consequently, even though a cloud of carbon particles be dispersed as uniformly as possible in air, and the temperature of the mixture is high enough

for combustion to proceed, the combustion must take appreciable time. For a flame carrying much free carbon, mixing should be as efficient as possible, but in addition, sufficient time must be allowed for the particles to burn. Clearly, also, the smaller the particles the faster they will burn. Carbon particles may be present in a flame due to intentional or unintentional "cracking" of hydrocarbon; and of course in a pulverised coal flame the particles consist of coke forming by the driving of volatile matter from the powdered coal. The cracking of hydrocarbons is sometimes desirable in order to produce the luminous flame which is advantageous for some classes of work (see Chapters V and VI). It may be obtained with a fuel containing (either naturally or by addition) hydrocarbons, particularly heavy hydrocarbons and tarry matter, and by permitting sufficient preliminary combustion to decompose part of the hydrocarbons before thorough mixing with the secondary air. If the combustion chamber is small and the time required for the gases to pass through the furnace is therefore short, a luminous flame is undesirable. It by no means follows that a luminous flame is desirable even when there is sufficient time to consume all the carbon particles—the earlier combustion takes place, the more time the flame has to give up its heat, and consequently if luminosity is obtained by greatly delayed combustion there is a possibility of the waste gas escaping at a higher temperature (see Chapter VI).

The mixing of gas streams, and the inspiration of one gas stream by another, are governed by differences of pressure, velocity, density, and temperature in the furnace.

If the mixing is not complete by the time the gases leave the furnace, combustion will naturally be incomplete. Further, if part of the burning or unburnt gas strikes a cold surface such as cold stock or a water pipe in the furnace, that part of the gas will probably be cooled below the temperature at which combustion can proceed, and unless there is sufficient time and opportunity for the gas to reach its ignition temperature again, the residual combustible gases and carbon will remain unburnt. In most cases it is desirable that the gas shall be completely burnt some distance before passing out through the vents, otherwise it may escape at an unnecessarily high temperature.

Inadequate Air Supply.—This second cause of incomplete combustion may be an intentional condition in certain heating furnaces where it is desired to minimise scaling of the stock. In such cases, a "reducing" or "neutral" flame may be maintained

in actual contact with the stock, the remaining calorific value of the fuel being developed at some other point where there is no danger of oxidation.

Apart from this special case, for given mixing conditions there will be a minimum quantity of excess air necessary to ensure complete combustion. In general, except where gas and air are pre-mixed, an increase in the air supply will ensure earlier combination of all the combustible matter with oxygen, and will therefore produce a shorter flame. By increasing the tendency of hydrocarbons to burn rather than to decompose, a larger amount of excess air will tend to prevent luminous flames.

In a given type of furnace, the poorer the mixing conditions, the larger will be the amount of excess air necessary for complete combustion.

Optimum Amount of Excess Air.—To the question "How much excess air should be used?" no general answer can be given. From Section 5 of the illustrative problem, it is seen that 1 per cent. of carbon monoxide in the 22.9 cu. ft. of escaping gas (indicating that about 5 per cent. of the heat of combustion of the fuel remains undeveloped) represented a loss of heat to the stock of 74.4 B.Th.U's. per sec. From the sensible heat of air at the exit temperature, it is found that if this heat had been developed it would have been capable of heating 1.8 cu. ft. per sec. of cold air, or 3.4 cu. ft. of preheated air, to the exit temperature of the waste gas. These air quantities are 15 per cent. and 28 per cent., respectively, of the theoretical air quantity.

It appears, therefore, that for a fixed rate of fuel consumption, so long as an additional 15 per cent. of excess air for cold air or 28 per cent. for preheated air will decrease the carbon monoxide in the waste gas by over 1 per cent., then increasing the air quantity is thermally desirable. Conversely, it should be desirable to decrease the air supply so long as the carbon monoxide does not increase more rapidly than 1 per cent. for each 15 per cent. decrease of cold air.

Again, secondary effects are ignored. These include apparent change in the carbon monoxide by dilution with increasing excess air and the unknown change in hydrogen content of the waste gas. Other considerations may outweigh any thermal advantage, and even if the draught permitted, it might be poor policy to cause a large increase in the waste gas quantity. If the draught is inadequate for the most economical operation, then it may be necessary to use a larger ratio of fuel to air in order to use the air as completely

as possible, even though part of the fuel escapes unburnt. Such operation would of course be uneconomical.

It may be concluded that the economic limit to increase of excess air is a matter which must be considered for each individual furnace and even for each phase of a furnace operation. The amount of excess air permissible to eliminate traces of carbon monoxide in the waste gas will be greater with higher air preheat and greater with lower waste gas exit temperature.

Furnaces have frequently been operated with extremely small or zero excess of air. Also, in many furnaces, which from the flue gas analysis are supposedly working with a large excess of air, much of the excess could be traced to infiltration if a careful survey were made. Thus it does not necessarily follow that approach to perfect combustion as shown by flue gas analysis is a matter for congratulation. The real question is, how complete is combustion within the furnace chamber (as distinct from subsequent combustion in the flues)? and would some further excess of air be beneficial or otherwise?

If a furnace is in good repair and operated in a normal manner, but requires an unusually large excess of air for a particular type of operation, faulty design of furnace or of burner is usually indicated.

Heat of Producer Gas.—Just as the amount of unburnt gas and the amount of excess air are dependent to a considerable extent one on the other, so the temperature and the quality of producer gas are closely related.

Other conditions (blast saturation temperature, nature of coal, etc.) remaining the same, if an increase occurs in the temperature of the producer gas, this will probably be accompanied by an increase in the carbon dioxide content of the gas at the expense of carbon monoxide. If the producer is built into the furnace as a single structure, the decreased heat of combustion will be balanced by the higher sensible heat of the gas. Apart from increased clinking trouble, wear on the producer and slightly greater radiation loss, there will in this case be little thermal difference between a cool high quality gas and a somewhat hotter inferior gas.

If the producer is built as a separate unit, the gas always cools considerably in the gas main. Sensible heat is subject to loss, but chemical heat is not; therefore, in this case, the cooler the gas the better, provided that there is a corresponding increase in the heat of combustion. However, when the carbon dioxide increases at the expense of the carbon monoxide, there is still partial

compensation in the greater sensible heat of the gas reaching the furnace.

If the producer gas is to be heated to a higher temperature by regeneration, then the sensible heat of the gas, as delivered from the producer, may play a very small part, and the highest possible heat of combustion is desirable.

Importance of Fuel Economy.—A decrease in the fuel consumed per ton of output produces an obvious direct saving in cost. This, however, is not the major economy effected by careful attention to the individual factors which may result in a reduction of fuel consumption. There may also be indirect savings in cost of raw materials, as well as maintenance, overhead and labour charges—these frequently amounting to many times the direct saving.

Utilisation of Thermal Savings Effected.—The extra heat transfer per unit of fuel achieved by any improvement in operating conditions may be utilised to reduce production costs in different ways.

(a) *Same Output.*—The fuel and air supply may be decreased so as to give the same heat transfer as before. For the same output, this will save fuel directly, and for high temperature furnaces will greatly prolong the life of the furnace due to lower gas velocity. The lower volume of gases will tend to still further economy by reason of the slower passage of gas through the furnace, giving more time for heat transfer and better opportunities to attain complete combustion. Avoidance of unnecessary excess air also results in a slower burning and softer flame with better radiating properties, such a flame also being less severe on the furnace lining than the fierce flame obtained with a moderately large excess of air.

Cutting down air and fuel results in lower pressure differences throughout the system. In regenerative furnaces relying on natural draught, this means that the furnace can be operated much longer before trouble is encountered due to choking of checkers, and also that there will be less air infiltration into the system. The improvement in draught conditions may be utilised in other ways. Economies in the furnace design may be effected by making flues, valves, chimney, etc., smaller. For furnaces operating with mechanical draught the power saving due to decreased draught may be appreciable.

(b) *Increased Output.*—The same rate of fuel consumption may be maintained and the extra heat transferred will then serve to increase the output. This results in direct saving of fuel per ton of product, saving in operating costs and fixed charges, and may

result in less oxidation of a metallic charge due to the shorter time during which oxidation can take place. The furnace will certainly have an increased life on a tonnage basis, and it does not even follow that its life on a time basis will be decreased because, as before, the elimination of excess air will result in lower gas velocity.

(c) The same rate of fuel consumption may be used and in a batch type furnace the size of the batch may be increased. This is practically the same as (b).

(d) A combination of (a) with either (b) or (c) may be adopted. The exact compromise to obtain the maximum benefit can be determined only in relation to the particular operation.

The way in which advantage is taken of thermal economies will evidently depend on the nature of the process. Some processes merely require, at least during certain stages, the transfer of a definite quantity of heat to the stock, without any particular restriction on the time occupied in the heat transfer—in most such cases, rapid heating is desirable as it will result in less loss by oxidation. On the other hand many processes require that a given amount of heat shall be transferred to the stock at a restricted speed, the maximum permissible rate depending on the process, while the minimum rate is usually determined by economic considerations and possibly by the tendency of the stock to oxidise.

Influence of Furnace Dimensions on Heat Transferred to the Stock.—Attainment of perfect combustion implies that the full heat of combustion has been developed in the flame. Efficient operation requires more than this—it requires that the heat *developed* in the flame shall be *transferred* to the stock. The laws governing this transfer of heat will be explained in Chapters V and VI; from these laws it may be deduced, for example, that—

1. The volume of the furnace chamber in relation to the rate of fuel consumption, by determining the time taken for the gases to pass through the furnace, will influence the transfer of heat.

2. The efficiency of utilisation of the furnace space must be considered as well as the actual volume. Good utilisation is achieved when all parts of the gas stream escape at approximately the same temperature, and when the chamber contains no large “dead” spaces out of the main gas stream. The first of these conditions requires that there shall be a minimum of short circuiting of gas from burner to vent, such as tends to occur in furnaces where the optimum path of the gases does not coincide with the shortest possible path. Absence of “dead” spaces provides that the

gases shall not pass through the furnace more quickly than is warranted by the furnace dimensions. It may happen, however, that the presence of "dead" spaces may be conducive to a turbulent flame condition, this condition sometimes being favourable to combustion and to heat transfer. The shape of the furnace (length in relation to breadth and height) has an important bearing on heat transfer from the flame.

✓3. The area of the furnace lining determines its heat receiving capacity. This capacity is important because the lining can act as an intermediate heat distributor, receiving heat from the flame and then passing it on to the stock.

✓4. The area of the stock is a major factor in determining the rate of useful heat absorption, both by direct transfer from the flame and by indirect transfer from the walls and roof. So far as concerns the indirect transfer, it is the ratio *wall and roof area/effective stock area* which is important. The larger this ratio, the greater will be the rate of indirect heat transfer per square foot of stock.

✓5. The nature of the stock (such as thickness, voids, heat conductivity, and other physical properties) will determine the possible rate of heat penetration (for a raw material) or the permissible rate of heat penetration (for a semi-finished material).

✓6. The properties of the flame, including temperature, size, shape, luminosity, and chemical composition of the flame gases, are shown to be very important in calculating the rate of heat transfer.

VI.—CONTROL OF COMBUSTION CONDITIONS— FLUE GAS ANALYSIS.

With more general realisation of the importance of maintaining good combustion conditions, the installation of automatic regulators has extended rapidly.

Automatic Combustion Control.—Simple pressure regulators may be used to maintain constant draught for removal of waste gas, constant fuel-gas pressure to avoid fluctuations of fuel input, constant (zero) furnace pressure to prevent infiltration or gas escape at the doors of a hearth type furnace, constant steam pressure from a boiler, etc.

Proportioning regulators are installed to maintain a given ratio of fuel to air. The ratio may be adjusted to a given per cent. excess of air, or to deficiency of air to avoid oxidation, but the

ratio will remain the same for all rates of firing. The fuel may be controlled by hand, the air following automatically; or both may be controlled automatically by a pyrometer. Mixed gaseous fuels (such as blast furnace gas with coke oven gas) may be used in a furnace, the air requirement of each being automatically controlled. Other types of specialised equipment are also available.

The most important users of automatic equipment are boiler furnaces and iron and steel plants (including coke plants and steel processing plants).

There is no doubt as to the advantages of these automatic devices. A constant fuel-air ratio may not be an ideal, because when a furnace is being forced, a slightly greater excess of air may be necessary to obtain complete combustion in the furnace. An absolutely constant ratio will, in fact, not be achieved owing to errors in the metering devices and changes in atmospheric conditions. However, a variation of 5 per cent. or so in the ratio due to these causes is certainly very much smaller than the average variation in a furnace controlled by eye.

On account of expense, installation of full automatic equipment will naturally be considered only for large furnaces with high operating cost, or for furnaces where a change of furnace atmosphere or temperature may lead to a large increase of scrap through spoilage of the stock. Draught or pressure control alone finds a wider field of application.

Flue Gas Analysis.—Where automatic proportioning equipment is installed, there is little to be done concerning the air-fuel ratio beyond checking the flue gas analysis periodically. But even without such equipment, much may be accomplished by careful attention to the flue gas analysis. The most satisfactory control is obtained with automatic recording instruments determining the carbon dioxide or the oxygen in the waste gas. Failing this, analysis should be made periodically. The cost of this determination is so trivial compared with the furnace operating costs, that there are few furnace operations where the omission of this as a routine determination can be justified. Further, the mere taking of a gas sample for analysis at a certain time every day is too haphazard to be of much value. It is just as easy to eject a small continuous gas stream from the flue, and to tap the aspirator sample from this stream, adjusting the water flow in the aspirator to a slow drip which will permit collection of the sample over a period of eight hours, or whatever period is desired. In this way a composite sample for the entire period is obtained.

Summary of Flue Gas Calculations.—In ordinary furnace practice, there should be no appreciable quantity of carbon monoxide in the waste gas, the gas analysis showing only carbon dioxide, oxygen and, by difference, nitrogen. In these cases calculations are simplified, and when automatic carbon dioxide or oxygen recording apparatus is installed, the simplified formulæ will be used.

(a) *Flue Gas Analysis Showing No Carbon Monoxide.*—In the following formulæ CO_2 , O_2 and N_2 represent the per cent. of these gases shown by the gas analysis. U is the ultimate CO_2 (per cent.) of the fuel, and v is the volume of dry flue gas produced per 100 volumes of air when perfect combustion is obtained.

If both the CO_2 and the O_2 are determined, the ultimate CO_2 may be obtained from the formula

$$U = \frac{100 CO_2}{100 - 4.78 O_2} \quad . \quad . \quad . \quad (3)$$

Having once determined U , if a partial gas analysis shows either CO_2 or O_2 , we can find the other from the formula

$$\frac{CO_2}{U} + \frac{O_2}{20.9} = 1 \quad . \quad . \quad . \quad (4)$$

Having found U from Equation (3) or from the fuel analysis, we need to know only the CO_2 or the O_2 analysis of the flue gas (not both) in order to estimate the excess air.

$$\text{Per cent. excess air} = v \left(\frac{U}{CO_2} - 1 \right) \quad . \quad . \quad . \quad (5a)$$

$$\text{or} = v \times \frac{O_2}{20.9 - O_2} \quad . \quad . \quad . \quad (5b)$$

For coal, liquid fuels, and other fuels containing comparatively small amounts of nitrogen, v is obtainable from the formula

$$v = 100 \times \frac{79.1}{100 - U} \quad . \quad . \quad . \quad (6)$$

which will give a value for v varying from 92 to 100.

For producer gas and other fuels containing large quantities of nitrogen, v must be determined from the fuel analysis by the method explained earlier in this chapter.

These formulæ are naturally not suitable for direct use, and they should be converted into charts or tables for everyday use. As an example, the combustion data for the producer gas given on

page 11 will be used. The ultimate carbon dioxide was found from the gas analysis (instead of from Equation 3) to be 18.5 per cent. It was also shown that, for theoretical combustion, 1 cu. ft. of gas with 1.21 cu. ft. of air yielded 1.84 cu. ft. of dry waste gas. The quantity v is therefore

$$\frac{1.84}{1.21} \times 100 = 152 \text{ cu. ft.}$$

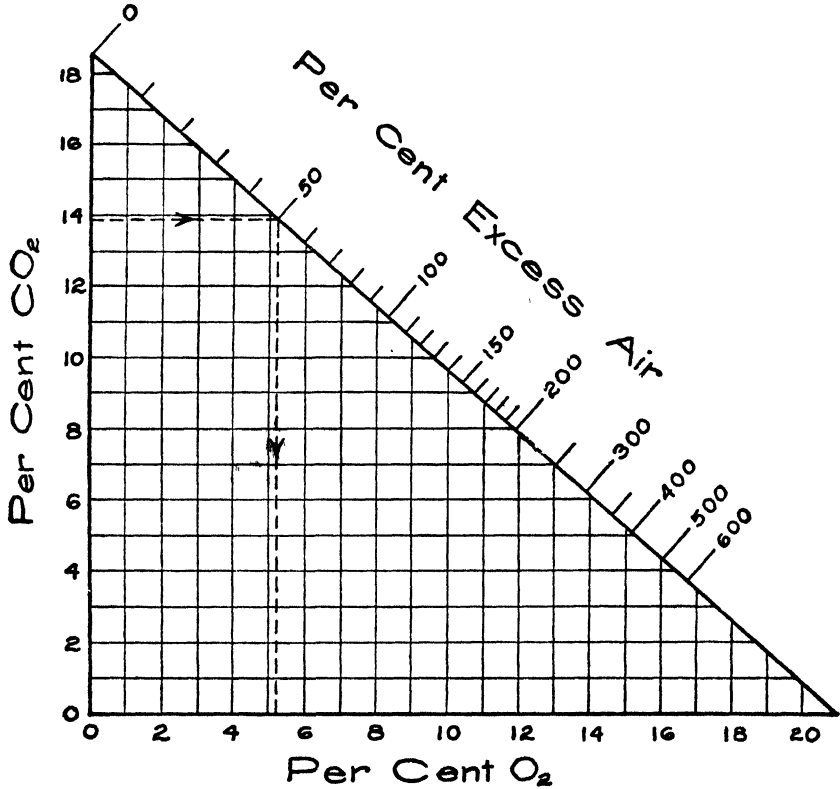

Fig. 3.

To construct a diagram for the combustion of this gas, mark off to scale 20.9 in a horizontal direction (the O₂ scale) and 18.5 in a vertical direction (the CO₂ scale), and join these points as shown in Fig. 3.

The figure now represents Equation 4. If a carbon dioxide determination has been made, a line run along from the corresponding point on the CO₂ scale, as shown by the arrows in the

figure, will give the per cent. of oxygen in the waste gas. If the oxygen is known, then the reverse procedure is followed.

To complete the chart, Equation 5a is arranged to the form

$$\text{CO}_2 = \frac{Uv}{X + v} \left(\text{or Equation } 5b \text{ to the form } \text{O}_2 = \frac{20.9 X}{X + v} \right)$$

where X is the per cent. excess of air. In the example chosen,

$$\text{CO}_2 = \frac{18.5 \times 152}{X + 152}$$

and convenient values for X are chosen in order to determine the corresponding carbon dioxide values. For example, when $X = 10$, $\text{CO}_2 = 17.4$. A horizontal line run along from 17.4 on the CO_2 scale shows the point on the oblique line to be marked "10 per cent." The other excess air values shown in the figure have been calculated by similar substitution of assumed values for X .

A chart constructed as explained may be used to determine the excess air either from a carbon dioxide determination or from an oxygen determination, and is therefore suitable for use with automatic gas analysing apparatus determining either of these constituents. Instead of constructing the chart in this way, either Equation 5a or 5b may be plotted as a simple curve for reading excess air.

If a table is preferred, then values may be chosen for carbon dioxide or oxygen in Equation 5a or 5b and the corresponding air excess calculated. For the producer gas example the values would be:—

O_2 (%)	.	.	0	1	2	3	4	5	* 6	7	8	9	10	11	12	etc.
Excess Air (%)	.	.	0	8	16	25	36	48	61	77	94	115	139	169	205	
CO_2 (%)	.	.	18.5	18	17	16	15	14	13	12	11	10	9	8	etc.	
Excess Air (%)	.	.	0	4	13	24	35	49	64	82	104	129	160	200		

Fig. 3 covers the full possible range from zero to infinite excess of air, and the table also covers a wide range. For a particular operation, the working range would be fairly narrow and it would be better to make a large-scale chart or a detailed table covering only the usual operating range. Both chart and table show that a variation of 1 per cent. in the carbon dioxide or oxygen indicates that there will be a much larger variation in the per cent. of excess air, if the latter is already large.

(b) *Flue Gas Analysis Showing Carbon Monoxide and Excess Oxygen.*—It has been estimated that the presence of more than a trace of carbon monoxide in the waste gas

is not a normal condition except where a deficiency of air is maintained intentionally. When carbon monoxide is present, it is necessary to imagine the carbon monoxide and accompanying hydrogen burnt in the excess oxygen present, and then to recalculate the per cent. composition for the slightly reduced volume (dry basis). The per cent. of carbon dioxide after combustion would be

$$\frac{100 (\text{CO}_2 + \text{CO})}{100 - \frac{1}{2} (\text{CO} + 3 \text{H}_2)}$$

and this must be substituted for "CO₂" wherever the latter occurs in the previous formulæ. Similarly,

$$\frac{100 [\text{O}_2 - \frac{1}{2} (\text{CO} + \text{H}_2)]}{100 - \frac{1}{2} (\text{CO} + 3 \text{H}_2)}$$

must be written in place of "O₂."

If the additional variable (CO) is included in Fig. 3, the latter becomes an Ostwald¹ chart. If tabular representation is preferred, this is achieved by choosing values for carbon monoxide and constructing a table in two variables. For example, for the producer gas with determinations of carbon dioxide and carbon monoxide in the flue gas, a table may be made as follows²:—

DETERMINATION OF EXCESS AIR FROM CARBON DIOXIDE AND CARBON
MONOXIDE IN PRODUCTS OF COMBUSTION OF PRODUCER GAS.

		Per cent. CO ₂ .											
		18.5	18	17	16	15	14	13	12	11	10	9	8
Per cent CO	0	0	4	13	24	35	49	64	82	104	129	160	200
	1			2	11	22	33	46	62	79	100	125	156
	2				0.3	9	19	31	44	59	76	97	122
	3						7	17	28	41	56	74	94
	4	Deficiency of Air or Impossible							5	15	26	39	53

Thus if the flue gas analysis shows CO₂ 14 per cent. and CO 1 per cent., the excess air is 33 per cent. Intermediate values may be estimated.

Estimation of Air Infiltration.—By taking gas simultaneously at any two points in the furnace, it is easy to determine how much air infiltration has taken place between these points. From formulæ, charts, or tables, the percentage of excess air at each of these points may be found, the difference

¹ For Ostwald charts see General Reference (at end of this chapter) No. 4, and for other graphical representations General Reference No. 2.

² The amount, H₂, of unburnt hydrogen has been taken as one-half of the corresponding amount, CO, of unburnt carbon monoxide. This estimated value is determined from the products of perfect combustion (p. 12) and the formula (p. 455)—

$$\text{H}_2 = \text{CO} \times \frac{\text{H}_2\text{O}}{\text{CO}_2} = \text{CO} \times \frac{10.2}{16.6} = \text{CO} \times 0.6$$

to one-half this value, or CO × 0.3. The intermediate value of 0.5 was selected—the correction for hydrogen makes but little difference to the table.

between the two values being the air infiltration, expressed as a percentage of the air required for perfect combustion.

In illustration, suppose in the combustion of our producer gas, waste gas samples, taken on leaving the furnace and at the base of the stack, gave the following analyses:—

	CO ₂	O ₂	N ₂
Furnace vent, . . .	16.3	2.4	81.3
Base of stack, . . .	13.9	5.1	81.0

The ultimate CO₂ for this fuel is known to be 18.5 per cent., and *v* was found to be 152. Then from Equation 5*a* or 5*b*—

$$\text{Excess air at first position} = \left(\frac{18.5}{16.3} - 1 \right) \times 152 = 20\%$$

$$\text{or} = \frac{2.4}{20.9 - 2.4} \times 152 = 20\%$$

$$\text{Excess air at second position} = \left(\frac{18.5}{13.9} - 1 \right) \times 152 = 50\%$$

$$\text{or} = \frac{5.1}{20.9 - 5.1} \times 152 = 50\%$$

these figures being expressed as percentages of the theoretical air quantity. The infiltration is therefore 30 per cent. The same result would be obtained from the chart or from a detailed table.

Although either the carbon dioxide or the oxygen basis may be used, one may be better than the other. It is usually preferable to avoid subtraction of large approximately equal numbers (such as 18.5 — 16.5), because small percentage errors in the large figures are likely to result in a relatively large percentage error in the small difference.

As an extreme example of the uncertainty of subtracting approximately equal numbers, may be quoted calculation of excess air from the nitrogen. A formula may be derived involving subtraction of nitrogen contents (81.3, 81.0, 79.1 in the above example), but this gives the excess air in the two cases as 14 per cent. and 40 per cent., instead of 20 per cent. and 50 per cent. The error from an ordinary Orsat analysis using nitrogen as the basis, would probably be much greater.

Instruments for Automatic Gas Analysis.—The majority of instruments for recording flue gas analysis are designed for carbon dioxide determination. This is partly because instruments

measuring this constituent are the simplest in principle and operation. There is a considerable range of types of instrument from which to choose, some types requiring frequent but simple attention in the matter of replacing reagents, while others require infrequent but more skilled attention.

If no carbon monoxide is present in the waste gas and if the reactions taking place in the furnace charge do not contribute large quantities of carbon dioxide, the carbon dioxide reading will show how much excess air is being used. It is well to remember these two stipulations, because, although in most cases a carbon dioxide reading smaller than the ultimate value is an indication of excess air, cases may occur where the low reading is due to unburnt carbon monoxide, either with or without excess air. Also a high carbon dioxide reading may flatter the combustion conditions if much of the carbon dioxide results from chemical reactions taking place in the charge.

Instruments are also installed to record the sum of the carbon monoxide and hydrogen in the waste gas. These are valuable in that they give an immediate indication of a deficiency of air or of insufficient excess air—the only instruments that can do this directly. During the greater part of the time, when combustion is complete, they record zero, and can do nothing to indicate an excess of air, however large it may be. For this reason, these instruments are not used alone, but are used mainly in conjunction with carbon dioxide meters.

The third kind of instrument measures the oxygen content of the waste gas. This type is the most positive in showing the amount of excess air used, but on the other hand it cannot indicate the amount of unburnt gases present.

Selection of automatic gas recording equipment will be determined by circumstances. Disregarding cost, an ideal arrangement would be a combination of the carbon monoxide plus hydrogen meter and the oxygen meter. The first would call attention to incomplete combustion and the second would show the amount of excess air. The furnace operator should keep the first reading zero and the second as low as experience shows to be practicable. This combination would be independent of reactions taking place in the charge.

An oxygen meter is preferable to a carbon dioxide meter if an appreciable amount of carbon dioxide is added to the furnace gases from the charge, particularly if the amount liberated varies during the process. It has been pointed out that an oxygen meter

can give no indication of carbon monoxide in the gas. A carbon dioxide meter on the other hand will show a lower reading when there is much carbon monoxide present—it will be necessary to investigate whether this lower reading is due to too much or to too little air. For furnaces operating with only a small excess of air, this indication of incomplete combustion, although uncertain, is a point in favour of the carbon dioxide meter as compared with the oxygen meter.

Whatever instrument be used, it is advisable to check it from time to time against a laboratory determination. The laboratory analysis will show carbon dioxide, oxygen and carbon monoxide, giving as complete information as is necessary to ascertain the combustion conditions, and for this reason alone should be obtained periodically.

When interpreting gas analyses, it is necessary to remember firstly that there may be much air infiltration between the furnace hearth and the point from which the gas sample is taken, and secondly that absence of unburnt gas in the sample does not necessarily mean that combustion was complete at the flue end of the hearth. The normal change in gas analysis between the two points may be ascertained by taking simultaneous samples for laboratory analysis. It is of course desirable to install the sample pipe of a recording instrument as close to the furnace as possible.

VII.—FLAME TEMPERATURE.

On the assumption that the entire heat of combustion plus sensible heat (if any) of preheated air and fuel is expended in raising the temperature of the products of combustion, it is a simple matter to calculate the temperature of these products. The calculated value obtained, when combustion is complete and only the theoretically necessary amount of air is used, is called the theoretical flame temperature.

Calculation of Theoretical Flame Temperature.—The problem is to find firstly the total heat available for a given quantity of fuel (usually 1 cu. ft. for a gaseous fuel, or 1 lb. for a solid or liquid fuel), secondly what products of combustion are formed, and lastly from the sensible heat tables to find a temperature at which these products will contain the whole of the heat supplied.

To illustrate the method of calculation, two examples will be given. The first example is applicable to gases, and the more complex case will be taken, where both gas and air are preheated. The second example relates to fuel oil, using the combustion data previously calculated and again using highly preheated air. This example obviously applies equally to other liquid fuels and to coal.

1. *Gaseous Fuels.*—The producer gas data given on page 11 are used. Both gas and air are assumed to be preheated to 2100° F. (1150° C.). The data are incorporated in the accompanying table for determining the total heat input per cubic foot of dry producer gas.

	Constituent Gas.	Cu. Ft.	Sensible Heat per cu. ft. of constituent.		Sensible Heat per cu. ft. of gas.	
			B.Th.U's.	(C.H.U's.)	B.Th.U's.	(C.H.U's.)
Sensible Heat of 1 cu. ft. of Producer Gas at 2100° F. (1150° C.)	CO ₂	0.03	62.4	34.8	1.9	1.0
	H ₂	0.12	37.8	21.1	4.5	2.5
	O ₂ +CO+N ₂	0.823	39.0	21.8	32.1	17.9
	CH ₄ *	0.025	102.3	57.1	2.6	1.4
	C ₂ H ₄ *	0.002	92.9	51.8	0.2	0.1
	H ₂ O (water vapour)	0.04	48.8	27.2	2.0	1.1
		1.040		Total,	43.3	24.0
Sensible Heat of 1.21 cu. ft. of Air at 2100° F. (1150° C.)	O ₂ + N ₂	1.21	39.0	21.8	47.2	26.3

		B.Th.U's.	C.H.U's.
Total sensible heat,	.	90.5	50.3
Heat of combustion,	.	148.7	82.9
Total heat available,	.	239.2	133.2

Now we must find by trial at what temperature 0.34 cu. ft. CO₂ + 0.21 cu. ft. H₂O + 1.50 cu. ft. N₂ contain 239 B.Th.U's. (133 C.H.U's.).

The guesses are tabulated:—

Temperature tried.	Heat in 0.34 CO ₂ .	Heat in 0.21 H ₂ O.	Heat in 1.50 N ₂ .	Total in round figures.	Remarks.
4000° F.	131 × 0.34 = 44.5	113 × 0.21 = 23.7	81 × 1.5 = 121.5	190	Too low
4500° F.	150 × 0.34 = 51.0	134 × 0.21 = 28.1	94 × 1.5 = 141.0	220	Too low
5000° F.	169 × 0.34 = 57.5	159 × 0.21 = 33.4	107 × 1.5 = 160.5	251	Too high

The theoretical flame temperature lies between 4500° and 5000° F. and can be calculated as follows: 251 - 220 = 31 B.Th.U's. corresponds to 500° F., or 1 B.Th.U. corresponds to 16° F. in this range. The actual B.Th.U's. available are 239 - 220 = 19 above that required for 4500° F., and this corresponds to 19 × 16 = 300° F. The theoretical flame temperature is 4800° F.

* It is probable that these hydrocarbons are largely decomposed at the temperature of preheat, causing changes in both sensible heat and heat of combustion; but as the quantities of these gases are small the final error is also small.

In a like manner for the centigrade calculation we find by trial at what temperature 0.34 cu. ft. CO₂ + 0.21 cu. ft. H₂O + 1.50 cu. ft. N₂ contain 133 C.H.U.'s. Tabulating our guesses:—

Temperature tried.	Heat in 0.34 CO ₂ .	Heat in 0.21 H ₂ O.	Heat in 1.50 N ₂ .	Total.	Remarks.
2600° C.	88 × 0.34 = 29.9	80 × 0.21 = 16.8	55 × 1.50 = 82.5	129	Too low
2800° C.	96 × 0.34 = 32.6	90 × 0.21 = 18.9	61 × 1.50 = 91.5	143	Too high

The theoretical flame temperature lies between 2600° C. and 2800° C. 143 - 129 = 14 C.H.U.'s. corresponds to 200° C. or 1 C.H.U. to 14° C. Therefore the theoretical flame temperature is 2600 + (133 - 129) 14 = 2650° C.

As an alternative to arithmetic interpolation, the temperatures and heat quantities may be plotted as shown in Fig. 4. The temperature corresponding to the heat supplied is obtained as shown by the arrows.

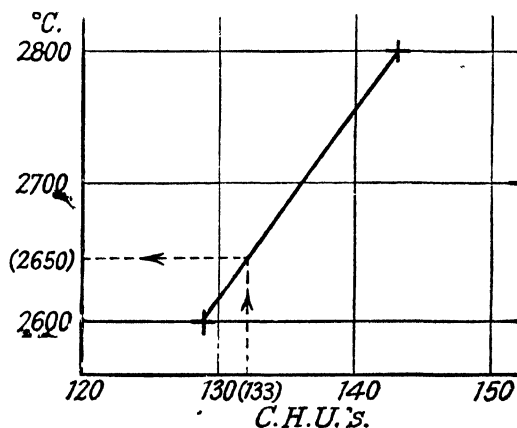

Fig. 4.

Yet again, the specific heat curves may be used to find what rise in the temperature of the waste gases between 2600° and 2800° C. would be produced by 133 - 129 = 4 C.H.U.'s.

2. *Liquid Fuels.*—The data previously assumed and developed for fuel oil are used in illustration. The data for combustion of 1 lb. of oil are summarised:

Steam used for atomising,	0.3 lb.
Air required for combustion,	187 cu. ft.
Products of combustion,	{ 27 cu. ft. CO ₂ 31 cu. ft. H ₂ O 148 cu. ft. N ₂

The following additional assumptions are made:—

Temperature of steam for atomising,	380° F. (corresponding to 180 lb. per sq. in. gauge pressure.)
Oil heated to,	180° F.
Air regenerated to,	2100° F.
Calorific value (lower) per lb. of oil,	17,800 B.Th.U's.

The specific heat of oil and the heat of the steam are taken from Table X. The value for steam makes allowance for the loss of heat due to expansion of steam at the burner. The amount of heat brought in by the steam and oil is seen to be negligible in these calculations.

	Quantity.	Specific Heat.	Temperature above 60° F.	B.Th.U's.
Sensible heat of oil,	1 lb.	0.45	120° F.	54
Sensible heat of steam,	0.30 lb.	(118 B.Th.U's. total heat)		35
Sensible heat of air,	187 cu. ft.	(39 B.Th.U's. sensible heat)		7293
Total,				7382
Calorific value (lower) per lb. of oil,				17,800
Total heat supplied,				25,182
Or, approximately,				25,200 B.Th.U's.

By trial for different temperature we find:—

Temperature tried.	Heat in 27 cu. ft. CO ₂ .	Heat in 31 cu. ft. H ₂ O.	Heat in 148 cu. ft. N ₂ .	Total in round figures.	Remarks.
4500° F.	150 × 27 = 4050	134 × 31 = 4150	94 × 148 = 13,910	22,100	Too low.
5000° F.	169 × 27 = 4560	159 × 31 = 4930	107 × 148 = 15,840	25,300	Approx. Correct.

The theoretical flame temperature is 4985° F. (2750° C.).

True Flame Temperature.—Even in very high temperature furnaces, temperatures are rarely registered much in excess of 3400° F. (1870° C.). Apart from possible unreliability of the observed temperature, there are three main reasons for this.

1. In practice, excess air over the theoretical requirement causes loss of temperature. If, for example, the producer gas is burnt with 20 per cent. of excess air, there will be an increase in heat supplied due to the sensible heat of the additional air; but when the total heat input is spread over the increased quantity of waste gases, the calculated flame temperature will be about 190° F. (105° C.) lower than for perfect combustion. For fuel oil, 20 per cent. of excess air causes a drop of temperature of 340° F. (190° C.).

2. During combustion, the flame radiates heat to its surroundings, so that all of the available heat does not appear in the products of combustion. The more rapid the combustion, the less time there is for radiation, and the more nearly will the actual temperature approach the theoretical value. In industrial furnaces, combustion is by no means instantaneous, nor is it usually desirable that it should be; and during the appreciable time taken to approach complete combustion (frequently the time taken for the gases to pass through the combustion chamber), much heat is transferred to the furnace and stock by radiation and by direct contact, so that the observed temperature of the flame is correspondingly lowered. This transfer of heat is naturally what is required, while the consequent lowering of flame temperature is often desirable to avoid early destruction of the furnace lining. The extent of heat transfer from the flame is the subject of study in later chapters—it is sufficient to depress the flame temperature far below the calculated value.

3. The third reason is that the so-called theoretical flame temperature is not even theoretically possible. The calculation is based on the assumption that the reactions

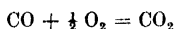

and

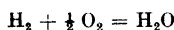

proceed to completion, and yield the full heat of combustion.

In actual fact these reactions at very high temperatures are not complete, some carbon monoxide and some hydrogen remaining unburnt even in the presence of oxygen. These equations should, when high temperatures are considered, more correctly be written

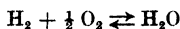
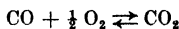

indicating that the reaction is reversible and proceeds only until a certain amount of carbon dioxide or steam is formed, at which point a balance is reached. Similarly, if we started with carbon dioxide or steam and heated either of these gases to a high temperature, there would be partial dissociation into carbon monoxide and oxygen or hydrogen and oxygen, the reactions proceeding from right to left until the proper balance was established. In this case a quantity of heat would have to be supplied, equal to the heat of formation of the dissociated fractions. Balanced reactions are more fully discussed in Chapter IX.

If we recalculate the true theoretical flame temperature, making allowance for this condition of incomplete combustion (a tedious calculation), we find that the maximum temperature theoretically possible for the producer gas with theoretical air supply is 4240° F. (2340° C.), which is 560° F. (310° C.) lower than would be obtained if complete combustion were possible. At this temperature the flame gases would consist of 4.85 per cent. CO, 0.55 per cent. H₂, 2.7 per cent. O₂, 11.3 per cent. CO₂, 9.4 per cent. H₂O, 71.2 per cent. N₂. From this it is seen that while the proportion of carbon monoxide unburnt is large (equivalent to 30 per cent. of the combustible carbon supplied), the amount of hydrogen remaining unburnt is comparatively small.

For the fuel oil the maximum temperature, allowing for the balanced condition, is 4380° F. (2420° C.), which is about 600° F. (330° C.) lower than the figure obtained without allowing for incomplete combustion. The flame gases at this temperature would consist of 4.8 per cent. CO, 1.15 per cent. H₂, 3.0 per cent. O₂, 7.9 per cent. CO₂, 13.55 per cent. H₂O, 69.6 per cent. N₂.

Without at present going into further detail, the following points relative to these balanced reactions may be noted:—

(a) At very high temperatures the incomplete combustion of carbon monoxide may be considerable, while that of hydrogen is smaller.

(b) An increase in the amount of free oxygen present in the flame causes a decrease in the amounts of unburnt carbon monoxide and hydrogen.

(c) The balance changes very rapidly with temperature; and the amount of theoretically unburnable carbon monoxide and hydrogen, although high at some calculated temperatures, becomes small at all actual furnace temperatures.

Evidently the potential chemical heat of carbon monoxide and hydrogen unburnt at the calculated flame temperature is not lost, but is developed later as the temperature drops and combustion is enabled to proceed further. The amount of retarded heat development in the theoretical examples calculated above, is in both cases about 15 per cent. of the total sensible and chemical heat supplied. It has already been pointed out that delayed heat development is frequently desirable because of the less intense local heat.

Reviewing the three causes of comparatively low actual flame temperature, it is seen that heat transfer from flame is a major and inevitable cause and that the small excess of air usually present in a well operated furnace is an important contributory cause. Although the effect of balanced reactions would be considerable under certain improbable conditions, the lowering of temperature due to other causes and the presence of excess oxygen render this effect of smaller importance even in very high temperature furnaces. Of course, incomplete combustion through improper mixing must not be confused with that due to balanced reactions.

In addition to the above, there are a number of other factors contributing to the discrepancy between calculated and observed temperatures. The effect of moisture in the air is one of these. The amount of moisture present is readily obtained from meteorological reports or can be reported by the laboratory. If required, the effect of moisture on flame temperature could easily be calculated by adding the quantity of moisture to the products of combustion, and crediting the extra sensible heat contributed at the temperature of air preheat.

Use of Theoretical Flame Temperature.—The difference between theoretical and actual flame temperatures is so great that calculation of flame temperature is practically valueless in an established industry operating along normal lines.

If a new type of fuel is to be introduced for a particular purpose, it would be reasonable to see that the theoretical flame temperature fell in the same range as for fuels normally employed. Again, if a fuel is to be burnt with a deficiency of air in order to produce a reducing or non-scaling atmosphere, the theoretical temperature for the given mixture should be calculated, and should be at least several hundred degrees higher than the maximum temperature to be reached by the stock.

VIII.—CHARACTERISTICS OF INDUSTRIAL FUELS.

Table V shows the ordinary ranges in the composition and calorific value of the more common industrial fuels.

TABLE V.—CHARACTERISTICS OF FUELS.

A.—Solid Fuels.*

Fuel.	Fixed Carbon (Per cent.).	Volatile Matter (Per cent.).	Composition.			Calorific Value (Lower)	
			C %	H %	O %	B.Th.U's. per lb.	C.H.U's. per lb.
Lignite (including black lignite or sub-bituminous coal),	40-60	40-60	63-75	4-5-6	15-30	10,200-12,600	5700-7000
Bituminous (including semi-bituminous) coal,	60-88	12-40	70-92	4-6	4-20	11,500-15,500	6400-8600
Anthracite (including semi-anthracite or anthracitic coal),	88-97	3-12	90-95	2-4-5	2-4	14,500-15,500	8100-8600
Coke,	—	Up to 4%	94-98	—	—	about 14,500	about 8100

* These values are based on the "coal substance," assumed to be moisture and ash free. The ash will ordinarily be from 3 to 12 per cent. (but may be much greater), and moisture will vary from 2 to 15 per cent. for true coal and from 10 to 60 per cent. for lignite.

B.—Liquid Fuels.

Fuel.	Composition.				Calorific Value (Lower).	
	C %	H %	(O+N) %	S %	B.Th.U's. per lb.	C.H.U's. per lb.
Mineral fuel oil,	82-87	10-15	1-4	up to 2	17,250-18,800	9600-10,500
Coal tar (dry),	85-90	6-8	1-5	up to 1	15,750-16,200	8750-9000

C.—Gaseous Fuels.

Fuel.	Composition.							Calorific Value (Lower) per normal cubic foot.	
	CO	H ₂	CH ₄	C ₂ H ₄ *	CO ₂	O ₂	N ₂	B.Th.U's.	C.H.U's.
Producer gas (for furnaces), . . .	16.30	10.19	2.5	0.2-0.4	2.5-10	0.0-2	50.60	125-165	70-90
Blue water gas, . . .	37.45	45.53	0.4-2	—	2.5-5	0.4-0.6	2.5	260-290	145-160
Blast furnace gas, . . .	20.34	0.5-6	0.0-5	—	6-18	—	55-64	80-115	45-65
Carburetted water gas,	18.35	28.40	10.25	5-15	1.5	—	2.8	400-700	220-390
Coal gas,	5-14	42-48	20-42	3-7	0.5-5	0.5	2-10	400-600	220-330
Coke oven gas, . . .	5.8	47-60	25-35	2-6	1.3	0.5-1	2-12	390-550	215-310
Natural gas,	Up to 99 per cent. hydrocarbon, the chief constituent being CH ₄ , C ₂ H ₆ , or C ₃ H ₈ (usually the first), according to the source,							870-2270	480-1260

* These values in some cases include small quantities of hydrocarbons other than ethylene.

Empirical Relation Between Air Quantity, Heat from Combustion, and Waste Gas Quantity.—For very rough calculation, it is convenient to remember that, with the exception noted below, the theoretical air quantity is approximately one hundredth of the B.Th.U's. (lower) produced by combustion. Thus if 1 lb. of coal yields 13,500 B.Th.U's., then the theoretical air requirement per pound of coal is 135 normal cu. ft.; if the calorific value per cubic foot of coke oven gas is 450 B.Th.U's., then 1 cu. ft. of coke oven gas requires 4.5 cu. ft. of air; if the calorific value of fuel oil is 140,000 B.Th.U's. per U.S. gallon, then 1 gallon of oil requires 1400 cu. ft. of air. This rule cannot be applied to fuels of the producer gas family (including blast furnace gas) without making an adjustment. For these gases, if the percentage of carbon monoxide in the gas be subtracted from the B.Th.U. value per cubic foot, one hundredth of the remainder will approximate fairly closely to the air requirement. Thus in the producer gas used in earlier examples

$$\text{Calorific value} - \% \text{CO} = 149 - 28 = 121$$

One hundredth of this quantity gives, in this case, exactly the same result as obtained by full calculation.

The volume of flue gas, including moisture from combustion, is usually about 5 per cent. greater than the volume of air. Again this rule fails for the gaseous fuels high in nitrogen; and for these gases, as an approximation the per cent. of nitrogen in the

gas may be added to the B.Th.U. value per cubic foot, and the result divided by 100. In the producer gas example this gives $\frac{149 + 54}{100} = 2.03$ cu. ft. of flue gas, compared with 2.05 cu. ft. calculated.

The rules suggested here are usually accurate to within 10 per cent. and are frequently much closer. They may be useful when only the calorific value of a fuel is known.

SUMMARY OF USEFUL DATA AND FORMULÆ.

1. *Relation Between Molecular Weight and Volume.*—At 60° F. (15° C.) and 30 inches of mercury, one pound-molecule (the molecular weight considered as pounds) of any gas occupies 380 cu. ft. (p. 9).

2. *The Air.*—

(a) The composition of air by volume is 20.9% O₂, 79.1% N₂ (p. 10).

(b) The composition of air by weight is 23.2% O₂, 76.8% N₂ (p. 10).

(c) The mean molecular weight of air is about 28.8 (see p. 125).

(d) 1 cu. ft. of oxygen is accompanied in the air by 3.78 cu. ft. of nitrogen (p. 10).

3. *Air Required (Theoretically) for Combustion of Fuels.*—

(a) 1 cu. ft. of gaseous fuel requires

$$\frac{4.78}{100} \left(\frac{1}{2} \text{CO} + \frac{1}{2} \text{H}_2 + 2 \text{CH}_4 + 3 \text{C}_2\text{H}_4 - \text{O}_2 \right) \text{ cu. ft. of air,}$$

where CO, etc., represent the volume percentages present in the fuel.

(b) 1 lb. of coal, oil or tar requires approximately

$$1.5 \left[\text{C} + 3 \left(\text{H} - \frac{1}{8} \text{O} \right) \right] \text{ cu. ft. of air,}$$

$$\text{or } 0.115 \left[\text{C} + 3 \left(\text{H} - \frac{1}{8} \text{O} \right) \right] \text{ lb. of air,}$$

where C, H and O are the weight percentages present in the fuel.

4. *Products of Combustion (Theoretical) of Fuels.*—

(a) 1 cu. ft. of gaseous fuel yields

Carbon Dioxide = $1/100 [\text{CO}_2 + \text{CO} + \text{CH}_4 + 2 \text{C}_2\text{H}_4]$ cu. ft.Steam = $1/100 [\text{H}_2 + 2 \text{CH}_4 + 2 \text{C}_2\text{H}_4 + \text{H}_2\text{O}]$ cu. ft.Nitrogen = $1/100 [\text{N}_2 + 3\cdot78 (\frac{1}{2} \text{CO} + 2 \text{CH}_4 + \frac{1}{2} \text{H}_2 + 3 \text{C}_2\text{H}_4 - \text{O}_2)]$ cu. ft.where CO_2 , etc., are the volume percentages present in the fuel.

(b) 1 lb. of coal, oil or tar yields

Carbon Dioxide = $0\cdot317 \text{ C}$ cu. ft. = $0\cdot0367 \text{ C}$ lb.Steam = $1\cdot88 \text{ H} + 0\cdot21 \text{ H}_2\text{O}$ cu. ft.= $0\cdot09 \text{ H} + 0\cdot01 \text{ H}_2\text{O}$ lb.Nitrogen = $1\cdot19 [\text{C} + 3 (\text{H} - \frac{1}{8} \text{O})] + 0\cdot135 \text{ N}$ cu. ft.= $0\cdot088 [\text{C} + 3 (\text{H} - \frac{1}{8} \text{O})] + 0\cdot01 \text{ N}$ lb.

where C, etc., are the weight percentages present in the fuel.

5. *Ultimate CO_2 from Fuel Analysis.*—Gaseous, solid or liquid fuels.

$$\text{Ultimate } \text{CO}_2 = \frac{\text{Carbon dioxide} \times 100}{\text{Carbon dioxide} + \text{Nitrogen}}$$

where these quantities are calculated on a volume basis as in 4 (a) or (b) of this summary.

6. *Ultimate CO_2 from Flue Gas Analysis.*—

$$\text{Ultimate } \text{CO}_2 = \frac{\text{CO}_2 \times 100}{100 - 4\cdot78 \text{ O}_2}$$

where CO_2 and O_2 are the values obtained by actual flue gas analysis.7. *Other Stoichiometric Calculations.*—See Examples 1-9 (pp. 18-24).8. *Conversion of Higher to Lower Calorific Value.*Lower value (B.Th.U's.) = Higher value (B.Th.U's.) - $1050 (9 \text{ H} + \text{H}_2\text{O})$ Lower value (C.H.U's.) = Higher value (C.H.U's.) - $585 (9 \text{ H} + \text{H}_2\text{O}),$ where H and H_2O are the weights of hydrogen and water respectively in 1 lb. (or 1 cu. ft.) of fuel (p. 27).

9. *Calorific Value of Fuels from Analysis.*—

(a) Gaseous fuels, per normal cubic foot.

$$\begin{aligned} \text{Lower calorific value} &= (15.45 \text{ C}_2\text{H}_4 + 3.21 \text{ CO} + 2.75 \text{ H}_2 \\ &\quad + 9.12 \text{ CH}_4) \text{ B.Th.U's.} \\ &= (8.6 \text{ C}_2\text{H}_4 + 1.79 \text{ CO} + 1.53 \text{ H}_2 \\ &\quad + 5.08 \text{ CH}_4) \text{ C.H.U's.,} \end{aligned}$$

where C_2H_4 , etc., are the per cent. values shown by the gas analysis.

(b) Coal, per lb. (Dulong's formula, omitting sulphur and moisture).

$$\begin{aligned} \text{Lower calorific value} &= 146 \text{ C} + 517 \text{ H} - 76 \text{ O B.Th.U's.} \\ &= 81 \text{ C} + 287 \text{ H} - 42 \text{ O C.H.U's.,} \end{aligned}$$

where C, etc., are the percentages shown by the ultimate coal analysis (p. 33).

10. *Specific Heat and Sensible Heat.*—

$$\begin{aligned} Q &= W \times (t - t_0) \times c \\ &= W \times S \end{aligned}$$

where Q is the sensible heat of the quantity, W , of any substance at the temperature t as measured from a base temperature t_0 (60° F . or 15° C .), c is the mean specific heat per unit quantity of the substance, and S is the sensible heat per unit quantity of the substance, also measured from the base temperature (p. 35).

11. *Available Heat.*—The portion of the heat from combustion that is available to a furnace charge is the heat brought in by the fuel and air, minus the heat lost from the furnace chamber as explained on pages 40 *et seq.*

12. *Use of Flue Gas Analysis.*—When combustion is complete,

$$U = \frac{100 \text{ CO}_2}{100 - 4.78 \text{ O}_2} \quad (\text{p. 61})$$

$$\frac{\text{CO}_2}{U} + \frac{\text{O}_2}{20.9} = 1 \quad (\text{p. 61})$$

$$\begin{aligned} \text{Per cent. excess air} &= v \left(\frac{U}{\text{CO}_2} - 1 \right) \\ &= v \times \frac{\text{O}_2}{20.9 - \text{O}_2} \quad (\text{p. 61}) \end{aligned}$$

where U is the Ultimate CO_2 value, CO_2 and O_2 are the values reported in the flue gas analysis, and v is the volume of dry flue gas produced per 100 volumes of air with theoretically perfect combustion.

13. *Approximate Relation Between Air Quantity, Heat from Combustion, and Waste Gas Quantity.*—(a) Fuels which have not been manufactured by partial preliminary combustion.

Theoretical air requirement (in normal cubic feet) for any quantity of fuel = $\frac{\text{B.Th.U's. generated}^1}{100}$.

Theoretical volume of products of combustion (including moisture) = (Theoretical air requirement) \times 1.05.

(b) Fuels which have been manufactured by partial preliminary combustion (producer gas, blast furnace gas, etc.).

Theoretical air requirement (in normal cubic feet) for 1 cu. ft. of fuel = $\frac{(\text{Calorific value in B.Th.U's.}) - (\text{Per cent. CO in fuel})}{100}$.

Theoretical volume of products of combustion = $\frac{(\text{Calorific value in B.Th.U's.}) + (\text{Per cent. N}_2 \text{ in fuel gas analysis})}{100}$.

General References :—

1. W. A. Bone : *Coal and Its Scientific Uses.*
2. R. Haslam and R. Russell : *Fuels and Their Combustion.*
3. W. K. Lewis and A. H. Radasch : *Industrial Stoichiometry.*
4. W. Trinks : *Industrial Furnaces.*

¹ Based on lower calorific value. Values in C.H.U's. must be multiplied by 1.8 to convert to B.Th.U's.

CHAPTER III.

PROCESS BALANCE SHEETS.

I.—THE MATERIAL BALANCE.

IN any process involving a distributional change, it is possible to make a balance sheet showing all the materials entering into the process, and accounting for all of these materials in the output of the process. The principal purpose of a material balance sheet is to show where losses of a valuable product occur, to focus attention on the causes, and to indicate what may be done to control the extent of these losses.

A balance sheet may be constructed for a purely physical process such as the casting of metal, in which case the final distribution might include good castings, scrap castings, risers, runners, skulls, miscellaneous scrap, and unaccounted for losses. In the concentration and mechanical separation of complex ores of the non-ferrous metals, the establishment of a material balance sheet is of the greatest importance. It is intended to deal here with processes which combine both physical redistribution and chemical changes.

Recovery and Yield.—In any metallurgical process the recovery of the principal metal, expressed in per cent. of the input of that metal, should be known. For commercial purposes the term "yield" is frequently used to indicate the weight of the principal product expressed in per cent. of the weight of the metallic or metalliferous charge. For technical purposes this is inadequate. For example, the statement that the yield of pig iron from a blast furnace is 50 per cent. of the weight of ore conveys no indication of the extent of the metallic losses. The latter can be calculated only from the percentages of metal (iron and manganese) in the charge and in the pig iron. An acid Bessemer converter blow may show a yield of 90 per cent., but since 5 per cent. of the apparent loss may be due to elimination of the non-metallic and unwanted impurities, carbon and silicon, and part of the remaining 5 per cent. of metal is recovered as pouring scrap, the per cent. metallic recovery based on the actual metal content of the charge will be

much higher than the yield of 90 per cent. Steel open hearth furnace yields may, for similar reasons, indicate a fictitiously high loss ; or according to some methods of calculation which ignore metal introduced in the form of ore, they may show a figure much higher than the actual recovery, yields calculated on this basis often being over 100 per cent.

In some simple processes it is sufficient to know the per cent. recovery, this figure subtracted from 100 giving the loss. An ingot heating furnace in a rolling mill furnishes a typical example. If the loss in heating is 2 per cent., it is known that this is entirely an oxidation loss. In such a case the only technical question which can arise is whether this loss is typical of ordinary good practice for the particular type of furnace and fuel, size of ingot, conditions of heating, etc. The nature of the loss is definitely known, and also the factors which control this loss. In this instance, assuming that the ingots are charged free from runner scrap, brick, etc., the terms "yield" and "recovery" are synonymous.

In processes where losses occur in several ways, the individual losses should be investigated. The most important losses of metal in a smelting process are oxide losses in chemical combination with the slag, unrecovered metallic shot in the slag, mechanical losses during handling of the liquid metal, and unrecovered metal in dust and fume passing from the furnace and lost in handling of ores.

A material balance sheet relates to a given quantity (*e.g.* one ton, 100 parts by weight, or the actual weights as recorded in a test) of the principal product or of any other material entering into the process. It shows as completely as possible the weights of all the elements or compounds entering into the process, and the final distribution of these elements and compounds. The establishment of a detailed balance sheet requires complete and accurate knowledge of the weights and analyses of all materials entering and leaving the furnace.

Usually, the regular production data do not provide sufficient information for the construction of a complete balance sheet. The imperfect balance sheet which may be constructed from such data in many cases provides valuable indications. In other cases it may be desirable to collect additional data in a special test run, under conditions which are representative of the average practice.

Numerous balance sheets have been published in the technical journals covering all the more important metallurgical operations. Consequently it is not desirable to particularise here ; but since

abstract discussion must necessarily be more or less vague, the basic open hearth steel process has been selected as providing a good illustration of the construction and use of the balance sheet. It is believed that most readers will be sufficiently acquainted with the broad outline of this process to follow the discussion. To avoid details of no consequence to those not associated with this process, the balance sheet has been much simplified and cannot be regarded as typical of open hearth practice. Those associated with open hearth furnaces will readily appreciate how the balance sheet may be modified and amplified to suit actual conditions.

Basic Open Hearth Material Balance.—Suppose the balance sheet to be based on 100 tons of metal charged to the furnace. By “metal” is understood, in this instance, the full weight of steel scrap, pig iron and ferro-alloy additions, plus the iron and manganese content of ore additions. The actual weight of an element supplied by a constituent of the charge is obtained from the weight of that constituent and its chemical analysis. For example, suppose that 45 tons of liquid pig iron is charged and that the pig analysis shows 4.0 per cent. C, 1.2 per cent. Si, 1.0 per cent. Mn, 0.4 per cent. P; then the weights of the elements supplied by the pig iron are $45 \times 4.0/100 = 1.8$ tons of C, $45 \times 1.2/100 = 0.54$ ton of Si, 0.45 ton of Mn, 0.18 ton of P, and, by difference, 42.03 tons of Fe. Suppose the total quantities of the principal elements from the various sources are 2.0 tons of C, 0.6 ton of Si, 1.2 tons of Mn, 0.2 ton of P, and 96.0 tons of Fe. These figures are shown in Table VI, row 1. During the process, the silicon is

TABLE VI.—THE MATERIAL BALANCE SHEET.

		Weight (tons).	C.	Si.	Mn	P.	Fe.	SiO ₂ .	CaO.	
1.	Input	Metallic charge,	100	2.0	0.6	1.2	0.2	96.0	(1.29)	—
2.		Non-metallic charge,	—	—	—	—	—	0.5	5.0	
3.		Total,	—	2.0	—	1.2	0.2	96.0	1.79	5.0
4.	Output	Steel tapped,	94.0	0.09	—	0.47	0.02	93.42	—	—
5.		Slag tapped,	12.0	—	—	0.65	0.18	1.8	2.16	4.92
6.		Total,	—	0.09	—	1.12	0.20	95.22	2.16	4.92
7.	Balances	Unaccounted for losses,	—	1.91	—	0.08	—	0.78	—	0.08
8.		Unaccounted for gain,	—	—	—	—	—	—	0.37	—

oxidised entirely to silica. It is consequently convenient to calculate the quantity of silica produced and to enter this figure, $0.6 \times \frac{28 + 32}{28} = 1.29$, under the SiO_2 column, cancelling the entry under the Si column. It will be observed that all of the information necessary for completing row 1 is either directly available from routine data, or can be very closely estimated.

In a study of the balance sheet, the non-metallic constituents of the charge are at least as important as the metallic portions. Neglecting less important contributions, suppose that the fluxes, ore, etc., contribute 0.5 ton of SiO_2 and 5.0 tons of CaO. Again the weights and analyses of the most important sources of these earthy materials are known. Minor sources may be estimated fairly closely. Table VI, row 2, shows these substances, and row 3 gives the totals, completing the input side of the balance sheet.

Turning to the output, the "yield" of liquid steel is known from the weight of ingots and pouring scrap, with a suitable small allowance for handling losses. Suppose the 100 tons of "metallic charge" to yield 94 tons of liquid steel, showing an analysis of 0.1 per cent. C, 0.0 per cent. Si, 0.5 per cent. Mn, 0.02 per cent. P, then the output of these elements and also of iron in the form of steel may be calculated, and is recorded in Table VI, row 4.

The other important item on the output side is the slag. If this weighs 12 tons and contains 15 per cent. Fe (as FeO and Fe_2O_3), 5.4 per cent. Mn (as MnO), 18 per cent. SiO_2 , 41 per cent. CaO, 1.5 per cent. P (as P_2O_5), then the weights of these elements and oxides are as calculated and entered in row 5. The manganese and usually the iron present in the slag are reported in the analysis as oxides. These are converted by calculation to give actual iron and manganese content, in order that the weights may be on a basis comparable with that used to record input of these elements.

Of the quantities referred to, the weight of slag is the only one not ordinarily available. In a test run this quantity may easily be obtained; but if this is not found convenient, in most cases it may be calculated with reasonable accuracy. If, for example, we know that 5 tons of CaO enters the slag from the limestone, dolomite, and ore, and that the slag analysis shows 41 per cent. CaO, then the weight of slag must be $5 \times 100/41 = 12$ tons. There are also other methods available for calculating the weight of slag.

The balance sheet represents tons, but being based on 100 tons of metallic charge, the figures also show the per cent. distribution.

From the balance sheet it is seen that, although the yield of steel tapped is only 94 per cent., the recovery of iron is $93.42/96.0 = 97.3$ per cent. of that supplied. The balance given is not complete, the less important constituents having been omitted in order to simplify the illustration. Also the fuel and air entering into the process have been omitted, partly because these quantities are frequently not easily measured, but mainly because they are of minor importance in the interpretation of the results.

Rows 7 and 8 of Table VI show the quantities of materials not accounted for, these being the differences between the input and output totals. The 1.91 per cent. of carbon naturally passes out through the chimney with the waste gases as carbon dioxide. Volatile constituents of fluxes, etc. (not shown in the balance sheet) are accounted for in the same way. Since the furnace gases are not considered, there is no need to consider the redistribution of oxygen involved in the conversion of elements to oxides and *vice versa*. A small loss of all materials occurs through carrying of dust and fume from the melting chamber with the waste gases. This would account for the small manganese and lime losses and for about one-half of the iron loss. The remaining iron "loss" is due partly to loss of metallic shot in the slag,¹ but mainly to non-metallic impurities weighed in with the metallic charge. These impurities include oxygen and moisture associated with rusty scrap, earthy material, and other substances recorded as iron. This "loss" of iron is therefore fictitious, being in reality in the nature of a weighing error. Some silica is lost with the waste gases, but this is more than offset by the accidental charging of earthy material, etc., with scrap, and by the fluxing away of acid portions of the furnace, showing the 0.37 ton gain recorded in the table.

Interpretation of the Material Balance.—The balance sheet serves to draw attention to the following points:—

(a) About 3.4 tons of carbon, silicon, manganese and phosphorus are oxidised from the charge. This represents an unavoidable loss of yield—but not of iron recovery. If the nature of the available raw materials or the process makes this quantity of impurities either unavoidable or desirable, then this represents an inevitable smelting loss.

(b) From Table VI, row 5, we find that 2.16 tons of silica in the slag is associated with 2.45 tons of iron and manganese.

¹ The iron in the slag shown by the balance sheet does not include metallic shot, metallics always being separated from the ground slag prior to analysis.

This ratio for a given type of charge and method of operation will be more or less constant, so we may say that each ton of silica entering the charge will cause a direct loss of at least one ton of metal. One ton of silicon in the metallic portion of the charge will produce a little over 2 tons of silica and therefore will cause a loss in the slag of over 2 tons of metal, in addition to the loss referred to in point (a).

(c) If the slag contains about 20 per cent. of acid oxides ($\text{SiO}_2 + \text{P}_2\text{O}_5$), then each ton of silica introduced results in the formation of 5 tons of slag; and each ton of silicon produces about twice this quantity.

Considerations (b) and (c) will have an important bearing on the relative value of the different raw materials which may be available.

(d) The unaccounted for iron "loss" of 0.78 ton is indicative of a good grade of scrap. With very light rusty scrap the loss may be very much greater. If this greater loss is due only to the presence of rust and moisture, there will be a "loss of yield" due to the weight of contained oxygen and hydrogen recorded as scrap, and also actual "loss of recovery" due to the much greater loss of iron carried out by the furnace gases. The amount of earthy material present in this grade of scrap is likely to be greater than in the case of heavy scrap. This should show in row 8 of the balance sheet as an abnormally large gain of silica. The effect of this extra silica (considerations (b) and (c)) would constitute an additional disadvantage of this type of scrap.

Modifications of the Material Balance.—The above illustration demonstrates the principle of balance sheet construction, and the nature of conclusions which may be drawn from the tabulated data. Naturally the method of treatment will vary for different processes. For example, in processes carried out in hearth type furnaces, like that used in illustration, it is convenient to leave the fuel and waste gases out of consideration. In other cases, such as blast furnace processes, the fuel may make important contribution of matter to the metal or slag, or to both. In such processes the fuel, and desirably the air supplied and the waste gases, should also be included. Gas quantities may be calculated as explained in Chapter II.

It will be observed that some of the conclusions reached from the illustration might have been arrived at without actual construction of the balance sheet; others required the balance sheet. In any case, the orderly method of tabulation established

in a balance sheet forms a desirable basis for calculation. The material balance sheet is moreover helpful in the construction of the heat balance sheet, considered later in this chapter.

In many processes it may be just as important to trace the distribution of an objectionable impurity as to account for the principal metal charged to the furnace. In the open hearth illustration, sulphur may prove to be an example. If there is an unaccounted for pick up of sulphur, it most probably comes from the fuel. The extent of sulphur contributed by different sources may be a determining factor in the selection of raw materials.

The small real losses incidental to most processes are usually too difficult to determine from routine data or even from minor extension of routine procedure. These include loss in the form of dust and fume carried away by the waste gases (in some cases a very heavy loss), loss as dust in the handling of raw materials (particularly friable ores), loss as metallic shot in the slag, and losses through splashing and oxidation during the handling of liquid metal. In most cases, carefully conducted experiments have determined what will be the probable extent of these losses, and these results will be found in the original contributions to technical literature. If the unaccounted for losses found from a balance sheet are consistent with published data for the process, further investigation of these will be unnecessary. A serious discrepancy, on the other hand, should be investigated more closely, if necessary by a special test run.

Associated with the real losses are the apparent losses due to inaccuracies of data, including errors in weighing, errors in sampling, and errors in analysis. Weighing errors may be eliminated in a test run by weighing separately the charge car after it has dumped its contents in the furnace. This is particularly necessary when molten material is being handled, owing to solidification in the ladle of skulls which may be weighed repeatedly and yet never reach the furnace. In ordinary practice, excepting in the case just cited, it is sufficient to deduct the tare as recorded on the car.

Sampling errors are very important in dealing with non-ferrous ores, and especially in the case of ores or base metal smelter products containing precious metals. Steel smelting processes present a special problem in that there is no practical means of sampling the miscellaneous scrap used. In this case, as already explained, the balance sheet is actually used as a means, other losses being normal, of estimating the weight of foreign material present. The

average analysis, apart from foreign material, is of course fairly easy to estimate from the nature of the scrap.

Errors of analysis must not be overlooked as a source of inaccuracy in the balance sheet. Still larger errors may result from foreign matter introduced, but for obvious reasons not included in the analysis. The most important of these are moisture and snow, which vary in accordance with the weather and storage facilities, and earthy matter which may be picked up with material stored on the ground. Slag floating on the surface of liquid metal charges may frequently cause further inaccuracy.

In addition to these general observations, it is clear that an individual process may show potential sources of error peculiar to that process. Special cases may cover such losses as theft in the case of precious metal processes; solution losses in the case of wet extraction methods; losses in the form of soot and tar, unburnt carbon in the ashes, and gas leakage in the case of producer gas manufacture; and a host of others in the different fields of metallurgy.

In conclusion, it may be said that while it is essential to know the recovery of metal, it does not follow that the maximum recovery or the maximum yield attainable is necessarily consistent with the maximum economy. A great many other factors may combine to make it uneconomical to retrieve a loss which is metallurgically recoverable.

II.—HEAT BALANCE.

A material balance sheet shows all the materials entering a furnace charge, and accounts for these materials on the output side of the balance sheet. In exactly the same way it is possible to make a heat balance sheet, showing all the heat units put into the furnace system and all taken out from it. If all sources of heat input and output were accurately known, the totals would be found to be equal, so that in establishing a heat balance it is necessary to itemise as carefully as possible all these sources.

Usually the chief sources of heat input are :—

- (1) Heat of combustion of fuel.
- (2) Sensible heat of fuel (if preheated).
- (3) Heat content of hot material charged to the furnace.
- (4) Heat supplied by chemical reactions taking place in the charge.

The most important sources of heat output are :—

- (1) Heat content of hot solid and liquid products of the operation.
- (2) Sensible heat of waste gases.
- (3) Heat losses from the furnace structure to the surroundings, and heat used to raise the temperature of the structure.
- (4) Heat loss due to incomplete combustion of the fuel.
- (5) Heat required by chemical reactions taking place in the charge.

It will be observed that chemical reactions in the charge are given as a possible source of input and also of output. In some cases the charge supplies heat as a net result of chemical action, and in some cases the reactions require heat. Ordinarily this item will appear either on the input side or on the output side, but not on both sides of the balance sheet.

The heat supplied by fuel may be replaced by heat from electric energy. In furnaces where preheated air is used, the sensible heat of the air is entered on the input side, provided this heat has been supplied by an external source, as in the blast furnace. If the air has received its preheat from the sensible heat of the waste gas, it is usually more convenient to treat the heat exchanging apparatus as part of the furnace, and not to credit the sensible heat of the air as input.

An example of a heat balance will be helpful in discussing the various sources of input and output. A steel charge was used in illustration of the material balance, and we can do no better than construct a heat balance for the same process. The various items can then be explained in general terms.

Construction of Heat Balance.—In establishing a heat balance, it is necessary to know much of the information shown in the material balance sheet. The material balance sheet given in the earlier part of this chapter has been used in constructing Table VII.

A heat balance sheet may be based on any convenient quantity or time. For example, it could be made on the basis of an entire batch; but, as in the case of a steel heat, the heat quantities would be inconveniently large and would not be convenient for purposes of comparison. It could be based on the complete operation for one ton of charge, or one ton of finished product, etc. In the illustration, the basis is one ton (2240 lb.) of steel tapped from the furnace. Again, it would be possible to base the heat balance on the quantity of material entering and leaving

TABLE VII.—HEAT BALANCE FOR ONE TON (2240 LB.) OF STEEL TAPPED.

HEAT INPUT.		
Heat Contribution.	Heat Units (in millions).	
	B.Th.U's.	C.H.U's.
Heat from combustion of producer gas.	4.47	2.48
Sensible heat of producer gas,	0.63	0.35
Heat contained by hot material charged (liquid pig iron),	0.58	0.32
Net heat supplied by chemical reactions in the charge,	0.76	0.42
Total,	6.44	3.57
HEAT OUTPUT.		
Heat Distribution.	Heat Units (in millions).	
	B.Th.U's.	C.H.U's.
Heat contained by molten steel,	1.41	0.78
" " " slag,	0.27	0.15
Sensible heat of waste gases,	1.80	1.00
Heat losses through walls of furnace, etc. (Balance),	2.96	1.64
Total,	6.44	3.57

the furnace in a period of time, such as one hour, although this would not be a logical basis for batch type furnaces. When the balance sheet has been completed, it is often convenient to convert it to a per cent. basis, taking, for example, the total heat input (or output) to be 100, and converting the other heat quantities proportionately. Thus, Table VII would be converted to:—

TABLE VIII.—HEAT BALANCE ON A PER CENT. BASIS.

Contribution.	Per cent. of total.	Distribution.	Per cent. of total.
Heat from combustion of producer gas,	69.4	Heat contained by molten steel,	21.9
Sensible heat of producer gas,	9.8	Heat contained by molten slag,	4.2
Heat contained by hot material charged,	9.0	Sensible heat of waste gases,	27.9
Net heat supplied by chemical reactions,	11.8	Heat losses through walls, etc.,	46.0
Total,	100.0	Total,	100.0

The individual items of the Heat Balance Sheet (Table VIII) will now be explained.

Heat from Combustion of Producer Gas.—The quantity of producer gas may be calculated (Chapter II) from the average gas analysis and the weight of coal consumed at the producers over a test period, or from average production figures. For this illustration, the quantity assumed is 30,000 normal cu. ft. The calorific value per cubic foot is calculated from the gas analysis, the value here used being 149 B.Th.U's. (83 C.H.U's.) per cu. ft.

Instead of working on this basis, we could have taken the heat supplied by the fuel as the heat of combustion of the coal fed to the producers, *i.e.* lb. of coal multiplied by calorific value of coal. This method is simpler, but it includes heat losses at the producer itself, preferably the subject of a separate study. For fuels which lend themselves to direct metering, the determination is simple. For mixed gases it is best to calculate the different fuels separately.

The Sensible Heat of the Producer Gas is obtained from the quantity of gas and the sensible heat per cubic foot. The latter is calculated as previously explained, the value in this example being taken as 21 B.Th.U's. (12 C.H.U's.) per cu. ft. If the heat of combustion had been obtained directly from the coal used, the sensible heat of the producer gas would have been omitted, since this would have been produced by partial combustion of the coal and would therefore have been included in the calorific value of the coal. On the other hand, for a balance in which this second course is followed, the sensible heat of the steam used in the producers should be added to the heat of combustion of the coal. For liquid fuels, sensible heat is often supplied by warming the fuel, and also by steam when the latter is used for atomising—both should be included in the heat input unless the waste gases are used to supply the preheat.

Heat Content of Hot Material.—The heat content per pound of hot material is obtained from Table IX, A and B. Except where otherwise stated, the values in this table are calculated from tables and equations by K. K. Kelley.¹ Kelley also lists numerous other elements and compounds of smaller metallurgical importance, and for additional data the reader is referred to the original publication.

¹ Kelley, K. K. "Contributions to the Data on Theoretical Metallurgy. II.—High-Temperature Specific Heat Equations for Inorganic Substances," *Bureau of Mines, Bulletin* 371, 1934. Also, "I.—The Entropies of Inorganic Substances," *Bulletin* 350, 1932, and "V.—Heats of Fusion of Inorganic Substances," *Bulletin* 393, 1936.

TABLE IXA.—SENSIBLE HEAT PER POUND OF MATERIAL (FAHRENHEIT UNITS, CONSTANT PRESSURE).

I.—ELEMENTS.

Temperature ° F.	Ag.		Al.		As.	Au.		Bi.		C. (graphite.)		Cd.		Co.		Cr.†		Cu.		Temperature ° F.
	Sens. Heat.	Diff. per ° F.	Sens. Heat.	Diff. per ° F.	Sens. Heat.	Sens. Heat.	Diff. ° F.	Sens. Heat.	Diff. ° F.	Sens. Heat.	Diff. ° F.	Sens. Heat.	Diff. ° F.	Sens. Heat.	Diff. ° F.	Sens. Heat.	Diff. ° F.	Sens. Heat.	Diff. ° F.	
60	0	-057	0	.21	0	0	-029	0	-021	0	-057	0	-037	0	-107	0	-114	0	-083	60
200	8	-055	11	.225	4	4	-03	4	.29	29	8	-055	15	-11	15	-12	16	13	-095	200
400	19	-06	28	.24	10	10	-03	10	.79	79	19	-06	37	-115	37	-13	40	32	-10	400
600	31	-06	45	.265	17	39	-035	39	139	139	31	-06	60	-125	60	-135	66	52	-10	600
800	43	-065	63	.27	24	46	-035	46	205	205	68	-06	85	-13	85	-145	93	72	-10	800
1000	56	-066	81	(1217.5° F. 170)*	31	53	-034	53	281	281	80	-06	111	-14	111	-15	122	92	-11	1000
1500	89	(1762° F. 45)*26	48	71	-036	71	494	494	...	(1413° F. 383)†	181	-16	181	-17	199	146	(1983° F. 88)*	1500
2000	170	89	89	-042	89	717	717	...	Specific Heat of Vapour = 0.0445	263	-17	263	-18	284	290	-12	2000
2500	110	...	-044	...	954	954	...	(2714° F. 112)*	349	-20	349	-20	376	349	-12	2500
2750	121	1072	1072	...	(3326° F. 167)*	501	-20	501	-20	425	379	-12	2750

* Melting Point. † Boiling Point. ‡ Based on private communication from K. K. Kelly (Nov. 1937).

TABLE IXA.—SENSIBLE HEAT PER POUND OF MATERIAL (FAHRENHEIT UNITS)—(continued).
I.—ELEMENTS—(continued).

Temperature ° F.	Fe.		Mn.		Mo.		Ni.		Pb.		Sb.		Si.		Sn.		W.		Zn.		Temperature ° F.
	Sensible Heat.	Diff. per ° F.	Sensible Heat.	Diff. per ° F.	Sensible Heat.	Diff. per ° F.	Sensible Heat.	Diff. per ° F.	Sensible Heat.	Diff. per ° F.	Sensible Heat.	Diff. per ° F.	Sensible Heat.	Diff. per ° F.	Sensible Heat.	Diff. per ° F.	Sensible Heat.	Diff. per ° F.	Sensible Heat.	Diff. per ° F.	
60	0	.107	0	.114	0	.057	0	.107	0	.029	0	.05	0	.18	0	.077	0	.036	0	.093	60
200	15	.12	16	.125	8	.065	15	.12	4	.035	7	.05	25	.19	8	.06	5	.03	13	.095	200
400	39	.135	41	.135	21	.07	39	.13	11	.03	17	.06	63	.265	20	.06	11	.035	32	.105	400
600	66	.15	68	.16	35	.07	65	.135	17	.03	29	.05	104	.21	57	.06	18	.055	53	.105	600
800	96	.165	100	.175	49	.075	94	.135	34	.035	39	.055	146	.215	69	.055	25	.03	117	.13	800
1000	129	.175	135	.20	64	.079	121	.135	41	.034	50	.055	189	.22	80	.054	31	.036	143	.13	1000
1500	231	.188	233	.195	102	.082	187	.14	58	.032	150	.058	300	.22	107	.054	49	.036	206	.13	1500
2000	320	.195	330	.205	143	.09	258	.14	74	.03	179	.06	67	.038	Specific Heat of Vapour = 0.065	...	2000
2500	397	.205	544	.22	188	.092	327	.14	86	.04	2500
2750	444	.21	594	...	211	96	2750

* Melting Point. † Boiling Point. ‡ Crystalline Change.

TABLE IXA.—SENSIBLE HEAT PER POUND OF MATERIAL (FAHRENHEIT UNITS)—(continued).

2.—BINARY COMPOUNDS OF THE HEAVY METALS.

Tem- perature ° F.	Bi ₂ O ₃		CaO.		CaS.		Cr ₂ O ₃		CuO.		Cu ₂ S.		Cu ₃ S.		FeO.		Fe ₃ O ₄		Tem- perature ° F.
	Sen- sible Heat.	Dif- fer- ence per ° F.	Sen- sible Heat.	Dif- fer- ence per ° F.	Sen- sible Heat.	Dif- fer- ence per ° F.	Sen- sible Heat.	Dif- fer- ence per ° F.	Sen- sible Heat.	Dif- fer- ence per ° F.	Sen- sible Heat.	Dif- fer- ence per ° F.	Sen- sible Heat.	Dif- fer- ence per ° F.	Sen- sible Heat.	Dif- fer- ence per ° F.	Sen- sible Heat.	Dif- fer- ence per ° F.	
60	0	-.057	0	-.079	0	-.083	0	-.18	0	-.136	0	-.12	0	-.12	0	-.17	0	-.16	60
200	8	-.06	13	-.085	13	-.09	25	-.185	19	-.14	17	-.12	17	-.12	24	-.18	22	-.185	200
400	20	-.065	31	-.085	31	-.085	62	-.185	47	-.155	56	-.145	41	-.125	60	-.18	59	-.215	400
600	33	-.065	50	-.085	50	-.09	99	-.185	78	-.16	85	-.14	66	-.13	96	-.19	102	-.22	600
800	46	-.075	68	-.085	68	-.085	136	-.195	110	...	113	-.135	92	-.13	134	-.19	146	-.24	800
1000	61	...	87	-.08	87	-.086	175	-.20	140	-.13	118	-.14	172	-.20	194	-.245	1000
1500	...	(1503° F. 26)	135	-.10	135	...	272	-.21	204	...	187	...	273	...	317	...	1500
2000	-.10	374	-.22	2000
2500	-.11	480	2500
2750	534	2750

* Melting Point. † Crystalline Change.

TABLE IXA.—SENSIBLE HEAT PER POUND OF MATERIAL (FAHRENHEIT UNITS)—(continued).

2.—BINARY COMPOUNDS OF THE HEAVY METALS—(continued).

Temperature ° F.	Fe ₂ O ₃		FeS.		FeS ₂		HgS		MnO.		Mn ₂ O ₃		Mn ₃ O ₄		MnO ₂		MnS.		Temperature ° F.
	Sensible Heat.	Diff. per ° F.	Sensible Heat.	Diff. per ° F.	Sensible Heat.	Diff. per ° F.	Sensible Heat.	Diff. per ° F.	Sensible Heat.	Diff. per ° F.	Sensible Heat.	Diff. per ° F.	Sensible Heat.	Diff. per ° F.	Sensible Heat.	Diff. per ° F.	Sensible Heat.	Diff. per ° F.	
60	0	.16	0	.16	0	.12	0	.05	0	.15	0	.16	0	.15	0	.16	0	.136	60
200	22	.18	23	(380° F. 21)†	17	.125	7	.055	21	.155	22	.18	21	.17	23	.19	19	.145	200
400	58	.20	79	.15	42	.135	18	.055	52	.17	58	.195	55	.18	61	.21	48	.15	400
600	98	.22	109	.155	69	.145	29	.055	86	.175	97	.215	91	.20	103	.23	78	.155	600
800	142	.23	140	.16	98	...	40	.06	121	.19	140	.23	131	.21	149	.235	109	.16	800
1000	188	.235	172	.165	52	...	159	.20	186	.23	173	.22	196	...	141	.16	1000
1500	306	...	253	.18	258	.21	303	.23	285	.23	222	.17	1500
2000	342	(2183° F. 102)†	361	.21	402	.23	306	.165	2000
2500	466	.21	516	.23	389	.17	2500
2750	518	.21	573	.23	431	...	2750

* Melting Point. † Crystalline Change.

TABLE IXA.—SENSIBLE HEAT PER POUND OF MATERIAL (FAHRENHEIT UNITS)—(continued).
 2.—BINARY COMPOUNDS OF THE HEAVY METALS—(continued).

Tem- perature ° F.	Pbs.		Sb ₂ O ₃ .		Sb ₂ O ₄ .		Sb ₂ S ₃ .		SnO.		SnO ₂ .		SnS.		ZnO.		ZnS.		Tem- perature ° F.
	Sen- sible Heat.	Dif- fer- ence per ° F.	Sen- sible Heat.	Dif- fer- ence per ° F.	Sen- sible Heat.	Dif- fer- ence per ° F.	Sen- sible Heat.	Dif- fer- ence per ° F.	Sen- sible Heat.	Dif- fer- ence per ° F.	Sen- sible Heat.	Dif- fer- ence per ° F.	Sen- sible Heat.	Dif- fer- ence per ° F.	Sen- sible Heat.	Dif- fer- ence per ° F.	Sen- sible Heat.	Dif- fer- ence per ° F.	
60	0	·05	0	·086	0	·083	0	·086	0	·079	0	·083	0	·086	0	·12	0	·11	60
200	7	·05	12	·09	13	·095	12	·085	11	·08	13	·093	12	·085	17	·135	16	·12	200
400	17	·055	30	·095	32	·10	29	·095	27	·085	32	·11	29	·085	44	·14	40	·125	400
600	28	·055	49	·105	52	·115	48	·095	44	·09	54	·11	46	·09	72	·145	67	·13	600
800	39	·055	70	·11	75	·11	67	·10	62	·09	76	·12	64	·085	101	·155	93	·13	800
1000	50	...	92	(1211° F. 83)*	97	·12	87	(1015° F. 30)*	80	·095	100	·13	81	·09	132	·155	119	·135	1000
1500	158	128	·11	163	·14	127	...	209	·16	186	...	1500
2000	...	(2037° F. 31)*	(180)	...	232	289	2000
2500	2500
2750	2750

* Melting Point.

TABLE IXA.—SENSIBLE HEAT PER POUND OF MATERIAL (FAHRENHEIT UNITS)—(continued).

3.—EARTHY MATERIALS AND COMPOUNDS OF THE LIGHT METALS.

Temp- erature ° F.	Al ₂ O ₃		AlF ₃ · 3NaF.		CaO.		CaCO ₃		MgO.		SiC.		SiO ₂ (Quartz)		SiO ₂ (Cristobalite).		ZrO ₂ .		Temp- erature ° F.
	Sen- sible Heat.	Dif- fer- ence per ° F.	Sen- sible Heat.	Dif- fer- ence per ° F.	Sen- sible Heat.	Dif- fer- ence per ° F.	Sen- sible Heat.	Dif- fer- ence per ° F.	Sen- sible Heat.	Dif- fer- ence per ° F.	Sen- sible Heat.	Dif- fer- ence per ° F.	Sen- sible Heat.	Dif- fer- ence per ° F.	Sen- sible Heat.	Dif- fer- ence per ° F.	Sen- sible Heat.	Dif- fer- ence per ° F.	
60	0	.20	0	.24	0	.19	0	.21	0	.23	0	.18	0	.19	0	.20	0	.11	60
200	28	.22	33	.265	26	.20	29	.225	32	.24	23	.21	26	.21	28	.22	15	.135	200
400	72	.25	86	.285	68	.22	74	.25	80	.265	67	.23	69	.245	72	.25	42	.135	400
600	122	.27	143	.34	110	.235	124	.275	133	.27	113	.26	118	.26	128	.25	69	.14	600
800	176	.275	211	.36	157	.24	179	.285	187	.285	165	.265	172	.275	178	.265	97	.15	800
1000	231	.28	283	.40	205	.25	236	...	244	.29	218	.28	227	(1067° F. 6)†	231	.275	127	.17	1000
1500	372	.33	482	(1830° F. 140)*	328.5	392	.31	359	.31	372	.29	389	.28	213	.20	1500
2000	537	.35	883	.68	546	.31	514	...	515	.28	509	.29	314	.22	2000
2500	712	.36	702	.32	657	...	656	.30	423	...	2500
2750	801	781	731	2750

* Melting Point.

† Crystalline Change.

TABLE IXA.—SENSIBLE HEAT PER POUND OF MATERIAL (FAHRENHEIT UNITS)—(continued).
5.—IMPORTANT MIXTURES (TYPICAL VALUES).

Temperature ° F.	* Earthy mixtures and slags.		† Fireclay and Silica Brick.		Magnesite Brick.		‡ Chrome Brick.		Temperature ° F.
	Sensible Heat.	Diff. per ° F.	Sensible Heat.	Diff. per ° F.	Sensible Heat.	Diff. per ° F.	Sensible Heat.	Diff. per ° F.	
60	0	.19	0	.20	0	.23	0	.18	60
200	27	.215	28	.21	32	.245	25	.19	200
400	70	.25	70	.225	81	.265	63	.20	400
600	120	.26	115	.245	134	.27	103	.215	600
800	172	.27	164	.26	188	.28	146	.215	800
1000	226	.28	216	.27	244	.28	190	.23	1000
1600	361	.30	358	.31	392	.32	304	.24	1500
2000	509	.31	514	.33	554	.34	425	.25	2000
2500	663	.31	678	.34	(724)	...	(550)	...	2500
2750	(740)	.31	759	.34	2750

* Mixtures made up chiefly of light oxides and their compounds. Slags containing much of the oxides of the heavy metals will have a lower specific heat. The figures should be used only up to the melting point of the material.

† Composite values from various sources.

‡ Calculated value for a mixture containing 60 per cent. Cr_2O_3 + FeO and 40 per cent. earthy materials.

TABLE IXB.—SENSIBLE HEAT PER POUND OF MATERIAL (CENTIGRADE UNITS, CONSTANT PRESSURE).

1.—ELEMENTS.

Temperature °C.	Ag.		Al.		As.		Au.		Bi.		C (graphite.)		Cd.		Co.		Cr.†		Cu.		Temperature °C.
	Sens- ible Heat.	Diff. per ° C.	Sens- ible Heat.	Diff. per ° C.	Sens- ible Heat.	Diff. per ° C.	Sens- ible Heat.	Diff. per ° C.	Sens- ible Heat.	Diff. per ° C.	Sens- ible Heat.	Diff. per ° C.	Sens- ible Heat.	Diff. per ° C.	Sens- ible Heat.	Diff. per ° C.	Sens- ible Heat.	Diff. per ° C.	Sens- ible Heat.	Diff. per ° C.	
15	0	-059	0	-082	0	-035	0	-035	0	-085	0	.21	0	-059	0	-106	0	.118	0	.094	15
100	5	-05	18	-08	7	-03	3	-03	3	-03	18	.25	5	.06	9	.11	10	.12	8	.09	100
200	10	-06	41	-09	15	-03	6	-03	6	(271° C. 12)*	43	.29	11	.06	20	.115	22	.13	17	.10	200
300	16	-06	65	-08	24	-03	9	-03	21	-035	72	.34	17	(321° C. 13)*	31.5	.125	35	.13	27	.10	300
400	22	-065	91	-085	32	-035	12	-035	24.5	-0375	106	.38	36	.06	44	.13	48	.145	33	.105	400
600	35	-065	145	...	51	...	19	-035	32	-035	182	.43	48	.065	70	.14	77	.155	58	.105	600
800	48	(901° C. 25)*	293	26	-035	39	-04	268	.445	(767° C. 213)†	Specific Heat of Vapour = 0.0445	98	.155	108	.165	79	.115	800
1000	87	-075	345	33	(1063° C. 15)*	47	...	357	.46	129	.165	141	.18	102	(1084° C. 49)*	1000
1200	102	56	.035	449	.47	162	(1490° C. 62)*	177	.19	174	.12	1200
1500	67	591	277	(1830° C. 93)*	234	...	209	...	1500

* Melting Point. † Boiling Point. ‡ Based on private communication from K. K. Kelley (Nov. 1937).

TABLE IXB.—SENSIBLE HEAT PER POUND OF MATERIAL (CENTIGRADE UNITS)—(continued).

I.—ELEMENTS—(continued).

Temperature °C.	Fe.		Mn.		Mo.		Ni.		Pb.		Sb.		Sl.		Sn.		W.		Zn.		Temperature °C.
	Sensible Heat.	Diff. per °C.	Sensible Heat.	Diff. per °C.	Sensible Heat.	Diff. per °C.	Sensible Heat.	Diff. per °C.	Sensible Heat.	Diff. per °C.	Sensible Heat.	Diff. per °C.	Sensible Heat.	Diff. per °C.	Sensible Heat.	Diff. per °C.	Sensible Heat.	Diff. per °C.	Sensible Heat.	Diff. per °C.	
15	0	-106	0	-106	0	-059	0	-106	0	-035	0	-047	0	-175	0	-059	0	-035	0	-084	15
100	9	-12	9	-13	5	-065	9	-12	3	-03	4	-05	15	-19	5	-06	3	-03	8	-10	100
200	21	-13	22	-14	12.5	-065	21	-13	6	-03	9	-06	34	-20	11	(231.8°)	6	-03	18	-10	200
300	34	-15	36	-15	18	-07	34	(323°)	9	(327.4°)	15	-05	54	-21	31	(14.5°)*	9	-04	28	-11	300
400	49	-165	51	-175	25	-075	49	(C. 1.6)†	18	-035	20	-055	75	-215	37	-055	13	-035	39	(419.5°)	400
600	82	(768°)	86	-20	40	-075	75	-185	25	-035	31	(630°)	118	-225	48	-055	20	-035	87	(C. 24.4)*	600
800	124	(908°)	126	(835°)	55	-085	102	-185	32	-03	82	(C. 39)*	163	...	59	-055	27	-035	112	(905°)	800
1000	164	(1044°)	164	(1044°)	72	-085	129	-14	38	...	91	70	...	34	-035	...	(C. 432)†	1000
1200	194	(1401°)	205	(1220°)	89	-09	157	(1462°)	(1427°)	41	-04	...	Heat of Vapour = 0.065	1200
1500	246	(1530°)	328	(C. 63)*	116	...	272	(C. 72)*	(C. 337)*	53	1500

* Melting Point. † Boiling Point. ‡ Crystalline Change.

TABLE IX.B.—SENSIBLE HEAT PER POUND OF MATERIAL (CENTIGRADE UNITS)—(continued).
2.—BINARY COMPOUNDS OF THE HEAVY METALS.

Temperature °C.	Bi ₂ O ₃		CdO.		CaS.		Cr ₂ O ₃		CuO.		Cu ₂ S.		Cu ₃ S.		FeO.		Fe ₃ O ₄		Temperature °C.
	Sens- ible Heat.	Diff. per °C.	Sens- ible Heat.	Diff. per °C.	Sens- ible Heat.	Diff. per °C.	Sens- ible Heat.	Diff. per °C.	Sens- ible Heat.	Diff. per °C.	Sens- ible Heat.	Diff. per °C.	Sens- ible Heat.	Diff. per °C.	Sens- ible Heat.	Diff. per °C.	Sens- ible Heat.	Diff. per °C.	
15	0	-.059	0	-.082	0	-.094	0	-.175	0	-.13	0	-.12	0	-.12	0	-.175	0	-.15	15
100	5	-.06	7	-.08	8	-.09	15	-.18	11	-.15	10	(103) ^o C. 8)†	10	-.12	15	-.19	13	-.19	100
200	11	-.06	15	-.08	17	-.09	33	-.19	26	-.15	30	-.15	22	-.13	33	-.18	32	-.21	200
300	17	-.07	23	-.09	26	-.10	52	-.19	41	-.16	45	-.14	35	-.13	51	-.19	53	-.22	300
400	24	-.075	32	-.09	36	-.09	71	-.19	57	...	59	-.135	48	-.13	69	-.19	75	-.24	400
600	39	...	50	-.09	54	-.095	109	-.205	86	...	74	...	107	-.195	123	...	600
800	...	(817) ^o C. 15)*	68	-.095	73	-.10	148	111	...	102	...	146	...	172	...	800
1000	87	...	93	...	189	130	1000
1200	106	-.103	230	-.21	...	(144) ^o C. 35)*	...	(1127) ^o C. 33)*	(1880) ^o C. 107)*	1200
1500	137	-.106	294	-.22	1500

* Melting Point. † Crystalline Change.

TABLE IXB.—SENSIBLE HEAT PER POUND OF MATERIAL (CENTIGRADE UNITS)—(continued).
 2.—BINARY COMPOUNDS OF THE HEAVY METALS—(continued).

Temperature °C.	Fe ₂ O ₃ .		FeS.		FeS ₂ .		HgS.		MnO.		Mn ₂ O ₃ .		Mn ₂ O ₄ .		MnO ₂ .		MnS.		Temperature °C.
	Sensible Heat.	Diff. per °C.	Sensible Heat.	Diff. per °C.	Sensible Heat.	Diff. per °C.	Sensible Heat.	Diff. per °C.	Sensible Heat.	Diff. per °C.	Sensible Heat.	Diff. per °C.	Sensible Heat.	Diff. per °C.	Sensible Heat.	Diff. per °C.	Sensible Heat.	Diff. per °C.	
15	0	.15	0	.165	0	.047	0	.047	0	.14	0	.15	0	.15	0	.165	0	.14	15
100	13	.18	14	(183° C.12)†	4	.06	4	.06	12	.16	13	.19	13	.17	14	.19	14	.14	100
200	31	.20	43	.15	10	.05	10	.05	28	.17	31	.20	30	.18	33	.21	33	.15	200
300	51	.21	58	.15	15	.06	15	.06	45	.18	51	.21	48	.19	54	.23	41	.15	300
400	73	.23	73	.165	21	.06	21	.06	63	.185	72	.225	67	.215	77	.23	56	.16	400
600	119	.245	106	.16	100	.20	117	.24	110	.225	88	.165	600
800	168	...	138	.175	140	.205	165	...	155	.235	121	.165	800
1000	173	(1195° C.57)*	181	.21	202	.23	154	.17	1000
1200	263	223	.21	248	.23	188	.17	1200
1500	285	316	238	.17	1500

* Melting Point. † Crystalline Change.

TABLE IXB.—SENSIBLE HEAT PER POUND OF MATERIAL (CENTIGRADE UNITS)—(continued).
 2.—BINARY COMPOUNDS OF THE HEAVY METALS—(continued).

Temperature °C.	Pbs.		Sb ₂ O ₃ .		Sb ₂ O ₄ .		Sb ₂ S ₃ .		SbO.		SbO ₂ .		Sns.		ZnO.		Zns.		Temperature °C.
	Sen- sible Heat.	Dif- fer- ence per Heat. °C.	Sen- sible Heat.	Dif- fer- ence per Heat. °C.	Sen- sible Heat.	Dif- fer- ence per Heat. °C.	Sen- sible Heat.	Dif- fer- ence per Heat. °C.	Sen- sible Heat.	Dif- fer- ence per Heat. °C.	Sen- sible Heat.	Dif- fer- ence per Heat. °C.	Sen- sible Heat.	Dif- fer- ence per Heat. °C.	Sen- sible Heat.	Dif- fer- ence per Heat. °C.	Sen- sible Heat.	Dif- fer- ence per Heat. °C.	
15	0	-047	0	-082	0	-094	0	-082	0	-082	0	-094	0	-082	0	-13	0	-12	15
100	4	-05	7	-09	8	-09	7	-09	7	-08	8	-10	7	-09	11	-13	10	-12	100
200	9	-05	16	-10	17	-10	16	-09	15	-08	18	-10	16	-08	24	-14	22	-13	200
300	14	-06	26	-10	27	-11	25	-10	23	-09	28	-11	24	-09	38	-15	35	-13	300
400	20	-06	36	-11	38	-115	35	-10	32	-09	39	-12	33	-09	53	-15	48	-13	400
600	32	...	58	(655° C. 46)*	61	-125	50	-095	63	-125	51	-09	83	-15	75	-13	600
800	86	-135	69	-105	88	-14	69	-095	113	-16	101	...	800
1000	...	(1114° C. 17)*	(113)	90	...	116	-14	(88)	...	145	-165	1000
1200	(144)	178	1200
1500	1500

* Melting Point.

TABLE IX.B.—SENSIBLE HEAT PER POUND OF MATERIAL (CENTIGRADE UNITS)—(continued).
 5.—IMPORTANT MIXTURES (TYPICAL VALUES).

Temperature ° C.	* Earthy mixtures and slags.		† Fireclay and Silica Brick.		Magnesite Brick.		‡ Chrome Brick.		Temperature ° C.
	Sensible Heat, 1 per ° C.	Diff. per ° C.	Sensible Heat, 1 per ° C.	Diff. per ° C.	Sensible Heat, 1 per ° C.	Diff. per ° C.	Sensible Heat, 1 per ° C.	Diff. per ° C.	
15	0	.19	0	.20	0	.22	0	.18	15
100	16	.24	17	.21	19	.25	15	.19	100
200	38	.25	33	.22	44	.26	34	.20	200
300	63	.26	60	.24	70	.27	54	.21	300
400	89	.265	84	.26	97	.28	75	.22	400
600	142	.27	136	.29	153	.30	119	.23	600
800	196	.285	194	.31	213	.315	165	.24	800
1000	255	.30	256	.32	276	.34	213	.25	1000
1200	315	.31	320	.33	344	...	263	.25	1200
1500		1500

* Mixtures made up chiefly of light oxides and their compounds. Slags containing much of the oxides of the heavy metals will have a lower specific heat. The figures should be used only up to the melting point of the material.

† Composite values from various sources.

‡ Calculated value for a mixture containing 60 per cent. CaO + FeO and 40 per cent. earthy materials.

In the tables, the first column under a particular material gives the heat content per pound of substance at the indicated temperature. The second column gives the change in heat content per pound of substance for each degree of temperature difference. These difference columns are used to determine the sensible heat at intermediate temperatures. For example at 740° C. the sensible heat of copper is obtained from the 600° C. reading of 58 C.H.U's. plus $0.105 \times (740 - 600) = 14.7$ C.H.U's., giving a total of approximately 73 C.H.U's. per pound of copper. Evidently the difference figures are in reality the mean specific heats of the materials over the indicated temperature intervals. As, however, they change in steps according to increases in the sensible heats, which are given to the nearest whole number, the differences do not always show quite the same regularity of change which is ordinarily associated with specific heat.

Where a change of state or of physical condition occurs during the temperature interval, no difference (or mean specific heat) is given. The values in parenthesis, substituted for the differences in such cases, indicate the temperature at which the change occurs and the heat required to effect the change (or the heat liberated, on cooling). Where marked with an asterisk, the change temperatures correspond with fusion of the materials, and the heat quantities are the **latent heats of fusion**. Changes marked with a dagger, or †, are crystalline or other changes of the material.

In Chapter II it was explained that to convert 1 lb. of water at 60° F. (15° C.) into vapour at the same temperature it was necessary to supply 1050 B.Th.U's. (585 C.H.U's.), the reason being that 1 lb. of gas or vapour has more energy than 1 lb. of the liquid at the same temperature. Similarly, to melt ice at 32° F. (0° C.) to water at the same temperature, it is necessary to supply 144 B.Th.U's. (80 C.H.U's.) because a liquid contains more energy than the solid at the same temperature. The amount of heat necessary to melt unit quantity of a solid is called the latent heat of fusion.

Crystalline changes taking place on heating certain substances also absorb heat.

In extrapolation for the sensible heat within a temperature interval which includes a physical change, care must be taken to consider whether the material is above or below the change temperature. An example will illustrate the need of this distinction.

Example.—To find the heat content per pound of copper at 1100° C. This temperature comes within the interval (1000-1200° C.) which includes the fusion temperature for copper. The melting point of copper as found from the table is 1084° C. At 1100° C. the copper is therefore molten, and extrapolation must be made

by subtraction from the first sensible heat figure which includes the latent heat of fusion, *i.e.* from the next highest figure, in this case 174 C.H.U's. corresponding with a temperature of 1200° C. Since the sensible heat is required at a temperature 100° C. lower than this, it is necessary to subtract from 174 C.H.U's. the difference between the sensible heats at 1200° C. and 1100° C. Ordinarily it is sufficient to use the difference value for the nearest unbroken temperature interval for the appropriate state of the material, in this case liquid, the table showing a value 0.12 C.H.U's. per lb. per °C. Subtracting $0.12 \times 100 = 12$ C.H.U's. from 174 C.H.U's., we find the sensible heat of copper at 1100° C. to be 162 C.H.U's. For a temperature somewhat below the melting point, extrapolation would be upwards from the sensible heat value at 1000° C., using the mean difference between 800° C. and 1000° C. of 0.115, or at discretion a value somewhat higher.

In addition to the sensible heat data, some specific heat data are given in Table X for certain substances for which high temperature thermal data are few. These values are also taken from the collection by Kelley.

Table X also gives some isolated sensible heat data, and from these has been taken the sensible heat of liquid pig iron used in the illustrative balance sheet. 1080 lb. of liquid pig, having a heat content of 540 B.Th.U's. (300 C.H.U's.) per pound, results in a heat contribution of 580,000 B.Th.U's. (320,000 C.H.U's.).

Approximate Rules for Determining Specific Heat.—Tables IX, A and B, may be supplemented by the following approximate rules. In most cases the rules yield good results, but in relatively few cases they yield results rather widely different from experimental values. They should be used, therefore, only in the absence of direct experimental data.

1. At temperatures not greatly above that of the atmosphere, the atomic heat¹ of nearly all solid elements is about 6.2—the law of *Dulong and Petit*. Carbon (1.8), silicon (4.8), beryllium (3.7) and boron (3.3) are exceptions, the values for these elements being lower, as shown by the figures in parentheses. The values for sulphur and phosphorus are also rather low at 5.4. These elements, constituting exceptions, show a rapid increase of specific heat with temperature, bringing their atomic heats more closely into line with those of other elements at higher temperatures.

¹ The atomic heat is the heat capacity per degree, per pound-atom of an element. It is therefore obtained by multiplying the specific heat by the atomic weight of the element.

TABLE X.—OTHER SPECIFIC AND SENSIBLE HEAT DATA.

DATA FROM COLLECTION BY K. K. KELLY.

Substance.	Temperature Range.	Specific Heat per pound.	Substance.	Temperature Range.	Specific Heat per pound.
Ag ₂ S . . .	32-615° F. (0-324° C.)	·08→·09	FeSi	32-1112° F. (0-600° C.)	·14→·165
AlF ₃ . . .	59-127° F. (15-53° C.)	·23	Hg (liquid)	to 675° F. (to 357° C.)	·329
As ₂ O ₃ . . .	32-527° F. (0-275° C.)	·11→·18	(Vapour, monatomic) (All temperatures)		·248
As ₂ S ₃ . . .	68-572° F. (20-300° C.)	·14	HgO	41-208° F. (5-98° C.)	·053
CaO . P ₂ O ₅ . . .	57-208° F. (14-98° C.)	·20	MgCO ₃	68° F. (20° C.)	·20
CaMoO ₄ . . .	32-75° F. (0-24° C.)	·165	MnCO ₃ . . .	32-932° F. (0-500° C.)	·17→·40
CaWO ₄ . . .	66-120° F. (19-49° C.)	·10	Mn ₂ O ₃ . H ₂ O	64-120° F. (18-49° C.)	·17
CuFeS ₂ . . .	66-118° F. (19-48° C.)	·13	NiS . . .	32-615° F. (0-324° C.)	·12→·14
FeAs ₂ . . .	50-212° F. (10-100° C.)	·09	PbCO ₃ . . .	55-117° F. (13-47° C.)	·09
FeAsS . . .	50-212° F. (10-100° C.)	·10	PbSO ₄ . . .	68-210° F. (20-99° C.)	·09
Fe ₃ C . . .	32-1112° F. (0-600° C.)	·13→·15	Pt . . .	32-2912° F. (0-1600° C.)	·032→·0415
FeCO ₃ . . .	68-203° F. (20-95° C.)	·20	S . . .	32-246° F. (0-119° C.)	·168→·190
Fe ₂ O ₃ . 3H ₂ O . . .	55-212° F. (13-100° C.)	·22	TiO ₂ . . .	32-824° F. (0-440° C.)	·166→·172

MISCELLANEOUS DATA.

SENSIBLE HEAT PER POUND OF LIVE STEAM.*

Pressure (lb./in. ² gauge)	50	100	150	200	250
Temperature, °F.	298	338	366	388	406
„ „ °C.	(148)	(170)	(186)	(198)	(208)
Sensible Heat (B.Th.U's.)	99	110	116	119	122
„ „ (C.H.U's.)	(55)	(61)	(64)	(66)	(68)

* This is the heat supplied by steam at an oil burner or steam injector. The values represent the heat content of water vapour after expansion, calculated from the usual base temperature 60° F. (15° C.). The temperatures and sensible heat values are for saturated steam, which is the usual condition of steam at these appliances.

- Specific heat of fuel oil (ordinary temperatures), 0·4-0·5.
- Specific heat of liquid iron, 0·20.
- Sensible heat of liquid pig iron (including latent heat of fusion), 540 B.Th.U's. (300 C.H.U's.).

Latent heat of fusion of slags (to be added to the appropriate figure from Table IX, 5). (The latent heat of fusion of glassy slags is low, because glasses already have the same physical constitution as liquids.) Up to 180 B.Th.U's. (100 C.H.U's.).

2. The atomic heat of solid elements rises to about 7 at the melting point or first critical point (Kelley).

3. The atomic heat of liquid metals is about 7.5 (Kelley).

Example.—The approximate specific heat of solid copper at the melting point is $\frac{7}{63.6} = 0.11$; the specific heat of liquid copper is $\frac{7.5}{63.6} = 0.12$. These values agree with the tabulated figures.

4. At temperatures not greatly above that of the atmosphere, the molecular heat ¹ of a compound is equal to the sum of the atomic heats of its component elements—*Kopp's Law*.

In applying Kopp's Law, values recommended ² for elements which do not conform with the Law of Dulong and Petit are:—oxygen 4.0, hydrogen 2.3, carbon 1.8, sulphur 5.4, phosphorus 5.4, and fluorine 5.0. The value for silicon may be taken as 4.8. For the other elements, the actual atomic heats may be calculated from the table, by multiplying the specific heat at low temperature by the atomic weight, or the mean value of 6.2 may be used.

Example.—To find the specific heat at ordinary temperatures of limestone (CaCO_3).

	Ca	C	O ₃		
The molecular heat is	6.2	+	1.8	+	(3 × 4.0) = 20
„ „ weight is	40	+	12	+	(3 × 16) = 100

∴ The specific heat is $20 \div 100 = 0.20$, conforming with the value given in the table.

5. To apply Kopp's Law at higher temperatures, use the atomic heats of the individual elements at the required temperature. The values will in all cases be higher than at atmospheric temperature, and the atomic heats for oxygen, carbon, etc., will have approached the values for other elements.

For fused compounds, Kelley suggests a mean value of 8 for the atomic heat of the constituent atoms, *i.e.* the molecular heat is $8 \times$ (number of atoms in the formula).

6. Compounds having similar chemical constitution and physical properties, have approximately the same molecular heat—(*Neumann's Law*). This is in accordance with Kopp's Law, but

¹ The molecular heat is the heat capacity per degree, per pound-molecule of an element. It is therefore obtained by multiplying the specific heat by the molecular weight of the compound.

² Perry, J. H., Elgin, J. C., Ryan, W. P., in Perry's *Chemical Engineers' Handbook*, First Edition, 1934, p. 552.

while the latter applies to temperatures under the boiling point of water, the present law may be applied, in conjunction with the tables, at high temperatures.

Example.—Suppose the specific heat of zinc sulphide (ZnS) is known to be 0.13 in the temperature range from 1000-1500° F., and that the specific heat of lead sulphide (PbS) is required. The molecular heat of zinc sulphide and therefore of lead sulphide in the given temperature range is $(65 + 32) \times 0.13 = 12.6$. The specific heat of lead sulphide in this range is therefore $\frac{12.6}{(207 + 32)} = 0.053$, which is again in close agreement with the tabulated value.

In the absence of crystalline or other changes in the temperature range considered, the method may be applied directly to determination of sensible heat.

7. *Coke.*—The sensible and specific heat of coke may be obtained from the per cent. of ash in the coke, using the figures for graphite and earthy matter.

Example.—To determine the sensible heat, at 1000° C., of coke containing 10 per cent. of ash.

The sensible heat of the carbon in the coke is 90 per cent. of 357, and the sensible heat of the ash is 10 per cent. of 250, giving a total of 346 C.H.U's.

For charcoal (amorphous carbon) Goodenough and Felbeck¹ give an equation which yields results substantially the same as for graphite.

8. The atomic heat of monatomic gases (practically all metals are monatomic in the gaseous state) at constant pressure is 5.00, and is independent of temperature. The specific heat of zinc vapour is therefore $\frac{5.00}{65.38} = 0.0765$ per unit weight at all temperatures.

Sensible Heat Contributed by Cold Materials.—The heat content of all materials is calculated from 60° F. (15° C.). If the "cold charge" is at some other temperature, then its sensible heat should theoretically be included as heat input. At temperatures below 60° F. (15° C.) the sensible heat must be regarded as negative. Practically, excepting in climates where extreme cold is experienced, or where the other heat quantities in the balance sheet are very small, variation in the temperature of the cold charge may be disregarded.

¹See reference on p. 38.

The sensible heat of the cold air supply at temperatures above or below standard may be just a little more important. In this particular balance sheet, the air quantity used with 30,000 cu. ft. of gas can be calculated, and it will be found from the sensible heat tables for gases, that an air temperature fluctuation of 18° F (10° C.) would cause a change of heat input of 13,000 B.Th.U's (7000 C.H.U's.). Compared with other heat quantities, this is small and may usually be ignored. Still less is it worth while troubling about the moisture content of the air in a thermal balance.

Chemical Reactions.—One of the purposes of most metallurgical operations is to effect chemical changes. These changes are always accompanied by heat changes which may be determined from the heats of formation of the reacting substances as explained in Chapter II. The material balance, Table VI, represents the distribution mainly by elements and does not therefore give any indication of the nature of chemical changes occurring. The chemical changes are, however, clearly indicated by the data from which the final balance sheet was made, and also by an intermediate balance sheet which it is frequently convenient to make, showing compounds as they actually occur rather than as the component elements. Thus, it would have been clear that iron, manganese, phosphorus and silicon do not occur in the slag as elements, but as oxides. Since, in the metallic portions of the charge, these substances and also carbon were actually present in an unoxidised form, one of the chemical reactions which have taken place is the oxidation of the elements. Oxidation is, in this process, partly effected by the furnace gases and partly by additions of iron oxide. The added iron oxide can accomplish oxidation only by being itself reduced, the reduction being another of the chemical reactions occurring in the charge. The principal reactions contributing to the "Net Heat Supplied by Chemical Reactions in the Charge" will be itemised, since many of these reactions occur in a number of other metallurgical operations and are typical of smelting reactions.

Heat of Formation of Oxides.—When an oxide is formed from oxygen and some other element, in all cases of practical importance heat is generated during the oxidation. Familiar examples of this are burning in air of carbon, hydrogen, phosphorus and sulphur, during which heat is evolved—burning is of course only a case of vigorous oxidation, oxides being formed in all these examples.

Table XI shows the heats of formation of metallurgically important oxides and other binary compounds.

The values given in Table XI have been taken principally from *Physikalisch-chemische Tabellen*, Landolt Börnstein, 1931. More recent values referred to in Chapter II have been used for "Combustion Products." With this exception, it was thought better not to include scattered data which have been published during the last few years, but which have not yet been published in collected form.

In certain instances, the results obtained by different investigators vary rather widely. Also, there may be considerable difference in the heat of formation for crystalline and for amorphous varieties of the same substance. The heats of formation of carbon monoxide and carbon dioxide are for graphitic carbon; in other cases also, the values for crystalline materials have been given where available.

For heats of formation of additional compounds, see (a) *Physikalisch-chemische Tabellen* (referred to above), or (b) *International Critical Tables*.

In Table XI, for convenience of reference, classification is mainly according to the more metallic constituent of the compound. The first column following the chemical formula of the compound gives the weights of the constituent elements represented by the formula and the molecular weight. The three columns under both Fahrenheit and Centigrade headings give the heats of formation per pound-molecule, per pound of compound, and per pound of metal,¹ respectively. The values per pound of compound and per pound of metal were obtained by dividing the molecular heat of formation by the respective weights of compound and of metal per pound-molecule. It is entirely a matter of convenience for a particular calculation which column is selected.

Referring again to the balance sheet, the weight of an element oxidised is known from the composition and weight of the charge. The total heat generated by oxidation of an element is obtained by multiplying the weight oxidised by the heat of oxidation found from Table XI. If an oxide is decomposed into the element and oxygen, heat has to be supplied instead of being generated. The amount of heat is equal to the heat of formation, but is written with a minus sign to indicate absorption, e.g. we write,

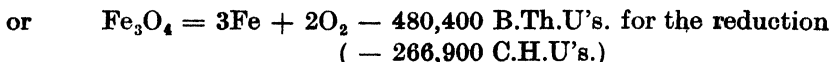
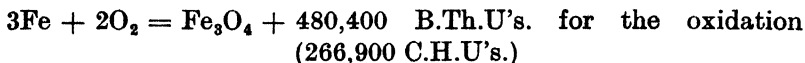

Exothermic and Endothermic Reactions.—When heat is generated during a chemical reaction, the reaction is said to be

¹ Or principal element.

TABLE XI.—HEAT OF FORMATION OF BINARY COMPOUNDS.*

	Compound.	Molecular Weight.	B.Th U's.			C.H.U's.			Compound.
			Per lb. mole ule.	Per lb. of compound.	Per lb. of mctal. †	Per lb. molecule.	Per lb of compound	Per lb of mctal. ‡	
COMBUSTION PRODUCTS.	CO†	12.0 + 16.0 = 28.0	47,950	1713	3996	26,640	951	2220	CO†
	CO ₂ †	12.0 + 32.0 = 44.0	169,630	3855	14,136	94,240	2142	7853	CO ₂ †
	H ₂ O (st'm)	2.0 + 16.0 = 18.0	104,130	5780	51,662	57,850	3211	28,701	H ₂ O (st'm)
	SO ₂	32.1 + 32.0 = 64.1	127,620	1992	3981	70,900	1107	2211	SO ₂
CALCIUM.	CaO	40.1 + 16.0 = 56.1	273,780	4880	6832	152,100	2711	3796	CaO
	CaS	40.08 + 32.06 = 72.1	169,740	2354	4235	94,300	1308	2353	CaS
	CaC ₂	40.1 + 24.0 = 64.1	(Per 25,380	396	634	(Per 14,100	220	352	CaC ₂
	CaF ₂	40.1 + 38.0 = 78.1	520,920	6669	12,989	289,400	3705	7216	CaF ₂
COPPER.	Cu ₂ O	127.1 + 16.0 = 143.1	76,140	532	600	42,300	296	333	Cu ₂ O
	CuO	63.6 + 16.0 = 79.6	71,460	898	1123	39,700	499	624	CuO
	Cu ₂ S	127.1 + 32.1 = 159.2	34,200	215	269	19,000	119	149	Cu ₂ S
	CuS	63.57 + 32.06 = 95.6	20,880	218	329	11,600	121	183	CuS
IRON.	FeO	55.8 + 16 = 71.8	115,650	1611	2071	64,250	895	1151	FeO
	Fe ₂ O ₃	111.7 + 48.0 = 159.7	357,300	2237	3199	198,500	1243	1777	Fe ₂ O ₃
	Fe ₃ O ₄	167.5 + 64.0 = 231.5	480,400	2075	2867	266,900	1153	1593	Fe ₃ O ₄
	FeS	55.8 + 32.1 = 87.9	41,530	472	744	23,070	262	413	FeS
	FeS ₂	55.84 + 64.12 = 120.0	(Per 63,900	532	1144	(Per 35,500	296	636	FeS ₂
			(Per 39,900	532	996)	(Per 21,500	296	554)	
LEAD.	PbO	207.2 + 16.0 = 223.2	93,600	419	452	52,000	233	251	PbO
	Pb ₃ O ₄	621.6 + 64 = 685.6	310,390	453	499	172,440	251	277	Pb ₃ O ₄
	PbO ₂	207.2 + 32.0 = 239.2	118,740	496	573	65,960	276	318	PbO ₂
	PbS	207.2 + 32.1 = 239.3	39,600	166	191	22,000	92	106	PbS
MAGNESIA.	MgO	24.3 + 16.0 = 40.3	262,440	6503	10,802	145,800	3618	6001	MgO
	MgS	24.3 + 32.1 = 56.4	147,960	2623	6089	82,200	1457	3383	MgS
MANGAN- ESE.	MnO	54.9 + 16.0 = 70.9	173,700	2448	3163	96,500	1360	1757	MnO
	Mn ₂ O ₄	164.8 + 64.0 = 228.8	621,000	2714	3767	345,000	1508	2093	Mn ₂ O ₄
	MnO ₂	54.9 + 32.0 = 86.9	226,800	2610	4131	126,000	1450	2295	MnO ₂
NICKEL.	NiO	58.7 + 16.0 = 74.7	106,020	1418	1805	58,900	788	1003	NiO
	NiS	58.7 + 32.1 = 90.8	37,440	412	638	20,800	229	354	NiS
			(Per 106,020	412	1166)	(Per 58,900	788	648)	
SILICOR.	SiO ₂	28.1 + 32.0 = 60.1	367,200	6109	13,066	204,000	3394	7259	SiO ₂
	SiC	28.1 + 12.0 = 40.1	45,000	1122	1602	25,000	625	890	SiC
	SiF ₄	28.1 + 76.0 = 104.1	648,360	6228	23,058	360,200	3460	12,810	SiF ₄
TIN.	SnO	118.7 + 16.0 = 134.7	120,420	894	1014	66,900	497	564	SnO
	SnO ₂	118.7 + 32.0 = 150.7	248,040	1646	2090	137,800	915	1161	SnO ₂
ZINC.	ZnO	65.4 + 16.0 = 81.4	149,400	1836	2284	83,000	1020	1269	ZnO
	ZnS	65.38 + 32.06 = 97.4	77,400	795	1184	43,000	442	658	ZnS
MISCELLANEOUS.	Al ₂ O ₃	53.9 + 48.0 = 101.9	685,440	6730	12,717	380,800	3739	7065	Al ₂ O ₃
	Cr ₂ O ₃	104.0 + 48.0 = 152.0	520,020	3422	5000	288,900	1901	2778	Cr ₂ O ₃
	P ₂ O ₅	62.0 + 80.0 = 142.0	665,820	4680	10,740	369,900	2605	5967	P ₂ O ₅

* At constant pressure.

† From β-graphite.

‡ Or principal element.

exothermic. When heat is *absorbed* during a chemical reaction, the reaction is said to be *endothermic*. The first of the above equations, representing the oxidation of iron, indicates by the plus sign an exothermic reaction; the second one, representing removal of oxygen from iron oxide, indicates by the minus sign an endothermic reaction.

Heat of Formation of Other Compounds.—Oxidation of elements, and decomposition of oxides, constitute the principal exothermic and endothermic reactions in metallurgical work. Next in order of importance are the heats of formation of sulphides and other binary compounds also given in Table XI. There are still other important reactions, most of which involve the union between two oxides or the decomposition of a compound into oxides. In such cases, the heat of formation from the elements is not required, and it is simpler to use the heat of formation of the compound from its component oxides. Some of the important values are given in Table XII. In this table, the heats of combination of the oxides are given in the four different forms which it may be convenient to use on different occasions. The values per pound of oxide were obtained by dividing the molecular heat of formation by the molecular weight of the oxide. The values in this table for carbonates are due to Kelley and Anderson¹, and the other values are taken largely from "Anhaltzahlen für den Energieverbrauch in Eisenhüttenwerken," Third Edition, Table 129.

Example.—Heat of Decomposition of Limestone in the Balance Sheet.—The heat balance sheet has been constructed to include the decomposition of 147 lb. of calcium carbonate. The heat of formation per pound of calcium carbonate from its oxides is found from Table XII to be 764 B.Th.U's. (425 C.H.U's.). The heat of decomposition is therefore — 764 B.Th.U's. (— 425 C.H.U's.) per pound, giving approximately — 112,000 B.Th.U's. (— 62,000 C.H.U's.), which figures were charged to the balance as a heat requirement.

Heat of Formation of Slags.—Considerable heat is produced when basic oxides (CaO, FeO, MgO, MnO, etc.) combine with acid oxides (SiO₂ and occasionally other oxides such as P₂O₅) to form a slag. The heats of combination of the compounds, between individual acids and bases, are given in Table XII.

¹ Kelley, K. K., and Anderson, C. T.: "Contributions to the Data on Theoretical Metallurgy, IV.—Metal Carbonates—Correlations and Applications of Thermodynamic Properties," *Bureau of Mines, Bulletin 384*, 1935.

TABLE XII.—HEAT OF REACTION FROM COMBINATION OF OXIDES.

Reaction.	Formula Weights	B.Th U's			C.H.U's.				Compound.		
		Per lb. molecule.	Per lb. com- pound.	Per lb. of basic oxide.	Per lb. of acid oxide.	Per lb. molecule.	Per lb. com- pound.	Per lb. of basic oxide.		Per lb. of acid oxide.	
CARBONATES.	CaO + CO ₂ = CaCO ₃	56.1	76.480	1364	1738	42,490	425	758	966	CaO.CO ₂	
	CuO + CO ₂ = CuCO ₃	79.6	20,140	253	458	11,190	91	141	254	CuO.CO ₂	
	FeO + CO ₂ = FeCO ₃	71.8	35,620	308	496	19,790	171	276	450	FeO.CO ₂	
	MgO + CO ₂ = MgCO ₃	40.3	50,890	603	1262	28,270	335	701	643	MgO.CO ₂	
	MnO + CO ₂ = MnCO ₃	70.9	51,370	447	724	28,540	248	402	649	MnO.CO ₂	
	PbO + CO ₂ = PbCO ₃	228.2	37,980	142	171	863	21,100	79	95	480	PbO.CO ₂
	ZnO + CO ₂ = ZnCO ₃	81.4	30,510	243	375	693	16,950	135	208	385	ZnO.CO ₂
SILICATES.	CaO + SiO ₂ = CaO.SiO ₂	56.08	37,630	323	689	20,850	179	372	347	CaO.SiO ₂	
	2CaO + SiO ₂ = 2CaO.SiO ₂	112.16	51,120	297	455	28,400	165	253	472	2CaO.SiO ₂	
	3CaO + SiO ₂ = 3CaO.SiO ₂	168.2	51,660	226	307	28,700	126	171	478	3CaO.SiO ₂	
	FeO + SiO ₂ = FeO.SiO ₂	71.84	10,620	81	148	5900	45	82	98	FeO.SiO ₂	
	2FeO + SiO ₂ = 2FeO.SiO ₂	143.68	39,820	196	277	22,120	109	154	358	2FeO.SiO ₂	
	MnO + SiO ₂ = MnO.SiO ₂	70.93	13,860	106	195	7700	59	109	128	MnO.SiO ₂	
PROP. PHATES.	3CaO + P ₂ O ₅ = 3CaO.P ₂ O ₅	168.24	287,280	925	1708	159,600	514	949	1123	3CaO.P ₂ O ₅	
	4CaO + P ₂ O ₅ = 4CaO.P ₂ O ₅	224.32	289,440	790	1291	160,800	439	717	1131	4CaO.P ₂ O ₅	
	3MgO + P ₂ O ₅ = 3MgO.P ₂ O ₅	120.96	207,360	790	1716	115,200	439	953	811	3MgO.P ₂ O ₅	

Unfortunately the heat generated during the formation of a slag depends on the actual constitution of the latter, *i.e.* not only on the chemical analysis, but also on the amounts of each of the compounds present in the slag on solidification. No general rule can be given for estimating the heat of formation of a mixture. The only practical rule is to determine whether the basic oxides or acid oxides are in excess of the requirements for formation of the probable compounds. If, for example, there is a deficiency of acid oxides, as an approximation we may assume the more basic oxides to be satisfied first, placing the principal bases in the order CaO, MgO, FeO. The quantities of the different compounds are found and the heats of formation added. If the acid oxides (nearly always silica) are in excess, then all the bases are combined with silica and the heat of formation is obtained from the quantities of bases. Table XIII will assist in judging the probable constitution of a given slag.

Heats of formation of other silicates will be found in the physico-chemical tables to which reference has already been made.

Depending on the temperature and constitution of the slag, there are a number of possible compounds which alumina may form with silica, lime, magnesia, etc. Ordinarily, it is a matter of conjecture which of these compounds will be formed; and moreover there is some question as to the reliability of certain of the available data concerning the heat of formation of such compounds. Probably we can do no better than to disregard the alumina in estimating the heat of formation of a slag.

From a comparison of the heats of reaction of lime and magnesia with other substances, the heat of combination of magnesia with silica per pound of magnesia might be expected to be about the same as the heat per pound of lime for the corresponding calcium silicate. This however is only a guess.

Example.—The basic slag in the heat balance has the analysis,

Fe ₂ O ₃	FeO	Al ₂ O ₃	SiO ₂	CaO	MnO	P ₂ O ₅	MgO
5	15	3	18	42	7	2.5	7

The basic oxides are CaO, MgO, FeO, MnO. The distinctly acid oxides are SiO₂ and P₂O₅. The other two oxides, ferric oxide (a weak acid) and alumina, are disregarded.

It is probable that bases in this slag are in excess. If the calcium silicate formed is 2CaO . SiO₂, Table XIII shows that by weight 1 part SiO₂ requires 1.87 parts of CaO, or the 18 parts of SiO₂ in 100 parts of slag require 33.6 of CaO, leaving 42 - 33.6 = 8.4 CaO. Similarly 2.5 P₂O₅ present as 4CaO . P₂O₅ requires 2.5 × 1.58 = 4.0 of CaO. There is still an excess of 8.4 - 4.0 = 4.4 per cent. of CaO, so that the other basic material present is probably to a large extent uncombined.

TABLE XIII.—RATIO OF BASIC TO ACID OXIDES
IN SLAG COMPOUNDS.

Compound.	Ratio.
CaO . SiO ₂ .	CaO : SiO ₂ = 1 : 1.07 = 0.935 : 1
2CaO . SiO ₂ .	CaO : SiO ₂ = 1 : 0.54 = 1.87 : 1
3CaO . SiO ₂ .	CaO : SiO ₂ = 1 : 0.36 = 2.80 : 1
FeO . SiO ₂ .	FeO : SiO ₂ = 1 : 0.84 = 1.19 : 1
2FeO . SiO ₂ .	FeO : SiO ₂ = 1 : 0.42 = 2.39 : 1
MnO . SiO ₂ .	MnO : SiO ₂ = 1 : 0.85 = 1.18 : 1
3CaO . P ₂ O ₅ .	CaO : P ₂ O ₅ = 1 : 0.85 = 1.18 : 1
4CaO . P ₂ O ₅ .	CaO : P ₂ O ₅ = 1 : 0.63 = 1.58 : 1
3MgO . P ₂ O ₅ .	MgO : P ₂ O ₅ = 1 : 1.17 = 0.85 : 1

The heat of formation is next calculated from the weight of combined acid. For 1 lb. of slag, 0.18 lb. of SiO₂ combines with CaO yielding 0.18 × 850 B.Th.U's. (472 C.H.U's.) = 153 B.Th.U's. (85 C.H.U's.); and 0.025 lb. of P₂O₅ combines with CaO yielding 0.025 × 2036 = 51 B.Th.U's. (28 C.H.U's.).

This method of calculation is extremely crude, but it appears better than completely ignoring so large a heat quantity as 204 B.Th.U's. (113 C.H.U's.) per lb. of slag. The heat from this source in the present balance is about 60,000 B.Th.U's. (30,000 C.H.U's.), but in some processes it may amount to a much greater proportion of the total input.

Net Heat of Oxidation.—It was indicated earlier that oxidation, in the process under review, was effected partly by oxygen from the furnace gases and partly by oxide of iron added in the form of ore. From the detailed record of the heat (not from Table VI, which is only a general summary), we know exactly how much of the different elements and oxides of iron were present at the beginning and at the end of the heat, and therefore the amounts of the elements which have been oxidised and the amounts of iron oxides reduced. We have in this instance no precise knowledge of the mechanism of oxidation and reduction.

During an open hearth heat, when Fe₂O₃, Fe₃O₄ and FeO are fed in the form of ore and scale, these oxides are first absorbed by the slag. Part of the iron oxides remains in the slag; the remainder, after conversion of higher oxides into FeO by contact with

liquid iron, enters into solution in the metal as FeO and then oxidises part of the impurities carbon, silicon, manganese and phosphorus. This process results in reduction of iron from its oxides.

Also, especially during the melting stage, iron oxide is formed by oxidation of iron, *i.e.* the reverse of the above process. Even after the metal is completely melted and covered with slag, oxidation by furnace gases still continues by the indirect process of oxidation of ferrous oxide in the slag to higher oxides, these higher oxides then acting as carriers of oxygen to the metal. As in the case of direct oxide addition, part of the ferrous oxide formed dissolves in the metal and effects oxidation of other elements while part of the iron oxides remains in the slag.

It is probable that, owing to the relatively small quantities of these elements present, practically the whole of the oxidation of the carbon, silicon, manganese and phosphorus is effected by this dissolved ferrous oxide, whether derived from oxide additions or formed by furnace gas oxidation.

The actual mechanism and the relative extent of direct and indirect oxidation of impurities are, however, of no thermal significance. If, for example, manganese is oxidised by free oxygen, the process is represented by the equation,

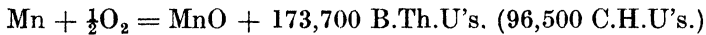

Now suppose instead of being oxidised directly, the manganese is oxidised indirectly through the intermediate formation of ferrous oxide as shown by the equations,

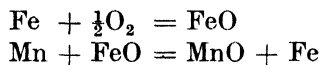

The final material result is the same as for direct oxidation, as may be seen by inspection, or by adding the equations and cancelling,

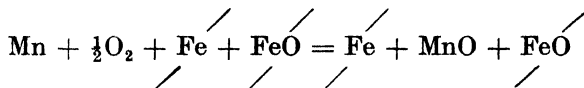

Re-writing these equations to show the thermal effect, we have,

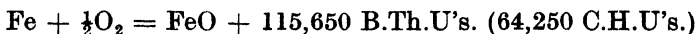

and

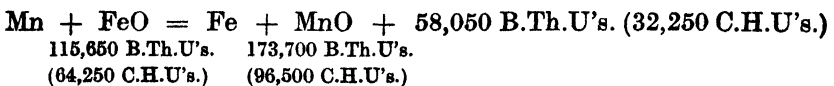

The heat of reaction shown in the second equation, 58,050 B.Th.U's., is obtained by subtraction of the heats of formation on opposite sides of the equation, as explained earlier.

In adding the two equations to get the final material

distribution, the heats of reaction are also additive, giving a total of $115,650 + 58,050 = 173,700$ B.Th.U's. (96,500 C.H.U's.). This is naturally the same as the heat liberated by the direct oxidation of manganese by oxygen.

Thus, although there is a big difference between the heats of oxidation of manganese by oxygen and by ferrous oxide, if the ferrous oxide has merely acted as a carrier of oxygen, the total heat liberation is the same. This is an example of *Hess's Law of Constant Heat Summation*¹, which tells us that, for the same starting and end products, no matter by what devious route a series of chemical changes may take place, the heat evolved or absorbed is always the same.

This makes it possible for us to imagine the reactions to have taken place in whichever way we please, provided that the starting and end products are correct. The entire heat balance is of course based on this law.

The simplest way of calculating the final thermal result due to oxidation is to suppose

(1) all of the added heavy metallic oxides to be first decomposed to the metals (in this case iron) and oxygen,

(2) all of the pre-existing compounds of materials oxidised to be decomposed into the elements (elements such as sulphur, carbon and phosphorus are usually present as metallic sulphides, carbides, phosphides, etc. If the heat of decomposition of these binary compounds is small, or if the quantities of the elements are small, the heat of decomposition may be neglected),

(3) all oxidation of the elements to have been effected directly by oxygen,

(4) the metallic oxides in the slag to have been formed by re-oxidation of metal.

The quantities on which the present heat balance was based showed

(1) a heat requirement of 220,000 B.Th.U's. (120,000 C.H.U's.) to decompose the added oxides of iron,

(2) a negligible heat change to decompose the compounds with iron of carbon, silicon, and phosphorus,

(3) and (4) a heat yield of 1,000,000 B.Th.U's. (560,000 C.H.U's.) for the formation of all oxides produced during the process, including oxides of iron present in the final slag.

Net Heat from Chemical Changes.—From the data used in

¹ Hess's Law is a special form of the *Law of Conservation of Energy*, and is true only if there is no input or output of other forms of energy, such as electric energy.

constructing the given balance sheet, the heat values found were approximately :—

	B.Th.U's.	C.H.U's.
Net heat from oxidation and reduction reactions,	+780,000	+440,000
Heat of formation of slag,	+60,000	+30,000
Heat of decomposition of limestone,	-110,000	60,000
Net heat supplied,	<u>+730,000</u>	<u>+410,000</u>

It is the net result which has been carried to the balance sheet. If the net result had been negative, as in the smelting of oxidised ores, then it would have been entered on the output side of the balance sheet.

Output Side of Balance Sheet.—To determine the heat content of steel, slag and waste gases, the quantities and temperatures of these materials are used in conjunction with the heat content tables. The steel quantity is obtained by weighing, and the slag quantity either by weighing or by calculation as explained in connection with the material balance. Calculation of waste gas quantity from the weight of fuel and the flue gas analysis has already been explained.

There may be additional heat requirements which will be evident in individual cases. These include the heat required to bring a furnace to temperature when the process is intermittent, and the latent heat of evaporation of water in a boiler furnace or drying process. The heat required to evaporate moisture in most metallurgical processes is too small to be worth considering.

The heat losses through the walls and roof to the surroundings, to the foundations, to water cooling systems, etc., are merely the balance required to make heat input and output sides of the balance sheet equal. It is possible by calculation (described in Chapters V and VI) and by experimental work to subdivide these losses and to itemise them with tolerable accuracy.

Value of the Heat Balance.—The modified heat balance in Table VIII shows that only 21·9 per cent. of the total heat input to be used by the steel or 26·1 per cent. by steel and slag combined. The distribution of the remaining heat is shown. Just as the material balance helps to show where recovery might be improved, so the heat balance helps to show where fuel consumption may be cut. One very big difference between these two cases is apparent. The scope for improvement of material recovery is somewhat restricted, since the metallic losses are relatively small; but in the case of the thermal balance, the enormous heat losses

appear to leave room for substantial improvement. The largest heat loss, namely, to the furnace surroundings, may be greatly diminished by close attention to furnace construction. In this type of furnace the air and producer gas are preheated in regenerators, using the sensible heat of the waste gases leaving the melting chamber, and reducing the heat loss in the waste gases to the still very large figure given in the balance sheet. The only way of further reducing this loss is to attain still higher preheat of gas and air and so return more heat to the furnace. The principles involved in decreasing the two big heat losses are described in later chapters.

Most types of furnace show better heat utilisation than the one considered, the losses in this case being due to an operating temperature which, for a direct fired furnace, is extremely high. A lower temperature furnace, or a continuous type furnace (particularly of the shaft or blast furnace type) should, intrinsically, show a much better heat utilisation. Electric furnaces, even at the highest temperatures, show very high heat utilisation, because there are practically no gases carrying sensible heat from the furnace, and the compactness of the furnace permits losses to the surroundings to be reduced to a minimum.

Thermal Efficiency.—The “recovery” obtained from the material balance sheet is a simple expression of the metallurgical perfection of a process. In the same way thermal efficiency is used as an expression of the thermal performance of a furnace or process.

$$\text{Thermal Efficiency} = \frac{\text{Heat Utilised}}{\text{Heat Supplied}}$$

This looks perfectly simple, but it is necessary to define clearly what we mean by “heat supplied” and “heat utilised.” If we use the modified balance sheet in Table VIII, depending on the viewpoint, we may consider the “Heat Supplied” to be:—

1. The total heat input = 100
- or 2. The chemical and sensible heat of the fuel = 79.2

Similarly we may consider the “Heat Utilised” to be,

3. The heat content of the metal = 21.9
- or 4. The heat content of slag and metal = 26.1

Probably the best expression of the efficiency of the process as a whole would be,

$$\frac{\text{No. 4}}{\text{No. 1}} = 0.261 \text{ or } 26.1\%$$

If the net result of the chemical reactions showed a heat requirement this item would occur on the output side and would be included in the "Heat Utilised."

The chemistry of the process is, however, more or less fixed, and it is more useful to obtain the efficiency of the furnace itself. The heat supplied then becomes the heat of the fuel, in this case, = 79.2. The amount of this heat utilised is the heat in the liquid steel and slag, minus any heat which the batch itself supplies and retains (or plus any chemical heat which it requires). So far as the balance sheet shows, the heat utilised is 21.9 (steel) + 4.2 (slag) - 9.0 (liquid pig iron) - 11.8 (heat of chemical reactions) = 5.3. The furnace efficiency on this basis is therefore $5.3/79.2 = 0.067$ or 6.7 per cent.

In this particular process the entire heat of the chemical reactions is *not* retained by the charge. The carbon is oxidised only to carbon monoxide in the batch, the remainder being oxidated to carbon dioxide, as credited in the balance sheet, occurring elsewhere. Adjustment for this and similar local effects is easily made in order to find how much of the chemical heat is actually generated within the charge. In this case the correction is highly important, as the heat actually generated in the charge is only 4.7 per cent. of the total, instead of 11.8 per cent., assumed, raising the efficiency to

$$\frac{21.9 + 4.2 - 9.0 - 4.7}{79.2} = 15.6\%$$

All things considered, an abridged balance sheet like that given in Table VIII is likely to be of more value than an expression of efficiency, the basis of whose calculation is controversial.

Further Examples of Use of Heat of Formation Tables.—It would have been possible to write the chemical equations representing a large number of important chemical reactions and to give the heat of the reaction represented by these equations. The tabulated results would have been a little unwieldy, and a few more examples are given here to show how the heats of reaction are obtainable from the heats of formation given in Tables XI and XII.

Example 1.—To find the heat of decomposition of steam by carbon in the gas producer, to yield carbon monoxide and hydrogen. The equation representing the reaction must be written, and the heats of formation are written under the corresponding formulæ,

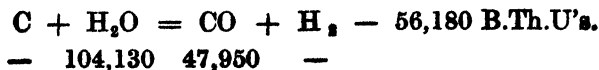

The sum of the heats of formation on the left-hand side of the equation are subtracted from the sum of the heats of formation on the right-hand side,

$$(47,950 + 0) - (0 + 104,130) = - 56,180 \text{ B.Th.U's.}$$

The resulting heat absorption may be written after the equation as shown.

Example 2.—To find the heat of reaction of a selection of reactions common in the metallurgy of the non-ferrous metals and in other furnace processes. The heats of formation are in each case first written under the equation, and the net heat of reaction, shown on the same line as the equation, is obtained by addition and subtraction,

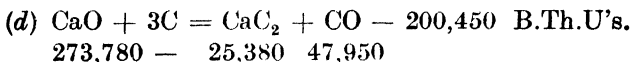
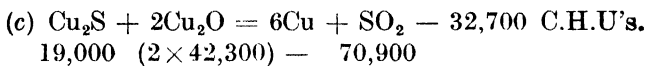
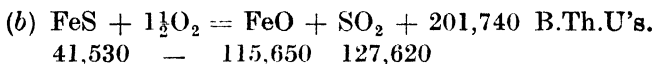
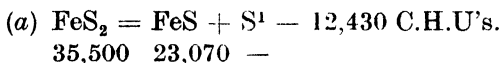

In the above examples, equations showing a positive net heat of reaction represent exothermic reactions; those showing net negative values represent endothermic reactions.

To find the net heat of reaction per pound of any of the reacting substances, the heat of reaction for the equation is divided by the weight of that substance represented in the equation. For example, in the last equation suppose we require to know how much heat is absorbed in the formation of 1 lb. of calcium carbide. The weight of calcium carbide represented in the equation is 64 lbs. The heat of reaction per pound of carbide is therefore,

$$200,450 \div 64 = 3132 \text{ B.Th.U's.}$$

General References :—

1. A. Butts : *A Textbook of Metallurgical Problems.*
2. J. W. Richards : *Metallurgical Problems.*

¹This equation is only an approximate representation of the decomposition of pyrites by heat.

CHAPTER IV.

THEORY OF GAS FLOW.

GASES and liquids have many properties in common, so it is natural when considering gas flow to draw comparisons with the more generally appreciated laws governing hydraulic flow.

Some of the points of similarity between gases and liquids are given below :—

1. When two or more liquids are mixed, provided that no reaction takes place between them, the resulting volume is the sum of the volumes of the individual liquids. This also applies to gases provided these are at the same temperature and pressure. Although well recognised, this is sometimes forgotten when one of the gases is water vapour. For example, 1 cu. ft. of moist air containing 5 per cent. of moisture is equivalent to only 0.95 cu. ft. of dry air.

2. Water flowing in a pipe ordinarily travels from the high pressure to the low pressure end of the pipe. Gases flowing in a duct obey the same general rule. There are two main exceptions for water flow, and each of these has an analogy in the flow of gases.

3. The first exception occurs when water flows through a pump. The water enters at low pressure and the pressure is raised mechanically by the pump. Fans, blowers, compressors, etc., serve the same purpose in the case of gas flow.

4. The second exception occurs when water flows downhill in a pipe. The water will travel down even against the pressure, if the effect of gravity is greater than the pressure difference. A gas will do the same if it is heavier than air ; but if it is lighter than the air, the reverse effect, buoyancy, may carry it upwards even against the pressure.

5. The pressure of a stationary body of compressed liquid is the same at all points in the same horizontal plane. This applies also to gases. The basic law may be applied to find the pressure of the liquid or gas at another level, and may also be extended to determine pressure conditions in a moving body of liquid or gas.

I.—VOLUMETRIC GAS LAWS.

An important characteristic differentiating gases from liquids is the ease with which the volume of a gas may be changed as compared with the very small volume changes which can be produced in liquids.

Density of Gases.—The density of a gas is the weight of 1 normal cu. ft. of the gas (*i.e.* measured at standard temperature, 60°F. (15°C.), and at standard atmospheric pressure, 30" of mercury). The word "density" is sometimes used to indicate the weight of a cubic foot measured at the actual temperature and pressure of the gas. This may lead to confusion, and "density" will be used here only in the sense of the above definition.

To calculate the density of a gas, we may use the information given earlier, that the pound-molecule (molecular weight in pounds) of any gas occupies 380 cu. ft. under standard conditions. A figure which, for some purposes, may be more conveniently used, is the reciprocal of the density. This gives the number of cubic feet, at standard temperature and pressure, occupied by 1 lb. of the gas. This is sometimes called the specific volume of the gas.

Example 1.—*To find the Density of Air.*¹—Air contains by volume 20.9 per cent. O₂ and 79.1 per cent. N₂. One pound-molecule of air therefore contains 0.209 lb.-molecule of oxygen and 0.791 lb.-molecule of nitrogen. A pound-molecule of oxygen weighs $16 \times 2 = 32$ lb., and a pound-molecule of nitrogen, $14 \times 2 = 28$ lb.; from which 1 lb.-molecule of air (equal to 380 cu. ft.) weighs $(32 \times 0.209) + (28 \times 0.791) = 28.8$ lb. The figure 28.8 may be regarded as the mean molecular weight of air.

Then

$$1 \text{ cu. ft. of dry air weighs } \frac{28.8}{380} = 0.076 \text{ lb.}$$

$$\text{or 1 lb. of dry air occupies } \frac{380}{28.8} = 13.2 \text{ cu. ft.}$$

¹ The following calculation is made for dry air. If the small quantities of other gases present in the air be taken into account, the mean molecular weight of dry air is found to be about 28.95 instead of the 28.8 calculated. If, however, the air be assumed to have an average moisture content of 1 per cent. by volume, and if the more accurate molecular volume of 379 cu. ft. be used instead of 380 cu. ft., owing to cancellation of opposing tendencies the density and specific volume will be found to be 0.076 and 13.2 respectively as given by the rough calculation. These figures will therefore be used for air under average conditions.

The volume per pound could equally well have been obtained by taking the reciprocal of the density, thus,

$$\frac{1}{0.076} = 13.2 \text{ cu. ft.}$$

Example 2.—To find the Density of Dry Producer Gas.—The weight of 1 lb.-molecule of gas is obtained as under :—

Constituent, . . .	CO ₂	C ₂ H ₄	O ₂	CO	H ₂	CH ₄	N ₂	
Per cent. composition,	3.0	0.2	0.2	28.0	12.0	2.5	54.1	
Lb.-molecules per molecule of gas, .	0.03	0.002	0.002	0.28	0.12	0.025	0.541	
Molecular weight (lb.),	44	28	32	28	2	16	28	
Weight per molecule of gas (lb.), .	1.32	0.056	0.064	7.84	0.24	0.40	15.148	<i>Total</i> = 25.068

380 cu. ft. of gas weighs 25.07 lb.

$$\therefore \text{density} = \frac{25.07}{380} = 0.066 \text{ lb. per cu. ft.}$$

$$\text{and 1 lb. of gas occupies } \frac{380}{25.07} \text{ or } \frac{1}{0.066} = 15.2 \text{ cu. ft.}$$

The molecular weights of ethylene, carbon monoxide and nitrogen are the same. For density calculations the number of molecules of these gases may be added and then their combined weight calculated together.

Moisture in Gas.—The moisture in any gas is most conveniently expressed as the per cent. by volume based on the dry gas.

(a) If it is given in grains per normal cubic foot, it may be converted to volume per cent. by multiplying by 0.3. For example, 15 grains per cu. ft. = $15 \times 0.3 = 4.5$ per cent. by volume.

(b) If it is given as grains per pound of gas, multiply by $0.3w_0$ to get per cent. by volume. For example, 50 grains of moisture per cubic foot of dry air (0.3×0.076) $\times 50 = 0.023 \times 50 = 1.15$ per cent. by volume.

(c) If it is given as per cent. by weight, the conversion factor to per cent. by volume is $21w_0$, where w_0 is the density of the gas. From the values for w_0 obtained in Examples 1 and 2 it follows that to convert the weight per cent. of moisture in air to volume per cent., it is necessary to multiply by 1.6; for producer gas, multiply by 1.4.

In (a), (b) and (c), if the moisture content is given on the dry basis,

the per cent. moisture by volume will also be expressed on the dry basis; if given on the wet basis, the result will be based on 100 cubic feet of moist gas—the value is then easily converted to the dry basis.

Example 3.—To find the Density of Moist Producer Gas.—The moisture in the producer gas is taken to be 4.0 per cent. by volume, or 0.04 lb.-molecule per pound-molecule of dry gas. On the gas quantity tabulated in Example 2, the moisture represents an additional weight of $0.04 \times 18 = 0.72$ lb. and an additional volume of $0.04 \times 380 = 15$ cu. ft. The density of the moist gas becomes $\frac{25.79}{395} = 0.065$ lb. per cu. ft. In calculating the

density of a moist gas, the moisture would normally be listed and added with the other gases of the table in Example 2.

The effect of moisture on density and volume is so small that it may be neglected in calculations pertaining to movement of air and of fuel gases. It should be taken into account in dealing with the products of combustion of fuels containing much hydrogen or requiring steam for atomisation.

Effect of Pressure on Gases.—Up to the present, a pressure of 30 inches of mercury has been assumed. At a lower pressure, the gas will expand to a greater volume; at a higher pressure it will be compressed to a smaller volume. **Boyle's Law** tells us that the volume varies inversely as the absolute pressure. By absolute pressure is meant the sum of the atmospheric pressure and the gauge pressure of a gas.

Suppose, for example, that v_0 is the volume of gas at 30 inches of mercury and that we wish to find the volume at 29 inches of mercury. The lower pressure indicates a greater volume; therefore the new volume is given by

$$v = v_0 \times \frac{30}{29}$$

the pressures 30 and 29 having been arranged to give a fraction which is greater than unity. If the new pressure is to be 31 inches, this must give a smaller volume than at 30 inches, therefore we write,

$$v = v_0 \times \frac{30}{31}$$

Similarly, if v were the volume of gas actually measured under a

pressure of 29 inches, the volume under the standard pressure of 30 inches must be less, or $v_0 = v \times \frac{29}{30}$. Again, to convert a volume measured at 31 inches to the standard pressure of 30 inches, $v_0 = v \times \frac{31}{30}$, in order to give the greater volume expected at the lower pressure.

Pressure naturally has the reverse effect on the weight per cubic foot; thus if the density of producer gas is 0.066 lb. per cu. ft., then the weight at 31 inches of mercury pressure will be $0.066 \times 31/30 = 0.068$ lb. per cu. ft. and at 29 inches it will be $0.066 \times 29/30 = 0.064$ lb. per cu. ft.

In calculating volume and weight per cubic foot the pressure used should properly be the total pressure, *i.e.* the barometric pressure plus any pressure exerted by the gas itself, this also being expressed in inches of mercury. Pressures exerted by gases in the majority of furnaces are so slight that they can be ignored. In blast furnaces the pressure is considerable and cannot be ignored. For most purposes, changes in atmospheric pressure can be neglected.

When the gauge pressure of compressed air is measured in pounds per square inch, the atmospheric pressure must be measured in the same unit to calculate the effect on volume. The normal barometric pressure of 30 inches of mercury is equivalent to 14.7 lb. per sq. in.

Effect of Altitude.—The effect of reduced barometric pressure at high altitudes may be of importance in some instances. Roughly, for each 1000 ft. above sea level there is a reduction in barometric pressure of 1 inch. For a works 5000 ft. above sea level, all gas volumes would be about 20 per cent. greater and it would be logical to construct flues, valves, chimneys, etc., of larger cross section to allow for this. Particularly if forced draught is used, it is important to allow for high altitudes in the design of fans, these needing to be bigger and requiring more power.

Effect of Temperature on Gases.—An increase in temperature causes an increase in the volume of gas. The volume of any gas is proportional to the absolute temperature¹ (**Charles' Law** or

¹ The lowest temperature theoretically attainable is -460° F. (-273° C.) and is called the absolute zero. To convert temperatures measured on the ordinary scale to absolute temperatures, the value 460° F. (or 273° C.) must be added.

Gay-Lussac's Law). If v_0 is the volume at 60° F., the volume v at 2000° F. must be greater and will be

$$v = v_0 \times \frac{460 + 2000}{460 + 60} = v_0 \times 4.73$$

0° F. being 460° on the absolute Fahrenheit scale.

In Centigrade units, if v_0 is the volume at 15° C., and v is the volume at 1000° C.,

$$v = v_0 \times \frac{273 + 1000}{273 + 15} = v_0 \times 4.42$$

0° C. being 273° on the absolute Centigrade scale.

Effect of Pressure and Temperature Together.—When pressure and temperature change together, the volume changes in accordance with both the above laws. If v_1 , t_1 and p_1 represent the volume, temperature and pressure under one set of conditions, and v_2 , t_2 and p_2 are the values for the same quantity of gas under another set of conditions, we may write,

$$\frac{p_1 v_1}{460 + t_1} = \frac{p_2 v_2}{460 + t_2} \quad \text{for } ^\circ \text{F.} \quad . \quad . \quad . \quad (7a)$$

$$\frac{p_1 v_1}{273 + t_1} = \frac{p_2 v_2}{273 + t_2} \quad \text{for } ^\circ \text{C.} \quad . \quad . \quad . \quad (7b)$$

It is better to consider each individual problem separately.

Example 1.—If the initial volume of the gas is 100 cu. ft. at a pressure of 30 inches of mercury and temperature of 100° F. and we have to find the volume at 29 inches of mercury and 1000° F., we argue that a lower pressure will produce an increase in volume, therefore our pressure factor must be $30/29$; and the higher temperature will also give a greater volume, the temperature factor being $\frac{1000 + 460}{100 + 460}$

$$\therefore v = 100 \text{ cu. ft.} \times 30/29 \times 1460/560 = 270 \text{ cu. ft.}$$

Example 2.—The density, w_0 , of a producer gas, is 0.065 lb. per cu. ft. Find w , the weight per cu. ft. at 31 inches of mercury and 1200° C.

According to the definition of density, w_0 must have been measured at 15° C. and 30 inches pressure. The effect of higher pressure will be to increase the weight per cu. ft., so w_0 must be

multiplied by 31/30. The effect of higher temperature will be to decrease the weight per cu. ft., so the temperature factor is

$$\frac{273 + 15}{273 + 1200} = \frac{288}{1473}$$

$$\therefore w = 0.065 \times 31/30 \times 288/1473 = 0.013 \text{ lb. per cu. ft.}$$

Use of Nomograms.—Fig. 5 is a nomogram for direct reading of the effect of temperature and pressure on the volume and weight of a cubic foot of gas. As nomograms provide an extremely convenient means of evaluation, and will be used for other determinations, a brief description of the method of application is not out of place.

The nomogram shows three distinct scales, although in this case each is calibrated in two different sets of units, possibly giving an illusion of complexity. We will confine our attention in the first place to the left-hand calibration of each of the three scales.

Example.—Suppose gas is at a temperature of 2000° F. and at a gauge pressure of 10 lb. per sq. in. In order to find the actual volume occupied, the known volume in normal cubic feet must be multiplied by the volume occupied by 1 normal cu. ft. under the given conditions.

Step 1.—Find the absolute pressure,

$$10 + 14.7 = 24.7 \text{ lb. per sq. in.}$$

Step 2.—Stretch a fine black thread from the estimated position of 24.7 on the left pressure scale through the 2000° F. point on the temperature scale.

Step 3.—Read the volume per normal cubic foot on the middle scale,

$$\text{Result} = 2.8 \text{ cu. ft.}$$

A fine thread is much superior to a straight-edge for this purpose, because it leaves an uninterrupted view of the scales, and also because any slight curvature of the page does not interfere so much. A suitable length of thread may conveniently be kept in the book. For quick adjustment the thread should be pressed to the page with the thumbs close to the two outside scales.

The alternative scales are used in exactly the same way. For example, if the weight of 1 cu. ft. of air at 1000° C. and 29 inches of mercury (absolute) is required, the thread is stretched between these two figures. It is found to cut the middle scale (right hand

calibration) at 0.0166 lb., which is the weight per cubic foot under the given conditions.

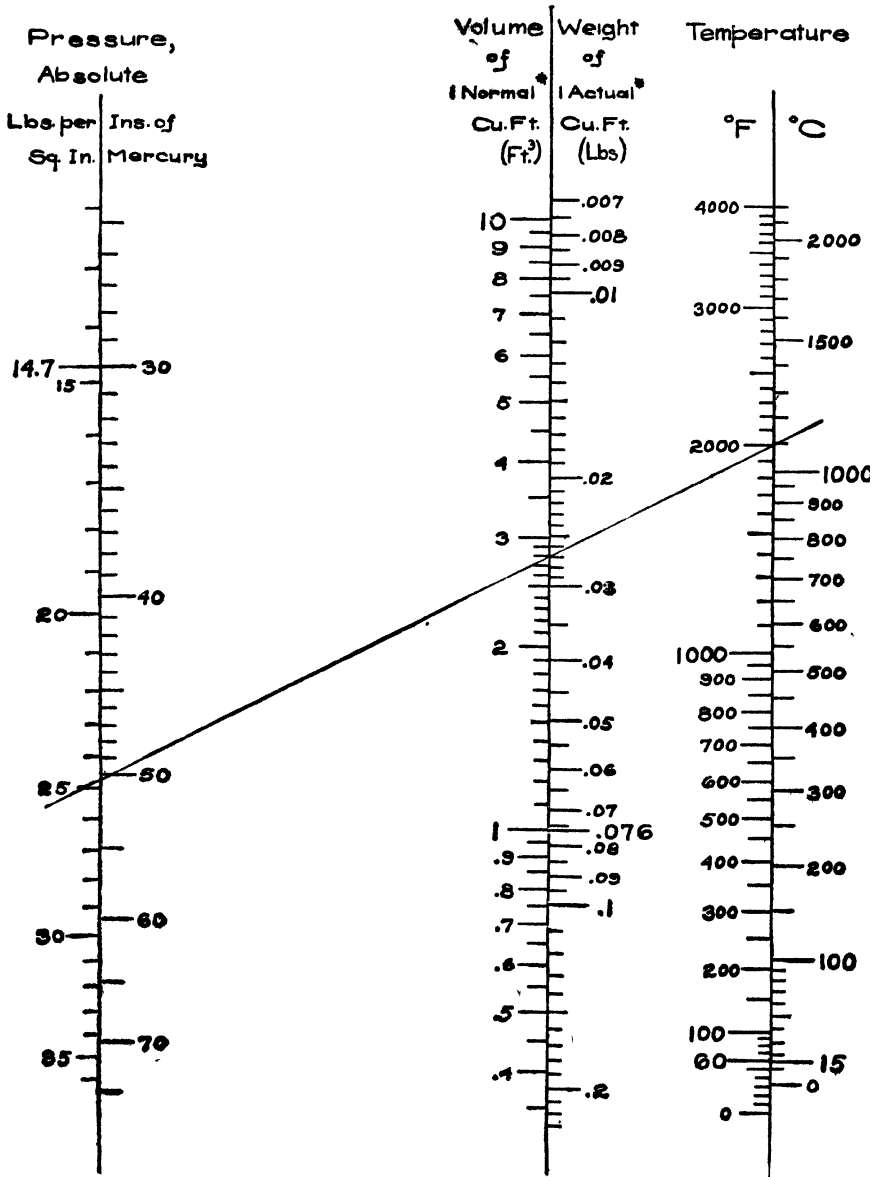

Fig. 5.—Temperature-Pressure Relation of Gases.

The temperature scale gives actual temperatures, there being no need to convert to the absolute values when reading the nomogram.

II.—TYPES OF GAS FLOW.

The words "streamline" and "turbulent" are frequently applied, in loose semi-technical parlance, to two commonly observed types of fluid movement. It is unfortunate that the meaning when used in this way is quite different from that accorded by science.

Scientific Nomenclature.—Physicists recognise two distinct types of flow in a straight pipe.

(a) *Streamline Flow.*—When heavy oil flows in a pipe at ordinary speeds, the motion is strictly viscous or streamline. Our conception of viscous flow in a circular pipe supposes the fluid to be made up of concentric cylindrical films. The outer film in contact with the pipe is practically stationary, the one inside it moves very slowly, the one inside that a little faster, and so on, the centre film moving most rapidly of all. The movement therefore consists of true parallel flow, the increase in velocity towards the centre being, of course, continuous, and not occurring as a series of steps.

(b) *Turbulent Flow.*—Above a certain speed, called the critical velocity, the placid streamline flow breaks down, excepting quite close to the pipe wall, and is superseded by a more or less orderly forward rush of the fluid body. This is called turbulent flow. The critical velocity for a less viscous fluid is lower than that of a more viscous one under similar conditions, *i.e.* the lower the viscosity the more easily is streamline flow broken down into turbulent flow. Gases are very much less viscous (*i.e.* more mobile) than water, and water is in turn very much less viscous than heavy oils. The critical velocity is also dependent on the pipe diameter, being higher for small diameters. It follows that there is a greater probability of finding streamline flow in small pipes than in large ducts. In furnaces, the gases are always moving faster than the critical velocity (even in recuperators and narrow straight flue types of regenerator checkers), so that flow is never streamline according to the scientific conception. Water flow is usually turbulent also, and in furnace practice streamline flow is ordinarily found only for viscous liquids like fuel oil and tar.

Practical Nomenclature.—It would doubtless be desirable to adhere in technical work to the scientific definitions. But the

moderately steady "turbulent flow" of physicists is often referred to as "streamline flow" by practical men, who reserve the word "turbulence" and even "turbulent flow" for streams sustaining violently irregular movement due to sudden bends, etc. When they speak of "streamlining" aeroplanes, automobiles, trains, etc., engineers mean that they eliminate to a large extent these irregular movements; but they certainly do not achieve viscous flow, the "streamline flow" of the engineer being again the "turbulent flow" of the scientist.

Owing to the confusion which is likely to arise in some cases, the words "streamline" and "turbulent" will be relinquished in the present study, and so far as the flow of gases is concerned, we recognise two different types of flow:—

(a) *Steady Flow*.—This term is here used to designate undisturbed flow in a straight duct. The velocity for gases is, in practice, always above the critical velocity, and steady flow hence corresponds to the scientific definition of turbulent flow.

(b) *Eddying Flow*.—This term as used here indicates the abnormally violent flow induced by sudden bends, changes in section, etc. Scientifically, this type of flow is referred to as turbulent eddying flow—since even true streamline flow may be eddying. No confusion can result from the technical use here advocated for the word "eddying," since it is the only type of eddying flow of practical importance.

It should be understood that the terms "steady" and "eddying" are not generally accepted. They are used reluctantly in order to avoid possible misunderstanding of the accepted, but frequently misused, terms.

Examples of Steady and Eddying Flow.—Fig. 6a represents the steady flow of gas in a straight duct. The lines are drawn to indicate the general forward direction of the stream—they are *not* intended to indicate true streamline flow.

Fig. 6b shows the effect of a right-angle bend on the flow of gas. The gas still chooses the smoothest possible path, shooting beyond the inner corner to avoid sudden change in direction. The lines are again used to indicate the main flow of the gas stream. The zone between the bottleneck in the main gas stream and the walls of the duct, is filled with gas in irregular movement. This is shown in the diagram by small broken circles representing eddy currents, really minute whirlwinds of the entrapped gas. It is to such abnormal gas (or liquid) movement that we are here applying the term "eddying flow." The gas does not resume

its steady movement for some distance downstream, more or less large eddies forming and continuing in the main stream until they are finally damped out by friction. The condition will be well recognised by anyone who has watched the eddies and whirlpools at a sharp bend in a fast moving river.

Fig. 6c shows a smooth curve substituted for the sharp bend. If the radius of the bend is large compared with the diameter of the duct—at least five times as great—there will be very little disturbance of the steady type of flow. If the curve is sharper, there will be rather more disturbance, but very much less than in case *b*.

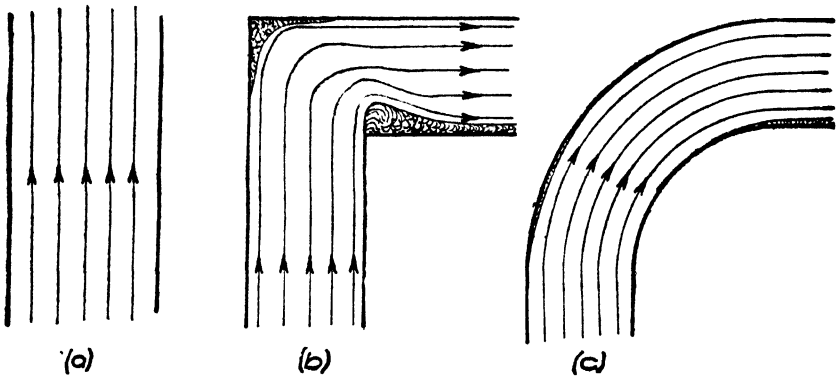

Fig. 6.

Eddying flow may supersede steady flow due to a change in direction or cross section; due to an obstruction; or due to a stream being divided or to streams meeting and combining. Each of these conditions has an analogy in the flow of water.

III.—ENERGY OF GASES.

Pressure Energy or Static Energy of Gases.—That compressed air is capable of performing work is well known; for example, compressed air is used for operating machinery such as air chisels and pneumatic cylinders. The amount of work which the compressed gas is capable of performing is called the energy of the gas, and it depends both on the quantity and the pressure of the gas. The available pressure is of course not the absolute pressure, but only the excess over atmospheric pressure, *i.e.* the pressure ordinarily indicated by a gauge or manometer. In the

case of air working against a back pressure, it is the difference between supply and discharge pressures which determines the available energy.

In furnace systems we are concerned only with the difference between the gas and atmospheric pressures; this is the pressure which is measured by the draught or pressure gauge. The pressure or static energy of a quantity of air or other gas is obtained simply by multiplying the gauge pressure by the actual volume.¹ In the theoretical treatment of gas energy, it is slightly more convenient to take, as the unit of quantity, 1 cu. ft. at the actual temperature and pressure instead of 1 normal cu. ft. The pressure energy per actual cubic foot of gas is given by,

$$E_p = p$$

It is essential to use the same units of measurement throughout, and since the unit of length is the foot, p must be measured in pounds per square foot. *To convert inches water gauge to pounds per square foot multiply by 5.2.* Pressure gauge readings giving pounds per square inch should be converted to pounds per square foot by multiplying by 144. If, for example, the gas pressure measured is 0.5 inch water gauge,

$$E_p = 0.5 \times 5.2 = 2.6 \text{ ft. lbs. per actual cu. ft. of gas.}$$

Dynamic Energy of Gases.—It has long been known that air which is not compressed, *i.e.* gas which is at atmospheric pressure, can, if in motion, perform work. The windmill is an ancient example of this. The energy of air which is in motion, but which is not under pressure, is proportional to the square of the velocity. This is illustrated by the barely perceptible force exerted by a breeze of 8 miles per hour, and the much more than doubled effect of a 16 mile per hour wind; also by the rapidly increasing effect of air resistance to motion of trains, aeroplanes, etc., at high speeds.

The energy due to motion, called dynamic or kinetic energy, of 1 actual cu. ft. of gas (or of any other substance) is expressed by

$$E_D = w \times \frac{V^2}{2g}$$

¹ This is true where the pressure changes involved in a system or part of a system are small, which is the case for practically all furnaces and parts of furnaces except the stock column of blast furnaces. In this last case the use of gas energy equations falls for other reasons also.

where w is the weight of 1 actual cu. ft. of the gas, V is the actual velocity of the gas and g is the acceleration constant of gravity equal to 32.2 ft. per sec. per sec. The quantity $\frac{V^2}{2g}$ is frequently referred to as the "velocity head" of the gas.

It has already been shown how the density, w_0 , of a gas may be calculated from the gas analysis, and how the weight per actual cubic foot, w , may be obtained from density, temperature and pressure. Suppose that w is found to be 0.016 lb. per cu. ft., and that the velocity of the gas at some point is found to be 40 ft. per sec.

Then,

$$E_D = 0.016 \times \frac{40 \times 40}{2 \times 32.2} = 0.4 \text{ ft. lb. per actual cu. ft. of gas}$$

Total Energy.—Any gas under pressure and at the same time in motion, has both pressure energy and dynamic energy, the total energy per actual cu. ft. being,

$$E = p + \frac{wV^2}{2g} \quad . \quad . \quad . \quad . \quad (8)$$

p is easily found by means of a properly installed draught gauge. Methods of measuring velocity are described later.

Conversion of Static and Dynamic Energy.—The two forms of energy are convertible one into the other. If a tank contains gas under pressure and all outlets are closed, there will be no motion, hence the gas has only static or pressure energy. If, now, a valve be opened to an outlet pipe at a lower pressure than the tank, gas will commence to flow from the tank through the pipe, and the gas so flowing will have acquired dynamic energy. This energy represents a partial conversion of the pressure energy into velocity energy, as witnessed by a steady fall in the pressure of the gas remaining in the tank.

Loss of Energy.—Movement of gas, whether steady or disturbed, implies that the gas has dynamic energy. The energy due to irregular movement of eddy currents, however, serves no useful purpose; and when such eddies are finally destroyed, the dynamic energy which they possessed is lost. When we speak of "loss" of energy, we mean that the mechanical energy has become converted into heat energy. The quantity of heat produced is quite negligible as far as heat addition to the furnace is concerned.

It is clear that loss of energy, whether due to eddies or to friction against the walls of the duct, depends on movement of the gas. In most furnace systems, the gas is continually moving, and therefore has dynamic energy at all points in the system. The amount of dynamic energy per cubic foot of gas, $\frac{wV^2}{2g}$, will depend partly on the velocity. This in turn depends on the gas flow in normal cubic feet per second, and on the temperature and cross-section of the gas stream at a particular point. It is evident therefore that the velocity varies continuously and almost every variation in speed or direction is accompanied by much disturbance (eddying).

Notwithstanding continual loss of dynamic energy, the gas must keep moving and must therefore continue to have energy of motion; pressure energy serves as a reserve for continual replacement of lost dynamic energy. The total pressure energy necessary is therefore many times greater than the dynamic energy at any one point in the system.

For mechanical draught a fan gives this pressure directly on the input side. On the exhaust side, a fan produces suction, which means that it lowers the static pressure in the flue. It has been explained that the available pressure or static energy depends on the difference between the pressure of the gas upstream and the pressure at the outlet. Lowering the static pressure in the flue by an exhaust fan increases the available pressure difference between the furnace and the flue. It therefore has exactly the same effect as would be obtained if it were possible to increase the pressure of the gas at the outlet of the furnace proper, and to leave the furnace flues directly open to the atmosphere.

Formerly, fans were not much used in furnaces operating approximately at atmospheric pressure; and of course most furnaces continue to use natural draught to supply the necessary static pressure differences. Natural draught produces a difference of static pressure by reason of the tendency of a hot column of gas to rise.

Magnitude of Pressure Changes.—In most furnace systems pressure variations are very small. This certainly must not be taken to mean that they are unimportant. The weight of a cubic foot of gas is so small that a very slight pressure will produce considerable movement in the gas.

As an illustration of this, 1 inch of water pressure would be capable of producing the same motion in cold air as would be

produced in water by a pressure of 30 lb. per sq. in.—a pressure 800 times greater. The gas flow from an opening in a gas container at 1 inch of water pressure would be the same in cubic feet per minute as the water flow through a sluice at the bottom of a dam 68 ft. high. In further illustration, a pressure of $\frac{1}{100}$ of an inch of water would permit the escape of 400 cu. ft. of cold air per minute per square foot of opening.

These illustrations show the importance of seemingly insignificant pressure differences in gas systems.

Calculation of Energy Loss.—As it is the destruction of dynamic energy which is responsible for energy loss, the losses must first be calculated in terms of dynamic energy. On the other hand, the available pressure represents the reserve on which the system must draw to make good the losses; it is therefore necessary to recalculate the losses as an equivalent amount of pressure energy.

Suppose a stream of gas weighing w lb. per cu. ft. is travelling at a velocity of V ft. per sec., both w and V being measured at the actual temperature and pressure of the gas. The dynamic energy per cubic foot of gas is $\frac{wV^2}{2g}$. Suppose the pressure equivalent of this dynamic energy, *i.e.* the static pressure which would be used up to supply this motion, is $p.e'$ lb. per sq. ft. This is, in general, only a small fraction of the total gas pressure, being the amount of pressure which would be lost if the entire dynamic energy were destroyed and had to be replaced at the expense of pressure energy. The pressure energy represented by $p.e'$ is given by,

$$p.e' = wV^2/2g = 0.0155 wV^2 \text{ lb./ft.}^2$$

$$\text{or } p.e. = 0.3 wV^2 \text{ hundredths of an inch of water.}$$

In this formula both w and V are dependent on temperature, and if we neglect changes of volume due to small deviations from atmospheric pressure, the formula is more conveniently written,

$$p.e. = 0.000574 w_0 V_0^2 (460 + t) \quad . \quad . \quad (t = ^\circ \text{F.})$$

$$= 0.00104 w_0 V_0^2 (273 + t) \quad . \quad . \quad (t = ^\circ \text{C.})$$

where $p.e.$ is measured in hundredths of an inch of water, w_0 is the density of the gas (*i.e.* the weight per cubic foot under standard conditions), and V_0 the velocity if the gas were at standard temperature. The value of w_0 is known or is easily found; V_0 is equal to the volume of gas, in normal cubic feet,

passing per second, divided by the area of cross section of the duct. For air at 60° F. (15° C.), $p.e. = 0.0227 V_0^2$.

Evaluation of $p.e.$, the pressure equivalent of dynamic energy, is best achieved directly from Fig. 7, which renders the use of formulæ unnecessary. The nomogram (Fig. 7) is constructed for air under standard pressure. For flue gases and other gases differing but slightly from air in density, and for gases whose pressure differs from that of the atmosphere by only a few inches water gauge, the nomogram may be applied without correction.

For light fuel gases (also for certain heavy hydrocarbon gases) the nomogram reading is to be multiplied by,

$\frac{\text{Density of gas}}{0.076}$ (*i.e.* by the specific gravity of the gas relative to air.)

For compressed air (*e.g.* in blast furnace mains) the nomogram reading is to be multiplied by,

$$\frac{14.7}{14.7 + \text{Gauge pressure}}$$

if the air pressure is measured in pounds per square inch, or,

$$\frac{30}{30 + \text{Inches of mercury pressure}}$$

if a mercury manometer is used. In reading the nomogram, the velocity calculated to atmospheric pressure is used.

Suppose, for example, V_0 is 60 ft. per sec., the temperature is 100° F. (40° C.), and the gauge pressure is 12 lb. per sq. in. Fig. 7 shows that the dynamic energy under atmospheric pressure would be equivalent to 89 hundredths of an inch of water. For the actual pressure, this must be multiplied by $\frac{14.7}{14.7 + 12} = 0.56$, giving 50 hundredths of an inch of water.

If, due to a bend or to some other obstruction, the whole of the dynamic energy is destroyed and replaced, the value obtained from Fig. 7 would be the pressure loss. If a fraction, represented by f , of the dynamic energy is destroyed, then,

$$\text{pressure consumption} = f \times p.e. \quad . \quad . \quad . \quad (9)$$

The factor f may be less than 1, indicating that in the particular case only part of the dynamic energy is lost; or it may be greater

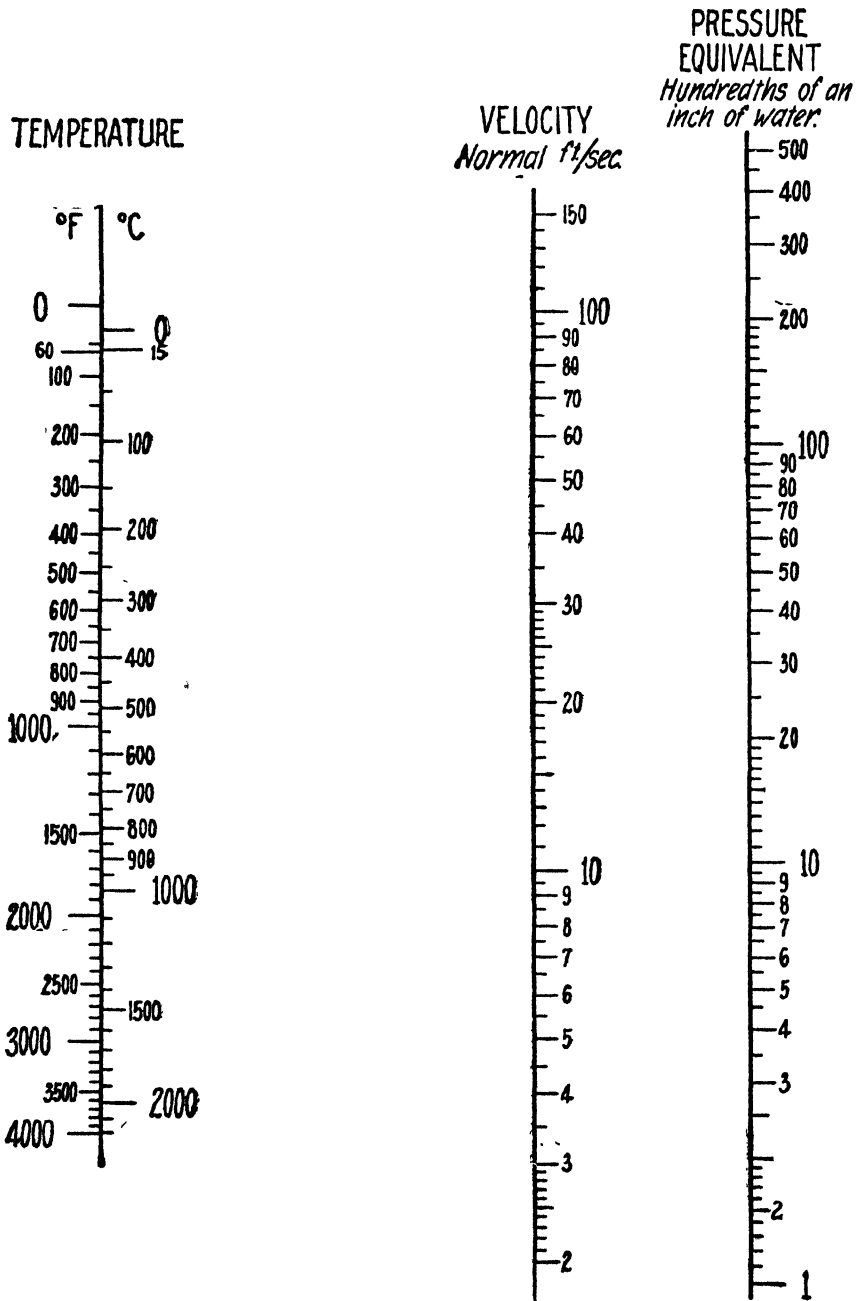

Fig. 7.—Pressure Equivalent of Gas Movement.

than 1, indicating that an amount of pressure energy greater than the initial dynamic energy has to be expended to compensate for the losses. Fig. 8 shows the value of f for a number of important cases. The many published data from which these loss factors have been selected are far from consistent, and the values must not be regarded as accurate. The values given are due principally to Wesemann,¹ Brabbée,² and Bansen³. The values for rectangular ducts are based on experiments by Wirt⁴. Some values well known in hydraulic engineering have been included. (Additional values for the flow of water will be found in engineering handbooks—these may be used also in calculations of gas flow.) Some of the values were determined for metal pipes, and some for bricked channels. In those instances where values have been determined for both metal and bricked ducts, there is no appreciable difference between the eddy current losses in the two cases; consequently no distinction is made here between the two types of duct. The additional friction losses for a bricked duct will be considered in Section V of this chapter.

The individual pressure losses in a furnace system are usually too small for separate measurement; by measuring the pressure at different parts of a furnace system Heil⁵ has compared over-all experimental energy losses with the values obtained by calculation. Heil found some discrepancy between experimental and calculated values; but as high percentage accuracy is not claimed for the energy loss factors, the general agreement must be considered fairly satisfactory.

As an example of the use of this chart, we find that for a right angle bend in a circular brick-lined pipe, f is 1.2. This means that the amount of energy destroyed is 1.2 times the initial dynamic energy. A combination of two 45° bends instead of one 90° bend is shown to be better, because f is then 0.4, showing only $\frac{1}{3}$ of the

¹ Wesemann, F.: "Die Ermittlung des Druckabfalls durch Reibung in Leitungen für Gase, Druckluft, Dampf und Wasser unter besonderer Berücksichtigung graphischer Verfahren," *Mitt. Wärmetelle d. Verein. deut. Eisenh.*, No. 95 (1926).

² Brabbée, K., and Rietschels, H.: *Leitfaden der Heiz- und Lüftungstechnik.*

³ Bansen, H.: "Beiträge zur Untersuchung der Vorgänge in Siemens-Martin-Öfen," *Ber. Stahlwerksaussch. d. V. deut. Eisenh.*, 1926, No. 111.

Bansen, H.: "Berechnung des Druckabfalls in Gasleitungen und gemauerten Kanälen," *Archiv f. d. Eisenhüttenwes.*, Sept., 1927, vol. 1, 1927-28, pp. 187-192.

⁴ Wirt, L.: "New Data for the Design of Elbows in Duct Systems," *General Electric Review*, June, 1927.

⁵ Heil, W.: "Errechnung der Druckverluste insbesondere in Siemens-Martin-Öfen," *Archiv f. d. Eisenhüttenwes.*, June, 1928, vol. 1, 1927-28, pp. 729-740.

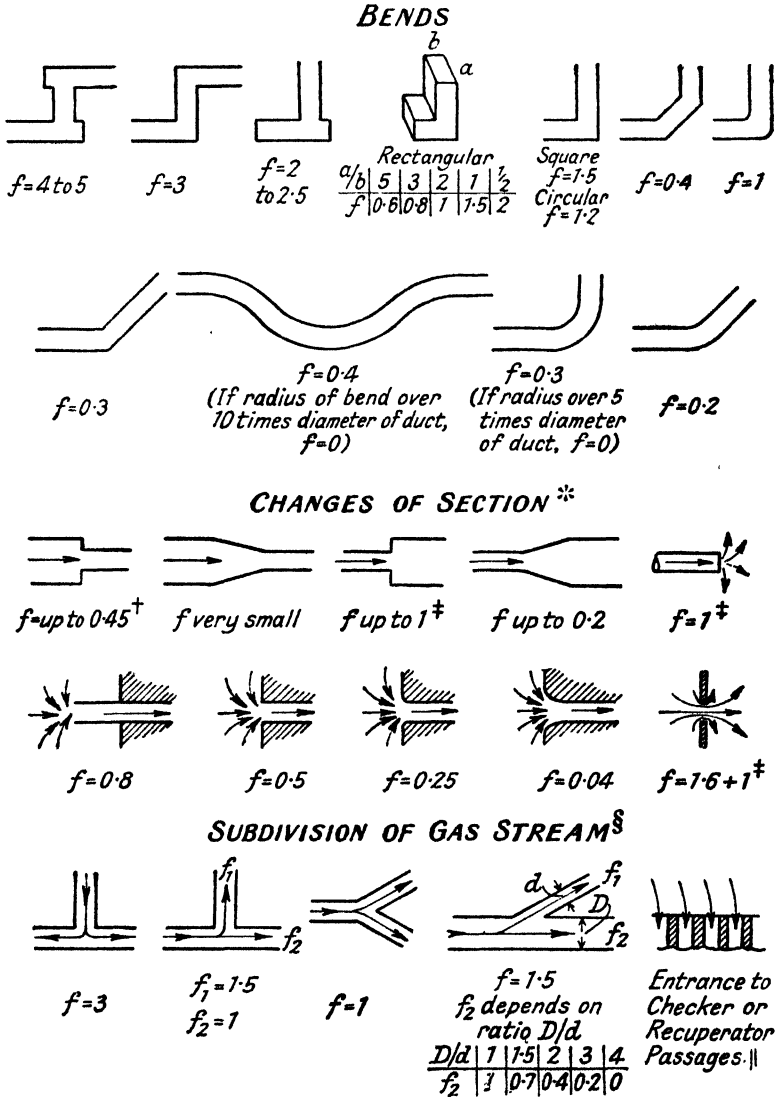

Fig. 8.—Energy (Pressure) Loss Factors.

Notes on Fig 8.

* The values of f for changes of section are to be used in conjunction with the velocity in the narrower duct, i.e. with the higher velocity.

† For a large chamber discharging into a narrow duct, Bansen gives values which range from 0.1 for a well-rounded outlet, through 0.5 for a short conical reducing section, to 1.5 or a little more for a sharp cornered outlet. This last figure is much in excess

former pressure loss. Arrangements not given on the drawing may be estimated by comparison with similar cases. The value found for f is to be multiplied by the pressure equivalent of the dynamic energy as found from Fig. 7.

Example.—Suppose that a chimney flue is built with a sharp right angle bend, that the gas flow is 12,000 normal cu. ft. per min., that the temperature of the gas is 1400° F. (760° C.) and that the area of cross section of the flue is 40 sq. ft. The velocity

$$V_0 \text{ (at standard temperature) would be } \frac{12,000}{60 \times 40} = 5 \text{ ft. per sec.}$$

Fig. 7 shows that *p.e.*, the pressure equivalent to the dynamic energy, is 2 hundredths of an inch of water. This assumes the density of the waste gas to be the same as that of air—clearly a close enough approximation. Fig. 8 shows that, for a flue approximately rectangular in shape and higher than it is wide, f is about 1.25 (estimated by comparing the values for square and for rectangular ducts), therefore the total pressure loss is,

$$2 \times 1.25 = 2.5 \text{ hundredths of an inch of water}$$

Loss of Energy in Checkers.—In passing through regenerator checkers, the gas stream suffers a change in the form of its cross section in passing from each course¹ of bricks to the next. In the usual type of checker, this change consists of a contraction in one dimension and a simultaneous enlargement in the other dimension of the cross section. The distance between successive changes

of the 0.45, due to Weisbach, shown in the diagram. Bansen's figures indicate a great proportionate saving by breaking the sharp corners where a contraction of section occurs.

‡ The value 1 corresponds to the complete loss of dynamic energy when a gas stream merges into a stationary body of air.

§ Values for diverging and converging gas streams are dependent on the relative velocities in the individual channels, as well as on the construction of the junction. A summary of recent work, giving values of f under different conditions, may be found in *Der Chemie-Ingénieur*. This handbook summarises much other valuable work on the flow of fluids.

|| For 30 to 40 per cent. free passage, and velocities up to 10 normal ft. per sec., the averages of values given by Bansen are 1.2, 1.8 and 2.15 for long narrow rectangular openings, for square openings, and for circular openings, respectively. For rounded off entrance to the openings, Bansen gives values from 0.5 to 1.0. By analogy with Footnote †, these values might be considered high, if Weisbach's values are preferred for a contraction of section.

¹ In referring to "courses" a vertical checker is assumed. For a horizontal checker, the equivalent quantity is the number of vertical rows of bricks between inlet and outlet, *i.e.*, perpendicular to the direction of the gas stream.

of section is so short, usually $4\frac{1}{2}$ inches, that the stream does not have an opportunity to spread fully before it is again constrained to change its form. The losses are therefore usually less than if the gas stream were permitted to conform unrestrictedly with the actual changes of section. It is therefore not satisfactory to apply the change of section factor given later (Fig. 11) to calculation of this energy loss.

Kistner¹ gives an empirical formula for pressure drop through unstaggered checkers, having a free opening² varying from $2\frac{3}{8}'' \times 2\frac{3}{8}''$ to $4\frac{3}{4}'' \times 4\frac{3}{4}''$. The formula shows that the pressure loss does not vary very rapidly with change of diameter of the opening, and from a consideration of Kistner's results a value for f of 0.3 per course of bricks is suggested here as a practical figure for this type of checker.

Example.—An unstaggered checker contains 30 courses of brick. The mean velocity of air passing through the checker is 2 normal ft. per sec. (based on the free cross section of the opening), and the mean temperature is 1000° F. The pressure drop due to eddying in the checker is required.

The loss factor for the checker is $0.3 \times 30 = 9$.

The value $p.e.$ for the gas is found from the nomogram, Fig. 7, to be 0.26³ hundredths of an inch of water.

The pressure loss due to eddying is $9 \times 0.26 = 2.34$ hundredths of an inch of water.

If the condition of the inlet and outlet to the checker were known, the appropriate factors could have been added to the internal loss factor of 9.

For staggered checkers, the loss factor would be greater than for unstaggered.

For the simple flue³ type of regenerator packing (*i.e.* for straight passages without lateral openings), there is no pressure loss due to change of section. In this case loss is by friction only, and evaluation of this loss is explained in Section V. of this chapter. Loss in this type of packing is much smaller than in the more usual type of checker. For the same air velocity and temperature

¹ Kistner, H.: "Grossversuche an einer zu Studienzwecken gebauten Regeneratorkammer, Part II, Bestimmung der Wärmeübergangszahlen und Druckverluste bei doppelt versetzter und nicht versetzter Rostpackung," June, 1930, *Archiv f. d. Eisenhüttenwes.*, 1929-30, pp. 751-768.

² By "free opening" is meant the unobstructed passage seen when looking down the checker.

³ This value comes outside the range of the nomogram. The method described on p. 196 was employed.

as in the above example, and for new straight flues whose diameter is 6 inches and whose length is 30 courses of $4\frac{1}{2}$ inches = 135 inches, the friction loss factor may be shown to be approximately $135/6 \times 0.05 = 1.1$. The pressure loss due to friction will be $1.1 \times 0.26 = 0.29$ hundredth of an inch of water. There is some loss by friction in the type of checker considered previously, but this relatively small value is included in the factor 0.3.

IV.—MECHANISM OF ENERGY LOSSES DUE TO DISTURBANCE.

In making calculations of pressure losses, the method described above is to be used. At the same time, a general conception of the state of the gas stream in the neighbourhood of an obstruction is of value in deciding how a pressure loss is likely to be affected by minor changes of flue construction.

Liquid and Gaseous Movement.—Almost all of the different conditions which may influence the nature of gas flow in ducts have an analogy in the flow of liquids. If we wish to find out experimentally how gas will flow in a particular case, we may construct a model having glass windows and test the type of flow by forcing a liquid through it. The validity of this substitution of liquids for gases is demonstrated by Groume-Grjimailo's¹ practical application of such models to furnace design. If, then, we have difficulty in visualising the behaviour of gas flowing in a furnace duct, we may draw on our wider acquaintance with the behaviour of liquids, and imagine how water would flow in similar circumstances.

Stream Shape.—When a gas (or liquid) stream is compelled to change its direction or shape, it will not, in general, follow closely the walls of the channel where the change occurs. Figures 6, 9, 10 and 12 illustrate the behaviour of the main stream in certain cases. The stream in each instance will choose its own path, which might be called its natural channel. It will be seen that this natural path in all cases avoids sudden changes of direction, forming smooth curves; and when it leaves or approaches the wall of a duct it always does so tangentially. The sketches, especially 10 and 12, illustrate also that, in the vicinity of some

¹ Groume-Grjimailo, W. E.: *The Flow of Gases in Furnaces*, translated by A. D. Williams. (A newer and more complete work by Groume-Grjimailo has not been translated from the Russian.)

cause of disturbance, the gas stream tends to follow the walls of the duct more closely on the upstream side of the disturbance than on the downstream side—we may imagine that the gas does not realise the presence of an obstruction until the latter is almost reached.

At places where the main stream is not in contact with the walls, the sectional sketch shows an area between the stream and the duct which is filled with gas (or liquid) having a whirling or eddying motion, but with little bodily forward movement. It has been intimated that much, if not the greater part, of the energy loss is due to the destruction of mechanical energy in this area of irregular movement.

Although it is not a scientific conception, it is helpful to imagine that reduction of losses due to disturbance is dependent on a reduction in the area (referring to the sectional sketches) of wasteful irregular movement¹; and that the more we can reduce this area the more nearly we shall approach a condition of steady flow. This conception will be referred to in considering the following examples; but it should be understood that its value is qualitative rather than quantitative and that it should be used with considerable discretion.

Change of Direction.—Fig. 9 shows the type of gas stream to be expected with different types of bend. These are placed in order of increasing loss as determined experimentally. The considerations which have determined the sketching of the main stream are that the stream attempts to shoot beyond the initial obstruction and is thereafter gradually constrained to change its direction to conform with the new direction of flow—this explains the preponderance of disturbed areas at the inner corners. The qualitative value of the whirlwind area conception is apparent. For example, *e* should be twice as bad as *c*, but provided the elbows are not too far apart, *d* is not twice as bad as *c*, because after passing the first bend the inner edge of the main stream has an initial curvature which enables it to keep closer to the wall after the second bend.

Change of Section.—The energy loss due to a change of section

¹ It has been shown (R. Bambach, *Forsch.-Arb. Ing.-Wes.*, vol. 327, 1930) that eliminating a turbulent area, by building up the inner side of the duct to conform with the stream shape, may result in considerably less energy loss (e.g. 40 per cent. less for a right-angle bend in a square duct). However, such effects as this cannot always be anticipated. For example, L. Wirt (see reference on p. 141) finds, under the conditions of his experiments, that the loss in a curved right-angle bend, as in Fig. 9 (*a*), is greater than if the inner radius of Fig. 9 (*a*) had been combined with the sharp outer corner of Fig. 9 (*e*).

increases with the abruptness of the change. Again, comparison is based on sketches showing the probable stream flow.

Enlargement.—Fig. 10 shows two common examples of enlargement. The energy loss in case (a) may be calculated in general terms. The value of f in this case is given by $\left(\frac{A_2 - A_1}{A_2}\right)^2$, where

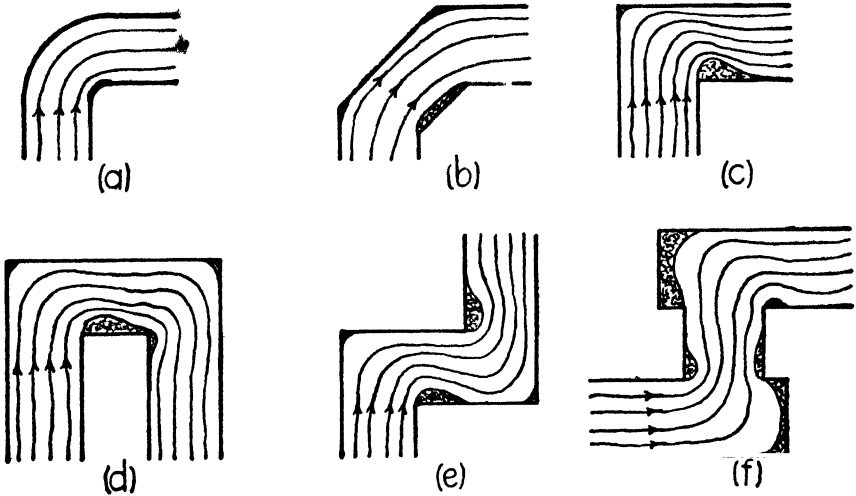

Fig. 9.

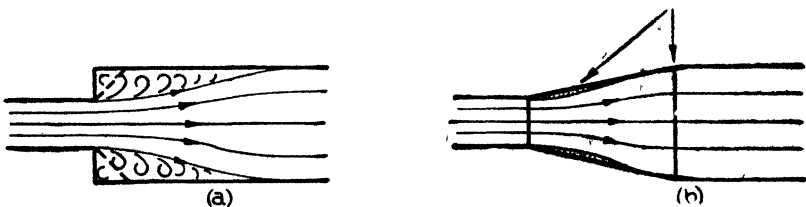

Fig. 10.

A_2 and A_1 are the larger and the smaller areas of cross section respectively, the initial velocity (*i.e.* that in the smaller duct) being used in obtaining the pressure equivalent of velocity. To simplify calculation the value of f may be obtained from Fig. 11 after first finding the ratio A_1/A_2 .

The broken lines drawn at 45° in Fig. 10 show that by cutting off the corners in this way, a comparatively small reduction in the disturbed area would result, and that a large saving of energy

could not be expected from such a modification. Experiments¹ (using water) show that the saving is negligible—about 1 per

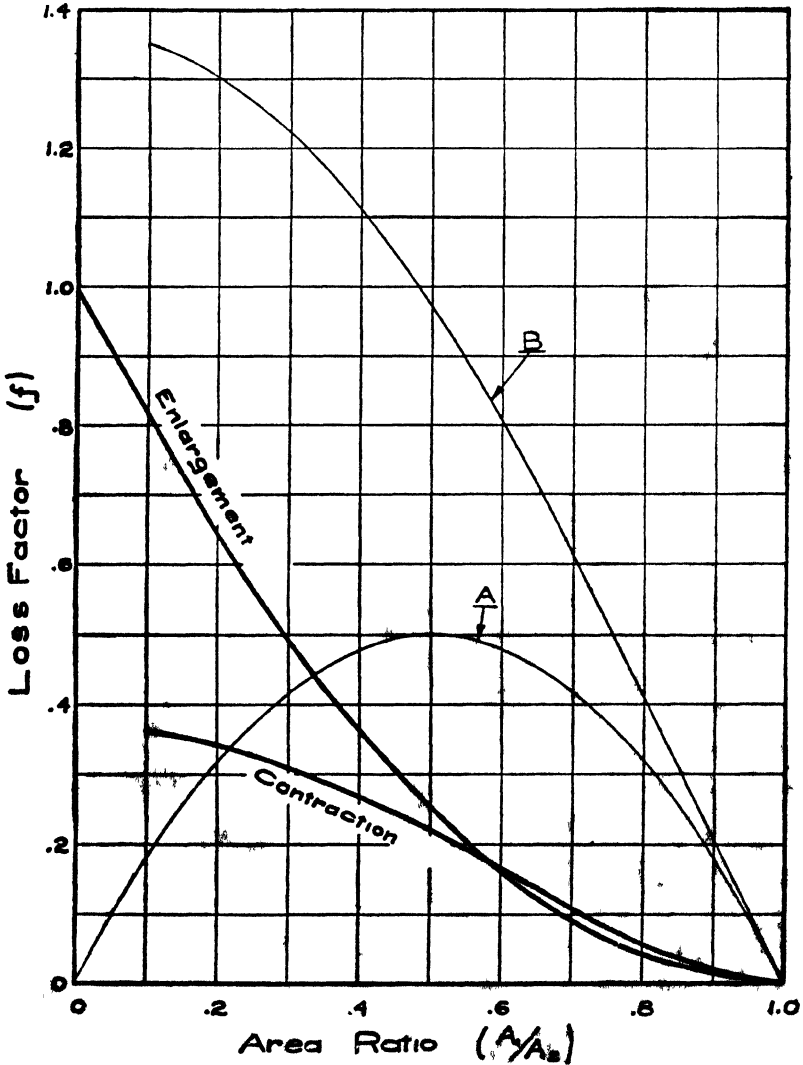

Fig. 11.

cent. under the conditions of the experiment. It is not until the angle becomes quite small (15° or less) that really worth while

¹ Le Conte, J. N.: *Hydraulics*, Third Edition, p. 105.

saving is effected. A 5° angle (on each side) would be desirable, but is rarely practicable on account of the length of taper which would be necessary to effect a substantial change of area. Fig. 10 gives a qualitative idea of the losses in an enlarging taper (circular cross section) forming an angle of 10° with the axis—in the experiments referred to by Le Conte these were about 45 per cent. of those found for a sudden change in section.

Tables are available giving the value of f for various enlargement angles and ratios of enlargement—*e.g.* H. W. King and C. O. Wisler: *Hydraulics*, Third Edition, p. 184. Formulæ are also available.

Contraction.—Fig. 12 shows typical cases of contraction in a

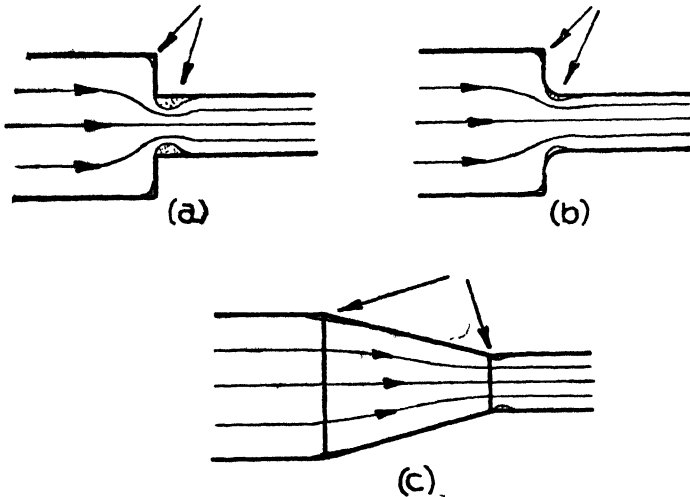

Fig. 12.

gas stream, again placed in order of decreasing loss. In Fig. 11 are plotted the values of f found by Weisbach¹ using water for case 12a—the values for gases should not be greatly different. It should be noted that f is to be used in connection with the velocity in the smaller (downstream) duct instead of in the larger (upstream) duct—this is because in many cases where there is a large reduction in area, f in terms of the low upstream velocity would be inconveniently large. The use of a taper section, Fig. 12c,

¹ Weisbach's experiments were made in 1855, yet his results are still generally accepted as the best available. Calculated values, also using experimental data by Weisbach, are sometimes substituted, these being up to 0.1 higher than the values given by the "Contraction" curve in Fig. 11.

even though fairly steep, greatly reduces the loss. In this respect it differs from a taper section in an enlargement, which we have seen must be extremely gradual to have any appreciable effect. We may construe this as being due to the positive guiding effect of a reducing taper. A sharply enlarging taper, on the other hand, stands clear of the main gas stream, and does not prevent the gas stream from rushing straight out from the narrow upstream pipe and spreading only at its natural angle of about 5° (1 inch per foot) on each side.

Fig. 12 (b) shows marked improvement over 12 (a) due to rounding of the sharp corners that, in 12 (a), are responsible for throwing the stream away from the wall in the downstream section. This condition may be approached by burning off of the corners in the hotter parts of a furnace, or it may be simulated by breaking the corner with a 45° bevel. Similarly, breaking the corners at the downstream edge of the reducing section, 12 (c), should result in smaller energy loss, or should permit a much sharper taper section without increasing the loss. Interesting photographs and models have been made showing the nature of the gas disturbance under different conditions.¹

Energy and Pressure Losses.—The calculated “pressure consumption” (Equation 9) represents the energy loss expressed in hundredths of an inch water gauge. From a practical point of view, it is convenient to regard this as the pressure loss caused by the obstruction. In certain cases, there is a distinction between “pressure loss” and “energy loss.” This has been taken care of, where necessary, in values given for f ; and in calculating the pressure requirements of the system, the values are to be applied directly.

When a gas stream is made to change its direction without any accompanying change in cross section of the duct, the energy loss due to eddying is supplied entirely by the pressure energy. The loss of energy per cubic foot of gas is, therefore, in this case, equal to the loss of pressure.

When an enlargement occurs in a duct, whether sudden or rather gradual (Fig. 10), there is always eddying and therefore always energy loss. On the other hand, the slower moving gas in the larger downstream duct has less dynamic energy than in the smaller upstream duct. The reduction of dynamic energy is accompanied by an equivalent increase of pressure energy, which more than offsets the loss of pressure due to eddying. Consequently, there is an increase of static pressure following an enlargement; thus we have an example of gas flowing locally from a point of lower

¹ For example, Prandtl, L. and Tietjens, O. G.: *Applied Hydro- and Aeromechanics*. Wirt, L.: “New Data for the Design of Elbows in Duct Systems,” *General Electric Review*, June, 1927.

pressure to a point of higher pressure. Curve A, Fig. 11, shows the factor representing rise of pressure; this factor is to be multiplied by *p.e.* for the gas in the narrow upstream duct. The maximum pressure rise is seen to occur when the enlarged section has exactly double the area of the upstream section; in this instance, 25 per cent. of the upstream dynamic energy is retained by the more slowly moving enlarged stream, 25 per cent. is lost by eddying, and 50 per cent. appears as an *increase* of pressure energy.

At a contraction of section, the dynamic energy of the gas must be augmented, requiring expenditure of pressure energy additional to that required to make good the eddy losses. Curve B, Fig. 11, shows the total pressure drop factor for contraction. For a 50 per cent. reduction in cross section, Fig. 11 shows an energy loss factor (contraction curve) of 0.22, and a pressure loss factor (Curve B) of 0.97. These factors, which are to be applied in terms of the high velocity (downstream duct), show that, although the pressure drop is 97 per cent. of the dynamic energy, only 22 per cent. represents energy loss, the remaining 75 per cent. being absorbed as additional dynamic energy of the accelerated gas stream.

In determining the total losses in a system, it is the loss of energy which is important. Thus, in the last case considered, the 75 per cent. is not yet lost, and is, at least theoretically, reconvertible into static energy. Any subsequent loss of this dynamic energy at some later obstruction will be taken into account in the loss factor for that obstruction. Consequently we must use the energy loss factors (the heavy curves in Fig. 11), not the pressure loss factors.

V.—FRICTION.

In addition to energy losses due to the different types of disturbance described above, there is always a loss by friction when gas flows in a duct. In long pipe lines this loss may be large, but in most furnace systems it is much smaller than the loss due to bends, etc.; and in ducts of large cross section and only moderate length, it may frequently be disregarded.

The pressure loss due to friction may be written in the general form

$$\text{Friction loss} = f' \times \frac{wV^2}{2g}$$

but the value of f' depends on a number of factors, the most evident being the length and diameter of the duct. For a given gas velocity, the longer and narrower the duct, the greater will be the friction loss. We may indicate this by writing the formula in its final form—

$$\begin{aligned} \text{Friction loss} &= f \times \frac{L}{D} \times \frac{wV^2}{2g} \\ &\text{or } f \times \frac{L}{D} \times p.e. \quad . \quad . \quad (10) \end{aligned}$$

where L and D are the length and diameter, respectively, of the duct, both measured in the same unit (usually in feet).

Evaluation of f in Equation 10.—This requires a study

- (a) of a particular group of physical quantities,
and (b) of the nature of the surface of the duct.

(a) *Reynolds' Number.*—The last two terms of Equation 10 account for most of the effect on friction of the variables D , w , and V ; but these variables, and also the *absolute viscosity* of the gas, μ , have subsidiary effects which must be allowed for in selecting a value for f . The variables are grouped in the expression $\frac{DVw}{\mu}$, called Reynolds' number, and denoted by Re ; in a given case, by calculating the value of Re and by using published experimental data,¹ it should be possible to determine f .

(b) *Roughness.*—For extremely smooth pipes (*e.g.* bright, drawn brass), when f is plotted against Re , all experimental data lie on a single curve. Table XIV, Part A, shows the variation of f with temperature and with the product DV_0 .* This table is for pipes slightly less smooth than drawn brass—it represents the smoothest condition likely to be found in practice. For ducts showing a greater degree of roughness, the values of Table XIV, A, are used with an adjustment as indicated in Table XIV, Part B.

There are two aspects of the quality "roughness"—(i) the degree of roughness and (ii) the nature of the roughness.

(i) Degree of roughness. "Roughness" of a duct results from small irregularities of the surface. For ducts of the same material (*i.e.* of the same absolute roughness), the effect of the surface irregularities is greater in a small duct than in a large one. If ducts of different diameters have geometrically similar profiles (*i.e.* if the profiles of irregularities are similar in shape but proportional to the duct diameters in size, that is if the profile of the

¹ For a summary of experimental data see Kemler, E.: "A Study on the Data on the Flow of Fluids in Pipes," *Trans. A.S.M.E.*, 1933, Hyd. 55-2, pp. 7-32; also Eason, A. B.: *Flow and Measurement of Air and Gases* (Griffin).

* Reynolds' number may be written $\frac{DV_0w_0}{\mu}$; μ is obtainable from critical tables, and w_0 for air is 0.076. The viscosity, μ , increases with temperature, but extrapolation indicates that the value at 3000° F. is only about four times the value at 0° F. This, and the relatively slow rate of change of f with Re , makes it convenient to express f as a function of the product DV_0 for a few selected temperatures.

large duct looks like a photographic enlargement of the profile of the small one), then the ducts are said to have the same relative roughness; ducts having the same relative roughness have the same friction coefficient for a given value of Reynolds' number.

(ii) Nature of roughness. Some surfaces exhibit the roughness of a granular material—the small sharp cavities and projections characteristic of such a surface may be felt by passing the fingers over a rough surfaced brick or rough or rusted cast iron. In other surfaces, the projections may be gently wavy in character—irregularities which may be felt and yet which are smooth to the touch are usually of this type (*e.g.* unevenness of new commercial rolled steel products). For a given height of projection, the angular type of roughness causes much more friction than the wavy type—largely because of the greater number of projections per unit area on a granular surface.

For smooth pipes, the friction coefficient is seen (Table XIV, A) to decrease as the product DV_0 increases—at first rapidly, and then slowly. It is believed that at very high values of DV_0 (or more correctly of Re), f reaches a constant value. This condition is not reached in practice for fairly smooth ducts, but is frequently reached for ducts showing extreme roughness of a coarsely granular type—the rougher the duct the sooner the condition of constancy is reached. A distinction is therefore made between these two types of roughness in presenting Tables XIV, B and C.

In Table XIV B, the correction to be applied for extremely smooth pipes is based on the experiments of Stanton and Pannell¹—the work of all later experimenters on smooth pipes confirms these results. The corrections to be applied for other types of duct are based on curves by Pigott.² It is seen from this table that moderate roughness has no appreciable effect on the higher values of f (*i.e.* for low values of DV_0). The rougher (relatively) the duct the earlier is the departure from the smooth pipe value. This is consistent with the earlier approach to a constant value of f as the relative roughness increases.

Table XIV C is based on the experiments by Nikuradse.³

¹ Stanton, T. E., and Pannell, J. R.: "Similarity of Motion in Relation to Surface Friction of Fluids," *Phil. Trans. Roy. Soc., A*, 1914, vol. 214, p. 199.

² Pigott, R. J. S.: "The Flow of Fluids in Closed Conduits," *Mechanical Engineering*, Aug., 1933. Also, Discussion of Kemler's paper (see footnote on p. 152).

³ Nikuradse, J.: "Flow in Rough Pipes," *Zeit. f. angew. Math. u. Mech.*, vol. ii (1931), pp. 409-411.

These experiments were conducted with artificially roughened pipe, using sand stuck to the inside of the pipe. Curves were obtained for various conditions of relative roughness (defined as the ratio of the size of the sand particles to the radius of the pipe), and all showed departure at some point from the smooth pipe curve, an approximately constant value being approached subsequent to the departure. In furnace practice, a similar type of roughness may be found in flues which have become encrusted with coarse particles carried over by the flue gas and in the soot encrusted walls of gas producer mains; but appraisal of the relative roughness of such ducts can obviously be little better than a guess. For this reason it was thought sufficient to give values for this type of roughness as a broad approximation to Nikuradse's values instead of giving a detailed correction table. For the normal roughness of a brick surface, Pigott's values were preferred because they do not require estimation of the relative roughness of the duct.

TABLE XIV.—FRICTION COEFFICIENT FOR GASES.

$$\text{Loss of Pressure} = f \times \frac{L}{D} \times p.e. \text{ inches of water.}$$

A. Value of f for Smooth Pipes.*

Temperature	DV_0								
	0.5	1	2	4	6	10	20	50	100
60° F. (15° C.)	0.044	0.036	0.031	0.027	0.025	0.022	0.019	0.017	0.015
0° F. (-18° C.)	0.042	0.035	0.030	0.026	0.024	0.021	0.018	0.016	0.014
500° F. (260° C.)	0.050	0.040	0.034	0.030	0.027	0.024	0.021	0.017	0.015
1000° F. (550° C.)	0.056	0.044	0.036	0.032	0.029	0.026	0.022	0.018	0.017
2000° F. (1100° C.)	0.058	0.048	0.040	0.033	0.031	0.028	0.024	0.019	0.017
3000° F. (1650° C.)	0.068†	0.052	0.042	0.035	0.032	0.029	0.025	0.020	0.018

* This table is for the smoothest pipes likely to be found in practice. For various degrees of roughness, these values are to be corrected as indicated in part B of this table.

† The reason for this abnormally high value is explained in the additional notes on Table XIV.

B. Correction Table for Various Classes of Duct.‡

Value of <i>f</i> from Part A . . .	0.050	0.045	0.040	0.035	0.030	0.025	0.020	0.015
<i>Extremely smooth</i>	-.002	-.002	-.002	-.002
<i>Steel and wrought iron pipe—</i> 4" to 1' diam. Over 1' "	+.001
<i>Galvanised pipe—</i> 4" to 1' diam. Over 1' "	+.001	+.002
<i>Best cast iron, light riveted pipe, sheet metal ducts—</i> 4" to 9" diam. 9" to 2' " Over 2' "	+.001	+.001	+.001	+.001	+.002	+.004
<i>Average cast iron, concrete—</i> 4" to 1' diam. 1' to 3' " Over 3' "	+.002	+.002	+.002	+.002	+.003	+.005
<i>First class brick, § heavy riveted pipe—</i> 4" diam. 9" to 18" " 18" to 6' " Over 6' "	...	+.003	+.005	+.007	+.008	+.009	+.010	+.011
	+.002	+.002	+.002	+.003	+.004	+.006
	+.001	+.003
	+.001

‡ To be used in conjunction with Table A.

§ For brick ducts in furnace practice, the values of *f* will almost always be higher than indicated here. See footnote to Table C.

C. Friction Coefficient for Gases Flowing in Ducts made of Coarsely Granular Material.¶

Index of roughness *	0.001	0.002	0.004	0.008	0.016	0.033
Minimum value of <i>f</i>	0.018	0.022	0.027	0.033	0.043	0.060

¶ For use in conjunction with Table A for very rough ducts where it is possible to estimate the relative roughness. Values from Table A should be used if they are higher than these minimum values—Table C is used when Table A indicates a value below the minimum for a given roughness.

For average brick ducts in furnaces it is suggested here, arbitrarily, that the quantity 0.025 be divided by the diameter of the duct in feet (or that 0.3 be divided by the diameter in inches), and that the value obtained be used as the index of roughness in the above table to find the minimum value of *f*.

* Equals (Grain size) ÷ (diameter of duct), and is equal to one-half the "relative roughness."

Brick Ducts.—The values given for the friction coefficient in Table XIV are based on the assumption that the surface irregularities causing roughness are not large enough to cause measurable contraction and enlargement in the area of cross section of the gas stream. The normal effect of rivets (for steel pipes) and joints (for steel and brick ducts) has been included in Table XIV B, it being understood that for steel pipes the joints are of normal construction and for brick ducts that the brickwork is in first class condition.

In furnace practice, brick ducts in first class condition, within the meaning of the table, are not very common. Even though a flue be perfectly constructed, after a short time in service, open joints, uneven erosion or slag and dust deposits will produce a condition causing greater pressure loss than indicated by Table XIV B. Irregular alignment of the bricks, a spalled condition, projecting partially fallen bricks from the roof, pieces of brick and piled up dust on the floor—all these will cause obstructions which increase the pressure loss above the values for true friction. Evidently, selection of a value for furnace ducts must be a matter of judgment where conditions do not conform to those specified in the table. Some such scheme as that suggested in the footnote to Table XIV C might prove satisfactory.

Example.—A chimney is 175 ft. high and has an average diameter of 8 ft.; 500 cu. ft. per sec. (standard conditions) of waste gas is flowing and the actual temperature of the waste gas is 600° F. (315° C.).

1. Average area of cross section = $8^2 \times \pi/4$ = 50 sq. ft.
 $\therefore V_0$ = 500/50 = 10 ft. per sec.
2. DV_0 = 8×10 = 80

From Table XIV A we find the value of f for $DV_0 = 80$ and temperature 600° F. is about 0.017. Table XIV B shows a correction for first class brickwork of less than 0.001; but to allow for the probably uneven condition of the brickwork, the rule suggested in the footnote to Table XIV C is used; the index of roughness is $\frac{0.025}{8} = 0.0031$, and corresponding to this it is seen from Table C that the minimum value for f is approximately 0.025—this value is therefore adopted.

3. Taking the density of the flue gas as 0.078, we find from Fig. 7 that the dynamic energy is equivalent to 4.8 hundredths of an inch water gauge.

4. The pressure drop due to friction is

$$0.025 \times \frac{175}{8} \times 4.8 = 2.6 \text{ hundredths of an inch of water.}$$

Additional Notes on Table XIV.—1. The high value of f marked with a dagger in the table, corresponds to true streamline flow (scientific definition). For true streamline flow friction is governed by an entirely different law—the value of f increases more rapidly with falling values of DV_0 and with rising temperatures, and f is independent of the roughness of the duct. This type of flow is not likely to occur for gas flow in furnaces.

2. The effect of temperature on f is seen from Table XIV A to be comparatively small, especially for low values of f (*i.e.* high values of DV_0). The effect of roughness (Table XIV B) is marked for low values of f , but negligible for high values.

3. The effect of variation of gas composition is twofold. Firstly there is the direct effect of density on the pressure equivalent of dynamic energy. This may be taken care of as explained on page 139. Secondly the differences in density and viscosity lead to a difference in the Reynolds' number and hence to a different value of f . The value of f has been calculated for air; the change of f is, however, negligible for gases such as producer gas, blast furnace gas and flue gas; and even for gases such as coke oven and natural gas for all ordinary conditions (DV_0 greater than 5) f is not much changed.

For pure hydrogen, f is considerably greater than for other gases; this is due to the value of $\frac{w}{\mu}$ being only about $\frac{1}{4}$ of that for air. The value of f for hydrogen can be found approximately from Table XIV A by looking under the DV_0 value three columns to the left of that actually indicated. For example, if pure hydrogen at 60° F. is flowing at a normal velocity of 10 feet per second in a duct 2 feet in diameter, $DV_0 = 20$. The value of f is not 0.019 as indicated in the table, but 0.027, as found three columns to the left. For a gas containing 50 per cent. by volume of hydrogen and 50 per cent. of a gas more normal in its density to viscosity ratio, the displacement would be only one half column to the left, thus justifying the use of the table without adjustment even for gases comparatively high in hydrogen.

4. For compressed air an adjustment is necessary, as previously explained, in calculating the pressure equivalent of the dynamic energy. No other allowance is necessary, as the value of f is not affected by gas pressure.

5. In the table, D represents the diameter for a circular or

square duct. For a rectangular duct of breadth a and depth b , the equivalent diameter is given by

$$D = \frac{2 \times a \times b}{(a + b)} \quad . \quad . \quad . \quad . \quad . \quad . \quad (11)$$

More generally, for any flue

$$D = \frac{4 \times \text{Area of Cross Section}}{\text{Perimeter}} \quad . \quad . \quad . \quad (11a)$$

Pressure Losses through Beds and Columns of Solids.—These losses are due both to friction and to eddying, and do not lend themselves to simple calculation. A very thorough investigation of pressure losses of this type has been made by Furnas.¹ Furnas gives formulæ expressing the pressure drop as a function of

(a) the temperature, the pressure, the normal velocity (based on the free area of cross-section and the rate of flow), and the composition of the gas,

(b) the size classification of the stock, and

(c) the diameter of the shaft.

The pressure drop was found to vary with velocity raised to a power lying between 1 and 2 instead of the usual velocity squared for turbulent flow (scientific definition).

For a given type of stock of mixed sizes it should not be a difficult matter to obtain the pressure drop at ordinary temperatures in an experimental shaft. Constants obtained could then be correlated with Furnas's formulæ for extension to operating conditions.

Chilton and Colburn² present data on this type of pressure loss in a scientifically rational form. Bansen³ and Jakob⁴ give a summary of work by German investigators also on this type of resistance to gas flow. The formulæ, due principally to Ramsin,⁵ take into

¹ Furnas, C. C.: "Flow of Gases through Beds of Broken Solids," *Bureau of Mines, Bulletin* 307, 1929.

² Chilton, T. H., and Colburn, A. P., *Ind. Eng. Chem.*, 1931, **23**, 913, and *Trans. Amer. Inst. Chem. Eng.*, 1931, **26**, 178.

³ Bansen, H.: "*Wärmewertigkeit, Wärme- und Gasfluss, die physikalischen Grundlagen metallurgischer Verfahren*" (Revised from a Report to the World Engineering Congress at Tokio in October and November, 1929).

⁴ *Der Chemie-Ingenieur*, vol. 1, part I, 1935 Edition, pp. 132-136.

⁵ Ramsin, L. K.: "Der Gaswiderstand verschiedener Schüttstoffe," *Wärme*, 1928, p. 301.

account relatively few variables. Ramsin was therefore able to represent the pressure drop by simple curves, which are reproduced in the summaries quoted.

VI.—BUOYANCY.

The natural tendency of a hot gas to rise has been used, consciously or otherwise, from the earliest days of furnace construction. Mathematical evaluation of this effect of buoyancy (chimney effect) is useful, not only to the furnace designer, but also to the furnace operator, because of its important bearing on the flow of gases. Probably the earliest and most complete description of the application of the phenomenon of buoyancy to the design of furnace is due to Groume-Grjimailo.¹

Calculation of Static Pressure Arising from Buoyancy.—Imagine a closed vessel (Fig. 13), H ft. high, full of a gas lighter

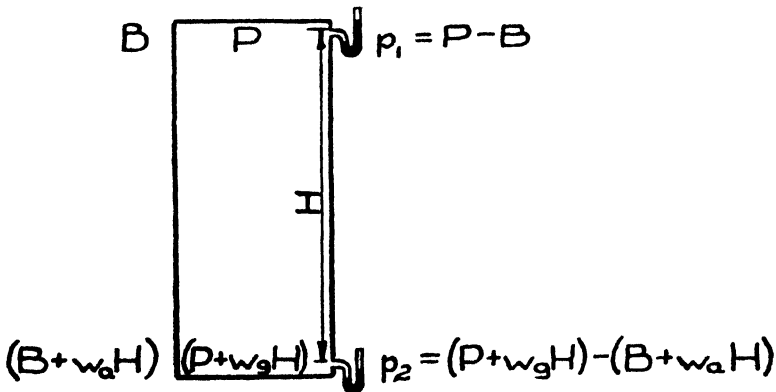

Fig. 13.

than the surrounding air. Let the barometric pressure of the outside air, measured level with the top of the vessel, equal B . Let the absolute pressure (that is, the total pressure, not merely the excess above atmospheric pressure) of the gas at the top of the vessel be P . If a draught gauge is connected at the top of the vessel, it will indicate the difference between the gas pressure and the barometric pressure at that level. If p_1 is the pressure difference, we may write

$$p_1 = P - B$$

All pressures are understood to be in pounds per square foot.

¹ General Reference No. 4 (at end of chapter.)

Barometric pressure is due solely to the weight of atmosphere above the level at which the pressure reading is taken. Thus B is equal to the weight of a column of air, one square foot in cross section, extending from the level at which this pressure is measured, right to the upper limit of the atmosphere. The weight of this 1 sq. ft. column extended downwards to the level of the bottom of the vessel is clearly equal to B plus the weight of the additional 1 sq. ft. column of air H ft. high. If w_a is the weight of 1 cu. ft. of air, then this additional pressure will be $w_a \times H$, and the total atmospheric pressure at the bottom will be

$$B + (w_a \times H)$$

Similarly, the pressure of the gas at the bottom of the column will be equal to the pressure at the top (P), plus the weight of a one square foot column of gas, H ft. high. If w_g is the weight of 1 cu. ft. of the gas, the weight of the column is $w_g \times H$ and the total pressure at the bottom is

$$P + (w_g \times H)$$

The pressure p_2 , as indicated by a draught gauge (in pounds per square foot) is the difference between the gas pressure and the barometric pressure at the bottom, *i.e.*

$$\begin{aligned} p_2 &= (P + w_g H) - (B + w_a H) \\ &= (P - B) - (w_a - w_g)H \end{aligned}$$

Subtracting p_2 from p_1

$$p_1 - p_2 = (w_a - w_g)H \quad . \quad . \quad . \quad . \quad . \quad (12)$$

Expressing this result in words, *the difference in pressures due to "buoyancy" is the difference between the weights of 1 cu. ft. of air and 1 cu. ft. of the lighter gas (under actual conditions) multiplied by the height of the column.*

The difference in weight per cubic foot may be due to a difference in actual density; or, more commonly, it may be due to a difference in temperature, the hotter gas being lighter by reason of expansion. Usually the furnace gases are so much hotter than the outside air that temperature is the principal factor in producing pressure differences associated with the phenomenon of buoyancy.

Equation 12 tells us that if a stationary column of gas is lighter than air (in most cases meaning a column of hot gas), the available

pressure (*i.e.* the excess over atmospheric pressure at the same level) is greater at the top of the column than at the bottom.

Now if we consider the column still to be closed at the bottom, but completely open at the top, it represents a chimney stack with the flue damper closed. The pressure at the top of the chimney must equal that of the air at the same level, because both pressures result from the same height of overlying atmosphere; or from another point of view, because p_1 could not be greater than zero without partial escape of gas occurring from the chimney top. In the case of a chimney, with $p_1 = 0$, Equation 12 becomes

$$p_2 = - (w_a - w_g)H$$

indicating that at the bottom of the stack there is a suction which is equal to the difference in the weights per cubic foot, multiplied by the height of the chimney.

If the bottom of the hot gas column were open and the top closed, then the pressure at the bottom would be zero and that at the top would be given by

$$p_1 = (w_a - w_g)H$$

The equations give pressures in pounds per square foot. To convert to inches of water divide by 5.2.

Change of Buoyancy with Temperature.—The pressure difference per foot of height of a column of hot air is $(w_1 - w)$ lb. per sq. ft., w_1 being the weight per cubic foot of air at the outside temperature and w that at the hot air temperature. From Fig. 5 both w_1 and w are obtainable, and the difference divided by 5.2 (Plate I, Scale 3) gives the pressure difference in inches of water per foot of height. Where the outside air is at standard pressure and temperature, w_1 is the density of air, and for this condition a direct reading scale for buoyancy is given in Plate I, Scale 4. It is clear from this scale that the first few hundred degrees rise of temperature of the hot air column produces a rapid increase in the draught. At higher temperatures the rate of increase becomes progressively smaller.

The effect of variation in the outside temperature may be quite marked. To determine the draught by means of the direct reading scale find the value for normal atmospheric temperature, Plate I, Scale 4. Then find the value on the scale corresponding to the true outside temperature, and subtract algebraically.

Example.—A column of hot gas, having the same density as air, is at a temperature of 500° F. and the atmospheric temperature is 0° F.

Plate I, Scale 4, gives a draught value at 500° F. of 0.67 and a draught value at 0° F. of -0.19. Subtracting algebraically, we find the true draught to be 0.86 hundredths of an inch water gauge per foot of height.

An alternative method of allowing for atmospheric temperature, is to use the scale as before for the hot gas temperature, and then to apply a correction of 0.03 for each 10° F. (0.05 for each 10° C.) variation from normal, the correction to be added for temperatures below normal and subtracted for temperatures above normal.

In some climates the change of draught due to change of atmospheric temperature may evidently be considerable, especially when the waste gas temperature is low.

Effect of Density.—Under similar conditions, the lower the density of a gas the greater will be its buoyancy; most gaseous fuels are lighter than air. Gases heavier than air, such as the products of combustion of coal, have a lower buoyancy. For gases lighter or heavier than air the chimney effect is still expressed by $(w_a - w_g)$ lb. per foot of height; w_a under ordinary conditions is still 0.076; w_g is calculated from the density of the gas and the temperature of the gas column. In calculating the density of a gas, the moisture content should be included.

At high temperatures, w_g becomes small, and its importance when subtracted from 0.076 diminishes correspondingly. We conclude that, at high temperatures, small differences of density are unimportant. This parallels the previous finding that when the temperature is high, variations, even of a few hundred degrees, have comparatively small influence on the chimney effect.

The density of the products of combustion and the density of gaseous fuels may easily be calculated from the fuel analysis. Typical values (at 60° F. or 15° C. and 30 inches of mercury) are given in Table XV.

The densities listed for products of combustion are for theoretically perfect combustion. The greater the amount of excess air, the closer will the density approach that of air. For most purposes, in calculating the effect of buoyancy, it is sufficient to assume the flue gas density equal to that of air.

Effect of Atmospheric Pressure.—A higher barometric pressure will increase both w_a and w_g in the ratio of the higher pressure

TABLE XV.—DENSITY OF FUELS AND PRODUCTS OF COMBUSTION.

Fuel.	Products of Combustion.		Gaseous Fuel.	
	Density. (lb. per cu. ft.)	Specific Gravity. (Relative to air.)	Density. (lb. per cu. ft.)	Specific Gravity. (Relative to air.)
Blast furnace gas, . . .	0.083	1.09	0.0765	1.01
Coal,	0.079	1.04
Producer gas,	0.078	1.03	0.067	0.88
Coal tar,	0.078	1.03
(Air)	0.076	1.00)
Fuel oil,	0.076	1.00
Water gas,	0.074	0.97	0.04	0.53
Natural gas,	0.073	0.96	0.043*	0.57*
Coke oven gas,	0.071	0.93	0.03	0.40

to the standard pressure (30 inches of mercury). Chimney effect therefore varies directly with the barometric pressure. At high altitudes the reduction in buoyancy needs to be taken into account in the design of furnaces, particularly as the gas volumes are greater at the lower pressure.

Effect of Temperature Variation.—Where the temperature of a hot gas column changes continuously from top to bottom, it is quite close enough to use the average of top and bottom temperatures in making buoyancy calculations.

Gas Flow in Furnaces.—By a combination of mathematical formulæ due to Esmann (Yesmann) and of experiments with models using water and kerosene, Groume-Grjmailo has shown the type of gas flow to be expected in furnaces. Observation of gas flow in actual furnaces and modern trends in furnace design confirm, with certain reservations, the conclusions which Groume-Grjmailo arrived at from his calculations and experiments. Qualitatively, the principle is illustrated by the following examples. Gas streams will not be so clearly defined as implied by the illustrations, and further stipulations will be found at the end of this section.

1. *Gas Flow in Direct-Fired Hearth-Type Furnaces.*—When the book is turned so that the word "Furnace" in Fig. 14 is the right way up, the diagrams show in sectional elevation different arrangements in the level of the furnace outlet, the inlet being in the same position in all cases except (f) and (g).

* High CH₄ gas.

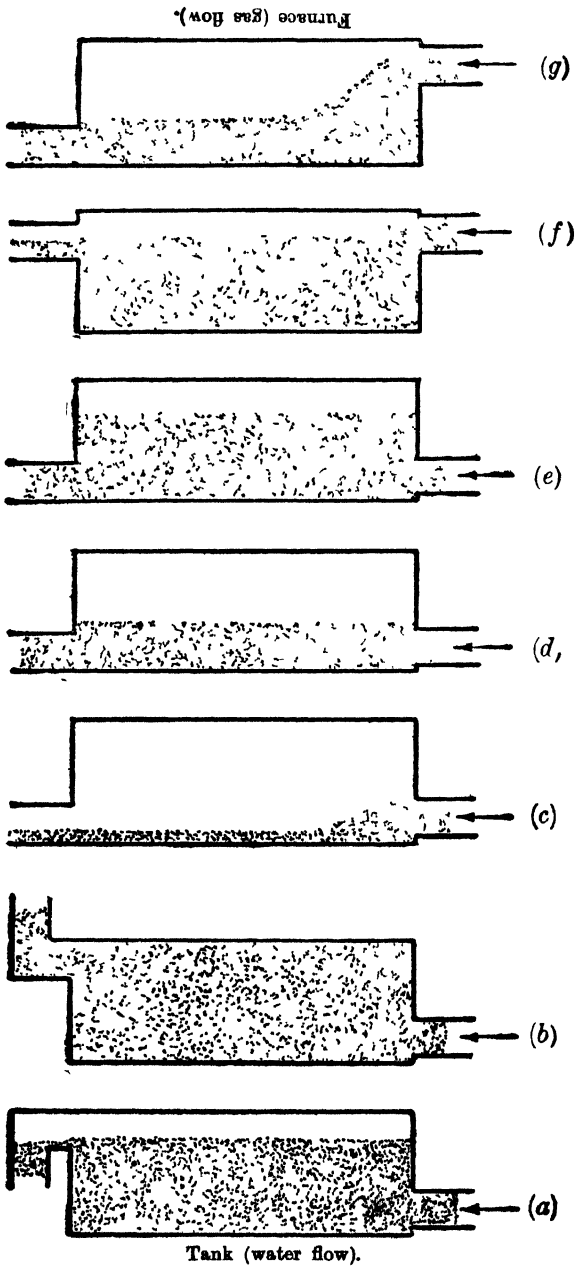

Fig. 14.

When the book is turned the other way, the diagrams represent tanks in a water circuit with different outlet levels. The way in which water will flow through the circuit is evident, and the shaded areas show the depth of water in the tank.

Still from the point of view of a water circuit :—

Tank (a) will flow more or less full, the actual depth of water above the weir at the outlet depending on the rate of flow. With a greater flow of water, the level will pile up higher above the weir level in order to supply the additional pressure necessary to discharge the total flow. It would even be possible to increase the flow until the tank was full to the top.

Tank (b) differs from tank (a) in that it must be completely filled before outflow occurs.

Tanks (c), (d) and (e) are identical tanks with the exit at the bottom. The differences in water level represent different rates of flow, the rate increasing from (c) to (e). A smaller opening in the outlet will have exactly the same effect as a higher rate of flow in causing the level to rise in the tank.

Tanks (f) and (g) show other possible arrangements, these also being subject to variation. The water level is determined by the consideration that water is heavier than air, and therefore must fill in all space below the level of the outlet.

The main stream of burnt and burning gas in a furnace is hotter than the relatively stationary gas which has collected in pockets and so has had time to cool. Gas in the main stream is therefore lighter, and will seek to fill the higher levels first. Having sketched the water level for a tank, it is necessary only to invert the diagram to find how a light gas will behave in a furnace. Since, in reverberatory furnaces, the hot burnt gases should come in contact with the charge, (a) and (b) represent good arrangements, (b) being the better of the two. Arrangements (c), (d), (e) and (g) are bad. In these it is true that with water by increasing the rate of flow, or by throttling the outlet, the water stream may be forced to fill the entire tank before the pressure builds up sufficiently to permit the necessary rate of discharge ; but the perfect adjustment necessary under such conditions could not very well be maintained. Moreover, it will be explained later that the analogy between water and gas flow is in this case defective, and that filling of a furnace with gas in this way would not be possible.

Arrangement (f) would ordinarily be bad because the fuel gas or flame would be brought into immediate contact with cold

stock, seriously interfering with combustion. Arrangement (g) combines this bad effect with the one mentioned above.

2. *Effect of Regulating Discharge.*—It has been mentioned that, to avoid leakage, the mean furnace pressure should be equal to that of the atmosphere. This can be secured only by controlling separately the pressure at the burner and the pressure at the vents, that is, a deficiency of pressure at the burner should not be made up by increasing the suction in the flue, for this would

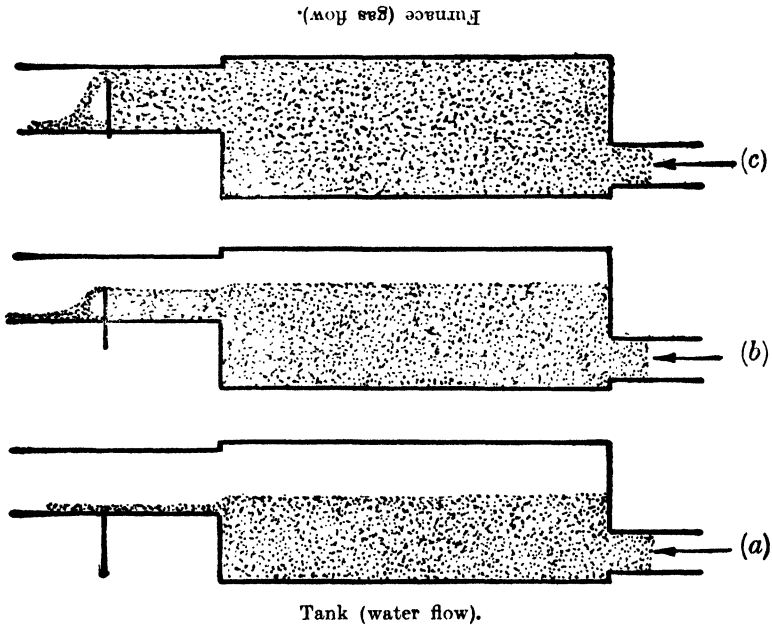

Fig. 15.

cause increased infiltration; nor should a deficiency of draught be made up by increased pressure at the burner, for this would cause increased outward leakage of hot gas and flame. Inlet and outlet pressure, however, are not entirely independent one of the other.

The effect of different positions of the flue damper is shown in Fig. 15. Closing the damper causes the pressure to build up in the furnace, and for the same flow of gas the additional pressure, as represented by the additional "head" of water in the tank or of gas in the furnace, will be transferred back to and must be supplied by the incoming gases. Where, as in the illustration,

the outlet is large, or where it is necessary to have the outlet some distance above the hearth, the under level of the hot gas may be forced down by building up the back pressure as shown in (b) or (c). The operating adjustment may be a compromise between working with a "full" furnace, and the necessity to avoid excessive outward leakage.

The design of the furnace vents should give approximately correct discharge characteristics, and the damper then represents the fine adjustment of the system.

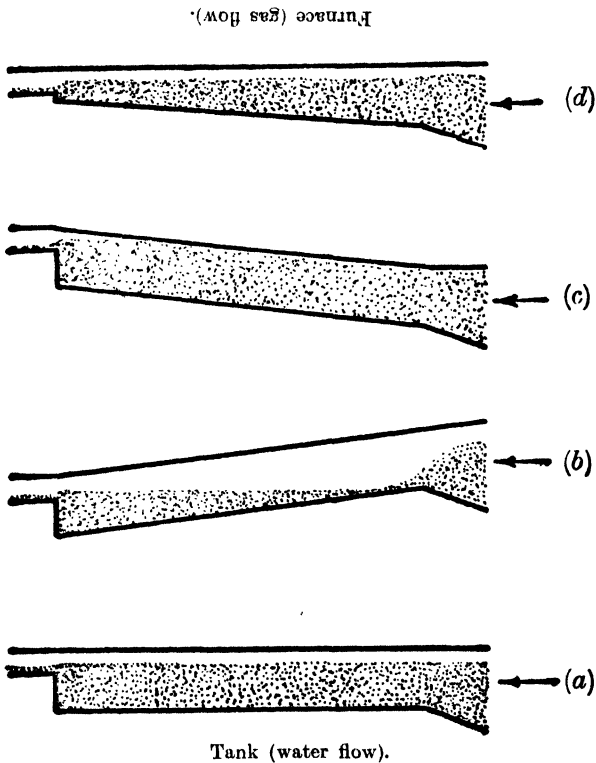

Fig 16.

3. *Continuous Type Reverberatory Furnaces.*—Fig. 16 shows the position of the hot gas body in continuous furnaces having slight differences of construction. The arrows show the entrance of gases from the combustion chamber, combustion being largely complete before the low, more or less parallel section of the furnace

is reached. The outlet is shown at the lower part of the chamber.¹ Departure from this construction will give decidedly inferior results. The shaded stream is again drawn for water, with the furnace inverted. As pointed out by Groume-Grjimailo, arrangement (c), with the stock forced uphill from the flue end to the hot end, gives much better filling of the furnace with hot gases down to the hearth level than either a horizontal hearth (a) or movement of the stock in a downward direction (b). Dropping the roof towards the flue (d) would cause slight depression of the gas stream towards the hearth, but the position and size of the vent has far more effect than roof slope. If the gas vents were the entire height of the furnace at the flue end, (c) and (d) would be worse than shown, and (a) and (b) would be much worse.

3. *Effect of Jets*.—It has been assumed that the gases flood over into the furnace at low velocity. In many types of furnace the gas flow is very largely controlled by projecting the gases into the furnace at high velocity. The application of hydraulic theory is again shown by Groume-Grjimailo.

Fig. 17 (a) is drawn as a water fountain, and when inverted shows a furnace with a vertical burner throwing a fountain of hot gas downwards against the force of buoyancy.

Fig. 17 (b) shows a melting furnace where, for practical reasons, the gas outlet must be placed rather high. The force of the incoming jet throws water up, or hot gas down, to follow the profile of the furnace hearth.

Fig. 17 (c) shows an unsatisfactory construction which has been used in the past. Jet action does not assist in holding the hot gases down to the hearth level, and the throttling effect of the series of holes in the roof is alone responsible for checking the outflow of water or gas until it has piled up to a level that gives the necessary "head."

Reference to Fig. 17 (a), from the hydraulic aspect, shows that the tank is more or less full of water from the fountain, but since the actual water level is low, there is a much lower static pressure than if the tank had been filled by pressure. This must

¹ In furnaces of this type, wherever the nature of the stock permits, the waste gas leaves the furnace through vents in the hearth; theoretically, this is better than the arrangement shown in the Figure. However, the necessarily leaky construction of the furnace end destroys much of the advantage of this lower location; for this reason, the venting of such furnaces has been considered equivalent to that shown in the diagrammatic representation in Fig. 16.

also be true for a furnace, so that filling a furnace by jets, instead of by pressure, will have an important effect in reducing outward leakage of hot gas.

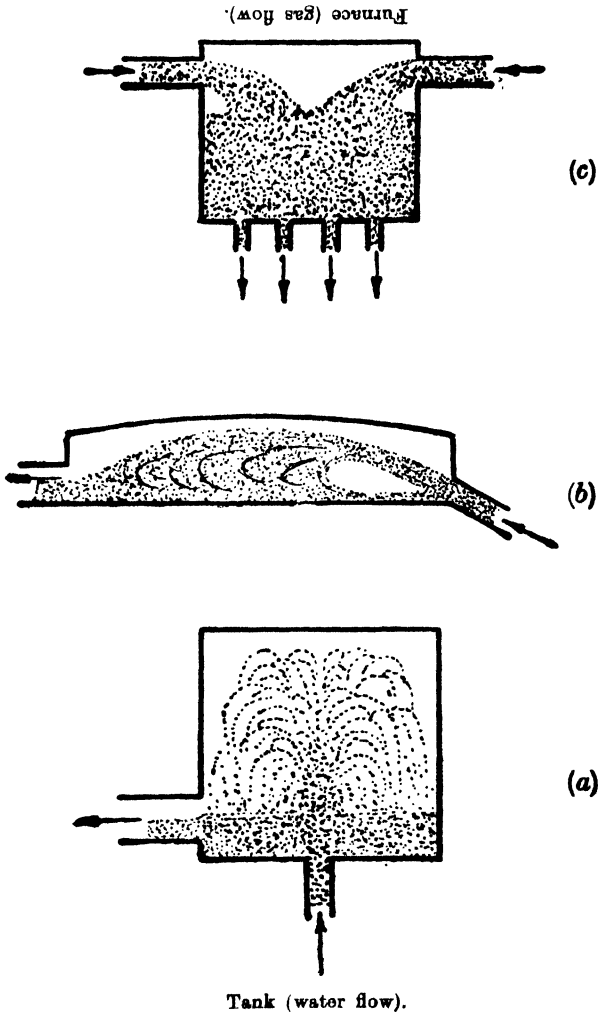

Fig. 17.

Important Differences between Water Flow and Gas Flow.—

The analogy between water flowing through a tank and gas flowing through a furnace is not perfect. The great difference between the densities of water and air ensures a well defined water level in the tank illustration. There is much less difference between

the densities of the very hot gas stream and the relatively cool gas pockets. Consequently, in a furnace there is not nearly so sharp a line of demarcation between flowing gas and idle gas. Moreover, the temperature of the gas stream varies from a minimum where combustion has barely commenced, to a maximum as combustion proceeds, and then to a new minimum as the gases cool off towards the flue. At the burner, the gas stream may be cooler and heavier than the average furnace gases, and may therefore tend to fall at first. Even models employing oil and water do not truly depict the flow of hot and cool gases in furnaces, because the two liquids are immiscible, whereas gases are completely miscible.

The dissimilarity with respect to density will cause another important difference between the behaviour of water and of hot gases. This may be illustrated with the aid of Fig. 14 (c), (d) and (e). The water circuit can change from condition (d) to condition (e), as the back pressure increases, only if the air pocket shown in (d) can be cleared by leakage from the tank or by other means. If the air pocket cannot be cleared, then the necessary pressure to discharge the stream against increasing back pressure will be built up by a slight rise in water level, until the air in the pocket is compressed sufficiently to maintain the necessary pressure. For a gas circuit, this same preliminary reasoning will apply. Leakage through the clean brickwork will occur readily enough; but if the lower part of the furnace has been washed with slag, condition (e) cannot be reached. Even if condition (e) is reached, there will be less through flow of gas at the bottom than at the top of the furnace; the gases in the lower part will therefore cool and tend to restore and maintain condition (d), which shows heavy cool gas on the furnace bottom. Consequently, it is not possible to force a gas stream down by pressure to a level much below the outlet or inlet, whichever is the lower, to the furnace.

Again, it is well recognised that water may flow across a tank from a small inlet to a small outlet with very little movement of the main body of water in the tank. An active stream may select its natural channel from inlet to outlet without very much disturbing the surrounding body of water which merely acts as an hydrostatic support to the stream. With gases flowing in furnaces, such a stream flowing through a stagnant lake is not likely to occur. As soon as a condition such as this commenced to establish itself, the overlying stationary gases

would cool and fall, causing lateral spreading of the gas combined with upward circulation of hot gas to replace the falling gas.

Summarising the density and convection tendencies of hot gas flow as compared with water flow, we may say:—

(1) There will be some forward movement and considerable irregular movement in the cool pockets, which, according to the water analogy, should represent “dead” space.

(2) The active part of a hot gas stream will spread laterally and vertically upwards towards the side walls and roof of the furnace. There will be little tendency for the stream to spread in a downward direction below the level of the vent or of the burner, whichever is the lower.

For hydraulic flow, the height to which water will build up in a tank for given flow conditions may be determined mathematically.

Groume-Grijmailo and Esmann¹ have extended the mathematics of hydraulic flow to calculation of the depth of hot gas streams.

These formulæ, however, are based on the supposition that there is no mixing between the hot gas stream and the supposedly stationary cool underlying gas layer.

Value and Limitations of the Water Analogy.—The filling of a furnace by the active gas stream may be regarded as a theoretical ideal; the water analogy is helpful in estimating the closeness of approach to this ideal. In practice, there are many considerations which may dictate departure from the ideal case. It may be necessary, in a continuous furnace, for the stock to travel downhill (Fig. 16 (b)) in order that gravity may promote discharge of the material; or it may be necessary to modify a construction in order to minimise leakage—in this respect, downhill movement of stock in a long continuous furnace is favourable (see description of Fig. 20 on page 185). It may be desirable to throw the flame on to the stock as in melting scrap; or it may be desirable to keep the flame away from the stock as in reheating semi-finished material.

Other very important factors influencing the distribution of the gas stream in a furnace include

(a) the entraining action of high velocity gases from the burners;

(b) the furnace design (particularly the deflecting action of baffles and “wavy” roofs built as a series of arches with their axes transverse to the direction of flow); and

¹ General Reference No. 4 at end of this chapter.

(c) the arrangement of the stock within the furnace.

In conclusion, it may be said that the whole problem of gas flow in a furnace is closely associated with the problem of heat transfer.

VII.—DRAUGHT.

To remove the products of combustion from a furnace it is ordinarily necessary to supply draught or suction, either by means of a chimney or by mechanical means.

Natural Draught.—The difference of gauge pressure, due to buoyancy, between the top and the bottom of a stationary column of hot gas in a chimney may be obtained from Plate I, Scale 4. In a furnace system, part of this pressure difference is absorbed in driving the gases through the chimney itself, and the remainder is available to meet the pressure requirements between the furnace and the chimney.

The pressure used up in the chimney is equal to

$$p.e. \left(1 + f \frac{H}{D} \right)$$

The first term, $p.e. \times 1$, is the pressure equivalent of the dynamic energy of the gases escaping from the top of the chimney. The second term, $p.e. \times f \times \frac{H}{D}$, represents the loss by friction, H and D being the height and diameter respectively both measured in the same unit, and f being the friction coefficient obtained from Table XIV. In chimneys of normal proportions, the friction term is of the same order of magnitude as the loss of pressure due to the velocity of escape of the gases, $f \frac{H}{D}$ frequently not differing greatly from unity.

Temperature of Gases.—There is a loss of temperature as the gases pass up the stack, according to the laws of heat transmission to be explained in Chapters V and VI, and also on account of air infiltration into the chimney. Calculation of these losses requires a knowledge of the chimney size and construction and the rate of gas flow. Normally, a temperature drop of 5 to 15 per cent. of the difference between the base temperature and the temperature of the outside air may be expected for each 100 feet of height. In calculating buoyancy and chimney pressure losses, it is quite close

enough to use the average of the waste gas temperatures measured at the bottom and at the top of the stack.

Energy losses due to all causes have been shown to increase directly as the absolute temperature. Pressure differences due to buoyancy at first increase rapidly with rising temperature, but at higher temperatures the rate of increase becomes small. From this it follows that cooling of the waste gas in the flues may, up to a definite point, give increased gas removing capacity, because the loss of buoyancy may be more than balanced by smaller pressure losses in the flues.

In a given case it is possible to calculate the most effective temperature of the waste gases in the chimney, this temperature depending principally on the total pressure loss in the flues relative to the pressure loss in the chimney. For the limiting theoretical case where there is no pressure loss in the flues, the maximum chimney capacity would be obtained with a waste gas temperature of 580° F. (303° C.).¹ For actual furnace systems, the most effective temperature will be considerably higher, increasing with increase of pressure loss in the flues.

Where calculation shows that a considerable temperature drop from furnace to chimney will increase the capacity of the system, the temperature drop should be effected as close to the furnace as possible. Insulation at the chimney end of the flue will almost certainly increase the chimney capacity, while the converse may sometimes apply at the furnace end of the flue. Judicious use of insulation may lead to economy of stack dimensions.

The discussion naturally refers to flue systems from which waste heat is not recovered. Where waste heat is recovered, the stack temperature is almost certain to be below the value which would yield maximum capacity.

Cold air infiltration will always result in loss of draught because, notwithstanding the chilling action, the pressure losses will increase, and in addition buoyancy will decrease.

Where mechanical draught is used, the cooler the gases at all points in the flue, the less will be the power consumption, or the greater will be the capacity.

Chimney Dimensions.—The minimum height of a chimney is determined technically by the pressure difference which it must develop to overcome pressure losses in the system, or

¹ Equivalent to twice the absolute temperature of the atmosphere. Thus, $2(460 + 60) = 1040^\circ \text{ F. Abs.}$ and $1040 - 460 = 580^\circ \text{ F}$

practically by such considerations as elimination of fire hazard, smoke nuisance, or noxious fumes. The minimum diameter of a lined stack is determined by bricklaying limitations. Apart from these considerations, the design of a chimney is entirely a matter of economics. A given furnace would work equally well with a wide chimney of sufficient height, or with a narrower chimney having extra height to overcome the added chimney losses due to higher velocity. The gas velocity in chimneys lies commonly between 5 and 25 normal ft. per sec.

Similarly, flues may be made smaller if provision is made for additional draught in the chimney design. The most economical design may be obtained by means of a curve showing arbitrarily selected flue sizes plotted against the corresponding total cost of the flue and a suitable chimney. The curve will show the minimum cost corresponding to the flue dimension giving the most economical construction.

Theoretically, owing to additional friction loss and fall of gas temperature, there exists a limiting chimney height, beyond which there is no increase in available draught. Practically, this limit is not likely to be approached, as the chimney losses are much smaller than the other losses in the system. Consequently, increasing the chimney height, although expensive, will almost invariably result in additional draught.

Chimney Capacity.—In considering the pressure effects of a furnace system, it is logical to include the chimney as part of the system, and not to treat it as a separate unit. If the chimney is considered separately, the height and gas temperature will permit calculation of the static suction at the bottom of the stack. If the stack were working against no other resistance than that caused by the friction in the chimney itself, the velocity of the gases could be calculated. Multiplying this by the area of cross section of the chimney, we could find the chimney "capacity" in normal cubic feet per second against zero external resistance. Chimneys, however, do not work against zero resistance, and consequently the calculated result has little meaning. The static pressure measured by a draught gauge at the base of the stack is the pressure against which the chimney is actually working. If this measured pressure were subtracted from the calculated pressure due to buoyancy in the stack, the difference would give the amount of pressure used in the stack. Dividing this difference by $\left(1 + f\frac{H}{D}\right)$, usually about 2, we should obtain *p.e.*, the pressure equivalent of the gas velocity in the stack, and from the nomogram, Fig. 7, we could obtain the velocity and hence the true stack capacity under operating conditions. In most cases the pressure difference would be too small to yield dependable results.

In boiler furnaces, the chimney may have to assist in sucking air through the fuel bed. Empirical formulæ for chimney and grate dimensions are used in such cases.

Mechanical Draught.—Centrifugal fans may be employed
(a) to supply draught or suction on the exhaust side of the furnace,

(b) to supply pressure on the input side of the furnace.

In practice, chimney draught rarely exceeds 2 inches water gauge, and is usually much less. When fans are used, much greater suction could be obtained, if necessary, without undue cost.

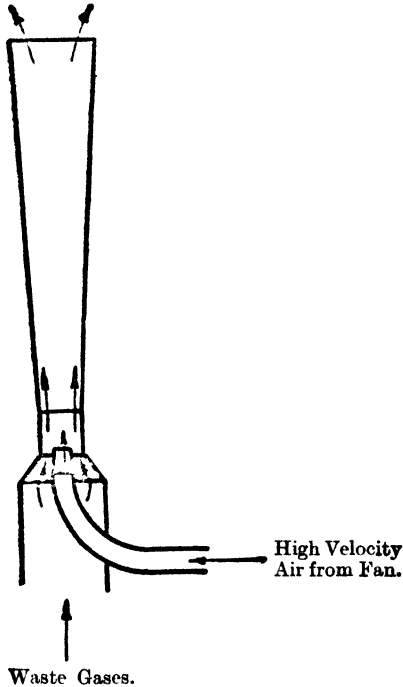

Fig. 18.—Ejector.

Higher suction have led to operating economy in some types of furnace ; but abuse of mechanical draught by over-driving is to be avoided. Infiltration of air into the flues will tend to be greater on account of the bigger pressure difference. This may restrict the working rate of the furnace if the fan cannot handle the increased gas quantity, and will in any case result in additional power consumption. Naturally, the increased tendency for leakage under higher suction merely demands that greater care shall be taken in constructing the flues.

For very hot gases or for gases injurious to the fan, an ejector may be used. Cold air at high velocity from a fan enters a restricted throat in a specially constructed stack (Fig. 18). The air stream inspirates the flue gases and ejects them from the stack. The diverging portion of the stack above the mixing chamber is designed to convert part of the dynamic energy of the high velocity gases at the neck to pressure energy, and so to reduce the losses in the stack. A steam jet is sometimes installed in an ordinary chimney in boiler furnaces to increase the draught to meet peak loads.

To take advantage of the greater working rate attainable with mechanical exhaust fans, it may be necessary to supply more air than can be delivered by natural draught. In such cases fans are supplied on the input side to force air into the furnace. The pressure in hearth type furnaces should of course be maintained as near to atmospheric pressure as possible. In other types of furnace, it may be permissible to force air into the system at a pressure sufficiently high to push the gases along the flues without any great assistance from the chimney; or the exhaust fan may exert a sufficiently powerful suction to draw the air into the furnace at the grate or burner. A forced draught system, with pressure on the input side only, will show a greater tendency for outward gas leakage, and an induced draught system, with mechanical suction on the exhaust side only, will show more air infiltration.

VIII.—GAS LEAKAGE.

Since a furnace system is at most points either under positive pressure or under suction, there will always be a tendency for outward leakage of gases or for infiltration of air. There are two distinct types of leakage:

- (1) through definite holes or openings such as occur at open doors and sight holes or at badly fitting doors and dampers, and
- (2) through the extremely narrow but very extensive cracks which are almost unavoidable in the joints of the brickwork.

Leakage Through Openings.—When gas escapes through an opening, the pressure difference is expended partly in supplying the velocity of the escaping gas, and partly in overcoming eddying and friction resistances. If h is the available pressure difference, $p.e.$ is the pressure equivalent of the moving gas, and

F is the sum of all the pressure loss factors (f) due to eddying and friction, then

$$h = p.e. + (p.e. \times F)$$

or

$$p.e. = \frac{1}{1 + F} h$$

$$= Ch$$

In order to find the velocity, it is necessary first to multiply the pressure difference by the constant, C , for a particular opening, and then from the resulting value for $p.e.$, to find the velocity, V_0 , from the nomogram, Fig. 7. The rate of gas escape, v_0 cu. ft. per sec., is obtained by multiplying V_0 by the area of the opening measured in square feet.

The values of C for some simple types of opening are given in Fig. 19; and in the ensuing discussion C may be regarded as that fraction of the pressure difference which, by direct energy conversion, is available to produce velocity. The calculated velocity is that obtaining at the minimum cross section of the opening (not of the gas stream).

Notes on Fig. 19.—The area used in calculating the rate of gas discharge is in all cases the narrowest cross section of the opening. The constants used here are the squares of what are commonly called the “discharge coefficients” of openings.

The effect of contraction on C is approximately the same for all cross sections of the opening; thus the values for Fig. 19 (a), (b), (d) and (e) hold for all shapes of opening. Where friction contributes largely to the value found for C , the equivalent diameter (as defined on p. 158) should be used in calculating the effect of friction for openings other than circular or square in cross section. This applies to Fig. 19 (c) and (f).

Fig. 19 (a). The given constant applies when the diameter of the opening is at least twice the thickness of the wall.

The value of C is the smallest possible for a simple opening; it takes into account not only the unrestricted eddying due to absence of guiding effect, but also the contraction of the emerging stream to a cross section smaller than that of the opening.

Very large openings may, in some cases, have a somewhat larger constant, because there will be a more pronounced general gas movement in the furnace, axial to the opening, and consequently a less pronounced contraction of the gas stream. The maximum “velocity of approach” would occur if the opening were equal to the furnace

cross section, when the coefficient C would theoretically equal unity. However, the coefficient does not commence to increase rapidly until the area of the opening is at least half that of the wall in which it occurs. In leakage problems the constant 0.38 may therefore be used even for large openings.

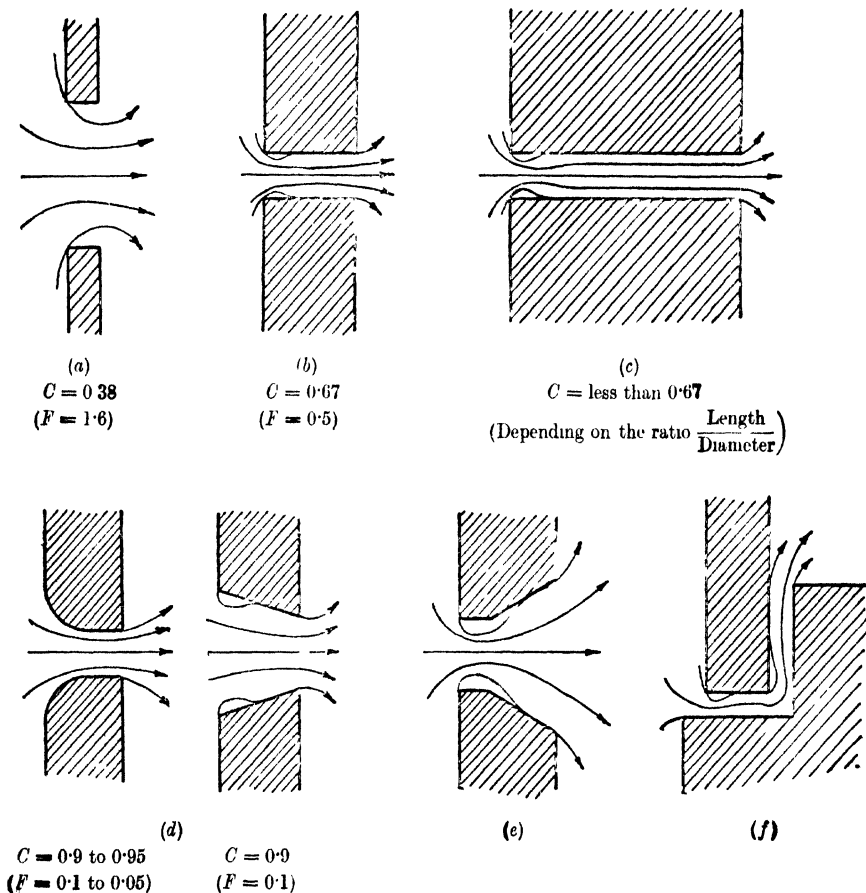

Fig. 19.—Gas Leakage Through Openings.

Fig. 19 (b). This represents an opening in a wall having a thickness of $2\frac{1}{2}$ to 3 times the diameter of the opening. It differs from (a) in that the gas stream spreads within the tunnel and then emerges as a parallel jet. The wastage of energy is therefore less than for a wall which is thin compared with the diameter of the opening. For proportions between those of (a) and (b), the value of C will lie between the two values 0.38 and 0.67.

Fig. 19 (c). This differs from case (b) only in that any increase of length of tunnel produces additional pressure loss by friction. Suppose, for example, that the wall thickness is 10 times the diameter of the hole,

$$C = \frac{1}{1 + F}$$

where F is the known loss for the first 3 diameters, 0.5, plus the loss by friction for the additional seven diameters length of the opening. If the coefficient of friction is 0.04, the factor representing the friction loss is

$$0.04 \times L/D = 0.04 \times 7 = 0.28 \text{ (from Equation 10)}$$

F is therefore 0.78, giving a value for C of

$$\frac{1}{1 + 0.78} = 0.56$$

Fig. 19 (d). The effect of guiding the gas stream gently by rounding the inner edge of the opening is to increase C considerably, the value in some cases being as high as 0.95. Many furnace openings where outward leakage occurs will show this type of opening either by construction or by burning off of corners. Door openings are commonly of a type intermediate between types (a) and (d).

Fig. 19 (e). This opening would show a high coefficient if gas flow were in a direction the reverse of that shown. In the direction shown the value would be higher than for (a) because some of the eddying is eliminated, but not as high as for (b). With a rounded entrance and a very small angle of divergence, the value of the constant may be increased even above unity. This would also apply to (d) if the downstream side of the tunnel were extended as a divergent cone.

Fig. 19 (f). This example is included to show how air infiltration under a door, or through any other irregular channel, may be calculated.

Example.—A furnace door 3 ft. wide leaves a $\frac{1}{2}$ -inch space underneath and behind it as shown in Fig. 19 (f). The length of the passage so provided is 8 inches. There is a suction in the furnace, level with the bottom of the door, of 2 hundredths of an inch of water. Find the rate of air infiltration.

The entrance factor is found from Fig. 19 case (b) to be 0.5.

The factor for a right-angle bend in a rectangular passage is 0.6 for a width to breadth ratio of 5 : 1 (Fig. 8)—for the narrow slot in this problem a factor of 0.5 is taken. The equivalent diameter of cross section of the passage is

$$\frac{4 \times \text{Area}}{\text{Perimeter}} = \frac{4 \times 36'' \times \frac{1}{2}''}{2(36'' + \frac{1}{2}'')} = 1'' \text{ (approx.)}$$

$$\text{The ratio } \frac{\text{Length of passage} - 1\frac{1}{2}''^*}{\text{Diameter of passage}} = 6.5$$

For the high relative roughness of so narrow a passage, a coefficient of friction of 0.06 is taken (Table XIV C). The friction factor is therefore $0.06 \times 6.5 = 0.4$.

The sum of all the resistance factors, F , is 1.4, giving a value for C of

$$\frac{1}{1 + 1.4} = 0.42$$

Multiplying C by the pressure, we find a pressure equivalent of the air velocity of 0.84 hundredth of an inch of water. Referring to Fig. 7, we find this value to be outside the range of the nomogram. We multiply the pressure by 100, giving 84 hundredths, and correct by dividing the nomogram reading for velocity by 10.† Supposing the infiltrating air to be at a mean temperature of 200° F., we find that a pressure of 84 hundredths gives a velocity, V_0 , of 53, therefore the actual pressure gives a velocity of 5.3 normal ft. per sec.

The area of cross section of the air stream is $3 \times \frac{1}{2} \times 1\frac{1}{2} = 0.125$ sq. ft. and the rate of air infiltration is

$$\begin{aligned} 5.3 \times 0.125 &= 0.66 \text{ normal cu. ft. per sec.} \\ &= 40 \quad \text{,,} \quad \text{,,} \quad \text{,,} \quad \text{min.} \end{aligned}$$

The leakage constants of Fig. 19 assume that there is no flow of gas towards the opening, except such movement as is occasioned by the gas escape (from a furnace under positive pressure). If an opening occurred, for example, at a sharp bend so that the gas stream impinged directly on to the opening, the escape of gas would be much greater, and might occur even though there were a slight static suction in the flue.

* Three diameters are included in the entrance factor—this is interpreted to mean $3 \times \frac{1}{2}''$.

† That is, divide by the square root of the multiplier 100. This rule applies only to Fig. 7.

Leakage Through Brickwork.—Owing to the great length of travel in relation to the diameter of the narrow cracks through the brickwork, friction is the principal resistance to this type of gas leakage.

Using silica brick, Bansen¹ has shown that gas leakage takes place almost entirely through the joints in the brickwork, the porosity of the brick itself being unimportant. He finds that the permeability of the brickwork increases rapidly as the furnace becomes older. The rate of leakage through a wall may be expressed by the formula,

$$v = a \frac{p}{d}$$

where v is the rate of gas leakage in cubic feet per second per square foot of wall surface; p is the pressure difference in inches water gauge between the two sides of the wall; d is the wall thickness in inches; and a is a constant for the particular conditions.

Bansen found that, although a is determined principally by the condition of the wall, it is governed also by the actual value of p/d , i.e. by the pressure drop per inch of wall thickness. For example, his figures show that for a given $4\frac{1}{2}$ -inch wall, at 4 inches of pressure difference, the value of a is about one-half of the value at 0.4 inches of pressure. Values selected here from Bansen's laboratory investigation are for the lower pressure difference—at higher pressure differences the leakage is less than implied by the formula, while for the low values of p/d commonly encountered in furnace practice, the values of a are likely to be greater than those found by Bansen.

The following approximate values of a are taken from Bansen's laboratory experiments with $4\frac{1}{2}$ -inch walls at a pressure difference of 0.4 inches ($p/d = 0.09$):—

Bricks laid with $\frac{1}{8}$ -inch mortar joints and dried	$a = 0.16$
„ „ dry, without special care	$a = 5.6$
„ „ „ , pressed together	$a = 1.25$
„ „ „ , surfaces ground true	$a = 0.45$

The value of a for the brick itself was found to be from 0.0008 to 0.0025, and for carefully dried uncracked mortar about 0.09. Based on the permeability of brick and mortar, Bansen calculated that a for brickwork with mortar absolutely free from cracks should be only 0.009. He concludes that the relatively high figure of 0.16, found for the experimental wall, must be due almost entirely to the fine drying cracks in the mortar.

¹ Bansen, H.: "Gasdurchlässigkeit von Silikastein, Mörtelfugen und Mauerwerk im Siemens-Martin-Ofen." *Archiv f. d. Eisenhüttenwes.*, May, 1928, vol. 1, 1927-28, pp. 687-692.

In actual furnace walls the following conditions tend greatly to accentuate leakage as compared with values determined in the laboratory :

(a) Uneven settling and expansion of the brickwork results in cracks and open joints.

(b) Firing shrinkage of ordinary mortars and cements causes considerable increase in the number and size of cracks.

(c) Blowing away of dried and loosened particles of mortar may increase the size of the cracks, particularly if the masonry is disturbed by occasional explosions.

(d) The exposed joint surface per square foot of wall is usually greater, Bansen's experimental walls consisting entirely of stretcher courses.

(e) Greater wall thickness, for the same pressure difference, should yield higher values of a than found by Bansen.

In the following respects, practical conditions are somewhat more favourable than those of the investigation :

(a) Staggering of the joints in thick walls lengthens the path taken by the gases.

(b) Vitrification of the mortar at high temperatures will tend to close up cracks on the inner face of the wall. Special cements are valuable in this connection. See pp. 424-426.

(c) Bansen's figures are for air under atmospheric conditions. Increase of actual air or gas volume at higher temperature will result in decreased leakage when measured in terms of normal cubic feet. To allow for the effect of temperature, we may assume Bansen's formula to give the actual volume of leakage at the average of the inner and outer wall temperatures.¹ This volume may then be converted to normal cubic feet by calculation or by use of Fig. 5, p. 131.

In an investigation of a new wall in an actual furnace structure, Bansen found a value for a of 0.215; under similar conditions for an old wall the value may be ten times this figure.

Example.—A brick chimney is 100 ft. high, has an internal diameter of 5 ft., and a mean brick thickness of $22\frac{1}{2}$ inches (1.875 ft.). The mean suction over the chimney height is 0.3 inches of water. For a leakage coefficient $a = 0.2$, it is required to determine the extent of air infiltration.

The average of the internal and external diameters of the chimney is $5 + 1.875 = 6.875$ ft.

¹ Obviously this adjustment is not mathematically correct; but neither the mean gas temperature nor the exact leakage coefficient of the brickwork can be determined.

The mean area through which infiltration occurs is $6.875 \times 3.14 \times 100 = 2160$ sq. ft.

The rate of air infiltration per second per square foot of surface is

$$a \frac{p}{d} = 0.2 \times \frac{0.3}{22\frac{1}{2}} = 0.0027 \text{ cu. ft.}$$

Total rate of infiltration = $0.0027 \times 2160 = 5.8$ normal cu. ft. per sec. This figure might be about 3 per cent. of the normal volume of the furnace waste gases; actual infiltration is likely to be greater as the value taken for a probably flatters the brickwork. For furnace walls, much higher values are probable.

Value of the Experimental Figures.—Every furnace worker knows the importance, when working on a narrow margin of surplus draught, of keeping the brickwork in good superficial condition. What is not generally appreciated, is that leakage through an exposed wall in excellent condition approaches the high figures demonstrated by Bansen. While a dependable estimate of the value of a in a particular case cannot be made, calculation of the possible leakage for different values of a will stress the importance of paying closest attention to the condition of the joints, particularly in the laying of the brick; it is doubtful whether a badly laid wall can ever be made reasonably tight by application of cement washes.

For portions of a low pressure furnace where the interior becomes coated with slag, leakage may be slight provided that the joints are not heavily eroded. In such cases the slag forms a viscous fluid seal, which is not easily broken by slight pressure differences.

Pressure in Furnace Hearth.—It is evidently not possible to make the combustion chamber of a hearth type furnace gas tight, since doors need to be opened from time to time for working or inspecting the charge. It is essential, therefore, that this part of the furnace shall be as near atmospheric pressure as possible to avoid either air infiltration or outward leakage of gas and flame.

There are three circumstances which make it impossible, even theoretically, to maintain true atmospheric pressure at all parts of the furnace. The first is the slight change in pressure from burner to flue end associated with the gas movement.

The second, and usually the most important, is the effect of buoyancy, which causes increased pressure at higher levels of a hot gas body. Thirdly and of smaller importance, changes of

temperature from one end of the furnace to the other, as well as changes in the area of cross section and direction of the flame, cause changes in dynamic energy with resulting change in static pressure.

From Plate I, Scale 4, it will be found that at common furnace temperatures the pressure difference due to buoyancy is from 1.15 to 1.25 hundredths of an inch of water per foot of height. If a furnace door is 3 ft. high, the furnace might be operated with zero pressure at the bottom of the door, and a positive pressure of about 3.5 hundredths of an inch of water at the top; it might be operated with zero pressure at the top and a suction of 3.5 hundredths at the bottom; or it might be operated with some intermediate point at zero pressure, distributing the total pressure difference between positive pressure at the top and suction at the bottom.

When an opening is left in a system under pressure, gas escapes from inside to the lower pressure of the atmosphere outside, acquiring a velocity in so doing. If we assume the whole of the pressure energy of the escaped gas to be converted into kinetic energy, the velocity of the escaping gas may be found from the nomogram, Fig. 7. For a pressure of 3.5 hundredths of an inch water gauge the nomogram shows a gas velocity of 5.6 normal ft. per sec. for furnace gas at 2000° F., and 4.8 normal ft. per sec. at 3000° F. This is equivalent to an outward leakage of 340 and 290 normal cu. ft. per min. respectively, per square foot of opening. For a suction of 3.5 hundredths, the rate of cold air infiltration per square foot would be 740 normal cu. ft. per min. It has been shown earlier in this section that, due to pressure losses when gas discharges through an opening, the actual leakages are less than the above values, commonly being from 60 to 75 per cent. of the calculated values, depending on the nature of the opening.

It may appear at first sight that the total amount of leakage through openings is not very serious, but when all of the openings due to badly fitting doors, working openings, sight holes, etc., are taken into consideration, apart from the time when doors are actually open, it will be found that in many furnaces the area will total several square feet. The bad effects of cold air infiltration and hot gas escape have been studied in Chapter II.

In actual operation, every effort should be made to reduce the area of openings by using tight-fitting doors and temporary covers for other necessary openings, and by maintaining the

brickwork in good condition. Defective brickwork may be responsible for far greater leakage than the measurable openings, particularly in low or medium temperature furnaces where the bonding material between the bricks does not reach a temperature at which it "vitrifies," excepting on the inner surface of the wall.

Having reduced the leakage area to a minimum, the operator must reach a satisfactory compromise between infiltration at points below atmospheric pressure, and outward leakage at points above atmospheric pressure. It has been shown in Chapter II that, thermally, infiltration of cold air is much worse than escape of hot gas. Practically, in high temperature furnaces, outward leakage may cause serious damage to the brickwork and furnace structure.

The most favourable compromise will depend on the process and on the type of furnace. In a long furnace the problem is further complicated by the drop in pressure from burner to flue end of the furnace. Fig. 20 shows the possible plane of zero

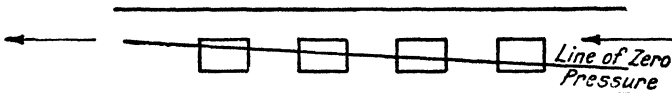

Fig. 20.

pressure in such a furnace, pressures above this plane being positive, and below, negative.

Whenever the furnace temperature is sufficiently low, it is probably best to work with outward leakage over most of the furnace. The mere escape of hot gas at the top of the doors is of course not evidence that such a condition exists; if the flame from a burning torch held at the bottom of the door is drawn into the furnace, then the bottom of the door is under suction.

Air Infiltration into Flues.—After the gases pass out of the furnace, they will ordinarily be below atmospheric pressure at all points in the flues, consequently the tendency is for air infiltration to occur. The effect of cold air infiltration may fall in three categories :—

1. The infiltrating air may increase the gas quantity to be exhausted from the system beyond the available draught capacity, enforcing a reduction in the furnace output. The lower temperature of the stack gases will contribute to this effect by decreasing the draught.

2. The draught capacity may be adequate to meet the additional demand. The furnace will then operate quite normally,

but with the dampers opened wider. In fact, controlled infiltration has been used as a simple means of regulating suction at the furnace, instead of the more usual method of regulating by damper.

3. If the flue gases are to be passed through a waste heat recovery system such as a recuperator, regenerator, or waste heat boiler, cooling of the waste gases by infiltration between the furnace and the exhaust side of the heat exchanger will result in smaller recovery of waste heat. The effect of lower air preheat where recuperators or regenerators are used has been explained in the section on "Available Heat" in Chapter II. Calculation of the actual loss of preheat is explained in Chapter VII.

Infiltration of cold air on the flue side of the furnace may take place through slots large enough to be called openings, such as may occur at valves and dampers, and also through defective brickwork. Calculation shows that where the area of exposed brickwork is large, infiltration can be very great, particularly since suction may be high and temperatures are frequently only high enough to dry instead of "burn" the cement used in laying the brick. Gas analyses at the furnace vent and at the base of the stack will establish the actual extent of infiltration.

Where the brickwork is completely encased in steel plates, leakage is naturally reduced to a minimum. Where the masonry is exposed, careful and periodic attention will be necessary if the draught is inadequate or if waste heat is recovered. In other cases, where the stack can handle the additional gas volume, infiltration is of small consequence. When mechanical draught is used, infiltration should be kept to the minimum to save power.

IX.—PRESSURE CALCULATION OF A FURNACE SYSTEM.

The over-all pressure developed in a furnace system for maintaining continuous movement of the gases, and the consumption of this pressure to overcome the various resistances, are functions of

- (1) the construction of the system, and
- (2) the method of operation.

Construction of the System.—Reference has already been made to the interdependence of the size of flues, valves, etc. and the dimensions of the chimney or exhaust fan. In actual practice, the

proportions of flues, etc., are to a great extent selected empirically; this aspect of design is outside the scope of the present volume.

Apart from economic considerations determining flue sizes, every effort should be made to minimise pressure losses due to eddying. Fig. 8 is particularly helpful in showing the biggest causes of pressure loss. Right-angle bends, tees and sudden changes of section should be avoided, particularly where the velocity is high.

Pressure Losses.¹—The itemized pressure loss throughout a system should be calculated for the maximum rate of fuel consumption. The rate of gas flow, v_0 , in normal cubic feet per second is first calculated from the fuel consumption as explained in Chapter II. The items are tabulated as follows:—

1	2	3	4	5	6	7	8	9
Part of furnace system	Area of cross section	Normal velocity v_0	Mean gas temp in section	Pressure equiv of dynamic energy	Sum of factors due to eddying.	Friction factor	Sum of cols 6 & 7	Pressure loss
	A	$\frac{v_0}{A}$	t	p_e		$\frac{L}{D} \times f$		col 5 \times col 8
(a), (b), etc.,								

Total Losses, _____

Column 1 lists in sequence the parts of the furnace, flues and chimney, conveniently subdivided into portions which, by reason of approximately equal cross section, may be regarded as separate integral parts.

Column 2 gives the area of cross section, A , of such parts.

Column 3 is obtained by dividing the normal gas flow, v_0 , by the area of section, A .

Column 4 gives the measured or estimated gas temperature.

Column 5 gives the pressure equivalent as determined from column 3 (normal velocity) and column 4 (temperature), with the aid of the nomogram, Fig. 7.

Column 6 is filled in from Fig. 8 or Fig. 11, which give the pressure loss coefficients for the bends, changes in area, etc., in the portion considered. If, for example, there is one right-angle

¹ See "Energy and Pressure Losses," p. 150.

bend in a brick flue approximately rectangular in section, and if this flue later discharges suddenly into a flue of double the cross section, then the factor for the right-angle bend might be found from Fig. 8 to be 1, and the factor for the enlargement is found from Fig. 11 to be 0.25, giving a total under column 6 of 1.25.

Column 7 lists the quantity $\frac{L}{D} \times f$, where L and D are the length and diameter of the flue subdivision (both measured in feet or both in inches), and f is the friction coefficient given in Table XIV, page 154, the value usually being about 0.04.

Column 8 adds the factors in columns 6 and 7, representing the losses by eddying and friction respectively.

Column 9 shows the total pressure loss in each part of the system, being the product of column 5 (the pressure equivalent) multiplied by column 8 (the sum of the loss factors).

The chimney should be included in the table, the pressure losses to include friction and the entire dynamic energy of the gases escaping from the top (*i.e.* a factor of 1 for this loss).

Buoyancy Effects.—The pressure developed or absorbed due to ascending or descending gas streams should be listed similarly.

1 Part of furnace system.	2 Difference in level.	3 Mean gas temperature in section.	4 Pressure per foot of height due to buoyancy.	5 Pressure generated by buoyancy.
(p), (q), etc.,				

Net pressure, _____

Column 1 lists in sequence, parts of the system where the gas stream changes from one level to another. Change in the cross section of the gas stream is of no consequence in this connection, so that the subdivisions in no way correspond to those previously used in determining pressure losses.

Column 2 gives the difference in level between the top and the bottom of the individual sections. In the event that the gas descends and, after a short travel, ascends again with practically no change of temperature, the buoyancy in one vertical (or inclined) limb will partly balance that in the other. In such cases it is not necessary to treat each limb of the circuit separately,

it being sufficient to take the net change of level in the section which includes such a dip (or its converse, a ridge). If there is appreciable temperature change, as will occur in a hot producer gas main, each change of level should be treated separately.

Column 3. Where there is a marked change of temperature, as when air or gas passes through a regenerator or recuperator, it is sufficiently accurate to take the average of the top and bottom temperatures.

Column 4. The pressure per foot of height is calculated as explained earlier, or read from Plate I, Scale 4.

Column 5. The pressure generated by buoyancy is obtained by multiplying Column 2 by Column 4. The values in this column are designated *pressure generated*. If the hot (*i.e.* lighter) gas has been made to descend in the system, this will cause a loss or absorption of pressure and a negative sign should be given in Column 5. If the hot gas rises, then pressure is developed and a positive sign applies.

Net Pressure.—If the furnace operates on natural draught, then the pressure generated by buoyancy will be equal to or greater than the total pressure losses by eddying and friction. Any surplus represents a margin above the normal maximum requirement, and this is throttled out in operation by dampers, or otherwise destroyed until the pressure supply and demand exactly balance.

If the furnace operates on mechanical draught, the excess of pressure requirement over the pressure supplied by buoyancy represents the balance to be made up by mechanical means.

Reduction of Pressure Losses in Operation.—The loss factors obtained from Fig. 8 depend on the construction of the furnace and are therefore only to a small extent within the control of the operator. The actual pressure requirements are obtained by multiplying these more or less fixed factors by the pressure equivalent of dynamic energy; and the latter is a function of the velocity squared and the temperature of the gases, and is therefore directly under the control of the operator.

The effects of various factors on the amount of heat available to the charge per unit of fuel consumed were described in Chapter II. It was shown that, for a given furnace output, the fuel consumption may be reduced if important details receive proper attention. Any reduction in the fuel consumption is accompanied by smaller waste gas quantities, lower velocities and smaller pressure losses. Reduction of excess air produces additional

direct pressure saving. Reduction of air infiltration has been already mentioned.

X.—MEASUREMENT OF GAS PRESSURE AND FLOW.

In metallurgical furnaces operating under appreciable pressure, and in steam power plants, engineers have long realised the importance of close attention to gas flow and pressure measurement. In most types of low pressure metallurgical furnace, pressure and flow metering devices were, until comparatively recently, conspicuously few in number. This is partly because of the difficulty of measuring the low pressures and velocities at most parts of the furnace, partly due to difficulties of interpreting the results on account of changing conditions, and partly due to lack of appreciation of the value of the information which may be obtained from such devices.

The successes achieved by automatic fuel and air proportioning equipment are based on the continuous metering of fuel and air supply. For a manually controlled furnace equipped with similar metering devices, the results obtained must approach those of a similar automatic furnace, depending on how closely conditions permit the furnace operator to follow the dial indications of the instruments.

In certain high temperature melting furnaces, the greatest care is taken to obtain balanced draught conditions in the melting chamber, the pressure being regulated to one hundredth of an inch water gauge. In most instances this is left to the judgment of the furnace operator. Although it is quite possible that the operator can adjust the pressure to the requisite degree of accuracy without the help of a draught gauge, the gauge has the advantage of calling immediate attention to maladjustment. Apparatus is sometimes installed for balancing automatically the pressure in the melting chamber.

The object of metering air and fuel supply is to attain as nearly as possible perfect combustion. Automatic flue gas analysing equipment is employed with the same objective. Each of these methods has its advantages. Direct metering of air (and fuel) supply has the advantage that air infiltration on the flue side does not interfere, and although some outward leakage occurs, the extent of this is usually much too small to constitute a serious interference. Gas analysis has the advantage of being sensitive to the effect on the air requirement of gases liberated by the

charge, and it can also be used to give an indication of the extent of air infiltration. Either type of instrument alone would be better than none, but the fullest information is obtained by the two in conjunction.

The two measurements important in determining gas flow conditions are

- (1) static pressure, and
- (2) dynamic pressure, velocity, or rate of flow, these three quantities being convertible one into another.

Measurement of Static Pressure.—The simplest form of static pressure gauge is a U-tube manometer, one limb being connected through a rubber hose to a pipe open to the gas stream, and the other limb being open to the atmosphere. Coloured water is in most cases suitable for measuring the pressure; the difference in level on the two sides, as measured on a scale between the limbs of the U-tube, gives the gas pressure or suction in inches of water. Where there is danger of freezing, or where evaporation is considerable, special gauge liquids may be used to meet the particular circumstances. In this case, if it is desirable to convert the pressure to inches of water, allowance should be made for the specific gravity of the gauge liquid.

If the pressure is not fluctuating, the U-tube can be used to measure pressures within 0.05 inch. This is satisfactory for high pressures or suction, *e.g.* air supplied by mechanical draught to gas producers, chimney flue if suction is high. For low pressures it is not accurate enough, and inclined draught gauges may be used. The principle is the same as that of the U-tube, but by inclining one limb of the tube, movements of the liquid are magnified. Pressures of $\frac{1}{100}$ of an inch may be measured by this type of instrument provided the pressure is steady. Special manometers are available for reading to greater accuracy.

Precautions to be Taken in Measuring Pressure.—In a smooth metal pipe, the pressure connection should be made to a small hole perpendicular to the pipe, and if possible the inner edge of the hole should be rounded off.

For rough metal pipes the hole should be larger, while for very rough brick ducts it is probably better to push the pressure tube right into the gas stream. The opening of the pressure tube should be perfectly square to the gas stream. If pointed slightly upstream there will be an impact effect due to the movement of the stream, and this will cause a high pressure reading.

If pointed slightly downstream, the movement of the gas will produce a slight suction effect. For the same reason, the edges of the tube should be free from irregularity. A disc brazed on to the end of the tube and then ground perfectly even (Fig. 21) has been shown¹ to be an improvement on a simple tube, where conditions are not very favourable. Another satisfactory device for use in a rough duct is a tube in the form of an L, the foot of the L being plugged at the end but having one or more small holes drilled through the side. This branch is placed in the duct parallel to the direction of flow, and the manometer is connected to the other branch. This type of tube corresponds to the static pressure part of the pitot tube, described later.

Measurement of static pressure at points of disturbance in the gas stream should be avoided, because irregular motion of the gas at points of disturbance is always liable to register as additional pressure or suction due to the local movement not being square to the tube. This effect may be partly eliminated by special devices. In the **piezometer ring**, pressure taps are made at several points around the duct in an effort to decrease the effect of local movement, all taps being connected through a manifold to the same gauge. Even with a piezometer ring, dependable readings cannot be expected in a region of considerable eddying.

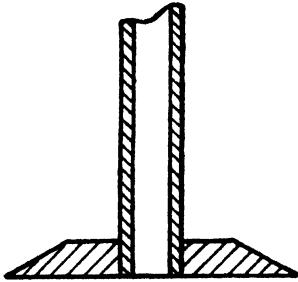

Fig. 21.

It has been shown that in a body of hot or low density gas, buoyancy causes the static pressure to be higher at the top than at the bottom. This is important when comparing pressures at different levels.

Where the pressure is to be recorded at a distance from the point of actual measurement, the connecting pressure line is important. The pressures or suction are so small that even the slightest leakage in the line will render the pressure reading worthless. For the same reason, pipes of large diameter should be used for all connections. Long horizontal portions of pipe connection should be avoided, and above all any "valley" in the line where moisture might condense and collect. Provision

¹ Heenan, H., and Gilbert, W., *Proc. Inst. Civil Engineers*, vol. cxxiii, 1896. "The Design and Testing of Centrifugal Fans."

should be made for blowing out the pipe line when necessary, and a means of testing the gas tightness of the line is also desirable. The remarks concerning pipe line installation apply equally to dynamic pressure measurement.

Velocity and Rate of Flow.—The rate of flow, whether measured as v (the actual number of cubic feet passing a given point per second) or as v_0 (cubic feet under standard conditions), is obtained by multiplying the velocity (V or V_0 respectively) in feet per second by A , the area of cross section at the given point,

$$v = A \times V$$

A is known for any part of the furnace, so that if either v or V is known, the other can be found. If an instrument is used for measuring gas movement, it can give either v or V directly if so calibrated. No distinction is therefore made in the following treatment between velocity and rate of flow measurement.

Measurement of Velocity.—Most of the practical methods of measuring dynamic energy consist in converting a known portion of the dynamic energy into static energy, and then measuring the static energy so produced.

Venturi Meter.—The principle of the venturi meter is illustrated in Fig. 22. The gas stream converges in a conical reducing section to enter a narrow cylindrical throat, the angle between reducer and throat being smoothed to a tangential curve. In the constricted section, for a given flow of gas, the velocity is greater than in the larger upstream section, so that the gas has

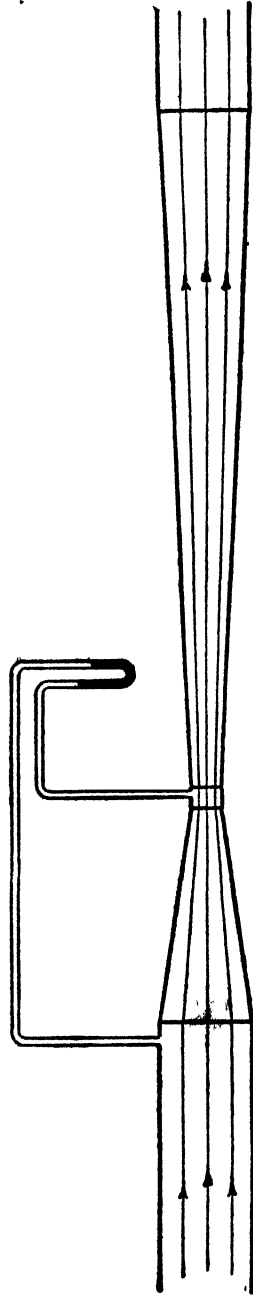

Fig. 22.—Venturi Meter.

more dynamic energy in the smaller section. Having more dynamic energy, at that point it must have less static energy. If there is no loss whatever of mechanical energy, the gain in dynamic energy must exactly equal the loss of static energy. The static pressure may be measured in the wide section and in the narrow section and the decrease determined. As a matter of convenience, instead of measuring both static pressures separately, the two pressure connections are joined to opposite limbs of the pressure gauge, and the gauge then indicates static pressure drop directly. A U-tube, inclined draught gauge, or any other type of static pressure instrument or recorder may be used in conjunction with the venturi tube.

The pressure taps commonly take the form of piezometer rings built into the tube.

Let the actual velocity in the parallel upstream portion of the pipe be V and let the ratio

$$\frac{\text{diameter of the pipe at upstream pressure connection}}{\text{diameter at the throat}} = n$$

The ratio of the areas will therefore be $n^2 : 1$ and the velocity in the throat will be $n^2 V$.

If there were no loss of energy between the pipe and the throat, the total energy at the two pressure taps would be the same, giving, by Equation 8,

$$p_1 + \frac{wV^2}{2g} = p_2 + \frac{w(n^2V)^2}{2g}$$

where p_1 and p_2 are the pipe and throat static pressures, respectively, in pounds per square foot, w is the weight of gas per cubic foot under actual conditions and g has its usual significance, and is equal to 32.2 ft. per sec. per sec.

Rearranging the above equation we get

$$p_1 - p_2 = \frac{V^2 w}{2g} (n^4 - 1)$$

The quantity $V^2 w / 2g$ is recognised as the pressure equivalent, *p.e.*, of the gas in the upstream section of the pipe, and transforming the equation once again, we have

$$p.e.' = \frac{p_1 - p_2}{n^4 - 1} \text{ lb. per sq. ft.}$$

or

$$p.e. = \frac{h}{n^4 - 1} \text{ inches water gauge,}$$

where h is the pressure difference as recorded by the pressure gauge.

Practically, the above expression must be multiplied by a coefficient to take care of small pressure losses due to friction and eddying in the meter, giving the equation in its final form,

$$p.e. = \frac{C}{(n^4 - 1)}h \quad . \quad . \quad . \quad . \quad . \quad (13)$$

$$= kh$$

The constant of the venturi tube, k , incorporates the two constants C and n . The value of n is known for a particular tube, and the value of C for a venturi meter is approximately 0.96.¹

For the meter reading, h , at any rate of flow, $p.e.$ is obtained from Equation 13, this being the pressure equivalent (in inches of water) of the gas stream velocity in the main pipe. The nomogram, Fig. 7, is now used to find V_0 . Stretch a thread from the $p.e.$ value to the temperature scale and read off V_0 on the middle scale. If the gas density is not equal to that of air, or if the gas is under pressure, since the nomogram is to be read backwards, $p.e.$ must first be divided (not multiplied) by the factors given on page 139 (see also below).

Example.—A venturi meter having a 4-inch diameter throat is installed in a 12-inch pipe for measuring the rate of air flow. The air temperature is 150° F. and the meter shows a pressure difference of 2 inches of water. Find the rate of flow in normal cubic feet per minute,

$$n = \frac{12}{4} = 3 \quad \therefore n^4 = 81$$

$$k = \frac{0.96}{81 - 1} = 0.012$$

$$p.e. = 0.012 \times 2 = 0.024 \text{ inches of water.}$$

Stretching a thread from 150° F. on the temperature scale to 2.4 hundredths of an inch on the pressure equivalent scale, we find,

$$V_0 = 9.4 \text{ normal ft. per sec.}$$

$$\text{The pipe area, } A, = \pi/4 \times (12/12)^2 = 0.785 \text{ sq. ft.,}$$

¹ This is the square of the discharge coefficient C' , used with the conventional formula,

$$V \text{ (actual)} = C' \sqrt{\frac{2g(p_1 - p_2)}{w(n^4 - 1)}} = C' \times 18.3 \sqrt{\frac{h}{w(n^4 - 1)}}$$

giving a rate of flow of 7.4 normal cu. ft. per sec. or 440 normal cu. ft. per min.

Effect of Density.—For a gas whose density differs from that of air, multiply the *p.e.* value obtained by the ratio,

$$\frac{0.076}{\text{Density of gas}}$$

before using the nomogram.

If, for example, a gas having a density of 0.05 lb. per normal cu. ft. had been flowing instead of air, then

$$0.024 \times \frac{0.076}{0.05} = 0.0365$$

and applying this to the nomogram we find a velocity of 11.8 normal ft. per sec.

Effect of Pressure.—A similar adjustment is necessary for air or gases at pressures appreciably different from atmospheric. For a compressed gas, multiply the *p.e.* value by the ratio,

$$\frac{\text{Absolute gas pressure}}{\text{Atmospheric pressure}}$$

before using the nomogram.

If the air in the above example had been under a pressure of 10 lbs. per sq. in., then the value used in the nomogram would have been

$$0.024 \times \frac{10 + 14.7}{14.7} = 0.040 \text{ inch of water}$$

giving a velocity of 12.4 normal ft. per sec.

Calibration of Instrument.—Ordinarily, isolated velocity or rate of flow calculations would be unnecessary, since the instrument would be calibrated. A calibration curve may be made by calculating V_0 (velocity in feet per second) or v_0 (rate of flow in cubic feet per second) for a number of values of h and plotting a curve, or a calibrated scale may be pasted directly on to the draught gauge, permitting direct reading of V_0 or v_0 .

Extension of Nomogram Range.—It may happen that the calculated *p.e.* value is below 0.01 inch of water, so lying outside the nomogram range. Multiply whatever value is obtained by 100, apply this to the nomogram, and divide the resulting velocity, V_0 , by 10 (*i.e.* $\sqrt{100}$).

Thus, to find V_0 if $p.e.$ is 0.005 and the temperature is 100° C., read for 0.5 inch (50 hundredths) and 100° C., giving 41 normal ft. per sec., and divide this by 10, giving 4.1 normal ft. per sec.

Constructional Characteristics of the Venturi Meter.—The A.S.M.E. Report on Fluid Meters¹ recommends a total angle of the converging section of about 21°, and a total angle of 5° to 5½° for the diverging section or diffuser.² The object of the small angle diffuser is to minimise loss of energy due to eddying; and by conversion of the excess dynamic energy of the throat section, to restore as completely as possible the static energy contained by the gas in the upstream pipe. Some overall loss of energy is unavoidable, the loss usually being 10-20 per cent. of the differential reading, h . Thus if a reading of as much as 2 inches of water is required, as in the numerical example, there will be an actual loss of pressure due to the meter of 0.2-0.4 of an inch of water.

The meter should be installed at a point free from eddies, and it is recommended that there shall be an upstream length of pipe free from bends or changes of section, equal to 5 to 20 times the pipe diameter. The value of the constant C falls off rather rapidly at low throat speeds, particularly if the throat is narrow. If the value, 0.96, is to be used for C , the throat speed for air should be at least 15 feet per sec. in throats over 12 inches in diameter, at least 25 ft. per sec. in throats 12 to 6 inches in diameter, and at least 60 ft. per sec. for 6- to 3-inch throats. The constant will also be affected by faulty installation.

In the numerical example, the calculated pipe velocity was 9.4 ft. per sec., and the throat velocity was $n^2 = 9$ times this, giving a throat velocity of 85 ft. per sec., which is satisfactory for a 4-inch throat.

Variations in C may in any case be taken care of by calibration, or by using curves showing the variation of C with low velocities.

Orifice Meter.—An orifice meter consists of the usual pressure arrangement, and an annular plate inserted between the flanges of a pipe at any convenient point. The plate may be of thin sheet metal, or of thicker material chamfered on the downstream side as shown in Fig. 23. For measurement of gas flow, orifice meters have the advantage over venturi meters of lower cost and greater ease of installation in an existing pipe line.

¹“Fluid Meters, their Theory and Application, Part I.” Report of A.S.M.E. Special Research Committee on Fluid Meters.

² According to some authorities an angle of 7° is permissible.

In principle, the orifice meter differs but little from the venturi meter, and similar precautions must be taken to ensure that the meter is installed at a point of steady flow. The orifice must also be concentric with the pipe, this usually being ensured by carefully machining the orifice to conform with the bolt circle of the flange.

The location of the pressure taps is important in an orifice meter. The upstream tap is commonly one-pipe diameter from the orifice plate, but is sometimes installed quite close to the plate and may be up to two diameters from the plate. When the location of the pressure tap is abnormal, the orifice should be calibrated experimentally rather than calculated.

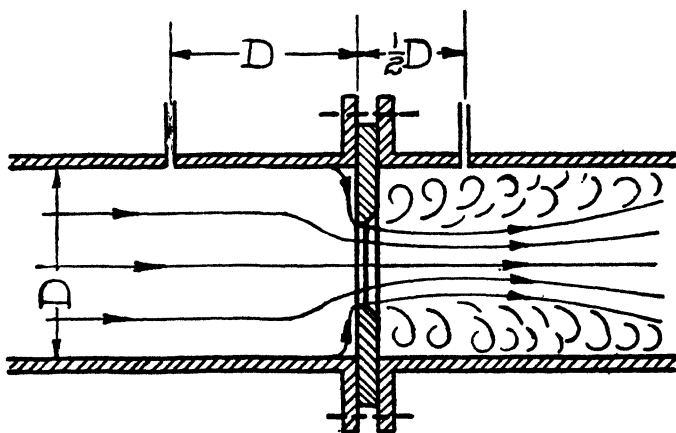

Fig. 23.—Orifice Meter.

The narrowest point of the gas stream is not at the orifice, because the stream continues to converge to a minimum diameter, called the *vena contracta*, some distance downstream from the orifice. The downstream pressure tap is usually made at this point, corresponding to the throat of a venturi tube, because this will record the biggest static pressure difference. The position of the *vena contracta* is independent of the gas velocity and is therefore fixed for a given installation. It varies with the ratio of the orifice diameter to the pipe diameter, but when the orifice diameter is from $\frac{1}{4}$ to $\frac{3}{4}$ of the pipe diameter (covering nearly all industrial installations) the downstream pressure tap may be set at one half-pipe diameter downstream from the orifice plate.

Calculation of gas velocity and quantity for an orifice meter

It may be found more convenient to locate the pressure taps differently, for example, quite close to the orifice plate. The value for C will in this case be different, and it may be obtained from curves (see A.S.M.E. Report), or if possible the instrument should be calibrated against an accurate meter.

The orifice is inferior to the venturi in that no attempt is made to cut down loss of mechanical energy by eddying of the gas stream. The actual loss of pressure due to the meter increases from 45 per cent. of the measured pressure difference for a large orifice $\frac{3}{4}$ of the pipe diameter, to over 90 per cent. for a small orifice $\frac{1}{4}$ of the pipe diameter. In the calculated example (orifice $\frac{1}{2}$ of pipe diameter) the loss is about 70 per cent. of the measured pressure difference of 3 inches of water, so that the meter causes an unrecovered pressure loss of 2.1 inches of water. In fact, in some orifice meters this overall pressure drop is used to measure the gas flow. The downstream tap is then placed $4\frac{1}{2}$ or more pipe diameters from the orifice plate, the meter serving to measure the pressure drop due to the eddying flow caused by the obstruction. In this case the constant may be obtained from curves.

Excepting when the instrument is to be calibrated by direct experiment, it is essential to avoid rounding of the upstream edge of the orifice. Breaking of the sharp edge will produce a guiding action on the stream, will measurably lessen the extent of contraction, and will therefore increase the value of C .

Recently, a standard arrangement has been adopted by the Verein Deutscher Ingenieure for a chamfered plate orifice, with both pressure taps adjacent to the plate. The constants for this arrangement are minutely specified, with correction factors for all the variables which can affect the value of the constant, C , of the orifice. A concise summary of these exhaustive rules is given by Ower.¹

Flow Nozzles.—Contraction of the gas stream is sometimes effected by a short nozzle built into the pipe. The guiding effect of this nozzle eliminates the vena contracta produced by a sharp plate orifice, so that the maximum contraction of the gas stream is given by the actual areas of cross section of the pipe and of the nozzle discharge. The constant for nozzles is therefore approximately the same as for venturi tubes, provided the nozzle diameter is less than $\frac{3}{4}$ of the pipe diameter. The characteristics of the German standard nozzle are summarised by Ower.

¹ Ower, E. : *The Measurement of Air Flow*, pp. 86-99.

Pitot Tube.—The principle of the pitot tube is somewhat different and is illustrated in Fig. 24. The straight pipe clearly measures the static pressure in the flue. The curved pipe is also subject to the same static pressure, but in addition it receives the impact effect of the moving gas stream—it records the sum of the static and the dynamic pressures. When the two pipes are connected to opposite limbs of a draught gauge, the static pressure effects balance, and the instrument shows directly the inches of water equivalent of the dynamic energy, *p.e.*

All that is necessary, then, is to read the nomogram, Fig. 7, backwards to find what velocity corresponds to the water gauge reading. Variations of pressure or density from normal should be allowed for as usual.

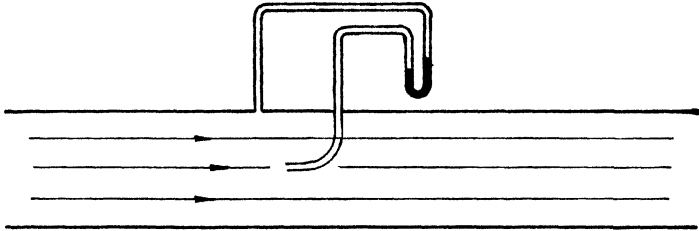

Fig. 24.—Pitot Tube.

Example.—A pitot tube in a compressed air pipe line measures 0.5 inch of water. The air pressure and temperature are 10 inches of mercury and 30° C.

The corrected pressure equivalent is given by

$$p.e. = 0.5 \times \frac{30 + 10}{30} = 0.667$$

From Fig. 7, $V_0 = 53$ normal ft. per sec.

The volume, v_0 , in normal cubic feet per second is obtained by multiplying by the cross-section of the pipe in square feet.

Types of Pitot Tube.—The common type of pitot tube combines the two tubes in one unit. The instrument consists of two concentric tubes, the inner one being open to receive the combined static and impact effects, and the outer one communicating with the gas stream by means of a few small holes drilled through the tube so as to measure static pressure only.

Fig. 25 shows a form of pitot tube recommended by the A.S.M.E. Research Committee on Fluid Meters. Other authorities recommend slightly different arrangements.

Characteristics of the Pitot Tube.—The chief problem in design or installation of a pitot tube is to secure a correct pressure effect in the static tube. Where separate tubes are employed, as in Fig. 24, measurement of the true static pressure is governed by the considerations explained earlier. Where a combined tube is used the problem will have received the attention of the manufacturer. In some manufactured instruments, the "static" tube does not measure the true static pressure, and this is

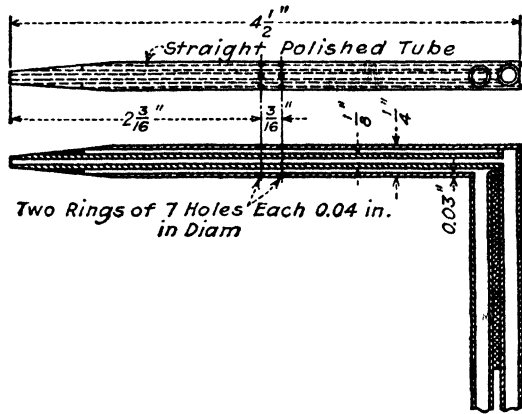

Fig. 25.—*A Good Form of Combined Pitot Tube.

allowed for by calibration or by use of a constant in the equation

$$p.e. = Ch$$

In the normal type of instrument, C is equal to unity. In the "reversed tube" instrument the static tube is replaced by a tube similar to the impact tube, but pointing directly downstream, so that the instrument measures the sum of the dynamic pressure on the upstream tube and the suction caused by the gas stream rushing past the downstream opening, static effects balancing as before. For this type of instrument, C is 1.18 to 1.2.

Installation of a Pitot Tube.—The pitot tube is particularly sensitive to errors in installation of the instrument. It is evident that care must be taken to see that the tube points truly upstream.

* Reproduced from "Fluid Meters," Part I, Fourth Edn., 1937, by permission of the American Society of Mechanical Engineers.

Unlike the other meters mentioned, the pitot tube measures the velocity at one point only of the stream instead of metering the entire stream. For a pipe carrying gas under steady flow conditions, the velocity is greater at the centre than at the walls of the pipe.

For a circular pipe, the pitot tube should be installed at the axis of the pipe; the mean velocity will then ordinarily be 0.8¹ of the measured value, and this may be taken care of in calibrating the instrument. It is possible to install the instrument at some point where the actual velocity is equal to the mean velocity of the stream. It is, however, not satisfactory to locate this point according to a general rule, since the velocity distribution in a pipe is a function of several variables.

For pipes which are not circular in section, as well as for circular pipes where conditions are not ideal, accurate measurements can be made only by determining experimentally the factor to be applied for converting the measured value at the pipe axis to the mean value. This is done by mapping out the entire cross section into equal areas, taking actual velocity readings at representative points in each of these areas, and then determining the average of the measured velocities.

Other Types of Meter.—There are several other types of flow meter based on pressure difference resulting from contraction. Operating on an entirely different principle, thermal meters add a quantity of heat to the stream, and from the rise of temperature produced the rate of flow may be calculated. In other types of instrument, of small metallurgical importance, gas velocity is measured by the rotation or displacement of a moving part placed in the gas stream.

Makeshift Quantity Meters.—In any gas duct where there is loss of pressure due to eddying, this loss is proportional to the square of the velocity. Provided that the duct does not vary appreciably in section with time, due to dust or soot deposits, that there is no variable resistance such as a damper in the length of duct under consideration, that there are no buoyancy effects

¹This value presupposes true steady flow, requiring a considerable length of straight pipe upstream. For accurate work, this length should be not less than 40 pipe diameters, although for technical work shorter distances down to 15 diameters are permissible. Apart from more or less violent eddying caused by fans, changes of section, etc., even large radius curves will upset pitot tube readings due to increased velocity at the outer section resulting from centrifugal force. The value 0.8 decreases somewhat for pipes which are rough in relation to their diameter, and decreases slightly as Reynolds' number decreases.

due to unbalanced vertical portions of the duct, and that temperature conditions are steady, then the pressure drop between two points may serve as a velocity and hence as a quantity meter if some method of calibration is available. With an inclined draught gauge a measurable pressure drop can thus be found sometimes where ordinary means of measurement are not available.

For approximate calculation, where mechanical draught is used, a set of characteristic curves of the fan, if obtainable from the manufacturer, may be used to estimate air quantity.

Metering of Producer Gas.—The direct metering of raw producer gas is considered by many engineers to be impracticable. Even if the temperature is reasonably constant and if the pressure connections are kept clear by compressed air or steam, the measurements are unreliable on account of continual changes in the area of cross section of the gas stream due to deposition of soot. In Chapter II it was shown how the quantity of air supplied to generate 1 cu. ft. of producer gas may be calculated from the gas and coal analysis. Provided these analyses remain reasonably steady, there seems no objection to metering the air to the producer instead of the producer gas. This can usually be arranged when a fan or turbo-blower is used to supply the air. Even with a steam injector, by placing vanes in the rather short length of blast pipe available, it would be possible to straighten out the flow sufficiently for metering. This arrangement should be much better, cheaper and easier to install than a meter in the gas main.

Metering of Liquids.—The theory of flow applies equally to liquids and gases—in fact the theory of gas flow is adapted from the laws of hydraulics. Liquid fuels can therefore be metered in exactly the same way, provided they are moderately clean and fluid, and that a suitable velocity is maintained. For the very dirty fuel oils now being used in some furnaces, a positive displacement type of meter is probably preferable. The pitot tube is clearly not suitable for measurement of dirty liquid fuel.

For metering water in open channels weir meters are used.

Precautions to be Taken in Velocity Measurement.—The importance of correct installation has been mentioned under the individual types of meter. In general, we may summarise by saying that measurements should not be taken in the neighbourhood of bends, sudden changes of section, dampers, valves, fans or other causes of eddying. Normally, there should be a straight portion of pipe upstream from the metering device at least six

times the diameter of the pipe, and a straight portion downstream at least three times the diameter—for a pitot tube the distance must be greater. The German specifications for orifices demand much greater lengths of straight pipe upstream, the distance depending on the nature of the nearest upstream obstruction and the orifice size relative to the pipe diameter. If the weight per cubic foot of gas, as metered, is likely to differ from that of the atmosphere, the metering instruments should be installed in a horizontal length of pipe to avoid errors due to the buoyancy of the gas.

While the constants given for venturi and orifice meters may be accepted for many practical purposes, it is well to note that, even when the meter is carefully installed, there are several minor factors which may slightly modify the values of the constants. These include the physical properties of the gas, the ratio of the throat or orifice diameter to pipe diameter, the velocity range under consideration, and the roughness of the pipe taken in relation to the diameter. The general values given assume that it is permissible to neglect such expansion of the gas as is caused by the slight pressure drop at the meter. In rare instances, where the pressure drop is very large and accurate results are required, a correction factor may be applied. For application of the various minor correction factors, the reader is referred to General References 1, 3 and 7 at the end of this chapter.

If the calibration curve is to be obtained by calculation, it is particularly important to see that the instruments are correctly installed. Even in these cases, it is desirable to check the calibration against a standard metering device. This may be done without loss of time during repairs to a furnace.

Limitations to the Usefulness of Instruments for Gas Measurement.—To determine the velocity or flow by meters based on the principle of conversion of energy, it is always necessary to know the weight per cubic foot of gas. From a practical point of view, this means that the temperature must be steady. In many furnaces where the temperature of the gas is variable, this virtually restricts the use of these meters to the measurement of cold gases, such as air, coke oven gas, blast furnace gas and natural gas. Steam is also metered by venturi or orifice meters, because for a boiler working at a given pressure, the temperature is approximately constant. Naturally for purposes of special investigation, the temperature of the gas may be measured to permit calculation of the flow of hot gas.

For measurement of gas flow, the pitot tube is considered first. For practical purposes the pressure difference should not be much under $\frac{1}{4}$ inch, this of course being magnified, usually by means of an inclined draught gauge. To give this difference with cold air, the nomogram, Fig. 7, shows that the velocity would have to be 33 ft. per sec. It is only in metal piping with mechanical draught that the air normally has so high a velocity, so that the pitot tube is practically useless in furnace ducts.

The venturi meter increases the velocity locally. If the throat diameter is, for example, one-third of the diameter of the main, the velocity is increased nine times, which in most cases would give a sufficiently large pressure drop for accurate reading. The same applies to the orifice meter, but with the orifice there is a much greater permanent loss of mechanical energy due to eddying. This is not so important where the loss can be made up by fans or blowers, but cannot usually be permitted where natural draught is used.

Selection of Instruments.¹—It is obvious that too many pressure and quantity meters will serve only to confuse and may result in all the measurements being ignored. Measurements which are worth taking should be indicated in clear view of the furnace operator.

Most important to the furnace operator is the quantity of fuel and air flowing. Where mechanical draught is used, this information should be made available by installing orifice or other meters. Where natural draught is used, it may not be possible to meter the air.

If the fuel quantity cannot be metered, then for a gaseous or liquid fuel there should at least be a static pressure gauge on the supply side of the regulating valve if there is any likelihood of pressure fluctuation. If the fuel supply is adjusted by the valve, the adjustment will be good only at the pressure for which the valve was set, and the furnace operator should at least have his attention called to any change of pressure.

The gas pressure from hand fed producers is liable to fluctuate widely, even to the extent of doubling itself within a few minutes. In a producer plant, three pressure readings can be of use to the gas maker. A pressure reading from a point as near to the furnace as possible will enable him to see that the furnace man has a steady

¹ "Fluid Meters, Description of Meters, Part II," Report of *A.S.M.E.* Special Research Committee on Fluid Meters, describes the construction of the principal meters of American make.

gas pressure at the regulating valve. This same pressure reading, combined with a pressure measurement at the producer outlet, will indicate the condition of the gas mains. Thirdly, a reading of the blast pressure, in conjunction with the gas outlet pressure, will afford an index of the state of the fuel and ash bed. Of these three pressure readings the first is the most important.

Recording instruments are an improvement on mere indicators ; and automatic regulating equipment, whether for maintaining constant pressure or constant fuel-air ratio, is naturally better still. Automatic equipment for maintaining approximately atmospheric pressure in the furnace is valuable in some types of furnace. Dial-type pressure indicators are much more convenient to read than liquid gauges.

SUMMARY.

1. *The Air*.—(a) 1 normal cu. ft. of air weighs 0.076 lb. (p. 125).

(b) 1 lb. of air occupies 13.2 cu. ft. under standard conditions (p. 125).

2. *Moisture in Gases*.—(a) 1 grain of moisture per normal cubic foot of gas = 0.3 per cent. by volume (p. 126).

(b) 1 per cent. of moisture by weight = 1.6 per cent. by volume (for gases having about the same density as air) (p. 127).

3. *Effect of Pressure and Temperature on the Volume of a Gas*.—

$$\frac{p_1 v_1}{460 + t_1} = \frac{p_2 v_2}{460 + t_2} \text{ (for } ^\circ \text{F.)} \quad . \quad . \quad . \quad \text{(p. 129)}$$

$$\frac{p_1 v_1}{273 + t_1} = \frac{p_2 v_2}{273 + t_2} \text{ (for } ^\circ \text{C.)} \quad . \quad . \quad . \quad \text{(p. 129)}$$

where p_1 , v_1 and t_1 are the absolute pressure, the volume and the actual temperature respectively of a given quantity of gas under one set of conditions, and p_2 , v_2 and t_2 the corresponding values under another set of conditions. The absolute pressure is the gauge pressure plus the atmospheric pressure (the normal value being taken as 30 inches of mercury = 14.7 lb. per sq. in.). The figures 460 and 273 are the absolute temperatures of 0° F. and 0° C. respectively.

4. *Types of Gas Flow*.—(a) The term “steady flow” is here used to denote undisturbed flow in a straight duct.

(b) The term "eddy flow" is used to denote irregular movement due to some disturbing influence (pp. 132-134).

5. *Conversion of Pressure Units.*—(a) Standard atmospheric pressure is taken as 30 inches of mercury = 14.7 lb. per sq. in. = 408 inches (34 ft.) of water.

(b) To convert pounds per square inch to inches of mercury, multiply by 2.04.

(c) To convert inches of water to inches of mercury, multiply by 0.0735.

6. *Energy of One Cubic Foot (Actual) of Moving Gas.*—

$$E = p + \frac{wV^2}{2g} \quad \text{. (p. 136)}$$

where E is the total energy in foot pounds, p is the pressure above that of the atmosphere in pounds per square foot, w is the weight of 1 cu. ft. of the gas under actual conditions, V is the actual velocity of the gas in feet per second, and $g = 32.2$.

The first term p is the static or pressure energy of the gas, and the second term $\frac{wV^2}{2g}$ the dynamic or velocity energy of the gas.

7. "*Pressure Equivalent*" of *Dynamic Energy.*—The dynamic energy of the gas is supplied by the pressure energy. Consequently acquirement of a given velocity V at temperature t by a gas having a density (*i.e.* under normal conditions) of w_0 , requires the expenditure of a definite amount of pressure. The pressure requirement, called here the "pressure equivalent", is given by

$$p.e. = 0.000574w_0V_0^2(460 + t) \text{ for } ^\circ\text{F.}$$

$$\text{or } p.e. = 0.00104w_0V_0^2(273 + t) \text{ for } ^\circ\text{C. . . . (p. 138),}$$

the values for $p.e.$ being in hundredths of an inch of water. Evaluation is effected by means of the nomogram on p. 140.

8. *Pressure Losses.*—(a) All pressure losses due to disturbance may be expressed as an appropriate factor (Fig. 8 and Fig. 11) multiplied by the pressure equivalent of the dynamic energy (Fig. 7).

$$\text{Loss due to eddying} = f \times p.e. \quad \text{. . . (p. 139)}$$

$$(b) \text{ Pressure loss due to friction} = f \times L/D \times p.e. \text{ (p. 151),}$$

where f is the coefficient of friction (Table XIV), L and D are the length and diameter of the duct both measured in the same unit,

and *p.e.* is the pressure equivalent of the dynamic energy (Fig. 7).

(c) Equivalent diameter of a flue.—In calculating friction loss for a flue which is not circular or square in section,

$$D = \frac{4 \times \text{Area of Cross Section}}{\text{Perimeter}} \quad . \quad . \quad (\text{p. 158})$$

9. *Calculation of Pressure due to Buoyancy.*—The difference in pressure between different levels of a body or column of gas is given by

$$\text{Pressure difference} = (w_a - w_g)H \quad . \quad . \quad (\text{p. 160})$$

where w_a and w_g are the weights of 1 cu. ft. of atmospheric air and of gas, respectively, under the actual conditions, and H is the height in feet between the different levels. This pressure difference will be in pounds per square foot and may be converted to inches of water by dividing by 5.2 or by means of Plate I, Scale 3.

For gases of approximately the same density as air (see Table XV, p. 163), Plate I, Scale 4, gives the draught in inches of water directly for any given temperature of the waste gases. For atmospheric temperatures varying considerably from normal, this scale may be used as explained on p. 161.

Buoyancy increases with higher barometric pressure.

10. *Gas Flow in Furnaces.*—Some conception of the way in which hot gases will flow in a furnace may be obtained by imagining the furnace inverted, with water flowing through the system. The position of the water stream will, with certain restrictions, correspond to that of the gas stream in the actual furnace. The outlet from a reverberatory furnace should usually be as near the level of the hearth as possible, in order that the hot gas stream shall extend down as far as the hearth. The gas stream may also be forced down by projecting the flame downwards at high velocity to produce an inverted fountain, or by restricting the outlet to build up a greater thickness of gas stream measured downwards from the roof (pp. 163-172).

11. *Natural Draught.*—The pressure used up in a chimney is commonly about 2 *p.e.* where *p.e.* is the pressure equivalent of the stack velocity. The effective draught is the buoyancy minus the pressure used up, and this is the value registered by a draught gauge at the bottom of the stack (pp. 172-174).

12. *Gas Leakage through Openings.*—The pressure difference between the two sides of an opening is available as a driving force compelling gases to escape from the high pressure to the low

pressure side. The sum of the pressure requirements of friction, eddying and discharge velocity is equal to the available pressure difference. For simple cases the constants given in Fig. 19, and for more complicated cases calculation as explained on p. 179, will permit evaluation of the escape velocity. The velocity multiplied by the discharge area gives the rate of gas escape.

13. *Gas Leakage through Brickwork.*—The volume of gas escape per square foot of brick surface is a constant multiplied by the pressure difference and divided by the wall thickness. Some values of the constant for different conditions of the brickwork are given on p. 181.

14. *Pressure in Direct-fired Furnace Hearths.*—Although the average pressure in a direct-fired furnace hearth should approximate to atmospheric pressure, there will be considerable variation in pressure at different parts of the hearth. Consequently all doors, etc., should fit as tightly as possible, unnecessary height of openings, and openings at different levels (unless located on a plane of zero pressure—Fig. 20) in particular being undesirable (pp. 183-185).

15. *Pressure Calculation of a Furnace System.*—If, at some stage of a furnace life or operation, there is a shortage of draught, then calculation of the pressure losses at different points of the system will indicate what measures may possibly be taken to remedy the condition (pp. 186-190).

16. *Measurement of Gas Pressure.*—Gas pressure is measured by means of a draught gauge fitted to a pipe open to, and absolutely square with, the direction of the gas stream. The measurement should not be taken where eddying conditions prevail (pp. 190-193).

17. *Measurement of Gas Velocity and Rate of Flow.*—The most important instruments for measuring gas flow are

- (a) the venturi meter,
- (b) the orifice meter,
- (c) the pitot tube.

These instruments all measure the pressure equivalent of the dynamic energy of the gas, the pitot tube directly, and the venturi and orifice meter magnifying the value by a constant quantity depending on the details of the installation. The velocity or rate of flow is then calculated, or read from a calibration curve. These instruments must not be installed at points of eddying flow.

The pitot tube is very easily inserted and causes no loss of

pressure. As it cannot magnify the pressure equivalent of velocity, it can be used only when the velocity is high, limiting its application mainly to the flow of air in metal pipes. The orifice meter is more easily installed than the venturi meter, but causes a much greater pressure loss (pp. 193-207).

General References :—

1. A.S.M.E. (Report by Special Research Committee): *Fluid Meters, their Theory and Application.*
2. T. Baumeister: *Fcms.*
3. A. B. Eason: *Flow and Measurement of Air and Gases.*
4. W. E. Groume-Grjmailo: *The Flow of Gases in Furnaces* (Translation and Appendices by A. D. Williams).
5. J. E. Lister and C. H. Harris: *Mechanical Draught.*
6. J. G. Mingle: *Draught and Capacity of Chimneys.*
7. E. Ower: *The Measurement of Air Flow.*
8. W. H. Walker, W. K. Lewis and W. H. McAdams: *Principles of Chemical Engineering.*
9. Textbooks on Hydraulics.

CHAPTER V.

PRINCIPLES OF HEAT TRANSFER.

It is important to attain a high proportionate rate of heat transfer from furnace gases to hearth, and to minimise the heat losses from a furnace system. It has been shown that this is particularly true for high temperature furnaces; such furnaces may demand, in addition, maintenance of high air (and gas) preheat. Attempts to attain these objectives depend on a knowledge of the laws of heat transmission. It is necessary to understand the basic principles governing four different types of heat transfer :

- (a) conduction,
- (b) convection,
- (c) radiation (by which is understood radiation from and to solids or liquids),
- and (d) gas radiation.

The existence of these four forms of heat transfer is qualitatively appreciated by every furnace worker; we are here concerned with methods of quantitative evaluation. The formulæ and data given in this chapter represent the work of a very large number of experimenters. Where the data here used are the work of a single investigator, a reference has been given. Where the data represent a composite value due to a number of investigators, it is unfortunately not practicable to quote references in a book of this type. In the specialised treatises on heat transmission (see General References at end of chapter) complete bibliographies will be found. It is suggested that at first reading, the portions of this chapter in small type be omitted by those readers who are encountering the subject for the first time, or who wish to make rapid calculations without studying the underlying theory.

I.—CONDUCTION.

When a furnace wall is heated on the inside, the outer surface will gradually warm up, until it finally reaches a more or less

steady temperature—usually much below the temperature of the interior. When this condition is reached, although the temperature of the wall remains unchanged, there is a steady flow of heat from the hot interior to the cooler exterior, the heat being lost to the surroundings as fast as it reaches the outer surface. The process by which heat flows through a solid substance from a hotter to a cooler portion is called conduction. Strictly speaking, conduction can take place through gases and liquids, but for practical purposes we shall confine our study to conduction through solids.

Conduction through a Single Material.—The laws determining the quantity of heat flowing in a given time (for technical work the hour is taken as unit of time) are very simple. Imagine a straight wall 1 inch thick with the temperature of the inner surface 1° higher than that of the outer surface. Heat will flow from the inner surface to the outer surface, and we shall represent the amount of heat passing in 1 hour, through each square foot of this wall, by the symbol k . If the temperature of the inside of such a wall were t_1 , and the outer temperature t_2 , the temperature difference would be $t_1 - t_2$, instead of 1° ; this higher driving force would cause a heat flow per hour of $k \times (t_1 - t_2)$ for each square foot of wall. Now if the area of the wall were A sq. ft., the heat flow for the whole wall would be A times as much as for 1 sq. ft., or $k \times A \times (t_1 - t_2)$ heat units per hour. Lastly, if the wall were 2 inches thick instead of 1 inch, the heat flow per hour would be only one half, owing to the greater thickness; if 9 inches thick the heat flow would be $\frac{1}{9}$; and if the wall were d inches thick, the heat flow would be $\frac{1}{d}$ times that for a 1 inch wall.

All these simple laws can be put into the single formula

$$q = \frac{kA(t_1 - t_2)}{d} \quad . \quad . \quad . \quad (14)$$

where q is the heat flow in 1 hour, A is the area of the wall in square feet, t_1 and t_2 the inner and outer temperatures of the wall, d the thickness of the wall in inches, and k the quantity of heat which would have been transferred in the case of the unit wall 1 foot square, 1 inch thick, and with a temperature difference equal to 1° .

It will be observed that for determination of the heat conducted in a given case, A and d would be known and t_1 and t_2 could be either measured or estimated fairly closely. The unknown, k , is the

coefficient of conductivity. It is frequently called simply the "conductivity." This is permissible as long as the meaning is quite clear, but the full term will be used here to avoid confusion with another and entirely different meaning of the word "conductivity."

The values of k for different materials have been determined experimentally, and are found to vary with the temperature of the material. Fig. 26 shows the values at different temperatures for the more important refractories in which we are principally interested. Determination of the coefficient of conductivity is a very difficult matter, and the results obtained by various experimenters are widely different. The difference would appear to be due at least as much to the methods employed, as to actual differences in the physical properties of different samples of a particular refractory. The values may, moreover, be somewhat lower when applied to a wall, owing to imperfect contact between bricks. Fig. 26 is constructed from determinations and curves by Norton.¹ The fireclay curve in the figure is an average for two different clay bricks investigated by Norton.

It will be noticed that, with the exception of magnesite brick, the coefficients of conductivity of the refractories increase considerably at high temperatures.² Where B.Th.U.'s are used, t_1 and t_2 must be measured in °F.; and where C.H.U.'s, in °C.

For a given material, in finding the value of k , from the table, it will be close enough in all cases to use the average value of the inside and the outside temperatures of the wall, i.e. $\frac{t_1 + t_2}{2}$, and to take the value of k in Fig. 26 corresponding to this average temperature.

Example.—As a preliminary example showing how these data can be used, suppose the inside of an open-hearth furnace-roof to be at a temperature of 3000° F. (1650° C.). Actual measurement on the outer surface of the roof might show a temperature of 600° F.

¹ Norton, F. H., *Refractories*, (McGraw-Hill).

² With increasing temperature, the conductivity decreases for crystalline substances, increases for glassy substances, and increases with porosity. Most refractory substances contain much glassy material and have considerable porosity—hence the general tendency of greater conductivity at higher temperatures. Magnesite, silicon carbide, and graphite, are notable exceptions to the general rule of increasing conductivity with temperature, as are some of the highly crystallised high alumina materials.

(315° C.). If we take the average brick temperature of $\frac{3000 + 600}{2}$
 = 1800° F. (980° C.), we find from the curve that for silica brick the

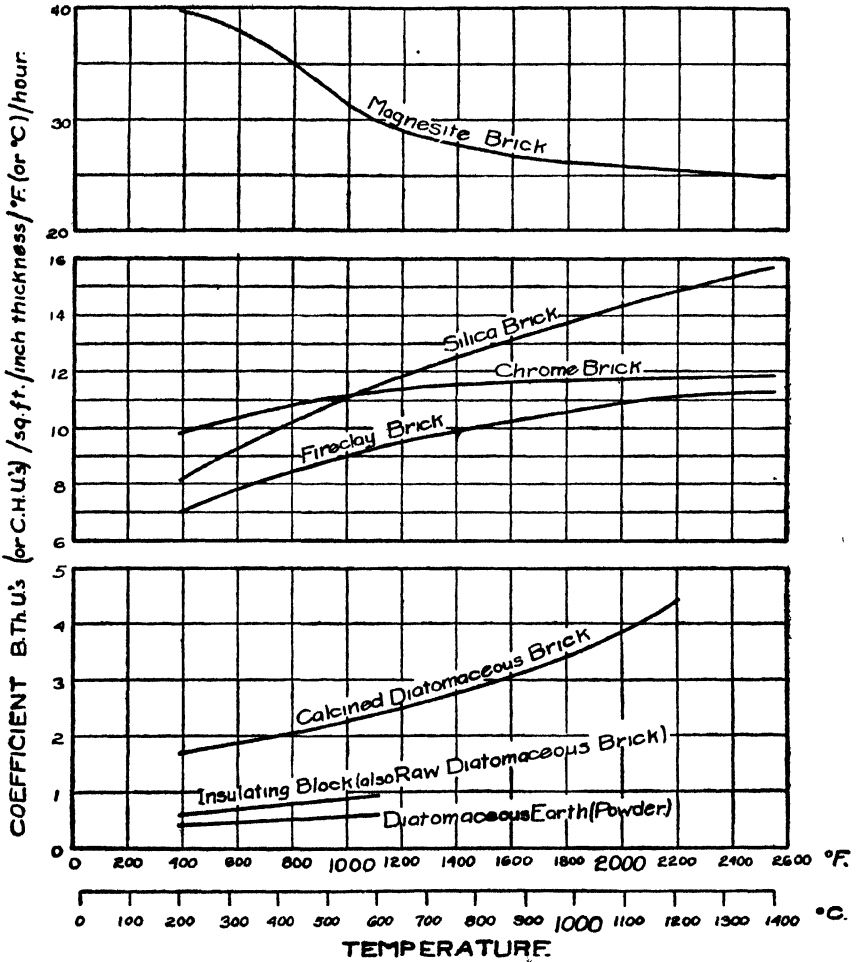

Fig. 26.—Thermal Conductivity of Refractories.

coefficient of conductivity is about 14 B.Th.U.'s (14 C.H.U.'s). Suppose that the width of the roof (between front and back walls, measured along the curvature so as to give the actual width of conducting brickwork) is 22 ft., and that the length is 50 feet, giving an area of 1100 sq. ft. If the average roof thickness is 15

inches, the heat flow through the roof, which is of course the heat loss in this direction, is given by

$$\frac{14 \times 1100 (3000 - 600)}{15} = 2,460,000 \text{ B.Th.U.'s per hour.}$$

$$\frac{14 \times 1100 (1650 - 315)}{15} = 1,370,000 \text{ C.H.U.'s per hour.}$$

Strictly speaking, in the case of a curved wall the area of the outside surface is greater than that of the inside surface, but for so large a radius of curvature as an open hearth roof, the difference is too small to matter.

For a small radius, *e.g.* a gas main, it is better to take the average of the inner and outer areas. For thick-walled pipes more complicated formulæ are occasionally used, but there are very few cases occurring in practice where this is necessary. The potential errors in conductivity calculations are much greater than the one or two per cent. of difference shown by the mathematically more accurate formulæ.

Example.—A gas producer main (clean) is 50 ft. long and has an external diameter of 4 ft. It is lined with $4\frac{1}{2}$ inches of firebrick, the inside and outside temperatures of which are 1200° F. (650° C.), and 400° F. (205° C.) respectively.

The inside diameter will be 3.25 ft., and the average diameter $\frac{4 + 3.25}{2} = 3.625$ ft., giving a mean circumference of $3.625 \times 3.14 = 11.4$ ft. The mean area is $11.4 \times 50 = 570$ sq. ft. At the average temperature of $\frac{1200 + 400}{2} = 800^\circ \text{ F. (430}^\circ \text{ C.)}$, the coefficient of conductivity for firebrick is seen from Fig. 26 to be 8.5. The heat loss,

$$q = \frac{8.5 \times 570 \times (1200 - 400)}{4\frac{1}{2}} = 860,000 \text{ B.Th.U.'s per hr.}$$

$$\text{or } q = \frac{8.5 \times 570 \times (650 - 205)}{4\frac{1}{2}} = 480,000 \text{ C.H.U.'s per hr.}$$

The more complicated method of calculation mentioned above would give a result $\frac{3}{10}$ of 1 per cent. lower than this. With a bigger ratio of outside to inside diameter the discrepancy would increase, but even with an outside diameter equal to twice the inside diameter it would be only 4 per cent.

Conduction through Layers of Different Materials.—With heat insulating materials becoming far more common in furnace construction, there are comparatively few cases of simple conduction through a single material. An example will now be taken of conduction through a wall made of three different materials.

Fig. 27 shows a section through such a wall, indicating the thicknesses of each part and the temperatures of the various interfaces. The coefficients of conductivity of the materials (1), (2) and (3) are k_1 , k_2 and k_3 respectively.

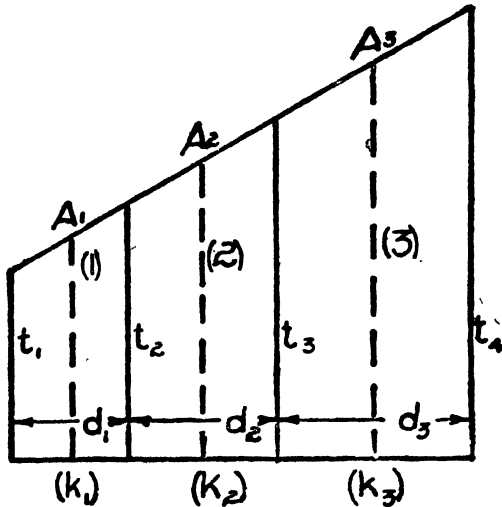

Fig. 27.

Taking the usual case, where the area (at right angles to the flow of heat) of the wall is greater outside than inside, let A_1 , A_2 and A_3 represent the areas of the three portions of the wall. These areas should be calculated at the centre plane of each separate portion of the wall as indicated in Fig. 27, so that A_1 , for example, is really the average of the inside and outside areas of the material (1).¹ The quantities of heat passing through each part of the wall in 1 hour are

$$\frac{k_1 A_1 (t_1 - t_2)}{d_1}, \quad \frac{k_2 A_2 (t_2 - t_3)}{d_2}, \quad \frac{k_3 A_3 (t_3 - t_4)}{d_3}$$

respectively.

¹ There are formulae which theoretically are more accurate for finding the mean area, but these have little place in practical calculations.

When steady conditions are reached, the quantity of heat travelling through must be the same at all points—just as the flow of water in gallons per hour through a pipe having no side inlets or outlets must be the same at all points, even though the pipe section varies. We can write, therefore,

$$q = \frac{k_1 A_1 (t_1 - t_2)}{d_1} = \frac{k_2 A_2 (t_2 - t_3)}{d_2} = \frac{k_3 A_3 (t_3 - t_4)}{d_3}$$

The quantities k , A and d are known from the dimensions and material of the wall; t_1 , the inner temperature, is presumed to be known; while t_4 , the outside temperature, can be measured; t_2 and t_3 , the temperatures within the wall, are not known and usually are not required. They are eliminated by applying two arithmetical rules:—

(1) We can take any factor of the numerator of a fraction and place it in the denominator in an inverted form, thus

$$q = \frac{t_1 - t_2}{\frac{d_1}{k_1 A_1}} = \frac{t_2 - t_3}{\frac{d_2}{k_2 A_2}} = \frac{t_3 - t_4}{\frac{d_3}{k_3 A_3}}$$

To express what we have done in another way, we have multiplied both numerator and denominator by the quantity $1/kA$.

(2) When any number of fractions are equal to one another, we can add together the numerators of two or more of these fractions, and provided we add the denominators of the same fractions, the resulting fraction will be equal to each of the original fractions. In this case we add the three numerators and the three denominators and get

$$\frac{(t_1 - t_2) + (t_2 - t_3) + (t_3 - t_4)}{\frac{d_1}{k_1 A_1} + \frac{d_2}{k_2 A_2} + \frac{d_3}{k_3 A_3}}$$

or

$$q = \frac{t_1 - t_4}{\frac{d_1}{k_1 A_1} + \frac{d_2}{k_2 A_2} + \frac{d_3}{k_3 A_3}}$$

A simple example of this rule is of greater practical value than a formal proof. The fraction $\frac{2}{3}$ is equal to $\frac{6}{9} = \frac{12}{18} = \frac{12}{18}$. If we add the last three numerators and the last three denominators we get $\frac{22}{27}$, or adding the first and second we get $\frac{18}{27}$, or second and third $\frac{24}{27}$, or third and first $\frac{24}{27}$. Each of these results is equal to $\frac{2}{3}$.

The results are summarised in the formula

$$q = \frac{t_1 - t_2}{\frac{d_1}{k_1 A_1}} = \frac{t_2 - t_3}{\frac{d_2}{k_2 A_2}} = \frac{t_3 - t_4}{\frac{d_3}{k_3 A_3}} = \frac{t_1 - t_4}{\frac{d_1}{k_1 A_1} + \frac{d_2}{k_2 A_2} + \frac{d_3}{k_3 A_3}} \quad (15)$$

All the quantities in this final fraction are known or are measurable and the heat flow q through the compound wall can therefore be calculated.

II.—CONVECTION.

When a stream of cool gas passes along the surface of a hot solid or liquid, heat is transferred from the hot body to the gas, cooling the hot surface and heating the gas. In technical work this type of heat transfer is known as convection. Convection occurs, for example, in regenerative and recuperative furnaces, where the air is preheated by contact with the hot checkers or recuperator passages. If the portions of the gas stream coming into actual contact with the hot surface were able to pass freely the heat received to other parts of the gas stream, such heat transfer would be extremely rapid. This condition would imply unrestricted intermingling of gas particles in a direction at right angles to the direction of the gas stream. It has been established, however, that although this freedom of motion may exist in the main body of the gas stream, it does not extend right up to the hot surface, owing to the presence of a very slowly moving film of gas clinging to the surface. By interfering with direct gas particle impingement, such a "dead" gas film prevents direct heat exchange, and being a very poor heat conductor, is an extremely important factor in determining the rate of heat transfer by convection.

In Fig. 28, t_1 is the wall temperature, t_2 the temperature of an air stream, and d and k the thickness and the coefficient of conductivity, respectively, of the "dead" gas film. The heat transfer may be regarded as a matter of simple conduction through the gas film, whence,

$$q = \frac{kA(t_1 - t_2)}{d}$$

Calculation would be simple if we knew the thickness of film, d ; but it is not surprising that this thickness varies with the velocity of the air stream as well as with other factors. A higher air velocity

tends to scrub off the film, with a corresponding increase in the rate of heat transfer. Conditions tending to increase transverse movement of the particles in the body of the gas stream will assist greatly in passing heat on from the "dead" film to the centre of the stream.

Since, then, d is not known directly, nor is it the only factor involved in this type of heat transfer, it is usually combined with t for the film in a general coefficient α_0 . We write

$$q = \alpha_0 A (t_1 - t_2) (16)$$

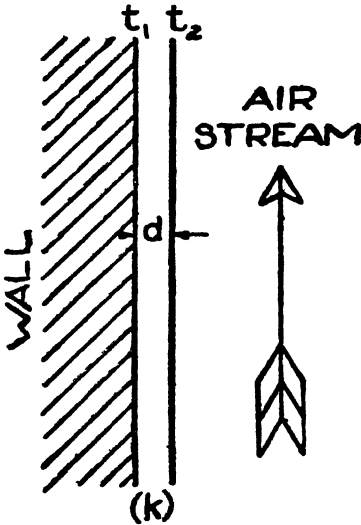

Fig. 28.

α_0 is obviously the amount of heat transferred in 1 hour for 1 sq. ft. of surface when the difference between the temperature of the hot solid and the cool air is 1°. If the gas is hotter than the solid, heat is transferred from the gas to the solid in accordance with the same law, t_1 in equation (16) this time being the temperature of the air, and t_2 that of the solid. The evaluation of α_0 is not so simple as conductivity in the case of solids.

In furnace operation, it is convenient to distinguish between two types of heat transfer by convection :

- (1) Forced convection, in which a body of gas is made to move, by an imposed pressure difference, along or across a surface.
- (2) Natural convection, in which natural air currents, induced solely by density differences due to an external hot surface, cause loss of heat from that surface.

Forced Convection.—There are many different conditions under which forced convection occurs, and it is proposed here to discuss only those of greatest importance to furnace operators.

(a) Flow of gas along a duct :—It has been shown in the section on conduction how, given the inner and outer temperatures, we can find the heat flow through a given wall. If, instead of the inside temperature of the wall, we know the temperature of the gas being driven past the wall, and if we know α_0 , which may be regarded

as the heat carrying capacity of the "dead" gas film, the total heat flow may still be calculated.

In practice it is much more difficult to measure gas temperatures than wall temperatures, so that calculations of forced convection are less frequently made than ordinary conduction calculations. It has been explained that the forced convection coefficient, α_0 , increases with the velocity; α_0 also varies with the diameter of the duct, being smaller with larger diameters.

For calculation of α_0 , Schack¹ recommends the formula²

$$\alpha_0 = \frac{0.31 V_0^{0.8}}{D^{0.25}} \quad . \quad . \quad . \quad . \quad (17)$$

a modification of a formula by E. Schulze. D is the diameter of the duct measured in feet. V_0 is the velocity of the gas stream reduced to a temperature of 60° F. (15° C.), i.e. the gas volume flowing per second under atmospheric conditions divided by the area of cross section of the duct.

The nomogram (Fig. 29) may be used for ready evaluation of this formula. The thread should be stretched across from the diameter, "General Scale," to the velocity scale on the right. The result, α_0 , is read off on the long middle scale. The other diameter scale, marked "Regenerators Only," should be used only for the special purpose described in Chapter VII (and this Chapter, p. 225). For ducts which are not circular or square, the equivalent diameter is given by

$$\frac{4 \times \text{Area of Cross Section}}{\text{Perimeter}}$$

If the gas temperature, t_1 , and the duct temperature, t_2 , are known, the heat transfer follows the rule

$$q = \alpha_0 A (t_1 - t_2) \quad . \quad . \quad . \quad . \quad (18)$$

The more general case, where t_2 is not known, is considered later. The nomogram and the formula from which it is derived require the "normal" velocity, V_0 , to be used. For air under pressure, e.g. the blast used in the blast furnace where the absolute pressure may be double that of the atmosphere, V_0 must therefore be based on the free volume of air, i.e. corrected to standard temperature and pressure.

¹ See General Reference No. 3.

² The constant 0.31 has been adjusted for the pressure and temperature standards adopted in this book.

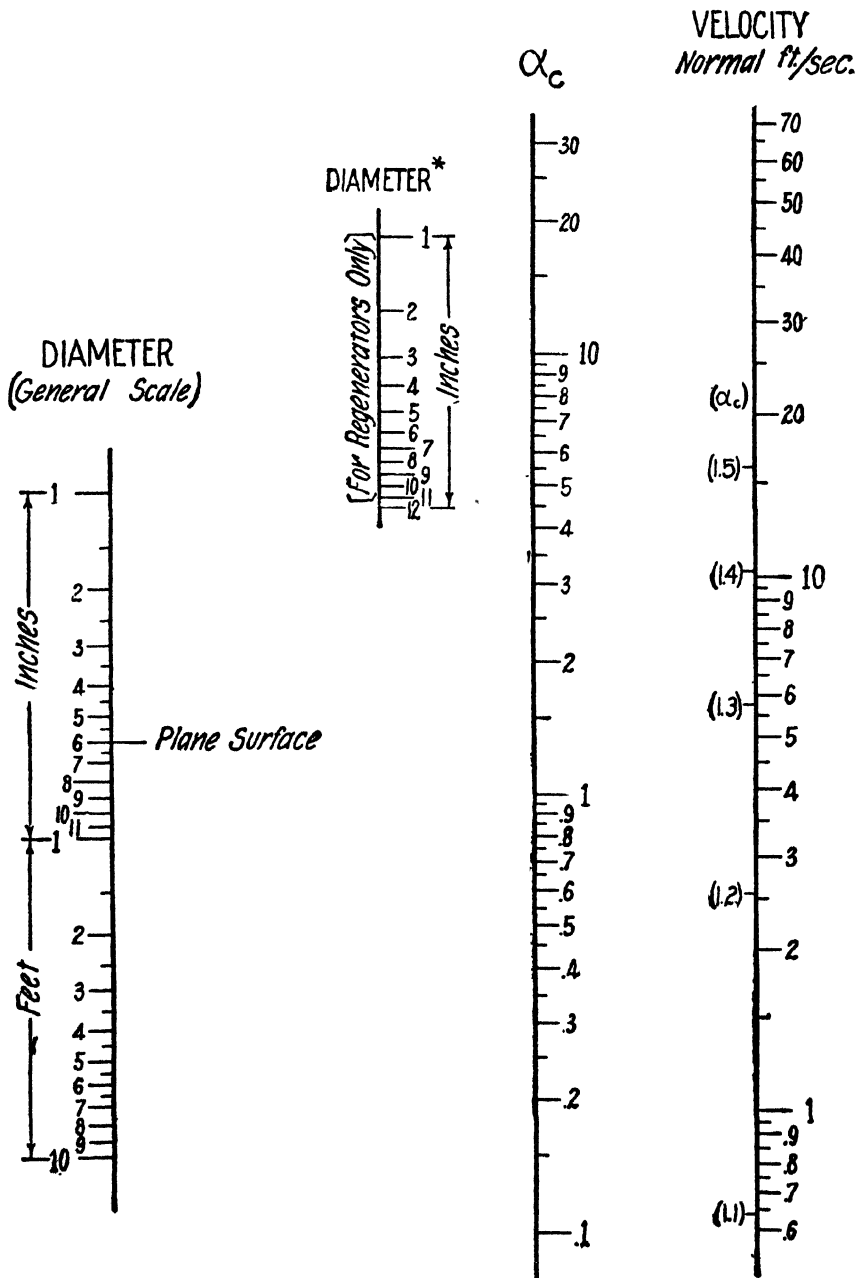

Fig. 29.—Forced Convection.

* Use of this scale is explained on page 225. Use of the subsidiary scale on the left of the velocity scale is explained on page 223.

Minimum Value of a_0 .—For moderately large ducts, the values for a_0 given by the nomogram are frequently under 1.5, unless the velocity is high. Small channels may show similar low values with low or medium velocities. This is of course consistent with the formula on which the nomogram is based, but these low results are, in general, not acceptable.

It will be explained later that even in "still" air (equivalent to zero velocity) convection takes place, and Plate I, Scale 5, shows that the coefficient of convection in still air ("natural convection") is usually over 1.0. Now at zero velocity, Equation 17 would give $a_0 = 0$, a result which is inconsistent with the still air values. Even in ordinary cases of actual flow, the formula may give values as low as 0.2, which, in view of the experimental values for still air, are not likely. When the nomogram gives values of a_0 below those for natural convection, the solution would be to accept the still air values instead.

It will also be explained later, however, that when convection takes place between a gas stream and a plane surface placed in the stream, the coefficient of convection is nearly always over 1.0, and shows decided increase above this figure with increasing velocity. This type of convection consequently gives, in general, values for a_0 higher than those for natural convection.

The walls of a duct are in some respects similar to a plane surface placed in a gas stream. In cases where Equation 17 (and consequently Fig. 29) breaks down due to low velocity or large diameter, a_0 probably lies somewhere between the value for natural convection and that for transfer between a plane surface and a gas stream.

The following method of evaluation is tendered:—

When the nomogram gives values for a_0 less than 1.5, base the value on the velocity alone, taking a_0 from the figures in parenthesis on the left of the velocity scale. In the event that the value so read is less than that indicated on the regular a_0 scale, then the latter should be retained.

The subsidiary scale is based on the formula,

$$a_0 = 1 + \frac{\sqrt{V_0}}{8}$$

This formula has no scientific basis but, when used as recommended, it will give results for a_0 which are at least reasonable. It makes some allowance for velocity, and presumes diameter, temperature, etc., to be of secondary importance.

Other Factors Influencing Forced Convection in a Duct.—Factors other than the velocity of the gas in a duct may exert important influences on the thickness of the gas film and hence on the rate of heat transfer. Impingement of the gas stream directly on to a surface has been found to increase considerably the heat transfer at that surface, presumably due to partial scrubbing away of the "dead" gas film. Oblique impingement will produce a similar but smaller effect.

It has been found that a close relationship exists between heat transfer and frictional resistance to flow, conditions which increase friction tending also to increase convection. A rough surface, for example, gives increased friction and also increased convection. However, while the effect of the surface on friction may be considerable, the effect on convection is relatively small.

The effect of eddying flow is usually, but probably not always, to increase the rate

of heat transfer. It has been mentioned that if there were no transverse intermingling of gas molecules, heat transfer could take place only by the extremely slow process of conduction through the gas, such as obtains in true (scientific) stream-line flow (page 132). The normal irregular transverse movement in "steady" (scientifically "turbulent") flow is likely to be increased by eddy currents, and in addition there will be local impingement of portions of the stream against the wall. It is possible, however, that in special cases the effect might be detrimental to heat transfer due to the stream having been deflected away from the surface.

A feasible conception of these varying effects is illustrated in Fig. 30, which shows an obstruction in a steady gas stream.

Region (1) should show increased heat transfer due to direct impingement, and region (2) should show almost normal conditions for a stream flowing parallel to a surface. Region (3) is sheltered from the main stream and might reasonably be expected to show a lower rate of heat transfer than normal. It is, however, possible that eddy

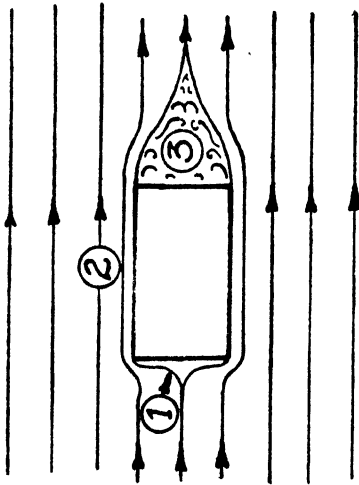

Fig. 30.

currents might increase the rate of heat transfer at (3) to, or even above, normal. Region (3) would certainly be responsible for much loss of static pressure, but this loss would be mainly an internal loss in the fluid and not a friction loss; consequently an increase in heat transfer can hardly be argued from the increased loss of pressure.

A number of other effects have been investigated by various experimenters. Some of the results are conflicting or difficult to interpret, but in general the following broad conclusions may be drawn:—

1. The dimensions of the surface influence the convection coefficient, due to differences of temperature distribution and varying eddy effects. Over the ordinary range of surfaces met with in metallurgical practice these effects may be neglected.

2. According to theoretical deduction, the actual temperatures of the surface and the gas should influence the value of the

coefficient a_0 . Experimental corroboration is not conclusive.

3. The effect of gas composition on a_0 is not important.

4. A large number of special cases of heat transfer by forced convection have been the subject of experimental determination. Although highly important in certain fields, it is felt that their application to metallurgy is not sufficiently wide to justify more than a passing reference here. These special cases include:—

(a) Convection between a gas stream and a series of parallel pipes. Examples of application: steam boilers, metallic recuperators.

(b) Flow of air past a cylinder.—Calculations involving this type of convection are of minor importance. The effect of wind on heat loss from a chimney or gas main constitutes an example of this type. It happens that the law governing a_0 is, for cylinders more than an inch or so in diameter, not very widely different from that used for convection in a duct. Consequently, if it should be necessary to make calculations of this class, evaluation of a_0 from Fig. 29 will give results which are at least of the

right order of magnitude. For small cylinders, the value for cross flow is appreciably greater than for flow in a pipe of the same diameter.

(c) *Flow of air past a plane surface.*—The value of a_0 may be determined approximately from the nomogram (Fig. 29), using the point on the left-hand scale marked "Plane Surface." This makes use of the results of W. Jürges,¹ with some allowance for the fact that the exposed surface will usually be larger than that used in Jürges' experiments. At low velocities when the nomogram yields values less than 1.5, it will be sufficient to use the values shown on the velocity scale, as explained on page 223. When the air current is blowing directly on to the surface instead of along it, the value of a_0 will naturally be greater.

For a summary of Jürges' results and conclusions see General References at end of Chapter.

(d) *Regenerator checkers.*—The checker used in regenerators does not usually form continuous smooth channels. The lateral openings in the channels result in modification of the convection coefficient. The value of a_0 may be obtained from Fig. 29, using the D scale specially constructed for this important case. The scale is constructed from the formula by H. Kistner,²

$$a_0 = 1.23 \frac{\sqrt{V_0}}{\sqrt[3]{D}}$$

This formula applies to non-staggered checkers. For staggered checkers the value as read from the nomogram should be increased by 16 per cent.³ The application of these data is discussed in the chapter covering regenerators.

(e) Convection between liquids and pipes. Examples of application: heat exchangers and condensers used in power plants, in chemical plants, and in the oil industry; refrigerating plant; water cooling elements in furnaces.

(f) Convection between gas streams and thin wires. Examples of application: temperature measurement of gases by thermo-couples, electric air heaters.

(g) Flow of gases through beds of broken material. Example of application: heating the stock in a shaft type of furnace.

The many variables controlling this type of heat transfer have been investigated and expressed in a series of formulæ by Furnas.⁴

Natural Convection.—When a hot surface is exposed to otherwise still air, there is always a local upward movement of air from or along the surface, due to the buoyancy of air heated by the surface. Convection induced by these natural air currents is referred to as natural convection, and is of particular importance in connection with heat losses from furnace exteriors.

$$\text{Equation 16, } \quad q = a_0 A (t_1 - t_2)$$

¹ Jürges, W.: "Der Wärmeübergang an einer ebenen Wand." *Beihefte zum Gesundheits-Ingenieur*, I, 19, 1924.

² Kistner, H.: "Grossversuche an einer zu Studienzwecken gebauten Regeneratorkammer." *Archiv f.d. Eisenhüttenwesen*, 3, II, 751-68 (1929-30).

³ This figure was taken from Kistner's original publication. Elsewhere, Kistner's research has been quoted as showing a 10 per cent. increase for staggered checkers.

⁴ Furnas, C. C.: "Heat Transfer from a Gas Stream to a Bed of Broken Solids." *Bureau of Mines, Bulletin 361*, 1932.

indicates that the heat flow q is proportional to the difference in temperature between wall and air. In the case of natural convection, the greater this difference ($t_1 - t_2$), the greater will be the tendency for upward currents of air along the wall. The increase in the upward velocity will cause a decrease in the thickness of the "dead" air film and so cause an indirect increase in the value of α_c due to temperature.

In a critical survey of existing experimental data on heat transmission, Fishenden and Saunders¹ show in the form of a curve the results for natural convection obtained by different experimenters. From this curve they express the combined direct and indirect effect of temperature on natural convection for all surfaces more than 6 to 12 inches high, by the formula,

$$q = 0.32A(t_1 - t_2)^{1.25} \quad . \quad . \quad . \quad (18a)$$

q being the B.Th.U. loss per square foot of surface per hour, t_1 and t_2 being the temperatures in °F.

For C.H.U.'s and °C., the formula becomes

$$q = 0.37A(t_1 - t_2)^{1.25} \quad . \quad . \quad . \quad (18b)$$

The exponent 1.25 has been found by a number of different experimenters, and is generally used in natural convection calculations. But nearly all of these experimenters used comparatively small surfaces in their laboratory determinations. The curve by Fishenden and Saunders gives unmistakable indication that under average furnace conditions with large exterior surfaces at temperatures well above atmospheric, natural convection follows a somewhat different law. From the curve, under usual furnace conditions, the following equations are calculated:

$$q = 0.22A(t_1 - t_2)^{4/3} \quad . \quad . \quad . \quad \text{B.Th.U.'s (°F.)}$$

$$q = 0.27A(t_1 - t_2)^{4/3} \quad . \quad . \quad . \quad \text{C.H.U.'s (°C.)}$$

Although these modified formulæ give results which should conform more closely with average furnace practice, yet the exponent 1.25 has been so widely accepted, that it is thought better to continue its use here than to invite suspicion of the exponent $4/3$.

Plate I, Scale 5 (end of book) permits direct evaluation of α_c (natural convection) for a given temperature difference ($t_1 - t_2$). The actual heat loss per square foot per hour is the product of α_c and ($t_1 - t_2$). The heat loss by natural convection is also shown in Fig. 31, this figure also showing, for comparison, the value of q according to the formulæ given in the small-type section above (dotted curve).

¹ Fishenden, M. and Saunders, O. A.: *The Calculation of Heat Transmission*.

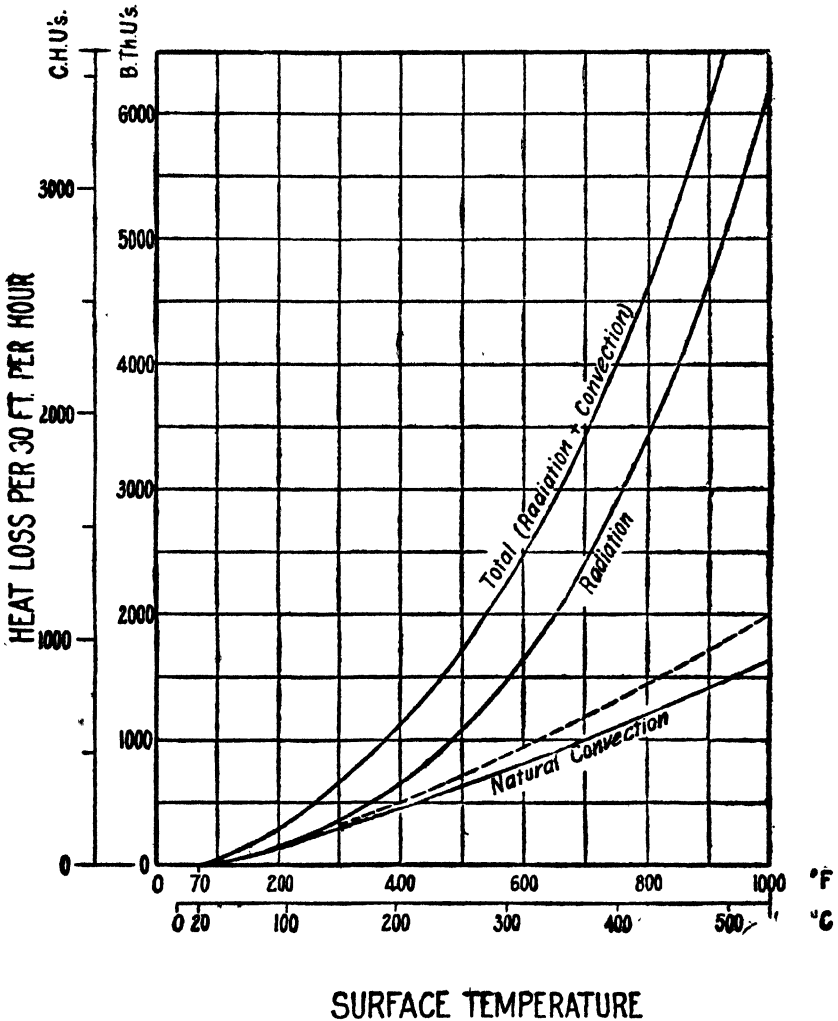

Fig. 31.—Heat Loss from a Hot Surface.

Example.—Suppose the wall temperature is 350° F. (175° C.) and the air temperature is 70° F. (20° C.). To find the rate of heat loss by convection :

Step 1.— $t_1 - t_2 = 350 - 70 = 280^\circ \text{F. (} 155^\circ \text{C.)}$.

Step 2.—From Plate I, Scale 5, $a_0 = 1.31$.

Step 3.—For the heat loss by convection alone,

$$q = 1.31 \times 280 = 370 \text{ B.Th.U.'s per sq. ft. per hr.}$$

$$= 1.31 \times 155 = 200 \text{ C.H.U.'s per sq. ft. per hr.}$$

At this moderate temperature, the equations having $\frac{1}{3}$ as exponent would give a convection loss of 400 B.Th.U.'s (225 C.H.U.'s). As the temperature rises, the discrepancy increases. When $t_1 - t_2$ is 600° F. (330° C.), the two formulæ give convection losses of 950 B.Th.U.'s and 1110 B.Th.U.'s (525 C.H.U.'s and 610 C.H.U.'s) respectively.

Abnormal surfaces.—The formulæ are for vertical plane surfaces where the rising air currents sweep evenly along the surface. In general, it will not be necessary to use these formulæ, because the normal loss by convection is incorporated in the "total" heat loss curve of Fig. 31 (see later).

For plane surfaces which are not vertical, the heat losses by convection are somewhat different. Mathematical analysis shows the balance of rather conflicting evidence to suggest that the heat loss by convection from a hot horizontal surface facing upwards is about $\frac{1}{3}$ greater than for a vertical surface; and from a horizontal surface facing downwards, about $\frac{1}{3}$ less than for a vertical surface. For horizontal or vertical cylindrical surfaces more than a few inches in diameter, such as gas mains, the heat loss per square foot is the same as for vertical plane surfaces. For smaller cylinders α_0 is larger, becoming very large for thin wires.

The effect of any baffle or obstruction to the free passage of air can only be estimated. For example, the pan of a ventilated furnace hearth is usually a horizontal surface. If it were freely ventilated the heat loss per square foot by convection should be $\frac{2}{3}$ of the normal heat loss for a vertical wall. In many cases, the steel structure supporting the pan and furnace binding offers considerable obstruction to air circulation, and in these cases the $\frac{2}{3}$ might be reduced to $\frac{1}{3}$ or less. In some cases the beams supporting the pan may actually increase the factor above $\frac{2}{3}$, as they may act like the radiating fins of a motorcycle cylinder.

For abnormal surfaces, Plate I again is used, making suitable allowance for the special conditions. For example, suppose the outer surface of the roof of a furnace is at a temperature of 550° F. (290° C.) and that the temperature of the surroundings is 70° F. (20° C.). The temperature difference, $t_1 - t_2$, is 480° F. (270° C.). For a vertical surface, Plate I, Scale 5, shows that the heat loss by convection alone per square foot per hour at this temperature difference would be 1.5 ($t_1 - t_2$) = 720 B.Th.U.'s (405 C.H.U.'s). The furnace roof approximates to a horizontal surface, so these figures may be increased by $\frac{1}{3}$, giving 960 B.Th.U.'s. (540 C.H.U.'s) per sq. ft. per hour. This correction should be used with discretion in cases where the furnace binding (above the level of the skewbacks) seriously interferes with free convection.

Convection loss from a wall is not affected by the presence of a second parallel wall, provided the latter is at least one inch away, each wall losing heat at its normal rate. If the walls are closer, then convection is impeded.

III.—RADIATION FROM SURFACES.

The heat that is felt when standing near a hot ingot, when there is no air current or draught blowing towards one, is an example of heat transfer by radiation. If there is a draught blowing from the ingot to the observer, the different sensation produced by the hot blast is unmistakable, and this would be an example of heat transfer by convection and by radiation simultaneously.

Radiation Laws.—The laws which are sufficiently accurate for solving most practical radiation problems are simple, though the calculations involved are occasionally rather tedious. Every object, at whatever temperature, radiates heat. The quantity of heat radiated per hour is expressed by the formula

$$q = C_1 A T^4$$

where A is the surface area (so long as the solid has no re-entrant angles) and T is the absolute temperature. Since C_1 is very small and T is large, it is convenient to divide T by 100 and to allow for this reduction by using a new constant C , thus,

$$q = CA \left(\frac{T}{100} \right)^4$$

If a solid of surface area A at absolute temperature T_1 is surrounded by a surface at absolute temperature T_2 , it will radiate to its surroundings $CA \left(\frac{T_1}{100} \right)^4$ heat units per hour, but it will at the same time receive and absorb from these surroundings $CA \left(\frac{T_2}{100} \right)^4$.

The net *loss* to the surroundings in the case where the body is the hotter will be

$$q = C \left[\left(\frac{T_1}{100} \right)^4 - \left(\frac{T_2}{100} \right)^4 \right] \text{ heat units per hour per sq. ft.,}$$

and the net *gain*, where the body is cooler, will be

$$q = C \left[\left(\frac{T_2}{100} \right)^4 - \left(\frac{T_1}{100} \right)^4 \right] \text{ heat units per hour per sq. ft.}$$

When both body and surroundings are at the same temperature, the interchanges of heat will be exactly equal and the net change will be zero.

T_1 , T_2 and the surface area are known for a particular problem. C varies, but can be estimated fairly closely for given conditions.

Black Body Radiation.—For a perfect radiator, known as a “black body,” C has its maximum value of 0.173 if the ° F. and B.Th.U. are used, or 1.01 for the ° C. and C.H.U. A rough blackened surface is practically a perfect radiator, hence the term “black body”; but other surfaces, although not necessarily black in colour, may approach black body radiating qualities. In an enclosed space at uniform temperature all surfaces conform to

black body conditions ; a furnace interior may approximate to these conditions.

Exposed refractory brick surfaces usually radiate about 0.7 to 0.9 of the heat which would be radiated by a black body at the same temperature. The exact figure varies according to the refractory, the actual temperature, etc. ; and moreover experimental determinations are not in entire agreement. 0.8 is probably a good average figure for brick furnace exteriors, this figure being called the Emissivity of the material.

The Emissivity of a surface is consequently the heat radiating quality of the surface expressed as a decimal of black body radiation. If we represent the emissivity by E , the equations for evaluation of heat transfer by radiation may be rewritten

$$q = 0.173E \left[\left(\frac{T_1}{100} \right)^4 - \left(\frac{T_2}{100} \right)^4 \right] \text{B.Th.U.'s per hour per sq. ft.} \quad (19a)$$

$$q = 1.01 E \left[\left(\frac{T_1}{100} \right)^4 - \left(\frac{T_2}{100} \right)^4 \right] \text{C.H.U.'s per hour per sq. ft.} \quad (19b)$$

Table XVI gives the emissivities of some important surfaces.

TABLE XVI.—EMISSIVITY.

	Emissivity, E .
Closed chambers at uniform temperature—all surfaces,	1.0
Iron and steelwork, oxidised (value increasing with roughness and degree of oxidation),	0.65-0.95
Average value for furnace binding,	0.85
Red brick,	0.9
Refractory brick,	0.75-0.8
Painted surfaces (any colour),	0.9-0.95
Aluminium paint,	0.55 (0.4-0.7)
Molten iron, with normal oxide film,	0.4
Polished metal surfaces,	About 0.05

The values given in the table may be taken as typical, but they increase with the roughness of the surface, and usually increase with temperature. (With the exception of the molten iron value, the figures are for atmospheric temperature.) The effect of colour is much smaller, even surfaces which are white at room temperatures being, contrary to what is sometimes believed, in many cases excellent radiators under furnace conditions.

Effective Surface Area.—For a surface having no re-entrant angles, the total area, whether plane or curved, is effective radiating surface. For a surface having re-entrant angles (*e.g.* many furnace structures and irregular shaped stock in an annealing furnace) the increased area due to the concavity must not be included in the total area. The projected area, that is the least surface which could be built across the concave portion, must be estimated in these cases. Actually, concavity of surface does to some extent increase radiation, because it has the effect of increasing the emissivity of the imaginary projected area, never of course above unity, which figure would imply perfect black body radiation.

The effect in this last connection is similar to the increased emissivity of a roughened surface. A rough surface has a large number of minute cavities and projections, thus increasing the total surface in relation to the "projected" or measured exterior surface.

Rapid Calculation of Radiation.—It will be noticed that, in Equations 19, the same emissivity constant, E , is used as a factor for the two terms $\left(\frac{T_1}{100}\right)^4$ and $\left(\frac{T_2}{100}\right)^4$ representing respectively the heat radiated from and absorbed by the body. This is permissible because, for practical purposes, the emissivity and the absorption coefficient of a given body are identical; which is only a more exact statement of the generalisation that good absorbers (*e.g.* rough matt surfaces) are also good radiators of heat, and that poor absorbers (*e.g.* highly polished surfaces) are also poor radiators. Fig. 32 is a nomogram for easy solution of radiation problems.

Example.—To find the rate of heat loss by radiation from a firebrick wall having an area of 100 sq. ft., the wall surface being at a temperature of 300° F. (150° C.) and the mean temperature of the surroundings being 70° F. (20° C.).

Step 1.—From Table XVI we find the emissivity of firebrick to be 0.8.

Step 2.—Stretching a fine thread from 0.8 on the emissivity scale in Fig. 32 through the 300° F. (150° C.) point, we find the heat radiated from the surface to be 450 B.Th.U.'s (250 C.H.U.'s) per sq. ft. per hour.

Step 3.—The surface also receives heat from the surroundings. The amount is obtained by stretching the thread from the same emissivity or absorption value (0.8) through the 70° F. (20° C.) point, and is found to be 110 B.Th.U.'s (60 C.H.U.'s) per sq. ft. per hour.

Step 4.—The net heat lost is obtained by subtracting the heat received from the heat lost

$$450 - 110 = 340 \text{ B.Th.U.'s (approx.) per square foot per hour.}$$

$$250 - 60 = 190 \text{ C.H.U.'s (approx.) per square foot per hour.}$$

Step 5.—Multiply the heat loss per square foot by the area.

$$340 \times 100 = 34,000 \text{ B.Th.U.'s per hour.}$$

$$190 \times 100 = 19,000 \text{ C.H.U.'s per hour.}$$

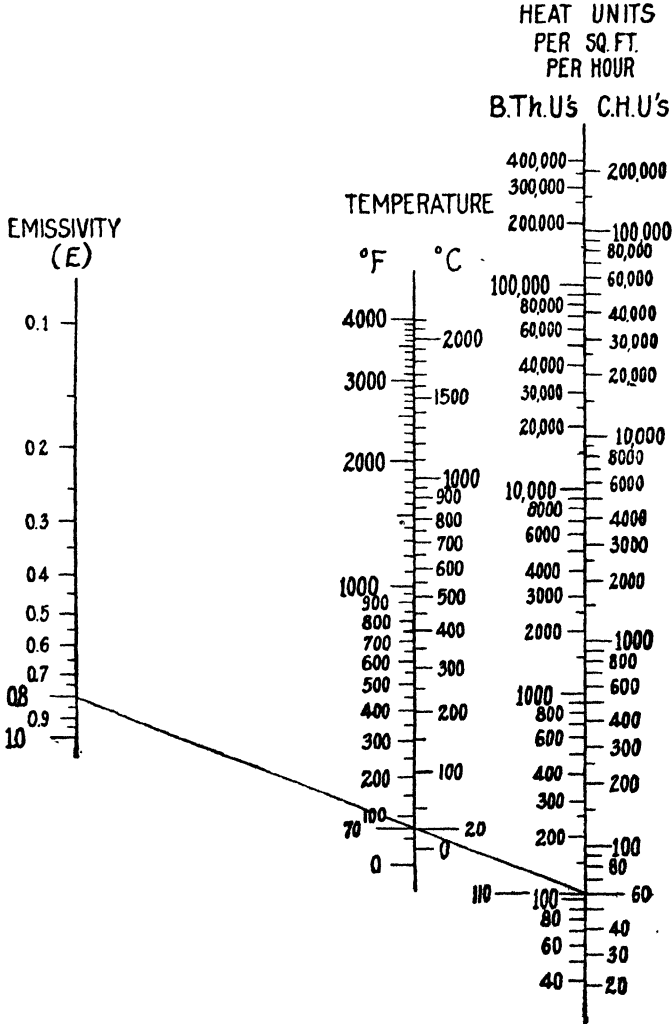

Fig. 32.—Radiation from Surfaces.

Radiation Coefficient.—As will be evident later, heat transfer calculations are greatly facilitated if we know the heat transfer coefficient, α_R , for radiation. The heat radiated per square foot

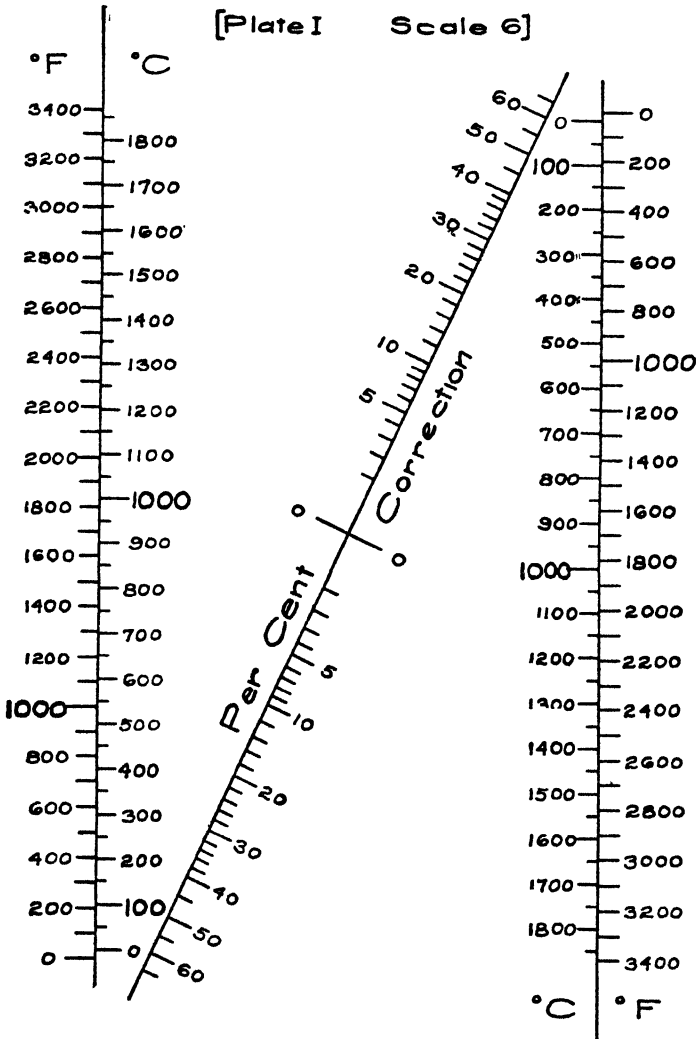

Fig. 33.—Correction Nomogram for Radiation Coefficient.

per hour is then the product of α_R and the temperature difference. Plate I, Scale 6, shows the value for α_R corresponding to the average of the temperatures of the heat exchanging surfaces. This scale,

which will be used more extensively than the nomogram given in Fig. 32, has the advantage of a more open scale, and hence greater reading accuracy. In constructing the scale, an emissivity of 0.8 was assumed. For higher or lower values of E , α_R may be increased or decreased proportionately.

Mathematically, this scale for evaluation of the radiation coefficient involves an approximation. If the temperatures of the radiating surfaces are widely different, α_R as read from Plate I will be too low. Where desirable, the per cent. correction read from Fig. 33 should be *added* to the approximate value for α_R . To read the nomogram (Fig. 33), pick out one temperature on each scale, join and read the per cent. correction to be *added* on the middle scale. The two temperature scales, and the upper and lower halves of the correction scale, may be used interchangeably.

A correction of only 5 per cent. or so is scarcely worth considering, and it will be found that in most cases the correction does not exceed this figure. When both temperatures are above 1800° F. (or 1000° C.) no correction is necessary. For radiation between an outer furnace wall and its surroundings, correction is usually unnecessary. When one surface is cold and the other hot, as in the case when cold material is charged into a hot furnace (even if the latter is below a red heat), correction is usually required.

Example.—To solve the preceding problem (page 231) by means of the radiation coefficient.

The average temperature is $\frac{300 + 70}{2} = 185^\circ \text{ F. (} 85^\circ \text{ C.)}$.

From Plate I, Scale 6, $\alpha_R = 1.5$. Fig. 33 shows that correction is unnecessary. Heat loss per square foot per hour

$$\begin{aligned} &= (300 - 70) \times 1.5 = 345 \text{ B.Th.U.'s} \\ &= (150 - 20) \times 1.5 = 195 \text{ C.H.U.'s} \end{aligned}$$

Applicability of Heat Radiation Laws.—The radiation law expressed by Equations 19 is applicable, with certain reservations, to a surface completely enclosed by another surface. It covers the most important cases of radiation, including :—

(1) Material being heated on a furnace hearth and filling the hearth—only the upper surface of the material is effective, this surface being completely enclosed by the walls and roof of the furnace.

(2) Material heated in a furnace from practically all sides. This occurs where the material is raised above the hearth, or where the object, heated on the hearth, has a small base in comparison with its total surface, such as a crucible or an ingot heated in a vertical position.

(3) Electric heating elements radiating to the furnace walls.

(4) Objects in the open, radiating heat to the surroundings.

It is important to note that in all cases the rate of heat transfer per square foot applies to the area of the enclosed (*i.e.* the smaller) surface. The heat transferred per square foot of the enclosing surface may be found by calculating the total heat exchange to the enclosed surface and dividing this by the area of the surrounding surface.

Effect of Size and Emissivity of Enclosing Surface.—It has been explained that when a body radiates heat freely to its surroundings (*e.g.* a hot billet in the open, or a furnace either inside or outside a building), radiation from the body depends on the emissivity of its surface. It was further explained that the body receives heat from its surroundings, depending also on its absorbing capacity (the same as its emissivity). In certain circumstances, the heat received from the surroundings may also depend on the emissivity of the surroundings themselves. In ordinary calculations it is unnecessary to take this into account, and radiation is in accordance with Equations 19, E being the emissivity of the hot body. This may be taken as accurate, provided either

- (a) that the surroundings are not too near the body—*i.e.* that the enclosing surface is large compared with the enclosed surface, or
- (b) that the surrounding surfaces themselves have a high emissivity.

In most cases of a body radiating heat freely to its surroundings *both* of these conditions apply.

In such cases further explanation is necessary concerning the "temperature of the surroundings," T_s . Usually the surroundings are not uniform in temperature, and it is necessary to take a mean value for T_s . This value is, strictly, the temperature which the body under investigation would assume, if left until it reached a steady temperature under the single influence of radiation from the surroundings. This cannot well be determined in practice, but it will be near enough to take the temperature as 70° F. (20° C.) for all normal conditions inside a building. Judgment may be used in modifying this temperature for surfaces exposed to other large near-by heated objects, or to cold outer walls during the winter.

When stock placed on a furnace hearth is heated by radiation from the walls and roof of the furnace, the enclosing surface may not be very large relative to the enclosed surface; for a furnace interior having an emissivity substantially below unity, this comparative smallness of the enclosing surface may, theoretically, demand adjustment according to special formulæ. However, the adjusted value will usually lie between

$$E = \frac{1}{\frac{1}{E_1} + \frac{A_1}{A_2} \left(\frac{1}{E_2} - 1 \right)} \quad \text{and a minimum value} \quad E = \frac{1}{\frac{1}{E_1} + \frac{1}{E_2} - 1}$$

where E is to be used in place of the emissivity of the enclosed surface, E_1 and A_1 are the true emissivity and the area of the enclosed surface, and E_2 and A_2 are the emissivity and the area of the enclosing surface. For example, if E_1 and E_2 are both 0.8 and

$A_1/A_2 = 0.5$, the first formula gives $E = \frac{1}{\frac{1}{0.8} + 0.5 \left(\frac{1}{0.8} - 1 \right)} = 0.73$, and the second

gives $E = \frac{1}{\frac{1}{0.8} + \frac{1}{0.8} - 1} = 0.67$. Taking into account increased emissivity at furnace

temperatures, a net value of 0.8 will prove satisfactory for almost all furnace conditions, so that the above special formulæ need not be used.

If two objects are enclosed by a surface, and if the objects and their enclosure are all at different temperatures, calculation of the rate of heat exchange between the objects is more complicated. For this and other special cases, see General Reference 2 at end of Chapter.

IV.—TOTAL HEAT LOSS FROM HOT SURFACES.

It has been shown that heat is lost from a hot surface in two entirely independent ways—by radiation and by natural convection. The total heat loss per square foot of wall surface is the sum of the two independent heat losses.

Expressing this mathematically, if t_1 is the surface temperature, and t_2 is the temperature of the air and surroundings (assumed to be the same),

$$q = 0.173E \left[\left(\frac{t_1 + 460}{100} \right)^4 - \left(\frac{t_2 + 460}{100} \right)^4 \right] + 0.32(t_1 - t_2)^{1.25} \text{ B.Th.U.'s per sq. ft. per hr.}$$

$$q = 1.01 E \left[\left(\frac{t_1 + 273}{100} \right)^4 - \left(\frac{t_2 + 273}{100} \right)^4 \right] + 0.37(t_1 - t_2)^{1.25} \text{ C.H.U.'s per sq. ft. per hr. ;}$$

t_1 and t_2 are known and it is necessary to select a value for E . With the aid of Fig. 32 and Plate I, Scale 5, the total heat loss per hour, q , may be calculated.

Using the scales given in Plate I, we may express the heat loss more simply by,

$$q = (\alpha_r + \alpha_c)(t_1 - t_2)$$

where α_r and α_c are the coefficients of radiation and of natural convection respectively.

It will be observed that the heat loss by radiation depends on the nature of the surface, but that the loss by natural convection may be considered independent of the surface. The convection loss is given for still air, such as normally obtains inside a building. For convection losses outside the building (*e.g.* chimney losses), wind very greatly increases the loss by convection, but does not affect loss by radiation. For example, the convection loss from the chimney would be two to three times greater in a 20 mile per hour wind than in still air, if the surface temperature remained the same. Actually, the coefficient of surface loss is only one of the factors determining heat loss from the chimney. The immediate effect of a wind would be to cool the chimney surface, tending to decrease the surface loss to a value which is not necessarily greatly in excess of that in still air. This tendency will be demonstrated later (p. 276).

Practical Calculation of Heat Loss from a Surface.—Even with the aid of the tables given, the calculation is a little cumbersome, and for all average conditions it will be entirely satisfactory to read off the total heat loss from Fig. 31, multiplying by the area of the surface in square feet. The curve is drawn on the assumptions that the temperature of the surroundings is 70° F. (20° C.), that the surface emissivity is 80 per cent. of the black body figure, and that normal convection losses occur.

The lower curves show the separate effects of convection and radiation under the assumed conditions. It will be observed that up to 200° F. (or 100° C.) convection and radiation losses from an

exposed surface are about equal in magnitude, but that at higher temperatures the proportion of radiation to convection becomes progressively greater. It follows that at high temperatures the effect of emissivity is more important, while abnormal convection conditions are of smaller importance. If, after bearing this last point in mind, it seems that actual conditions are too widely different from those assumed in Fig. 31, the more detailed calculation indicated above may be used. There are few cases where this is necessary. The broken line curve in Fig. 31 shows rate of heat loss by natural convection according to the $(t_1 - t_2)^{4/3}$ law, explained on p. 226.

V.—GAS RADIATION.

Until recently, this type of heat transfer has been largely ignored in practical calculations, owing to the imperfection of data available. That flames radiate heat is common experience. When one is standing near a flame, but out of the influence of heat radiated by hot solids or conveyed through convection by draughts, the heat thrown off by the flame can readily be felt and is in many cases intense. That some flames are better radiators than others has long been known, particularly by operators of reverberatory type furnaces. The good radiating power of producer gas rich in methane is well recognised by steel and glass makers. The early difficulties encountered in the use of by-product coke oven gas in open hearth furnaces were due to the low radiating power of the flame developed.

Again, it has long been known as a scientific fact that some gases radiate heat also at temperatures well below that of "flame"; but it is only recently that methods have been developed, by Schack, for practical application of the data. It is convenient to distinguish between two different types of gas radiation:—

(1) Heat radiated by solid particles of carbon suspended in the flame or hot gas. It is these particles of carbon, due to decomposition of hydrocarbons, which produce the luminous yellow flame usually desirable in hearth type furnaces. Radiation in this case is perhaps not true gas radiation, since the heat is thrown off by solid particles, but owing to the extreme smallness and discontinuity of the particles, the phenomenon is mainly governed by the laws of gas radiation explained below.

(2) Certain hot gases radiate heat even when no combustion is taking place. These gases include carbon dioxide, steam, the

hydrocarbons, carbon monoxide, sulphur dioxide, and other gases of no metallurgical importance. Carbon monoxide is, however, a relatively poor radiator. The gases hydrogen, oxygen, and nitrogen are, from a practical point of view, non-radiators. Experiments with gases consisting mainly of carbon monoxide have established that the heat radiated from the "non-luminous" flame (*i.e.*, a pale blue transparent flame, as distinct from yellow and more or less opaque flames) is due almost entirely to the radiating qualities of the carbon dioxide present in the products of combustion.

Laws Governing Gas Radiation.—Gas radiation could naturally take place from a hot gas body to a cooler gas body; but in practice it is necessary to consider only cases of heat transfer between a gas and a solid (or liquid). Such heat transfer is only in some respects similar to that between two solids.

The transfer is again an exchange of heat, the gas radiating heat to the solid and the solid also radiating heat, part of which is absorbed by the gas. The capacity of the gas for absorbing heat is governed by the same coefficient as that which determines its radiating power; from which it follows that those gases which do not radiate heat cannot absorb radiant heat; and that the best gaseous radiators are also the best heat absorbers.

When heat is exchanged between a gas and a solid, the solid radiates and absorbs heat according to the laws already explained. The heat radiated from the wall follows the CT^4 law, the constant incorporating the emissivity, E , of the surface. Of the heat striking the surface by radiation from the gas, the fraction E is absorbed, and the balance is reflected back from the surface.

To determine the net heat exchange between the solid and the gas, it is necessary to know, in addition, how much heat is radiated from the gas to the surface, and how much of the heat radiated from the surface can be absorbed by the gas.

The radiating and absorbing capacity of the gas body is affected, not only by the temperature, but also by additional factors which may be better understood from the following illustration (Fig. 34). The diagram represents two parallel walls extending perpendicular to the page. They are both at the same temperature t_1 , approximately conforming to the majority of cases where gas radiation occurs in practice. A gas at temperature t_2 , consisting of a mixture of radiating gases (*e.g.* carbon dioxide and steam) with non-radiating gases (*e.g.* oxygen and nitrogen) is passing between these walls. The molecules of radiating gas are indicated by small circles, it being understood that the principle only is here being illustrated,

and that in reality such molecules are extremely small, but on the other hand very numerous. The non-radiating gas molecules (nitrogen, oxygen, hydrogen) have not been shown because they take no direct part in either heat radiation or absorption.

Each radiating gas molecule will throw off heat, and the total heat radiated from the gas to the walls will evidently depend on a physical constant for the radiating gases at the temperature t_2 , and also on the actual number of molecules (as represented by the number of circles in the diagram).

The number of molecules opposite 1 sq. ft. of wall will depend, apart from temperature and pressure conditions, on the per cent. of radiating gas in the mixture, and the distance between the two walls. It has been indicated that the heat radiated by the gas depends on the number of molecules; but even this does not follow a simple rule, and double the distance between walls (or double the per cent. of radiant gas), although resulting in double the number of radiating molecules, will not result in exactly twice as much heat transferred to the walls. The doubled number of molecules will certainly radiate twice as much heat, but part of this extra heat will strike other radiating molecules. Much of the heat so intercepted will be absorbed by the molecules struck, part however being transmitted to reach the walls. Molecules of different radiating gases will also to some extent interfere one with the other.

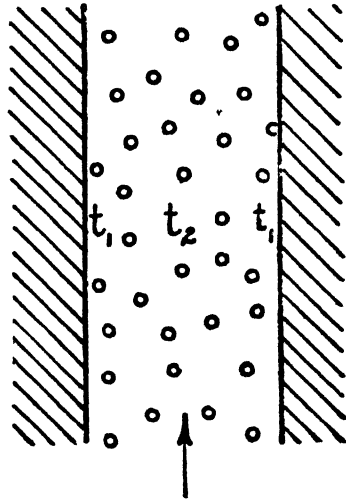

Fig. 34.

We may summarise the rather complicated heat exchange between 1 sq. ft. of wall and gas as follows:—

(1) The heat striking the walls from gas radiation depends on the temperature of the gas and on the nature and amount of radiating gas between the walls (the amount depending in turn on the per cent. of radiating gases in the mixture, the distance between the walls, and the pressure and temperature of the gas). The different factors may be incorporated in a single gas radiation constant for a given case.

(2) Of the heat radiated by the gases to the walls, only the fraction E (*emissivity*) is retained by the walls, the rest being reflected back.

(3) Simultaneously with the above transfer of heat from gas to walls, heat is radiated by the hot walls according to the usual laws of surface radiation.

(4) Owing to the relatively low absorption coefficient of gases, only a small part of this heat (3) is absorbed by the gas, the rest striking the opposite wall. Assuming the walls to be at the same temperature, the amount of heat which "gets through" will be the same in both directions, so that resultant wall-to-wall radiation is zero. The heat absorbed by the gases will be governed by the same factors as specified in (1), but with wall temperature substituted for gas temperature.

If the wall is at a higher temperature than the gas, the gas will receive more heat than it supplies to the wall. If the wall is at a lower temperature, the balance will be from gas to wall. If wall and gas are at the same temperature, the heat radiation in opposite directions exactly balances, so that there is no net gain or loss of temperature by either gas or wall.

Schack has developed in the form of a series of curves, a method for practical calculation of carbon dioxide and steam radiation over ranges covering industrial conditions. Fig. 35 is constructed from the data contained in Schack's curves.

In Fig. 35, the quantity DP is the diameter of the gas body (*i.e.* the distance between walls) multiplied by the actual per cent. of carbon dioxide or steam (taken separately) in the gas mixture. If the gas is under a pressure appreciably different from that of the atmosphere, the quantity $D \times P$ must be multiplied by the absolute pressure of the gas in atmospheres; t is the *average* temperature of the wall and gas. The coefficient of gas radiation $\alpha_{G.R.}$ is read from the nomogram, and the rate of heat transfer per square foot is given by the usual formula

$$q = a(t_1 - t_2)$$

For ducts which are not circular or square in cross section, the equivalent diameter

$$\frac{4 \times \text{Area}}{\text{Perimeter}}$$

gives satisfactory results.

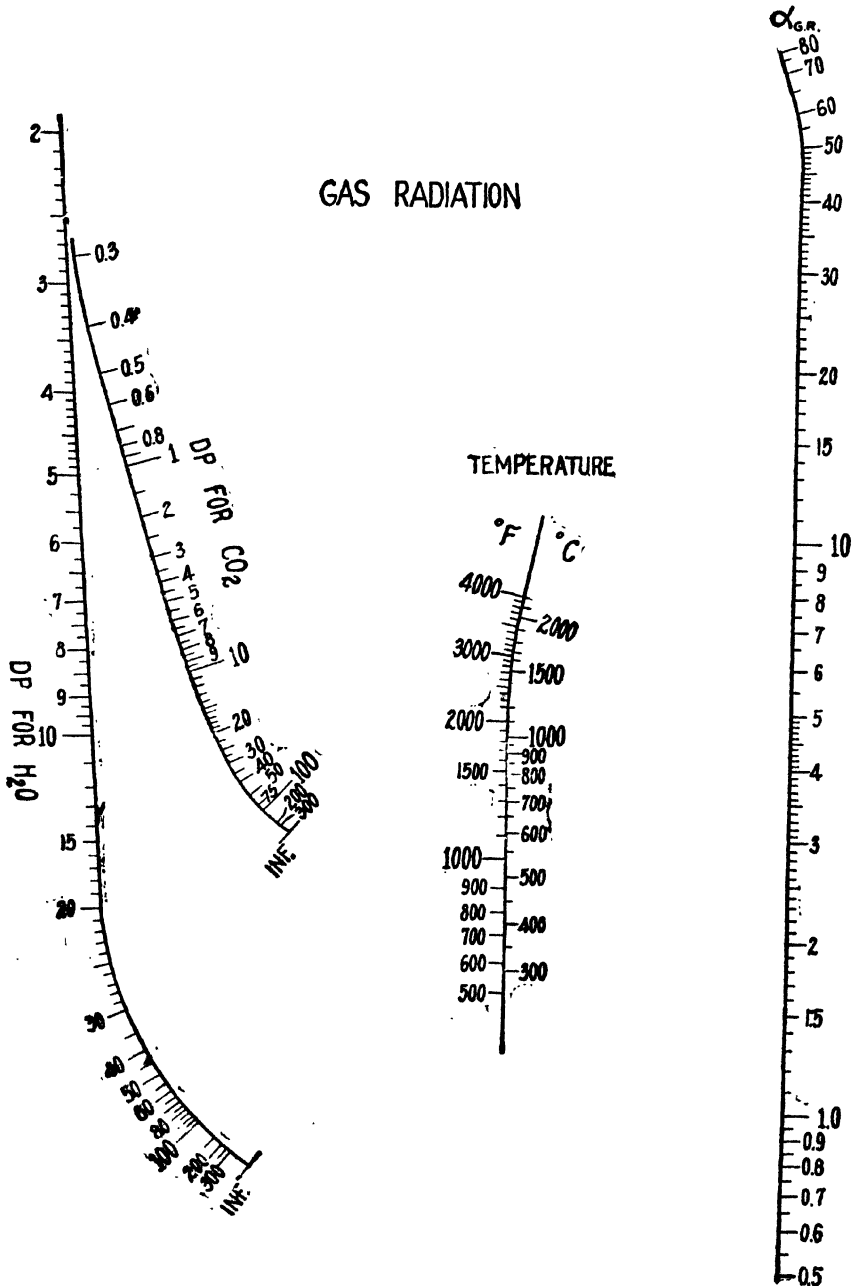

Fig. 35.—Gas Radiation.

$DP = (\text{Diameter in feet}) \times (\text{Per cent. of H}_2\text{O or CO}_2)$
 The value for $\alpha_{G.R.}$ must be multiplied by the emissivity of the walls.

Example.—Products of combustion containing 14 per cent. CO_2 and 6 per cent. H_2O are passing through a brick flue 4 ft. in diameter. The waste gas temperature is 2000°F . (1100°C .) and the wall temperature is 1650°F . (900°C .) Find the rate of heat transfer by gas radiation.

$$\begin{aligned}\text{Step 1.}— \text{ For } \text{CO}_2 \text{ } DP &= 4 \times 14 = 56 \\ \text{ For } \text{H}_2\text{O } DP &= 4 \times 6 = 24\end{aligned}$$

$$t = \text{average temperature} = \frac{2000 + 1650}{2} = 1825^\circ\text{F. (}1000^\circ\text{C.)}$$

Step 2.—Stretching a fine thread from 56 on the CO_2 curve through 1825°F . (1000°C .) on the temperature scale, we find a value for a of 6.0. For H_2O , $a = 8.3$. By addition, $a_{\text{G.R.}} = 14.3$.

Step 3.—The value of $a_{\text{G.R.}}$ (G.R. = gas radiation) as found in step 2 would give the radiation coefficient between the gas and a wall radiating as a perfect black body. Since ordinary surfaces radiate and absorb only the fraction E of the black body rate, a as obtained above must be multiplied by E for the brick flue. In the absence of experimental values of E for selective radiation (p. 245) the values given in Table XVI on p. 230 are used. E for brick being 0.8, the actual value of $a_{\text{G.R.}}$ in this example is

$$14.3 \times 0.8 = 11.4$$

Step 4.—If the rate of heat transfer by gas radiation alone is required, it is necessary only to multiply this value for $a_{\text{G.R.}}$ by the temperature difference between wall and gas. Thus

$$\begin{aligned}q &= a_{\text{G.R.}} (t_1 - t_2) \\ &= 11.4 (2000 - 1650) = 4000 \text{ B.Th.U.'s per sq. ft. per hr.} \\ &= 11.4 (1100 - 900) = 2300 \text{ C.H.U.'s per sq. ft. per hr.}\end{aligned}$$

Step 5.—To obtain the total radiant transfer per hour, multiply by the number of square feet of duct surface.

Effect of Pressure.—Imagining a case where the gas is at a pressure of 10 lbs. per sq. in. gauge pressure, then the absolute pressure is $\frac{14.7 + 10}{14.7} = 1.68$ atmospheres. In the above example $DP \times 1.68$ would have been 94 for CO_2 and 40 for H_2O , giving black body values for $a_{\text{G.R.}}$ of 6.4 and 12.5 respectively and actual radiation transfer of 5300 B.Th.U.'s (3000 C.H.U.'s) per sq. ft. per hour.

The effect of pressure may be worthy of consideration in connection with heat exchange in blast furnace stoves (referring to moisture in the air) and in water gas sets. Small pressure differences in ordinary furnaces and changes in barometric pressure are not worth considering.

In high temperature steam engineering (*i.e.* within the range of the nomogram) the effect of pressure should be considered in estimating the value of $a_{G.R.}$. However, the calculation of total heat loss from a steam pipe constitutes a specialised problem, and will not be considered in this book.

Basis of Gas Radiation Nomogram.—The curves given by Schack, for determining gas radiation, represent mathematical functions so complicated that they cannot truly be represented by a chart as simple as Fig. 35. The mathematical inaccuracy inherent in Fig. 35, however, is certainly not greater (and is probably far less) than the errors which would be involved in reading any but a large scale reproduction of Schack's curves. The greater reading accuracy attained in Fig. 35 is due to the substitution of the coefficient $a_{G.R.}$ for heat quantity q . This achieves slight simplification of the calculation (since in most cases $a_{G.R.}$ must in any case be found, as will be evident later), and permits greater compactness in presentation of the data.

Presentation in nomographic form is rendered permissible by the following considerations :—

1. Excepting at extremely high temperatures and at temperatures below 1200° F., the values of $a_{G.R.}$ for a particular DP value may be expressed very closely by a series of equations of the type $a_{G.R.} = k(t - 500)^n$. This permits construction of parallel logarithmic a and t scales for temperatures down to about 1200° F.

2. The DP scales are then drawn by trial, using known values of a and t .

3. Local distortions of the t scale afford correction for low temperature and very high temperature deviation from the power law assumed.

4. Distortion of the upper range of the a scale provides further correction, necessary in the case of high DP values for water vapour used in conjunction with high temperatures.

5. The value of n in the above equation does not differ widely from unity. The extreme values of n are approximately 0.8 (for $DP_{CO_2} = 0.2$ and $DP_{H_2O} = 2$) and 1.2 (for $DP_{CO_2} = \text{infinity}$). This closeness to unity permits us, in calculating the heat exchange for two widely different temperatures, to use the mean temperature $\frac{t_1 + t_2}{2}$ in determining $a_{G.R.}$

Over an extreme temperature range, very slight increase of accuracy is obtained by dividing the range into two equal parts, determining the values for $a_{G.R.}$ for these two half ranges, and taking the average value.

Example.— $DP_{H_2O} = 20$. Temperatures 3500° F. and 100° F. The mid-point of this range is 1800° F. The mid-points of the half ranges, 100–1800° F. and 1800–3500° F. (*i.e.* the quarter points of the entire range) are 950° F. and 2650° F. respectively. From the nomogram, for $DP_{H_2O} = 20$, we find

$$\begin{aligned} a_{950^\circ \text{F.}} &= 3 \\ a_{2650^\circ \text{F.}} &= 11.3 \\ a_{\text{Average}} &= \frac{3 + 11.3}{2} = 7.15 \end{aligned}$$

Direct reading of a for the mid-point gives 7.2. By similar calculation for DP_{CO_2} = infinity, we find, for the same temperature range, a by the quarter point method equals 7.7 against 7.4 for the mid-point method. The theoretically better method of subdividing the range therefore offers no real advantage.

Careful investigation over the entire range of the nomogram has confirmed the conclusion that a single reading for a , at the average temperature of a range, yields excellent results, even for temperatures which are widely separated.

There are two very important applications of Schack's radiation data :—

(1) Heat transfer from a non-luminous flame and from burnt gases in direct-fired furnaces.

(2) Heat exchange by gas radiation in regenerators and recuperators.

The second application is explained in Chapter VII. The first is only an extension of the example for determining heat transfer in a flue.

Example.—A refining furnace is 40 ft. long, 15 ft. wide and the average height above the slag line is 5 ft. During refining, the bath and furnace walls are at an average temperature of 2500° F. (1370° C.). The flame (which is non-luminous) and the products of combustion have an average temperature of 2900° F. (or 1600° C.); the gases contain 14 per cent. CO₂ and 6 per cent. H₂O.

The equivalent diameter of the furnace is

$$\frac{4 \times (\text{Area of Cross Section})}{(\text{Perimeter of Cross Section})} = \frac{4 \times 15 \times 5}{2(15 + 5)} = 7.5 \text{ ft.}$$

$$DP_{CO_2} = 7.5 \times 14 = 105 \quad DP_{H_2O} = 7.5 \times 6 = 45.$$

Average temperature = 2700° F. (1485° C.).

From Fig. 35, $\alpha_{G.R.}$ (for a black body) = 11.3 + 21.3 = 32.6.

Assuming a wall and bath emissivity of 0.8, $\alpha_{G.R.} = 26$.

For the heat transferred to the furnace per hour by gas radiation,

$$\begin{aligned} q &= \alpha_{G.R.} A(t_2 - t_1) \\ &= 26 \times 1600 \times (2900 - 2500) \\ &= 16,600,000 \text{ B.Th.U.'s} \\ &\quad (9,600,000 \text{ C.H.U.'s}). \end{aligned}$$

Additive Effect of Gas Radiation Coefficients.—It has been mentioned that radiation from the numerous minute particles of solid carbon, suspended in a luminous yellow flame, is governed by laws similar to those determining true gas radiation.

It is desirable, however, to make certain distinctions between true gas radiation and solid particle radiation. Radiant heat is made up of waves of different length. A black body can radiate and absorb all wavelengths perfectly. Solid surfaces which are not black bodies, radiate and absorb imperfectly, but usually without any very marked discrimination over a wide range of wavelengths. The gases (carbon dioxide, water vapour, etc.), on the other hand, are definitely selective in their absorbing and radiating capacity. That is, they can absorb heat radiation corresponding to certain relatively narrow ranges of wavelength only, and even though the layer of gas were of great thickness, it could not absorb or radiate appreciably heat of other wavelengths. This explains why, for finite layers, gas radiation can never even approach the intensity of black body radiation for the corresponding temperature.

Fig. 36 shows the wavelength distribution for black body radiation corresponding to temperatures of 1830° F. and 2190° F. The heat energy radiated by a black body at these temperatures is seen to include wavelengths from 0 to 20 microns.¹ The amount of heat energy corresponding to, for example, the wavelength range from 5 to 6 microns, is represented by the area bounded at the sides by the verticals through 5 and 6, and at the top and bottom by the temperature curve and base line respectively. The total heat energy radiated at a given temperature is represented by the total area lying under the corresponding temperature curve. The diagram shows that, at the temperatures given, there is greater intensity of radiation at wavelengths of about 2 microns than at other wavelengths. The energy corresponding to visible light radiation (wavelengths under 0.8 micron) is seen from the diagram to be a negligible factor in heat radiation at these temperatures, the area lying almost entirely in the infra-red region of the spectrum.

The three shaded bands in Fig. 36 show the wavelength ranges which can be emitted or absorbed by carbon dioxide. The boundaries of these absorbing bands are not very clearly defined, and absorption at the edges may be feeble. For gas bodies of moderate thickness, the feebly radiating wavelengths are unimportant, and have therefore been ignored by Schack in calculating the radiation constants for carbon dioxide; for abnormally great thicknesses, these wavelengths become important. In this connection, it may be mentioned that in the gas radiation nomogram, Fig. 35, the carbon

¹ The micron, μ , is a unit of length equal to one thousandth part of a millimetre or 0.0003937 inch.

dioxide point for infinite thickness has been located, for the sake of consistency, without taking into account the feebly radiating bands. Actually, the feebly radiating wavelengths, negligible in finite layers, should for infinite thickness double or treble the

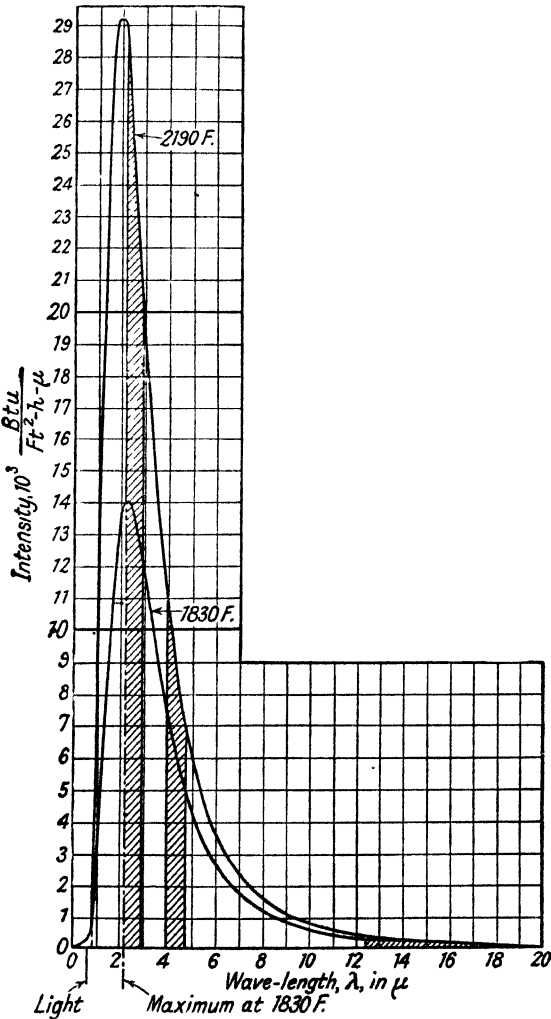

Fig. 36.—*Intensity of Radiation as a Function of Wavelength for a Black Body at 1830° and 2190° F.

* Reprinted by permission from "Industrial Heat Transfer," by Schack, Goldschmidt and Partridge, published by John Wiley and Sons, Inc.

gas radiation accounted for by the strongly radiant wavelengths. In fact, if all wavelengths were capable of radiating, although so feebly as to defy detection in finite layers, an infinitely thick layer would radiate like a black body. The values for infinite thickness have, however, no practical significance, and the discrepancy is therefore of no importance.

It happens that there is only slight overlapping of the wavelength ranges which carbon dioxide and water vapour can absorb, that is, each gas is capable of absorbing and radiating heat waves to which the other is, in the main, transparent. It is for this reason that we are able to add directly α_{CO_2} and $\alpha_{\text{H}_2\text{O}}$ as obtained from Fig. 35. This also contributes to the general effect, that for a given total value of DP (thickness of gas stream times per cent. of radiant gas), the maximum radiation will nearly always be obtained when both gases are present.

Example.—In illustration of the effect of varying proportions of carbon dioxide and water vapour in a non-luminous flame, suppose the combined total of these gases is 20 per cent. and that the gas layer is 5 feet thick. In Fig. 37 has been plotted the total value of α for gas radiation (from Fig. 35) for different proportions of carbon dioxide and water vapour to give a total of 20 per cent. The curves show the results for temperatures of 2000° F. and 3000° F. In this particular example, it is seen that, starting with 20 per cent. of CO_2 , the replacement of 4 per cent. of CO_2 by H_2O results in doubling the heat transfer; a mixture of 10 per cent. CO_2 and 10 per cent. H_2O radiates as effectively as 20 per cent. H_2O alone; the maximum rate of radiation occurs with 14.19 per cent. H_2O and 1.6 per cent. CO_2 .

The nomogram shows that, excepting for low values of DP (under 7), steam is always a better radiator than carbon dioxide. This is particularly true at higher temperatures. These conclusions are, however, subject to the accuracy of the experimental data on which Schack's curves are based.

Luminous Flames.—Mathematical determination of the radiation coefficient of luminous flames presents a formidable problem owing to the difficulty of evaluating the degree of luminosity. Moreover, as the carbon particles become smaller and fewer in number due to oxidation, the luminosity of the flame decreases towards the flue end of the furnace. Again, for a non-luminous flame, all "dead" spaces in the furnace, out of the main gas stream, may be assumed to be filled with products of combustion. Consequently the total thickness of the gas layer (with a temperature adjustment on account

of the cooler dead gas) is effective in determining gas radiation. Where the flame is luminous, the actual thickness of the luminous main gas stream would have to be estimated—gas not in the main stream is likely to be non-luminous on account of the longer time available for consumption of solid carbon particles. Because of the difficulties in the way of mathematical treatment, only general

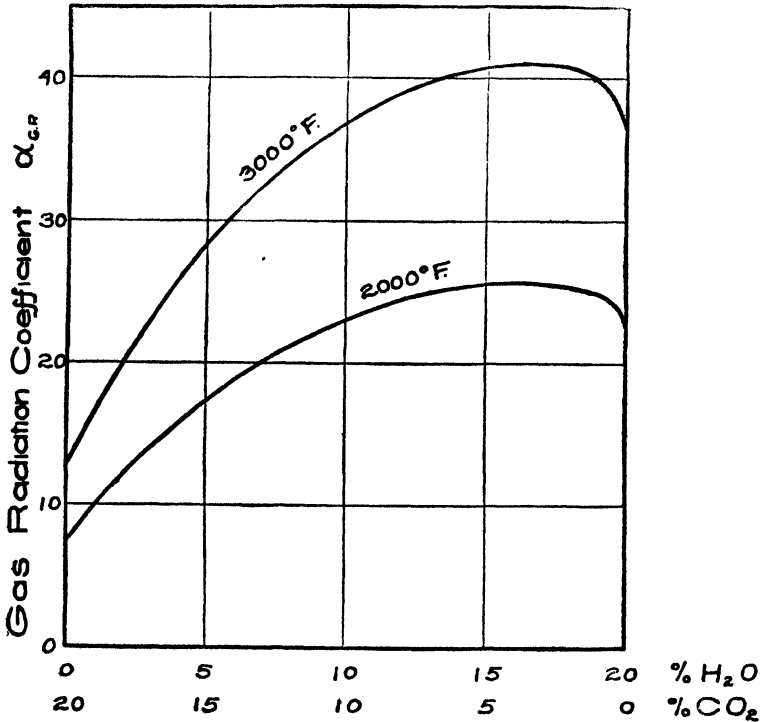

Fig. 37.

principles will be discussed in this study of heat transfer from luminous flames.

It is a little simpler to discuss the mechanism of heat absorption by a cloud of minute particles, than to discuss radiation from the particles. Then, we know that whatever laws are found for absorption must apply equally to radiation. If a thin flake or thread of glassy slag is held up to the light, it is seen to be transparent. Usually this transparency is selective, permitting, for example, green light to pass through freely, but to some extent stopping (*i.e.* absorbing) other colours. In the same way, because of the

extreme smallness of the carbon particles suspended in a flame, a single particle is largely transparent to heat which strikes it, only a small portion of the heat being absorbed. As in the case of the slag sliver, the absorption is selective to the extent that some wavelengths pass more freely through the particle than others. All wavelengths, however, suffer partial absorption; in this, the carbon particles differ from carbon dioxide and water vapour, which are perfectly transparent to some wavelengths.

If a thicker piece of slag (equivalent to a number of thin flakes) is held to the light, it is found to be translucent only, even wavelengths which appeared to pass freely through a single flake now being largely suppressed (absorbed). Finally, a very thick piece is practically opaque to all wavelengths, and hence without selective properties. Similarly, the quantity of heat which has passed through the first particle of carbon will suffer progressive absorption as it passes through successive particles, until, given a sufficient density and depth of flame, practically all of the heat which struck the first line particles will have been absorbed. It follows that a thick flame is non-selective and will be a perfect absorber of heat. Consequently it is also a perfect radiator, and should radiate like a true black body surface.

In furnace practice, the thickness of the luminous flame is restricted, and moreover it is not possible to maintain a highly luminous flame over the entire area of the hearth. Consequently, in the first place, the radiation intensity of the flame must always fall short of black body intensity, and in the second place the heat received by the hearth is a function of the relative size of the flame. It may be concluded, therefore, that the heat received by the hearth from a luminous flame never even approaches the heat which would be received from a black body surface equal in area and parallel to the hearth, and at the same temperature as the flame. Whether, in normal practice, flame radiation can approach black body rate even locally appears doubtful. It is possible that, for a very large and highly luminous flame, the mean radiating power over the entire hearth might be as high as 40 per cent. of the black body value, and locally the value might be still higher. If the emissivity of the furnace walls and stock is 0.8, then 40 per cent. of the value read from Plate I, Scale 6, could be used for the radiation coefficient, the average temperature of the furnace and flame being used—use of more complicated formulæ is not warranted unless the flame emissivity can be determined with fair accuracy. For a smaller or less luminous flame, a value may be selected intermediate

between this maximum value and the value for clear gas radiation. It must be remembered that for a given fuel, a luminous flame usually means imperfect or delayed combustion, resulting in a lower flame temperature, and therefore partially offsetting the effect of solid particle radiation. A limit will be reached beyond which further imperfection of combustion is detrimental to flame radiation.

If a practical method should be developed for estimating intensity of luminosity, and if this should be applied for calculating carbon particle radiation, then the carbon dioxide and water vapour radiation would probably be disregarded in the calculation. The wavelengths selectively absorbed by water vapour and carbon dioxide are also absorbed (non-selectively) by carbon particles. The two effects cannot therefore be added directly, and allowance for the combined effect would be a little too complicated to be practical. For faintly luminous flames it might be necessary to calculate the combined effect.

Direct Measurement of Flame Radiation.—It would seem possible to make a direct measurement in some cases of luminous flame radiation. A radiation pyrometer measures the total heat radiated from a flame or surface. It is calibrated to read temperature directly, when the radiating body is "black," according to the T^4 law. Therefore, if a temperature reading of t° (F. or C.) is obtained by focussing the instrument on to a radiating body, the total heat reaching one square foot of receiving surface is the same as would have been received from a black body of the same dimensions at a temperature t . The apparent temperature t_1 of the flame and roof may be obtained by sighting the total radiation pyrometer through the flame towards the hot roof so that the pyrometer and the hearth "see" the flame and hot refractory as closely as possible under identical conditions. The apparent temperature t_2 of the stock on the hearth may be obtained in the same way, this time sighting the pyrometer on to the stock in such a way that it receives as little as possible of the direct heat from the flame and hot gas. The heat exchange by radiation may be calculated from the temperatures t_1 and t_2 , assuming perfect emissivity at these apparent temperatures. This suggested method has not been subjected to experimental verification. It should be noted that the suggestion applies only to true radiation pyrometers, which are non-selective. Optical pyrometers cannot be directly applied, because they are highly selective, measuring the intensity of certain wavelengths only.

A very interesting method of determining both flame

temperature and rate of flame radiation is described in General Reference 2 at the end of this Chapter. This method depends on measuring the flame temperature with two optical pyrometers sensitive to light of different wavelengths, and interpreting the readings by means of curves. In this method it is necessary to see that the instrument receives no additional radiation from hot surfaces. If a flame is so thick and dense that the back wall is not visible, it is probable that visible light waves from the back wall are completely absorbed by the flame. This cannot be considered certain, because our eyes may be deceived by the glare of the flame; but even if no light waves are able to penetrate the flame from the back wall, it would be quite wrong to conclude that none of the longer heat waves get through. If it is possible to sight the pyrometer through the flame on to an opening in the back wall, a true reading will be obtained. Sighting towards a water cooled element might be fairly satisfactory, provided its emissivity was high (to minimise the effect of reflection).

Effect of Dust and Slag Particles.—In principle, these should act in a similar way to carbon particles. In practice, the number of particles is relatively small and the emissivity is lower. Dust radiation may therefore be ignored.

VI.—GENERAL CASE OF HEAT FLOW.

The four types of heat transfer have been described separately, but in practice two or more types of transfer usually occur together. For example, in a combustion chamber, heat is transferred to the inner face of the wall by forced convection and by gas and flame radiation. It is then carried through the wall to the outer surface by conduction. From the outer surface, heat is lost to the surroundings partly by radiation and partly by natural convection.

The following illustration is intended to show how to combine, mathematically, the various data presented in this chapter. The illustration also affords a valuable comparison of the relative importance of the different types of heat transfer. However, the method is not suitable for general use. In the next chapter will be developed a simple and almost equally accurate method, divested of all theoretical considerations, for practical solution of this and similar problems.

Example.—*To find the heat loss from the downtakes of an open hearth furnace.*—Fig. 38 represents a slice, 1 ft. high, cut from one

of the two waste gas downtakes (*i.e.* flues) carrying 5,000 normal cu. ft. of waste gas per minute at an average temperature of 2650° F. (1455° C.). The waste gas contains 14 per cent. CO₂ and 6 per cent. H₂O. From this information we will estimate the total heat loss from the downtakes.

In Fig. 38, the downtake is shown to have three exterior faces, while the fourth face is adjacent to an equally hot portion of the furnace and therefore suffers no heat loss. This is adjudged to be an average condition for the downtakes in this type of furnace.

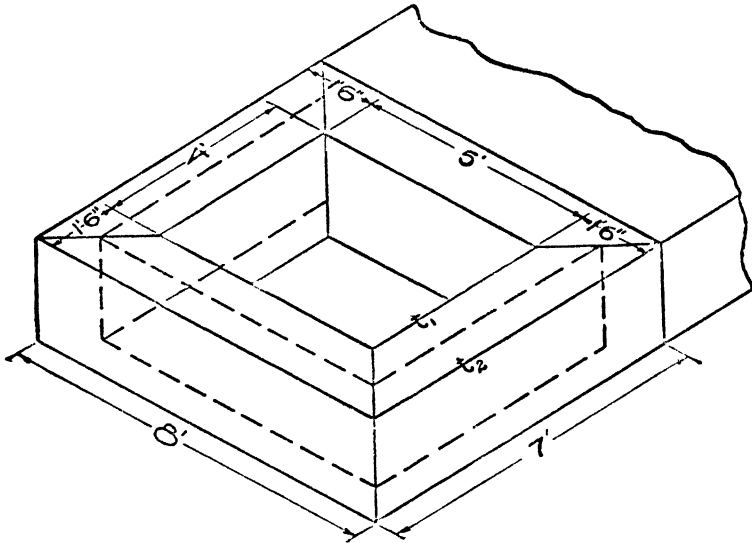

Fig. 38.

In the course of this calculation, a number of assumptions must be made, as the solution depends partly on a method of trial and error. These assumptions are numbered, and their accuracy is subsequently investigated.

Forced Convection.—To obtain the heat transfer by forced convection from gas stream to wall, we must find the normal velocity of the waste gas and the equivalent circular diameter of the rectangular duct. The normal velocity is the quotient of the normal volume flowing in cubic feet per second ($\frac{5000}{60} = 83.3$ cu. ft. per sec.) divided by the area of cross section of the duct (20 sq. ft.). The normal velocity is therefore 4.2 ft. per

sec. The equivalent circular diameter of the downtake is

$$\frac{4 \times \text{Area}}{\text{Perimeter}} = \frac{4 \times 20}{18} = 4.4 \text{ ft.}$$

The regular scale of Fig. 29 indicates a coefficient of forced convection of 0.67. Since this value is under 1.5, the subsidiary scale of Fig. 29 is used (see p. 223), giving the more probable value for α_C of 1.2 to 1.3; 1.2 is used in this calculation.

Gas Radiation.—The values DP for CO_2 and H_2O are $4.4 \times 14 = 61.6$ and $4.4 \times 6 = 26.4$ respectively. To determine the coefficient of gas radiation, as a first approximation the temperature of the inner face of the wall must be estimated. In view of the evidently high rate of gas radiation at these DP values (see Fig. 35), it would be a reasonable guess that the wall temperature is only 50°F. (28°C.) lower than the gas temperature. This gives an average gas-wall temperature of 2625°F. (1440°C.). For this temperature Fig. 35 shows $\alpha_{\text{CO}_2} = 10$ and $\alpha_{\text{H}_2\text{O}} = 14$. The total, $\alpha_{\text{G.R.}} = 24$. For a brick emissivity = 0.8, $\alpha_{\text{G.R.}} = 19.2$.

Total Rate of Heat Transfer from Gas to Wall.—The rate of heat transfer per square foot of wall per hour is given by

$$20.4 (2650 - t_1) \text{ B.Th.U.'s or } 20.4 (1455 - t_1) \text{ C.H.U.'s,}$$

the 20.4 being the sum of α_C and $\alpha_{\text{G.R.}}$ and t_1 being the inner temperature of the wall.

It is now necessary to determine what area, per foot of height, is effective in receiving heat from the gas for transmission to the outer face. Owing to the flow of heat, the inner faces of the three exposed walls will be cooler than the hot gas stream, and the heat received by convection and gas radiation is proportional to the difference in temperature. So far as the fourth wall is concerned, it is evident that there can be no appreciable heat flow, and there is therefore a tendency for this wall to reach the same temperature as the hot gas stream. This would result in one wall being hotter than the other three, and there would then be an exchange of heat by radiation. Now surface radiation is ordinarily much more rapid than either convection or gas radiation, and this leads us to our first assumption.

Assumption 1.—All four interior walls are at the same temperature, t_1 , they all receive heat by convection and gas radiation, and the wall which does not transmit heat radiates all heat received by it to the transmitting walls. The effective heat receiving area is therefore 18 sq. ft. per foot of height.

The rate of heat transfer from waste gases to wall per hour, for one foot of height, is given by

$$q = 20.4 \times 18(2650 - t_1) = 370(2650 - t_1)$$

$$= \frac{2650 - t_1}{\frac{1}{370}} = \frac{2650 - t_1}{0.003} \text{ B.Th.U.'s}$$

or $q = 20.4 \times 18(1455 - t_1) = \frac{1455 - t_1}{0.003} \text{ C.H.U.'s.}$

The final inverted form is used with the object of subsequently eliminating t_1 .

Conduction.—We need to know the coefficient of conductivity of the brick, and since this is to some extent dependent on the brick temperature, we must again use our preliminary guess at the inner temperature, t_1 , and must also assume an outer temperature t_2 . If the outer temperature is assumed to be 300° F. (150° C.), the average temperature of the brick will be 1450° F. (790° C.). If the downtakes are made of silica brick, Fig. 26 shows the coefficient of conductivity to be 12.7, which is *assumption* 2. The mean conducting area (*i.e.* the average of the inner and outer faces of the conducting walls) is that shown by the broken lines. This is $2(4 + 1\frac{1}{2}) + (5 + 1\frac{1}{2}) = 17\frac{1}{2}$ sq. ft. per ft. of height. The thickness of the wall is 18 inches.

For conduction, therefore,

$$q = \frac{12.7 \times 17\frac{1}{2}(t_1 - t_2)}{18} = \frac{t_1 - t_2}{\frac{18}{12.7 \times 17\frac{1}{2}}} = \frac{t_1 - t_2}{0.081} \text{ B.Th.U.'s or C.H.U.'s.}$$

Combined Surface Transfer and Conduction.—We now have two separate equations for the same heat flow q , one for surface transfer from gas to wall and one for conduction. Both of these contain t_1 , and by adding numerators and denominators we eliminate t_1 , and obtain

$$q = \frac{2650 - t_2}{0.003 + 0.081} \text{ or } 12(2650 - t_2) \text{ B.Th.U.'s}$$

$$q = \frac{1455 - t_2}{0.003 + 0.081} \text{ or } 12(1455 - t_2) \text{ C.H.U.'s.}$$

Subsequent treatment depends on circumstances. If t_2 is obtained by actual measurement, q may be found directly. If

t_2 may be guessed fairly closely, the same procedure may be followed. If, for example, t_2 is about 300° F. (150° C.) then q is $12(2650 - 300) = 28,200$ B.Th.U.'s (15,600 C.H.U.'s). Usually, this would be quite close enough, and an error of 100° F. (55° C.) in estimating the surface temperature involves only a little over 4 per cent. error in the calculated result. If it is desired to calculate fully, we must find t_2 , making use of the surface loss values.

Surface Losses.—The heat flow, q , must be expressed in terms of the heat lost from the outer surfaces. The total outer area per foot of downtake is $(2 \times 7) + 8 = 22$ sq. ft. The heat loss per square foot by radiation and natural convection may be found for any assumed value of t_2 from Fig. 31. This loss multiplied by the 22 sq. ft. will give the total surface loss per foot of downtake.

Over-all Heat Flow.—The surface heat loss must equal the heat loss, q , as given by the expression for combined forced convection and gas radiation inside the downtake and conduction through the wall. There is only one value of t_2 which satisfies this condition, and there is no direct method of finding it. We must adopt a trial method, trying different values of t_2 until approximately the same values are obtained for q by the two expressions.

Great accuracy is never required in calculations of this type— in fact the available data are not sufficiently dependable to warrant any attempt at accuracy. This being so, the problem is solved with very little trouble by tabulating as follows :—

1 Value tried for t_2 .	2 Total surface loss per sq. ft. (Fig. 31).	3 Surface loss per ft. of downtake (Col. 2 \times 22).	4 Heat transfer by forced convection, gas radiation and conduction. $12(2650 - t_2)$.
300° F., . . .	650	14,300	28,200
400° F., . . .	1100	24,200	27,000
500° F., . . .	1700	37,400	25,800

Column 3 is seen to increase with the temperature t_2 , while column 4 decreases. Somewhere between 400° F. and 500° F. the two values must be the same. To estimate the true value of q , column 4 is used on account of the far more gradual change of values :— q must be about 26,500 B.Th.U.'s per hour.

A closer approximation may be made by trying intermediate temperatures ; or far simpler, by plotting the values for 400° and 500° F. on squared paper as shown in Fig. 39. The two surface loss points (column 3) are joined by a straight line, and also the two

points obtained from column 4. The point of intersection gives approximately the temperature $t_2 = 420^\circ \text{F.}$ and the heat transfer as 26,800 B.Th.U.'s per hr. per ft. of height. The equivalent centigrade figures are 215°C. and 14,900 C.H.U.'s per ft.

Check on Assumption 1.—We will first find t_1 , the inner wall temperature. Using the Fahrenheit units, and writing 26,800 for q , the formula for heat transfer from waste gas to wall gives

$$26,800 = 20.4 \times 18(2650 - t_1)$$

$$t_1 = 2580^\circ \text{F.}$$

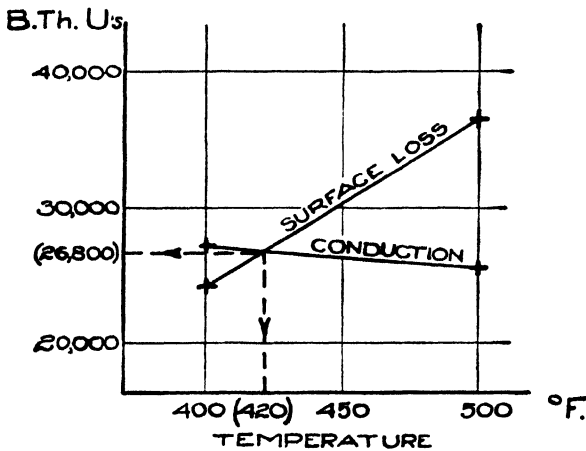

Fig. 39.

Of the 26,800 B.Th.U.'s transferred from the gases, it has been assumed that the internal wall receives its full share, *i.e.* $26,800 \div 18 = 1490$ B.Th.U.'s. per sq. ft. This supposes that its temperature is also 2580°F. , and it is now necessary to find what its temperature must be in order to radiate this quantity of heat to the other three walls. Plate 1, Scale 6, shows that at a temperature of 2580°F. , α for surface radiation is 155. In order to radiate 1490 B.Th.U.'s per sq. ft., the temperature difference between the internal and the exposed walls would have to be $\frac{1490}{155} = 9.6^\circ \text{F.}$ or just a little

more, because some of the radiated heat would be absorbed by the carbon dioxide and steam of the waste gases. Since the three exposed walls have been found to be 70°F. cooler than the waste gases, the interior wall will be only 60°F. cooler than the waste

It will consequently receive less heat from the gases and

will therefore be only about 80 per cent. effective in passing heat to the other walls. If convection had been the only cause of heat transfer, as in an air duct, there would have been a big temperature drop from air to walls, and the fourth wall would have been practically 100 per cent. effective.

In the present instance, the incorrectness of Assumption 1 is quite immaterial, because to accommodate themselves to the additional heat received from the hotter wall, the inner temperature t_1 of the exposed walls will need to drop only 6 or 7° F.

Check on Assumption 2.—The inner and outer wall temperatures are now established as being around 2580° F. and 420° F. respectively. At the average temperature of 1500° F., the coefficient of conductivity is found to be 12.8 instead of the 12.7 assumed. Recalculation on this account is certainly not necessary.

Total Heat Loss from Downtakes.—The heat loss per foot of height may be taken as 27,000 B.Th.U.'s (15,000 C.H.U.'s). Further refinements of calculation would be useless in view of the large probable errors in the data used. It should, however, be noted that this example, chosen as a rather more than ordinarily complicated case, assumes conditions of steady heat flow. This is not actually the case, because the waste gas in this type of furnace passes through the downtake intermittently. The calculation being here treated only as an example, correction for this is not given, as it would involve extension of the calculation to determine the conditions existing during the intervals when there is no flow of waste gas through the downtake.

If each of the two downtakes is 22 ft. long, the total heat loss is $27,000 \times 22 \times 2 = 1,200,000$ B.Th.U.'s (660,000 C.H.U.'s) per hour.

Fall of Temperature of Waste Gas.—At a flow of 10,000 normal cu. ft. per min., the heat loss is equal to $\frac{1,200,000}{10,000 \times 60} = 2$ B.Th.U.'s

(1.1 C.H.U.'s) per cu. ft. of gas. For waste gas containing 14 per cent. CO₂, 6 per cent. H₂O and 80 per cent. (N₂ + O₂), the specific heat per normal cubic foot at 2650° F. (1455° C.) is found to be (Fig. 1) 0.024 (for either ° F. or ° C.). The temperature drop is therefore $\frac{2}{0.024} = 83^\circ \text{F.}$ ($\frac{1.1}{0.024} = 46^\circ \text{C.}$). This assumes perfect

condition of the downtakes and no water-cooling. Normally the fall of gas temperature in the downtakes would be much greater, due to air infiltration.

Modifications.—The entire calculation may be made more general by taking a composite wall made of different refractories.

It is then necessary to write t_2 , t_3 , etc. for the different interface temperatures, and eliminate these unknowns as explained on p. 218. As a final check, these interface temperatures may be determined to make sure that correct values have been used for the coefficients of conductivity.

Value of Above Calculation.—Regarded as a calculation, the above example has little practical value; as already stated, a sufficiently accurate solution may be obtained with only a fraction of the work put into the full solution. The calculations, however, afford an excellent example of the relative importance of the different types of heat transfer.

Points Illustrated.—Some of the more interesting conclusions which may be drawn from the example are :—

(1) Under the conditions assumed, the values of a for surface radiation, gas radiation and convection inside the duct were 155, 19.2 and 1.2 respectively. The insignificance of convection in a large duct at high temperatures is noteworthy when radiant gases are present. In the absence of radiant gases, convection becomes important as the *only* direct medium of heat transfer from gas to wall.

(2) With a moderately thick wall, the temperature drop from inside to outside of the wall is much greater than the temperature drop from gas to wall, or from outer surface to surroundings. An error in guessing interior or exterior temperatures of the wall of 100° F. (55° C.) would, in this case, involve an error of under 5 per cent. in the actual temperature drop through the wall. A close approximation to the heat flow may consequently be made by guessing inner and outer wall temperatures, and calculating the flow between these temperatures on a plain conductivity basis. For example, guessing inner and outer wall temperatures at 2600° F. (1425° C.) and 300° F. (150° C.), the coefficient of conductivity of silica brick at the average temperature (1450° F. or 790° C.) is 12.7. For the heat loss per foot of height,

$$q = \frac{\text{Average wall area.} \times \text{Coeffi-} \times \text{Temperature}}{\text{Wall thickness.}} = 28,400 \text{ B.Th.U.'s per hour.}$$

cient of
 ductivity.
 difference.

$$\text{or } q = \frac{17.5 \times 12.7 \times (1425 - 150)}{18} = 15,750 \text{ C.H.U.'s per hour.}$$

On the other hand, calculation should not be made on the basis of surface loss to the surroundings from an assumed exterior surface temperature. This is evident when we consider the very rapid change in the rate of heat loss shown in column 3 of the tabulation on p. 255. For example, an error of 100° F. (55° C.) in the estimated temperature shows an error in the heat flow of about 50 per cent.

(3) The temperature of the surrounding air and objects is not very important. If, for example, due to the presence of hot surfaces, the average surrounding temperature were 150° F. (65° C.), the surface under consideration would be only 35° F. (20° C.) hotter than with normal surroundings. This would not have much effect on a wall with a moderately high temperature drop from inside to outside. The effect of abnormal natural convection is also small.

(4) In cases where a non-radiant gas (*e.g.* air) flows through a large duct, the smallness of the convection coefficient may interpose a high resistance to heat flow, and cause a big temperature drop from gas to wall. For example, if instead of flue gas the same quantity of air had been flowing along the duct at the same temperature,

(a) the inner temperature of the wall, t_1 , would have been about 1860° F. (1015° C.) instead of 2580° F. (1415° C.).

(b) the outer temperature of the wall would have been 335° F. (170° C.) instead of 420° F. (215° C.).

(c) the heat loss per foot of height would have been 17,000 B.Th.U.'s (9,500 C.H.U.'s) instead of 27,000 B.Th.U.'s (15,000 C.H.U.'s).

In a problem of this type, calculation based only on an assumed value for t_1 , as given in note 2 above, is likely to be rather unsatisfactory owing to the possibility of a large error in the guess.

(5) In cases of very abnormal emissivity *together with* very abnormal convection conditions, the full calculation *might* be used.

(6) Where walls have an irregular outline, or where there is a *very* large change of area from inside to outside, calculation *might* again be warranted.

VII.—APPLICATIONS OF THE THEORY OF HEAT TRANSFER TO PYROMETRY.

While a discussion of the principles of high temperature measurement cannot be given in this book, two important applications of the laws of heat transfer deserve special mention.

Measurement of Gas Temperature.¹—When hot gases are flowing through a duct, the gases are usually hotter than the walls of the duct, due to heat losses from the wall and the low coefficient of convection, a_c , from gas to wall. For example, in Section VI., calculation showed that with waste gas at 2650° F. (1455° C.) flowing continuously in the channel, the inside wall temperature would be 2580° F. For air flow under the same conditions, the wall temperature would be 2050° F., showing a much more pronounced difference.

When a thermocouple is placed in a gas stream under these conditions, it will exchange heat with the gases by convection and (for a radiant gas) by gas radiation; it will also exchange heat with the walls by surface radiation. In the example in Section VI. quoted above, the heat exchange coefficients found were 155, 19.2 and 1.2 for surface radiation, gas radiation and convection respectively. If these figures held for heat transfer to a thermocouple, it is evident that the couple would assume a temperature much closer to that of the wall than to that of the gas, particularly if the gas contained no gas radiating constituents. Although the rate of convection to a wire or even to a thermocouple sheath placed in a gas stream is considerably greater than to a large duct, the couple may, in extreme cases, still indicate temperatures which differ by hundreds of degrees from the gas stream temperature which is required. The accepted method of measuring gas temperatures under these conditions is by means of a suction pyrometer. The thermocouple is inserted in a small tube pushed into the duct, and gas is sucked out through the tube at high velocity. The rate of heat transfer by convection to the thermocouple and the surrounding tube is very greatly increased by the combination of high velocity with small diameter, and at the same time the couple is shielded from direct radiation. Under these conditions, the couple reads very close to the true temperature of the gas stream. The couple may be protected from the gases by a light sheath if necessary. It is naturally important that temperature measurements be made at a point where the gas stream may be assumed to be at a uniform temperature across its section.

Measurements with Radiation and Optical Pyrometers.—Imagine a radiation pyrometer to be sighted through a small hole in a furnace on to an object within the furnace. This object will radiate E (its emissivity) times the black body rate for its temperature. The object will, however, absorb only E times the heat striking it from

¹ Haslam, R. T., and Chappell, E. L., *Ind. Eng. Chem.*, **17**, 1925, pp. 402-8.

the surrounding walls of the furnace, and will therefore reflect $(1 - E)$ times this incident heat. The reflected heat, as well as the heat radiated from the body, will be measured by the pyrometer.

One of the following conditions may apply.

1. If the furnace walls are at the same temperature as the object, the reflected heat will exactly compensate for the imperfect emissivity of the body, and the true temperature will be indicated by the instrument.

2. If the object is cooler than the furnace walls, reflected heat will more than compensate for imperfect emissivity, and the temperature reading will be too high.

3. If the object is hotter than its surroundings, the reflected heat will only partly compensate for imperfect emissivity, and the temperature reading will be too low. Fume and smoke also cause low readings.

Temperature readings in the open of metal and slag streams, hot billets, etc., correspond to condition 3. There is a simplification in this case, because the temperature of the surroundings is known and does not vary appreciably. Correction curves for different materials, based on their emissivities, permit the true temperature to be determined from the indicated temperature.

For objects in a furnace, this method would not be convenient, because the furnace temperature would have to be measured separately; nor would it be dependable because reflection from the flame would yield high readings. Here it is best to simulate perfect emissivity by sighting into a deep cavity in the object, or into a closed pipe with the bottom touching the object. A temperature reading taken through a large opening will tend to be lower than when taken through a small opening, because of the decrease in reflected heat.

The above reasoning applies equally to radiation and to optical pyrometers. The correction factors will, however, not be the same in the two cases.

SUMMARY.

1. *Conduction.*—The rate of heat flow per square foot through a wall by conduction is given by the formula

$$q = \frac{k(t_1 - t_2)}{d}$$

where q is the heat flow per hour, k is the coefficient of conductivity,

t_1 and t_2 are the temperatures of the two faces of the wall, and d is the thickness of the wall in inches.

2. *Convection*.—The rate of heat flow per square foot by convection is given by the formula

$$q = a_c(t_1 - t_2)$$

where q is the heat flow per hour, a_c is the convection coefficient, t_1 and t_2 are the surface temperature and the temperature of the gas body.

The value of a_c depends on convection conditions. For forced convection in a flue or in checkers the value may be found from the nomogram of p. 222 (Fig. 29). For other cases of forced convection see pp. 224-5. The value of a_c for natural convection will be found on Plate I, Scale 5.

3. *Radiation*.—The rate of heat exchange by radiation per square foot of an enclosed surface is given by the formulæ :—

$$q = 0.173 E \left[\left(\frac{T_1}{100} \right)^4 - \left(\frac{T_2}{100} \right)^4 \right] \text{ B.Th.U.'s per hr. per sq. ft.}$$

$$q = 1.01 E \left[\left(\frac{T_1}{100} \right)^4 - \left(\frac{T_2}{100} \right)^4 \right] \text{ C.H.U.'s per hour per sq. ft.}$$

The value of E for average furnace exteriors is about 0.8; for detailed values see Table XVI, p. 230. T_1 and T_2 are the absolute temperatures of the heat exchanging surfaces, measured on the appropriate temperature scales.

More simply,

$$q = a_R(t_1 - t_2)$$

where t_1 and t_2 are the actual temperatures (not absolute) of the two surfaces, and a_R is the radiation coefficient corresponding to the average temperature $\frac{t_1 + t_2}{2}$ in Plate I, Scale 6. In certain cases, a correction factor, read from Fig. 33, should be applied to the value obtained for a_R (p. 233).

4. *Total Heat Loss from a Surface*.—This is the sum of the losses by radiation and convection, and may be read from Fig. 31 or obtained from the formula

$$q = (a_R + a_c)(t_1 - t_2)$$

where α_R and α_C are the radiation and natural convection coefficients taken from Plate I.

5.—*Gas Radiation*.—The gases oxygen and nitrogen can neither radiate heat nor absorb radiant heat. Certain other gases, of which carbon dioxide and water vapour are the most important, both radiate and absorb heat. The rate of heat exchange between a body of gas and the surrounding surface is given by the formula

$$q = \alpha_{G.R.}(t_1 - t_2)$$

where q is the net heat lost or gained per hour per square foot of enclosing surface, $\alpha_{G.R.}$ is the coefficient of gas radiation, and t_1 and t_2 are the wall and mean gas temperatures.

The value of $\alpha_{G.R.}$ is obtained as follows :—

Multiply the mean diameter (in feet) of the duct by the per cent. of carbon dioxide in the gas ; from the value DP_{CO_2} obtained and the average temperature of wall and gas, $\frac{t_1 + t_2}{2}$, read the value of $\alpha_{G.R.}$ for carbon dioxide from the nomogram, Fig. 35 ; repeat for water vapour ; add the two values of $\alpha_{G.R.}$; multiply by 0.8, the assumed emissivity of the brick.

Luminous (*i.e.* yellow) flames radiate and absorb at a considerably greater rate than non-luminous flames, possibly reaching a maximum value of about 40 per cent. of the black body rate (p. 249).

6. *Equivalent Diameter*.—In forced convection and gas radiation calculations, for channels which are neither circular nor square in cross section,

$$\text{Equivalent diameter} = \frac{4 \times \text{Area of cross section}}{\text{Perimeter of channel}}$$

7. *Calculation of Heat Flow Through a Wall* can be made from the basic data given in this chapter. A very much more convenient method is given in the next chapter.

8. *Temperature Measurement*.—A thermocouple pushed into a duct carrying hot gases will usually indicate a temperature much closer to the wall temperature than to the gas temperature. To obtain the gas temperature, the rate of convection must be increased by sucking a small stream of the gas at high velocity past a thermocouple placed in a small tube.

A radiation or optical pyrometer sighted on to an object will be influenced by the temperature of the surfaces surrounding the object. If the surroundings are cooler, the pyrometer will read low ;

if hotter, it will read high ; *i.e.* the reading is biased *towards* the temperature of the surroundings. Means are available for correcting the readings.

General References :—

1. M. Fishenden and O. A. Saunders : *The Calculation of Heat Transmission.*
2. W. H. McAdams : *Heat Transmission.*
3. A. Schack : *Industrial Heat Transfer* (translated by H. Goldschmidt and E. P. Partridge).

CHAPTER VI.

PRACTICAL SOLUTION OF HEAT TRANSFER PROBLEMS.

IN the present Chapter, simplified practical solutions are given, covering most of the common heat flow problems met with in furnace practice. Some special cases of heat flow are also considered.

It has been stressed that even detailed calculations cannot be regarded as accurate but give, rather, an idea of the magnitude of a heat loss, where otherwise we should be completely in the dark unless it were possible to make elaborate experimental determinations. This being so, moderate errors caused by simplifications in applying formulæ are of no importance.

I.—HEAT TRANSFER THROUGH A WALL.

The most important heat transfer calculations fall in this class. It is usually quite sufficient to base calculations on the average of internal and external wall areas. It then becomes simpler to express q as the rate of heat transfer per square foot of wall area.

Standard Brick Equivalent.—It is convenient to express all refractories on a common conductivity basis. For example, if at a certain temperature a fireclay brick has a heat conductivity four times that of an insulating brick, so far as concerns heat conductivity, each inch of insulating brick may be considered to be equivalent to and replaced by 4 inches of firebrick. Thus, the higher the resistance (*i.e.* the lower the conductivity) the higher will be the standard brick equivalent. Table XVII has been compiled to permit conversion of the refractories at different temperatures into equivalent thicknesses of a common standard. On pages 270-3 will be found the equivalents for some other materials commonly used in furnace construction.

A brick having a coefficient of conductivity of 10 B.Th.U.'s (or C.H.U.'s) per hour per sq. ft. of area per inch of thickness per degree has been selected as standard. This figure is not far from the coefficient of conductivity of silica, fireclay and chrome bricks at moderate temperatures. The figures given in Table XVII indicate the number of inches of standard refractory which would be equivalent to 1 inch of the different refractories at given average temperatures. For example, from the table it is seen that at

2500° F. 1 inch of chrome brick is equivalent to 0.85 inch of standard brick ; or 1 inch of silica brick at 1000° C. is equivalent to approximately 0.7 inch of standard brick.

TABLE XVII.—STANDARD BRICK EQUIVALENTS.*

Temperature.		Common Refractories.				Insulating Materials.†				Less Common Refractories.			
		Fireclay brick.	Silica brick.	Chrome brick.	Magnesite brick.	Diatomaceous brick (calined, large pores).	Diatomaceous brick (calined, fine pores).	Diatomaceous brick (raw) also Insulating block.	Diatomaceous earth (powder).	Silicon carbide brick.	Fused alumina brick (bonded).	Zirconia brick.	Spinel brick.
FAHRENHEIT.	500°F.	1.35	1.15	1.0	0.26	5.9	5.4	15.5	23	...	0.52	1.0	0.9
	1000°F.	1.1	0.9	0.9	0.32	4.3	4.6	11.5	18	0.075	0.43	0.85	0.8
	1500°F.	1.0	0.8	0.85	0.37	3.2	3.8	0.09	0.38	0.8	0.75
	2000°F.	0.9	0.7	0.85	0.39	2.2	3.3	0.11	0.35	0.75	0.7
	2500°F.	0.9	0.65	0.85	0.40	0.13	0.33	0.7	0.7
(3000°F.)	0.85	0.6	0.85	0.41	0.15	0.31	0.7	(0.65)	
CENTIGRADE.	200°C.	1.4	1.25	1.0	0.25	6.3	5.6	16.5	25	...	0.56	1.0	0.95
	400°C.	1.2	1.0	0.95	0.28	5.0	5.0	13	20	(0.065)	0.47	0.9	0.85
	600°C.	1.1	0.9	0.9	0.34	4.0	4.4	10.5	16	0.08	0.42	0.8	0.8
	800°C.	1.0	0.8	0.85	0.36	3.2	3.8	0.09	0.39	0.8	0.75
	1000°C.	0.95	0.7	0.85	0.38	2.5	3.4	0.105	0.36	0.75	0.75
	1200°C.	0.9	0.65	0.85	0.40	1.8	3.1	0.12	0.34	0.7	0.7
	1400°C.	0.9	0.65	0.85	0.40	0.13	0.33	0.7	0.7
	(1600°C.)	0.85	0.6	0.85	0.41	0.145	0.31	0.7	(0.65)

* In calculating heat flow, each inch of refractory may be replaced by the given number of inches of a refractory having "standard" conductivity (10 heat units per hour per square foot of area per inch of thickness per degree of temperature difference).

To convert a given coefficient of conductivity, k (as defined on pages 213-214), to standard brick equivalent :—

$$\text{Standard brick equivalent} = \frac{10}{k}$$

Conversion may also be made from Plate I, Scale 7, reading k for α .

† See also Table XXXIII, p. 428.

All the data given in the table have been taken from Norton's curves. In later publications,¹ Norton gives approximate values which differ slightly from those used here. For example, chrome brick is given as having the same coefficient of conductivity as fireclay, and the brick equivalent of silica brick as calculated from the "Metals Handbook" is 0.1 higher than in Table XVII.

When we wish to find the rate of heat transfer through a given

¹ In *Fuels and Furnaces*, 10, Nov.-Dec., 1932; and in *Metals Handbook*, American Society for Metals, 1936.

wall, we first use Table XVII, to find the equivalent thickness in inches of standard brick. Plate II is then used, picking out the point corresponding to this equivalent thickness and the inner temperature of the wall, t_1 . A horizontal line, drawn through this point to the vertical axis, will show directly the rate of heat loss per square foot per hour.

Example.—A well ventilated open hearth furnace bottom is built up as shown in Fig. 40. The top surface will be at the

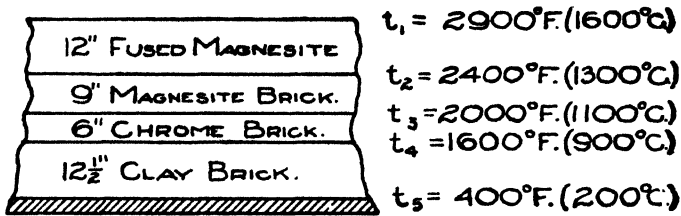

Fig. 40.

same temperature as the steel, the maximum usually being about 2900° F. (1600° C.).

Step 1.—We must first assume temperatures at the different interfaces in order to get the mean temperatures of the different layers. This is only in order to allow for changes in conductivity with temperature, and if judgment is used, no significant error will be introduced in this way. The temperatures guessed are shown to the right of the figure, these values having been chosen with some regard to the relative conductivities of the different refractories.

Step 2.—In obtaining the equivalent thickness of the bottom, the following tabulation is used.

1 Refractory Layer.	2 Average Temperature.		3 Standard Equivalent from Table XVII.	4 Actual Thickness.	5 Equivalent Thickness. (Col. 3 × Col. 4)
	°F.	°C			
Fused Magnesite,	2650	1450	0.40	12"	4.8"
Magnesite brick,	2200	1200	0.40	9"	3.6"
Chrome brick, .	1800	1000	0.85	6"	5.1"
Clay brick, .	1000	550	1.1	12½"	13.8"
			Total, .	. .	<u>27.3"</u>

The equivalent thickness is taken as 27 inches.

Step 3.—Running an imaginary line up from the interior temperature (2900° F. or 1600° C.) in Plate II until a point corresponding to the 27 inch thickness is reached, and then running a horizontal line along the left hand scale, it is found that the heat loss per square foot of bottom is 920 B.Th.U.'s (510 C.H.U.'s) per hour.

Additional Information Obtainable from Plate II.

1. Referring to the above example, it will be found that the horizontal line, drawn to find the heat loss, passes through the heavy line marked "Outer Surface of Wall," at a point corresponding to a temperature of 370° F. (190° C.). This gives directly the *temperature of the outer surface*, without recourse to the lengthy calculation explained in Chapter V.

2. The method here described provides a very simple means of determining the *temperatures at the interfaces or at any other points in the wall*.

Example.—To find the interface temperatures for the previous example.

Step 1.—Obtain the equivalent thickness at the interfaces of the various layers measured from the outside :—

	Equivalent thickness from outside.
Inner face of clay brick,	13·8 inches.
„ „ chrome brick,	$13·8 + 5·1 = 18·9$ „
„ „ magnesite brick,	$18·9 + 3·6 = 22·5$ „
„ „ fused magnesite,	$22·5 + 4·8 = 27·3$ „

Step 2.—Still using the horizontal line drawn in determining the heat loss, it is found that corresponding to these thicknesses, we have temperatures of 1630° F. (890° C.) at 13·8 inches, the clay-chrome interface; 2090° F. (1140° C.) at 18·9 inches, the chrome-magnesite brick interface; and 2480° F. (1360° C.) at 22·5 inches, the interface between the magnesite brick and the fused magnesite.

In determining these interface temperatures, it will be found convenient to place a piece of paper with one edge extending horizontally from the heat loss figure—in this case 920 B.Th.U.'s. or 510 C.H.U.'s. On the edge of the paper, pencil marks may be made corresponding to the equivalent wall thickness at the interfaces, and the paper may then be moved down to the temperature scale. In this way the temperatures may be read more easily.

This method may be extended to the initial reading of the chart for heat loss as follows:—Place the paper so that its right hand vertical edge passes through the temperature of the furnace interior (2900° F. or 1600° C.), and slide the paper up or down until the top right hand corner lies on the correct wall thickness line (27"). The horizontal edge then passes through the heat loss scale. The interface thicknesses may then be marked off on the paper and the interface temperatures determined as described above. Tracing paper is even better for this purpose, because it leaves a clear view of all curves and scales.

The temperatures of interfaces should be determined for two reasons:—

(a) To ascertain that no material exceeds its safe working temperature. It is particularly desirable to check the inner face temperature of concrete and of insulating materials.

Also where acid and basic refractories adjoin without a neutral parting, it is necessary to be sure that the slagging temperature is not exceeded.

(b) The brick equivalents used for the different refractories were based on the interface temperatures assumed. If the temperatures subsequently found differ widely from those assumed, it may be necessary to regard the original calculation as a first approximation, and to recalculate the equivalent thickness on the basis of the temperatures read off from the curve. Unless the original guesses were in error by over 200° F. (or 100° C.), recalculation is not necessary.

3. The diagram may readily be used to determine the most desirable wall construction for a given furnace.

4. Other resistances to heat flow, such as occur in radiation and convection, may be allowed for in using the diagram.

Uses 3 and 4 are explained later.

In two respects the example chosen is a little abnormal. In the first place, the bottom is made up of rather a large number of different materials. In the second place, the rate of heat dissipation from the bottom plates is, in practice, much less than normal for an external surface. Plate II assumes normal surface loss, and it is necessary to investigate the extent of the error introduced.

Effect of Abnormal Surface Loss.—The surface loss in the problem under consideration is below normal, partly because the mean temperature of the surroundings (i.e. the ground level beneath the pan, the side walls of regenerators, etc.) is higher than the 70° F. (20° C.) usually figured, and partly because the convection coefficient from the bottom is much lower than normal. The mean temperature of the surroundings will now be taken as 120° F. (50° C.), a temperature which appears to be at least high enough when we remember that the bottom "sees" some of the cooler outside surfaces as well

as the hotter ones mentioned. Convection takes place from a horizontal freely exposed under-surface at about $\frac{3}{4}$ of the rate for a normal vertical surface. Allowing for the baffling effects of beams, etc., supporting the bottom, the loss by convection may be only about half of this, or $\frac{1}{2}$ of the normal rate.

The problem has been recalculated on the basis of temperature of surrounding objects and air equal to 120° F. (50° C.), and a convection coefficient equal to $\frac{1}{2}$ of normal. The method given on pp. 251-9 was used, and gave a heat loss of 900 B.Th.U.'s (500 C.H.U.'s) per sq. ft. per hour, and an outside temperature of 440° F. (225° C.). The heat loss per square foot obtained by this method of calculation is only 2 per cent. less than that obtained by the quicker and more practical method. It is hardly necessary to reiterate that in most cases an error even five times greater than this would not be important.

The difference in the values obtained for the outer temperature of the pan is a little greater, and consequently the temperature distribution throughout the bottom will tend to be a little higher than indicated. This could be of importance only if a layer of insulating material is used in building the bottom. In this case it is necessary to make sure that the temperature of this material does not become excessive.

In further illustration of the effect of abnormal surface loss, consider a furnace wall of 18 inches equivalent brick thickness. Suppose the inside temperature of the wall is 2000° F. and the temperature of the furnace surroundings is 70° F. Plate II shows that the outer surface of the wall is at a temperature of 370° F. and that the rate of heat loss is 920 B.Th.U.'s per sq. ft. per hour. Suppose now that the steel-encased furnace is coated with aluminium paint, and that the emissivity is thereby reduced from 0.8 to 0.5. Solving by trial, and making use of Plate I, we find that the surface temperature is now 415° F. and that the heat loss through the wall is 880 B.Th.U.'s per sq. ft. per hour. The effect of the aluminium paint is thus seen to be comparatively small. This type of furnace finish has, however, real value on account of the psychological effect of its clean appearance.

Again, for the same 18-inch wall, suppose the emissivity remained normal, but that the convection coefficient was doubled on account of wind. In this case the outside temperature is lowered to 305° F. but the heat loss is increased only to 945 B.Th.U.'s per sq. ft. per hour.

It may be concluded that, except in the most abnormal cases, the rapid method of determining heat loss may be used with entire confidence.

For walls of lower equivalent thickness and for lower interior temperatures (*e.g.* for chimneys), the relative effect of surface conditions is greater. On p. 275 is described a simple method of obtaining both heat loss and surface temperature for abnormal surface conditions.

Standard Brick Equivalents of Other Constructional Materials.—

To supplement Table XVII, the following information will be found useful. The values given are based on the results of a large number of different experimenters. It cannot therefore be expected that these results will correspond one with the other as closely as those given in the table.

Common red brick (clay).—At ordinary temperatures 1 inch of red brick or other clay product is equivalent to 2 inches of standard refractory. At higher temperatures, within the working temperature of the brick, the values for fireclay brick may be used.

For soft burned red brick (a better heat insulator than the hard burned brick) the value may be 50 per cent higher.

High alumina brick.—Bricks in this class include the whole range of aluminous bricks, commencing with the fireclay bricks rather high in alumina, and passing through the important kaolin and mullite bricks (p. 415 *et seq.*) to bricks still higher in alumina. Experimental results indicate increasing conductivity (hence decreasing standard equivalent) as the per cent. of alumina increases. Published data, however, are far from consistent, and so much depends upon porosity, etc., that perhaps it will be more satisfactory to use the values given in the table for fireclay brick.

Dolomite.—Possibly about the same as chrome.

Carbon and graphite.—Both amorphous carbon and graphite have inherently high thermal conductivities; but the conductivity of bonded refractories of these materials varies widely with the texture of the refractory. When used for making electrodes, the material is prepared so as to give high electrical conductivity, and the thermal conductivity is correspondingly high; on the other hand, some common grades of bonded graphite and carbon refractories may have values as low as those for fireclay brick. If these extreme cases be disregarded, a standard brick equivalent of 0.2 might be acceptable as a mean value for graphite refractories and 0.4 for carbon refractories.

Porous fireclay brick.—Bricks of this type are widely used for heat insulating purposes, particularly at temperatures higher than admissible with most grades of diatomaceous materials. The conductivity is governed by the per cent. porosity and by the actual size and nature of the pores. Evidently then, this material can vary widely in its insulating value.

The standard equivalent of these insulating refractories may range between the values for fireclay and those for calcined diatomaceous brick. For a good grade of porous fireclay brick, the brick equivalent may be taken as three-fourths of that of calcined diatomaceous brick.

Dry sand.—At atmospheric temperatures, 1 inch of this material, widely used as an inexpensive insulator, is equivalent to 4 to 4.5 inches of standard brick. At higher temperatures, the value may be expected to fall rather rapidly.

Other powdered and loose granular materials.—In all materials of this nature, the principal resistance to heat flow arises from the discontinuity of the material. Conductivity from particle to particle is hindered because contact exists only at a number of points. If

the air spaces between particles are small, there is probably not much heat transfer by convection because there is very little air movement; direct conduction across the air gaps is also of a small order. (If radiation and air movement could be entirely prevented, the resistance offered to heat flow by one inch of air at ordinary temperatures would be equal to that of 60 inches of standard brick). In loose materials, radiation from particle to particle therefore plays a more important role than in bonded refractories. It follows that the shape and size of the particles, and the emissivity of the material, are likely to be important in insulators of this class. The brick equivalent, per inch of these materials at ordinary temperatures, may vary from 2 inches of standard refractory for coarsely granular materials of low porosity, to 10 or 20 inches for powdered materials of low emissivity, such as magnesia and zirconia. Powdered diatomaceous earth shows values as high as 25 inches.

At higher temperatures, radiation increases very rapidly (Fig. 31), consequently at higher temperatures all insulating materials show marked decline in their resistance to heat flow.

Other materials (besides clay, diatomaceous earth and magnesia) are used in powdered form for heat insulators, and are sold also in brick form. According to trade bulletins many of these are excellent insulators.

Non-refractory Materials.—For purposes of comparison, some materials used in other industries are grouped below, roughly according to their insulating values at atmospheric temperature.

Standard brick equivalent of 40 inches—felt, wool, feathers.

Standard brick equivalent of 35 inches—cork, aluminium foil insulation, glass wool, rock wool, slag wool.

Standard brick equivalent of 25 inches—sawdust.

Standard brick equivalent of 20 inches—laminated asbestos felt, "85 per cent." magnesia.

Standard brick equivalent of 10 inches—ordinary asbestos insulation, average of several common kinds of wood.

In this rough classification, the conductivity of fibrous materials (wood and felt) is assumed to be measured perpendicular to the fibre—along the fibre the insulating value may be much smaller. For loose fibrous insulators, the material is assumed to be packed normally.

Concrete (dry).—At atmospheric temperature, 1 inch of concrete is equivalent to 1.5 to 1.9 inches of standard brick. At higher temperatures, as with nearly all materials in the low or medium

conductivity class, this value may be expected to fall with rise of temperature, possibly approaching a value of 1 inch at the mean temperature of furnace foundations.

Earth (cold).—1 inch of dry compacted earth is equivalent to 2.8 inches, 1 inch of moist earth to 0.6 inch, and 1 inch of sandstone to 1 inch of standard brick.

Mild steel and cast iron.—Where these materials are used merely as a casing for a furnace structure, the resistance offered by them to flow of heat is too small to be considered. At atmospheric temperature, one inch of mild steel is equivalent to 0.025 inch of standard brick; and one inch of cast iron to 0.03 inch. Where large masses of iron need to be heated, the conductivity, in conjunction with the density and specific heat, will determine the rate of heating. Such problems, however, are usually solved by empirical rules which have been developed practically.

Contact Resistance.—Poor contact between bricks has little effect at high temperatures. Plate I, Scale 6, shows that at 1500° F. (or 800° C.) the coefficient of radiation is over 40, and even a complete gap between bricks, no matter how wide, cannot interpose a resistance greater than 0.25 inch of standard brick (Plate I, Scale 7). In cooler parts of the wall, the rate of radiation is lower; and an air space, perpendicular to the direction of heat flow, may interpose considerable resistance. Given all necessary measurements, calculation would be easy enough; but in practice the width of accidental air gaps is obviously unknown. However, in order to show the possible magnitude of the resistance, we will imagine an air gap $\frac{1}{8}$ inch wide and a mean temperature at the gap of 400° F. (200° C.). Plate I shows a radiation coefficient of 3.5; we assume the convection coefficient in so narrow a gap to be negligible; there remains direct thermal conduction by stationary air across the gap. The coefficient of conductivity of air at 400° F. is found from physical tables to be 0.24. As will be shown later in this chapter, the coefficient of transfer across the gap by conduction is $0.24 \div \frac{1}{8} = 3.8$; and the total transfer coefficient for the gap is $3.5 + 3.8 = 7.3$. Plate I, Scale 7, shows that this corresponds to a resistance of 1.4 inches of standard brick. For a still lower temperature or for a wider gap, the resistance would be greater.

Large areas of complete discontinuity may occur between the masonry and the steel shell. Inside a well bonded wall, such areas are usually small, and the mean resistance interposed may be unimportant for the wall as a whole.

Other Brick Equivalents.—Any resistance to heat flow may be expressed as the number of inches of standard brick which would have an equivalent resistance.

Suppose, for example, that heat is transferred to a wall by convection, and that a_c is the coefficient of convection. For a temperature drop from gas to wall of $t_1 - t_2$, the rate of heat transferred per square foot per hour is given by

$$q = a_c(t_1 - t_2)$$

Clearly, it would be possible to find a thickness, d , of standard brick (coefficient of conductivity = 10) which, with inner and outer faces at temperatures t_1 and t_2 , would permit the same rate of heat flow. In this case,

$$q = \frac{10(t_1 - t_2)}{d}$$

and for equal values of q ,

$$a_c = 10/d \text{ or } d = 10/a_c$$

It has been explained in the preceding chapter how, with the help of diagrams given, a_c may be determined under different conditions. The value of d ($= 10/a_c$) may be read from Plate I, Scale 7. This, representing a brick thickness, is to be added to the equivalent thickness of the wall.

When two types of heat transfer to a wall take place in parallel (*i.e.* simultaneously and independently), the two component values of a must be added before the equivalent thickness is obtained. For example, if a wall receives heat from a gas stream by convection and by gas radiation simultaneously, and if the values for a_c and $a_{G.R.}$ are 1 and 3 respectively, then $a_{Total} = 4$, and the brick equivalent is $10/4 = 2.5$ inches of standard brick. Obviously, it would have been wrong to say the brick equivalent of convection is $10/1$ and the brick equivalent of radiation is $10/3$, giving a total of 13.3 inches, since this would imply a greater resistance to heat transfer than offered by either of the individual factors.

The resistance to surface loss from the outer face of a wall may also be expressed in terms of brick thickness. Imagine the hot surface to be losing heat in a normal way by radiation and natural convection. Now imagine a surface at the same temperature with a brick wall built up outside it, and suppose the outer face of this added wall to be maintained at a temperature of 70° F. (20° C.). The thickness of the added wall for the same rate of heat flow is the brick

equivalent of the surface loss coefficient. In Plate II, along the "Outer Surface of Wall" curve, have been inserted, in parenthesis, figures varying from 1.5 to 6. These are the brick equivalents corresponding to various surface temperatures under normal conditions.

Approximate Solution with Abnormal Surface Loss.—Suppose, for normal surface loss, solution of a particular problem indicates the surface resistance to be equivalent to 4 inches of standard brick. Suppose the actual rate of surface loss be estimated to be only 80 per cent. of normal. Then the brick resistance of the surface is $4 \times 100/80 = 5$ inches. Solve the problem by adding the extra inch of surface resistance to the equivalent wall thickness, and read the surface temperature from the "1 inch" line instead of the "Outer Surface" line.

For cases of abnormally high surface loss, a similar approximation may be made.

Problem.—To solve by means of Table XVII and Plate II the problem enunciated on page 251.

Step 1.—Assume reasonable temperatures for the inner and outer faces of the wall. The considerations explained on page 253 will govern the inner temperature assumption.

Inner temperature assumed = 2600° F. (1430° C.).

Outer temperature assumed = 300° F. (150° C.).

Step 2.—Determine the brick equivalent of the waste gas to wall heat transfer. As before, α for convection plus gas radiation = 20.4. From Plate I (or from 10/20.4) the brick equivalent is approximately 0.5.

Step 3.—Determine the brick equivalent of the wall. The average brick temperature assumed is $\frac{2600 + 300}{2} = 1450^\circ \text{F.}$ or $\frac{1430 + 150}{2} = 790^\circ \text{C.}$ From Table XVII we find that at this temperature 1 inch of silica brick is equivalent to 0.8 inch of standard brick. The brick equivalent of the wall is therefore $0.8 \times 18 = 14.4$ inches.

Step 4.—Add all brick equivalents (except the external surface loss).

$$0.5 + 14.4 = 14.9 \text{ inches.}$$

Step 5.—Determine the rate of heat transfer per square foot from Plate II, for the gas temperature of 2650° F. (1455° C.),

and preferably using two edges of a sheet of paper as described on page 269. The heat loss per square foot per hour is found to be 1490 B.Th.U.'s (830 C.H.U.'s), and the inner and outer wall temperatures are found to be 2600° F. (1430° C.) and 460° F. (240° C.) respectively.

Step 6.—The average wall area is $17\frac{1}{2}$ sq. ft. per foot of height. Multiplying this by 1490 B.Th.U.'s we obtain a heat loss of 26,000 B.Th.U.'s (14,500 C.H.U.'s).

All of these values are in sufficiently close agreement with those obtained by the detailed calculation given in the previous chapter. Such deviations as occur are mainly due to the rather big difference between inside and outside areas of the channel.

Modification to Allow for Change of Area.—If desired, the effect of change in area may be allowed for as follows:—

1. Base the calculation on 1 sq. ft. of exterior surface. The exterior surface is 22 sq. ft. per foot of height.

2. The equivalent thickness of the silica brick wall was found above to be 14.4 inches. The average of the inner and outer areas of the silica brick wall is 17.5 sq. ft. which is equivalent to $17.5/22 = 0.795$ sq. ft. per square foot of external surface. This reduced area causes a greater resistance, therefore the brick equivalent of the silica brick wall is $14.4/0.795 = 18.1$ inches.

3. Similarly the brick equivalent of the gas-wall transfer, in terms of 1 sq. ft. of exterior surface, is $0.5'' \times \frac{22}{18} = 0.6''$. (Again, a smaller effective area inside indicates a bigger resistance and demands that the ratio be arranged to give a bigger brick equivalent thickness).

4. Taking the gas temperature as 2650° F. (1455° C.) and the equivalent wall thickness as 18.7, solve from Plate II as before. This shows a heat loss per square foot of outer surface of 1200 B.Th.U.'s (670 C.H.U.'s), an outer surface temperature of 420° F. (215° C.) and an inner wall temperature of 2590° F. (1420° C.). Multiplying the heat loss figure by the external area (22 sq. ft.) we obtain the total heat loss per foot of height, 26,500 B.Th.U.'s (14,700 C.H.U.'s). The solution is now entirely in line with that given in the previous chapter.

Wall Design and the Proper Use of Insulation.—Suppose a wall is to be constructed for an allowable heat loss of 600 B.Th.U.'s per sq. ft. per hour, the interior lining to be common firebrick, and the temperature of the inner face to be 2500° F. Plate II shows that the equivalent thickness of the wall must be 37 inches. This is obviously a case demanding the use of insulating material, since the amount of red brick to bring up the equivalent thickness to 37 inches would be excessive.

Suppose it is decided to use burnt diatomaceous brick and insulating block to secure the required insulation. The first consideration naturally relates to the relative cost of these materials.

Reviewing the standard brick equivalents (Table XVII) in conjunction with cost, it will be found that of the materials under consideration the better insulator is decidedly the cheaper material. For example, diatomaceous brick is three to four times as good an insulator as firebrick, but the cost, including material and labour, is on the average only slightly higher for the same *actual* thickness. Again, insulating block has a brick equivalent over $2\frac{1}{2}$ times that of diatomaceous brick, but the average cost is less than double for the same actual thickness.

This basis of cost comparison is conservative, because it does not take into account the increased outside area of a furnace constructed of a poorer insulator but designed for the same heat loss. This increase of area naturally tends to augment heat flow. The objections to undue wall thickness on account of weight, floor space, etc., are evident. It will be noted that red brick could compete with diatomaceous brick only if the cost, including labour, does not exceed $\frac{1}{3}$ to $\frac{1}{4}$ that of the diatomaceous brick. This does not, however, take into account furnace structures where red brick is used to avoid the necessity of encasing the furnace in steel.

To return to the problem, it is evident that the better insulators should be used as far as possible. Generally, however, the better the insulator the lower its maximum working temperature (see Chapter VIII). The maximum safe temperature for a high grade burnt diatomaceous brick is about 2400° F. (or 1300° C.), and for insulating block 1350° F. (or 750° C.). Suppose it is decided to use these materials with a margin of safety of 200° F. in each case, then we solve the problem as follows:—

Step 1.—Place a strip of paper along the temperature scale of Plate II. Mark off, on the edge of the paper, the limiting temperatures 2200° F. and 1150° F., the interior temperature 2500° F., and also the left-hand boundary line of the chart (0° F.). See Fig. 41.

Step 2.—Slide the paper up, keeping the left-hand mark on the edge of the diagram, until the 600 B.Th.U. point is reached. Under the temperature marks, note the corresponding brick thicknesses ($14\frac{1}{2}$ inches, $31\frac{1}{2}$ inches and 37 inches).

Step 3.—Make a mark corresponding to the outer surface and note its temperature (290° F.).

Step 4.—The whole of the outer $14\frac{1}{2}$ inches may be replaced by an equivalent quantity of insulating block. At the average temperature indicated $\left(\frac{290 + 1150}{2} = 720^{\circ}$ F.), Table XVII shows the brick equivalent of insulating block to be about 14. The required

thickness of block is therefore $14\frac{1}{2}/14$, or a little over 1 inch. 1 inch of block will therefore be used, and this will be equivalent to 14 inches of standard brick.

The 14-inch thickness is marked off on the edge of the paper, and the temperature (approximately 1120°F.) is noted.

Step 5.—The equivalent thickness $31\frac{1}{2} - 14 = 17\frac{1}{2}$ inches may be supplied by diatomaceous brick. At an average temperature of $\frac{1120 + 2200}{2} = 1660^{\circ}\text{F.}$, Table XVII shows the brick equivalent to be about 3.2. The thickness required is therefore $\frac{17\frac{1}{2}}{3.2} = 5.5$ inches. $4\frac{1}{2}$ inches (*i.e.* one half brick thickness) of insulating brick is therefore called for, and this would be equivalent to about $4\frac{1}{2} \times 3.4 = 15$ inches. The 3.4 is used instead of 3.2 in anticipation of the lower average temperature of the material. Mark off on the paper the $14 + 15 = 29$ inch point. Note that the corresponding temperature is 2030°F. The average temperature of the insulating brick is $\frac{1120 + 2030}{2} = 1575^{\circ}\text{F.}$, justifying the equivalent of 3.4.

Step 6.—An equivalent brick thickness of 29 inches has now been accounted for. The remaining 8 inches must be made up of firebrick. At an average temperature of $\frac{2030 + 2500}{2} = 2260^{\circ}\text{F.}$, the equivalent for firebrick = 0.9. The thickness required is therefore $8/0.9 = 9$ inches.

The wall will therefore be made up of 1 inch of insulating block, $4\frac{1}{2}$ inches of calcined diatomaceous brick, and 9 inches of fireclay brick. The various steps are summarised in Fig. 41.

The economic desirability of using the maximum permissible thickness of insulating block (the cheapest material in relation to its insulating qualities) does not appear to be as fully appreciated as it might be. It is not uncommon to see a furnace whose temperature differs widely at different parts, yet carrying the same thickness of insulating block throughout. In such cases, either some parts are uneconomically constructed through the use of insufficient insulation, or in other parts the interior face of the insulation is exceeding its proper working temperature. In selecting the insulating block, full advantage should be taken of the wide range of thicknesses available (from $\frac{1}{2}$ " up to $4\frac{1}{2}$ ", increasing in small steps.)

Effect of Wall Thickness.—Particularly in small furnaces, a thick wall may lead to considerable increase of external surface area.

The outer layers tend to offer lower resistance to heat flow on account of this larger area, and the resistance to surface dissipation is also somewhat lower. Insulation, by keeping down the external dimensions of the furnace, consequently leads to indirect thermal advantage, apart from the other economic advantages. Also the value of the high temperature porous clay refractories (p. 429) is enhanced by the fact that they may be placed nearer to the source of heat, where the area at right angles to the direction of flow is least.

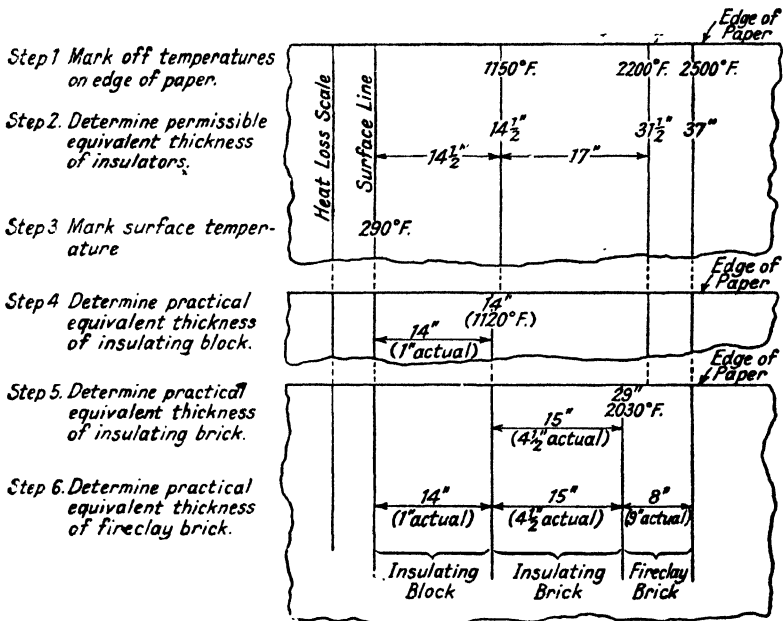

Fig. 41.

Graphical Solutions for Steady Heat Flow.—Steel ingots used for making heavy forgings are teemed into moulds having very large feeder-heads, *i.e.* the steel is poured into cast iron moulds having high superimposed extensions lined with refractory brick. As the steel (which is of the fully “killed” variety) freezes and cools in the cast iron mould, considerable shrinkage occurs, tending to leave a cavity or pipe, principally at the top of the ingot. The unchilled liquid metal in the head feeds down as shrinkage continues, so that the pipe is located entirely in the head. Incidentally, there is usually heavy segregation of impurities in

the last portions of a "killed" steel to solidify; use of a feeder-head transfers regions of harmful segregation from the sound portion of the ingot to the head. The head of the ingot is eventually discarded, but in forging the ingot in the press or under the hammer, it is convenient to use this head for handling purposes. The ingot is therefore placed in the furnace with the pipe end protruding through the door and the opening is then bricked up around the head. It is evident that there must be considerable loss of heat by conduction through the head; but calculation of this loss would be very difficult because the heat flow is at first axial along the ingot, and then divergent to reach all surfaces exposed to the air. For solution of such problems where the heat flow does not follow a simple path, graphical methods may be used. For an explanation of these methods, see Chapter V, General Reference 1; for some applications of the method, see Chapter I, General Reference 4.

Over-all Conductivity.—Frequently the heat carrying capacity of a wall is expressed by a figure called the over-all conductivity, or merely the **conductivity** of the wall. This constant for the wall, written K , is the heat transfer per square foot of wall, per hour, per degree of difference between the inside temperature of the wall (t_1) and the temperature of the external surroundings (t_0). The heat loss q per square foot per hour is then written¹

$$q = K(t_1 - t_0)$$

By inversion of this equation $K = \frac{q}{t_1 - t_0}$. Thus for the open hearth furnace bottom (Fig. 40, p. 267)

$$\begin{aligned} K &= \frac{920}{2900 - 70} = 0.32 \text{ in Fahrenheit units.} \\ &= \frac{510}{1600 - 20} = 0.32 \text{ in Centigrade units.} \end{aligned}$$

An advantage of this method of calculating heat flow is apparent— K is a small easily remembered figure depending mainly on the wall construction. t_1 is known approximately, and t_0 is usually taken as 70° F. (20° C.). At first sight, an obvious disadvantage of using the constant K appears to be that it can be found only by

¹ Since q also equals $\frac{10}{d}(t_1 - t_0)$, $K = \frac{10}{d}$ and $d = \frac{10}{K}$, where d is the brick equivalent thickness for the heat transmission.

first using Table XVII and Plate II to find q , and then dividing by the temperature difference. The procedure may, however, be simplified somewhat.

It has been explained that the resistance to heat dissipation from an exposed surface may be represented by an equivalent thickness of standard brick. The "Outer Surface" curve on Plate II shows that the equivalent varies within rather narrow limits, being 5 inches at 150° F. (65° C.), 4 inches at 245° F. (120° C.), 3 inches at 400° F. (205° C.), 2 inches at 650° F. (345° C.). As an approximation, we may take 4 inches as the brick equivalent of heat dissipation from the surface.

This gives a simple rule for finding the value of K :—

(1) Obtain the equivalent wall thickness from Table XVII, and add 4 inches for the surface effect. For surfaces known to be very hot, a smaller figure may be taken for the surface equivalent.

(2) Divide 10 B.Th.U.'s (10 C.H.U.'s) by the value obtained. (Plate I, Scale 7, read either left to right or right to left, will effect this division). This serves as a basis for rough calculations where tables are not available. For example, suppose we need to calculate roughly the heat loss per square foot of a firebrick wall 18 inches thick and with an internal temperature of 2000° F. (or 1100° C.). We take this as 18 inches of standard brick and add 4 inches for the surface loss, giving 22 inches total.

$$K = 10/22 = 0.45$$

For the heat loss,

$$q = 0.45(2000 - 70) = 870 \text{ B.Th.U.'s per sq. ft. per hour.}$$

$$q = 0.45(1100 - 20) = 490 \text{ C.H.U.'s per sq. ft. per hour.}$$

It will be observed that K is dependent on the actual temperatures only to the extent of variations with temperature in the equivalent conductivities of the refractories. For a given location in a furnace, temperature fluctuations are insufficient to cause material change in K . This constitutes one of the advantages of using K as a means of determining variations in q for slightly different temperatures.

II.—HEAT LOSS BY GAS LEAKAGE.

The factors influencing gas leakage and its effect on efficiency have been discussed earlier. It is evident that leakage has a distinct effect on heat loss from a wall, but the evaluation of this effect has little meaning. Compare, for example, two walls of similar construction, one of them relatively gas tight and the other leaky. Suppose there is a slight suction inside the furnace in both cases. Cold air will be sucked through

the cracks of the leaky brickwork and will cool down the entire wall, resulting actually in a smaller heat loss from the defective wall. This seeming economy of heat is naturally many times offset by the bad effects of cool air entering the furnace chamber. If the furnace chamber is under pressure, there will be outward leakage of the hot gas. This will, in fact, cause a greater heat loss from the walls of the leaky furnace, due to the sensible heat of the escaping gases. Again, the mere loss of heat is likely to be of minor importance compared with damage to refractories, insulation, etc.

It is concluded that the effect of leakage constitutes a separate problem, and should not be complicated by the unnecessary introduction of heat flow considerations.

III.—UNSTEADY HEAT FLOW—HEAT STORAGE.

In considering heat flow through a wall, steady temperature conditions have been assumed; that is, the inner face of the wall is assumed to have reached its working temperature, and each successive layer of brick is assumed to have reached its equilibrium temperature for the normal rate of heat flow through the wall. It is evident that when a furnace is first heated up after a stoppage, this temperature equilibrium does not exist. While the furnace interior may reach its working temperature in a period varying from a few hours to several days, depending on the type of furnace, the outer parts may not even approach their normal temperatures within this time. The reason is, that heat which first passes through the inner layer of brickwork is largely absorbed in heating the next layer, and is therefore not passed on in the usual way. When the inner layers have approached their normal temperatures and are saturated with heat, then they commence to pass on all the heat which they receive to the centre, and finally to the outer layers of the wall.

In illustration of the amount of heat required to bring a wall to its working temperature, consider a firebrick furnace wall 18 inches thick, with an inner temperature of 2200° F. (1200° C.) and an outer temperature of 375° F. (190° C.). The volume of wall corresponding to one square foot of wall surface is 1.5 cu. ft. or, at a density of 120 lb. per cu. ft., 180 lb. of brick. At an average temperature of 1290° F. (695° C.) and a specific heat of 0.28, the normal heat content of the wall above atmospheric temperature is

$$(1290 - 60) \times 0.28 \times 180 = 62,000 \text{ B.Th.U.'s.}$$

$$(695 - 15) \times 0.28 \times 180 = 34,000 \text{ C.H.U.'s.}$$

Under steady conditions this wall would transmit only about 975 B.Th.U.'s (540 C.H.U.'s) per hour. It is, therefore, not surprising that many hours or days must elapse before such a wall can approach its final temperature equilibrium.

Mathematical and graphical methods are available for ascertaining the temperature at any part of a wall after a given time interval during the heating period, and also the rate of heat absorption by the wall at any moment, etc. An hydraulic device has also been developed for solving unsteady heat flow problems which would otherwise present great difficulty.¹ It is thought, however, that, from the furnace operator's point of view, the practical value of these extremely interesting solutions is not sufficiently great to warrant inclusion of a description here. During the heating period, although the time required for the wall temperature to reach a steady condition is very long, this does not necessarily imply very greatly increased heat extraction from the furnace interior except during the first few hours. Suppose the time required for the heat flow into the wall to approach the normal value for heat loss through the wall is h hours, and suppose d represents the wall thickness in inches. Then, very roughly,

$$h = \frac{d^2}{8}$$

This formula is too crude to give more than an imperfect idea of the time. Briefly, it has been derived as follows:—

Let t_1 and t_2 be the inner and outer temperatures of the wall, respectively; t_0 the air temperature; q the normal heat loss per square foot of wall under steady conditions; h the time in hours for the rate of heat inflow into the wall to fall approximately to the steady flow value, q ; k the coefficient of conductivity as formerly defined; and a the "diffusivity" of the brick. $\pi = 3.14$.

The physical constant diffusivity is given by

$$a = \frac{\text{Coefficient of conductivity}}{12 \times (\text{Specific heat}) \times (\text{Density per cu. ft.})}$$

It may be proven mathematically that, subject to restrictions mentioned below, the heat flow per square foot per hour into a wall h hours after starting from cold is given approximately by

$$q = \frac{k(t_1 - t_0)}{12\sqrt{\pi ah}}$$

(The 12 in this equation and in the formula for diffusivity is necessary to achieve consistency of units, k being here expressed in terms of *square feet* of surface and *inches* of thickness).

The heat passing through the wall under conditions of steady flow is

$$q = \frac{k(t_1 - t_2)}{d} \quad \dots \dots \dots \quad \text{(p. 213)}$$

¹ Moore, A. D., "The Hydrocal," *Ind. and Eng. Chem.*, Vol. 28, June 1936, pp. 704-708

When these are equal (the condition for which it is required to find h),

$$\frac{k(t_1 - t_0)}{12\sqrt{\pi ah}} = \frac{k(t_1 - t_2)}{d}$$

from which

$$\frac{1}{12\sqrt{\pi ah}} = \frac{1}{d} \sqrt{\frac{t_1 - t_2}{t_1 - t_0}}$$

If we let the fraction $\frac{t_1 - t_2}{t_1 - t_0} = x$,

$$h = \frac{d^2}{144\pi ax^2}$$

The value of x may be found if t_1 , t_2 , and t_0 are known. The values of x^2 are tabulated below for $t_1 = 2500^\circ \text{F.}$, $t_0 = 70^\circ \text{F.}$, and for various values of t_2 (these being calculated for assumed thicknesses of a firebrick wall):—

Outer temperature, t_2 , .	870° F.	570° F.	500° F.	410° F.	350° F.	290° F.
(Wall thickness,)	3''	9''	12''	18''	24''	36''
x^2 ,	0.45	0.63	0.68	0.74	0.78	0.83

Disregarding the value for a three-inch wall, it is seen that the value of x^2 does not differ widely from a mean value of 0.7. For other values of t_1 there is no substantial change in this value,

$$\text{If } a = \frac{10}{12 \times 0.28 \times 120} = 0.025, \text{ and } x^2 = 0.7,$$

$$h = \frac{d^2}{144 \times 3.14 \times 0.025 \times 0.7}$$

$$= \frac{d^2}{8}$$

If the diffusivity differs greatly from 0.025, the denominator, 8, may be replaced by $320 \times \text{Diffusivity}$.

Modification of the denominator would also be necessary if used for walls under 9 inches thick. For thin walls, particularly if the working temperature is low (below 2000°F. or 1100°C.), the denominator may be decidedly smaller than 8; in other words the time may be considerably greater than indicated by the formula, $h = \frac{d^2}{8}$.

Again, the formula assumes rapid heating of the interior face to its working temperature. If the interior is brought to temperature very slowly, the time to approach steady flow is greater.

During the early part of the heating period, the flow of heat into the wall may be several times the normal heat loss through the wall. The average heat penetration over the whole time, h , as given by the above formula, is approximately double the normal heat loss for the wall—this may be shown mathematically. The following additional conclusions are derived by mathematical analysis.

(1) The average rate of heat lost from the outer wall surface during the heating period is about one-half the usual rate for steady flow; or the total heat quantity so lost is one quarter of the heat entering the wall during the heating period. As a corollary, the heat stored in the walls during this period is about three-quarters of the total heat passing into the walls from the furnace interior, or at the rate of $1\frac{1}{2}$ times the normal steady heat flow.

The heat stored per square foot of wall is

$$\left(\frac{t_1 + t_2}{2} - t_0\right) \times (\text{specific heat}) \times (\text{density}) \times \frac{d}{12}$$

By algebraic manipulation, using the equations in small type above, we may express this as $\frac{1}{19} \left(\frac{2}{x} - 1\right) \frac{8h}{144a}$. Substituting 0.025 for a and 0.85 for x (corresponding to $x^2 = 0.72$), we find that the expression becomes 1.5 qh .

Example.—To find the heat absorbed during heating of the 18-inch firebrick wall used in illustration on page 282. Under steady operating conditions, this wall would transmit to the outside 975 B.Th.U.'s (540 C.H.U.'s) per sq. ft. per hour (Table XVII) and Plate II.

The time required for approach to steady flow is given by

$$\begin{aligned} \text{Time} &= \frac{18^2}{8} \\ &= 41 \text{ hours.} \end{aligned}$$

The heat absorbed during this time, at double the normal heat loss rate, is

$$\begin{aligned} 975 \times 2 \times 41 &= 79,000 \text{ B.Th.U.'s per sq. ft. of wall} \\ 540 \times 2 \times 41 &= 44,000 \text{ C.H.U.'s per sq. ft. of wall;} \end{aligned}$$

of this quantity, one quarter, or 20,000 B.Th.U.'s (11,000 C.H.U.'s), is lost to the surroundings, and the remaining three quarters (59,000 B.Th.U.'s or 33,000 C.H.U.'s) is stored in the wall.

As a check on this last conclusion, we refer to page 282, and find the figures of 62,000 B.Th.U.'s (34,000 C.H.U.'s) quite consistent with the rough rule. The agreement, however, depends on the correctness of the diffusivity assumed; direct calculation of heat

content from the temperature and physical data of the wall is therefore preferable.

2. Heat stored in the wall will naturally tend to check rapid temperature changes in the furnace structure, where the furnace is not ordinarily maintained at a steady temperature. Whether this is advantageous or otherwise will depend on the nature of the process.

3. At the commencement of the heating period, a thick wall will absorb more heat than a thin wall of the same material. This is due to the chilling action of the additional mass of masonry. At a later stage of the heating period, the rate of loss for the thinner wall will overtake and surpass that for the thicker wall.

Utilisation of Heat Stored in Walls.—When a batch has just been discharged from a furnace and a cold batch is charged, the inner surface of the walls will drop, by radiation, to a temperature below that of the layers just beneath the surface. This will cause an inflow of heat from the hotter part of the wall, surface losses to the outside continuing with very slight interruption. The inflow of heat may be calculated approximately in a given case, but the calculation is not particularly easy. Any heat which is given up to the charge from the walls, during the early stages, must be replaced later. The return of stored heat is therefore not worth considering. In fact it is distinctly undesirable in a furnace where one batch follows another immediately, because the walls supply heat when heat is cheap (during the low temperature period) and then demand a return of this heat when heat is expensive (during the high temperature period). Stored heat may be responsible for actual loss of time in those processes where the nature of the material treated makes it necessary to cool the furnace before charging a fresh batch.

There is slight compensation for the undesirable effect of storage and return of heat by the inner layers of the wall—the average heat loss through the walls is slightly lower. This may be taken advantage of in the case of a furnace which operates during the day shift only, or which closes down for the week-end. If the process permits, the furnace may be charged at the close of its working period and the doors made tight; the cold charge will chill the furnace, and induce inflow of heat until the charge has reached the temperature of the furnace interior. With a fairly long period of interruption, the heat absorbed by the charge is responsible for noticeable reduction in the external heat losses, and economy of time and fuel may be effected.

Effect of Insulation.—The heat stored by an insulated wall at its working temperature is always much less than by an uninsulated wall giving the same total heat loss. This arises from the much smaller weight of material in the insulated wall, due in turn to the thinner wall and the low weight per cubic foot of insulating materials.

For a wall made up of materials of different diffusivity (see p. 283) it is not possible to apply the approximate rule given for heat loss and absorption during heating. However, the diffusivity of diatomaceous and porous clay brick may not be widely different from that of firebrick, since the conductivity and density of these materials in many cases decrease approximately in proportion. On the other hand, the diffusivity of block insulation may be under one-half that of firebrick.

If differences of diffusivity may be ignored, the above rules apply directly.

Otherwise, differences of diffusivity and conductivity can be allowed for only by using a more complicated expression for the total heat loss.

To determine the heat stored in the wall when steady flow has been established, a direct calculation should be made, using the temperature, specific heat, density, and thickness of the different materials forming the wall.

Furnaces Operated Intermittently.—In these furnaces, a considerable part of the heat loss may be due to heat which is stored, and then either largely or completely lost between operations. It may be seen, from the rough rules for estimating the time of heating and the quantity of heat stored, that for furnaces operating on short time cycles, the loss by storage alone is likely to be greater than the steady flow loss during the cycle; and that the storage loss may greatly exceed the heat usefully transferred to the stock.

Complete analysis of problems involving storage loss requires complex mathematical (or graphical) treatment beyond the scope of this book. The general indications of such calculation may be discussed as follows.

(a) According to the laws of steady heat conduction, for a given material, the thicker the wall the less will be the heat flow when steady conditions are reached.

(b) For a given material, the thinner the wall the less will be the storage loss.

(c) The total loss by conduction during a cycle is the sum of the losses (a) and (b); for a given furnace temperature, and for a given heating and cooling cycle, there is a particular wall thickness, for a given material, which will yield a minimum combined loss by transmission and storage. The shorter the cycle, the thinner is the wall which will yield the minimum heat loss.

(d) Use of an insulating refractory as the inner lining of a furnace, where permissible, greatly reduces the heat loss. For the same thickness, the steady heat flow loss may be about one third of that for firebrick, and the storage loss is reduced in approximately the same ratio.

(e) *Addition* of insulation outside a given refractory lining would be effective in reducing the steady state heat loss; but it would be much less effective in reducing the combined storage and transmission losses for a short cycle operation—for a very short cycle, temperature penetration might be so slight as to render the insulation almost useless. On the other hand, *replacement* of the outer layer of refractory by an equal thickness of insulation would show commensurate reduction of storage and transmission

losses. Thus, to be properly effective in short cycle furnaces, insulation should be placed as close to the furnace interior as possible.

(f) A thinner wall will lead to a more rapid initial rise of the inner surface temperature, but a slower subsequent rise because the maximum inner temperature will be lower than for a thicker wall. A thinner wall may therefore permit an earlier start for an operation which requires a preheated furnace—or it may delay the start.

Effective insulation will always lead to a more rapid rise of the inner temperature.

Heating of Metal.—When stock is heated, the temperature of the interior always lags behind the temperature of the surface. The extent of this lag, which governs the permissible rate of heating, is determined by the rate of heat transfer to the surface of the stock, the time from the commencement of heating, and the shape, size, and diffusivity of the stock. For mathematical consideration see the following General References: Chapter I., No. 4, Chapter V., Nos. 1, 2 and 3.

IV.—HEAT LOSS IN FOUNDATIONS.

Estimation of these heat losses presents a problem of extraordinary difficulty. Calculations on the basis of unsteady heat flow, graphical methods, laboratory experiments with models measuring electrical or hydraulic flow, and elaborate temperature measurements of the actual furnace foundations may provide an approximate solution.

During the initial heating of a new furnace, when unsteady heat flow prevails, the heat loss is at its maximum, the heat being absorbed in warming the foundations and surrounding soil. Steady flow conditions may not be even approached for several months. When conditions approximate to steady flow, most of the heat flowing into the earth finds its way to the surface and is lost by convection, radiation, etc. Any heat not so transmitted corresponds to unsteady flow and serves to warm up the earth in the indefinitely increasing temperature field of the foundations.

Steady Heat Flow Through Foundations.—Keller¹ has contributed a valuable mathematical study of the heat losses in unventilated hearths. Under conditions of approximately steady

¹ Keller, J. D.: "The Flow of Heat Through Furnace Hearths," *Transactions Am. Soc. Mech. Eng.*, Vol. 50 (1928), FSP-50-37.

heat flow, the heat loss per square foot of hearth (internal area) may be expressed by the formula

$$q = \frac{3}{D}(t_1 - t_0) \text{ B.Th.U.'s or C.H.U.'s,}^1$$

where D is the internal diameter or least internal width of the hearth measured in feet, t_1 and t_0 are the internal hearth temperature and the atmospheric temperature, respectively. The value $3/D$ corresponds to K , the over-all conductivity of the equation on p. 280, and may be used in comparing the heat losses under conditions of steady flow with the corresponding loss for ventilated hearths.

We may interpret one of Keller's conclusions rather loosely by saying that the heat loss through a solid foundation, under conditions of steady flow, is approximately the same as would be found for a well ventilated fireclay brick hearth equal in thickness to one quarter of the least internal diameter of the hearth. For calculation the given equation is preferable.

The equation is for furnaces with a side wall thickness equal to $\frac{1}{4}D$, and for the hearth raised a distance $\frac{1}{4}D$ above the ground level. Keller finds that increasing the wall thickness to $\frac{1}{2}D$ reduces the heat loss through the hearth by 5 per cent. ; decreasing the thickness to $\frac{1}{8}D$ increases the loss by 8 to 10 per cent. ; but raising the hearth level does not have much effect until the level has been raised to a distance $\frac{1}{2}D$. When the "hearth" is submerged, as in the case of the bottom of a flue or regenerator chamber, the steady heat loss will naturally be less.

In order to calculate the relation between temperature and depth at points vertically below the centre of the hearth, Keller derived a formula which may be written

$$z = 1.2D \log_{10} \frac{t_1 - t_0}{t_z - t_0}$$

where z is the distance below the hearth ; D is the least internal diameter of the hearth ; t_1 , t_0 and t_z are the hearth temperature, the atmospheric temperature, and the temperature on the vertical axis of the hearth at the depth z . The most valuable application

¹ The quantity, 3, is the product, SC , of two constants :— S is a shape factor which is equal to 0.333 for a circular hearth, 0.367 for a square hearth, and which for rectangular hearths decreases with the length of hearth from the value for a square hearth to 0.311 for a very long rectangular hearth ; C is the mean coefficient of heat conductivity of the hearth materials and surrounding earth. The values used in the above formula are $S = 0.333$, and $C = 9$ heat units per sq. ft. per inch of thickness per degree. In special cases, other values of the product SC may be used.

of this formula is in calculating the minimum thickness of fireclay brick necessary to ensure a safe temperature at the upper surface of the concrete. Assuming a maximum permissible temperature for concrete to be 900° F. (480° C.), we may use this value for t_z , 60° F. (15° C.) for t_0 , assign values for t_1 , and calculate the corresponding values of z in terms of D .

The following values have been so calculated for temperatures t_1 of 1600° F., 900° F. and 500° F.

Hearth temperature, t_1 .	3000°F. (1650°C.)	2500°F. (1370°C.)	2000°F. (1090°C.)	1500°F. (820°C.)	1000°F. (540°C.)
Brick thickness, z , for a temperature, t_1 , of 1600° F.,	0.34 <i>D</i>	0.24 <i>D</i>	0.12 <i>D</i>
Thickness for $t_2 = 900°$ F.,	0.65 <i>D</i>	0.56 <i>D</i>	0.44 <i>D</i>	0.28 <i>D</i>	0.06 <i>D</i>
Thickness for $t_2 = 500°$ F.,	0.99 <i>D</i>	0.89 <i>D</i>	0.77 <i>D</i>	0.62 <i>D</i>	0.40 <i>D</i>

These figures show that for medium temperature furnaces operating continuously, if disintegration of the surface of the concrete is to be avoided (900° F. maximum), the thickness of firebrick should be approximately one half of the hearth diameter.

The Effect of Insulation on the heat loss through a hearth may be determined from the ratio of the standard brick equivalent thickness of the uninsulated hearth to that of the insulated hearth. The equivalent thickness, in inches, of the uninsulated hearth is $\frac{10}{K} = \frac{10}{3/D}$ or $\frac{10D}{3}$ (Footnote p. 280, and p. 289), where D is measured in feet.

The equivalent thickness of the insulated hearth is $\frac{10D}{3} + d(n - 0.9)$, d being the actual thickness of the insulation in inches, n being the standard brick equivalent for the material, and 0.9 being the standard equivalent of the firebrick which has been replaced by insulation. We may now write

$$\frac{q'}{q} = \frac{\frac{10D}{3}}{\frac{10D}{3} + d(n - 0.9)}$$

$$\text{or } q' = \frac{1}{1 + \frac{3d(n - 0.9)}{10D}} q$$

q' and q being the rates of heat loss per hour per square foot of hearth for the insulated and uninsulated hearths, respectively. If, for example, the insulation consists of 4 inches of insulating concrete (standard brick equivalent per inch equal to 4), the formula becomes

$$q' = \frac{1}{1 + \frac{3.7}{D}} q$$

and for hearth diameters of 5 feet, 10 feet, and 15 feet, the reduction in the heat loss would be 42.5 per cent., 27 per cent. and 20 per cent. respectively, all based on the heat loss for the corresponding uninsulated hearth. It is concluded that the larger the hearth, the less effective will be the use of insulation in reducing the heat loss per square foot of hearth. The method of calculation assumes the most favourable condition, where the insulation is close to the surface of the hearth. In practice, in order to avoid overheating of the insulating material, the latter must frequently be placed at a considerable depth below the surface of the hearth; for a maximum permissible temperature of 1600° F. (870° C.) see table on p. 290. The increased area of the insulating material, measured perpendicular to the direction of heat flow, renders the insulation less effective as the depth increases.

Unsteady Heat Flow into Foundations.—Keller also gives a means of calculating the rate of heat absorption and temperature penetration before steady flow has been established. In a particular illustration, he shows that, during the time taken to heat the foundations, the heat loss from the hearth is considerably greater than for steady flow, and is 10 per cent. greater even after a period of six months of continuous furnace operation.

It is evident that conclusions pertaining to steady flow conditions must not be applied directly to furnaces operated intermittently. The temporary stoppages for repairs in a continuously operated furnace may probably be disregarded, because the temperature field under the foundations changes extremely slowly, and there would be little interruption of steady flow conditions.

With intermittent operation, the following points are especially noteworthy.

(a) The heat loss to the foundations per hour of operation will be greater for an intermittently operated furnace.

(b) Temperature penetration into the hearth will be less than

for steady flow, consequently the thickness of firebrick necessary to protect insulating material and concrete will be less.

(c) Insulation is relatively more effective in an intermittently operated furnace.

V.—HEAT LOSS BY WATER COOLING.

In some modern high temperature furnaces the quantity of heat lost in cooling systems is very large. These losses may be determined either by direct measurement or by calculation.

Direct Measurement.—Any experimental determination is better than a calculated value, provided that field measurements are reasonably dependable and that they may be made without difficulty. The heat carried away by water lends itself excellently to direct determination. The rate of flow is determined by diverting the water from the outlet pipe into a receptacle for a measured interval of time. This gives the rate of flow in gallons or cubic feet per hour (by calculation from the diameter and depth of water in the receptacle), or in pounds per hour (by weighing the receptacle empty and then with the water collected). The temperature rise is found by taking the cold water temperature (at any convenient outlet) and the hot water temperature. The heat carried away per hour is given by—

$$\begin{aligned} q &= \text{lbs.} \times t \\ &\text{or cu. ft.} \times 62.4 \times t, \\ &\text{or U.S. galls.} \times 8\frac{1}{3} \times t, \\ &\text{or Imperial galls.} \times 10 \times t, \end{aligned}$$

t being the temperature rise in either °F. or °C. (q being in the corresponding unit), and the water quantity being the flow in 1 hour.

Where large quantities of water are used, a meter may be used to measure the flow.

Calculation.—In some cases the heat lost to the cooling water is easily calculated without experiment; in other cases calculation is impossible. Two simple and fairly common cases will be considered first.

Exposed Water-cooled Surface.—If the surface of a water-cooling element be exposed directly to the furnace interior, it will receive heat by radiation from the hot surfaces of the furnace. According to Fig. 32, at a surface emissivity of 0.8 the cold surface will receive 200,000 B.Th.U.'s (110,000 C.H.U.'s) per sq. ft. per hour from a furnace interior at 3000° F. (1650° C.). The amount

of heat radiated from the cold surface to the furnace interior is too small to be worth considering ; for example, Fig. 32 shows that at a temperature of 450° F. (230° C.) the cold surface would return to the furnace 1000 B.Th.U.'s (550 C.H.U.'s) per sq. ft. per hour, which is only one half of one per cent. of the heat received.

Experiments on steel melting furnaces show that this figure of 200,000 B.Th.U.'s (110,000 C.H.U.'s) per sq. ft. per hour is correct. It is true that this method of calculation is not quite correct, because some heat will be received by gas and flame radiation, and some by convection ; but the agreement between calculated and observed values shows that surface radiation is the predominant cause of heat loss in this case.

This is by far the biggest rate of heat transfer considered up to the present, and the cooling surface must be able to absorb and carry away heat at this rate. In spite of the high coefficient of conductivity of mild steel, 410 B.Th.U.'s (410 C.H.U.'s) per degree per sq. ft. per inch thickness per hour, there will be a big temperature difference between inner and outer surfaces of the steel. For $\frac{3}{8}$ inch thick steel plate, if the temperature difference between inner and outer faces is t ,

$$\begin{aligned} \text{then} \qquad 200,000 &= \frac{410t}{\frac{3}{8}} \text{ or } t = 183^\circ \text{ F.} \\ 110,000 &= \frac{410t}{\frac{3}{8}} \text{ or } t = 101^\circ \text{ C.} \end{aligned}$$

Again, on the inner surface, heat is transferred from the plate to the moving water by forced convection. This transfer follows a law similar to that for forced convection of gases, but for the same velocity α_c is normally at least 500 times as great. The probable formation and condensation of steam bubbles is another important factor in heat transmission from steel to water, and under the conditions considered, is more likely to assist than to retard heat flow. Depending on the design of the water cooling element and the flow of water, a fairly large temperature difference may be set up between the inner surface of the frame and the water. The life of exposed cooling frames and the reliability of welds are undoubtedly influenced by these factors.

In illustration, if we represent the temperature difference between the water and the inner face of the steel by t' , and if we take the coefficient of convection from steel to water to be 500,

$$\begin{aligned} 200,000 &= 500t' \\ \therefore t' &= 400^\circ \text{ F. (220}^\circ \text{ C.)} \end{aligned}$$

If the water temperature is, for example, 100° F. (40° C.) it is thus possible for the inner and outer surfaces of the steel pipe to be at temperatures of 500° F. (260° C.) and 680° F. (360° C.) respectively.

Protected Water-cooled Surface.—Suppose a plane water cooled surface to be covered with a 2-inch layer of silica brick (Fig. 42), but otherwise exposed to the furnace interior under conditions similar to those for the bare surface previously considered. Suppose t_1 and t_2 are the temperatures of the two surfaces of the brick layer. The problem is solved by a trial method which is greatly simplified because we can predict very closely the temperatures t_1 and t_2 . Owing to the low conductivity of brick compared with the high rate of heat transmission by radiation at elevated temperatures, t_1 will not be very much lower than the average furnace temperature. As a result, the rate of heat flow will be much smaller than for a bare water cooled surface, and consequently the difference between t_2



Fig. 42.

(the brick-steel interface) and the water temperature will be much smaller than before.

For a furnace interior temperature of 3000° F. (1650° C.), as a first approximation suppose that the water temperature is equal to 100° F. (or 40° C.). The heat flow can now be calculated on the basis of simple conduction through the silica brick. At an average temperature of $\frac{3000 + 100}{2} = 1550^\circ \text{F.}$ ($\frac{1650 + 40}{2} = 845^\circ \text{C.}$), we find from Fig. 26 (p. 215) that $k = 13$.

$$q = \frac{13 \times (3000 - 100)}{2''} = 18,800 \text{ B.Th.U.'s per sq. ft. per hour,}$$

$$q = \frac{13 \times (1650 - 40)}{2''} = 10,500 \text{ C.H.U.'s per sq. ft. per hour.}$$

We use this approximate figure for q to find the real value of t_1 . As in the previous example, the wall receives 200,000 B.Th.U.'s (110,000 C.H.U.'s) by radiation from the hot surfaces. As it conducts

only about 18,800 B.Th.U.'s (10,500 C.H.U.'s) it must radiate back to the furnace about 180,000 B.Th.U.'s (100,000 C.H.U.'s), and according to Fig. 32, at an emissivity of 0.8 the temperature t_1 must be a little over 2,900° F. (1600° C.). q is now recalculated from the conduction formula with this value for t_1 , and it is found to be very slightly lower than the first approximation at 18,200 B.Th.U.'s (10,100 C.H.U.'s).

The calculation shows the great advantage of covering a water cooled surface with refractory, no matter how thin the layer. A 2-inch covering of brick is seen to reduce the heat loss to less than one tenth. Even 1 inch of brick would reduce the loss to one fifth, and the temperature rise from the water to the outer surface of the steel is decreased approximately in proportion.

Unevenly Cooled Brickwork.—Where pipes are used as cooling elements, the protection will not approximate to that illustrated

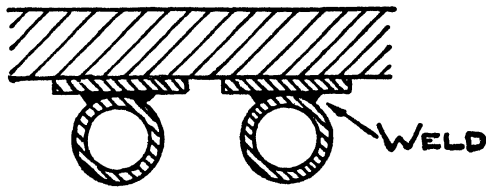

Fig. 43.

in Fig. 42 unless the pipes are spaced very close together. Where the spacing is wide, calculation is not dependable; and although graphical solutions may help, the estimation of heat loss appears to be a clear case for direct measurement.

The practical advantages of pipes as water cooling elements may be combined with those of the water jacket as shown in Fig. 43. Strips of steel plate are welded to the side of the pipe which faces inwards. The weld presents a large contact surface between plate and pipe, and the plate provides good and continuous contact between the wall and the cooling element; this construction facilitates bricklaying. In the author's experience these tangential fins, if not unduly long, show no tendency to burn off.

Effect of Water Cooling on Furnace Efficiency.—The object of water cooling is to preserve the furnace structure and prolong the life of the refractories. There has been some controversy concerning the effect on heat losses. Bare cooling elements certainly cause great heat loss; for a covered surface, the effect is less evident.

Comparing two walls of equal thickness operating under identical

conditions, one wall water cooled and the other uncooled, the inner face of the uncooled wall will at first reach a slightly higher temperature. This will cause more rapid erosion of the uncooled wall until the inner temperature of the two walls is the same, the rate of heat loss through the thinner uncooled wall being then equal to that through the thicker water cooled wall. The effect of water cooling is therefore to cause rather greater heat loss only during the earlier part of the furnace life. Thermally, this disadvantage of water cooling is usually outweighed by the better condition of the brickwork, and the consequent reduction of leakage resulting from open joints, partly collapsed brickwork, and warped doors and door frames. In addition to this, water cooling may lead to better combustion conditions by preserving the shape of the burner openings. The presence of cooling elements may, on the other hand, render the protected brickwork inaccessible for hot repairs.

VI.—HEAT LOSS THROUGH OPENINGS.

In the previous section, it was stated that the loss by radiation to a bare water cooling element is about 80 per cent. of the black body rate at the temperature of the furnace interior—the remaining 20 per cent. is reflected from the surface of the cooling element back to the furnace interior.

For a large opening in a thin walled furnace, there can be practically no reflection of the heat which passes through the opening—the heat is permanently lost to the furnace, and heat radiated from the surroundings through the opening to the furnace interior is negligible. It might be expected, therefore, that rate of heat loss through an opening would correspond almost to black body radiation from the hot furnace lining, with some additional radiation from the still hotter flame.

In practice, it is found that the rate of radiation through openings is always less than the black body rate. Fig. 44 is used to illustrate one reason for this. The diagram on the left represents an opening in a furnace having a very thin front wall. A person standing in the space marked "shadow" would not be able to see any portion of the hot furnace interior, and no direct radiant heat would be received in this space. Bounded by the shadows caused by the wall thickness, there will be a wide angled pyramid (for a rectangular opening) embracing all points which are reached by light, and therefore by direct radiant heat from the furnace. Comparing

an opening of this type with the opening shown on the right of Fig. 44, it is evident that the thicker walls of the latter will cast a bigger shadow, *i.e.* they will intercept more heat. Heat shadows are not so sharp as light shadows, because the sides of the opening reflect to the outside some of the heat received from the interior, and also radiate heat according to the surface temperature of the sides. Part of the reflected and re-radiated heat reaches the so-called shadow. On the other hand, even in the "radiation angle," there is partial screening by the walls, this being least at the centre, and increasing towards the edges. Another reason for radiation falling below the black body rate is that, with a large opening, the furnace interior no longer radiates as a black body.

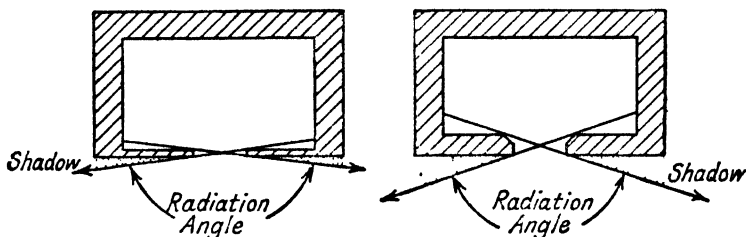

Fig. 44.

It has been found for steelmaking furnaces that the rate of loss through large openings, such as open furnace doors, is approximately the same as the loss to a bare cooling element inside the furnace. Consequently, for large openings of this type, the heat loss per square foot per hour may be evaluated from Fig. 32 (the radiation nomogram) using the temperature of the furnace interior and an emissivity¹ of 0.8.

Dependence of Heat Loss on Dimensions of Opening.—The shape of the opening, and also the ratio of the diameter of the opening to the thickness of the wall, determines what proportion of radiant heat is intercepted by the edges of the opening. For openings smaller than doors of normal dimensions, an emissivity of 0.8 may not be acceptable for calculation. Curves are given by Hottel and Keller² for the emissivity of openings of various shapes and

¹ Use of the word "emissivity" in connection with an opening is hardly correct, but it satisfactorily expresses the meaning.

² Hottel, H. C., and Keller, J. D.: "Effect of Re-radiation on Heat Transmission in Furnaces and Through Openings," *Transactions A.S.M.E.*, 1933, IS-55-6, pp. 39-49.

having diameters up to six times the wall thickness ; the following table is based on these curves.

"Emissivity" of Furnace Openings.								
Shape of Opening.	Ratio $\frac{\text{Diameter or Least Width}}{\text{Thickness of Wall}}$.							
	0.01	0.1	0.2	0.5	1	2	4	6
Circular,	0.02	0.10	0.18	0.35	0.52	0.67	0.80	0.86
Square,	0.02	0.11	0.20	0.36	0.53	0.69	0.82	0.87
Rectangular,								
2 : 1,	0.03	0.13	0.24	0.43	0.60	0.75	0.86	0.90
Very long slot,	0.05	0.22	0.34	0.54	0.68	0.81	0.89	0.92

The values given assume the sides of the opening to be perpendicular to the wall. For openings which are rounded or bevelled on the inside, the emissivity will be greater than given in the table if the total wall thickness is used in obtaining the ratio—or will be less if only the parallel sided portion of the opening is considered to be the thickness of the wall at the opening.

When the brickwork of a furnace has expanded along the inner face while the cool outer face remains unexpanded, the red hot interior portions of the wall may be visible through the open joints—in high temperature furnaces when the brickwork is in poor condition this may even give the impression that the joints are open to the furnace interior. In such cases, the emissivity corresponds to a small ratio for a long slot. It is interesting to note that the loss from these joints may be less than might be imagined from the amount of light visible. If, for example, the visibly hot part of the joint is $\frac{1}{32}$ " wide and is at a depth of 6 inches from the outer wall surface, the ratio of least width of opening to thickness of wall is about 0.005. The emissivity of a long slot having this ratio is about 0.03, and if the temperature is 2000° F. (1100° C.), we find that the heat radiated per square foot of actual opening is nearly 2000 B.Th.U's. or 1100 C.H.U's. (obtained by reading Fig. 32 for an emissivity of 0.3 and dividing by 10). If the wall has six and a half linear feet of glowing joint per square foot of wall surface, the actual area is $6\frac{1}{2} \times \frac{1}{32} \times \frac{1}{12} = 0.017$ sq. ft. The heat loss due to direct radiation is therefore 2000 B.Th.U's. \times 0.017 = 34 B.Th.U's. (19 C.H.U's.) per square foot of wall. This is likely to be a small proportion of the total heat loss from a wall in the condition envisaged.

VII.—HEAT TRANSFER TO CHARGE OR STOCK IN A DIRECT FIRED FURNACE.

Heat transfer to the material on a furnace hearth takes place by a series of rather complicated exchanges. Some of these exchanges may be evaluated tolerably well; but others can be discussed only on a qualitative basis.

Direct Heat Transfer.—Transfer of heat from flame to furnace lining and to the material being heated takes place by convection and by gas radiation.

(1) *Convection.*—If we apply the nomogram for forced convection in a pipe, we shall find that in most cases, due to the large diameter and rather low velocity (in normal feet per second), the apparent coefficient of forced convection will be considerably under 1.5. The subsidiary scale of Fig. 29 is therefore used, giving a convection rate which does not greatly exceed 1. As will appear later, this value is very small compared with the coefficients of gas and flame radiation; and so far as concerns the walls and arch of the furnace, there appears to be no condition which might falsify this conclusion.

It may be pointed out that, although α_0 is normally small, most of the damage caused to furnace roofs by faulty operation results from heat transfer by convection. When a flame is deflected directly on to the roof or wall of a furnace, the effect of impingement is to increase α_0 ; also replacement of the relatively cool gas layers by the very high temperature gases of the flame causes an enormous further increase in the heat transfer. If the roof cannot absorb and conduct this heat away quickly enough, it will be "burnt" (i.e. melted).

Again, if the joints of the roof are not tight, the static pressure at the top of the hot gas column will cause an escape of hot gases through the joints. These gases will ordinarily be hotter than the more or less stationary layers existing under a tight roof. The joints, being narrow, are equivalent to extremely small diameter pipes, lying outside the range of the convection nomogram. α_0 under these conditions will be decidedly larger than the general value inside the furnace, and rapid fusion and enlargement of the joints will result. If gas combustion continues in the joints the damage will be much more rapid, due to the still higher temperature.

Apart from abnormally high local convection due to bad operating conditions, the rate of convection to the hearth may be greatly increased due to the nature of the material being heated. For example, during the melting of a tangled mass of scrap, the flame cuts down into the metal and finds channels through the scrap itself. This often causes, locally, an increased convection rate. The mechanism of convection is now more closely allied to that from a gas stream to a series of objects placed in the stream,

than to convection from a stream to the walls of its containing duct. Data have not been given in this book for convection of this type, but under these conditions the diameter of the obtruded objects (together with the gas stream velocity) determines α_C . An idea of the magnitude of α_C may be obtained from Fig. 29 (convection nomogram), using the general diameter scale to denote the average diameter of the material being heated. The value found for α_C must be multiplied by 4 to allow for the effect of impingement.¹ The convection coefficient cannot properly be calculated in these circumstances owing to the indeterminate nature of the variables. If, however, the normal velocity of the gases in the stock were 1 ft. per sec., and the mean diameter of the stock were 1 inch, then Fig. 29 shows α_C to be 0.58, and multiplying this by 4 according to the above rule, we obtain a convection coefficient of 2.3. With a normal velocity of 3 ft. per sec. and an average stock diameter of $\frac{1}{2}$ inch, α_C would be nearly 8.

While the value of α_C , as illustrated above, may be greater than the general value for the furnace, there is another factor which is very much more effective in increasing the rate of heat transfer to stock lying on the hearth. This is the large increase in surface area offered to this type of heat transfer. The rate of heat transfer, q , is a function of the *product* of α_C multiplied by the exposed area.

Convection to materials being heated on a hearth will vary in degree according to the freedom offered to the passage of gas currents, the diameter and surface area of the stock, etc. The heating of ore on a hearth, annealing of small castings piled high, brick burning, etc., all manifestly may afford widely different opportunities for convection.

Activity in a melted batch is another cause of greatly increased convection heat transfer. During a "boil," slag and metal may be set in motion, varying from a wavelike ripple to violent projection of molten material into "spouts" or columns a foot or more in height. Heat transfer in the latter case follows the

¹ The factor 4 is applied to the value as read from the nomogram, even though this value is under 1.5. However, if the final value after multiplication be still under 1.5, then this final value should be replaced by that read from the subsidiary convection scale of the nomogram.

The factor ordinarily varies between 3 and 6, 4 being a typical value. The value is greater for small diameters and low velocities, and is in less degree dependent on the temperature. For calculation of heat transfer by convection to a bundle of pipes transverse to the gas stream, see General Reference 2 or 3 of Chapter V. (Reference 2 gives a more complete correlation of data, but Reference 3 will be found easier to use).

law for a gas flowing past a series of small diameter pipes, giving a favourable convection coefficient combined with a very large area. Secondary splashing from the bath is probably a valuable source of increase in the convection transfer.

(2) *Gas Radiation*.—Carbon dioxide plus water vapour radiation may be readily evaluated from Fig. 35. It will be found that, covering a wide range of metallurgical furnaces (excluding those of small size), the value for $\alpha_{G.R.}$ will vary between 10 and 40. This large figure indicates the greater importance of gas radiation as compared with convection except when the latter occurs under conditions which are extremely favourable.

There is, however, an important factor tending to minimise the value of gas radiation as compared with convection. In heat transfer by convection, it was seen that the effective area of material being heated might be much in excess of the hearth area. According to the laws of surface radiation, the area effective in receiving heat by radiation is the area of a convex surface which would cover the material being heated. That is, increased area due to voids, channels or holes in the charge cannot be taken into account, excepting in so far as they may cause some small increase in the emissivity. When a material is being heated on a hearth, it follows that the radiant area does not ordinarily exceed the area of the hearth. Where the stock is heated in a vertical position, as occurs in the heating of ingots in a soaking pit or the annealing of castings, the area of the vertical sides should be added to the horizontal surface of the stock, but this increase of area is not of the same order of magnitude as that obtained in the case of convection.

(3) *Luminous Flame Radiation*.—Luminosity will always produce great local increase in the heat transfer coefficient. The size of the luminous part of the flame will influence the average increase in $\alpha_{G.R.}$. Where luminosity is achieved at the expense of flame temperature, the smaller temperature difference will in some measure offset the higher value of $\alpha_{G.R.}$

Temperature Difference.—The rate of heat transfer to each square foot of furnace interior is obtained by multiplying the total heat transfer coefficient, α , by the temperature drop from furnace gases to walls. The wall temperatures may be determined fairly closely, but evaluation of the gas temperature presents greater difficulty.

The cooler gas layers near the roof and walls have the same composition as the main gas stream, and hence they both radiate

and absorb heat. They will therefore (being hotter than the wall) radiate some heat to the walls; but (being cooler than the main gas body) will also absorb part of the heat, radiated from the main gas body, which would otherwise have reached the wall. These cool layers may thus act as a buffer, interposing resistance to direct heat transfer from flame gases to walls. The value of α for non-luminous gas radiation depends therefore on a mean gas temperature which is decidedly lower than that of the flame gases.

The radiations from a luminous flame include all wavelengths. Only certain ranges of wavelength can be partially intercepted by cool carbon dioxide and water vapour layers, consequently luminous radiation may be calculated in accordance with the actual temperature of the luminous flame.

A well directed flame, sweeping along the hearth, will increase the convection rate. In addition to this, it will also sweep out cool gas layers above the hearth, and so prevent interference with gas radiation. At the same time, such a flame will foster the reverse conditions on the roof, which will be desirable in the case of high temperature furnaces.

Indirect Heat Transfer.—In most furnaces, the stock is at a lower temperature than the walls and roof of the furnace, at least during much of the time. Of the heat directly received by the furnace brickwork, the larger quantity is normally transferred by surface radiation to the stock, and the balance is lost by conduction through the walls.

Suppose, for example, that the roof and walls of a furnace are at a temperature of 2000° F. (1100° C.) and that the surface of the stock is at a temperature of 1500° F. (820° C.). Suppose, for the present, that the furnace gases are perfectly transparent to radiant heat; then taking the emissivity of the stock to be 0.8 we may calculate the amount of heat received by the stock from the walls and roof. Fig. 32 may be used, or more conveniently Plate I, Scale 6, from which we find that α_R at the average temperature of $\frac{2000 + 1500}{2} = 1750^\circ \text{F. (960}^\circ \text{C.)}$ is 61, giving a heat transfer of $61 \times 500 = 30,000$ B.Th.U's. ($61 \times 280 = 17,000$ C.H.U's.) per hour per square foot of stock. The calculated quantity of heat received by the stock is contributed by the entire surface of the walls and roof—an area which is normally a good deal larger than the area presented by the stock. If the area of the stock is, for example, one-third of the area of

the walls and roof, then the heat received per square foot, of stock will have been radiated from 3 sq. ft. of indirect heating surface, or the heat radiated per square foot of the latter will be $\frac{30,000}{3} = 10,000$ B.Th.U's. $\left(\frac{17,000}{3} = 5700$ C.H.U's.) per hour.

Plate II shows that at an equivalent brick thickness of 12 inches and an internal surface temperature of 2000° F. (1100° C.), the heat loss through the walls would be 1290 B.Th.U's. (720 C.H.U's.) per sq. ft. per hour. It is clear, therefore, that in this case most of the heat received by the walls from the flame is transferred to the charge, only a little over 10 per cent. escaping through the wall.

Transfer from the wall of this quantity of heat (10,000 + 1290 = approx. 11,300 B.Th.U's. or 6400 C.H.U's.), implies that the wall receives an equal amount by convection and flame radiation. If the total transfer coefficient from flame to walls were 50, this would require a mean temperature drop from flame to walls of $\frac{11,300}{50} = 226^\circ$ F. $\left(\frac{6400}{50} = 128^\circ$ C.), an entirely feasible condition.

The accompanying illustrative table is based on similar calculations, the area of the hearth being again taken as one-third of the indirect heating surfaces. The figures give the number of B.Th.U's. per square foot per hour radiated from these surfaces and, on the present assumptions, each square foot of hearth would receive three times these quantities by surface radiation.

Wall and Roof Temperature.	Heat loss by conduction through a 12" wall.	Heat radiated per square foot of roof and wall surface to stock at various temperatures.					
		2900° F.	2400° F.	1900° F.	1400° F.	1000° F.	500° F.
3000° F., . . .	2050	7500	(35,000)	(52,000)	(62,000)	(65,000)	(68,000)
2500° F., . . .	1670	...	4600	21,000	31,000	34,000	35,000
2000° F., . . .	1300	7,900	11,500	15,000	16,000
1500° F., . . .	950	1,300	4,700	6,500

Figures placed in parenthesis show that the indicated combination of stock and wall temperatures could not be maintained under actual conditions. As mentioned above, the heat radiated from the walls, plus the relatively small quantity of heat lost by conduction through the walls, implies an equivalent reception of heat from the flame and furnace gases. It may be shown that, at a wall temperature of 3000° F., the exceptionally

high figures in parenthesis would demand a rate of heat transfer from the flame not obtainable at working temperatures and normal values of α . It is inferred that, with a charge cooler than 2400° F., the furnace roof and walls could not remain at so high a temperature as 3000° F., but must cool off until a balance is reached between heat received and heat dispensed. Depending on the type of furnace, some of the other figures may be similarly impossible.

The interior temperature of the roof and walls of a well constructed direct fired furnace will almost inevitably exceed the stock temperature. This may be attributed to the fact that the brickwork has had time to reach its mean equilibrium temperature, while the heat absorbing capacity of the stock keeps the temperature of the latter at a lower level. An exception to this rule is found when the rate of heat transfer from the flame is cut to the very low figure which can be entirely accounted for by loss through the walls. Such factors as air infiltration and water cooling are not considered in this connection.

Many interesting problems arise in connection with this complex study of heat transfer in a direct fired furnace.

1. *Limitations Imposed by Working Temperature of Refractory.*—Referring to the figures tabulated above, it is seen that the rate of heat transfer from walls to stock shows a rapid decline as the stock temperature approaches that of the brickwork. For rapid heating, in order to make the best use of this extremely important surface radiation, it is therefore desirable to maintain the highest possible temperature of the brickwork. In the case of very high temperature furnaces, it may be necessary, at the end of a heat, to restrict heat transfer from the flame to a figure appropriate to the working temperature of the refractory—the surface may then play but a small part in the heat transfer to the batch.

In such furnaces it is common practice to construct the roof sufficiently thin for the interior surface to be kept at a safe temperature. The heat loss through a 12-inch silica brick roof with an internal temperature of 3000° F. (1650° C.) is 2650 B.Th.U's. (1470 C.H.U's.) per sq. ft. per hour (Table XVII and Plate II). Calculation shows that with a 3 : 1 wall to hearth ratio, if the roof is able to radiate to the charge without interference, complete insulation of the roof would result in a temperature rise of the inner surface of only 35° F. (19.5° C.), all of the heat previously lost then being passed to the hearth. In practice, flame interference will check the rate of surface radiation assumed

in the calculation; but the great value of a relatively small increase in the working temperature of a refractory is apparent. Experiments, with insulated silica brick roofs in very high temperature furnaces, show that it is the more gradual temperature drop through the brick, rather than the very slightly higher surface temperature, which may cause trouble due to deeper slag penetration with consequent lowering of the melting point to a considerable depth beneath the surface of the brick; the deteriorated refractory may then be severely melted by accidental flame impingement.

As a corollary to the advantage of increasing the brick equivalent thickness of the walls, may be mentioned the disadvantage of permitting the brickwork of doors to become too thin, particularly in the extreme case where the door temperature drops below that of the hearth.

2. *Effect of Wall (and Roof) to Hearth Ratio.*—The heat received per square foot of hearth (the smaller enclosed surface), by radiation from roof and walls (the larger enclosing surface), is fixed by the brick and hearth temperatures, and is practically independent of the ratio of wall to hearth area (p. 235). Suppose the temperatures of hearth and walls are such that each square foot of hearth receives from the walls q heat units per hour. With a wall to hearth ratio of 3 : 1, each square foot of wall will be able to get rid of only $q/3$ heat units by radiation. With a ratio of 2 : 1, the walls could get rid of $q/2$, an increase of 50 per cent. This would permit either a higher rate of heat transfer from the flame, or heavier insulation of roof and walls, with no increase in the working temperature of the brick. From these considerations it should follow that, in very high temperature furnaces, the smaller the chamber the faster the furnace will operate in the high temperature period.

In low temperature furnaces the reverse conditions should obtain for a similar reason. A wall of large surface relative to the hearth cannot transfer so much heat per square foot, because the heat receivable by the hearth is limited by the area of the hearth itself. The wall temperature will therefore rise due to heat received until, at the higher temperature, the walls are able to radiate to the hearth all of the heat received, except that lost by conduction. This would also apply in the high temperature furnace if a higher brick temperature were permissible. Naturally these considerations are subordinate to questions of cost, extreme heat loss from the surface, combustion requirements, etc. The wall

surface area has another important effect, mentioned on the following page.

3. *Available Heat—Temperature of Outgoing Gases.*—While the present study concerns the laws governing rate of heat transfer in furnaces, it must be remembered that the conclusions drawn are valid only when taken in conjunction with the quantity of heat which is actually available to the furnace. This quantity of heat is the amount of heat supplied and developed in the furnace by combustion, less the amount of heat removed from the furnace by the products of combustion at the lowest theoretically possible temperature, *i.e.* the temperature of the charge. The heat actually transferred, including losses through the walls, is governed by the heat supplied and the sensible heat of the gases at the actual outlet temperature.

Temperature of Outgoing Gases.—Theoretically, calculations are possible on the rate of temperature drop in the flame, actual quantity of heat transferred to the furnace, etc.; but these require a knowledge of the progress of combustion within the furnace. In general, the earlier combustion takes place in the furnace, the greater will be the heat transfer and the lower will be the exit temperature of the waste gases. If it were possible for the theoretical maximum temperature of the flame to be developed instantaneously at the burner for a batch-type furnace the outgoing waste gases would be hotter than the furnace temperature by the amount,

$$(\text{Theoretical maximum temperature} - \text{mean furnace temperature}) \times x$$

The factor x depends on the coefficient of heat transfer, α , of the furnace; the total area, A , of the walls and hearth; the specific heat, c , of the furnace gases; and the volume of the furnace gases, v , in normal cubic feet passing through the furnace per hour. The quantity $\frac{\alpha A}{cv}$ may be evaluated, and the approximate value of x^* is then obtained from the tabulation:—

$\frac{\alpha A}{cv}$	0	1	2	3	4	5	6	7	8	9	10
x	1	.37	.14	.05	.018	.007	.0025	.0009	.0003	.0001	.00004

$$* x = \frac{1}{e^{\alpha A/cv}} \text{ or } \log_{10} x = \frac{-0.43 \alpha A}{cv}$$

If, for example, $\alpha = 50$, $A = 4000$ sq. ft., c at the furnace temperature $= 0.026$, $v = 20,000 \times 60$,

$$\text{then } \frac{\alpha A}{cv} = \frac{50 \times 4000}{0.026 \times 20,000 \times 60} = 6.4$$

From the table, x is approximately 0.0015. If the furnace temperature at a particular moment was 2800°F . and the theoretical flame temperature was 4800°F ., then the exit gases would be hotter than the bath by only

$$(4800 - 2800) \times 0.0015 = 3^\circ\text{F. } (2^\circ\text{C}).$$

Another example may be taken by way of contrast :—

$\alpha = 10$, $A = 40$, $c = 0.023$, $v = 300 \times 60$, furnace temperature $= 1500^\circ\text{F}$., theoretical flame temperature $= 2800^\circ\text{F}$. In this case $\frac{\alpha A}{cv} = 0.97$, whence $x = 0.37$, and the exit gas temperature would exceed the furnace temperature by

$$(2800 - 1500) \times 0.37 = 480^\circ\text{F.}$$

These values are of interest only in so far as they show the best results even theoretically possible. With delayed combustion the exit temperature will be much higher. The temperature differences change very sharply with a change in the ratio $\frac{\alpha A}{cv}$. For example, if A (or α) were halved in the two illustrations, the excess of waste gas temperature over furnace temperature would amount to 80°F . and 800°F . respectively.

For these increases in outlet temperature, due to halving the area A , the extra sensible heat carried from the furnace could be calculated. Also, in a given case, the saving in heat loss by conduction through the walls, due to reduced area, is easily calculated. In the large high temperature furnace, it will be found that the smaller heat loss to the surroundings, with the reduced area, more than offsets the extra heat carried out at the higher exit temperature. In the small low temperature furnace example, the calculated tendency is in sharp contrast to the first example, an increase in area being desirable. Such calculations, of course, can only illustrate opposing tendencies, since they are based on hypothetical cases and do not take into account other important factors, such as the effect of area on indirect heat transfer to the stock.

4. *Effect of Heat Absorption by Furnace Gases.*—It has been assumed so far, that the furnace gases do not interfere with radiation to the hearth from walls and roof. This is far from true, as the gases will absorb radiated heat in proportion to their gas radiation coefficient. This does not affect the earlier conclusion that the hearth will, after allowing for loss by conduction, receive practically the whole of the heat transferred to the walls.

The disposal of a given heat quantity through a body of radiant gas demands, however, a higher wall temperature than would be indicated by a simple surface radiation calculation. According to the theory of heat exchange, the walls must supply heat to the gas, the heat quantity q in the equation

$$q = \alpha_{GR}(t_1 - t_2)$$

merely representing q_1 (heat from gas to wall) minus q_2 (heat from wall to gas). The total heat to be radiated from the walls is therefore equal to q_2 (returnable to the gases as a result of gas radiation exchange), plus the unabsorbable surplus q , after suitable allowance for loss through the walls.

If, for example, q_2 (the absolute heat quantity absorbed by the gases) is 25 per cent. of the total surface radiation, the wall temperature may need to be 125-350° F. (about 70-200° C.) higher to account for a given heat transfer to the stock. In practice, so large a rise would be checked by the falling value of q as the temperature difference ($t_1 - t_2$) between flame and wall decreased.

5. *Luminous Flame.*—It may be a reasonable conclusion from the previous section that, under some circumstances, a luminous flame covering too large an area is undesirable. We may make use of an extreme illustration. Suppose the flame exhibits 100 per cent. black body properties (i.e. it is a perfect radiator and also a perfect absorber) and that it covers the entire hearth. Neglecting the probably lower temperature of such a flame, it is evident that the heat transfer coefficient to the hearth, ranging from 100 to 400 according to the temperature, must be higher than attainable with any other type of flame. So far as concerns the hearth, this is ideal, but it is necessary to consider what is happening above the flame. The roof commences to receive heat at a very high rate, and owing to the opacity of the flame, it is not able to radiate to the cooler hearth, and can get rid of only a relatively small quantity by conduction. Its temperature will rise until it approaches that of the flame. If the flame temperature were low,

there would be no objection to this, but in the majority of furnaces it would not be admissible. It follows also, that although a less luminous flame would give a much lower heat transfer coefficient, there would be considerable compensation due to heat transfer from walls to hearth.

Although a non-luminous flame radiates heat corresponding to certain wavelengths only, when heat from such a source is absorbed by a surface, the wavelength distribution of the heat energy radiated back is determined only by the nature and temperature of the surface. Consequently a non-luminous flame can never reabsorb more than a fraction of the heat which it has transferred to the walls. On the other hand, if the emissivity of the walls is 0.8, 20 per cent. of the heat striking the surface is reflected without change of wavelength, and this must be largely reabsorbed by the gas body.

It has been assumed that the temperature does not depend on luminosity. This is true when the luminosity is obtained by the addition of a small quantity of hydrocarbon without other adjustment. If the luminosity is obtained by poor mixing, then a limit may be reached where the higher value of α is offset by the lower temperature difference between flame and furnace. For example,

$$q = 60(2400^\circ \text{ F.} - 2200^\circ \text{ F.})$$

is no better than

$$q = 30(2600^\circ \text{ F.} - 2200^\circ \text{ F.})$$

Large batch type furnaces are particularly well adapted to benefit by a luminous flame. In these furnaces the luminous flame rarely extends over more than one-half the hearth. The roof over the luminous flame can receive heat at a high rate and radiate this heat obliquely to cooler portions of the upper furnace and through the less opaque parts of the flame at the flue end. If the furnace is regenerative and subject to periodic reversals of the flame, the advantages are even greater.

The rotary kiln is another furnace which, for a different reason, can benefit to the full by a luminous flame. Here the lining of the kiln stores heat which it cannot radiate, the temperature naturally rising. Then, as the heated surfaces rotate to the bottom, they give up their heat to the charge by actual contact.

For a rolling mill furnace Schack found, by a combination of experiment and calculation, that of the heat received by the billets, 54 per cent. was due to direct gas radiation, 34 per cent. to furnace-vault radiation, and 12 per cent. to convection. For this type of furnace he suggests the following equation for

determining the heat transfer coefficient for temperatures over 1800° F. (1000° C.) :—

$$\begin{aligned} \alpha &= 10 + 0.06(t - 1300) & . & . & \text{Fahrenheit} \\ &= 10 + 0.1(t - 700) & . & . & \text{Centigrade} \end{aligned}$$

t being the gas temperature.

In conclusion, it is necessary to state that the treatment given in Section VII of this chapter is not rigidly mathematical, and that such calculations as have been attempted are merely illustrative.

SUMMARY.

1. *Standard Brick Equivalent.*—Silica, chrome and fireclay bricks have, at low to moderate temperatures, a coefficient of conductivity of approximately 10 heat units per square foot of area per inch of thickness per degree of temperature difference. This mean value of 10 is selected as the conductivity of an arbitrary standard brick. At any temperature, 1 inch thickness of any material may be expressed, from a conductivity point of view, as an equivalent thickness of standard brick.

Table XVII gives, for important materials, the equivalent thickness in inches of standard brick per inch of material. At common working temperatures, some typical values taken from the table are :—

1 inch of fireclay brick is equivalent to 1 inch of standard brick.

1 inch of silica brick is equivalent to 0.75 inch of standard brick.

1 inch of chrome brick is equivalent to 0.85 inch of standard brick.

1 inch of magnesite brick is equivalent to 0.4 inch of standard brick.

1 inch of silicon carbide brick is equivalent to 0.1 inch of standard brick.

1 inch of diatomaceous (calcined) brick is equivalent to 4.5 inches of standard brick.

1 inch of insulating block is equivalent to 13.5 inches of standard brick.

1 inch of diatomaceous (raw) brick is equivalent to 13.5 inches of standard brick.

1 inch of diatomaceous earth (powder) is equivalent to 20 inches of standard brick.

Values for other materials are given in the table and also on pages 270-273.

2. *Determination of Heat Loss through a Wall.*—The wall thickness is expressed in terms of the equivalent of standard brick. Using the interior temperature and this equivalent thickness, we may then read the heat loss directly from Plate II.

3. *Additional Uses of Plate II.*—In addition to showing directly the heat loss through a wall, Plate II indicates :—

(a) The temperature of the outer surface of the wall (p. 268).

(b) The temperatures of the interfaces between different materials comprising the wall (p. 268).

(c) It may be used in the design of walls (p. 276).

(d) Other resistances to heat flow (radiation, convection and gas radiation resistances) may be expressed as brick equivalents (Plate I, Scale 7), and added to the equivalent wall thickness in using Plate II.

(e) Cases where inner and outer wall areas differ widely may also be handled (p. 276).

4. *Over-all Conductivity.*—This constant, K , multiplied by the difference between inside temperature and atmospheric temperature, gives the heat loss per square foot per hour through the wall,

$$q = K(t_1 - t_0).$$

K is found as follows :—Obtain the equivalent wall thickness, add 4, and divide 10 by the result (p. 280).

Another useful form of the equation is $q = \frac{10}{d}(t_1 - t_0)$, where d is the sum of all the equivalent brick thicknesses of the heat transmission.

5. *Heat Storage.*—During heating of a furnace, the structure absorbs much heat which, in general, is not recoverable. The heat lost in heating a wall may be expressed very roughly as

$$2 \times \frac{d^2}{8} \times q,$$

where d is the actual wall thickness in inches, and q is the normal hourly heat loss through the walls. Of this quantity about $\frac{1}{4}$ is

stored in the wall and $\frac{1}{4}$ represents the average heat loss to the surroundings during the preheating period of $d^2/8$ hours.

6. *Water Cooling*.—Where convenient, heat loss to water cooling is best measured by direct experiment. A bare cooling element receives heat from the hot walls approximately in accordance with surface radiation laws, using an emissivity of 0.8. This heavy loss may be greatly reduced by even a very thin covering of brick, and bare cooling elements should be avoided wherever possible.

7. *Heat Losses through Openings* are approximately equal to the losses for directly exposed water-cooled elements.

8. *Heat Transfer to Stock in Direct Fired Furnaces*.—In a direct fired furnace, by a process of exchange, the stock receives heat from combustion—

- (a) by convection from the hot gases,
- (b) by radiation from non-luminous flames,
- (c) by radiation from luminous flames,
- (d) by surface radiation from roof and walls. The heat so radiated primarily reaches the brickwork through processes (a), (b) and (c).

Convection may account for considerable heat transfer when the stock presents a large surface and affords channels through which the hot gases may pass. Where the surface of the charge is unfavourable to convection, this form of heat transfer may be relatively unimportant.

Non-luminous gas radiation is always a highly important source of heat transfer, since all flames contain a considerable amount of carbon dioxide or steam, or more usually, both.

Luminous flames show a far higher coefficient of heat transfer than non-luminous flames. The great value of this type of flame may be tempered by smallness of the luminous portion of the flame, and by a lower flame temperature where luminosity is achieved by delayed combustion.

Tentative values of α for direct heat transfer from flame to bath are :—

Convection under unfavourable conditions, α_c a little over 1; under favourable conditions α_c per square foot of hearth may be very greatly increased.

Gas radiation $\alpha_{g.B.} = 10$ to 40.

Luminous flame α up to 100 or more, depending on size and

temperature of the flame, the value for α applying to the entire hearth area.

(Black body radiation α_R up to 250).

In general, the roof and walls of a direct fired furnace receive from the flame far more heat than is lost through the brickwork. This leads to a brick temperature somewhat higher than the hearth temperature in order that the surplus heat received by the brickwork shall be radiated back and largely absorbed by the charge. With a highly luminous flame, the importance of this indirect heat transfer is less.

General Reference :—

1. A. Schack : *Industrial Heat Transfer* (translated by H. Goldschmidt and E. P. Partridge).

CHAPTER VII.

HEAT EXCHANGERS.

In all batch type furnaces, where the entire charge reaches the finishing temperature at the same time, the waste gases must escape from the combustion chamber at a somewhat higher temperature than the working temperature of the furnace. Even in continuous furnaces, where the charge enters the cold end of the furnace and travels continuously towards the hot end, practical considerations usually lead to a high exit temperature of the waste gases. Amongst continuous furnaces, shaft and blast furnaces constitute a notable exception. Here, the combination of excellent heat transfer obtained by intimate contact of the furnace gases with the charge, and absence of radiation from hot to cold end of the furnace, usually permits a low escape temperature.

In metallurgical and other furnaces, the utilization of waste heat carried from the furnace by hot products of combustion presents a problem of great importance. In this chapter we are concerned with the utilization of this heat to preheat the air used for combustion in the furnace. This return of waste heat to the furnace results in important fuel and other savings; it produces in some cases metallurgical as well as economic advantages, and in a few cases it is essential to the commercial success of the process.

Recuperation and regeneration, the two means of effecting heat transfer from waste gases to air, each has its own well established field of usefulness; and in addition there is a fairly wide field where either one or the other may be used, depending on particular conditions.

In a recuperator, the hot waste gases and the cold air are led through separate channels in close contact, the heat being transferred from the waste gas to the air through partitions separating the two sets of channels.

Regenerators operate on a different principle. The hot waste gases pass from the furnace through one of a pair of chambers

filled with checker brickwork. After a period, varying from a few minutes to an hour or more, depending on the type of furnace, the waste gases are cut off from this chamber and passed through the second chamber, usually for an equal length of time. Cold air for combustion is passed through the chamber not at the time being heated, and it extracts heat from the hot checker work before entering the furnace. Maintenance of a continuous supply of preheated air is achieved by reversing valves which permit periodic diversion of air and waste gas to the appropriate chambers.

The hot blast stoves used for heating the air supplied to a blast furnace are also classed as regenerators. The temperature of the top gases from the blast furnace is much too low for useful exchange of sensible heat. These gases, however, contain 20 to 30 per cent. of carbon monoxide and a little hydrogen, and by burning part of the gases in a combustion chamber built into the hot blast stoves and then passing the hot products of combustion through the checkerwork of the stoves, the regenerative principle is applied for preheating the blast.

In some types of regenerative furnace (blast furnace stoves, continuous rolling mill furnaces, etc.), the direction of the flame through the furnace does not change. A complication in this type of furnace is that reversing valves are necessary on the hot side of the heat exchanger as well as on the cold side. In other types of regenerative furnace (open hearth furnaces, soaking pits, etc.) the direction of the flame reverses with each reversal of the valves. A disadvantage of this reversal through the furnace is that both ends of the furnace must be designed to permit free outlet of the furnace gases—an arrangement which, in general, is not consistent with efficient burner design, but which has some compensating advantages.

Recuperators offer certain advantages as compared with regenerators. The continuous flow of waste gas and air, without periodic reversal, is an obvious operating advantage. The chambers need not be built in pairs. Heat exchange is not dependent on the heat storage capacity of the system, consequently the interior brick construction of a recuperator may and should be built of thin tile. The regenerator, on the other hand, depends on absorption and storage of heat by the brickwork, and consequently the actual weight of brickwork is important in the second type of heat exchanger.

While the recuperator offers advantages in simplicity of operation, its success is dependent on the gas tightness of the

partitions separating waste gas from air. With reference to brick construction, tightness is only a relative term. For high temperature furnaces (where there is usually considerable fluxing action due to dust and slag carried over from the furnace), and for furnaces operated intermittently (causing repeated expansion and contraction of the brickwork), eventual excessive leakage is inevitable, and tile recuperators are then not satisfactory owing to poor preheat and loss of draught. The most important furnaces in the high temperature regenerative class are open hearth furnaces, large glass melting tanks, steel mill soaking pits, and regenerative coking ovens. Furnaces of less importance include the gas-fired crucible furnace. Again, furnaces using air at pressures appreciably above that of the atmosphere (more than a fraction of an inch of water) must use regenerators rather than refractory recuperators. For example, the use of refractory recuperators would be quite out of the question for preheating the air used in the blast furnace, or with those types of water-gas generator which employ heat exchangers.

It will be shown later that when tile recuperators are in question, the pressure restrictions may seriously hinder achievement of the most satisfactory heat transfer conditions. On the other hand, in the recuperator, the two sets of passages may be designed to suit the individual needs of air and waste gas; whereas the same passages of a regenerator serve alternately for waste gas and for air, and the design is therefore a compromise.

The lighter construction of the recuperator has an advantage in the time taken to bring the heat exchanger up to its operating temperature. This would be a big advantage in a furnace operating with frequent stoppages; but, owing to leakage troubles, tile recuperators cannot be used under these conditions. It is sometimes claimed as an advantage of regenerative furnaces that the greater amount of heat retained by the regenerators during a stoppage results in a time economy when operations are resumed. This argument is used frequently in favour of heavily constructed checkers instead of thinner brick. The contention however does not appear to be sound. During a stoppage extending over a few days or more, the heavier construction must result in greater absolute heat loss, because the inner temperature of the chamber will fall more slowly, resulting in a more sustained heat loss through the walls. Thus, after relighting the furnace, although the heavier checker will be hotter, it will have to receive more heat than the lighter checker before it can be brought to its original temperature.

The furnace with the heavier checker can usually be started a little sooner, but it will work sluggishly for a time, and it appears that the sharper working of the light checker, during the first few days, will more than compensate for a delayed start. The extreme case occurs when the stoppage is so long that the checkers become quite cold. Here, the lighter checker will undoubtedly have the advantage. Similarly, the recuperator will have the thermal advantage over the regenerator. In some furnaces, however, the heat retained by a regenerator during a short shut down is of value, because it permits easier and safer relighting of the furnace due to the instant supply of hot air. Heavy checkers are better able to store heat during the high temperature phases of a batch operation, the heat being returned to the furnace during low temperature phases. This is an advantage in that extreme rise of checker temperature is avoided; but in a melting furnace, for example, the advantage of faster melting during the low temperature period is usually outweighed by the slower response of the checkers to rising temperature during the high temperature period.

Another point decidedly in favour of the regenerator is its greater robustness against abuse. If a recuperator is heated above its normal working temperature, no matter for how short a time, it will expand in accordance with the peak temperature. Such peaks may be caused by permitting too long a flame in the furnace, by interrupting the charging of a continuous furnace, by overloading the furnace, by stopping the air supply, etc., and after a few repetitions a leaky condition will result. Extreme cases may even cause failure of the tile due to overheating. The regenerator, on the other hand, cannot suffer by a little added expansion and contraction; the greater mass of brickwork permits better absorption of heat, checking extreme rise of temperature; and a certain amount of slagging or fusion is not very serious. In selection of a recuperator, whether refractory or metallic, it is the highest temperature which may be achieved under adverse conditions which must be considered. Thus, although the partitions will normally lie between waste gas and air temperatures, it must be recognised that peak temperatures equal to the maximum waste gas temperature are possible.

For attaining high temperatures from combustion of low calorific value gaseous fuels (producer and blast furnace gases), it may be necessary to preheat the fuel gas as well as the air. For this purpose, tile recuperators are unsuitable because gas leakage,

itself wasteful, would cause combustion in the excess air of the waste gases, and would very rapidly cause fusion of the brickwork, resulting in ever-increasing leakage. There would also be other practical difficulties. For preheating fuel gases, regenerative systems are therefore employed.

It may be concluded that for small furnaces and for furnaces where no great benefit would accrue from the substitution of regenerators, the recuperator is to be preferred. For low temperature work, cast iron or steel recuperators may be used. For medium temperature work, the use of heat-resisting alloy recuperators is extending rapidly. Silicon carbide recuperators have also been used, these of course not being subject to the same temperature restriction as metallic recuperators. In the silicon carbide type of recuperator, leakage may be considerably reduced, and in the metallic type, leakage may be practically eliminated. Expense is the main consideration at present restricting the use of these recuperators to more or less small furnaces, for which purpose they have many definite advantages. Tile recuperators cannot be used for intermittently fired furnaces.

In addition to the rather well marked fields served separately by each of the two types of heat exchanger, there is a wide field served by, alternatively, either type. This field includes rolling mill heating and forge furnaces, glass making furnaces (excepting large tanks, which are regenerative), and zinc distilling furnaces.

I.—FACTORS GOVERNING HEAT TRANSFER IN RECUPERATORS AND REGENERATORS.

Some of the conditions determining heat exchange are common to both types of heat exchanger, and these will be considered first. Other considerations peculiar to each type will be studied under the appropriate headings. Heat transfer in heat exchangers is governed by the laws described in Chapter V, but calculations require special application of these laws.

Convection.—The rate of gas to wall heat transfer by convection per hour is given by

$$q = \alpha_c A (t_1 - t_2)$$

α_c being the heat transfer coefficient, A the area of wall surface exposed, and t_1 and t_2 the gas and wall temperatures. It has been explained that the value of α_c for convection in a flue is dependent

on a "dead" gas film adhering to the walls, and that the value of α_c may, in general, be expressed by

$$\alpha_c = 0.31 \frac{V_0^{0.8}}{D^{0.25}} \quad . \quad . \quad . \quad . \quad (17)$$

where V_0 is the gas velocity referred to standard temperature and pressure and D is the flue diameter in feet. For checkers having lateral opening, as frequently used in regenerators, the law determining α_c is not quite the same, the values for the constants in the above formula being different (see page 225). The ensuing discussion, however, is not affected by these differences.

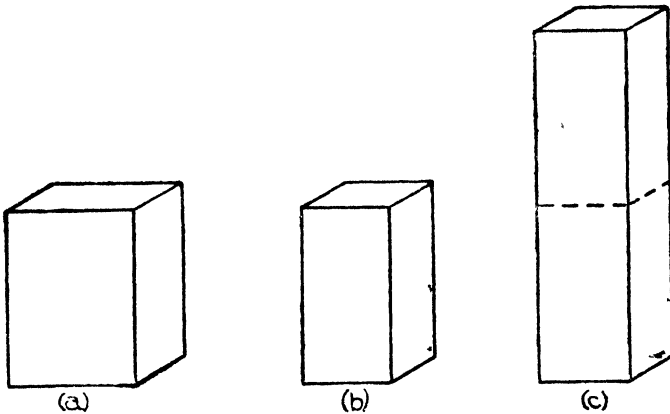

Fig. 45.

It is evident from the formula that α_c increases with the velocity (V_0), and that it also increases as the diameter (D) decreases. To obtain the maximum value for α_c then, it is necessary to attain as high a velocity as possible in the heat exchanger flues, and to make the diameter of these flues as small as possible. The extent to which these objectives may be carried will be determined by draught considerations and the increased tendency for small passages to choke up. These factors in recuperator and regenerator design are considered later.

In Fig. 45, *a* represents a recuperator or regenerator chamber of given volume; *b* represents a chamber having one-half the plan area of chamber *a*, but equal in height; *c* represents a chamber equivalent to two of the chambers *b* placed one on top of the other. The flues within the three chambers are supposed to be identical in cross section. In referring to "height," it is supposed here

that air and waste gas are travelling without change of direction, in upward and downward directions respectively. Cases of horizontal flow, cross flow, etc., are governed by identical principles.

Now if V_0 is the gas velocity in chamber a , for the same total gas flow the velocity in chamber b will be $2V_0$, since the velocity equals the volume of gas flow per second divided by the area of cross section. The velocity in c will also be $2V_0$, since the area of cross section is the same as in b . It follows from Equation 17 that in b and c , α_c will be $2^{0.8} = 1.74$ times the value for chamber a . But in b , by cutting the plan area in half, we have halved the area of the flue surface which is effective in heat exchange. It is naturally a high rate of exchange per hour, q , which is desired, and this is directly proportional to the area A as well as to α_c . Thus, other things remaining equal, the heat transfer is a function of the product $\alpha_c A$. In case b , the higher value of α_c is more than offset by the 50 per cent. decrease in A , and the product $\alpha_c A$ is only 0.87 of the value for a . In case c , A remains as in a , so that the product $\alpha_c A$ is in fact increased 1.74 times, and from a thermal point of view a real advantage would be achieved. If the type of flue or checker is predetermined, the surface area is proportional to the volume of the chamber, and volume may be substituted for A in determining the effect of chamber shape and height.

It is evident, then, that statements to the effect that the higher the gas and air velocities in the heat exchanger the higher will be the heat transfer, are, to say the least, misleading, unless the even more important factor of heat exchanging surface is considered. For a given flue construction, any decrease in plan area to give increased velocity, must be accompanied by extra height to give equal or greater heat transfer. Owing to the increase in α_c , however, the increase in height need not be proportional to the decrease in plan area, so that economy of volume may always be attained by increased height. In the design of heat exchangers, it is one of the designer's tasks to decide, for a given value of $\alpha_c A$, when the reduction of cost for a smaller chamber is offset by the extra cost and operating troubles consequent on the additional draught necessitated by increased velocity and height. The economic limit may of course be determined by such factors as available height; the depth to which it is possible to excavate before reaching water level; and less economical construction of the containing chamber as the length, breadth and height dimensions become more unequal.

A difficulty in economical recuperator construction is apparent; α_c cannot be greatly increased by the use of higher velocity on account of the extra pressure necessary and the leakage which would result.

Diameter of Channels.—Again ignoring practical considerations, it is instructive to investigate the effect of reducing the diameter of the channels. For purposes of illustration, a straight flue type of regenerator is considered. The reasoning may of course be extended equally to recuperators. Fig. 46, *a* and *b*, represents cross sections through the passages. The linear dimensions of *a* are exactly double those of *b*.

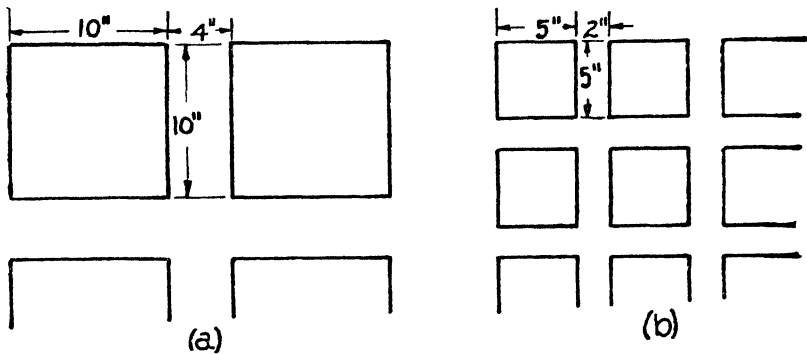

Fig. 46.

Converting the diameters to feet, it is found that the values of $\frac{1}{D^{0.25}}$ are 1.05 and 1.24 respectively, giving a ratio of about 1.2. For the same total ground plan (and hence the same velocity in the flues), it is seen that there is approximately a 20 per cent. improvement in *b* as compared with *a*.¹

For the same ground plan, the total perimeter of the ducts in Fig. 46*b* is exactly double that for *a*, and for equal height of the chambers the exposed surface is also double. The heat exchange characteristic $\alpha_c A$ in *b* is therefore $1.2 \times 2 = 2.4$ times that in *a*, showing an increase of 140 per cent.

Gas Radiation.—Convection is supplemented by gas radiation for gases which contain carbon dioxide, water vapour, hydrocarbon gases, etc. In metallurgical practice, this practically confines

¹ For checkers α_c is proportional to $\frac{1}{\sqrt[3]{D}}$, which will show a 25 per cent. improvement instead of 20 per cent.

consideration of gas radiation to the waste gases and to fuel gases. The calculation for waste gases may be made exactly as explained in Chapter V. For fuel gases such as producer gas and mixed coke oven and blast furnace gas, there are difficulties which make heat transfer calculation very uncertain. Firstly, simplified data like those for carbon dioxide and water vapour are not at present available for the other gases; secondly, decomposition of hydrocarbons in the regenerator is responsible for much solid carbon radiation; and thirdly, the chemical reactions taking place between the different gases at high temperatures cause temperature changes which would make calculation of the heat, q , very difficult even if α were known. It is certain, however, that the rate of heat transfer for gases containing hydrocarbons is higher than for waste gases.

While the convection rate is practically independent of temperature, and is therefore the same at the inlet and outlet ends of the heat exchanger channels, the rate of gas radiation increases with the temperature. In making calculations on heat exchangers, it is therefore necessary, as a first approximation, to assume temperatures at inlet and outlet ends of the heat exchanger. The average gas and wall temperatures are then found. $\alpha_{G.R.}$ may be obtained from Fig. 35, by using a temperature mid-way between the average gas and wall temperatures.

The accompanying table is used in illustration of the magnitude of the gas radiation coefficient (from Fig. 35) for waste gas under different conditions. The same table gives the convection coefficient (from Fig. 29) for purposes of comparison, the convection values being for air or gas in straight flues, not in checkers.

GAS RADIATION AND CONVECTION IN HEAT EXCHANGERS.

Diameter of Channel.	GAS RADIATION.			CONVECTION.		
	Average Temperature.			Velocity V_0 .		
	500° F. (260° C.)	1000° F. (540° C.)	1500° F. (815° C.)	1 ft. per sec.	5 ft. per sec.	10 ft. per sec.
3", . . .	0.4	1.2	2.3	1.1*	1.6	2.8
6", . . .	0.6	1.7	3.2	1.1*	1.4	2.4
9", . . .	0.8	2.1	4.0	1.1*	1.3	2.1
12", . . .	0.9	2.6	4.8	1.1*	1.3*	2.0

* The values have been taken from the subsidiary scale in Fig. 29, in accordance with the explanation given on p. 223.

The gas radiation figures are for flue gas containing 14 per cent. CO_2 and 8 per cent. H_2O , a brick emissivity of 0.8 being used in obtaining the values. It is seen that, excepting at abnormal combinations of high velocity in narrow ducts, and low temperatures, the values for gas radiation are decidedly greater than those for convection. Broadly speaking, over the range given, halving the duct diameter decreases the radiation coefficient to $\frac{2}{3}$ of its original value. On the basis of Fig. 46, however, the smaller ducts will give twice as much total surface for the same size chamber. The rate of heat transfer, *i.e.* the product of $\alpha_{\text{G.R.}}$ multiplied by A , will therefore show an increase of $\frac{1}{3}$. It follows that a reduction in the size of the channels produces, for the same total height and area of cross section, some advantage with respect to gas radiation, but not nearly so much as was shown for convection.

The coefficient of gas radiation due to moisture in the air falls a little outside the range of Fig. 35. The values may be estimated from Table XVIII.

TABLE XVIII.—STEAM RADIATION AT LOW DP VALUES.

DP .	Temperature F.				Temperature C.			DP .
	1000°F.	1500°F.	2000°F.	2500°F.	500°C.	1000°C.	1500°C.	
0.5	.1	.2	.3	.4	.1	.3	.4	0.5
1	.2	.4	.6	.8	.2	.5	.9	1
1.5	.3	.6	.9	1.2	.25	.8	1.3	1.5
2	.4	.8	1.1	1.5	.3	1.0	1.7	2

In the table, DP again represents the product of the channel diameter (in feet) multiplied by the per cent. by volume of moisture present in the air. For compressed air, this product must be multiplied by the air pressure in atmospheres. Like Fig. 35, the table does not incorporate the emissivity of the exposed surface. For brick channels $\alpha_{\text{G.R.}}$ as estimated with the help of Table XVIII should be multiplied by 0.8.

Brick Thickness.—Brick thickness is the third factor governing heat exchange. In the recuperator, it is evident that the thinner the partition walls between air and hot gas channels, the less will be the resistance to heat transmission. In regenerators, on the other hand, the actual weight of brick is an essential factor

in the storage of heat during the waste gas period, and the discharging of accumulated heat during the cold air period. The effect of brick thickness being fundamentally different in the two cases, this subject will be discussed under the separate sections dealing with recuperators and regenerators.

II.—RECUPERATORS.

The three fundamentally different types of gas flow in recuperators are illustrated diagrammatically in Fig. 47. In each case it is understood that the recuperator is constructed of a large number of such ducts, built side by side.

The parallel flow type of recuperator (*a*) is subject to the obvious limitation that the air, being always cooler than the flue gas at the corresponding position, escapes at a preheat temperature below the final escape temperature of the waste gases to the

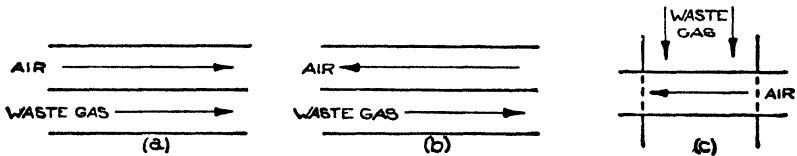

Fig. 47.

chimney. This system has therefore an inherently low efficiency. It has however one advantage, particularly when a metallic recuperator is used. The temperature of the dividing wall at any point lies between the temperatures of the waste gas and the air at that point. By having the cold air enter at the same end of the recuperator as the hot gases, the normal temperature of the metal at the hot end of the recuperator is kept to a minimum.

In the counter-flow type (*b*), cold incoming air is able to extract relatively low temperature heat from the partly cooled waste gases, and to receive its final preheat where the waste gases enter the system at their maximum temperature. This is evidently the most efficient arrangement, and provided the gas and air quantities are suitable, it is theoretically (but of course not practically) possible to achieve a perfect exchange of heat, with the escaping gas approaching the cold air temperature and the air preheat approaching the hot gas temperature.

A simple cross-flow recuperator (*c*) is in some respects intermediate between the other two types. In metallurgical furnaces, "cross-flow" recuperators are usually built so that the incoming air passes across the gas stream at the cool end, and then the warmed air is brought across the gas stream at a higher level (*i.e.* nearer the hot end) and so on backwards and forwards. Again, the air may pass straight up and the waste gases may be led backwards and forwards, or both gas and air may travel in this criss-cross fashion. This important type of recuperator has approximately the characteristics of the counter-flow type, and may be regarded as belonging to that class.

Calculation of heat transfer in recuperators is based on expression of the rate of heat exchange in three different ways, and then elimination of the unwanted quantities. The following notation is used :—

q = rate of heat exchange per hour,

t = temperature,

c = mean specific heat of gas or air over the temperature range to which it is applied. This is conveniently taken as the actual specific heat at the average temperature.

v = the volume of gas or air flowing per hour, measured under standard temperature and pressure conditions.

d = the thickness of standard brick (conductivity 10), equivalent to the over-all gas, *via* brick, to air resistance offered by the recuperator to heat transfer. The value, expressed in inches, is the sum of the individual brick equivalent resistances found in the recuperator.

A is the heating surface. The surfaces exposed to air and to waste gases are, for the present, considered to be equal. The effect of unequal surfaces will be explained later.

The suffixes g and a indicate gas and air respectively.

The suffixes i and o indicate inlet and outlet respectively.

The suffix m indicates the mean or average value.

For example, $t_{g.i.}$ indicates the inlet temperature of the gas, c_a is the mean specific heat of the air (between the air inlet and air outlet temperatures), $t_{a.m.}$ is the mean air temperature between the inlet and outlet ends of the recuperator.

For the heat given up by the waste gases per hour,

$$q = c_g v_g (t_{g.i.} - t_{g.o.}) \quad . \quad . \quad . \quad (p. 39)$$

For the heat received by the air per hour,

$$q = c_a v_a (t_{a.o.} - t_{a.i.})$$

In each case the higher of the two temperatures within the parenthesis is placed first.

For the heat actually transmitted through the recuperator partitions per hour,

$$q = \frac{A \times 10(t_{g.m.} - t_{a.m.})}{d}$$

The difference between the "mean" temperatures of gas and air constitutes the driving force behind heat transmission through the partition wall. These "mean" temperatures approximate in many cases to the average gas and air temperatures, $\frac{t_{g.i.} + t_{g.o.}}{2}$ and $\frac{t_{a.i.} + t_{a.o.}}{2}$, but in some cases there is a marked

difference. The values of the mean temperatures will be quite different for the three different types of recuperator. Here we shall consider only the most important class—counter-flow, including those cross-flow recuperators which have counter-flow characteristics.

Counter-flow Recuperators.—The most useful combination of the three equal expressions for q , gives the two equations,

$$t_{a.o.} = t_{g.i.} - (t_{g.i.} - t_{a.i.})f \quad . \quad . \quad . \quad (20)$$

$$t_{g.o.} = t_{a.i.} + (t_{g.i.} - t_{a.i.})f' \quad . \quad . \quad . \quad (21)$$

or equations similar to these in form.

The factors f and f' incorporate all the variables except q (which has been entirely eliminated), and the temperatures. These factors may be evaluated as follows:—

(1) Determine the constants a and b , representing the quantities grouped as shown:—

$$\text{For determining } f, a = \frac{10A}{dc_g v_g}, b = \frac{c_g v_g}{c_a v_a}$$

$$\text{For determining } f', a' = \frac{10A}{dc_a v_a}, b' = \frac{c_a v_a}{c_g v_g}$$

(2) Locate a (horizontal scale) and b (the series of curves) in Fig. 48 and read off f or f' on the vertical scale. This figure is reproduced from "Industrial Heat Transfer," to which the reader

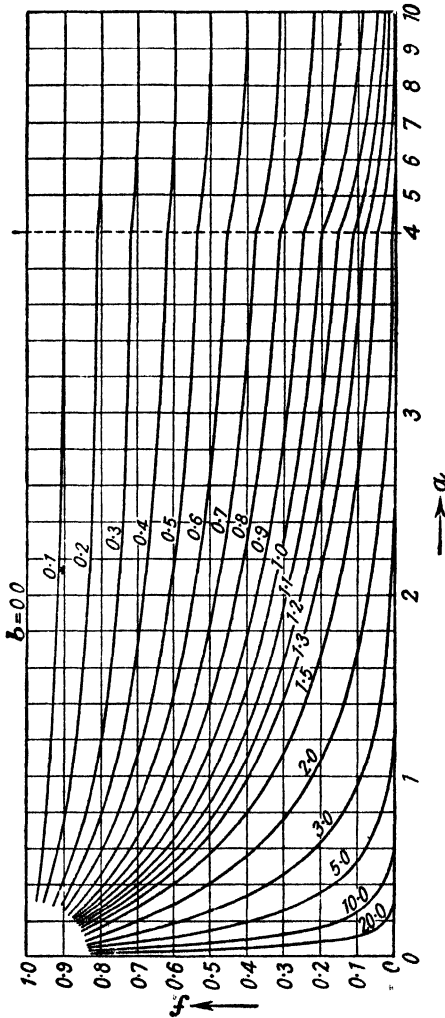

Fig. 48.—Heat Exchanger Factor. *

* Reprinted by permission from "Industrial Heat Transfer," by Schack, Goldschmidt and Partridge, published by John Wiley & Sons, Inc.

is referred for a detailed account of the mathematics and methods which are summarized and adapted here.

Illustrative Problems.—Further discussion of the physical principles involved in recuperation may be greatly simplified by

a concrete example. To facilitate reference, the problem and solution are summarized as follows:—

Given Data :—

	<i>Page</i>
Waste gas volume, 45,000 normal cu. ft. per hour,	328
Waste gas analysis, 14% CO ₂ , 8% H ₂ O,	329
Air volume, 28,000 normal cu. ft. per hour,	328
Gas and air velocities, 5 normal ft. per sec.,	,,
Diameter of gas flues, 6 inches,	,,
Diameter of air flues, 3 inches,	,,
Thickness of tile, 1½ inches,	,,
Heating surface, 600 sq. ft.,	,,
Waste gas inlet temperature, 2000° F. (1100° C.),	329
Air inlet temperature, 60° F. (15° C.),	,,

Calculated Values :—

Resistance to heat transfer expressed as equivalent brick thickness, <i>d</i> , 10·1 inches,	330
<i>f</i> , 0·40,	331
<i>f'</i> , 0·68,	,,
Temperature of air preheat 1225° F. (665° C.),	,,
Temperature of gases to chimney, 1380° F. (755° C.),	,,
Maximum brick temperature during normal operation, 1860° F. (1020° C.),	334
Efficiency of recuperator, 60 per cent.,	340
Recovery of total heat, 32 per cent.	,,

Data.—From the coal consumption and flue gas analysis, it is calculated that a furnace consumes 20,000 normal cu. ft. of producer gas per hour. Similarly, it is calculated that the quantity of secondary air used, including excess air, is 28,000 normal cu. ft. per hour, and the quantity of moist waste gas is 45,000 normal cu. ft. per hour.

A recuperator is used to preheat the air supplied to the furnace. The mean diameter of the gas flues is 6 inches, of the air flues 3 inches, and the mean brick thickness is 1½ inches. The mean heating surface is 600 sq. ft., and the tile is arranged for both gas and air velocities of 5 normal ft. per sec.

The waste gases containing 14 per cent. of CO_2 and 8 per cent. of H_2O enter the recuperator at a temperature of 2000°F . (1100°C .) and the air enters at 60°F . (15°C .)

It will be shown in the course of the calculation that, in the selection of this example, certain principles of good recuperator design have been ignored. It is planned in this way to lead up to a consideration of the improvement effected by adherence to the principles in question.

1. To Find the Exit Temperatures of Air and Waste Gas.—Step 1. Assume likely exit temperatures for gas and air. This is necessary in order to obtain heat transfer coefficients. If the final results prove too widely different from the assumed values, then the transfer coefficients may not be close enough, and the calculation must be regarded as a first approximation. By reason of their greater volume, the waste gases contain nearly twice as much heat as the air could absorb. It is therefore probable that the waste gases will escape at a temperature of at least 1100°F . (600°C .) The air preheat may reach 1300°F . (700°C .)

The mean waste gas temperature in the system would then be $\frac{2000 + 1100}{2}$

$= 1550^\circ\text{F}$. (850°C .), and the mean air temperature would be $\frac{60 + 1300}{2} = 680^\circ\text{F}$. (360°C .) The mean brick temperature will lie closer to the gas temperature because of the poorer heat transfer from the brick surface to air. 1300°F . (700°C .) is assumed. The problem is summarized in Fig. 49, the given data being shown in heavier type, and assumed data in normal type.

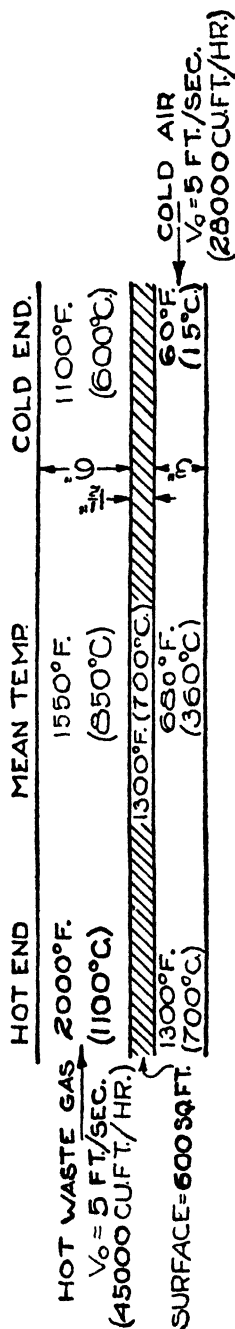

Fig. 49.

Step 2. Calculate the brick equivalent resistance of gas to air heat transfer for the mean temperatures.

(i) Waste gas to brick transfer.

The convection nomogram, Fig. 29, shows that $\alpha_c = 1.35$. This is greater than the value given in the subsidiary scale of Fig. 29, and is therefore accepted.

For gas radiation, DP for CO_2 is 7 and for H_2O is 4. At the mean gas-wall temperature of $\frac{1550 + 1300}{2} = 1425^\circ \text{F. (775}^\circ \text{C.)}$,

the gas radiation nomogram, Fig. 35, gives $\alpha_{\text{G.R.}} = 2.35 + 1.4 = 3.75$. This value must be multiplied by 0.8, the emissivity of brick, giving a value of 3.0. The combined heat transfer coefficient is $3.0 + 1.35 = 4.35$, and from Plate I, Scale 7, (or from $\frac{10}{\alpha}$), this is found to be equivalent to 2.3 inches of standard brick.

(ii) Wall resistance. At a temperature of $1300^\circ \text{F. (700}^\circ \text{C.)}$ 1 inch of firebrick is equivalent to 1.0 inch of standard brick (Table XVII, p. 266). The "wall equivalent" is therefore $1.0 \times 1.5 = 1.5$ inches.

(iii) Wall to air transfer. The coefficient of forced convection is 1.6, and the brick equivalent is therefore 6.3 inches (Plate I, Scale 7).

The total brick equivalent resistance of the transfer is,

Waste gas to brick	+	Conduction through brick	+	Brick to air	=	Total
2.3"		1.5"		6.3		10.1"

Step 3. Determine the quantities cv (the heat capacity per degree) of the air and waste gas :—

(i) The specific heat of air at $680^\circ \text{F. (360}^\circ \text{C.)}$ is 0.0187 (Fig. 1),

$$c_a v_a = 0.0187 \times 28,000 = 524$$

(ii) From the gas analysis and Fig. 1, the specific heat of the waste gas at $1550^\circ \text{F. (850}^\circ \text{C.)}$ is found to be 0.0218,

$$c_g v_g = 0.0218 \times 45,000 = 980$$

Step 4.

$$\begin{aligned} \text{(i) Evaluate } a &= \frac{10A}{dc_g v_g} = \frac{10 \times 600}{10 \cdot 1 \times 980} \\ &= 0.61 \end{aligned}$$

$$\text{and } a' = \frac{10A}{dc_a v_a} = \frac{10 \times 600}{10 \cdot 1 \times 525} = 1.13$$

$$\text{(ii) Evaluate } b = \frac{c_g v_g}{c_a v_a} = \frac{980}{524} = 1.87$$

$$\text{and } b' = \frac{c_a v_a}{c_g v_g} = 0.54$$

(iii) Determine f and f' from Fig. 48,

$$f = 0.40 \qquad f' = 0.68$$

Step 5. Determine the air and gas outlet temperatures,

$$\begin{aligned} \text{(i) } t_{a.o.} &= t_{g.i.} - (t_{g.i.} - t_{a.i.})f \\ &= 2000 - (2000 - 60) \times 0.40 \\ &= 2000 - 775 = 1225^\circ \text{ F.} \end{aligned}$$

$$\text{or } t_{a.o.} = 1100 - (1100 - 15) \times 0.40 = 665^\circ \text{ C.}$$

$$\begin{aligned} \text{(ii) } t_{g.o.} &= t_{a.i.} + (t_{g.i.} - t_{a.i.})f' \\ &= 60 + (2000 - 60) \times 0.68 = 1380^\circ \text{ F.} \end{aligned}$$

$$\text{or } t_{g.o.} = 15 + (1100 - 15) \times 0.68 = 755^\circ \text{ C.}$$

Step 6. Review the preliminary assumptions.

The original air preheat temperature guess was good, being only 75° F. (35° C.) in error, but the exit gas temperature assumed was 280° F. (155° C.) in error. A recalculation has been made on the basis of the temperatures found above, and then a final recalculation involving determination of the mean temperature on both sides of the brick partition. The final result showed a resistance of 9.8 inches, a corrected air preheat temperature of 1245° F. (675° C.) and a corrected waste gas exit temperature of 1360° F. (745° C.). It is concluded that the method is mathematically but little affected even by relatively large errors in the assumed temperatures. The reason for this is easily found by referring again to Step 2. By far the biggest resistance to the

heat transfer is the 6.3 inches equivalent of air convection, and this is entirely independent of temperature, consequently the closeness of our guess at the air outlet temperature did not contribute to the accuracy of the solution. The two minor resistances (gas to wall transfer, and conduction through wall) are dependent on temperature. Trial will show, however, that the gas and brick temperature guesses would have to be almost incredibly bad to account for an error of 5 per cent. on the total equivalent of the transfer. Errors in the estimated air temperature have no effect on d . Naturally, if the resistance of transfer to air is more nearly equal to that from waste gas, the effect of the inaccuracy in determining the latter increases.

Inaccuracy of the assumed temperatures may also affect the calculation slightly, through corresponding errors in determination of the specific heats of the gases.

2. Refinements of Methods of Calculation.—The method and example, as described, illustrate the general principles involved. Certain refinements may be desirable, or in some cases even essential, in order to arrive at a satisfactory solution.

Heat Transmitting Surface.—The high resistance of the brick to air transfer in the illustrative example (64% of the total of 9.8) makes it very desirable that the surface of the air ducts shall be as large as possible. In accordance with this principle, the air surface is nearly always considerably larger than the waste gas surface. In such cases, it is inaccurate to make use of the average area throughout in calculations, because this would not show the full proportionate reduction in the resistance to transfer on the air side of the recuperator tile. The most satisfactory method of allowing for the differences in area is to calculate on the basis of either air surface, waste gas surface, or average surface, making proper adjustment of the three resistances to allow for changes in area.

Suppose, for example, the surface areas in the example were 700 sq. ft. on the air side and 500 sq. ft. on the gas side. We will elect to use the average area of 600 sq. ft. in making the calculation. The brick equivalent of the wall resistance is again 1.5 inches (p. 330). The equivalent resistance of the waste gas to wall transfer is again 2.3 inches of standard brick per square foot of surface; but the waste gas surface per square foot of the area selected as a basis (600 sq. ft.) is only $\frac{500}{600}$ sq. ft. The reduced effective surface will interpose a higher resistance, so that the true resistance of

the gas-wall transfer is $2.3 \times \frac{600}{500} = 2.8$ inches. On the other hand, the increased area on the air side produces the decreased resistance of $6.3 \times \frac{600}{700} = 5.4$ inches. The total resistance per square foot of mean surface would therefore be $2.8 + 1.5 + 5.4 = 9.7$ inches instead of 10.1 inches.

The calculation could just as well be made on the basis of the 500 sq. ft. or on the 700 sq. ft. surface, the resistances being reduced or increased accordingly; but in completing the solution, it is essential to take for A the area on which the first part of the calculation was based.

Mean Resistance to Heat Transfer.—The resistance to heat transfer from tile to air is the same at the hot and cold ends of the recuperator; the resistance of the tile itself varies a little; the resistance from waste gas to tile may vary widely between the two ends. The method of taking the resistance at the average temperatures of air, tile and waste gas will be reliable only if the actual over-all resistances, d , at the two ends of the recuperator are not widely different. This is usually the case if the gas to tile resistance is the least important of the three resistances at the cold end, as well as at the hot end of the recuperator. Where the resistances, d_1 and d_2 inches of standard brick, are not even approximately equal at hot and cold ends, instead of finding d as explained above, the harmonic mean of d_1 and d_2 should be used,

$$d = \frac{2d_1d_2}{d_1 + d_2}$$

In the example, making use of the temperatures found at the hot and cold ends of the recuperator, it is found that at the hot end,

$$d_1 = 9.4 \text{ inches}$$

and at the cold end

$$d_2 = 10.8 \text{ ,,}$$

$$\therefore d = \frac{2d_1d_2}{d_1 + d_2} = 10.0 \text{ inches}$$

which is clearly close enough to the 10.1 inches obtained by the average temperature method, and to the corrected value for that method of 9.8 inches.

Brick Temperature.—The brick temperature may be of interest at the hot end of the recuperator. In metal recuperators it is particularly important to see that the working temperature of the material is not exceeded.

In the example, at the hot end of the recuperator the following resistances to heat transfer are found :—

Waste gas to brick	+	Conduction through brick	+	Brick to air	=	Total
1.7"		1.4"		6.3"		9.4"

The temperature drop from waste gas to air was $2000 - 1225 = 775^\circ \text{F.}$ (435°C.). This drop is distributed in proportion to the individual resistances. The drop from gas to brick surface is $775 \times \frac{1.7}{9.4} = 140^\circ \text{F.}$ (80°C.); the drop through the brick is $775 \times \frac{1.4}{9.4} = 115^\circ \text{F.}$ (65°C.); and the drop from brick to air is $775 \times \frac{6.3}{9.4} = 520^\circ \text{F.}$ (290°C.). The temperatures of the brick surfaces are therefore $2000 - 140 = 1860^\circ \text{F.}$ (1020°C.) and $1860 - 115 = 1745^\circ \text{F.}$ (955°C.).

As expected, the brick temperature lies much closer to the waste gas temperature (2000°F. or 1100°C.) than to the air temperature (1225°F. or 665°C.). This should be borne in mind in determining the gas radiation coefficient. With increased relative surface on the air side, or with increased air convection rate, the resistance from brick to air would be decreased and the temperature of the partition brought closer to the air temperature.

Moisture in the Air.—The effect of radiation from brick to air due to moisture in the air has not been considered. If the air in the problem had contained 5 per cent. of moisture, $DP = 5 \times 0.25 = 1.25$ (the air duct diameter is 3 inches or 0.25 foot). At the cold end of the recuperator, transfer of heat to the air by gas radiation is practically zero. At the hot end, assuming an average wall to air temperature of 1500°F. (800°C.), Table XVIII shows that the steam radiation coefficient would be about 0.5. Multiplying this by the brick emissivity, 0.8, we have $\alpha_{\text{G.R.}} = 0.4$. Adding this to the air convection figure of 1.6 we obtain a total of 2.0, giving a resistance for this stage of the transfer of 5.0 inches instead of the 6.3 inches calculated for dry air. (A moisture content of 5 per cent. is of course extreme.)

Taking the harmonic mean of the resistances at hot and cold ends, the resistance for the complete transfer will be found to be

$$\frac{2 \times 8.1 \times 10.8}{8.1 + 10.8} = 9.2''$$

in place of 10.1 inches for dry air. This would cause, in the example, an additional air preheat of 50° F. (28° C.).

In practice, this extra air preheat will not compensate for the heat carried out of the furnace by the additional steam. It is true calculation shows that cases are conceivable where the increased temperature might result in thermal savings; but this would be possible only if the convection rate were abnormally low.

Heat Losses Through the Walls of the Recuperator.—The heat lost through the walls of a recuperator will be supplied principally by the waste gases, both on account of their higher average temperature and their much greater heat transfer coefficient. Also, where the design permits, it is usual to avoid placing air ducts in contact with the outer walls of the chamber. The resultant cooling of the waste gases will in turn cause reduced air preheat. This may be taken care of in the calculation by diminishing

the quantity $c_g v_g$ by the quantity $\frac{q}{t_{g.i.} - t_{g.o.}}$, where q is the heat loss through the walls per hour.

In the example, if the heat loss is 180,000 B.Th.U's. per hour (100,000 C.H.U's. per hour),

$$\frac{q}{t_{g.i.} - t_{g.o.}} = \frac{180,000 \text{ B.Th.U's.}}{2000^\circ \text{ F.} - 1380^\circ \text{ F.}} = 290 \text{ B.Th.U's./}^\circ \text{F.}$$

or,

$$\frac{100,000 \text{ C.H.U's.}}{1100^\circ \text{ C.} - 755^\circ \text{ C.}} = 290 \text{ C.H.U's./}^\circ \text{C.}$$

The modified value for $c_g v_g$ is $980 - 290 = 690$.

Recalculation of the temperatures for the recuperator shows a reduction in the air preheat of 70° F. (40° C.), and a reduction in the temperature of the escaping waste gases of 230° F. (130° C.).

Obviously, this method of calculation is defective in several respects—chiefly in that it assumes uniform preheat of the air, whereas in reality the preheat is greatest at the middle and least near the outer walls of the recuperator. Such calculations may, however, be useful in evaluating the advantages of insulation.

Effect of Leakage.—When air leaks through from the air passages to the waste gas passages, there is a loss of air preheat due to part of the transferred heat being received by air which subsequently escapes, and an additional loss due to cooling of the waste gases by the air leakage. Dilution of carbon dioxide and water vapour in the waste gases will, moreover, result in lower heat transfer on account of decrease in the gas radiation coefficient. The problem is complicated by uneven distribution of the leakage, due to pressure differences and varying condition of the tile at different temperature levels. Possibly some idea of the effect of leakage might be obtained by calculating for the two extreme cases, (a) where all the leakage occurs at the cold end of the recuperator, and (b) where all the leakage occurs at the hot end. The former case will merely affect the gas exit temperature by dilution. The second will produce a lowering of air preheat due to greater air quantity, and then a lowering of the gas inlet temperature by dilution, with some compensation, however, due to an increase in the value of $c_g v_g$. A weighted average of these two extremes might be taken.

The effect of air infiltration from the outside through the walls will also be uncertain. It is suggested that this be treated similarly, assuming first dilution of the waste gases by cold air at the hot end, then at the cold end. The average effect would be much nearer to the cold end value by reason of the greater suction at this end.

3. Conclusions to be Drawn From the Calculation.—Probably the most obvious of the conclusions which may be drawn will be found in the relative resistances offered by the three phases of the heat transfer. Step 2 of the problem shows the gas-to-brick, conduction-through-brick and brick-to-air resistances to be in the ratio 2.3 : 1.5 : 6.3.

(a) Evidently, for a recuperator chamber of given dimensions, if the efficiency is to be increased appreciably, the largest of these resistances, brick to air, must be decreased. The methods available have already been indicated—the relative surface area exposed to the air stream may be increased, the duct diameter may be decreased, the velocity of the air may be increased, or eddying flow may be induced in the air stream by avoiding smooth channels. Increase of area is usually accomplished by decreasing the channel diameter, in order to increase the number of channels; or by the use of narrow slots instead of passages having an approximately equidimensional cross-section. All of these

methods require increased pressure, and therefore cannot be carried too far. The most effective method is undoubtedly to increase the area, involving incidental decrease in the channel diameter, although the importance of velocity must not be overlooked. Further comment on this subject is reserved for the section on pressure requirements of heat exchangers.

(b) The waste gas to brick transfer is much smaller than the brick to air transfer. Consequently, less will be gained by a proportionate decrease in this resistance. Since, in this example, convection played the smaller part in heat transfer from the waste gases, the effect of velocity is of minor importance. Increase in area exposed per cubic foot of tile will naturally decrease the resistance.

If the exit temperature of the waste gases is low, then gas radiation at the cold end will be small. It then becomes important to increase the convection rate, possibly by the use of a different tile at the cool end, where higher velocities (in normal feet per second) or smaller diameters would be possible without causing undue pressure drop.

(c) It is interesting to note that the resistance offered to passage of heat through the tile is, in this particular example, the least important factor, being only 15 per cent. of the total—this per cent. value would naturally be higher with better heat transfer from brick to air. The heat actually transferred per square foot is no greater than would pass through a wall 10 inches thick, whose surfaces were held at the gas and air temperatures respectively. The effect of a small increase or decrease in the tile thickness would therefore, in the problem selected, be of minor importance. However, a thin tile is desirable because, for a given heat flow from one face of the tile to the other, the thinner the tile the smaller will be the temperature difference between the two faces, the less uneven will be the expansion, and the less will be the tendency for a leaky condition to develop. A high conductivity tile (e.g. silicon carbide) is advantageous for the same reason, i.e. not so much to reduce the resistance, as to equalise the temperatures between opposite faces.

It may be concluded that the high efficiency obtained in metal and silicon carbide recuperators is attributable even more to the higher permissible pressure, allowing high air velocities and small diameters without leakage, than to the thin partitions and high conductivity of the materials.

(d) Dust, deposited on the surface of the brick from the flue

introduces a very large resistance to heat transfer from waste gas to brick—the resistance to heat transfer from waste gas to brick may be increased even twofold or more. The increased resistance may be counteracted by increasing the tile surface exposed to waste gas considerably above that indicated by calculation for a clean tile. Periodic cleaning of waste gas passages to remove low conductivity dust layers is highly desirable.

The effect of dust deposit will further decrease the relative importance of the resistance offered by the tile itself to heat flow.

(e) The resistance d is used in the term $\frac{10A}{dcv}$ in determining

f and f' . It is clear, therefore, that for a reduction in the resistance d , the mean area A , and hence the volume of the recuperator, may be reduced proportionately to achieve the same final temperatures and efficiency. Thus if the resistance to heat flow could be halved, the size of the recuperator could be halved.

(f) The most economical size of recuperator is naturally determined by considerations of additional cost and the additional benefits derived.

Where this balance will be found of course depends on local as well as on metallurgical conditions. The temperature changes resulting from a change in the volume, and hence in the mean area A , are easily determined if all the other factors are fixed.

Referring back to the illustrative problem, all that is necessary is to assume different values for A , determine f and f' and complete the solution. The following temperatures are found :—

Surface, A , in sq. ft.,	200	400	600	800	1000	1200
Temperature of gases to chimney, t_{g_0} , . .	1690° F. 925° C.	1510° F. 825° C.	1380° F. 755° C.	1280° F. 700° C.	1210° F. 660° C.	1160° F. 630° C.
Temperature of air preheat, t_{a_0} , . .	630° F. 335° C.	980° F. 525° C.	1225° F. 665° C.	1390° F. 760° C.	1520° F. 830° C.	1610° F. 880° C.
Efficiency of recuperator, . .	30%	47%	60%	69%	75%	80%
Increase of air preheat over previous column, . . .	(570° F.) (320° C.)	350° F. 190° C.	245° F. 140° C.	170° F. 95° C.	130° F. 70° C.	90° F. 50° C.

From the last line it is seen that each additional 200 sq. ft. of surface produces an additional air preheat which becomes

successively smaller, and it is quite clear that an economic limit will soon be reached.

The efficiencies of the recuperators are also given in the table. The meaning of, and method of determining, efficiency will now be explained.

4. **Efficiency of a Recuperator.**—The efficiency of a heat exchanger is expressed by,

$$\frac{\text{Heat transferred}}{\text{Heat theoretically transferable}}$$

The quantity of heat transferable is subject to the conditions that the waste gas outlet temperature can never fall below the air inlet temperature, and that the air preheat can never exceed the waste gas inlet temperature. For example, suppose the waste gases, in falling from their inlet temperature to the inlet temperature of the air, would give up 2,000,000 heat units per hour; and suppose the air in being heated from its inlet temperature to the inlet temperature of the gas would require only 1,500,000 heat units per hour. Clearly the heat theoretically transferable is only 1,500,000 units, and the efficiency would have to be based on this figure, the balance of 500,000 units being theoretically irrecoverable by recuperation. If the air capacity had been greater than that of the waste gases, then again the lower figure would have to be taken. We are here concerned with recuperator efficiency as distinct from furnace efficiency.

To obtain the efficiency of a counter-flow recuperator, take the *smaller* of the two values f and f' . Then

$$\text{Efficiency} = 1 - f \text{ (or } 1 - f')$$

or to convert to per cent., multiply by 100.

If, in a recuperator, the actual temperatures are known by direct measurement, then, neglecting a small adjustment for changes of specific heat,

$$\text{Efficiency} = \frac{t_{g.i.} - t_{g.o.}}{t_{g.i.} - t_{a.i.}} \text{ or } \frac{t_{a.o.} - t_{a.i.}}{t_{g.i.} - t_{a.i.}}$$

the greater of the two numerators to be taken. Put into words this may be expressed as the larger of the accomplished temperature changes, divided by the accomplishable temperature change. To clarify the matter a little further, the true efficiency is the larger of the two conceivable values.

Example.—In the recuperator example (pages 328-332), the smaller of the two f values was 0.40. The efficiency is therefore $1 - 0.40 = 0.60$ or 60 per cent. Suppose, alternatively, that the waste gas inlet and outlet temperatures had been found experimentally to be 1100°C. and 755°C. , and the air temperatures were found to be 15°C. and 665°C. The drop in gas temperature is therefore 345°C. and the rise in air temperature is 650°C. The former value is not required, since it is the smaller of the two. The difference between the two inlet temperatures is 1085°C.

$$\text{Efficiency} = \frac{650}{1085} = 0.60 \text{ or } 60\%.$$

Per Cent. Recovery of Total Heat.—If it is desired to know what part of the total heat content of the waste gases, measured from gas inlet to air inlet temperature, is recovered by the air, this is expressed simply by

$$1 - f'$$

In the example, $1 - 0.68 = 0.32$ or 32 per cent.

Where f' is smaller than f , the per cent. heat recovery is identical with the efficiency. The values obtained above may of course be checked by calculating the heat absorbed by the air, and the heat available, using the volumes, specific heats and temperatures of the gases.

5. Application to the Design of Heat Exchangers.—The real application of the mathematical theory of heat exchange is naturally in the design of heat exchangers. In order to illustrate principles, we have been content to assume the heating surface, and then to calculate waste gas and air outlet temperatures.

In the design of a recuperator, the required temperature of preheat would be given, and the heating surface would be unknown. The solution would be essentially the same, excepting that the factor f would be determined from Equation 20, and this value would be used with the group $\left(\frac{c_g v_g}{c_a v_a}\right)$ to determine from Fig. 48 the group $\frac{10A}{dc_g v_g}$. The surface, A , can then be determined for given values of d , c_g , and v_g . The waste gas outlet temperature, etc., may then be calculated.

Actual arrangement of the flues is dependent on pressure considerations to be considered in Section IV of this chapter.

III.—REGENERATORS.

Extension of the theory of recuperation to the calculation of regenerators is due to Heiligenstädt, Rummel, Schack and others. The two most important points of difference to be taken into account are :—

(1) In a regenerator waste gas and air flow intermittently (the times of flow not necessarily being equal), and consequently heat exchange between brick and each of the two fluids is reduced in proportion to the actual time of flow. The total time occupied by one waste gas period plus one air period is called a **cycle**.

(2) In a recuperator, steady heat flow takes place through the refractory dividing partition, this partition merely introducing a resistance which becomes greater as the thickness increases. In a regenerator, the flow of heat in the brick is never steady, being from surface to centre during the waste gas period, and from centre to surface during the air period. Under these conditions, the heat transfer from waste gas to air is dependent on the readiness with which heat is soaked up and released by the brick. This depends on the speed of removal of heat from the surface towards the interior during the waste gas period, depending in turn on the physical constants and also on the thickness of the brick. Owing to the greater mass of interior cool material, a thick brick, up to a limit, will carry heat back from the surface faster than a thin brick, and consequently in a regenerator *the thicker the brick the less the resistance to heat exchange*. The process of heat delivery from the centre is of course governed by the same laws as those governing heat inflow.

Calculation of Heat Exchange in a Regenerator.—The resistance to heat flow is again found in terms of standard brick thickness.

(a) *Resistance of Heat Transfer from Waste Gas to Checkers.*— $\alpha_{G.B.}$ for gas radiation is determined in the normal way from the gas analysis and the channel diameter. α_c for convection is obtained from Fig. 29. For unstaggered checkers the scale marked "For Regenerators Only" is used. For double staggered checkers this same scale is used, but the values obtained should be increased by 16 per cent. If the regenerator passages consist of straight flues without lateral openings, then the usual scale is to be used as for recuperators.

The two values $\alpha_{G.R.}$ and α_C are added, and the brick equivalent is found from Plate I, Scale 7 $\left(\frac{10}{\alpha}\right)$. This, however, cannot be used directly if the solution is to parallel that for a recuperator. Heat transfer derived directly from this brick equivalent would imply continuous flow, and therefore would be too great. It is necessary to find a standard brick thickness which, on the basis of steady flow, would transmit the same amount of heat per hour as the calculated brick equivalent relating to interrupted flow. Clearly, for continuous flow a greater resistance would be required, and the thickness, as determined, is to be multiplied by

$$\frac{\text{Total time of cycle}}{\text{Time of waste gas flow}}$$

Commonly, the times of waste gas and air flow are equal, and the ratio then becomes 2, *i.e.* the calculated brick resistance must be doubled.

(b) *Resistance of Transfer from Checkers to Air.*—This is determined exactly as for the waste gas transfer, the factor naturally being

$$\frac{\text{Total time of cycle}}{\text{Time of air flow}}$$

(c) *Resistance Offered by the Checkers.*—The actual rate of heat transfer, during each phase of the complete cycle, is dependent on the temperature difference between brick surface and fluid, as well as on the heat transfer coefficient. Due to the imperfect heat absorbing properties of the brick, the mean surface temperature of the latter will be higher during the waste gas period than during the air period. This may be seen by imagining a checker with negligible heat absorbing capacity. During the first few moments of the waste gas period, the brick surface would heat very rapidly until the waste gas temperature was approached. Thereafter heat transfer would practically cease, so that the average checker temperature during this period would be almost equal to that of the gas. Similarly during the air period, the checker would cool extremely fast at first and then reach an almost constant temperature, approximately that of the air. The mean brick temperature during the air period would therefore be much lower than during the waste gas period.

TABLE XIX.—RESISTANCE OF CHECKERS TO HEAT FLOW.

1.—FIRECLAY BRICK (DIFFUSIVITY = 0.023).

Brick Thickness.	Length of Complete Cycle.										
	2 mins.	5 mins.	10 mins.	15 mins.	20 mins.	30 mins.	40 mins.	1 hr.	2 hrs.	3 hrs.	4 hrs.
1 inch	.33 (27%)	.49 (45%)	.66 (67%)	.82 (81%)	1.0 (87%)	1.4 (93%)	1.9 (98%)	2.7 (99%)	5.3 (100%)	8.0 (100%)	10.7 (100%)
2 inch	.33 (14%)	.50 (22.5%)	.65 (34%)	.82 (40.5%)	1.0 (45%)	1.2 (56%)	1.3 (67.5%)	1.6 (81%)	2.8 (93%)	4.1 (97%)	5.4 (99%)
3 inch	.33 (9%)	.50 (15%)	.65 (23%)	.82 (27%)	1.0 (30%)	1.2 (37%)	1.3 (45%)	1.6 (54%)	2.3 (77%)	3.1 (87%)	3.9 (92%)
4 inch	.33 (7%)	.50 (11%)	.65 (17%)	.82 (20%)	1.0 (22.5%)	1.2 (28%)	1.3 (34%)	1.6 (40.5%)	2.3 (58%)	2.8 (72%)	3.3 (81%)
Over 4* inch	.33 (27% thickness)	.50 (45% thickness)	.65 (68% thickness)	.82 (81% thickness)	1.0 (90% thickness)	1.2 (112% thickness)	1.3 (135% thickness)	1.6 (162% thickness)	2.3 (230% thickness)	2.8 (280% thickness)	3.3 (325% thickness)

* Actually, for all thicknesses lying beneath the heavy dividing line.

NOTE.—1. The resistance is given as the equivalent thickness of standard brick (coefficient of conductivity = 10).

2. The figures in parentheses denote the efficiency of the brick.

3. Values below the heavy line imply that, from a thermal point of view, the thickness of the brick exceeds the optimum value.

TABLE XIX.—RESISTANCE OF CHECKERS TO HEAT FLOW—(continued).
2.—SILICA BRICK (DIFFUSIVITY = 0.032).

Brick Thickness.	Length of Complete Cycle.										
	2 mins.	5 mins.	10 mins.	15 mins.	20 mins.	30 mins.	40 mins.	1 hr.	2 hrs.	3 hrs.	4 hrs.
1 inch	.29 (34%)	.45 (54%)	.61 (79%)	.84 (88%)	1.0 (93%)	1.5 (96%)	2.1 (99%)	2.9 (99%)	5.8 (100%)	8.7 (100%)	11.6 (100%)
2 inch	.29 (17%)	.45 (27%)	.61 (39.5%)	.80 (45%)	.90 (54%)	1.1 (69%)	1.2 (77%)	1.7 (88%)	3.0 (98%)	4.4 (98%)	5.9 (99%)
3 inch	.29 (11%)	.45 (18%)	.61 (26%)	.80 (30%)	.90 (36%)	1.1 (46%)	1.2 (52%)	1.6 (62%)	2.25 (86%)	3.1 (92%)	4.1 (95%)
4 inch	.29 (8.5%)	.45 (18.5%)	.61 (20%)	.80 (23%)	.90 (27%)	1.1 (34.5%)	1.2 (39%)	1.6 (46%)	2.1 (69%)	2.6 (82%)	3.3 (89%)
5 inch	.29 (7%)	.45 (11%)	.61 (16%)	.80 (18%)	.90 (22%)	1.1 (28%)	1.2 (31%)	1.6 (37%)	2.1 (55%)	2.6 (67%)	3.1 (76%)
Over 5* inch	.29 (34%)	.45 (54%)	.61 (79%)	.80 (91%)	.90 (108%)	1.1 (138%)	1.2 (155%)	1.6 (185%)	2.1 (275%)	2.6 (335%)	3.1 (380%)

* Actually, for all thicknesses lying beneath the heavy dividing line.
NOTE.—1. The resistance is given as the equivalent thickness of standard brick (coefficient of conductivity = 10).
2. The figures in parentheses denote the efficiency of the brick.
3. Values below the heavy line imply that, from a thermal point of view, the thickness of the brick exceeds the optimum value.

The loss of heat transfer, due to inequality of the mean brick temperatures during the two phases of a cycle, is conveniently expressed as a resistance to heat flow, and Table XIX gives the resistance in terms of equivalent brick thickness. Further explanation of this table is given later.

When the equivalent resistance to heat flow has been determined, calculation proceeds exactly as for a counter-flow recuperator. In evaluating f and f' , it is necessary to bear in mind that the volumes of waste gas and air, v_g and v_a , are the quantities actually passing through one regenerator per hour. If, for example, waste gas and air periods are equal, then v_g and v_a are one-half of the total hourly quantities passing through the furnace.

Illustrative Problem.—Again an example will be used to indicate the full procedure and to illustrate important principles.

<i>Given Data :—</i>	<i>Page</i>
Waste gas volume, 12,000 normal cu. ft. per min.,	346
Waste gas analysis, 14% CO ₂ , 8% H ₂ O,	,,
Air volume, 8000 normal cu. ft. per min.,	,,
Waste gas velocity, 3 normal ft. per sec.,	,,
Air velocity, 2 " " " " " "	,,
Dimensions of passages, 6" × 6",	,,
Type of checker, Unstaggered,	,,
Thickness of brick, 3",	,,
Heating surface, 15,000 sq. ft.,	,,
Waste gas inlet temperature, 2550° F. (1400° C.),	,,
Air inlet temperature, 200° F. (95° C.),	,,
Time of complete cycle, 30 mins.,	,,
(Equal gas and air periods, time between reversals 15 mins.)	

<i>Calculated Values :—</i>	<i>Page</i>
Resistance to heat transfer expressed as equivalent brick thickness, d , 13.1"	347
f , 0.19	348
f' , 0.54	,,
Temperature of air preheat, 2100° F. (1150° C.)	,,
" " gases to chimney, 1470° F. (800° C.)	,,

		<i>Page</i>
Average change of temperature of brick surface during a cycle,	173° F. (98° C.)	349
Fluctuation of air preheat during a cycle,	80° F. (45° C.)	351
Fluctuation in temperature of gases to chimney during a cycle,	218° F. (121° C.)	,,
Efficiency of regenerator,	81%	354
Recovery of total heat,	46%	,,

Data.—A regenerator chamber is built of 3-inch checker brick with passages not staggered, 6 inches \times 6 inches, and a total heating surface of 15,000 sq. ft. 12,000 normal cu. ft. per min. of waste gas are used to preheat 8000 normal cu. ft. of air. The analysis of the waste gas shows 14 per cent. CO₂ and 8 per cent. H₂O, and the gas enters at a temperature of 2550° F. (1400° C.). The air enters the checker at 200° F. (95° C.). The normal velocities of waste gas and air in the passages are 3 ft. per sec. and 2 ft. per sec. respectively. The furnace is operated on a 30-minute complete cycle, air and waste gas periods being equal.

1. To Find the Exit Temperatures of Air and Waste Gas.—

Step 1. As in the recuperator solution, assume outlet temperatures for gas and air, taking into account the relative quantities of the two fluids. Suppose the temperature of air preheat to be 2100° F. (1150° C.) and the temperature of the escaping gases to be 1500° F. (820° C.). Then the mean gas temperature is 2025° F. (1110° C.) and the mean air temperature is 1150° F. (625° C.). The mean brick temperature is assumed to be 1800° F. (980° C.).

Step 2. Calculate the brick equivalent of the transfer.

(i) Waste gas to brick transfer.

For convection, $\alpha_c = 2.6$ (the special regenerator scale of Fig. 29 is used).

For gas radiation, at the mean gas-wall temperature, $\alpha_{g.R.} = (3.5 + 2.0) \times 0.8 = 4.4$.

The total coefficient is 7.0, which would give, for continuous flow, a brick equivalent of 1.4 inches. Since flow is intermittent, this is to be multiplied by,

$$\frac{\text{Time of cycle}}{\text{Time of gas flow}} = \frac{30 \text{ mins.}}{15 \text{ mins.}} = 2$$

giving an equivalent brick resistance of 2.8 inches. }

(ii) Brick to air transfer.

For convection, $\alpha_c = 2.2$. Neglecting radiation due to moisture, this gives a brick equivalent of 4.55 inches. This must also be multiplied by $\frac{\text{Time of cycle}}{\text{Time of air flow}} = 2$, on account of the intermittent nature of the flow, giving a resistance of 9.1 inches.

(iii) Resistance due to brick.

For a 3-inch brick and 30-minute cycle, Table XIX shows that for fireclay brick the equivalent resistance is 1.2 inches (for silica brick 1.1 inches).

The total resistance, d , is

Waste gas to brick		Brick to air		Checker resistance	Total
2.8	+	9.1	+	1.2	= 13.1"

Step 3. Determine the quantities cv (the heat capacity per degree) of air and waste gas, remembering that the volume v is the hourly flow multiplied by the fraction of the whole time that each fluid is flowing, *i.e.*

$$\frac{\text{Time of flow}}{\text{Time of cycle}} \quad (\text{For equal gas and air periods this fraction is } \frac{1}{2})$$

(i) The specific heat of the air at its assumed mean temperature of 1150° F. (625° C.) is 0.0190 (Fig. 1).

$$c_a v_a = 0.0190 \times (8000 \times 60) \times \frac{1}{2} = 4560$$

$$(ii) \quad c_g v_g = 0.0228 \times (12,000 \times 60) \times \frac{1}{2} = 8210$$

$$\text{Step 4. (i) Evaluate } a = \frac{10A}{dc_g v_g} = \frac{10 \times 15,000}{13.1 \times 8210} \\ = 1.39$$

$$\text{and } a' = \frac{10A}{dc_a v_a} = \frac{10 \times 15,000}{13.1 \times 4560} \\ = 2.51$$

$$(ii) \text{ Evaluate } \quad b = \frac{c_g v_g}{c_a v_a} = 1.80$$

$$\text{and } b' = \frac{c_a v_a}{c_g v_g} = 0.56$$

(iii) Determine f and f' from Fig. 48.

$$f = 0.19 \qquad f' = 0.54$$

Step 5. Determine the air and waste gas outlet temperatures :—

$$\begin{aligned} \text{(i)} \quad t_{a.o.} &= t_{g.i.} - (t_{g.i.} - t_{a.i.})f \\ &= 2550 - (2550 - 200) \times 0.19 \\ &= 2100^\circ \text{F.} \end{aligned}$$

$$\begin{aligned} \text{or } t_{a.o.} &= 1400 - (1400 - 95) \times 0.19 \\ &= 1150^\circ \text{C.} \end{aligned}$$

$$\begin{aligned} \text{(ii)} \quad t_{g.o.} &= t_{a.i.} + (t_{g.i.} - t_{a.i.})f' \\ &= 200 + (2550 - 200) \times 0.54 \\ &= 1470^\circ \text{F.} \end{aligned}$$

$$\begin{aligned} \text{or } t_{g.o.} &= 95 + (1400 - 95) \times 0.54 \\ &= 800^\circ \text{C.} \end{aligned}$$

Step 6. Check the temperature assumptions and if desired apply any of the refinements described under the calculation of recuperators.

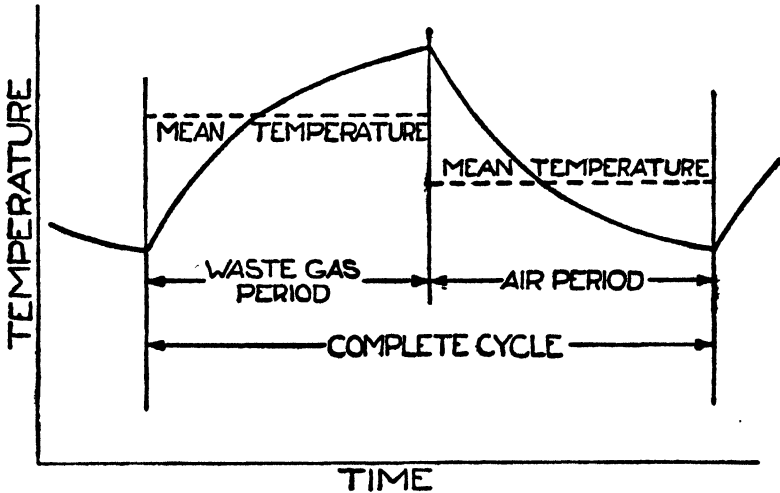

Fig. 50.

2. Temperature Changes During the Cycle.—The storage and release of heat by the checkers naturally involves change of temperature of the brick. A normal temperature curve for the brick surface during a cycle is shown in Fig. 50. The varying brick temperature naturally results in similar fluctuations in the outlet temperatures of both waste gas and air. Changes of air

preheat are undesirable, and although it is generally recognised that the longer the cycle and the thinner the brick the greater will be these fluctuations, a merely qualitative appreciation of this does not indicate when a limit may be approached in the advantages of a shorter cycle or a heavier brick.

Changes in Brick Temperature.—The heat stored during a cycle may be expressed in three different ways :—

$$\begin{aligned} Q &= Wc(t_1 - t_2) \\ &= (t_{g.i.} - t_{g.o.}) \times c_g v_g \times (\text{Time of cycle in hours}) \\ &= (t_{a.o.} - t_{a.i.}) \times c_a v_a \times (\text{Time of cycle in hours}) \end{aligned}$$

where W is the effective weight of checker and is equal to the actual weight of checker multiplied by its efficiency (Table XIX),

c is the specific heat of the brick,

$(t_1 - t_2)$ is the average temperature change undergone by the surface of the checkers during a cycle,

$t_{g.i.}$, etc., have their usual significance, it being understood that the volumes of gas and air, v_g and v_a , are the quantities actually flowing through the chamber in one hour, taking into account that the fluids are passing during part of the time only.

By equating the first expression to either of the others, the temperature change of the brick $(t_1 - t_2)$ may be obtained.

A convenient means of evaluation is given by,

$$t_1 - t_2 = \frac{1}{4A} (t_{a.o.} - t_{a.i.}) c_a v_a \times (\text{Brick Resistance of Checker})$$

where A is the surface area; the Brick Resistance is given in Table XIX. The waste gas data may be substituted for the air data in the formula.

In the worked example, using the air data and Fahrenheit units,

$$\begin{aligned} t_1 - t_2 &= \frac{1}{4 \times 15,000} \times (2100 - 200) \times 4560 \times 1.2 \\ &= 173^\circ \text{ F.} \end{aligned}$$

Or, using the waste gas data and Centigrade units,

$$\begin{aligned} t_1 - t_2 &= \frac{1}{4 \times 15,000} \times (1400 - 800) \times 8210 \times 1.2 \\ &= 98^\circ \text{ C.} \end{aligned}$$

This temperature variation of the brick was for a 3-inch brick thickness and a thirty-minute cycle (*i.e.* 15-minute reversals). Reference to Table XIX shows that use of a thicker brick does not decrease the resistance, and consequently would not decrease the temperature fluctuation during a cycle. In fact the brick thickness could be decreased to 2 inches without disadvantage in this respect.

On the other hand, if the cycle were shortened to 20 minutes, the temperature fluctuation would be decreased by about 17 per cent. In addition there would have been a small improvement in the matter of heat transfer due to the effect on over-all resistance. This, however, would have led to a decrease in temperature fluctuation of only 4 per cent.

In the case of longer periods of 2 hours or more, such as are usual in preheating the air for blast furnaces, it is seen that a 3-inch brick has a distinct advantage over a 2-inch brick, and that in some cases a 4-inch brick would be better for keeping down the temperature fluctuation.

Fluctuation of brick temperature is important in three respects. Firstly, the mean temperature of the brick at the hot end of the checker always lies nearer to the entrance temperature of the hot gases than to the exit temperature of the air, the reason being the much higher heat transfer coefficient of the waste gas. If, taking into account the slag and dust carried over by the waste gases, the mean temperature of the upper part of the checkers is already sufficiently high for slagging to be a serious problem, then even a relatively small rise of temperature may greatly accelerate the erosion. The possibility of combustion continuing in the checkers, due to poor furnace conditions, is an additional reason for avoiding extreme periodic rise of temperature in the checkers.

Secondly, the fluctuation of brick temperature is of course the cause of fluctuation in temperature of preheat. In high temperature furnaces, the smaller the deviations of the temperature from the mean value, the more efficient the furnace. The steadier temperature is also less severe on the brickwork of the furnace, as much damage may be done in a few minutes of excessively high temperature.

Thirdly, in furnaces working on natural draught, the rate of flow depends on the mean temperature of the hot air and gases. Fluctuations in temperature will cause fluctuations in the air supply, and fluctuations in the static pressure in the furnace. Where mechanical draught is used, these effects will be small.

Changes in Temperature of Air Preheat.—The fluctuation in temperature of air preheat during the cycle is given by

$$\frac{2.5 \times (\text{Checker Resistance}) \times (t_{g.i.} - t_{a.o.})}{d \left\{ 1 + \frac{c_a v_a \times (\text{Brick to Air Resistance})}{10A} \right\}}$$

Substituting the temperatures found in Step 5 and the resistances in Step 2,

$$\begin{aligned} \text{Temperature fluctuation of air} &= \frac{2.5 \times 1.2 \times (2550 - 2100)}{13.1 \left\{ 1 + \frac{4560 \times 9.1}{10 \times 15,000} \right\}} \\ &= 80^\circ \text{ F. (} 45^\circ \text{ C.)} \end{aligned}$$

To be precise, d should have been recalculated for the top of the checkers instead of the mean value of 13.1 being used.

The above expression is adapted from a formula which Schack states to give results in close accordance with experimental observation, provided that neither b' nor b $\left(\frac{c_a v_a}{c_g v_g} \text{ and } \frac{c_g v_g}{c_a v_a} \right)$ exceeds 3. In nearly all cases this condition is fulfilled.

Changes in Waste Gas Exit Temperature.—The above formula is applied with obvious substitutions,

$$\frac{2.5 \times (\text{Checker Resistance}) \times (t_{g.o.} - t_{a.i.})}{d \left\{ 1 + \frac{c_g v_g \times (\text{Gas to Brick Resistance})}{10A} \right\}}$$

Due to the lower coefficient of gas radiation, the resistance to heat transfer from waste gas to brick is decidedly greater at the bottom of the checker. Taking the mean brick temperature at the bottom during the waste gas period to be 1100° F. (590° C.), the average of this temperature and the waste gas temperature of 1470° F. (800° C.) is 1285° F. (695° C.); we find the resistance of gas to brick transfer is 3.9 inches of standard brick and the over-all resistance at the bottom is 14.2 inches. Using these figures, we find a fluctuation in the temperature of the gases to the chimney of 218° F. (121° C.). The temperature fluctuation is in this case greater at the cold end than at the hot end. This is not general, but depends on the particular problem.

3. Optimum Length of Cycle.—It has been shown that increased length of cycle increases the fluctuation of air preheat (and also fluctuations of waste gas and brick temperature), and results

in a lower mean temperature of preheat due to increased checker resistance to the heat transfer. These effects are illustrated in Fig. 51.

Although, theoretically, the shorter the cycle the closer we get to the ideal of a uniform high temperature, there are two practical considerations which limit the shortness of the cycle. The first is the inconvenience of frequent reversal. This is much less important where mechanical reversal is used, and the cycle in such furnaces has been considerably shortened in comparison with earlier days of hand reversal. Reversal of blast furnace stoves, however, is a rather complicated procedure owing to high pressures and separate gas and blast valves, so the tendency here is towards longer cycles than are used in simpler types of installation.

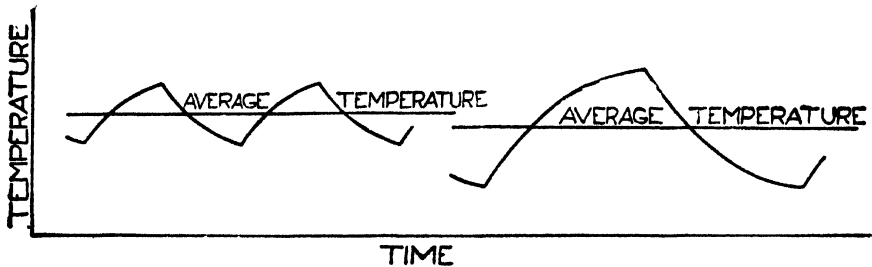

Fig. 51.

Loss of Heat during Reversal.—The second objection to a short cycle is loss of heat to the furnace during reversal. These losses fall into four classes.

1. The ordinary losses by radiation, etc., continue during the reversal, and are the more serious because momentarily no heat is being supplied to the furnace. The actual time lost is easily estimated from the rate of combustion, the volume of the chambers and ducts, and the time required to reverse the valves.

2. Immediately after reversal, the chamber into which air is diverted is still full of partly cooled waste gases from the previous phase of the cycle. The incoming air has to sweep this waste gas back through the furnace, exerting a definite cooling action on the charge before combustion can commence again.

3. For furnaces using a gaseous fuel which is regenerated, the cooling action explained in 2 occurs, and in addition there is a direct loss due to a regeneratorful of fuel gas being sucked back to the chimney instead of proceeding to the furnace. This loss is unavoidable; but, apart from some extraction of heat from the

checkers, it really constitutes a fuel loss, rather than a loss of heat from the charge.

4. The fourth cause of loss, prevented in many modern installations, applies also only to furnaces in which a gaseous fuel is regenerated. In older types of reversing valve, during the moment of reversal, the gas main is connected directly to the chimney as the valve passes through the "centre" or neutral position. Since the gas in the main is usually under pressure and the chimney exerts suction, there is a sudden rush of gas to the chimney, quite out of proportion to the very short time available for such to occur. This causes some increase in fuel consumption, but does not otherwise affect the furnace operation.

For furnaces where both fuel-gas and air are regenerated, it may be of interest to decide, from the point of view of time loss, whether to reverse gas or air first. The minimum loss will occur when air and gas enter the furnace after reversal at approximately the same time. Thus, where the gas chambers are so much smaller than the air chambers that the time of passage of the gas is shorter in spite of the smaller quantity, it may be better to reverse the air valve first. Where a large excess of air is customary, as in many older installations, the greater rate of air passage may cause quicker evacuation of the air chambers, in spite of the smaller volume of the gas chambers and the higher average temperature of the producer gas. Again, furnaces working on cool lean gases such as wood producer gas require gas chambers as large as the air chambers. Here the smaller quantity of the cold gas results in quicker clearing of the air chambers, and the gas should be reversed first. Of course, if the power unit for reversal is large enough for simultaneous reversal of air and gas, at least nothing can be lost by reversing both at the same time.

The most satisfactory cycle for any particular stage of a process in a given furnace is a matter of practical experience.

The effect of length of cycle on spalling of the brick is not clear. The more frequent reversals with a short cycle may cause greater spoilage of brick lying within the spalling temperature range; the bigger temperature fluctuation with a long cycle may increase the amount of brick within the spalling temperature range. Spalling affects the salvage of brick when the lower portion of the checkers is taken out for cleaning.

It has been shown above that the length of the cycle is important in its effect on temperature of air preheat. In earlier days of regenerative furnace operation it was the custom to reverse the

furnace at fixed time intervals. A good furnaceman would depart from this practice when he found that, for a particular stage of the process, the time intervals were too great for the high uniform temperature required; he would also modify the lengths of the half-cycles when the two checkers reached, fortuitously, different mean temperatures. The present trend in large furnaces is to use pyrometric control to reverse the furnace automatically at a fixed temperature difference between the two sides of the regenerative system. The length of cycle is still the primary consideration, as the instrument can be set to reverse at any temperature difference desired, but temperature inequality between the two sides is automatically avoided.

4. Efficiency of the Regenerator.—The smaller of the two f values was 0.19. The efficiency is therefore $1 - 0.19 = 0.81$ or 81 per cent.

The per cent. recovery of the heat contained by the waste gases is

$$(1 - f') \times 100 = (1 - 0.54) \times 100 = 46\%$$

5. Conclusions to be Drawn from the Calculation.—As in the recuperator, the resistance to heat transfer will be considered first. Step 2 of the problem shows waste gas to brick, brick to air, and brick absorption resistances of 2.8 inches, 9.1 inches and 1.2 inches.

(a) Again the brick to air resistance is the one offering most scope for improvement. The conditions which are favourable to increased convection have already been discussed: small diameters and high velocities increase the convection coefficient. Checkers have a higher coefficient of convection than simple flues. By the use of staggered checkers the convection values may be increased by 16 per cent.; but the pressure requirement will also increase, and the checkers cannot well be cleaned without complete removal.

(b) Reduction of the gas to brick and brick storage resistances cannot result in much improvement, so long as the brick to air resistance remains at an appreciably higher level than these two resistances.

(c) The general comments with reference to recuperators on pp. 336-339 apply equally to regenerators.

(d) The resistance offered to heat transfer by the checkers is seen in the example to be quite small (under 10 per cent. of the total). Referring to Table XIX it is seen that for the materials

freelay and silica there is no way in which we can reduce this resistance for a 30-minute cycle. An increased brick thickness would be without effect, and the thickness could be reduced to 2 inches without any increase in resistance.

The tables show that, for very long cycles, these resistances are likely to become more important, particularly if the brick is too thin. Where the cycle is less than one hour, it is far commoner to find brick which is much thicker than necessary, and therefore wasteful of space. In certain cases there may be practical considerations tending to justify this.

Another effect of increased brick resistance, whether due to length of cycle or to insufficient brick thickness, is the fluctuation of preheat from beginning to end of the heating period. This constitutes a far bigger reason for making the periods reasonably short than the slight gain effected in the average temperature of preheat.

Neither the table nor the method of calculation takes into account another and much more important resistance to heat transfer. This is the insulating effect of dust deposits in the checker. Curves published by Schack indicate that for a heavily dust encrusted checker, an increase in the total resistance to heat flow of the order of 25 per cent. or more is quite possible. It should be noted that this refers to the total value for d , not merely to the resistance of the brick itself. Here again, extra brick thickness will be of no assistance. Naturally, it is unlikely that such an increase in resistance will be general throughout the checker, and in the higher temperature portions the checker will be kept clean by slagging of the deposits.

Explanation of Table XIX.—The resistance to heat flow offered by the brick is influenced as follows :—

Resistance decreases as the specific heat of the brick increases.

Resistance decreases as the density of the brick increases.

Resistance decreases as the diffusivity $\left(\frac{\text{conductivity}}{12 \times \text{specific heat} \times \text{density}} \right)$ of the brick increases.

Resistance decreases as the thickness of the brick increases.

Resistance increases as the time of the cycle increases.

The physical properties for the materials ordinarily used vary between somewhat narrow limits, consequently the brick thickness and the time of the cycle are the two factors which really determine the resistance offered by a clean checker. Table XIX has been based on the application to regenerator calculation, by Rummel, of Groeber's mathematical analysis of heat storage under fluctuating temperature. The thermal characteristics of the materials have been chosen with regard to the rather high operating

temperatures usually involved. Changes in these values are, however, of minor importance. The values used were :—

	Density (lbs. per cu. ft.)	Conductivity.	Specific Heat.	Diffusivity.
Fireclay brick, . . .	120	10	0.3	0.023
Silica brick, . . .	110	12.8	0.3	0.032

The table shows, in parenthesis, the per cent. efficiency of the brick in each case. The efficiency is the quantity of heat actually stored during a cycle, divided by the quantity which would have been stored if the entire brick had reached the same temperature as the surface. It will be observed that the thinner the brick and the longer the cycle, the higher will be the efficiency. Since the resistance also increases with these factors, it may be concluded that a high efficiency of brick utilisation (say over 75 per cent.) implies insufficient brick thickness. On the other hand, too low an efficiency is wasteful of brick and space.

Use of Other Materials for Checkers.—The table shows very little difference between the resistances for fireclay and silica brick. The actual resistance offered, in terms of inches of standard brick, is given by,

$$\frac{160 \times (\text{Time of cycle in minutes})}{\left(\frac{\text{Specific heat}}{\text{heat}}\right) \times \left(\frac{\text{Brick thickness}}{\text{in inches}}\right) \times \left(\frac{\text{Density in lbs.}}{\text{per cu. ft.}}\right) \times \left(\frac{\text{Brick efficiency}}{\text{per cent.}}\right)}$$

Any material to be used as a substitute for the common refractories, with a view to decreasing the resistance, must therefore have a higher specific heat, density, or efficiency. Cast iron bricks have been tried in the cooler parts of regenerators, and heat resisting metal bricks have been suggested and possibly tried. Clearly this is perfectly sound. The high conductivity of these materials will ensure a high efficiency—in most cases nearly 100 per cent. The specific heat of these materials in the low temperature range is only about 0.6 of that for firebrick and silica brick; but the density is nearly 4 times as great, so that the resistance of an iron checker, for the same time of cycle and thickness, is likely to be about 40 per cent. of the value for brick.

Iron bricks were used primarily with the object of washing off the dust during repairs, without the necessity of removing and brushing the lower portion of the checkers. Only limited success was achieved in this direction, and on account of the great weight of the material, the use of metal in large regenerators has, so far as the author is aware, been abandoned after a few experimental campaigns.

Referring back to the above expression for resistance, it is evident that if the thickness of the iron brick had been decreased in the same ratio as the increase in density, *i.e.* if its weight had been kept the same as that of the refractory brick which it was replacing, the only cause of increased resistance would have been the lower specific heat of iron. Consequently an iron brick could have been used, with no greater resistance to heat flow, by merely increasing the weight about 60 per cent. as compared with firebrick, and using an iron section only 40 per cent. of the original brick thickness. Stability could be achieved by using special shapes, hollow bricks or cast grids. A considerable increase in area could be introduced on account of the smaller volume occupied by this part of the checker.

The use of silicon carbide instead of the common refractories has also been suggested on account of its high conductivity. It may be pointed out, however, that the only effect of increased conductivity is to produce an increase in efficiency. If the efficiency as shown in Table XIX is already high for a particular case, then the margin for improvement on account of increased efficiency may be quite small. The higher specific heat of

silicon carbide, over certain temperature ranges, would produce some improvement for equal weight of material, and the higher density of silicon carbide would produce greater improvement for equal thickness.

After this discussion, it may be well to stress again the smallness of the checker resistance with the ordinary materials in cases of moderately short cycles, and the comparative insignificance of the probable improvement due directly to better heat absorption by the brick. Again, the effect of dust deposits will not be much reduced by the better absorbing properties of the brick. However, any increase of area which may be effected by the use of a different material will be highly beneficial—in fact, up to a limit it may be beneficial actually to decrease the brick thickness with a view to increasing the area, even though the brick resistance is thereby increased. The effect of increased resistance on the temperature fluctuation is of course another matter which needs to be borne in mind.

IV.—PRESSURE CONSIDERATIONS.

The design of regenerators and recuperators is evidently very closely bound up with questions of available or permissible pressure, since methods of increasing heat transfer by convection all entail increased pressure loss. Pressure losses in a heat exchanger may occur by:—

- (1) Friction in a straight flue.
- (2) Eddying flow in the passages of the heat exchanger.
- (3) Changes of direction, etc., external to the effective heat transfer surface, as in cross-flow recuperators.
- (4) Buoyancy, which produces a pressure loss when a hot gas descends, and a pressure gain when a hot gas ascends.

Heat Exchange “Characteristic.”—In determining the values of the factors f and f' in heat exchanger calculations, one of the necessary groups of quantities (p. 326) contains the quantity A/d (A = heat exchanging surface, d = resistance to heat flow). This is the only expression representing the actual construction of the heat exchanger, and we may regard A/d as a characteristic of the construction, increase in the value of this fraction yielding improved heat exchange for given waste gas and air inlet temperatures and quantities. It has already been explained that improvement can equally well be achieved by a decrease in d or by an increase in A .

Effect of Velocity.—All pressure losses by eddying or by friction increase as the square of the velocity. The coefficient of convection, α_0 , increases with the velocity, but at a rate which is not even directly proportional. For example, doubling the velocity will cause approximately four times the pressure loss, but less than double the convection rate. Since convection transfer constitutes

only one, although usually the largest, of the resistances to heat transfer, the proportionate effect on the over-all resistance, d , is still less. Consequently, where the pressure is limited, it is well to look into other means of increasing the characteristic A/d .

Effect of Flue Diameter.—Other things being equal, the pressure loss by friction in a straight flue varies approximately¹ inversely as the diameter. The heat transfer coefficient α_c also increases as the diameter decreases, but much more slowly. For example, halving the diameter will double the pressure loss, but will produce only a 20 to 25 per cent. increase in α_c . Since, however, the surface area exposed will be doubled for the smaller flues, the characteristic A/d will increase faster than the pressure.

Small flues, therefore, imply a more economical utilisation of pressure than high velocities. This principle should be carried to the limits imposed by practical considerations. The minimum velocity will naturally be determined by the maximum ground space which it is desired to use in construction of the heat exchanger—the velocity is the volume of air used per second divided by the total plan area of the passages. So far as concerns the air, the minimum diameter of the passages will then be determined by the height and available pressure. For waste gas or fuel gas passages, the speed with which the passages choke up, and the facilities, if any, for cleaning them will limit the reduction in size.

Shape of Flues.—For a given area of cross-section of the passage, the surface area presented by the walls depends on the shape of the channel, being smallest for a circular section, a little larger for a square, and still larger for a rectangular section. The most suitable shape will depend on the permissible pressure drop, the gas and air quantities, the general arrangement of the passages, etc. For a predetermined cross-sectional area, the pressure drop is directly proportional to the wall area.² Readjustment of the shape to increase the surface therefore represents an economical use of pressure.

If the passages are to be moderately small, a square or circular

¹ Actually a little faster, halving the diameter resulting in more than double the pressure drop.

² For a rectangular passage whose adjacent sides are a and b , and whose area of cross section ab is constant, the surface presented is proportional to the perimeter, $2(a + b)$. The pressure drop in a flue is approximately inversely proportional to the equivalent diameter, $\frac{4ab}{2(a + b)}$, and therefore directly proportional to the quantity $2(a + b)$, $4ab$ being presumed constant. Thus the surface and the pressure increase at the same rate, for a mere change in shape of the section.

passage will suffer far less constriction from dust deposition than a narrow rectangular passage of equal cross-sectional area. Consequently, in regenerators, the cross section of the passages is, as a rule, approximately equiaxial. The same will apply to the waste gas passages of a recuperator, except where the smaller diameter is large enough to preclude serious choking.

For the air passages of a recuperator, conditions are entirely different, firstly because there is no danger of clogging, and secondly because efficient heat exchange demands an increase of area exposed to air flow as compared with the area exposed to gas flow. Air passages consisting of narrow slots are therefore permissible. In a particular recuperator design, the position, shape and size selected for the gas passages will determine whether long rectangular slots or small square channels should be adopted for the air.

Effect of Size of Heat Exchanger.—It is possible to have two heat exchangers, one large and the other small, having equal values of the characteristic A/d , and therefore having equal efficiencies. The smaller heat exchanger will require a greater pressure difference, since retaining the same value of A/d will demand passages of smaller diameter to maintain the value of A (or means of decreasing the resistance d).

The larger chamber will involve greater capital cost, but may be economically sound if the operating costs to meet the pressure requirements are sufficiently decreased. An important factor in the balance between capital and operating costs for a given preheat is the proportion of operating to idle time.

Effect of Eddying Flow in a Regenerator.—Convection in a checker, whether staggered or unstaggered, will have some of the characteristics of convection between a gas stream flowing at right angles to a series of parallel pipes (Fig. 52). The rate of heat transfer is much increased by this eddying, as expressed by the special regenerator scale in the convection nomogram, Fig. 29. The pressure drop is also much greater than that due to friction alone in solid flues of equivalent diameter (pp. 144-5). It will be assumed, for the sake of discussion, that the increase in convection caused by eddying is proportional to the increase in pressure.

Example.—For an unstaggered checker built of 6-inch courses (the depth of brick on which the checker scale in Fig. 29 is based), with openings 6-inch square, and with a normal velocity of 3 ft. per sec., the convection coefficient α_c is found from the nomogram, Fig. 29, to be 2.6. The pressure drop per foot of height (two courses) is $0.3 \times 2 \times p.e. = 0.6 p.e.$ (p. 144).

If this same pressure were to be absorbed by friction alone in a straight flue 6 inches square, the normal velocity would need to be 6.7 ft. per sec., giving a pressure loss of

$$0.06 \times \frac{1}{0.5} \times p.e.' = 0.06 \times \frac{1}{0.5} \times \left(\frac{6.7}{3}\right)^2 \times p.e. = 0.6 p.e.$$

(Table XIV C, p. 155.)

At this velocity, α_c for a straight flue is found to be 1.7.

The convection figures 2.6 and 1.7 indicate, for equal pressure consumption, some advantage for a checker as compared with a straight flue. The difference, however, cannot be considered

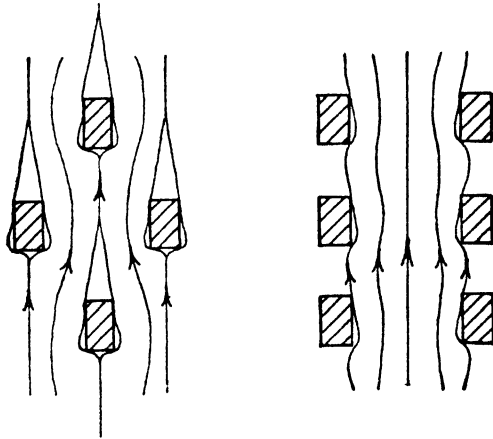

Fig. 52.

large enough to be conclusive, and it is better to proceed on the basis that the relative merits are not clearly established.

Suppose, the diameter of the passages being predetermined, we have a given pressure difference available for use within the passages. On the assumption of equal pressure loss for the same convection coefficient, it is possible to apply this pressure with equal heat transfer results by using solid flues in a chamber of small plan and considerable height (thereby attaining high velocities); or by using checkers instead of solid flues in a chamber of larger ground plan and smaller height (thereby inducing eddy flow). If staggered checkers were used, the ground plan could be still a little larger and the height a little less than for unstaggered checkers. Instead of the "considerable height" postulated for the solid flue type, it would of course be permissible to use two- or three-pass

checkers to give the same velocity, but there would be additional pressure loss due to changes of direction.

In selection of the type of packing, taken in relation to the actual proportions of the regenerator, the first consideration is that the surface exposed shall be a maximum, implying that the diameter of the channels shall be made as small as practicable. Then if solid flues would utilise the full available pressure drop, this type of packing must be used. In blast furnace stoves, with cleaned blast furnace gas as fuel, there is relatively little dust deposit, and passages of small diameter are admissible. This makes it possible to use the available pressure most effectively in a straight flue packing, since a checker packing would necessitate larger flues, with reduction of heat exchanging surface.

If, after reducing the diameter of the passages to a minimum, there is a sufficient surplus of pressure, checkers should be substituted for straight flues. If even then sufficient pressure is available, staggered checkers may be used, or the question of multiple pass checkers may be investigated.

In comparing straight flues with checkers, the surface area exposed for equal volumes of packing must of course be taken into account. In a checker, more of the surface of each brick is exposed, but since there are less bricks per cubic foot, the total area exposed may be either greater or less for the same volume of packing. Caution must always be exercised in replacing any type of packing by one having a lower exposed area per cubic foot. Even though calculation on the basis of improved convection from brick to air may show a marked reduction in the resistance d , the effect of dust deposit will be to decrease this apparent improvement. In other words, if a reduction of A is contemplated, provision should be made for a more than corresponding reduction in d , calculated for a clean checker.

An extremely important factor in selection of the type of packing is the extent and distribution of dust and slag accumulation on the different types. This will affect the rate of heat transfer to the brick, and will also affect the size of opening permissible. The complete closing of some of the continuous flues by fallen brick or by slag accumulation, as compared with complete choking of some of the lateral openings in a checker with loss of brick surface are factors which add to the complexity of the problem.

Change in Type of Packing.—The coefficient of convection does not change conspicuously with temperature. Pressure losses increase approximately in proportion to the absolute temperature.

In the lower temperature portion of a heat exchanger, heat transfer may be increased (by smaller diameters, higher velocities or increased eddying) more economically with respect to pressure than is possible in the high temperature portion of the heat exchanger. It is thus logical, where convenient, to use in the lower portion of the heat exchanger a packing having a higher heat transfer characteristic, with a greater incidental pressure loss factor. This is also in keeping with the advantage of increasing the convection coefficient from waste gas to brick at temperatures where gas radiation is less effective. The problem of choking by dust deposition must of course receive consideration.

Thickness of Brick.—Particularly in the case of regenerators, it is important to give full consideration to the matter of brick thickness. The desirability of a large weight of checker tends to be overstressed, on the specious theory that the greater the weight the greater the heat absorbing capacity of the checker. It has been shown in this chapter that a fairly thin brick is just as effective for preheating, gives a greater free space with lower pressure loss, and is much more responsive to a rise in the waste gas temperature. In favour of a brick thicker than necessary according to Table XIX, it may be said that it is mechanically stronger, will not slag away so quickly, and will not overheat so readily during the highest temperature phases of the furnace operation.

Since reduction in the diameter of the passage implies increase in the number of brick partitions, rearrangement for passages of smaller size should usually include use of a thinner brick. A disadvantage of thick bricks is that they may dictate uneconomically wide passages, because adoption of narrower passages causes rapid decrease in the proportion of free passage.

With reference to the different types of packing, straight flues and checkers, a moment's reflection will show that, so far as weight of brick is concerned, there need be no difference between the different types. If the same brick thickness is used, the continuous flue type will clearly be much heavier; but the greater mechanical stability of this type of packing makes it possible to use considerably thinner brick. Also, since all exposed surfaces of the brick are considered effective in heat transfer, there is less incentive to use a thinner brick in a checker type of packing, because there would be a reduction in the exposed horizontal surfaces which would partly offset the gain in vertical surface due to the greater number of channels packed into the same ground plan.

Numerous patented bricks and methods of laying checkers are

designed to increase the surface or the rate of heat transfer, or to decrease the pressure losses. These will not be considered in this volume.

Preheating of Fuel Gas.—In regenerators used for preheating producer gas or other low calorific value gaseous fuel, convection plays only a small part in heat transfer, since the coefficient of heat transfer from brick to fuel is high due to absorption of radiant heat by gaseous constituents, assisted by solid carbon particles. It is possible in this case that the brick resistance becomes relatively important, but this resistance cannot as a rule be materially decreased except by shortening the cycle.

Increased eddying will therefore be of small service in increasing the characteristic A/d . A can be increased by using passages of smaller diameter, but this time there will be little corresponding increase in d due to the lower gas radiation coefficient. It seems reasonable in gas chambers to use straight flues of the smallest permissible diameter, in order to use the pressure to the best possible advantage.

The factors which should be taken into account in determining the relative size of fuel gas and air chambers are

1. The fuel gas quantity is smaller than the air quantity.
2. The fuel gas usually enters the regenerator hot.
3. The waste gases passing through the fuel gas chambers must escape to the chimney at a higher temperature than that of the incoming fuel gas.
4. The resistance to heat flow is less for fuel gases than for air.
5. Part of the heat transferred to the fuel gases is used to induce endothermic chemical changes which improve the calorific value of the gas. This is a valuable form of heat recovery, and is apparent only if careful gas analyses are made. Rise of fuel gas temperature being restricted on account of these endothermic reactions, the rate of heat transfer tends to increase due to the greater difference between fuel and waste gas temperatures.

All factors except 5 point to construction of a gas chamber decidedly smaller than the air chamber. Modern practice supports this conclusion; but it is possible that in some cases full allowance is not made for the benefit, indicated by 5, accruing from a large gas chamber.

Source of Pressure Differences.—In hearth types of furnaces, which can never be made even approximately airtight, it is essential

to maintain the static pressure at the doors of the hearth as near atmospheric pressure as possible. This means that the waste gases must be sucked out of the furnace, and the air must receive a positive static pressure in order to overcome resistances in the preheater and flues. In earlier types of furnaces, as well as in many modern furnaces, the air receives its pressure due to the buoyancy of the hot column of air in the heat exchanger and ducts to the burner head, the burner necessarily being at a considerably higher level than the cold air intake to the heat exchanger chamber. From Plate I, Scale 4, it will be found that this natural pressure will usually be about one-hundredth of an inch of water for each foot of height of the hot air column; the air pressure developed by buoyancy will therefore be rather small. Since efficient heat exchange is accompanied by loss of pressure, it is particularly important in this type of installation

1. to reduce to a minimum the pressure losses by bends, etc., external to the checker, in order to increase the pressure available in the checker itself, and

2. to secure the maximum possible difference of level between the bottom of the chamber and the burner, preferably with the checker occupying a large proportion of this difference of level.

At the flue end of the furnace, the hot column of gas is forced to descend against the static pressure produced by its own buoyancy. This pressure, and also the pressure requirements of friction, eddying, and changes of direction, are very commonly supplied by stack draught.

The difficulty of attaining high rates of heat exchange due to the restricted pressure available from natural draught, have led to increasing use of mechanical draught both for air supply and, in some types of furnace, for removal of waste gases. With mechanical draught, the possibility of smaller openings and greater velocities is greatly increased, but a more gas-tight structure must be used to combat greater leakage tendency. The additional pressure also permits faster driving of the furnace—a valuable improvement which, however, if abused, leads to rapid damage to the checkers.

Distribution of Waste Gas and Air in Regenerators.—It has become an accepted principle in the construction of any heat exchanger that, where conditions permit, the heating gas shall pass downwards and the heated gas upwards. In passing any gas from a header through a number of flues, there will always be a strong

tendency to uneven distribution. In passing cold air up a cold regenerator McLoughlin¹ has shown the air velocities in different flues to vary all the way from zero up to nearly 10 feet per second, while in a few passages there was even a reverse flow of air against the general direction. Now if a hot gas be passed up through a cooler checker, a flue carrying more than its quota of gas will become more strongly heated than the others, and its chimney effect will be increased; it will therefore take a still bigger flow of gas, causing still more heating, producing a cumulative effect which reaches a limit only when increased pressure losses due to the higher velocity balance the increased chimney effect. The pressure losses in a checker for ordinary speeds is usually smaller than the chimney effect. If the hot gas be passed downwards, a flue carrying more than its quota of gas becomes more strongly heated, and thus generates a chimney effect opposing the passage of gas and tending to equalise the flow in the battery of flues. The same considerations demand that the cold gas shall travel upwards. Where this principle (probably first insisted on by Groume-Grjimailo) is adhered to, the distribution of gases is probably fairly uniform. Also the higher the pressure loss through the checkers, the more even will be the distribution.

There are two important types of regenerator which to some extent violate this principle. The first is the horizontal regenerator which is used with furnaces built on ground level, and where there is consequently no head room to supplement the depth of the regenerator below ground. Here the air is usually supplied by a fan, and a moderately high checker resistance (implying also good heat transfer characteristics) will assist in fairly good distribution. The second violation is found in some multiple pass regenerators.

Good distribution is favoured by a high pressure loss through the checker—this does not, of course, imply that a high pressure loss is of itself a desirable characteristic. Considerable height of checker will, for this reason, be favourable.

Proper design of headers contributes largely to good distribution. Such design should provide ample height above and below the checker. Tapering of this height in the direction of flow is conducive to good distribution and is economical of head room—this tapering is effected by retaining the usual floor and arch

¹ McLoughlin, T. J. : "The Theory and Application of Regenerative Principles in the Steel Industry." Year Book of the American Iron and Steel Institute, 1929.

arrangement, and building the rider walls with three or more steps, so that the checker at the back of the chamber, although of the same height as that at the front, is set at a lower level. Fan-tails should be designed with as narrow an angle as possible and should enter the regenerator chamber over its entire width.

Initial good distribution may be seriously impaired during a furnace campaign by slagging. In steel-making furnaces small elevated regenerator chambers have been built, extending from the furnace ports down to the slag chambers on the pit floor level. The checkers in these chambers have wide passages and, due to the high operating temperature, the slag remains fluid and runs down to the slag chamber without forming obstructions. These high-temperature checkers should be of silica brick (not fireclay brick)—at high temperatures silica brick is as resistant to spalling as fireclay brick, is much stronger and is more resistant even to basic slags (see Chapter VIII). The hot waste gas, with most of the slag removed in the upper checker and slag chamber, then passes over to the main checkers.

In order to ensure that the whole checker surface in conventional type regenerators shall remain effective, several wells are sometimes formed at the top of the checker, extending to a depth of several courses of brick. If a large number of the entrances of the checker passages become choked by slag accretions, a path still exists through the lateral openings in the sides of the wells. This expedient is used chiefly where the normal operating temperature at the top of the checker is not high enough to permit slag flow.

In furnaces where both fuel-gas and air are preheated in regenerators, the proportioning of waste gas to the gas and air checkers is very important. A theoretical study of this problem would necessarily be lengthy; in practice, however, this problem deserves more attention than the haphazard setting of dampers which is all it sometimes receives.

Two- and Three-Pass Regenerators.—Where mechanical draught is used, it frequently happens that after applying the principles explained to increase the heat transfer, there is still a surplus of available pressure beyond that required by the conventional packing in a simple chamber. This pressure is sometimes used to increase the velocity of the gases by using a multiple pass regenerator, in which the chamber is divided usually into two or three compartments so that the gases have to pass through each of them in series at increased velocity (Fig. 53).

The two-pass regenerator on the left of Fig. 53 preserves the principle of down-flow of hot gases and up-flow of cold air, but achieves this by provision of an idle pass between the two chambers. In the three-pass regenerator, the middle pass is enlarged and filled with checker, so constituting an active pass which is, however, in violation of the principle explained. In view of McLoughlin's experiments, there can be little doubt that this middle chamber will operate at rather low efficiency. If it is added by increasing the dimensions of the chamber, it becomes a question of additional expense versus additional benefit derived. If it is added by reducing the size of the other two chambers, the problem is to decide whether the additional low efficiency area compensates for the reduction in high efficiency area.

"Three-pass" blast furnace stoves operate, so far as the regenerator packing is concerned, on a two-pass system, the third

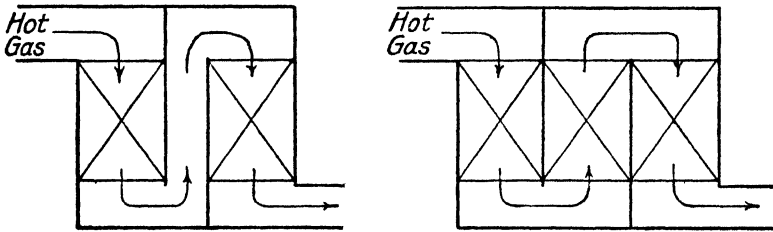

Fig. 53.

pass being the combustion chamber. Owing to the great height and cost of these stoves, an idle pass is out of the question, so the burnt gases from the top of the combustion chamber pass down one section of the checker (adhering to the principle) and up the second pass (violating the principle). The same applies to the air.

An advantage of two- and three-pass regenerators is that different types of checker packing can conveniently be used in the different passes, permitting accommodation to meet the different operating conditions (slagging and choking) and the different resistance to heat transfer at different temperature levels. Also in cleaning the checkers, there is no need to disturb any section of the checker which has remained in good condition. This, in general, refers to a section in the middle of the waste gas and air path. Here, the temperature is high enough for dust deposits to fuse, but on the other hand the checker is far enough down to be protected from the severe slag erosion common at the top courses of the checker. In

a single pass checker this brick, although in good condition, must be taken out to reach the dust choked lower courses; and owing to the bricks in this position being glazed together, there can be very little salvage from this part of the checker.

A disadvantage of multiple pass heat exchangers is the loss of pressure in the flues connecting the different passes. These losses, due to a series of sharp changes of direction and cross section, external to the heat exchanging surface, represent wastage of pressure which would otherwise have been available to increase the heat transfer characteristic of the heat exchanger. This disadvantage should probably restrict the use of multiple pass heat exchangers to those cases where decrease in passage diameter and increase of eddying have been carried to the practical limit, still without using all the available pressure in a single pass checker. For example, if the pressure is just enough to operate with a checker of given opening, it would probably be uneconomical to replace this single pass checker by a two-pass chamber having straight flues of the same diameter. Although the area and the total pressure consumption might be the same, yet the smaller pressure consumption within the heat exchanger packing for the two-pass chamber would probably result in a lower heat transfer characteristic.

Recuperators.—In discussion of pressure in its relation to heat transfer, regenerators have been referred to frequently. This is only because this type of heat exchanger presents in some respects the more general case. In tile recuperators, it is more than ever important to keep the pressure as low as possible on account of probable leakage troubles; it is here often the permissible, rather than the available, pressure which governs the recuperator design. With respect to pressure, decreasing the passage diameter is the most efficient method of increasing the heat transfer characteristic. In recuperators this applies more particularly to the air passages, since it has been shown by calculation that the air surface should be considerably larger than the gas surface. Since air and gas passages in recuperators are constructed separately the question of choking of air flues does not arise. A cross-flow recuperator in which the air or waste gas travels backwards and forwards, is similar to a multiple pass regenerator. There is much pressure loss due to external reversal of direction, with practically no compensating increase in heat transfer. Many manufacturers of recuperators prefer to eliminate reversals of air flow, using vertical straight-through passes for air.

V.—POSSIBLE IMPROVEMENTS IN HEAT EXCHANGER PRACTICE.

Published suggestions have been made for increase of heat recovery by various combinations, such as the use of metal recuperators in series with refractory recuperators or regenerators. The thermal advantage of such systems is self-evident; but in nearly all cases such combinations must be ruled out, owing to increased capital cost or operating difficulties. It is not proposed here to discuss either these combinations, or the numerous patented tiles which are used in heat exchangers.

Assuming the validity of recuperator and regenerator calculations (and there is not the slightest doubt as to principle, only the heat transfer data being a little uncertain), a number of highly interesting conclusions may be drawn. Each of the following suggestions has been carefully checked, and the author has no hesitation in saying that they are mathematically correct, but space does not permit inclusion of the mathematics here. Experimental corroboration is lacking, and the third suggestion also involves the question of economic balance between cost and benefits derived.

1. Bypassing Part of the Waste Gas in Regenerative Systems.— Many furnaces operate with chimney draught for removal of waste gases, but with mechanical draught for air supply. In such furnaces, there is no difficulty in getting air to the furnace even when the checkers are choked up, but difficulty is experienced in removing the waste gases, so the furnace must be slowed up towards the end of a campaign if the passages are designed for a maximum average efficiency. The quantity of waste gas is usually appreciably larger than the air quantity. The checkers are therefore in reality designed for the waste gases rather than for the air.

If part of the waste gases from the furnace were bypassed to the chimney (or to a waste heat boiler) smaller flues could be used in the checker. This would result in a larger area and a somewhat higher rate of convection from brick to air, Rather more pressure would be required by the air; but owing to lower velocity, no additional suction would be required to carry the waste gases through the checkers. Actual calculation shows that the increase in the quantity $\frac{10A}{dc_g v_g}$ may much more than counterbalance the decrease in the quantity $\frac{c_g v_g}{c_a v_a}$, and that a marked increase in air

preheat would be obtainable; or alternatively, the size of the chamber could be materially decreased. Lower waste gas velocity and quantity, and cooler checkers, should also result in longer life of the regenerators.

The system could be applied by packing the checkers closer than an ordinary system would stand, and either bypassing part of the waste gas from the start, or passing the whole of the waste gas through the checkers at first, and then bypassing more and more waste gas as the checkers choke up. The first method would be easier on the checkers, while the second would ensure extra sharp working during the early part of the furnace campaign.

The idea of bypassing part of the waste gas is of course not new, and the application of bypassed waste gas to steam raising has been admirably discussed by Dyrssen.¹ This paper was read before the development of the full mathematical theory of regeneration, and did not contemplate the possibility of consequent increase in the temperature of the air preheat.

2. Use of Fillers in the Air Passages of a Recuperator.—It has



Fig. 54.

been shown that quite small air passages are permissible in a recuperator, and are necessary in order to increase the ratio of surface on the air side to that on the waste gas side. Corrugations of the surface, parallel to the direction of air flow so as not to increase the pressure drop, may assist in this direction. Also, increase of the idle surfaces of both gas and air passages, arranged so as not

to increase pressure loss, will augment heat transfer by surface radiation.

An important difficulty, in the use of small and numerous passages, is that the space occupied by the tile partitions becomes relatively large, with consequent increase in the recuperator size, or decrease in its efficiency.

It is possible that in the cooler part of the recuperator, a non-obstructing metal surface having a cross section as shown in Fig. 54, or any other suitable form, might be inserted in the air flues. This would merely divide the flues up into smaller passages with very little decrease in the free space. The theory underlying this suggestion is that the metal surface would reach a temperature almost equal to that of the walls by radiation—this may very easily be proved by calculation. The immediate effect would therefore

¹ Dyrssen, W.: "Recovery of Waste Heat in Open Hearth Practice," *Journal of the Iron and Steel Institute*, 1924, No. 1.

be to increase the exposed surface nearly $2\frac{1}{2}$ times. Other sections, or even a series of metal pipes, might be used in the same way. Further, this idea might be extended, by the use of heat resisting alloy steels, even to the high temperature zones of most recuperators. This is evident when we consider that although the waste gas temperature may be in excess of the working temperature of these alloys, there must be a drop of two or three hundred degrees Fahrenheit from the waste gas to the metal filler; also some local damage to the filler would not be serious.

The arrangement suggested might lead to other distinct advantages, in addition to economy of space. It has been mentioned that in the low temperature part of a heat exchanger, closer packing of the flues is logical on account of the smaller pressure loss for the same convection rate at lower temperatures. As a rule, it is inconvenient to use two types of tile in a recuperator, except in the multiple pass type; the use of a filler in the lower part of the packing would combine the advantages of closer packing at the cool end and use of a single type of tile. It may be noted, however, that in the cool zone, the coefficient of surface radiation would not be very high, and the temperature of the packing might lie appreciably below that of the tile surface.

The arrangement would make for flexibility, since a single tile design, possibly with relatively large square air passages, could be adapted to each particular furnace by the use of different packings; the form of packing, if desired, may be different at different temperature levels of the recuperator.

Pressure considerations must be remembered when applying the above suggestion. Subdividing a channel must cause some increase in pressure loss, even ignoring the decrease in effective section caused by the filler—see Table XIV on friction loss. On the other hand, the smoother surface of metal fillers may be expected to have a compensating effect.

3. Recuperator Type Packing in a Regenerator.—Because the passages of a recuperator are separately designed to meet the needs of air and waste gas, permitting high convection rates for air, combined with low resistance large ducts for the waste gas, it follows that for the same volume a recuperator would be very much more efficient than a regenerator if it were not for the leakage trouble. Calculation shows that if a modified inexpensive recuperator tile were used in regenerator chambers, the air passing through narrow channels and the waste gas passing through large channels (but possibly being permitted to use the narrow channels, also),

a very high efficiency could be achieved. The heat exchanger would be operated as a pair of true regenerators with the usual reversals. Leakage of air from the narrow ducts would be of no importance because both wide and narrow ducts would lead into the same header at the top of the regenerator.

This arrangement might be particularly suitable in the cooler chamber of a two-pass regenerator, because here there would be no danger of damage to the more expensive packing, and the straight-through waste gas flues could be very easily cleaned, while the air flues would not require cleaning. In any case this type of packing would be capped by several courses of regular checker.

4. Radiation to Air.—It has been indicated that humidification of the air to promote gas radiation is not a promising avenue for improvement—a result which is not unexpected but which is also not obvious. Neither does it appear likely that much benefit would accrue if it were found practicable to impregnate the air with fine dust.

5. Increasing Air Velocity in a Regenerator.—If an air regenerator were divided into two or more equal parts, it would be possible to pass air through one of these for half of the air period, and through the other one for the other half. This would increase the air velocity, but since there would be only half the active surface area, the result must be definitely inferior to the normal method of using the entire chamber.

However, using a standard type of checker, a practical method does exist, whereby the air velocity may be artificially increased without decreasing the active surface (or time of passage of the gas through the checker); according to calculation, a large increase of efficiency is indicated.

The above suggestions are merely examples of what we may expect to result from modifications according to the theory of heat exchange; there are of course other possibilities. Application to full size furnaces alone can show whether such modifications as suggested are of practical and economic value.

VI.—MINOR DEVICES FOR RETURN OF HEAT.

Other means of less importance are available for the return to the furnace of part of the heat normally lost. The chief heat losses from the furnace are the sensible heat of the waste gases, the heat loss through the walls of the furnace, and the heat in the hot products of the process.

Sensible Heat of Waste Gases.—Apart from recuperation and regeneration, recirculation of part of the waste gases may sometimes be used as a means of returning sensible heat to the furnace. If a process demands a much lower temperature than is obtained by direct combustion, the temperature may be kept down by the use of a large excess of air. This is wasteful on account of the increased loss of sensible heat.

A thermally more efficient method is to recirculate part of the hot waste gases to the furnace, instead of using excess air. This permits combustion of a smaller quantity of fuel to maintain the desired temperature and rate of heat input to the furnace chamber.

The mere use of waste heat external to the furnace, as in waste boilers, although a valuable means of reducing production costs, is of course not an example of return of heat to the furnace. Such devices as preheaters placed in the waste gas stream for air or steam used for atomization with oil burners, and preheaters for the oil, are other examples of return of sensible heat of the waste gases to the furnace.

The most efficient of all fuel fired furnaces are continuous furnaces, particularly shaft furnaces. Here the sensible heat of the gases from the high temperature discharge end of the furnace is absorbed by the cool charge as the latter travels gradually towards the hot zone. In batch type furnaces, it is sometimes practicable to preheat the cool charge in a separate chamber through which are passed the hot gases from the finishing chamber. The high efficiency of the true continuous process is of course not approached, and the method involves additional handling expense.

Heat Losses through the Brickwork.—Parts of certain furnaces need more positive cooling than provided by natural convection and radiation from the exterior. Sometimes air under light pressure is carried in ducts along such surfaces, and the slightly preheated air is then used for combustion. This system may be extended by building air ducts into the hearth, or constructing an air chest over the roof, etc.

Excepting where the air is carried in enclosed metal ducts, the brickwork in such installations must be reasonably air tight. Inward leakage will be mainly at the joints of the brickwork, and owing to its uneven distribution can hardly be considered a useful factor in keeping the walls cool.

Heat of Furnace Products.—The hot furnace products must eventually be cooled, and the sensible heat is theoretically recoverable. For practical reasons, there are very few processes where the

return of part of this heat to the furnace presents a promising field for investigation. Certain continuous tunnel kilns, where the material is heated to effect physical or chemical changes, may prove an exception. The raw material is slowly heated to a maximum temperature at some point within the tunnel, and then the calcined product cools off slowly as it travels towards the discharge end of the tunnel. Here the sensible heat of the cooling charge may be used to preheat the air used for combustion at the high temperature zone. This method of heat recovery is employed in brick burning tunnel kilns and continuous compartment kilns.

SUMMARY.

1. *Recuperators and Regenerators.*—Recuperators have the advantages of continuous operation, steady preheat temperature, chambers built in single units instead of in pairs, and absence of reversing valves. Their general application is restricted by the difficulty in some cases of keeping leakage to an acceptable minimum. This leakage includes that unavoidable in a brick structure, and that due to unsuitable service conditions, such as alternate heating and cooling, high peak temperatures, or slag action.

The regenerator is relatively insensitive to severe working conditions, and can therefore be used where very high preheats are necessary, where high pressures are employed, and in other cases where a recuperator might not prove satisfactory.

2. *Mechanism of Heat Transfer.*—The two groups of factors determining heat exchange and air preheat are the properties and quantities of waste gas and air, and the constructional characteristics of the heat exchanger. Referring to the latter, the factors directly conducive to efficient heat exchange are the area across which heat flow occurs, and the "smallness" of the resistance to heat flow expressed as a standard brick thickness. Quantitatively, these two factors are of equal importance.

(a) The effective area in a heat exchanger may be increased by increasing the size of the chamber, by increasing the number and decreasing the cross section of the passages through the heat exchanger, or by adopting a channel shape which presents a larger surface per unit of volume.

(b) In both recuperators and regenerators the free passage of heat is impeded by three resistances. These resistances are caused by transfer of heat from waste gases to brick; by

transmission through the brick in recuperators, or by storage in the brick in regenerators; and by transfer of heat from brick to air. The sum of these resistances may be expressed as the equivalent thickness of standard brick.

Heat transfer from brick to air is dependent on convection alone, and the equivalent brick thickness may reach a value of several inches. Owing to the supplementary action of gas radiation, the resistance to heat transfer from waste gas to brick tends to be much lower for this stage of the heat flow; the value will ordinarily be less than 3 inches of standard brick. The value for the brick itself will usually be somewhat less than that for the waste gas to brick transfer. Dust deposits on the brick may very greatly impede heat exchange.

Since the total resistance to transfer is the sum of the three thickness equivalents, the largest of the three is the one which offers the most scope for improvement in the over-all heat transfer. The actual coefficient of convection for air may be increased by the use of narrower air passages, or by maintaining higher velocities. There are practical considerations limiting the extent to which these means may be applied to decrease the resistance. If the area of the brick surface exposed to air, relative to the surface exposed to waste gas, is increased, the result is equivalent to a decrease in the resistance to heat flow from brick to air.

Taking into consideration the importance of increased surface and decreased resistance, for a given size of heat exchanger it follows that decreasing the diameter of the passages must be the most effective means of improving heat exchange, because it both increases the surface and decreases the resistance to heat flow. For radiant gases, decreasing the diameter of the passages is much less effective, because the increased area is partly offset by a decrease in the coefficient of gas radiation. Increasing the velocity to increase the convection rate will not result in proportionate decrease in over-all resistance; if the increased velocity is achieved by decreasing the cross section of the heat exchanger, there will be improvement in the heat exchange only if there is accompanying increase in the length of passage.

3. *Resistance to Heat Flow (Standard Brick Equivalent Thickness).*—(a) *Recuperators.*—The gas to wall and wall to air resistances are determined directly from the convection and gas radiation data. Allowance must be made for difference between the surface exposed to gas and that exposed to air. The brick transmission resistance is based on the mean thickness of the tile

parallel to the direction of heat flow. The three resistances are added to give the over-all resistance.

(b) *Regenerators*.—Owing to the intermittent nature of the heat flow, the calculated gas to brick and brick to air resistances must be increased in the ratio,

$$\frac{\text{Total time of cycle}}{\text{Time of gas or air flow}}$$

For regenerators operating on equal gas and air periods, this means that the resistances determined must be doubled. Owing to its imperfect heat absorbing capacity, the brick in a regenerator offers resistance to heat flow. This resistance is determined by the properties of the brick, the length of the cycle, and the thickness of the brick. Its value may be found from Table XIX. The three resistances, after adjustment as explained, are to be added.

4. *Heat Exchanger Calculations*.—The method of calculation given applies to counter-flow types of heat exchanger. The waste gas and air quantities and inlet temperatures being known, the method is applicable either to determination of the outlet temperatures for a given heat exchanger, or to design of a heat exchanger for a given air preheat.

In making these calculations, two factors f and f' are determined from Fig. 48 according to the values of certain groupings of the heat capacities of waste gas and air, the heat exchanging surface, and the resistance to heat transfer. The method is described in detail on pages 326-340 and pages 345-354. The efficiency and per cent. heat recovery are also obtainable from the factors f and f' .

5. *Temperature Fluctuations in Regenerators*.—In regenerators, the temperatures of air preheat, brick and escaping chimney gases vary during a cycle. Methods are given for calculating the extent of variation. The brick commonly employed in regenerators is of such thickness that no appreciable decrease in fluctuation can be expected by increasing the thickness. Short cycles, on the other hand, will always decrease the fluctuation, although less than proportionately—the fluctuation is proportional to the checker resistance as given in Table XIX. For practical reasons, the cycle should not be too short.

6. *Pressure Loss in Relation to Heat Exchange*.—The characteristic A/d (A = heat exchanging surface, d = resistance to heat flow) determines, so far as the heat exchanger construction is concerned, the efficiency of heat exchange. This characteristic

may be increased in various ways, and the problem is to obtain the biggest possible value for a given pressure difference.

The most economical method, with reference to pressure, is to increase A by reducing the diameter of the passages, or in some cases by using passages of elongated cross section.

The diameter of the passages having been reduced to a minimum, excess pressure should be used to induce a greater rate of convection either by greater velocity or by increased eddying of the gas stream. If a single pass is to be used, increased velocity involves a smaller cross section and additional height of the chamber. Increased eddying is produced by changing from straight flues to checkers, staggered checkers still further increasing eddying. There does not appear to be a wide difference between the degrees of improvement resulting from increased velocity and increased eddying. For equal consumption of pressure, these methods are much less efficient than decrease in passage diameter.

If after the above two principles have been adhered to, there remains an excess of available pressure, this may be used to obtain further increase of velocity in multiple pass systems.

For a given rate of flow in normal cubic feet per second, the dynamic energy (pressure equivalent) of a gas increases with the temperature. This points to the economy of using passages of smaller diameter at the cool end than at the hot end of a heat exchanger. In this way, the heat exchanger characteristic may be increased with relatively small corresponding increase in pressure requirement.

Calculation shows that in many instances of regenerator construction, the brick employed is too thick to be economical of pressure and space.

In the preheating of fuel gases, gas radiation decreases the resistance to heat flow, convection then being relatively unimportant. The preheating of fuel gases may yield valuable increase in the calorific values due to endothermic reactions between hydrocarbons and carbon dioxide or water vapour.

Particularly where natural draught is used, it is important to minimise pressure losses external to the heat exchanger surface, whether in the ducts leading to the furnace or chimney or in the connections between passes in a multiple pass checker. The pressure difference developed by buoyancy varies as the difference of level between the burner and the cool end of the heat exchanger.

To ensure good distribution of air and waste gas across the

whole section of a heat exchanger, gases hotter than the heat exchanger surface should descend; cooler gas should ascend. It may sometimes be expedient to violate this principle, as in horizontal passes, and in some multiple pass checkers.

7. *Miscellaneous*.—Based on the mathematical theory of heat exchange, some suggestions are offered for the possible improvement of heat exchanger design.

Reference is made to heat exchange devices of minor importance.

General References :—

1. W. Heiligenstaedt: *Der Industrieofen, Band V, Regeneratoren, Rekuperatoren, Winderhitzer*.
2. A. Schack: *Industrial Heat Transfer*. (Translated by * H. Goldschmidt and E. P. Partridge).

CHAPTER VIII.

REFRACTORY MATERIALS.

FIGURES by F. H. Norton¹ show that, of the refractories used in the United States, nearly 75 per cent. are fireclay and nearly 20 per cent. are silica. So far as these two refractories are concerned, it is possible that in most other countries the total percentages are not widely different. Of the fireclay products, boiler furnaces were stated to account for 35 per cent., open hearth furnaces 20 per cent., blast furnaces 10 per cent., forging and heat treating furnaces 10 per cent., and the remaining 25 per cent. was divided approximately evenly between non-ferrous furnaces, malleable iron furnaces, the glass industry, the ceramic industry, the lime and cement industry, and "other uses." These detailed figures will obviously vary somewhat in different countries. Norton's figures for consumers of silica brick are:—open hearth furnace 60 per cent., gas industry 17 per cent., glass industry 8 per cent., non-ferrous industry 8 per cent., electric steel industry 2 per cent., "other uses" 5 per cent.

In any industry where refractory replacements constitute an important item in the costs of production, it is necessary to pay close attention to the service rendered by refractories. It is assumed that readers of this book have some acquaintance with the general characteristics of the principal refractories. This being so, it is thought that for purposes of reference and comparison it will be more convenient to divide this chapter according to the major properties of refractory materials, with the individual common refractories listed as subdivisions, rather than the reverse procedure.

In most cases, after a brief description of the property being considered, a rough working theory is given. The theory does not necessarily represent what actually happens, but it will assist in anticipating how certain physical and chemical characteristics of the refractory will affect its performance.

¹ Norton, F. H.: "Refractories for Industrial Furnaces," *Fuels and Furnaces*, Vol. 10, No. 6, June, 1932.

I.—MELTING POINT.

The majority of pure chemical compounds, provided they do not decompose before fusing, melt sharply at a definite temperature.

Table XX gives the melting points of the pure compounds which form the basis of most of the common refractories.

TABLE XX.—MELTING POINTS OF PURE COMPOUNDS.

Pure Compound	Formula.	°F.	°C.
Alumina, . . .	Al ₂ O ₃	3720	2050
Chromite, . . .	FeO.Cr ₂ O ₃	3955	2180
Magnesia, . . .	MgO	5070	2800
Silica, . . .	SiO ₂	3120	1715

Pyrometric Cone Equivalent.—Additions of other substances nearly always lower the melting point of a material. Moreover, mixtures of substances do not, in general, show a sharp melting point. They soften sufficiently to deform under their own weight at a temperature usually much below that at which fusion is complete. For this reason the technical use of the term “melting point” with reference to refractory materials has been discarded by the ceramic industry, resistance to heat now being expressed in terms of Pyrometric Cone Equivalents (P.C.E.). The Pyrometric Cone Equivalent is determined by placing a test pyramid of the refractory in a laboratory furnace with a series of numbered standard pyramids called Seger or Pyrometric Cones. These pyramids must be made and placed according to specific standard conditions and must be heated at a definite rate. Heating is continued until the test pyramid softens and bends over far enough for its tip to be level with the base, and the *number* of the standard cone which has shown the same degree of collapse under the combined time-temperature conditions of the test is referred to as the Pyrometric Cone Equivalent of the refractory.

From the consumer's point of view, it is more convenient to use the temperature corresponding to the Pyrometric Cone Equivalent, and for the sake of brevity, this temperature will here be called the “melting point” of the refractory, the words “fusion” and “melting” being used in the same sense. It will

be observed that the technical term "Pyrometric Cone Equivalent" and the non-technical term (as applied to a refractory) "melting point" in reality indicate the limiting temperature of the material under the most favourable conditions.

Theoretical Considerations.—If an impurity is added to a substance and the mixture is heated, the impurity will associate with a small portion of the original matter to form a substance which has, in general, a considerably lower melting point than the pure material. If a pyrometric cone of the material is heated, the lower melting material will fuse as soon as its melting point is reached, the cone then consisting of a skeleton of solid grains surrounded by a more or less viscous liquid. If the amount of impurity and hence of liquid were very large, the cone might bend over immediately; but in ordinary refractories, the quantity of liquid is small and the cone remains quite stiff enough to support its own weight. As the temperature rises, however, the liquid commences to dissolve out the higher melting material, so that the quantity of liquid increases and the quantity of solid decreases until finally the cone collapses and bends over at a lower temperature than the melting point of the pure higher melting grains.

It is clear that the bad effect of this foreign material will depend on:—

- (1) the amount present,
- (2) the melting point of the lower fusing constituent,
- (3) the capacity of this constituent for dissolving the higher melting point material at relatively low temperatures.

A certain amount of impurity is of course essential to the manufacture of most refractories, as the more fusible mixtures serve as a bond to hold the more refractory particles together. The fused product solidifies to a slag-like material which is usually non-crystalline, and is called a glass. The process of glass formation is called vitrification.

When several impurities are present together, they tend to produce a lower melting fusible constituent than the same total quantity of a single impurity. As a general rule, basic oxides (lime, magnesia, ferrous oxide, manganous oxide, alkalies, etc.) are most active in lowering the melting point of an acid refractory, while acid oxides (silica) are most active in lowering the melting point of a basic refractory.

The above statement appears to be a truism, and is consistent with the ready attack of basic slags on acid refractories and vice

versa. The cases however are not quite parallel, in one case the refractory being subjected to the action of a very large quantity of flux, and in the other to a very small quantity. A glance at the equilibrium diagrams of the different slag forming constituents shows (International Critical Tables, etc.), that a sweeping statement on this matter is by no means justified. For example, the lowest melting mixture of the two basic oxides lime (CaO) and magnesia (MgO) is about 500° F. (275° C.) lower than the melting point

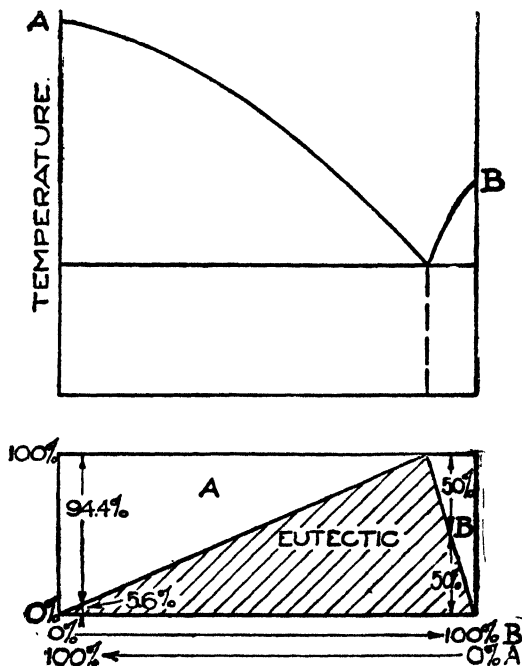

Fig. 55.—Eutectic Diagram.

of lime (the more fusible of the two oxides). In contrast with this considerable lowering of the melting point may be cited the action of the basic oxide magnesia on the acid oxide silica (SiO_2), the maximum lowering caused in the melting point of silica being only about 110° F. (60° C.). Perhaps a better analysis of the position may be found in the two accompanying equilibrium diagrams.

Simple Eutectic Diagram.—Fig. 55 is a hypothetical diagram for two oxides of widely different melting point which form a simple "eutectic" series. Two basic oxides would be expected to form a series of this type. The eutectic is the lowest melting

mixture which it is possible to make from the two constituents *A* and *B*, and the composition of this mixture will correspond with the *V* of the diagram. The curves in the upper diagram show the temperature at which a given mixture will be just completely liquid. Every mixture in the series will contain one of the free substances *A* or *B*, together with some of the low-melting eutectic, the amounts being shown in the lower diagram. The figure shows that 5 per cent. of *B* as an impurity in the high melting oxide *A* can produce 5.6 per cent. of the fusible eutectic. At the other end of the diagram, 5 per cent. of *A* in the lower melting oxide *B*, can produce as much as 50 per cent. of eutectic. It follows that 5 per cent. of the high melting oxide is a much more serious impurity in the lower melting oxide than *vice versa*, not so much because the higher melting oxide is better able to stand a lowering of its melting point, but rather because of the greater quantity of flux produced at the low temperature end of the diagram. In a simple series like this, it is also clear that the higher the melting points of *A* and *B*, the higher will be the melting point of the eutectic. For example, the eutectic between magnesia and lime (the major constituents of burnt dolomite), is itself a highly refractory substance.

SiO₂ - Al₂O₃ Diagram.—Fig. 56, due to Bowen and Greig,¹ is the very important silica-alumina diagram. It differs from Fig. 55 chiefly in that a compound, mullite ($3\text{Al}_2\text{O}_3 \cdot 2\text{SiO}_2$), is formed between the two constituent oxides. The effect of this compound is to displace the triangular eutectic diagram towards the right. 5 per cent. of Al_2O_3 in otherwise pure silica may produce about 90 per cent. of fusible eutectic (melting point 2810° F. or 1545° C.) rendering the silica of small value as a refractory.

Owing to the fact that mullite decomposes into Al_2O_3 and SiO_2 before it melts, the addition of 5 per cent. of SiO_2 to alumina produces no eutectic at all. About 17.7 per cent. of mullite would be present in the cold refractory; but as the decomposition temperature of this compound is 3290° F. (1810° C.), moderate quantities of silica have no serious effect on the melting point of alumina.

¹ Bowen, N. L., and Greig, J. W.: "The System Al_2O_3 - SiO_2 ," *Journal of the Amer. Ceramic Soc.*, 7, 238 to 254, 1924. The temperature scale of the Geophysical Laboratory (used in this diagram) differs from the International Temperature Scale. The difference is negligible at 1500° C. but increases at higher temperatures, e.g. the melting point of platinum is given as 1755° C. on the Geophysical Laboratory Scale, as compared with 1770° C. on the International Scale. The melting point shown for alumina, however, conforms with the International Scale.

If mullite had been stable at its melting point, there would have been a second but much less fusible eutectic between 0 and

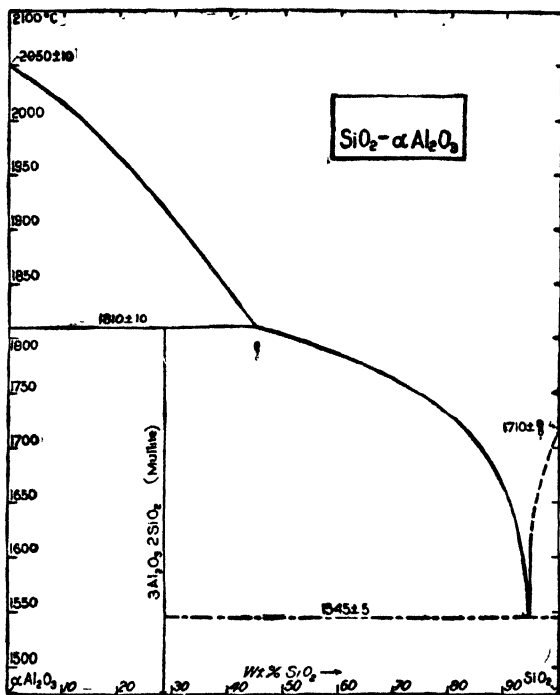

Reproduced from "International Critical Tables," Vol. IV, by permission of the publishers, The McGraw-Hill Book Company, Inc.

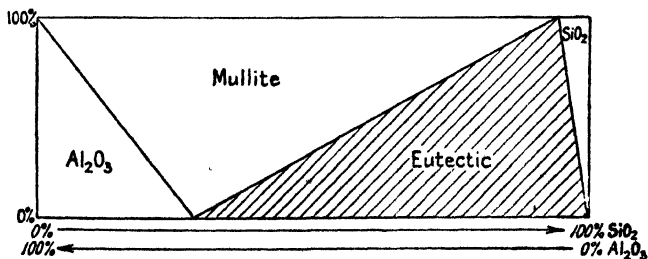

Fig. 56.—Silica-Alumina Diagram.

28 per cent. of SiO_2 . 5 per cent. of SiO_2 in alumina would then have produced a considerable quantity of this eutectic.

When two oxides *A* and *B* form a compound on the *A* side of

the diagram, the melting point of this compound is usually, but not always, lower than the melting point of *A*. The eutectic formed between this compound and *B* will therefore probably have a lower melting point than would be obtained between *A* and *B* if no compound were formed. Also, a small percentage of *A* as an impurity in *B* will tend to produce a greater amount of eutectic, if a compound exists in the series.

If two or more compounds are formed in the series, both these effects will tend to be enhanced, depending on the melting points of the compounds formed. For example, the very highly refractory oxides alumina and lime form four compounds, resulting in the formation of eutectics, two of which melt at about 2550° F. (1400° C.).

Two basic oxides do not readily form compounds, whereas an acid and a basic oxide do usually form at least one, and more often a whole series of compounds. Hence the generalisation that basic impurities are most objectionable in an acid refractory, and acid impurities in a basic material. Again, it must be remembered that most basic refractories have an already very high melting point, and that they can stand a good deal more fluxing impurities than, for example, silica refractories. Impurities which themselves have fairly low melting points (*e.g.* FeO), are likely to produce very easily fusible eutectics.

It is well to remember that the equilibrium diagrams represent the constitution of a material cooled extremely slowly from the liquid state. Owing to the coarsely heterogeneous nature of most refractories it cannot be expected that the equilibrium diagram will give an accurate picture of the constitution of the commercial material in respect to its chemical analysis.

In pursuance of the rule concerning the dependence of fluxing properties on the type of oxide, it is necessary to consider certain important oxides which are neither obviously basic nor obviously acid.

The most important of these is alumina. With silica, it forms a compound and in other ways behaves like a basic oxide. It also forms a compound with magnesia and a whole series of compounds with lime. Alumina will therefore act as a base when in contact with an acid refractory (*e.g.* silica brick), and will act as an acid when in contact with a basic refractory (*e.g.* dolomite).

Ferric oxide (Fe₂O₃) probably acts at high temperatures as an acid oxide. It would consequently have small fluxing action on silica brick when in this form. At moderate temperatures, this oxide is decomposed to magnetic oxide of iron (Fe₃O₄), and

under mildly reducing conditions the latter is further reduced to ferrous oxide (FeO). Ferrous oxide is a basic oxide having a low melting point and it therefore has a strong fluxing action on acid refractories. Consequently acid refractories should not contain too much iron, even though the latter be present as ferric oxide (Fe_2O_3). For use in an oxidising atmosphere, more iron is permissible than for use in a reducing atmosphere. A given refractory may show a much lower melting point in a reducing atmosphere than in an oxidising atmosphere.

Chromic oxide (Cr_2O_3), like alumina, can probably act as either a base or an acid; but it is nearly always present as the high melting compound chromite ($\text{Cr}_2\text{O}_3 \cdot \text{FeO}$). The reactions, either acid or basic, of this compound are extremely feeble, and it is widely used as a "neutral" refractory.

Silica Brick.—Silica brick normally contains 96 per cent. of SiO_2 . It approaches, therefore, more nearly to a pure chemical substance than other common refractories, and it is not unexpected to find that the melting point of silica brick is only slightly lower than that of pure silica. The melting point is $3050\text{--}3090^\circ\text{F}$. ($1680\text{--}1700^\circ\text{C}$.)

Fireclay Brick.—Fireclays vary widely in composition and properties. Kaolin, or "china clay," is the clay substance of nearly all fireclays. Pure kaolin is a chemical compound having the formula $\text{Al}_2\text{O}_3 \cdot 2\text{SiO}_2 \cdot 2\text{H}_2\text{O}$, but when burnt it loses its water and the dehydrated material is probably no longer a compound. The only compound known to exist between alumina and silica at furnace temperatures is mullite, $3\text{Al}_2\text{O}_3 \cdot 2\text{SiO}_2$, the formula indicating that the compound contains 71.8 per cent. of Al_2O_3 and 28.2 per cent. of SiO_2 . Burnt kaolin contains 46.2 per cent. of Al_2O_3 and 53.8 per cent. of SiO_2 , consequently a brick made from pure kaolin should consist of a mixture of mullite and considerable excess silica. Actually the formation of mullite may be far from complete if time and temperature of firing are not favourable.

Ordinary fireclay refractories in the raw state consist of kaolin associated with varying amounts of excess silica. When burnt they also consist essentially of mullite, more or less perfectly developed, together with a great deal of excess silica; and being mixtures, they do not have well defined melting points. In fact even mullite does not show the sharp melting point expected of a pure compound, because it decomposes at 3290°F . (1810°C .) with the formation of a relatively large amount of fused material.

At this temperature a pyrometric cone bends over, marking the so-called melting point of the material.

The melting point of a brick made from pure kaolin is 3245° F. (1785° C.). As the amounts of silica and other impurities in the clay increase and the alumina content falls to that normally present in burnt fireclays (30 to 45 per cent.), the melting point decreases. The melting points of fireclay refractories range from 2900° F. (1600° C.) to 3200° F. (1750° C.), the average being nearer to the lower figure. For low temperature work, fireclay bricks of still lower melting point are sometimes used.

High Alumina Refractories.—A recent trend in many industries where high temperatures are employed, has been the adoption of high alumina refractories. Broadly, by high alumina refractories we mean those containing over 45 per cent. of Al_2O_3 , the balance being mainly silica. Several grades are made containing up to 80 per cent. of Al_2O_3 .

The melting point of pure alumina is 3720° F. (2050° C.). As the percentage of alumina increases from that of a low grade fireclay, up through that of a high grade fireclay, a kaolin, a mullite, and finally beyond that of mullite towards pure alumina, the melting point increases progressively. The purer grades of commercial kaolin brick melt at about 3200° F. (1750° C.); and commercial mullite at about 3250° F. (1800° C.).

Magnesite.—Commercial magnesite refractories frequently contain only about 85 per cent. MgO , the remaining 15 per cent. being made up largely of Fe_2O_3 , CaO and SiO_2 . As would be expected, the acid oxides silica and ferric oxide form mixtures or compounds with magnesia which melt at a much lower temperature than pure magnesia. Since the melting point of magnesia is extremely high, the mixtures so formed, although having melting points many hundreds of degrees lower, are still highly refractory. There is more likelihood of mixtures formed between the different impurities themselves being the cause of low melting slags surrounding the magnesite grains. Even so, assuming the presence of as much as 15 per cent. of fluid slag in the refractory, the magnesite dissolves in this slag but slightly with increasing temperature, so that a pyrometric cone of commercial magnesite shows a high melting point—usually about 3900° F. (2150° C.).

The high melting point of pure magnesium oxide makes the presence or addition of fluxing oxides essential in order to yield a material which may be fritted at a reasonable temperature.

Even with the high percentage of impurities usually present, slag addition is necessary in making a furnace bottom of "grain" (*i.e.* granular) magnesite.

Dolomite.—The most fusible mixture of magnesia and lime melts at about 4170° F. (2300° C.). The refractory can consequently, like magnesite, carry a high percentage of impurities without serious lowering of its melting point. Also like magnesite it *must* contain a fairly high percentage to permit the material to be fritted on to a bottom. An ordinary melting point for commercial dolomite is 3500° F. (1925° C.).

Chrome Brick.—The pure mineral chromite ($\text{FeO} \cdot \text{Cr}_2\text{O}_3$) contains 32 per cent. of FeO and 68 per cent. of Cr_2O_3 . It belongs to a class of minerals of which the constituent oxides may be replaced by MgO and Al_2O_3 respectively. In naturally occurring chromites, part of the FeO is always replaced by MgO and part of the Cr_2O_3 by Al_2O_3 , these replacements being in molecularly equivalent quantities. Over a wide substitution range the mineral remains highly refractory, and this complex substance comprises at least 75 per cent. of the weight of the chrome brick. The glassy material of the brick usually consists of comparatively low melting mixtures of magnesium silicates. It should be noted that one part of the MgO (present in the chrome mineral) is refractory and that the excess (present as silicates) is a constituent of the fluid glass. Similarly, excess of either FeO or Al_2O_3 over that held by the chrome mineral will be found in the glass, producing still greater fusibility of the glass. Thus chemical analysis may be of far less value for chrome bricks than for other types of refractory. The silica content may give some indication of the amount of glass present, although it will not show whether the glass has a high or a low melting point. Provided the amount of silica is not excessive, the melting point of chrome brick is not greatly affected by the glass, because chromite is very little subject to slag attack and the glass merely exists as a non-corrosive liquid which has soaked between the particles of the refractory mineral. However, the nature of the glass does have a very important bearing on other properties of chrome refractories.

The usual melting point of chrome brick is about 3900° F. (2150° C.).

II.—EXPANSION AND CONTRACTION.

There are two types of expansion and contraction with temperature change—reversible and irreversible. Both must

be borne in mind in the selection of refractories and in the building of furnaces.

Reversible Volume Changes.—There are three causes of reversible volume change with temperature.

1. All refractories are subject to the usual tendency of materials to expand with heat and contract with cold. Change due to this cause takes place more or less evenly as the temperature rises.

2. Certain minerals, notably silica, undergo distinct reversible changes in the crystalline structure at definite temperatures, the inversion in some cases taking considerable time. Inversion is usually accompanied by a marked volume change; and greater care is necessary in heating or cooling through these critical temperatures, because the volume change is sudden instead of being spread over a wide temperature range as in 1.

3. An internal expansion and contraction may take place due to changes in the character of the glassy material which is present in all refractories. Glasses are not stable, and in service at moderately high temperatures, below the melting point of the glass, crystalline compounds form within the glass, a volume change usually accompanying this separation. This is called devitrification of the glass. At higher temperatures, above the melting point of the glass, the process is reversed, and the crystalline compounds are re-dissolved.

Irreversible Volume Changes.—Irreversible expansion or contraction is due to permanent physical or chemical changes taking place in the refractory. As much as possible of this is taken care of in the manufacture of the brick, but in some classes of refractory a good deal of the original tendency remains to be taken care of in service.

1. The mixture of minerals constituting the raw material of a refractory usually changes considerably on firing by decomposition or changes in the original minerals. The distribution of the constituents changes as the time and temperature increase, and therefore will depend on the conditions of manufacture. If, in service, the bricks are subjected to a higher temperature than that used in firing, the redistribution will continue with accompanying volume changes. Even if the temperature is not higher, changes may continue in service due to the time element.

2. When approaching the melting point, most refractories show a marked shrinkage. This may be interpreted as being caused by the increased quantity of fused material formed by partial solution of the more refractory particles, with consequent decrease

in porosity of the material. This being a more or less plastic contraction, the effect of pressure will increase the tendency. A few refractories show the reverse tendency of expansion at high temperatures under test conditions. This is believed to be due to liberation of gas within the refractory, converting the fused material into a foam and causing the refractory to "bloat."

3. It was stated that some of the reversible crystalline changes require considerable time. In service there is ample time for a compound to reach its stable crystalline form for the working temperature, but on cooling off there may be insufficient time for the reverse change to take place; when the refractory is fairly cool, inversion practically ceases. For all practical purposes such changes may be considered permanent.

From the foregoing description, it is clear that in heating a refractory to a given temperature both reversible and irreversible changes may take place. If both tend in the same direction, the effect will be cumulative at the final temperature. If they tend in opposite directions, the final result will be the difference between the two tendencies, and may even give a zero net change. In all cases, when the refractory is cooled back to starting temperature, only the permanent volume change remains.

In the ensuing discussions the different tendencies are treated separately, and it is understood that the net result is the sum of the individual superimposed tendencies.

Silica Brick.—Silica exists in silica brick in four distinct varieties. The first is **quartz**, which is the essential mineral constituting the rock from which practically all silica brick refractories are made. Quartz is the stable form of silica up to 1600° F. (870° C.). Between 1600° F. and 2680° F. (870° C. and 1470° C.) the stable form of silica is called **tridymite**. Between 2680° F. (1470° C.) and the melting point the stable form is **crystalite**. The changes from one variety to another take place extremely sluggishly, and for practical purposes may be regarded as irreversible. In particular, the conversion of quartz to tridymite can take place only under favourable conditions; and since these are usually lacking in the manufacture of silica brick, most of the conversion in manufacture is from quartz to crystalite in a temperature range where tridymite is in reality the stable form. The final conversion from crystalite to tridymite takes place in service very slowly in those portions of the brick lying between 1600° F. and 2680° F. (870° C. and 1470° C.). The fourth form of silica is non-crystalline and is **silicate**

glass formed by partial fusion of silica and impurities (chiefly lime).

Irreversible Changes.—The specific gravity of quartz is 2.65, that of tridymite is 2.27 and that of cristobalite is 2.33. An ultimate conversion of quartz to tridymite is therefore accompanied by a 14 per cent. increase in volume. *A linear expansion is one-third of a volume expansion*, so that this represents nearly a 5 per cent. increase in length. So large an expansion is not permissible in service, and must be completed as far as possible in the manufacture of the brick. For this reason silica brick is fired to a high temperature—frequently above 2650° F. (1450° C.)—and heating is maintained for a considerable time. The conversion is incomplete; the ranges given by Hugill and Rees¹ and by Norton² for the composition of well burned British and American brick, respectively, are :—

	Quartz.	Tridymite.	Cristobalite.
Hugill and Rees, . . .	5.25%	10.45%	50.75%
Norton,	0.25%	4.40%	50.70%

According to Searle,³ however, British silica brick rarely even approaches the degree of conversion given above.

The true specific gravity, determined on the crushed brick, may be used as an index of the degree of inversion attained in firing. A specific gravity not greatly exceeding 2.4 may be taken as satisfactory, and a brick yielding this figure would have a "permanent" linear expansion of a little under 2 per cent. on conversion to tridymite. This growth would take place very gradually in service at a high temperature, and would partly be taken care of by plastic and elastic deformation, even in a material as rigid as silica brick. This is *not* the expansion which causes most trouble due to careless heating of silica brick arches and walls.

Reversible Changes.—Each of the three crystalline varieties of silica exists in at least two modified forms, inversion taking place at well defined temperatures, and being definitely reversible. In each case the change is accompanied by a sharp increase in volume with rising temperature, and a corresponding decrease in volume with falling temperature. Fig. 57 illustrates more clearly than words both the normal gradual contraction and expansion of the materials with temperature, and the superimposed sudden changes

¹ Hugill, W., and Rees, W. J. : "Silica Refractories for the Iron and Steel Industries," *Bulletin No. 12 of the British Refractories Research Association, April, 1926.*

² Norton, F. H. : "Refractories."

³ Searle, A. B. : "Refractory Materials, Their Manufacture and Uses" (Griffin).

corresponding with inversion. It should be noted that the silicate glass present in silica brick will contain a high percentage of lime, and will therefore not have the very low thermal expansion characteristics shown in the diagram for quartz glass.

The most important volume change is clearly due to the cristobalite inversion, both because it is the biggest (about 1 per cent. linear expansion) and because cristobalite is the major constituent of most new brick. The relative importance of the quartz and tridymite inversions will depend on the percentages

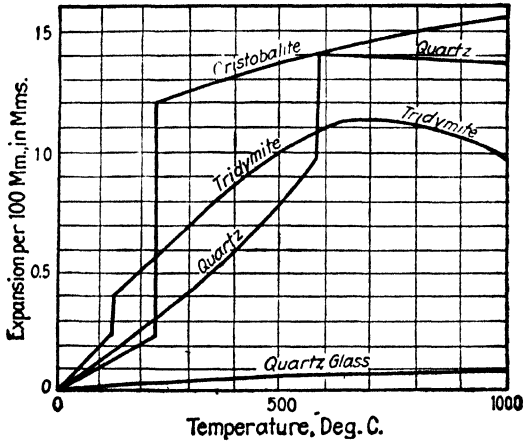

Fig. 57.—*Results of Le Chatelier's Experiments on Thermal Expansion.

of these constituents present in the bricks. According to Fenner,¹ the inversion temperatures are :—

	1070° F. (575° C.)	
Quartz	$\alpha \rightleftharpoons \beta$	
	243° F. (117° C.)	325° F. (163° C.)
Tridymite	$\alpha \rightleftharpoons \beta_1$	$\rightleftharpoons \beta_2$
	437° F. (225° C.)	
Cristobalite	$\alpha \rightleftharpoons \beta$	

* Reproduced from the Transactions, Vol. LVII, by permission of the American Institute of Mining and Metallurgical Engineers. The curves of this figure were drawn from the original, "La Silice," M.H. le Chatelier, *Revue universelle des Mines*, 5th Series, 1913, 1, p. 90, Fig. 1. Permission of the publishers of the *Revue* has also been obtained for this reproduction.

The curve for quartz represents the mean values for the different crystallographic axes.

¹ Fenner, C. N. : "The Stability Relations of the Silica Minerals." *American Journal of Science*, Vol. 36, p. 331 (1913).

The letters α and β are used to distinguish the two forms of the different minerals. It will be noted that there are two modifications of β tridymite, but that for practical purposes it is sufficient to assume the single volume change shown by Fig. 57 at about 275° F. (135° C.).

In heating a new silica brick structure, it is evident that the greatest care must be taken in heating up to 1100° F. (600° C.), but particularly in heating from 400° F. to 500° F. (200-250° C). In this connection it must be remembered that although the furnace interior may have passed all the critical temperatures safely, the brickwork a few inches back from the inner surface may still be below these points. However, the danger here is less, because heat penetration is always rather slow and there is no danger of sudden accidental temperature increase by currents of hot gas or flame.

Above a dull red heat there are no further sudden changes in volume; but there remain some gradual changes which may be important. The first is the "irreversible" continued conversion in the direction quartz to tridymite or cristobalite, this being most rapid above the firing temperature of the brick. The second volume change is due to devitrification of the silicate glass. This takes place at temperatures above 1800° F. (1000° C.), becoming more rapid as the temperature rises, but ceasing when the silicates melt. The volume changes accompanying separation of crystalline matter (cristobalite and tridymite) from the glass will probably set up high internal stresses. At lower temperatures, the crystalline changes of silica minerals completely imbedded in glass, are likely to cause cracks in the glass. At the hot end of a silica brick in steel and glass-making furnaces, the temperature is higher than that used in manufacture, and the glass in this portion dissolves crystalline silica, which is the converse effect of separation from the glass. This is the third "reversible" change listed on p. 389.

Fireclay Brick.—The reversible volume changes are of much smaller importance in fireclay products than in silica refractories. Most fireclay refractories contain some free silica, consequently fireclay products usually show reversible volume change corresponding with $\alpha \rightleftharpoons \beta$ silica inversions, the temperature and extent of these changes depending on the amount and form (as a rule, mainly quartz) of the free silica present.

In addition to some evidence of the silica critical points, fireclay of course shows the usual gradual expansion and contraction with temperature.

Permanent Volume Change.—Raw clays shrink considerably on firing, and this shrinkage often continues at temperatures above 2200° F. (1200° C.). The high temperature shrinkage has been explained as due mainly to the increasing quantity of fluid material formed within the refractory. Firebricks subject to this shrinkage should never be heated to a temperature in excess of the firing temperature. In an extreme case a firebrick of this type used at too high a temperature may shrink as much as 10 per cent. or more in length.

Another important class of fireclay brick already referred to, tends to expand even when heated beyond the firing temperature. There is nothing in the analysis to distinguish between the two types, the behaviour depending on the clay used in manufacture.

Apart from permanent shrinkage or expansion due to heating beyond the firing temperature, there may be some permanent expansion due to conversion of free quartz to cristobalite and tridymite. This will take place slowly in service even at temperatures below the firing temperature.

High Alumina Bricks.—These follow the same general tendencies as fireclay refractories, with such differences as may be expected from the composition. For example, the silica inversions decrease in magnitude and finally disappear as the amount of free silica decreases. Above the firing temperature these refractories shrink, and since they are used mainly at high temperatures, the firing temperature used in manufacture must be higher than for fireclays.

Magnesite.—Magnesite shows a very high reversible thermal expansion, independent of crystalline change, being a little over 2 per cent. from cold up to working temperatures.

At working temperatures, irreversible contraction takes place from two causes. The MgO obtained in the initial burning of raw magnesite is in an amorphous (non-crystalline) form. During burning of the refractory, which is conducted at a very high temperature, considerable shrinkage occurs due to a gradual increase in the density. At high temperatures, amorphous MgO slowly changes to a mineral, called periclase, whose density is not very much greater than that of fully "shrunk" amorphous MgO. Consequently, if the amorphous material has been well shrunk or largely converted to periclase during manufacture, the change from amorphous MgO to periclase in service will cause very little volume change. If the magnesite has been poorly burnt, there may be a very great permanent shrinkage in service.

Some magnesites are known to crystallise to periclase more readily than others.

The second cause of permanent shrinkage is the usual high temperature closing up of the texture due to the fluid slag constituent between the solid grains of the refractory.

Dolomite.—The behaviour of lime appears to be almost identical with that of magnesite. It is concluded that dolomite probably behaves also in a similar way.

Chrome Brick.—Chromite has a high average coefficient of expansion up to about 2200° F. (1200° C.), reversible and approximately equal to the silica and magnesite expansion. At higher temperatures shrinkage takes place, slow at first and then quite rapid. According to curves by Norton, the whole of the normal thermal expansion is lost by irreversible contraction between 2100° F. (1150° C.) and 3100° C. (1700° C.).

Expansion Joints.—Allowance for expansion in laying brick is of course based on the net expansion up to working temperatures. It is convenient to remember that 1 per cent. expansion is approximately equal to $\frac{1}{8}$ inch per foot.

Common allowances are :—

Silica brick,	$\frac{3}{16}$ inch per foot.
Fireclay brick,	$\frac{1}{16}$ " " "
Magnesite brick,	$\frac{3}{16}$ " " "
Chrome brick,	$\frac{1}{8}$ - $\frac{3}{16}$ " " "

III.—TEXTURE.

By texture is meant the size, nature and distribution of the individual grains, etc., constituting the refractory. Texture is of the utmost importance in its influence on all the physical properties required of a refractory.

It has been explained that the majority of refractories consist of relatively pure refractory grains surrounded by a less refractory bond, and that during firing of the refractory the bond fuses or vitrifies, gluing the purer solid particles together. The fused bond, or glass, does not fill up the entire space between the refractory particles, and moreover the refractory particles are frequently themselves porous, as for example the "grog" used in making certain fireclay bricks. A brick structure therefore includes refractory particles, glass and air pores.

Solid particles.—These, forming the skeleton which gives both mechanical strength and refractory properties, should be angular

rather than rounded, because flat faces present a better surface for gluing together by the glass. The particles are not, and should not be, of approximately equal size. The largest particles may be $\frac{1}{2}$ inch or more in diameter. If we consider a brick skeleton to be made up, first of all, of irregular particles all of the maximum desirable size, it is clear that there will be a considerable percentage of voids between the particles. Much of these voids may be filled up by particles of a smaller size; and voids between the latter by still smaller particles, and so on. In this way the space which is occupied by the minimum quantity of glass to form a satisfactory bond is reduced to a network of films. The principle is the same as in the mixing of concrete, where crushed stone is used to provide most of the bulk, angular sand is used to fill in the spaces between the stone, and cement is added to fill in the spaces around the sand grains.

Glass.—The bond does not fill in all the voids surrounding the solid particles of a refractory (wherein it differs from the cement in good concrete). A large amount of fusible bond would result in the dissolving of too much of the solid particles at high temperature, with lowering of the refractory properties of the material.

Porosity.—Porosity takes into account all spaces not actually occupied by matter. This includes pores in the solid particles themselves and also unfilled spaces between the particles. High porosity is desirable for some purposes and undesirable for others. The pores should be small and well distributed.

Firing temperature.—A brick fired at low temperature will show the minimum of glass, *i.e.* material which has been fused. If the same brick is fired at a higher temperature, the fused glass will increase in quantity at the expense of the solid grains, the smaller grains being most readily attacked. The high temperature brick will contain a larger quantity of glass, but since the glass will contain a greater quantity of the refractory constituent, it will have a higher melting point than glass in a brick fired at a lower temperature. This has a very important bearing on the mechanical properties of refractories. A brick in which a large amount of glass has been formed by firing to a high temperature is said to be well vitrified.

Increasing the degree of vitrification causes shrinkage in the refractory due to drawing together of the grains in the increasing quantity of fluid. The porosity also decreases in consequence. Of course the shrinkage may be offset, as in the case of silica

brick, by an internal change causing expansion of the material itself.

If a refractory is used in service at a higher temperature than that employed in manufacture, vitrification will increase; even at a somewhat lower temperature, due to the time element, there will be some increased vitrification. In general, increase of vitrification in service is not desirable, firstly because it is accompanied by volume changes, and secondly because in service the brick is rarely at a uniform temperature and consequently the changes will not be even, causing distortion and stress in the brick structure.

IV.—FAILURE UNDER LOAD AT HIGH TEMPERATURES.

Under load, refractories frequently fail at a temperature much below the melting point. This failure may take the form of a gradual deformation and collapse, similar to that which occurs without load at the melting point; or the refractory may fail by shearing, *i.e.* by breaking clean across, usually at an angle of 45° .

If the load on a particular part of the furnace were evenly distributed, failure of refractories under load in the furnace would be comparatively rare. Normally, the cool outer parts of the walls would be capable of taking all loads due to the mere weight and side thrusts of the structure. In practice, uneven expansion and brick movement may cause very great local stresses, resulting in failure at these points.

Theory.—The theory of failure under load is a corollary of the theory of melting—in the sense of the collapse of a pyrometric cone. It will be remembered that some fused material is present in the refractory long before the melting point is reached, and that the cone bends over only when the amount of liquid has increased considerably at the expense of the solid grains. It is easy to visualise that if slight pressure is applied during heating of the refractory, as soon as sufficient fluid has been formed to separate the refractory grains, or at least to leave the skeleton in a rotten and porous condition, failure will occur in one of the ways mentioned. Where the amount of liquid formed at a low temperature is large, failure under load will, in general, occur at a much lower temperature than the melting point. Where the amount of low melting glass is small, as in a refractory approximating to a pure compound, failure under load may not take place until within a few degrees of the melting point.

The actual nature of failure, whether by gradual deformation or by shearing, is less easy to explain. Some refractories show a greater tendency than others to shear under ordinary load tests—this is of course a function of the material. If the particles of the refractory are in the form of separate rounded grains, as soon as the bonding material fuses, plastic deformation can take place; if the particles are angular, forming an interlocking skeleton, plastic deformation does not take place so readily and the tendency is for shearing to take place, but at a higher temperature than the plastic deformation failure of the rounded grain structure—this is a function of the texture.

Under no pressure at all, failure takes place at the melting point by plastic deformation; at low pressure the tendency is for failure to occur also by deformation, but below the melting point; at high pressures failure will occur at a still lower temperature and, possibly by reason of the greater viscosity of the fused glass at the lower temperature, there will be a greater tendency to failure by shearing.

The question of time is also very important. The slag formed by fusion of the glass is usually very viscous and yields to pressure extremely slowly. Under light pressure a refractory might show no great deformation at a given temperature under a laboratory test, while it might fail by gradual creep in long service. The viscosity of the fused glass is doubtless an important factor in determining at what pressure the refractory will shear rather than deform. A familiar example of this idea is found in the behaviour of pitch. Pitch is in reality not a crystalline solid, but an abnormally viscous liquid. A lump of seemingly solid pitch will in time flow and flatten out under its own weight. Under light pressure it will flow faster, but there is a limit beyond which it cannot be hurried. If a large pressure be applied it will not flow, but will break across, exposing a bright brittle fracture.

Temperature-Load tests on high grade refractories are usually conducted by applying a steady load of the order of 25 or 50 lb. per sq. in. to two opposite faces of the specimen in a special furnace. The specimen is then heated at a definite rate until it shows for example a 10 per cent. shrinkage or until it fails by shearing. The point at which either occurs is taken to be the temperature of failure of the refractory under load.

This test can only give some indication of the resistance of the material to load. A low failure temperature under load does not necessarily condemn a refractory for use at this or a higher

temperature ; neither does a high test temperature of necessity show that the refractory can be used under load up to that temperature. The following additional service considerations must be taken into account :—

(a) The longer time in service gives greater opportunity for plastic deformation.

(b) The 25 lb. per sq. in. pressure, or whatever other pressure is used in testing, is arbitrary. If the working stress on the refractory is lower, failure will tend to take place at a higher temperature, and the failure will tend towards plastic deformation and away from shearing. At a higher working stress, failure should occur at a lower temperature and the tendency to shear will increase.

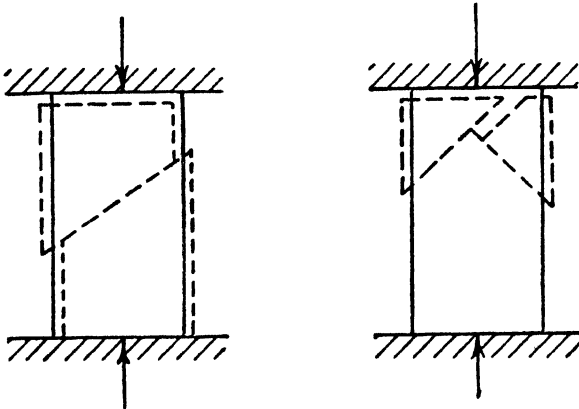

Fig. 58.

(c) If the refractory and conditions are such that failure tends to occur by plastic deformation, a small deformation will usually permit a readjustment of stress, permitting the cool outer parts of the structure to carry the load and so averting failure of the hot part of the refractory.

(d) If the tendency is to shear under load without much previous deformation, there can be no relief of local stresses, and it would appear that failure must occur as soon as the stresses reach the limiting value which the refractory can stand at the particular temperature. On the other hand, conditions with respect to shearing are not the same under furnace and test conditions. Fig. 58 indicates how, under test, a specimen might fail by shearing in its attempt to escape from the pressure. Commonly, there would be some plastic deformation before shearing occurred. In

service the brick would be supported laterally by the bricks surrounding it, and would consequently be prevented from shearing so readily. As a specific illustration, magnesite brick fails by shearing under test conditions below the service temperature reached in open hearth furnace bottoms, yet in open hearth practice no trouble at all is experienced from shearing of brick forming the bottom. Moreover, given sufficient time, such a material may deform sufficiently to relieve the strain.

The two tendencies described in paragraphs (c) and (d), to fail by plastic softening and by sudden shearing respectively, have a perfect analogy in the behaviour of a ductile and of a brittle metal under uneven stress.

Effect of Texture.—Deformation under load is clearly related to the melting point, viscosity and quantity of glass in the refractory. Owing to the higher quantity of glass in a well vitrified product, there will be greater rigidity at temperatures below the melting point of the glass. When greater vitrification has been attained by a higher firing temperature, the higher melting point of the glass will ensure rigidity and strength up to a higher temperature than for the same product fired at a lower temperature.

For a particular type of refractory, a more porous product is usually less resistant to load than a denser product owing to poor contact and mutual support between the grains. If the high porosity results in part from a low degree of vitrification due to a low firing temperature, this will be particularly conducive to weakness.

Silica Brick.—Silica brick is fired at a high temperature, and consequently contains a glass of high melting point. Owing to the high purity of the material, the quantity of fused material is small even at very high temperatures. The refractory therefore retains its stiffness to within a few degrees of its melting point. It then fails by shearing under test loads of 25 lb. per sq. inch. Provided the brick is not subjected to slag action, the maximum working temperature under load may be taken to be 3050° F. (1680° C.), although much higher, and also lower, load failure temperatures have been reported.

Fireclay Brick.—Fireclay brick consists of the decomposition products resulting from the burning of the raw clay substance. These products are probably made up largely of partially developed mullite and silica. Being a mixture, the brick produces on heating a considerable amount of fused material which melts at a lower temperature than either mullite or silica. In the absence

of fluxes this temperature is 2810° F. (1545° C.); but with the fluxes usually present (CaO, MgO, FeO, alkalis), the temperature may be much lower. Failure of the refractory under load is likely to occur as soon as much fluid has been formed; except in the higher alumina bricks this will never be much in excess of 2810° F. (1545° C.), and may be much lower. Fireclay bricks fail under the load test at 2600-2890° F. (1425-1590° C.), and usually 225-550° F. (125-300° C.) lower than the melting point of the material. In nearly all cases at the test loads commonly employed, firebrick fails by plastic deformation. This type of failure is particularly susceptible to the time factor and it may be concluded that fireclay brick is not satisfactory for use at high temperatures under heavy load. This conclusion must be qualified where the hot portion of the refractory receives support from cooler portions.

To some extent the load resisting properties of a fireclay brick may be improved. Fireclays commonly vitrify at a temperature 350-850° F. (200-450° C.) below the melting point, and for many purposes it is sufficient to fire the bricks at this temperature. In service, plastic deformation under load is likely to occur, at best, at some temperature not greatly in excess of the firing temperature. By employing a higher firing temperature, a more refractory glass is obtained, and failure under load may take place at a considerably higher temperature. For high temperature resistance to load, fireclay bricks are always fired at much above the usual vitrification temperature. These bricks have a lower porosity, and for some purposes, particularly with respect to spalling, are not so suitable as the more porous bricks.

High Alumina Brick.—Mullite, containing 72 per cent. Al_2O_3 , is a pure compound up to its melting point (pyrometric cone equivalent), at 3290° F. (1810° C.). The amount of flux present in the refractory should be small, so that very little slag material is present up to this temperature. For this reason a pure mullite may stand up under load to within 50° F. (25° C.) of its melting point. Commercial mullite fails under load at about 3200° F. (1750° C.). Again, on account of its composition, the effect of prolonged heating at lower temperatures under load does not cause slow plastic deformation such as occurs with refractories containing a high amount of viscous glass.

Kaolin lies between mullite and ordinary fireclays, containing some low melting glassy material, but less than fireclay. Its resistance to load-temperature tests therefore lies between the

two. It fails at about 2900° F. (1600° C.), but at lower temperatures is not immune from deformation if sufficient time is allowed.

Refractories containing an even greater percentage of alumina than mullite consist, in the cold state, of well developed mullite and free alumina. When these refractories are heated to the melting point of mullite, a large amount of liquid is formed and the load resisting properties are little, if any, better than mullite, unless the refractory contains very much more Al_2O_3 than mullite.

It may be concluded that the load resisting properties of aluminous refractories increase, other things being equal, as the Al_2O_3 increases from the percentage normally present in a fireclay up through kaolin to mullite, but that improvement thereafter is less rapid.

Magnesite.—This refractory contains up to 15 per cent. of impurities forming amongst themselves a highly fluid glass. It is therefore not unexpected that magnesite, although having a higher melting point than any other common refractory, fails at quite a low temperature under load. The actual temperature of failure under test depends on the bonding material but is usually 2550-2750° F. (1400-1500° C.). Under load tests magnesite brick always fails by shearing. Since it can stand but little plastic deformation, and fails under load below the working temperature, it is evident that care should be taken in laying magnesite walls to see that stresses are as far as possible avoided.

Chrome Brick.—Like magnesite, chrome is a very impure refractory containing a certain amount of low melting slag. It fails under load tests at about the same temperature as magnesite, also by shearing.

V.—SPALLING.

The word "spalling" was originally understood to mean the breaking up of a refractory due to changes of temperature when not subject to other influences. The word has subsequently been extended to include almost any mechanical failure of the refractory, including the result of pressure due to poor design or bricklaying, and sometimes even breakage through careless use of tools, etc. From a practical point of view, it seems more convenient to adhere to the original meaning of the word.

Expansion and Contraction.—The primary cause of spalling is volume change with varying temperature. A high thermal coefficient of expansion, such as that shown by magnesite, is conducive to spalling; but of far greater importance are the

reversible crystallographic changes occurring at definite temperatures. This is because the former expansion takes place over a wide temperature range, while the latter takes place suddenly at a definite temperature. Other volume changes which may cause spalling are those due to the "permanent" changes taking place in service, and to other structural changes described later.

When a refractory is made up of constituents having widely different expansion rates, there is always a strong tendency to spall. "Expansion rates" include the ordinary thermal coefficient of expansion, and also expansion due to structural changes.

Mechanical Properties.—A refractory having high mechanical strength will better resist the tendency to spall than a weaker material. The property of a material to yield under stress without rupture plays a very important part in resistance to spalling. This yielding may be elastic, taking the form of instant temporary stretching of some parts of the refractory and contraction of others; or it may be viscous, involving a slow but permanent flow of the bonding material to permit adjustment to the internal stresses.

Diffusivity.—Temperature differences between different parts of the refractory cause internal stress. With no internal temperature difference, one important cause of spalling would be eliminated. If one surface of a brick is heated, the faster it can pass heat on to raise the temperature back from the heated face, the less the spalling tendency—this involves conductivity. Suppose, again, that the refractory has an abnormally high specific heat per unit volume. When heat is passing from the hot end towards the cold end, much of it will be absorbed in heating the refractory, so that the cold end will remain cold for a longer time than for a material with the same conductivity but a lower specific heat per unit volume. The specific heat per unit volume is equal to the specific heat per unit weight multiplied by the density (weight of unit volume) of the material. The combination of the three constants as

$$\text{Diffusivity} = \frac{\text{Conductivity}}{12 \times \text{Specific Heat} \times \text{Density}}$$

has been referred to in other chapters.

The greater the diffusivity, the greater the tendency of temperatures within the brick to equalise, and hence the less the tendency to spall. This factor is inherently important, but it does

not vary very widely for bricks of the same class, and can therefore be left out of the present discussion.

Temperature Gradient through Brick.—In an exterior furnace wall the inner face of a brick is always hotter than the outer face. Volume changes therefore occur at different times throughout the brick, causing a tendency to split in layers parallel to the face of the wall. This is particularly important in a thin uninsulated boundary, such as the roof of a high temperature furnace.

Texture.—A refractory containing a relatively small quantity of glass is usually more resistant to spalling than a well vitrified product, notwithstanding the additional strength at low temperatures imparted by the glass. There may be several reasons for this.

1. The grains are less completely enclosed by glass. At low temperatures, while the glass is still hard, there is consequently more opportunity for free movement due to uneven expansion and less likelihood of breakage. The effect of high porosity, whether from this or other causes, may be similar, provided it is not so high as to reduce materially the strength of the refractory.

2. A lightly vitrified brick, burnt at a low temperature, will contain a low melting glass. This renders the refractory less rigid at higher temperatures.

3. The instability of glass at moderately high temperatures, below its melting point, has been referred to. With a low melting glass, implying a low firing temperature and usually a small quantity of glass, there is a much smaller temperature range during which internal stresses may be set up by separation of crystalline minerals from the glass. As soon as the melting point of the glass is reached, these strains are relieved.

Some very interesting experiments on spalling have been performed by Norton. Norton shows that a coarse grog decreases spalling, and also that there is an optimum quantity of grog for the best resistance to spalling. An excellent summary of the theory and causes of spalling is also given by Green and Dale.¹

Other Types of Failure.—Some other types of failure, having some of the characteristics of true temperature spalling, and sometimes included in the general term "spalling," are:—

1. *Pressure cracks.*—These are due to uneven expansion and are usually attributable to bad design or bricklaying, or to over-rapid heating. Many of the properties indicated under true

¹Green, A. T., and Dale, A. J.: "The Spalling of Refractory Materials," Bull. Brit. Refractories Assoc., 12, pp. 127-169, 1926.

spalling also play an important part in resistance to this type of failure.

2. "*Carbon transfer.*"—In a true reducing atmosphere, containing a large amount of carbon monoxide, particles of iron may be formed in the refractory by reduction of iron oxides present. Carbon monoxide diffuses into the brick and is decomposed into carbon dioxide and carbon, the latter being deposited most rapidly round the iron particles. This causes an internal growth and breakage, which is a serious problem in blast furnace practice, and occurs also in other furnaces under similar conditions. Cracking of hydrocarbons may have a similar effect.

3. *Slag penetration.*—When slag penetrates a brick, a difference of composition from inside to outside occurs. If this brick is subsequently cooled off, many of the factors tending to produce spalling are intensified.

Silica Brick.—In considering the spalling of this material, there is little to be added to the description of expansion and contraction with temperature. The strong spalling tendency of this brick at low temperatures is almost entirely due to the reversible $\alpha\beta$ inversions of the different minerals, particularly the cristobalite inversion at 437° F. (225° C.).

The tendency to spalling is relatively small above a dull red heat. There is, however, some tendency to spall above a bright red heat, due to crystallisation of the unstable glassy material surrounding the silica grains. This last effect was described on pp. 389 and 393.

Escape from spalling in silica refractories cannot be sought by burning at a lower temperature, because the high temperature is necessary to avoid a large amount of unconverted quartz in the brick.

Fireclay Brick.—Fireclay is one of the most resistant of all refractories to failure by true spalling. It follows the usual laws with regard to texture, burning temperature, expansion and contraction tendencies, etc. The high alumina bricks tend to be somewhat less resistant to spalling, but possibly because they are vitrified more completely by high temperature firing. There are, however, some notable exceptions to this general tendency, mullite brick in particular showing good resistance to spalling. There is evidence that spalling resistance is increased in clay refractories by the use of a coarser grog (refractory particles) in manufacture. In fireclay brick the biggest tendency to spalling occurs below 1500° F. (or 800° C.).

Other Refractories.—There is very little information concerning the causes and means of avoiding spalling in other refractories. Under laboratory test conditions, magnesite is slightly more resistant than silica, and chromite slightly better still. It must be remembered that a refractory, which in a certain temperature range shows poor resistance to spalling, may show good resistance at other temperatures. Silica brick is a good example of this.

VI.—SLAG ACTION.

Resistance to slag attack is one of the most difficult qualities to express in a comparative form. The relative resistance of different refractories changes with temperature, with moderate changes in the slag analysis, and the mechanical nature of the contact (*i.e.* whether the slag is stationary, moving, or carried as small particles by the flame).

Theory.—It is well to remember that at high temperatures there is practically no such thing as non-attack by a slag on a refractory. So long as compounds in the slag are capable of forming, with the refractory substance, mixtures which are fusible at the furnace temperature, then slag action must occur. The physical process of slag attack is similar to the formation of fusible material between the impure bond and the pure grain of a refractory, with the important difference that in slag attack there is an almost unlimited supply of the erosive material.

* We shall therefore adopt, as the starting point for our study of slag action, the view that *any ordinary molten slag will dissolve any common refractory*. Imagine a refractory wall in contact with a large body of liquid slag. The film of slag in contact with the surface will dissolve some of the refractory, however small the amount. The film will therefore be altered in composition, and this will, in general, either raise or lower the melting point of the film.

In the first case (melting point raised), after dissolving only a small quantity of refractory, the melting point of the slag film will be raised until at actual bath temperature it will become a sticky viscous material, inactive and incapable of dissolving more refractory without freezing. It is evident that such a film will not be removed readily, and will tend to protect the wall so long as it remains there. Action, however, will not cease entirely. Although viscous, the film is still a fluid, and will diffuse very

slowly into the slag body, the film being diluted by fresh slag, which will continue the gradual attack.

In the second case, the first action of the dissolved refractory is to lower the melting point of the slag film. The film will then continue to dissolve refractory rapidly, until its chemical composition has been sufficiently altered for its melting point to rise again in accordance with the theory of eutectic mixtures (p. 382). On further solution of the refractory, the film reaches the same inactive viscous state as in the first example. It is clear that in this case, the quantity of refractory dissolved by the film may be many times greater than in the first case; moreover the film passes through a state of greater fluidity, and at this stage diffusion is much more rapid, and there is a much better chance for the film to be replaced by fresh slag. During the fluid state there is also likely to be greater penetration of slag into the brick, and with its considerable solvent capacity, a slag of this type, by soaking into the brick, will lower the refractoriness of the entire brick from within.

Another factor, independent of the preceding, is the intrinsic rate at which the refractory tends to dissolve. As an illustration, it is well known that certain substances dissolve very quickly in cold water, and that other substances, although soluble, do not dissolve so quickly. Washing soda is an example of the first class. Sodium carbonate, which is washing soda from which the combined water has been removed, is an example of the second class. Although identical solutions can be made from these two substances, the speed of dissolving is very different. This must be regarded as a difference due to the physical or chemical nature of the material.

Usually, the melting point of an acid slag is lowered by the addition of a basic refractory, and the melting point of a basic slag by an acid refractory. Familiar examples are thinning an acid furnace slag by lime addition, and thinning a basic slag by sand or old silica brick addition. Conversely, a basic refractory addition (lime or dolomite) thickens, or raises the melting point of, a basic slag; and an acid refractory raises the melting point of an acid slag.

We may now accept the common statement that an acid slag attacks a basic refractory very rapidly, but does not readily attack an acid refractory; and similarly for a basic slag. While accepting this generalisation, it is well to remember that slag attack is not truly a matter of acidity and basicity, but is primarily

a matter of melting point and viscosity. In this way may be explained many results which, from the so-called theoretical point of view, are rather surprising. One of these is the comparatively high resistance of the basic refractory magnesite to materials of a decidedly acid nature. Although the first action of dissolved magnesia on acid slag is to lower the melting point of the slag film, the final result is a film of extremely high melting point and viscosity.

Again, the upper layers of brick in open hearth regenerators are usually made of silica brick instead of fireclay brick. This is because even the best fireclay brick, although less acid in nature and often having a higher melting point, is found in practice to erode much more rapidly than silica brick under the action of basic slag and dust carried over by the hot gases. This may be construed as being due to the lower melting point and greater quantity of slag formed during penetration of the aluminous brick.

From this conception of slag attack, we can frequently imagine what circumstances will tend to increase or decrease erosion of a given refractory by a given slag.

Effect of Temperature.—Temperature may have a fourfold effect on solution of the refractory. Firstly, an increase of temperature permits the film of slag in contact with the wall to dissolve a greater quantity of refractory before it reaches the viscous inactive stage. Secondly, diffusion is more rapid as the temperature increases, and the film is therefore more rapidly replaced by fresh active slag. Thirdly, the actual speed of solution increases with the temperature, just as salt dissolves much more rapidly in hot water, although its final solubility is not much greater in hot water than in water at 70° F. (20° C.). Fourthly, the fusible glass within the refractory becomes increasingly active and may aid the external slagging action.

These combined effects result in a very rapid increase in slag attack with rising temperature.

Effect of Slag Movement.—On the basis of the viscous film theory, it is evident that any movement tending to wipe the film off and replace it by fresh slag will have a very great effect in increasing slag attack.

Effect of Brick Texture.—A well vitrified, dense (*i.e.* low porosity) brick will present a smoother surface to the slag than a rough porous brick. The rough surface has the effect of increasing the area exposed to slag, and therefore accelerates the attack. Just as powdered materials dissolve in water more quickly than

lumps, the finer particles of a brick dissolve more rapidly than the coarser particles.

The glass is more fusible than the refractory grains, and is therefore more liable to dissolve and unite with the slag. The progressive fluxing away of the glass and smaller grains may result in disintegration of the surface and washing away of the larger particles, like the undercutting by rain of large stones embedded in a clay cliff. This shows the importance of using a sufficiently refractory bond—for resistance to slag attack, a bond even more resistant to erosion than the grog itself would be a logical development if this were possible.

Another effect resulting from high porosity is soaking of slag into the brick. This refers to capillary attraction only, and has nothing to do with the slow advance of slag by actual solution of the refractory. In a continuously operated furnace, this saturation of the brick by slag may not be very serious if the slag is not particularly active on the refractory. When it is once absorbed, the slag in this case will thicken after slight attack on the refractory, more particularly since the brick is cooler away from the surface. This thick slag will suffer very little replacement by diffusion, and will do little damage after the initial attack. We have an example of this saturation of a refractory with relatively harmless slag in the consolidation of new furnace hearths, both acid and basic, in direct-fired melting furnaces. In a furnace operated intermittently, the soaking of slag into a refractory is likely to have an extremely serious effect in causing rapid spalling due to uneven composition and texture within the brick. Even in a continuous furnace, absorbed slag can do no good, and a less porous brick should last longer if only because it contains a greater weight of refractory material.

Defective Brickwork.—Cracks or bad joints permit slag to penetrate the wall, eating into the brick from behind and eventually permitting pieces of brick to fall away from the wall. Cracks may be present in the brick before use, or they may be developed in the furnace due to temperature changes or to local pressure. Open joints may result from poor bricklaying; from the use of an unsuitable material in the joints, the material being eaten out faster than the brick itself; or from high temperature shrinkage of the brick.

Effect of Splashing.—In addition to the refractories in more or less constant contact with liquid slag, walls and arches may be subjected either to splashing or to the action of gas-borne slag

particles. When slag splashes against a wall, erosion is likely to be severe, as the slag running down tends to wash away the thickened less active slag layers adhering to the wall, and to replace them by fresh slag. The action of slag carried by gases is similar, and may be very severe due to the high temperature and velocity of the gases. Slag reaches the roof by the same agencies, but does not do so much damage in running off. It tends to collect in beads which drop off when they get too heavy, so that the mechanical factor in replacing spent slag is largely absent.

Resistance of Common Refractories to Slag Attack.—In view of the very many factors to be taken into consideration, the resistance offered by individual refractories to slag attack can be referred to only in a very superficial manner.

All of the common refractories excepting dolomite and magnesite¹ are moderately resistant to acid slags, but silica brick is the only one which may be described as showing good resistance.

Magnesite, dolomite and chromite show good resistance to basic slags, most of the other common refractories being poor. Some of the high alumina refractories² show fair resistance to some basic slags. The behaviour of refractories towards mill scale and other forms of iron oxide is similar to that towards basic slags. An interesting reaction occurs between magnesite and ferric oxide, which form the compound magnesioferrite ($MgFe_2O_4$). This compound is decidedly refractory, and the reaction is made use of in a patented magnesite refractory encased in steel sheet. Also, in the basic open hearth furnace magnesite bricks have been laid with steel sheet between the bricks to form a network of this cement. The formation of the compound yields a strong cement which materially decreases the spalling tendency of the magnesite.

At very high temperatures, carbon is capable of reducing nearly all of the oxides commonly present in refractories. There are comparatively few instances where this reaction is likely to be important.

VII.—OTHER PROPERTIES.

There are a number of other properties of refractories, some of general, and some of specific, importance. The true and apparent density of refractory materials will be found in the tabulated summary on pp. 412-3. Specific heats have been

¹ Even magnesite is fairly resistant to some acid slags.

² See reference to bauxite on p. 416.

given in Chapter III, and heat conductivities in Chapters V and VI. Rigidity, strength and resistance to abrasion at high temperatures are obvious requirements in many cases, but complete data at different temperatures are unfortunately somewhat scanty. In electric furnaces, the electrical conductivity of refractories at high temperatures becomes an important property, either desirable or undesirable.

Effect of Gases on Refractories.—The effect of steam and other gases on refractories is not very definitely established. Certainly gas attack may take place through chemical action, where such action is possible between the gas and the refractory. Reducing gases in particular may produce considerable lowering in the melting point of refractories, especially those containing free oxides of iron.

Water has a deleterious effect on cold refractories, if hydration or partial solution is possible. Of the common refractories, dolomite is the most susceptible to hydration, even the moisture in the air causing rapid disintegration. Magnesite suffers similarly, but less severely.

VIII.—LESS COMMON REFRACTORIES.

In recent years, a large number of special refractories have been introduced with considerable success in certain fields. It is probable that, with decreasing costs and greater realisation of the value of these special refractories, this trend will increase. The relative costs of different types of refractories will be found in Table XXI.

Modified Silica Bricks.—The presence of ferrous oxide lowers the temperature at which quartz inverts to tridymite. By addition of ferrous slag (plus carbon to retain the iron in the ferrous condition), it is therefore possible to produce a brick relatively free from unfavourable expansion characteristics, to lower the firing cost, or to use as the raw material varieties of quartzite which normally show poor inversion properties. These "black" silica bricks are being used in European steel melting furnaces; it is stated that, in spite of their slightly lower melting point, the bricks give better results than ordinary silica brick.

Another type of silica brick is made in Spain from a siliceous rock resembling agate. These bricks are called "agate bricks"; they are more expensive than silica brick, but are said to be superior in every respect.

TABLE XXI.—CHARACTERISTICS OF TYPICAL COMMERCIAL REFRACTORIES.

Type of brick.	Typical composition with respect to principal constituent.	Melting Point.*	Resistance to Load at High Temperatures.	Maximum Reversible Thermal Expansion (Linear).†	Resistance to Spalling.	Weight.			Mechanical Properties.	Resistance to Slags.		Relative Cost. ††	Remarks.
						Pounds per 9" x 4 1/4" x 2 1/2" Brick.	cu. ft. Pounds per	True Specific Gravity.		Acid.	Basic.		
Alumina (Fused & Bonded)	90% Al ₂ O ₃	3450°F. (1900°C.)	E	1-2%	P	9-10 1/2	155-175	3.6	G	P to F	P to G	600	
Alumina (Fused & Cast)	75% Al ₂ O ₃ , 20% SiO ₂	3360°F. (1850°C.)	E	..	F	..	183	2.95	E	G	G	..	Resistance to fused glass excellent. For cost, see p. 417.
Bauxite (Impure)	60% Al ₂ O ₃ , 35% SiO ₂	3300°F. (1800°C.)	G	0-8%	G	8	135	3-2	G	P to F	F	75-100	Diaopore brick has similar properties and composition. It has a lower fire shrinkage. Frequently diaopore brick is made from relatively pure material, much higher in alumina than many bauxites. Such refractories are naturally superior to those made from impure materials.
Carbon (Amorphous)	85-90% C	Practically infusible	E	..	E	5 1/2	95	1-8	G	F to G	P	..	Slag attack is due to reaction between carbon and oxides, particularly oxides of heavy metals.
Charone	35-50% Cr ₂ O ₃	3900°F. (2150°C.)	P to F	2%	VP to P	10 1/2-11 1/2	175-195	4-0	P to F	F to G	G	245	Excellent resistance to mill scale (iron oxide).
Dolomite	58% CaO, 38% MgO	3500°F. (1925°C.)	3-4	..	P	G	..	
Fireclay	30-40% Al ₂ O ₃ , 65-60% SiO ₂	2900-3200°F. (1600-1750°C.)	P to G	0-7%	P to E	7-8	120-135	2-7	G	P to F	P to F	30-35	Relative cost of super-quality fireclay 50-60.
Forsterite	57% MgO, 43% SiO ₂	3470°F. (1910°C.)	G	..	P	10	170	3-2	F	P to F	P	275	Cost in 1936.
Graphite + Clay	..	3000°F. (1650°C.)	E	..	E	6 1/2	110	2-25	G	F to G	P	..	

High Alumina	50-80% Al ₂ O ₃	3245-3335°F. (1785-1835°C.)	G to E	..	P to G	G	P to F	P to G	75-300	Cost depends on physical nature of brick as well as Al ₂ O ₃ content.
Kaolin	45% Al ₂ O ₃ , 52% SiO ₂	3150°F. (1725°C.)	G	0.7%	G	7½	130	2-7	G	P to F	P to F	180	
Magnesite	85% MgO	3900°F. (2150°C.)	P to G	2%	V.P.	9½-10½	160-180	3-5.5	P	P to F	G	320	Reacts vigorously with fire-clay. Excellent resistance to mill scale (iron oxide).
Magnesite (Fused & Bonded)	E	1.7%	F	3-6	E	1000 1200	
Mullite (also Sillimanite)	72% Al ₂ O ₃ , 28% SiO ₂	3250°F. (1790°C.)	E	0.7%	G	8-9½	135-150	3.0-3.2	G	F	F	174-656	Cost varies widely with nature of brick and per cent. of developed mullite.
Semi-Silica	81% SiO ₂ , 16% Al ₂ O ₃	3000°F. (1650°C.)	(See re- marks)	..	G	G	P	P	..	Resistance to load good at moderate temp. No gradual permanent volume change in service.
Silica	96% SiO ₂	3050-3090°F. (1680-1700°C.)	E	1.3%	(See re- marks)	6-6½	100-115	2.3-2.4	G	G	P	47	Resistance to spalling very poor from 200 to 1100°F. (100-600°C.). Excellent at higher temperatures.
Silicon Carbide	95% SiC or SiC + 10% Clay	(See remarks)	E	0.7%	E	8½-9½	145-160	3-1	E	G	P to G	1000	Does not melt. Decomposes at 4000°F. (2200°C.).
Spinel	70% Al ₂ O ₃ , 26% MgO	3700°F. (2050°C.)	F to G	1.2%	P to F	3-6	G	P to G	P to G	480	Excellent resistance to mill scale (iron oxide).
Zircon	..	4000°F. (2200°C.)	G	1%	G	4-5.5	G	F to G	F to G	..	
Zirconia	75% ZrO ₂	4000°F. (2200°C.)	G	0.7%	F	14	240	4.75	G	F to G	F to G	..	
Zircon-Magnesite	1330	General characteristics lying between those of zircon and magnesite.

NOTES TO TABLE XXI.

* "Melting Point" means pyrometric cone equivalent. Since the temperatures are merely typical values, the Fahrenheit and Centigrade values have been rounded off and are not exact equivalents. In a reducing atmosphere the melting points may be considerably lower. For those materials which show no shrinkage up to 3000° F. (1650° C.), the expansion to the temperature at which permanent shrinkage commences. For those materials which show no shrinkage up to 3000° F. (1650° C.), the expansion to this temperature is given.

† Reversible expansion is given to the temperature at which permanent shrinkage commences. For those materials which show no shrinkage up to 3000° F. (1650° C.), the expansion to this temperature is given.

‡ The relative figures are actually quotations received late in 1931 and in January 1932, in dollars per thousand 9" x 4½" x 2½" bricks, f.o.b. factory. The figures for fused alumina and for bauxite are taken from a table by F. N. Norton (*Bricks and Firebricks*, "Refractories for Industrial Furnaces," June 1932, Vol. 10, No. 6). Norton's table has also been referred to for certain other data. The current (March 1938) costs of first quality fireclay brick and silica brick (both about \$51 per thousand) reflect the dependence of cost on industrial conditions.

TABLE XXII.—SELECTION OF REFRACTORIES.

Temperature	Spalling Conditions.	Load Conditions.	Slagging Conditions.			
			None.	Acid.	Basic.	
High [Over 2550° F. (1400° C.)]	Severe	Heavy	High Alumina, Silicon Carbide Also, High-grade Fireclay Silica, High Alumina, Silicon Carbide Also, High-grade Fireclay	High Alumina Fused Magnesite Magnesite Chromite Dolomite	High Alumina	
		Light				
	Light	Heavy				
		Light				
Medium [2000-2550° F. (1100-1400° C.)]	Severe	Heavy	High-grade Fireclay Semi-silica	High-grade Fireclay	High Alumina	
		Light	Fireclay, High Temperature Insulator	High Alumina Silicon Carbide		
	Light	Heavy	High-grade Fireclay Semi-silica	Silica, High Alumina Dense Fireclay Silicon Carbide		Magnesite Chromite Dolomite
		Light	Fireclay, High Temperature Insulator	Silica, Dense Fireclay		
Low [Under 2000° F. (1100° C.)]	Light	Light	Low-grade Fireclay High Temperature Insulator	Low or Medium	Grade Fireclay	
		All other conditions				

Semi-Silica Brick.—These bricks are “special” only in the sense that they find limited application. They are made of fireclay with a large proportion of silica grog. A well-known brick manufactured in Scotland contains approximately 81 per cent. SiO_2 and 16 per cent. Al_2O_3 , or less than half the burnt clay content of a high grade firebrick.

Bricks of this class have a lower melting point than any but the lowest grades of fireclay brick, and show poor resistance to slag attack. Resistance to spalling is good. At moderate temperatures the material is resistant to load and does not suffer plastic deformation. Most important of all, the usual tendency of the clay to shrink when held at the working temperature for a long time is offset by the corresponding tendency of the silica to expand due to continued transformation to tridymite. The result is a material which shows a constancy of volume in service commonly associated only with much more expensive materials, making the brick particularly suitable for use where the temperature is not too high and where there can be no slag attack.

Siliceous-clay brick may have approximately the same composition and some of the characteristics of semi-silica brick. The distribution and texture will be different, and possibly less favourable.

Clay-bonded silica brick also has some of the characteristics of this class of material.

Firestone.—Quartzite, the raw material from which silica brick is made, in some places occurs as a laminated rock. This rock can easily be split and made into blocks. These have the same chemical properties as silica brick and the melting point may be over $3,000^\circ \text{F}$. ($1,650^\circ \text{C}$). Being essentially quartz, they will show considerable expansion on partial conversion to cristobalite or tridymite, and for this reason the blocks are laid up with thick raw fireclay joints. The shrinkage of the clay permits free expansion of the blocks. These blocks are sometimes used for lining cupolas, etc.

High Alumina Refractories.—These have already been referred to under the descriptions of the various properties of refractories. These refractories are sometimes referred to by the name of the principal mineral used in their preparation. Thus we sometimes hear of bauxite, sillimanite and of course kaolin bricks. Pure unburnt bauxite is $\text{Al}_2\text{O}_3 \cdot 2\text{H}_2\text{O}$, but commercial bauxite is associated with silica and other impurities. Bauxite, then, forms the basis of the most highly aluminous refractories of this series.

Sillimanite is a mineral containing rather less alumina than mullite. Kaolin has already been referred to. These are merely the most important representatives of three groups of minerals at different levels with respect to alumina content.¹ The different minerals are frequently mixed to give the desired alumina content. The least expensive mullite brick is made from a mixture of high alumina and low alumina materials. More expensive varieties are made from unmixed minerals, sintered to remove shrinkage, and bonded—these show a greater percentage of well developed mullite. There is also an experimental brick, very expensive, made from the sintered minerals in a similar way to recrystallised corundum products (see p. 420), without the addition of clay bond.

To avoid the high shrinkage shown by very high alumina refractories, fused alumina refractories may be used. These are made from electrically fused bauxite, crushed, bonded and refired. The alumina is then more completely converted to the crystalline variety, *corundum*. Fused alumina had been widely used in laboratory ware, under the trade name "Alundum;" long before it was used in brick form for electric furnace crowns, etc. The difference between the colour of the two products is due to the use of iron-free alumina in the manufacture of chemical ware in order to give a cleaner appearance. Fused alumina refractories are naturally characterised by a very high melting point and resistance to load at high temperatures. The coefficient of expansion is high, but there are no sudden volume changes resulting from critical points. Resistance to abrasion is excellent (this material is extensively used in grinding wheels); resistance to spalling is not good; the thermal conductivity is high (p. 266).

Bauxite bricks and fused alumina bricks are often classed as basic bricks, implying good resistance to the action of basic slags. Bauxite bricks have been used, apparently with success, in basic open hearth steel making. Yet from its chemical nature alone, alumina would not appear to be in the same class as magnesia and chromite in its resistance to basic slags. Alumina forms compounds and low melting eutectics with lime, and such resistance as it offers to attack by basic material is probably due to the high viscosity of the slags produced by erosion.

¹ Sillimanite, andalusite and cyanite (kyanite or disthene) are minerals differing in crystalline form but all having the same chemical formula, $Al_2O_3 \cdot SiO_2$; allophane is a hydrated amorphous mineral having the formula $Al_2O_3 \cdot SiO_2 \cdot 5H_2O$. Other minerals in the bauxite class are diaspore ($Al_2O_3 \cdot H_2O$) and gibbsite ($Al_2O_3 \cdot 3H_2O$). In the kaolin class, kaolin alone is important for its refractory qualities.

An electrically melted cast bauxite brick is also available. Being a cast product, it is non-porous and therefore highly resistant to slag attack. It is used in the form of large blocks in the walls and bottoms of glass melting tanks, where the refractory is subjected to continuous slagging action. The raw material contains enough silica to permit the melted refractory to flow into the moulds, and the cast refractory consists of mullite ($3\text{Al}_2\text{O}_3 \cdot 2\text{SiO}_2$) and corundum (Al_2O_3) crystals in a glassy matrix. It is extremely hard, has a porosity under 0.5 per cent., and a melting point of 3360° F. (1850° C.); there is little softening below the melting point. The cost (December, 1937) of the blocks is \$130 to \$200 per ton, and the density is 183 lb. per cu. ft. Bricks of lower cost, and showing spalling resistance superior to the cast blocks, are prepared by grinding the cast refractory, mixing with a binder and burning. The cost of the reprocessed 9-inch bricks is \$540 per thousand.

Magnesite Refractories.—In addition to magnesite brick and grain magnesite used for making hearths, some special magnesia refractories are obtainable. The principal weakness of ordinary magnesite brick is its poor resistance to spalling. Without going into the various theories to account for this, it is sufficient to say that it is apparently associated with the change from amorphous magnesia to the crystalline variety, periclase. During the burning of raw material, the higher the temperature the further the approach to a periclase constitution. It is a logical development, then, to sinter or fuse the magnesite in an electric furnace in order to complete the transformation. Moreover, the ordinary commercial grades of magnesite must be impure because the impurities facilitate the inversion to periclase at the ordinary temperatures. Owing to the higher temperature available, electrically "shrunk" magnesite may be of a high degree of purity.

The pure electrically sintered magnesite is crushed, bonded with a magnesia salt, and fired. The resulting product, known as fused magnesite brick has naturally the refractory qualities of magnesite much intensified, and in addition it shows fair resistance to spalling, and may be used in arches, particularly where subjected to high temperatures and basic slags. The cost is obviously high.

Steel encased magnesite brick (see p. 410) is a commercial product in a lower price range. These bricks, formerly made by packing grain magnesite in a steel case, are now made from a special mix to give improved strength and resistance to spalling.

Another type of magnesite refractory consists of burnt magnesite mixed with a bonding material and moulded into a brick, the brick being used in the unfired condition. The bonding material holds the brick together before use and develops a permanent bond at furnace temperature. These bricks show better spalling resistance and are stronger at high temperatures than magnesite. The bricks, and also the metal encased bricks, cost about 15 per cent. less than ordinary burnt magnesite.

Chrome Refractories.—The slightly lower price of chrome brick as compared with magnesite has led to wide use of chrome in basic processes formerly using magnesite. This substitution has been accompanied by careful study of chrome refractories, and the introduction of a number of modified chrome bricks. It was explained on p. 388 that chrome ore is a very complex substance; it occurs in considerable chemical and mineralogical variety, demanding special attention with regard to the distribution of the oxides forming the raw material. Recent improvements include addition of magnesite to form a less fusible glass with the slag material present in the chrome ore, high temperature burning, and the manufacture of special high magnesia, or high magnesia and alumina, chrome bricks. Unburnt chrome bricks, which are more resistant to spalling than burnt bricks, are available at about the same price as burnt bricks. The principal improvements achieved in these modified bricks are greater strength at high temperatures and better resistance to spalling.

“Siemensite” bricks have become prominent in European steel melting practice. These bricks are manufactured from an electric smelting by-product. Chemically, the refractory constituent of this material may be regarded as chromite ($\text{Cr}_2\text{O}_3 \cdot \text{FeO}$) having part of the Cr_2O_3 replaced by Al_2O_3 and most of the FeO replaced by MgO —it was explained on p. 388 that such substitution can take place in the mineral chromite in molecularly equivalent quantities. A typical composition of this brick is 30 per cent. Cr_2O_3 , 35 per cent. Al_2O_3 and 25 per cent. MgO . “Siemensite” is highly refractory (melting point 3630°F. , or 2000°C.) and is resistant to both acid and basic slags.

Forsterite is a magnesium silicate having the formula $2\text{MgO} \cdot \text{SiO}_2$, and therefore consisting of about 57 per cent. MgO and 43 per cent. SiO_2 . Its melting point is 3470°F. (1910°C.). This material has found some application in basic open hearth furnaces as a substitute for chrome or magnesite brick in parts of the furnace subjected to the action of gas-borne basic slag

particles but not to direct slag attack. Under these conditions forsterite may give better service than magnesite or chrome owing to its superior strength at high temperatures. Its resistance to spalling is poor to fair, and resistance to direct slag attack poor. These bricks lie midway between chrome and magnesite in cost per thousand. The weight per brick is about the same as magnesite. The thermal conductivity at high furnace temperatures is about 10 (*i.e.* standard brick equivalent = 1). This refractory is one of the small group whose conductivities are greater (brick equivalent smaller) at lower temperatures.

Spinel Brick.—The lowest melting mixture of MgO and Al_2O_3 fuses at 3500° F. (1925° C.). A compound in the series, MgO . Al_2O_3 , contains about 28 per cent. MgO and 72 per cent. Al_2O_3 , and when pure melts at 3875° F. (2135° C.). The refractory is made from a mixture of good grades of magnesite and bauxite in proportions to give the high melting compound. The properties are similar to those of ordinary magnesite brick. It shows better resistance to load at high temperatures, less expansion, and a heat conductivity little greater than that of silica or fireclay brick. Resistance to spalling is, like that of magnesite, poor. It appears to be more resistant to some slags than magnesite, and less resistant to others. The present cost is 50 per cent. greater than that of ordinary magnesite. It is generally believed that this refractory will increase in importance.

Carbon Brick.—Carbon bricks are usually made from crushed coke bonded with tar, clay or other binder. They are infusible, are resistant to load at high temperatures, and do not spall. The obvious big disadvantage of these bricks is slow burning away of the carbon. They can be used, therefore, only where powerfully reducing conditions prevail, or where it is possible to protect them adequately with a surface dressing. Slags attack carbon brick slowly, the carbon acting as a reducing agent on the oxides present.

Graphite.—Clay bricks have been made with graphite additions, but the principal use of graphite as a refractory is in the manufacture of crucibles.

Silicon Carbide.—Silicon carbide refractories cover a range of materials having similar characteristics. Silicon carbide has the formula SiC, and refractories having this composition, or even a somewhat different composition, are frequently referred to as *carborundum* refractories. Silicon carbide is made in the electric furnace, the product is sorted, crushed up, mixed with a clay or

similar binder, shaped and fired. In addition to the bonded refractories, many silicon carbide refractories are permitted to form their own bond by recrystallisation during the firing process, a temporary bond being used to hold the material together before firing. Silicon carbide refractories may be obtained as standard in any of the 9-inch brick series; in a wide range of sizes of plain tile; as muffles, hearths, etc., for small furnaces; as crucibles; as resistors for high temperature electric furnaces, etc.

Silicon carbide does not fuse even at temperatures as high as 4900° F. (2700° C.), but it decomposes slowly at temperatures in excess of 4000° F. (2200° C.). In fact it is stated that some decomposition takes place at temperatures as low as 2230° F. (1220° C.). Decomposition of silicon carbide takes place by volatilisation of the silicon and burning away of the carbon. This action is checked by the formation of a glaze on the material, particularly where a clay bond is used.

The coefficient of expansion is low and uniform. Resistance to spalling is excellent, and experiments conducted by Hartmann and Hougen¹ indicate that the clay bond brick is better in this respect than the recrystallised brick. The material is very strong and hard, and extremely resistant to abrasion—like corundum (Al_2O_3), silicon carbide is widely used in grinding wheels. These mechanical properties are well maintained at furnace temperatures, but clay bonded refractories should not be used at temperatures much above 3000° F. (1650° C.). Silicon carbide shows good resistance to the action of most slags, but is likely to be attacked by fused metallic oxides. The electrical and thermal conductivities are very high.

Besides products consisting of pure SiC, there are several silicon carbides containing an excess of either carbon or silicon, and also a number of substances corresponding in composition with silicon carbide plus 5.7 to 20 per cent. of oxygen. The latter are sold under various trade names such as "Siloxicon." Some of the commercial products also contain silicon nitride. The general characteristics of these materials are the same as those of SiC, but they generally tend to oxidise and decompose more easily.

High cost restricts the application of silicon carbide refractories to small furnaces and to uses for which cheaper refractories are very unsatisfactory, notably where high thermal conductivity is a requirement.

¹Hartmann, M. L., and Hougen, O. A., *Trans. Amer. Electrochem. Soc.*, **37**, 705-712, 1920.

Zircon and Zirconia.—Zircon ($ZrSiO_4$) and zirconia (ZrO_2) are highly refractory compounds, melting, when pure, at $4620^\circ F.$ ($2550^\circ C.$) and $4930^\circ F.$ ($2720^\circ C.$) respectively. Both minerals occur in sufficient quantity for the impure materials to find limited application as refractories. Bricks of both materials are fairly resistant to slag attack and show small expansion. Zirconia bricks (containing about 75 per cent. ZrO_2) cost more than magnesite but spall less and are said to be equally resistant to basic slags. Purer grades of zirconia are used for making laboratory crucibles.

Zircon brick shows still better resistance to spalling. Failure of this material by slag attack usually occurs by solution of the bond and washing out of the $ZrSiO_4$ grains. The cost of the brick is higher than that of silicon carbide.

Process Used in Manufacture.—The chemical and physical properties of refractories have been discussed from the user's point of view, but it is well to remember that brick manufacturing processes differ, and that there may be resulting differences in quality which are not readily apparent from the analysis or appearance of the brick. Such differences in character may result from the nature of the raw material available, from the widely different methods used in grinding, pressing and firing, and from the proportioning with respect to particle size. Although all processes for making, for example, fireclay brick, can be adjusted to produce different grades of fireclay brick, in some cases a process which is well adapted to one quality of brick may be less suitable for another quality.

That refractories can be improved is apparent from the great improvements effected in recent years in the mechanical properties and spalling resistance of chrome refractories (by paying attention to the nature of the glass) and of magnesite refractories (by using raw material lower in iron).

Super-duty fireclay bricks (priced from \$10 per thousand higher than first quality fireclay) show some of the properties of high alumina bricks and are more resistant to spalling than many of the latter.

IX.—REFRACTORY PLASTICS.

Refractory plastics are materials which, when mixed with water or other fluid, become sufficiently adherent to ram into a furnace structure, and which burn in, forming a monolithic lining.

Simple mixtures have long been made and used by furnace men for patching and ramming hearths. More recently a large number of prepared mixtures have been put on the market by the manufacturers of refractories.

Silica Plastics.—Probably one of the earliest mixtures consisted of crushed ganister rock, usually with the addition of a little fireclay, and enough water to give a plastic consistency. True ganister is a silica rock which, when finely ground, has some degree of plasticity,¹ but the term is loosely used and frequently applied to a silica-fireclay mixture suitable for patching or ramming. The proportions of clay and silica will depend on the degree of plasticity shown by the fireclay. Normally the proportion of clay should not exceed 1 part to 6 parts of ganister.

For filling holes in a silica lining, especially if the repair is made while the furnace is hot, it is better to make a concrete of broken pieces of old silica brick in a mortar prepared as above.

More adherent mixtures are made by adding a little Portland cement—this causes the plastic to set hard when cold, and the lime present acts as a bond when the material is heated. Water glass is perhaps even more extensively used, and for hot patching is more effective than Portland cement. These fluxes must be used with caution, because they lower the melting point of the refractory.

Fireclay Plastics.—In making a fireclay plastic, it is important to use a mixture which will not shrink unduly and so fall away. Crushed fireclay brick is usually mixed with fireclay and water.

A plastic mixture of this type finds extensive application for repairing boiler furnace walls and also for baffles, arches and roofs, the mixture being applied by means of a cement gun. A mixture suitable for this purpose may be made from three parts of crushed brick with one of fireclay, the water being supplied at the nozzle. Sometimes a small quantity of Portland cement or water glass is added. Walls of metallurgical furnaces and hot metal ladles may be "shot" in the same way. The cement gun can shoot a monolithic wall up to several inches thickness, and can also be used with plastics other than the fireclay type. For lining ladles more clay than ground brick-bats should be used. In any of these mixtures it is possible, but not always desirable, to substitute sand or other "grog" for the crushed brick.

¹ In America, the term ganister is applied to quartzite from which silica brick is manufactured, irrespective of plasticity.

Magnesite Plastic.—Dead burned magnesite is used for making open hearth bottoms. For this purpose it is mixed with crushed basic open hearth slag, and spread in layers on the bottom, each layer being burned in at high temperature, and then being allowed to cool somewhat to produce a hard set before the next layer is applied.

Dead burned magnesite (MgO) is not plastic; caustic magnesia, prepared by calcining raw magnesite ($MgCO_3$) at a relatively low temperature, is plastic when mixed with a little water. However, caustic magnesia shrinks considerably on firing. A mixture showing feeble plasticity but small shrinkage may be prepared from dead burnt magnesite with a little plastic magnesia. Much greater plasticity and cold setting strength may be obtained by mixing with magnesium chloride (or magnesium sulphate) solution instead of with water.

Dolomite Plastic.—Dolomite mixed with hot boiled tar makes an excellent basic material and has found application in basic steel making processes. For patching purposes it sets much more quickly than dead burned magnesite.

Chrome.—Chrome is probably the most valuable of the non-siliceous plastics. Crushed chrome ore is usually self bonding, but the chrome plastics on the market usually have admixtures to render them either cold setting or to increase the cohesion when placed in a hot furnace. A little fireclay may be added to chrome ore to improve the bonding quality.

Owing to the chemical neutrality of chrome, it is possible to make plastics of such materials as magnesite by the addition of crushed chrome ore and water. Used as a substitute for the clay bond in fireclay plastics, chrome has the advantage of a much lower shrinkage.

Prepared Plastics.—Ready mixed plastics may be purchased from the manufacturers, either dry or mixed with water. They are frequently available in a number of grades, giving different cold setting and hot bonding qualities, obtained by the addition of fluxes at some expense to the refractoriness of the material. Compared with the cost of making plastic mixtures on the spot, these mixtures are expensive. They are, however, mixed under careful supervision and are the result of experimental work indicating just how much flux gives the best results for a given purpose.

Many of the special refractories are obtainable as plastics, since the principal application of some of these materials is for facing less refractory brickwork, moulding burner openings, etc.

"Firesand," a granular variety of silicon carbide, is used for ramming linings and hearths, etc.

X.—CEMENTS.

There is no essential difference between plastics and cements, but cements are watered down to a thinner consistency and their selection may be governed by somewhat different considerations. The principal use of cement is of course as a mortar or batter to form the joints in laying refractories. The selection of a cement does not always receive the attention which it deserves. That it should have the same general characteristics as the refractory is well enough understood.

The cement should actually bond the bricks together, not too rigidly and without local fluxing of the bricks, and the joint should show reasonable strength over a wide temperature range. Most of the manufactured cements contain additions which give the material cold setting strength. As these cements are heated, the strength decreases owing to dehydration; but at temperatures above 1500° F. (or 800° C.) vitrification commences and a strong permanent bond results. So far as concerns strength, the ideal cement is one which retains much of its initial strength right up to the vitrification point, in order that the cool outer parts of the brick shall continue to be held together by the cement—instead of the bricks being separated by a powdered filler which is held in place imperfectly by the mere weight of the brick. Low temperature strength must not be achieved at too much expense to refractoriness of the material. A simple fireclay bond has little strength from the time it dries right up to the vitrification point.

Although the ideal of similar expansion coefficient to that of the brick can hardly be expected, at least the shrinkage of the bond should be as small as possible.

When it is remembered that slag penetration proceeds far more rapidly at the joints and that practically the whole of the air leakage through a furnace structure takes place through the joints, it is evident that the thinner these joints the better. Modern practice favours the use of poured and dipped joints, not more than $\frac{1}{8}$ inch in thickness. Trowelled joints must of course be used when a good fit cannot be otherwise assured, and are also sometimes recommended by manufacturers of special cements which are presumed to be more refractory than the brick itself.

Silica Cement.—Crushed silica brick with enough fireclay to give a thin slip with water is the most widely used “home-made” cement for laying silica brick. A small quantity of Portland cement is occasionally used instead of clay.

Clay Cements.—These cements, used for laying fireclay brick, usually consist of plastic fireclay mixed with varying proportions of crushed fireclay grog in order to minimise the shrinkage inherent in this class of cement.

Chrome Cement.—This cement can be used for laying almost any type of brick, and is therefore particularly useful as a substitute for cements containing a high percentage of raw clay, owing to its relatively low shrinkage. When this material is to be used, it is usually more satisfactory to purchase the prepared chrome cements, which are obtainable either wet or dry. Chrome cement finds application in the laying of fireclay brick, and, owing to its superiority over clay mortars, is particularly useful where thick joints are unavoidable.

Magnesite Cement.—Magnesite brick may be laid in a mixture of crushed magnesite bricks, plastic (lightly burned) magnesia, and magnesium chloride or sulphate solution. Tar-magnesite and other mixtures may be used, or the bricks may be laid dry with crushed magnesite. Chrome cement also makes a convenient bond for magnesite brick.

Prepared Cements.—The remarks on prepared plastics may be applied equally to the prepared cements. In fact some of the preparations are sold to be used alternatively as a plastic or as a cement. Like manufactured plastics, most of the cements are available in different grades to give in varying degrees a combination of hard setting properties when cold with strong bonding properties at higher temperatures.

Interbonding of Different Refractories.—Different types of brick may be interbonded with a suitable cement, provided the two materials do not exert mutual slagging action, and provided the coefficients of expansion are not too widely different. In a silica brick wall chrome brick panels are frequently interbonded to prevent heavy local erosion of the silica brick by basic slags.

Washes.—Practically all of the cements may be used as washes to be brushed over the surface of a wall after laying. The cements may be of the same material as the brick or bond, in which case it will merely serve to fill in joints from which the cement has been squeezed out and possibly decrease the surface porosity of the brick; or a superior refractory wash may be used, giving a

somewhat more durable surface. Plain fireclay brick walls which have been laid with thick clay joints (not an ideal practice) should receive washes from time to time on the external surface, because here the clay bond never reaches its vitrifying temperature, but crumbles and falls out, leaving the wall very leaky.

XI.—INSULATING MATERIALS.

The economic advantages derived from the use of heat insulating materials were explained in Chapter VI. Formerly, the only materials used to reduce heat losses from walls were loose sand and red brick. The former can be used only when the furnace is encased in steel plates, and even then it is open to the objection of extreme permeability to gases. The evil effects which may arise from this are sometimes seen in a gas producer where this construction has been used. The lower portion of the brickwork, if not very well laid, may develop a few cracks at the joints; air below the combustion zone passes through these cracks, finds a channel through the sand, and escapes to the inside of the producer through cracks higher up, usually just below the shapes supporting the crown (these being set back against the casing for rigid support). The condition is recognised by long tongues of flame shooting out from the wall due to the air "burning" in producer gas, to the detriment of the latter. Hot gases similarly escaping from the combustion zone of the producer may result in rapid enlargement of the cracks in the joints and cause hot spots on the casing. Naturally the higher the blast pressure, the greater the tendency for this short circuiting, and in furnaces operating approximately at atmospheric pressure the problem may not exist.

Red brick was widely used to serve the three-fold purpose of providing insulation, protecting the refractory materials and supporting any heavy upper parts of the furnace. In modern construction the more efficient insulators are found to be cheaper; steel casing is used for protection wherever practicable; and any really heavy superstructure is always supported independently of the brick walls. Even in boiler plants, where the wall surfaces are very large, red brick is replaced by insulation, protection being obtained either by a cement finish reinforced by wire netting or by sheeting of a hard asbestos composition, or in modern plants by a steel shell.

Points which have been touched upon previously in connection

with the use of insulating materials may be summarised as follows :—

(1) A smaller, lighter and often cheaper structure results, for equal or better heat conservation.

(2) There is less heat storage in the walls.

(3) The best insulators of a given class of material are usually the least refractory. In high temperature furnaces it usually pays to use the best furnace insulator outside and a less perfect but more refractory insulator between the outer insulation and the firebrick.

(4) Owing to the increase in area from inside to outside of a furnace, the nearer to the inside the insulation can safely be placed, the better the results. Thus in drying ovens it is excellent practice to use insulating materials, suitably protected against mechanical injury, as the inner furnace lining. This practice is rapidly extending also to higher temperature furnaces.

(5) All insulating materials are highly porous. Consequently if the working temperature is exceeded, very great permanent shrinkage is likely to occur, rendering the insulation almost worthless. The porosity also makes the brick mechanically weak and unsuitable for exposure to slag or dirty gases such as producer gas—at worst the brick will be destroyed, at best the pores will be filled up and the insulating properties greatly impaired. Most insulators spall readily.

The insulating materials available for furnace construction (naturally excluding combustible insulators such as cork, etc., which are extensively used in other industries), classified according to their method of application rather than according to their composition, are—

1. Insulating Brick,
2. Insulating Block or Sheeting,
3. Insulating Cements and Plastics,
4. Powdered or Granular Material.

Insulating Bricks.—These include diatomaceous earth bricks and porous fireclay bricks.

Diatomaceous Brick.—Diatomaceous earth, known also as kieselguhr or infusorial earth, is obtained as a very light rock formed from the highly siliceous skeletons of minute cellular plant organisms called diatoms. It is well known under trade names such as *Molar* (Europe), *Fosasil* (Britain), *Sil-O-Cel*, *Non-Parasil*, etc. The quality of these products, however, may vary considerably according to the deposits from which the material was obtained.

TABLE XXIII.—CHARACTERISTICS OF TYPICAL
REFRACTORY INSULATORS.

	Maximum Working Temperature.	Weight.		Relative Insulating Quality.*	
		Per Brick (9" × 4½" × 2½").	Per cu. ft.		
BRICK.	Porous kaolin	2800°F. (1540°C.)	1 9-2·8	32-48	4
	Porous fireclay	2300°F. (1260°C.)	4	68	3
	Calcined diatomaceous earth	1800-2500°F. (980-1370°C.)	2-25	38	4
	Calcined diatomaceous earth + clay	1600°F. (870°C.)	1-9	32	...
	Raw diatomaceous earth .	1600°F. (870°C.)	1-75	30	12·5
BLOCK.	Diatomaceous earth + asbestos	1600-1900° F. (870-1040° C.)	...	24	12·5
	Calcined diatomaceous earth	2000°F. (1100°C.)	...	40	5†
GRANULAR.	Diatomaceous earth + asbestos	1800°F. (980°C.)	...	18	...
	Raw diatomaceous earth .	1600°F. (870°C.)	...	15 to 22	8†
	Diatomaceous earth + Portland cement (4 : 1)	1800°F. (980°C.)	...	60	4

* Number of inches of "standard brick" (coefficient of conductivity = 10) equivalent to 1 inch of insulator at a temperature equal to one-half the maximum working temperature of the insulator.

† These figures vary widely according to the fineness of the material. For fine powder, the values may be more than double those given.

If the rock were pure it would consist when calcined almost entirely of silica, and would therefore be highly refractory. The actual working temperature is restricted by the percentage of impurities with which the diatoms have become contaminated. Three types of diatomaceous bricks are obtainable :—

(1) Bricks are cut from the raw rock and used directly. These have by far the best insulating properties (see Fig. 26, p. 215, or Table XVII, p. 266), but they contain associated water which is driven off at red heat with considerable shrinkage and loss of

insulating quality. These bricks should never exceed a temperature of 1600° F. (870° C.), but should be used in preference to other types of diatomaceous bricks at low temperatures. For some bricks of this type, the permissible temperature may be decidedly lower than that given here.

Diatomaceous rock has a laminated structure, and the bricks are cut to conform with the strata. Bricks should always be used so that the direction of heat flow is across the laminæ, as the insulating value in this direction is up to 50 per cent. greater than along the laminæ.

(2) For higher temperature work, the diatomaceous earth is calcined, bonded and reburnt. Depending on the quality of raw materials and the burning temperature, these bricks may reach in service a maximum temperature of 1800° F. to 2500° F. (980-1370° C.).

(3) Brick of greater porosity is sometimes made by admixture of some material which burns out in manufacture.

Diatomaceous brick is used both as an insulator behind firebrick, and as the actual lining for medium temperature furnaces where no slagging action is possible and where the mechanical and spalling requirements are light.

Porous Clay Brick.—The heat insulating properties of porous fireclays have been referred to in Chapter VI. These materials are made by mixing some combustible material with the clay. For good insulating properties at fairly high temperatures the pores should be small and evenly distributed. Kaolin appears to be particularly suited to the manufacture of clay insulating brick, possibly because it approximates to pure clay substance and therefore yields a product of uniform texture.

These bricks, which may have excellent insulating properties, may in some cases be used at rather higher temperatures than the high burn diatomaceous earth. They do not spall so readily and are therefore particularly suitable for use as an inner lining to medium temperature furnaces so long as there is no slag attack.

Insulating Firebrick.—Because the raw materials for porous clay bricks can be selected for purity, and because the porosity of the burnt brick is under control, it is possible to make different grades of material differing in refractoriness, insulating properties and cost. Within recent years it has become common practice to use such specially prepared bricks for the inner lining of many high temperature furnaces. These bricks do not constitute a special class of insulator, but rather a greatly improved variety of

the older porous clay refractory. The terms "insulating firebrick" and "insulating refractory" are frequently used to express the suitability of the material for use as the inner lining of furnaces. The materials are made of kaolin (or higher alumina clays) and are fired to temperatures higher than those to be used in service. They therefore show little shrinkage in service and are almost as resistant to high temperatures as the special refractories of similar composition. Being porous, the bricks are fragile; they must be heated carefully to avoid spalling; and they can be used only in furnaces where the products of combustion are free from slag or flux particles. With these restrictions, they may be used for lining furnaces operating at temperatures as high as 2900° F. (and even 3000° F.). Obviously a suitable cement must be used in laying the bricks.

In 1936 the cost of highly refractory insulating bricks was about \$200 per thousand as compared with the cost at that time of \$45 for "first quality" fireclay brick. So far as concerns thermal conductivity, one inch of insulating firebrick is the equivalent of three to four inches of ordinary fireclay brick; consequently, if only the steady heat flow losses were considered, insulating firebrick would be expensive compared with ordinary fireclay brick. However, for furnaces which are fired intermittently, the heat storage loss may greatly exceed the steady flow heat loss. Compared with an ordinary firebrick lining (assuming no external insulation) a lining of insulating refractory may need to be only one-quarter as thick for the same steady heat flow; and as the weight per brick of the insulating refractory may be one-quarter of that for an ordinary fireclay brick, the fireclay wall may store sixteen times as much heat as the insulating wall under similar conditions. This illustration is extreme, as modern refractory-lined furnaces are rarely built without external insulation; but the illustration serves to indicate the principal field of application of insulating refractories. The low heat storage capacity will permit more rapid heating of the furnace, restricted of course by the spalling tendency. The usual physical advantage of lightness and compactness of the furnace structure, and the ease with which bricks of this type may be cut with a saw, must be weighed against the disadvantages of fragility, permeability to gases, greater susceptibility to damage by flame impingement, etc. Improved resistance to flame impingement may be obtained by facing the interior with silicon carbide cement.

Insulating fireclay bricks are made in weights varying from

1.8 lb. to 2.75 lb. per brick, the particular weight employed depending on the temperature and other conditions of service.

Other Bricks.—Other insulating bricks include light weight silica, weighing about 2.25 lb. per brick.

Insulating Block.—This material, sold in blocks usually 3 inches \times 18 inches to 12 inches \times 36 inches and up to 4 inches thick, is a bonded mixture of powdered diatomaceous earth and asbestos. It is sometimes called "high temperature insulating block" to distinguish it from less refractory material sold in sheet form, but it is not so refractory as burnt diatomaceous brick. It has approximately the same insulating properties and maximum working temperature as raw diatomaceous brick—some types of block may be used at slightly higher temperatures.

For insulating block employed in a lower temperature range, powdered magnesia is usually used in place of diatomaceous earth. Several other asbestos products are widely used for temperatures up to 1000° F. (540° C.). Most of the block or sheet types of insulation are also made in segment form to fit standard pipe, and in other forms for power plant and general use.

Insulating Cements and Plastics.—For the laying of diatomaceous bricks and insulating block, special cements are supplied by the makers. The joints should be as thin as possible. If the furnace is under positive pressure, it is particularly important also to see that the joints of the inner refractory lining are as tight as possible, in order that the insulation shall not be damaged by escaping hot gases.

Concrete made of calcined granular diatomaceous earth and Portland cement is an extremely valuable insulator for insulating furnace bottoms and flues, and steel encased furnace structures. It also gives excellent results as a monolithic lining for small medium temperature furnaces and for doors. It may also be applied to the outer surface of furnaces, either with a cement gun or cast in forms. Suitably prepared alumina cements may be substituted with advantage for Portland cement for making many types of heat resisting plastics. These cements form calcium aluminates, whereas Portland cement forms calcium silicates that disintegrate at 1000° F. or lower.

* Plastics containing asbestos or other fibrous insulating material also give good results when spread on to furnace walls and roofs. Expanded mica has been used in the same way. These materials are mixed with a bonding substance such as fireclay, bauxite or asphaltic material.

High temperature porous insulating refractories are also available as plastics.

Granular Material.—Granular burnt diatomaceous earth, similar to that used in making insulating concrete, is used as an insulating filling material to replace sand. Occasionally asbestos is added to decrease the tendency of the loose material to settle.

Indirect Effects of Insulation.—Apart from its direct effect of heat conservation with a minimum weight of furnace structure, insulation may have an indirect bearing on the service conditions imposed on the refractory lining. By decreasing the temperature drop through the actual refractory wall, uneven stressing and movement of the structure is diminished. There is greater probability of vitrification of the refractory bonding cement, with consequent decrease in the leakage. If a furnace is worth insulating, it is imperative to use every effort to secure a gas-tight structure, because the escape of hot gas or the inward leakage of cold air will largely offset the increased efficiency which is the presumed objective of insulation.

As was shown in Chapter VI, it is not a logical conclusion that insulation will necessarily cause appreciable increase in the interior surface temperature of the refractory. It is therefore wrong to assume that insulation is inadmissible because a refractory is already working near to its limiting temperature. On the contrary, insulation may afford just that additional margin of available heat to the furnace, permitting less severe combustion conditions, which, combined with more even expansion, may prove definitely easier on the refractory. A possible detrimental effect of insulation has been referred to on page 305. This concerns refractories subject to failure through slag attack, insulation in such cases causing deeper penetration of slag into the refractory. Also in the case of a material showing poor resistance to load at high temperatures, insulation may tend to decrease the stability of the lining, due to a reduction in the proportion of cool strong material.

Benefits derived from insulation, besides those attributable to fuel economy, include more comfortable working conditions at the furnace, protection of concrete foundations, and in some cases better draught.

SUMMARY.

1. *Melting Point.*—Pure substances usually melt sharply at a definite temperature. Most refractory materials consist of high

melting particles bonded together by a less refractory cement or glass. At high temperatures the glass fuses, and as the temperature rises the resulting slag increases in quantity by partial solution of the refractory particles. The temperature at which this action results in failure of a test pyramid to support its own weight is called, for convenience, the melting point of the refractory.

2. *Expansion and Contraction.*—Reversible changes are due to normal thermal expansion, to crystalline changes (particularly in the silica minerals) and to changes in the glassy constituents of refractories. Irreversible changes are due to distributional changes at temperatures above those used in manufacture of the brick, or to changes which proceed too slowly to have been completed in manufacture.

3. *Texture.*—Texture is important in its relation to the qualities demanded of a refractory material. This property refers to the macrostructure and microstructure of the material, revealing the relation between refractory particles, bond and voids in the brick structure.

4. *Failure under Load at High Temperatures.*—Under load, a refractory may fail at temperatures considerably below its melting point. Some refractories tend to fail by shearing, and some by plastic deformation. The effects of texture, temperature, stress (*i.e.* load per square inch), and time are important factors in determining the nature of failure.

5. *Spalling.*—Resistance to spalling is governed by reversible volume changes (particularly those occurring over a narrow temperature range), mechanical and physical properties, and texture of the brick. In the majority of refractories, the problem of spalling is encountered principally in the low temperature range.

Norton¹ gives the following figures for the relative resistance to spalling:—

Silicon carbide brick (re-			
crystallised), ²	.	.	29
Silicon carbide brick (clay			
bonded), ²	.	.	21
Fireclay brick,	.	.	4.42 (Mean value = 14)
Kaolin,	.	.	20

¹ Norton, F. H.: "Refractories," and "Refractories for Industrial Furnaces," *Fuels and Furnaces*, 1932, Vol. 10, June.

² The relative resistance found for the two types of silicon carbide is in conflict with the indication mentioned on p. 420.

Mullite brick,	16
Bauxite,	15
Zirconia,	6
Zircon, ¹	3
Fused alumina,	2
Chrome,	2
Spinel, ¹	1
Magnesite,	1
Silica,	1

6. *Slag Action*—Slag action is governed by the chemical composition of the refractory and of the slag, by the physical nature of products of erosion, by the temperature, by the nature of the contact between slag and brick, and by the texture of the brick.

7. *Commercial Refractories*.—Characteristics of typical samples of commercial refractories are summarised in Table XXI.

The following notes supplement the table :—

(a) The only refractories which suffer from an **oxidising** atmosphere are carbon, graphite, and, at very high temperatures, silicon carbide.

(b) Earthy refractory oxides can be reduced only under highly reducing conditions at extremely high temperatures. Oxides of the heavy metals are much more readily reduced. Chrome brick should not be used under highly reducing conditions. Zirconia is more readily reduced than the majority of earthy oxides.

(c) In general, refractories are not attacked by molten metals. Carbide-forming metals attack carbon, graphite, and silicon carbide refractories.

(d) Most refractories (fireclay, bauxite, magnesite, kaolin, chrome and other mixtures) shrink when held at a high temperature for a long time, especially if the temperature is higher than that used in manufacture. Electrically fused products (e.g. fused alumina, fused magnesite, silicon carbide) do not show this tendency. Materials approximating to pure compounds (e.g. mullite, silicon carbide) form little glass and therefore, in the absence of crystallographic changes, do not tend to contract until the temperature approaches the melting point. Silica tends to expand due to conversion to forms having a lower specific gravity. In semi-silica brick the tendencies of fireclay to shrink and silica

¹ These values are in conflict with indications from other sources.

to expand are opposed so as to produce a brick whose volume undergoes little permanent change at moderate temperatures.

Table XXII gives some indication of the types of refractory available to meet particular service requirements. The table has been constructed on broad lines, and judgment must be used in interpreting some of the specifications. In particular :—

(a) Where fireclay is specified, the proper texture of the brick will be determined by the nature of the service demanded. For example, for high temperature, severe spalling, light load conditions, high grade fireclay brick is given as a possible choice, both in the absence of slag attack and also with acid slags. This does not mean that the same brick is suitable for both purposes. For resistance to slag attack, the brick should be dense and well vitrified, even at some expense to its spalling resistance.

(b) "High alumina" is used to signify brick containing more than 50 per cent. Al_2O_3 —and in some cases kaolin may be included in the term. The actual material implied will be governed by the conditions in question. For example, for high temperature resistance to the action of molten glass, high alumina may be interpreted as meaning mullite or possibly cast alumina brick.

(c) "Acid" and "Basic" are somewhat ill-defined terms as applied to slags, and a material showing good resistance to one type of basic slag may show poor resistance to another. Lime, the chief earthy basic oxide, and oxides of the heavy metals, frequently behave differently in their attack on a particular refractory.

(d) Generally, for light duty the more expensive refractories have not been specified in the table. Evidently a refractory suitable for severe conditions could be used for light duty of a similar category. For less severe service, it does not follow, however, that the heavy duty refractory is necessarily better than, or as good as, the cheaper refractory. The fact is, the less severe service has given an additional choice of materials, and the new material may be definitely better for the purpose than the more expensive materials. Second grade fireclay brick is usually much superior to first grade brick for work at low temperatures under conditions conducive to spalling.

(e) Some of the special refractories listed in Table XXI have not been included in Table XXII.

8. *Plastics and Cements*.—Plastics are materials which may be applied to a furnace as a substitute for manufactured brick. They may be applied as a complete lining or for patching purposes, the

furnace may be cold or hot, and the plastics may be mixed at the furnace or purchased ready mixed from the manufacturer. Plastics consist essentially of the required crushed refractory, mixed with a suitable bond, and watered to a proper consistency.

Cements are similar to plastics, but are watered down to a thin slip for laying brick with dipped joints. It is important that cements shall be refractory, shall exhibit strength over a wide temperature range, and shall show but little shrinkage on firing.

9. *Insulating Materials*.—Porous clay brick and burnt diatomaceous brick may be used to temperatures well above red heat. Up to red heat, raw diatomaceous earth or high temperature insulating block provide more efficient heat insulation. Insulators must be protected from mechanical abuse, slag action and overheating. When insulation is used, the furnace structure must be as gas tight as possible—outward leakage will damage the insulation; inward leakage will decrease the heat available to the furnace charge, tending to defeat the object of insulation.

Table XXIII shows some of the properties of typical samples of refractory and semi-refractory insulators.

General References :—

1. F. H. Norton : *Refractories*.
2. A. B. Searle : *Refractory Materials, Their Manufacture and Uses* (Griffin).

CHAPTER IX.

PHYSICO-CHEMICAL CONSIDERATIONS.

THE principles of physical chemistry may be of the greatest value to the production man, as well as to the research and laboratory metallurgist, in indicating the extent to which reactions are chemically possible under given conditions.

The classic example of early appreciation of the application of physico-chemical theory to smelting problems is found in Sir Lowthian Bell's *Chemical Phenomena of Iron Smelting*, published in 1872, and in a paper read by Bell before the Iron and Steel Institute in 1869. At that time Bell's publications undoubtedly prevented the expenditure of large sums of money for development of blast furnace practice according to prevalent mistaken ideas. During almost seventy years which have elapsed since Bell's work was first published, blast furnace practice has substantiated his conclusions with but little modification.

The Type of Problem to be Solved.—Changes, whether physical or chemical, are affected by the conditions under which they take place. Under atmospheric pressure water boils at 212° F. (100° C.); while in a boiler, under a gauge pressure of 250 lb. per sq. in., the boiling point is 406° F. (208° C.). When air is blown through white-hot coke as in a blast furnace or gas producer, practically the whole of the oxygen of the air may appear as carbon monoxide, the gas containing only a small quantity of carbon dioxide. At temperatures below 1830° F. (1000° C.) the proportion of carbon dioxide in the gas mixture must increase rapidly as the temperature becomes lower. Also, mixtures of oxidising gases such as steam and carbon dioxide with reducing gases such as hydrogen and carbon monoxide may either oxidise a metal or reduce an oxide of the same metal, according to the composition of the mixture, the temperature, and in some cases the pressure. Physical chemistry enables us to investigate a great variety of phenomena of this nature.

The laws of physical chemistry are partly qualitative, indicating only the tendency produced by a change in operating conditions ;

and partly quantitative, showing by calculation the actual result of such a change when a condition of equilibrium has been reached. Among the more important qualitative laws may be mentioned Le Chatelier's Principle which tells us whether a certain reaction will be favoured or otherwise by a change in conditions.¹ The most important quantitative laws are the Law of Mass Action and its combinations with the laws governing Vapour Pressures and Solutions. These quantitative laws permit calculation of the composition of the end products of a particular reduction or refining process. The calculations, however, are based on certain assumptions which may or may not be approximately justified in a particular process. Also, the available data are frequently uncertain. In many cases, therefore, the calculated results cannot be accepted as correct; but they will at least provide some index of magnitude. For example, if calculation indicates that a certain change should diminish the quantity of dissolved oxide in a metal from 0.5 per cent. to 0.1 per cent., even though these figures must be taken with reserve, the significance is vastly greater than a mere qualitative indication of diminution in the oxide content.

In this chapter no attempt is made to explain aspects of physical chemistry not directly applicable to metallurgical operations. Nor is any explanation offered of the methods and laws used in deriving important tabulated data. Moreover, the subject does not always admit of general treatment, it sometimes being necessary to use specific examples to illustrate principles. It is hoped that this treatment will assist readers, not previously acquainted with the subject, in following current specialised literature on the physical chemistry of metallurgy.

Dependence of Thermal Data on Conditions of Measurement.—

When a chemical or physical change tends to produce a volume change, the accompanying thermal data are usually expressed for one of two conditions:—

(a) the pressure is kept constant, permitting a change of volume, or

(b) the volume is held constant, involving a change of pressure.

For a given change, the heat effects at constant pressure and at constant volume may show quite a large difference—the data for calculating this difference are usually available. In industrial metallurgical work, practically all changes take place at

¹ Gibb's Phase Rule is another qualitative law, extremely valuable in some classes of work. In this book it has been preferred to devote as much space as possible to quantitative laws.

approximately constant pressure. Accordingly, all data given in this book are for changes taking place at constant pressure.¹ Constant pressure has been specified in Tables II, III and XI, and in Fig. 1, because the specific heat data for gases are sometimes given at constant volume. In Tables IX, X, XI and XII, constant pressure is implied because these data are almost invariably so expressed. It will be understood hereafter that constant pressure is implied in all cases.

Changes of Heat of Reaction with Temperature.—The heat of formation of any compound has a fixed value for a particular temperature, but the value changes with the temperature. Heats of formation given in the tables are the values at atmospheric temperature.² In furnace operations, the chemical changes take place at high temperatures, and the accompanying heat changes may be appreciably different from the laboratory determinations at atmospheric temperature.

The change in heat of formation or heat of reaction is entirely consistent with the law of conservation of energy, and its special form, the law of constant heat summation. Fig. 59 is used in elucidation. *C* represents the reacting constituents of a chemical reaction, and *P* represents the end products, both at atmospheric temperature, as indicated by their being placed on the same horizontal level. In a laboratory determination of the heat of reaction, the temperature of the constituents *C* would be measured, the reaction would be allowed to take place, the end products *P* would be cooled to the initial temperature, and the heat evolved in the whole process would be measured. This is the heat of formation or heat of reaction ordinarily given, after making certain adjustments, and its value is represented in Fig. 59 by Q_0 .

Suppose in practice that the reaction takes place at a higher temperature level, *t*, and that the heat of reaction at this

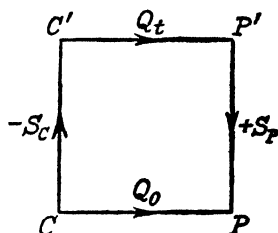

Fig. 59.

¹ Even in blast furnace calculations, constant pressure data should be used—in a heat balance the effect of gas expansion due to change of pressure may be allowed for separately.

² For scientific work, 77° F. (25° C.) is accepted as standard temperature; for practical work 60° F. (15° C.) is a more suitable temperature. In this book, values have been adjusted to the lower temperature in those cases where the probable accuracy of the experimental determination warrants making the small correction.

temperature is Q_t . In the diagram, C' and P' represent the same starting and end products at the higher temperature level, and the sensible heat of these substances at the higher level is represented by S_c and S_p respectively. Suppose the constituents are heated from standard temperature to the reacting temperature, allowed to react at this temperature and then the products of reaction are cooled to standard temperature, as indicated by the arrows in the diagram. In heating the constituents to the reacting temperature, the heat S_o must be supplied to or absorbed by the system, absorption being indicated in the diagram by the negative sign; the heat Q_t is evolved by the reaction, and then the sensible heat S_p is given up by the products of reaction in cooling.

Applying the law of constant heat summation, the net heat liberation in the indirect route $CC'P'P$ must be the same as if the direct route from C to P were taken, from which we obtain,

$$\begin{aligned} -S_c + Q_t + S_p &= Q_o \\ \text{or } Q_t &= Q_o + S_c - S_p \end{aligned}$$

Taking as another illustration the change indicated in Fig. 60 from C to P' by different routes, we get,

$$\begin{aligned} -S_c + Q_t &= Q_o - S_p, \text{ giving as before,} \\ Q_t &= Q_o + S_c - S_p \end{aligned}$$

Note that an upward direction of the arrow is negative and downward is positive.

Putting the equation into words, *the heat of reaction of a change taking place at a particular temperature is equal to the heat of reaction at standard temperature plus the sensible heat of the components minus the sensible heat of the products at the temperature of reaction.* This is known as Kirchhoff's law.

Example 1.—Combustion of Hydrogen :—The heat of combustion of hydrogen at standard temperature is 275 B.Th.U's. (153 C.H.U's.) per cu. ft. (Table II). The sensible heat of 1 cu. ft. of hydrogen plus $\frac{1}{2}$ cu. ft. of oxygen at 3100° F. (1705° C.) is 89.2 B.Th.U's. (49.6 C.H.U's.). The sensible heat of 1 cu. ft. of water vapour at the same temperature is 79.2 B.Th.U's. (44.0 C.H.U's.). The heat of combustion of hydrogen at this temperature is thus 10 B.Th.U's. (6 C.H.U's.) higher or 285 B.Th.U's. (159 C.H.U's.) per cu. ft. In powerfully exothermic reactions such as this, the effect of temperature on the heat liberated may appear small by comparison—the absolute effect is very important

Example 2.—Oxidation of Amorphous¹ Carbon by Ferric Oxide:—
The reaction,

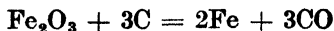

requires 194,220 B.Th.U's. (107,900 C.H.U's.) at standard temperature. At 1500° F. (815° C.) the sensible heat of the ferric oxide and the carbon is 66,800 B.Th.U's. (37,100 C.H.U's.), while that of the iron and the carbon monoxide is 56,700 B.Th.U's. (31,500 C.H.U's.). At this temperature the reaction requires only 184,100² B.Th.U's. (102,300 C.H.U's.), about 95 per cent. of standard temperature requirement. It is likely that at still higher temperatures the reaction becomes progressively less strongly endothermic, *i.e.* that the heat requirement becomes progressively smaller.

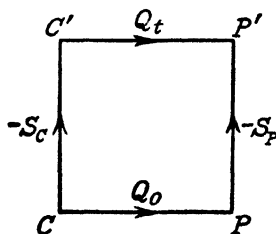

Fig. 60.

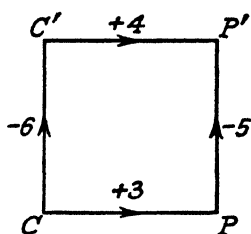

Fig. 61.

Reactions which are endothermic at ordinary temperatures may even become exothermic at higher temperatures, and vice versa. The reduction of ferrous oxide by hydrogen is an example of the former, with the oxidation of iron by steam following directly as an example of the converse.

It is not practicable to show the effect of change of heat of reaction with temperature in constructing thermal balance sheets, yet the redistribution between chemical and sensible heat may greatly affect a process. Suppose, for example, that the heat quantities represented in Fig. 60 are as shown in Fig. 61.

¹ The heat of formation of carbon dioxide from one pound-atom of amorphous carbon (weight in air) is greater than that from one pound-atom of graphite (weight *in vacuo*) by (97,800—94,240 = 3560 C.H.U's.) 6410 B.Th.U's. (see p. 31). The heat of formation of carbon monoxide from one pound-atom of amorphous carbon (weight in air) is therefore greater than the value given in Tables II and XI by the same amount, giving the required heat of formation of carbon monoxide as 54,360 B.Th.U's. (30,200 C.H.U's.).

² $Q_t = Q_o + S_c - S_p = -194,220 + 66,800 - 56,700 = -184,120.$

This diagram indicates that, following route CPP' , a reaction proceeds at atmospheric temperature liberating 3 units of heat and the products of reaction are then raised to the temperature t , requiring 5 units to supply the sensible heat of the hot products; or following route $CC'P'$, 6 units are used in raising the temperature of the constituents and then 4 heat units are liberated by the reaction. Heat balance sheets assume route CPP' , whereas route $CC'P'$ is usually more closely in accordance with actual operation. While both routes show a net heat requirement of 2 units, the actual route $CC'P'$ is thermally the more favourable. Heat transfer to a cold charge is relatively inexpensive, but transfer of the same quantity of heat to the charge when the latter is at a high temperature is much more costly. Sensible heat supplied to the charge is partly low temperature heat and partly high temperature heat; many metallurgical reactions take place at a high temperature, either yielding high temperature heat of enhanced value, or absorbing correspondingly expensive heat. The gain of 1 high temperature heat unit shown in Fig. 61, due to change in heat of reaction, therefore more than offsets the additional heat unit required in heating the constituents from C to C' as compared with heating the products from P to P' . The premium placed on chemical heat liberation at high temperatures therefore makes important any increase in exothermic heat of reaction or any decrease in endothermic heat of reaction with rising temperature.

Balanced Reactions.—From a practical point of view, chemical reactions are frequently divided into two classes:—

1. Those which, given sufficient time, proceed almost to completion, and
2. Those which, no matter how much time is allowed, can never even approach completion.

Theoretically no reaction can be complete, and in the present chapter no such distinction as the above concerning the degree of completion can be entertained. Practically, the combustion of hydrogen to form steam may be regarded as an example of a complete reaction. Yet in Chapter II it was indicated that, at very high temperatures, some free hydrogen and free oxygen must continue to exist in the products of combustion. Thus, this reaction at high temperatures cannot proceed to completion—nor in fact can absolute completion be reached even at lower

temperatures. When we wish to consider this aspect of a reaction, we write the equation,

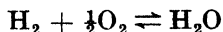

the symbol \rightleftharpoons indicating that hydrogen and oxygen combine to form water, but that a limit is reached beyond which combination cannot proceed; also that if steam is heated, a certain amount of decomposition must occur yielding oxygen and hydrogen.

Reactions which show a considerable degree of incompleteness, such as the reaction,

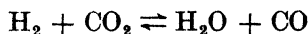

are commonly called balanced reactions. When we are applying the laws of physical chemistry to chemical reactions, all must be considered balanced.

Equilibrium.—Given sufficient time under a particular set of conditions, any chemical or physical change proceeds to a certain point at which the distribution becomes stable and shows no further tendency to change. This stable condition, when opposing tendencies precisely balance, is called a state of equilibrium. In this chapter, except where mention is made to the contrary, it will be assumed that sufficient time has been allowed for reactions to reach a state of equilibrium. The exact physical and chemical state of a system in equilibrium may depend on the temperature and pressure, on the chemical affinities and physical properties of the reacting substances, and on the relative quantities present.

A Phase is any homogeneous material forming part of a system, that is a material which is uniform at all points, even microscopic examination failing to reveal separate constituents.

Gases.—A mixture of gases is always a single phase, the different constituent gases being so dispersed as to constitute a homogeneous mixture.

Liquids.—A single liquid such as a fused slag is similarly homogeneous, the different constituents intermingling with such absolute freedom as to defy their separate physical identification. In most smelting operations, two distinct liquids are commonly formed—the metal with its homogeneously dissolved impurities, and the equally homogeneous though chemically more complex slag. Each is a separate phase. It is possible in smelting operations to have more than two distinct liquids, as in operations producing a matte or a speiss in addition to metal and slag; here again each is a separate phase.

Solids may appear as a single phase in the form of an element, compound or a solid solution.¹

Solids falling outside the above three classes are heterogeneous mixtures, consisting of more than one phase.

System.—The word “system” is frequently used; it may be defined as the particular combination of phases under consideration.

I.—MASS ACTION.

The application of this section is as follows:—

1. For a given temperature and pressure, and known quantities of the initial substances, to calculate the composition of the end products of a balanced reaction.

2. To show how the equilibrium may be shifted by changes imposed upon the system.

Concentration.—The composition of a substance is for ordinary purposes expressed by chemical analysis in per cent. by weight or by volume. For the present purpose it is necessary to express the composition as the number of molecules of each element or compound in a given quantity of the phase. The composition of a substance so expressed is called the concentration.

Reactions in a Gaseous Phase.—The “water gas” reaction,

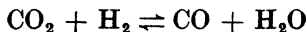

is selected as a preliminary illustration. The mechanism of a reversible reaction may be visualised² by reference to Fig. 62. The atoms of carbon, hydrogen and oxygen are represented as shown in the key, and the molecules of carbon monoxide, carbon dioxide, hydrogen and water are represented as being built up of the appropriate atoms. The molecules of a gas are in a state of extremely rapid motion, and consequently collisions between molecules take place very frequently.³

Carbon monoxide and hydrogen both have a very strong attraction or affinity for oxygen, and consequently, whenever a

¹ A solid solution is a mixture of two or more elements or compounds, which under the microscope appears as a perfectly homogeneous substance, no traces of the constituents being visible. The alloys of copper and nickel are of this type. Many alloys show separate constituents under the microscope.

² The ensuing description is illustrative rather than scientific.

³ The frequency of collision may be computed; but the calculated collisions per second in one cubic inch would be represented by numbers even more fantastic in their magnitude than the figures representing the distance of the stars from the earth.

hydrogen molecule comes into momentary contact with a carbon dioxide molecule, a struggle will ensue for one of the oxygen atoms contained in the carbon dioxide molecule. If the hydrogen succeeds, it will get away with an atom of oxygen as water vapour ; while the carbon dioxide, deprived of one atom of oxygen, will become a carbon monoxide molecule. If, on the other hand, the carbon dioxide molecule succeeds in hanging together during the brief contact, the carbon dioxide and hydrogen molecules will separate unchanged. This illustrates in a satisfactory if somewhat crude manner the mechanism of the change from left to right,



The *proportion* of encounters in which the hydrogen is successful in robbing the carbon dioxide of its atom of oxygen may be

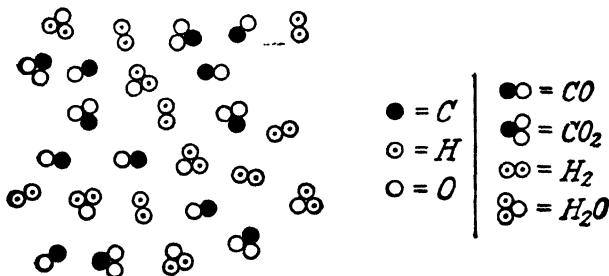

Fig. 62.

considered as a function of the relative affinities of carbon monoxide and hydrogen for oxygen. The actual *number* of encounters between hydrogen and carbon dioxide molecules depends on the number of each of these molecules present in a given volume of the gas, *i.e.* on the concentration of the different molecules. Therefore, the *speed* with which the reaction proceeds from left to right may be represented by the equation,

$$V_1 = k_1 \times [\text{CO}_2] \times [\text{H}_2]$$

where V_1 is the velocity of reaction from left to right, k_1 is a constant embodying both the proportion of successful raids by the hydrogen molecules and the physical constants of the moving gas molecules, and $[\text{CO}_2]$ and $[\text{H}_2]$ are convenient symbols representing the concentrations of carbon dioxide and hydrogen in the gas mixture.

The mechanism of the reaction from right to left is exactly

similar. Whenever a carbon monoxide molecule collides with a water vapour molecule, a similar struggle ensues, in which the carbon monoxide sometimes fails and sometimes succeeds in getting away with an oxygen atom as carbon dioxide and leaving hydrogen. The velocity of this reaction is also represented by

$$V_2 = k_2 \times [\text{H}_2\text{O}] \times [\text{CO}]$$

Collisions of other pairs of molecules within this gas mixture naturally take place, but they are not attended by any change in composition. For example, water vapour and hydrogen molecules may collide, and it may be presumed that the hydrogen sometimes robs the water vapour of its oxygen atom, but this is merely an exchange of partners by the oxygen, and the result is still one molecule of hydrogen and one of water. In the same way carbon dioxide and carbon monoxide, carbon dioxide and water vapour, or any of the other possible collisions, cannot result in any actual change of composition.

Suppose now a mixture containing only hydrogen and carbon dioxide be heated to 2100° F. (1150° C.). Since there is at first no water vapour or carbon monoxide, *i.e.* since $[\text{H}_2\text{O}] = 0$ and $[\text{CO}] = 0$,

$$\begin{aligned} V_2 &= k_2 \times 0 \times 0 \\ &= 0 \end{aligned}$$

The velocity V_1 will, however, be very rapid because the concentrations of hydrogen and carbon dioxide are high. This means that the reaction proceeds from left to right, with decreasing concentration of hydrogen and carbon dioxide and increasing concentration of water vapour and carbon monoxide. The result of the changes in composition will be an ever-decreasing rate, V_1 , of the change from left to right and a rapidly increasing rate, V_2 , of the change from right to left. Finally the increase in V_2 coupled with the decrease in V_1 must result in a condition when the frequency of changes from left to right is exactly equal to the frequency of changes from right to left, or

$$\begin{aligned} V_1 &= V_2 \\ \therefore k_1 \times [\text{CO}_2] \times [\text{H}_2] &= k_2 \times [\text{CO}] \times [\text{H}_2\text{O}] \end{aligned}$$

which may be transformed algebraically to

$$\frac{k_1}{k_2} = \frac{[\text{CO}] \times [\text{H}_2\text{O}]}{[\text{CO}_2] \times [\text{H}_2]}$$

Since k_1 and k_2 are both constants, the ratio $\frac{k_1}{k_2}$ is replaced by the single constant K , thus

$$K = \frac{[\text{CO}] \times [\text{H}_2\text{O}]}{[\text{CO}_2] \times [\text{H}_2]}$$

For a given temperature and pressure, K is constant for a particular reaction, and may be expressed in words as the *product of the concentrations of the substances represented on the right-hand side of the equation divided by the product of those on the left-hand side* when a balanced condition has been reached due to the forward and reverse velocities being equal. K is called the **Equilibrium Constant** of the reaction.

It will be noted that since the equilibrium constant is determined only by the final concentrations reached when the left-to-right and right-to-left reactions exactly balance, the value of K is independent of whether the reaction started from the right or from the left. It is important, however, to note which way the equation was written. Thus it is fully permissible to write the water gas equation,

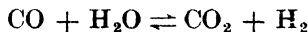

but in this case the equilibrium constant would equal $\frac{[\text{CO}_2] \times [\text{H}_2]}{[\text{CO}] \times [\text{H}_2\text{O}]}$, which is the reciprocal of K as formerly determined.

More Complex Systems.—In the water gas reaction, the equation shows only one molecule of each of the reacting substances. Many reactions are represented by equations showing more than one molecule of some of the reacting substances. A familiar example is found in the equation,

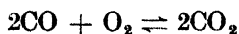

It may be shown algebraically that the number of molecular collisions between oxygen and carbon monoxide is proportional to the oxygen concentration and to the square of the carbon monoxide concentration. Similarly, the rate of reaction from right to left is proportional to the square of the carbon dioxide concentration. The resulting equilibrium constant is in effect the same as if the equation had been written,



which would have given the equilibrium constant,

$$K = \frac{[\text{CO}_2] \times [\text{CO}_2]}{[\text{CO}] \times [\text{CO}] \times [\text{O}_2]}$$

$$= \frac{[\text{CO}_2]^2}{[\text{CO}]^2 \times [\text{O}_2]}$$

The above reasoning is entirely general, and if a reaction is written,

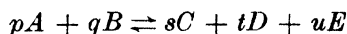

then

$$K = \frac{[C]^s \times [D]^t \times [E]^u}{[A]^p \times [B]^q}$$

the numbers of molecules in the equation becoming exponents of the concentrations in calculating the constant.

Again, if it is found more convenient to write the carbon monoxide reaction with oxygen in the form,

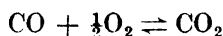

then

$$K = \frac{[\text{CO}_2]}{[\text{CO}] \times [\text{O}_2]^{\frac{1}{2}}} \text{ or } \frac{[\text{CO}_2]}{[\text{CO}] \times \sqrt{[\text{O}_2]}}$$

The value for K in this case will be the square root of that obtained with the equation written in the previous form.

Units Used in Measuring Concentration.—The concentration of the reacting substances may be expressed in any convenient units which will represent the number of molecules of a substance in a given quantity.

Liquids.—In dealing with reactions taking place within a liquid, it is often convenient to take as the unit of quantity one **mole**, *i.e.* one "pound-molecule" of the mixture. Suppose, for example, that molten steel contains 0.36 per cent. FeO and 0.12 per cent. C, the balance being assumed, for simplicity, to be iron. Dividing the percentages by the molecular weights, we obtain 0.005 lb.-molecule of FeO, 0.01 lb.-molecule of C and 1.777 lb.-molecules of Fe, giving a total of 1.792 lb.-molecules. The concentrations of the reacting substances (ferrous oxide and carbon) in 1 lb.-molecule of steel will therefore be 0.0028 lb.-molecule of FeO and 0.0056 lb.-molecule of C. When expressed in this way, the concentrations are referred to as **molar fractions** because they give the fraction of a lb.-molecule of the substance per mole of the mixture.

Gases.—When dealing with gases, it is not very convenient to express the concentration as the number of moles (pound-molecules) of the reacting gases in a fixed volume, because this number will vary with the effects of temperature and pressure on the gas. Since the equilibrium constant, calculated on any basis, is a function of temperature, it is a simple and logical procedure to include the effect of temperature on gas volume in the calculated values for K corresponding to different temperatures. The effect of pressure is taken care of by using the partial pressures of the reacting gases instead of the concentrations.

Partial Pressures.—Where the gas consists of a mixture at a given pressure, the total pressure is made up of the pressures contributed by the different constituent gases. The pressure contributed by a constituent gas is called its partial pressure and is proportional to the percentage of the gas present. Thus if the atmosphere contains 20.9 per cent. O_2 and 79.1 per cent. N_2 , the partial pressure of the oxygen is 0.209 atmosphere and of the nitrogen 0.791 atmosphere, giving the total pressure of one atmosphere. It is convenient to use one atmosphere as the unit of pressure in physico-chemical calculations, since most practical operations are carried out at atmospheric pressure, and in this case the partial pressure of a constituent is the per cent. composition divided by 100. More generally,

$$p = \frac{\text{Per cent. composition by volume}}{100} \times P \quad . \quad . \quad (22)$$

where p is the partial pressure of a constituent, and P is the total pressure of the gas, usually measured in atmospheres. Very many metallurgical reactions, such as oxidation and reduction, depend on the partial pressures in a gas mixture. It is the partial pressure of an active gas which is used in calculations, not the total pressure. For example, pure oxygen confined over a metal at a reduced pressure of 0.209 of an atmosphere would have exactly the same activity characteristics as air at 1 atmosphere—there would in fact be the same amount of oxygen present per unit volume in the two cases.

When partial pressures are substituted for concentrations per fixed volume, the equilibrium constant for the water gas reaction



is written

$$K_p = \frac{p_{CO} \times p_{H_2O}}{p_{CO_2} \times p_{H_2}}$$

In this particular reaction, if we substitute the equivalents of p as given in Equation 22, we find

$$K_p = \frac{(\%CO) \times (\%H_2O)}{(\%CO_2) \times (\%H_2)}$$

the quantities 100 and P introduced by the substitution being found to cancel. The constant for concentrations, K , is the same as the constant for partial pressures, K_p . These conclusions apply to all reactions represented by equations showing the same number of gaseous molecules on each side of the equation. In these cases, it is simpler to use percentages than partial pressures.

Calculation of Equilibrium Constants.—At low temperatures many reactions proceed so slowly that it becomes impossible to determine the equilibrium constant experimentally, while at very high temperatures practical difficulties may become serious. If the equilibrium constant can be determined over any range, an equation may be established to determine its value far outside the experimental range, calculated values for K thousands of times larger or smaller than those in the experimental range being acceptable. This calculation depends on Van't Hoff's equation connecting K with the temperature and heat of reaction, and Kirchhoff's law governing change of heat of reaction with temperature. Table XXIV gives the equilibrium constants for some important gaseous reactions, using partial pressures.

With the exception of the five values in parenthesis, values are calculated from equations by Goodenough and Felbeck.¹ The values in parenthesis, for K_w , are extrapolated from later data and therefore do not check exactly with the corresponding values for K_{CO} , and K_{H_2O} .

Illustrations of Use of Water Gas Reaction.—There is no question that the water gas reaction is of great importance in certain industrial operations. Calculated results, however, assume a state of equilibrium not normally reached in these operations. Calculations therefore show only the final trend, and the following two examples are used to illustrate the general use of the theory of mass action, without attaching too much importance to the accuracy of the results obtained.

¹ Goodenough, G. A., and Felbeck, G. T.: "An Investigation of the Maximum Temperatures and Pressures Attainable in the Combustion of Gaseous and Liquid Fuels." *Bulletin No. 139, Engineering Experimental Station, University of Illinois, 1924.*

TABLE XXIVA.—EQUILIBRIUM CONSTANTS FOR GASEOUS REACTIONS.

(USING PARTIAL PRESSURES IN ATMOSPHERES AND ° F.).

° F.	$\text{CO}_2 + \text{H}_2 \rightleftharpoons \text{CO} + \text{H}_2\text{O}$	$\text{CO} + \frac{1}{2}\text{O}_2 \rightleftharpoons \text{CO}_2$	$\text{H}_2 + \frac{1}{2}\text{O}_2 \rightleftharpoons \text{H}_2\text{O}$	$\text{C} + \text{CO}_2 \rightleftharpoons 2\text{CO}^*$
	$K_w = \frac{p_{\text{CO}} \times p_{\text{H}_2\text{O}}}{p_{\text{CO}_2} \times p_{\text{H}_2}}$	$K_{\text{C}_1/2} = \frac{p_{\text{CO}_2}}{p_{\text{CO}} \times \sqrt{p_{\text{O}_2}}}$	$K_{\text{H}_2\text{O}} = \frac{p_{\text{H}_2\text{O}}}{p_{\text{H}_2} \times \sqrt{p_{\text{O}_2}}}$	$K_c = \frac{p_{\text{CO}}^2}{p_{\text{CO}_2}}$
800	..	3.5×10^{16}	2.9×10^{15}	2.4×10^{-4}
900	..	9.6×10^{14}	1.3×10^{14}	1.9×10^{-3}
1000	(0.33)	4.2×10^{13}	9.2×10^{12}	1.1×10^{-2}
1100	(0.4)	2.9×10^{12}	9.1×10^{11}	5.2×10^{-2}
1200	(0.5)	2.7×10^{11}	1.2×10^{11}	2.0×10^{-1}
1300	0.6	3.3×10^{10}	1.9×10^{10}	6.8×10^1
1400	0.8	5.0×10^9	3.75×10^9	2.0
1500	1.0	9.3×10^8	8.85×10^8	5.1
1600	1.1	2.0×10^8	2.3×10^8	1.2×10
1700	1.3	5.2×10^7	6.95×10^7	2.6×10
1800	1.6	1.5×10^7	2.3×10^7	5.3×10
1900	1.8	4.6×10^6	8.5×10^6	1.0×10^2
2000	2.0	1.6×10^6	3.4×10^6	1.8×10^2
2100	2.3	6.2×10^5	1.4×10^6	3.1×10^2
2200	2.5	2.5×10^5	6.5×10^5	5.1×10^2
2300	2.8	1.1×10^5	3.1×10^5	8.0×10^2
2400	3.05	5.1×10^4	1.6×10^5	1.2×10^3
2500	3.3	2.5×10^4	8.4×10^4	1.8×10^3
2600	3.5	1.3×10^4	4.6×10^4	2.6×10^3
2700	3.75	7.0×10^3	2.6×10^4	3.6×10^3
2800	4.0	3.9×10^3	1.6×10^4	5.0×10^3
2900	4.2	2.3×10^3	9.5×10^3	6.8×10^3
3000	4.45	1.3×10^3	6.0×10^3	9.0×10^3
3100	4.7	8.2×10^2	3.8×10^3	..
3200	4.9	5.2×10^2	2.5×10^3	..
3300	5.1	3.4×10^2	1.7×10^3	..
3400	5.3	2.2×10^2	1.2×10^3	..
3500	5.55	1.5×10^2	8.3×10^2	..
3600	5.8	1.0×10^2	5.9×10^2	..
3700	6.0	7.2×10	4.3×10^2	..
3800	6.2	5.2×10	3.2×10^2	..
3900	6.4	3.7×10	2.4×10^2	..
4000	6.6	2.7×10	1.8×10^2	..
4100	6.8	2.0×10	1.4×10^2	..
4200	7.0	1.5×10	1.1×10^2	..
4300	7.2	1.2×10	8.5×10	..
4400	7.4	9.1	6.7×10	..
4500	7.6	7.1	5.4×10	..
4600	7.85	5.6	4.4×10	..
4700	8.1	4.4	3.6×10	..
4800	8.3	3.6	2.9×10	..
4900	8.5	2.9	2.4×10	..
5000	8.8	2.3	2.0×10	..

* Composite values for coke, charcoal and amorphous carbon.

TABLE XXIVB.—EQUILIBRIUM CONSTANTS FOR GASEOUS REACTIONS.

(USING PARTIAL PRESSURES IN ATMOSPHERES AND ° C.).

° C.	$\text{CO}_2 + \text{H}_2 \rightleftharpoons \text{CO} + \text{H}_2\text{O}$	$\text{CO} + \frac{1}{2}\text{O}_2 \rightleftharpoons \text{CO}_2$	$\text{H}_2 + \frac{1}{2}\text{O}_2 \rightleftharpoons \text{H}_2\text{O}$	$\text{C} + \text{CO}_2 \rightleftharpoons 2\text{CO}^*$
	$K_W = \frac{p_{\text{CO}} \times p_{\text{H}_2\text{O}}}{p_{\text{CO}_2} \times p_{\text{H}_2}}$	$K_{\text{CO}_2} = \frac{p_{\text{CO}_2}}{p_{\text{CO}} \times \sqrt{p_{\text{O}_2}}}$	$K_{\text{H}_2\text{O}} = \frac{p_{\text{H}_2\text{O}}}{p_{\text{H}_2} \times \sqrt{p_{\text{O}_2}}}$	$K_C = \frac{p_{\text{CO}}^2}{p_{\text{CO}_2}}$
400	...	2.5×10^{17}	1.5×10^{14}	7.9×10^{-5}
500	(0.3)	3.5×10^{14}	5.7×10^{13}	3.3×10^{-3}
600	(0.4)	2.2×10^{12}	7.1×10^{11}	6.2×10^{-2}
700	0.6	3.9×10^{10}	2.2×10^{10}	6.2×10^{-1}
800	0.9	1.5×10^9	1.3×10^9	3.9
900	1.3	9.9×10^7	1.2×10^8	1.8×10
1000	1.7	1.0×10^7	1.7×10^7	6.5×10
1100	2.1	1.5×10^6	3.0×10^6	1.9×10^2
1200	2.5	2.7×10^5	6.95×10^5	4.9×10^3
1300	3.0	6.5×10^4	1.9×10^5	1.1×10^3
1400	3.4	1.8×10^4	6.1×10^4	2.2×10^3
1500	3.8	5.8×10^3	2.2×10^4	4.1×10^3
1600	4.2	2.1×10^3	9.0×10^3	7.1×10^3
1700	4.7	8.6×10^2	4.0×10^3	1.2×10^4
1800	5.1	3.8×10^2	1.9×10^3	...
1900	5.4	1.8×10^2	1.0×10^3	...
2000	5.8	9.2×10	5.4×10^2	...
2100	6.2	5.0×10	3.1×10^2	...
2200	6.6	2.8×10	1.8×10^2	...
2300	6.9	1.7×10	1.2×10^2	...
2400	7.3	1.0×10	7.5×10	...
2500	7.7	6.6	5.1×10	...
2600	8.1	4.3	3.5×10	...
2700	8.5	2.9	2.5×10	...
2800	8.9	2.0	1.8×10	...

* Composite values for coke, charcoal and amorphous carbon.

Example 1.—Recalculating the producer gas analysis used in Chapter II to include the moisture, we obtain

CO_2	C_2H_4	O_2	CO	H_2	CH_4	N_2	H_2O
2.9%	0.2%	0.2%	26.9%	11.5%	2.4%	52.1%	3.8%

Considering the gases entering directly into the water gas reaction, we find that the ratio

$$\frac{(\% \text{CO}) \times (\% \text{H}_2\text{O})}{(\% \text{CO}_2) \times (\% \text{H}_2)} = \frac{26.9 \times 3.8}{2.9 \times 11.5} = 3.1$$

Table XXIV shows that if the temperature of the producer gas is 1400° F. (760° C.) the ratio should be 0.8, showing that the gas mixture is certainly not in equilibrium at the producer outlet. If the gas is to be preheated by regeneration, it will tend towards an equilibrium composition, due to the greater velocity of reaction at high temperatures. Reactions due to decomposition of the hydrocarbons will be ignored here—the ethylene on account of its small quantity, and the methane on account of its relatively low speed of decomposition.

The problem is to find the equilibrium mixture of carbon monoxide, carbon dioxide, hydrogen and water vapour at a regeneration temperature of 2100° F. (1150° C.). Regarding the per cent. figures as numbers of molecules per hundred molecules of gas, the numbers of atoms of the reacting elements are :

Gas	Molecules	Atoms		
		C	H	O
CO ₂	2.9	2.9	...	5.8
O ₂	0.2	0.4
CO	26.9	26.9	...	26.9
H ₂	11.5	...	23	...
H ₂ O	3.8	...	7.6	3.8
Total	.	<u>29.8</u>	<u>30.6</u>	<u>36.9</u>

Suppose the final mixture to contain x molecules of carbon dioxide, then

$$\text{Carbon monoxide} = 29.8 - x$$

The amount of oxygen accounted for in the carbon dioxide and carbon monoxide is

$$2x + 29.8 - x = 29.8 + x \text{ atoms}$$

The number of unaccounted for oxygen atoms is

$$36.9 - (29.8 + x) = 7.1 - x$$

and this must equal the number of steam molecules.

The hydrogen atoms unaccounted for equals

$$30.6 - 2(7.1 - x) = 16.4 + 2x$$

These are present as $8.2 + x$ molecules of hydrogen.

For the water gas reaction there is no need to convert to partial pressures, and these expressions may be inserted directly in the

equation for K . At 2100° F. (1150° C.) we find from Table XXIV, K for the water gas reaction is 2.3, giving

$$2.3 = \frac{(29.8 - x)(7.1 - x)}{x(8.2 + x)}$$

This leads to a quadratic equation from which we find $x = 3.5$, whence

$$\begin{aligned} \text{CO}_2 &= 3.5\% \\ \text{CO} &= 29.8 - 3.5 = 26.3\% \\ \text{H}_2\text{O} &= 7.1 - 3.5 = 3.6\% \\ \text{H}_2 &= 8.2 + 3.5 = 11.7\% \end{aligned}$$

At 1300° F. (705° C.) the equilibrium composition is similarly found to be

$$\begin{aligned} \text{CO}_2 &= 5.3\% \\ \text{CO} &= 24.5\% \\ \text{H}_2\text{O} &= 1.8\% \\ \text{H}_2 &= 13.5\% \end{aligned}$$

Example 2.—A fuel oil flue gas sample is taken at a temperature of 1300° F. (705° C.). An Orsat analysis, combined with methods of calculation described in Chapter II, indicated the gas analysis (wet basis) to be

CO ₂	CO	N ₂	H ₂ O
10%	2%	77%	11%

This indicates a slight deficiency of air for combustion, and the calculated moisture content is based on the assumption that all the hydrogen is burnt and that the 2 per cent. CO represents the only loss of fuel. Yet our knowledge of equilibrium indicates that some hydrogen must also be present in such a gas mixture. The determination of small quantities of hydrogen by actual analysis is too troublesome to undertake as a matter of routine, so that hydrogen present is included in the nitrogen reported.

At 1300° F. (705° C.) $K = 0.6$, and if x is the per cent. of hydrogen present in the gas mixture,

$$0.6 = \frac{(\% \text{CO}) \times (\% \text{H}_2\text{O})}{(\% \text{CO}_2) \times (\% \text{H}_2)} = \frac{2 \times (11 - x)}{10 \times x}$$

giving $x = 2.75$.

The heat loss as unreported hydrogen may therefore be greater than the loss as carbon monoxide. At higher temperatures the

value of K is greater, and the carbon monoxide would exceed the hydrogen. In fact, due to failure of the mixture instantly to follow the shifting equilibrium at lower temperatures, it is probable that in the case assumed the mixture would correspond to the equilibrium mixture of a higher temperature, and that the hydrogen content would be less than calculated.

For a known waste gas composition with respect to carbon dioxide, water vapour and carbon monoxide, the hydrogen content corresponding to equilibrium at 1500° F. or 815° C. ($K = 1$) may be expressed by the equation,

$$(\%H_2) = (\%CO) \times \frac{(\%H_2O)}{(\%CO_2)}$$

Corresponding to equilibrium at 2000° F. (1090° C.), the per cent. of hydrogen would be half this amount.

Combustion of Carbon Monoxide and Hydrogen.—In Chapter II it was explained that in the combustion of fuels the “theoretical” flame temperature could in no circumstances be reached because the reaction,

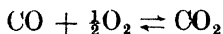

and the corresponding reaction for the combustion of hydrogen, are, at very high temperatures, by no means complete. For the carbon monoxide reaction,

$$K_p = \frac{p_{CO_2}}{p_{CO} \times \sqrt{p_{O_2}}}$$

In this reaction the numbers of molecules on the two sides of the equation are not the same—one and a half on the left, and one on the right. It is therefore not permissible to substitute per cent. composition directly for partial pressures. The per cent. composition must be converted to partial pressures according to Equation 22.

From the high values of K shown in Table XXIV, it is clear that at temperatures normally attainable either p_{CO} or p_{O_2} must be very small. With a theoretically exact mixture both will be small; with excess of oxygen, p_{CO} must be extremely small; or with the same excess of carbon monoxide, p_{O_2} would be even smaller.

For a given gas mixture at very high temperatures, it is possible to determine the final gas composition in a way similar to that used for the water gas reaction. This will lead to a cubic equation which may be solved by any of the usual rather tedious

methods, or which may frequently be simplified by disregarding addition or subtraction of any quantity known to be of a smaller order of magnitude than its companion.

Example.—Carbon has been burnt at atmospheric pressure with the theoretical air quantity necessary to produce only carbon dioxide and nitrogen. To determine the composition of the products of combustion at 4000° F. (2205° C.).

If combustion were perfect 100 mols. of air would yield 20.9 mols. of carbon dioxide and 79.1 mols. of nitrogen. At the given temperature, suppose x mols. of oxygen remain uncombined. It will be found that there must be $(20.9 - 2x)$ mols. of carbon dioxide and $2x$ mols. of carbon monoxide. The total volume of gas per 100 mols. of air is now $100 + x$. The equation is established from

$$K = \frac{p_{\text{CO}_2}}{p_{\text{CO}} \times \sqrt{p_{\text{O}_2}}}$$

$$\text{as } 27 = \frac{\frac{20.9 - 2x}{100 + x}}{\frac{2x}{100 + x} \times \sqrt{\frac{x}{100 + x}}}$$

or squaring and simplifying

$$730 = \frac{(20.9 - 2x)^2(100 + x)}{4x^3}$$

Solution shows that $x = 2.14$, giving a final gas composition of

$$\frac{20.9 - 2x}{100 + x} = 0.163, \text{ or } 16.3 \text{ per cent. } \text{CO}_2$$

$$\frac{2x}{100 + x} = 0.042, \text{ or } 4.2 \text{ per cent. } \text{CO}$$

$$\frac{x}{100 + x} = 0.021, \text{ or } 2.1 \text{ per cent. } \text{O}_2$$

$$\text{and } \frac{79.1}{100 + x} = 0.774, \text{ or } 77.4 \text{ per cent. } \text{N}_2$$

Total 100.0 per cent.

Checking,

$$\frac{p_{\text{CO}_2}}{p_{\text{CO}} \times \sqrt{p_{\text{O}_2}}} = \frac{0.163}{0.042 \times \sqrt{0.021}} = 27$$

The calculated compositions at different temperatures are shown below :

	2000° F. (1093° C.)	3000° F. (1649° C.)	4000° F. (2204° C.)	5000° F. (2760° C.)
%CO ₂ , . . .	20.8952	20.5	16.3	7.1
%CO, . . .	0.0032	0.36	4.2	12.5
%O ₂ , . . .	0.0016	0.18	2.1	6.25

As indicated in this table, at ordinary furnace temperatures the combustion of carbon monoxide (and also of hydrogen) proceeds almost to completion. Moreover, if there is a deficiency for theoretically perfect combustion of either oxygen or combustible gas, the increased demand for that gas will greatly decrease the amount remaining uncombined; and the mixture may then be regarded as consisting only of carbon

dioxide (or water vapour), nitrogen and the unused portion of the reacting gas which is in excess. Calculations of the type illustrated are therefore of very restricted value. The real importance of these equilibria will be apparent in the section on reduction and oxidation. Here the oxygen partial pressure, although very small in absolute value, becomes of great relative importance. Mathematical application in this connection is very simple.

The corresponding reaction for the combustion of hydrogen is

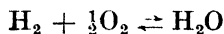

$$K_p = \frac{p_{\text{H}_2\text{O}}}{p_{\text{H}} \times \sqrt{p_{\text{O}_2}}}$$

Vapour Pressure.—It is well known that when air is enclosed over water, there is a certain amount of water vapour in the air. The partial pressure of this water vapour is called its vapour pressure. Provided that both air and liquid water are present in a state of equilibrium, for any given temperature this vapour or partial pressure is fixed, irrespective of the amount of water or the amount of air. If the air above the water were compressed, the temperature being kept constant, then part of the water vapour in the air would condense in order to maintain the original partial pressure.

In exactly the same way, not only other liquids such as molten metals, but also solids including carbon, metals, etc., exert vapour pressure. This means that a small quantity of the material evaporates until its partial pressure in the gases above the material has built up to a figure which is absolutely fixed for a given temperature. The actual extent of this evaporation is frequently of an extremely small order of magnitude, but is nevertheless important in this discussion. The partial pressure is independent of the amount of the solid or liquid material, and independent of the amount or absolute pressure of the gas.

Carbon and its Oxides.—The reaction between carbon and its oxides is of very great importance in gas making and in all reducing processes employing carbon or carbon monoxide. This reaction is written,

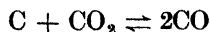

and the equilibrium constant for partial pressures may be written,

$$K' = \frac{p_{\text{CO}}^2}{p_{\text{C}} \times p_{\text{CO}_2}}$$

The constant referring to the gaseous phase, p_C , is the vapour pressure of carbon; and since this is constant for a given temperature so long as the gas mixture is in contact with solid carbon, p_C may be combined with K' , giving

$$K_p = \frac{p_{CO}^2}{p_{CO_2}}$$

Table XXIV shows that the value of K is low at temperatures below 1000° F. (540° C.) and high at temperatures above 1500° F. (815° C.), the shift in equilibrium being rather rapid.¹ It follows that below a dull red heat any equilibrium mixture of carbon monoxide and carbon dioxide can contain but little carbon monoxide in relation to the dioxide, while above a cherry red the converse is true (in contact with solid carbon).

Loosely, we may say that at low temperatures carbon dioxide is the more stable oxide, while at high temperatures carbon monoxide is more stable.

If, due to a fall of temperature, the equilibrium shifts from right to left, carbon monoxide will decompose and carbon will be deposited.

Combination of Chemical Equations.—It is permissible to add or subtract chemical equations representing possible reactions, and also to rearrange the terms in accordance with the laws governing algebraic equations. In illustration,

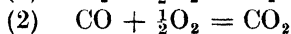
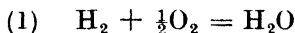

Subtract equation (2) from equation (1), and we get

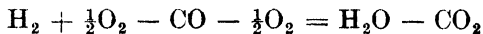

and rearranging the terms and cancelling,

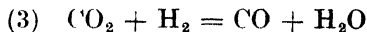

The equilibrium constants (using partial pressures) for equations (1) and (2) are

$$K_1 = \frac{p_{H_2O}}{p_{H_2} \times \sqrt{p_{O_2}}} \quad \text{and} \quad K_2 = \frac{p_{CO_2}}{p_{CO} \times \sqrt{p_{O_2}}} \quad \text{respectively.}$$

¹ The major shift in equilibrium occurs where K changes from a value denoted by a 10^{-3} or 10^{-1} factor to values greater than unity. As, in this case, the change occurs over a narrow temperature range, the shift must be rapid.

If we divide K_1 by K_2 we get

$$\frac{p_{\text{H}_2\text{O}}}{p_{\text{H}_2} \times \sqrt{p_{\text{O}_2}}} \div \frac{p_{\text{CO}_2}}{p_{\text{CO}} \times \sqrt{p_{\text{O}_2}}} = \frac{p_{\text{H}_2\text{O}}}{p_{\text{H}_2} \times \sqrt{p_{\text{O}_2}}} \times \frac{p_{\text{CO}} \times \sqrt{p_{\text{O}_2}}}{p_{\text{CO}_2}}$$

$$= \frac{p_{\text{CO}} \times p_{\text{H}_2\text{O}}}{p_{\text{CO}_2} \times p_{\text{H}_2}}$$

which equals K_3 , the equilibrium constant for reaction (3). It will be found that the values for the water gas constant in Table XXIV are the quotient of the hydrogen constant divided by the carbon monoxide constant.

This method is quite general and we conclude that

(a) if two equations be added, the equilibrium constant of the resulting equation is the product of the constants for the two equations,

(b) if an equation A be subtracted from another equation B , the equilibrium constant is obtained by dividing the constant for B by that for A ,

(c) if either equation is multiplied by a number n before making the addition or subtraction, the equilibrium constant of that equation must be raised to the power n before multiplying or dividing the constants.

These rules may be used when the equilibrium constant is not directly available for a particular reaction, but when the equation may be derived by addition or subtraction of equations for which constants are available.

Le Chatelier's Principle.—It is frequently useful to determine, without recourse to mathematical methods, what effect a change of conditions will produce in a balanced system. Le Chatelier's rule tells us that if, by a shift in the equilibrium, a system can tend to nullify an imposed change in conditions, it will do so. The three conditions which may change are temperature, pressure and composition.

1. *Change of Temperature.*—If a mixture of carbon monoxide, oxygen and carbon dioxide be in equilibrium at a certain temperature, any shift in the equilibrium with a rise of temperature must be in a direction which will tend to cool the mixture, permitting partial escape from the imposed effect. Dissociation of carbon dioxide is strongly endothermic, therefore some carbon dioxide will decompose in an effort to combat the rise of temperature. This conclusion is consistent with calculations shown on page 456.

A rise of temperature always produces a shift in equilibrium favouring the endothermic direction of reaction. If the reduction of an ore by a reducing agent is endothermic,¹ the higher the temperature the more complete will be the reduction; if the reduction is exothermic, a lower operating temperature will favour complete reduction provided that the time is sufficient for approach to a condition of equilibrium. Oxidation of phosphorus from steel by iron oxide is exothermic—it proceeds most completely at a moderately low temperature. Oxidation of carbon from steel by iron oxide is endothermic—the manufacture of very low carbon steel requires a high temperature.

2. *Change of Pressure.*—If an increase be made in the pressure of a mixture of carbon monoxide and carbon dioxide in contact with solid carbon, the system will tend to escape from the extra pressure by a contraction in normal volume according to the equation,

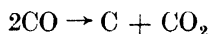

two volumes of carbon monoxide yielding only one of carbon dioxide plus a negligible volume of deposited solid carbon.

In the water gas reaction,



a shift in equilibrium is not accompanied by change of volume, there being the same number of molecules on each side of the equation. The system therefore cannot readjust itself to escape from a pressure change, and pressure has no effect whatever on the equilibrium.

3. *Change of Composition.*—It hardly requires Le Chatelier's principle to tell us that if any constituent of a reaction be added, the reaction, conforming with the law of mass action, will shift in the direction away from the added constituent, tending to decrease the increment of that constituent.

If a homogeneous phase be diluted with an inactive substance the reaction will shift to give, if possible, a greater quantity of the active compounds, thus opposing the dilution. If the reaction is represented by an equation showing on each side the same number of molecules in the homogeneous phase, then there can be no escape

¹ According to Kirchhoff's Law (p. 440) it is possible for a reaction which is endothermic at atmospheric temperature to become exothermic at higher temperatures, and vice versa. In applying Le Chatelier's principle to the few important reactions which so change, it is necessary to consider the nature of the reaction at the actual temperature under review—not that at ordinary temperatures

from the dilution, and the equilibrium will not be affected. If the equation shows a greater number of molecules on one side, then the equilibrium will shift towards that side.

II.—VELOCITY OF REACTION.

Calculated values of the equilibrium composition of a mixture assume that sufficient time has been allowed for realisation of a steady condition. In certain metallurgical operations such a condition may be approximately attained; in others a contact may extend over a few seconds or a mere fraction of a second, rendering even an approximation to equilibrium frequently unattainable.

A study of the laws governing velocity of reaction will indicate what conditions will assist in forcing an intrinsically slow reaction towards a desired conclusion.

For the general equation,

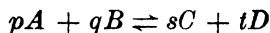

it has been explained that, whether equilibrium exists or not the reaction is proceeding simultaneously in both directions. The velocity from left to right is given by

$$V_1 = k_1 \times [A]^p \times [B]^q$$

and from right to left by

$$V_2 = k_2 \times [C]^s \times [D]^t$$

k_1 and k_2 being velocity constants of the opposing reactions. It was further explained that at equilibrium

$$V_1 = V_2, \text{ from which } \frac{k_1}{k_2} = \frac{[C]^s \times [D]^t}{[A]^p \times [B]^q}$$

The ratio $\frac{k_1}{k_2}$ was represented by the equilibrium constant K , which does not require a knowledge of the absolute values of k_1 and k_2 .

On the other hand, if equilibrium is not reached, the net velocity of the reaction from left to right is expressed by

$$\begin{aligned} \text{Net velocity} &= V_1 - V_2 \\ &= k_1[A]^p[B]^q - k_2[C]^s[D]^t \end{aligned}$$

To determine this velocity, the absolute values of k_1 and k_2 must be known, as well as the composition of the mixture at a particular moment. The equilibrium constant K is usually known for a particular reaction, and since $K = \frac{k_1}{k_2}$, knowledge of either of these velocity constants implies knowledge of the other. Calculation of the extent to which a reaction will have proceeded in a given time requires knowledge of k_1 and k_2 , and even then presents a problem which cannot be solved by simple algebraic methods.

Exceptionally Rapid Reactions.—Reactions involving combustion of gaseous fuels proceed, in general, with extreme rapidity. If a mixture of hydrogen and oxygen could be heated uniformly to its ignition temperature, combustion would be almost instantaneous—much faster than combustion by ignition at a single point, since the latter is dependent on the speed of flame propagation. In this and similar reactions, the question of velocity does not enter into the problem, and equilibrium conditions may be assumed, no matter how short the contact time. Perfect pre-mixing of the reacting gases must be stipulated.

Reactions in Heterogeneous Mixtures.—Certain reactions may be presumed from chemical considerations to belong inherently to the class just described; but the velocity may be checked by a purely physical restriction. In its affinity for oxygen, carbon is comparable with hydrogen. That it can combine with oxygen very rapidly is shown in the combustion of powdered coal fuel. When carbon in lump form is burnt, combustion is very much slower, on account of the very imperfect mixing of the reacting substances. Oxygen coming in contact with hot carbon will naturally combine almost instantly; but contact of fresh oxygen with carbon is dependent on mixing of the gases by eddying in the fuel bed—mixing by diffusion would be even slower. Diffusion of gases into and through the fuel, particularly if coke or charcoal, will greatly increase the rate of combustion. Oxygen so diffusing will escape combined with excess of carbon as carbon monoxide, and this will burn on subsequent mixing with unused oxygen.

In a certain iron melting cupola operating on unusually long runs, difficulty was experienced on account of freezing of slag above the tuyères and gradual throttling of the effective shaft diameter. The trouble was due to delayed combustion owing to poor surface contact between coke and blast, resulting in a cool zone beneath the slag ring accretion. The difficulty was wholly avoidable by using a smaller size of coke, thus presenting a bigger

contact surface, securing earlier combustion, and maintaining a higher temperature in the neighbourhood of the tuyères.

The chemical reaction

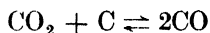

is usually associated with the combustion of carbon in a fuel bed. Unlike the case of direct combustion, this cannot be classed at moderate temperatures as an exceptionally rapid reaction. The actual velocity of chemical reaction is therefore likely to be the dominant factor instead of the conditions of surface contact. On the other hand, the speed of probably all chemical reactions increases very rapidly with increasing temperature, so that at very high temperatures the surface effect may again become the controlling factor.

Speed of reaction between slag and metal may be governed largely by area of contact and speed of diffusion, these in turn being controlled by factors such as agitation of the bath, viscosity, and temperature.

It is important to note that while k_1 and k_2 are constants for a given reaction, the velocity of reaction varies with the proportions of the reacting substances, and the greater the deviation from a state of equilibrium, the faster the reaction. This is continually made use of in practice. For example, if impurities are to be oxidised from a metal in a refining process, this could be effected by holding the slag very slightly oxidising; but this might require considerable time. By making the slag highly oxidising, the driving force is increased and the reaction proceeds much more rapidly. Similarly, in the reduction of an ore, the rate of reaction will be increased by more highly reducing conditions.

MAKING OF PRODUCER GAS.

One of the most valuable of research contributions concerning the influence of velocity of reaction on industrial processes is to be found in Bulletin 7 of the Bureau of Mines on "Essential Factors in the Formation of Producer Gas," by J. K. Clement, L. H. Adams and C. N. Haskins. Some of the findings are given in this section.

Carbon dioxide was passed over different forms of carbon of uniform size at various temperatures and various rates of flow.

The gas formed was analysed to determine the degree of conversion to carbon monoxide according to the equation,

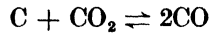

From the results, equations were derived for the constants of forward and reverse velocities, k_1 and k_2 respectively. The calculated values for k_1 and k_2 could then be used to calculate the gas composition after a given time at any temperature. The values were applied mathematically to the practical problem of determining the per cent. of carbon monoxide attainable by blowing air through a coke bed, at varying temperatures, for various times of contact between gases and fuel. The calculated carbon monoxide content of gas obtained by blowing dry air through coke is shown for selected temperatures and times of contact in the accompanying table.

CALCULATED CARBON MONOXIDE CONTENT.

Time of Contact.	Temperature.			
	1832° F. (1000° C.)	2192° F. (1200° C.)	2372° F. (1300° C.)	2552° F. (1400° C.)
0.1 sec., . . .	Under 1%	1	4	9
0.2 " . . .	"	2	6	15
0.5 " . . .	"	5	13	26
1, . . .	"	8	22	33
2, . . .	1	15	29	34
20, . . .	9	34	34.5	34.5
Infinite, . . .	33	34.5	34.5	34.5

The carbon dioxide content of the gas dropped from 21 per cent. to a mere trace, as the carbon monoxide increased from zero to its maximum value of about 34.5 per cent. The figures in the last row for infinite time of contact show the approximate composition under equilibrium conditions. It is noticeable that in the range above 1832° F. (1000° C.) the equilibrium composition shows practically no change with temperature. The importance of reaction velocity is well illustrated by considering the values for 2 second contact and the rapid rise with temperature of the carbon monoxide from a negligible quantity at 1000° C. to the near-equilibrium composition at 1400° C.

It is concluded from the experiments and calculations, as illustrated in the above table, that for the relatively short contact time usual in gas producer practice, a hot zone temperature in

the neighbourhood of 2372° F. (1300° C.) is desirable. The shorter the time of contact the more important it becomes to maintain the highest practicable temperature. It is the great speed of reaction at high temperatures which permits the high rate of gasification obtainable in slagging producers.

Change of Reaction Velocity with Temperature.—The observed forward velocity constant, k_1 ,¹ found for coke is given in the following table :

	1652° F. (900° C.)	1832° F. (1000° C.)	2012° F. (1100° C.)	2192° F. (1200° C.)	2372° F. (1300° C.)
k_1	0.00231	0.02323	0.1335	0.4095	1.483
Relative increase	—	10.1	5.7	3.1	3.6

The last row of the table shows how many times the value of k_1 has increased as compared with its value for the temperature 180° F. (100° C.) lower. The figures illustrate the general rule that the lower the temperature the greater will be the probable relative increase in the velocity constant with rise of temperature. Chemical reactions proceeding at measurable velocity at ordinary temperatures may show many thousandfold increase in rate for a 180° F. (100° C.) temperature rise. On the other hand, the absolute increase in rate is likely to be greater at higher temperatures, as typified by the actual figures for k_1 .

Application of Experimental Values to Producer Practice.—In applying the research to gas producer operation there are several factors to be borne in mind. When coal is charged into a producer, moisture and volatile matter are driven off in the upper or green zone. As the coal travels down, the more or less weak coke formed by distillation is heated by the rising gases to the temperature of the hot active zone ; below this is the cool ash zone. The three zones are fairly well marked and the extent and approximate temperature of the hot zone may be found by driving a poker through the bed from a poking hole, and withdrawing it when it has had time to reach the temperature of the bed.

When dry air passes up through the ash bed, at the lower edge of the fuel bed the oxygen will be converted mainly to carbon dioxide rather than to carbon monoxide, owing to the excess of oxygen at this point and to the imperfect contact between gas and coke. The heat generated will be carried up as sensible heat

¹ The values of k_1 related to concentration measured in gram-molecules per litre. The trend of the values is well expressed by the figures taken from the table, and the actual units used are of small importance.

by the gases, maintaining the temperature of the carbon monoxide forming zone and supplying the heat of the endothermic reaction,



The rising gas mixture, now consisting mainly of nitrogen and carbon monoxide, will transfer heat to the fuel in the distillation zone, and the final gas temperature will be further lowered by admixture with cool distillation products.

It is evident that the two important variables, temperature and time of contact in the hot zone, can, for practical reasons, be varied only within limits.

Temperature.—Over ordinary operating ranges, the curves shown in Bulletin 7 suggest that temperature is likely to be a more important factor than time of contact, raising the temperature 90° F. (50° C.) producing more or less the same effect as doubling the time of contact. When operating cold, there is an increase in the relative importance of temperature as compared with time.

Practical considerations determine the highest acceptable temperature. Serious clinkering of the ash must be checked by admitting steam with the blast. The permissible temperature is determined by the composition and quantity of ash, and by the type of producer.

Another reason for using steam with the blast is to convert some of the sensible heat of the escaping gases into chemical heat, by the endothermic formation of hydrogen and carbon monoxide from steam and carbon. The velocity of this reaction was studied by Clement and Adams, and a summary of their conclusions is given later.

Time of Contact.—The time of contact may be taken as,

$$t = \frac{h}{V} \times \frac{\%}{100}$$

where t is measured in seconds, h is the depth in feet of the hot zone, V is the rate of flow in cubic feet per second per square foot of cross section at the actual temperature of the zone, and % denotes the per cent. of free space between the pieces of coke.

In actual fact, it does not appear that the contact time is very much under control for a given rate of flow and temperature and a sufficient total fuel depth. The cooling of the coke bed from its maximum temperature to a temperature at which reaction becomes quite slow (probably not much over 1800° F. or 1000° C.)

¹ From graphitic carbon—the value from amorphous carbon is 67,320 B.Th.U.'s.

is due principally to the endothermic solution of solid carbon by carbon dioxide, which is the function of this zone. Unless the fuel depth is abnormally shallow, it appears that this will be accomplished irrespective of the relative compactness of the charge. The only difference is that a very compact charge will cause a higher actual velocity through the bed, a lower rate of carbon monoxide formation per inch of height, a lower cooling rate of the bed, and therefore a greater depth of hot zone, thus compensating for the shorter contact time per inch of height. An adequate depth to ensure proper preheating of the fuel and even distribution through the bed are presupposed.

Rate of Blowing.—With increased speed of gasification, provided uniformity of distribution can be maintained, temperature should still be the controlling factor in gas quality. The temperature being kept the same, the thickness of the hot zone would vary in proportion to the blast volume—disregarding changes in the porosity of the bed due to different blowing rates.

Nature of the Coke.—Clement, Adams and Haskins carried out separate sets of experiments using charcoal, coke and anthracite. For corresponding temperatures, the velocity of reaction using charcoal was very much greater than for coke, and coke in turn showed greater reactivity than anthracite. Except at very low gas velocities the results obtainable with charcoal are comparable with those for coke at a temperature about 400° F. (220° C.) higher. The friable coke obtained from most gas coals is likely to be more reactive than true coke, and this is to be taken into account in applying the experimental findings to operating conditions.

In the experiments, the authors used sized particles of about 0.2 inch diameter. They concluded from their results that the reaction is, over the experimental range, not governed by factors influencing the rate of mixing of the reacting gases, but by the velocity of chemical reaction. Assuming then that the rate of chemical reaction is intrinsically so slow that improved contact can have practically no effect, it should follow that in the absence of channelling the size of the coke particles in a producer will not affect the results or cause them to differ materially from the experimental values.

Effect of Cooling the Gas.—From a curve in Bulletin 7, the following approximate equilibrium compositions are read for dry air passed through coke :

Temperature	600° C.	700° C.	800° C.	900° C.	1000° C.	1100° C.
CO	6%	13%	25%	31%	33%	34.5%

Given sufficient time, a rich carbon monoxide mixture when cooled must revert to the composition corresponding to equilibrium at its final temperature. At high and moderately high temperatures, the reverse velocity of reaction is, however, even slower than the forward velocity, so that it is quite safe to assume that the mixture attained in the high temperature zone of a gas producer will not deteriorate by subsequent decomposition of carbon monoxide at lower temperatures.

Boiler Furnaces.—The authors of the bulletin concluded that to minimise carbon monoxide formation in boiler furnaces, the fuel bed should be thin, and that increased velocity should decrease the percentage of carbon monoxide formed.

Water Gas Generation.—In their experimental investigations, Clement and Adams passed steam over carbon in an apparatus similar to that used for passing carbon dioxide over carbon. At the temperature of the hot zone of a gas producer, the reaction,



proceeds almost to completion in the left to right direction if given sufficient time. Under the same conditions the analogous reaction,



also proceeds almost to completion.

It has been explained that the $\text{C} + \text{CO}_2$ reaction does not, in practice, reach its equilibrium condition owing to the short contact time, and that some carbon dioxide remains unchanged in the final gas. Similarly the $\text{C} + \text{H}_2\text{O}$ reaction does not have time to achieve completion, and some steam gets through unchanged. Since steam in the mixture will react with carbon monoxide according to the water gas equation,



the gas mixture must contain carbon dioxide also. The gas obtained by blowing steam through incandescent carbon consists therefore of a mixture of carbon monoxide, carbon dioxide, hydrogen and steam.¹

The experimental results closely parallel those for the carbon and carbon dioxide reaction. It is difficult to quote, concisely, values illustrating the effects of time and temperature, because of the greater number of variables to be expressed. Figure 16,

¹ This conclusion may be arrived at by various arrangements of equations, but the actual mechanism does not affect the present discussion.

of the paper quoted, shows that for a contact time of two seconds the percentage of steam decomposed increases from about 13 per cent. at 1832° F. (1000° C.) to about 91 per cent. at 2372° F. (1300° C.). The gases formed in this range are mainly carbon monoxide and hydrogen, with carbon dioxide decreasing from 10 per cent. of the dry gas volume at 1000° C. to 0.3 per cent. at 1300° C.

Application of the Steam Equilibrium Constant to Gas Producer Practice.—In the experiments, the carbon was maintained artificially at the desired temperature. In practice, the endothermic decomposition of steam will cool the fuel bed, and the temperature of the latter is regulated by the quantity of steam used. The quantity of steam is in turn commonly ascertained by the blast saturation temperature, which is the temperature of the air and steam after mixing. Some blast saturation temperatures and the per cent. by volume of steam based on the dry air volume are :

Temperature	100° F.	110° F.	120° F.	130° F.	140° F.	150° F.	160° F.
Per cent. water vapour } water vapour }	6.9	9.5	13.0	17.8	24.5	33.9	47.6

The blast will ordinarily contain slightly more moisture than indicated, on account of condensed water carried in addition to water vapour.

In an investigation on an actual producer, made prior to the laboratory research cited, Bone and Wheeler¹ concluded that for furnace purposes the best saturation temperature is about 122° F. (50° C.). This figure has met with general acceptance by furnace men, excepting where a higher steam saturation temperature is necessary to check clinkering. With higher blast temperatures, *i.e.* with a bigger proportion of steam, the cooler bed causes increase in carbon dioxide at the expense of carbon monoxide and increase in the percentage of unchanged steam; this more than offsets the value of the increased hydrogen content of the gas.

For the effect of the per cent. of steam on the *equilibrium* composition of producer gas, assuming certain ideal conditions, see calculations by G. A. Goff in *Industrial and Engineering Chemistry*, vol. 18, No. 6, p. 585.

The Water Gas Reaction.—It has been intimated that the amount of water vapour in producer gas is ordinarily greatly in excess of the equilibrium quantity for the water gas reaction,

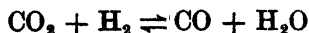

¹ Bone, W. A., and Wheeler, R. V. : *Journal of the Iron and Steel Institute*, 1907, No. 1, p. 126; 1908, No. 2, p. 206.

The moisture in producer gas is attributable partly to free and combined water in the coal and partly to undecomposed steam from the blast. The water from the coal, both combined and uncombined, is driven off from the upper layers of the coal bed at a low temperature, when chemical reactions of the type here considered are certainly so slow as to be negligible. Similarly, much of the hydrogen from the volatile matter of the coal is driven off at a comparatively low temperature. It is therefore not surprising that the producer gas composition does not conform with the water gas equilibrium. Under moderately favourable conditions, the water gas reaction approaches an equilibrium condition rather rapidly.

Velocity of Reaction and Le Chatelier's Principle.—Le Chatelier's principle may show which way the equilibrium of a reaction will move with a change of temperature; it gives no indication of velocity of reaction. For example, Le Chatelier's principle may indicate that, for equilibrium, a reaction must be the more complete the lower the temperature; but a lower temperature implies a lower velocity of reaction, and it is quite possible that in a limited time the extent to which such a reaction proceeds may be less at the lower temperature. This is particularly true where the rate of reaction is relatively slow.

If Le Chatelier's principle indicates a greater degree of completion for equilibrium at a higher temperature, then the shift demanded will produce an additional accelerating effect on the usual increase of velocity of reaction with rising temperature.

Catalysis.—Certain substances, while not apparently entering into chemical combination with the active substances of a reversible reaction, have the property of very greatly influencing the velocity constants of reaction, k_1 and k_2 . Such substances are called catalysts, and the phenomenon is called catalysis. Catalysis does not affect the final equilibrium of a system, but only influences the rate of approach to the stable condition.

An important example of catalysis in metallurgical work is afforded by the action of iron on the reaction,

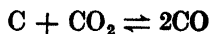

It has been shown that as the temperature falls below a red heat, equilibrium of this reaction requires a pronounced shift towards the left hand direction of the equation. It has also been shown that with falling temperature there is a rapid decline in the velocity of reaction, or more accurately the values of the velocity constants,

k_1 and k_2 . Ordinarily, at low temperatures the rate of reaction is so small as to be negligible. Iron, particularly if in a spongy form, acts as a powerful catalyst, causing this reaction to proceed actively at comparatively low temperatures. In the blast furnace, reduced spongy iron promotes "carbon transfer" from gas to metal according to the right to left direction of the equation; this produces carburisation of the metal, and also results in a lower CO/CO₂ ratio in the blast furnace gas, with corresponding coke economy. Reference has been made to the deleterious effect of this same catalytic action on firebrick under certain conditions. Other metals of the iron group exert a similar catalytic effect on this reaction.

Another reaction in which iron is an active catalyst is the decomposition of methane according to the equation,

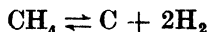

At low temperatures, equilibrium demands a high percentage of methane, but a rapid shift occurs at higher temperatures, resulting in deposition of carbon black and formation of hydrogen—this decomposition is largely reponsible for the luminosity of flames. Like the carbon monoxide reaction, the methane reaction is ordinarily sluggish except at high temperatures. There should be considerable direct formation of methane in the gas producer according to equilibrium considerations, while actually there is very little, most of the methane in the gas coming from the volatile matter of the coal. Again it is possible to preheat methane to fairly high temperatures with a degree of decomposition falling very much short of the equilibrium value. Metals of the iron group have a strong catalytic effect on this reaction, accelerating formation of methane at low temperatures and decomposition at high temperatures.

It may be noted that if a catalyst increases the forward constant of reaction, k_1 , for a particular temperature, it must also increase the reverse constant, k_2 , in the same ratio. This follows directly from the fact that k_1/k_2 must have a constant value—that of the equilibrium constant, K .

Catalysis may occur in homogeneous systems, or, as in the cases considered, in heterogeneous systems. While most of the important catalysts accelerate reaction, some retard the rate of reaction. Catalysts may lose their efficacy due to the action of impurities developed in the course of reaction; they may also have their catalytic powers either intensified or diminished by

the action of other substances. The nature of the surface of a solid catalyst greatly affects its activity, surfaces of a spongy or highly porous texture being most active.

III.—OXIDATION AND REDUCTION.

The purpose of this section is to show how to calculate the requirements

- (1) for the reduction of an oxide,
 - (2) to avoid oxidation of a metal;
- and (3) to indicate how the methods of calculation may be extended to reactions with elements other than oxygen.

When a base metal is heated in the air or in oxygen, an oxide is formed. This being theoretically an incomplete reaction, it follows that if an oxide is heated in a neutral atmosphere there must be some decomposition into oxygen and metal, although with most metallic oxides the degree of decomposition is immeasurably small. If a system consisting of a metal and its oxide in contact with an inert gaseous phase be heated to a definite temperature, liberation of oxygen from the oxide will proceed until a definite oxygen partial pressure has been established in the space above the oxide.

Oxygen Decomposition Pressure.—The oxygen partial pressure built up as described is called the oxygen decomposition or dissociation pressure of the oxide.

Actually, the decomposition pressure is an equilibrium constant, using partial pressures for the gaseous phase. Consider, for example, the reaction,

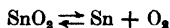

The gas phase will contain traces of tin oxide vapour, tin vapour and oxygen, and the equilibrium constant for the gaseous phase may be written,

$$K_p' = \frac{p_{\text{Sn}} \times p_{\text{O}_2}}{p_{\text{SnO}_2}}$$

Assuming the presence of metallic tin and stannic oxide as separate phases, p_{Sn} and p_{SnO_2} must be constant for a given temperature. They may therefore be incorporated in the constant K_p' , giving

$$K_p = p_{\text{O}_2}$$

It is assumed that neither the metal nor its oxide is sufficiently volatile to cause any major change in gas composition.

K_p or p_{O_2} having been determined directly or indirectly over some temperature range, it is possible to calculate the value for any other temperature

If the trace of oxygen formed spontaneously could be removed as fast as it is liberated from the oxide, decomposition would continue in an effort to build up the natural oxygen pressure until the oxide was all decomposed, leaving the metal. It is not practically possible to remove the oxygen mechanically; but if a gaseous reducing agent such as hydrogen or carbon monoxide be present at a high enough temperature, it will combine with the oxygen and so destroy the oxygen pressure with exactly the same result. Here, then, we have at least one aspect of the mechanism of the process familiar to us under the name "reduction."

As reduction proceeds, the amounts of carbon dioxide or water vapour in the products of reaction will increase. Now since both carbon dioxide and water vapour show slight dissociation, yielding traces of oxygen, it follows that when these gases reach a certain concentration, the oxygen pressure of the gas mixture may, and usually does, build up until the dissociation pressure of the metallic oxide is reached. Reduction of the oxide then ceases. Conversely a metal will be oxidised if the oxygen partial pressure of the gaseous phase exceeds the decomposition pressure of the metallic oxide, oxidation ceasing when the two pressures balance.

This section is largely devoted to determination of the actual proportions of oxidising and reducing gases which will neither oxidise nor reduce. A mixture on one side of this critical composition will effect reduction of an oxide, and on the other side will effect oxidation of a metal.

Since reduction of a metallic oxide phase depends on keeping the oxygen partial pressure of the reducing gases, usually containing carbon monoxide or hydrogen, below the oxygen dissociation pressure of the oxide, calculation of the minimum reducing requirements demands a knowledge of

- (1) the oxygen decomposition pressure of the oxide, and
- (2) the oxygen partial pressure which may exist in equilibrium mixtures containing carbon monoxide and carbon dioxide, or hydrogen and steam.

Decomposition Pressure of Oxides.—Owing to the extreme smallness of the oxygen pressure exerted by most oxides at practically attainable temperatures, direct measurement of the decomposition pressure is out of the question.

In the case of iron oxide, very careful experiments have been made to determine the $\text{CO}_2 : \text{CO}$ and $\text{H}_2\text{O} : \text{H}_2$ ratios which will neither oxidise iron nor reduce iron oxide. From these, assuming the accuracy of the values given in Table XXIV for K_{CO_2} and

K_{H_2O} , it is possible to calculate the oxygen pressure of iron oxide. The values for ferrous oxide, including those obtained from some very recent investigations, are given in Table XXV.

For oxides of other metals, we are compelled to rely almost entirely on theoretical calculation. Such calculation is made possible by the Nernst Equation, provided that we have complete thermophysical and thermochemical data of all the substances entering into the reaction—in this case, the metal, oxygen, and the metallic oxide. Unfortunately these data are far from complete; and even granted the impeccability of the Nernst Equation, fairly dependable figures for the oxygen decomposition pressure can be made only after making a very careful study of available data. Such a study has been made¹ for zinc. In the manufacture of zinc, the oxide is reduced at a temperature higher than the boiling point of the metal. It follows that, in equilibrium under operating conditions, solid or liquid zinc cannot remain in contact with zinc oxide, and the oxygen decomposition pressure of zinc oxide, as previously defined,² has no meaning. Instead of the decomposition pressure, the equilibrium constant (interpolated from Maier's values) of the reaction,

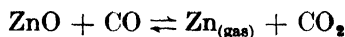

has been given in Table XXV.

Calculated oxygen pressures are given for cuprous oxide, litharge, and nickelous oxide. These values, due to Stahl,³ can hardly be considered dependable, since there has been much

¹ Maier, C. G. : "Zinc Smelting from a Chemical and Thermodynamic Viewpoint," *Bureau of Mines, Bulletin* 324, 1930.

² In speaking of the oxygen dissociation or decomposition pressure at a given temperature, we mean that pressure at which metal and oxide can co-exist as separate stable phases. In the absence of one of these two solid or liquid phases, the oxygen pressure of the system (i.e. the oxygen pressure of each of the phases present) is *not* equal to the oxygen decomposition pressure of the oxide. In such a system, the single solid or liquid phase must assume an oxygen pressure equal to the oxygen partial pressure of the gas phase.

Most metals in the liquid state are capable of dissolving limited quantities of their oxides, and the liquid oxides also dissolve some metal. In the solid state the solubilities are usually much lower. It will be shown in Section IV that this influences the vapour and decomposition pressures, and that complete reduction of oxide dissolved in metal is theoretically unattainable. This is disregarded in the present discussion; "metal" is understood to mean the metallic phase, with whatever oxide it may contain in solution; and "oxide" is understood to mean the oxide phase with its traces of dissolved metal.

³ Stahl, W. : *Metallurgie*, 4, p. 882 (1907).

TABLE XXV.—OXYGEN DECOMPOSITION PRESSURES.
A.—FAHRENHEIT.

Temperature	$2\text{FeO} \rightleftharpoons 2\text{Fe} + \text{O}_2$	$\text{ZnO} + \text{CO} \rightleftharpoons \text{Zn}_{\text{gas}} + \text{CO}_2$	$2\text{Cu}_2\text{O} \rightleftharpoons 4\text{Cu} + \text{O}_2$	$2\text{PbO} \rightleftharpoons 2\text{Pb} + \text{O}_2$	$2\text{NiO} \rightleftharpoons 2\text{Ni} + \text{O}_2$	Temperature
800°F.	...	$K^* = \frac{p_{\text{Zn}} \times p_{\text{CO}_2}}{p_{\text{CO}}}$ 1.3×10^{-8}	$p_{\text{Cu}_2\text{O}, \text{Cu}}$ $17. \times 10^{-20}$	$p_{\text{PbO}, \text{Pb}}$ $19. \times 10^{-18}$	$p_{\text{NiO}, \text{Ni}}$ $25. \times 10^{-32}$	800°F.
1000°F.	8.6×10^{-28}	1.2×10^{-6}	7.6×10^{-16}	$56. \times 10^{-22}$	4.8×10^{-26}	1000°F.
1200°F.	9.9×10^{-24}	3.5×10^{-5}	$42. \times 10^{-14}$	$12. \times 10^{-16}$	4.4×10^{-22}	1200°F.
1400°F.	1.6×10^{-20}	5.0×10^{-4}	$63. \times 10^{-12}$	$59. \times 10^{-16}$	$60. \times 10^{-20}$	1400°F.
1600°F.	6.1×10^{-18}	4.0×10^{-3}	$35. \times 10^{-10}$	$81. \times 10^{-14}$	2.0×10^{-16}	1600°F.
1800°F.	8.0×10^{-16}	2.2×10^{-2}	9.8×10^{-8}	$48. \times 10^{-12}$	2.5×10^{-14}	1800°F.
2000°F.	4.4×10^{-14}	9.2×10^{-2}	1.7×10^{-6}	$15. \times 10^{-10}$	1.4×10^{-12}	2000°F.
2200°F.	1.4×10^{-12}	3.1×10^{-1}	$18. \times 10^{-6}$	2.8×10^{-8}	$46. \times 10^{-12}$	2200°F.
2400°F.	$27. \times 10^{-12}$	8.7×10^{-1}	1.5×10^{-4}	$35. \times 10^{-8}$	9.2×10^{-10}	2400°F.
2600°F.	1.9×10^{-10}	2.1	8.9×10^{-4}	3.2×10^{-6}	1.2×10^{-8}	2600°F.
2800°F.	8.3×10^{-10}	4.6	$45. \times 10^{-4}$		$12. \times 10^{-8}$	2800°F.
3000°F.	...	9.1	1.8×10^{-2}		$90. \times 10^{-6}$	3000°F.
			B.—CENTIGRADE.			
400°C.	...	3.7×10^{-9}	1.7×10^{-20}	1.1×10^{-28}	$83. \times 10^{-34}$	400°C.
500°C.	...	3.1×10^{-7}	$58. \times 10^{-16}$	2.5×10^{-22}	$11. \times 10^{-28}$	500°C.
600°C.	$22. \times 10^{-26}$	9.2×10^{-6}	3.2×10^{-14}	$56. \times 10^{-20}$	$11. \times 10^{-24}$	600°C.
700°C.	3.7×10^{-22}	1.3×10^{-4}	4.8×10^{-12}	2.5×10^{-16}	1.4×10^{-20}	700°C.
800°C.	$15. \times 10^{-18}$	1.4×10^{-3}	4.5×10^{-10}	6.8×10^{-14}	$11. \times 10^{-18}$	800°C.
900°C.	$24. \times 10^{-18}$	6.5×10^{-2}	$88. \times 10^{-10}$	2.6×10^{-12}	7.9×10^{-16}	900°C.
1000°C.	$15. \times 10^{-16}$	2.9×10^{-2}	$16. \times 10^{-8}$	$88. \times 10^{-12}$	5.1×10^{-14}	1000°C.
1100°C.	5.8×10^{-14}	1.0×10^{-1}	2.0×10^{-6}	$18. \times 10^{-9}$	1.8×10^{-12}	1100°C.
1200°C.	1.3×10^{-13}	2.9×10^{-1}	$21. \times 10^{-6}$	2.5×10^{-8}	$41. \times 10^{-12}$	1200°C.
1300°C.	$19. \times 10^{-12}$	7.5×10^{-1}	1.1×10^{-4}	$25. \times 10^{-8}$	6.2×10^{-10}	1300°C.
1400°C.	1.3×10^{-10}	1.7	6.0×10^{-4}	1.9×10^{-6}	$66. \times 10^{-10}$	1400°C.
1500°C.	5.5×10^{-10}	2.9	$26. \times 10^{-4}$	$12. \times 10^{-6}$	5.6×10^{-8}	1500°C.
1600°C.	$(18. \times 10^{-10})$	6.8	$97. \times 10^{-4}$		$37. \times 10^{-8}$	1600°C.
1700°C.	...	$1.2 \cdot 10^1$	3.3×10^{-2}		2.2×10^{-6}	1700°C.

* For the reason stated on p. 474, an equilibrium constant is given for zinc reduction instead of the oxygen pressure.

change in the accepted values of thermophysical and thermochemical data since 1907. It may be presumed that values, recalculated in the light of more recent experimental data, will eventually be forthcoming.

Suffixes Used.—To distinguish the equilibrium constants for different reactions, a system of suffixes will be used. In every case the constant is for partial pressures so that suffix p is dropped and replaced by suffixes as follows :

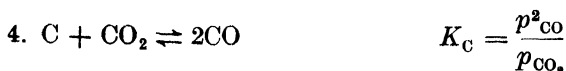
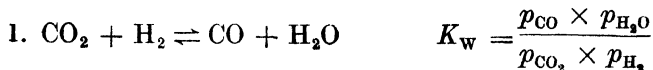

5. Oxide dissociation equations of the type :



meaning, the oxygen pressure of ferrous oxide in contact with iron as a separate phase.

Carbon Monoxide and Carbon Dioxide.—For the second of the above reactions, the equation for the equilibrium constant may be transformed to the form,

$$\frac{p_{\text{CO}_2}}{p_{\text{CO}}} = K_{\text{CO}_2} \sqrt{p_{\text{O}_2}}$$

$$\text{giving } \frac{\% \text{CO}_2}{\% \text{CO}} = K_{\text{CO}_2} \sqrt{p_{\text{O}_2}} \quad \cdot \quad \cdot \quad \cdot \quad (23)$$

For a given metallic oxide, the oxygen decomposition pressure at a particular temperature is known (Table XXV). If this decomposition pressure be substituted for p_{O_2} , the ratio indicated in Equation 23 will represent a gas mixture whose oxygen pressure is exactly equal to that of the oxide. A higher ratio, indicating a greater proportion of carbon dioxide to carbon monoxide, would oxidise the metal; a lower ratio, corresponding to a smaller proportion of carbon dioxide, would reduce the oxide.

To ascertain the neutral ratio, separating oxidising from reducing conditions, it is now necessary only to obtain the value for K_{CO_2} from Table XXIV.

Example 1.—It is required to find what the limiting $\frac{CO_2}{CO}$ ratio must be in the blast furnace at 2000° F. (1093° C.) to effect reduction of ferrous oxide (FeO).

At 2000° F. Table XXV shows that p_{O_2} for ferrous oxide is 4.4×10^{-14} and Table XXIV that K_{CO_2} is 1.6×10^6 . Substituting these values,

$$\begin{aligned} \frac{CO_2}{CO} &= K_{CO_2} \sqrt{p_{(FeO, Fe)}} \\ &= 1.6 \times 10^6 \sqrt{4.4 \times 10^{-14}} = 1.6 \times 10^6 \times 2.1 \times 10^{-7} \\ &= 0.34. \end{aligned}$$

Similarly, the ratios for other temperatures are:—

Temperature	{ 1000° F. (538° C.)	1400° F. (760° C.)	1800° F. (982° C.)	2200° F. (1204° C.)	2600° F. (1427° C.)
$\frac{CO_2}{CO}$ ratio,	1.23	0.63	0.42	0.30	0.18

The figures show that at relatively low temperatures a rather poor mixture will suffice to reduce ferrous oxide; but as the temperature increases a richer mixture is necessary.

At the higher temperatures of the blast furnace, the gases in contact with solid carbon would necessarily be much richer than the minimum requirement calculated above. (See Section II on producer gas).

Incidentally, for the lower temperatures at the top of the blast furnace, it would not be possible to get an *equilibrium* mixture rich enough in carbon monoxide to effect reduction of ferrous oxide.

Attention has been called to the sharp change below a cherry red heat in the equilibrium of a mixture containing carbon monoxide and carbon dioxide in contact with solid carbon. At low temperatures, under conditions favouring establishment of equilibrium, the carbon monoxide decomposes largely to carbon dioxide and carbon. Using the method of calculation shown above, we find that at 1112° F. (600° C.) reduction of ferrous oxide to iron requires a CO_2/CO ratio not exceeding 1.03. For the reaction

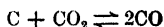

$$K_C = \frac{p_{CO}^2}{p_{CO_2}}$$

At the temperature under consideration, the low value for K_C , 6.2×10^{-8} indicates

a small equilibrium value for p_{CO} and a high value for p_{CO_2} . If the value for p_{CO_2} were 0.2 atmosphere, p_{CO} is calculated to be 0.11, giving a $\frac{\text{CO}_2}{\text{CO}}$ ratio of 1.8. A gaseous equilibrium mixture at atmospheric pressure could therefore contain 20 per cent. of carbon dioxide and only 11 per cent. of carbon monoxide. This gas would be oxidising to iron, since reduction at this temperature has been stated to require a ratio not exceeding 1.03. Extrapolation of the table shows that, at lower temperatures, an equilibrium mixture of carbon oxides becomes progressively more oxidising to iron.

Although theoretically, carbon monoxide should, at the temperature of the top of a blast furnace, decompose to yield a mixture oxidising to iron, the low velocity of this decomposition results in a top gas normally very high in carbon monoxide and therefore highly reducing.

In striking contrast to the high equilibrium $\frac{\text{CO}_2}{\text{CO}}$ ratio for gases in equilibrium with solid carbon below 1112° F. (600° C.), it is found that at 1832° F. (1000° C.), and for approximately the same oxygen content of the gases, the equilibrium ratio is 0.006. This is much lower (*i.e.* more reducing) than the requirement for reduction of ferrous oxide at that temperature. The high percentage of carbon monoxide maintained at elevated temperatures in gases in contact with carbon may, in certain cases, possibly be counted a disadvantage of this type of reducing system—the conditions may be so highly reducing as to be wasteful.

Example 2.—To investigate the feasibility of reducing silica by carbon monoxide at 2750° F. (1510° C.), given that $p_{\text{SiO}_2, \text{Si}}$ at this temperature is 10×10^{-16} .* Assuming that reduction is possible, the neutral composition is given by

$$\frac{\text{CO}_2}{\text{CO}} = K_{\text{CO}_2} \sqrt{p_{\text{SiO}_2, \text{Si}}}$$

By interpolation from Table XXIV, we find that at a temperature of 2750° F. (1510° C.),

$$K_{\text{CO}_2} = 5.4 \times 10^3$$

Substituting this value,

$$\begin{aligned} \frac{\text{CO}_2}{\text{CO}} &= 5.4 \times 10^3 \sqrt{10 \times 10^{-16}} = 5.4 \times 10^3 \times 3.2 \times 10^{-8} \\ &= 1.7 \times 10^{-4} \end{aligned}$$

The extreme smallness of this ratio indicates that, starting with a carbon monoxide mixture absolutely free from carbon dioxide, reduction would cease almost at its inception due to formation or the merest trace of carbon dioxide.

* The figure is an extremely rough estimate, and may be very far from the true figure. The example must therefore be regarded merely as an illustration of the application of decomposition pressure.

A process based on this reaction is so far from being feasible that it is really beside the point to inquire whether a CO_2/CO ratio as low as 1.7×10^{-4} could exist at 2750°F . (1510°C). In actual fact, at ordinary concentrations of carbon oxides in gases, it could exist.

A similar calculation for reduction of alumina by carbon monoxide would lead to the conclusion that a mixture as rich as indicated by calculation could not exist, and the mixture would deposit carbon according to the reaction,

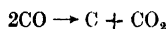

yielding a gas which is oxidising to aluminium. As corollaries, a gas containing carbon monoxide, with no measurable carbon dioxide, will oxidise aluminium; and aluminium will reduce carbon monoxide with formation of carbon and alumina.

Example 3.—To show the application of the zinc reduction equilibrium constant to zinc distillation.

In zinc smelting, zinc oxide is mixed with coal in a retort and heated until a maximum temperature of from 1200°C . to 1450°C . is reached. The zinc oxide is reduced to zinc, and the latter, which boils at 905.4°C ., distils over and is condensed. During the principal stages of the process, the only gases present in the retort are zinc, carbon monoxide, and a little carbon dioxide. If the carbon dioxide concentration exceeds a certain figure, zinc vapour may suffer oxidation; also, globules of zinc forming in the gas by condensation will be coated with an oxide film and will fail to coalesce, the resulting product being "blue powder" instead of spelter.

Certain relationships may be established from the conditions of formation of the distillation gases.

$$(i) \quad p_{\text{Zn}} + p_{\text{CO}} + p_{\text{CO}_2} = 1$$

This is an expression of the facts that zinc vapour, carbon monoxide and carbon dioxide are the only gases present in the retort, and that the sum of the three partial pressures must equal one atmosphere.

$$(ii) \quad p_{\text{Zn}} = p_{\text{CO}} + 2p_{\text{CO}_2}$$

This must be so, because the total number of oxygen atoms contained by the gases carbon monoxide and carbon dioxide must equal the number of atoms of zinc (one atom of zinc was associated with one atom of oxygen in the zinc oxide)—molecular concentration and partial pressures of the gases are proportional.

$$(iii) \quad \frac{p_{\text{Zn}} \times p_{\text{CO}_2}}{p_{\text{CO}}} = K$$

From equations (i) and (ii) we obtain

$$p_{\text{CO}} = \frac{1 - 3p_{\text{CO}_2}}{2}$$

$$\text{and } p_{\text{Zn}} = \frac{1 + p_{\text{CO}_2}}{2}$$

Substituting in equation (iii) and rearranging, we get

$$p_{\text{CO}_2} = \frac{\sqrt{(1 + 3K)^2 + 4K} - (1 + 3K)}{2}$$

Substituting the values for K at different temperatures and calculating, values are obtained as follows:—

	1500° C.	1400° C.	1300° C.	1200° C.	1100° C.	1000° C.	905.4° C.
p_{CO_2} .	.29	.27	.215	.145	.073	.026	.0072
p_{CO} .	.065	.10	.175	.285	.39	.46	.49
p_{Zn} .	.645	.63	.61	.57	.54	.51	.50
%CO ₂ * .	81.7	73.0	55.1	33.7	15.8	5.3	1.4

It appears from the above figures that, although it would be possible to reduce zinc oxide with production of gas relatively high in carbon dioxide, yet with such a gas, reoxidation of zinc vapour would certainly take place as the temperature fell in the cooler part of the retort. According to the figures, the gases should not contain more than 1.4 per cent. of carbon dioxide. It is, however, necessary to investigate a little further. Although zinc does not boil below 905.4° C. at atmospheric pressure, yet at lower temperatures the gases may still contain much zinc vapour, just as air below 100° C. can still hold much water in true vapour form. Also, in the presence of other gases, the partial pressure of the zinc vapour will be less than one atmosphere, so that condensation of zinc vapour will not commence until the temperature falls appreciably below the normal boiling point. This vapour is still subject to oxidation. Moreover, particles of zinc which have condensed to a mist but which have not yet separated and coalesced may still be converted to unwanted "blue powder." In this temperature range below the boiling point, equation (ii) no longer holds, due to condensation of part of the zinc. However, in this temperature range p_{Zn} , in contact with

* Based on CO + CO₂, after condensation of Zn.

some condensed liquid zinc, is known, so that we have the following solution :

$$(i) \quad p_{Zn} + p_{CO} + p_{CO_2} = 1, \quad \therefore p_{CO} = 1 - (p_{CO_2} + p_{Zn})$$

$$(iii) \quad \frac{p_{Zn} \times p_{CO_2}}{p_{CO}} = K$$

Combining these two equations,

$$p_{CO_2} = \frac{K(1 - p_{Zn})}{K + p_{Zn}}$$

The values obtained are :

	900° C.*	800° C.	700° C.	600° C.	500° C.
p_{Zn}^*	. (·503)	·309	·0788	·0145	·00167
p_{CO_2}	. (·0063)	·0031	·0015	·0006	·0002
p_{CO}	. (·491)	·688	·9197	·9849	·9981
%CO ₂	1·27	·45	·16	·06	·02

It is evident from the figures that, in order to avoid extensive oxidation of zinc prior to condensation, the carbon dioxide content of the gases must be less than 1 per cent. Unless the carbon dioxide can be kept to a mere trace, some oxidation will occur in the low temperature range due to traces of zinc vapour in the gas (seen from the partial pressures to be still 1·45 per cent. of the gas volume at 600° C.), and to the mist of condensed but undeposited particles of zinc carried by the gases.

At the high temperature prevailing in the retort, the equilibrium of carbon and its oxides makes it possible to achieve the very low carbon dioxide concentration necessary for a high recovery of metallic zinc. The rapid shift of the equilibrium at lower temperature in the direction,

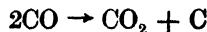

should result in a mixture which is oxidising to zinc in the condensing range. Possibly the low reaction velocity prevents much damage due to this shift.

* Zinc partial pressure in contact with liquid zinc given by Maier, *loc. cit.* ; under the conditions of distillation there will be no zinc condensation above 850° C. The 900° C. values are therefore calculated on the same basis as for temperatures above the melting point.

Hydrogen and Water Vapour.—Calculations on reduction by hydrogen are exactly similar to those for carbon monoxide. Using the equation,

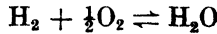

$$\text{the ratio } \frac{\% \text{H}_2\text{O}}{\% \text{H}_2} = K_{\text{H}_2\text{O}} \sqrt{p_{\text{O}_2}} \quad . \quad . \quad . \quad . \quad . \quad (24)$$

p_{O_2} again being the oxygen pressure of the oxide under investigation.

Example 4.—It is required to find the minimum proportion of hydrogen with respect to water vapour which could theoretically be obtained in the waste gases if hydrogen were used to reduce nickel oxide at 1832° F. (1000° C.).

From Table XXV we find that at 1832° F. (1000° C.) the oxygen dissociation pressure of nickel oxide is 5.1×10^{-14} atmospheres. From Table XXIV we find that $K_{\text{H}_2\text{O}}$ for the combination of oxygen and hydrogen is 1.7×10^7 .

$$\begin{aligned} \frac{\% \text{H}_2\text{O}}{\% \text{H}_2} &= K_{\text{H}_2\text{O}} \sqrt{p_{\text{NiO, Ni}}} \\ &= 1.7 \times 10^7 \sqrt{5.1 \times 10^{-14}} \\ &= 1.7 \times 10^7 \times 2.26 \times 10^{-7} \\ &= 4 \text{ (approx.)} \end{aligned}$$

The figures show that it would be theoretically possible to effect reduction with dry hydrogen until the gases contained four parts of steam to one part of hydrogen. This residual proportion of hydrogen could not be utilised and would escape from the reducing chamber with the spent gases.

Reduction by Carbon.—Reduction of a solid oxide by solid carbon may approximate to reduction by carbon monoxide, the carbon dioxide produced being continually reduced by solid carbon according to the equation,

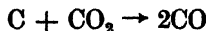

The reducing gas is thus held at the richest possible level, giving at elevated temperatures a value for p_{CO} in the neighbourhood of 0.34 if all the oxygen has come from the air, or higher if the gas is under pressure or if much oxygen has been contributed by reduction of oxides.

The expression,

$$K_C = \frac{p_{CO}^2}{p_{CO_2}}$$

may be rearranged to the form,

$$\frac{p_{CO_2}}{p_{CO}} = \frac{p_{CO}}{K_C} \quad . \quad . \quad . \quad . \quad (25)$$

The value of p_{CO} is known approximately (normally 0.34) and K_C can be found from Table XXIV. By substitution, the ratio of CO_2 to CO in the gas is found. This ratio will be continuously maintained for a particular temperature so long as any solid carbon remains. To ascertain whether carbon will reduce a given solid oxide, it is necessary only to find whether this ratio is richer than demanded for equilibrium between a metal and its oxide according to the method explained on page 476.

Example 5.—To show that silica can be reduced at 1510° C. by solid carbon. At 1510° C., $p_{SiO_2, Si} = 10 \times 10^{-16}$ (see example on p. 478), $K_{CO_2} = 5.4 \times 10^3$, and $K_C = 4.3 \times 10^3$. If we suppose $p_{CO} = 0.34$, from Equation 25 we have :

$$\frac{p_{CO_2}}{p_{CO}} \left(\text{or } \frac{CO_2}{CO} \right) = \frac{p_{CO}}{K_C} = \frac{0.34}{4.3 \times 10^3} = 7.9 \times 10^{-5}$$

giving the actual gas ratio.

Also, we have :

$$\begin{aligned} \frac{CO_2}{CO} &= K_{CO_2} \sqrt{p_{SiO_2, Si}} \\ &= 5.4 \times 10^3 \sqrt{10 \times 10^{-16}} = 17 \times 10^{-5} \end{aligned}$$

giving the maximum ratio permissible for reduction. Since the ratio maintained is smaller (*i.e.* richer in carbon monoxide) than that required, reduction will take place. At this temperature, it is seen that the calculated margin between the two figures is small, and would be entirely lost under a gauge pressure of one atmosphere, due to the doubled value of p_{CO} .

Velocity of Reduction.—The reduction even of porous oxides proceeds as a rule somewhat slowly, the velocity of reaction being governed by laws explained in Section II. Increase of temperature or use of a richer reducing gas mixture will accelerate reaction. There are few numerical data available on reduction rates of oxides, some recent work on iron oxide constituting a notable exception.

Application to Other Reactions.—Oxidation and reduction have been treated in this section because they are the most important examples of the application of partial pressures to the calculation of metallurgical reactions. Given the necessary data, these methods of calculation are available for other types of reaction.

De-sulphurisation.—A reaction of very great importance is the passage of sulphur between solid and gaseous phases. This is involved in elimination of sulphur from pyritic ores in smelting and roasting, and in cases where pick-up of sulphur from flue gases is to be avoided. In such cases the sulphur dissociation pressure of the solid sulphide phases is required, and also the sulphur vapour partial pressure for a given sulphur dioxide content, temperature and pressure of the furnace gases.

Decomposition of Compounds.—The decomposition of limestone is a good and much quoted example of increase of decomposition pressure with temperature. The reaction is represented by the equation,



At a given temperature the minute partial pressures of lime and undissociated calcium carbonate in the gas phase must, in contact with the respective solid phases, be constant.

According to the equilibrium constant,

$$K_p = \frac{p_{\text{CaO}} \times p_{\text{CO}_2}}{p_{\text{CaCO}_3}}$$

the carbon dioxide partial pressure must be constant for a given temperature. This partial pressure is found to increase from a small value at 900° F. (480° C.) to 0.2 atmosphere at about 1400° F. (760° C.), and 1 atmosphere at about 1670° F. (910° C.). It follows that, in contact with furnace gases at atmospheric pressure and containing 20 per cent. of carbon dioxide, limestone cannot decompose below 1400° F. (760° C.); at higher temperatures it could decompose completely. If the gas pressure were increased, with the same percentage of carbon dioxide in the gases, a higher temperature would be necessary for decomposition, due to the increased partial pressure of carbon dioxide in the gas phase. There may even be cases where limestone is prevented by pressure from decomposing at high temperatures; such a case may occur in a hot-metal steel-making process where molten pig iron is permitted to run down and freeze over relatively cool limestone. Carbon dioxide can no longer escape freely and a high

carbon dioxide partial pressure may build up until released by re-fusion of the iron, accompanied by violently rapid decomposition of the liberated limestone.

Reduction of a Higher Oxide to a Lower Oxide.—In reduction of a metallic ore consisting of a higher oxide, the oxide is usually reduced first to a lower oxide or oxides, then to the metal. The higher oxide will have the higher oxygen dissociation pressure; this is the oxygen pressure at which the higher and the lower oxides can coexist as separate stable phases. If the oxygen partial pressure of the gas phase be held below the decomposition pressure of the higher oxide, reduction will take place. At any pressure between the decomposition pressures of the two oxides, the lower oxide must be formed; at pressures less than that of the lower oxide, the metal will be the only stable phase.

Mixture of Pure Oxides.—If the oxides of several metals occur together as distinct phases, the oxygen pressure of the system must be at least equal to the highest of the dissociation pressures. If the oxygen pressure fell below the decomposition pressure of any one of the oxides, that oxide would be reduced either to a lower oxide or to the metal.

The stability of systems consisting of pure oxide and metallic phases is illustrated in Fig. 63. It is supposed the metal *X* forms three mutually insoluble oxides and the partial pressures for the possible equilibria at a given temperature are indicated by the horizontal divisions on the first vertical band. The metal *Y* is supposed to form two oxides, and the metal *Z* one only, the oxygen dissociation pressures shown in the diagram all being for the same temperature. If, for this temperature, the oxygen pressure of the gaseous phase corresponds to broken line 1, the solid phases *X*, *YO* and *Z* will be in equilibrium, no other phases being possible.

An oxygen partial pressure corresponding to line 2 denotes coexistence of *XO*, *YO* and *ZO*.

Line 3 has been made to correspond to the decomposition pressure for

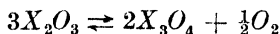

At the selected temperature and pressure of the system and at this oxygen partial pressure, X_2O_3 , X_3O_4 , Y_2O_3 and *ZO* are in equilibrium. Any slight change in the level of line 3 implies elimination of one of the oxide phases of the metal *X*.

The positions of the phase dividing lines will vary with

temperature and total pressure of the system. Suppose the $p_{X_2O_3}$ and $p_{X_3O_4}$ lines approach each other with a change in these arbitrary variables and for a particular combination finally coincide. In this case for the corresponding value of $p_{X_2O_3} = p_{X_3O_4}$, there can coexist all three oxide phases of the metal X , as well as one oxide each of the metals Y and Z .

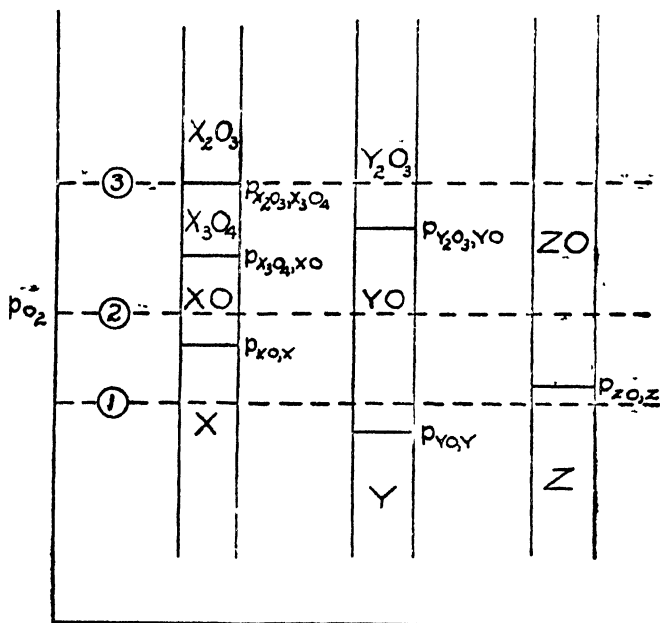

Fig. 63.

Solution of Oxides.—Having first considered the case of insoluble oxides, it is now necessary to consider what oxygen pressure will be exerted by solutions of oxides. Ferrous oxide and magnetic oxide of iron form solid solutions, *i.e.* homogeneous mixtures. The oxygen partial pressure of a gas phase in equilibrium at a particular temperature with such a solid solution will have a value intermediate between the dissociation pressures of “ferrous oxide” and “magnetic oxide,”¹ increasing from the pressure for the lower

¹ Owing to mutual solubility, ferrous oxide must always contain some dissolved magnetic oxide, and vice versa. There will also be some dissolved ferric oxide particularly in solutions rich in magnetic oxide. The dissociation pressures referred to cannot therefore be those of pure ferrous oxide and magnetic oxide, but rather of solutions containing high percentages of the respective oxides.

oxide to that for the higher oxide according to the relative amounts of the two oxides. Further explanation of the laws governing pressures of solutions will be given in the next section.

In the reduction of a higher oxide to a lower oxide, an important difference is apparent between the case of oxides not forming solutions and the case of oxides forming solid or liquid solutions. In the case of insoluble oxides, as soon as the oxygen partial pressure of the gas falls below that of the higher oxide, complete reduction to the lower oxide must occur—the pressure needs to be only just below that of the higher oxide and may be

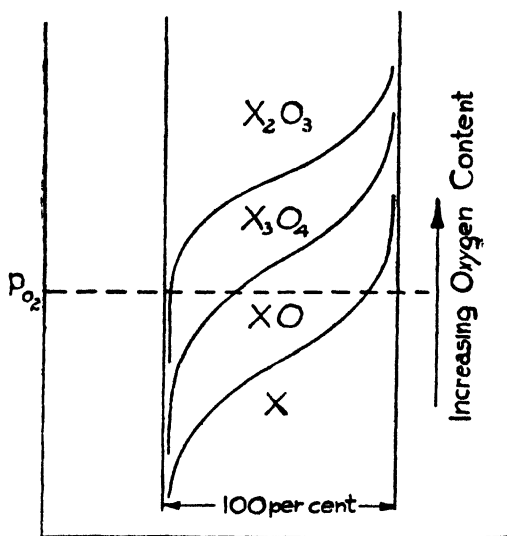

Fig. 64.

considerably above that of the lower oxide. In the case of soluble oxides, a drop in the oxygen partial pressure to a value just below that of the higher oxide will cause only slight reduction, yielding a solution still consisting principally of the higher oxide. Successive lowering of the oxygen partial pressure, down to the dissociation pressure attributed to the lower oxide, will produce a continuously increasing proportion of the lower oxide.

Fig. 64 shows an extension of the diagrammatic representation to the case of a metal X showing perfect mutual solubility of the metal and its three oxides, XO , X_2O_4 and X_2O_3 . The horizontal oxygen pressure boundary lines between the phases are replaced by curved lines which approach, but never quite reach, the vertical

sides of the band. The width of this band has been given special significance; it represents the composition of the solid or liquid phase. For an oxygen partial pressure corresponding to the position of the broken line, there can be only one solid or liquid phase, since mutual solubility is assumed, and the diagram indicates that the phase consists mainly of X_3O_4 and XO , the proportion being estimated by the width of the respective fields intercepted by the broken line. It is further indicated that traces of both X_2O_3 and metal X must also be present in the solution.

If the partial pressure line be moved, corresponding to each position the composition of the solution is seen to be fixed.

Also, in the diagram the per cent. of oxygen in the solution increases continuously from the base line upwards, the per cent. of metal showing a continuous decrease; for a given temperature and total pressure, there can consequently be only one oxygen partial pressure for an arbitrarily selected per cent. of oxygen or metal, and the phase composition becomes also perfectly defined with respect to the different oxides and metal.

IV.—REACTIONS BETWEEN SLAG AND METAL.

The laws of solution have been applied in combination with other physico-chemical laws to study—

- (1) the elimination of impurities from a metal in a refining process,
- (2) the deoxidation of a metal in contact with slag,
- (3) the formation of non-metallic inclusions in metals.

In applying the values of oxygen dissociation pressure to reduction problems, we have considered merely the elimination of the oxide as a separate phase, and the production of the phase which is commonly called metal. In varying degree, the metals are capable of dissolving their own oxides—for convenience the dissolved oxide is frequently reported as “dissolved oxygen.” When reduction is complete, the metal phase will still contain oxide dissolved homogeneously in the metal. Particularly in the refining of the structurally important metals, study of the laws governing the extent of oxide solution warrants the attention of furnace operators.

In the case of steel making, both in the laboratory and in the melting shop very valuable and extensive studies have been made into the physical chemistry of slag reactions. While the specialised application to steel manufacture places a study of these

researches outside the scope of this book, it is noteworthy that the experimental and practical results are very closely in accordance with theoretical indications.

Most metals are produced and refined in the liquid state under a slag; consequently discussion will be confined to the chemical and physical equilibria existing between these two liquid phases. In nearly all smelting operations the slag contains an appreciable amount of metallic oxide. For a particular operation, the smaller the quantity of unreduced oxide remaining in the slag, the more powerfully reducing must the conditions become to effect further reduction; so that practically there is a limit beyond which it becomes impossible to decrease the metallic loss as oxide in the slag. It follows from the solubility of oxide in the metal and the presence of oxide in the slag, that metals produced industrially must always contain dissolved oxide. When slag and metal are in equilibrium, the following conditions must obtain:

1. Reversible chemical reactions taking place between constituents of the slag phase must be in equilibrium.
2. Reversible chemical reactions taking place between constituents of the metal phase must be in equilibrium.
3. The oxygen pressure of oxides in the slag must equal that of oxides dissolved in the metal.

Reversible Reactions in Slag and Metal.—The equilibrium within the separate phases requires little comment. At high temperatures the chemical reactions involved in metallurgical processes usually proceed rapidly, and it is probable that the individual reactions within the separate liquid phases approximate to equilibrium conditions. Probably an exception to this generalisation occurs when one of the products of reaction is a gas showing only slight physical solubility in the liquid phase. Important illustrations of this exception are found in the oxidation of carbon from steel by ferrous oxide and in the oxidation of sulphur from copper by cuprous oxide. In both cases the gaseous products of reaction (carbon monoxide and sulphur dioxide respectively) escape from the bath. According to the law of mass action, the escape of one of the reaction products will permit the process to proceed almost to completion, absolute completion being rendered impossible only due to some degree of solubility of the gaseous product. As the reaction proceeds, however, the greatly reduced concentration of one of the reacting substances (carbon or sulphur) may reduce the velocity of reaction so that approximate equilibrium is not established in the time allowed.

Equilibrium between Slag and Metal.—Two separated liquid phases may be in a state of internal equilibrium, but when brought into contact they may react, indicating absence of mutual equilibrium between the two phases. In fact, one of the functions of a refining slag is to disturb the equilibrium of the metal phase and so to eliminate impurities. If the oxygen pressure of one phase is higher than that of the other, oxidation of the lower pressure phase will occur with resulting chemical reduction of the high pressure phase, *i.e.* oxygen will travel from the high pressure to the low pressure phase. While oxygen pressures could be used in a study of the equilibrium between slag and metal, a more convenient method of approach is afforded by consideration of the relative concentrations of oxides in slag and metal.

Ideal Solutions.—Certain important laws have been established applying to dilute solutions or to "ideal solutions." An ideal solution is a solution whose constituents do not enter into chemical combination or undergo changes in their molecular associations.

It is probable that in metallurgical processes the conditions may, not infrequently, be considered to conform approximately with these stipulations—nor is this entirely accidental. The oxide of the metal being smelted usually has a much higher dissociation pressure than the oxides of other metals present in the slag—if it were not so, the other oxides would be reduced in preference to the principal metal. The negligible dissociation pressure of the earthy oxides, coupled with their very slight solubility in the heavy metal phase, makes it permissible to ignore them entirely in considering distribution and equilibrium between slag and metal; they are regarded as inert matter merely diluting the active oxide of the slag, and reactions among these constituents cannot affect the oxygen pressure. From the present point of view, the dissolved substances in the solutions are the oxides of the heavy metals; the solubility of oxides in metals is small, and economy dictates that the concentration of these oxides in the slag shall be small wherever practicable. Thus the stipulation for a dilute solution of the active oxide is commonly satisfied. Reference is made below to a type of process constituting a notable exception.

In keeping the amount of active oxide in the slag to a minimum, more strongly basic oxides, usually lime, are used. The silica in the slag is usually satisfied by this earthy base, leaving the heavy metallic oxide mainly uncombined. Further, there is no evidence of molecular change when an oxide dissolves in slag or metal.

Physical Solution of Gases.—Many metals in the liquid state doubtless dissolve gases. It is, however, frequently difficult to distinguish between true physical solution, where the gases are present as a homogeneous mixture with the metal, and chemical solution, where the gas enters into chemical combination with some constituent of the metal and so can no longer be considered in physical solution.

Henry's Law, applying only to physical solutions, states that the concentration, on a weight or molecular basis, of dissolved gas in a liquid is proportional to the partial pressure of that gas in the gaseous phase.

Oxygen Pressure of a Solution.—Section III has shown the application of oxygen pressures to calculations involving oxidation of a metal phase or reduction of an oxide phase. It was stated that the phases were saturated solutions of oxide in metal and metal in oxide, the solubility usually being rather small. In this section it has been shown that if a metal phase be in equilibrium with a phase containing dissolved oxide of the metal, the oxygen pressures of the two phases must be equal. The actual value of this oxygen pressure can be obtained by combining the law of mass action with laws governing solutions.

Example 1.—It is required to find the oxygen pressure of copper in equilibrium with a slag containing the molar fraction x of cuprous oxide, ideal solutions being assumed.

Suppose we have two separate systems, system A consisting of the metal phase in equilibrium with the undiluted oxide phase; and system B being the actual system under investigation. Suppose, further, that each system is in equilibrium with a gas phase. For the reaction,

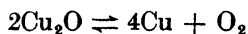

the equilibrium constant in the gas phase is given by

$$K_p = \frac{p_{\text{Cu}}^4 \times p_{\text{O}_2}}{p_{\text{Cu}_2\text{O}}^2}$$

the symbols in this expression being used to denote the partial pressures for system A consisting of undiluted cuprous oxide in contact with copper.

For the given system B, the cuprous oxide partial pressure will be $x \times p_{\text{Cu}_2\text{O}}$. For simplicity we will neglect the difference in the copper vapour pressures of the two systems due to relatively small

differences in the free copper concentration of the two metal phases. Then, if p_{O_2}' represents the oxygen pressure of system B,

$$K_p = \frac{p_{Cu}^4 \times p_{O_2}'}{(x \times p_{Cu_2O})^2}$$

Eliminating identical quantities from the expressions for systems A and B, we find,

$$p_{O_2}' = p_{O_2} \times x^2 *$$

Putting this relation into words, the oxygen pressure of the system is equal to the oxygen pressure of cuprous oxide (found for any temperature from Table XXV) multiplied by the square of the molar fraction of oxide in the slag.

If the molar fraction of copper oxide in the slag is 0.005 (0.5 per cent.), the oxygen pressure will be only 0.000025 of that necessary to effect reduction of copper oxide to copper saturated with oxide. It is evident therefore that metallurgical processes need to be conducted under far more strongly reducing conditions than the minimum requirement for conversion of the oxide phase to the metal phase.† The concentration of oxide in metal in system B will be x times the saturation value.

While production of reasonably well deoxidised metal requires conditions far more reducing than for mere production of the metal phase, in another respect solubility of one metal in another may result in reduction which would otherwise be impossible.

Example 2.—Silica is an oxide ordinarily reducible only with considerable difficulty. For the equation,

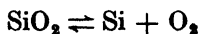

$$K_p = \frac{p_{Si} \times p_{O_2}}{p_{SiO_2}}$$

* The exponent of x is the number of molecules of the oxide necessary to produce one molecule of oxygen. For most metals x^2 applies.

This result may also be deduced by combination of the law of mass action with Henry's law.

† When reduction is effected by the usual agents, we may apply, for example, Equation 23,

$$\begin{aligned} \frac{\%CO_2}{\%CO} &= K_{CO_2} \sqrt{p_{O_2}'} \\ &= K_{CO_2} \sqrt{p_{O_2} \times x^2} \\ \text{giving } \frac{\%CO_2}{\%CO} &= K_{CO_2} \times x \sqrt{p_{O_2}} \end{aligned}$$

The gas ratio is therefore proportional to x only, not to x^2 .

If silica be present as a separate phase, p_{SiO_2} will be fixed for a given temperature, and K_p is also fixed. Consequently the product $p_{\text{Si}} \times p_{\text{O}_2}$ is fixed. In the electric arc furnace it is possible to produce the element silicon in a comparatively pure form. In this process p_{Si} will have its maximum value, and very highly reducing conditions are necessary to yield the exceptionally low oxygen decomposition pressure of silica.

In the blast furnace, pig iron is produced with some dissolved silicon. Assuming merely physical solution and assuming also the presence of the oxide silica as a distinct phase, the partial pressure of silicon in solution will be much lower than for a separate silicon phase. Since $p_{\text{Si}} \times p_{\text{O}_2}$ is fixed, the lower value of p_{Si} for a solution will permit a higher value for p_{O_2} in the gas phase, i.e. the conditions do not need to be so strongly reducing to produce silicon dissolved in another metal as to produce pure silicon.

Actual blast furnace conditions differ from those assumed here in two respects. Firstly, solution of silicon is not purely physical, there being combination between iron and silicon—this further lowers the silicon vapour pressure and makes reduction still easier. Secondly, at the higher temperatures of the blast furnace, the silica of the charge has been incorporated in the slag and no longer exists as a separate phase—this decreases the vapour pressure of silica and acts in an opposite direction to the first deviation from assumed conditions. A more acid slag, by increasing the silica partial pressure, will increase the per cent. of silicon in the pig. A higher temperature will, by Le Chatelier's principle, favour the strongly endothermic reduction of silicon from silica.

The effect of solution accounts for the reduction and presence of metallic impurities in the non-ferrous base metals. Certain impurities might not be reducible as separate phases, under the somewhat mildly reducing conditions sufficient to reduce some of the base metals; yet the solubility of these impurities renders reduction possible. In subsequent furnace refining processes much of these impurities can be eliminated by maintaining sufficiently oxidising conditions; but a trace of each impurity must remain.

Oxygen Pressure of a Homogeneous Mixture of Oxides.—In a system of heterogeneous oxides, the oxygen pressure was seen to be at least equal to the highest of the individual oxygen decomposition pressures (p. 485).

For a homogeneous phase consisting of one oxide of relatively high oxygen decomposition pressure mixed physically with oxides

having much lower decomposition pressures, the oxygen pressure of the phase was seen to be controlled by the oxide having the high decomposition pressure. The common occurrence of a slag consisting of earthy oxides with the oxide of a heavy metal was quoted. In such a mixture, although the heavy metal controls the oxygen pressure, since all the oxides are in equilibrium the oxygen pressure of every oxide present must be increased to the same value.¹

For a homogeneous mixture containing more than one oxide which may have an important influence on the oxygen pressure of a slag-metal system, the oxygen pressure may be determined from either metal, provided ideal solution may be assumed. For example, if an iron-manganese alloy is in equilibrium with a slag containing uncombined ferrous and manganous oxides, the equilibrium constants are given by

$$K_{\text{Fe,FeO}} = \frac{p_{\text{Fe}} \sqrt{p_{\text{O}_2}'}}{p_{\text{FeO}}}$$

and

$$K_{\text{Mn,MnO}} = \frac{p_{\text{Mn}} \sqrt{p_{\text{O}_2}'}}{p_{\text{MnO}}}$$

By extending the method of analysis used on page 493 ("Oxygen Pressure of a Solution") it will be found that, for the Fe-FeO equilibrium,

$$p_{\text{O}_2}' = p_{\text{O}_2} \times \frac{x^2}{y^2}$$

where p' is the actual oxygen pressure, p_{O_2} is the oxygen dissociation pressure of iron oxide, x is the molar fraction of iron oxide in the

¹ Further explanation is afforded by the following example. When we say that the oxygen decomposition pressure of silica at a certain temperature is 10×10^{-16} we mean that at this oxygen partial pressure silicon and silica can coexist as separate stable phases. We know that the "silicon" must be saturated with dissolved SiO_2 , and that the "silica" must be saturated with Si. If, as is usual in smelting operations, the oxygen pressure were too great to permit existence of silicon as a separate phase, the disappearance of this phase would cause a decrease in the concentration of Si in the "silica" phase, i.e. a slight increase in the oxygen content of this phase. It is this capacity to take a slight supercharge of oxygen, as compared with the condition when saturated with dissolved metal, which permits oxides, whether existing as separate phases or in solution with other substances, to assume the oxygen pressure of the system. Similarly, under more highly reducing conditions than required to produce the metal phase in contact with and saturated with oxide, the oxygen pressure of the metal phase adjusts itself to that of the system by suboxidation as compared with its saturated condition.

slag, and y is the molar fraction of iron in the metal. If the corresponding values of p_{O_2} , x and y are taken for manganese, the value found for p_{O_2}' should theoretically be the same. This oxygen pressure equality is rendered possible by the

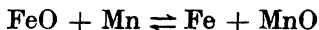

equilibria within the slag and metal phases. The equality of oxygen pressure for all oxides in ideal solution may be utilised to predetermine the probable extent of elimination of a metallic impurity from metal to slag in the form of oxide. The oxygen dissociation pressure p_{O_2} of the oxide being known, and the oxygen pressure of the system p_{O_2}' having been determined from the slag composition with respect to the principal metal, the ratio x/y may be determined for the impurity ($x/y = \sqrt{p_{O_2}'/p_{O_2}}$). Taking into account the weights of metal and slag, the values of x and y may then be determined. Transfer of an impurity from slag to metal by reduction of an oxide follows identical laws.

Some Processes which have been Studied from a Physico-Chemical Standpoint.—Among the more important metallurgical processes which have been made the subject of study may be mentioned :

(a) The selective elimination of impurities from steel in the open hearth furnace. The same principles apply to the Bessemer process, with the reservation that velocity of reaction may become relatively important.

(b) The subsequent deoxidation of steel.

(c) The formation of non-metallic inclusions in steel. Non-metallic inclusions may occur in metals due to mechanical entanglement of slag or dirt, through separation of non-metallic matter which is soluble in liquid metal but which separates on solidification of the metal, and due to formation during chemical reactions of matter having low solubility in the metal phase. Mechanically entangled matter ordinarily floats to the surface, and should not appear in the ingot or casting unless the contamination has occurred just before or after the metal has commenced to solidify. Separation due to change in solubility is a case for physico-chemical study. The non-metallic matter formed due to chemical reaction is in an extremely fine state of division, and just as a very fine precipitate settles slowly in water so these fine particles are very slow to rise to the surface of the metal. This effect has been carefully studied, and it has been established that when these products of reaction are fusible, they will coalesce and rise very much faster.

(d) The scaling of steel in forge furnaces, etc.

(e) De-sulphurising of steel.

(f) Formation of producer gas.

(g) Manufacture of pig iron in the blast furnace, including reduction of ore and impurities.

(h) Sulphide reactions of the base metals where mutual solubility of reacting substances does not constitute serious interference.

(i) Manufacture of zinc.

Among the more important general fields which are, at best, but little explored may be mentioned :—

(a) Refining and dross forming processes for the base metals.

(b) Matte and speiss forming processes where there is much mutual solubility of sulphides, arsenides and antimonides of different metals.

(c) Bessemerisation processes involving selective oxidation of sulphides.

SUMMARY.

1. *Change of Heat of Reaction with Temperature.*—Owing to differences between the specific heats of the reacting constituents and the products of a chemical reaction, the heat of reaction is a function of temperature,

$$Q_t = Q_o + S_c - S_p$$

where Q_t is the heat of reaction at the given temperature, Q_o is that at laboratory temperature as ordinarily reported, S_c is the sensible heat of the constituents measured at the temperature of reaction, and S_p is that of the products of reaction.

2. *Balanced Reactions.*—Theoretically, no chemical reaction can proceed to completion. When a reaction has proceeded as far as is possible, a state of equilibrium is said to be reached.

3. *Mass Action.*—In a chemical reaction which may be represented by the equation,

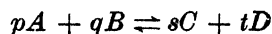

the *Equilibrium Constant*, K , is given by

$$K = \frac{[C]^s \times [D]^t}{[A]^p \times [B]^q}$$

where the symbols $[A]$, $[B]$, etc., represent the concentrations of the corresponding substances in a homogeneous phase.

The *Concentration* of a substance is here the relative composition with regard to the substance expressed in molecules instead of per cent. When stated as the fraction of a molecule in one "molecule" of the mixture, the concentration is said to be expressed in *molar fractions*.

4. *Partial Pressure*.—In a gas mixture, each constituent of the mixture contributes to the total gas pressure in proportion to the per cent. present by volume. The pressure contributed by each gas constituent is called its partial pressure. Where p is the partial pressure of a constituent and P is the total gas pressure,

$$p = \frac{\text{Per cent. by volume} \times P}{100}$$

P is the sum of the partial pressures of all the gases making up the mixture, and in most furnace operations is equal to 1 atmosphere.

For gaseous reactions the equilibrium constant is most conveniently expressed in terms of partial pressures, instead of concentrations.

5. *Vapour Pressure*.—When a solid or liquid is in contact with a gas, some degree of vaporisation occurs, the vapour present in the gaseous phase exerting a partial pressure. This partial pressure is called the vapour pressure of the substance, and for a pure substance the value is fixed for any particular temperature, irrespective of quantities and the total pressure of the system. If a system comprising several unassociated pure constituents be heated to a definite temperature, the gaseous phase will sustain individual partial pressures, mathematically exact even though immeasurably small, equal to the values for each substance treated separately.

In considering equilibrium between gases and solids, the equilibrium constant is written in terms of partial pressures for the gaseous phase. The partial pressures due to pure solid phases are constant for a particular temperature, and these are therefore incorporated in the equilibrium constant for the reaction.

6. *Le Chatelier's Principle*.—Wherever theoretically possible, change in conditions imposed on a system in equilibrium will be partially offset by a spontaneous counter-effect within the system.

(a) If the temperature of a system be increased, equilibrium

will shift in such a way that some heat will be absorbed, tending to check the rise of temperature.

(b) If the pressure of a system be increased, where possible there will be a decrease in the number of molecules of gas, providing partial release from the increased pressure.

(c) If any substance be added to a system in equilibrium, the equilibrium will, if possible, shift in a direction tending to decrease the concentration of that substance.

7. *Velocity of Reaction.*—In many practical operations, restricted time of contact prevents approach to a condition of equilibrium. Reactions in heterogeneous systems may be impeded by poor contact of the phases—the theory of velocity of reaction is not applied to such cases. Reactions both in heterogeneous and in homogeneous systems may be slow due to inherent sluggishness of the chemical changes—it is to these that the theory applies.

The further the system from a state of equilibrium, the more rapidly will be its instantaneous velocity of reaction; and the closer it approaches equilibrium, the slower will be the velocity. The effect may be likened to release of compressed air through a small valve, from a vessel or balloon—at first the air escapes with considerable force, but as the pressure approaches that of the atmosphere the rate of escape diminishes rapidly.

The coefficient of velocity of reaction increases very rapidly with rising temperature. Certain substances, called catalysts, may exert a powerful influence on the velocity of a particular reaction.

8. *Oxidation and Reduction.*—A metallic oxide exerts an oxygen pressure due to slight decomposition of the oxide. This is called the *oxygen decomposition or dissociation pressure* of the oxide; and assuming the metal and oxide to exist as separate phases, this pressure is determined (from a practical standpoint) only by the temperature.

Gases containing carbon dioxide and steam have a slight oxygen partial pressure due to some dissociation of these gases. This partial pressure is determined by the equilibrium constant for the gases, and varies with the gas composition as well as with the temperature.

For reduction of an oxide, the oxygen partial pressure of the gas must be less than the oxygen decomposition pressure of the oxide.

For oxidation of a metal, the oxygen partial pressure of the gas must be greater than the oxygen decomposition pressure of the metallic oxide.

The neutral composition of a gas with respect to metal in equilibrium with its oxide is given by

$$\frac{\text{CO}_2}{\text{CO}} = K_{\text{CO}_2} \sqrt{p_{\text{O}_2}}$$

and

$$\frac{\text{H}_2\text{O}}{\text{H}_2} = K_{\text{H}_2\text{O}} \sqrt{p_{\text{O}_2}}$$

where $\frac{\text{CO}_2}{\text{CO}}$ and $\frac{\text{H}_2\text{O}}{\text{H}_2}$ represent the ratio of the gases by volume per cent., K_{CO_2} and $K_{\text{H}_2\text{O}}$ are the equilibrium constants for the combustion of carbon monoxide and hydrogen respectively, and p_{O_2} is the oxygen decomposition pressure of the oxide.

In calculating the maximum permissible $\frac{\text{CO}_2}{\text{CO}}$ ratio for reduction of an oxide, a further consideration may arise. Due to the reaction,

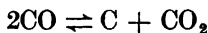

it may not be possible to maintain an equilibrium gas mixture sufficiently rich in carbon monoxide to conform with the calculated requirement for reduction. This may occur in the reduction of iron at low temperatures, iron acting as a catalyst assisting the gaseous mixture in its ordinarily slow shift towards an equilibrium composition. It may also occur at high temperatures in connection with oxides requiring for reduction an abnormally low $\frac{\text{CO}_2}{\text{CO}}$ value,

sometimes implying a richness in carbon monoxide not attainable in view of the carbon monoxide decomposition equilibrium. According to Le Chatelier's principle, or according to the law of mass action, a lower absolute gas pressure or lower partial pressures of carbon oxides in contact with carbon will produce a gas richer in carbon monoxide.

For a heterogeneous mixture of oxides to exist in equilibrium, the oxygen pressure of the system must be at least equal to the highest of the individual oxygen decomposition pressures. The metal component of an oxide cannot separate so long as an oxide having a higher decomposition pressure is present in the system.

9. Other Decomposition Pressures.—Compounds other than oxides must also exert decomposition pressures. The sulphides are the most important examples encountered in metallurgical processes.

10. *Reactions between Slag and Metal.*—Just as there is no such thing as a complete chemical reaction, so there is no such thing as complete insolubility. In melting operations, slag and metal are obtained as distinct layers, yet the constituents of the slag show slight solubility in the metal, while a trace of metal dissolves physically in the slag. Some constituents of the slag are more soluble in the metal than others, and it is these which are largely responsible for oxidised metal and non-metallic inclusions in metals.

Equilibrium between slag and metal demands homogeneous equilibrium within each of the liquid phases, and also equality of oxygen pressure between the two phases. Equality of other vapour pressures (*e.g.* sulphur pressure) is also necessary, but the data available for these other vapour pressures are few.

Laws of Solution.—(a) The vapour pressure or oxygen pressure of a substance in dilute or ideal solution is equal to the pressure for the pure substance at the corresponding temperature, multiplied by the molar fraction of the substance in the solution.

(b) If a soluble substance be added to a system consisting of two phases, at a given temperature, it will distribute itself between these phases according to a constant composition ratio. For ideal solutions this ratio would be approximately equal to the ratio of maximum solubilities of the added substance in the two phases, solubility being expressed in molar fractions. For a substance which is perfectly miscible with a phase, the maximum solubility in molar fractions equals unity; for limited miscibility, the maximum solubility is the saturation value. Distribution may be expressed,

$$\frac{\text{Actual concentration in metal}}{\text{Actual concentration in slag}} = \frac{\text{Maximum possible concentration in metal}}{\text{Maximum possible concentration in slag}}$$

The right hand ratio gives the distribution coefficient. In a case of perfect solubility 1 is substituted for the corresponding maximum concentration; in a case of limited solubility the saturation value is substituted. For example, ferrous oxide is perfectly miscible with a calcium silicate slag, but iron can dissolve only about 0.01 molar fraction of ferrous oxide at 2910° F. (1600° C.). The distribution coefficient is therefore $\frac{0.01}{1}$, showing that at this temperature the concentration of iron oxide in the metal is, subject to the validity of the assumptions made, always about 1 per cent. (in molar fractions) of that in the slag.

11. *De-oxidation of Liquid Metals.*—The minimum requirements for reduction of a metallic oxide, based on the oxygen pressure as given in Table XXV, assume the production of the metal phase saturated with oxide, in contact with the undiluted oxide phase. The slags produced in metallurgical processes should show a relatively low oxide concentration, and the oxide content of the metal phase must therefore be only a small fraction of the saturation value. For attainment of these results, the oxygen pressure of a system may need to be many thousands of times smaller than that necessary to produce a fully oxidised metal phase.

Although an oxide may not ordinarily be reducible under a particular set of conditions, partial reduction will occur in the presence of a metal phase capable of dissolving the element resulting from such partial reduction. This accounts for the large amount of impurities in crude metals, and for the traces of impurities in refined metals.

General References :—

1. F. Sauerwald : *Physikalische Chemie der metallurgischen Reactionen.*

2. R. Schenck : *The Physical Chemistry of the Metals* (translated by R. S. Dean).

3. There are many good general textbooks on physical chemistry, such as—

A. Findlay : *Introduction to Physical Chemistry.*

J. N. Friend : *A Textbook of Physical Chemistry* (Griffin).

TABLE XXVI.—INTERNATIONAL ATOMIC WEIGHTS.

Element.	Symbol.	Atomic Weight.	Element.	Symbol.	Atomic Weight.
Aluminium .	Al	26.97	Molybdenum .	Mo	96.0
Antimony .	Sb	121.76	Neodymium .	Nd	144.27
Argon .	A	39.944	Neon .	Ne	20.183
Arsenic .	As	74.91	Nickel .	Ni	58.69
Barium .	Ba	137.36	Nitrogen .	N	14.008
Beryllium .	Be	9.02	Osmium .	Os	191.5
Bismuth .	Bi	209.00	Oxygen .	O	16.0000
Boron .	B	10.82	Palladium .	Pd	106.7
Bromine .	Br	79.916	Phosphorus .	P	31.02
Cadmium .	Gd	112.41	Platinum .	Pt	195.23
Calcium .	Ca	40.08	Potassium .	K	39.096
Carbon .	C	12.00	Praseodymium	Pr	140.92
Cesium .	Cs	132.91	Radium .	Ra	226.05
Cerium .	Ce	140.13	Radon .	Rn	222
Chlorine .	Cl	35.457	Rhenium .	Re	186.31
Chromium .	Cr	52.01	Rhodium .	Rh	102.91
Cobalt .	Co	58.94	Rubidium .	Rb	85.44
Columbium .	Cb	92.91	Ruthenium .	Ru	101.7
Copper .	Cu	63.57	Samarium .	Sm	150.43
Dysprosium .	Dy	162.46	Scandium .	Sc	45.10
Erbium .	Er	167.64	Selenium .	Se	78.96
Europium .	Eu	152.0	Silicon .	Si	28.06
Fluorine .	F	19.00	Silver .	Ag	107.880
Gadolinium .	Gd	157.3	Sodium .	Na	22.997
Gallium .	Ga	69.72	Strontium .	Sr	87.63
Germanium .	Ge	72.60	Sulphur .	S	32.06
Gold .	Au	197.2	Tantalum .	Ta	180.88
Hafnium .	Hf	178.6	Tellurium .	Te	127.61
Helium .	He	4.002	Terbium .	Tb	159.2
Holmium .	Ho	163.5	Thallium .	Tl	204.39
Hydrogen .	H	1.0078	Thorium .	Th	232.12
Indium .	In	114.76	Thulium .	Tm	169.4
Iodine .	I	126.92	Tin .	Sn	118.70
Iridium .	Ir	193.1	Titanium .	Ti	47.90
Iron .	Fe	55.84	Tungsten .	W	184.0
Krypton .	Kr	83.7	Uranium .	U	238.14
Lanthanum .	La	138.92	Vanadium .	V	50.95
Lead .	Pb	207.22	Xenon .	Xe	131.3
Lithium .	Li	6.940	Ytterbium .	Yb	173.04
Lutecium .	Lu	175.0	Yttrium .	Y	88.92
Magnesium .	Mg	24.32	Zinc .	Zn	65.38
Manganese .	Mn	54.93	Zirconium .	Zr	91.22
Mercury .	Hg	200.61			

INDEX

A

ABBREVIATIONS used, x.
 Absolute pressure, 127.
 ——— temperature, 128.
 Absorption of heat by gases, 238-240, 308.
 Acid oxides, 381.
 Adams, L. H., with Clement, J. K., 468
 Adams, L. H., with Clement, J. K., and
 Huskins, C. N., 463, 467.
 "Agate" bricks, 411.
 Air, Composition by volume, 10.
 ———, ——— weight, 10.
 ———, Density of, 125.
 ———, Excess (see Excess air).
 ——— flow (see Gas flow).
 ——— for combustion (see Combustion, Air
 required for).
 ——— infiltration, 176-186.
 ——— ———, Calculation from gas analysis,
 64-65.
 ——— ———, Effect on available heat, 45.
 ——— leakage (see Air infiltration).
 ——— ——— in recuperator, 336.
 ———, Moisture in, 47, 111, 125-127, 334,
 372.
 ———, "Molecular weight" of, 125.
 ——— preheat, Calculation of, in recuperator,
 326-332.
 ——— ———, ———, in regenerator, 345-
 348.
 ———, "Primary," 53.
 ———, "Secondary," 53.
 ——— temperature, Effect on available heat,
 43-44.
 ——— ———, ——— chimney draught, 161-
 162.
 Alignment chart (see Nomograms).
 Allophane, 416.
 Altitude, Effect on barometric pressure, 128.
 Alumina, Chemical nature of, 385, 416.
 ———, Fused, 416 (see also Fused alumina).
 ——— refractories (see High-alumina brick).
 Alumina-silica diagram, 383-384.
 Aluminous cements, 431.
 Alundum, 416.
 Amorphous carbon, Heat of combustion of,
 31, 441.
 Analysis of coal, Calorific value from, 32-33.
 ——— of flue gas, Importance of, 60.
 ——— of fuel gas, Calorific value from, 32.
 Anderson, C. T., with Kelley, K. K., 114.

Applications of heat transfer to pyrometry,
 259-261.
 Approach, Velocity of, 177.
 Asbestos in insulating materials, 431-432.
 A.S.M.E. Report on Fluid Meters, 197, 200,
 202, 206.
 Atmospheric pressure, Effect on air volume,
 128.
 ——— ———, ——— buoyancy, 160, 162.
 Atom, Pound-, 5.
 Atomic heat, 107, 109.
 ——— weights, Complete table, 504.
 ——— ———, Short table, 5.
 Automatic combustion control, 59-60.
 ——— gas analysing instruments, 65-67.
 Available heat, 40-59.
 Effect of air infiltration, 45.
 ——— air temperature, 43, 44.
 ——— chemical changes in the batch,
 48.
 ——— excess air, 44, 55-56.
 ——— fuel gas composition, 46.
 ——— fuel gas temperature, 46.
 ——— fuel quantity, 49.
 ——— furnace dimensions, 58-59, 306-
 307.
 ——— furnace temperature, 48.
 ——— heat loss through walls, 43, 47.
 ——— incomplete combustion, 45-46.
 ——— loss of gas from furnace, 47.
 ——— mixing of fuel and air, 51-54.
 ——— moisture in air, 47.

B

BALANCE sheet, 79-123.
 ———, Material, 79-86.
 ———, Thermal, 86-123.
 Balanced reactions, 442-444, (Summary)
 478.
 ———, Effect on flame temperature,
 71-72.
 Bambach, R., 146.
 Bansen, H., 141, 142, 158, 181.
 Barometric pressure, Effect on air volume,
 128.
 ———, Effect on buoyancy, 160, 162.
 Basic oxides, 381.
 Batch-type furnace with preheating
 chamber, 373.
 Baumeister, T., 211.

- Bauxite bricks, 412, 415-417.
 ———, Cast, 412, 417.
 ———, Spalling of, 434.
 Beds of solids, Gas flow through, 158.
 ———, Heat transfer in, 225.
Bell, Sir Lowthian, 437.
Berthelot, 31, 492.
 Binary compounds, Heat of formation of, (Table) 113.
 Black body radiation, 229.
 Blast furnace stove, Length of cycle, 352.
 ———, ———, Three-pass, 367.
 ——— saturation temperature, (Table) 469.
 "Bloating" of refractories, 390.
 "Boil," Effect on heat transfer, 300.
 Boiler furnaces, Formation of carbon monoxide in, 468.
 ———, Waste heat, in conjunction with regenerators, 369.
 Bonding of refractory brick, 424-426.
Bone, W. A., 78.
Bone, W. A., and *Wheeler, R. V.*, 469.
Bowen, N. L., and *Greig, J. W.*, 383.
 Boyle's law, 127.
Boylé, K., and *Rietschels, H.*, 141.
 Brick(s) (see Refractories, Insulating brick and particular brick required).
 Brick ducts, Gas flow in, 145, 156.
 ——— equivalent, Standard (see Standard brick equivalent).
 ——— laying (see Refractory cements), 424-426.
 ——— ———, Expansion allowance, 395.
 ———, Red, as heat insulator, 276, 426.
 ———, ———, Thermal conductivity, 270.
 Brickwork, Contact resistance to heat flow, 273.
 ———, Gas leakage through, 181-183.
 ———, Recovery of heat losses through, 373.
 ———, Slag attack on defective, 409.
 B.Th.U. (B.th.u., B.T.U., B.t.u.).
 Conversion to C.H.U., Direct-reading Scale, Plate I, facing p. 504.
 ———, ——— ———, Formula, 26.
 ———, Definition of, 25.
 Buoyancy, 159-172.
 ———, Effect of atmospheric pressure on, 162.
 ———, ——— density on, 162.
 ———, ——— temperature on, 161, 163.
Butts, A., 123.
 Bypassing of waste gas in regenerator, 369-370.
- C**
- CALORIFIC value, 26-28, (Table) 73-74.
 Calculation of, for coal, 32-33, 77.
 ———, for fuel oil, 34.
 ———, for gaseous fuels, 32, 77.
 Gross or higher, 27.
 Net or lower, 27.
- Carbon, Amorphous, Heat of combustion, 31, 441.
 ———, β -graphite, Heat of combustion, 30, 31.
 ——— brick, 271, 412, 419.
 ———, Chemical equilibrium with carbon oxides, 457-458.
 ———, Reduction by, 482-483.
 ———, Reduction of silica by, 483.
 Carbon dioxide—
 Heat of formation from amorphous carbon, 31, 441.
 — — — — — graphite, 30, 31, 441.
 Meter, 65-66.
 Oxidation by, 476-481.
 — of iron, 477-478.
 — of zinc, 479-481.
 Ultimate, 12.
 —, Calculation from flue gas analysis, 18.
 —, Formula for determining, 61.
 Carbon monoxide—
 Formation in boiler furnaces, 468.
 Heat of formation from amorphous carbon, 441.
 — — — — — β -graphite, 30, 31.
 Reduction by, 476, 478.
 — of ferrous oxide by, 477-478.
 Carbon transfer—
 Chemical equilibrium of, 470.
 Promoted by spongy iron, 471.
 Spalling caused by, 405.
 Carborundum (see also Silicon carbide), 419-420.
 Catalysis—
 Definition of, 470.
 in heterogeneous systems, 471.
 in homogeneous systems, 471.
 of methane reaction, 471.
 Catalysts, Effect of impurities on, 471.
 Cement(s), 424-426.
 Cement, Aluminous, 431.
 ——— gun, Use with plastics, 422.
 ———, Portland, in insulating concrete, 431.
 ——— ———, in refractory cements, 425.
 ——— ———, in refractory plastics, 422.
 ——— washes, 425.
 Centigrade, Conversion to Fahrenheit, Direct-reading Scale, Plate I, facing p. 504.
 C.H.U. (c.h.u., pound calorie, p.c.u., pound centigrade unit),
 Conversion to B.Th.U., Direct-reading Scale, Plate I, facing p. 504.
 ———, ——— ———, Formula, 26.
 ———, Definition of, 25.
 Change of direction in gas stream, 146.
 ——— ——— ———, Factors for, 142.
 Change of section in gas stream, 146-151.
 ——— ——— ——— ———, Factors for, 148.
Chappell, E. L., with *Haslam, R. T.*, 260.
 Charles' law, 128-129.

Checkers (*see* Regenerator checkers).

Chemical changes in batch, Effect on available heat, 48.

— — — — —, Heat from, 111-120.

Chemical equation(s)—

Calculation of gas quantity from, 8-25.

— — — — — heat of combustion from, 28-30.

— — — — — reaction from, 111-120.

— — — — — volume from, 8-10.

— — — — — weights from, 7.

Combination of, 458-459.

Chemical equilibrium (Summary), 498-503.

among carbon and its oxides, 457-458.

and carbon transfer, 471.

between slag and metal, 488-497.

Definition of, 443.

Effect of composition on, 460.

Effect of pressure on, 460.

Effect of temperature on, 459-460.

in combustion of carbon, 456.

in combustion of carbon monoxide, 455-457.

in combustion of hydrogen, 440, 457.

in manufacture of zinc, 474, 479-481.

in producer gas, 452-454.

in products of combustion, 454-455.

in reduction of ferric oxide, 441.

in water gas reaction, 450-455.

Chemical reactions, Balanced, 71-72, 442-444.

— — — — —, Completed, 442.

Chilton, T. H., and *Colburn, A. P.*, 158.

Chimney capacity, 174.

— — — — —, Cooling in, 172.

— — — — —, dimensions, 173-174.

— — — — —, draught (formula), 172.

— — — — —, Direct-reading Scale, Plate I, facing p. 504.

— — — — —, Gas velocity in, 174.

China clay (*see* Kaolin).

Chrome brick (tables of properties), 412, 414.

Composition of, 388.

Expansion allowance, 395.

Expansion and contraction of, 395.

Failure under load, 402.

Melting point of, 388.

Recent improvements in, 418.

Slag action on, 410.

Spalling of, 406, 434.

Special, 418.

Strength at high temperatures, 402.

Thermal conductivity of, 215, 266.

Unburnt, Chemically bonded, 418.

Chrome cement, 425.

— — — — —, plastics, 423.

Chromic oxide, Chemical nature of, 386.

Chromite, Nature of, 388.

Clay (*see also* Fireclay), Shrinkage on firing, 394.

Clay-bonded silica brick, 415.

Clay cement, 425.

Clement, J. K., and *Adams, L. H.*, 468.

Clement, J. K., *Adams, L. H.*, and *Haskins, C. N.*, 463, 467.

Clinkering in gas producer, 466, 469.

Coal, Calorific value of, 32-33.

— — — — —, Characteristics of (table), 73.

Coal tar, Characteristics of (table), 73.

Coefficient of conductivity, 213-215.

— — — — —, Conversion to standard brick equivalent, 266.

— — — — — convection, Forced (Nomogram), 222.

— — — — —, Natural (Plate I), facing 504.

— — — — — discharge, 177, 195.

— — — — — friction for gases (table), 154-155.

— — — — — gas radiation (*see* Gas radiation) (Nomogram), 241.

— — — — — radiation, 233-234, (Direct-reading Scale, Plate I) facing 504.

Coke, Sensible and specific heat of, 110.

Colburn, A. P., with *Chilton, T. H.*, 158.

Colour, Effect on radiation, 230.

Combustion, 8-78, (Summary) 75-78.

Combustion, Air required for—

Actual, Calculation of, 21, 24.

Theoretical, Calculation of, 10-17.

— — — — —, Empirical rule, 74.

— — — — —, Formula for, 75.

Combustion, Control of, 59-67.

Combustion, Heat of, 25-34.

Carbon, 30.

Fuel gases (table), 30.

Sulphur, 30.

Combustion, Incomplete, Effect on available heat, 45-46.

— — — — —, Products of, (*see* Products of combustion).

— — — — —, Speed of, 462.

— — — — —, Stoichiometric calculations, 10-25.

— — — — —, Surface, 52.

Combustion, Theoretical products of—

for coal, 14-17.

for gaseous fuel, 11-13.

for liquid fuel, 14-17.

Compartment kilns, 374.

Compounds, Heat of formation of, (tables) 30, 113.

Concentration, (Summary) 499.

— — — — —, Definition of, 444.

— — — — —, Units used in measuring, 448.

— — — — —, — — — — —, for gases, 449.

— — — — —, — — — — —, for liquids, 448.

Concrete, Insulating, 431.

— — — — —, Safe temperature, 290.

— — — — —, Thermal conductivity, 272.

Conduction, 212-219, (Summary) 261.

— — — — — through composite wall, 217-219.

Conductivity, Coefficient of, 213-215 (*see also* Thermal conductivity).

— — — — —, Over-all, 280-281.

Constant heat summation, Law of, 110, 440.

— — — — — pressure, 438.

— — — — — volume, 438.

Contact resistance to heat flow, 273.
 Continuous compartment kilns, 374.
 — furnaces, Gas flow in, 167-168.
 Contraction and expansion of refractories, 388-395.
 — in gas stream, 149-151.
 Convection, 219-228.
 Convection, Forced, 220-225.
 Effect of dimensions, 224.
 — eddying, 223-224.
 — gas composition, 224.
 — impingement, 223, 299, 300.
 — roughness, 223.
 — temperature, 224.
 Factors influencing, 223-225.
 in heat exchangers, 318-321.
 in liquids, 225.
 in regenerator checkers, 225, (Nomogram) 222.
 to a plane surface, 225, (Nomogram) 222.
 to series of cylinders, 224.
 to single cylinder, 224.
 to stock, 299-300.
 to thin wires, 225.
 through beds of material, 225.
 Convection, Natural, 225-228, (Curve) 227.
 Direct-reading Scale (Plate I), facing 504.
 for abnormal surfaces, 228.
 for horizontal surfaces, 228.
 Conversion of coefficient of thermal conductivity to standard brick equivalent thickness, 266.
 — — heat units, 26.
 — — — — —, Direct-reading Scale, Plate I, facing 504.
 — — higher to lower calorific value, 27-28.
 — — temperature, Direct-reading Scale, Plate I, facing 504.
 — — water gauge to pressure, 135.
 Cooling, Water, 292-296 (see also Water cooling).
 Corundum, 416.
 Cost of cast bauxite brick, 417.
 — — forsterite brick, 419.
 — — insulating firebrick, 430.
 — — refractories, (table) 412-413.
 — — special chrome brick, 418.
 — — magnesite brick, 418.
 — — spinel brick, 419.
 — — super-duty fireclay brick, 421.
 Counter-flow recuperators, 326-340.
 Cracks, Pressure, in refractories, 404.
 Cragoe, C. S., 34.
 Critical speed, 132.
 "Cross flow" recuperator, 325.
 Crystalline changes in refractories, 389-394.
 Crystobalite, 390-393.
 Cubic foot, Normal, 8.
 Cyanite, 416.
 "Cycle" in regenerator, 341 (see also Regenerators).

D

Dale, A. J., with Green, A. T., 404.
 "Dead" gas film, 219.
 Dean, R. S., with Schenck, R., 503.
 Decomposition of compounds, Heat of (see Heat of formation).
 — — — limestone, 114, 484.
 — — — — —, Physical chemistry of, 484.
 Decomposition pressure of oxides, 473-476, (table) 475 (see also Oxygen pressure).
 Density of gases, Effect on friction, 157.
 — — — — —, — on pressure equivalent, 139.
 — — — — —, — on velocity measurement, 196.
 — — of air, 125.
 — — of gases, 125-126, (table) 163.
 — — of products of combustion, (table) 163.
 De-oxidation of metals, 488-495, (Summary) 503.
 De-sulphurisation, Physical chemistry of, 484.
 Devitrification of glass, 389.
 Diaspore, 416, (table) 412.
 Diatomaceous brick, 427-429.
 — — — — —, Maximum safe temperature, 277, 428.
 — — — — —, Thermal conductivity, 215, 266, 428.
 — — earth, (table) 428.
 — — — — — for insulating block, 431.
 — — — — — concrete, 431.
 — — — — — Granular, 432.
 — — — — —, Thermal conductivity, 215, 266, 428.
 Diffusivity, Effect on furnace time, 283-284.
 — — — — —, Effect on spalling of refractories, 403.
 — — — — — of checker brick, 355.
 Direct-fired furnace—
 Gas flow in, 163-172, (Summary) 209.
 Heat transfer in, 299-310, (Summary) 312-313.
 Pressure in, 183-185.
 Discharge coefficient, 177, 195.
 Disthene, 416.
 Distribution coefficient of oxides between slag and metal, 492.
 Dolomite, (table) 412.
 — — — — —, Expansion and contraction of, 395.
 — — — — —, Melting point of, 388.
 — — — — — plastics, 423.
 — — — — —, Thermal conductivity, 271.
 Draught, 159-162, 172-176.
 — — — — —, Direct-reading Scale, Plate I, facing 504.
 — — — — — formula, 172.
 — — — — — gauge, 191.
 — — — — — in regenerators, 364.
 — — — — —, Mechanical, 137, 175-176.
 — — — — —, Natural, 172-174.

Duct, Air infiltration into, 185-186.
 —, Non-circular, Equivalent diameter of, 158.
Dulong (formula for calorific value of coal), 32, 33.
Dulong and Petit (rule for finding specific heat), 107, 109.
Dust, Effect on gas radiation, 251.
 — in recuperators, 337-338.
 Dynamic energy per cubic foot of gases, 135-137.
Dyrsen, W., 370.

E

EARTH, Thermal conductivity of, 273.
Eason, A. B., 152, 211.
Eckman, J. R., and *Rossini, F. D.*, 31.
 Eddying flow, 133.
 — — —, Effect on convection, 224.
 — — —, in regenerators, 143-145, 359-361.
Efficiency, Thermal, 121-122.
 —, Effect of water cooling, 295-296.
Ejector, 175.
 Electric energy, Heat from, 87.
Elements, Symbols and atomic weights, (table) 5, 504.
Elgin, J. C., with *Perry, J. H.*, and *Ryan, W. P.*, 109.
 Elimination of impurities in refining processes, 497.
Emissivity, Definition, 230.
 —, Effect of Colour, 230.
 —, — — — shape, 231.
 —, — — — temperature, 230.
 —, (table) 230.
 "Emissivity" of furnace openings, 298.
Endothermic reactions, 112, 114, 442.
 — — —, Change to exothermic, 460.
 — — —, in regenerators, 363.
Energy loss of gases, 136.
 Calculation of, 138-145.
 due to disturbance, 145-151.
 in checkers, 143-144.
Energy, of gases, 134-145.
Enlargement of gas stream, 147-149.
Equation, Chemical (*see* Chemical equation).
Equilibrium, Chemical (*see* Chemical equilibrium).
Equilibrium constant—
 by combination of equations, 458-459.
 Calculation of, 450.
 Definition, for more complex systems, 448.
 —, for simple systems, 447.
 for carbon and its oxides, 455-457.
 for gaseous reactions, (table) 451-452.
 with concentrations in partial pressures, 449.
 — — — — per cent., 450.

Equilibrium, Physical, 443.
 Equivalent diameter of flue, 158.
 — — — of heat exchanger passages, 358.
Escape of gas (*see* Gas leakage).
Eutectic, 382.
Excess air, Calculation from flue gas analysis, 17-18.
 — — — chart, 62.
 — — —, Effect on available heat, 44-45.
 — — —, (Optimum amount of, 55-56.
 — — — table, 63, 64.
Exothermic reaction, 112, 114, 442.
 — — —, Change to endothermic, 460.
Expansion allowance in brick laying, 395.
 — — — and contraction of refractories, 388-395.
 — — —, Relation between linear and volume, 391.

F

FAHRENHEIT, Conversion to Centigrade, Direct-reading Scale, Plate 1, facing 504.
Felbeck, G. T., with *Goodenough, G. A.*, 38, 450.
Fenner, C. N., 392.
Ferric oxide, Chemical nature of, 385-386.
 — — —, Reduction of, 477-478.
Film, Gas, 219.
Findlay, A., 503.
Fiock, E. F., with *Osborne, N. S.*, and *Stimson, H. F.*, 26.
Firebrick (*see* Fireclay brick, etc.).
 Fireclay brick, (tables) 412, 414.
 Composition of, 386-387.
 Expansion and contraction of, 393-394.
 — — — allowance, 395.
 Growth of, 394.
 in regenerator checkers, 343.
 Insulating, 429-431.
 Melting point of, 387.
 Plastic deformation of, 401.
 Resistance to heat flow in regenerator checkers, 343.
 Shrinkage of, 394.
 Silica inversions in, 393.
 Spalling of, 405, 433.
 Strength at high temperatures, 400, 401.
 Super-duty, 421.
 Thermal conductivity, 215, 266.
 Vitrification, temperature, 401.
Fireclay plastics, 422.
Firesand, 424.
Firestone, 415.
Firing temperature of refractories, 396-397.
Fishenden, M., and *Saunders, O. A.*, 226, 264.
Flame(s), Heat transfer from luminous, 247-251, 301-302, 308-310.
 — — —, Length of, 52.
 — — —, Rate of propagation, 52.
 — — —, Reducing, Neutral, 54, 472-483.

- Flame luminosity, Effect on temperature, 250.**
 — radiation, Measurement of, 249, 250.
 — temperature, 67-72.
 — —, Actual, 70-72.
 — —, Measurement of, 250-251.
 — —, Theoretical, Calculation of, 67-70.
- Flow of gases (see Gas flow).**
- Flowmeters (see Venturi meter, Orifice meter, Pitot tube, Flow nozzles).**
 — nozzles, 200.
- Flue gas (see Products of combustion).**
 — — analysis, Importance of, 59-67.
- Flue gas temperature—**
 Calculation of, in recuperator, 326-332.
 — —, in regenerator, 346-348.
 Effect of furnace dimensions, 306-307.
 Effect of heat transfer in furnaces, 306-307.
 — on available heat, 46.
- Flues, Air infiltration into, 185-186.**
 —, Non-circular, Equivalent diameter of, 158.
- Forced convection, 220-225 (see Convection, Forced).**
 — draught, 175.
- Formation, Heat of (see Heat of formation).**
- Forsterite brick, 418-419, 412.**
- Fosalsil, 427.**
- Foundations, Steady heat loss in, 288-291.**
 —, Unsteady heat loss, 291-292.
- Free convection (see Convection, Natural).**
- Friction (gas), 151-159.**
 —, Coefficient of, (table) 154-155.
 —, Effect of gas composition, 157.
 —, — — pressure, 157.
 —, — — roughness, 152.
 —, — — temperature, 157.
 — in non-circular duct, 158.
 — through beds of solids, 157.
- Friend, J. N., 503.**
- Fuel(s)—**
 Calorific value of, (formula) 77.
 Carbon-hydrogen ratio from flue gas, 20.
 Characteristics of, (table) 73-74.
 Density of gaseous, (table) 163.
 Nitrogen in, 22.
 Oxygen in, 22.
 Products of combustion (see Products of combustion).
 Sulphur in, 23.
 (See also Products of combustion, Coal, Fuel oil, Gaseous fuels.)
- Fuel economy, Importance of, 57.**
 — gases, Preheating of, 322, 363.
 — —, Thermochemical data for, 30 (see also Gaseous fuels).
 — losses, 25.
- Fuel oil—**
 Air for combustion of, 14-17.
 Calorific value of, 34, (table) 73.
 Characteristics of, (table) 73.
- Fuel oil—**
 Metering of, 204.
 Products of combustion, 14-17.
- Fuel quantity, Effect on available heat, 49.**
- Furnace, Boiler, Carbon monoxide formation in, 468.**
- Furnace dimensions, Effect on available heat, 58-59, 306.**
 — —, Effect on flue gas temperature, 306-307.
 — —, — — heat transfer, 305.
- Furnace efficiency, 121-122.**
 — —, Effect of water cooling on, 295-296.
- Furnace, Gas flow in, 163-172 (see also Gas flow in furnaces).**
 — gases, Heat absorption by, 238-240, 308.
 — hearth, Pressure in, 183-185.
 — lining, Effect of temperature on heat transfer to stock, 302-304.
 — openings, "Emissivity" of, 298.
 — system, Pressure calculation of, 186-190.
 — temperature, Effect on available heat, 48.
 — —, under foundations, 289-290.
- Furnaces operated intermittently, Heat loss in, 287-288 (see also Heat loss, Unsteady flow).**
- Furnas, C. C., 153, 225.**
- Fused alumina brick, 416, (table) 412.**
 — — —, Spalling of, 434.
 — — —, Thermal conductivity, 266.
- Fused magnesite brick, 417, (tables) 413, 414.**
- Fusion, Latent heat of, 106.**
 — point of refractories (see Melting point of refractories).

G

GANISTER (gannister), 422.

Gas(es)—

- Absorption of heat by, 238-240, 308.
 Analysis of, Automatic, 65-67.
 Buoyancy of, 159-172.
 Cooling in duct, 257.
 Density of, 125-126 (see also Density).
 Dynamic energy of, 135-136.
 Effect of pressure on volume, 127-132, (Summary) 207.
 — — temperature on volume, 128-132, (Summary) 207.
 — on refractories, 411.
 Energy of, 134-145.
 Escape from furnace (see Gas leakage).
 Moisture in, Effect on density, 125-127.
 — —, — — heat transfer (see Gas radiation).

Gas(es)—

- Pressure energy of, 134-135.
 — equivalent (*p.e.*) of, 138-139, (Nomogram) 140.
 Sensible heat of, 35-40, (table) 36-37.
 Solubility in metals, 488, 493.
 Specific heat of, 35-40, (curve) 38.
 Static energy of, 134-135.
 Temperature-pressure relations of, (Nomogram) 131.
- Gas composition, Effect on available heat, 46.**
Gas film, 219.
 — flow, 124-211, (Summary) 207-211.
 — —, Analogy with liquid flow, 124, 163-172.
 — —, Change of direction, 147, (chart) 142.
 — —, Change of section, 146-151, (chart) 142, (curve) 148.
 — —, Difference from water flow, 169-172.
 — —, Effect of damper, 166-167.
 — —, — jets, 168-169.
 — —, Friction coefficient of, (table) 154-155 (*see also* Friction).
 — — in continuous direct-fired furnaces, 167-168.
 — — in ducts, 145-158.
 — — in furnaces, 163-172.
 — —, Measurement of, 193-207 (*see* Meters for gas flow).
 — —, Pressure equivalent (*p.e.*) of, 138-139, (Nomogram) 140.
 — — through beds of solids, 158.
- Gas flow, Types of, 132-134.**
 Eddying, 133.
 in recuperators, 324-325.
 Parallel or viscous, 132.
 Steady, 133.
 Streamline, 132.
 Turbulent, 132.
- Gas laws, Volumetric, 125-132, (Summary) 207, (Nomogram) 131.**
- Gas leakage, 176-186.**
 Effect on available heat, 47.
 Heat loss by, 281-282.
 in recuperator, 336.
 through brickwork, 181-183.
 — openings, 176-180.
- Gas pressure, Measurement of, 191-193.**
 — producers (*see* Producer gas, Producers).
 — —, Blast saturation temperature in, 469.
 — —, Optimum amount of steam in, 469.
 — quantity, Calculation of, 8-25.
- Gas radiation, 237-251, (Summary) 263.**
 Applications, 244.
 Effect of duct shape, 240.
 Effect of pressure, 242.
 from steam (table for low *DP* values), 323.
 in furnaces, 301, 308.
 in heat exchangers, 321-323.

Gas radiation—

- Laws governing, 238-243.
 Nomogram, 241.
 —, Basis of, 243-244.
 Selective nature of, 245-247.
 Simultaneous, by two gases, 244-247.
 Wavelength distribution, 245-247.
- Gas solubility in metals, 488, 493.**
 — temperature, Effect on available heat, 46.
 — —, Measurement of, 260.
 — — stream, Contraction in, 149-151.
 — —, Distinction between energy and pressure losses, 150.
 — —, Friction in, 151-158 (*see also* Gas flow, Friction).
 — velocity, in chimneys, 174.
 — —, Measurement of, 193-207.
- Gaseous fuel(s)—**
 Air for combustion (*see* Combustion, Air required for).
 Calorific value of, 32, (formula) 77, (table) 74 (*see also* Calorific value).
 Characteristics of, (table) 74.
 Products of combustion (*see* Products of combustion).
 Speed of combustion, 462.
- Gaseous phase, Definition of, 443.**
 —, Reactions in, 444-448 (*see also* Chemical equilibrium).
 — reactions (*see* Chemical equilibrium).
 — —, Equilibrium constants for (table) 451-452.
- Gay-Lussac's law, 129.**
Gibb's phase rule, 438.
Gibbsite, 416.
Gilbert, W., with *Heenan, H.*, 192.
Glass, Devitrification of, 389.
 — in refractories, 381, 389, 396.
Goff, G. A., 469.
Goldschmidt, H., and *Partridge, E. P.*, with *Schack*, 264, 313, 378.
Goodenough, G. A., and *Felbeck, G. T.*, 38, 450.
- Graphical solution for steady heat flow, 279-280.**
 — — — unsteady heat flow, 283.
- Graphite, 30, 31, 441.**
Graphite brick, 419, (table) 412.
 —, Thermal conductivity, 271.
- Green, A. T.*, and *Dale, A. J.*, 404.
Greig, J. W., with *Bowen, N. L.*, 383.
Groeber, 355.
Grog, 395-396.
 —, Effect on spalling, 404-405.
Groume-Grjimaio, W. E., 145, 159, 211, 365.

H

- Harris, C. H.*, with *Lister, J. E.*, 211.
Hartmann, M. L., and *Hougen, O. A.*, 428.
Haskins, C. N., with *Clement, J. K.*, and *Adams, L. H.*, 463, 467.

- Haslam, R. T., and Chappell, E. L.*, 260.
Huslam, R., and Russell, R., 78.
 Hearth, Furnace, Heat loss through foundations, 288-292.
 —, —, Pressure in, 183-185.
 —, —, Temperature under foundations of, 289-290.
 Heat absorption by furnace gases, 238-240, 308.
 —, Atomic, 107.
 —, Available, 40-59 (*see* Available heat).
 —, Sensible (*see* Sensible heat).
 —, Specific (*see* Specific heat).
 Heat balance, 86-123.
 Heat input, 86.
 — output, 87.
 Heat conduction, 212-219 (*see* Thermal conductivity).
 Heat exchange characteristic, 357.
 — — — factor (curve), 327.
 Heat exchangers, 314-378, (Summary) 374-378 (*see* Recuperators, Regenerators).
 Brick thickness, 323.
 Convection in, 318-321.
 Design calculation, 340.
 Diameter of passages, 321, 358.
 Direction of flow in, 365, 367.
 Effect of air humidity, 372.
 for fuel gases, 322.
 Gas radiation in, 321-323.
 — velocity in, 319-320, 357-358.
 Improvements in, 369-372.
 Mathematical theory of, 326-327.
 Mean resistance to heat transfer, 333.
 Minor types of, 372-374.
 Multiple pass, 366-368.
 — — —, Pressure loss in, 368.
 Pressure loss in, 357-368.
 Proportions of, 319.
 Shape of flues, 358.
 Heat flow, Steady—
 General case, 251-259.
 Graphical solution, 279.
 Resistance of brick joints to, 273.
 through complex wall, 217-219.
 (*See also* Heat exchangers, Recuperators, Regenerators, Heat loss.)
 Heat flow, Unsteady—
 Graphical solution, 283.
 Hydraulic solution, 283.
 into foundations, 291 (*see* Heat loss).
 Heat from chemical changes in batch, 111-120.
 — input, 86.
 — insulators (*see* Insulation).
 Heat loss, Steady flow—
 Brick equivalent of, 281.
 by gas leakage, 281-282.
 Effect on available heat, 47.
 from hot brick joints, 298.
 from hot surfaces, 236-237, (curve) 227.
 Heat loss, Steady flow—
 in foundations, 288-292.
 — — —, Effect of insulation, 290.
 through openings, 296-298.
 — — —, Effect of dimensions, 297-298.
 through walls, 269-270.
 — — —, Effect of external temperature, 259, 269-270.
 — — —, — — — surroundings, 269-270.
 — — —, Practical calculation of, 265-281.
 — — —, — — — — —, for abnormal surface loss, 275.
 — — —, Recovery of, 373.
 — — —, Use of Plate 11, 267, 270, 275-279.
 to water cooling, 292-296.
 — — —, Exposed cooling elements, 292-294.
 — — —, Protected elements, 294-295.
 (*See also* Heat flow.)
 Heat loss, Unsteady flow—
 by heat storage, 282-288.
 — — —, Effect of insulation, 286-288, 430.
 Conditions affecting, 287.
 during heating, 282-286.
 during regenerator reversal, 352-353.
 in furnaces operated intermittently, 287.
 Heat, Molecular, 109.
 — of combustion, 25-34, (table) 30 (*see also* Coal, Fuel oil, Gaseous fuel).
 — — — decomposition (*see* Heat of formation).
 — — — of limestone, 114, 484.
 Heat(s) of formation, 28.
 Carbon dioxide from amorphous carbon, 31, 441.
 — — — — graphite, 36, 441.
 — — — oxides, 30.
 Compounds (table), 113.
 Examples, 114, 122-123.
 Hydrocarbons (table), 30.
 Slags, 114-117.
 Steam (table), 30.
 Sulphur dioxide (table), 30.
 Heat of fusion, Latent, 106.
 Heat of reaction (tables), 30, 113, 115.
 Calculation, 122-123.
 Change with temperature, 439-442, (Summary) 498.
 Endothermic, 112, 114, 442.
 Exothermic, 112, 114, 442.
 Heat output, 87.
 — radiation (*see* Radiation, Gas Radiation).
 Heat stored in walls, 282-288.
 Effect of insulating refractories on, 287.
 — — — insulation on, 286-288, 430.
 Utilisation of, 286.

- Heat transfer, 212-313, (Summary) 261-264, 310-313.**
 Across joints in brickwork, 273.
 Applications to pyrometry, 259-261.
 Coefficients, Relative magnitude, 258.
 Effect of absorption by furnace gases, 238-240, 308.
 — — — "boil," 300.
 from luminous flames, 247-251, 301-302, 308-310.
 General case, 251-259.
 in beds of solids, 225.
 in direct-fired furnaces, 299-310, (Summary) 312-313.
 in heat exchangers, 318-324.
 Practical calculation, 265-313.
 Principles of, 212-264.
 Simultaneous in two ways, 274.
 (See also Thermal conductivity; Conduction; Radiation; Gas radiation; Luminous flames; Convection, Forced; Convection, Natural; Heat flow; Heat loss.)
 Heat transfer to stock, 58-59, 299-310.
 by convection 299-300.
 by gas radiation, 301, 308.
 by luminous flames, 247-251, 301-302.
 Effect of wall temperature, 302-303.
 — — — wall to hearth ratio, 305-307.
 Indirect, 302-310.
 Heat transmitting surface in recuperator, 332.
 — — — units, Conversion of, 26 (Direct-reading Scale, Plate I, facing p. 504).
 — — —, Definition, 25.
Heenan, H., and Gilbert, W., 192.
Heil, W., 141.
Heiligenstaedt, W., 341, 378.
 Henry's law, 493.
Hermansen, A., 7.
Hess, Law of constant heat summation, 119.
 High-alumina brick, 415-417, (tables) 412, 413, 414.
 Cast, 417.
 Composition of, 387.
 Expansion and contraction of, 394.
 Fused, 416.
 Melting point of, 387.
 Spalling of, 405, 433-434.
 Strength at high temperatures, 401.
 Thermal conductivity, 271.
 High temperature insulating block (see Insulating block).
 Homogeneous mixture of oxides, Oxygen pressure of, 495-497.
Hotel, H. C., and Keller, J. D., 297.
Hougen, O. A., with Hartmann, M. L., 420.
Hugill, W., and Rees, W. J., 391.
 Hydraulic device for solving unsteady heat problems, 283.
 Hydrocal, 283.
- Hydrocarbons, Heat of combustion of,** (table) 30.
 — — —, Heat of formation of, (table) 30.
Hydrogen, Combustion of, 440, 457.
 — — —, Equilibrium with water vapour, 457, (tables) 451-452.
 — — — in flue gas, 20, 64, 71, 454-455.
 — — —, Reduction by, 482.
- I
- IDEAL solution, Definition of,** 490-491.
 Ignition temperature, 53, 462.
 Imperfect mixing, Effect on available heat, 51-54.
 Impingement of gas, Effect on convection, 223, 299, 300.
 Incomplete combustion, Effect on available heat, 45-46.
 Induced draught, 175-176.
 Infiltration, Air, 176-186.
 — — —, — — —, Calculation from gas analysis, 64-65.
 — — —, — — —, Effect on available heat, 45.
 — — —, — — —, in recuperators, 336.
 Infusorial earth, 427.
 Insulating block, 431, (table) 428.
 Economic considerations, 278.
 Maximum safe temperature of, 277.
 Thermal conductivity, 215, 266, 428.
 Insulating brick, 427-431, (table) 428.
 Insulating firebrick, 429-431.
 Porous clay brick, 429.
 Refractory insulators, 429-431.
 — — —, Cost of, 430.
 Thermal conductivity, 215, 266, 428.
 Use as inner lining of furnaces, 427, 429-430.
 Insulating cements, 431.
 — — — concrete, 431, (table) 428.
 — — —, Thermal conductivity, 428.
 — — — Material(s), 426-432, (table) 428 (see Insulating block and Insulating brick).
 — — — Material(s), Granular, 432, (table) 428.
 — — —, — — —, Thermal conductivity, 215, 266, 271, 428.
 — — —, Non-refractory, 272.
 — — — Plastics, 431, (table) 428.
Insulation—
 Advantage of, 276-279, 427.
 as inner lining, 279, 427, 429-430.
 Effect on heat loss through hearth, 290-291.
 Effect on heat storage, 286-288, 430.
 for furnace roofs, 305, 431.
 Indirect effects of, 431.
 Interbonding of different refractories, 425.
 Interface temperature, Calculation of, 268-269.
 Intermittent operation of furnaces, Heat storage, 287-288.

Iron, Oxidation by carbon dioxide, 477-488.
 — oxide, Chemical nature of, 385-386.
 — —, Effect on silica brick, 385-386.
 — —, Reduction of, 477-478.
 — —, Refractories resistant to, 410,
 (table) 412-413.
 —, Spongy, as catalyst, 471.

J

Jakob, 158.
Jungfleisch, 492.
Jürges, W., 225.

K

KAOLIN (table), 413
 —, Composition of, 386.
 —, Melting point of, 387.
 —, Spalling, 433.
 —, Strength at high temperatures, 401.
 —, Thermal conductivity, 271.
Keller, J. D., 288, 291.
Keller, J. D., with *Hotel, H. C.*, 297.
Kelley, K. K., 89, 90, 98, 108, 109.
Kelley, K. K., and *Anderson, C. T.*, 114.
Kemler, E., 152.
Kieselguhr, 427.
 Kilns, Continuous compartment, 374.
 —, Rotary, 309.
 —, Tunnel, 374.
 Kinetic energy of gases, 135.
King, H. W., and *Wiser, C. O.*, 149.
 Kirchhoff's law, 440, 450, 460.
 —, Illustrations of, 440-442.
Kistner, H., 144, 225.
 Kopp's law, 109.
Kropff, A. H., with *Sherman, H. C.*, 34.
 Kyanite, 416.

L

LATENT heat of fusion, 106.
 Law of constant heat summation, 119, 440.
 — mass action, 438.
 Leakage of air or gas, 176-186.
 Conditions in furnace causing, 182,
 183-185.
 in recuperator, 336.
 through brickwork, 181-183.
 through openings, 176-180.
Le Chatelier, M. H., 392.
 Le Chatelier's principle, 438, 459-460,
 (Summary) 499.
 —, and velocity of reaction, 470.
Le Conte, J. N., 148.
Lewis, W. K., and *Radasch, A. H.*, 78.
Lewis, W. K., with *Walker, W. H.*, and
McAdams, W. H., 211.

Limestone, Decomposition of, 484.
 —, Heat of decomposition of, 114, 115.
 Linear expansion, 391.
 Liquid fuel (table), 73.
 —, Calorific value of, 34, 73.
 — phase, Definition of, 443.
 Liquids, Metering of, 204.
Lister, J. E., and *Harris, C. H.*, 211.
 Loss of gas, Effect on available heat, 47.
 Losses, in metallurgical processes, 80, 85-86.
 Luminous flames, Heat transfer from,
 247-251, 301-302, 308-310.

M

McAdams, W. H., 264.
McAdams, W. H., with *Walker, W. H.*, and
Lewis, W. K., 211.
McLoughlin, T. J., 365.
 Magnesias, Amorphous and crystalline, 394.
 —, Powdered, in insulating block, 431.
 Magnesite brick, (table) 413, 414.
 Allowance for expansion, 395.
 Composition of, 387.
 Expansion and contraction of, 394.
 Laying in sheet steel, 410.
 Melting point of, 387.
 Periclase in, 394.
 Resistance to acid slag attack, 408.
 Slag action, 410.
 Spalling of, 406, 417, 434.
 Special, 417-418.
 Steel-cased, 417.
 Strength at high temperatures, 402.
 Thermal conductivity, 215, 266.
 Unburnt, Chemically bonded, 418.
 Magnesite cement, 425.
 —, Fused, 417, (table) 413, 414.
 — plastics, 423.
Maier, C. G., 474, 481.
 Manometer, 191.
 Mass action, 438, 444-461, (Summary) 498.
 Material balance sheet, 79-86.
 —, Sources of error in, 85-86.
 Matte, 443, 498.
Mawhinney, M. H., 7.
 Maximum safe temperature for diatom-
 aceous earth, 277.
 — for insulating block, 277.
 Mechanical draught, 137, 175-176.
 Melting point of refractories, 380-388.
 — refractory oxides, 380.
 Metal and slag, Equilibrium between, 488-
 497.
 Metal(s), Deoxidation of, 488-495, (Sum-
 mary) 503.
 —, Heating of, 288.
 —, Solubility of gases in, 488, 493.
 —, — oxygen in, 474, 486-488.
 Metallcase bricks, 417.
 Metallic losses in smelting, 80, 85-86.
 — recuperators, 318.

P

- Pannell, J. R., with Stanton, T. E.*, 153.
 Parallel flow of gases (streamline flow), 132.
 ——— type of recuperator, 324.
 Partial pressures, 449, (Summary) 499.
 Partition coefficient, 492.
Partridge, E. P., with Schack, A., and Goldschmidt, H., 264, 313, 378.
 P.C.E., 380.
 P.e. (pressure equivalent of dynamic energy), 138, (Nomogram) 140.
 Periclase, 394.
Perry, J. H., Elgin, J. C., and Ryan, W. P., 109.
 Phase(s), 443.
 Phase rule, 438.
 Physical chemistry, 437-503.
 Application to manufacture of producer gas, 463-470.
 ——— water gas generation, 469.
 Metallurgical processes which have been studied, 497-498.
 (See also Maas action, Velocity of reaction, Oxidation and reduction, Reactions between slag and metal.)
 Piezometer ring, 192.
Pigott, R. J. S., 153, 154.
 Pitot tube, Characteristics of, 201-203.
 Plastic deformation of refractories, 398.
 Plastic(s), Insulating, 431, (table) 428.
 ———, Refractory, 421-424.
 Porosity of refractory, 396.
 ———, Effect on slag attack, 409.
 Porous clay brick, Insulating properties of, 429.
 Portland cement in insulating concrete, 431.
 ——— in refractory cements, 425.
 ——— in refractory plastics, 422.
 Pound-atom, 5.
 ——— -calorie (see C.H.U.), 25.
 ——— -molecule, 5.
 ——— of gas, Volume occupied by, 9.
Prandtl, L., and Tietjens, O. G., 150.
 Pressure—
 Absolute, 127.
 Atmospheric, 128, 160, 162.
 Barometric, 128, 160, 162.
 Conversion to water gauge, 135.
 due to buoyancy, 160.
 Effect on gas radiation, 242.
 ——— volume, 127.
 ——— p.e. of gas, 139.
 ——— velocity measurement, 196.
 in furnace hearth, 183-185.
 ——— system, 186-190.
 Standard, 8.
 Static, Measurement of, 191-192.
 Pressure changes in gas flow, Magnitude of, 137.
 ——— cracks in refractories, 404.
 ——— energy, Effect of contraction and enlargement, 146-151.
- Pressure equivalent of dynamic energy (p.e.), 138.
 Effect of density on, 139.
 ——— pressure on, 139.
 Nomogram, 140.
 Pressure loss, 136-145, 150.
 ——— due to disturbance, 136-151.
 ——— ——— friction (formula), 151.
 (see also Friction).
 ——— factors (charts), 142, 148.
 ——— in checkers, 143-144.
 ——— in furnace systems, 186-188, (Summary) 208.
 ——— in regenerators and recuperators, 357-368.
 ——— through beds of solids, 158.
 ——— -temperature relations of gases (Nomogram), 131.
 Primary air, 53.
 Principles of heat transfer, 212-264.
 Producer gas—
 Air for combustion of, 11-13.
 Application of physical chemistry in manufacture, 463-470.
 Calculation of air used in manufacture, 24.
 ——— volume from weight of coal, 23.
 Chemical equilibrium in, 452-454.
 Clinkering in manufacture, 466, 469.
 Density of, 126.
 Depth of fuel bed, 466-467.
 Effect of cooling gas, 467-468.
 Heat from combustion of, 41-42.
 Metering of, 204.
 Nature of coal, 467.
 Products of combustion, 11-13.
 ———, Density of (table), 163.
 Size of coal, 467.
 Temperature of fuel bed, 466.
 Time of contact between fuel and gas, 466.
 Total heat of, 41-42, 56.
 Producers, Blast saturation temperature in, 469.
 ———, Optimum amount of steam in, 469.
 Products of combustion—
 Calculation of excess air from, 18.
 ——— moisture content in, 16, 19.
 ——— volume, 21.
 Calculations on, 18-23, 61-64.
 Chemical equilibrium of, 454-455.
 Density of (table), 163.
 Hydrogen in, 20, 64, 71, 454-455.
 Instruments for automatic analysis of, 66-67.
 Moisture content, 16, 19, 22.
 Quantity of (empirical rule), 74.
 Products of combustion, Theoretical, 11-17, 76.
 Coal, 14.
 Gaseous fuel, 11-13.
 Liquid fuel, 14.

- Pyrometer, Optical, Measurement with, 250-251, 260.
 —, Radiation measurement with, 250-251, 260.
 Pyrometric cone equivalent, 380.
 Pyrometry, Application of theory of heat transfer to, 259-261.
- Q**
- QUARTZ, 390-392.
 Quartzite, 415.
- R**
- Radasch, A. H.*, with *Lewis, W. K.*, 78.
 Radiation, 228-236, (Summary) 262.
 Black body, 229.
 by dust, 251.
 Direct-reading Scale for, Plate I, facing 504.
 Correction nomogram for direct scale, 233.
 Effect of colour, 230.
 — roughness, 230.
 — shape, 231.
 — size, 235.
 — temperature, 230.
 Factors affecting, 235.
 from gases, 237-251 (*see* Gas radiation).
 — luminous flames, 247-251, 301-302, 308-310.
 — outer surfaces, 228-237, (curve) 227.
 in furnaces, 301-303.
 laws, 229.
 Nomogram for, 232.
 to stock, 301 (*see also* Gas radiation).
 Radiation pyrometer, Measurement with, 260.
 —, — of flame temperature, 250-251.
Ramsin, L. K., 158.
Raoult, 491.
 Reaction(s) between slag and metal, 488-498.
 —, Heat of, (tables) 30, 113, 115 (*see also* Heat of reaction).
 — in gaseous phase, 444-461 (*see also* Chemical equilibrium, Equilibrium constant, etc.).
 —, Velocity of, 445-446, 461-472 (*see* Velocity of reaction).
 Recirculation of waste gases, 373.
 Recovery and yield in metallurgical processes, 79-80.
 Recuperators, 314-318, 324-341.
 Air leakage in, 336.
 — passages, Design of, 359.
 Brick temperature in, 334.
 Comparison with regenerators, 315-318.
 Counter flow, 324, 326.
 Cross flow, 325, 368.
 Dust in, 337-338.
 Recuperators—
 Efficiency of, 338-340.
 Fillers in air passages, 370-371.
 Furnaces using, 315-318.
 Heat losses through walls, 335.
 — transfer in, 318-324.
 — transmitting surface, 332.
 Metallic, 318.
 Most economical size, 338.
 Parallel flow, 324.
 Pressure loss in, 357-368.
 — cross flow, 368.
 Resistance to heat transfer, 325, 330-333, (Summary) 374-376.
 Silicon carbide, 318, 337.
 Temperature of air preheat (calculation of), 326, 329-333.
 — flue gas (calculation of), 326, 329-333.
 (*See also* Heat exchangers, Recuperators and regenerators.)
 Recuperators and regenerators—
 Air and gas distribution in, 364-365.
 Bypassing of waste gas, 369.
 Comparison between, 315-318.
 Factors governing heat transfer in, 318-324.
 Red brick as heat insulator, 276, 426.
 —, Thermal conductivity, 270.
 Reducing flame, 54.
 — gases, Effect on refractories, 411.
 Reduction (and oxidation)—
 Assisted by solution, 494-495.
 Nature of, 473.
 Physical chemistry of, 472-488, (Summary) 500-501.
 Velocity of, 483.
 Reduction by carbon, 482-483.
 Silica, 483.
 Reduction by carbon monoxide, 476-481.
 Ferric oxide, 477-478.
 Silica, 478, 483, 494.
 Zinc oxide, 479-480.
 Reduction of higher to lower oxide, 485.
 — of mixed oxides, 485-488.
Rees, W. J., with *Hugill, W.*, 391.
 Refining processes, 488-490, 495-498.
 Refractories, 379-436.
 " Bloating " of, 390.
 Bonding of, 424-426 (*see* Refractory cements).
 Characteristics of (table), 412-413.
 Supplementary notes on, 434-435.
 Cost of, (table) 412-413.
 —, Cast bauxite, 417.
 —, Forsterite, 418, 419.
 —, Special chrome, 418.
 —, Special magnesite, 418.
 —, Super-duty fireclay, 421.
 Crystalline changes in, 389-394.
 Density of, (table) 412-413.
 Devitrification in, 389.
 Diffusivity, Effect on spalling, 403.

- Refractories—
 Effect of gases on, 411.
 ——— water on, 411.
 Expansion and contraction of, 388-395.
 ———, Allowance for, 395.
 ———, Effect on spalling, 402.
 Failure under load, 397-402.
 Firing temperature, 396-397.
 Glass in, 381, 389, 396.
 ———, Effect on spalling, 404.
 Grog in, 395-396.
 ———, Effect on spalling, 404-405.
 Heat conductivity of, 215 (*see also*
 Thermal conductivity, Standard brick
 equivalent).
 Interbonding of, 425.
 Internal stress (*see* Spalling).
 Iron oxide in, 385-386, 411.
 Irreversible volume changes in, 389-394.
 Melting point, 380-388.
 Plastic deformation of, 398.
 Porosity of, 396.
 ———, Effect on gas leakage, 181-
 183.
 ———, ——— slag attack, 408.
 Poured and dipped joints, 424.
 Pressure cracks in, 404.
 Process used in manufacture, 421.
 Properties of, (table) 412-413.
 Resistance to iron oxide, 410, (table)
 412-413.
 ——— load at high temperatures, 397-
 402.
 Reversible volume changes, 389-394.
 Selection of, (table) 414.
 Sensible heat of, 97, 105.
 Shearing of, 398-399.
 Shrinkage of, 390.
 Slag attack, 406-410, (table) 414 (*see also*
 Slag attack on refractories).
 Spalling of, 402-406 (*see also* Spalling and
 particular refractory).
 Special, 411-421.
 Specific gravity of, 412-413.
 ——— heat of, 97, 105.
 Strength of, at high temperatures, 397-
 402.
 Texture of, 395-397.
 Effect on slag attack, 408.
 ——— spalling, 404.
 ——— strength at high temperatures,
 400.
 Thermal conductivity of (*see* Thermal
 conductivity and Standard brick
 equivalent).
 Trowelled joints, 424, 426.
 Vitrification of, 381.
 Effect on slag attack, 408.
 ——— spalling, 404.
 ——— strength at high temperatures,
 400.
 ——— texture, 396.
 (*See also* particular refractory.)
- Refractory cements, 424-426.
 ——— insulation, 426-432 (*see* Insulating,
 Insulation).
 ——— oxides, Melting points of, 380.
 ——— plastics, 421-424.
 Regenerator(s), 314-318, 341-357.
 Bypassing of flue gas, 369-376.
 Comparison with recuperators, 315-318.
 Draught in, Natural and mechanical,
 364.
 Eddying flow in, 359-361.
 Efficiency of, 354.
 Endothermic reactions in, 363.
 Factor, (curves) 327.
 Fan-tails, 366.
 Furnaces using, 315-318.
 Headers, 365.
 Heat losses during reversal, 352-353.
 Heat transfer in, 318-324, 341-342.
 By convection, (Nomogram) 222.
 ———, for staggered checkers, 225,
 354.
 Resistance of checkers to, (table) 343-
 344.
 Heating fuel gases in, 322, 363.
 Horizontal, 365.
 Multiple-pass, 365-368.
 Pressure loss in, 143-144, 357-368.
 Recuperator tile in, 371.
 Resistance to heat transfer, 341-347,
 (Summary) 374-376.
 Size, Relative, for air and gas, 363.
 Temperature fluctuations during cycle,
 348-351.
 Effect of length of cycle, 351-354.
 Temperature of air, Mean, 348.
 ——— preheat, Calculation of, 346-
 348.
 Temperature of flue gas, 346-348.
 Two and three pass, 366-368.
 (*See also* Heat exchangers, Recuperators
 and regenerators, Recuperators, Re-
 generator checkers, etc.)
- Regenerator checkers—
 Brick thickness, 354-357, 362-363.
 Checkers *versus* straight passages, 359-
 361.
 Choking of, 361, 362.
 Cleaning of, 367.
 Diffusivity of, 355-357.
 Heat transfer in (*see* Regenerators, Heat
 transfer in).
 Materials for—
 Fireclay brick, (table) 343.
 Metal, 356.
 Silica brick (table), 344.
 Silicon carbide, 356-357.
 Resistance to heat flow, (tables) 343-
 344.
 Spalling of, 353.
 Temperature fluctuations in, 349, 350.
 ——— of, Effect on life, 366.
 Wells in, 366.

- Regenerator cycle, 341.
 Effect on spalling, 353.
 Optimum length of, 351-354.
 Regenerators and recuperators (*see* Re-
 recuperators and regenerators).
 Reverberatory furnaces (*see* Direct-fired
 furnace).
 Reversible reactions (*see* Chemical equi-
 librium).
 Reynolds' number, 152, 157.
 Richards, J. W., 7, 123.
 Ritschels, H., with Brabbée, K., 141.
 Rotary kiln, Heat transfer in, 309.
 Roth, W. A., and Naeser, W., 31.
 Roughness, Degree of, 152.
 —, Nature of, 153.
 Rummel, 341, 355.
 Ryan, W. P., with Perry, J. H., and Elgin,
 J. C., 109.
- S**
- SAND, as heat insulator, 271, 426.
 Saturated solutions, 491.
 Sauerswald, F., 503.
 Saunders, O. A., with Fishenden, M., 226, 264.
 Schack, A., 221, 240, 244, 245, 246, 264,
 309, 313, 341, 355, 378.
 Schenck, R., 503.
 Schulze, E., 221.
 Searle, A. B., 391, 436.
 Secondary air, 53.
 Seger cones, 380.
 Selection of flowmeters, 206.
 — — — gas analysing equipment, 66-67.
 Semi-silica brick, 415, (table) 414.
 Sensible heat, 35-40.
 Definition, 35.
 of coke, 110.
 of gases, (table) 36-37.
 of refractories, 97, 105.
 of solid and fused substances, (tables)
 90-105, 108.
 of steam, 108.
 of vapours, 110.
 Shearing of refractories, 398-399.
 Sherman, H. C., and Kropff, A. H., 34.
 Shrinkage of refractories, 390.
 "Siemensite" bricks, 418.
 Silica—
 Inversion temperatures of, 392.
 Reduction of, by carbon, 483.
 — — —, by carbon monoxide, 478.
 — — —, in solution, 494.
 Silica-alumina diagram, 383-384.
 Silica brick, (tables) 413, 414.
 "Agate," 411.
 Allowance for expansion, 395.
 "Black," 411.
 Clay-bonded, 415.
 Composition of, 386.
 Contraction and expansion of, 390-393.
- Silica brick—
 Cristobalite in, 391.
 Effect of iron oxide on, 386, 411.
 in checkers, Resistance to heat transfer,
 (table) 344.
 Irreversible changes in, 391, 393.
 Melting point, 386.
 Modified, 411.
 Quartz in, 391.
 Resistance to basic slag, 408.
 Reversible changes in, 391-392.
 Semi-silica, 415, (table) 414.
 Silicate glass in, 391.
 Slag action, 410, (tables) 413, 414.
 Spalling of, 405, 415, 434.
 — — —, at high temperatures, 405.
 Strength of, 400.
 Thermal conductivity of, 215, 266.
 Tridymite in, 391.
 Silica cement, 425.
 — — — plastics, 422.
 Silicate glass, 391.
 Siliceous clay bricks, 415.
 Silicon carbide, 419-420.
 for checkers, 356-357.
 for recuperators, 318, 337.
 Silicon carbide brick, 419-420, (tables)
 413, 414.
 Spalling of, 433.
 Thermal conductivity, 266.
 Silicon nitride, 420.
 Sillimanite, 415, 416.
 "Sil-O-Cel," 427.
 "Siloxicon," 420.
 Slag and metal, Equilibrium between, 488-
 497.
 — — — — —, Speed of reaction between,
 463.
 Slag(s)—
 Constitution of, 114-117, 490-491.
 Heat of formation, 114-117.
 Oxygen pressure of, 490, 493-497.
 Vapour pressure of, 491.
 Slag attack on refractories, 406-410.
 — — — — — by gas-borne particles, 410, 418-
 419.
 — — — — —, Effect of brick texture on, 408-
 409.
 — — — — —, — — — defective brickwork on,
 409.
 — — — — —, — — — slag movement, 408.
 — — — — —, — — — splashing, 409-410.
 — — — — —, — — — temperature, 408.
 — — — — —, — — — on spalling, 405, 409.
 — — — — —, Refractories resistant to, 410,
 (tables) 412-414 (*see also*
 particular refractory).
 Solid phase, Definition of, 444.
 — — — solution, Definition of, 444.
 Solution(s), (Summary) 502.
 Distribution coefficient of, 492.
 Ideal, 490-491.
 of gases in metals, 493.

- Solution(s)**—
of oxides, Oxygen pressure of, 486-488.
Oxygen pressure of, 493-495.
Reducibility of, 494-495.
Saturated, 491.
Vapour pressure of, 491.
- Spalling of refractories**, 402-406, 412-414, (tables) 412-414, 433-434.
by carbon transfer, 405.
by pressure cracks, 404.
by slag penetration, 405.
Effect of diffusivity on, 403.
— expansion rate on, 402-403.
— glass, 404.
— grog on, 404, 405.
— mechanical properties on, 403.
— slag absorption, 409.
— temperature gradient, 404.
— texture, 404.
— vitrification, 404.
in regenerators, 353.
(See also particular refractory.)
- Specific heat**, 35-40, (Summary) 310-311.
Definition, 35.
of coke, 110.
of gases, (curve) 38.
of refractories, 97, 105.
of solids and fused substances, (tables) 90-105, 108.
of steam, 108.
of vapours, 110.
Rules for determining, 107-110.
- Speed of reaction**, 445-446, 461-472 (see also Velocity of reaction).
- Speiss**, 443, 498.
- Spinel brick**, 419.
—, Spalling of, 434.
—, Thermal conductivity, 266.
- Splashing of slag**, Effect on refractory erosion, 409-410.
- Spongy iron**, as catalyst, 471.
- Stahl, W.**, 474.
- Standard brick equivalent(s)**, 265-268.
Contact resistance, 273.
Conversion from coefficient of conductivity, 266.
Definition, 265.
of checkers, (table) 343-344.
of construction materials, 270.
of convection, 274.
Direct-reading Scale (Plate I) facing p. 504.
of gas radiation, 274.
Direct-reading Scale (Plate I) facing p. 504.
of heat transfer in parallel, 274.
of non-refractory material, 272-273.
of radiation, 274.
Direct-reading Scale (Plate I) facing p. 504.
of refractory and insulating materials, (table) 266, (other values) 271-273, 428.
of surface heat loss, 274-275, 281.
- Standard conductivity, 266.
Standard temperature (for gas volume), 8.
— (for thermal data), 439.
Stanton, T. E., and Pannell, J. R., 153.
Static pressure, Measurement of, 191.
Steady flow of gases, 133.
— heat flow (see Heat flow, Steady; and Heat loss, Steady).
Steam, Radiation from, (Nomogram) 241, (table) 323.
—, Sensible heat of, 108.
Stimson, H. F., with Osborne, N. S., and Fiock, E. F., 26.
Stock, Heat available to, 40-59 (see Available heat).
—, Heat transfer to, 58-59, 299-310 (see also Heat transfer).
—, Pressure loss through beds of, 158.
Stoichiometric calculations, 10-25.
Storage of heat in walls, 282-288 (see also Heat stored).
Stream shape, 145.
Streamline flow, 132, 157.
Strength of refractories at high temperatures, 397-402 (see also particular refractory).
Sulphur, Heat of combustion of, 30.
— in fuel, 23.
—, Physical chemistry of elimination, 484.
- Super-duty fireclay bricks**, 421.
Surface combustion, 52.
— heat loss, Standard brick equivalent of, 274-275, 281.
— radiation, 228-237, (curve) 227 (see also Radiation).
- Surface temperature**—
Calculation of, 255-256.
Determination of, by Plate II, 268.
Effect of surroundings on, 269-270.
System, Definition, 444.

T

- TAB**, Characteristics and calorific value of, (table) 73.
- Temperature**—
Absolute, 128.
Beneath furnace hearth, 289-290.
conversion, Direct-reading Scale (Plate I), facing p. 504.
Effect on buoyancy, 161.
Direct-reading Scale (Plate I), facing p. 504.
Effect on gas volume, 128-129, (Nomogram) 131.
— heat of reaction, 439-442.
— slag attack of refractory, 408.
— velocity of reaction, 465.
- Flame**, 67-72.

Temperature—
 Interface, Determination of, by Plate II, 268.
 of flue gas (*see* Flue gas temperature).
 Surface (*see* Surface temperature).
 Temperature measurement—
 Flame, 250-251.
 Gases, 260.
 Solids or liquids, by optical and radiation pyrometers, 260-261.
 Temperature of fuel, Effect on available heat, 46.
 — — — furnace walls, Effect of wall to hearth ratio, 305.
 — — — outer surface of wall (*see* Surface temperature).
 Temperature-pressure relation of gases (Nomogram), 131.
 Texture of refractories, 395-397 (*see* Refractories, Texture of).
 Theoretical flame temperature—
 Calculation of, 67-70.
 Value of, 72.
 Theory of gas flow, 124-211.
 Thermal (*see* Heat).
 — — balance sheet, 86-123.
 — — — — —, Heat input, 86.
 — — — — —, — — output, 87.
 — — conduction, 212-219.
 — — conductivity of refractories, Coefficient of, 214 (*see also* Standard brick equivalent).
 — — data, Dependence on conditions of measurement, 438.
 — — efficiency, 121-122.
 Thermo-chemical data, (tables) 30, 113, 115.
 — — — — —, Standard temperature for measurement of, 439.
 (*See* Heat of combustion, Heat of formation, Heat of reaction.)
 Thermo-couple for measurement of gas temperature, 260.
 Three-pass blast furnace stoves, 367.
 — — — regenerators, 365-368.
 Tietjens, O. G., with Prandtl, L., 150.
 Time to heat wall, 283-287.
 Ton, Long or gross, 3.
 — — —, Short or net, 3.
 Tridymite, 390.
 Trinks, W., 7, 78.
 Tunnel kilns, 374.
 Turbulent flow, 132.
 Two-pass regenerators, 365-368.

U

ULTIMATE CO₂, 12.
 — — — — —, Calculation from flue gas analysis, 18.
 — — — — — Formula for, 61.

Units used in text, 3.

Unsteady heat flow, 282-288, 291 (*see also* Heat flow, Unsteady; and Heat loss, Unsteady).

V

VAN'T HOFF'S equation, 450.

Vapour pressure, (Summary) 499.

— — — — —, Definition of, 457.

— — — — — of solutions, 491.

V.D.I. fluid meter standards, 200, 205.

Velocity head of gas, 136.

— — —, Normal, 138, 221.

— — — of approach, 177.

Velocity of gas flow—

Measurement of, 193-207.

Precaution in measurement of, 204-206.

(*See* Orifice meter, Venturi meter, Flow nozzles, Pitot tube.)

Velocity of gas in chimneys, 174.

Velocity of reaction, 445-446, 461-472, (Summary) 500.

and Le Chatelier's Principle, 470.

between slag and metal, 463.

Change with temperature, 465.

Dependence on physical variety of reactant, 467.

Effect of catalysts, 470-471.

in heterogeneous mixtures, 462.

in manufacture of producer gas, 463-470.

in reducing processes, 483.

Laws governing, 461.

Vena contracta, 198.

Venturi meter, 193-297.

Verein Deutscher Ingenieure, 200, 205.

Viscous flow of gases, 132.

Vitrification of refractories, 381 (*see also* Refractories, Vitrification of).

Volumetric gas laws, 125-132.

Von Babo, 491.

W

Walker, W. H., Lewis, W. K., and McAdams, W. H., 211.

Wall(s), Design of, by Plate II, 276-279.

— — —, Heat loss through, 269-270 (*see also* Heat loss through walls).

— — —, Heat stored in, 282-288 (*see also* Heat stored in walls).

— — —, Over-all conductivity of, 280-281.

— — —, Time to heat, 283-287.

Washes, Cement, 425.

Waste gas (*see* Products of combustion, Flue gas).

— — — — — in regenerative systems, By-passing of, to boiler, 369.

- Waste gas, Recirculation of, 373.
 — heat boiler, in conjunction with regenerators, 369.
- Water cooling, Effect on furnace efficiency, 295-296.
 — —, Heat loss by, 292-296.
 — —, — — —, Measurement of, 292.
 — —, Effect on refractories, 411.
 — — gas generation, Physical chemistry of, 468.
 — — — reaction, 444-447, 450-455.
 — — — — in gas producers, 469-470.
 — — gauge, inches, Conversion to lb. per sq. ft., 135.
 — — vapour, Oxidation by, 482.
- Weisbach*, 143, 149.
Wesemann, F., 141.
Wheeler, R. V., with *Bone, W. A.*, 469.
Williams, A. D., 145, 211.
- Wirt, L.*, 141, 146, 150.
Wisler, C. O., with *King, H. W.*, 149.
Wullner, 491.
- Y**
- YIELD and recovery in metallurgical processes, 79.
- Z**
- ZINC distillation, Application of physical chemistry to, 474, 479-481.
 Zircon brick, 421, (table) 413.
 — — —, Spalling of, 434.
 Zirconia brick, 421, (table) 413.
 — — —, Spalling of, 434.
 — — —, Thermal conductivity, 266.

